

JOURNAL OF THE A. I. E. E.

DECEMBER 1929



PUBLISHED MONTHLY BY THE
AMERICAN INSTITUTE OF ELECTRICAL ENGINEERS
33 WEST 39TH ST.
NEW YORK CITY

MEETINGS

of the

American Institute of Electrical Engineers

DISTRICT MEETING, Great Lakes District No. 5,
Chicago, Illinois, December 2-4, 1929

WINTER CONVENTION, New York, N. Y., January
27-31, 1930

DISTRICT MEETING, North Eastern District No. 1,
Springfield, Mass., May 7-10, 1930

SUMMER CONVENTION, Toronto, Ontario, Canada,
June 23-27, 1930



MEETINGS OF OTHER SOCIETIES

The American Society of Mechanical Engineers, Engineering
Societies Building, December 2-6, 1929

The American Society of Refrigerating Engineers, New York,
N. Y., December 4-7, 1929. (D. L. Fiske, 37 West 39th Street,
New York, N. Y.)

American Mathematical Society, Annual Meeting, Lehigh
University, Bethlehem, Pa., December 27-28, 1929

National Electric Light Association
North Central Division, Engineering Section, Nicollet Hotel,
Minneapolis, Feb. 24-25. (J. W. Lapham, 803 Plymouth
Building, Minneapolis, Minn.)

JOURNAL of the A. I. E. E.

PUBLISHED MONTHLY BY THE AMERICAN INSTITUTE OF ELECTRICAL ENGINEERS
33 West 39th Street, New York

PUBLICATION COMMITTEE

W. S. GORSUCH, *Chairman*, H. P. CHARLESWORTH, F. L. HUTCHINSON, DONALD McNICOL, E. B. MEYER

GEORGE R. METCALFE, *Editor*

Changes of advertising copy should reach Institute headquarters by the 15th day of the month for the issue of the following month.
Subscription: \$10.00 per year to United States, Mexico, Cuba, Porto Rico, Hawaii and the Philippines, \$10.50 to Canada, Central America, South America, Haiti, Spain and Colonies, and \$11.00 to all other countries.
Single copies \$1.00.

Entered as matter of the second class at the Post Office, New York, N. Y., May 10, 1905, under the Act of Congress, March 3, 1879. Acceptance for mailing at special rate of postage provided for in Section 1103, Act of October 3, 1917, authorized on August 3, 1918.

Vol. XLVIII

DECEMBER 1929

Number 12

TABLE OF CONTENTS

Papers, Discussions, Reports, Etc.

President's Message.....	863	Annual Report of Committee on Applications to Marine Works, W. E. Thau, Chairman.....	895
Some Leaders of the A. I. E. E.....	864	Annual Report of Committee on General Power Application (Abridged), J. F. Gaskill, Chairman.....	896
A Recording Torque Indicator, by G. R. Anderson.....	865	Spray and Fog Tests on 220-Kv. Insulators, by R. J. C. Wood.....	900
Automatic Regulation of Synchronous Condensers, by L. W. Thompson and P. J. Walton.....	868	Annual Report of Committee on Applications to Mining Work, Carl Lee, Chairman.....	905
Electricity Applied to Strip Coal Mining.....	871	Audio-Frequency Transformers, by Paul Klev, Jr., and D. W. Shirley, Jr.....	907
Series Synchronous Condensers, by T. H. Morgan.....	872	Annual Report of the Committee on Automatic Stations (Abridged), W. H. Millan, Chairman.....	911
The Future of Higher Steam Pressures, by I. E. Moulthrop.....	875	Annual Report of Committee on Production and Application of Light (Abridged), B. E. Shackelford, Chairman.....	913
Seek Fog-Penetrating Light.....	877	Illumination Items	
Annual Report of Committee on Electrochemistry and Electrometallurgy, G. W. Vinal, Chairman.....	878	The Electrical Engineer and Light Therapy, by W. C. Kalb.....	917
An Economic Study of an Electrical Distributing Station, by W. G. Kelley.....	881	Mobile Color Lighting at Barcelona Exposition, by C. J. Stahl.....	918
Atom Not Like Solar System.....	883	The Motor Vehicle Light Testing Laboratory in Minnesota, by Prof. W. T. Ryan.....	919
Current Transformer Excitation (Abridged), by D. E. Marshall and P. O. Langguth.....	884		
Annual Report of the Committee on Transportation, W. M. Vandersluis, Chairman.....	888		
Progress in the Study of System Stability (Abridged), by I. H. Sunners and J. B. McClure.....	891		

Institute and Related Activities

The 1930 Winter Convention.....	920	Obituary.....	925
Chicago District Meeting.....	921	A. I. E. E. National and District Prizes.....	928
World Engineering Congress.....	921	Section Activities	
Engineering Foundation		Power Group of New York Section Meets December 9.....	929
Visit of Professor Van Hecke.....	922	New York Section to get Statistics on How Much Light.....	929
American Committee—World Power Conference.....	922	Future Section Meetings.....	929
Meeting of American Mathematical Society.....	922	New York Section Power, Transportation, and Communication Groups Meet.....	929
New York Section Meetings of Illuminating Engineers.....	922	New York Section Meeting on Wonders of Sound Transmission.....	930
Standards		First Power Group Meeting—Chicago Section.....	930
Symbols for Photometry and Illumination.....	922	Past Section Meetings.....	930
Navigational and Topographical Symbols.....	922	Student Activities	
National Electrical Code Approved.....	923	Electrical Show Held at Montana State College Branch.....	932
Protection of Electrical Circuits and Equipment against Lightning.....	923	Past Branch Meetings.....	932
Faraday Electromagnetic Centenary.....	923	Engineering Societies Library	
American Engineering Council		Book Notices.....	936
Annual Meeting.....	923	Employment	
A. E. C. Mapping Program.....	923	Positions Open.....	938
Recommends Engineers for International Joint Commission.....	923	Men Available.....	938
200th Anniversary of Birth of First Engineer President.....	923	Membership	
St. Lawrence Waterway.....	924	Applications, Elections and Transfers.....	939
Consulting Engineers for Government Service.....	924	A. I. E. E. Officers.....	944
Study of Airports Considered.....	924	List of Sections.....	944
Advisors for Rosenwald Museum.....	924	List of Branches.....	945
Relief of Engineers from Duty with Combat Forces.....	924	Affiliated Student Society.....	946
Plea for Forest Conservation.....	924	Geographical Districts.....	946
Personal Mention.....	924	Digest of Current Industrial News.....	956

A REQUEST FOR CHANGE OF ADDRESS must be received at Institute headquarters at least ten days before the date of issue with which it is to take effect. Duplicate copies cannot be sent without charge to replace those issues undelivered through failure to send such advance notice. With your new address, be sure to mention the old one, indicating also any changes in business connections.

Copyright 1929. By A. I. E. E.

Printed in U. S. A.

Permission is given to reprint any article after its date of publication, provided proper credit is given,
(The Journal of the A. I. E. E. is indexed in Industrial Arts Index.)

AMERICAN INSTITUTE OF ELECTRICAL ENGINEERS

—Some Activities and Services Open to Members—

The Winter Conventions are usually the outstanding technical meetings of each year and are held in the eastern section of the country, generally in New York City. The programs consist chiefly of technical sessions which occupy practically all the available time of a five-day meeting, except one day which is set aside for inspection trips to engineering works of interest in the neighborhood of the convention city. Aside from the entertainment provided for ladies in attendance, the only social function is a dinner-dance held on one evening during the convention. The Winter Conventions have been described as the "working conventions" of the Institute because the social and entertainment features are almost entirely subordinated to the consideration of technical papers.

Presentation of Papers. An important activity of the Institute is the preparation and presentation of papers before meetings of the Institute. Opportunity is offered for any member to present a paper of general interest to engineers at an Institute meeting, or of having shorter contributions published in the *JOURNAL* without verbal presentation. In preparing a paper for presentation at a meeting the first step should be to notify the Meetings and Papers Committee about it so that it may be tentatively scheduled. Programs for the meetings are formulated several months in advance and unless it is known well in advance that a paper is forthcoming, it may be subject to many months delay before it can be assigned to a definite meeting program. Immediately upon notification the author will receive a pamphlet entitled "Suggestions to Authors" which gives in brief form instructions in regard to Institute requirements in the preparation of manuscripts and illustrations. This pamphlet contains many helpful suggestions and its use may avoid much loss of time in making changes to meet Institute requirements.

Manuscripts should be in triplicate and should be sent to Institute headquarters at least three months in advance of the date of the meeting for which they are intended; then are they submitted first to the members of the technical committee covering the subject of the paper, and if approved, will next go to the Meetings and Papers Committee for final disposal. After final acceptance the paper goes to the Editorial department for printing, which requires usually from two to three weeks. Advance copies are desired about ten days prior to the meeting in order to distribute the paper to members desiring to discuss it. Considering the routine through which all papers must pass, the advantage of prompt notification and early submission of manuscripts will be apparent.

Attendance at Conventions.—Taking part in the Institute conventions is one of the most useful and helpful activities which membership in the Institute affords. The advantages offered lie in two distinct channels; technical information and personal contacts. The papers presented are largely upon current problems and new developments, and the educational advantages of hearing and taking part in the discussion of these subjects in an open forum cannot but broaden the vision and augment the general knowledge of those who participate. Equally advantageous is the opportunity which conventions afford to extend professional acquaintances and to gain the inspiration which grows out of intimate contact with the leaders in electrical engineering. These conventions draw an attendance of from 1000 to 2000 people and constitute milestones in the development of the electrical art.

Library Service.—The Engineering Societies Library is the joint property of the four national societies of Civil, Mining, Mechanical, and Electrical Engineers and comprises one of the most complete technical libraries in existence. Arrangements have been made to place the resources of the library at the disposal of Institute members, wherever located. Books are rented for limited periods, bibliographies prepared on request, copies and translations of articles furnished, etc., at charges which merely cover the cost of the service. The Director of the library will gladly give any information requested as to the scope and cost of any desired service. The library is open from 9 a. m. to 10 p. m. every day except holidays and during July and August, when it closes at 5 p. m.

JOURNAL OF THE A. I. E. E.

DEVOTED TO THE ADVANCEMENT OF THE THEORY AND PRACTISE OF ELECTRICAL ENGINEERING AND THE ALLIED ARTS AND SCIENCES

*The Institute is not responsible for the statements and opinions given in the papers and discussions published herein.
These are the views of individuals to whom they are credited and are not binding on the membership as a whole.*

Vol. XLVIII

DECEMBER, 1929

Number 12

A Message From the President.

A very Merry Christmas and a Happy New Year to all

FRIENDSHIP AND GOOD WILL

THIS number of the Journal goes to the membership of the Institute with the approach of the Christmas Season and it is appropriate to emphasize the element of friendship and good will always involved in our activities. On behalf of all Institute officers, it is a happy privilege to extend to the entire membership the most cordial of holiday greetings and good wishes for a Merry Christmas and a Happy New Year.

It requires little thought to realize the countless opportunities, in our common work for the Institute, for those who appreciate such friendship and good will. Those who value this feature as among the greatest of their possessions make the most of these opportunities. It is not easy to estimate the loss experienced by those who maintain isolation from these influences. In particular, Section, District, and National Meetings offer personal contact and opportunity for all those influences which are always felt and especially so at this season of the year. Based upon a common professional interest in Electrical Engineering, the addition of broad human sympathies applied throughout the year cements friendships of enduring character,—“A man is known by his friends.”

The rare privilege of visiting and meeting the membership of twenty-three sections of the Institute during the past four months and the inspiring hope of meeting the membership of thirty or forty other sections and branches during the next eight months has given great emphasis to this thought. When these peregrinations are completed, it is hoped to use one of these pages to record more of the resulting reactions.

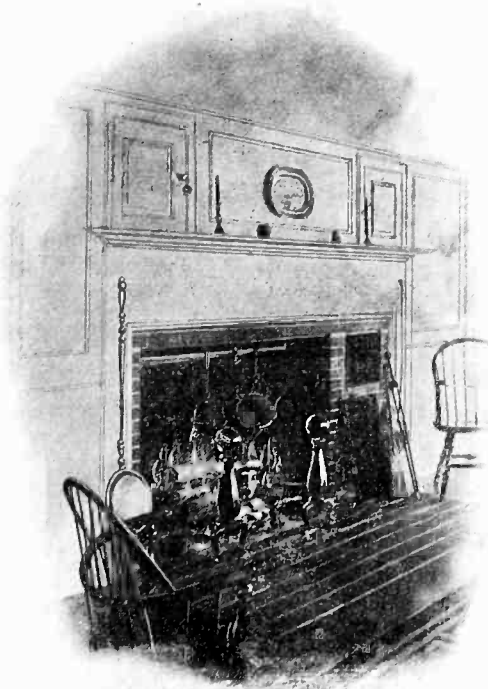

Now, at this Christmas Season, let us draw about the blazing old time hearth of cheer and comfort to gather in to ourselves all that these days have to offer to each and every member of the Institute. Throw aside, at least for the moment, all of care or sorrow or pressing responsibility either of professional or personal character in the realization of a great brotherhood united in a common cause even greater and finer than that of its purely professional aspect.

May we hope that these blazing logs will radiate a cheerful, helpful thought and good wish to each member of the Institute at whatever distance.

Harold B. Smith

President

Some Leaders of the A. I. E. E.

William B. Jackson, Rate Engineer of The New York Edison Company and a member of the Institute since 1897 (Life Member), was its Manager from 1912 to 1915 and a Vice-President from 1918 to 1919. Coincidentally, he was a Manager and Vice-President of the American Society of Mechanical Engineers, 1915; also President of the Western Society of Engineers in 1915. His papers before the Institute and Western Society of Engineers on *Advantages of Unified Electric Systems Covering Large Territories*, and *Hydraulic Developments as Related to Electric Installations* were in early presentation of the lines along which electric and power development has since progressed.

He was born at Kennett Square, Pennsylvania, June 23, 1870; and was graduated from the Pennsylvania State College in Mechanical Engineering in 1890 with the degree of B. S., later, in consideration of his work in electrical construction and operation, receiving the degree of M. E.

In 1894 he went with The United Electric Light & Power Company in New York City, but shortly thereafter entered the Test Department of the Stanley Electric Manufacturing Company at Pittsfield, Mass. He later became Assistant to Mr. C. C. Chesney, Chief Engineer, taking part in developing the equipment and designs for the first large transmission systems in California, undertaken by his company. In 1895 he was appointed his company's engineer for the Northwest, this service including the supervision of the construction and the starting of the 12,000-volt, two-phase transmission from Lowell to Grand Rapids, Mich., which was the first transmission of such high voltage east of the Rocky Mountains, and the distribution system. He later took temporary charge of this hydroelectric property, during which time he developed effective means for making all transmission line repairs while alive,—something new in the art for such high voltages,—to obviate the necessity of shutting down his Grand Rapids service for such repairs.

After returning to the Stanley Company, he supervised the installation and starting of engine generators on Staten Island for his company in 1897, and then remained with the Staten Island Electric Company as General Superintendent and Chief Engineer and Consulting Engineer of the Staten Island Electric Railway Company. During this period, he reconstructed the system for supply from a single generating station and changed it from single-phase 133-cycle, to two-phase 60-cycle operation.

In 1899 he became General Superintendent and Chief Engineer of the Colorado Electric Power Company, transmitting energy from its steam station in Canyon City to Cripple Creek District for various mine and ore reduction operations. Here again it was not practicable to shut down the single transmission line, so that it was necessary for him to develop means for repairing his

22,000-volt line while alive. The mine operators gradually became so impressed with the reliability of the service and with the possibilities of electric hoists, (which were also new in such work), that it became difficult to supply the demand. Due to the novel kinds of service, it was necessary for him to work out appropriate methods of charging for them.

Returning from this work to the Stanley Electric Manufacturing Company, he again took up problems of plant operation and development, including a comprehensive layout of hydroelectric development for the State of South Carolina, such as is now in progress in that territory. He also spent about six months in Europe for his company, studying European methods, including the electrification of railways.

After returning from Europe in 1903, he decided to form, with his brother Dugald C. Jackson, the Consulting Engineering firm of D. C. and Wm. B. Jackson. This firm soon opened offices in Chicago and Boston and was occupied with general engineering advisory work, design of electric plants and systems, and inventory and valuation of electrical properties until our country entered the World War, and both brothers entered the military service. Entering the Construction Division as Major in the United States Army in 1918, and taking charge of all operations and maintenance of electric lighting and power, refrigeration, buildings and grounds, roads, sewage and sewage disposal, water supply, heating, fire protection, etc., at Camp Merritt, N. J., the Chief embarkation camp of the Port of New York, Mr. W. B. Jackson later added to these the duties of Constructing Quartermaster.

Upon leaving the Government Service in 1918, he spent several years in consulting engineering work while operating his farm in Massachusetts, and was then employed by John W. Lieb, Vice-President and General Manager of The New York Edison Company, to work out engineering and rate problems. He has remained with that Company as Rate Engineer and in advisory capacity with its affiliated electric companies. He had general charge of the recent Inventory and Valuation of The New York Edison Company's entire property.

As Lieutenant-Colonel of the Engineer Reserve Corps, he has charge of matters relating to the U. S. Reserve Corps, Military Training Camps, and the Corps Area Engineer, for The New York Edison Company and its affiliated electric companies.

He is a member of the American Society of Mechanical Engineers, the American Society of Civil Engineers, the Western Society of Engineers, the Society of American Military Engineers, the Reserve Officers' Association, the American Legion, the Academy of Political and Social Science, and other important engineering, civilian, and military organizations. He is a member of the Engineer's Club of New York, the University Club of White Plains, and the Pittsfield Country Club. He also finds much pleasure in his farm in the Berkshire Hills.

A Recording Torque Indicator That Records the Torsional Effort of Motors During Acceleration

BY G. R. ANDERSON¹

Member, A. I. E. E.

Synopsis.—The measurement of torque under unstable conditions of speed is usually extremely difficult and inaccurate when a dynamometer, prony brake, or similar torque measuring equipment is used. The device described in this paper was developed primarily to obtain torque measurements under unstable conditions as well as

under stable conditions, and to obtain a permanent record of these measurements. It has been particularly successful in recording speed-torque curves of motors during acceleration and it can also be applied very effectively to other fields.

* * * * *

INTRODUCTION

It is a relatively simple matter to measure, with a fair degree of accuracy, the speed and torque of an induction motor for any load between no-load and the pull-out point of the motor if the speed is steady. The static torque of the motor is also easily measured, but between these points where the speed is usually unstable, it is much more difficult to obtain satisfactory

capable of transmitting the torque of the motor and giving an angular deflection proportional to the torque, and (2) an electromagnetic circuit of two elements that are displaced from each other by an angle equal to the deflection of the spring. A recording electrically-operated position finder is connected to the device to record the amount of angular deflection, which is proportional to the torque.

The helical torsion spring is accurately finished and is mounted so as to eliminate any distortion due to centrifugal forces. The spring is equipped with a damping sleeve that prevents fluctuations due to the

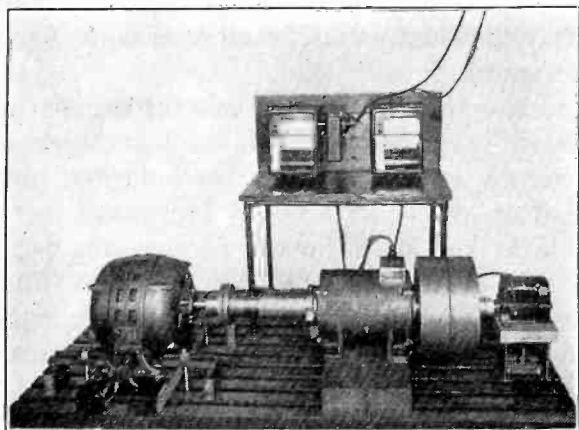

FIG. 1—TORQUE INDICATOR SET-UP FOR MEASURING STARTING TORQUE OF INDUCTION MOTOR

measurement. With the development of line-start motors, condenser motors, etc., it is becoming increasingly more important to know exactly the torque characteristics that the motor will develop. Dips in torque due to harmonics or other causes may be present in sufficient magnitude to seriously hinder the motor in accelerating its load. A device that will quickly and accurately record this torque should therefore find many uses in analyzing and improving motor characteristics. Such a device is described in this paper.

DESCRIPTION OF TORSIONAL INDICATOR

Fig. 1 illustrates the torsional indicator set up to take speed and torque curves on a squirrel-cage induction motor. The device consists of (1) a helical spring

1. Development Engineer, Fairbanks, Morse & Co., Beloit, Wisconsin.

Presented at the Great Lakes District Meeting of the A. I. E. E., Chicago, Ill., Dec. 2-4, 1929. Printed complete herein.

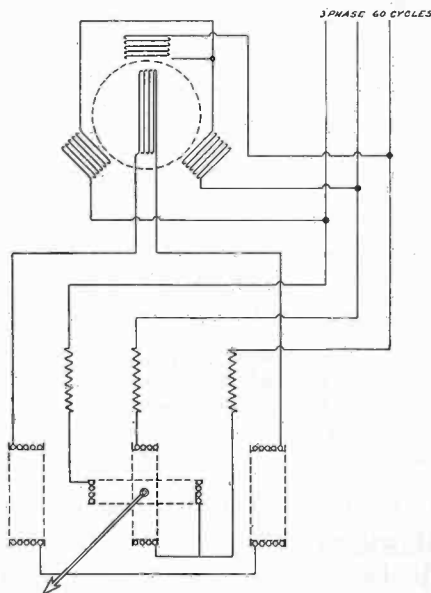

FIG. 2—CIRCUIT DIAGRAM OF TORQUE INDICATOR

natural period of vibration of the spring and elements, from being recorded on the chart. Full-scale deflection on the meter is obtained with a spring deflection of 60 degrees. Several sizes of springs can be interchangeably mounted to take care of various ranges of torque.

The electromagnetic elements are mounted on two concentric cores, one of which revolves with the motor and the other with the load. The first element consists of a three-phase winding arranged symmetrically outside of the second element. This is shown diagrammatically in Fig. 2. This three-phase winding is

excited through slip-rings from an external three-phase source of power. The second element contains a winding which is connected by another set of slip rings to the position finder as shown. The moving coils of the position finder are connected to the external source of power. When the first element is turned with respect to the second, the phase angle of the voltage generated in the second, is changed and this causes a deflection of the position indicator proportional to the torque. A tachometer generator and recording meter are used to measure the speed. The charts for recording both the torque and the speed are mounted on the same shaft in order to provide synchronized readings. Gear combinations in the tachometer generator allow different full-scale values of speed on the chart. It is obvious that the meter circuit can be so designed that the needle deflection is closely proportional to the angular deflection in the electromagnetic circuit of the device, thereby allowing the use of standard chart paper.

The device is similar in action to a d-c. meter

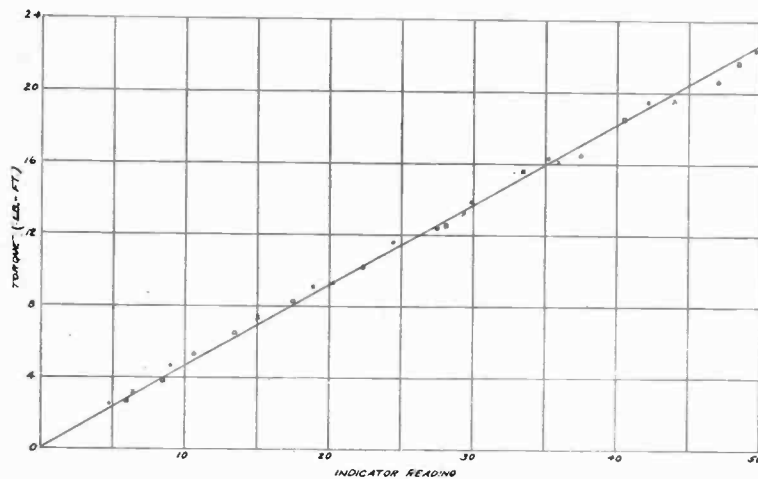

FIG. 3—CALIBRATION CURVE OF TORQUE INDICATOR

- * — 1800 Rev. per min.
- x — 1200 Rev. per min.
- o — 600 Rev. per min.
- — 0 Rev. per min.

in that it records average values and is well damped. It will not record very rapid fluctuations of torque but it does produce fairly accurate quantitative measurements.

CALIBRATION

Calibration of the device is accomplished by placing it between a dynamometer and a load and recording the torque output of the dynamometer and the instrument reading. Fig. 3 is a calibration curve for a given spring showing the relation between actual torque and instrument reading. The plotted readings were taken over a wide range of speed and of torque and clearly indicate that centrifugal force has no serious influence on the accuracy of the device. While the calibration curve is actually slightly S-shaped, for practical purposes it may be considered a straight line, since the error introduced by such assumption is extremely small.

METHODS OF LOADING

Since this device indicates transmitted torque and speed simultaneously and records these values on a chart, it is obvious that any suitable method of loading can be applied. In the case of taking speed and torque curves on motors during acceleration it has been found that a simple flywheel load is most satisfactory. Under these conditions, the entire torque output of the motor is utilized to accelerate an inertia load, neglecting friction, and the rate of acceleration is proportional to the torque transmitted at that speed. The rate of acceleration can be readily determined from the speed-time chart. The torque indicated on the chart is the torque transmitted through the spring, and is equal to the torque developed by the motor less that required to accelerate its rotor. Thus the indicated torque during acceleration will be slightly less than that shown at stable speeds and will be proportional at all speeds to the ratio of the WR^2 of the flywheel and device to the WR^2 of the entire rotating mass. By calculating the WR^2 of the rotor and determining the rate of acceleration from the chart, the ratio of developed torque to transmitted torque can be found. It is obvious that this ratio will hold constant for all conditions of acceleration of a simple flywheel load.

In practise the torque available for bringing a load up to speed is the developed torque less that necessary to accelerate the rotor so that the indicated torque as produced on the chart actually represents the torque available at the shaft for the accelerating period as shown. In general it will be found that when the accelerating period exceeds 15 or 20 sec., the difference between the developed torque and transmitted torque will be less than four or five per cent. The necessary time to allow for full acceleration of a motor should not be less than 10 or 15 sec. in order that the pen of the instrument may follow accurately the changes of torque. It has been noted also that accelerating periods of 20 to 30 sec. usually cause such a small change in motor temperature that this factor can be neglected.

In the following examples the instrument chart speed was 12 in. per min., each cross-division representing a time of 3.75 sec.

APPLICATIONS

Fig. 4 is an example of speed and torque charts taken on a 5-hp., 1800-rev. per min., 60-cycle, repulsion-induction motor. The variations in torque at start due to the commutator are clearly shown as well as the point of operation of the short-circuiting device and change over from repulsion to induction torques. Charts of this kind were taken to show the effect of setting the short-circuiting device to operate at different speeds.

Other charts taken on repulsion-induction motors, clearly show the change in shape of the repulsion torque curve due to change in brush setting and the lowering

of pull-in torque when the brushes are displaced from neutral by more than the proper angle.

Fig. 5 shows records taken on a line-start squirrel-cage induction motor. In addition to the charts of torque and speed, synchronized charts that recorded the current and power input were also obtained with a constant voltage applied to the terminals of the motor. Several of these motors with different types of rotor construction were tested in order that an accurate comparison of the characteristics of each type might be obtained.

It was noted from the charts that each of these motors having a rotor winding of special shape designed to lower the current drawn by the motor from the line

noisy. Investigation with this device also verified the general belief that dips in torque due to harmonics in squirrel-cage motors are more pronounced at low

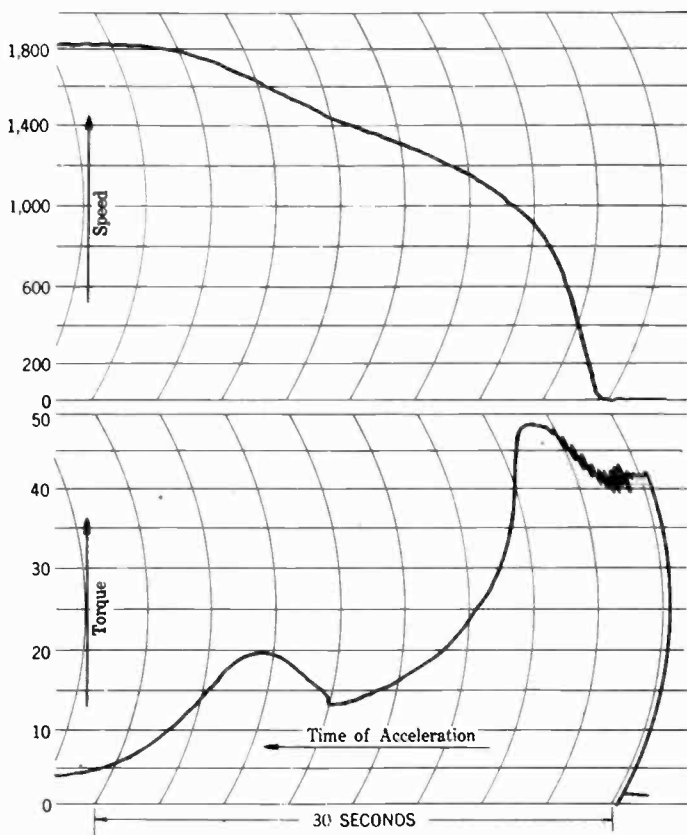

FIG. 4—SPEED AND TORQUE CURVES OF REPULSION-INDUCTION MOTOR DURING STARTING

This is a 5-hp. 1800-rev. per min. 60-cycle. 220-volt single-phase motor

during starting, had an appreciable dip in accelerating torque. The knowledge thus obtained of the exact amount of accelerating torque at all speeds should prevent misapplications of these motors.

By means of the addition of current and wattmeter readings, the factors affecting the developed torque of the motor can be determined from tests for all speeds. The change in rotor resistance and reactance with changes in slip can be calculated and the value of any particular type of rotor construction for a given condition can thereby be determined.

In making tests on squirrel-cage induction motors it was found that invariably the indicator recorded distinct torque pulsations whenever the motor became

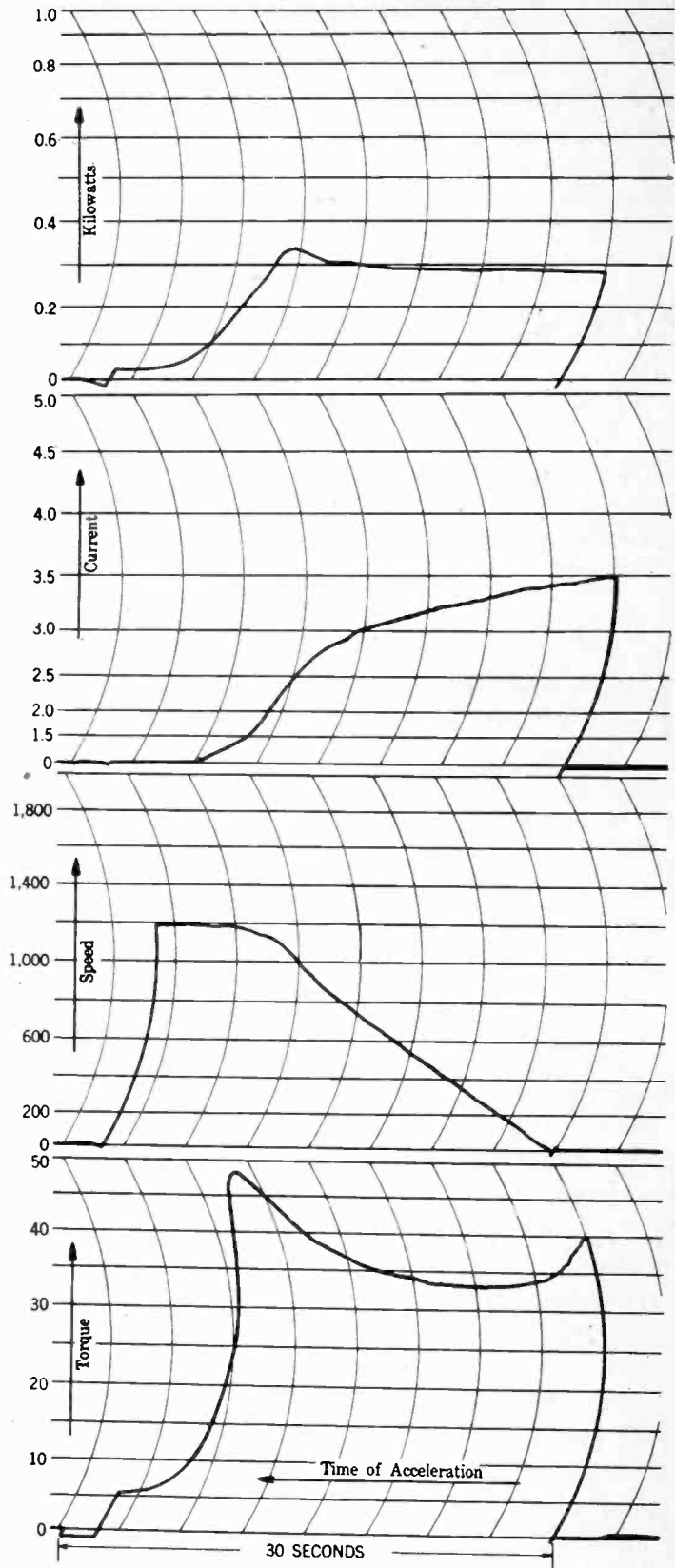

FIG. 5—RECORDS TAKEN DURING ACCELERATION OF A LINE-START INDUCTION MOTOR

Curves are shown for kw., amperes, speed, and torque of a 20-hp. 1200-rev. per min. three-phase 60-cycle motor

voltage than at high voltage. A series of curves taken on a motor with different values of voltage applied to the terminals showed a damping out of harmonics as

the voltage was increased. It seems reasonable therefore to assume that if a motor develops a satisfactory speed-torque characteristic on reduced voltage, it will show an equally satisfactory characteristic at any higher voltage.

The charts shown here illustrate the speed and torque characteristics of motors of various types. It is quite apparent, however, that a recording torsional indicator can be used to advantage also in many other fields of investigation. For example, its operation can be

reversed and in place of recording the torque output of a motor it could record the torque necessary to start and run a given load. By so doing definite data could be obtained as to the load and the most economical type and size of motor could be applied.

ACKNOWLEDGEMENT

The writer wishes to acknowledge the valuable assistance given by Mr. D. J. Angus of the Esterline Angus Company in developing the meter for this device.

Automatic Regulation of Synchronous Condensers Equipped with Superspeed Excitation

BY L. W. THOMPSON¹

Non-member

and

P. J. WALTON²

Member, A. I. E. E.

Synopsis.—This paper describes extensive field tests made on the super-high-speed excitation equipment used with the 30,000-kv-a. synchronous condensers at the Plymouth Meeting Substation of the Philadelphia Electric Company. Oscillograms and calculated

curves showing the performance of the synchronous condensers with this equipment are included, together with a discussion of the results obtained.

* * * * *

THE speed and maximum voltage characteristic of the excitation system used on synchronous condensers is of prime importance in determining the amount of corrective kv-a. which can be furnished by the condenser during a system disturbance.

On the Conowingo Line at the Plymouth Meeting Substation there are installed three 30,000-kv-a. condensers equipped with a supersystem of high-speed excitation and a method of control that is sufficiently novel to warrant a general description.

To obtain the same corrective kv-a. with ordinary types of excitation, a much larger installation of condenser capacity would be required.

These machines are installed for the purpose of voltage regulation of the system and as an aid during transient conditions. Since other articles have described the synchronous condensers, no description is given herein.

Excitation for the main exciter field is furnished from a subexciter. The subexciter itself is of standard design and is a straight shunt-wound machine. The main exciter is of very special design. It has laminated poles and yoke, heavy series winding (which will be referred to later), and an armature ceiling voltage of approximately 1000. Also, it is provided with two shunt-field windings.

The main shunt field is directly connected to the subexciter through a simple motor-operated rheostat which if properly set will give in general the proper main exciter volts to produce the desired kv-a. on the condenser under steady conditions of load and voltage.

1. General Electric Co., Schenectady, N. Y.

2. General Electric Co., Philadelphia, Pa.

Presented at the Great Lakes District Meeting of the A. I. E. E., Chicago, Ill., December 2-4, 1929. Printed complete herein.

At this time there will be little or no current in the second or regulating shunt field on which the regulator contacts operate. This of course is very desirable.

This regulating or auxiliary field itself will not produce an exceedingly high rate of rise of the exciter voltage, but can take care of ordinary conditions of load and voltage that may come during normal operation. This range of the auxiliary field itself is somewhat unusual as it is capable of controlling the condenser from approximately 20,000-kv-a. lag to 60,000-kv-a. lead under all steady-state conditions, and if there were any requirement for it even this range could be extended.

The regulator is of the high-speed type equipped with a three-phase torque motor as the master voltage element, so as to provide proper response of the regulator on any type of disturbance. The relay contacts of this regulator are connected to the auxiliary field through an unbalanced resistance bridge so that a reversal of the auxiliary field can be obtained, depending on the ratio of time opened to time closed of these relay contacts. This regulator controls the line voltage under normal conditions because of its ability to vary the condenser kv-a. through the above mentioned range.

However, for transient conditions, resulting from line-to-ground, double-line-to-ground, or three-phase faults when the average line voltage is depressed five per cent or more, the main shunt field is brought into play by means of a second master voltage relay which operates a high-speed contactor, opening the regulating field and cutting out the resistance in series with the main shunt-field winding. When this resistance is cut out of the main field, a rate of rise of approximately 7000 volts per sec. is obtained on the main exciter. This resistance is not cut-in again until the line voltage is

restored or until the kv-a. per condenser has reached approximately 60,000.

At this time a current relay in the main condenser field operates at a value corresponding to this maximum kv-a., which again inserts the resistance in the main exciter field, the auxiliary field being closed simultaneously with the insertion of this resistance. This transition between the two shunt fields is very smooth and

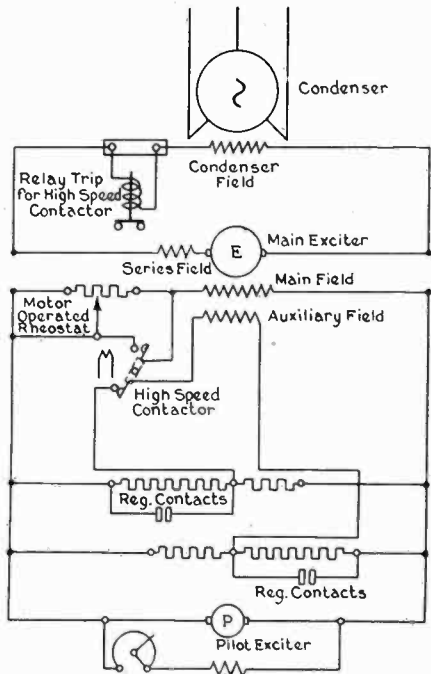

FIG. 1—HIGH-SPEED EXCITATION SCHEME FOR SYNCHRONOUS CONDENSER

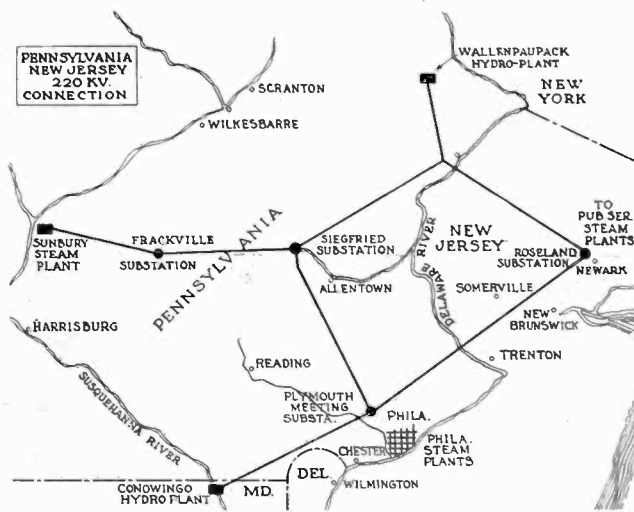

FIG. 2—MAP OF INTERCONNECTION

does not produce fluctuations to any extent in the main exciter voltage, or any fluctuations in the kv-a. on the main unit, as the transformer action between these fields tends to keep the flux constant. As the main field tends to collapse, it induces substantially a corresponding increase in ampere-turns in the auxiliary field sufficient to maintain the original flux produced by the main field. After this change the regulator again operates upon the auxiliary field either to maintain voltage or a maximum kv-a.

At a time when conditions return to normal, the regulator rapidly backs the exciter voltage down from its original high value to the value required to give the proper voltage on the system bus. This rapidity of die-

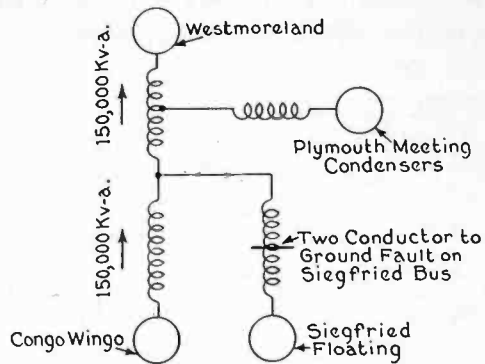

FIG. 3—SCHEMATIC DIAGRAM OF SYSTEM UPON WHICH CALCULATIONS WERE BASED

The fault *F* on Siegfried bus results in a decrease in positive phase sequence voltage at the terminals of the condensers of 30 per cent and an increase in positive phase sequence condenser current of 208 per cent.

Conowingo assumed to be furnishing 150,000 kv-a. to Westmoreland

down is due to the auxiliary shunt field at this time receiving a reversed voltage, which in turn accelerates the decay of the main exciter. This scheme of connections is shown in Fig. 1.

DISCUSSION OF CURVES AND CALCULATIONS

The benefit derived from superexcitation in regard to increased condenser capacity can best be understood by considering a specific example.

The diagram of system connections is shown in Fig. 2; schematic diagram of system in Fig. 3.

Consider Siegfried, Conowingo, and Westmoreland interconnected, Siegfried floating on the line, and Conowingo feeding 150,000 kv-a. to Westmoreland. If a two-conductor-to-ground fault occurs at *F* on the Siegfried bus and two condensers are operating at

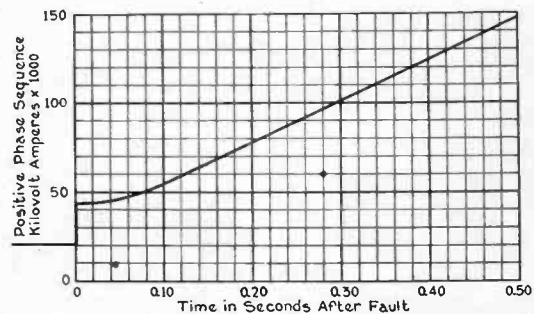

FIG. 4—GRAPH SHOWING RISE OF CONDENSER KV-A. AFTER TWO-CONDUCTOR-TO-GROUND FAULT

Plymouth Meeting at 10,000 kv-a. leading, giving a total of 20,000 kv-a., there will be an instantaneous rise to 43,000 leading kv-a. from the Plymouth Meeting condensers at the moment of fault.

After the fault has been applied, the condenser kv-a. will continue to rise as determined by the superexcitation system from the above-mentioned initial value of

43,000 kv-a. to approximately 150,000 kv-a. in 0.5 sec. This is shown graphically in Fig. 4.

From Fig. 5 it is seen that two condensers with standard excitation are, at the first instant, equal in corrective effect to two condensers with superexcitation, but at the end of one-half second, approximately ten

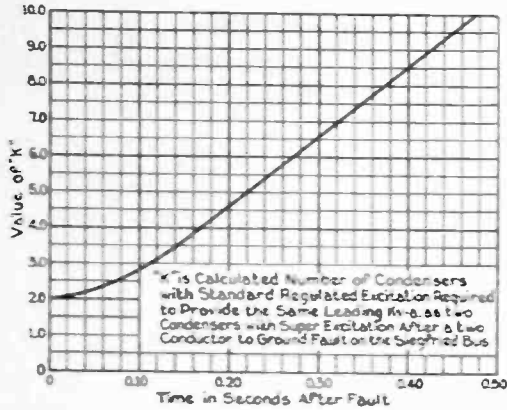

FIG. 5—CURVE SHOWING NUMBER OF CONDENSERS NEEDED WITH STANDARD EXCITATION TO GIVE SAME CORRECTION AS TWO CONDENSERS WITH SUPEREXCITATION

Before the fault occurs it is assumed that the condenser bus voltage is being held at its proper value by the 20,000 kv-a. delivered by the two connected condensers. In order to deliver this same initial kv-a. with a larger number of condensers with ordinary excitation, the excitation on each condenser would necessarily be less than that of either one of the two units with superexcitation.

Referring to Fig. 5, the integrated kv-a. or kv-a. seconds shown, could be furnished by approximately five and one-half condensers with standard excitation at the end of 0.5 sec., but the maximum instantaneous kv-a. at the end of 0.5 sec. with two condensers having superexcitation is approximately equal to ten condensers with ordinary excitation.

REQUIREMENTS

It was required of the condenser that it be capable of operating at 10,700 kv-a. lag up to 55,000-kv-a. lead; also with the condenser carrying 10,000 kv-a. lead initially, the time from the occurrence of a fault on the

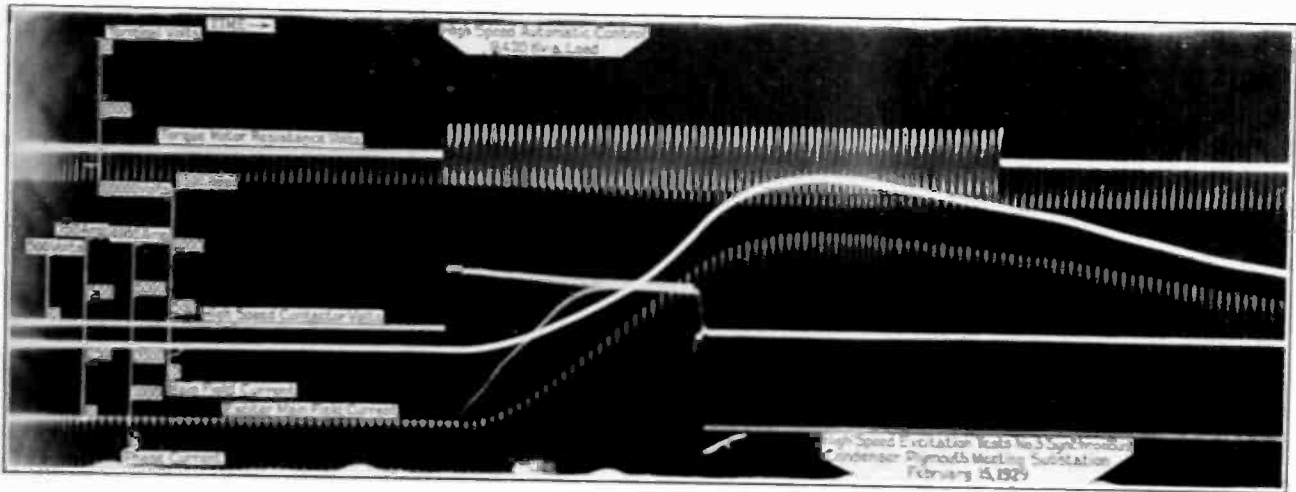

FIG. 6—OSCILLOGRAPH RECORDS OF HIGH-SPEED EXCITATION TESTS

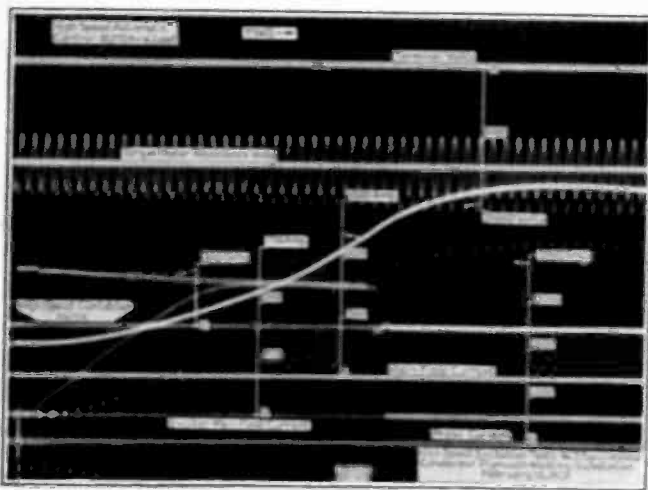

FIG. 7—OSCILLOGRAMS OF TEST ON CONDENSER HAVING HIGH-SPEED EXCITATION

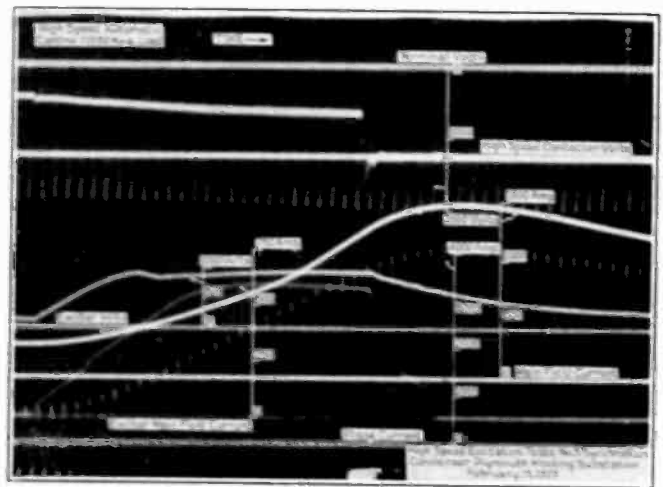

FIG. 8—OSCILLOGRAMS OF HIGH-SPEED EXCITATION TEST

condensers with standard excitation are required to give corrective effect equivalent to two condensers with superexcitation.

system to reaching 55,000-kv-a. lead to be not more than 30½ cycles on the basis of 60-cycle time, the exciter voltage to be not more than 900-volts ceiling.

These requirements meant that the voltage regulator

must operate over a range of from about zero volts to 900 volts.

This condition will be appreciated when it is remembered that the usual voltage regulator is required to operate over a range of from 70 to 140 volts or a range of 1 to 2.

In case of a short circuit on a line, it is possible for the voltage of one-phase to be higher than before the short circuit occurred and for this reason, the voltage-regulator element and the element for applying the super-excitation each consists of a three-phase torque motor.

To insure the high-speed feature being applied independently of the regulating equipment used for normal conditions, and to have it come in with the least amount of time delay after the occurrence of a fault and to adjust the voltage at which it would be applied independently of other conditions, a separate torque motor was used for the purpose of applying the high-speed excitation in addition to the torque motor operating as a normal voltage regulator.

TESTS

The kv-a. taken by a condenser for a given field current depends upon the voltage at the condenser terminals. It was impossible to hold constant voltage when suddenly increasing from 10,000 kv-a. to 55,000 kv-a. owing to the reactance of the transformer bank, to the tertiary winding of which the condenser is connected.

In testing, therefore, to determine the time to increase from 10,000 kv-a. to 55,000 kv-a., the starting point was taken as the field current to produce 10,000 kv-a. at rated voltage 13,800 volts; and at the starting point, the voltage was reduced by having lagging kv-a. on another condenser to try to reach 13,800 volts when the kv-a. reached 55,000 on the condenser under test.

In other words, the time is that required to build up the field current of the condenser, as the a-c. amperes depend on the condenser field flux, and tests showed that there was practically no time delay between field amperes and a-c. amperes and consequently field flux.

Referring to Fig. 6, the torque motor resistance is the voltage across a resistance inserted in the torque motor circuit to reduce the voltage applied to the torque motor to correspond to a short circuit on the system.

When the system voltage dropped as indicated by the voltage across this resistance, it will be noted that within a cycle, the torque motor contact closed, applying voltage to the coil of the high-speed contactor.

The instant when the high-speed contactor closed is indicated by the point when the exciter main field current starts to increase.

Following the short-circuiting of the resistance in the exciter main field by the high-speed contactor, the field

current of the main exciter rapidly increases, building up the exciter voltage to the desired value, approximately 900 volts, as shown in Fig. 7. After this the exciter voltage held practically constant because of the combined effect of lowering the pilot exciter voltage by omitting its series field and by the action of the series field of the main exciter. This is also shown in Fig. 8.

With the adjustments used, the kv-a. of the condenser built up to about 73,000, or well beyond the 55,000 kv-a. agreed upon.

Summarizing these tests, the time required to reach the required kv-a. is approximately 25 cycles on a 60-cycle basis, though in actual practise the required kv-a. would be reached much earlier because of an instantaneous increase of kv-a. through a reduction in terminal voltage resulting from a short circuit on the line, to which is added the subsequent increase due to the high-speed excitation. Additional benefit in regard to rate of rise is obtained from a very heavy series field on the main exciter which tends to raise the exciter voltage due to the transient increase in the condenser field current, raising the exciter voltage before any of the automatic equipment installed for this purpose comes into play.

ELECTRICITY APPLIED TO STRIP COAL MINING

More than a thousand people traveled from Chicago, St. Louis and other cities to the Fidelity Mine of the United Electric Coal Company, near Duquoin, Ill., on November 7, to see an electric shovel said to be the biggest in the world, which is used for stripping the earth from the coal vein which is being mined.

The shovel was designed for use with a 20-cu. yd. bucket, but this size was reduced to 15 cu. yd. in order to permit an extension of the boom. The reach of the dipper is sufficient to place material about 85 ft. above the ground. The complete shovel weighs approximately 1650 tons. It is operated by one man by means of Ward Leonard control on the conversion equipment supplying direct current to the motor. The 4000-volt alternating-current power supply drives a five-unit motor-generator set consisting of a 1700-hp. motor, one 860-kw. generator, two 350-kw. generators and a 50-kw. exciter.

The electrical equipment was furnished by the General Electric Company. A very large tippie designed by the Jeffrey Manufacturing Company serves seven railroad tracks and has a capacity of 800 tons of coal per hour. The tippie is operated by 43 electric motors ranging from 3 hp. to 150 hp. and aggregating approximately 1000 hp. Nearly all are three-phase, 60-cycle machines operating on 440 volts, and with but few exceptions they are standard slip-ring induction motors. Virtually all are operated by magnetic push-button control.

Series Synchronous Condensers for Generation of Voltage Consumed by Line Inductance

BY THEODORE H. MORGAN*

Associate, A. I. E. E.

Synopsis.—The factors determining the power-carrying capacity of a transmission system are briefly discussed in this paper. The principal effects obtained by the operation of synchronous condensers used to compensate for the system consumption of lagging reactive kv-a. are pointed out. This method of compensation is contrasted with the direct method of supplying the reactive kv-a. to the line in the manner in which it is consumed, i. e., by the series method.

A plan for obtaining direct or series reactive kv-a. compensation by a method employing electric machinery is described. This includes a description of a method for producing the required voltage and inserting it into the system.

Some of the characteristics of operation and advantages to be gained by the use of the described method are given.

* * * * *

PRINCIPLES AND PRACTISE

A COMPLETE investigation of the transmission line power-limit problem shows that in the final analysis the limit of the amount of power which can be transmitted over a given system at a fixed maximum voltage and load power factor is determined by the total series inductive reactance of the system. The combined inductive reactance effects of the circuit, from the point of generation of the internal e. m. f. in the alternator to the point of voltage drop due to the e. m. f. of the load end machinery, determine the maximum amount of power that can be transmitted from the rotor of the generator to the rotors of the load machines.

The inductive reactive kv-a. of the load has its influence in limiting the maximum power which a system can transmit. An understanding of this principle, combined with the necessity of maintaining constant voltage at the load, has led to the practise of operating synchronous condensers at the load end of the line. These condensers may be considered as a source of inductive reactive kv-a. capable of compensating totally for load power factor, but only partially for line consumption of reactive kv-a. Such a method of compensation gives load end voltage control while increasing the system power limit. In fact, voltage control and reactive kv-a. compensation are inter-related, one action accompanying the other. The ultimate power limit is reached with the limit of compensation. The important fact related to synchronous condenser operation at the load end of the line is that complete compensation for line effects becomes impossible with increasing load, and the load and generator machinery finally fall out of step because of the inability of the system to transmit the load required of it.

About a year and a half ago, in an attempt to test out a new practise, an installation of series capacitors was placed in operation on a transmission line.¹ Such capacitors provide a method of

series inductive compensation which is direct and inherently automatic. They produce a voltage across them which is opposite in phase angle to the voltage caused by the inductive reactance of the line. By proper choice of the capacitor size these two voltages may be made to entirely counteract each other, thus compensating for the inductive effects of the system. The line effects are completely eliminated and the amount of power which it is possible to transmit is very materially increased.

General Methods. It may be said that there are in general two methods by which reactive kv-a. may be supplied to a transmission system. First, it may be furnished indirectly by apparatus connected across the line in a manner similar to an ordinary load; or second, it may be added in a direct manner through apparatus connected in series relation to the line conductors. Each method gives compensating effects which are different in character and results obtained.

The first method changes the phase angle of the line current with respect to its voltage and in this way produces a line drop at such an angle that the load end voltage is held constant at a required value which may be equal to that of the generator end. This is shown in a simple case by the vector diagram of Fig. 1, in which the line charging current and resistance drop are omitted. With increase of line current, the angle between the generator-end voltage and the load current increases and the compensating reactive power supplied must increase with the load in order that the load voltage may be maintained. The maintenance of synchronism between generator and load is dependent entirely upon this principle when the phase angle between load current and generator-end voltage becomes large. This is because the power represented by these two quantities considered by themselves becomes diminishing under these conditions.

In the second method, the compensation is obtained by the addition of a series voltage to the system. This plan does not alter the line current, but the reactive kv-a. is produced by the inserted voltage acting with this current. The compensation is direct and the reactive kv-a. is supplied in the same manner that it is

*Assistant Professor of Electrical Engineering, Stanford University, Palo Alto, Calif.

1. See Bibliography 2 and 3.

Presented at the Pacific Coast Convention of the A. I. E. E., Santa Monica, Calif., Sept. 3-6, 1929. Printed complete herein.

consumed. Referring to Fig. 2, E_L , the voltage produced by line inductance is counteracted by the voltage E_C , equal to it and opposite in phase angle. In this case the line effects have been completely compensated for, and the load end voltage becomes identically equal in magnitude and phase to that of the generator end.

A NEW METHOD

The problem at its present status would seem to demand that all possibilities and options should again

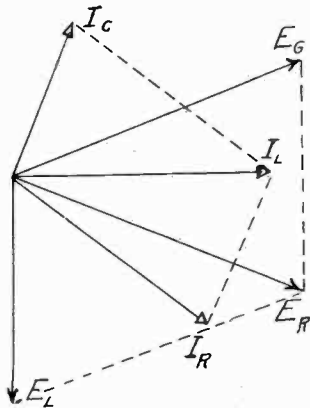

FIG. 1—VECTOR DIAGRAM SHOWING COMPENSATION WITH SYNCHRONOUS CONDENSER

E_G is generator end voltage
 I_R is load current
 I_C is correcting current
 I_L is line current
 E_L is voltage produced by line inductive reactance
 E_R is load end voltage

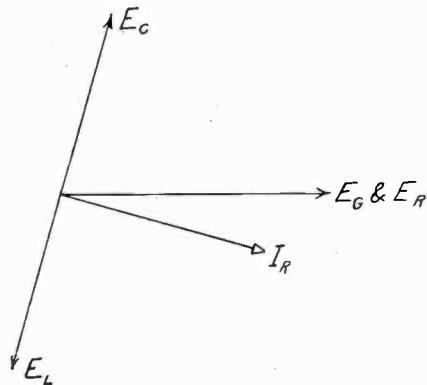

FIG. 2—VECTOR DIAGRAM SHOWING DIRECT COMPENSATION

E_G and E_R are generator end and load end voltages
 I_R is load current
 E_L is voltage produced by line inductance
 E_C is voltage supplied by correcting apparatus

be investigated. With the belief that the direct or second method is preferable to the one now commonly used, an attempt has been made to develop a plan by which the desired results may be obtained by the use of electrical machinery. It was realized that if a voltage identical both in magnitude and phase to that produced by series capacitors be generated and applied in series to the circuit, effects similar in general character to those realized by capacitors may be obtained. The following system of machine operation has been devised for this purpose.

Description. The general plan of arrangement is shown by the wiring diagram of Fig. 3. The reactive kv-a. required for compensation is supplied by a machine similar in construction to a synchronous condenser, which for want of a better name will be called the "inductive compensating generator." This machine is driven at synchronous speed by a synchronous motor, operated in the ordinary way from a bank of transformers connected across the line.

The voltage to be supplied to the line by the driven machine should be proportional to the line current since its purpose is to compensate for a voltage caused by this current flowing through the line inductive reactance. With the iron of the magnetic circuit of the machine below the point of saturation, this would require an exciting current which is at all times proportional to the alternating current of the line. This immediately suggests using the line current for machine

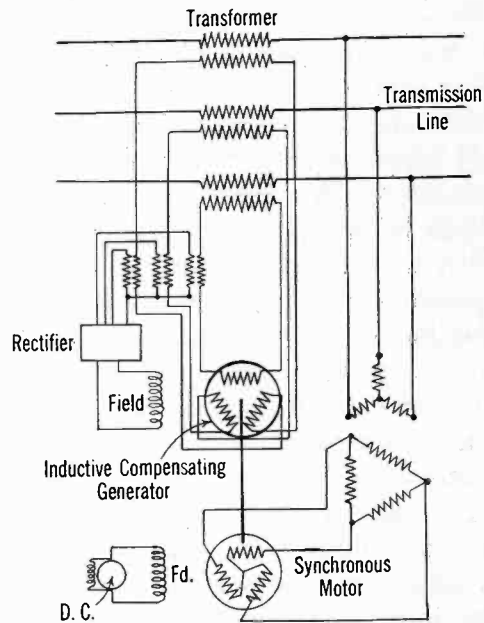

FIG. 3—WIRING DIAGRAM OF ARRANGEMENT OF APPARATUS

excitation purposes. This current may be passed through current transformers to obtain a suitable magnitude, then rectified with a polyphase mercury arc or other rectifier, and passed through the field circuit of the machine. Special current transformers with sufficient iron in the core would produce voltage impulses on sudden changes of line current, thus providing rapid response in machine excitation.

The requirements of frequency and magnitude having been met, there is the question of maintenance of proper phase relation for the compensating voltage. Due to its inherent characteristic, the driving synchronous motor would hold the rotor of the inductive compensating generator to an approximately constant phase position with respect to the line voltage. If it were possible to maintain constant power factor on the line, this is all that would be required, once the original setting of the angle between the two rotors had been correctly adjusted. However, since there is a pos-

sibility of change of line power factor angle with change of load, it would seem that provision should be made to meet this contingency. The machine should normally operate with the voltage which it produces in leading quadrature relation to the current through it. By arranging the stator of either the driving motor or the inductive compensating generator so that it can be moved in such a way as to alter the relative phase angle between their armature windings, the required condition can be maintained. The real power output will always be zero and the stator position could be automatically controlled to produce this condition for all phase positions of the line current.

In cases where compensation is to be made on relatively low-voltage lines, the separate phase windings of the machine could be connected directly in series with the line wires. When used on high-voltage lines transformers would be necessary. These transformers would have their high-voltage windings placed in series with the transmission line wires and low-voltage windings connected to the machine phases. Such transformers would perform both series and potential duty and in addition, insulate the machine from the line voltage. They would act as series or current transformers in permitting passage of line current, the ampere-turns of both windings being equal. In stepping-up and introducing the machine voltage into the line they would be doing potential transformer duty.

With the inductive compensating generator being driven so that its generated e. m. f. is in leading quadrature to the current in its windings, there will be no torque or power developed by the machine. However, it will be operating in a condition of unstable equilibrium. By this is meant that on any relative displacement of the rotor and stator from the required position, a torque will be produced which will tend to still further increase the displacement. This torque will increase with the amount of the displacement up to the 90 electrical degree angle in either direction. The position of 180 electrical degrees from the required operating position is the stable one, and the rotor would seek this position if allowed to do so. In order to maintain the desired operation it is necessary that the driving motor be designed to produce more torque for small angles of displacement than that produced by the driven machine. Under normal operation the load on the driving motor would be very small as it would only be required to supply the rotation losses of the compensating machine. Thus for the driving machine, there would be required a relatively small motor with special characteristics.

Characteristics and Advantages. When this plan of compensation is applied to very long lines it might be desirable to insert a number of compensating units at intervals along the line, so that the supplied voltage would not be excessive at any single unit. This would also aid in keeping the line voltage more uniform throughout the entire length. For all cases of complete

compensation, irrespective of the number or location of the units, the total reactive kv-a. supplied would be equal to the inductive reactive kv-a. consumed by the line if the line charging kv-a. be neglected. Also complete compensation by compounding the line inductance voltage would eliminate, in every case, its detrimental effects on voltage regulation and power-carrying capacity, leaving only the factor of line resistance.

The one operating benefit derived from line inductance is its effectiveness in limiting short-circuit currents. If the compensation were sufficiently complete to counteract all inductance effects of the line and transformers over the range of all possible currents, the short-circuit currents would be excessively high. The machine system of compensation, however, has the decided advantage that the magnetic circuit of the machine becomes saturated at certain currents and that its compensating ability is thus limited. As a result of this characteristic of the machine, it is possible to obtain full compensation up to a critical current, after which any appreciable increase in compensation becomes impossible. The effect desired is obtained by the inherent characteristic of the machine without any supplementary control. In this respect, compensation by machinery is far superior to that obtained with a series capacitor, which must be short-circuited on heavy currents with the resulting system disturbance upon its subsequent return to the circuit. With machine compensation, on the disappearance of the heavy line current, normal operation is restored by smooth action as the excitation on the machine is reduced.

In other respects it would seem that all the advantages claimed for series capacitor operation would apply to this method.

The inductive compensating generator is connected to the circuit in such a way that it will not supply its storage of rotational energy to a short circuit in the manner in which a synchronous condenser operates under such conditions.

CONCLUSION

The above described system of inductance compensation has been devised with the hope that it may in some small way point toward the solution of a vital problem in power transmission. No claim is made that the general plan is finally or completely worked out in all its details. On the basis of conformity to present practise, it will have no advocates. Because of its departure from methods now employed, many matters realized only through operating experience are as yet undetermined. However, granted that the general plan is fundamentally sound, its success must be inseparably linked with the ability to maintain complete, dependable, automatic machine control. In this regard it may be said that the rapid advance which is being made in the art of electrical controls is positive proof that this phase of the problem can be satisfactorily solved when the demand arises.

ACKNOWLEDGMENTS

The author wishes to express his appreciation to the faculty of the Electrical Engineering Department of Stanford University for many helpful suggestions, and particularly to Dr. Harris J. Ryan for his inimitable encouragement and assistance in the development of this plan.

Bibliography

1. "Tuned Transmission Lines," by H. H. Skilling; Thesis, Stanford University, June 1927.
2. "The Series Capacitor Installation at Ballston, N. Y.," by E. K. Skelton, *General Electric Review*, August, 1928.
3. Editorial: "And Now the Series Capacitor," by T. A. E. Belt, *General Electric Review*, August, 1928.

The Future of Higher Steam Pressures in Steam Electric Generating Stations

BY IRVING E. MOULTROP¹

Fellow, A. I. E. E.

Synopsis.—Construction and operating experience has shown that a large part of the theoretically possible gains in efficiency due to higher steam pressures has been obtained in practise.

What are the future possibilities of higher pressures?

The biggest problem before station designers today is to reduce the cost of construction per unit of capacity. Some engineers have suggested that we should build cheaper and less economical stations. This is an unsatisfactory answer to the problem. The proper answer is to maintain the high standards of efficiency that have been established and reduce the cost of construction by intensive study and better design. Better engineering in the future is the answer to the problem.

By the use of large turbine generator units and large steam generating units, the unit cost of construction can be reduced materially. The present practise of installing several boilers to serve one turbine generator increases the cost of construction. The use of large steam generating and turbine generator units will reduce the unit cost of high-pressure stations more than it will reduce the unit cost of normal pressure stations.

If the steam generating units match the turbine generator units in capacity, we can design for unit construction. This unit construction will not only reduce the cost of construction but will also simplify operation.

* * * * *

MUCH has been written about the present state of development in the use of higher steam pressures in steam electric generating stations. The plants in service and under construction have been discussed at length in the technical press, and it would be useless to endeavor to present to you a detailed picture of what has been accomplished. It is sufficient to say that a large part of the theoretically possible gain in efficiency has been obtained in practise, and there is every reason to believe that we will, in the near future, obtain as near the theoretical efficiencies possible as we have in stations designed for more moderate operating pressures.

It would appear to be of more use to attempt to take stock and discuss the future possibilities of higher pressures.

In meeting our every-day problems, we are prone to see only the immediate job before us and to lose sight of the broad economic problem with which we are dealing. It is becoming more and more necessary to keep the broad problem before us continually and to so conduct our every-day work that it will fit into the larger picture to the best advantage.

A résumé of the accomplishments of the past is helpful only in focusing our attention on the possibilities of the future. The work done so far in raising the

operating steam pressure has produced results that are very satisfactory. They are satisfying principally, however, because they indicate that we have made progress and lead us to believe that we will continue to do so in the future.

Looking back at the development of the steam electric generating station since Mr. Edison started the Pearl Street Station in New York City, what can we learn of particular moment to guide us in the design of new stations?

Many things have been accomplished and the best of these should be incorporated in the new installations that we are about to make.

Many costly mistakes have been made and these should not be repeated, for while it is excusable to err, to repeat an engineering error is an economic waste.

Let us select for discussion a few salient points of a general nature, and let us confine ourselves to those points that need to be kept constantly before us in our new designs.

First and foremost, we find that in the past we have so designed our stations that the fixed charges on the cost of construction are several times the combined cost of fuel, maintenance, and operating labor. It is therefore apparent that by attention to this fact we can make the largest saving in the cost of generating electrical energy. This problem undoubtedly takes precedence over all others before the industry today. What is the answer?

1. Chief Engineer, The Edison Electric Illuminating Company of Boston, Boston, Mass.

Presented at the Great Lakes District Meeting of the A. I. E. E., Chicago, Ill., Dec. 2-3-4, 1929. Printed complete herein.

Some engineers have gone so far as to recommend that we forget our efforts for higher thermal efficiencies and build cheaper and less economical generating stations. That is not a satisfactory answer. It is not right that we should cast aside the accomplishments of the past, for the facts of the case prove that those accomplishments have resulted in reducing the cost of supplying electric service.

What we should do is to maintain the higher efficiencies that have been obtained and at the same time reduce the cost of construction by more intensive study and better design.

Better engineering in the future is the answer to our problem.

We are doing better engineering today than in the past because of the accumulated engineering data available and because of the extensive research work of the past few years. Better engineering will result in more economical designs, more economical use of the materials of construction, more economical production, greater simplicity and ease of operation, and probably higher thermal efficiencies.

As a matter of fact, we are fortunately trapped by circumstances for our own good. We cannot afford to build stations today of the same design as those built a few years ago. A careful study will show that if our fuel cost us nothing we could not afford to build stations with as low thermal efficiencies as were built ten or fifteen years ago. No! The answer to the problem is not to take a backward step but to go forward. By better design we can maintain the high standards of efficiency and at the same time reduce the cost of construction and the fixed charge item in the cost of supplying electric service to our customers.

As electrical systems have grown in size, the capacity of the prime movers and generators has grown likewise. The use of larger turbine generator units, when intelligently used, has reduced the unit cost of generating stations irrespective of the operating pressure. However, it appears from the facts available at this time that the use of large turbine generator units favors the higher pressure stations more than it does those designed for more moderate pressures. Today a 50,000-kw. unit for 1200-lb. pressure costs somewhat more than one designed for 350-lb. pressure, but a 125,000-kw. unit costs about the same whether designed for 1200- or 350-lb. pressure.

It would therefore appear advisable in high pressure stations to install as large-sized turbine generator units as practical from the operating standpoint. The recent designs of turbines that give practically the same economy over wide ranges of load have made it advisable today to use larger units than would have been advisable a few years ago for the same system load conditions.

Interconnections of electric systems also permit the installation of larger turbine generator units than would be advisable without interconnections. This factor

should not be lost sight of if the fullest advantages are to be obtained by interconnections.

In the past, the size of our steam generating units in our stations has always lagged behind the size of our turbine generator units. From three to five boilers are often installed to serve one turbine generator with a resultant large increase in the unit cost of our boiler plants when compared with a design in which the steam generating unit matches the size of the turbine generator unit.

There seems to be no basic reason why the steam generating units should not match the turbine generator units in reliability. Already steam generating units have been operated with availability factors in excess of 90 per cent. If this performance can be matched consistently, there seems to be no reason why one steam generating unit should not supply all of the steam for operating one turbine generator unit. We can then have unit construction, one boiler feed pump, one boiler, one turbine, one condenser, one circulating water pump, and one auxiliary power supply. A reasonable number of cross-connections will insure continuity of service and will reduce the unit cost of spare equipment.

It is also true that this better balance between the size of steam generating units and turbine generator units is desirable irrespective of the operating pressure employed, but the accomplishment of the proper balance will make a greater reduction in the unit cost of the high pressure stations because of the higher unit cost of high pressure boiler plant equipment.

The argument of "the larger the unit, the lower the unit cost" carries throughout the station, for it applies to station structures, piping, and auxiliaries. It likewise applies to transmission lines, substations, and distribution systems right up to the customer's meters. The basic reason for this is the fact that the larger units permit the most economical use of the materials of construction, labor, and supervision.

Construction experience has very definitely shown that the size of the unit has a great deal to do with the comparative cost between high-pressure and moderate pressure installations. Undoubtedly a 5000-kw. 1200-lb. installation would cost more per kilowatt than one for 350 lb., while for much larger units there appears to be little if any difference in unit cost. This is undoubtedly the reason why comparative studies for small plants for industrials usually show that the normal pressure installation is the cheaper, all factors considered.

The recent A. S. M. E. Steam Table Research Committee's publication of the Total Heat Entropy Diagram extended to 3500 lb. per sq. in. and 1000 deg. fahr. total steam temperature has very clearly pointed out that for every steam temperature there is a theoretically economical pressure. The higher the temperature, the higher the economical pressure. For a temperature of 750 deg. fahr. and the regenerative reheat cycle, the economical pressure is in the neighbor-

hood of 1400 lb. per sq. in. In other words, the steam temperature is in reality the governing factor.

Already the Detroit Edison Company has decided to lead the way in an attempt to raise the operating steam temperature to 1000 deg. fahr. They have purchased a turbine generator to operate with steam at moderate pressure at this temperature for their new Delray Station.

As the difficulties with the higher temperatures are worked out, the higher temperatures will be combined with higher pressures and there is a possibility that we will be faced with the necessity of raising operating pressures even higher than 1400 lb.

The development of equipment suitable for utilizing steam at 1000 deg. fahr. will result in justifying the use of higher pressures without reheat, and who can say that with reheat 3200 lb. per sq. in. will not be justified?

If the time comes when pressures considerably in excess of 1400 lb. are justified, we must depart radically from our present designs of boilers. We must abandon thermal circulation in boilers and water-cooled furnace walls and adopt forced circulation. Just because we cannot at once reconcile our minds to such a radical departure in design is no reason for our feeling that there is nothing in the idea before it has been given a thorough trial. Some European engineers believe that forced circulation is advisable for pressures as low as 1500 lb.

The European trend is distinctly toward higher steam temperatures at moderate pressures because the engineers over there believe that the unit cost of high pressure equipment is too great to be justified by the fuel savings to be obtained by its use. On the other hand, in America the trend is just the other way; *i. e.*, higher pressures at moderate temperatures. It is the opinion of American engineers that higher temperatures call for the use of alloy steels and the proper alloys are not available today at prices that make their use profitable.

There is no doubt that many engineers on both sides of the Atlantic Ocean are fully alive to the proper relation between pressures and temperatures, and you can find many instances where certain companies are going far ahead of the general trend. Two noteworthy examples of this are the Detroit Edison Company's purchase of 1000 deg. fahr. equipment, and the recent purchase of a 300,000 lb. per hr., 3200 lb. per sq. in. Benson boiler for the Langerbrugge Station in Belgium.

We have been told on many occasions that the laws of diminishing returns will preclude going much higher in pressures or temperatures, and yet both in America and Europe engineers are going ahead and accomplishing results with higher pressures and temperatures that may force a revision or a reinterpretation of that law of diminishing returns. It is indeed very dangerous to draw definite conclusions from trends; it is wiser to watch the accomplishments of the pioneers.

The experience thus far gained in the construction and

operation of high pressure and high temperature stations has very clearly shown that the design and operation calls for engineering talent of the highest type. Designs and construction details must be worked out with the greatest care or otherwise the cost of construction will increase to a point where the fixed charges will offset the savings in fuel. On the other hand, if the proper skill is exercised there does not appear to be any additional capital burden and the greater economy pays a handsome dividend on the effort expended. The argument that greater skill is required is no valid reason for refraining from using the most economical equipment any more than a merchant should refuse to enlarge his business for fear that the larger and more profitable business will require more careful planning and attention.

Construction experience has shown also that high-pressure stations need not be confined to base load operation. Since they can be built for practically the same unit cost as low-pressure stations, they impose no additional capital burden and can be justified for supplying the normal load of the system. This fact will undoubtedly greatly increase the use of higher pressures in the future because it is seldom practical to operate a generating station as a base load station for a long period of years.

Just as the hand-fired grate for large boilers has passed into the discard with the development of efficient automatic fuel burning equipment, so have "rule of thumb" design, construction and operating practices passed on. Brains instead of brawn rule today.

SEEK FOG-PENETRATING LIGHT

There has been a great deal of talk about the fog-penetrating power of the light produced by means of certain lamps, but according to impartial experts on the subject such a source of light is not yet.

Speaking on the subject before the Chicago Section of the Society of Automotive Engineers, R. E. Carlson, of the Westinghouse Lamp Co., said:

"I wish we knew how to design lamps for use in fog. From time to time, particularly in aviation work, one hears about certain wave-lengths of light being more suitable for fog penetration. I have in mind some tests that were well controlled and well conducted by the Bureau of Standards in Massachusetts last year. Those tests showed that, for fog penetration, the difference between a tungsten-filament incandescent lamp and a neon lamp is not great enough to measure within close limits.

"From my own experience, I think the less light one has in a fog the better, because the back glare impairs visibility. On the Pacific Coast, up in Oregon and that region, what are known as 'fog lights' are mounted low so that they reduce, as much as possible, the reflection and back glare. We have no solution for that problem yet; I wish we had."

Electrochemistry and Electrometallurgy

ANNUAL REPORT OF COMMITTEE ON ELECTROCHEMISTRY AND ELECTROMETALLURGY*

To the Board of Directors:

The Committee on Electrochemistry and Electrometallurgy submits the following report covering some of the outstanding matters of interest within the field of the committee. Such a review can never claim to be complete. The past year has brought several items of unusual interest. As an innovation in the report of the committee, for the present year somewhat more details are given about certain materials and their production, including the features likely to be of interest to electrical engineers. For this reason, the number of items covered in the report is somewhat less than in the reports for the several years preceding.

D-C. SUPPLY FOR ELECTROLYTIC USES

Approximately 200,000-kw. capacity in d-c. machinery is now purchased yearly by growing electrolytic industries throughout the world. Electrolytic processes are essentially d-c. processes requiring large current at relatively low voltage per unit. The problem of a suitable and economical source of power, therefore, is of importance, and one requiring careful study to determine the best conditions in any particular case. The generation of direct current may have some advantages as to cost and maintenance, if the electrolytic plant is not far removed from the source of power, and if exhaust or bleed steam can be used to advantage in process work. Such a source of supply, however, is limited in its application and does not permit of interconnection to other sources of power. When power is purchased, the problem of converting it from alternating current to direct current usually arises. Synchronous converters and motor-generator sets both find use for this purpose. Possibly, large mercury rectifiers also may find extended use in the future. In several papers which have recently appeared, it has been pointed out that the proper choice in any particular case must depend, (1) upon voltage and other characteristics of the transmission line; (2) the range of voltage, the current, and other characteristics of the electrolytic circuit; and (3) the efficiency under particular operating conditions; and (4) the initial investment and interest charges. It frequently happens that materials produced by electrochemical means are more costly than

similar materials produced without the expenditure of electrical energy; and yet the electrochemical processes are justified by the higher quality of material or by unusual physical or chemical properties. The problem is therefore a complex one which will have much to do with the success or failure of electrolytic production, because the power costs are usually a considerable fraction of the total cost per unit of the material.

CHROMIUM PLATING

Chromium plating which was first accomplished 70 years ago has undergone a sensational development in the electroplating field within the past three years. It is only recently that the mechanism of the processes has become sufficiently well understood to make possible its commercial application. From the various uses proposed for chromium plating, it is becoming apparent what may reasonably be expected.

Scratch tests on thin films of chromium indicate that the hardest chromium is harder than any other metals or alloys previously tested; its ductility is almost zero; its expansivity is about the same as for glass or platinum; it resists tarnish to a remarkable degree. The reflecting power of chromium is 65 per cent as compared with silver 95 per cent. Its electrical conductivity is about that of aluminum.

As a protective coating, thin films are desirable. For some purposes 0.00002- to 0.00004-in. are used over a preliminary coat of copper or nickel. Thicker deposits may tend to crack. Chromium deposits are made from a chromic acid bath to which a sulphate has been added. The anodes are of iron or lead. The conditions for making satisfactory deposits are rather critical as to temperature and current density, the latter ranging from 100 to 300 amperes per sq. ft. From the standpoint of the electrical engineer, the large amount of energy required is of interest. The voltage across the tank ranges from 6 to 12 volts. The current must be large and since the valence is 6 and the efficiency of the process low, the amount of metal deposited per coulomb is very small. It has been estimated that chromium plating requires 15 times the electrical energy used for nickel plating in equivalent amounts. However, in the case of chromium but little metal is needed. The process brings with it hazards that require carefully designed ventilating systems to protect the workers. In spite of difficulties which may seem numerous, the desirable properties of chromium as a protective coating, its resistance to wear, its hardness, and its pleasing appearance have brought it into use in many industries. Some of the applications which have been made of it have not been successful; as, for example, in stamping

*COMMITTEE ON ELECTROCHEMISTRY AND ELECTROMETALLURGY:

G. W. Vinal, Chairman,	E. B. Dawson,	C. G. Schluederberg,
Lawrence Addicks,	F. A. J. Fitzgerald,	J. A. Seede,
Arthur N. Anderson,	F. C. Hanker,	Magnus Unger,
T. C. Atchison,	W. E. Holland,	J. B. Whitehead,
P. H. Brace,	F. A. Lidbury,	E. A. Williford,
Farley G. Clark,		J. L. Woodbridge.
Safford K. Colby,		

Presented at the Summer Convention of the A. I. E. E., Swampscott, Mass., June 24-28, 1929. Printed complete herein.

dies. The chromium is brittle and flakes off. In the popular mind chromium is associated with automobile and plumbing fixtures, but in a less conspicuous way, chromium plating has proved its worth by prolonging the life of gages, tapes, measuring devices, forming dies, spinning tools, and printing plates.

An important development during 1928 was the installation of several completely automatic equipments for chromium plating. The electroplating industry has learned the value of chemical control and now it is adding automatic electrical control of current density and control of temperature.

ELECTROPLATING OF VARIOUS METALS

In other fields of electroplating, new finishes have been developed. Cadmium plating, which can be easily done on any commercial metal, promises valuable service as a preventative of rust, but it is handicapped by the high price of metal. A process has long been sought for electroplating aluminum on other metals. A step in this direction has been made in the experimental work of depositing aluminum on other metals from organic solutions. New developments are taking place in the electrodeposition of alloys. Whereas in the past this has been confined chiefly to brass and bronze, today there are a dozen different alloys that may be deposited from aqueous solutions. Nickel-plating continues to increase in spite of the threatened competition of chromium plating. Actually, the latter needs an underlying layer of nickel, and so it has been said that chromium plating has actually stimulated the demand for nickel. The trend in nickel plating is towards the use of very pure anodes containing not less than 99 per cent of nickel.

HYDROGEN FOR INDUSTRIAL USES

Industrial uses for hydrogen are rapidly increasing. The electrolytic process is particularly well adapted to the production of hydrogen of a high degree of purity. It is of more than passing interest that a large research laboratory is provided with pure hydrogen piped to the various rooms and consuming in the experimental work more than 2,000,000 cu. ft. of hydrogen per month. In the fat-hardening industries the demand for pure hydrogen is increasing and larger electrolytic cell units in some cases amounting to 4 to 5 times the capacity of present installations are being sought. More electrolytic hydrogen is likewise being used in the synthesis of liquid ammonia, the production of which in 1928 was so large that it became the cheapest alkali per unit. It has been found that liquid ammonia is a very convenient form for transporting hydrogen. Of particular interest to electrical engineers is the use of hydrogen as a cooling agent. It naturally diffuses faster than other gases and has a high thermal conductivity so that it can be used to advantage where it is important to remove heat rapidly. High-speed motors and generators are being operated in hydrogen gas in development

tests and a commercial application of hydrogen cooling has recently been made in the case of a large synchronous condenser which is totally enclosed. The capacity of this condenser with hydrogen cooling is said to be 12,500 kv-a., as compared with 10,000 kv-a. if air-cooled. The use of hydrogen for such a purpose is beneficial in other ways, since oxygen and dirt are excluded and the effect of corona on the insulation eliminated. As a safeguard, the pressure of hydrogen is maintained above atmospheric pressure and the purity of the gas is continuously recorded. An alarm is sounded if the purity falls below 91 per cent.

COPPER

The change in the copper situation during 1928 was sensational. A sluggish market which had persisted for years with comparatively little prospect of marked advancement was transformed by the increasing demand for this metal. Existing stocks were reduced and outlets for even the high-cost copper provided. Copper as a product of electrochemical industry and as a basic material of electrical construction has a double interest for the electrical engineer. Part of the increased use of copper may be attributed to systematic efforts of a research association to extend its uses and part may be attributed to the growth of electrical industry, which is said to consume in one form or another, more than one-half of the total supply. It has been estimated that the mines of the United States will produce over a million tons during the present year and most of this will be used within this country.

ELECTROLYTIC ZINC

A large plant has recently been installed in Idaho for the production of electrolytic zinc by the "Tainton-Pring" process. Good deposits of very pure zinc are obtained from the strongly acid solutions. The cathodic current density is about 100 amperes per sq. ft. and the voltage per cell, about $3\frac{1}{2}$ volts. The nominal capacity of the plant is 50 tons of zinc per day, with provision for trebling this output. Direct current of 16,000 amperes at 500 volts is supplied by two synchronous motor-driven generator units. The electrolytic cells are arranged in two groups of 150 cells, connected in series. Each cell contains 20 aluminum cathodes faced by anodes of a lead alloy. By grounding the midpoint of the circuit, the maximum voltage to ground is reduced to 250 volts. The purified zinc sulphate solution is circulated to the cells until 90 per cent of the zinc has been extracted when the solution contains about 28 per cent acid. The deposition process is a continuous one with periodic changes of the electrolyte. The current efficiency of the electrolytic process averages about 85 per cent. The zinc obtained by this process is of high purity and soft.

NICKEL

Improved smelting and refining methods have re-

sulted in improving the purity of commercial grades of nickel. Electrolytic nickel, averaging 99.90 per cent or better, is the highest grade produced on a commercial scale. This is especially suited to the production of alloys containing high percentages of nickel. It is available as "electro-squares" in a variety of convenient sizes. The ferro-nickel alloys containing large percentages of nickel are finding increased use in radio transformer cores because of their extraordinary permeability.

ALUMINUM

Figures have been published to show that the world's production of aluminum has grown from 24,000 tons in 1908, to 214,000 tons in 1927. Aluminum is typically an electrochemical product. At present two great outlets for aluminum and its alloys are in the manufacture of automobiles and aircraft. It is said that more than 30,000,000 aluminum pistons were made in 1928. Aluminum cylinder heads are beginning to appear. Aluminum alloy frames for motor coaches are decreasing the non-profitable load of these bulky machines. Aluminum crank cases and housings are already familiar. Light and strong alloys are necessary for airplane construction. The strength of a variety of these alloys is now very well known. The fire hazard in the airplane has been reduced and quantity production as in the case of automobiles has become possible. A new material called "alclad" which combines the strength of duralumin and the resistance to corrosion of pure aluminum seems destined to become important in many fields. Aluminum which at one time was considered a material chiefly for cooking utensils, has thus found a wider field. Aluminum cooking utensils continue to increase, but as an outlet for this metal, this application is overshadowed by the newer uses in airplanes, automobiles, trucks, railway cars, furniture, roofing, decorative castings, and foil which competes with tin.

ELECTRIC FURNACES

In the electric furnace industry there has been a decided increase in the use of the high-frequency furnace. These furnaces, using a motor-generator type of equipment, have entered the field of silver melting, and it is reported that 3.76 kilograms per kw-hr. can be melted with this form of equipment as compared with 2.9 kilograms per kw-hr. for the earlier type operated by an oscillator. The high-frequency furnace is well established in the non-ferrous field, and it seems likely that it will find use in the steel foundry as a convenient means of holding the heat. A large number of electric furnaces, mostly of the resistor type, has been installed for the nitriding processes for steel. A very hard surface is obtained similar to that produced by case hardening but superior in some respects.

Ceramic engineers have accomplished much after years of experimentation and many failures, and have

succeeded in introducing the electric furnace into glass and porcelain industries.

In the carbide industries, the desire to increase the unit by increasing the ampere input at 100 to 200 volts has met with difficulties and the electric furnace engineer is confronted with the problem of how to overcome these limits of design without increasing voltage. At 25 to 60 cycles, the present electrical equipment will not permit of commercial operation beyond 3000 amperes per furnace unit.

A number of electric furnace installations has been recorded in different parts of the world for the production of phosphoric acid and potassium phosphate. There is every indication at the present time that the electric furnace will eventually displace the sulphuric acid process in the manufacture of phosphoric acid. A noteworthy event has been commercialization of the electric furnace for smelting zinc from its ore. At one plant a furnace turning out 50 tons of pure spelter per day has been reported.

The largest peace-time electrolytic alkali-chlorine plant has been put in operation in the vicinity of Charleston, West Virginia. This locality is rapidly becoming a center of electrochemical industry.

BATTERIES

In the battery field, the production of batteries for automobiles has continued to increase, the number produced yearly being variously estimated from 11 to 15 millions. Since the standard specifications were adopted for them several years ago the quality of dry cells has increased and a proposal to materially increase the minimum requirements for the various sizes and kinds is now before the Sectional Committee on Dry Cells. The dry-cell industry has felt the inroads of the a-c. radio sets, but it is likely that a large number of battery sets will continue to be used. In the field of small rectifiers, the most important development has been the copper-copper oxide type which has displaced many of the electrolytic types.

ELECTROCHEMICAL RESEARCH

Interesting results are being obtained in the study of the nature of conduction found in dielectrics and particularly in insulating oils. This field of research requires a knowledge of both electrical and chemical processes. Relationships have been found between the variation of conductivity with time, the accumulation of space charges, and the final dissymmetry of the potential gradient.

A new material of extreme hardness for machine cutting tools has been placed on the market under the name of "carboly." It consists of tungsten carbide and cobalt. The carbide is extremely hard and the cobalt increases the strength.

The demands of industry for new and pure materials has encouraged the development of electrical processes. Rare metals have been produced by electrolytic methods

and these are gradually coming into the field of technology. We can not anticipate the uses that they may ultimately find in the service of mankind, but the experience with others which we now regard as common indicates that uses rapidly arise when such materials become available commercially. The further purification of the more common metals and the elimination of almost the last fractional percent of the impurities has

revealed surprising changes in their mechanical and chemical properties. Electric furnace products bear the brand of superior quality and by the use of electric heating many improvements have been made in working conditions.

The Committee wishes again to acknowledge the helpful cooperation of Professor Colin G. Fink, Secretary of the American Electrochemical Society.

An Economic Study of an Electrical Distributing Station

BY W. G. KELLEY¹

Fellow, A. I. E. E.

Synopsis.—This paper outlines some of the physical reasons and economic advantages influencing the establishment of Washington Park Distributing Station of the Commonwealth Edison Company of Chicago.

This station is located at the electrical center of the load which it supplies. It receives energy at 66 kv. from an outlying generating station, State Line Station. The voltage is reduced at the distributing station and fed to a number of substations at 12 kv.

The past practise of this company has been to feed the substations

at 12 kv. directly from generating stations. However, a study indicated several reasons for discarding the practise in this case.

The main physical reasons were the congested condition in the underground cable system surrounding Calumet Generating Station and the distance from Calumet Station to its dependent substations.

The economic advantages consisted primarily of the decrease in transmission line costs due to the location of the distributing station at the center of the zone load and the savings resulting from the use of 66-kv. instead of 12-kv. for the primary transmission system.

THE subject matter contained in this paper is confined to a study of the transmission costs incident to the establishment of the Washington Park Distributing Station of the Commonwealth Edison Company of Chicago.

A distributing station differs from a generating station in that it receives electrical energy over transmission lines instead of producing the energy by means of generators. The energy is usually transmitted to the station at a higher voltage and distributed from the station at a lesser voltage to a number of adjacent substations.

The three-phase electrical system supplying energy to the distributing station may be termed the primary transmission system and consists in this case of three single-conductor 750,000-cm., 66-kv. cables. The three-phase system conveying energy from the distributing station to the substations may be termed the secondary transmission system, and the feeders are in this case three-conductor, 500,000-cm., 12-kv. cables.

A map of the City of Chicago, showing the various generating stations, Washington Park Distributing Station, and the substations receiving energy from the distributing and generating stations is given in Fig. 1. The various zones or districts fed by the generating and distributing stations are also outlined on the map. As the generating stations must be located on property

accessible to water for condensing purposes, they can seldom be located at the electrical center of load for their respective zones.

Table I and Fig. 2 show the load in kilowatts for the various station zones from the years 1920 to 1928, inclusive.

In the case of Calumet and Fisk-Quarry Stations, the zone loads now exceed the generating capacity and part of the energy is supplied to these two zones from State Line Generating Station by means of 66-kv. underground transmission lines.

The distribution of energy in the Calumet Station zone has introduced certain physical and economic difficulties; first, due to the high cable temperatures in the underground conduit system resulting from the large number of heavily loaded cables radiating to the west and north of the station; and second, due to the length of the 12-kv. secondary transmission lines from Calumet Station to the various substations in the zone.

The number of 12-kv. underground cables at Calumet Station is designated by the figures shown on the conduit line in Fig. 3.

Due to the fact that a considerable portion of the zone load is brought into the district at 66 kv. and not generated at Calumet Station, it was proposed that a new station be established at the electrical load center of the northern half of the Calumet zone for the purpose of receiving energy from State Line Station at 66 kv. and distributing it to the various substations at 12 kv.

1. Assistant Engineer of Distribution, Commonwealth Edison Co., Chicago, Ill.

Presented at the Great Lakes District Meeting of the A. I. E. E., Chicago, Ill., Dec. 2-4, 1929. Printed complete herein.

TABLE I
GROWTH OF 60-CYCLE ZONE LOAD AT TIME OF SYSTEM MAXIMUM

	1920 Kw.	1921 Kw.	1922 Kw.	1923 Kw.	1924 Kw.	1925 Kw.	1926 Kw.	1927 Kw.	1928 Kw.
Northwest.....	50,000	65,000	81,430	91,000	84,780	101,850	118,210	128,922	143,260
Fisk-Quarry.....	140,000	122,000	155,200	91,980	112,985	136,276	140,220	190,840	177,723
Crawford.....				53,920	80,350	103,019	158,020	177,932	218,777
Washington Park.....		26,000	38,770	91,290	101,187	141,885	159,000	172,952	55,388
Calumet.....									123,880
Total.....	190,000	213,000	275,400	328,190	379,302	483,030	575,450	670,646	719,028

A preliminary study of the secondary transmission cables on the 12-kv. system expressed in circular-mil-feet per kilowatt, showed that a 10 per cent reduction in this ratio could be effected for the entire Chicago area by the establishment of Washington Park Distributing Station.

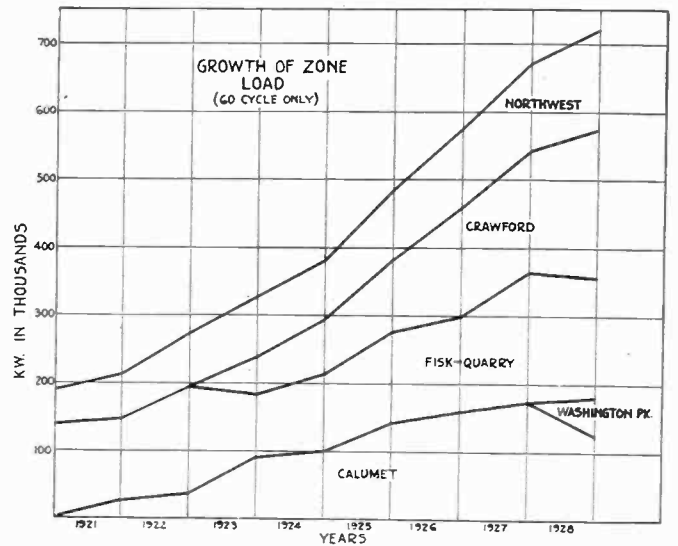

FIG. 2—GROWTH OF ZONE LOAD FOR THE YEARS 1920 TO 1928, INCLUSIVE

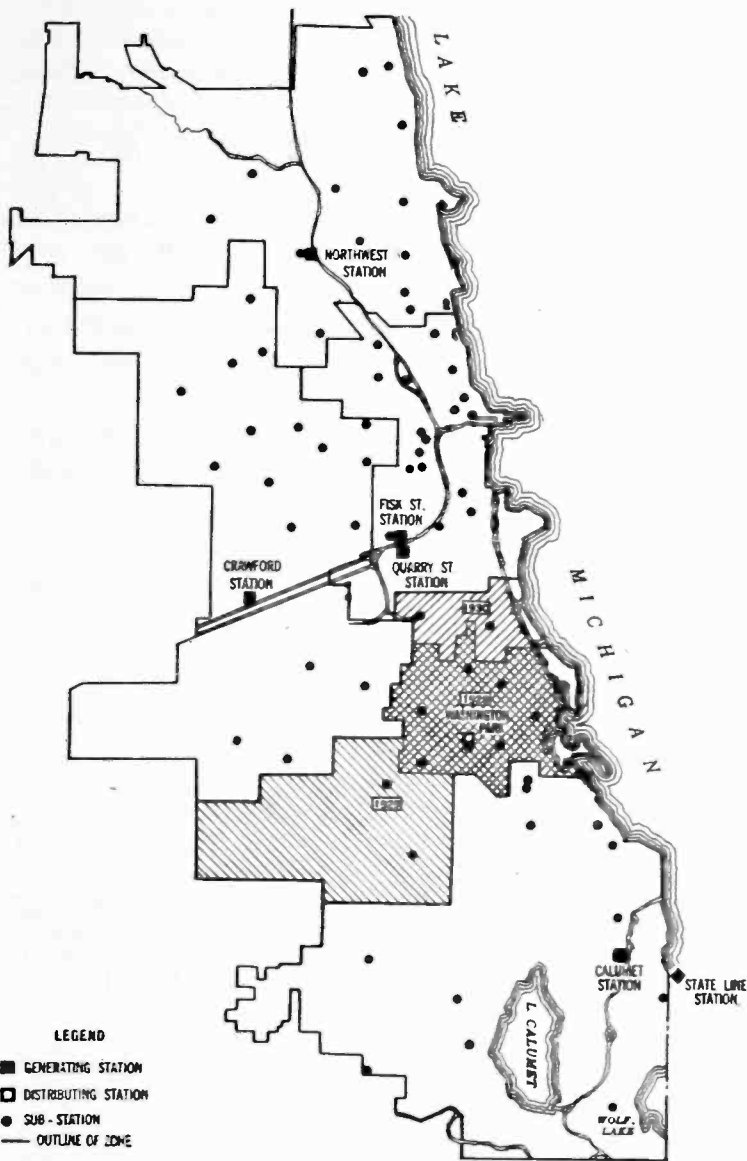

FIG. 1—MAP OF CHICAGO SHOWING THE LOCATION OF STATIONS AND SUBSTATIONS

Eight substations were tentatively selected to form a zone load for the first year for Washington Park Distributing Station and for the year 1928, the load in this zone was 55,388 kw.

Table III shows the load on the eight substations

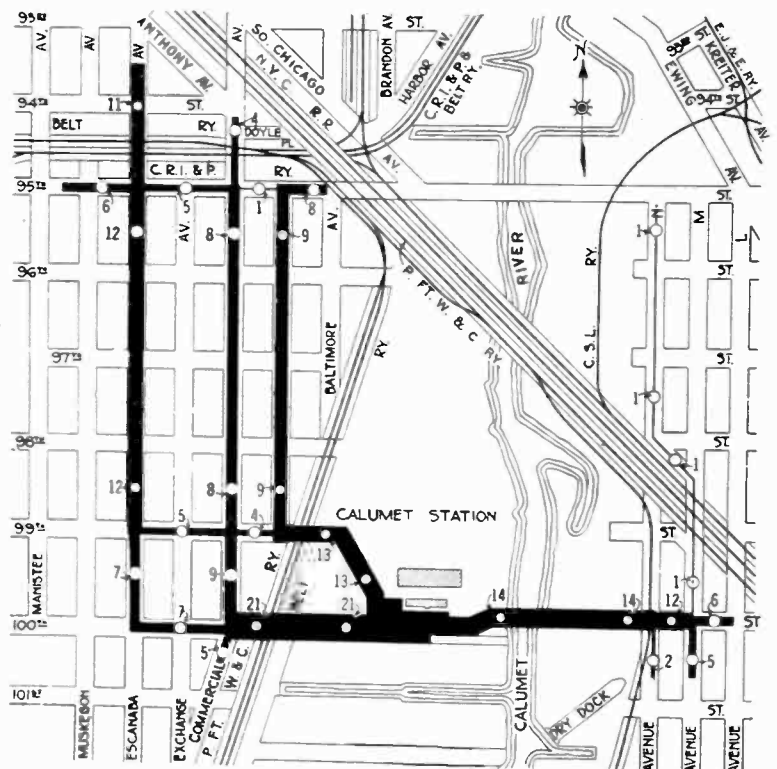

FIG. 3—DIAGRAM OF UNDERGROUND TRANSMISSION CABLES AT CALUMET STATION

The numerals denote the number of three-phase 12-kv. cables in each conduit line

selected for the years 1923 to 1928, inclusive, segregated under the three headings, four-kv., railway, and industrial load.

The average distance from these substations to Calumet Generating Station, weighted for load, was found to be 41,600 ft., while the average distance to

to be the same whether installed at one point or the other.

The cost per kilowatt of the 66-kv. primary transmission lines, with the necessary conduit from Calumet Station to Washington Park Distributing Station, was \$11.40, and the total cost allocated to the Washington Park Distributing Station plan, based on the load of 55,388 kw., was therefore \$630,000. The cost of 12-kv. secondary transmission lines and conduit from Washington Park Distributing Station to the eight substations, was \$220,000, making a total cost for this plan, of \$850,000.

TABLE II

TRANSMISSION COPPER IN 12-KV. DIRECT TRANSMISSION LINES

	Length circuit feet	Copper Volume 1,000,000 cir. mil. ft. (one phase)	Peak load	1,000,000 cir. mil. ft. per kilowatt
1923	1,961,882	728,885	328,100	2.22
1924	2,202,563	980,044	379,302	2.58
1925	2,376,517	1,079,283	483,030	2.23
1926	2,887,780	1,352,029	575,450	2.35
1927	3,183,648	1,505,647	670,646	2.24
1928	3,118,895	1,483,448	719,028	2.06

The cost of 12-kv. secondary transmission lines and conduit from Calumet Station to the various substations, assuming Washington Park is not to be built, was found to be \$994,000, making a difference of \$144,000 capital investment in favor of the construction of Washington Park Distributing Station.

Washington Park Distributing Station, weighted for load, was found to be only 8690 ft. This represented a marked decrease in the amount of cable necessary,

This saving is due primarily to the development of 66-kv. underground cable and the greater economy of transmission at this voltage over the use of 12-kv. cable.

TABLE III

GROWTH OF PROPOSED WASHINGTON PARK ZONE LOAD

	1923	1924	1925	1926	1927	1928
Hyde Pk.....	11,600	10,400	9,880	8,900	7,430	8,100
Prairie.....	5,180	4,920	5,890	5,630	4,900	5,740
62nd St.....	9,100	7,820	8,825	9,270	9,400	10,200
Harper.....		3,660	4,450	4,300	5,300	5,210
56th St.....	10,720	9,320	9,600	9,650	7,560	7,350
Lowe.....	760	3,100	4,530	3,950	6,360	7,400
Total 4-kv.....	37,360	39,220	43,175	41,700	40,950	44,000
62nd Railway.....	5,760	5,520	4,140	4,130	4,070	4,058
E. 63rd Railway.....			1,970	2,670	4,000	3,370
Total Railway.....	5,760	5,520	6,110	6,800	8,070	7,428
Hyde Pk. Indus.....			22	655	416	104
62nd Indus.....			149	663	445	1,573
56th Indus.....			307	436	1,148	1,460
Wash. Pk. Indus.....				457	725	323
Total Indus.....			478	2,211	2,734	3,460
Grand Total.....	43,120	44,740	49,763	50,711	51,754	54,888

It is proposed to put additional substations as shown in Fig. 1 in the Washington Park Distributing Station zone during the years 1929 and 1930, thereby increasing the zone load, and also to establish additional distributing stations in the central and northern sections of the city, when economic conditions warrant.

ATOMS NOT LIKE SOLAR SYSTEMS

As every modern school child knows, the atoms of matter which were thought indivisible even 30 years ago are now considered to be complicated agglomerations of positively charged protons and negative electrons. But the manner in which the structure of the atom is visualized has changed vastly during the past few years. The modern physicist has discarded the entire picture-theory of imagining the atom as a small replica of the solar system.

These facts were stated at a recent meeting of the Detroit Section of the Society of Automotive Engineers by Professor Vladimir Karapetoff, of Cornell University, who pointed out that when physicists endowed an atom with the central nucleus and imagined electrons like little spheres revolving around that central nucleus, what they did was not different in principle from the process whereby the primitive man creates his god in his own likeness. They knew the solar system was so made, so they put it in the atom. This method worked well enough for hydrogen, composed of only one nucleus and one electron; but the complexity of the atoms of the very heavy chemical elements spelled the death knell of the picture theory of the atom and the attempts to express the motion of approximately 92 electrons by equations and to solve these equations.

and formed one of the main economic factors leading to the construction of Washington Park Distributing Station.

The following cost data were used in making the study:

- 12-kv. three-conductor cable.....\$1.95 per ft.
- 66-kv. single-conductor cable.. 2.64 to 3.07 per ft.
- Conduit per duct..... 1.00 per ft.

Due to the fact that the energy for this zone is brought to it at 66 kv., it would have been necessary to install switching equipment, transformers, and the necessary buildings either at Calumet or Washington Park Stations, and the cost of these was assumed

Abridgment of Current Transformer Excitation Under Transit Conditions

BY D. E. MARSHALL*

Associate, A. I. E. E.

and

P. O. LANGGUTH*

Associate, A. I. E. E.

Synopsis.—Tests of circuit breakers, relays, and similar devices in which current transformers have been used to step down the large currents involved to values measurable by the oscillograph, have shown peculiar errors in the records during the transient portion of the current wave.

The purpose of this paper is to show that the abnormal excitation of the magnetic circuit of the current transformer required during

transient conditions is the cause of these errors, and to point out how the errors may be minimized sufficiently to be negligible.

Mathematical expressions are also derived to make it possible to predetermine the ability of a transformer to handle transients correctly and to be a guide in the design of transformers for this service.

* * * * *

THIS paper is closely related to the problem of the measurement of transient alternating currents.

When certain apparatus such as circuit breakers are subject to short-circuit tests, it is desirable to have a correct indication of current during the transient condition.

In the past, two methods have been used for measuring heavy transient currents; namely, the non-inductive shunt and the current transformer. Considerable field testing has demonstrated that these methods have introduced difficulty under some conditions. When the shunt is used, it is of course necessary to insulate it and associated oscillograph apparatus from ground to the extent of full-line voltage. Furthermore, non-inductive shunts can be used only with non-inductive measuring devices and therefore cannot be used with the current coil of watt oscillograph elements, which are highly inductive, for the measurement of instantaneous power.

Even with resistive burdens inaccuracies will result due both to self-inductance and mutual inductance on multi-phase set-ups.

The use of the current transformer for the measurement of transients under certain conditions has resulted in some inaccuracies. In this paper effort has been made to determine the causes of the errors which occur, the extent of the errors, and means for elimination or minimization. The causes of the errors are first briefly outlined. A discussion of the practical importance of the errors is given as is also mathematical exposition of the theory including the formulas for designing transformers having suitable characteristics for the measurement of transients. A number of oscillograph records amplifying and checking the theory is presented; and finally a method is given for testing transformers to determine their suitability for use under transient conditions.

The authors are indebted to Mr. J. F. Peters for

*Westinghouse Elec. & Mfg. Co., East Pittsburgh, Pa.

Presented at the Regional Meeting of the Middle Eastern District of the A. I. E. E., Cincinnati, Ohio, March 20-22, 1929. Complete copy upon request.

constructive criticism, and to Mr. L. R. Smith for assistance in conducting the tests.

OUTLINE OF CAUSES OF ERRORS AND THEIR CHARACTERISTICS

If the circuit in which the primary of the current transformer is connected contains both resistance and inductance, the current flowing in that circuit just after its switch is closed will not assume always immediately a pure sinusoidal wave form, but will be dis-

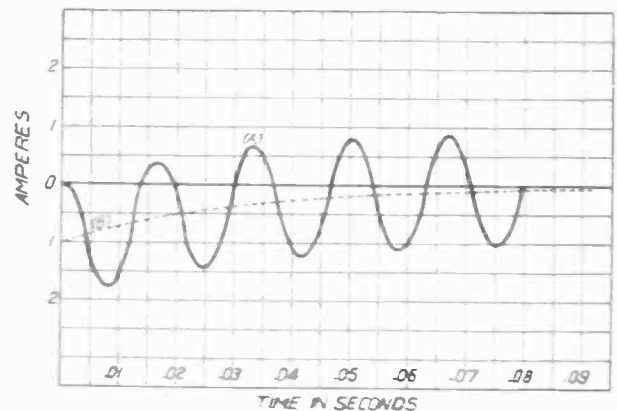

FIG. 1—TRANSIENT CURRENT FOR INDUCTIVE CIRCUIT HAVING TIME CONSTANT 0.0304 AT 60 CYCLES

(A) = Asymmetrical current wave
(B) = Displaced zero axis

placed from its normal zero axis in a manner similar to the current curve shown in Fig. 1. (Eq. (4) of complete paper.)

This asymmetry rapidly decreases and in practical circuits disappears in about 3 to 15 cycles of 60-cycle current. The degree of asymmetry depends on the point of the voltage wave at which the switch is closed. The current wave is practically normal if the switch is closed when the voltage is at its maximum and may be entirely above or below the zero line, if the switch is closed at the zero of the voltage wave. The point on the voltage wave at which the switch is closed is usually a matter of chance, although it is sometimes argued that inasmuch as in high-voltage circuits the current might start before the switch is completely closed, the first case is the more probable. Thus in the majority of

cases, the transient will be comparatively slight. (Fig. 1 is calculated on the basis of a closure under the worst possible conditions.)

The important thing to appreciate, so far as this paper is concerned, is that this dissymmetry is quite likely to occur just after the switch is closed. The paper therefore treats of the effect of the dissymmetry on the magnetizing current and the resultant error in a current transformer under such transient conditions.

The error is due to the over-saturation of the transformer which is caused by the d-c. component of the asymmetrical current. This condition is of course aggravated if the secondary burden is excessive. The error in transformation also will vary depending upon the amount of residual magnetism and its polarity with respect to that of the d-c. component. For this reason, in tests where accuracy is essential, the transformer selected for use in measuring transients must be designed for a low degree of saturation at the burden to be imposed, and must be demagnetized between successive heavy shots. On tests which do not come up to the knee of the saturation curve, the residual will probably be so slight that demagnetization will not be required.

A complete mathematical exposition is included in this paper and will be printed in full in the TRANSACTIONS. The equations and the data indicate that the inaccuracies of the current transformer during unsymmetrical transients are caused by the large flux required to generate the voltage necessary to reproduce the transient in the burden of the transformer. The maximum value of transient flux is dependent upon the magnitude of the current, the duration of the transient, the design of the transformer, and the secondary burden.

A series of tests was made to check and amplify the mathematical theory and the data thus secured are given under the heading of Test Data in this paper.

PRACTICAL IMPORTANCE OF ERRORS

As these errors are caused by the dissymmetry of the primary current which is dependent on the cyclic time of closing the switch, their appearance is rather uncertain, but always possible, and may cause erroneous conclusions on an important test.

The magnitude of these errors is generally comparatively slight, although on extremely heavy short circuits of a high degree of asymmetry, with a particularly unsuitable transformer having a heavy secondary burden, the degree of over-saturation may be so great as to cause an error of, roughly, 50 per cent in the r. m. s. value of the first current wave. The most noticeable effect of the errors is the distortion of the secondary current wave shape rather than serious diminution of the crest value.

In most cases the error thus introduced is comparatively unimportant except in the cases of high-speed relay operation and watt oscillographs. The great majority of tests to determine rupturing capacity of circuit breakers are so made that the current has

reached a steady-state condition before arcing starts. Even though this condition has not been reached, the r. m. s. current of the first half cycle of arcing is usually determined from the crest value, with due allowance for the displacement of the neutral axis, on the assumption that the wave is of sinusoidal shape which partially corrects for the error but always indicates a lower current than actually occurred.

In oscillograph testing, however, the accuracy required is not of so high an order as required for current transformers used with watt-hour meters; hence the allowable flux density is higher. The oscillograph burden is lower than the usual burdens. These two factors tend to compensate for the high value of transient flux required, thus making the problem of applying or designing a suitable current transformer less difficult than might appear.

The only competitor of the current transformer has been the non-inductive shunt. This method, however, presents difficult insulation problems, as the oscillograph elements must be directly connected to the high-voltage lines.¹ It should also be fully appreciated that a non-inductive shunt is only allowable for use with non-inductive burdens. It must always be of the same time constant as the burden. This effect is not serious for straight current-measuring oscillograph elements. Watt oscillograph elements, however, having current coils of relatively high inductance, cannot be used with non-inductive shunts.

The current transformer works better, if anything, for inductive than for resistive burdens, and may be used for any type of element. Against the disadvantages of demagnetizing transformers may be set the added safety to operators, the lack of necessity of insulating the operator and instrument from ground, and the possibility of using the transformers supplied in the apparatus under test instead of special equipment.

MATHEMATICAL EXPOSITION

If the primary current is unsymmetrical, it may be represented by the following equation as given earlier in the paper: (See Fig. 1.)

$$i = I [\sin (\omega t + \alpha) - \sin \alpha \epsilon^{\frac{-t}{T}}]$$

If this expression is substituted in (15) the equation for the magnetizing current will be found to be:

$$i_1 = I \left\{ \frac{\sqrt{R_2^2 + \omega^2 L_2^2}}{R_2 \sqrt{1 + \omega^2 T_1^2}} \left[\sin (\omega t + \alpha + \phi - \Delta) - \sin (\alpha + \phi - \Delta) \epsilon^{\frac{-t}{T}} \right] + \frac{L_2 - R_2 T}{R_2 (T - T_1)} \sin \alpha (\epsilon^{\frac{-t}{T}} - \epsilon^{\frac{-t}{T_1}}) \right\}$$

$$T_1 = \frac{L_1 + L_2}{R_2}; \tan \phi = \frac{\omega L_2}{R_2}; \tan \Delta = T_1 \omega; (i_1 = 0), (t = 0).$$

(16)

1. For references see Bibliography.

If we substitute in Equation (16), $L_2 = 0$, $\sin \alpha = 1$, where as before, which causes maximum primary transient), we have:

$$i_1 = I \left[\frac{1}{\sqrt{1 + \omega^2 T_1^2}} \cos(\omega t - \tan^{-1} \omega T_1) - \frac{T}{T - T_1} \left(\epsilon^{-\frac{t}{T}} - \epsilon^{-\frac{t}{T_1}} \right) + \frac{\epsilon^{-\frac{t}{T_1}}}{1 + \omega^2 T_1^2} \right] \quad (18)$$

which gives the shape of the magnetizing current as a function of $(T_1) = \frac{L_1}{R_2}$. This factor is easily calcu-

lated from the magnetizing current—voltage characteristic of the transformer, and the total secondary resistance.

Maximum Value of Transient Flux. As given before, the transient term may be represented by Equation (17):

$$A \epsilon^{-\frac{t}{T}} - (A + B) \epsilon^{-\frac{t}{T_1}} = u$$

where u represents the transient portion of the magnetizing current. Differentiating (17) and equating to zero, we find that

$$t = \log_e \left[\frac{T_1}{T} \frac{A}{A + B} \right]^{\frac{T T_1}{T_1 - T}} \quad (19)$$

which is the time at which the transient term reaches its maximum value.

Substituting this expression in Equation (17), we have for the maximum value of the transient magnetizing current:

$$U_{max} = A \left[\frac{T_1}{T} \frac{A}{A + B} \right]^{\frac{-T_1}{T_1 - T}} - (A + B) \left[\frac{T_1}{T} \frac{A}{A + B} \right]^{\frac{-T}{T_1 - T}} \quad (20)$$

By substituting the values of the constants of Equation (17) in the above Equation (20), the correct maximum value of the transient magnetizing current will be obtained.

For design purposes Equation (18) is accurate to a high degree. By taking the coefficients as given there and substituting in (20), and by the use of a justifiable assumption, the following simpler equation for the maximum is derived:

$$U_{max} = I \left(\frac{T_1}{T} \right)^{\frac{-T_1}{T_1 - T}} \quad (21)$$

$$T_1 = \frac{L_1}{R_2}, T = \text{time constant of primary transient,}$$

and I = maximum value of the steady-state primary current.

TEST DATA

As a check on the theory, a series of tests was made on several through type current transformers. For the purpose of separating the exciting current component from the primary current, a scheme shown in Fig. 10 was used. A primary circuit was set up to have definite pre-determined values of resistance and inductance such that transients of definitely known time constant (T) could be obtained. To obtain the total secondary current and the total primary current, non-inductive shunts were used in parallel with the oscillograph elements V_1 and V_3 . A combination of three shunts of equal value was used in the differential circuit with oscillograph element V_2 for the purpose of obtaining the difference between the primary and

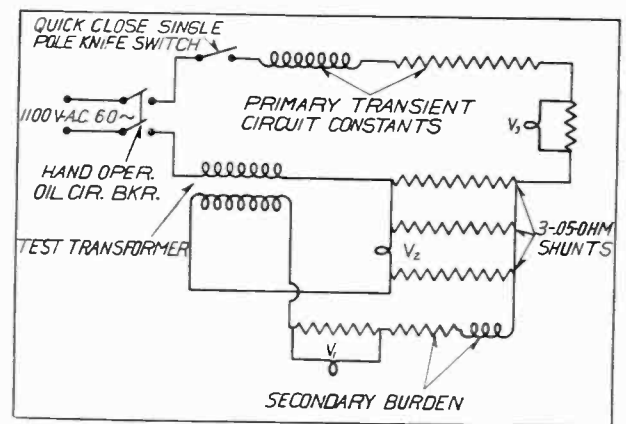

FIG. 10—SCHEMATIC DIAGRAM OF TRANSIENT TESTING CIRCUIT

secondary currents. As the ratio of the transformer is 2 to 1, and as the resistance of element V_2 is high in comparison with the resistance of the shunts, the deflection of the element V_2 will be proportional to the difference between the primary and secondary currents, thus giving a measure of the exciting current or instantaneous error of the transformer.

The transformer used for these tests was of ring type, constructed to fit the standard 37,000-volt condenser type bushing having design constants

- a. Secondary turns 100
- b. Core diameter inside $4\frac{3}{8}$ in.
- c. Core diameter outside $6\frac{1}{8}$ in.
- d. Core cross sectional area 4.26 sq. in.
- e. Secondary resistance 0.1668 ohms.
- f. Saturation characteristic (referred to secondary).

Amperes	Volts
0.2	32
0.5	73
1.0	90
2.0	99
8.0	112

By short-circuit impedance test of the transformer with wound primary, it was determined that the leakage inductance of both primary and secondary is exceedingly small, (power factor 99 per cent), thus justifying the assumption made in the theory of zero leakage inductance.

To allow the use of the measuring scheme of Fig. 10, it was found necessary to use relatively low values of current. Thus, to simulate the actual transformer performance under heavy short circuits, it was necessary to wind a primary of 50 symmetrically spaced turns on the transformer, thus giving the effect of 800 amperes, (800 ampere-turns).

Numerous tests were made under various conditions of circuits and transformer.

The results of a few of the tests and their analysis

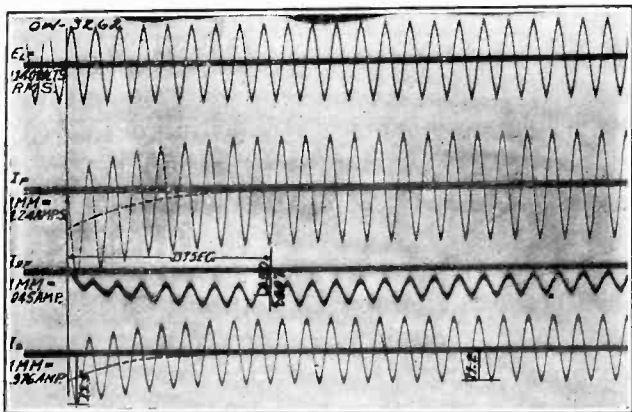

FIG. 12—OSCILLOGRAM OF OC TRANSIENT WITH OSCILLOGRAPH AND SHUNT BURDEN

are given individually in the form of oscillograms.

The oscillogram, Fig. 12, was taken with the transformer thoroughly demagnetized, and approaches closer to the theoretical curves than any of the oscillograms. The primary current is identified as I_p , the secondary by I_s , and the differential or exciting current by I_{df} . The transient portion of the magnetizing current is well above the zero line. This current gradually dies down to a steady state of very small amplitude symmetrical with respect to the zero line. This film should be compared with Figs. 1, 5, and 6 of the complete paper.

The power factor of the primary circuit is 5.77 per cent, which corresponds to a time constant (T) of 0.0447. The total secondary circuit resistance including oscillograph shunts is 0.30. Since the exciting current of the transformer is one ampere at 90 volts on the "knee" of the saturation curve, we can determine that the average value of (T_1) in Equation (18) is 0.795.

The time at which the transient portion of the magnetizing current should be a maximum is given by Equation (19). Substituting the value of T_1 calculated above, the time obtained is 0.137 seconds. This time is indicated on the film for comparison with the actual maximum as shown on the oscillograph.

The maximum exciting current is given in percentage by the Equation (21), which, calculated for the above constants, is 4.8 per cent. From measurements of the oscillogram, Fig. 12, the secondary current is 11.2 amperes and the maximum transient exciting current is 0.45 ampere, giving a per cent maximum exciting current of 4.02. These values check quite closely when the errors in measurement and oscillograph calibration are taken into account.

METHOD OF SELECTING SUITABLE TRANSFORMER

When a current transformer is to be used for short-circuit testing, before making tests, some information should be obtained regarding its adaptability for use on transients. It is a relatively simple matter to test a current transformer to determine its suitability for measuring transients. The first operation necessary is to obtain the saturation curve of the transformer by taking readings of volts and amperes into the secondary with the primary circuit open. Then the resistance of the secondary may be measured with a small testing set, to which should be added the oscillograph shunt resistance. (Designate this sum by R_2 .) Using values up to the knee of the saturation curve, divide each voltage by the corresponding current and obtain an average of these results for a value (Z_1). The factor T_1 may be calculated from the following formula:

$$T_1 = \frac{Z_1}{2 \pi f R_2}$$

Calculate the time constant (T) of the primary circuit as the ratio of inductance to resistance of the primary circuit. Knowing (T_1) and (T), the ratio of maximum transient exciting current to maximum secondary steady state current can be extrapolated from Fig. 8, or calculated from Equation (21). This ratio gives directly the percentage maximum error due to the transient in instantaneous values of secondary current.

Dividing the r. m. s. exciting current just below saturation as obtained from the saturation curve, by the above ratio, will give the r. m. s. value of steady-state secondary current which the transformer is capable of handling without excessive errors due to saturation under the given transient conditions.

If the percentage error is within the limits of accuracy desired, and if the current to be measured is not greater than the amount calculated above, the transformers should be satisfactory for use in that transient test. The authors' experience has been that the calibration and measurement of oscillograph films give results of an average accuracy of ± 5 per cent. The

transformers should be of about the same order of accuracy.

If transient tests are to be made in fairly close succession, and especially for heavy OCO transients, the transformers should be demagnetized before each test. This is easily done by arranging the current transformer circuits to allow them to be switched easily from the oscillograph elements to a source of alternating current of a value comparable to the saturation current obtained previously. This current should then be reduced smoothly to zero by the use of slide wire resistors or their equivalent. In general, if the source of power is 110 volts, two resistances will be required in series; one of the magnitude of 0 to 50 ohms and the other from 0 to 500 ohms. The first should be of sufficient capacity for saturation current, and the second should introduce enough resistance to reduce the current to a minimum value for thorough demagnetization.

At first thought, the demagnetizing operation would

seem an added burden to the complexities of oscillographic testing. If, however, a source of low-voltage alternating current is available, the arrangement of the demagnetizing circuits adds but little to the set-up, and its use becomes a small matter of extra routine on the part of the oscillograph operators.

Bibliography

1. *Short-Circuit Testing on Alabama Power Company System*, by H. J. Scholtz and C. B. Hawkins, A. I. E. E. JOURNAL, Vol. 48, April 1929, p. 264.
2. *Tests on High- and Low-Voltage Oil Circuit Breakers*, by Philip Sporn and H. P. St. Clair, A. I. E. E. TRANSACTIONS, Vol. 46, 1927, p. 289.
3. "Alternating Currents," by C. E. Magnusson, p. 144.
4. "Differential Equations," by D. A. Murray, p. 27.
5. Papers on Current Transformers—Bulletin No. 2, University of Toronto.
6. "Electric Discharge Waves and Impulses," by C. P. Steinmetz.

Transportation

ANNUAL REPORT OF COMMITTEE ON TRANSPORTATION*

To the Board of Directors:

Following established precedent, your Committee submits a brief review of the year's development in the application of electricity to transportation.

STEAM RAILROAD ELECTRIFICATION

Pennsylvania Railroad. The Pennsylvania Railroad has completed the electrification of its suburban service from Philadelphia to Wilmington, Delaware, on its main line to Washington, and to West Chester, Pa., on the Wawa Branch. The 11,000-volt, 25-cycle, single-phase system with overhead catenary used is in accordance with the original electrification work on the Pennsylvania in the vicinity of Philadelphia.

Of far greater importance, however, is the announced program and actual starting of work on the electrification of the entire road train service, freight and passenger, between New York and Wilmington, Delaware.

The project covers the passenger and freight service on 325 mi. of line and 1300 mi. of track, beginning at Hell Gate Bridge, New York, where connection is made with New England, and extending west and south to Wilmington, west from Philadelphia on the Main Line in the direction of Harrisburg as far as Atglen, and the low grade freight lines which join at Columbia,

Pennsylvania, and connect the cities of New York, Philadelphia, and Wilmington with the West.

Work is already under way on the 132,000-volt transmission line through Philadelphia for the extension to Trenton.

Great Northern Railway. The Great Northern Railway has completed and placed in service the extension of the present single-phase electrification through the new tunnel from Scenic to Berne and then east to Wenatchee. This required the abandonment of its old line from Scenic to Cascade through the snow sheds, which electrification was completed about two years ago.

All traffic is now handled between Wenatchee and Skykomish with motor-generator locomotives having d-c. traction motors, the overhead contact system supplying energy at 11,000 volts, 25 cycles, single-phase.

Boston, Revere Beach & Lynn Railroad. This narrow gage line has completed its electrification of 15 route miles, using 600-volt d-c. overhead catenary system with multiple-unit operation.

Cleveland Union Terminal Company. In connection with the building of a combined terminal station and office building in the heart of the business district of Cleveland, it is necessary to handle all trains electrically. Through passenger trains of the New York Central, C. C. C. & St. L., and N. Y. C. & St. L. will be so handled through the city. It has been decided to use 3000 volts direct current with overhead catenary system. Twenty-five 204-ton passenger locomotives, with a rating of about 3000 hp. each, have been ordered and active work on substations and distribution system

*COMMITTEE ON TRANSPORTATION:

W. M. Vanderstul, Chairman.		
R. Boeuwkes,	W. K. Howe,	W. B. Potter.
A. E. Bettis,	D. C. Jackson,	Ralph H. Rice,
J. V. B. Duer,	John Murphy,	N. W. Storer,
Horace H. Field,	W. S. Murray,	Richard H. Wheeler,
E. R. Hill,		Sidney Withington,

Presented at the Summer Convention of the A. I. E. E., Swampscott, Mass., June 24-28, 1929. Printed complete herein.

started. Power will be purchased from the local power company.

Interurban and suburban trains will also use the station over separate tracks with 600-volt d-c. overhead trolley construction.

Reading Company. The Reading Company has started construction on the Philadelphia Suburban Electrification, which, initially, will include multiple-unit service from the terminal in Philadelphia to Chestnut Hill, Lansdale on the Bethlehem Branch, Hatboro on the New Hope Branch, and Langhorne on the New York Branch. This electrification was decided on not to meet any particular operating difficulty or municipal requirements, but to furnish a better service at a lower operating cost and with a hoped for increase in traffic and revenue.

The initial installation will consist of 50 route miles and 110 track miles, and the 11,000-volt, 25-cycle, single-phase system will be used.

Delaware, Lackawanna & Western Railroad. This company is actively engaged on the design and construction work covering the electrification of its suburban service with multiple-unit car trains from its Hoboken terminal to Dover, New Jersey, via Morristown; also the Montclair Branch and the Passaic & Delaware Branch. The running tracks between West End Junction and Kingsland are included in the program, as the inspection and repair facilities are to be located at the latter point. Certain freight movements between Secaucus and Hoboken Yards will be made electrically.

Power will be supplied through five substations at 3000 volts, direct current, to the catenary system. The program calls for the electrification of 150 track mi. of main line and 25 mi. of yards and sidings.

City of Rochester. The city of Rochester has completed and put in service an electrified railroad through the city, in the bed of the old Erie Canal, the right of way being purchased from the State. A modern boulevard has been built over the tracks for a considerable distance in the heart of the city.

The line is nine miles in length with two tracks the full distance, one additional freight track for seven miles, and two other freight tracks for 1½ miles. Interchange tracks with steam railroads are provided. Frequent rapid transit cars are operated.

The overhead construction is of the catenary type using three wires with one contact wire. Inclined catenary is used on all curves except the slight ones at station approaches. Operation is at 600 volts direct current.

DIESEL-ELECTRIC LOCOMOTIVES

The development of oil-electric locomotives using prime movers of the Diesel type is continuing. A 300-hp. prime mover is most in use to date, one manufacturer having delivered 25 locomotives weighing about 60

tons each, equipped with one 300-hp. Diesel engine with generator and d-c. traction motors.

Eight locomotives with the same type of power plant, but in duplicate, (the locomotive weighing about 108 tons), are also in service. This is in addition to the New York Central combination third rail, overhead, and storage battery locomotive equipped with the same type of 300-hp. Diesel engine with generator for operation off the trolley or third rail and for charging the battery.

The New York Central has recently accepted delivery of a Diesel-electric locomotive for passenger service on its Putnam division. The engine is a four-cycle air-injection Diesel of the 12-cylinder V-type with a full-load rating of 900 b. hp. On the same division is also a freight locomotive with a six-cylinder 750-hp. solid-injection Diesel. Electrical equipment covers a main generator and an auxiliary generator direct-connected to the engine, four d-c. traction motors, control equipment air compressors, and auxiliaries.

Another manufacturer has supplied the Long Island R. R. with an articulated locomotive for switching purposes, equipped with two 330-hp. Diesel engines and electrical equipment. The complete locomotive weighs 87 tons.

The largest single-unit Diesel-electric locomotive built so far, however, is that purchased by the Canadian National Railways. It consists of two separate cabs, each cab containing a 12-cylinder Diesel engine of the solid-injection type rated at 1330 hp. at 800 rev. per min. Each unit weighs 325,000 lb., of which 240,000 lb. are on driving wheels. The present gear ratio was laid out for high-speed passenger service.

Other experimental oil-electric locomotives of varied horsepower are in process of development.

GENERAL PURPOSE LOCOMOTIVE

The Commonwealth Edison Company has ordered for trial what might be called a General Purpose Locomotive. It will weigh 85 tons with all weight on drivers and is intended primarily for switching work. It can operate directly from the overhead at 1500, 750, or lower voltage. A storage battery having a capacity of 544 ampere-hours at the six-hour rate is provided, this battery to be charged through a motor-generator set when operating under the wire, or from two 155-hp. gasoline engines driving generators. The engines can be operated with distillate fuel. The four motors are rated at 250 hp. each, at 750 volts, one-hour rating. This locomotive will be put in switching service on the Illinois Central Railroad in the near future, for trial.

RAIL CARS. DIESEL-ELECTRIC

The Canadian National Railways has in service 14 Diesel-electric rail cars, four, six, and eight cylinders each, with a rating of from 200 to 400 hp. They are continuing the use of the Diesel type of motive power rail

cars and now have on order nine cars to be equipped with six-cylinder engines, rated at 400 hp., each at 900 rev. per min.

GASOLINE-ELECTRIC

Over 120 gasoline-electric rail cars primarily for branch line service were put in service during the past year.

They vary in weight, and also in power from 200 to 800 hp. in one- two- and three-unit power plants with individual engines rated up to 400 hp. The majority have single power plants with engines of from 275 to 400 hp., the tendency in the last year being toward the larger units. One company is putting out power plants of 135 hp. each, one, two, or three being used, depending upon the weight of a car and the desired trailer load. The largest cars have two of the 400-hp. power plants and are in service on the Chicago, Rock Island, and Pacific Railway.

MARINE PROPULSION

The electric-drive airplane carriers *Saratoga* and *Lexington* broke all existing speed records for capital naval ships in their sea trials.

The use of turbine-electric drives for large ships and Diesel-electric drive for smaller ships, ferries, and tugs continues to grow.

CAR RETARDERS

Refinements have been made in the design of both electro-pneumatic and straight electric car retarders for regulating the speed of cars being operated over humps to classification tracks.

Where formerly all switches were controlled from one central point by electropneumatic or electric switch machines and where each cut of cars was accompanied by a car rider to control the speed of the cut, now a large yard may be handled from separate towers near the switches, each tower controlling a group of switches and retarders with car riders eliminated. Several such yards are in successful operation.

RADIO COMMUNICATION

Several installations of radio communication between locomotive, caboose, and station have been in successful operation. Apparatus as mentioned above is now available for radio communication between trains and between hump engines and the various control towers.

CENTRALIZED OR DISPATCHERS CONTROL

The railroads are making great strides in the movement of trains by signal indication only and have made use of the recent developments in centralized or dispatchers control for this purpose.

It is now possible and practicable to control electrically from a central point all desired switches and signals over a considerable route mileage. This arrangement facilitates meeting and passing points and thereby

decreases running times between terminals with consequent savings.

Between Stanley and Berwick, Ohio, on the New York Central Railroad, the principal switches, some 30 in number, with all signals, are controlled from one point. This covers 37 mi. of single track and three of double track.

There are over 20 installations of varying lengths in service or on order, and the use of this scheme is growing rapidly.

TRAIN CONTROL

Covering the installation of train control on some 44 Class 1 railroads, the orders of the Interstate Commerce Commission have been complied with and there are now over 15,000 track mi. and about 9000 locomotives equipped. In addition, there have been voluntary installations covering over 3000 road miles and over 750 engines.

The installations cover continuous control, intermittent control, and speed control.

While no new orders of the Interstate Commerce Commission are contemplated, yet the Division of Safety is following up the whole subject and suggesting further installations where, in their opinion, conditions warrant them.

SUPERVISORY CONTROL

The use of supervisory control in the handling of substation and switching station apparatus has continued. The last year has seen considerable development work done on the so-called synchronous selector and relay types, with initial installation of the first mentioned on the Cincinnati Street Railway System, and of the second at the Grimm Avenue Substation of the Chicago Surface Lines.

MERCURY ARC RECTIFIERS

The use of mercury arc rectifiers has continued rapidly, there now being in the United States in the vicinity of 40 installations for street railway, interurban, and steam road electrifications. These are arranged for manual, semi-automatic, and automatic control. The tendency has been to increase the capacity per bowl, there being one installation by the Commonwealth Edison Company in Chicago, having a capacity of 5000 amperes at 600 volts in one bowl. This is an automatic station for railway use.

HIGH-SPEED CIRCUIT BREAKERS

The high-speed a-c. circuit breakers of both the air and oil type as mentioned in last year's report have been completed and are now in successful operation on the Wilmington and West Chester extension of the Pennsylvania single-phase electrification. These circuit breakers interrupt short circuits in a half cycle or less and are comparable to the high-speed d-c. breakers which have been in use on steam railroad electrification for the last three years.

Abridgment of Progress in the Study of System Stability

BY I. H. SUMMERS*

Member, A. I. E. E.

and

J. B. McCLURE*

Associate, A. I. E. E.

Synopsis.—In the second part of this paper and in the appendices, attention is given to simplified methods of treating the problem of system stability. Methods which have been found useful in making many system studies are recorded. These methods have had considerable verification by tests both on a model system and on large operating systems and have been simplified to such an extent that many operating companies are now finding it to their advantage to undertake the work of making careful studies of their own systems,

just as they now make short-circuit studies which formerly were thought too difficult and too highly theoretical.

The first part of the paper gives some comments and conclusions of the authors and their colleagues as a result of many such system studies as well as studies involving more detailed methods, and also as the result of practical experience through contact with various operating companies. Some of these comments are based directly upon an example which is given in detail in Appendix I.

INTRODUCTION

THE literature on Power System Stability is growing rapidly.† It includes papers on theoretical methods of calculating stability, the observations of actual systems, and on methods of improving stability. This paper is intended to give the conclusions of the authors and their colleagues, based on many careful system studies and observations and tests on actual and model systems.

The conditions under which instability occurs may be classified as,

Case 1. Under steady-load conditions due to inadequate synchronizing power.

Case 2. Under steady-load conditions due to hunting.

Case 3. During disturbances, particularly those due to short circuits.

Case 1. Various criteria have been developed to permit the design of a system which will be stable under these conditions.^{1, 15, 21} Continuously vibrating regulators are helpful in increasing the power limit, especially when the machine synchronous reactances are a large percentage of the whole reactance. To allow for some swings and hunting, a power system must be stable under steady-load conditions for a reasonable margin above the expected load; otherwise the system will be liable to lose synchronism at any time. Therefore, no system should be considered practical unless such a margin is established at the outset. Thus, in practise, the problem reduces to the consideration of cases 2 and 3.

Case 2. This type of instability occurs principally at light loads and when the resistance of the lines involved is high. Continuously vibrating regulators are apparently helpful in eliminating danger from this cause.

Case 3. This is the type of instability which de-

mands most attention today. Faults may be conductor-to-ground, conductor-to-conductor, two-conductors-to-ground, or three-conductors, short-circuited in the order of their severity. Experience indicates that some systems are subjected largely to one-conductor-to-ground faults, while others are subjected chiefly to two-conductor-to-ground faults. The character of the fault, whether one-conductor or two-conductor-to-ground, has a decisive influence in the design of systems for stability at all times.

The effect of these faults is to throw an active and reactive load suddenly on the system and to reduce the synchronizing power between machines. As a result, the position of the rotors of the machines in the system tends to vary, the variation being in general such as to increase the angular separation between the generators and motors.

An accurate analysis involves a step-by-step calculation of the motion of each machine in the system, the principle factors involved being the line reactances, machine synchronous and transient reactances, time constants of the machine field structures, governor and regulator actions, switching times, and machine inertias. Simplified methods of analysis in certain cases are available.*

THE RELATION OF SYSTEM CONNECTIONS AND APPARATUS TO STABILITY

An endeavor has been made to investigate the effects of various bus and apparatus arrangements in a typical transmission system which is required to withstand shocks ensuing from major switching operations and fault conditions.

In Fig. 16 is shown the simplified diagram of such a typical generating station delivering power over high-voltage transmission lines to a large interconnected system which is represented as an equivalent motor. The generating station is assumed to consist entirely of waterwheel generators. The power is to be transmitted over 154-kv. lines where two circuits are considered and over 110-kv. lines where four circuits are considered. These ratios of voltages and number of circuits are chosen in order that the maximum steady-state powers

*See Bibliography I and Appendixes II and III.

*Both of the Central Station Engineering Dept., General Electric Company, Schenectady, N. Y.

†See Bibliography.

1. For references see Bibliography in complete paper.

Presented at the Pacific Coast Convention of the A. I. E. E., Santa Monica, Calif., Sept. 3-6, 1929. Complete copy upon request.

under normal conditions may be equal. The curves in Part I show the results found in this particular study.

As a result of studies such as this, and also of practical experience, a discussion of various factors has been prepared. On account of space limitations, this abridgment includes only a few of the items presented in the complete paper.

APPARATUS

(a) Generators

(III) Damper Windings. Damper windings have two effects: the first, a damping action, and thesecond, an

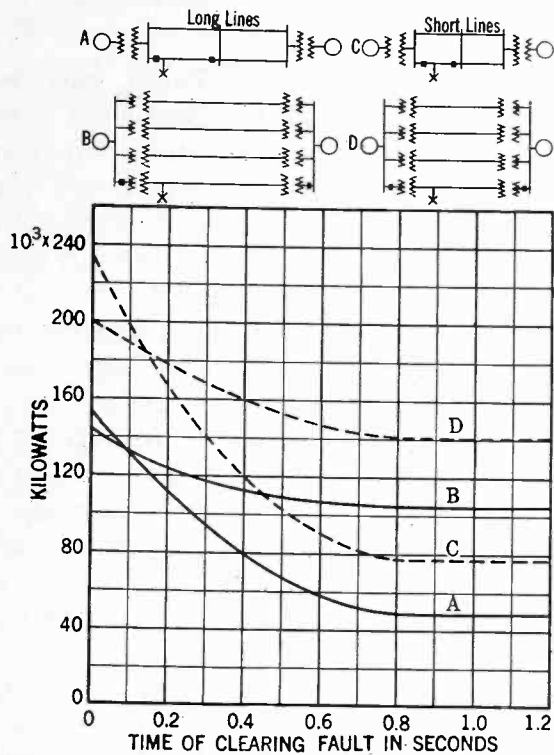

FIG. 2—POWER WHICH MAY BE CARRIED THROUGH A TWO-CONDUCTOR-TO-GROUND FAULT OUTSIDE THE GENERATOR TRANSFORMERS Versus TIME OF CLEARING THE FAULT.

— Long lines
 - - - Short lines

increase in fault current and shock to the system. The latter effect is due to the reduction in generator negative-phase sequence reactance. If the shock to the system is relatively small, a slight increase in shock, because of the reduction in reactance, will not be serious. If the shock is so severe that synchronism will be lost without damper windings, their presence cannot make matters worse. There will be a critical shock which is just great enough to cause instability when no damper winding is used. Calculations made on typical systems have indicated that with a shock of this magnitude, the beneficial effect of damping exceeds the disadvantageous effect of increased shock. Furthermore, the presence of damper windings produces a markedly beneficial effect in extinguishing arcs more quickly, due to the reduction in the recovery voltage. Therefore, the use of low-resistance damper windings on water-wheel generators would, in general, appear desirable. Such windings should be especially desirable in cases where stability is determined after several swings. Field tests are required to verify these data.

(b) Excitation Systems

It has been definitely shown that regulators which act quickly are effective in improving stability. For example, as stated in paragraph (I) of the complete paper, under *Generators*, with proper regulators both steady-state and transient power limits may be materially increased. To accomplish this result it is necessary that the excitation systems be fast enough to respond sufficiently. The practical criterion of the speed of response necessary has been investigated and a tentative figure of 200 volts per second determined.^{1, 16} Field tests should be made on an actual system to verify this decision.

The use of the appropriate type of regulator tends also to prevent hunting.

(c) Neutral Impedance

The effect of neutral reactors is to lower the shock when faults involving grounds are considered.

For conductor-to-ground faults the benefit is very great, and it is considerable for two-conductor-to-ground faults also. Quick switching tends to reduce the gain due to reactors, but even with 0.2 second switching time they still have a considerable value. The improvements which may be expected from the use of neutral reactors are shown in Figs. 6 and 7.

The amount of neutral reactance is necessarily a

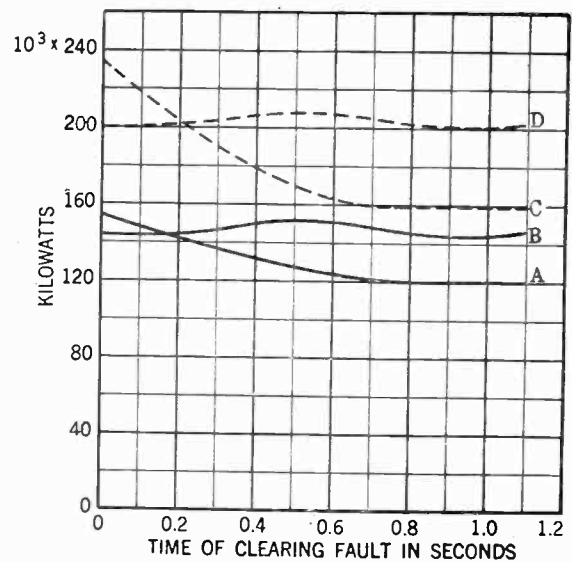

FIG. 3—POWER WHICH MAY BE CARRIED THROUGH A ONE-CONDUCTOR GROUND FAULT Versus TIME OF CLEARING THE FAULT

FOR DIAGRAMS SEE FIG. 2

— Long lines
 - - - Short lines

compromise between gain in stability, reduction in circuit-breaker duty, reduction in current available for actuating relays, reduction in telephone interference, and an increase in phase voltage to ground during disturbances.

The latter consideration becomes important in connection with lightning arresters and overvoltage relays. Studies have shown that when ground relays are used, a reactor of about two and one-half to three times the reactance of the transformer is usually correct. In cases of sufficient importance, this figure should be checked by special calculation. The neutral reactance

so far discussed does not in any way approach the dimensions of a Petersen coil, and therefore does not involve resonance phenomena. The Petersen coil is merely a reactor which permits a reactive fault current equal to the line charging current-to-ground under fault conditions, and this reduces the fault current to a low value.^{3, 4} In addition, it operates to cause the voltage across the arc to recover slowly in case the arc is extinguished. When the arc extinguishes, both the voltage across it and the dielectric strength of the arc space begins to increase. The arc will extinguish permanently if the recovery voltage across it is always less

the reactor is usually cheaper. Therefore, in general, as a current-limiting device, reactors are preferable. Whether or not a braking type of resistor is preferable to a current-limiting reactor is a question which is not yet entirely clear. However, for general applications, the reactor appears preferable since the choice of braking resistor requires very careful study in each particular case, which is not the case with reactors. Furthermore with a braking resistor there is a greater danger of telephone interference than if either a current-limiting resistor or reactor is used.

(d) Synchronous Condensers

The authors believe that the use of synchronous condensers wholly or principally as an aid to stability is not, in general, desirable except, perhaps, in a few isolated cases. This belief is based on the observation of certain synchronous condensers under transient conditions and also on calculations of the type leading to curves shown in Figs. 24 and 25 of the complete paper. These curves show how slight is the gain obtained in the case for which the calculations were made. Thus it appears that normally condensers should be purchased only on the basis of their function in supplying wattless kv-a. In other words, it is thought that in most cases the gain is not sufficient to justify them solely on the basis of their stabilizing effect. In cases where it is desired to increase any stabilizing effect they may accomplish, this may be done advantageously by pro-

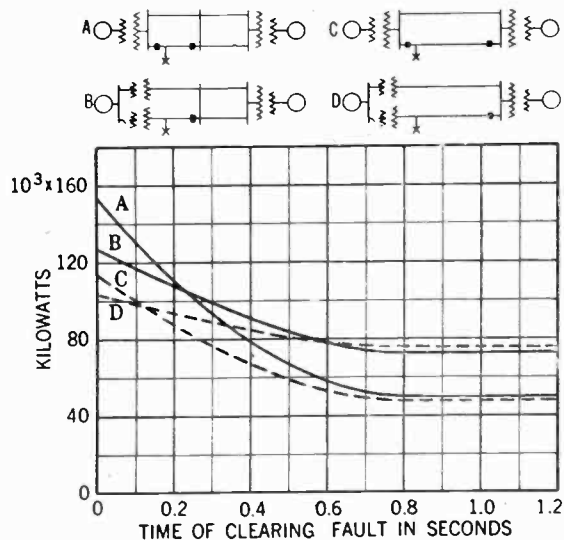

FIG. 4—POWER WHICH MAY BE CARRIED THROUGH A TWO-CONDUCTOR-TO-GROUND FAULT OUTSIDE THE GENERATOR TRANSFORMERS Versus THE TIME OF CLEARING THE FAULT
 ——— Long lines, mid-sectionalizing bus
 - - - - - Long lines, no mid-sectionalizing bus
 A and C High-voltage Busses
 B and D Low-voltage Busses

than its dielectric strength.²⁴ Thus the magnitude of recovery voltage is a measure of arc stability. The magnitude of the recovery voltage in the first quarter cycle depends on the degree of "tuning" and is proportional to the ratio of fault current with the Petersen coil to the fault current without the Petersen coil. Even with only a moderate degree of tuning, this ratio is small and experience shows that even on widely distributed systems with large charging currents, the arc is unstable and goes out. Petersen coils are much used abroad, but have so far been used little in this country. Experience abroad would indicate that their use here should be reconsidered.

Neutral resistors may be of two types; current-limiting and braking. The former is of relatively high resistance and acts primarily to reduce the shock to the generator and the system having the fault. The latter is of low resistance and is used to load the generator, thus providing a braking action. With this type of resistor the shock to the generator is reduced, while the shock to the system is increased.

It has been shown¹⁸ that the current-limiting type of resistor causes greater phase-to-ground voltages than a reactance would for the same gain in stability. Further,

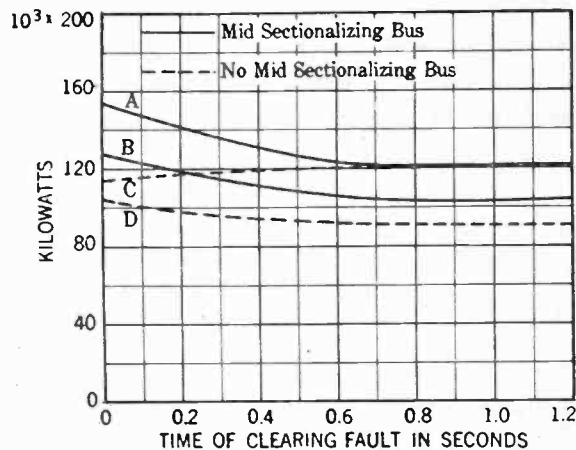

FIG. 5—POWER WHICH MAY BE CARRIED THROUGH A ONE-CONDUCTOR-TO-GROUND FAULT OUTSIDE THE GENERATOR TRANSFORMERS Versus TIME OF CLEARING FAULT (SEE FIG. 4 FOR DIAGRAM)

viding a balancing type of regulator and high ceiling excitors. When considering the use of condensers, it is important to bear in mind that they may not, and apparently usually do not, increase the transient limit as much as the steady-state limit.

(e) Governors

From a stability standpoint governors should operate quickly and should possess anti-hunting features tending to reduce swinging after disturbances. Governor operation in direct response to fault indication may prove desirable. Field tests as an aid to improvement of governor characteristics under transient conditions would be very desirable.

Automatic control of frequency is being tried on certain systems; to the extent that each system and each station holds very closely to the exact system frequency, the problem of tie-line loading should be simplified and a corresponding improvement in stability will result.

Switches and Relays

When the duration of short circuit is low, the im-

minimum reduction in synchronizing power after the faulted line has been cleared. If the shock is already small as in the case of a single-conductor-to-ground fault when neutral reactances are employed, or if the duration of the fault is short as when high-speed switches are used, this is a desirable arrangement from a stability standpoint. If these conditions do not exist, this type of arrangement may prove unsatisfactory.

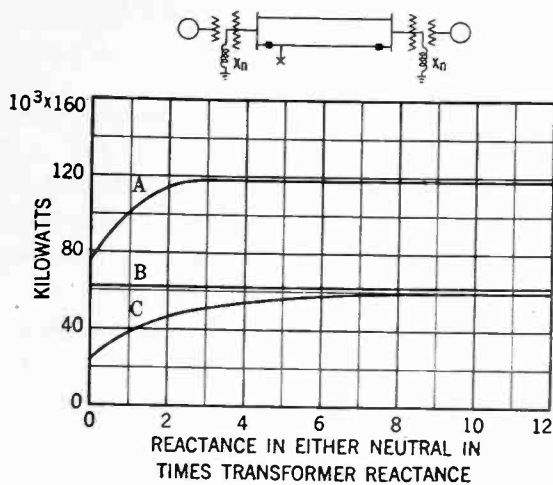

FIG. 6—POWER WHICH MAY BE CARRIED THROUGH FAULTS OUTSIDE THE GENERATOR TRANSFORMERS Versus REACTANCE IN EITHER NEUTRAL WHEN THE FAULT IS CLEARED IN 1.0 SEC. Long lines with high-voltage busses and no mid-bus
 A One conductor-to-ground fault
 B Conductor-to-conductor fault
 C Two conductor-to-ground fault

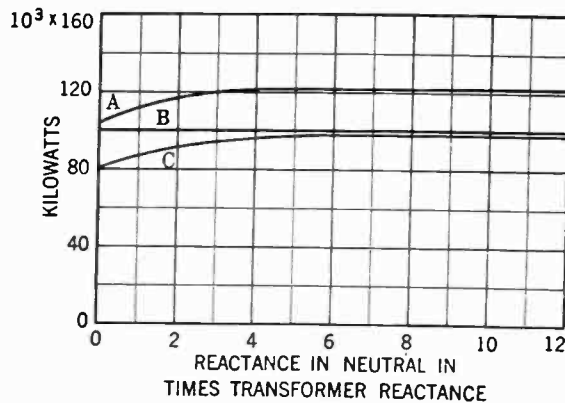

FIG. 7—POWER WHICH MAY BE CARRIED THROUGH FAULTS OUTSIDE THE GENERATOR TRANSFORMERS Versus REACTANCE IN THE NEUTRAL WHEN THE FAULT IS CLEARED IN 0.2 SEC. Long lines with a high-tension bus and no mid-bus. For diagrams see Fig. 6
 A 1 conductor to ground fault
 B Conductor to conductor fault
 C 2 conductor to ground fault

pulse given to machine rotors is small, and hence stability is improved. From this standpoint, therefore, high speed in both relays and circuit breakers is very desirable.

TABLE I

Time of clearing fault in seconds	Power which may be carried through a two-conductor-to-ground fault
0.0	100 per cent
0.1	83 per cent
0.2	68 per cent
0.3	56 per cent
0.5	42 per cent
0.75	33 per cent

Table I shows the average reduction in power limit over transmission systems involving waterwheel generating capacity due to delayed switching,* with power limit at zero switching time as reference, for two-conductor-to-ground faults.

SYSTEM CONNECTIONS

(a) High-Voltage Bus*

The use of a high-tension bus either at the generator or system end of the line or as a mid-bus results in a maximum shock during the occurrence of a fault, but a

*Figs. 4 and 5 show the comparison between high- and low-voltage busses

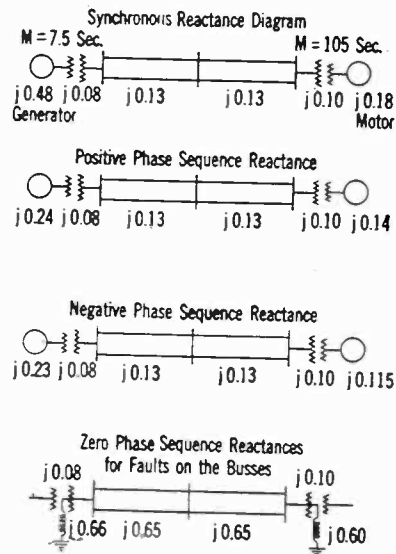

FIG. 16—DIAGRAM SHOWING DISTRIBUTION OF REACTANCES IN A SAMPLE SYSTEM WHICH HAS BEEN USED TO DEMONSTRATE THE EFFECT OF BUS ARRANGEMENTS. WHEN LOW-TENSION BUS ARRANGEMENTS ARE CONSIDERED, THE REACTANCES ARE SIMILAR

Reactance base 120,000 kv-a., 154 kv.
 Generator capacity 120,000 kv-a.

(b) Low-Voltage Bus*

A low-voltage bus has the advantage over a high-voltage bus that the reactance to the fault is increased. On the other hand, when the fault clears, the synchronizing power is less than with a high-voltage bus. If there are several lines,—say four or more,—the low-voltage bus is very advantageous. A further advantage

is that high-speed switching is not required, provided that faults do not involve more than one conductor.

For long distance transmission, this arrangement will usually be uneconomical, but for transmission over relatively short distances, it offers great promise. The curves in Fig. 2 show the indicated results with this arrangement.

(c) *Split Bus*

Another solution is to use a low-voltage bus at the system end of the line and to split the lines at the generator end, putting part of the generating capacity on each bus.^{5, 6, 7} When this is done it is usually possible for the generators on any one line to ride through the disturbance occasioned by a fault on another. However, for long distance transmission lines even with this arrangement a higher speed of switching than has heretofore been commonly available in the higher voltage switches will be required to insure stability.

It seems possible that high transformer reactance at the system end of the line may be beneficial with this arrangement since it tends to reduce the shock to the generators on the unaffected lines. This point is being investigated.

CONCLUSION

One outstanding conclusion which may be derived from the foregoing discussion is that the development of high-speed high-voltage circuit breakers and relays will mark the greatest single advance in the solution of present stability problems.

ACKNOWLEDGMENT

The authors gratefully wish to acknowledge the contributions to this article by Mr. R. H. Park. They also wish to thank Miss Edith Clarke and Messrs. E. M. Hunter and Myron Zucker for their assistance in the preparation of the paper.

Applications to Marine Work

ANNUAL REPORT OF COMMITTEE ON APPLICATIONS TO MARINE WORK*

To the Board of Directors:

The activities of the Committee on Applications to Marine Work this year were devoted chiefly to the consideration of future revisions in the Marine Standards (A. I. E. E. Standard No. 45) and in further efforts to induce the U. S. Steamboat Inspection Service to arrange for proper recognition and classification of the electrical engineer on shipboard. Owing to the few active matters for consideration by the committee, and the unusual activity in new marine construction placing a large demand upon the time of most of the committee, the meetings of the committee were curtailed.

For certain reasons not pertinent to this report, the committee's progress with the U. S. Steamboat Inspection Service has been extremely slow, even though the committee has done considerable constructive work to assist in bringing about a solution. Apparently, certain obstacles have been encountered which will have to be economically dispensed with if our efforts are to succeed; however, the committee is hopeful of a final solution which will obtain for the electrical engineer the recognition and classification which he deserves. It is recommended that the committee pursue this activity with unceasing efforts and possibly through other channels.

*COMMITTEE ON APPLICATIONS TO MARINE WORK:

W. E. Thau, Chairman,

Edgar C. Alger,	Wm. Hetherington, Jr.	Wm. H. Reed,
R. A. Beekman,	H. L. Hibbard,	Edgar P. Slack,
H. C. Coleman,	A. Kennedy, Jr.,	H. M. Southgate,
E. M. Glasgow,	J. B. Lunsford,	Oscar A. Wilde,
H. F. Harvey, Jr.,	E. B. Merriam,	J. L. Wilson,
C. J. Henschel,	I. H. Osborne,	R. L. Witham,
	G. A. Pierce,	

Presented at the Summer Convention of the A. I. E. E., Swampscott, Mass., June 24-28, 1929. Printed complete herein.

The past year has seen the following major marine activities in which electricity has contributed its full share:

1. The placing in service of five turbine electric drive U. S. coast guard cutters. These ships use the dual-drive system for the auxiliaries.
2. The placing in service of the 18,000-ship hp. twin screw turbine electric drive passenger vessel, *S. S. Virginia*, a sister ship to the *S. S. California*.
3. The construction of a third 18,000-ship hp. turbine electric drive passenger vessel, *S. S. Pennsylvania*, a sister ship to the *Virginia* and the *S. S. California*.
4. The construction of two 14,600-ship hp. twin-screw turbine electric drive vessels for the Ward Line.
5. The construction of a 12,600-ship hp. twin-screw turbine electric drive vessel for the Grace Line.
6. The placing in service of three 4000-ship hp. single-screw Diesel electric drive cargo ships: *M. S. Courageous*, *M. S. Triumph*, and *M. S. Defiance* by the U. S. Shipping Board.
7. Several smaller craft utilizing Diesel electric drive.

The results of the Jones-White Act are already being felt by the marine industry. A few large ships taking advantage of the provisions of this Act are in the course of construction and contracts for several large vessels are pending, most of which will probably employ turbine electric drive.

The use of electric auxiliary machinery is established, and in most cases the auxiliaries throughout the ship are driven electrically.

Abridgment of General Power Applications

ANNUAL REPORT OF COMMITTEE ON GENERAL POWER APPLICATIONS*

To the Board of Directors:

Your Committee on General Power Applications has attempted to keep in close touch with the development of power applications during the year through the selection by the various members of the committee of specific industries in which they were deeply interested and on which they agreed to furnish a condensed report early in 1929.

No attempt has been made to cover the entire industrial field so that there are undoubtedly many new applications which have not been brought to the attention of your committee. An effort was made, however, to cover the outstanding developments in basic industries which should be a true measure of the advance during the past year.

MARINE EQUIPMENT

During the year 1928 there were placed in commission or under construction, a total of 38 electrically-propelled vessels of various sizes and types ranging from the small river towboat to the most modern of passenger liners. The aggregate shaft horsepower of the electrical equipment in these vessels was over 132,400, of which 88 per cent was supplied by turbines and 12 per cent by Diesel engines. However, of the 38 vessels electrified, 24 were of the Diesel-electric drive.

Outstanding developments in the application of electricity to marine work during 1928 were the launching of the largest electrically-propelled passenger liner, the *Virginia*, the breaking of all existing speed records for capital naval ships by the airplane carriers, *Saratoga* and *Lexington*, and the installation on three freighters owned by the U. S. Shipping Board, of the biggest d-c. motors ever put on a ship.

ELECTRIC RAILWAYS

Although electric railways come under the jurisdiction of the Transportation Committee, there are several unusual applications of power in this field which it will be well to mention briefly.

To speed up the classification of freight and to eliminate so far as possible the hazardous occupation of car riding, several railroads have adopted electric retarders in their hump yards. The apparatus required con-

sists of a motor and brake coupled to a gear mechanism adjacent to the retarder with remote-control to enable operation from conveniently located towers in the freight yard.

The year also was marked by the number of oil electric locomotives and gas electric motor cars put in service by the railroads. Ranging in size from 60 to 150 tons, and in power from 100 to 900 hp., oil electric locomotives were successfully used by both railroads and industrial plants.

The popularity of the gas electric motor car is indicated by the total of 117 cars placed in service during the past year. These cars are rapidly replacing steam trains on the short branch line roads.

Distillate fuel has been successfully used in place of gasoline by several companies operating gas-electric trains. This fuel has also been adopted by a large city transit company for use in its gas electric busses.

In the street railway industry there has been a decided tendency toward lighter and faster motors, lighter car bodies, and improved methods of drive.

STEEL MILL INDUSTRY

The total horsepower of main-drive motors installed by steel companies during 1928 reached 212,300, with an average motor size of 1250-hp. Of this total, approximately 80 per cent are d-c. machines.

During the year there were several outstanding installations where steam engine drives were replaced by d-c. reversing motors. The largest d-c. motors in the world are now found driving the big reversing mills of the steel industry.

Strip mills are a distinctly new development and are gradually replacing the old sheet mills for doing the same work. The new continuous hot strip mill of the American Rolling Mill Company at Middletown, Ohio, is the highest powered of any strip mill yet built. The main rolls are driven by 21,800 hp. in motors; four 3000-hp., and three 2000-hp. d-c. motors on the finishing end, and 3800-hp. in induction motors on the roughing end. This mill purchases 66,000-volt power and has three 4000-kw. motor-generator sets to supply direct current for the main roll motors.

MATERIAL HANDLING

During the past year, industry as a whole was much benefited by the improvement and increase in the number of applications for handling materials electrically. In many cases the removal of the human element has resulted in astounding increases in plant efficiency, while in certain industries the development of proper equipment for handling odd shapes and sizes

*COMMITTEE ON GENERAL POWER APPLICATIONS:

J. F. Gaskill, Chairman.

D. H. Braymer,

O. W. Drake,

Harry L. Grant,

Clyde D. Gray,

C. Francis Harding,

E. W. Henderson,

George H. Jones,

P. O. Jones,

A. C. Lanier,

A. M. Lloyd,

A. M. MacCutcheon,

W. S. Maddocks,

N. L. Mortensen,

E. B. Newill,

K. A. Pauly,

D. M. Petty,

W. W. Price,

H. I. Smith,

A. H. Stebbins,

E. C. Stone,

W. H. Tumble,

F. M. Weller,

M. R. Woodward,

W. C. Yates

Presented at the Summer Convention of the A. I. E. E., Swampscott, Mass., June 24-28, 1929. Complete copy upon request.

generally conceded forever assigned to unskilled labor has effected considerable saving.

In general the year was characterized by the application of mechanical handling to a wider variety of uses.

Equipment for handling freight cars was further developed during the year. One of the newest type car dumpers, capable of dumping a car a minute, is being constructed for the New York Central Railroad at Toledo, Ohio. The total electrical equipment aggregates 3000 hp. and consists of both a-c. and d-c. motors with special control by means of variable voltage.

Two other installations now under construction for loading ships, one at New Orleans and the other at Havana, Cuba, are of an unusual type. This equipment will load refrigerating cars on a ship specially designed with tracks to handle about 95 cars. These cranes will lift 165 tons at the rate of 50 ft. per minute and use two 250-hp. totally enclosed mill type d-c. motors for drive. These cranes are the first ever designed for loading and unloading ships with standard freight cars.

Prior to 1928 the largest electrical shovel was the 8-cu. yd. or 300-ton shovel. A number of 12-cu. yd. capacity shovels was placed in service during the past year. Due to the extreme fluctuation of current demand, it was necessary to design special equipment for the drive and control of these shovels. Three motor-generator sets, with the generators all differentially wound, are capable of generating 750 kw. The four motors for the various drives aggregate 650 hp. One of these shovels recently established a new world's record for material handled when it moved 15,497 cu. yd. of overburden in 24 hr.

Numerous other improvements in material handling have been made during the year, especially in regard to the method of connecting the drive to the conveyor, as well as the use of anti-friction bearings, gear replacement of pulleys, and other similar refinements.

PAPER INDUSTRY

The paper industry was long since converted to motor drive of the main rolls, but this year has seen the principle pushed still further. Cylinder machines have a larger number of small rolls, baby presses, and cylinder molds, which heretofore have been driven by the felt carrying the paper pulp. The long, broad belt of high grade felt is decidedly expensive, and the practise of using it as a drive necessitated frequent replacements. A new mill at Port Townsend, Washington, eliminated this illogical expense; small motors, held in extraordinarily exact speed agreement, drive each element.

Carbon pile regulators, which have been successful in the control of single-motor paper mills elsewhere, have been further developed to aid in the exact speed regulation of the Port Townsend machines.

A variable-speed turbine with reduction gear was an important development in isolated power plant equipment for paper mills. The low-speed end of the gear is connected through sheave pulleys to the paper mill

and exhaust steam from the turbine is used in the can dryers. Speed can be held within very narrow limits between 65 rev. per min. and 390 rev. per min. on the driven shaft. This unit is rated at 475 hp. at 4200 rev. per min. and operates at 110 lb. gage steam pressure with back pressures varying from 20 to 40 lb. gage.

CEMENT INDUSTRY

Productive capacity far in excess of normal consumption has caused the cement industry to turn to electricity for economical operation. New plants are universally electrically driven while mechanical drives are rapidly being replaced in the older mills.

Isolated generating plants utilizing the heat from cement kiln gases are still popular although during the year several contracts were signed with public utilities calling for an interchange of power. While this exchange provides an outlet for the excess power of these plants, it also places a premium that formerly did not exist on economies in power generation and mill operation.

Notable developments have been several specialized types of synchronous motors designed to provide the high torques necessary for heavy crushing and grinding machinery.

Another application of the synchronous motor is on hammer mills. A novel feature of this installation is the overload relay. When the overload is great enough to pull the motor out of step, the relay operates, cutting off the material being fed to the hammer while permitting the motor to regain speed, running as a straight induction motor.

Push-button control has become almost universal, even for motors of the smaller sizes. One large mill, completed this year, points with pride to the elimination of starting equipment other than push-button controlled, full automatic circuit breakers of high interrupting capacity. Low starting kv-a. of the motors has made such installations possible; in some cases, the motor starts directly across the line.

An important application of specialized control is the automatic blending of dry cement materials as developed in connection with the Fuller-Kinyon System. The Fuller-Kinyon pumps handle the pulverized rock mixture like water, and a very ingenious control system for the pumps and valves has been designed. Electrical interlocks and time clock regulation permit almost unlimited combinations for blending the contents of bins or silos to produce a constant quality feed for the kilns.

MINING

The coal mining industry endeavored during the past year to solve many of its troubles by the wider application of electricity and the adaptation of more adequate and more efficient machinery.

An outstanding feature of the year was the new mine locomotive built for the Pemberton Coal and Coke Company, Bluefield, W. Va. This locomotive, although weighing only 30 tons, develops 532 hp. and will haul a

full load of 168 tons up a 1.5 per cent grade at 10½ mi. an hour. Electropneumatic control and air-brakes are features which are most unusual on this type of locomotive.

Ore Reduction. The first commercial size plant in this country to utilize the Tainton process, *i. e.*, strong acid and high current density for the electrolytic reduction of zinc, was installed by the Sullivan Mining Company at Kellogg, Idaho. Current is supplied by two three-unit 4000-kw. motor-generator sets.

The Anaconda Copper Mining Company during 1928 put in operation the largest motor-generator sets ever used in an electrolytic zinc plant. There are four three-unit sets, each rated at 5500 kw.

OIL INDUSTRY

As the oil industry passes the stage of adventuring with its picturesque engine and rig, and becomes more and more a leading industry with an economic problem of conservation, it is marked by the application of electricity to give the best results at the lowest cost. Well-drilling has become an affair requiring large capital, as several wells have already cost over a quarter of a million dollars and have reached depths of over 8000 ft. One well in West Texas has been drilled 8255 ft. or 1.56 mi. deep and is the deepest hole ever dug by man. Two 25/65-hp. oil well motors, driving a cable tool rig, supply the power for the drilling which is still continuing.

Until very recently it was thought impossible to apply centrifugal pumps to oil pipe lines. A development of suitable high-speed centrifugal pumps which would not emulsify the oil enabled the economic use of electrical drive. A new pipe line, 400 mi. long, went into service during the past year, using this equipment. Forty-four 400-hp. squirrel-cage, 1800-rev. per min. motors drive the pumps in the 13 stations along its length.

ELECTRIC WELDING

Only a few of the more important developments in electric welding can be mentioned in this short résumé. One of the most important advances has been the increased size of the electrode used, which, in general, reduces the time for welding in about the inverse proportion to the size of the electrode.

Another development of considerable importance is the introduction of the new atomic hydrogen method of electric welding, which makes possible the welding of thin metals and alloys that could not be welded before because of the oxidation of the materials by the heat of the arc. This new method introduces hydrogen gas into the arc flame, the gas being broken down into atomic hydrogen by the heat of the arc. This atomic hydrogen effectively prevents oxidation of the materials so that a satisfactory joint can be obtained. This enables countless small objects, which otherwise would require more expensive methods of union, to be welded.

The importance of electric welding in the industrial

field can be emphasized by the faith of the Ford organization in this type of welding. It is stated that the Ford Company has recently expended over \$100,000,000 for equipment and methods to produce their new model "A" car, which depend primarily on electric welding. Here electric welding is reduced to an almost automatic process requiring very little personal supervision.

A new process was developed for producing electrically-welded railroad ties from scrap rails, which is done entirely automatically and produces a very satisfactory tie at a low cost from scrap material.

INDUSTRIAL HEATING

During 1928 the use of electricity for industrial heating has increased rapidly due to the development work of the manufacturers and the recognition of the central stations to the desirability and importance of the load.

Electric Stereotyping. The first electric stereotype pot was built and installed in 1925, but it has been during the past year that most of the large installations were made. More than 100 are now in operation, varying in size from 40 kw. for small pots to 360 kw. for large 9-ton pots. The pots make use of an immersion element placed in the lead with automatic temperature control. The total load in many metropolitan plants runs from 800 to 1500 kw., connected load, for this service. Indications point to the complete electrification of stereotype pots in the next few years.

Silk Moistening. An important application has occurred in the full-fashioned hosiery manufacturing field for the moistening of silk before passing through the needles of the knitting machine. Units consisting of an insulated box, containing water with felts for the silk to pass through and having electric heating units of 173 watts each, are placed so that from 3 to 7 threads are moistened on the way to the needles.

The water is kept at about 160 deg. fahr. and the evaporation of water moistens the felt so that the silk picks up enough moisture to eliminate back winding.

Loads of 990 kw., connected in one plant, have been noted, and in the Philadelphia district, approximately 2000 kw. is in use in this class of business.

Electric Brazing Furnaces. The application of electric furnaces to copper brazing steel parts together has made possible the assembly in one operation of complicated structures from simple parts by a strong alloy weld. This is accomplished by placing copper wire or chips next to joints to be brazed, and then heating the assembly in a furnace containing a hydrogen atmosphere to a temperature above the melting point of copper.

In the process of brazing, the hydrogen performs the function of a flux as well as excluding air from the heating chamber.

Both intermittent and continuous types of furnaces are in use for this work and have extensive application in the assembly of refrigerator evaporation shells.

The use of protective gases in other type electric

furnaces is recognized as metallurgically beneficial in the heat treatment of various steels and in cases where bright annealing is essential.

High-Frequency Furnaces. Recently the application of the high-frequency induction type furnace to melting and heat treating steel has been given greater consideration. Furnaces are in use for making cast steel in ingot form for production work and for heat treating high-speed steel in liquid baths.

Gray Iron Melting. The application of the indirect arc type electric furnace to the production of synthetic cast iron is a comparatively recent development. Gray iron borings from the manufacturer's machine shop, which have a very small market value, are utilized in the production of iron of good physical properties, and the over-all melting cost per ton is less than that for cupola operation. This has opened a new field for development in the iron industry.

CONTROL

During 1928 improvements in design and applications of control have been in keeping with the general trend of the past several years. Although a great many individual instances could be cited, a few general examples will be sufficient to indicate the general trend of the various types of control equipment.

Most of the motor control is now of the definite time accelerating type. A time—current control has developed for d-c. equipment which provides maximum time saving in motor acceleration within predetermined current limits under conditions of light or normal loads and forced acceleration at a predetermined rate where the load is too heavy for the motor to start with the normal accelerating current setting.

The conventional form of master switches, using segments and fingers, has been replaced in the last few years by the cam-operated switches. The past year produced further development of the cam operation, special attention being paid to simplicity of design. An outstanding example of this is a small, compact device which was designed to fulfill three purposes,—controller, disconnect switch, and overload relay. A complete line of master switches was also produced which required only a few different fundamental cams to obtain a great variety of combination of contact sequence. Still another indication of the trend towards simplified design is in the compact limit switch developed for use on motor-driven valve equipment. By means of intermittent gears it is possible to get an adjustment of from 1 to 1365 turns on the valve stem.

Push-button control incorporating simplicity and sturdiness of design without sacrificing dependability of service is rapidly replacing the cumbersome and complicated control systems of a few years back.

MISCELLANEOUS APPLICATIONS

Rubber Industry. The large expansion of this industry in the past few years has caused engineers to devote their attention to new plants and extensions

to present mills rather than the development of new applications. The slow-speed synchronous motor has been the predominant type in new installations. Full-voltage starting, together with dynamic braking, has been almost universally adopted. All new installations have the thermal, and particularly the thermostatic, type of overload protection.

Power Applications in Telephone Industry. Power applications in the telephone industry are naturally limited. The drives that are used generally make only small power demands and are commonly rather special in their nature. Special motors are required for television and sound pictures, with very ingenious speed regulation; but they are of too narrow scope for discussion in this report. The development of large capacity filters to eliminate noise-producing ripples in the generating current has permitted the application of standard generators for telephone battery charging.

Small Motors. Improvement in design of small motors was apparent during the year. Single-phase motors received a great deal of attention, and the improvements made will be of considerable advantage to various industries.

Single-phase repulsion induction motors, ranging in size from $\frac{3}{4}$ to 2 hp. at 1800 rev. per min., were produced with a high-starting torque and constant speed. Better magnetic utilization of the steel was accomplished in these motors by using square stator punchings with graded slots.

Single-phase condenser motors having practically the same efficiency as a two-phase motor and operating at or near 100 per cent power factor were designed. The motor develops even more torque than the two-phase motor, whereas the current required is considerably less.

Recent tests in the textile industry have indicated the desirability of applying the a-c., brush-shifting, shunt-characteristic polyphase motor for obtaining variable speed in the spinning of cotton as well as worsted yarns.

Electric Elevators. The development of high-speed, full, and semi-automatic elevators was furthered during the year. Deficiencies affecting the riding qualities of elevators in the automatic control of the rates of acceleration and retardation were removed by the application of a small auxiliary d-c. machine to act upon the generator field of the motor-generator set of the generator-voltage type of elevator drive. By this means, the acceleration and retardation are caused to begin at very moderate rates, increase to higher rates and again diminish as the speed change nears completion.

An automatic leveling system was developed, embodying a radical departure from previous practise. This system utilizes radio-frequency devices wherein, the position of the car with respect to the floor controls the leveling speed of the elevator accordingly. The particular advantage of this control is the elimination of all mechanical engagement with its noise and ultimate

deterioration, a minimum clearance of $\frac{3}{8}$ in. existing between the parts on the car and the corresponding part in the hatchway.

Printing. The main advance during the past year in the printing industry has been the increase in the speed of the presses. Where a few years ago, 24,000 to 25,000 papers an hour were considered good production,

presses today operate at the rate of 60,000 to 75,000 papers an hour. This has meant the application of higher speed motors in some cases, while in others, it was simply a matter of increasing the gear ratio. The horsepower of the motors has increased in proportion, while new improved and simplified methods of control have accompanied the change.

Spray and Fog Tests on 220-Kv. Insulators

BY R. J. C. WOOD¹

Associate, A. I. E. E.

Synopsis.—To determine insulation for an outdoor 220-kv. station on the coast subject to ocean spray, an insulator test rack was installed at Redondo, California.

Ten types of insulator, including widely different designs, were tested continuously for two years and a half at 150 kv. to ground. Comparative results were obtained by adding or subtracting units in suspension strings until an equality against arc-over was approximated. Ninety arc-overs occurred.

The surface leakage resistance was found to be a fair index of the resistance to arc-over under salt spray conditions. The shape of the insulator made no difference as long as the total surface resistance of the string remained the same.

The surface resistance is that calculated upon the assumption of a uniform conducting coating upon all the exposed surface of the insulator and is the line integral of distance divided by circumference along the shortest surface path from cap to pin.

Accidental differences of conditions are such that one insulator string would not consistently arc-over in preference to another unless its surface resistance were less than 80 per cent of the other.

Suspension strings having a total surface resistance of 11.0, using inch units, were found satisfactory for a steady 150 kv. to ground under the conditions at Redondo.

A spray method of cleaning insulators while energized was devised.

INTRODUCTION

IN the latter part of 1926 it was seen that it would soon become necessary to decide upon the kind of insulation to be used in the Southern California Edison Company's 220-kv. outdoor station that was to be built

coast, the location being chosen as one of the most subject to ocean spray and fog upon the system, and where considerable insulator trouble on both 66-kv. and 16-kv. lines had been experienced.

CLIMATIC CONDITIONS

The storm winds are westerly and drive the spray from the ocean surf directly into the test rack, the accumulation of salt upon the insulators having been

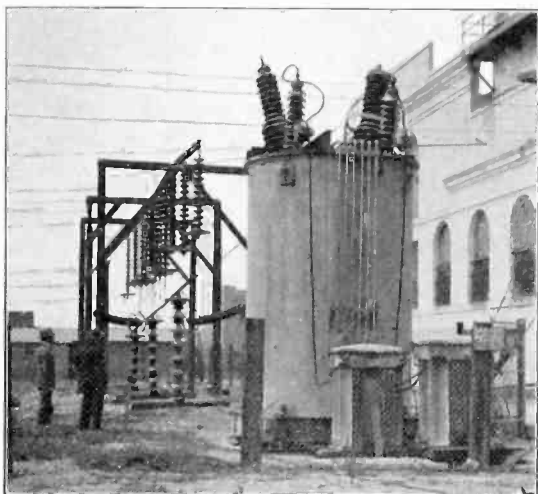

FIG. 1—TEST RACK, ENERGIZING TRANSFORMER, AND TWO SMALL TRANSFORMERS USED AS REACTORS. LOOKING NORTH

at Long Beach, on the coast south of Los Angeles.

A test rack was therefore set up at Redondo on the

1. Research Engineer, Southern California Edison Co., Los Angeles, Calif.

Presented at the Pacific Coast Convention of the A. I. E. E., Santa Monica, Calif., Sept. 3-6, 1929. Printed complete herein.

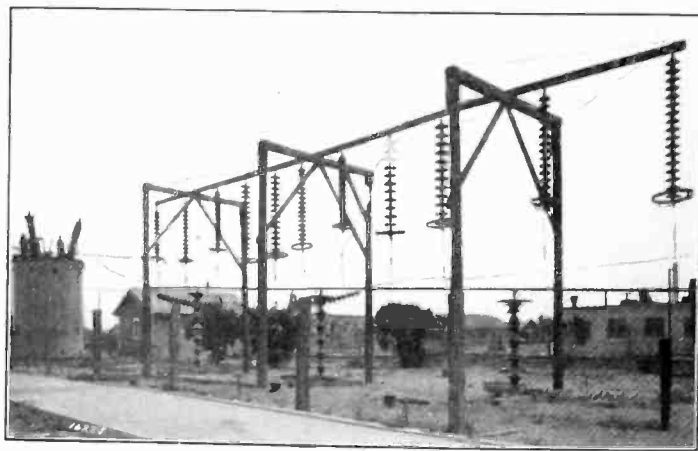

FIG. 2—TEST RACK. LOOKING SOUTHWEST

such at times that during the heat of the day small crystals of salt have been observed scattered all over the surface of the porcelain. At night the deposition of moisture upon the insulators is frequently sufficient so that they drip and the sandy soil underneath is all pock marked

from the dropping water. In addition to the salt deposit there is a certain amount of dust and sufficient soot to blacken any rag used for cleaning.

The time of year during which arc-overs are most prevalent is from March or April until the first rains of the season, which may come in September or October.

DESCRIPTION OF APPARATUS

The rack illustrated in Figs. 1, and 2, was situated

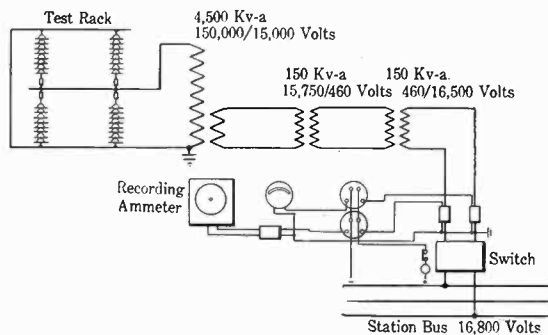

FIG. 3—DIAGRAM OF CONNECTIONS BETWEEN STATION BUS AND TEST RACK

about 500 ft. from the ocean front. The pipe bus was energized to 150 kv. to ground.

Electrical connections were as in Fig. 3, the two 150-kv-a. banks of transformers in series with the 4500-kv-a. transformer being used as reactors to limit the short-circuit current to 10 amperes over an insulator and 100 amperes on the station bus.

To indicate which of the insulator strings had arced-over, a one-ampere enclosed fuse was connected between each insulator string and the bus. These fuses were further protected against weather and corona by short lengths of one-inch pipe and may be seen in Figs. 1 and 2.

The types of insulator tested are shown in Fig. 4; some of their physical constants in Table I. The quantity called "Surface Resistance" is not any measured resistance, but is the calculated surface leakage resistance from cap to pin of a single insulator unit, assuming the exposed porcelain surface to be uniformly coated with a conducting layer. Should the conducting layer have a resistance of one megohm per

square inch, then the figures of Table I give the surface resistance from cap to pin in megohms.

The rack was kept energized both day and night whenever possible; an arc-over would cause the relays to open the main 16-kv. switch; the operator would at once close the switch again; if upon the third trial the arc-over still persisted the switch would be left open until the next day. Arc-overs practically always occurred during the night when fog or dew was heaviest.

PROGRAM OF TESTS

During the period from January 1, 1927, to June 1, 1928, a number of rather long suspension strings was

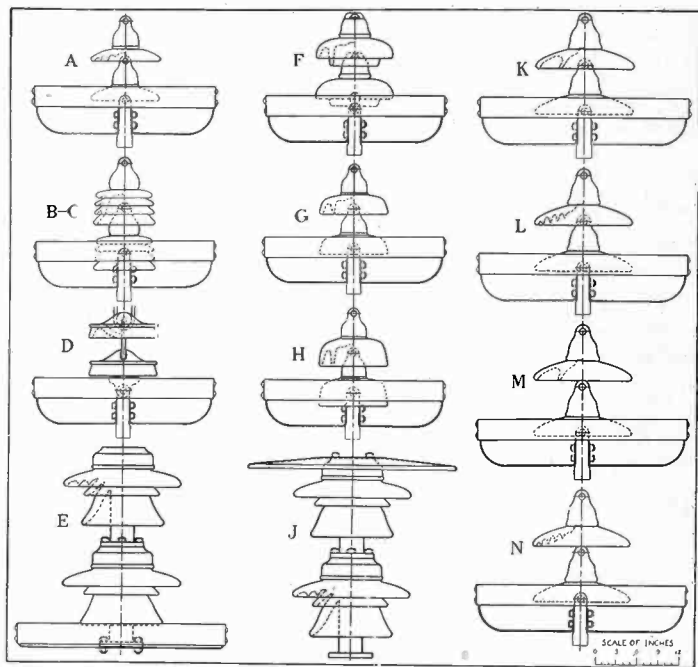

FIG. 4—TYPES OF INSULATOR UNDER TEST

under test, no changes being made except to disconnect two short strings of 13 Type A and 13 Type D which arced-over.

The strings under test during this period are detailed in Table II. They were all washed by hand on February 9, 1927. 6-E and 6-J were washed immediately after each arc-over, and 5-J was washed frequently as described later.

TABLE I
PHYSICAL CONSTANTS OF INSULATORS: INCH UNITS

Type	Diameter	Leakage distance	Surface resistance	Resistance per inch leakage	Axial length per unit	Resistance per axial inch
A	10	10.75	0.651	0.0605	5.75	0.1132
B	9	20.0	1.062	0.0531	6.5	0.1634
C	9	18.25	0.955	0.0523	6.5	0.1468
D	10	11.0	5.37	...
E	17	33.0	1.163	0.0352	14.5	0.0802
F	11	16.5	0.811	0.0492	5.75	0.1411
G	10	13.12	0.715	0.0545	5.75	0.1244
H	10	15.5	0.837	0.0540	5.75	0.1455
J	17	33.0	1.163	0.0352	14.5	0.0802
K	14	16.5	0.848	0.0514	6.6	0.1285
L	14	19.0	0.908	0.0478	6.6	0.1375
M	14	16.5	0.848	0.0514	8.0	0.1060
N	14	19.0	0.908	0.0478	8.0	0.1135

Note: Resistance is not easily calculated for Type D. From test results it seems to have approximately the same resistance as Type A.

Beginning June 1, 1928, the program was changed. Strings 8-E, 7-E, 6-E, were removed (the number and letter designating the number of units of a certain type).

The other types in service had the effective number of units in a string reduced by short-circuiting any required

TABLE II
INSULATOR STRINGS UNDER TEST 1-1-27 TO 6-1-28

Number in string	Type and position	Leakage distance	Surface resistance	Period under test
13	A suspension	140	8.47	1-1-27 to 3-12-27
17	A "	183	11.06	1-1-27 to 6-1-28
15	AA dead end	161	9.77	1-14-27 to 6-1-28
*				
15	AA " "	161	9.77	1-14-27 to 6-1-28
12	B suspension	240	12.75	1-1-27 to 6-1-28
13	D "	143		9-23-27 to 2-1-28
6	E "	231	6.98	1-1-27 to 6-1-28
7	E "	231	8.14	" " "
8	E "	264	9.30	" " "
5	J post	165	5.81	" " "
6	J "	198	6.98	" " "
7	J "	231	8.14	" " "
15	K suspension	248	12.72	" " "
12L + 3	K "	278	13.43	2-10-27 " "
12	M "	198	10.17	1-1-27 " "
12	N "	228	10.89	2-10-27 " "

number of units, at the upper end of the string, with wire.

The general practise was then followed of adding a unit, by moving the short-circuiting wire, on any one string after it had arced-over on two separate days. This wire device enabled units to be added or subtracted without handling the units and changing their surface condition.

It was expected in this way to arrive gradually at an equality in the different strings.

Types H and G were not put on test until October 15, 1928; Types C and F were added January 10, 1929.

In order to get comparative results, types C, F, G, H, N, M, were all washed by hand on January 15, 1929, so as to have them in the same condition as the recently added types. None of the other suspension strings had been washed, except by natural rains, since February 9, 1927, and they were now left in that state but reduced in number of units per string and the process of building up to an equality started in again.

On June 15, 1929 the program was again changed and all types, except the posts J, had units added until there was one more unit in each string than the maximum number that had arced-over at any time.

ARC-OVERS

The first period of the test showed that neither the five- nor six-unit post, type J, would be satisfactory without periodic cleaning; it was found feasible, however, to spray the five-unit post with water, while energized, without danger of its arcing-over, provided the spraying were done frequently. Cleaning once a week apparently kept this post in good condition. The special spray nozzle used washed practically the entire porcelain surface.

13-A, 13-D proved inadequate, each arcing over twice.

There were six arc-overs on 6-E in suspension and three on 6-J as a post, in each case the insulator being hand washed immediately after arcing-over. This difference in behavior between post and suspension may have been due to the slight difference in the shielding, or to the cap in one case and the pin of the insulator in the other being at bus potential or, what seems most probable, that at the greater elevation above ground of the suspension string there was a greater wind velocity and more spray and dirt were deposited upon the porcelain; heat radiation would also be greater in the more exposed position and deposition of dew greater,—all of which would render the suspension string more liable to arc-over than the post. The post 5-J arced-over four times but not after regular washings were inaugurated. No relative values for the remaining suspension strings

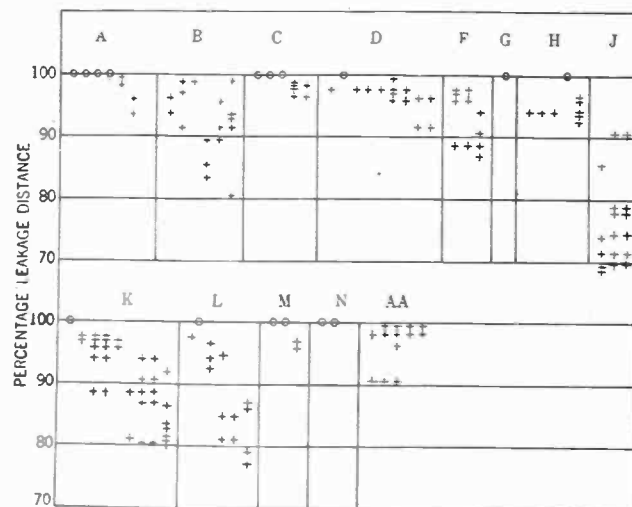

FIG. 5—COMPARISON OF TYPES UPON A LEAKAGE DISTANCE BASIS

The insulator string having the shortest leakage distance is not always the one to arc-over. Each cross shows the percentage leakage length of a string that was shorter than the one arcing-over. A circle shows the shortest arcing-over.

were obtained as none arced-over. Altogether there were 17 arc-overs in this period.

From June 1, 1928 to September 30, 1928 there were 30 arc-overs. The first rain of the season occurred October 11, 1928, and no further arc-overs took place until March 4, 1929. From March 4, 1929 to July 19, 1929 there were 43 arc-overs, giving a total of 73 arc-overs from which to analyze the relative performance of the different types of insulator.

ANALYSIS OF ARC-OVERS

In Fig. 5 each flashover has been plotted with a view to seeing whether the leakage distance might not be the controlling factor in arc-over; if so, the string arcing over should have the least leakage distance of all under test. When this was the case it was plotted as a circle at 100 per cent. When, however, there were one or more strings having lower leakage distances than the one arcing-over, then they were plotted as crosses showing their leakage distances as a per cent of that of the string that arced. Thus in Fig. 5 any type which has many

low-percentage plots is apparently not so good as one in which the plots are of a higher percentage, remembering that the comparison is not unit per unit, but is based upon strings of equal leakage distance.

It is seen at once that this basis of comparison is not entirely satisfactory. Due to the unavoidable variations

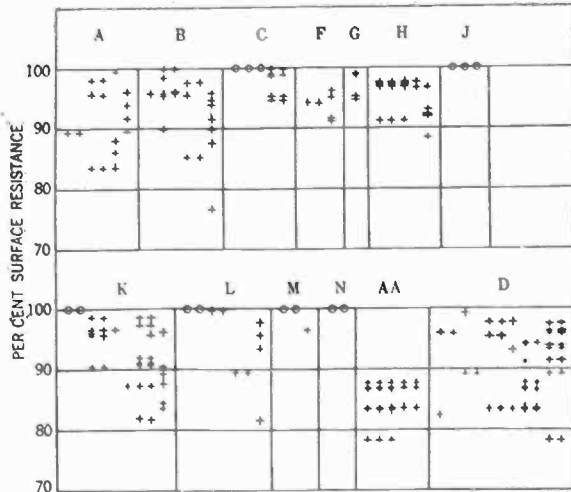

FIG. 6—COMPARISON OF TYPES UPON A SURFACE RESISTANCE BASIS

Each cross shows the percentage resistance of a string that was less than that of the one arcing-over. A circle shows the lowest resistance arcing-over

in amount of deposit, dew, wind, no two strings of insulators subjected to field conditions would ever behave exactly in accordance with any of their physical dimensions, except by accident. It would, however, be expected that they would average in some relation to

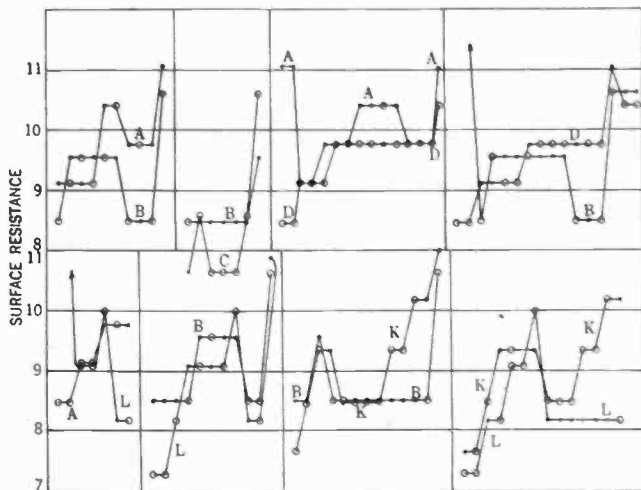

FIG. 7—COMPARISON OF TYPES BY PAIRS UPON A SURFACE RESISTANCE BASIS

The string arcing-over is marked with a circle vertically over or under the one not arcing. Insulators not washed since Feb. 9, '27

some measuring stick, each exhibiting departures on either side of a mean. When these departures from the mean were the same for each, then they would be considered as equal, according to the particular basis of measurement chosen. Extending this argument to a number of different types of insulator, a true basis of

comparison will have been found if in such a plot as Fig. 5 all the types exhibit equal divergencies. It is seen at once that Fig. 5 fails chiefly with respect to Type J, which by reason of its position should show up better than all others. Fig. 5 shows it as the worst. The intercomparison of the other types is fair in view of the fact that C, F, G, H, N, M, were all washed January 15, 1929, and would be expected to show up better than the others last washed February 9, 1927. It will be found significant that the ratio of surface resistance to inch of leakage distance does not vary over a wide range until Type J is considered.

In Fig. 6 a plot similar to that of Fig. 5 is shown, the total surface resistance of the string, instead of the leakage distance, being made the basis of comparison. Type D is given an arbitrary resistance per unit equal to that of Type A for reasons referred to later. This plot exhibits a much greater uniformity than Fig. 5.

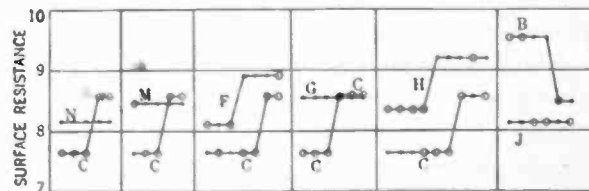

FIG. 8—COMPARISON OF TYPES BY PAIRS UPON A SURFACE RESISTANCE BASIS. INSULATORS NOT WASHED SINCE JAN. 15, '29

Types A, B, K, L, AA, D are practically identical as to the range covered and are all types not washed since February 9, 1927. Types C, F, G, H, also have about the same range; M and N are restricted in range but the number of observations is small for each. The same qualification applies to type J; however, J is now in its proper place, not having arced-over unless it had the lowest resistance, which is as it should be considering its preferred position near the ground.

As a further test of the supposition that the surface resistance is a comparative measure of the resistance to arc-over, a direct comparison between types, taken in pairs, covering the whole period January 1, 1927 to July 19, 1929 is given in Figs. 7 and 8.

Comparing for instance Types A and B, each arc-over that has occurred upon either one of these is plotted, showing in the same vertical line the surface resistance of the two strings, the one that arced-over marked with a circle, and the one that did not, with a dot. Drawn lines connect points of the same type and do not represent any relation between coordinates. Type D has arbitrarily been assigned such a resistance per unit as would make it best fit the comparisons A-D and D-B, A and B being radically different designs. This arbitrary resistance of D turns out to be the same per unit as the calculated value for A.

If there were none of the accidental variations previously referred to and the surface resistance were an exact measure of the arc-over resistance, then the circle points would always be on the lower line. This is not the

case, considering those pairs of points where the higher resistance string has arced-over. The amount of the discrepancies is shown in Table III.

TABLE III
PERCENTAGE DISCREPANCIES OF FIGS. 7 AND 8

Pair of types considered	Average difference in surface resistances as per cent of the greater	Period of test
A-B	5.38	1- 1-27 to 7-19-29
B-C	7.07	" " "
A-D	6.15	" " "
D-B	2.76	" " "
A-L	4.17	" " "
B-L	4.40	" " "
B-K	8.60	" " "
K-L	8.22	" " "
B-J	0.00	" " "
N-C	3.72	1-15-27 to 7-19-29
M-C	1.28	" " "
F-C	5.80	" " "
G-C	0.12	" " "
H-C	8.23	" " "

It will be noted that the discrepancies are not large after all, considering the nature of the original data, and it is certainly impossible to assign to any one type rather than another any materially greater liability to arc-over when equal surface resistances of each are taken and exposed to the same conditions.

It therefore appears that the surface leakage resistance is a close measure of the ability of these types of insulators to stand up under such conditions as are found at Redondo and that there is no particular virtue in one shape over another, except in so far as it may afford more surface resistance and enable a fewer number of units to provide the total required.

There is a limit to the reduction in number of units

TABLE IV
LIMITS REACHED IN ARC-OVER, LEAKAGE, AND RESISTANCE

Type	Max. number arced-over	Min. number not arced	Leakage arced-over	Distance not arced	Surface arced-over	Resistance not arced
A	16	17	172	193	10 41	11 06
B	10	11	200	220	10 62	11 69
C	9	10	164	183	8 59	9 55
D	16	17	176	187	10 41	11 06
E	7	8	231	264	8 14	9 30
F	11	12	182	198	8 92	9 73
G	12	13	158	171	8 58	9 30
H	11	12	171	188	9 21	10 04
J	7		231		8 14	
K	12	13	198	215	10 17	11 01
L	11	12	209	228	9 99	10 89
M	10	12	165	198	8 48	10 17
N	9	11	171	209	8 17	9 99

Note: Resistance per unit of "D" assumed equal to that of "A".

per string imposed by ordinary dry and wet arc-over requirements and the danger of puncture when too few thicknesses of porcelain are used between line and ground. It would seem conservative to satisfy the ordinary line conditions as to number of units and then choose the type and perhaps greater number of units which will furnish the necessary surface resistance to

suit the locality at the minimum of cost for both insulators and supporting structures.

The final results of the elimination contest are shown in Table IV.

It is seen that strings having a surface resistance of from 9.99 to 10.62 have arced over, these strings having gone through the whole period of the test from 1-1-27 to 7-19-29 without being artificially washed, but that the strings washed 1-15-29 had in competition with them arced-over resistances of from 8.17 to 9.21, showing to some extent quantitatively how the washing done by natural rains compares with careful artificial cleaning. It further seems that a string with surface resistance of 11.0 will satisfactorily insulate against a steady 150 kv. to ground for three years under climatic conditions similar to those encountered at Redondo.

Acknowledgments are due practically all the insulator manufacturers for their ready response with samples of "fog type" insulators without which it would have been impossible to arrive at such definite results.

CONCLUSIONS

1. Insulators may be compared, as to their ability to withstand arc-over under spray and fog conditions, by their surface leakage resistance, calculated as the line integral of length divided by circumference along the shortest surface path from cap to pin.
2. There is no virtue in any particular shape except as it provides surface leakage resistance.
3. One insulator string will not consistently arc-over in preference to another unless its surface leakage resistance is less than 80 per cent of that of the other.
4. A surface leakage resistance of 11.0, in inch units, per string, appears sufficient for a steady voltage of 150 kv. to ground with conditions as at Redondo, Calif. On a line, allowance may have to be made for surges.
5. It has been found practical to clean some insulators, while energized, with a water spray and thus use a smaller number of units than would otherwise be safe.

An investigation of concentric and parallel duplex types of trailing cables made by the Bureau of Mines engineers leaves no doubt as to the greater relative safety of the parallel duplex cable for use on bureau-approved equipment, and it is hoped that after a careful study of the matter presented as a result of these investigations, the industry will arrive at the same conclusions and take steps to use the safest type of cable.

Field inspections showed that from the standpoint of reeling there is some preference for concentric cable. However, at mines where reeling difficulties have been overcome it was shown that if proper spooling devices are used practically no trouble is experienced in reeling parallel duplex rubber-sheather cable.

Applications to Mining Work

ANNUAL REPORT OF COMMITTEE ON APPLICATIONS TO MINING WORK*

To the Board of Directors:

In the past many criticisms have been made against the mining industry as being backward in modern developments. Certainly such criticisms are no longer justified to the same extent as a decade or two ago.

During the past year there have been many developments of electrical apparatus for mining work and the operators have not disregarded the applications offered. In fact, the operators have sought relief in every possible way to reduce operating costs. Over development during the war has not been absorbed by increased consumption of coal. This is largely due to rapid improvement in efficiency in large electric power plants, electrical interconnection, and in improved railroad performance.

Metal mines have been similarly affected from overdevelopment and lack of increased demands.

It is generally predicted that both coal and metal mining are entering a new era of development. Further mechanization is considered as a solution to the problem of cost reduction. Mechanization implies further electrical application to all types of mining equipment.

A few years ago there was considerable discussion on superpower systems. Without a great deal of publicity these superpower systems have developed until now practically every industrial and mining field is served from high-voltage interconnected lines receiving energy from large efficient power plants. Thus it is logical that the major part of the further electrification and mechanization of mines will be served from the electric utilities.

Hoists. Due to high cost of equipping shaft mines with electric hoists the change over from steam to electric is slow. One such change over a medium capacity mine is worthy of note, not for its size but for the rapid cycle. A 750-kw. synchronous motor-generator set supplies an 850-hp., 116-rev. per min. motor through Ward Leonard control.¹

The hoist operates in balance and is designed for 230 trips per hour from a depth of 282 ft., with a maximum rope speed of 3300 ft. per min. The cycle allows for 5 sec. acceleration, 1.65 sec. full-speed running, 5 sec. retardation, and 4 sec. caging. Actual per-

formance of 258 trips per hour has been attained by reducing the caging or stop period to two sections.

The motor-generator set is remote-controlled from the operator's platform. No auxiliary hoist motor is provided. The hoist is controlled through master controller and time limit relays for both acceleration and retardation.

In the mountain mines, a-c. motors have been applied for control and regenerative braking to control heavy descending loads previously handled by large drums and mechanical brakes. The power saving is appreciable and safety of control is valuable.

Fans. Synchronous motor drives for fans have been applied in sizes up to 500 hp.² Increased efficiency and improved power factor are accomplished.

Continued applications of automatic starters for fan motors have proved desirable to reduce to a minimum the delay in the restarting of fans after power interruption.

Motor-Generator Sets. Automatic substations for motor-generator sets have increased in number both to save in labor of attendance and to provide better service for supply of direct current to remote load centers.

Automatic power-factor control on synchronous motors has been accomplished on several sets.

Cleaning Plants. With the mechanical loading of coal being accomplished and with more discriminating buyers of coal, the industry has turned to mechanical cleaning. Several large bituminous coal cleaning plants were completed during the year.³ Thus, the soft coal industry is approaching the practise of the anthracite breakers. These wet washing plants use around 150 motors of various sizes, aggregating some 1200 hp. connected load. Texropes or V-shaped multiple belts, permit of standard motors in most applications to secure proper speed reduction in short space. Three such plants on one public utility service add a very desirable day load.

Shovels. In metal mining the 3-, 4-, and 5-yd. electric shovels using shunt motors and Ward Leonard control continue to be installed to effect economies.

Additional 15-yard stripping shovels, weighing 1550 tons, and carrying motor-generator sets with 1500-hp. synchronous motors continue to be installed.⁴

Improved rubber covering for trailing cables has made these safer and more dependable. They usually carry 4000 volts, three-phase with a fourth wire for ground. Occasionally when blasting, these cables are damaged. Field vulcanizing has been perfected so that the outer covering is repaired so well that it will stand up through

2. Installed at Chicago, Wilmington, and Franklin New Orient mine, West Frankfort, Ill.

*COMMITTEE ON APPLICATIONS TO MINING WORK:

Carl Lee, Chairman.

A. R. Anderson,
F. N. Bosson,
Graham Bright,
M. M. Fowler,
E. J. Gealy,
L. C. Isley,

G. M. Kennedy,
R. L. Kingsland,
A. B. Kiser,
W. H. Lesser,
John A. Malady,
C. H. Matthews,

F. C. Nicholson,
W. F. Schwedes,
F. L. Stone,
E. B. Wagner,
J. F. Wiggert,
C. D. Woodward.

1. Equipment furnished by General Electric Co. and installed at Peabody Coal Co., Mine 53, Springfield, Ill.

Presented at the Summer Convention of the A. I. E. E., Swampscott, Mass., June 24-28, 1929. Printed complete herein.

water and oil the same as the original cable, thus saving a great deal on replacement costs.

Slushers. Metal mines have almost completely adopted motor-driven underground slusher machines to replace air-driven machines.

Locomotives. One manufacturer has developed roller-bearing application to motor support on axles to maintain the gears in exactly correct mesh.⁵ Experience in the field has not yet proved whether this will be acceptable practise.

Heavy service due either to large locomotives or very frequent travel of locomotives has led a number of mines to go to 6/0 trolley wire instead of 4/0.

Mining Machines. The manufacturers of mining machines have brought out improved track-mounted cutters (Fig. 1). These can be built to cut at any height in the coal seam that is required. These machines consist essentially of a heavy frame mounted on trucks containing traction motor and a swinging section pivoted at the

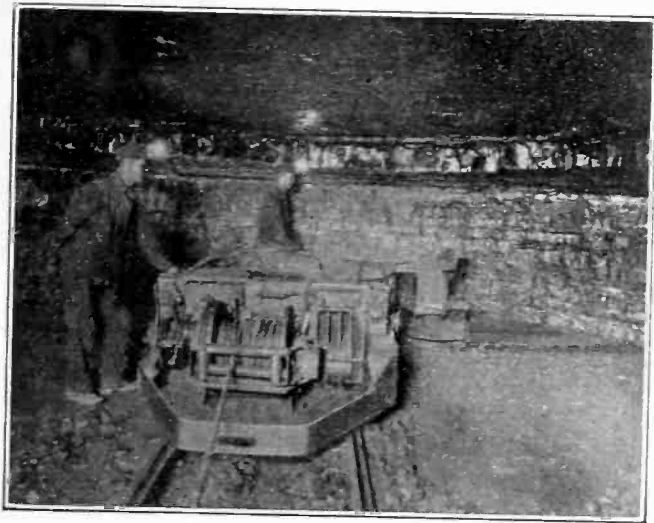

FIG. 1—TRACK-MOUNTED BOTTOM CUTTER

front end of frame. This section carries the motor gearing, raising, lowering, and tilting mechanism, and the cutter bar and chain proper. The advantage of this type cutting machine over the breast machine and short-wall machine is that no unloading or loading of cutting machine proper is required. This feature eliminates most of the manual labor, and through higher power and saving of time enables the operator to practically double his productivity. One make of machine is equipped with a drill so that the same crew can drill for the blasting.⁶

In cutters for coal seams less than 30 in. high, it is difficult to place all controls convenient to the operator. One manufacturer has partially overcome this by applying contactor control to the machine. This control is of the "permissible" type construction, having

3. Pittsburgh Coal Co., Pittsburgh, Pa.
4. The United Electric Coal Co. at DuQuoin, Ill.
5. Jeffrey Manufacturing Co.
6. Sullivan Machinery Co.

been worked out to meet the tests of the Bureau of Mines.⁵

A recently developed machine is the hitch cutter.⁷ This is a very special type drill to cut hitches in sides of rooms of coal mines to enable timbering to be carried to the face without interfering with cutting and loading machines. This should materially reduce accidents at the coal face.

Loading Machines. One type of loading machine usually called pit-car loader has been extensively in-

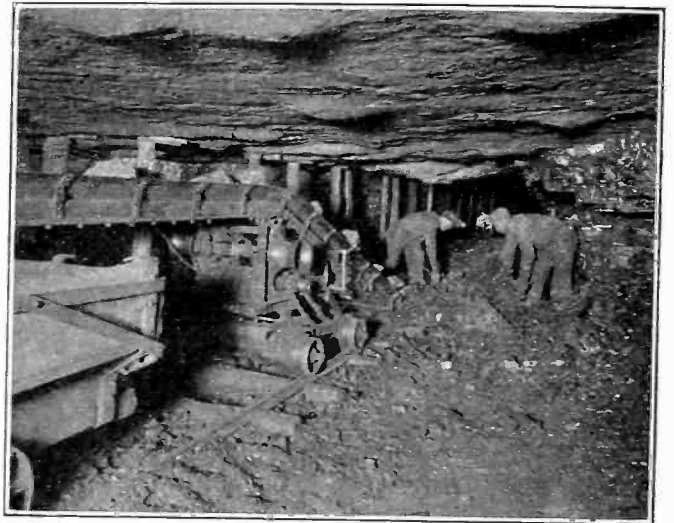

FIG. 2—PIT-CAR LOADER

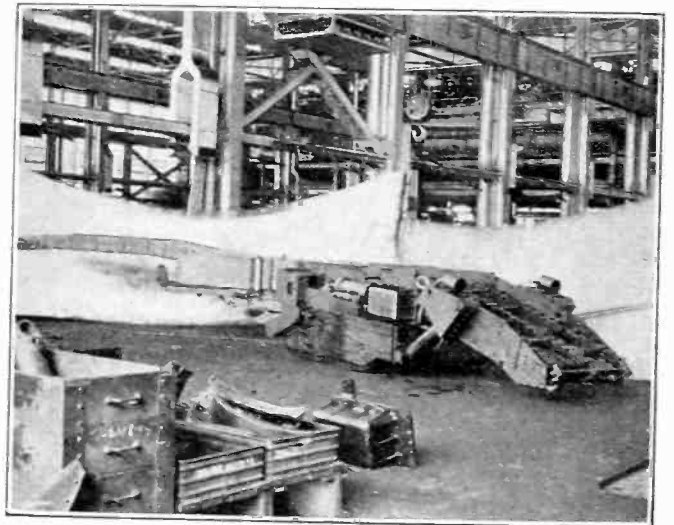

FIG. 3—TANK TREAD LOADER

stalled (Fig. 2). Approximately 2000 have been placed in service. They consist of short-drag type conveyer driven by $\frac{1}{2}$ - to $7\frac{1}{2}$ -hp. motor. In this machine coal is shoveled onto the loader which discharges into mine car.

Full mechanical loaders of several types have been improved and are coming into more general use (Fig. 3). These vary in design, using from one to eleven motors,

7. Goodman Manufacturing Co.

having from 15 to over 100 connected horsepower. Reports indicate that approximately 3 per cent. of the soft coal mined in 1927 was loaded mechanically and most recent reports indicate over 22 per cent of coal mined in Illinois was loaded by mechanical and pit-car loaders.

Blasting. Continued experiments in smokeless shooting of coal have been made.⁸ In this a gas is compressed to high pressure in the cartridge, then fired by means of fuse in heavy detonation or heating element. This fuse requires about 100 amperes at 180 volts to set off heating element.

Telephones. One company installed a complete system, using lead-covered pair in conduit laid in the floor of the mine.⁹ In rapid hoisting, the caging is limited to 1½ or 2 sec. This does not permit the check puller to safely detach the identification checks. Several mines overcame this by installing loud speaking telephones between top and bottom.¹⁰ The bottom man pulls the check and telephones the weighman giving him the number of the check.

8. Cardox.

9. Youngstown Sheet and Tube Co., Dehue, W. Va

10. Peabody Coal Co., Mine No. 8, Tovey, Ill.

Switch Throw. An electrically-operated switch throw has been successfully applied to mine switches.¹¹ This eliminates the danger of having these thrown by hand. Also signal lights are worked in conjunction with the throw.

Welding. Electric arc welding is becoming more common for repair work. It is almost universally used for welding rail bonds. This year has brought a new use in the welding of a very hard special metal to the tips of mining machine bits, to produce ten times the wear.¹²

Safety Work. The Bureau of Mines continues to test all types of equipment to be used in gaseous mines. They have now placed their stamp of approval on 30 types of motors.

The approved cap lamp with greatly increased illumination is being rapidly adopted.¹³ Over 30,000 of this type have been placed in use. A new cap lamp with lead battery and dry electrolyte has been developed.¹⁴ This should reduce accidental burns from electrolyte.

11. Mines Equipment Co., St. Louis, Mo.

12. "Blackor."

13. Edison Models E & F.

14. Concordia.

Audio-Frequency Transformers

Voltage-Ratio Characteristics Determined by the Low-Voltage Cathode Ray Oscillograph

BY PAUL KLEV, Jr.¹

and

D. W. SHIRLEY, Jr.¹

Synopsis.—The usual method of determining the voltage ratio of audio-frequency transformers employs a three-element vacuum tube in the circuit. Due to the fact that the results are a combination of both transformer and vacuum tube characteristics this method is not entirely satisfactory. This paper describes a new method, using a low-voltage cathode ray oscillograph, by means of which the voltage ratio of a transformer is determined independent of any other apparatus. This newly developed method is accurate and simple in operation, and gives the actual characteristics of the transformer

for all frequencies and d-c. components. The ratios of several makes of transformers were determined over a frequency range of 20 to 10,000 cycles and at different degrees of magnetic saturation. The results indicate that the ratios are very good between frequencies of 40 and 3000 cycles. Saturation within the usual operating limits was found to have little effect. The method developed was found to be exceptionally good, as the results are accurate and are readily reproduced. However, precautions must be taken to eliminate stray fields which may influence the tube unless properly shielded.

INTRODUCTION

IN the last few years, the radio industry has experienced an exceptional growth. Accompanying this growth is the desire on the part of the public for better reproduction of voice and music; and closely connected with this is the amplification of audio frequencies. This in turn calls for audio-frequency transformers which have good characteristics; that is, good voltage ratios over a wide range of frequencies. This

being the case, it is important to be able to determine the characteristics of audio-frequency transformers independent of the apparatus which would influence the results. This paper describes a method by means of which the voltage ratio of transformers may be determined entirely independent of all other equipment.

METHOD OF OBTAINING DATA

Under actual operating conditions, an audio-frequency amplifying transformer has impressed on the primary a direct current with a superimposed alternating current of audible frequency. The d-c. component of this pulsating current largely determines the point on the saturation curve at which the transformer

1. Students in Electrical Engineering at Oregon State College.

This paper received the A. I. E. E. National Prize for Branch Paper (year 1928).

Presented before the Portland Sections of The A. I. E. E. and The N. E. L. A., May 25, 1928.

operates, and therefore may influence the voltage ratio at various frequencies. Before attempting to determine the voltage ratios, the magnetization curves of the transformers were obtained so that values of direct current within the working range could be used.

The magnetization curves were determined with a circuit arrangement as shown in Fig. 1. The data were

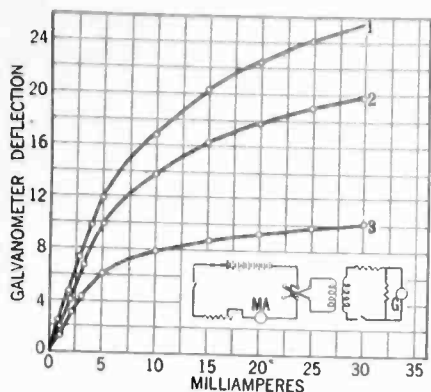

FIG. 1—SATURATION CURVES FOR TRANSFORMERS TESTED

- Curve 1.....Transformer A
- Curve 2.....Transformer B
- Curve 3.....Transformer C

obtained by adjusting the direct current in the primary to certain values and then reversing the switch shown. The resulting galvanometer deflections, also shown plotted in Fig. 1, indicate the degree of saturation of the core. The curves in Fig. 1 should not be regarded as indicating the relative degree of saturation since different galvanometer shunts were used; also, the number of secondary turns and other transformer constants

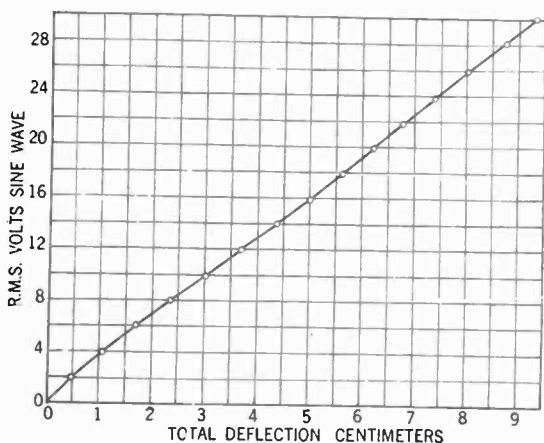

FIG. 2—CALIBRATION CURVE FOR WESTERN ELECTRIC TYPE 324-A LOW-VOLTAGE CATHODE RAY OSCILLOGRAPH

Anode voltage 312. using deflector plates PY

were not the same for each. This figure does show, however, the shape of the magnetization curves and thus indicates the range of d-c. values which may be used in the primary.

A Western Electric 324-A low-voltage cathode ray oscillograph tube was used for measuring the primary and secondary voltages. Since this low-voltage oscillograph is comparatively new, a brief explanation of its

construction and operation will be given. The general arrangement of parts is shown in Fig. 7.

A stream of electrons is projected from the heated filament on to the fluorescent screen where it produces a bright spot. This electron stream may be deflected by subjecting it to an electric or magnetic field, and the position of the spot at any time is an indication of the strength and direction of the field at that instant. If properly connected, these deflecting fields will vary with the current or voltage under observation and thus electrical phenomena are made visible on the screen.

Due to the fact that the moving element consists of a stream of electrons, the cathode ray tube is practically free from inertia or resonance effects. This feature makes the frequency limits at least as high as the upper radio frequencies, which are far beyond the highest frequencies used in these tests. Another feature which makes this tube very desirable is its accuracy. This may be shown by the calibration curve, Fig. 2. As can be seen, the maximum deviation of any point from the experimentally determined calibration curve is about one-half of one per cent.

Due to the action of the earth's magnetic field and

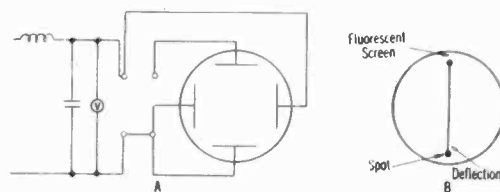

FIG. 3—CIRCUIT USED FOR CALIBRATION OF THE CATHODE RAY OSCILLOGRAPH

other stray fields, and partly because of the lack of mechanical alinement of the tube parts, the fluorescent spot may fall several centimeters from the center of the screen. It is necessary to bring the spot to the center, and here this was accomplished by means of a large electromagnet mounted upon a movable platform. The spot may be brought to the center of the tube with a small magnet nearer the tube; however, less distortion results if a strong magnet is used some distance away. By moving the position and regulating the value of current in the electromagnet, the spot was brought to the center of the tube and at the same time the value of current supplied was noted. This current value was held constant for all tests.

Due to the fact that the deflector plates are not the same distance from the screen and that they are not a given distance apart, it is necessary that the tube be calibrated for quantitative results. The circuit used for calibrating the tube is shown in Fig. 3A. A known sine wave alternating voltage was applied to the deflector plates used and the length of the deflection, which is a straight line, Fig. 3B, on the fluorescent screen was measured. Various values of voltage were impressed and the corresponding deflection observed. The calibration curve, Fig. 2, was then drawn by plotting

effective (r. m. s.) volts as ordinates and total deflection in centimeters as abscissas.

Every precaution was taken to eliminate errors in obtaining data for the calibration curve of the cathode ray tube. The current supplied to the electromagnet, used to compensate for the earth's field, was held constant during the entire test. Also, the effects of stray fields were eliminated; first, by using closely

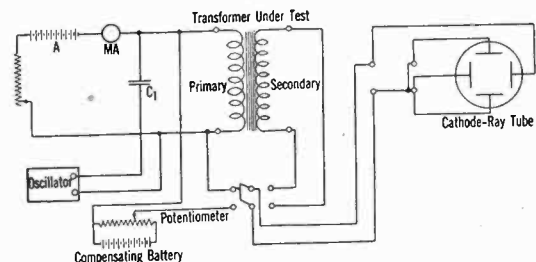

FIG. 4—CIRCUIT USED FOR DETERMINING AUDIO-FREQUENCY TRANSFORMER RATIOS USING THE LOW-VOLTAGE CATHODE RAY OSCILLOGRAPH

twisted parallel conductors for all current-carrying circuits; and second, by shielding the tube from electrostatic fields. The calibration varies with the anode voltage and thus this voltage was held constant for all tests. For calibrating, the wave form of the applied voltage should be a sine wave, and to obtain this as nearly as possible, the harmonics were practically eliminated with a filter as shown in Fig. 3. An oscillogram of the voltage was made and showed the wave to be a sine wave with practically no harmonics, less than two per cent deviation, and a crest factor of practically 1.414. The calibrating voltage was obtained from a three-phase 220/127-volt alternator. All instruments used in making current and voltage measurements were carefully calibrated against accurate standards.

The connections used for measuring the transformer ratios is shown in Fig. 4. As indicated in the diagram, a battery "A" was connected through a resistance and a milliammeter to the primary of the transformer. This battery supplied the component of direct current which is present in the primary of all audio-frequency transformers. The variable-frequency voltage was obtained from a Western Electric 8-A oscillator which had a frequency range from 100 to 50,000 cycles and a good wave shape. The voltages at frequencies below 100 cycles were taken from an alternator driven at different speeds so as to generate the frequency desired. The voltage wave of the alternator was practically a sine wave. A condenser, C 1 Fig. 4, was connected in series with the oscillator to prevent the direct current from entering the oscillator circuit. To facilitate making measurements, a double-pole double-throw switch was connected to the primary and secondary of the transformer and to the oscillograph, as shown in Fig. 4.

The voltage drop due to the d-c. component in the primary of the transformer caused the electron stream to be thrown entirely off the fluorescent screen, and consequently, some means had to be devised to compensate

for this deflection. A method was finally adopted which used a compensating potentiometer, as shown in Fig. 4. This potentiometer voltage was connected to oppose the constant component of the pulsating voltage that would otherwise be applied to the cathode ray tube. By properly adjusting this compensating potentiometer, the spot was brought to the center of the screen. As a test to determine whether the constant component was balanced, the deflector plates were short-circuited. If the spot remained stationary when this was done, no constant voltage was impressed on the oscillograph. The position of the compensating potentiometer and the battery in the circuit has no effect on the oscillograph, but merely acts as an additional load on the oscillator.

As previously explained, the oscillograph is very sensitive to stray fields, and in view of this fact, all current-carrying leads were twisted. The leads from the switch or transformer to the oscillograph should be as short as possible and not twisted. The reason for this is that at high frequencies, the charging current due to the capacitance of long twisted wires acts as a load on the transformer when measuring the secondary voltage. It was found that if long twisted leads were used, the voltage ratios were lower for frequencies above 2000 cycles.

Several types of transformers were received and three transformers which were considered to be representative were chosen for the tests. The ratio of transformer A was 3 to 1; the core is of silicon steel and is extra large, the entire transformer weighing very nearly five pounds. Transformer B has a ratio of 2.7 to 1 and weighs about one and three-quarters pounds. Transformer C has a ratio of 5 to 1, and weighs approximately two pounds.

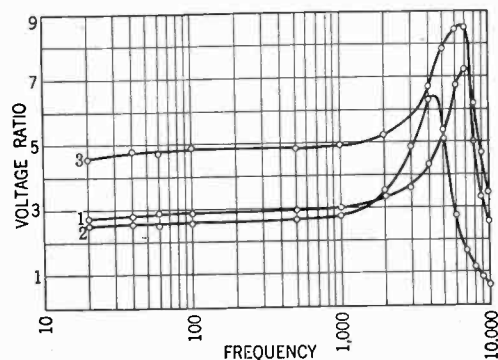

FIG. 5—VOLTAGE RATIO OF TRANSFORMERS TESTED, PRIMARY CURRENT THREE MILLIAMPERES

- Curve 1..... Transformer A
- Curve 2..... Transformer B
- Curve 3..... Transformer C

All of these transformers are standard makes and are used extensively in radio work. Other information regarding their construction was not available at the time these tests were made.

From a study of the magnetization curves, (Fig. 1) and a general knowledge of the primary currents usually found in radio receivers, it was decided to use currents of one, three, and five milliamperes for the transformer tests.

In making all measurements, the value of current in the electromagnet producing the compensating field was adjusted to the predetermined value and held constant. The direct current in the primary was then adjusted to the desired value. As previously mentioned, the d-c. component of voltage in the primary must be balanced so that the reading could be made in the

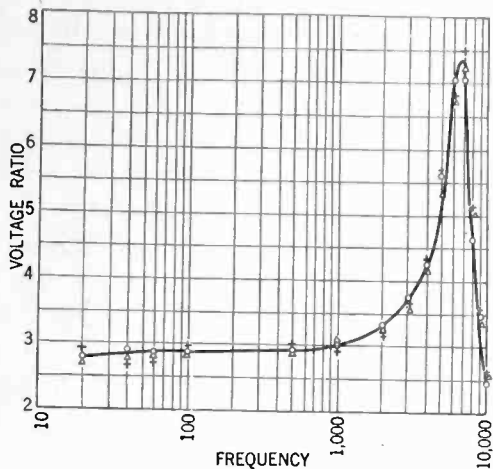

FIG. 6—VOLTAGE RATIO OF TRANSFORMER A USING VARIOUS VALUES OF PRIMARY CURRENT

- Primary current—1 milliampere
- △ Primary current—3 milliamperes
- + Primary current—5 milliamperes

center of the oscillograph screen. This was accomplished by adjusting the potentiometer across the compensating battery until the spot remained stationary when the deflector plates were short-circuited. A voltage of the proper frequency was then applied to the primary of the transformer and its magnitude adjusted to give a reading of primary and secondary voltage on the working range of the fluorescent screen.

In measuring the length of the deflections, a piece of thin paper was placed over the fluorescent screen and the maximum deflections of the visible spot were marked for both primary and secondary readings. To be sure the readings were accurate, each reading was checked. In a similar manner, other readings were made using different frequencies and various degrees of core saturation for each transformer tested.

DISCUSSION OF RESULTS

The curves, Fig. 5, show the voltage ratios of transformers A, B, and C with a primary current of three milliamperes. These curves show that in all cases the transformer ratios are very good at frequencies between 40 and 3000 cycles. The curves also show that "peaks" occur within a range of frequencies from 4000 to 7000 cycles. Although each transformer had a different ratio, transformer C (curve 3) seems to have the best characteristics as the per cent increase in ratio at 3000 cycles is less than for either of the other two. However, transformer A (curve 1) is practically as good as transformer C in this respect.

The curves in Fig. 6 were made for transformer A to show the effects of saturation. Due to the fact that the

curves would fall so close together, only one curve has been drawn, and points have been shown only for the other two curves. The curves seem to indicate that the degree of saturation has little effect on the transformer ratio. However, the fact that these curves were taken at degrees of saturation below the knee of the magnetization curve must be considered, and these results hold for such values only.

Again referring to Figs. 5 and 6, the curves indicate that in all cases the points are uniform and closely follow the curve. This indicates not only that the measurements were accurately made, but also that this method is satisfactory.

CONCLUSIONS

The major conclusions to be drawn from this study are as follows:

1. The method here outlined for determining

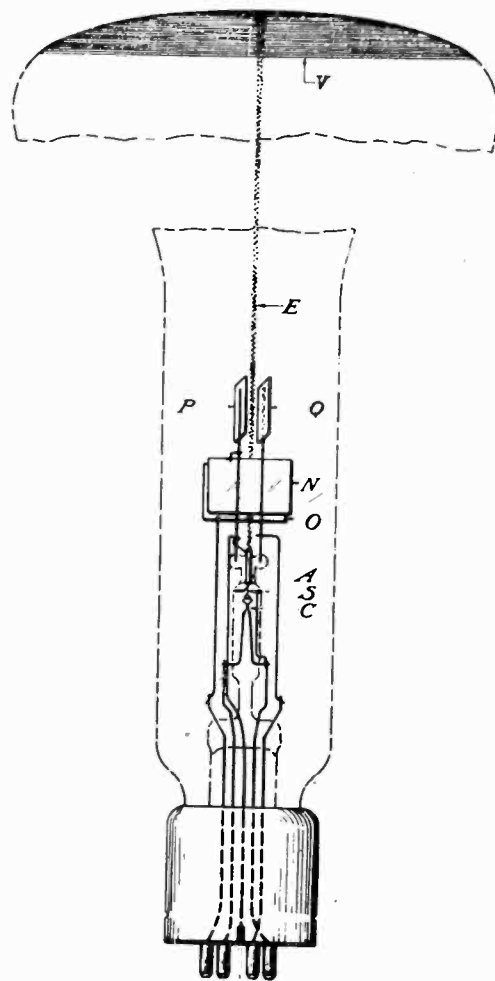

FIG. 7—SCHEMATIC VIEW OF THE CATHODE RAY TUBE

- Key,—
- V—Viewing screen
 - P, Q—Upper deflecting plates
 - N, O—Lower deflecting plates
 - A—Anode
 - S—Shield
 - C—Cathode
 - E—Stream of electrons

transformer voltage ratio is simple, direct, and accurate. The error in making individual measurements is not more than one-half of one per cent.

2. After the circuit is once adjusted, measurements can be made very quickly. With a little experience,

two men can obtain data for a curve in about 15 min.

3. To insure a high degree of accuracy, stray fields must be eliminated by doubling all current-carrying conductors; by using leads from the transformer to the oscillograph which are as short as possible, and by keeping them far apart; and by shielding the cathode ray tube. Furthermore, the compensating field current and the tube anode voltage must be maintained at constant values.

4. The results obtained from the transformers tested indicate that the best working range is between 40 and 3000 cycles per sec.

5. Below the knee of the magnetization curve, the degree of core saturation did not materially affect the voltage ratios over the entire range of frequency from 20 to 10,000 cycles.

The faculty of the Electrical Engineering Department at Oregon State College deserves mention for its hearty cooperation in connection with this study. Considerable credit is due F. O. McMillan, Associate Professor of Electrical Engineering, and Messrs. A. L. Albert and E. C. Starr, Instructors in Electrical Engineering, for their assistance and many valuable suggestions.

Abridgment of

Automatic Stations

ANNUAL REPORT OF THE COMMITTEE ON AUTOMATIC STATIONS

To the Board of Directors:

This terminates the second year of the existence of this committee. The field of action in which this relatively new committee finds itself is so broad and has so many inviting byways that it has been difficult to outline the work. The engineering connection with the application of automatic control is so fascinating as to result in so many new ideas being steadily developed that sometimes the fundamentals are almost overlooked. In the following report, this committee attempts to outline some of the development and offer suggestions which are intended to benefit this branch of the industry.

SCOPE

The scope of this work covers automatic, and partially automatic, generating stations and substations, the committee having complete jurisdiction over all apparatus associated with such stations. In addition, it has jurisdiction over systems of remote dispatching, control, indications, etc., associated with the industry. The committee is interested in the dissemination of the knowledge and experience already gained in the design and operation of such equipment and combinations thereof, in order that this branch of the industry may be more fully developed.

ECONOMICAL CONSTRUCTION

The developments of the year indicate a general

tendency to take advantage of the economical construction possible with the use of automatic stations. It is still hard to realize the radical difference in station arrangement and set-up between the old firmly rooted manual system of operation and modern automatic operation.

It is believed that one of the most radical and economical changes in station arrangement has been the elimination of the continuous switchboard. When this is studied it is found that there is no longer a necessity for assembling all of the control wiring from remote parts of a station at one point at the expense of thousands of feet of wire and conduit.

The above is particularly true in a-c. substations and hydro station applications where the details of control can and properly should be located as near the equipment controlled as is consistent with good fire protection and safety. It is now becoming common to see control panels located in various places throughout a station close to the equipment controlled, thus saving considerable in wire, conduit, and hazard.

Another saving has been realized from the reduction in size and, in some cases, the complete elimination of heating plants.

Ventilation has also been reduced, as in many cases a considerable amount of air over and above that actually essential to station apparatus for the comfort of the operating employees was required.

The problem of station location has been eased somewhat by the advent of automatic control, as stations can be located now in places where it would be almost impossible to keep operating men on the job on account of the absence of what might be considered the amount of daylight, pure air, water, etc., necessary for the continuous maintenance of human beings.

*COMMITTEE ON AUTOMATIC STATIONS

W. H. Millan, Chairman,

P. H. Adams,	H. C. Don Carlos,	O. Naef,
Caesar Antoniono,	P. E. Hart,	E. W. Seeger,
L. D. Bale,	Joseph Hellenthal,	Roy M. Stanley,
C. A. Butcher,	Chester Lichtenberg,	L. J. Turley,
M. S. Coover,	S. J. Lisberger,	F. Zogbaum.
	G. H. Middlemiss,	

Presented at the Summer Convention of the A. I. E. E., Swampscott, Mass., June 24-28, 1929. Complete copy upon request.

RESEARCH AND DEVELOPMENT

Research during the past year has brought forward many improvements in detailed apparatus which are contributing much to simplify the problems of applications. Careful analysis of operating records disclosed the need of more simple means for the adjustment of equipment to meet a wide range of applications, particularly for the calibration of relays. Much has been done in this connection with the result that not only have improvements in relays simplified matters of calibration, but by extending the range of applications, the number of types of relays required has been reduced, thus greatly simplifying routine inspection and maintenance.

Simplified and improved supervisory control and remote metering systems have been produced as a result of experience with several very successful schemes in numerous applications.

Some work has been done in the development of devices for recording operations, quantities, etc., on charts, but this appears to be one of the weakest points in automatic development.

Simplified schemes of control for the automatic switching of rotating apparatus looking toward reduction in the number of moving parts are being tried out. The economics of application are being given a great deal of study. On a number of metropolitan street railway properties, the items of power consumption from the generating stations to the car wheels are being carefully analyzed. Operating voltages best suited to given areas will be selected and means for automatically or remotely controlling the substation apparatus for proper adjustment of the voltage to operating conditions will be provided.

OPERATING REPORTS AND INSPECTION

The predecessors of this committee have stated that the art would advance much more rapidly if more operating engineers would avail themselves the opportunity at Institute meetings to tell, through papers, of their individual experiences and freely taking part in discussion. It is felt that in this way the annual reports of this committee will be more representative. With this idea in mind, your committee has this year sent out questionnaires attempting to gather operating, maintenance, and inspection data from a wide field of experience covering a variety of applications. While these questionnaires may be considered a burden by some, this committee feels that a large number of engineers are vitally interested in the subject and are willing to furnish the data requested to the end that the art may be more universally applied and incidentally improved. Some answers to the questionnaire have been received, but not a sufficient number to present a recapitulation in the pages of this report. This committee intends to turn this partly finished work over to

its successors with the earnest recommendation that they carry it forward.

Inspection and maintenance of automatic plants may be catalogued into two general classifications,—quality and quantity,—depending entirely upon the continuity of service expected and demanded of the automatic plants and by the individual managements.

The word "maintenance" is used advisedly in view of the fact that inspection and maintenance are so closely allied at times as to be almost inseparable.

Past and present experience as reported by the various operating engineers seem to disclose the fact that to properly function, automatic equipment should be given casual and periodical inspections. These inspections vary according to the needs and conditions of the individual installation and the severity of service. The casual inspections on metropolitan systems as reported are made as often as two hours apart during the heavy hours of the day, and two or three days apart on other systems and conditions.

These inspections usually consist of observing the functioning of equipment in service, overheated contacts, graphic chart clocks for time, inking, bearings, overheating, ventilation, etc. For stations outside of metropolitan districts the casual inspections are likewise reported as being made daily on some systems, and weekly on others, ranging in the average of two or three times a week, with a tendency to make fewer inspections when the stations are equipped with supervisory control. The actual time required to make a casual inspection is much less than the traveling time.

STANDARDS

Standards for Automatic Stations (No. 26) were adopted and issued in 1928. It was realized that in view of the rapid progress of this branch of the industry, it would be necessary to revise these standards from time to time. A subcommittee has worked out some desirable changes which are not sufficiently voluminous to warrant a revision of the Standards as published. However, this committee will add to this group of changes from time to time, until it is felt that it is worth while to present them to the Standards Committee with recommendations.

BIBLIOGRAPHY

With the idea that a complete bibliography of "Automatic Station" literature would be of inestimable value to the electrical engineer, this committee published as an appendix to its report of last year a complete bibliography up to the date of this report. A supplement covering literature published since the last report and up to March 1, 1929 is included as an appendix to this report. Acknowledgment and thanks is hereby given to the Main Library, of the General Electric Company for this service.

Abridgment of Production and Application of Light

ANNUAL REPORT OF COMMITTEE ON PRODUCTION AND APPLICATION OF LIGHT*

To the Board of Directors:

INTRODUCTION

The report of the Committee on Production and Application of Light calls attention to the outstanding advancements and trends in the art of lighting by electricity. Material used in the compilation has been furnished not only by members of the committee but by other authorities in various fields.

PRODUCTION OF LIGHT

As was the case a year ago, most of the developments in production of light during the past year have been of the nature of improvements rather than radically new devices or methods.

INCANDESCENT FILAMENT LAMPS

Standard Multiple Lamps. The 60-watt inside-frosted lamp is now made in the A21 bulb, as is also the 50-watt. This simplification is of advantage not only to the manufacturer but to the user.

There has been brought out a 75-watt inside-frosted

Street Series Lamps. There has been further standardization of bulb sizes for street series lamps with resultant greater flexibility in manufacture and in use.

Aviation Lamps. The ideas of illuminating engineers on the subject of floodlighting for aviation landing fields crystallized during the year to the point where it was impossible to standardize a group of four lamps for this service. These are the 1500-watt 32-volt T-24, the 3000-watt 32-volt GT-38, the 5000-watt 115-volt G-64, and the 10,000-watt 115-volt G-80 airport floodlighting lamps.

Motion Picture and Sound Recording Lamps. The introduction of motion pictures accompanied by sound required the development of a number of new types of incandescent lamps designed for use both in the studio where the pictures are taken and in the projection apparatus. In the studio, in addition to the standard general lighting lamps, three high-wattage lamps especially designed for this service are used. These are the 2000-watt 115-volt G-48 bulb spotlight, the 5000-watt 115-volt G-64 and the 10,000 watt 115-volt G-80.

General application	Volts	Amperes	Watts	Bulb	Base	Filament	Rated aver. life (hours)
Night indication, including switch lamps, semaphores, wig-wag highway crossing and crossing gates.....	3.5	0.3		S-11	S. C.	C-2	1000
	10.	0.25		S-11	S. C.	C-2	1000
	13.5	0.25		S-11	S. C.	C-2	1000
	10.			S-11	S. C.	C-2	1000
Day and night indication including light signals and highway crossing flashing signals.....	10.		5	S-11	S. C.	C-2	1000
	10.		10	S-11	S. C.	C-2	1000
	10.		18	S-11	S. C.	C-2	1000

bulb lamp in the A23 bulb, having the same dimensions as the 100-watt lamp.

Special Multiple Lamps. The 10-watt 115-volt in the C9 $\frac{1}{4}$ bulb has been improved in appearance and a new 25-watt 115-volt T6 $\frac{1}{2}$ bulb lamp has been announced. This lamp is for use in showcase and other small reflectors.

Railway Signal Lamps. Several types of lamps have been standardized by the Signal Section of the American Railway Association—these have the popular C-2 filament form.

*PRODUCTION AND APPLICATION OF LIGHT:

B. E. Shackelford, Chairman, Westinghouse Lamp Co., Bloomfield, N. J.
 W. T. Blackwell, H. H. Highbie, F. H. Murphy,
 J. R. Cravath, C. L. Kinsloe, F. A. Rogers,
 W. T. Dempsey, A. S. McAllister, W. T. Ryan,
 Lewis Fussell, G. S. Merrill, W. M. Skiff,
 G. C. Hall, P. S. Millar, C. J. Stahl,
 L. A. Hawkins, G. H. Stickney.

Presented at the Summer Convention of the A. I. E. E., Swampscott, Mass., June 24-28, 1929. Complete copies upon request.

Colored Lamps. Light's Golden Jubilee, celebrated this year to commemorate the 50th anniversary of the incandescent lamp, is made more colorful by the use of inside-colored lamps, a process developed during the year. By this process, the coloring material is sprayed on the inside of the bulb walls instead of on the outside. Thus the coloring material is protected from the weather, is rendered permanent and proof against fading or scratching, and the outside of the bulb is left smooth to retard the accumulation of dirt and permit easy cleaning.

Bases, Sockets, and Adapters. There has been brought up a mogul prefocused base, similar to the medium screw base brought up on last year's report. This is used for various spotlight lamps, floodlight lamps, airplane headlight lamps and airway beacon lamps. New vibration resisting adapters have been developed for use in lamp sockets in order to give still

further protection to lamps burning under conditions of extreme vibration.

Voltage Standardization. It is common practise to refer to the lighting circuit voltage as "110 volts" but it may surprise many to learn that 110-volt lamps comprised only 8.1 per cent of the total number in the 100- to 130-volt range sold during 1928. Approximately 48 per cent were rated at 115 volts and 39 per cent at 120 volts. The remaining 5 per cent were scattered among the other voltages in that range.

GASEOUS CONDUCTOR LAMPS

Mercury Arc Lamps. To meet the demand for industrial lighting units giving a radiation more nearly equivalent to direct sunlight in the effect on general health, mercury arc tubes have been made up in forms identical with those used for industrial lighting, but in glass of slightly higher ultra violet transmission.

The rapidly expanding field of application of quartz mercury arcs in both therapeutic and health lighting has brought forth a variety of new types of arc, all of them differing from older designs in minor mechanical details of construction and appearance only.

Neon Lamps. Smaller electrodes are being used than were formerly thought possible and lamps of higher current density are coming into greater use. New color effects have been obtained by means of filter glass tubing and by the use of different gases.

Hot-cathode low-voltage and negative glow socket type of neon lamps have undergone further development during the past year.

Induction Lamp. The electrodeless discharge in neon, in the form of an induction lamp, has undergone development during the past year and is being used experimentally as a light source for airway beacons. A three-in. clear fused quartz bulb incloses the luminous gas. The lamp under operating conditions has a brightness in excess of 40 candles per sq. cm. and when used at the focus of a 36-in. mirror, a beam candle-power of the order of 500,000 is obtained.

Carbon Arc Lamps. A number of types of arc lamps using impregnated carbons has been placed on the market for therapeutic use. While some of these are of the cheapest construction, others are very well made and provided with filtering glasses for proper ranges in the ultra violet spectrum.

Application of Light

INTERIOR ILLUMINATION

Industrial Lighting. The past year has witnessed an increasing acceptance on the part of production managers of high levels of general illumination. Among the new lighting systems installed was a goodly number in which 15 to 30 foot-candles of general illumination are obtained; in some instances higher illumination values of 40 to 60 foot-candles over large areas have been found economical.

Following closely upon the acceptance and installation of these higher levels of illumination is an increasing

interest in special lighting for specific jobs. Group lighting, a system in which the lighting units are located with respect to the machine groups, has been adopted in a number of plants, especially those where the location of the machine groups is fairly permanent and in which the direction of light desired is constant.

The development of group lighting applications requires characteristic distribution curves of light which are necessary to obtain the greatest utilization over any given area; more and more attention is being paid to the control of light to fit these requirements.

COMMERCIAL LIGHTING

Mention was made last year that installations designed along modernistic lines were beginning to appear.

The merchant is always in search of the new to attract customers, and it is natural that he is one of the first to adopt the new school. The distinctive shops have given us some wonderful examples of the use of light for decoration and even the department stores under construction are decidedly modernistic in feeling.

The entrance and lobbies of the new office buildings are striking and generally lighted in such a way as to take full advantage of the potentialities of present day light sources.

RESIDENCE LIGHTING

The modernistic trend in home lighting equipment has made a vast stride in the past year. American manufacturers are offering many varieties of fixtures closely resembling the designs which European artists have been developing. Decorative portables, wall brackets, and center luminaries are designed with pronounced geometric plane surfaces representing in many instances an assembly of rectangles, triangles or squares of various light colored tints, plain shades, and artistic mixtures. These glass planes not only conceal the lamps from general view but also diffuse the light over a wide area, thereby creating a quality of illumination which engineers have been striving for years to introduce into the American home for wholesome lighting.

Light Ornaments. A few years ago the use of light simply for decoration was encountered only rarely. Now one scarcely passes a single gift shop which does not display one or more forms of light ornaments. During the past year American manufacturers have developed some very commendable types. These use cast figures against lighted background, translucent colored urns, cut crystal figures lighted from beneath, and even translucent porcelain.

MOTION PICTURE LIGHTING

A census taken about the first of February shows that of some 60 or more pictures in the process of being photographed approximately 60 per cent were being made with incandescent lamps, an increase from 25 per cent as of July 1, 1928. The general practise of the studios has been to make their sound pictures

entirely with incandescent lamps and to restrict the use of other illuminants to the silent pictures.

The Universal Studio has recently completed the filming of the picture "Broadway," taken from the popular New York success of the same name. The largest indoor set ever constructed was used for the cabaret scene. This scene, together with several others immediately adjacent and really becoming a single large set, was lighted entirely with 4800 incandescent lamps whose wattage totalled 3,900,000. The largest part of this energy was employed in regulation motion picture photographic lighting equipment. There were, however, many thousands of lamps of lower wattage employed for decorative effects.

INSTALLATION STANDARDS

For several years illuminating engineers have been feeling an increasing degree the limitation of inadequate wiring as an obstacle to the development of good lighting practise in commercial and industrial buildings. From a study of the problem it was concluded that this situation and other problems could best be met by co-operation on the part of central station lighting service bureaus with architects. In formulating a plan certain officials of the American Institute of Architects were consulted with gratifying response. Therefore in the Fall of 1928 a committee of the National Electric Light Association started in on a program of constructive effort. Two courses of instruction for central station lighting service engineers have already been held at which pertinent technical information was reviewed.

To express the adequacy features of wiring so that the illuminating engineer may plan proper lighting a set of model specification paragraphs has been prepared containing some new features which facilitate checking up on the wiring construction work.

A third phase of the program is a plan of advertising to emphasize to architects the importance of good lighting and to interest them in cooperation with the lighting experts of the central station companies.

Based on experience in Chicago, the Society for Electrical Development has adopted a simplified method of planning and figuring the lighting installation in accordance with present-day standards. This is known as the Franklin Red Seal Lighting Specification, the rules being published in pamphlet form and providing for all conditions ordinarily existing in that field.

EXTERIOR ILLUMINATION

Street Lighting. Street lighting practise is progressing slowly but at a rate which with a few sporadic exceptions is inadequate to meet the rigorous demands of modern high speed traffic. The average light output of incandescent street series lamps sold during 1928 was 5.8 per cent higher than the output of such lamps sold during 1927 (Report of Lamp Committee, N. E. L. A.).

This is one indication of progress, since the use of larger lamps suggests improved street lighting. Yet it is the general testimony of the best informed engineers

that a marked advance not only in the amount of light produced for street lighting but also in the skilful application of that light is required before street lighting practise may be considered to be abreast of modern requirements.

The outstanding development in street lighting is the increasing recognition of the importance of a comprehensive street lighting plan prepared in coordination with city planning at large and particularly with regard to street traffic problems. The practise of classifying projected street lighting plans by stating the illumination required for streets of different character is also a growing tendency which promises a more definite and scientific treatment in the future.

It is coming to be recognized increasingly that the only thoroughly satisfactory solution of the automobile headlighting problem is to provide street or highway lighting sufficiently to permit safe and expeditious transit without the employment of powerful far-reaching headlights, and at least with depressed headlight beams. In the case of interurban highways, the problem of providing fixed lighting is receiving much attention. Where needed, enabling acts to permit counties and villages to provide for highway lighting are being sought.

TRAFFIC SIGNAL LIGHTING

In the year 1928 much was done towards standardization of traffic signals. The report of the Committee of the American Engineering Council on Street Traffic Signs, Signals, and Markings was finally finished and has been issued in pamphlet form. This report is very complete and does a great deal to lead to standardization of traffic signal practises. Very little change has occurred in traffic signals themselves since these had reached a very high state of development prior to 1928. During the year, however, traffic control apparatus took another step forward in that practically all manufacturers developed control apparatus for a full coordinated movement of traffic.

Portable Flasher. There is being brought out a portable electric flasher designed primarily for traffic warnings where kerosene lanterns have been extensively used. It has, however, many other possible uses in connection with both land and water traffic. Although the initial cost of the beacon is considerably more than that of oil lantern, its maintenance cost is so much less that in the long run, it provides the most economical warning signal.

Automobile Headlighting. Committees of the Illuminating Engineering Society and the Society of Automobile Engineers have been active during the past year considering such subjects as Specifications for Headlamp Mountings, Specifications for the Test of Rear and Signal Lamps, and Comments on the Existing Specifications for test of Headlamps of the dual beam type.

The outstanding achievement during the past year in

motor car lighting has been the adoption of fixed-focus construction for headlamps. Various investigations have shown that the principal cause of glaring lights has been improper focusing of the lamps.

SIGN LIGHTING

The two schools of electrical advertising sponsored by the National Electric Light Association in the Spring of 1928 were so successful that it was decided to try out local schools in the geographic divisions. Three of these schools have already been opened, New England Division in Boston, Mass., Great Lakes Division in Chicago, Ill., and East Central Division in Cincinnati, Ohio. Others are planned for the Fall. The Society for Electrical Development, Electrical Advertising Section, is bringing out a Plan Book suggesting methods by which public utilities can stimulate electrical advertising.

Among the developments in sign lighting during the past year, should be mentioned the new S11 sign lamps supplied in colors and with the intermediate screw base, the so-called "Talking Signs" in a variety of sizes and the continued improvement in gaseous tube signs. Some of the latter are used in combination with incandescent lamps for very effective combined signs.

LIGHTING OF BUILDING EXTERIORS

Floodlighting is being used more extensively to bring out the architectural beauty of offices and public buildings at night. In the larger cities new buildings are generally erected with step-back construction at the higher levels and these offsets made the use of floodlighting particularly effective. Architects are also showing a greater appreciation of the value of floodlighting with the result that in some instances the exterior lighting of the buildings is considered at the time the designs for the building are made. Colored lighting is receiving more attention, and the combination of color and motion in what has been called mobile color lighting is unfolding new possibilities for attractive night displays in building decoration. There is a very decided trend toward the use of colored lighting either with or without motion as this type of lighting has much greater possibilities than the use of plain white light.

LIGHTING FOR AVIATION

Beacons and course lights have been installed on approximately 9000 mi. of the national airways by the U. S. Department of Commerce, and about 2000 additional miles will be lighted by the end of June, 1929. Where course lights are mounted on beacon towers, when no landing field is near by they are equipped with a red color screen; when a suitable landing area is in the vicinity, with an amber color screen.

During the past year there has been great activity in equipping airports for night flying with a view to obtaining an "A" rating from the U. S. Department of Commerce, which has issued Aeronautics Bulletin No. 16 explaining the requirements in detail.

The retractable airplane headlight may be operated on the retracted position with beam pointing downward for pick-up and can also be used in any intermediate position to forward, where it is usually held when contact is made with the ground. The fixed headlights are usually stream lights in the wings to reduce air resistance. A smaller headlight with a 6-in. reflector has has recently been developed using a 100-watt 12-volt A-19 bulb lamp with intermediate profocused base. The subject of airplane headlighting is being studied by a committee of the Society of Automotive Engineers.

LIGHTING OF BRIDGES AND TUNNELS

Since the opening of the Holland Vehicular Tunnel under the Hudson River, a new standard for the lighting of underground vehicular passageways has been established which is being followed by several similar installations, notably the Zion-Mount Carmel Tunnel in Utah and the Detroit Vehicular Tunnel between that city and Windsor. An item of interest may be recorded; namely, that higher intensities of roadway illumination without glare speeds up traffic very materially and quite directly returns a greater revenue from the investments in the complete structure. This same fact is now recognized in connection with bridge traffic as is also fairly well recognized the fact that bridge lighting should be of the order of two to three times the intensity of the connecting highways. The floodlighting of bridge structures, especially the approaches thereto, has resulted in a considerable beautification of water fronts incidentally affording greater safety to aviation pilots.

UNDERWATER LIGHTING

Considerable interest has been displayed in the application of electric incandescent lamps to under water illumination. The 1000-watt, 115-volt, G-40 bulb special diving lamp which is self-contained and designed to be operated directly immersed in the water is standard equipment for all capital ships in the U. S. Navy. Luminous fountains have been constructed with light projectors mounted beneath water-tight glass plates or with separate water-tight self-contained projectors located in the water or at the base of the fountain jets. Various types of equipment are now available, some consisting of lamps mounted behind glass plates, others being water-tight metal units moulded in the pool wall, and still others being water-tight self-contained units operating completely surrounded by water but located generally in niches prepared for them in the pool wall.

INTERNATIONAL COMMISSION ON ILLUMINATION

The last year was a very important one for the U. S. National Committee, inasmuch as the American meeting of the International Commission on Illumination was held then.

The commission has some 15 technical committees, all of which met at Saranac Inn and considered the

recommendations and reports from various national committees, with a view to formulating recommendations for adoption by the commission. The technical papers at this meeting covered a wide variety of subjects, the practical details of lighting practise receiving a very large amount of attention.

The proceedings of the meeting which are now being printed will make a volume upward of 1500 pages, constituting a very notable summary of the existing state of the art and science of illumination not only in this country but throughout the world.

The next meeting of the commission, in 1931, is to be held in England.

The committee wishes to acknowledge the cooperation of the following men not members of the com-

mittee: E. W. Beggs, H. S. Broadbent, R. E. Carlson, R. W. Cost, C. Dick, S. G. Hibben, H. C. Rentschler, Geo. H. St. John, and R. L. Zahour of the Westinghouse Lamp Company; R. E. Farnham and James M. Ketch of the National Lamp Works of the General Electric Company; A. L. Broe, E. B. Fox, A. L. Powell and G. F. Prideaux of the Edison Lamp Works of the General Electric Company; C. A. B. Halvorson of the General Electric Company, West Lynn, Mass.; H. P. Gage, of the Corning Glass Works; Loyd A. Jones of the Eastman Kodak Company; K. W. Mackall of the Crouse-Hinds Company; R. D. Mailey of the Cooper Hewitt Electric Company; S. R. McCandless of the School of Fine Arts, Yale University; and C. H. Sharp of the Electrical Testing Laboratories.

ILLUMINATION ITEMS

Submitted by the Committee on Production and Application of Light
THE ELECTRICAL ENGINEER AND LIGHT THERAPY
 W. C. KALB¹

The popularity of the present sun-tan vogue and its hearty endorsement by prominent members of the medical profession point to the probability of the demand for artificial sources of sunshine being permanent rather than the fad of a day.

It is as essential to life and health as food, water, or air. Normal growth and development of the child demand complete sunshine.

The electrical engineer is not concerned primarily with the application of light in the therapeutic sense;

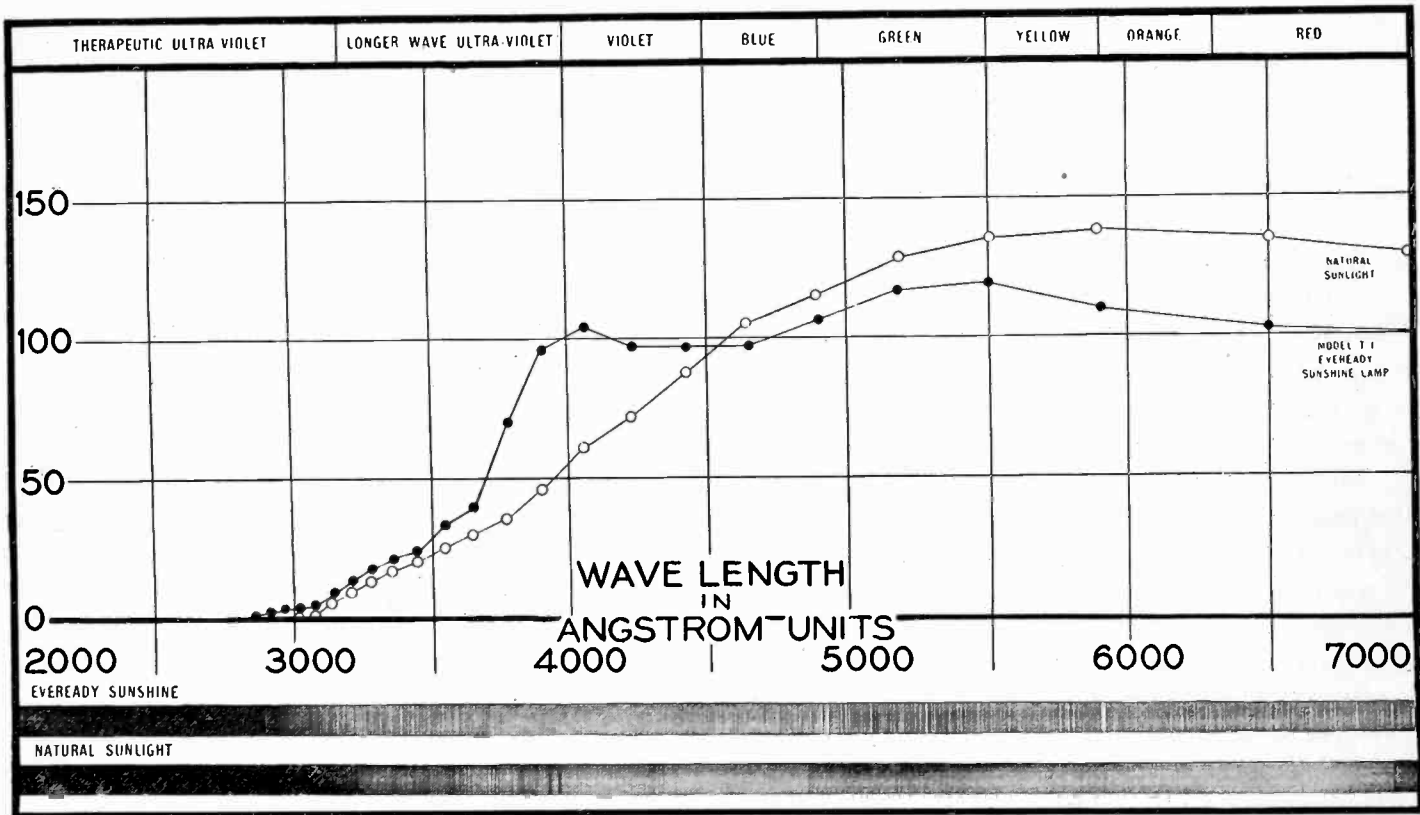

Due to this fact there has been a marked stimulation of research with the purpose of producing artificial sources of illumination closely approximating the radiations received from natural sunlight. Through the centuries, mankind has grown accustomed to sunshine.

the treatment and cure of disease is essentially the function of the physician, not of the engineer. However, electrical sources of illumination having been found to be the most practicable means of reproducing

1. National Carbon Company, Cleveland, O.

all the bands of radiation found in sunlight and even rays of shorter wavelength valuable in light therapy, the electrical engineer is vitally concerned with the growth of knowledge in this field to the end of providing still more efficient light producing units.

Through the demand for an artificial source of sunshine to be used in the home and a dependable source of ultra-violet radiation for use in light therapy, the carbon arc has received a new stimulus. Instantly available at full intensity and free from loss of efficiency with use, this type of illuminant is attracting marked attention.

Carbons used for light treatment are almost invariably of the flame type. The outer shell of pure carbon is filled with a core of flame-supporting material and the greater portion of the radiation comes from the flame of the arc rather than the incandescent tips of the carbons. By varying the composition of the core, the characteristics of the radiation emitted can be modified.

For the close reproduction of natural sunlight, cerium is used in the core of the carbon electrodes. The bare arc thus formed has a distribution of radiant energy close to that of natural sunlight. Like all carbon arcs, however, it emits some rays of wavelengths shorter than 2900 Angstrom units, the shortest rays reaching us in natural sunlight. These can be screened out by using a suitable filter of special ultra-violet transmitting glass. The efficiency of this arc for purposes of irradiation and the similarity to the radiant energy distribution of natural sunlight can be further increased by the use of a suitably designed reflector. The accompanying figure illustrates by means of curves and spectrograms the distribution of radiant energy for natural sunlight in comparison with that of a cerium-cored carbon arc backed by a carefully designed chromium plated reflector and screened by a filter of special ultra-violet transmitting glass.

In the treatment of physical disorders the physician makes use of ultra-violet radiations shorter than those found in natural sunlight as well as infra red rays of greater proportional intensity than that normal to sunlight. The carbon arc may be adapted to these special requirements by selecting suitable materials for the composition of the core.

The use of iron in the core of the carbon electrodes gives strong ultra-violet radiation in the band from 2300 to 3200 Angstrom units. A polymetallic core composed of iron, nickel, aluminum, and silicon is particularly strong in the zone from 2700 to 3200 Angstrom units. This embraces that band of rays which medical authorities consider most effective in the cure and prevention of rickets as well as those rays having the most rapid action in producing pigmentation of the skin.

Cobalt in the core of the carbon gives considerable ultra-violet intensity from 3100 to 3500 Angstrom units, but its most striking effect is that the proportion of

radiant energy in wavelengths less than 2500 Angstrom units to total radiant energy is greater than that for any of the other core materials here discussed.

To produce a carbon emitting a high percentage of infra red rays, strontium is used in the core. The light from the arc formed by this carbon is decidedly reddish in color, and the quantity as well as the percentage of infra red radiation greater than that obtained from any of the other core materials.

The foregoing statements clearly illustrate the versatility of the carbon arc. By modifying the composition of the core many other variations are possible. Experience, however, indicates that with the five types of carbon electrodes here described it is possible to obtain practically any distribution of radiant energy which the physician may desire in the practice of light therapy.

MOBILE COLOR LIGHTING AT BARCELONA EXPOSITION

C. J. STAHL¹

From the standpoint of mobile color lighting, the International Exposition held this year at Barcelona, Spain, is the most exquisite display of its kind ever produced. It is particularly interesting as to the quantity of colored light employed and the extent of the area over which coordinated sequence is maintained. In length, this area is approximately one-third of a mile, and in width it averages 350 ft. Both as to colors and intensities, this widespread synchronized mobility is controlled through a multiplicity of circuits which appear hopelessly intricate until the systematic design and arrangements are understood. The apparatus, to control automatically the changing colors, (5000-kw. connected load), cost approximately \$250,000.00 exclusive of freight, erection, wiring, or the electric distribution system.

The sloping exposition area was transformed into a series of terraced gardens where luxuriant trees, beautiful flower beds, fountains, statuary, and cascades adorn the grounds.

Throughout this area, the colored lighting display is composed of the following elements:

1. There is an aurora of searchlight beams from 24 to 36 in.; 150-ampere searchlights placed back of the dome of the National Palace.
2. There are four cascades which are illuminated in mobile colors, so that the color seems to flow down like the water that carries it; only more slowly.
3. There are more than fifty fountains all fully illuminated and controlled so that color changes may be synchronized with the changing colors of the cascades.
4. There are approximately two hundred glass columns of various shapes and, in addition, many urns,

¹ Manager, Illuminating Engineering Bureau, Westinghouse Elec. & Mfg. Co., South Bend, Ind.

flower pots, and fire pots, most of which can be synchronized in like manner.

From back of the dome of the National Palace over-towering the central area, an aurora of colored search-light beams fan out over the heavens. As the aurora radiates upward, the ground display is a great stream of color consisting of the cascades, fountains, crystal columns and various other ornamental shapes, all aglow with colored light which progresses through consecutive dimming and brightening so that it seems to flow down the inclined central area. The effect is that of a mammoth staircase, almost half a mile in length, illuminated with slowly moving waves of color. Blue, for example, starts from the National Palace at the top and moves slowly down. When the blue has gone 200 meters, the effect of a mixture of red appears, gradually changing to pure red. Green follows, and then white, which holds until the advancing colors have reached the lower end of the Avenida de Americas, the time consumed being twelve minutes. By pressing a button at the central-control station, the entire cycle is repeated. At this station, one or more artists supervise the composition of the almost endless variety of color combinations, of which twenty may be set up in advance. Considering that the color panorama of the central area takes in four cascades, three large fountains and more than fifty small ones, as well as some two hundred or more glass ornaments, a most beautiful effect in mobile colors is produced. Adding to this the colored lighting of facades bounding the central area (which can be carried forward in steps to coordinate with the mobile progressions) also the changing aspects of the fountains due to great flexibility in hydraulic controls, we begin to picture a spectacle of supereminent beauty.

The floodlighting of facades, domes, and minarets is accomplished mostly by light directed upward. This creates shadows, and these, as well as small arches, niches, and other architectural indentures, are lighted from concealed sources in soft contrasting colors to accentuate the architectural embellishments both by depth and color contrasts. Yellow, red, and light green are used most for this purpose.

Where facades are illuminated in order to give the impression of interior life, the windows, doors and porticos are illuminated from the back, all in soft tones harmonizing with the lighting of the facades.

Stone incense pots showing colored vapors are also employed at certain locations. In general, green and light blue colors for static effects of considerable duration are preferred to deep reds; orange and gold, however, are not lacking. All elements are softly illuminated with diffused light, avoiding unpleasant glare. The qualities of comfort, mystery, elusiveness and colossalism are outstanding.

In general, reactors are employed for the dimming of

lights. Many of these are of 200-kw. capacity. They are placed at remote points close to the load they control. Motor-generator sets are used in connection with the 200-kw. reactors, the control being effected by bringing the shunt-field circuit of the d-c. generator to the dimming resistance plate at the central control station.

As resistance is cut out in the dimming cycle, the d-c. voltage of the motor-generator set increases and the direct current delivered to the reactor by the motor-generator set therefore also increases. This decreases the effective resistance of the reactor, which is connected in series with the primary winding of the 5600-volt, 50-cycle transformers supplying energy to the lamp circuits. When the current in the d-c. winding of the reactor is at maximum, the secondary voltage of the supply transformers is at full normal voltage, and the lights at full brightness.

Space does not permit of a complete description of the Barcelona Exposition lighting here; a more detailed account was given at the Annual Convention of the Illuminating Engineering Society, September 1929.

THE MOTOR VEHICLE LIGHT TESTING LABORATORY OF MINNESOTA

PROF. W. T. RYAN

The regulations with respect to automobile headlamps, included in the Uniform Traffic Act of the State of Minnesota, have now been in force for over two years.

The Department of Electrical Engineering of the University of Minnesota established a testing laboratory which was designated by the Department of Highways, as the official testing laboratory for the State of Minnesota where the manufacturer's samples are checked to see that required specifications are met. Professor E. W. Johnson, Director of the Motor Vehicle Light Testing Laboratory, has served also as an adviser to the Department of Highways on questions relating to lamp specifications, testing, and approvals.

Samples from all of the principal manufacturing companies have been tested and the system is in active operation. A start has been made also in the enforcement of the headlamp adjustment requirements of this law, but much remains to be done in that line.

Improvement is apparent, however, in night driving conditions, although really only a beginning has as yet been made. One large contributing factor is the decided improvement in the quality of the headlamps coming in on the new cars. The worst offender among old ones, some of which could not be adjusted to give a good driving light and others exceedingly sensitive to focal adjustment, are gradually disappearing.

*Professor, Electrical Power Engineering University of Minnesota, Minneapolis, Minn.

INSTITUTE AND RELATED ACTIVITIES

The 1930 Winter Convention

LIVE TECHNICAL SUBJECTS AND ENJOYABLE ENTERTAINMENT ARE ON PROGRAM

One of the most interesting technical programs ever offered by the A. I. E. E. will be presented at the 1930 Winter Convention to be held in New York, January 27-31.

Other attractive features which will make this a most enjoyable convention are also being planned. These include inspection trips, a lecture, the Edison Medal presentation, a smoker, and a dinner dance.

The technical papers will cover the subjects of protective devices, power-system planning, field investigation of lightning, transoceanic telephony and telegraphy, dielectrics, welding, and electrical machinery.

A special program for the ladies—sightseeing tours, shopping trips, teas, card parties, etc.—is being arranged by the Ladies Entertainment Committee.

Reduced railroad rates on the certificate plan will be in force; under this plan the round trip will cost only one and a half times the single fare. In order that this special rate may be obtained, everyone going to the Convention should secure a certificate from his local ticket agent. The return trip must have the same routing as used in attending the Convention and there are certain other restrictions which may be learned from local ticket agents.

As tentatively arranged the schedule of events is given below:

TENTATIVE PROGRAM OF WINTER CONVENTION

MONDAY, JANUARY 27

- 10:00 a. m. Registration
- 2:00 p. m. Session on Protective Devices
- 8:15 p. m. Joint Session with Illuminating Engineering Society on Ultra Violet Radiation

TUESDAY, JANUARY 28

- 10:00 a. m. Session on Power System Planning
- 2:00 p. m. Session on Selected Subjects
- 8:00 p. m. Smoker with Entertainment

WEDNESDAY, JANUARY 29

- 10:00 a. m. Session on Lightning Investigations
- 2:00 p. m. Inspection Trips
- 8:30 p. m. Edison Medal Presentation and Lecture

THURSDAY, JANUARY 30

- 10:00 a. m. Session on Transoceanic Communication
- 2:00 p. m. Session on Welding
Session on Dielectric
- 7:00 p. m. Dinner Dance

FRIDAY, JANUARY 31

- 10:00 a. m. Session on Electrical Machinery
- 2:00 p. m. Session on Electrical Machinery

The technical papers deal with very live topics. The papers selected have been chosen from a very large number which were available. The following is a tentative selection of the papers to be presented.

SESSION ON PROTECTIVE DEVICES

January 27—2:00 p. m.

- Metal-Clad Switchgear at State Line Station*, A. M. Rossman, Sargent & Lundy, Inc.
- Development of the New Autovalve Arrester*, J. Slepian, R. Tanberg and C. E. Krause, Westinghouse Electric & Mfg. Co.
- Thyrite, A New Material for Lightning Arresters*, K. B. McEachron, General Electric Co.

Extinction of a Long A-c. Arc, J. Slepian, Westinghouse Electric & Mfg. Co.

Use of Oil in Arc Rupturing with Special Reference to System Stability, B. P. Baker and H. M. Wilcox, Westinghouse Electric & Mfg. Co.

JOINT SESSION WITH ILLUMINATING ENGINEERING SOCIETY January 27—8:15 p. m.

- Production and Control of Ultra Violet Radiation*, M. Luckiesh, National Lamp Works of General Electric Co.
- An Ultra Violet Light Meter*, H. C. Rentschler, Westinghouse Lamp Co.

SESSION ON POWER SYSTEM PLANNING

January 28—10:00 a. m.

- System Connections and Interconnections in Chicago District*, G. M. Armbrust and T. G. Le Clair, Commonwealth Edison Co.
- Fundamental Plan of Power Supply in the Detroit District*, S. M. Dean, Detroit Edison Co.
- Fundamental Plan of Power Supply in the Philadelphia Area*, Raymond Bailey, Philadelphia Electric Co.
- Turbine-Governor Tests at Colfax Power Station*, T. C. Purell and A. P. Hayward, Duquesne Light Co.
- Controlling Power Flow with Phase-Shifting Equipment*, W. J. Lyman, Duquesne Light Co.

SESSION ON SELECTED SUBJECTS

January 28—2:00 p. m.

- The Units of the Magnetic Circuit*, A. E. Kennelly, Harvard University
- The Calculation of Induced Voltages in Metallic Conductors*, H. B. Dwight, Massachusetts Institute of Technology
- Induced Voltage of Electrical Machines*, L. V. Bewley, General Electric Co.
- Design and Application of a Cathode Ray Oscillograph with Norinder Relay*, O. Ackermann, Westinghouse Electric & Mfg. Co.

SESSION ON LIGHTNING INVESTIGATIONS

January 29—10:00 a. m.

- Résumé of 1929 Lightning Investigations*, Subcommittee on Lightning, of Committee on Power Transmission and Distribution
- Cathode Ray Oscillograph Studies of Lightning on Transmission Lines*, J. H. Cox and Edward Beck, Westinghouse Electric & Mfg. Co.
- Surge Characteristics of Insulators and Gaps*, J. J. Torok, Westinghouse Electric & Mfg. Co.
- Lightning Voltages on Transmission Lines*, R. H. George, Purdue University and J. R. Eaton, Consumers Power Company
- Study of Traveling Waves on Transmission Lines with Artificial Lightning Surges*, K. B. McEachron and W. J. Rudge, General Electric Co., and J. G. Hemstreet, Consumers Power Co.
- Lightning Investigation on 220-Kv. System of Pennsylvania Power and Light Co.*, Nicholas N. Smeloff, Penn. Power & Light Co., and A. L. Price, General Electric Co.
- Lightning Investigation on Ohio Power Co. System*, F. W. Peek, General Electric Co. and Philip Sporn, American Gas & Elec. Co.

SESSION ON COMMUNICATION

January 30—10:00 a. m.

The Post-War Decade in Submarine Telegraphy, I. S. Coggeshall, Western Union Telegraph Co.

Transocean Telephone Service—General Aspects, J. J. Pilliod, American Telephone & Telegraph Co.

Short-Wave Radio Transocean Telephone Circuits

(a) *Transmission Features of Short-Wave Radio Circuits*, R. Brown, American Telephone & Telegraph Co.

(b) *Technical Features of the New Short-Wave Radio Station of the Bell System*, A. A. Oswald, Bell Telephone Laboratories, Inc.

(c) *Plan and Construction of Short-Wave Radio Systems*, F. A. Cowan, American Telephone & Telegraph Co.

SESSION ON WELDING

January 30—2:00 p. m.

Cathode Energy of the Iron Arc, G. E. Doan, Lehigh Univ.

Resistance Welding, B. T. Mottinger, Federal Machine & Welder Co.

Electrically Welded Structures under Dynamic Stress, Morris Stone and J. G. Ritter, Westinghouse Electric & Mfg. Co.

Welding with the Carbon Arc, J. C. Lincoln, Lincoln Electric Co.

SESSION ON DIELECTRICS

January 30—2:00 p. m.

Conductivity of Insulating Oils, J. B. Whitehead and R. H. Marvin, Johns Hopkins University

Behavior of Dielectrics, R. R. Benedict, University of Wisconsin

Three Regions of Dielectric Breakdown, P. H. Moon, and A. S. Norcross, Massachusetts Institute of Technology

Ionization Studies in Paper-Insulated Cables—III, C. L. Dawes and P. H. Humphries, Harvard Engineering School

High-Voltage Corona in Air, S. K. Waldorf, Johns Hopkins University

SESSION ON ELECTRICAL MACHINERY

January 31—10:00 a. m.

Loading Transformers by Temperature, V. M. Montsinger, General Electric Co.

Recommendations for Safe Loading of Transformers by Temperature, W. M. Dann, Westinghouse Electric & Mfg. Co.

Tap Changing Under Load for Voltages and Phase-Angle Control, H. B. West, Westinghouse Electric & Mfg. Co.

Telephone Interference from A-c. Generators Feeding Directly on Line with Neutral Grounded, J. J. Smith, General Electric Co.

Grounding Impedance, K. K. Palueff, General Electric Co.

SESSION ON ELECTRICAL MACHINERY

January 31—2:00 p. m.

Generalized Theory of Electrical Machinery, Gabriel Kron, Lincoln Electric Co.

Quiet Induction Motors, L. E. Hildebrand, General Electric Co.

Transient Torque—Angle Characteristics of Synchronous Machines, W. V. Lyon and H. E. Edgerton, Massachusetts Institute of Technology

Starting Performance of Salient-Pole Synchronous Machines, T. M. Linville, General Electric Co.

Ventilation of Revolving-Field Salient-Pole Alternators, C. J. Fechheimer, Westinghouse Electric & Mfg. Co.

Synchronous Machines, V, (Three-Phase Short Circuit), R. E. Doherty and C. A. Nickle, General Electric Co.

Committees

The 1930 Winter Convention Committee is as follows: H. P. Charlesworth, Chairman; J. B. Bassett, S. P. Grace, C. R. Jones, H. A. Kidder, G. L. Knight, E. B. Meyer, and C. E. Stephens.

The chairmen of the subcommittees are, respectively: *Entertainment*, J. B. Bassett; *Inspection Trips*, F. Zogbaum; *Dinner-Dance*, C. R. Jones; *Smoker*, G. J. Read, and *Ladies Entertainment*, Mrs. G. L. Knight.

District Meeting in Chicago

The three-day District Meeting at the Drake Hotel in Chicago December 2-4 has a splendid program for both members and students. Complete details of the meeting were announced in the November issue of the JOURNAL page 843. No extensive announcement is given in this issue as the meeting will be in progress before the issue reaches most of the membership.

World Engineering Congress, Tokyo

The American delegation to the Tokyo Congress arrived in Japan October 22 and 28 after an exceedingly interesting voyage across the Pacific on the steamers *President Jackson*, *Korea Maru* and *Empress of France*. Japanese reception committees welcomed the Americans and expedited their arrival at the various Hotels to which they were destined.

The Congress opened with an official reception at the Imperial Hotel Tokyo, on Monday evening October 28th.

The official opening of the Congress sessions occurred on the morning of October 29, the opening address being given by His Imperial Highness, Prince Chichibu, followed by addresses by the Prime Minister of Japan, Baron Furnichi, President of the Congress, and short addresses by representatives of the various National delegations.

The technical papers were presented in twelve separate sections covering various subjects. The total number of papers listed in the program comprised several hundred by authors from all parts of the world, making it necessary to hold ten sessions of the Congress simultaneously. The Tokyo Sectional Meeting of the World Power Conference was held in conjunction with the Congress, with a technical program so extensive that two sessions were conducted simultaneously each day.

The social events, excursions, etc., were so numerous that here mere mention only is possible. They included dinners, luncheons, teas, garden parties, and other hospitalities for which the Japanese are noted. Many events were arranged particularly for the ladies in attendance. Some of the functions of particular interest were a reception at the Prime Ministers official residence, a tea party and "Nō" dance at Baron Mitsui's residence, a garden party given by Prince and Princess Chichibu at the Imperial Gardens, a luncheon given by the Mayor of Tokyo, a garden party at the residence of Baron Iwasaki, and many others scheduled for the remaining days of the Congress.

The American Committee gave a dinner on October 31, at which the guests included Their Imperial Highnesses the Prince and Princess Chichibu and the delegates of all other countries represented at the Congress. The total attendance exceeded 700. Addresses were given by Chairman Sperry of the American Committee, Doctor F. B. Jewett and George Otis Smith.

At this writing, the Congress program is about half completed. After adjournment on November 7, the delegates and guests will participate in various excursions to places of engineering and scenic interest in Japan, Manchuria, China and elsewhere; a considerable number will continue their journey around the world.

Inquiries regarding the technical program and the availability of copies of the papers presented may be addressed to Mr. Maurice Holland, Secretary of the American Committee of the Congress, 29 West 39th St., New York.

Information relating to the technical papers presented at the World Power Conference may be obtained from Mr. O. C. Merrill, Chairman American National Committee, World Power Conference, 917 15th St., N. W., Washington, D. C.

ENGINEERING FOUNDATION

VISIT OF PROFESSOR ALBERT VAN HECKE OF LOUVAIN UNIVERSITY

As a fellow of the C R B Educational Foundation, Professor Albert Van Hecke, head of the Civil Engineering Department of Louvain University, is visiting Engineering Foundation and his other friends in the United States. He proposes to spend several weeks in study of recent advances in engineering research and practise in this country, his itinerary including Columbia University, University of Illinois, Massachusetts Institute of Technology, Princeton University and many others. By invitation he will participate in the celebration of the 175th anniversary of Columbia University; as the guest of Colone Arthur S. Dwight, a former Trustee of the University, he will attend the alumni dinner.

On Dr. Van Hecke's arrival in New York October 21st he was taken to the Edison celebration at Menlo Park as the guest of Doctor Edward Dean Adams, Past-President of the Edison Pioneers and Honorary Member of Engineering Foundation. Doctor Adams was also Chairman of the Louvain Library War Memorial to American Engineers. On the evening of October 22nd Doctor Van Hecke was the guest of honor at a dinner given at the Century Association by Alfred D. Flinn, Director of Engineering Foundation and Secretary of the War Memorial Committee, for members of the Committee and delegates to the dedication of the Library.

Professor Van Hecke is assisting also in developing American interest in the Steel Construction Congress to be held in Liege, Belgium, the latter part of the summer of 1930. The American Society of Civil Engineers and the American Institute of Steel Construction will participate in the Congress through the attendance of delegates and the presentation of papers and addresses. This Congress is a part of the celebration of the 100th anniversary of Belgian independence.

American Committee World Power Conference

The American Committee of the World Power Conference will give a dinner in honor of Doctor O. von Miller, Honorary President of the Second World Power Conference, Saturday, December 7th, at the Metropolitan Club, New York City.

Doctor von Miller is in the United States to discuss plans with prominent engineers and business men for the participation of this country in the World Power Conference to be held in Berlin, June 16-25, 1930.

Mr. Henry J. Pierce, Vice-Chairman of the American Committee, is in charge of arrangements here for the entertainment of Doctor von Miller, who is a Director of the Allgemeine Elektrizitäts Gesellschaft, and the founder and organizer of the German Museum for natural and technical science in Munich.

Special Symposium at American Mathematical Society Meeting

Among the special features of the Thirty-Sixth Annual Meeting of the American Mathematical Society to be held at Lehigh University, Bethlehem, Pennsylvania, December 26-28, 1929, are two sessions devoted to an Engineering Symposium with some of the most distinguished research engineers participating. The general topic chosen is *Differential Equations of Engineering* and it is proposed that at each of the sessions on Saturday three half-hour papers be given by men eminent in their respective fields. The following is a list of the papers proposed:

The problem of diffusion, Professor H. W. March, University of Wisconsin.

Integrals for differential equations, Professor Vannevar Bush, Massachusetts Institute of Technology.

Numerical integration of differential equations, Dr. T. H. Gronwall, Physics Department, Columbia University.

Plasticity and related problems of non-rigid bodies, Dr. A. Nadai, Westinghouse Electric and Manufacturing Company (formerly Professor of Applied Mechanics, University of Göttingen).

Analytic determination of flux plots, Mr. R. H. Park, Engineering Department, General Electric Company.

Problems in elasticity, Professor S. Timoshenko, University of Michigan (formerly with Westinghouse Electric and Manufacturing Company).

The meetings will be held in the new Packard Laboratory for electrical and mechanical engineering, a building which sets a new standard in equipment for teaching and research in engineering.

Following the Symposium on Mathematics in Engineering, on Saturday evening, December 28, there will be a conference on the general topic of the establishment of a Journal in Applied Mathematics.

New York Section Meetings of Illuminating Engineers

At the December 12th meeting to be held in one of the newer hotels in New York City, The Modern Trend in Home Lighting will be discussed. Special arrangements are being made to make it of particular interest to the ladies, with an exhibit of some most recently developed types of equipment.

The January 9, 1930 meeting will be on Inspection of Novel Color Cove Lighting Installation in Main Ball Room at the Hotel St. George, Brooklyn, N. Y. F. J. Cadenas will demonstrate and explain the installation and M. Messner of Bing and Bing Corporation will speak on decorating with colored lighting versus paint and fabric.

STANDARDS

Symbols for Photometry and Illumination

A revision of the Symbols for Photometry and Illumination has been drawn up by a subcommittee of the Sectional Committee on Scientific and Engineering Symbols and Abbreviations working under the procedure of the American Standards Association. The present Section of the A. I. E. E. Standards No. 37, entitled "Illuminating Engineering Nomenclature and Photometric Standards" contains the list of symbols of which this report is a revision. No. 37 was prepared under the direction of the Illuminating Engineering Society and became an American Standard in 1925. The proposed revision was approved by the Board of Directors of the Institute, one of the sponsors at their meeting of October 18th. As soon as approval of the revision as an American Standard is obtained a revised edition of No. 37 will be issued.

Navigational and Topographical Symbols

A report on Navigational and Topographical Symbols has been submitted for approval by a subcommittee of the Sectional Committee on Scientific and Engineering Symbols and Abbreviations. This report is identical with the symbols covered by the chart "Standard Symbols Adopted by the Board of Surveys and Maps, United States of America," edition of 1925 except as follows: That the symbols for Aerial Navigation be superseded by those adopted by that Board in 1928; and that the abbreviations for use on military maps be omitted. The report of the subcommittee included some recommendations of a minor nature, particularly with regard to miscellaneous information shown on map. The report was approved by the Institute as one of the joint sponsors by action of the Board of Directors on October 18th. For details of report inquiry should be made through the headquarters of the American Standards Association, (Dr. P. G. Agnew, Secretary), 33 West 39th St., New

York, N. Y. Copies of the chart of Standard Symbols may be obtained through the U. S. Geological Survey, Washington, D. C. Price 40 cents.

National Electrical Code Approved

The 1929 edition of the National Electrical Code has been approved as an American Standard by the American Standards Association. The technical provisions of the new edition are not materially changed although certain new practises have secured recognition. Copies of the code can be obtained through the National Fire Protection Association, 109 Leonard St., New York, N. Y.

Protection of Electrical Circuits and Equipment Against Lightning

For a number of years, through the medium of a Sectional Committee organized under the procedure of the American Standards Association, the A. I. E. E. and the Bureau of Standards have been engaged in developing "Standards for Protection of Electrical Circuits and Equipment Against Lightning." The preliminary report of the Sectional Committee has just been published by the Department of Commerce as Miscellaneous Publication No. 95 of the Bureau of Standards. The protection of persons, buildings, oil tanks, etc., has been dealt with in the "Code for Protection Against Lightning" which is already an approved American Standard. Originally, it was intended that in addition to the material in this Code there should be additional facts dealing with the protection of power and railway circuits and equipment. Present practise in these fields has not however crystallized to the point where it is felt that definite standards could be set up. Nevertheless, the committee collected information as to methods of protection now in vogue and practises which have been found satisfactory. This preliminary report has therefore been issued not only to make available the material therein, but of presenting the present results for con-

sideration and criticism. Copies of the report may be purchased at a cost of 25 cents from the Superintendent of Documents, Government Printing Office, Washington, D. C.

Faraday Electromagnetic Centenary

Arrangements initiated by the Royal Institution for the celebration of the Centenary of Faraday's discovery of electromagnetic induction have already been announced. At a representative meeting held at the House of the Institution on February 5th, 1929 the formation of two committees was agreed to, and these committees are now at work. The first, consisting of representatives of the Royal Society, the British Association, and other scientific societies, as well as the Royal Institution, is concerned with the purely scientific aspects of Faraday's work in relation to the proposed celebrations; the second committee which has been called together by the Institution of Electrical Engineers consists of representatives of the principal organizations of those industries which have risen in the past hundred years upon the scientific foundation of Faraday's discoveries and is dealing with the industrial aspects of the celebrations.

The two committees are working in close cooperation; the preliminary discussions which have taken place indicate that the significance of the Centenary is very widely appreciated and that the celebrations are likely to arouse world-wide interest and support. The dates have now been fixed and the proceedings will commence in London on Monday, September 21st, 1931. Further, an intimation has been received from the British Association that their Centenary Meeting will be held in London during the week commencing September 23rd, 1931. These two Centenaries, with important electrical conferences and other events which are to take place about the same time, will thus conjoin to make the year 1931 a memorable one in this and every country where the genius of Faraday has borne fruit.

American Engineering Council

ANNUAL MEETING

It was decided that the annual meeting of American Engineering Council would be held in Washington, D. C., January 9-11, 1930.

A. E. C. MAPPING PROGRAM

Pursuant to the instructions of the Administrative Board of American Engineering Council, the Executive Secretary had conference with the Secretaries of Commerce and Interior and the Director of the Bureau of the Budget for the purpose of pointing out to them the need of an increased appropriation for the topographic and water resources work of the U. S. Geological Survey, and also for the Hydrographic Branch of the Coast and Geodetic Survey Branches. Those conferred with were keenly aware of the value of such work and the necessity of expediting it, and expressed a desire to do what they could to bring about an enlargement of the work.

Following an interview with Secretaries Wilbur and Lamont, President Hoover issued a statement saying that a program had been perfected by the Secretaries of Interior and Commerce under which topographic coast and geodetic surveys of the United States are to be completed within 18 years, instead of 20 years as originally planned. The program will be made effective in this year's budget. It is estimated that it will cost \$1,000,000 more annually to expedite the surveys. This would seem to indicate that the present administration is cognizant of the need of expediting the topographic survey program and that the provisions of the Temple Act are being taken seriously.

RECOMMENDS ENGINEERS FOR INTERNATIONAL JOINT COMMISSION

As a matter of policy, the question of securing engineering representation upon the International Joint Commission came up for consideration. Council voted to authorize and instruct the Executive Secretary to do what in his judgment seemed best to accomplish the appointment of civilian engineers on this Commission.

TWO-HUNDREDTH ANNIVERSARY OF BIRTH OF FIRST ENGINEER PRESIDENT

A special committee composed of Lieutenant-Colonel U. S. Grant, 3rd; Colonel C. H. Birdseye; Dean A. N. Johnson; Colonel D. H. Sawyer; A. G. Bruce, and J. C. Hoyt, have carefully studied the various projects offered as a possible means of engineering participation in the celebration of the two hundredth anniversary of the birth of George Washington, the first engineer President of the United States. This committee brought in four proposals, two of which received the endorsement of Council. The first was the endorsement of the Cramton bill (H. R. 26) which provides for the acquisition, establishment, and development of the George Washington Memorial Parkway along the Potomac from Mt. Vernon and Fort Washington to the Great Falls, and the acquisition of lands in the District of Columbia, and Virginia requisite to the comprehensive park and playground system of the National Capital. This bill embodies a broad and constructive vision of a park system which will place Washington in a most favorable position in comparison with great European capitals.

The Administrative Board voted that Council recommend to the engineering profession as an appropriate participation in the celebration of the two hundredth anniversary of the birth of Washington, and as a tribute to and memorial of Washington, the Engineer, that the profession undertake to repair sufficiently to preserve the structures of the so-called "Pawtowauck Canal," which canal is about one mile long, embracing five locks constructed under the personal supervision of Washington for the purpose of passing around the Great Falls of the Potomac River. The only structures now in existence known to have been the work of the first engineer President of the United States.

ST. LAWRENCE WATERWAY

The question of the St. Lawrence Waterway arose through consideration of S. J. Res. 37 and H. R. 733, the former proposing to state the position of the United States as endorsing the development of the St. Lawrence for ocean-going vessels, and the latter providing for a definite deep waterway for ocean-going vessels from the Great Lakes to the Atlantic by way of the St. Lawrence River and Welland Canal. Council favored these two bills in principle, and recommended the appointment of civilian engineers as well as Army engineers on the commission recommended by the two measures.

CONSULTING ENGINEERS FOR GOVERNMENT SERVICE

H. R. 4195 proposes to authorize the employment of consulting engineers for the Air Corps, Chemical Warfare, and Ordnance Departments. The maximum salary payable is \$50 per diem. Council endorsed the Public Affairs Committee's recommendation that the same action be taken in connection with this bill as with the bill of similar nature relating to employment of consulting engineers for reclamation work,—namely, that the bill be approved in principle but with the comment that the rates of compensation provided are not those at which competent consulting opinion is obtainable—and if secured by the Government at the rates provided in the bill, it will be at the personal sacrifice of those accepting them.

STUDY OF AIRPORTS CONSIDERED

The Committee on Research recommended that Council make a cooperative study with the Bureau of Aeronautics, Department of Commerce, on the subject of airports. This recommendation was given careful consideration by a special committee composed of O. H. Koch, H. E. Howe, George T. Seabury, R. C. Marshall, Jr., J. L. Harrington, which recommended "that a committee be appointed to confer with the Bureau of Aeronautics to work out a plan whereby the Bureau and American Engineering Council may cooperate in formulating a report for the general information and guidance of public bodies into the diversibility and importance of engineering problems in the design of airports." This recommendation was adopted by Council.

ADVISORS FOR ROSENWALD MUSEUM

Walter Kaempffert, Director of the Rosenwald Industrial Museum of Chicago, has requested Council's cooperation in the establishment of this museum. The Administrative Board approved the Executive Committee's recommendation that Council accept the invitation of the officers of the Rosenwald Museum, and designate one or two advisors for the Museum's board of directors.

RELIEF OF ENGINEERS FROM DUTY WITH COMBAT FORCES

Secretary of War James W. Good recently in a letter to Congress requested that the President be empowered to exempt officers of the Corps of Engineers, Medical Corps, Ordnance Department, and Chemical Warfare Service from the provisions of the section of our National Defense Act requiring periodic duty with troops of one or more of the combatant arms. Mr. Good's recommendation has been referred to the House Com-

mittee on Military Affairs and a bill has been introduced into the Senate (S. 1883) carrying the provision requested by the administration. Secretary Good pointed out that in view of the increasing responsibilities of the Corps in connection with flood control projects and river and harbor works, and because of the increasing need for unbroken administrative direction in particular projects, that it would serve the public interest to permit the assignment of engineer officers to public works for such periods as necessary to complete them. Ordinarily such details would not extend beyond the four-year period and very few officers would be affected. Furthermore the proposed legislation would be without cost to the Government. The advantage of securing continuity of administration in the large civil projects entrusted by Congress to the Corps of Engineers would, in the opinion of the Secretary of War be a substantial one. This is exactly the contention which representatives of American Engineering Council have continually made to Congress in hearings on the question of the establishment of a Department of Public Works.

PLEA FOR FOREST CONSERVATION

A delegation of individuals representing organizations interested in forest conservation called on President Hoover October 30 and presented a plea for increased appropriations for forest conservation work. The delegation was headed by George D. Pratt, President of the American Forestry Association. American Engineering Council was represented by L. W. Wallace, Executive Secretary.

Mr. Pratt, speaking to President Hoover on behalf of the delegation said, "These laws cannot become effective unless the appropriations authorized are granted by the Bureau of the Budget, the laws to which I refer are; 1. The Clarke-McNary Act with authorized appropriations of \$2,700,000; 2. The Woodruff-McNary Act, with authorized appropriations of \$8,000,000; unappropriated balance \$4,000,000. 3. The McSweeney-McNary Act, with authorized appropriations of \$3,575,000."

PERSONAL MENTION

ROBERT J. HANCHETT has recently organized the Southern Electric Works, Inc., 1167 East 63d Street, Los Angeles, California, of which he is President and Consulting Electrical Engineer.

E. P. DILLON has just been made Vice-President in Charge of Sales of the E. Y. Sayer Engineering Corporation, New York, N. Y. Previously Mr. Dillon was Manager of the Research Corporation.

M. A. MULVANY has resigned the position of Radio Engineer (civilian) with the Navy at Pearl Harbor, to become Chief Engineer and Director of Radio for the Advertising Publishing Co. Limited, of Honolulu, T. H.

SYLVAN HARRIS, identified with radio engineering for nearly ten years, has joined the engineering staff of Fada Radio, and has been assigned by F. A. D. Andrea, President of that company, to special research work in the Fada Laboratories in Long Island City.

D. MCFARLAN MOORE, Fellow of the Institute and Research Engineer of the General Electric Company on November 5th delivered an address on Gaseous Conduction to a very much interested audience at the Lehigh University Chapter of the Society of the Sigma Xi, of which is a member.

EDWARD B. NEWILL, of Forest Hills, has resigned as manager of the Control Engineering Department of the Westinghouse Electric and Manufacturing Company to become affiliated in an executive capacity with the radio manufacturing company being formed jointly by the General Motors Corporation and the Radio Corporation of America. Mr. Newill entered upon his new position October 16, under the title of assistant to the President of Deleo Products Company, with temporary headquarters at Dayton, Ohio.

Death of Honorary Secretary Pope

RALPH WAINWRIGHT POPE, pioneer member of the Institute, elected its Secretary in 1885 and for twenty-seven years consecutively thereafter, died November 1, 1929 at his home in Great Barrington, Massachusetts. Although in his eighty-fifth year, he had apparently been in good health and the end came suddenly of heart failure.

Great Barrington, where he spent most of his life, was also his birthplace, his rudimentary schooling being acquired in the little old red schoolhouse there. In the autumn of 1857 he left the local school to attend the academy at Amherst, but ill health overtook him and he left the Amherst Academy to enter the North Amherst district school. He always learned quickly and was a pupil of good application, but because of sickness he dropped behind his classes and finally returned to Great Barrington, where he completed his school life at the age of thirteen.

The nature of his future undertakings was strongly evidenced in his childhood amusements; mechanism fascinated him and he created quite a monopoly on the small wheels from the carts of the children with whom he played, building with these spare parts, waterwheels, miniature railroads and various other experimental structures of mechanical nature. From one of his mother's plaster bonnet blocks he made a mold for more cartwheels, pouring into it melted lead and building up quite a local activity among his playmates.

Upon his return to Great Barrington, he found his brother in charge of the local telegraph office. This offered a marvelous place in which to spend all his spare time, picking up a knowledge of telegraphy and unwittingly laying the foundation upon which his future career was built. Theodore M. Chapin, local station agent for the Housatonic Railroad, was without an assistant and took great interest in the boy, teaching him many phases of the railroad's activities and acquiring such faith in his ability to do that when the company was in need of a man, Ralph Pope was heartily recommended to Mr. Hunt, the assistant superintendent; at the age of fifteen he became telegrapher for the Housatonic Railroad Company. From that time he was continuously identified with electrical engineering work. The company sent him to the Bridgeport office, but he was returned to the Great Barrington office to meet an emergency situation arising in the service there.

The Hughes receiving instrument upon which Mr. Pope learned had now been changed to a Morse, but he easily accomplished the changeover in operation and was soon known as an "expert sound receiver." Consequently at the outbreak of the Civil War when dependable and competent operators were at a premium he was well qualified to offer his services and he was promptly installed in the New York office of the American Telegraph Company. The volume of work involved in the sending and receiving of war news was almost unlimited; close confinement was again telling upon Mr. Pope's health and much of night work with long hours was being pressed upon him. He was then

twenty-two years of age and was on the verge of giving up; but the scarcity of operators impelled him to continue. He was, however, transferred shortly to the New Haven office and then to Providence at a good increase in salary.

In 1865 he joined the Collins overland telegraphic expedition, a famous pioneer band whose ambition it was to establish a through service to Europe by way of Alaska and Siberia. Mr. Pope went with them into the wilds of British Columbia in true pioneer fashion, sailing for San Francisco in April of that year and proceeding at once to Victoria, B. C. Final preparation for the pioneer life was completed at New Westminster. The party traveled up the Frazer River, sleeping in the open much of the time with nothing but their blankets for shelter, traveling sometimes on foot, sometimes on mules, pulling their boats after them on

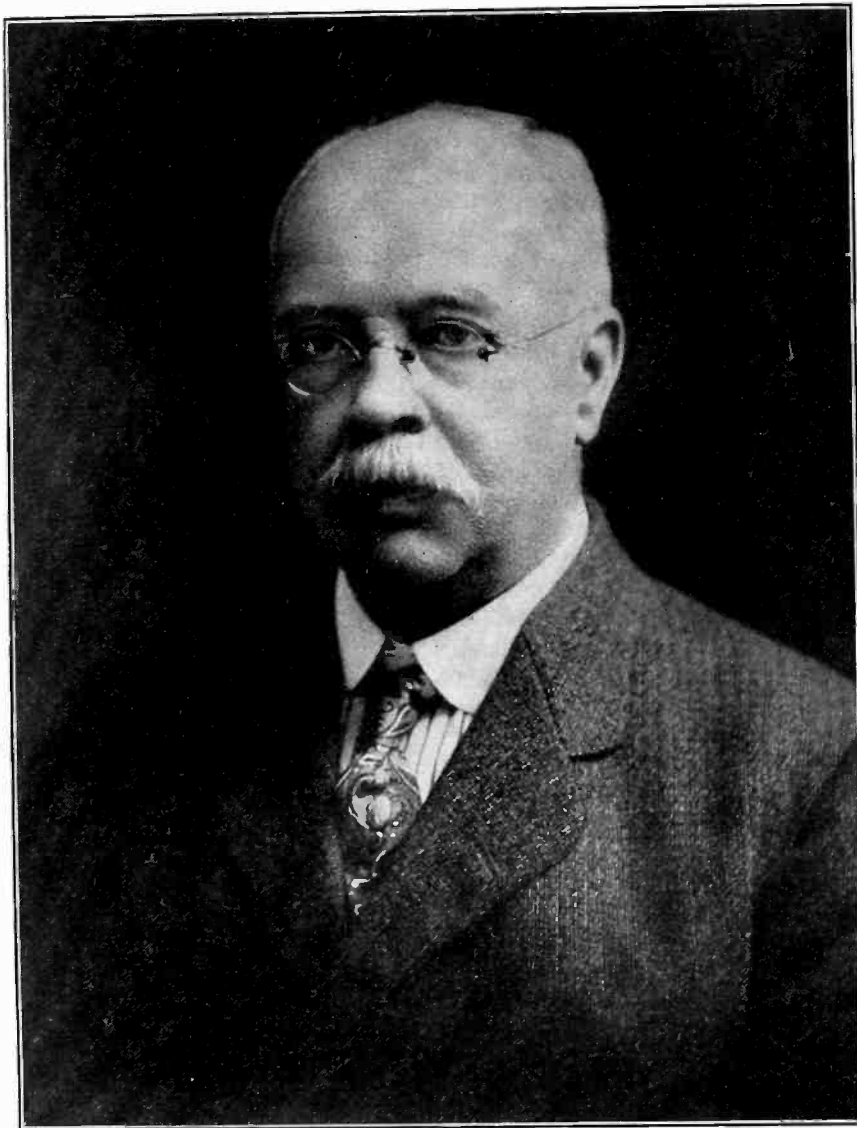

RALPH WAINWRIGHT POPE

land that they might have them for the necessary fording of the stream in other sections. There is no truer test of adaptability than that imposed by such an adventure and through the entire experience this key-note of all Mr. Pope's life was characteristically demonstrated. Further effort of this expedition was finally abandoned with the successful laying of a transatlantic cable replacing the necessity which they were striving to meet.

For ten years subsequent Mr. Pope was in the service of the Gold and Stock Telegraph Company, resigning a position as its deputy superintendent in 1883 and until 1888 becoming actively interested in the editing and publication of technical electrical journals. He was associate editor of *The Telegrapher* and *The Electrical Engineer*, and editor of *Electric Power*, which he founded.

Under the energy and tact of his part time secretarial administration the Institute made rapid and important strides in its development and in 1887 he was persuaded to devote practically all of his time to its activities and interests. Constantly studying the needs of its progression and ever watchful of opportunity to recommend or endorse the adoption of methods to improve its work of cooperation in any advancement of the profession and general good of humanity, he labored unceasingly and diligently. The office of Secretary was an elective one and perhaps the greatest tribute paid to the worthiness and steadfastness of Mr. Pope's character lies in his repeated reelection by a membership vote. His clear conception of detail, painstaking, orderly methods and, withal, a genial and sympathetic spirit, endeared him to all and earned for him the gratitude and affectionate appreciation not only of the directors and members of the Institute but that of the multitude of other friends and fellow workers with whom his full and active life brought him in contact. He relinquished his active work as Secretary of the Institute in 1911, and was their appointed Honorary Secretary for life.

It was at his suggestion that the Institute's Sections were developed. Past-President Professor Charles F. Scott describes this epoch-making period of the Institute's history in brief as follows:

"In the spring of 1902 while the vote for President of the Institute was being canvassed, Secretary Pope said to me, 'Mr. Scott, it seems pretty certain that you will be the next President and I want to suggest that this will be an opportune time to develop local meetings of the Institute. There are now such meetings in Chicago, and they were held for a time by the St. Paul-Minneapolis group. This is an enterprise which I have been considering for a long time but have not received active support. It seems to me that you might take up the extension of local meetings during your administration.' I replied that I would vigorously support his proposal, as it was a practical means of expanding institute activities geographically; it would extend to distant members the new interest and impetus which Doctor Steinmetz (then President) was giving to the monthly meetings in New York. The appointment of a committee on local organizations was made at the first meeting in the fall and at my suggestion this committee was authorized to establish Student Branches as well as Sections among the Institute members. While President and committees gave support to the project, it was the enthusiasm and indefatigable interest of Secretary Pope that was one of the strong contributing factors in the development of the Sections and Branches which have so amply justified the vision and efforts of the faithful Secretary who served the Institute during its first quarter of a century."

Obituary

John William Lieb, senior Vice-President of the New York Edison Company and an outstanding worker in the electric public utility field, died at his home in New Rochelle, New York, November 1, 1929, after an illness of several weeks.

Mr. Lieb was the Institute's President 1904-1905. Throughout his life he played an important part in organization and execution in electrical and allied fields. He was born in Newark, New Jersey in 1860 and in 1880, was graduated from Stevens Institute of Technology. Almost immediately he took a position as draftsman with the Brush Electric Company in Cleveland, but after a few months of service, he joined the Edison Electric Light Company of New York, becoming assistant in the Engineering Department. He showed high executive ability, and evidently impressed Mr. Edison at once, for he was soon doing important work in planning the pioneer task that lay ahead of the company in supplying the city with incandescent lighting and other forms of electric power. Following the erection of the Pearl Street Station, he worked with Mr. Edison in the subsequent tests of its use and the inauguration of its service. On September

4, 1882 he was appointed first electrician of the company. So thorough and representative was Mr. Lieb's work that in 1883 Mr. Edison selected him as the man to go to Milan, Italy, to supervise the erection and operation of the station for the Italian Edison Company, as Director of the Società Generale Italiana di Elettricità Sistema Edison, and for his work in introducing the use of electricity into Italy, he was made Knight Commander of the Royal Order of the Crown of Italy, in which he was later promoted to a Grand Officer. He was also made an officer of the French Legion of Honor.

At the invitation of the President of the Edison Electric Illuminating Company, Mr. Lieb in 1894 returned to New York as Assistant to the Vice-President. He was then made Vice-President and General Manager of the Company, and when the New York Edison Company was organized, he became Associate General Manager with the late Thomas E. Murray, eventually to occupy the office of Vice-President and General Manager. Last year, when the Brooklyn Edison was brought under the control of the Consolidated Gas Company—owner of the New York Edison and associated electric companies in the metropolitan district—with Mr. M. S. Sloan as President of the com-



JOHN WILLIAM LIEB

combined electric properties, Mr. Lieb retired from the more active duties of management to become Senior Vice-President.

The Edison Medal was awarded him in 1923 "for the development and operation of electric central stations for illumination and power." He was a pioneer in the field of technical education, writing and lecturing extensively himself and owning perhaps one of the most comprehensive private libraries in existence. He is accredited with having the largest collection dealing with the work of Leonardo da Vinci ever made and for many years he was engaged in investigating and translating text of da Vinci research in natural science and engineering. (Through his membership in the *Raccolta*), of which he was a correspondent, many of these translations were transmitted to Italy and republished.

During the war period, Mr. Lieb as Chairman of the National Committee on Gas and Electric Service rendered valuable national service. He was also President and Chairman of the Board of the Electrical Testing Laboratories, Vice-President of the Electric Light and Power Installation Corporation; former President of the Edison Pioneers, the New York Electrical Society, and the National Electric Light Association. Besides his office as such in the New York Edison Company, he held directorship in the Yonkers Electric Light and Power Company, the United Electric Light and Power Company, the New York and Queens Electric Light and Power Company, the International

Power Securities Company, the Brush Electric Illuminating Company and the Empire City Subway Company. He was a Past-President of the American Society of Mechanical Engineers, a Fellow of the American Academy of Sciences, trustee of the Stevens Institute of Technology; trustee and Vice-President of the The Museums of the Peaceful Arts; trustee of the United Engineering Society and the Italy-America Society; and a member of the American Society of Civil Engineers, the Illuminating Engineering Society, Franklin Institute of Philadelphia, American Association for the Advancement of Science, and numerous other professional and civic organizations, national and local. He was an honorary member of the Society of Italian Engineers and Architects, and of the Society of Italian Railway Engineers; Vice-President of the Union Internationale des Producteurs et Distributeurs d'Energie Electrique; and a member of the Elektrotechnischer Verein, the Associazione Elettrotecnica Italiana, the Institution of Electrical Engineers of Great Britain, the Royal Society of Arts, and the Newcomen Society of London. In 1921 Stevens Institute conferred upon him the honorary degree of Doctor of Engineering.

Mr. Lieb's strong personality and vigorous leadership will be greatly missed in the many activities in which he was collaborative.

Guido Semenza, one of the best internationally known electrical engineers and Honorary Secretary for the Institute in Italy, died November 7, at Milan, after a protracted illness. His passing will be mourned by a host of friends to whom he had endeared himself by his intellectual ability, lovable character and charming personality.

He was born December 19, 1868 in London of Italian parentage. As a child he returned to Italy with his parents where his early education and classical studies began, and in 1893 he was graduated an Industrial Engineer (Electrical Section) from the Royal Polytechnic of Milan. Subsequently he received another degree in electrical engineering at the Institute Montefiore in Liege. The following year he became associated with the Milan Edison Company, later becoming its technical director.

In 1895-1896 he directed the construction of one of the pioneer hydroelectric developments, the Paderno Plant on the Adda, transmitting power to the City of Milan, and in that connection as a result of his keen analysis of the economics of transmission, he developed the "A" type of towers.

While engaged in central station work he made many contributions to the development of the art of power transmission and distribution. His progressive ideas and sound judgment attracted the attention of engineers and utility executives not only in Italy but in other countries, and the call for engineering advice on many new important projects led Mr. Semenza to leave the employment of the Milan Edison Company and open a consulting engineering office. Since then, Mr. Semenza was retained in a consulting capacity by innumerable private and public undertakings in all branches of electrical applications, including power generation, telephony, traction, etc. Some of his work was in foreign countries, making business connections with important engineering firms abroad, such as Merz & McLellan. During this time he also served as a member of the Board of Directors of many electrical companies.

In 1923 he succeeded in enlisting the necessary support to reorganize the company known as the C. G. S. (formerly Olivetti). He became its president, and in a very few years it reached a high degree of prosperity, becoming the largest manufacturer of electrical meters and instruments in Italy.

Outside of these professional pursuits, Mr. Semenza was a most devoted worker in all activities affecting the intellectual and industrial development of electrical associations in Italy and throughout the world. The transactions of engineering associations and congresses as well as technical periodicals are replete with his articles, discussions, and contributions, characterized by profundity of thought and clearness of expression.

He was President of the Associazione Elettrotecnica Italiana,

to which he gave unsparingly of his time and ability, and a member of numerous foreign societies.

He was also one of the founders of the International Electro-technical Commission, to which, since its inception, he had given generously of his time and advice. From 1923-1927 he served as its President and as such he presided at the convention in New York two years ago.

To Mr. Semenza for his persistent work and unexcelled, tactful handling of the many questions arising before that organization, the I. E. C. owes a great debt of gratitude.

Mr. Semenza was the type of a great engineer endowed with the most propitious aptitude for scientific studies and industrial activities, to both of which he contributed abundantly on the one hand, by evolving keen synthetic analysis of arduous scientific questions and on the other by directing and promoting industries. He aimed constantly at results without consideration of material interests.

Both from Italy and foreign governments and associations, Mr. Semenza received innumerable decorations and testimonials of recognition and esteem, but perhaps the most cherished to him must have been the award last spring of the Faraday Medal by the British Institution of Electrical Engineers. The recipients of the medal in the order of award are: Oliver Heaviside, Sir Charles Parsons, Dr. S. Z. de Ferranti, Sir J. J. Thomson, Colonel R. E. B. Crompton, Dr. Elihu Thomson, Professor J. A. Fleming, Guido Semenza. The year previous he was made an officer of the French Legion of Honor.

Henry A. Coles, District Manager of the Westinghouse Electric and Manufacturing Company's branch at Atlanta, Georgia, died October 27 at the Roosevelt Hotel, New Orleans. He was 63 years old and moved to Atlanta 30 years ago from Niagara Falls, where he was Sales Engineer for the Westinghouse Company.

Mr. Coles was born at Tallwood, Va., and attended Roanoke College. He was graduated from the University of Virginia in 1891. For a year he was associated with the Edison General Electric Company in Schenectady, resigning in 1892 to join the Westinghouse Company. Mr. Coles joined the Institute as an Associate in 1904 and advanced to Member in 1913.

Francis A. J. FitzGerald, Consulting Electrical Engineer of the FitzGerald Laboratories Inc., Niagara Falls, N. Y. and former President of the Electrochemical Society, died of pneumonia October 26 at his home in Niagara Falls, N. Y. He was born in Dublin, Ireland, June 1, 1870, his first education being in a private school; later in attending public school at Uppingham, England. In 1892 he obtained a degree of B. A., moderatorship and medal in Experimental Physics and Chemistry at Trinity College, Dublin University, Dublin, Ireland. He then came to this country and earned his B. S. in Electrical Engineering at the Massachusetts Institute of Technology. In 1895 he engaged with the Carborundum Company of Niagara Falls in charge of the Electric Furnace and Chemical Departments and in Research Work; in 1903 the FitzGerald and Bennie Laboratories were organized with Mr. FitzGerald Consulting Engineer. This work included design, construction and operation of the induction furnace plant of the American Electric Furnace Company as well as many other important plants for the Cartner Electrolytic Alkali Company, the National Carbon Company and others. Mr. FitzGerald assisted in organizing the Acheson Graphite Company and in perfecting the graphite process; also aiding Doctor Acheson in other discoveries relating to graphite. He was a charter member of the Niagara Club. He became a Member of the Institute in 1914.

Walter H. Millan, Superintendent of Substations of the Union Electric Light and Power Co., died at his home at St. Louis, Mo. on November 13, 1929, at the age of 40. Mr. Millan was born at St. Louis, Mo. and was educated in the public and night schools of that city. In addition, he studied Electrical Engineering through the I. C. S. He began his service with the Union Electric Light and Power Co. in 1903 and has been a pioneer in the

development and application of automatic switching equipment for Edison systems and a-c. substations. Mr. Millan was elected an Associate of the Institute in 1914, a Member in 1921 and a Fellow in 1927. His interest in the Institute has been active and continuous. He served as Chairman of its Automatic Stations Committee in 1927 and 1928 and was a member of this committee in 1929. He served as Chairman of the St. Louis Section in 1927. In contribution to technical literature, in addition to various articles in the *Electrical World*, he has presented several papers before the Institute.

At the time of his death Mr. Millan was a member of the Engineers' Club of St. Louis; he was a Past Master of Pilgrim Lodge A. F. & A. M. No. 652 of St. Louis and a 14th degree Scottish Rite Mason.

Robert Meredith Searle, an Associate of the Institute since 1909 and President of the Rochester Gas & Electric Company, Rochester, N. Y., died at his home in that city November 13.

Mr. Searle was born at Peekskill, New York, March 3, 1869, he was educated, however, in the New York City schools. Ever since 1885 he had been in the gas and electric business, serving in almost every capacity from stationary engineer to president. Practical work in the engineering profession, with studying night and day, gave him high capability. His first work was as an office boy for Thomas A. Edison. Then he went to Philadelphia with the United Gas Improvement Company where his advancement was so rapid that before leaving to become foreman for the Consolidated Gas Company Plant in New York City, he had had charge of a number of plants as superintendent and engineer. Later he returned to the United Gas Company as Superintendent of its various plants and still later became operating executive of the Westchester Lighting Company at Mount Vernon, New York. In 1906 he was appointed General Manager of the Rochester Railway and Light Company, at that time controlled by the Andrews-Vanderbilt interests. The Rochester Gas and Electric Corporation grew out of this company, and Mr. Searle was advanced to the vice-presidency and ultimately to the presidency of the new company; in this office he remained the unanimous choice of holding concerns which subsequently controlled it. He also took a leading part in civic affairs and was at one time President of the Rochester Chamber of Commerce. In 1922 he became a member of an advisory committee to assist the Public Service Commission in aiding State public utilities to obtain coal during a strike period, and later became Fuel Administrator for the Western District of New York. For the past eight years he has worked on the problem of electrification of the New York Central's lines from New York to Buffalo, his ability in finance qualifying him to represent the railroad in this connection as well as from the electric power point of view. At the time of his death he was President and Director of the Rochester Gas and Electric Corporation, the Mount Morris Illuminating Company, the Mount Morris Water Power Company, the Genesee Gas Light Company, the Caneadea Power Corporation, the Hilton Electric Light, Power and Heat Company and the Cooper Electric Corporation. He was also a Director of the Rochester Security Trust Company.

Arthur C. Scott, Consulting Engineer of Dallas, Texas, and a Member of the Institute since 1917, died in that city, at the age of 56. He was a native of Belmont, N. Y., received his degree of B. S. from R. I. College of A. & M. Arts in 1895, Mechanical Course; attended the summer courses at Harvard, Cornell, Massachusetts of Technology and the University of Wisconsin, in Physics, Geology and Electricity. From the University of Wisconsin in 1902 he received his Ph. D. degree in Electrical Engineering, Physics, and Geology. After his graduation from R. I. College in 1895 he had charge of the Departments of Physics and Electrical Engineering and from 1897, of the college lighting plant. His work in the development of the Department of Electrical Engineering at the University of Rhode Island was representative and most efficient; he also spent some time at the

University of Ohio. He developed a number of principles bearing upon the operation of single-phase a-c. motors after he was professor in charge at the University of Texas, and in each instance he did excellent work. Professor Scott was a member of the Institute's Dallas Section.

A. I. E. E. National and District Prizes

The following National and District Prizes may be awarded each year:

National Prizes

1—FIRST PRIZES

Engineering Practice

Theory and Research

Public Relations and Education

2—PRIZE FOR INITIAL PAPER

3—PRIZE FOR BRANCH PAPER

1—The NATIONAL FIRST PRIZE in each of the three classes; namely, *Engineering Practice*, *Theory and Research* and *Public Relations and Education*, consisting of \$100.00 and a certificate, may be awarded to the author or authors of the best original paper presented at any National, District, or Section Meeting of the Institute.

2—The NATIONAL PRIZE FOR INITIAL PAPER, consisting of a certificate and \$100.00 in cash, may be awarded to the author or authors of the most worthy paper presented at any National, District, or Section meeting of the Institute provided the author or authors have never previously presented a paper which has been accepted by the Meetings and Papers Committee.

3—The NATIONAL PRIZE FOR BRANCH PAPER consisting of a certificate and \$100.00 in cash, may be awarded to the author or authors of the best paper based upon undergraduate work presented at a Branch or other Student meeting of the Institute, provided the author or authors are members of a Student Branch.

District Prizes

The following District Prizes may be awarded each year in each Geographical District of the Institute.

1—FIRST PRIZE

2—PRIZE FOR INITIAL PAPER

3—PRIZE FOR BRANCH PAPER

Each District Prize shall consist of a certificate of award issued by the officers of the Geographical District, and \$25.00 in cash. It may be awarded only to an author or authors who are located within the District, and for a paper presented at a meeting held within or under the auspices of the District.

1—The DISTRICT FIRST PRIZE may be awarded for the best paper presented at a National, District or Section meeting.

2—The DISTRICT PRIZE FOR INITIAL PAPER may be awarded for the best paper presented at a National, District or Section meeting, the author or authors of which have never before presented a paper before a National, District or Section Meeting of the Institute.

3—The DISTRICT PRIZE FOR BRANCH PAPER may be awarded for the best paper based on undergraduate work presented at a Branch or other Student Meeting of the Institute, the author or authors of which are members of a Student Branch.

The conditions of award of the various National and District Institute Prizes have been printed in pamphlet form, and during the month of October, a copy of this pamphlet was mailed to all District and Section officers and to the Counselors of all Student Branches.

Attention is directed to the fact that the conditions require that all papers presented during the calendar year 1929 and to be offered in competition for the National Prizes, must be received in triplicate at National Headquarters in New York on or before February 15, 1930. These papers may be submitted by the author or authors, by an officer of the Institute, or by the executive committees of Sections or Geographical Districts.

Papers to be considered in competition for District Prizes

should be submitted in duplicate by the authors or by the officers of the Branch, Section, or District concerned, to the District Committee on Awards, on or before January 10, 1930.

Any author or other member who is interested may obtain full information from the local Section or Branch officers, or by addressing Institute Headquarters, at New York.

A. I. E. E. Section Activities

POWER GROUP OF NEW YORK SECTION MEETS DECEMBER 9

The second meeting of the Power Group of the New York Section for this year will be held Monday evening, December 9, 1929 to 7:30 p. m. on the fifth floor of the Engineering Societies Building, 33 West 39th St., New York, N. Y.

The subject "System Connections" will include generally the various methods used for connecting systems with particular reference to the operation of the "synchronized-at-the-load" system in New York City. There will be three speakers; A. E. Powers, Westinghouse Elec. & Mfg. Co. will describe the general conception of stability both static and transient; I. H. Somers of the General Electric will present a paper dealing with the ring bus, the synchronizing bus, double windings, and the newer scheme, "synchronized-at-the-load." The third speaker, T. Maxwell, of the United Elec. Lt. & Pr. Co. will give a résumé of operating experience with the "synchronized-at-the-load" connections. There will be ample time for open discussion. To permit commuters to get an early train home, the meeting will adjourn at 9:30 o'clock.

NEW YORK SECTION TO GET STATISTICS ON "HOW MUCH LIGHT"

For a number of weeks an informal committee organized at the instance of the New York Section of the A. I. E. E. has been at work assembling statistics of artificial lighting in the United States with the idea of preparing an estimate of the country's "saturation" in artificial light similar to the well-known estimates of saturation for household electric appliances, etc. Not only have the statistics of the industry and of the country been collected and studied but a painstaking effort is being made to establish, on purely physiologic grounds, the lighting levels which constitute the minimum for satisfactory eye work and the optimum for average eyes under ordinary working conditions. A summary of this data, expected to be of great interest in outlining expansions and other future plans for the lighting industry, will be presented at the meeting of the New York Section of the A. I. E. E. to be held at the Westinghouse Lighting Institute, Grand Central Palace, 480 Lexington Avenue, New York City, at 8:00 p. m. on Wednesday evening, December 18, 1929.

The speakers who will present this subject are: Arthur E. Allen, Vice-President of the Westinghouse Lamp Company and E. E. Free, Consulting Engineer. Two other speakers of prominence may be added.

After the meeting, guides will be provided and opportunity will be given for members to inspect the exhibits of the Westinghouse Lighting Institute.

As the auditorium at the Lighting Institute seats but 450, admission to the meeting will be placed on a ticket basis, each member being entitled to one ticket only. Full details will be given in the notice to be mailed to the Section membership during the first week of December.

FUTURE SECTION MEETINGS

Akron

December 13, 1929. *Railway Electrification*, by J. V. B. Duer, Electrical Engineer, Pennsylvania Railroad Company.

January 10, 1930. *The Problem of Public Transportation in Akron*, by L. G. Tighe, Assistant General Manager, Northern Ohio Power and Light Company.

Boston

December 10, 1929. *The Technique of Color and Talking Motion Pictures*, by H. L. Danson of the R. C. A. Photophone Corp. and Dr. L. T. Troland of the Technicolor Motion Picture Corp. Buffet supper at 6:30 in North Hall, M. I. T.

Cleveland

December 12, 1929. *Anti-Aircraft Artillery*, by Major G. M. Barnes, Ordnance Department, United States Army.

January 16, 1930. *Electricity and the Universe*, by David Dietz, Scientist and Author.

Detroit-Ann Arbor

December 10, 1929. *Power House Design*, by Alex Dow, President The Detroit Edison Company. Inspection trip through the New Delray Power House in the afternoon. Joint meeting with the Detroit Engineering Society at the Detroit Edison Auditorium.

January 21, 1930. Ladies' Night. *Motoring through Europe*, by Professor A. H. Lovell, Electrical Engineering Dept., University of Michigan, Ann Arbor, Michigan.

Lynn

December 4, 1929. Technical Lecture by H. D. Brown (*Mercury Arc Rectifiers*).

December 18, 1929. Popular Lecture.

January 29, 1930. *The Mysteries of Science*, by Harry C. White.

Pittsburgh

December 10, 1929. *Latest Developments in Supervisory Control*, by R. J. Wensley, Westinghouse Elec. & Mfg. Co., Mansfield, Ohio.

January 10, 1930. Dinner meeting. Professor Harold B. Smith, President, A. I. E. E., "The Quest of the Unknown". English Room, Fort Pitt Hotel.

NEW YORK SECTION POWER, TRANSPORTATION AND COMMUNICATION GROUPS MEET

On the evening of Wednesday, October 30, 1929, the Power Group opened the meeting year of the New York Section with a session held in the Engineering Societies Building, 33 West 39th Street, New York. George Sutherland, Chairman of the group and Assistant General Superintendent of the New York and Power Company, presided. About 250 members and guests attended.

The general subject of the meeting was: "Generation and the Development of Generators." Two speakers covered the topic as follows: H. C. Forbes, of the New York Edison Company, delivered a paper dealing with the high lights of generator development in the last few years, including the double-winding generator, hydrogen cooling, and the probable future trend in generation and generators as viewed from the standpoint of the operating engineer. The other speaker was C. M. Gilt of the Brooklyn Edison Company. He described the economic aspects of the situation, particularly the advantages of large units and the probable trend in generation and construction,—a discussion participated in by a number of members followed.

On Monday night, November 4, 1929, the Transportation Group held its first meeting. There was an attendance of about 100. The meeting was opened by C. R. Jones of the Westinghouse Electric & Mfg. Company, who called for the report of the Nominating Committee. This was read, and a group of officers

lected which included C. R. Jones, Chairman, and Alfred G. Oehler, Editor of the *Railway Electrical Engineer* as Vice-Chairman. The first speaker, Guy C. Hecker, General Secretary of the American Electric Railway Association, gave a general outline of the developments in the electric railway field and the conditions existing in those fields. The second speaker was A. O. Austin, Control Engineer, Westinghouse Electric & Mfg. Company, who described the technical features of modern control apparatus and the attempt being made to develop street cars with greatly increased acceleration possibilities and more powerful motor equipments to meet modern traffic conditions. A discussion participated in by a number of members followed. The meeting closed with the showing of a very interesting two-reel talking motion picture on traffic conditions in general and in various cities. This picture was obtained through the courtesy of the R. C. A. Photophone and the American Electric Railway Association.

The Communication Group held its first meeting of the year on Wednesday night, November 13, 1929 in the Engineering Societies Building. R. H. Hughes, Chairman of the Group, Assistant Vice-President of the New York Telephone Company presided. The general subject of the meeting was, "Materials of Communication." Four speakers covered the subject, as follows: W. W. Brown of the General Electric Co., gave a talk on "Micalex." The second talk on "Copper Oxide" by I. R. Smith of the Westinghouse Elec. & Mfg. Co. dealt with the use and performance of that type of rectifier. "Developments in Communication Materials" was the subject of a talk dealing with insulating materials and metals, including duralumin, permalloy, brasses and bronzes given by W. Fondiller of the Bell Telephone Laboratories. In a talk entitled "Manufacturing Problems in Communication Materials" the last speaker of the evening, D. Levinger of the Western Electric Co., described the problems which have been developed through introducing some of the newer materials into the manufacture of communication apparatus. Lantern slides and movies illustrated the talks. Open discussion followed. Over 250 were in attendance.

NEW YORK SECTION MEETING ON "WONDERS OF SOUND TRANSMISSION" PROVES VERY POPULAR

On Friday, November 8, 1929, the New York Section of the Institute held its first general meeting of the year. Before an audience of about 1400, Sergius P. Grace, Assistant Vice-President of the Bell Telephone Laboratories, Inc., delivered a lecture-demonstration on the "Wonders of Sound Transmission." This meeting was one of the most popular ever held in the Engineering Auditorium as in addition to those who heard Mr. Grace, at least 500 were turned away. Chairman H. P. Charlesworth opened the meeting promptly at 8:00 p. m. and after a few brief announcements, turned it over to Vice-President H. A. Kidder of the New York District, who introduced the speaker. Then in an exceedingly entertaining manner Mr. Grace, as proof of the great practical value of scientific research, outlined some of the developments made in the Bell Telephone Laboratories. Among the modern marvels explained and demonstrated were the electric ear, scrambled speech, delayed speech, amplified muscle noises, the artificial larynx, and translation of mechanical impulses into speech. At the close of the meeting which was adjourned at 9:50 p. m., a very large number of the audience crowded to the stage to examine the exhibits and demonstration apparatus, and to question Mr. Grace.

FIRST POWER GROUP MEETING—CHICAGO SECTION

On Thursday October 17, the first Power Group meeting of the Chicago Section of the A. I. E. E. was held in the club rooms of the Western Society of Engineers.

Mr. R. C. Bergvall, General Engineer, Westinghouse Electric & Mfg. Company presented a paper on *Present Tendencies in Power Transmission*, special attention being given to the matter of system stability.

The meeting was attended by over 100 engineers who participated actively in the discussion. This is the first of a series of group meetings especially arranged to appeal to younger engineers; and the Chicago Section plans to start other similar groups on other subjects, such as communication and transportation, as soon as they can be organized and gotten under way.

PAST SECTION MEETINGS

Akron

Inspection trip to Ohio Box Board Company, preceded by dinner at United Brethren Church. Mr. Breakwood of that company gave a talk on the manufacture of their product. General discussion followed. October 17. Attendance 80.

Heavy Duty Mercury Arc Rectifiers by W. O. Marti, Chief Engineer of the American Brown Boveri Elec. Corp. Film "Arc Welding Steel Pipe" from the Lincoln Electric Co., Cleveland was shown. Supper at the Elks' Club preceded the meeting. November 8. Attendance 45.

Baltimore

A. C. *Distribution Network Systems*, by C. J. Brosnan, Engineer, Westinghouse Elec. & Mfg. Co. Chairman presented report on Conference of Officers and Delegates at Swampscott, June 1929, and Executive Committee meeting District No. 2 held in Pittsburgh, October 7. October 18. Attendance 125.

Inspection trip through the works of the Baltimore Copper Smelting and Rolling Company. A. S. M. E. members joined the A. I. E. E. members for this inspection. October 19. Attendance 75.

Boston

Inspection trip of the port facilities of the Boston Harbor on the City Steamship *Michael J. Perkins*. The trip was accompanied by Messrs. Davis and McSorley of the Boston Chamber of Commerce who gave information about the Harbor which was followed by a general discussion of possible improvements. October 5. Attendance 185.

Cleveland

Joint meeting with the Illuminating Engineering Society in honor of Edison's Golden Jubilee, preceded by dinner furnished by the National Lamp Works. Addresses by John C. Lincoln, Chairman of Board of Directors, Lincoln Electric Co. on *Edison and His Inventions*, and R. W. Shenton, Managing Editor "Light Magazine," *Tribute to Edison*. Meeting concluded with a cineograph of Edison's life. Previous to the dinner Chairman T. D. Owens reported to his Advisory Committee on the October 7 District meeting. October 10. Attendance 160.

Connecticut

Harry A. Haugh, Jr., Vice-President, Automatic Signal Corporation, gave an informal talk on traffic conditions, illustrated with demonstrations of several pieces of apparatus typifying street intersections, etc. Dinner preceded meeting at University Club. November 7. Attendance 45.

Denver

Dinner guests of the Mountain States Telephone & Telegraph Co., followed by an inspection of the new building of that company. October 18. Attendance 100.

Detroit-Ann Arbor

H. H. Green, National Lamp Works of G. E. Co., spoke on Light's Golden Jubilee. Joint meeting with the Illuminating Engineering Society. October 8. Attendance 200.

Erie

Talk by M. V. Wright of the Mutual Telephone Co. on telephone systems. Mr. Ramuling of the Erie Lighting Co. related his company's practise on power generators and transmission. Mr. Moore, Erie County Electric Co. gave a talk and demonstration on electric illumination. October 15. Attendance 50.

Fort Wayne

High Voltage Research in Cooperation with Industry, by Prof. C. Francis Harding, Purdue University. Discussion followed. Change in By-laws proposed and carried. October 30. Attendance 80.

Houston

Inspection trip to the Freeport Sulphur Company at Hoskin, Texas in the afternoon, then to the Bryan Mound Mine,

followed by a dinner at the Tarpoon Inn, Freeport, as guests of the Freeport Sulphur Co. A talk on the production of sulphur was given by E. L. Nims, Asst. General Manager of that company. October 26. Attendance 27.

Iowa

Committee appointments announced. James H. Foote, Stevens and Wood, Jackson, Michigan, presented his paper, *Problems of Interconnection*. This paper covered experiences with power systems in Michigan. October 28. Attendance 58.

Kansas City

Man's Progress in Terms of Light, by Professor O. D. Hunt, Kansas State Agricultural College, in honor of celebration of Light's Golden Jubilee. A short talk was given by J. F. Porter, President of the Kansas City Pr. & Lt. Co., an Edison Pioneer. Replicas of all types of lighting from the early olive-oil lamp to the present day Mazda presented. October 14. Attendance 92.

Lynn

First meeting of the Season held in recognition of Light's 50th Anniversary. Charles C. Pierce of the General Electric Co. who was in intimate contact with Mr. Edison for some years spoke on his accomplishments. Professor Thomson, Edison Pioneer, outlined the parallel but separated courses of development followed by the incandescent lamp and the arc lamp. Refreshments served. October 21. Attendance 141.

Today's Research—Tomorrow's Engineering, by L. A. Hawkins, Executive Engineer, General Electric Co. Research Laboratory. November 6. Attendance 120.

Mexico

Scott Lynn, Vice-President and General Manager of the Sangamo Electric Co. of Canada gave a lecture on *Electrical Metering Apparatus*. Elections and committee appointments announced. October 8. Attendance 27.

Annual Banquet at Hotel Mancera. October 19. Attendance 31.

Milwaukee

Meeting held in celebration of Light's 50th Anniversary. A. N. Brown, District Engineer, Westinghouse Elec. & Mfg. Co., talked on *Edison and His Achievements*, using slides to illustrate the steps in the development of the electric lamp and the illuminating effects possible with the modern electric lamp. History of Edison's life and his achievements reviewed by Mr. Brown. A. C. Langstadt read paper on the first central power station in operation at Appleton, Wis. A. R. Schmidt of Milwaukee enumerated experiences with the original Edison Company. Dinner preceded meeting. October 16. Attendance 150.

Minnesota

Wood Poles and Wood Preservation, by J. P. Wentling, Director Research Division, Western Red Cedar Association. October 28. Attendance 32.

New York

Power Group. Talks by H. C. Forbes of the New York Edison Co. and C. M. Gilt of the Brooklyn Edison Co. General meeting subject was *Generation and the Development of Generators*. October 30. Attendance 250.

Transportation Group. Guy C. Hecker, General Secretary of the American Electric Railway Association, gave a general outline of the developments in the electric railway field. A. O. Austin, Control Engineer, Westinghouse Elec. & Mfg. Co., described the technical features of modern control apparatus and attempts being made to develop street cars with greatly increased acceleration possibilities and more powerful motor equipment to meet modern traffic conditions. Two reel film on traffic conditions in various cities shown through the courtesy of the R. C. A. Photophone and A. E. R. A. November 4. Attendance 100.

North Carolina

Adoption of By-Laws. *Waterville Development of Carolina Power & Light Company*, by J. H. Paget, Supt. of Power, Carolina Power & Light Co., Raleigh, N. C.

New Era in Ship Propelling Machinery, by F. V. Smith, Federal and Marine Dept., General Elec. Co., Schenectady, illustrated with slides.

Hydroelectric Development in Canada, by W. S. Lee, Vice-President and Chief Engineer, Duke Power Co., Charlotte, N. C.

Lightning Disturbances, by F. W. Peek, Jr., Consulting Engineer, General Electric Co., Pittsfield, Mass., illustrated by slides and motion pictures.

Vice-President W. S. Rodman announced future activities and spoke on the relation of the Section to the Institute. Informal dinner. October 23. Attendance 95.

Inspection trip to the Riverbend Steam Station and Mountain Island Hydroelectric Station of the Duke Power Company. October 24.

Philadelphia

Joint meeting with the Illuminating Engineering Society. Professor Charles F. Scott, Yale University, presented a paper on *Fifty Years of Light and Power*. October 21. Attendance 200.

Pittsburgh

Joint meeting with the Engineers' Society of Western Pennsylvania and the Institute of Radio Engineers. *Making Sound Visible and Light Audible*, by Dr. John B. Taylor, Consulting Engineer, General Electric Co. Informal discussion followed. October 15. Attendance 440.

Portland

M. E. Noyes, Sales Engineer, Aluminum Co. of America, presented *New Developments in Mechanical Features of Transmission Lines*, illustrated with moving pictures. Aluminum cables were exhibited. *The New 110-Kv. Lewis River Transmission Line*, by E. F. Pearson, Electrical Engineer, Northwestern Electric Co. General discussion and buffet lunch followed. October 21. Attendance 108.

St. Louis

C. Carter Lewis, Lighting Engineer of the Union Electric Light & Power Co., gave an interesting talk, tracing the development of lighting as applied to the home from the earliest prehistoric times up to the present. Models to show the various developments in home lighting were presented. Prizes awarded lady guests. October 16. Attendance 75.

Schenectady

Reading of minutes of Annual meeting. Announcement of election of officers. The evening was devoted to a smoker celebrating the occasion of Light's Golden Jubilee. Two-reel film "The Benefactor" was shown. Smokes, refreshments, and musical numbers provided. October 12. Attendance 225.

The Fishing Banks and Fishing, by Bassett Jones, Consulting Engineer. Mr. Jones discussed the details of fishing and the geology of the fishing banks off Nova Scotia. Dinner preceded meeting. November 1. Attendance 200.

Seattle

Chairman L. N. Robinson read minutes of four previous meetings. Ray Rader gave report on the Summer Convention at Swamscott. A short talk was given by Professor R. G. Tyler, Dean of the Engineering College at the University of Washington. Lieut. L. Dreller, U. S. N., spoke on *The Propulsion and Other Electrical Equipment of the New Airplane Carrier, U. S. S. Lexington*. Coffee and sandwiches served. October 15. Attendance 75.

Springfield

Report of meeting of Executive Committee, District No. 1, held October 9 read. Future Section meetings announced. H. Schroeder, General Engineer of the Edison Lamp Works, Harrison, N. J., spoke on Edison's development of the incandescent lamp. Refreshments served. October 14. Attendance 50.

Syracuse

Executive Committee meeting. Resignation of former Chairman McCann accepted. F. E. Verdin chosen as Chairman for the remainder of the term. Charles W. Henderson elected Secretary. Section plans discussed. September 30.

Sound Pictures—Their Recording and Reproduction, by Philip C. Jones of the Technical Staff of Bell Telephone Laboratories. Sound pictures projection, films, and slides used to illustrate the lecture. October 28. Attendance 349.

The Quest of the Unknown, by Professor Harold B. Smith, President of the Institute. Dinner tendered to Professor Smith by the Section. November 1. Attendance 117.

Toledo

D. J. Finn of the General Electric Co. spoke on Light's Golden Jubilee. Ed. Thomas related experiences on experimental work while working for Mr. Edison in 1888. Five minute radio talks given daily by Messrs. Featherstone, Dubs, Rabbe, and Neuber.

Toronto

Paper presented by A. R. Wells on the *Use of Graphic Meters in Industry*. Mr. Wells described the use to which graphic meters might be put, their construction, and troubles likely to arise, and gave data relative to their correct connections into power circuits. Discussion followed. October 11. Attendance 80.

D. M. Jones of the General Electric Co. spoke on automatic frequency control and the difficulties experienced in securing satisfactory frequency regulation on systems of any magnitude. Discussion followed. October 25. Attendance 56.

Urbana

Electrical Engineering Applications of X-Rays, by Dr. H. L. Clark, Professor of Chemistry at the University of Illinois. October 9. Attendance 100.

R. E. Doherty, Consulting Engineer, General Electric Co., Schenectady, N. Y. spoke on *Constant Linkage Theorem*. October 25. Attendance 130.

Utah

C. B. Shipp presented a report of the Summer Convention at Swampscott. *Electric Motors and Their Proper Application*,

by L. Bradenburger, illustrated with lantern slides. Five reel film entitled "From Mine to Consumer—the Story of Anaconda" presented. October 14. Attendance 26.

Vancouver

The Quest of the Unknown, by Professor Harold B. Smith, President of the A. I. E. E. with lantern slides. Dinner at which President Smith spoke on Institute activities preceded the meeting. August 20. Attendance 45.

Inspection trip to Buntzen Hydroelectric Development, Plants 1 and 2, B. C. Electric Railway Co., Ltd. Luncheon at Wigwam Inn preceded the inspection. September 14. Attendance 19.

System Stability, by I. H. Summers, General Electric Co., Schenectady, N. Y. September 30. Attendance 30.

Washington

Former Section Chairman, Professor L. D. Bliss gave a report of the Swampscott convention. Film "The Story of Copper, From Mine to Consumer." Dinner preceded meeting. October 8. Attendance 153.

Worcester

Personal reminiscences of Edison by Dr. A. E. Kennelly, Harvard University. October 21. Attendance 30.

A. I. E. E. Student Activities

ELECTRICAL SHOW HELD AT MONTANA STATE COLLEGE BRANCH

The Montana State College Branch celebrated Light's Golden Jubilee by having an Electrical Show on the evening of October 21, 1929. Preparations were made by the juniors and seniors and the exhibits included a wide variety of interesting and instructive equipment and demonstrations. About twenty-five exhibits were provided including artificial lightning and television equipment.

An address was given by Professor C. F. Bowman of the Electrical Engineering Department on the correct use of light. This address was illustrated fully with demonstrations of various types of correct and incorrect lighting.

At 11:00 a. m. on Tuesday, October 22, an address on the "Romance of Light" was given by H. Plumb, Consulting Engineer of the General Electric Company, and in the evening of that date he gave a second address entitled "Painting with Light."

PAST BRANCH MEETINGS**Alabama Polytechnic Institute**

Minutes of previous meeting read and approved. Talk by Paul Brake, Student, on "Summer Work at Broadcasting Station W A P I." October 17. Attendance 18.

Failure of Bearings at Bartlett's Ferry Station, by R. F. Ham, Student; *The Electric Power Industry in Japan*, by J. A. Willman, Student; and *Stereoscopic Motion Pictures*, by W. R. Colman, Student. October 24. Attendance 26.

Armour Institute of Technology

The Electrification of Steam Railroads in Europe, by H. H. Field, Public Service Co. of No. Illinois, illustrated with slides. Joint meeting with local chapter of Western Society of Engineers. Committee appointments announced. November 1. Attendance 90.

Brooklyn Polytechnic Institute

X-Rays, by R. Muniz, illustrated with slides. Three-reel film, "The Single Ridge" describing the manufacture of insulated wire by the Okonite Co. October 23. Attendance 90.

California Institute of Technology

Professor R. W. Sorensen, Counselor, spoke on the activities of the A. I. E. E. E. C. Lee described the Pacific Coast Convention at Santa Monica in September. October 15. Attendance 34.

University of California

Branch activities discussed. Two-reel film describing student testing at the Schenectady plant of the General Electric Co. Refreshments served. October 23. Attendance 98.

Carnegie Institute of Technology

Film—*The Fabrication of Copper*, loaned by the U. S. Bureau of Mines. *The Trend in Public Utility Rate Making*, by L. B. McConaghy, Student. Refreshments were served. November 6. Attendance 86.

Case School of Applied Science

Committee appointments announced. Talks by Professors H. B. Dates, (Counselor) P. L. Hoover, R. C. Putnam, and G. A. Mills on past summer experiences. Dinner preceding meeting. October 15. Attendance 34.

Clarkson College of Technology

Inspection of Allen's Falls and Parishville Hydroelectric Stations. Professor A. R. Powers, Counselor, and several Students gave short talks. Dinner. October 31. Attendance 33.

Inspection of Hydroelectric Stations at Sugar Island, Hanawa Falls, and Brown's Bridge. October 15. Attendance 51.

Film depicting Edison's life. October 21. Attendance 69.

Clemson Agricultural College

Buying Supplies for a Large Electrical Concern, by C. E. Jarrard, Student; *Radio Interference from Line Insulators*, by E. E. Hembree, Student; *Current Events*, by C. G. Smoak, Student; and *Values*, by W. N. Coleman, Student. October 17. Attendance 18.

Life of Elihu Thomson, by J. M. Prim, Student; *The Engineer, Practical Idealist*, by E. H. Mazyck, Student; *New Ways for Oil in Industry*, by J. J. McFadden, Student; *Qualities of an Engineer*, by W. D. Craig, Student; *Current Events*, by J. L. Chapman, Student. Luncheon. November 7. Attendance 26.

Colorado Agricultural College

Business Meeting. L. Haubrich elected Secretary. Professor H. G. Jordan, Counselor, gave a talk on the A. I. E. E. September 23. Attendance 17.

Robert F. Bonney, Educational Director of the M. S. T. & T. Co., gave an illustrated lecture on Life of Edison and Light's Golden Jubilee. October 14. Attendance 101.

Prof. L. S. McDonald, Head of the Mathematics Dept. gave a lecture on Astronomy. October 29. Attendance 17.

University of Colorado

Talks by Dean H. S. Evans and Professor W. C. DuVall, Counselor. Film-slide lecture entitled *Light's Golden Jubilee*. Manuscript read by Geo. B. Steuart, Student. October 16. Attendance 85.

Engineering Thinking, by N. R. Love, Chief Engineer, Denver Tramway Co. and Secretary Denver Section. Discussion followed. Refreshments served. November 6. Attendance 65.

Cooper Union

Election of Officers. October 16. Attendance 9.

Cornell University

Get-together meeting. Professor R. F. Chamberlain outlined activities of the A. I. E. E. Talks by several professors and students. Refreshments served. October 11. Attendance 55.

University of Denver

Inspection of the new building of the Mountain States Tel. & Tel. Co. October 30. Attendance 15.

Drexel Institute

The Unforeseen in Engineering, by Professor E. O. Lange, Counselor. Talk by Dean Disque. Film—*Hydroelectric Power Production in the New South*. Sandwiches and coffee served. November 4. Attendance 25.

University of Florida

New members solicited. Talks by faculty and student members on attendance at A. I. E. E. meetings. October 14. Attendance 25.

Television, by L. R. Bassett, Student. R. T. Meeker, Student, gave a talk on summer experiences with the Florida Pr. & Lt. Co. Musical numbers. November 4. Attendance 43.

Iowa State College

Students of the Iowa State College Branch joined members of the Iowa Section at their meeting in Des Moines. October 28. Attendance 25.

Smoker. Talks by Harold Stahl, Branch President, B. S. Willis, and Prof. F. A. Fish, Counselor, on the activities of the A. I. E. E. Refreshments served. November 6. Attendance 122.

Kansas State College**(EVENING SECTION)**

Current events discussed by Mr. Butler. Talks on summer experiences with the Bell Telephone Co. and Westinghouse Elec. & Mfg. Co. by K. W. Ernst and B. E. Atwood, respectively. October 3.

C. J. McMullin discussed current events. Technical talk on low voltage networks by L. R. Kirkwood. October 17.

Technical and current events reviewed by Arlo Steel and J. W. Wilhite. Talk on sound pictures by I. R. Stenzel. Film—"Building New York's Newest Subway." October 24.

Kansas State College**(AFTERNOON SECTION)**

Current events, by R. Sage. Technical talk on Cuprox rectifiers by Art Owen. G. L. Quigley gave talk on *Reproduction of Sound in Movies*. Film—"Building New York's Newest Subway." October 31. Attendance 70.

Current events, by H. L. Winston. Talk by R. B. Heckert on methods of blasting. L. C. Paslay discussed Vacuum Tube Research. Film—"Driving the Cascade Tunnel." November 7. Attendance 54.

University of Kansas

Talks on summer experiences by Messrs. Leonard, Miller, and Reinhold, Students. Musical numbers furnished. October 17. Attendance 65.

New By-laws adopted. *The White Way System of St. Louis*, by Maurice A. Reagan, Student. Films—"Making of Steel," and "Wizardry of Wireless." October 30. Attendance 70.

Lafayette College

Flames from Electric Arcs, by Alfred Gano. October 19. Attendance 11.

Lehigh University

Smoker. Professors Barker and Beaver gave informal talks. Two-reel film—"Hydroelectric Power Production in the New South." Refreshments served. October 24. Attendance 85.

University of Maine

Slides commemorating Light's Golden Jubilee presented. Professor Barrows talked on the history of the incandescent lamp. Refreshments served. October 23. Attendance 25.

Marquette University

Relation of the Engineer to Industry, by S. H. Mortensen, Allis-Chalmers Mfg. Co. Professor Douglass reported on the number of Student papers received, some of which will be presented at the Chicago District Meeting. October 3. Attendance 55.

Massachusetts Institute of Technology

N. J. Darling, Works Manager of the G. E. Co., Lynn, discussed the opportunities and problems of engineering graduates in industry. Moving pictures showing some of the manufacturing processes of the General Electric Co. were shown. Dinner preceded meeting. October 31. Attendance 309.

Michigan State College

Two films—"The Potters Wheel" and "The Conductor." Six Students gave talks on summer experiences. Committee appointments announced. Refreshments served. October 8. Attendance 41.

University of Michigan

Election of officers. Prof. B. F. Bailey, Counselor, spoke on the aims and activities of the Institute. October 23. Attendance 35.

H. J. Iler, Bell Telephone Co., discussed the new exchange which has been installed on the campus. Talk by Prof. A. D. Moore on contact between seniors and leading electrical companies. November 6. Attendance 40.

Mississippi A. & M. College

W. F. Barksdale, Branch Chairman, related experiences pertaining to his employment with the Chicago Central Station Institute. Committee appointments announced. October 17. Attendance 22.

Missouri School of Mines and Metallurgy

Election of officers. Prof. I. H. Lovett, Counselor, spoke on the privileges and advantages of membership in the A. I. E. E. Discussion of plans for future meetings. November 6. Attendance 16.

University of Missouri

Election of officers. *A. I. E. E. and its Relation to the Student*, by Professor M. P. Weinbach, Counselor. *Aims of the Student Branch*, by Professor A. C. Lanier. Talks by J. M. Manley and L. E. Howard on experiences with the G. E. Co., Schenectady. October 3. Attendance 19.

Power Transmission Line Construction and Location on the West Coast, by Prof. Harry Rubey. Prof. M. P. Weinbach, Counselor, discussed plans for the Student Convention of the 7th District. November 6. Attendance 28.

Montana State College

The Welding of Metals with The Atomic Hydrogen Flame, by R. A. Weinman, given by Lowell Kurtz, Student;

Lightning Arrester Grounds Testing, by Edward Beck, Westinghouse Elec. & Mfg. Co., given by Homer Morton, Student. October 17. Attendance 156.

Transformer Neutral Reactors Reduce Breaker Duty, from *Electrical World*, Sept. 28, 1929, presented by Robert Jones, Student. October 24. Attendance 156.

750-Kw. High-Voltage Rectifier, by I. J. Kaar of the G. E. Co., given by Earle Rudberg, Student;

Neon Light Properties, by Leo Beck, Chief Engineer, Claude Neon National Laboratory, given by Carl Plumlee; and

Suggestion for a Simple Method for Keeping the Transmitter Disks in Step, by Thomas W. Benson, given by W. Hadley Queen. October 31. Attendance 159.

Economy of Buried Cables, by F. E. Smith, Chief Engineer, Nebraska Power Co., given by Ronald Crumley, Student;

Stubbing Poles Reduces Line Cost, by C. J. Marple, given by Roy Bjork, Student; and

D-C. Railway Substations for the Chicago Terminal Electrification—Illinois Central Road, by A. M. Garrett, given by James Giudici, Student.

University of Nebraska

Engineering in Business, by C. D. Robinson, Chief Engineer, Metropolitan Utilities District, Omaha. Joint meeting with A. S. M. E. members. October 23. Attendance 50.

Crystal Control, by Louis F. Lench. Harry E. Cook, Northwestern Bell Tel. Co., gave talk discussing the prospects for student engineers. Talks by W. E. Huddleston and James Kleinkauf, Students, relating experiences during summer employment. November 6. Attendance 37.

Newark College of Engineering

J. A. Hodges, Sales Manager, National Lamp Works of General Electric Co., related Edison's life. Inspection of the airport arrow on the laboratory building. October 21. Attendance 25.

University of New Hampshire

Informal talks by Students relating experiences during summer employment. September 28. Attendance 45.

R. Ballard, Student, spoke on summer experiences as radio man in the Naval Reserve. A. Whitcomb, Student, described interesting features in the Bellows Falls, Vt., Power Plant. October 5. Attendance 45.

J. J. Donnelly, Student, read paper on the Incandescent lamp, illustrated by lantern slides. R. Osgood, Student, spoke on his summer work as metal analyzer in a foundry. October 19. Attendance 49.

J. Arren spoke on *The Electrification of the Boston, Revere Beach, and Lynn Railroad*. W. Adams, Student, gave history of alternating current development in the U. S. F. Austin, Student, spoke on the use of space heaters in the home. October 23. Attendance 50.

University of New Mexico

First meeting of the Branch. *Electrolytic Rectifiers*, by W. I. Abbott, Branch Secretary. Discussion followed. October 29. Attendance 18.

Business meeting. Committee officers appointed. November 5. Attendance 10.

College of the City of New York

Film—"The Single Ridge." October 10. Attendance 12.

Business meeting. October 17. Attendance 12.

R. Fassnacht, Branch Chairman, spoke on the opportunities and benefits of membership in the Institute. November 7. Attendance 21.

Refractory Insulating Materials, by Mr. Fenwick, Chairman A. S. M. E. Branch. Joint meeting of the A. I. E. E., A. S. M. E., and Chemical Engineers. November 14. Attendance 30.

North Carolina State College

Executive business. Film—"From Mine to Consumer." October 15. Attendance 35.

H. W. Horney, Branch Chairman reported on the Section meeting in Charlotte. Oct. 23-24. Film "Behind the Button." November 5. Attendance 60.

University of North Carolina

Informal talks by Dean Braune, and Professors Bason, Lear, and Winkler on the advantages of A. I. E. E. membership. October 3. Attendance 33.

Problems of Grecian Architecture, by Dr. J. P. Harland, illustrated with slides. October 31. Attendance 26.

North Dakota State College

Light's Golden Jubilee, by Lewis Nelson and Walter Nelson, Students. Refreshments and music. October 24. Attendance 97.

University of North Dakota

Circuit Breaker Problems, by E. K. Reed, Westinghouse Elec. & Mfg. Co., illustrated with lantern slides. October 15. Attendance 19.

Northeastern University

Theory and Use of Submarine Signal Devices, by Horatio Lamson, General Radio Co. Discussion followed. October 29. Attendance 112.

University of Notre Dame

Airport Illumination, by Mr. Coomes, Student;
Life of Maxwell, by Mr. Scanlon; student, and

Low-Voltage Networks, by Mr. Diedrich, Indiana & Michigan Electric Co. Refreshments served. October 7. Attendance 55.

The Life of Dr. Lee de Forest, by Mr. Mohler, Student. John Mullane of the R. C. A. Photophone Corp. explained the principles of R. C. A. Photophone. Committee appointments announced. October 21. Attendance 87.

Ohio Northern University

Seamless Steel Tubes, by Louis Goodman, Student. October 10. Attendance 32.

Street Illumination in St. Louis, by E. Pankow, Student. October 24. Attendance 23.

Ohio State University

Smoker. Several talks by faculty members regarding A. I. E. E. benefits and opportunities. October 10. Attendance 60.

Oklahoma A. & M. College

Walter Hass, Student, spoke on the Tulsa Rolling Mills Co. M. L. Hendrickson gave résumé of his summer experiences with Shell Petroleum Corp. Charles Fry, Student, discussed methods used by Okla. Gas. & Elec. Co. Drafting Dept. October 31. Attendance 22.

Pennsylvania State College

Personal Recollections of Dr. Steinmetz, by R. E. Doherty, G. E. Co. October 8. Attendance 86.

Smoker. Talks by Professors Doggett, Stavelly, and Messrs. Crosby, Powel, and Robertson. A. D. Marshall, Asst. Secy. G. E. Co., visiting speaker, gave an interesting talk. October 15. Attendance 104.

Talk by Mr. Evans. Asst. Vice-President of Bell Telephone Co. of Pa. Talk by Dean Sackett. Election of E. L. Johnston, Junior Vice-President, and S. A. Adler, Assistant Secretary. November 6. Attendance 18.

Princeton University

Election of officers. Purpose and By-laws of the Branch described. October 11. Attendance 14.

Fortifications of the Swiss Railroads, by R. M. Schafer, Student; *Pilatron Tubes*, by H. W. Dodge, Student; and

Testing of Underground Cables, by C. F. Nesslage, Student. October 31. Attendance 13.

Purdue University

C. K. Huxtable presented paper on Thomas A. Edison. Illustrated talk given by a student on the life and history of Edison. October 22. Attendance 250.

Rensselaer Polytechnic Institute

Dr. Robb spoke on Edison. Demonstrations of old generators, and a replica of Edison's first lamp was exhibited. October 21. Attendance 95.

The Stock Market, by Professor Spafford, Dept. of Business Administration. Discussion followed. November 12. Attendance 110.

Rhode Island State College

Film—"Hydroelectric Power Production in the New South." October 16. Attendance 117.

Rose Polytechnic Institute

Light's Golden Jubilee, by D. F. Williams, illustrated. October 24. Attendance 18.

Rutgers University

General discussion. September 24. Attendance 17. Election of officers: G. E. Weglener, President; F. Kent, Vice-President. October 1. Attendance 18.

Radio Corporation of America, Bound Brook, N. J. Station, by A. Suone, Student; and

132-Kv. Underground Cable, United Electric Lt. & Pr. Co. New York, by F. E. Kent, Student. October 8. Attendance 20.

Committee appointments. Prof. Creager, Counselor, spoke on the activities of the Institute. October 15. Attendance 18.

South Dakota School of Mines

- Talks on summer experiences by Messrs. Walkling, Donaldson, Laws, and Sattler, Students. Prof. Kammerman, Counselor, gave a short talk. October 24. Attendance 25.
- Talk by M. E. Murphy of the Western Electric Co. on the development of talking pictures and the installation of Vitaphone equipment in the theatres in England. November 7. Attendance 57.

University of Southern California

- Summer experiences related by Messrs. J. McCarter, L. Slezak, G. Robertson, and John Wardell, Students. October 2. Attendance 32.
- William Hoag, General Electric Co., related experiences as a student engineer while at East Pittsburgh. October 9. Attendance 36.
- Past experiences related by Ivan Summers, General Electric Co. October 23. Attendance 39.
- Electrical Therapy*, by Sidney Rosen, Student; and *Telephoto*, by Edward McCarter, Student. October 30. Attendance 32.
- My Experiences with the Westinghouse Co.*, by Gilbert Dunstan, faculty member. November 6. Attendance 30.

Stanford University

- Election of Douglas H. Ring as Branch Chairman. October 7. Attendance 9.
- Chairman Ring spoke on the Institute's attitude toward the Student. Prof. Morgan, Counselor, outlined some of the papers given at the Conference on Student Activities at the Santa Monica convention. Dr. Ryan gave a short history of the Institute. October 24. Attendance 32.
- Film depicting the work by student engineers of the Test Course at the General Elec. Co. October 30. Attendance 28.

Syracuse University

- Neon Tubes, Their Construction and Their Applications*, by Alfred E. Davies, Student. November 12. Attendance 9.

University of Tennessee

- Film—"The Single Ridge." October 23. Attendance 20.
- Talk by J. M. Brooks on electrical devices used on automobiles and airplanes. A. M. Howery discussed the functions of a broadcasting station. November 6. Attendance 18.

Texas A. & M. College

- Effects of Loading on the Speed of Transmission of Deep Sea Cables*, by D. P. Tunstall, Student. Film—"Speeding up our Deep Sea Cables." November 8. Attendance 87.

University of Texas

- Two films—"Back of the Button" and "The Development of the Telephone." The purpose of Student enrolment discussed. October 10. Attendance 33.

University of Utah

- Frank Young, Jr., Student, read manuscript on Edison's life. Alvin Fagergren, Student, spoke on Edison's life. October 22. Attendance 59.
- Joint meeting with A. S. M. E. Branch. Film showing the building of the longest tunnel in America presented. November 5. Attendance 42.

University of Vermont

- Education for Engineers*, taken from the April and September issues of the A. I. E. E. JOURNAL, presented by F. E. Beckley, Student. October 1. Attendance 14.

Virginia Military Institute

- Film—"Hydroelectric Power Production in the New South." November 8. Attendance 95.
- Film—"Arteries of Industry." November 12. Attendance 40.

University of Washington

- The Outlook for the Electrical Engineering Student*, by Dr. C. E. Magnusson. October 11. Attendance 28.
- E. D. Engle, Student, presented a report on the 1929 Pacific Coast Convention of the A. I. E. E. October 18. Attendance 21.
- Television*, by J. M. Wallace, Student. J. M. Wallace elected Junior Representative to the Engineering Council. October 25. Attendance 19.
- Mr. Jenner, graduate student, related experiences while associated with the Goodrich Rubber Co. Branch activities discussed. November 1. Attendance 18.

Washington University

- Plans for future meetings discussed. October 10. Attendance 18.
- Talk by R. W. Brewster, Student, on summer experiences. Joyce Pittsbury elected Vice-Chairman. October 31. Attendance 20.

West Virginia University

- The following papers were presented by Students: *Electrical Status of Power Generation*, by C. E. Moyers, Chairman; *Small Loads can be Economically Connected to High-Tension Lines*, by W. H. Sutton; *Burned Out Incandescent Lamps*, by P. J. Johnson; *First Aid in Transformation Continuation of Large Transformers*, by E. D. Harris; *Ammeter for Measuring Motor Starting Currents*, by C. A. Bowers; *The DuPont Company, and Their Methods of Handling Heavy Currents*, by V. O. Whitman. October 14. Attendance 40.
- The following papers were presented by Students: *Future Street Car Control*, by R. C. Warder; *Accurate Load Forecasting*, by R. H. Pell; *Measuring of Pulsating Currents*, by E. Milam; *Edison's Life*, by F. E. Watson; *Welding with Atomic-Hydrogen Flame*, by J. E. Neucomer; *Advantages of Electric Shovel Over Steam Shovel*, by A. H. Goddin; *Million Volt Light Producer*, by C. F. Stewart; *Light Weight Railway Cars can be Obtained from Aluminum Alloys*, by M. Suppa. October 21. Attendance 41.
- The following papers were presented by Students: *Daniel Guggenheim Graduate School of Aeronautics*, by S. B. Wolfe; *Lighting St. Louis*, by H. W. Unger; *Electric Transmission versus Coal Transportation*, by H. O. Webb; *Toll Lines*, by C. E. Moyers; *Theory of Bowing in Telephone Cables*, by G. H. Hollis; *Methods of Splicing Large Cables*, by C. J. O'Leary; *Detroit-Canada Vehicular Tunnel*, by F. E. Houck; *The Gas-Electric Bus*, by G. S. Garrett. October 28. Attendance 41.
- The following papers were presented by Students: *Welding of Ferrous and Non-Ferrous Metals by the Atomic-Hydrogen Flame*, by P. J. Johnson; *Telephone Circuits for Program Transmission*, by J. S. Merritt; *Electrifying 8000 Farms*, by E. D. Harris; *Powdered Coal Plant*, by A. H. Huggins; *The Fundamental Requirements of the Modern Railway Car*, by G. W. Pride; *Experimentations on Seadromes*, by M. P. Hooker; *Requirements of Electrical Insulation*, by A. Dikea. November 4. Attendance 46.
- The following papers were presented by Students: *Part of Electricity in the Manufacture of Cement*, by A. F. Fervier; *Regulation of a 30,000-Kv-a., 13,000-Volt Line*, by R. H. Pell; *Foltinger Torsion Meter*, by E. Milam; *Hydrogen a Successor to Air*, by G. A. Stemple; *Effects of Corona in Different Gasses on Insulation*, by C. A. Bowers; *Lighting of Airways and Airports for Night Flying and Requisites*, by V. O. Whitman; *Development of Insulating Oils*, by J. E. Neucomer; *Ammeters for Starting Motors*, by A. H. Goddin. November 11. Attendance 45.

University of Wisconsin

- Professor Jansky, Counselor, spoke on Branch activities. Two films—"Anaconda Copper" and "Building New York's Newest Subway." October 10. Attendance 65.

Yale University

- Meeting held to celebrate Light's Golden Jubilee. Illustrated talk on "The Development of the Electric Light," by F. H. Eastman, Chairman. Refreshments provided. October 21. Attendance 40.

Engineering Societies Library

The Library is a cooperative activity of the American Institute of Electrical Engineers, the American Society of Civil Engineers, the American Institute of Mining and Metallurgical Engineers and the American Society of Mechanical Engineers. It is administered for these Founder Societies by the United Engineering Society, as a public reference library of engineering and the allied sciences. It contains 150,000 volumes and pamphlets and receives currently most of the important periodicals in its field. It is housed in the Engineering Societies Building, 29 West Thirty-ninth St., New York.

In order to place the resources of the Library at the disposal of those unable to visit it in person, the Library is prepared to furnish lists of references to engineering subjects, copies or translations of articles, and similar assistance. Charges sufficient to cover the cost of this work are made.

The Library maintains a collection of modern technical books which may be rented by members residing in North America. A rental of five cents a day, plus transportation, is charged.

The Director of the Library will gladly give information concerning charges for the various kinds of service to those interested. In asking for information, letters should be made as definite as possible, so that the investigator may understand clearly what is desired.

The library is open from 9 a. m. to 10 p. m. on all week days except holidays throughout the year except during July and August when the hours are 9 a. m. to 5 p. m.

BOOK NOTICES, OCTOBER 1-31, 1929

Unless otherwise specified, books in this list have been presented by the publishers. The Societies do not assume responsibility for any statement made; these are taken from the preface or the text of the book.

All books listed may be consulted in the Engineering Societies Library.

ADVANCED LABORATORY PRACTICE IN ELECTRICITY AND MAGNETISM.

By Earle Melvin Terry. 2d edition. N. Y., McGraw-Hill Book Co., 1929. 318 pp., illus., diags., tables, 9 x 6 in., cloth. \$3.00.

A course of experiments given to third-year students of electrical engineering at the University of Wisconsin, which includes, in addition to the usual work in electrical measurements, the discharge of electricity through gases, radio activity and thermionics.

DIE AKKUMULATOREN.

By W. Bermbach. 4th edition. Berlin, Julius Springer, 1929. 214 pp., illus., 9 x 6 in., paper. 8,50 r. m.

Professor Bermbach has thoroughly revised his book by incorporating the developments of the past ten years in storage battery practise, especially concerning rectifiers and the uses of accumulators. The book gives an excellent survey of theory and practise, comprehensive enough for ordinary needs, but not too detailed.

APPLIED INORGANIC ANALYSIS.

By W. F. Hillebrand and G. E. F. Lundell. N. Y., John Wiley & Sons, 1929. 929 pp., tables, 9 x 6 in., cloth. \$8.50.

This new work will be welcomed by every analytical chemist. Starting with an instructive discussion of apparatus, reagents and operations, the book then takes up the determination of the elements, the analysis of silicate and carbonate rocks and of soda-lime glass and high-alumina refractories. Emphasis is placed upon the preparation of the solution for the required determination.

The book is based upon the broad experience of its authors at the Bureau of Standards, and includes the substance of Dr. Hillebrand's well-known Bulletin on rock analysis.

BEGINNINGS OF TELEPHONY.

By Frederick Leland Rhodes. N. Y., Harper & Bros., 1929. 261 pp., illus., port., 10 x 6 in., cloth. \$4.00.

Bell's invention, the attacks on his patents, and the beginnings of the microphone transmitter, the overhead-wire plant, the telephone cable, loaded lines, the switchboard, the phantom circuit and long-distance lines are some of the topics that Mr. Rhodes discusses. His purpose is to give workers in telephony familiarity with the problems of pioneers in the field, to show how these were solved and to indicate the contributions of the various workers. His account of the litigation that arose over Bell's patents is especially good.

BLUEPRINT READING.

By Joseph Brahdy. N. Y., McGraw-Hill Book Co., 1929. 199 pp., illus., diags., tables, 9 x 6 in., cloth. \$2.00.

A course in the reading of working drawings, intended for those engaged in manufacturing industries and for students in trade schools.

DIRECT CURRENTS.

By Carl Edward Magnusson. N. Y., McGraw-Hill Book Co., 1929. 495 pp., illus., diags., 9 x 6 in., cloth. \$4.50.

A presentation in logical order of the basic principles of the electric circuit and of the characteristics of d-c. machines, apparatus, and distribution systems. Forms the first of a series of texts covering the fundamental laws of electrical phenomena as applied to engineering problems, the other volumes of which are "Alternating Currents" and "Electric Transients" by the same author.

DIRECTORY; FORGING, STAMPING AND HEAT TREATING PLANTS, 1928-29.

Pittsburgh, Steel Publications, Inc. 1929. 293 pp., 8 x 5 in., fabrikoid. \$7.50.

This directory gives the officers, equipment, products and railroad connections of the various companies, as well as a geographic index to them. Users of forgings and stampings, as well as dealers in plant supplies and machinery, will find this a useful guide.

ELECTRIC STREET LIGHTING.

By Charles J. Stahl. N. Y., John Wiley & Sons, 1929. 228 pp., illus., diags., 9 x 6 in., cloth. \$3.50.

Readers wishing a broad working knowledge of modern practise in the design of installations for lighting streets, will find here a statement of the most essential information, based on the author's experience. Modern requirements and current methods of design, the selection and use of suitable equipment are discussed concisely and practically.

ELECTROMAGNETIC PROBLEMS IN ELECTRICAL ENGINEERING.

By B. Hague. Lond. & N. Y., Oxford University Press, 1929. 359 pp., diags., 10 x 6 in., cloth. \$10.50.

Recent interest in the real physical nature of the internal reactions that occur within electrical machinery have prompted attempts to develop the theory of dynamo-electric machinery as a branch of electromagnetic theory. The present book is a contribution to this study.

Part one lays down the general theory of electromagnetism in a form suited to the requirements of engineers and occupies a middle ground between ordinary text-books of electricity and magnetism, and those on the design and operations of electrical machinery in which the engineering aspect is insisted upon. In part two, the principles laid down in part one are applied to the solution of a number of important electrotechnical problems, including the magnetic field and mechanical forces in non-salient pole machinery; the field within slots and between salient poles; the leakage field in transformers; the magnetic field of thick conductors with various forms of section; and the forces acting upon switchgear.

ELECTRON PHYSICS.

By J. Barton Hoag. N. Y., D. Van Nostrand Co., 1929. 208 pp., diags., tables, 9 x 6 in., cloth. \$3.00.

Intended to initiate students of physics to such concepts as

"electrons," "alpha, beta and gamma rays," "photoelectric effect," etc., by experiments that require only simple apparatus. The book presents these concepts simply, accompanied by the experiments. Follows a course in radioactivity and discharge through gases given at the University of Chicago.

ENGINEERING MECHANICS.

By William Brooke and Hugh B. Wilcox. Bost., Ginn & Co., 1929. (Engineering Series). 320 pp., 9 x 6 in., cloth. \$3.20.

A concise course in fundamental principles, intended for students of engineering with some knowledge of the calculus. Covers statics, kinematics and dynamics. Many problems are provided.

FORTY YEARS WITH GENERAL ELECTRIC.

By John T. Broderick. Albany, N. Y., Fort Orange Press, 1929. 218 pp., ports., 8 x 5 in., cloth. \$2.50.

Mr. Broderick's little book deals with the growth of the company, with some of the men who made it, and with various achievements in invention and management. He presents the Company as a living organism, showing the influences that have molded it and directed its growth.

HEAVISIDE'S OPERATIONAL CALCULUS AS APPLIED TO ENGINEERING AND PHYSICS.

By Ernst Julius Berg. N. Y., McGraw-Hill Book Co., 1929. (Electrical Engineering Texts). 214 pp., diags., 8 x 5 in., cloth. \$3.00.

Professor Berg's book, much of which has appeared in the General Electric Review, is based upon an extensive experience in demonstrating Heaviside's methods to students of electrical engineering. It provides a clear account of his calculus and a demonstration of its application to the study of transient phenomena.

INDUSTRIAL ACCOUNTING; Control of Industry through Costs.

By Thomas Henry Sanders. N. Y., McGraw-Hill Book Co., 1929. 371 pp., forms, 8 x 6 in., cloth. \$4.00.

The innovations in Professor Sanders' discussion of accounting are the extensive use of case material and the concentration of attention upon the objectives of cost accounting rather than upon the mechanics of cost gathering. The book seeks to conform to the modern tendency to curtail the volume of the routine gathering of figures and, while maintaining the current flow of essential control figures, to have the cost department free to investigate any matters of special interest at any time.

INTRODUCTION TO PHYSICAL OPTICS.

By John Kellock Robertson. N. Y., D. Van Nostrand Co., 1929. (University Physics Series). 422 pp., plates, diags., tables, 9 x 6 in., cloth. \$4.00.

Aims to provide a comprehensive introduction to the subject which shall be neither elementary or advanced, but will lay a thorough foundation for subsequent work. Starting with a thorough discussion of wave motion and its light ramifications, the author later introduces the quantum theory and, finally, considers briefly the problems now being studied by leading workers in optics.

LOKI; THE LIFE OF CHARLES PROTEUS STEINMETZ.

By Jonathan Norton Leonard. 291 pp., illus., ports., 8 x 6 in., cloth. \$2.75.

An interesting popular account of Steinmetz's life and his connection with the Central Electric Company, in which his personality, rather than his scientific achievements, is emphasized.

MACHINE DESIGN.

By P. H. Hyland and J. B. Kommers. N. Y., McGraw-Hill Book Co., 1929. 448 pp., illus., diags., tables, 9 x 6 in., cloth. \$4.00.

Covers the course given by the authors at the University of Wisconsin. While no claim is made for originality of subject matter, the arrangement, treatment and choice of matter are new in certain respects. The fundamental principles are presented with an analysis of only a few applications. Kinematics is incorporated as an integral part of machine design, a plan that obviates, in the opinion of the authors, any need for a separate text on it.

MANUEL PRATIQUE DE SOUDURE AUTOGENE.

By R. Granjon and P. Rosemberg. 2d edition. Paris, Dunod, 1929. 410 pp., illus., 9 x 6 in., paper. 33,70 fr.

This handbook of welding practise has been very popular for years in France and has also appeared in an English translation. Apparatus for autogenous welding, methods, and their application to steel, iron, copper, brass, lead, aluminum, etc., are

described in detail. This edition is revised, enlarged, and brought up to date.

MODERN AVIATION ENGINES.

By Major Victor W. Pagé. N. Y., Norman W. Henley Publ. Co., 1929. 2 v., illus., diags., tables, 9 x 6 in., cloth. \$9.00. 2 v.

Major Pagé has brought together a vast amount of practical information in these two volumes, which are intended chiefly for those occupied with maintenance and repair of aviation engines. The work includes detailed descriptions of practically every engine of any importance, with instructions for their care and repair, and also explains the theoretical principles involved in internal combustion engines. Good diagrams and illustrations are used profusely. A valuable reference book for practical men.

OIL ENGINE POWER PLANT HANDBOOK. 1929.

5th edition. N. Y., National Trade Journals, Inc., 1929. 288 pp., illus., 11 x 8 in., cloth. \$5.00.

A collection of practical articles on the operation of Diesel engines; on air filtration, oil purification, cooling towers and other plant accessories; and on the uses and economics of Diesel engines. Contains also brief descriptions and illustrations of the engines actively sold in America.

POPULAR RESEARCH NARRATIVES, v. 3.

Collected by the Engineering Foundation. Baltimore, Williams & Wilkins Co., 1929. 174 pp., ports., 8 x 5 in., cloth. \$1.00.

Fifty brief stories of what scientific research has accomplished or is accomplishing, covering a wide variety of topics. Each storyteller is intimately associated with the work that he describes, and tells his story simply and interestingly.

DAS RECHNEN MIT SYMMETRISCHEN KOMPONENTEN.

By Günther Oberdorfer. Lpz. u. Ber., B. G. Teubner, 1929. 74 pp., diags., 8 x 5 in., paper. Price not given.

A textbook upon the application of this method of calculation to the problems of electrical engineering. Starting with elementary principles, the method is developed and its application to various problems illustrated, with the object of making the method more widely known among engineers.

TECHNOLOGISCHES HANDBUCH DER ELEKTROTECHNIK UND DER ELEKTROCHEMIE.

By Alfred Schломann. Berlin, Technische Wörterbucher-Verlag, and V. D. I. Verlag, 1929. 1491 pp., illus., 10 x 7 in., cloth. 41.-r. m.

A concise encyclopedia of electrical engineering which gives a remarkable amount of definite, accurate information in a volume of moderate size. By the use of black-face type for important terms, of numerous sketches, and an unusual typographical arrangement, rapid use has been greatly facilitated, and an elaborate index has been provided also. The book is uniform with the author's well-known six-language dictionary and constitutes a sort of developed commentary to that work.

THEORY AND DESIGN OF ELECTRIC MACHINES.

By F. Creedy. N. Y., Isaac Pitman & Sons, 1929. 349 pp., illus., diags., tables, 9 x 6 in., cloth. \$9.00.

New possible types of dynamo-electric machines, says the author, are announced almost every month, and it is evident that the possibilities are endless. To assist development he has undertaken this general survey of theoretical possibilities, in which they are classified scientifically and lines along which development offers promise are indicated.

Starting with the theory of the general machine, one limitation after another is introduced and explained critically. Machines are thus classified into six groups, containing all possible types. Attention is then concentrated on cascade sets, multiple polarity machines and variable polarity apparatus, the three groups of which, in the author's opinion, we know least at present.

The final section gives general methods of designing which eliminate guesswork and estimating, and make possible a critical comparison of the possibilities of different types in advance of experiment.

WÄRMEWIRTSCHAFT IM EISENBAHNWESEN.

By Fr. Landsberg. Dresden u. Lpz., Theodor Steinkopff, 1929. (Wärmelehre und Wärmewirtschaft. . . . v. 7) 207 pp., illus., diags., tables, 9 x 6 in., paper. 13.-r. m.

An application of the general principles of fuel economy to the specific problems of railroad operations. Covers all the various uses of fuel in train operation, in shops, and in stations. The organization of the fuel department is considered, as well as technical methods of economy.

Engineering Societies Employment Service

Under joint management of the national societies of Civil, Mining, Mechanical and Electrical Engineers cooperating with the Western Society of Engineers. The service is available only to their membership, and is maintained as a cooperative bureau by contribution from the societies and their individual members who are directly benefited.

Offices:—31 West 39th St., New York, N. Y.,—W. V. Brown, Manager.

1216 Engineering Bldg., 205 W. Wacker Drive, Chicago, Ill., A. K. Krauser, Manager.

57 Post St., San Francisco, Calif., N. D. Cook, Manager.

MEN AVAILABLE.—Brief announcements will be published without charge but will not be repeated except upon requests received after an interval of one month. Names and records will remain in the active files of the bureau for a period of three months and are renewable upon request. Notices for this Department should be addressed to **EMPLOYMENT SERVICE, 31 WEST 39th Street, New York City**, and should be received prior to the 15th day of the month.

OPPORTUNITIES.—A Bulletin of engineering positions available is published weekly and is available to members of the Societies concerned at a subscription of \$3 per quarter, or \$10 per annum, payable in advance. Positions not filled promptly as a result of publication in the Bulletin may be announced herein, as formerly.

VOLUNTARY CONTRIBUTIONS.—Members obtaining positions through the medium of this service are invited to cooperate with the Societies in the financing of the work by contributions made within thirty days after placement, on the basis of one and one-half per cent of the first year's salary; temporary positions (of one month or less) three per cent of total salary received. The income contributed by the members, together with the finances appropriated by the four societies named above will it is hoped, be sufficient not only to maintain, but to increase and extend the service.

REPLIES TO ANNOUNCEMENTS.—Replies to announcements published herein or in the Bulletin, should be addressed to the key number indicated in each case, with a two cent stamp attached for reforwarding, and forwarded to the Employment Service as above. Replies received by the bureau after the positions to which they refer have been filled will not be forwarded.

POSITIONS OPEN

GRADUATE ELECTRICAL ENGINEER for publicity work. An attractive and permanent position immediately available. Give full outline of education, experience, and approximate expectations. Location, East. W-13.

ENGINEER, for Utilities Commission; must be college graduate in electrical or mechanical engineer with experience in utility operation or evaluation. Salary \$3600-\$4000 a year. Apply by letter. Location, South. W-14.

ELECTRICAL ENGINEER, thoroughly familiar with the requirements of the paper mill industry. Must be capable of designing, layout, installation and supervision of entire electrical system, wiring, apparatus, and equipment, all appertaining to construction and operation of modern paper mills. Apply by letter giving full and complete information such as age, technical training, previous experience, present salary, references, etc., location, South. X-9625-CS.

ELECTRICAL ENGINEER, college graduate, 28-38, with practical experience in electrical generation construction, transmission, and maintenance, for industrial concern. Apply by letter giving complete details. Location, Pennsylvania. X-9789.

ELECTRICAL ENGINEER with several years' experience in design of d-c. machines, for manufacturer of electrical machinery. Apply by letter stating age, education, experience, references, and salary expected. Location, Middle West. X-9812-C.

TRANSFORMER ENGINEER, experienced in the design of power transformers. Apply by letter giving age, married or single, experience, salary expected and when available. Location, New Jersey. X-9758.

DESIGNERS, electrical engineers with thorough technical education, and at least four years' commercial experience in synchronous-motor design and application engineering. Permanent employment with chance for advancement according to ability. Apply by letter. Location, Middle West. X-9911-C.

GRADUATE ELECTRICAL ENGINEER, with one or two years' experience in engineering and manufacturing practise with manufacturer of synchronous motors and their control and capacitors. Apply by letter. Location, Middle West. X-9912-C.

GRADUATE ELECTRICAL ENGINEERS for design and test work on accessories for underground power cables having wide range of voltages. One to five years' experience, not necessarily on cable work. Apply by letter. Location, Middle West. X-9960-C.

CABLE ENGINEERS for large public utility. Work is in tests, research specifications, and allied problems on underground power cables. Few years engineering experience, but cable experience not required. Apply by letter. Location, Middle West. X-9959-C.

ELECTRICAL ENGINEER, graduate, young, to enter sales department in connection with sale of miscellaneous heavy duty types of storage batteries; for instance, oil switch, emergency lighting and motive power installations. Opportunity. Apply by letter. Location, Maryland. X-7776.

ENGINEER, young, speaking at least one foreign language, for installation and maintenance of electro-medical apparatus. After approximately 18 months satisfactory work in the United States, may be sent abroad on sales and engineering assignments. Apply by letter giving complete details, references, etc. Headquarters, Chicago. X-7388-C.

RECENT GRADUATE, electrical engineer willing to locate in eastern territory near Philadelphia and to enter traveling sales work, handling a-c. motors and fans. Must have clean cut personality. Apply by letter. Headquarters, Middle West. X-3172-C.

ENGINEER, with telegraph and telephone experience. Must be qualified to handle engineering problems in telephone transmission, inductive interference, and telegraph and telephone installations. Apply by letter. Salary \$250 a month. X-9973.

MEN AVAILABLE

ELECTRICAL ENGINEER, 37, married, graduated from Germany. Six years' high-voltage sub power station, transmission line layout, design, material, with hydroelectric power plants in Europe. Six years of public utility, drafting, design, construction of sub and power stations in New York City. Available at short notice. C-2408

ELECTRICAL ENGINEER, wide experience in construction, operation, maintenance, generating, transmission at 100,000 volts, underground transmission, 6600 and 22,000 volts, outdoor and indoor substations, mill installations. Has had sales and managing experience in Latin America and India. Speaks English, Spanish, German, French and Hindustani. Location, immaterial. Now employed. C-4222.

ELECTRICAL ENGINEER, age 29, five years' varied experience; test floor, application, design, construction and maintenance. Now in charge of electrical department for mining company. Desires position as assistant plant

engineer or assistant electrical engineer with large industrial plant. Good personality and very well recommended. B-9001.

ELECTRICAL ENGINEER, having 10 years' practical experience in transmission distribution and testing, is desirous of a connection with progressive concern. Speaks French, German, and Russian. Location, Europe. B-7412.

HYDROELECTRICAL ENGINEERING GRADUATE of Washington State, (1928,) single, 26, eight months' experience in installation of switch-yard control apparatus and distribution, also previous construction experience. Desires work applying electrical engineering. Principals, anywhere. C-6586.

GRADUATE ELECTRICAL ENGINEER, EXECUTIVE, now employed, 33, married, 10 years' experience, design supervision of construction, generating and railway converter substations. Invites correspondence from public utilities where opportunity for advancement. Member N. E. L. A. B-6600.

ELECTRICAL ENGINEER, 38, college graduate, 12 years' experience in power-plant and substation design, construction, and maintenance. three years with consulting engineers specializing in public utilities problems; desires to connect with public utility company as assistant to manager or operating engineer. Location immaterial. Now employed. Opportunities for advancement of primary importance. C-3425.

ENGINEER EXECUTIVE, experienced in industrial relations and managerial problems. Diversified training includes design, production, economic studies, statistical analysis and personnel. Post graduate work in business administration. Permanent connection with industrial concern or consulting engineer desired. Available on month's notice. C-6609.

ELECTRICAL ENGINEER, 23, single, 1927 graduate, varied experience in test department of large power and light company and in engineering department of small electrical manufacturing concern, desires position in engineering department of public utility. Now employed. Location preferred, East. C-6583.

SUPERVISING AND ESTIMATING ENGINEER, 25 years' experience in commercial and industrial power installations. Has had wide experience in all classes of buildings construction work, from both a practical and theoretical standpoint including underground and substation installations. Capable executive and engineer. Location, New York if possible. C-1140.

ELECTRICAL ENGINEER, B. S. and M. S. in electrical engineering, M. I. T. General Elec-

ric Test and central station department training course with large utility, desires position with public utility, or firm of consulting engineers. Available about January 15. Location, immaterial. C-2753.

GRADUATE ELECTRICAL ENGINEER, 32, 10 years' experience, expert light, heat, power, plans specifications, engineering, correspondence, for theaters, hotels, skyscraper offices, apartments, public buildings, etc. Thorough experience with architects, contractors, and consulting engineers. Desires connection anywhere as designing or estimating engineer. Capable, neat, thorough, conscientious, possesses personality, initiative, a sense of values. B-4217.

ENGINEER, 31, single, with exceptional technical training, desires permanent position. Diversified engineering experience and specialized Diesel-electric development, testing or sales and service work preferred. Work conducive to individual development allowing advancement to executive position of primary importance. C-6493.

ELECTRICAL ENGINEER, 28, single, B. S., 1929, graduated with high honors, desires connection with manufacturer of electrical machinery or

utility company. Preferably production, management, or design. Opportunity for advancement considered most important. Two years' test floor experience. Location, Eastern States or abroad. Excellent knowledge of Russian. Available on short notice. C-6526.

TECHNICAL GRADUATE, 31, nine years electrical contracting, layout supervision estimating on theater electrical systems, public address system, hotel and office building power and light systems, street lighting. Long experience selling builders and executives. Knowledge of economics and finance, desires position where past experience and executive ability can be utilized. C-6613.

ELECTRICAL ENGINEER, 28, married, desires permanent connection. Four years with large rapid transit company maintenance, powerhouse, substation operation, high-voltage testing, calibration of potential and current transformers. One year cable manufacturing design, construction, estimating compute electrical characteristics, development work on cable and joints for 132-kv. underground cable. Location immaterial. C-4420.

ELECTRICAL-MECHANICAL ENGI-

NEER, 12 years' experience in testing, design, and development of d-c. motors and generators of the traction type. Now employed by electrical manufacturer as motor design engineer. Desires similar position with company offering opportunity for advancement in design and manufacture. Age 38, college graduate, married. B-3152.

ELECTRICAL ENGINEER, 29, 1923 graduate, married 1 1/2 years Westinghouse test, 1 1/2 years over-head distribution design, 3 1/2 years transmission line and substation extension planning, cost, estimating, calculating, budget, tax, and general public utility engineering office work; desires position of responsibility in distribution or transmission engineering in East or South. C-3694.

RESEARCH ELECTRICAL ENGINEER, 28, E. E. and M. E. graduate from European Technical College, naturalized, married, 7 years' experience in design of automatic-control apparatus. X-ray equipment, photoelectric measuring apparatus. Capable of original and independent work. Desires responsible position in research department of eastern concern. References. Available on short notice. B-6782.

MEMBERSHIP—Applications, Elections, Transfers, Etc.

RECOMMENDED FOR TRANSFER

The Board of Examiners, at its meeting of November 13, 1929, recommended the following members for transfer to the grade of membership indicated. Any objection to these transfers should be filed at once with the National Secretary.

To Grade of Fellow

ALGER, PHILIP L., Assistant to the Vice-President in Charge of Design Engg., General Electric Company, Schenectady, N. Y.

To Grade of Member

ACHARD, FRANCIS H., Instructor in Charge, Educational Bureau, Brooklyn Edison Co., Brooklyn, N. Y.

BEILER, ALBERT H., Electrical Engineer, American Gas & Elec. Co., New York, N. Y.

BROWNE, WILLIAM HAND, JR., Professor of Electrical Engineering, North Carolina State College, Raleigh, N. C.

CASTRO, CARLOS, Transmission Engineer, Columbia Engg. & Mgt. Corp., Cincinnati, Ohio.

DRESSNER, VICTOR D., Engineer in Transmission & Distribution Dept., New York Edison Co., New York, N. Y.

DU BOIS, WARREN L., Electrical Designer, Department of City Transit, Philadelphia, Pa.

FLACCUS, GEORGE W., Electrical Engineer, Electrical Research Products Inc., New York, N. Y.

HARRISON, WILLIAM H., Plant Engineer, American Tel. & Tel. Co., New York, N. Y.

HOLLISTER, FRANCIS H., Electrical Engineer, Sargent & Lundy, Chicago, Illinois.

IRVINE, C. NES, Electrical Engineer, Gustav Hirsch Organization, Columbus, Ohio.

KEELER, WILLIAM H. E., Assistant Engineer, New York Telephone Co., New York, N. Y.

MITCHELL, OSBORNE S., Editor, *Electrical News and Engineering*, Toronto, Ont., Canada.

PIATT, WILLIAM M., Professional and Consulting Engineer, Durham, N. C.

SERVICE, JERRY H., Head of Departments of Physics and Mathematics, Henderson-Brown College, Arkadelphia, Arkansas.

TENNEY, HARRY W., Section Engineer, Westinghouse Electric & Mfg. Co., East Pittsburgh, Pa.

APPLICATIONS FOR ELECTION

Applications have been received by the Secretary from the following candidates for election to membership in the Institute. Unless otherwise indicated, the applicant has applied for admission as an Associate. If the applicant has applied for direct admission to a grade higher than Associate, the grade follows immediately after the name. Any member objecting to the election of any of these candidates should so inform the Secretary before December 31, 1929.

Amitay, A., New Jersey Power Co., Asbury Park, N. J.

Babcock, C. W., General Electric Co., Schenectady, N. Y.

Baier, H., Otis Elevator Co., New York, N. Y.

Barber, H., New England Power Construction Co., Boston, Mass.

Barrett, T. L., T. M. E. R. & L. Co., Milwaukee, Wis.

Barry, L. A., Jr., 262 Elmwood Ave., Maplewood, N. J.

Barth, C. A., (Member), So. Bell Tel. & Tel. Co., Atlanta, Ga.

Barton, J. P., Westinghouse Elec. & Mfg. Co., Chicopee Falls, Mass.

Beck, D. B., Metropolitan Edison Co., Reading, Pa.

Becker, A., Diehl Mfg. Co., Elizabethport, N. J.

Beerman, M. R., Alabama Power Co., Birmingham, Ala.

Bellows, K. F., New York Edison Co., New York, N. Y.

Berry, P. M., W. N. Matthews Corp., St. Louis, Mo.

Black, R. R., General Electric Co., Fort Wayne, Ind.

Brandstoetner, W. H., American Tel. & Tel. Co., New York, N. Y.

Brumbaugh, K. D., Dingle-Clark Co., Cleveland, Ohio

Brundrett, G. T., Hubbard & Co., Dallas, Tex.

Caporale, P., Radio-Victor Corp. of America, Philadelphia, Pa.

Capron, R. B., Utica Gas & Electric Co., Utica, N. Y.

Carver, L. A., Paramount Fire Alarm Engineering Co., Cleveland, Ohio

Casciato, D., Electrical Research Products, Inc., Chicago, Ill.

Chubbuck, E. E., (Member), Phoenix Utility Co., Allentown, Pa.

Claridge, R. E., Northern Electric Co., Toronto, Ont., Can.

Clark, E. N., Northern States Power Co., Minneapolis, Minn.

Clements, L. J., Box No. 647, Redwood City, Calif. (Applicant for re-election.)

Coe, R. J., Connecticut Power Development Co., East Barnet, Vt.

Cohn, A. G., Kansas City Power & Light Co., Kansas City, Mo.

Culver, D. N., Bell Telephone Co. of Canada, Montreal, Que., Can.

Dansboe, H. H., Atlantic Oil Producing Co., Dallas, Tex.

de Carvajal, C. A. R., 229 East 26th St., New York, N. Y.

Deck, A. R., Metropolitan Edison Co., Easton, Pa.

De Leau, L. H., Brooklyn Edison Co., Brooklyn, N. Y.

Doty, P. I., General Electric Co., Schenectady, N. Y.

Dutton, A. G., Pennsylvania Power & Light Co., Allentown, Pa.

Eddlestone, J. E., N. Y. & Queens Elec. Lt. & Pr. Co., Flushing, (L. I.), N. Y.

Ehst, M. R., W. S. Barstow & Co., Inc., Reading, Pa.

Elge, E. A., General Electric Co., Pittsfield, Mass.

Emrick, A. B., Wagner Electric Corp., Dallas, Tex. (Applicant for re-election.)

Exner, D. W., Westinghouse Elec. & Mfg. Co., East Pittsburgh, Pa.

Finney, C. F., Jersey Bell Tel. Co., Newark, N. J.

Frambes, R. T., W. S. Barstow & Co., Inc., Reading, Pa.

Freundt, G. L., American Can Co., Maywood, Ill.

Frey, R. C., Pacific Telephone & Telegraph Co., San Francisco, Cal.

Gear, R. B., Commonwealth Edison Co., Chicago, Ill.

Geiser, W. D., Philadelphia Electric Co., Philadelphia, Pa.

George, H. C., Detroit Edison Co., Detroit, Mich.

Goeller, C. P., General Electric Co., Lynn, Mass.

Gough, J. H., Westinghouse Elec. & Mfg. Co., Chicopee Falls, Mass.

Grabow, H., Pacific Gas & Electric Co., San Francisco, Calif.

Gritte, J. M., Staten Island Edison Corp., Livingston, S. I., N. Y.

Hartig, C. F., New York Edison Co., New York, N. Y.

Hartig, O., (Member), Eagle Electric Mfg. Co., Brooklyn, N. Y.

Hartman, E. R., Firestone Tire & Rubber Co., Akron, Ohio

- Hauck, H. C., Western Electric Co., Inc., Newark, N. J.
- Herbert, L. P., Penn-Ohio Power & Light Co., Youngstown, Ohio
- Hertz, H. F., Philadelphia Electric Co., Philadelphia, Pa.
- Hicks, J. M., Century Electric Co., Philadelphia, Pa.
- Holland, J. T., Duke Power Co., Charlotte, N. C.
- Holman, W. J., Yale University, New Haven, Conn.
- Hoppe, W. H., General Railway Signal Co., Rochester, N. Y.
- Houston, C. A., Humble Pipe Line Co., Houston, Tex.
- Howard, A. W., General Electric Co., Fort Wayne, Ind.
- Hunter, J. A., Pennsylvania Power & Light Co., Danville, Pa.
- Hurley, E. P., Bright & Co., Reading, Pa.
- Innis, H. H., General Electric Co., Schenectady, N. Y.
- Jarvis, H. O., City of Baltimore, Dept. of Public Works, Baltimore, Md.
- Johanson, A. N., The Gamewell Co., San Francisco, Calif.
- Johnson, M. L., Kansas University, Benda, Kans.
- Johnson, R. E., Lake Shore Power Co., Wauseon, Ohio
- Jones, C. W., New England Power Construction Co., Boston, Mass.
- Jordan, H., Ontario Paper Co., Ltd., Outardes Falls, Que., Can.
- Kirkland, J. F., New York Central Railroad Co., New York, N. Y.
- Kleindienst, J. G., Delano Coal Co., Inc., New York, N. Y.
- Knight, E. B., Saskatchewan Govt. Telephones, Regina, Sask., Can.
- Korsznick, J., General Electric Co., Pittsfield, Mass.
- Langer, F. C., Alcazar Hotel, San Francisco, Calif.
- Leftwich, M. F., Duke Power Co., Charlotte, N. C.
- Lewis, R. C., So. New England Tel. Co., New Haven, Conn.
- Lindstrom, H. L., Westinghouse Elec. & Mfg. Co., East Pittsburgh, Pa.
- Lowe, H. L., Louisville Gas & Electric Co., Louisville, Ky.
- Luttrupp, A. L., Allis-Chalmers Mfg. Co., Pittsburgh, Pa.
- MacDonald, H. C., Western Union Telegraph Co., New York, N. Y.
- Miller, W. R., Needles Gas & Electric Co., Needles, Calif.
- Mitchell, G. T., General Electric Co., Schenectady, N. Y.
- Murphy, N. P., Harold E. Trent Co., Philadelphia, Pa.
- Nebbia, A. M., Public Service Electric & Gas Co., of N. J., Hackensack, N. J.
- Neri, J. M., 928 Washington St., Hoboken, N. J.
- Nichol, A. J., Board of Transportation, New York, N. Y.
- Noble, W. H., Penna. Pump & Compressor Co., Easton, Pa.
- Nowack, D. C., Westinghouse Elec. & Mfg. Co., East Pittsburgh, Pa.
- Oathout, V., Indiana Bell Tel. Co., Indianapolis, Ind.
- O'Brien, L. P., Bylesby Engineering & Management Corp., Chicago, Ill.
- Olmstead, L. M., Worcester Polytechnic Institute, Worcester, Mass.
- Oser, W. K., Bell Telephone Laboratories, Inc., New York, N. Y.
- Pasterok, J. E., Reading Co., Philadelphia, Pa.
- Pearson, R. H., Westinghouse Elec. & Mfg. Co., Houston, Tex.
- Peters, E. B., Pennsylvania Power & Light Co., Allentown, Pa.
- Phillips, J. H., Jr., 5510 Baum Blvd., Pittsburgh, Pa.
- Pierson, W. D., Erie Malleable Iron Co., New York, N. Y.
- Powell, W. M., Rome Wire Co., New York, N. Y.
- Ratajczak, F. X., W. S. Barstow & Co., Reading, Pa.
- Rehder, E. G., New York Telephone Co., New York, N. Y.
- Reibner, O. E., Electric Bond & Share Co., New York, N. Y.
- Rheins, J. J., Purdue University, West Lafayette, Ind.
- Rhodes, D., Bell Telephone Co. of Canada, Montreal, Que., Can.
- Roush, W. L., Westinghouse Elec. & Mfg. Co., Houston, Tex.
- Sahkovich, R. J. K., Westinghouse Elec. & Mfg. Co., East Pittsburgh, Pa.
- Schattle, R. B., Syracuse Washing Machine Corp., Syracuse, N. Y.
- Schmidt, M. L., General Electric Co., Fort Wayne, Ind.
- Schrock, J. E., General Electric Co., Erie, Pa.
- Schwietering, P. J., Cudahy Brothers Co., Cudahy, Wis.
- Searles, N. F., General Electric Co., Fort Wayne, Ind.
- Secor, C. K., Brooklyn Polytechnic Institute, Brooklyn, N. Y.
- Sergeant, R. E., Metropolitan Edison Co., Reading, Pa.
- Setterstrom, R. C., Westinghouse Elec. & Mfg. Co., East Pittsburgh, Pa.
- Silverman, J., Brooklyn Edison Co., Brooklyn, N. Y.
- Snyder, W. R., J. G. White Management Corp., Reading, Pa.
- Solomon, M. C., Central Illinois Light Co., Peoria, Ill.
- Sticher, J., Detroit Edison Co., Detroit, Mich.
- Stieglmeier, W. E., Chicago Rapid Transit Co., Chicago, Ill.
- Street, M. G., Westinghouse Elec. & Mfg. Co., Sharon, Pa.
- Taylor, T. A., American Tel. & Tel. Co., New York, N. Y.
- Thomas, H. E., R. C. A. Communications, Inc., Marshall, Calif.
- Trenary, H. I., Victor X-Ray Corp., Chicago, Ill.
- Underwood, R. J., New England Power Association, Providence, R. I.
- Verrall, V. E., General Electric Co., Fort Wayne, Ind.
- Weber, A. N., Lynn Gas & Electric Co., Lynn, Mass.
- Wheichel, C. C., Jr. (Member), General Electric Co., Schenectady, N. Y.
- White, C. E., General Electric Co., Fort Wayne, Ind.
- White, J. E., Westinghouse Elec. & Mfg. Co., East Pittsburgh, Pa.
- Whiting, J. G. (Member), Greene Engineers, Inc., Charlotte, N. C.
- Wilkie, H., Naval Research Laboratory, Anacostia, D. C.
- Williams, T. M., American Tel. & Tel. Co., Pittsburgh, Pa.
- Young, C. A., Northwestern Electric Co., Portland, Ore. (Applicant for re-election)
- Total 134
- Foreign**
- Adams, A. L. (Member), South Porto Rico Sugar Co., Ensenada, Porto Rico
- Green, J. F., The Macintosh Cable Co., Ltd., Derby, Eng.
- Heinlein, K., Heinlein & Cia., Buenos Aires, Argentina, So. America
- Lamy, R., Societe de la Mailleaye, Paris, France
- Oldfield, V. P., Gowerdene Hotel, London, W. C. 1, Eng.
- Picard, A., Compania Standard Electric, Buenos Aires, Argentina, So. America
- Rudenberg, R. (Member), Siemens-Schuckertwerke A. G., Verwaltungsgebäude, Berlin-Siemensstadt, Germany
- Taguchi, O., Asia Aluminum Co., Tokyo, Japan
- Venkatesan, A., T. T. D. Electric Construction, Tirupathi, Madras Presidency, India
- Venkateswaran, A. S., M. S. M. Ry., Triplicane, Madras, India
- Total 10
- STUDENTS ENROLLED**
- Abbott, W. Irving, University of New Mexico
- Adam, Ian M., University of British Columbia
- Adams, Norman H., University of California
- Adams, William C., University of Illinois
- Adcock, Maldan V., Texas A. & M. College
- Aldrich, Howard J., Northeastern University
- Alexander, Samuel N., University of Oklahoma
- Allan, Francis S., State College of Washington
- Allen, S. R., State College of Washington
- Allen, Stanley L., Northeastern University
- Altland, Frederick H., Lehigh University
- Anderson, Grant S., State University of New Mexico
- Anderson, John E., Calif. Inst. of Tech.
- Anderson, MeRoy A., South Dakota State School of Mines
- Andresen, Warren, University of California
- Andrews, Leo R., Virginia Military Institute
- Appl, Theodore, Kansas State Agri. College
- Archer, Samuel W., University of Illinois
- Arlio, Dominic C., Northeastern University
- Armstead, James G., Rensselaer Polytechnic Inst.
- Armstrong, William M., Stanford University
- Arvidson, Ernest R., University of Iowa
- Arvidson, Paul G., University of Iowa
- Ashley, Hilas C., University of California
- Ashton, Chester H., Bucknell University
- Asmann, James W., University of Cincinnati
- Atwood, Albert W., Jr., Calif. Inst. of Tech.
- Ayers, Jack W., University of Illinois
- Baer, Oscar W., Colorado State Agri. College
- Bailey, Charles F., University of Kentucky
- Bailey, James G., University of Minnesota
- Baker, Paul H., Rose Polytechnic Institute
- Baker, Robert F., Cornell University
- Balkow, Ernest C., University of Idaho
- Ballinger, Mark H., Purdue University
- Balzer, Harvey W., University of Missouri
- Banca, M. C., University of Illinois
- Bangerter, Harry G., State Univ. of New Mexico
- Banks, Carl W., Lehigh University
- Banks, Dwight H., Kansas State Agri. College
- Baptist, Noel A., Rose Polytechnic Institute
- Barksdale, Warren P., Mississippi A. & M. Col.
- Barlett, Theo. A., Ohio State University
- Barnes, George C., West Virginia University
- Barnwell, William M., Clemson Agricultural Col.
- Barrett, Josiah S., Mass. Inst. of Technology
- Baxter, Herbert M., Georgia School of Tech.
- Beach, Ralph G., University of California
- Beard, W. G., Lehigh University
- Bell, Richard A., Ohio State University
- Belsber, Gregory T., University of Idaho
- Benning, Harvey H., Jr., Cornell University
- Benson, John C., University of Kentucky
- Bergstrom, Roland F., University of California
- Berry, Leaman S., University of Maine
- Billman, Leroy S., Lehigh University
- Black, Addison F., Jr., Virginia Military Institute
- Black, Harry C., University of Kentucky
- Black, Raymond G., University of Illinois
- Blackwood, Herbert B., Virginia Military Inst.
- Blair, Royer R., Rose Polytechnic Institute
- Bloss, Theodore, University of Oklahoma
- Blum, Frederick A., University of Cincinnati
- Blythe, Joseph W., Iowa State College
- Bolliger, Theodore C., University of Wisconsin
- Bollman, V. L., University of Nebraska
- Bolton, Stanley W., Cornell University
- Bong, Tom, University of Washington
- Boltz, Jay Harold, Lehigh University
- Bondley, Ralph J., Iowa Northern University
- Bovey, Donald E., Iowa State College
- Bowen, H. L., Georgia School of Technology
- Bowen, Theodore L., University of Illinois
- Bowker, Marshall E., Univ. of New Hampshire
- Boyles, Ronald M., University of Washington
- Bozick, John F., Kansas State Agricultural Col.

- Brainard, William E., Cornell University
 Branaman, William H., University of Kentucky
 Branham, Elmer J., Kansas State Agri. College
 Branson, Orland D., Iowa State College
 Brewster, Todd W., Municipal Univ. of Akron
 Britt, Albert S., Virginia Military Institute
 Brodnax, Joe T., Virginia Military Institute
 Brower, Ralph B., University of California
 Brown, Charles T., Lafayette College
 Brown, Howard F., University of Kentucky
 Brown, Marion W., Purdue University
 Brown, Stuart C., University of Illinois
 Brown, Tommie M., University of Oklahoma
 Buch, Phil, Purdue University
 Buchanan, Royal S., University of Illinois
 Bull, James T., Cornell University
 Burbank, John H., Northeastern University
 Burge, Donald S., Purdue University
 Burgess, Everett H., Rensselaer Polytechnic Inst.
 Burnham, Lyle M., University of Texas
 Butler, Roland D., University of Maine
 Byrnes, Leon M., Clark College of Technology
 Caldera, Felix C., University of California
 Caldwell, Chester W., Purdue University
 Caldwell, F. R., Cornell University
 Caldwell, John H., Jr., Cornell University
 Calkins, Delos S., Cornell University
 Camp, Byron L., Pennsylvania State College
 Campbell, Doyne L., University of Oklahoma
 Campbell, Guy C., University of Utah
 Carbray F. J., McGill University
 Carland, James F., Iowa State College
 Carlen, Jans J., University of New Hampshire
 Carlson, Edward J., University of California
 Carlson, Reuben J., University of Washington
 Carlstad, Alvin, State College of Washington
 Carter, Ernest D., University of Missouri
 Caughman, Martin W., Clemson Agricultural Col
 Cawby, Elmer L., University of Kentucky
 Chaffee, F. Dudley, Worcester Polytechnic Inst.
 Chamberlain, Glenn J., Calif. Inst. of Tech.
 Chang, Kung-Huan, Cornell University
 Chanon, Henry J., Ohio State University
 Chapman, John L., Clemson Agricultural College
 Charbonneau, Allan P., University of Kentucky
 Cherry, John T., North Carolina State College
 Church, Robert A., University of Oklahoma
 Clark, Eldon M., So. Dak. State School of Mines
 Clark, George H., Cornell University
 Clark, John R., Northeastern University
 Clarke, George J., University of Illinois
 Cloran, Charles R., Northeastern University
 Cocanower, G. M., Purdue University
 Cochran, William L., Alabama Polytechnic Inst.
 Cohenour, Howard H., University of Illinois
 Colot, Robert, Rutgers College
 Colvin, Charles E., Jr., University of Kentucky
 Comerford, Thomas G., Northeastern University
 Comings, Mary B., Stanford University
 Conrath, Robert E., Cornell University
 Constantine, Jerry Jay, University of Kentucky
 Conway, Clarence E., University of Idaho
 Cooper, Robert D., So. Dak. State School of Mines
 Cooper, Robert E., Jr., University of California
 Cooper, Winfield T., University of Illinois
 Corbin, Joseph E., Pennsylvania State College
 Corley, John D., Ohio State University
 Corp. James H., Rose Polytechnic Institute
 Corwin, Newell J., Rensselaer Polytechnic Inst.
 Coryell, Walter R., Jr., Washington University
 Cottingham, Carey, University of Illinois
 Cousins, Byron I., Kansas State Agricultural Col.
 Cowles, Marion, Jr., Kansas State Agri. College
 Craig, William D., Clemson Agricultural College
 Crane, Howard W., Colorado State Agri. Col.
 Crawford, Elston R., Rutgers College
 Cronin, Wm. M., University of Illinois
 Cutting, Charles A., University of Maine
 Danilson, Paul A., University of Idaho
 Davault, Louis T., University of Texas
 Davidson, Harvey E., Kansas State Agri. College
 Davies, Alfred E., Syracuse University
 Davis, Arthur L., Newark College of Engineering
 Davis, Maurice W., University of Kentucky
 Davis, Nelson M., Ohio State University
 Davis, Paul, Kansas State Agricultural College
 Davis, Stuart, University of Oklahoma
 Dawson, Lee R., University of Washington
 Dawson, Royce Herbert, University of Missouri
 Deacon, Newell E., Purdue University
 Dean, Clair O., Cornell University
 Dickman, Forrest W., Purdue University
 Dicks, James H., Rose Polytechnic Institute
 Dimmitt, Herbert A., Kansas State Agri. College
 Dirks, Benjamin D., So. Dak. State School of Mines
 Dirks, Harold F., University of Detroit
 Dodds, Joseph W., State College of Washington
 Dodds, S. Harold, So. Dak. State School of Mines
 Dodge, Harold A., University of Illinois
 Donovan, Daniel J., Northeastern University
 Donovan, John F., University of Idaho
 Doremire, Clayton, Mich. Col. of Mining & Tech.
 Doty, Harold G., University of Idaho
 Douglass, George A., Clemson Agricultural Col.
 Dressor, Donald, Colorado State Agricultural Col.
 Duffus, Robert S., Iowa State College
 Dunleavy, Thomas P., Mass. Institute of Tech.
 Easton, Elmer C., Lehigh University
 Eaton, Bruce G., Jr., University of Illinois
 Ehrendardt, Carl E., Rose Polytechnic Institute
 Ehringhaus, Erskine E., Duke University
 Eklund, Lennart N., University of Idaho
 Ekstrom, Iver R., Lewis Institute
 Elam, Francis P., University of Tennessee
 Ellerbeck, Karl H., University of Washington
 Elliott, John E., Iowa State College
 Ellingson, Ellis M., University of Iowa
 Elliott, James D., Mass. Inst. of Technology
 Ellis, Eugene V., Calif. Inst. of Tech.
 Ellis, J. G., University of Southern California
 Elmquist, Melvin L., University of Minnesota
 Epting, George H., Clemson Agricultural College
 Erickson, John E., Mich. Col. of Mining & Tech.
 Ernst, Karl W., Kansas State Agricultural College
 Estel, George A., Jr., Iowa State College
 Evans, Carl B., University of New Hampshire
 Evans, John W., Ohio State University
 Evans, Lewis P., University of Illinois
 Evenson, Leonard, South Dakota School of Mines
 Everett, Leonard, Jr., Stanford University
 Faerber, Arno A., Washington State College
 Farris, Willard A., University of Maine
 Fay, Ernest E., Jr., University of Nebraska
 Fenner, Kermit F., So. Dak. State School of Mines
 Finch, Glenn O., North Carolina State College
 Fischer, Frederick P., Rutgers College
 Fiske, John H., University of California
 Fitch, Howard M., University of Kentucky
 Fleisher, Henry T., Penna. State College
 Fleming, Max C., Kansas State Agricultural Col.
 Fletemeyer, Louis H., Jr., Purdue University
 Folger, Walter C., Purdue University
 Fonville, Ralph W., Duke University
 Foss, Caldwell B., Rensselaer Polytechnic Inst.
 Formhals, William H., University of Illinois
 Forster, Arthur G., University of Calif.
 Fort, Robert I., University of Kentucky
 Franco, John J., Mississippi A. & M. College
 Friesell, Charles E., Ohio State University
 From, Arthur, University of Nebraska
 Frost, Louis H., Syracuse University
 Fry, Margaret E., University of Kentucky
 Fuhlbrugge, Herman, So. Dak. State School of Mines
 Funkhouser, Francis M., University of Illinois
 Gahagan, Joseph E., Rensselaer Polytechnic Inst.
 Gainer, William P., Engg. School of Milwaukee
 Galbraith, Robert E., Univ. of Calif.
 Galbreath, Robert R., Carnegie Inst. of Tech.
 Garcia, Nicolas, Jr., Virginia Military Institute
 Garrigus, Lewis L., Purdue University
 Gates, Clinton E., Calif. Inst. of Tech.
 Gay, Clarence G., Northeastern University
 Gearhisor, William P., Miss. A. & M. College
 Geiman, Herschel R., Kansas State Agri. College
 Gentilini, Celso, University of Illinois
 George, Ernest E., Princeton University
 George, Olin C., Ohio Northern University
 Gess, John T., University of Kentucky
 Ghamat, Shavax B., Engg. School of Milwaukee
 Gibson, John C., Mass. Inst. of Tech.
 Gibbens, John R., Rose Polytechnic Institute
 Giddings, Sylvester N., Calif. Inst. of Tech.
 Gill, Harry A., Northeastern University
 Gillespie, Kenneth T., University of Oklahoma
 Gillham, John N., University of Kentucky
 Glasco, Charles E., Kansas State Agricultural Col.
 Glenn, Robert R., University of Missouri
 Glover, Clinton A., University of Texas
 Godard, Posey W., Miss. A. & M. College
 Godsey, James S., University of Virginia
 Golightly, William B., Engg. School of Milwaukee
 Goodman, Louis M., Ohio Northern University
 Goodwyn, Charles A., Virginia Military Institute
 Gordon, Jess F., So. Dak. State School of Mines
 Gorton, William G., Northeastern University
 Gougler, Robert L., University of Illinois
 Gould, Winfield H., Ohio State University
 Graham, Joseph H., Purdue University
 Graham, Spencer W., Kansas State Agri. College
 Grant, Raymond A., Northeastern University
 Graves, Winter K., Rensselaer Polytechnic Inst.
 Gray, Gordon E., University of Illinois
 Green, David V., Lafayette College
 Green, Edgar L., Jr., Cornell University
 Green, Martin P., Univ. of Calif.
 Greene, Lawrence G., Rhode Island State College
 Griffith, William H., Bucknell University
 Grimes, Kenneth D., Kansas State Agri. College
 Grissler, Herman, Cooper Union
 Groch, Fred R., Calif. Inst. of Tech.
 Grout, Edward M., University of Florida
 Gruber, Albert, State College of Washington
 Grund, H. Maurice, Iowa State College
 Gurinian, Paul, Lewis Institute
 Haaf, George B., Syracuse University
 Haas, Gaylord Paul, University of Notre Dame
 Hadwin, Thomas F., Univ. of British Columbia
 Hagon, Thomas H., University of Wisconsin
 Hagood, George B., Clemson Agricultural College
 Hahn, Edward L., University of Nebraska
 Haines, Elliott, Jr., Johns Hopkins Univ.
 Hall, John L., Calif. Inst. of Tech.
 Ham, Richard F., Alabama Polytechnic Institute
 Hamp, John W., Lehigh University
 Hamrick, Aaron W., North Carolina State College
 Handy, John C., Johns Hopkins University
 Hane, Oscar G., Mich. Col. of Mining & Tech.
 Hanna, C. Raymond, Northeastern University
 Harrington, John A., State College of Washington
 Harshbarger, Lloyd A., Ohio State University
 Hartman, Herbert L., Ohio Northern University
 Hartong, Hobart H., University of Illinois
 Harvey, Gordon C., Ohio State University
 Haubrich, Lee, Colorado State Agricultural Col.
 Haun, Allison J., Univ. of Calif.
 Hay, Herbert R., Lafayette College
 Hayes, Harold H., So. Dak. State School of Mines
 Hayes, Russell R., Oklahoma University
 Haynes, Charles M., University of Missouri
 Heckert, Robert B., Kansas State Agri. College
 Heltzel, William E., Purdue University
 Hembree, Eugene E., Clemson Agricultural Col.
 Hemphill, Hugh F., University of Kentucky
 Henderson, Donald B., University of Maine
 Henderson, Donald E., Rose Polytechnic Institute
 Hendricks, Shelton, University of Kentucky
 Hendrickson, Charles T., University of Minnesota
 Herrmann, John A., Purdue University
 Hershberger, Carl A., Ohio Northern University
 Hess, B. Parker, Ohio State University
 Hesselberth, Wilfred M., University of Illinois
 Hewitt, George William, Iowa State College
 Higgins, Elmer R., University of Maine
 Hoaglund, Robert G., Northeastern University
 Hoffman, Eugene C., State College of Washington
 Hoffman, Gordon C., Clemson Agricultural Col.
 Hoffman, Gordon L., Johns Hopkins University
 Hollis, George H., West Virginia University
 Holmes, Burton E., Northeastern University
 Holmes, Richard H., Univ. of Calif.
 Honke, Akira, University of Illinois
 Horn, Virgil M., Purdue University
 Horning, Edward W., University of Illinois
 Horstman, Clifford C., Washington University
 Hoshino, Akira, Cornell University
 Howard, Clyde E., Ohio State University
 Howard, Jack M., University of Kentucky
 Howard, Richard P., University of Kentucky
 Howery, Allen M., University of Tennessee
 Hsu, Shih-Chuan, Purdue University

- Huang, Pienchun, Purdue University
 Huber, Louis P., State College of Washington
 Hudlow, Lloyd J., State College of Washington
 Huebner, Charles A., University of Illinois
 Huffer, J. Craig, University of Florida
 Hufnagel, Walter P., University of Illinois
 Hull, Francis M., University of Detroit
 Humphrey, Nathan T., Princeton University
 Humphrey, Thomas S., Jr., New York University
 Hunt, Donald L., Iowa State College
 Hunter, Charles W., Univ of Calif.
 Hurlbut, Charles C., Syracuse University
 Hurst, Thomas T., Mississippi A. & M. College
 Ibler, Harry, University of Illinois
 Imle, John F., University of Texas
 Ireland, John W., Jr., Virginia Military Institute
 Irvine, Leland K., University of Utah
 Isherwood, Robert A., Northeastern University
 Jacklin, Norman L., University of Illinois
 Jackman, Arthur A., Northeastern University
 Jacobs, John Wm., Northeastern University
 Jacroux, George, State College of Washington
 Jarrard, C. E., Clemson Agricultural College
 Jefferies, V. E., Kansas State Agr. College
 Jenkins, Russell C., University of Missouri
 Jester, Harold S., University of Illinois
 Jobbins, Daniel Manley, Rutgers College
 Johnson, Alva A., University of Virginia
 Johnson, Clarence B., Jr., Virginia Military Inst.
 Johnson, Elmer T., Northeastern University
 Johnson, Emmett M., State Col. of Washington
 Johnson, Ernest A., Rose Polytechnic Institute
 Johnson, Paul K., Rensselaer Polytechnic Inst.
 Johnson, Victor T., University of Calif.
 Johnson, William De Laporte, Univ. of Missouri
 Johnson, W. M., University of Florida
 Johnston, Thomas F., Texas A. & M. College
 Jones, Otis C., So. Dak. State School of Mines
 Jones, Willie H., University of Nebraska
 Jordan, Robert L., University of Illinois
 Jordan, Stanley R., University of Illinois
 Kaminky, Oscar H., University of Illinois
 Kanne, Donald W., University of Minnesota
 Kantayya, Anandarao G., Rensselaer Poly. Inst.
 Karnuth, Roy F., University of Illinois
 Katt, William J., University of Illinois
 Kelliher, James L., Northeastern University
 Kelsay, William D., University of Texas
 Kemper, Floyd L., Ohio State University
 Kennedy, Frank H., Rensselaer Polytechnic Inst.
 Kent, Frederick T., Jr., Rutgers College
 Kerley, James G., Miss. A. & M. College
 Kester, Edson E., University of Florida
 Kettering, Robert L., University of Washington
 Keyes, William R., Mich. Col. of Mining & Tech.
 Kiehle, E. G., Northeastern University
 Kime, Roy M., Princeton University
 Kimura, Henry A.
 Kinney, Floyd M., Ohio State University
 Kirk, Richard C., North Carolina State College
 Kirschner, Alfred E., Northeastern University
 Kliebenstein, W. Willard, State Col. of Wash.
 Klinker, Henry O., Rensselaer Polytechnic Inst.
 Klocker, Wallace C., State Col. of Washington
 Knack, Wallace L., Cornell University
 Knoll, Arthur F., University of Cincinnati
 Ko, C. C., Purdue University
 Koch, Theodore A., Ohio State University
 Koehler, Julius W., McGill University
 Kolb, Louis W., Lewis Institute
 Krebbiel, Menno P., Kansas State Agr. College
 Kriviskey, George, University of Illinois
 Kugler, John C., University of Idaho
 Kuhlman, Harold E., University of Oklahoma
 Kuklinski, Marcel, University of Kentucky
 Kwapi, Elmer G., University of Wisconsin
 Ladang, Alfredo C., Lewis Institute
 Lair, Otis W., Purdue University
 Lambert, William H., Carnegie Inst. of Tech.
 Lamkey, Frank R., Washington University
 Lancaster, Charles N., University of Kentucky
 Lancaster, Joseph G., University of Idaho
 Landa, Henry C., University of Wisconsin
 Lantz, Norman G., Purdue University
 Laramore, Chester E., Purdue University
 Larson, Carl G., Worcester Polytechnic Institute
 Lautler, Roger A., Rensselaer Poly. Inst.
 Lawman, Paul M., Carnegie Inst. of Tech.
 Lawrence, Walter T., Iowa State College
 Laws, Charles W., So. Dak. State School of Mines
 Lawyer, Hugh, University of Oklahoma
 Lazzari, Americo, Univ. of Calif.
 Leatherman, Henry A., Ohio Northern University
 LeCroy, James M., Miss. A. & M. College
 Lee, John H., North Carolina State College
 Lester, Julian T., University of Kentucky
 Leibovich, Harry, University of Missouri
 Leppert, Melvin L., Calif. Inst. of Technology
 Levine, David L., University of Illinois
 Levine, Samuel J., Mass. Inst. of Technology
 Levy, Francis E., Univ. of Calif.
 Lewis, J. Conrad, State College of Washington
 Lewis, John J., Rensselaer Poly. Inst.
 Lewis, Robert K., University of Kentucky
 Ley, John E., Kansas State Agricultural College
 Lichty, H. F., North Carolina State College
 Lightner, Paul J., University of Oklahoma
 Lindsey, Walter F., Virginia Military Institute
 Lindstrom, Jerome E., North Dakota Agri. Col.
 Locke, Arthur M., Rensselaer Polytechnic Inst.
 Logan, John W., University of Missouri
 Lorenz, Harold F., Worcester Polytechnic Inst.
 Losoncy, Wm. A., University of Detroit
 Lotze, Charles A., Rose Polytechnic Institute
 Lundberg, Fred C., University of Utah
 Lyle, R. Elmore, State College of Washington
 MacDonald, Alden F., University of Florida
 Macdonald, George E., Engg. School of Mil.
 Mace, Otis E., Worcester Polytechnic Institute
 Mack, Donald W., University of New Hampshire
 MacNamee, William R., Princeton University
 MacNeill, Gordon E., Northeastern University
 Macoy, Eugene W., Mass. Inst. of Technology
 Maier, Robert W., Northeastern University
 Makita, Victor K., University of Southern Calif.
 Malone, Creed, Jr., West Virginia University
 Mann, Hamilton H., University of Virginia
 Manville, Robert L., University of Illinois
 Marshall, Harrison G., University of Maine
 Marston, William R., University of Illinois
 Marvin, Gordon S., University of Illinois
 Massey, Victor H., Univ. of Calif.
 Mathisen, George, Lehigh University
 Matoian, Christopher G., Univ. of New Hampshire
 Matthews, George D., University of Illinois
 Mauney, B. S., North Carolina State College
 Mauney, James H., North Carolina State College
 Mauss, Lyle L., Iowa State College
 Mayer, F. N., So. Dak. State School of Mines
 Mayott, William E., Rensselaer Poly. Inst.
 Mazyck, Edward H., Clemson Agricultural Col.
 McClarren, D. W., University of Washington
 McConaghy, Louis B., Carnegie Inst. of Tech.
 McCowan, Howard L., University of Illinois
 McCrary, Samuel E., Virginia Military Institute
 McCulley, E. P., Kansas State Agr. College
 McCurdy, John D., Cornell University
 McDonald, Raymond K., State Col. of Wash.
 McDowell, Earle B., Iowa State College
 McFaddin, John J., Clemson Agricultural College
 McFarlin, Vernon S., Northeastern University
 McGinty, Norman W., University of Idaho
 McIntosh, F. R., Texas A. & M. College
 McKay, William M., Montana State College
 McKenzie, Daniel B., Virginia Military Institute
 McPherson, John M., Clemson Agricultural Col.
 McPhillamey, Wallace F., University of Idaho
 Meliza, Lyle H., University of Illinois
 Melton, Dewey P., North Carolina State College
 Mendel, Leo E., University of Illinois
 Meneely, James F., University of Idaho
 Menendez, Ernest, University of Florida
 Meschicovsky, Theodore, Worcester Poly. Inst.
 Meyer, George F., University of Illinois
 Meyers, George J., Jr., Mass. Inst. of Technology
 Meyers, M. Downing, Johns Hopkins University
 Meyers, Otto F., University of Texas
 Michael, Paul O., Purdue University
 Miller, Chas. J., University of Missouri
 Miller, Leo N., University of Iowa
 Miller, Richard A., Newark College of Engineering
 Miller, Wallace B., Virginia Military Institute
 Miner, H. Read, University of Illinois
 Mitchell, David B., University of New Mexico
 Montgomery, Glenn D., Montana State College
 Montojo, Edward P., Engg. School of Milwaukee
 Moody, Harold S., University of Southern Calif.
 Moon, Arthur W., Cornell University
 Moran, Francis P., University of Detroit
 Moran, Leo L., University of Detroit
 Morgan, Charles T., Northeastern University
 Morgan, James M., West Virginia University
 Morrow, Melvin J., Brooklyn Polytechnic Inst.
 Moptert, Paul L., University of Washington
 Muller, Hiram P., Cornell University
 Muntz, J. H., University of Illinois
 Murch, Kenneth C., Northeastern University
 Murphy, Frederick J., Northeastern University
 Murphy, William M., University of Kentucky
 Myrick, Eberhard P., State College of Washington
 Nahas, Jack N., Texas A. & M. College
 Nanartonis, Albert N., Worcester Poly. Inst.
 Nathan, Jack X., Carnegie Inst. of Tech.
 Nave, Clyde K., University of Kentucky
 Naylor, Charles W., Kansas State Agr. College
 Nazario, Arthur, Ohio Northern University
 Neidert, John H., University of Texas
 Nelsch, Walter R., University of Illinois
 Nelson, Ruben, So. Dak. State School of Mines
 Nelson, Walter E., North Dakota Agr. College
 Newman, Clyde, Kansas State Agricultural Col.
 Niemi, Arvo N., Mich. St. Col. of Agri. & Ap. Sci.
 Noe, Milford W., University of Kentucky
 Nolan, Robert A., Ohio State University
 Norris, Rollin H., Harvard University
 Nottingham, James R., West Virginia University
 Novak, Frank E., University of Wisconsin
 Noyes, Herbert E., Northeastern University
 O'Donnell, Cornelius E., University of Illinois
 O'Leary, Daniel F., Northeastern University
 Ordway, Robert D., Northeastern University
 Orner, Ralph J., University of Illinois
 Orth, Harry, University of Texas
 O'Sullivan, Robert G., Brooklyn Polytechnic Inst.
 Ott, Marvin G., Kansas State Agricultural Col.
 Owsley, Carl, University of Kentucky
 Pafford, Robert J., Kansas State Agr. College
 Pagella, Charles, Rhode Island State College
 Paine, Harold G., University of Illinois
 Palmer, Robert N., Rensselaer Polytechnic Inst.
 Pangborn, Redmond J., University of Idaho
 Paramore, Leslie, Kansas State Agr. College
 Parce, Earl T., Colorado State Agricultural Col.
 Pardonner, George N., Ohio State University
 Parker, Gordon S., Virginia Military Institute
 Parks, Lester A., Northeastern University
 Pascoe, Robert L., Lafayette College
 Patel, R. M., Cornell University
 Patterson, Russell H., Ohio State University
 Patterson, William R., University of Kentucky
 Peale, Alexander H., Mississippi A. & M. College
 Peale, A. W., Miss. A. & M. College
 Pearson, John S., Stanford University
 Pelatowski, S. M., State Univ. of New Mexico
 Pennington, Donald J., University of Illinois
 Pentz, Everett W., University of Kentucky
 Peralta, A., Cornell University
 Pernel, J. Herbert, University of Oklahoma
 Perry, James G., University of Kentucky
 Pettus, James F., University of Kentucky
 Phillips, Charles H., Rensselaer Poly. Inst.
 Pickels, George W., Jr., University of Illinois
 Pickens, Harold L., University of Oklahoma
 Pierce, Arthur F., Jr., Worcester Polytechnic Inst.
 Pierce, Charles J., Syracuse University
 Pilgrim, Charlie J., University of Texas
 Pitner, Gordon H., University of Illinois
 Platts, Ralph N., University of Kentucky
 Plomasen, Charles G., State Col. of Washington
 Poland, Harland O., University of Maine
 Poland, Merle G., State College of Washington
 Pollacek, Edgar H., Rutgers College
 Porter, William T., Stanford University
 Powell, Arnold E., Northeastern University
 Powell, George L., Univ. of Calif.
 Prentice, Bruce R., Kansas State Agr. Col.
 Pritchett, Jack D., Calif. Inst. of Tech.
 Procopio, Ralph G., Northeastern University

- Prucha, Alvin F., Iowa State College
 Radcliffe, Joseph H., Montana State College
 Ragsdale, John H., Univ. of Southern California
 Ranson, L. Russell, Duke University
 Rasmus, Peter A., Ohio State University
 Rayburn, Lawrence M., State Col. of Washington
 Read, G. Wilber, Calif. Inst. of Tech.
 Reinhard, James W., Univ. of Southern California
 Rentz, Cecil V., Clemson Agricultural College
 Rettig, V. G., University of Cincinnati
 Reynard, Charles L., University of Delaware
 Reynolds, Embree E., Univ. of Calif.
 Rhee, Wm. J., Purdue University
 Rhodes, Floyd C., Rensselaer Poly. Inst.
 Rice, Charles K., University of Kentucky
 Robbins, Fred E., Purdue University
 Robbeck, Clausen A., Johns Hopkins University
 Roberts, Frederick F., University of Idaho
 Robinson, Leonard E., University of Illinois
 Roblee, John E., University of Missouri
 Rodriguez, Carlos V., University of Texas
 Rogers, Arlington G., Mich. Col. of Mining & Tech.
 Romberg, Marvin, University of Texas
 Rosencrans, C. A., Lehigh University
 Ross, George A., Calif. Inst. of Tech.
 Rubin, Albert C., University of Illinois
 Rudasill, William A., Virginia Military Institute
 Rus, Albert F., University of Illinois
 Russell, Donald R., University of Idaho
 Russell, Lloyd W., Calif. Inst. of Tech.
 Rust, George D., Newark College of Engineering
 Ryan, Charles P., Iowa State College
 Sackman, George W., Clemson Agricultural Col.
 Saibara, Robert, Texas A. & M. College
 Salazar, Alberto, Rensselaer Poly. Inst.
 Sander, Willis C., State College of Washington
 Sanders, Jack, Kansas State Agricultural College
 Sanders, J. L., Jr., University of Florida
 Sargent, Charles S., University of Washington
 Sargent, Willard C., Northeastern University
 Sawyer, Richard M., Univ. of New Hampshire
 Scales, Samuel M., University of Texas
 Scheffer, Sebastian L., University of Maine
 Schierland, Raymond F., Univ. of Cincinnati
 Schlieder, Harold A., Rensselaer Polytechnic Inst.
 Schmuck, Rudolph, University of Texas
 Scholl, Robert A., Purdue University
 Scholz, Clarence W., University of Nebraska
 Schowe, Harvey F., University of Missouri
 Schroder, Lawrence D., University of Utah
 Schutz, Emil, Municipal University of Akron
 Schwarz, Howard C., University of Missouri
 Scott, Robert M., University of Maine
 Scott, Stewart D., Univ. of Southern California
 Seal, Philip M., Worcester Polytechnic Institute
 Searing, William H., Cornell University
 Seegal, Jacob, Brown University
 Seely, Raymond K., State College of Washington
 Seiler, George E., University of Oklahoma
 Sexton, Charles R., Univ. of Calif.
 Shapiro, Richard, University of Illinois
 Shearer, Robert L., University of Illinois
 Sheath, Samuel B., Jr., Rutgers College
 Shepherd, Marshall L., North Carolina State Col.
 Shields, C. B., Purdue University
 Shively, Harmon G., Municipal Univ. of Akron
 Shively, Russell D., Municipal Univ. of Akron
 Shomber, Harold H., Kansas State Agri. College
 Shraberg, Ben, University of Kentucky
 Shumaker, Henry H., Mississippi A. & M. College
 Schwetz, Patrick D., Northeastern University
 Sickel, Stanley J., South Dakota School of Mines
 Siegel, George M., Worcester Polytechnic Inst.
 Sievers, Arthur G., So. Dak. State School of Mines
 Siler, Harold D., Ohio State University
 Siniscalchi, Guy C., University of Illinois
 Smith, Benjamin T., Virginia Military Institute
 Smith, Carl E., Iowa State College
 Smith, George H., University of Delaware
 Smith, Floyd H., Kansas State Agri. College
 Smith, Howard G., Cornell University
 Smith, Laurence M., University of Idaho
 Smith, Paul Q., Mississippi A. & M. College
 Smith, Wm. S., North Carolina State College
 Smoot, E. P., Kansas State Agr. College
 Sodano, Michael C., Worcester Poly. Inst.
 Soliday, Victor W., Engg. School of Milwaukee
 Soskin, Samuel B., Lewis Institute
 Southam, W. W., McGill University
 Sowell, Thomas M., Texas A. & M. College
 Spadetti, Umberto, Rhode Island State College
 Sparks, Walter D., University of Kentucky
 Spencer, Julian L., University of Illinois
 Spencer, Lincoln O., University of Maine
 Sperr, Kenneth K., Rhode Island State College
 Sperotto, Joseph J., Rose Polytechnic Institute
 Spilker, Clifford J., So. Dak. State School of Mines
 Sprague, V. Gilbert, Ohio State University
 Spring, William S., Cornell University
 Stanton, Samuel W., Rutgers College
 Stearns, Richard H., Duke University
 Steel, J. Ira, West Virginia University
 Steers, William F., University of Kentucky
 Sterling, Oscar R., Bucknell University
 Stidfole, Fred S., Rensselaer Polytechnic Inst.
 Stieg, Henry R., Northeastern University
 Stiles, J. Ward, University of Toronto
 Stilphen, Lee E., Northeastern University
 St. John, Robert C., University of Illinois
 Stipp, Theodore F., Calif. Inst. of Tech.
 Stoll, Philip C., Georgia School of Technology
 Stuttle, Charles S., University of Detroit
 Sucre, Antonio J., Mass. Inst. of Tech.
 Sudack, William, Northeastern University
 Suydam, George M., Lafayette College
 Sullivan, Hays, Jr., Mississippi A. & M. College
 Sussin, David, University of Texas
 Sutherland, John G., University of Cincinnati
 Swain, Vernon T., University of New Hampshire
 Swanson, John A., Engg. School of Milwaukee
 Swift, Frederick T., Jr., Calif. Inst. of Tech.
 Szewczuk, Walter, University of Missouri
 Talbott, Arthur L., State College of Washington
 Talcott, Clifford P., Syracuse University
 Tankovich, James G., Ohio State University
 Taplin, Ernest L., State College of Washington
 Tarbet, Thomas V., Calif. Inst. of Tech.
 Tarun, Leighton P., So. Dak. State School of Mines
 Taylor, Theodore F., University of Iowa
 Taylor, Wm. L., University of Illinois
 Thayer, E. Merlin, Calif. Inst. of Tech.
 Thielman, Albert, Mich. Col. of Mining & Tech.
 Thom, E. H., Kansas State Agr. College
 Thomas, Peter G., Pennsylvania State College
 Thompson, Martin M., University of Kentucky
 Thompson, R. J., University of Oklahoma
 Thompson, William G., Jr., Univ. of Calif.
 Thomson, Howard M., University of Washington
 Thudin, Clyde F., Kansas State Agri. College
 Tolentino, Damaso M., Engg. School of Mil.
 Trekel, Harold E., Kansas State Agri. College
 Trompen, J. Milton, Rutgers College
 Trotter, Robert R., Miss. A. & M. College
 Trueb, Jack, Rose Polytechnic Institute
 Truesdell, Francis W., Clarkson College
 Tsiales, Panayiotis T., University of Maine
 Turner, R. Kenneth, Ohio State University
 Twelves, Charles M., Mass. Inst. of Tech.
 Unz, Clifford F., Iowa State College
 Valdes, Proencio, University of Texas
 Valentine, Weston W., Lehigh University
 Van Horn, Otto, Montana State College
 Van Meter, B. F., University of Kentucky
 Vant, Leslie M., Northeastern University
 Vencill, George J., University of Missouri
 Vieth, Edward L., Jr., University of Kentucky
 Villegas, Lucio P., State College of Washington
 Vipond, Leslie C., North Carolina State College
 Vogel, Charles P., Lafayette College
 Vogel, William H., Jr., Cornell University
 Waale, Theodore, So. Dak. State School of Mines
 Walden, George R., Univ. of New Hampshire
 Walker, John T., Jr., Virginia Military Institute
 Walsh, Tracy R., University of Florida
 Walsh, William C., Univ. of Calif.
 Walters, Thomas A., University of Kentucky
 Walton, Louis A., University of Kentucky
 Wamboldt, Henry, Colorado State Agri. College
 Wanner, Louis R., Lehigh University
 Warrick, Paul J., University of Illinois
 Watson, Frank E., West Virginia University
 Watson, Jack H., University of Oklahoma
 Weber, John C., University of Wisconsin
 Weckel, M. F., Kansas State Agri. College
 Weeks, Gilbert E., University of Maine
 Wegel, Fred C., Rutgers College
 Weiks, John E., Engg. School of Milwaukee
 Weil, Robert T., Jr., Brooklyn Polytechnic Inst.
 Weist, Glenn E., Purdue University
 Wells, Leslie S., University of Illinois
 Wells, Miner F., Worcester Polytechnic Institute
 Wells, Raymond G., University of Illinois
 Wenzel, Hubert A., University of Illinois
 Wergin, Clarence, Engg. School of Milwaukee
 Werner, Calvin J., University of Cincinnati
 West, Clarence V., Virginia Polytechnic Institute
 Westberg, V. L., University of Illinois
 Westerstrom, R. W., Iowa State College
 Wey, George, University of Illinois
 Wheeler, John N., Northeastern University
 Whisler, Clarence R., Iowa State College
 White, Irving S., Worcester Polytechnic Institute
 White, Raymond N., University of Kentucky
 Whiteside, Elbert B., Virginia Military Institute
 Whiteside, Foster C., University of Oklahoma
 Whitney, Carl E., University of Cincinnati
 Whitney, Walter N., Cornell University
 Whittaker, Earl S., Clarkson College
 Wick, Vernon C., Mich. College of Mining & Tech.
 Wickey, John R., Purdue University
 Wickland, Edward H., University of Illinois
 Wilcoxson, Arthur F., Ohio State University
 Wildes, Arthur F., Mass. Inst. of Technology
 Willey, Garner D., University of Kentucky
 Williams, Dudley F., Rose Polytechnic Institute
 Williams, Ralph P., So. Dak. State School of Mines
 Williams, Walter J., Montana State College
 Williamson, Edwin H., University of Virginia
 Willman, Joseph A., Alabama Polytechnic Institute
 Winsor, Paul B., Rhode Island State College
 Wirt, J. Raymond, Purdue University
 Wiseman, Donald M., University of Idaho
 Wolfe, J. C., University of Nebraska
 Wolfe, Theodore A., Lehigh University
 Wolff, Marvin A., Rutgers College
 Woll, Lazar, Columbia University
 Wood, Benjamin T., University of Maine
 Woodard, Walter M., Ohio Northern University
 Woodfill, J. R., University of Illinois
 Woodruff, Marion W., University of Illinois
 Woodruff, Robert T., Carnegie Institute of Tech.
 Woolhiser, Joy E., So. Dak. State School of Mines
 Worcester, J. A., Cornell University
 Word, John A., Univ. of Calif.
 Wright, James H., Harvard University
 Wright, Milton J., Syracuse University
 Wright, Norman H., Northeastern University
 Young, F. E., University of Utah
 Young, Frederick M., Northeastern University
 Young, Joseph W., So. Dak. State School of Mines
 Young, Richard, University of Missouri
 Younts, Glen L., Iowa State College
 Zable, Louis, Univ. of Calif.
 Zima, Thomas E., Carnegie Institute of Tech.
 Zimmerman, James W., University of Kentucky

Total 835.

OFFICERS A. I. E. E. 1929-1930

President
HAROLD B. SMITH

Junior Past Presidents
R. F. SCHUCHARDT
BANCROFT GIERARDI

Vice-Presidents
E. B. MERRIAM
H. A. KIDDER
W. T. RYAN
B. D. HULL
G. E. QUINAN

Directors
I. E. MOULTROP
H. C. DON CARLOS
P. J. CHESTERMAN
F. C. HANKER
E. B. MEYER
H. P. LIVERSIDGE

National Treasurer
GEORGE A. HAMILTON

HERBERT S. EVANS
W. S. RODMAN
C. E. PLEAGER
E. C. STONE
C. E. SISSON

J. ALLEN JOHNSON
A. M. MACCUTCHEN
A. E. BETTIS
W. S. LEE
J. E. KEARNS
C. E. STEPHENS

National Secretary
F. L. HUTCHINSON

General Counsel: PARKER & AARON
 30 Broad Street, New York

LOCAL HONORARY SECRETARIES

T. J. Fleming, Calle B. Mitre 519, Buenos Aires, Argentina, S. A.
 H. W. Flashman, Aus. Westinghouse Elec. Co. Ltd., Cathcart House, 11 Castlereagh St., Sydney, N. S. W., Australia.
 F. M. Servos, Rio de Janeiro Tramways, Light & Power Co., Rio de Janeiro, Brazil.
 A. P. M. Fleming, Metropolitan Vickers Elec. Co., Trafford Park, Manchester, England.
 A. S. Garfield, 45 Bd. Beausejour, Paris 16 E., France.
 F. W. Willis, Tata Power Company, Bombay House, Bombay, India.
 P. H. Powell, Canterbury College, Christchurch, New Zealand.
 M. Chatelain, Lesnoi Polytechnic Institute, Apt. 27, Leningrad, U. S. S. R.
 Axel F. Enstrom, 24a Ingeniorsvetenskapsakademien, Stockholm, S. Sweden.
 W. Eldson-Dew, P. O. Box 4563 Johannesburg, Transvaal, Africa.

A. I. E. E. COMMITTEES

(A list of the personnel of Institute committees may be found in the September issue of the JOURNAL.)

GENERAL STANDING COMMITTEES AND CHAIRMEN

EXECUTIVE, Harold B. Smith
FINANCE, E. B. Meyer
MEETINGS AND PAPERS, A. E. Knowlton
PUBLICATION, W. S. Gorsuch
COORDINATION OF INSTITUTE ACTIVITIES, H. A. Kidder
BOARD OF EXAMINERS, E. H. Everit
SECTIONS, W. B. Kouwenhoven
STUDENT BRANCHES, W. H. Timbie
MEMBERSHIP, J. Allen Johnson
HEADQUARTERS, R. H. Tapscott
LAW, L. F. Morehouse
PUBLIC POLICY, D. C. Jackson
STANDARDS, F. D. Newbury
EDISON MEDAL, Samuel Insull
LAMME MEDAL, Charles F. Scott

CODE OF PRINCIPLES OF PROFESSIONAL CONDUCT, P. B. Jewett
COLUMBIA UNIVERSITY SCHOLARSHIPS, W. I. Blichter
AWARD OF INSTITUTE PRIZES, A. E. Knowlton
SAFETY CODES, A. W. Bettesford

SPECIAL COMMITTEE

ADVISORY COMMITTEE TO THE MUSEUMS OF THE PEACEFUL ARTS, J. P. Jackson

TECHNICAL COMMITTEES AND CHAIRMEN

AUTOMATIC STATIONS, P. Zogbaum
COMMUNICATION, G. A. Kositzky
EDUCATION, Edward Bennett
ELECTRICAL MACHINERY, Philip L. Alger
ELECTRIC WELDING, A. M. Candy
ELECTROCHEMISTRY AND ELECTROMETALLURGY, P. H. Bruce
ELECTROPHYSICS, O. E. Buckley
GENERAL POWER APPLICATIONS, J. P. Gaskill
INSTRUMENTS AND MEASUREMENTS, Everett S. Lee
APPLICATIONS TO IRON AND STEEL PRODUCTION, M. M. Fowler
PRODUCTION AND APPLICATION OF LIGHT, George S. Merrill
APPLICATIONS TO MARINE WORK, W. E. Thau
APPLICATIONS TO MINING WORK, Carl Lee
POWER GENERATION, F. A. Allner
POWER TRANSMISSION AND DISTRIBUTION, H. R. Woodrow
PROTECTIVE DEVICES, E. A. Hester
RESEARCH, S. M. Kintner
TRANSPORTATION, Sidney Withington

A. I. E. E. REPRESENTATION

(The Institute is represented on the following bodies; the names of the representatives may be found in the September issue of the JOURNAL.)

ALFRED NOBLE PRIZE COMMITTEE, A. S. C. E.
AMERICAN ASSOCIATION FOR THE ADVANCEMENT OF SCIENCE, COUNCIL
AMERICAN BUREAU OF WELDING
AMERICAN COMMITTEE ON ELECTROLYSIS
AMERICAN ENGINEERING COUNCIL ASSEMBLY
AMERICAN MARINE STANDARDS COMMITTEE
AMERICAN STANDARDS ASSOCIATION
AMERICAN YEAR BOOK, ADVISORY BOARD
BOARD OF TRUSTEES, UNITED ENGINEERING SOCIETY
CHARLES A. COFFIN FELLOWSHIP AND RESEARCH FUND COMMITTEE
COMMITTEE OF APPARATUS MAKERS AND USERS, NATIONAL RESEARCH COUNCIL
COMMITTEE ON ELIMINATION OF FATIGUE, SOCIETY OF INDUSTRIAL ENGINEERS
COMMITTEE ON HEAT TRANSMISSION, NATIONAL RESEARCH COUNCIL
ENGINEERING FOUNDATION BOARD
JOHN PRITZ MEDAL BOARD OF AWARD
JOINT COMMITTEE ON WELDED RAIL JOINTS
JOINT CONFERENCE COMMITTEE OF FOUR FOUNDER SOCIETIES
LIBRARY BOARD, UNITED ENGINEERING SOCIETY
NATIONAL FIRE PROTECTION ASSOCIATION, ELECTRICAL COMMITTEE
NATIONAL FIRE WASTE COUNCIL
NATIONAL RESEARCH COUNCIL, ENGINEERING DIVISION
NATIONAL SAFETY COUNCIL, ELECTRICAL COMMITTEE OF A. S. S. E.—ENGINEERING SECTION
RADIO ADVISORY COMMITTEE, BUREAU OF STANDARDS
SOCIETY FOR THE PROMOTION OF ENGINEERING EDUCATION, BOARD OF INVESTIGATION AND COORDINATION
U. S. NATIONAL COMMITTEE OF THE INTERNATIONAL COMMISSION ON ILLUMINATION
U. S. NATIONAL COMMITTEE OF THE INTERNATIONAL ELECTROTECHNICAL COMMISSION
WASHINGTON AWARD, COMMISSION OF

LIST OF SECTIONS

Name	District	Chairman	Secretary	Name	District	Chairman	Secretary
Akron	(2)	W. A. Hillebrand	R. R. Krammes, The Ohio Power Co., Canton, O.	Kansas City	(7)	A. B. Covey	J. S. Palmer, Kansas City Pr. & Lt. Co., 1330 Grand Ave., Kansas City, Mo.
Atlanta	(4)	H. L. Wills	W. F. Bellinger, Electric Bldg., Atlanta, Ga.	Lehigh Valley	(2)	A. J. Althouse	E. F. Weaver, Pa. Pr. & Lt. Co., 901 Hamilton St., Allentown, Pa.
Baltimore	(2)	W. B. Kouwenhoven	G. S. Diehl, Pa. Water & Pwr. Co., 1611 Lexington Bldg., Baltimore, Md.	Los Angeles	(8)	N. B. Hinson	H. W. Hitchcock, So. Cal. Tel. Co., 740 So. Olive St., Los Angeles, Cal.
Birmingham	(4)	W. E. Bare	O. E. Charlton, Alabama Power Co., Birmingham, Ala.	Louisville	(4)	H. W. Wischmeyer	Philip P. Ash, Louisville & Nashville Rd. Bldg., 9th & B'way Ave., Louisville, Ky.
Boston	(1)	W. H. Colburn	G. J. Crowdes, Simplex Wire & Cable Co., Sidney St., Cambridge, Mass.	Lynn	(1)	I. F. Kinnard	H. K. Nock, General Elec. Co., West Lynn, Mass.
Chicago	(5)	T. G. LeClair	F. R. Innes, c/o Electrical World, 7 So. Dearborn St., Chicago, Ill.	Madison	(5)	R. E. Purucker	L. C. Larson, Univ. of Wisconsin, Madison, Wis.
Cincinnati	(2)	T. C. Reed	L. L. Bosch, Columbia Engg. & Mgmt. Corp., 314 West 4th St., Cincinnati, O.	Mexico	(3)	G. Solis-Payan	E. Leonarz, Jr., Apartado, 2601, Mexico City, Mexico
Cleveland	(2)	T. D. Owens	Wm. H. LaMond, Simplex Wire & Cable Co., 2019 Union Trust Bldg., Cleveland, O.	Milwaukee	(5)	E. W. Seeger	R. C. Siegel, Wisconsin Tel. Co., 418 Broadway, Milwaukee, Wis.
Columbus	(2)	R. A. Brown	W. C. Johnson, Ohio Bell Tel. Co., 42 E. Gay St., Columbus, Ohio	Minnesota	(5)	V. E. Engquist	Oscar Gaarden, Northern State Pr. Co., 15 S. 5th St., Minneapolis, Minn.
Connecticut	(1)	Sidney Withington	R. G. Warner, Yale Univ., New Haven, Conn.	Nebraska	(6)	D. H. Braymer	W. O. Jacobi, Omaha & Council Bluffs St. Ry. Co., 19 & Farnam Sts., Omaha, Neb.
Dallas	(7)	J. B. Thomas	A. Chatham-Strode, Dallas Pwr. & Light Co., Interurban Bldg., Dallas, Tex.	New York	(3)	H. P. Charlesworth	T. F. Barton, General Elec. Co., 120 Broadway, New York
Denver	(6)	W. H. Bullock	N. R. Love, 807 Tramway Bldg., Denver, Colo.	Niagara Frontier	(1)	Raymond T. Henry	E. P. Harder, Buffalo General Elec. Co., 205 Electric Bldg., Buffalo, N. Y.
Detroit-Ann Arbor	(5)	L. F. Hickernell	T. N. Lacy, Michigan Bell Tel. Co., 1365 Cass Ave., Detroit, Mich.	North Carolina	(4)	E. P. Coles	Marshall E. Lake, Duke Pr. Co. Power Bldg., Charlotte, N. C.
Erie	(2)	W. H. Pelton	Geo. I. Le Baron, General Electric Co., Erie, Pa.	Oklahoma City	(7)	C. Walker Mier	C. T. Almqvist, Univ. of Oklahoma, Norman, Okla.
Fort Wayne	(5)	F. W. Merrill	E. J. Schaefer, General Electric Co., Ft. Wayne, Ind.	Panama	(3)		
Houston	(7)	L. K. Del'Homme	C. D. Farman, Southwestern Bell Tel. Co., Houston, Texas	Philadelphia	(2)	R. H. Silbert	J. L. MacBurney, Elec. Storage Battery Co., 1955 Hunting Park Ave., Philadelphia, Pa.
Indianapolis-Laf.	(5)	J. B. Bailey	H. M. Stradling, 353 Mass Ave., Indianapolis, Ind.	Pittsburgh	(2)	J. A. Cadwallader	C. T. Sinclair, Byllesby Engg. & Mngmt. Corp., 435 Sixth Ave., Pittsburgh, Pa.
Iowa	(5)	C. L. Sampson	J. K. McNeely, Iowa State College, Ames, Iowa	Pittsfield	(1)	L. F. Blume	L. H. Burnham, General Electric Co., Pittsfield, Mass.
Ithaca	(1)	W. C. Ballard, Jr.	W. E. Meserve, 614 E. Buffalo St., Ithaca, N. Y.				

LIST OF SECTIONS—Continued

Name	Chairman	Secretary	Name	Chairman	Secretary
Portland, Ore.	(9) H. H. Cake	A. H. Kreul, Portland Elec. Pr. Co., Hawthorne Bldg., Portland, Ore.	Spokane	(9) Earl Baughn	Loren A. Traub, 215 Symons Bldg., Spokane, Wash.
Providence	(1) F. W. Smith	O. W. Briden, Blackstone Valley Gas & Elec. Co., Pawtucket, R. I.	Springfield, Mass.	(1) Fred L. Hunt	B. V. K. French, American Bosch Magneto Corp., Springfield, Mass.
Rochester	(1) Virgil M. Graham	Charles F. Estwick, General Railway Signal Co., Rochester, N. Y.	Syracuse	(1) F. E. Verdin	Chas. W. Henderson, 504 University Pl., Syracuse, N. Y.
St. Louis	(7) G. H. Quermann	O. J. Rotty, Union Elec. Lt. & Pr. Co., 315 No. 12th Blvd., St. Louis, Mo.	Toledo	(2) E. B. Featherstone	Max Neuber, 1257 Fernwood Ave., Toledo, O.
San Francisco	(8) L. F. Fuller	G. Ross Henninger, Electrical West, 883 Mission St., San Francisco, Cal.	Toronto	(10) F. F. Ambuhl	W. F. Sutherland, Toronto Hydroelec. Sys., 225 Yonge St., Toronto, Ont., Canada
Saskatchewan	(10) J. R. Cowley	A. B. Coward, Light & Power Dept., Regina, Sask., Canada	Urbana	(5) M. A. Faucett	C. E. Skroder, Univ. of Ill., Urbana, Ill.
Schenectady	(1) R. Treat	E. E. Johnson, Rm. 435, Bldg. 2, General Electric Co., Schenectady, N. Y.	Utah	(9) A. C. Kelm	L. B. Fuller, Utah Pr. & Lt. Co., Salt Lake City, Utah
Seattle	(9) L. N. Robinson	George S. Smith, Elec. Engg. Dept., University of Washington, Seattle, Wash.	Vancouver	(10) J. Teasdale	D. Robertson, Canadian Gen. Elec. Co., Ltd., Vancouver, B. C., Canada
Sharon	(2) J. B. Gibbs	S. S. Cook, Westinghouse E. & M. Co., Sharon, Pa.	Washington	(2) W. A. E. Doying	G. L. Weller, Chesapeake & Potomac Tel. Co. & Assoc. Cos., 725-13th St., N. W., Washington, D. C.
Southern Virginia	(4) H. C. Leonard	Cecil Gray, Westinghouse E. & M. Co., 912 Electric Bldg., Richmond, Va.	Worcester	(1) H. H. Newell	R. P. Bullen, General Elec. Co., 704 State Mutual Bldg., Worcester, Mass.
			Total 57		

LIST OF BRANCHES

Name and Location	District	Chairman	Secretary	Counselor (Member of Faculty)
Akron, Municipal Univ. of, Akron, Ohio	(2)	Glenn O. Hite	G. G. Clark	J. T. Walther
Alabama Polytechnic Inst., Auburn, Ala.	(4)	T. S. Winter	O. T. Allen	W. W. Hill
Alabama, Univ. of, University, Ala.	(4)			
Arizona, Univ. of, Tucson, Ariz.	(8)	Barney Shehane	F. F. Denney	J. C. Clark
Arkansas, Univ. of, Fayetteville, Ark.	(7)	D. J. Morrison		W. B. Stelzner
Armour Inst. of Tech., 3300 Federal St., Chicago, Ill.	(5)	J. Dollenmaier	S. Janiszewski	E. H. Freeman
Brooklyn Poly. Inst., 99 Livingston St., Brooklyn, N. Y.	(3)	F. J. Mullen	R. G. O'Sullivan	Clyde C. Whipple
Bucknell University, Lewisburg, Pa.	(2)	E. C. Metcalf	R. G. Tingle	W. K. Rhodes
Calif. Inst. of Tech., Pasadena, Calif.	(8)	E. C. Lee	J. L. Hall	R. W. Sorensen
Calif., Univ. of, Berkeley, Calif.	(8)	C. W. Mors	R. W. Hollis	L. E. Reukema
Carnegie Inst. of Tech., Pittsburgh, Pa.	(2)	J. R. Britton	S. A. Bottonari	B. C. Dennison
Case School of Applied Science, Cleveland, Ohio	(2)	R. B. McIntosh	H. L. Brouse	H. B. Dates
Catholic Univ. of America, Washington, D. C.	(2)			Thos. J. MacKavanaugh
Cincinnati, Univ. of, Cincinnati, Ohio	(2)	V. G. Rettig	R. D. Bourne	W. C. Osterbrock
Clarkson College of Tech., Potsdam, N. Y.	(1)	R. N. Roberts	F. W. Truesdell	A. R. Powers
Clemson Agri. College, Clemson College, S. C.	(4)	G. W. Sackman	Walter C. Snyder	Sam. R. Rhodes
Colorado State Agri. College, Ft. Collins, Colo.	(6)	G. R. Branch	L. Haubrich	H. G. Jordan
Colorado, University of, Boulder, Colo.	(6)	Wm. J. Dowis	E. E. Stoeckly	W. C. DuVall
Cooper Union, New York, N. Y.	(3)	H. Reuter	H. Grissler	A. J. B. Fairburn
Cornell University, Ithaca, N. Y.	(1)	Alexander B. Credle	J. D. McCurdy	Everett M. Strong
Denver, Univ. of, Denver, Colo.	(6)	L. J. Wright	R. B. Convery	R. E. Nyswander
Detroit, Univ. of, Detroit, Mich.	(5)	Wm. F. Haldeman	W. R. Moyers	H. O. Warner
Drexel Institute, Philadelphia, Pa.	(2)	D. M. Way	O. L. Eichna	E. O. Lange
Duke University, Durham, N. C.	(4)	R. H. Stearns	H. M. Sherard	W. J. Seeley
Florida, Univ. of, Gainesville, Fla.	(4)	J. W. McKay	A. L. Webb	J. M. Weil
Georgia School of Tech., Atlanta, Ga.	(4)	B. Mann	K. W. Mowry	T. W. Fitzgerald
Idaho, University of, Moscow, Idaho	(9)	Wayne McCoy	C. E. Conway	J. H. Johnson
Iowa State College, Ames, Iowa	(5)	H. H. Stahl	H. Kirk	F. A. Fish
Iowa State University of, Iowa City, Iowa	(5)	D. MacDougal		E. B. Kurtz
Kansas State College, Manhattan, Kansas	(7)	L. N. Lydick	L. C. Paslay	R. M. Kerchner
Kansas, Univ. of, Lawrence, Kansas	(7)	M. W. Hammond	H. W. Yenzler	G. C. Shaad
Kentucky, Univ. of, Lexington, Ky.	(4)	Wm. F. Steers	R. I. Fort	W. E. Freeman
Lafayette College, Easton, Pa.	(2)	E. C. Albert	Wm. F. Titus	Morland King
Lehigh University, Bethlehem, Pa.	(2)	B. O. Steinert	J. E. Zeaser	J. L. Beaver
Lewis Institute, Chicago, Ill.	(5)	G. W. Malstrom	E. R. Borden	F. A. Rogers
Louisiana State University, Baton Rouge, La.	(4)			M. B. Voorhies
Louisville, University of, Louisville, Ky.	(4)	H. T. Clark	O. M. Arehart	D. C. Jackson, Jr.
Maine, University of, Orono, Maine	(1)	A. E. Crockett	H. R. Mayers	Wm. E. Barrows, Jr.
Marquette University, 1200 Sycamore St., Milwaukee, Wis.	(5)	H. W. Haase	G. C. Reichert	J. F. H. Douglas
Massachusetts Institute of Technology, Cambridge, Mass.	(1)	R. H. Swingle	C. M. Twelves, Jr.	W. H. Timbie
Michigan College of Mining and Technology, Houghton, Michigan	(5)	Charles F. Sawyer	B. G. Swart	G. W. Swenson
Michigan State College, East Lansing, Mich.	(5)	R. L. Clark	G. A. Whitfield	L. S. Foltz
Michigan, University of, Ann Arbor, Mich.	(5)	Charles W. Doane	Glen R. Severance	B. F. Bailey
Milwaukee, School of Engineering of, 163 East Wells St., Milwaukee, Wis.	(5)	T. J. Coleman, Jr.	K. O. Werwath	Oscar Werwath
Minnesota, University of, Minneapolis, Minn.	(5)	R. W. Fenton	W. M. Taylor	J. H. Kuhlmann
Mississippi Agricultural & Mechanical College, A. & M. College, Miss.	(4)	W. F. Barksdale	A. H. Peale	L. L. Patterson
Missouri School of Mines & Metallurgy, Rolla, Mo.	(7)	George W. Douglas	J. D. Shelton	I. H. Lovett
Missouri, University of, Columbia, Mo.	(7)	L. G. Weiser		M. P. Weinbach
Montana State College, Bozeman, Mont.	(9)	E. B. Wilson	O. Van Horn	J. A. Thaler
Nebraska, University of, Lincoln, Neb.	(6)	D. E. Schneider	H. G. Wiltse	F. W. Norris
Nevada, University of, Reno, Nevada	(3)	A. McCullom	A. B. Chace	S. G. Palmer
Newark College of Engineering, 367 High St., Newark, N. J.	(8)	H. Harrison	A. L. Davis	J. C. Peet
New Hampshire, University of, Durham, N. H.	(1)	P. Nudd	D. Googins	L. W. Hitchcock
New Mexico, The University of, Albuquerque, New Mexico	(7)	F. A. Stortz, Jr.	W. I. Abbott	F. M. Denton
New York, College of the City of, 139th St. & Convent Ave., New York, N. Y.	(3)	R. Fassnacht	F. J. Wodicka	Harry Baum
New York University, University Heights, New York, N. Y.	(3)	N. G. Schutt	T. S. Humphrey	J. Loring Arnold
North Carolina State College, Raleigh, N. C.	(4)	H. W. Horney	E. R. Price	R. S. Fouraker
North Carolina, University of, Chapel Hills, N. C.	(4)	J. J. Alexander	F. R. Toms	J. E. Lear
North Dakota Agricultural College, State College Station, Fargo, N. D.	(6)	L. C. Langaunet	R. W. Scott	H. R. Rush
North Dakota, University of, University Station, Grand Forks, N. D.	(6)	R. W. Olson	G. E. Glass	H. F. Rice
Northeastern University, 316 Huntington Ave., Boston 17, Mass.	(1)	R. W. Littlefield	R. J. Edwards	Wm. L. Smith
Notre Dame, University of, Notre Dame, Ind.	(5)	E. G. Conroy	Ben South	J. A. Caparo
Ohio Northern University, Ada, Ohio	(2)	J. D. McGahan	R. I. Hartshorn	I. S. Campbell
Ohio State University, Columbus, Ohio	(2)	W. M. Webster	R. C. Moser	F. C. Caldwell
Ohio University, Athens, Ohio	(2)	C. Kenney	H. W. Giesecke	A. A. Atkinson
Oklahoma A. & M. College, Stillwater, Okla.	(7)	H. V. Anderson	E. F. Neal	Albrecht Naeter
Oklahoma, University of, Norman, Okla.	(7)	E. E. Brady	C. W. Anthony	F. G. Tappan
Oregon State College, Corvallis, Oregon	(9)	B. G. Griffith	D. H. Moreland	F. O. McMillan
Pennsylvania State College, State College, Pa.	(2)	W. C. Mason	Wallace J. Wood	L. A. Doggett
Pennsylvania University of, Philadelphia, Pa.	(2)	R. R. Creighton	N. Smith	C. D. Fawcett
Pittsburgh, University of, Pittsburgh, Pa.	(2)	W. A. Aeberlie	G. L. Bolender	H. E. Dyche
Princeton University, Princeton, N. J.	(2)	C. F. Nesslage	N. T. Humphrey	Malcolm MacLaren
Purdue University, Lafayette, Indiana	(5)	P. C. Sandretto	R. T. Orth	A. N. Topping
Rensselaer Polytechnic Institute, Troy, N. Y.	(1)	Wm. Mayott	R. N. Palmer	F. M. Sebest
Rhode Island State College, Kingston, R. I.	(1)	K. K. Sperl	C. Pagella	Wm. Anderson
Rose Polytechnic Institute, Terre Haute, Ind.	(5)	D. E. Henderson	J. H. Corp	C. C. Knipmeyer
Rutgers University, New Brunswick, N. J.	(3)	G. E. Weglener	E. R. Crawford	Paul S. Creager

LIST OF BRANCHES—Continued

Name and Location	District	Chairman	Secretary	Counselor (Member of Faculty)
Santa Clara, University of, Santa Clara, Calif.	(8)	T. L. Selna	J. D. Gillis	L. J. Neuman
South Carolina, University of, Columbia, S. C.	(4)	G. H. Preacher	B. F. Karick	T. F. Ball
South Dakota State School of Mines, Rapid City, S. D.	(6)	H. E. Sattler	B. Hagmann	J. O. Kammerman
South Dakota, University of, Vermillion, S. D.	(6)	E. Johnson	E. E. Lovejoy	B. B. Brackett
Southern California, University of, Los Angeles, Calif.	(8)	Del Mar Wright	G. M. Robertson	Philip S. Biegler
Southern Methodist University, Dallas, Texas	(7)	W. Cox	P. Lindsley, Jr.	E. H. Flath
Stanford University, Stanford University, Calif.	(8)	D. H. Ring	H. E. Hill	T. H. Morgan
Stevens Institute of Technology, Hoboken, N. J.	(3)	F. C. Gilman	G. Habach	F. C. Stockwell
Swarthmore College, Swarthmore, Pa.	(2)	D. B. Spangler	B. C. Algeo	Lewis Fussell
Syracuse University, Syracuse, N. Y.	(1)	D. A. MacGregor	M. J. Wright	C. W. Henderson
Tennessee, University of, Knoxville, Tenn.	(4)	F. P. Elam	A. M. Howery	Joseph G. Tarboux
Texas, A. & M. College of, College Station, Texas	(7)	S. L. Moseley	T. M. Sowell	H. C. Dillingham
Texas, University of, Austin, Texas	(7)	C. B. Norris	R. W. Chase	J. A. Correll
Utah, University of, Salt Lake City, Utah	(9)	L. A. Moore	S. Blomquist	J. H. Hamilton
Vermont, University of, Burlington, Vt.	(1)	F. E. Beckley	A. E. Merrill	L. P. Dickinson
Virginia Military Institute, Lexington, Va.	(4)	W. T. Saunders	A. S. Britt, Jr.	S. W. Anderson
Virginia Polytechnic Institute, Blacksburg, Va.	(4)	L. Backer	C. V. West	Claudius Lee
Virginia, University of, University, Va.	(4)	H. R. Holt	C. H. Dickinson	W. S. Rodman
Washington, State College of, Pullman, Wash.	(9)	T. Mathison	J. Livie	R. D. Stoen
Washington University, St. Louis, Mo.	(7)	Wm. L. Knaus	C. Hortsman	H. G. Hake
Washington, University of, Seattle, Wash.	(9)	K. E. Hammer	H. C. Hurlburt	G. L. Hoard
Washington & Lee University, Lexington, Va.	(4)			R. W. Dickey
West Virginia University, Morgantown, W. Va.	(2)	C. E. Moyers	G. H. Hollis	A. H. Forman
Wisconsin, University of, Madison, Wis.	(5)	G. H. Brown	A. N. O'Neill	C. M. Jansky
Worcester Polytechnic Institute, Worcester, Mass.	(1)	E. C. Milde	C. S. Greco	E. W. Starr
Wyoming, University of, Laramie, Wyoming	(6)	E. C. Moudy		G. H. Sechrist
Yale University, New Haven, Conn.	(1)	F. H. Eastman	A. K. Wing, Jr.	R. G. Warner
Total 104				

AFFILIATED STUDENT SOCIETY

Brown Engineering Society, Brown University, Providence, R. I. R. E. Tanner

GEOGRAPHICAL DISTRICTS

- No. 1—North Eastern District
- No. 2—Middle Eastern District
- No. 3—New York City
- Also all foreign countries
(Canada excepted)
- No. 4—Southern District
- No. 5—Great Lakes District
- No. 6—North Central District
- No. 7—South West District
- No. 8—Pacific District
- No. 9—North West District
- No. 10—Canada

ORDER FORM FOR REPRINTS OF PAPERS ABRIDGED IN THE JOURNAL*

(December 1929)

Number	Author	Title
<input type="checkbox"/> 29-95	J. F. Gaskill, Chairman	Report of Committee on General Power Application
<input type="checkbox"/> 29-98	W. H. Millan, Chairman	Report of Committee on Automatic Stations
<input type="checkbox"/> 29-116	B. E. Shackelford, Chairman	Report of Committee on Production and Application of Light
<input type="checkbox"/> 29-141	I. H. Summers and J. B. McClure	Progress in the Study of System Stability
<input type="checkbox"/> 29-144	D. E. Marshall and P. O. Langguth	Current Transformer Excitation

*Members, Enrolled Students, and JOURNAL subscribers are entitled to one complete copy of each paper free of charge; additional copies 25 cents each.

Name
Address

Please order reprints by number. Address Order Department A. I. E. E., 33 West 39th Street, New York, N. Y.

JOURNAL

OF THE

American Institute of Electrical Engineers

INDEX VOLUME XLVIII

January 1 to December 31, 1929

INDEX OF PAPERS, DISCUSSIONS, REPORTS, ETC.

A

A-C. Elevator Motors of the Squirrel-Cage Type. (Dreese)	32
— Low-Voltage Network, An. (Gamble and Baughn)	742
— Machinery, Transient Analysis of. (Ku)	269
Air Navigation, Radio as an Aid to. (Dellinger)	105
Analytical Determination of Magnetic Fields. (Robertson and Terry)	619
Analyzers for Power Telephone Systems, Electrical Wave. (McCurdy and Blye)	461
Anomalous Conduction as a Cause of Dielectric Absorption. (Whitehead and Marvin)	186
Application of Induction Regulators. (Wolfert and Brosnan)	669
Applications to Marine Work Committee Report. (Thau)	895
— Mining Work Committee Report. (Lee)	905
Arc Welding of Steel Buildings and Bridges. (McKibben)	393
Arcing Horns and Grading Rings, Fused. (Stewart)	390
— Line Connectors Caused Interference.	292
Arcs, Flames for Electric. (Slepian)	661
Atom Not Like Solar System.	883
Audio-Frequency Transformers. (Kiev and Shirley)	907
Automatic Mercury Rectifier Substation in Chicago. (Garrett)	301
— Reclosing High-Speed Circuit Breaker. (Anderson)	297
— of High-Voltage Circuits. (Robinson and Spurgeon)	707
— Regulation of Synchronous Condensers. (Thompson and Walton)	868
— Stations Committee Report. (Millan)	596
— Transformer Substations. (Edson)	440

B

Bare Wire Overhead Distribution Practise. (Miller)	471
Bessel Functions for A-C. Problems. (Dwight)	559
Bushing-Type Current Transformers for Metering. (Boyajian and Skeats)	308

C

Cable, Some Problems in High-Voltage Development. (Davis and Eddy)	52
— Transatlantic Telephone.	635
Cables, High-Voltage Interborough.	121
—, Ionization Studies in Paper Insulated—II. (Dawes, Reichard, and Humphries)	3
—, Losses in Armored Single-Conductor Lead Covered A-C. (Schurig, Kuehni, and Buller)	206
—, Reduction of Sheath Losses in Single-Conductor. (Halperin and Miller)	20
Calculations of System Performance. (Griscorn)	603
Calorimeter Test on 68,750-Kv-A. Turbine Generator. (Calvert)	842
Carrier-Current and Supervisory Control on Alabama Power Company System. (Woodcock and Robinson)	215

Carrier Telephone System for Short Toll Circuits. (Black, Almquist, and Ilgenfritz)	15
Carrying Peak Loads.	2
Cathode Ray Oscillograph Study. (McEachron and Goodwin)	374
Chain Drives for Factories.	808
Circuit Breaker, Automatic Reclosing High-Speed. (Anderson)	297
—, Field Tests of the Deion. (Jamieson)	101
—, Structural Development of the Deion. (Dickinson and Baker)	96
—, Theory of the Deion. (Slepian)	93
Commutator Operation, Influence of Temperature on. (Hague and Penney)	473
Condenser Motor, The. (Bailey)	273
Conductivity, The Theory of Electrical. (Houston)	795
Conductors, Forces on Magnetically Shielded. (Morecroft and Turner)	25
—, Movements of Overhead Line during Short Circuits. (Peterson and McCracken)	138
Contact Wire Wear on Electric Railroads. (Landhy)	756
Core Losses, No-Load Induction Motor. (Spooner and Kincaid)	285
Corona Ellipses. (Karapetoff)	203
Correspondence. (Dwight)	711
— (Jamieson)	392
Current Transformer Excitation. (Marshall and Langguth)	884

D

D-C. Railway Substation for the Chicago Terminal Electrification. (Garrett)	678
Decibel, The Name for the Transmission Unit. (Martin)	223
Design Features that Make Large Turbine Generators Possible. (Foster and Savage)	733
Development of Insulating Oils. (Skinner)	589
Developments in Network Systems and Equipment. (Brosnan and Kelly)	551
Dial Telephone System. (Wheelock)	800
Dielectric Absorption, Anomalous Conduction as a Cause of. (Whitehead and Marvin)	186
— Loss, Guarding and Shielding for. (Salter)	444
— Measurements, Some Problems in. (Dawes, Hoover, and Reichard)	450
Dielectrics, Power Factor and Dielectric Constant in Viscous. (Kitchin)	281
Distribution Practise, Bare Wire Overhead. (Miller)	471
Divorter Pole Generator, The. (Smith)	11

E

Easy Method of Approximating the Square Root, An.	60
Economic Study of an Electrical Distributing Station. (Kelly)	881
Education Committee Report. (Bennett)	677
— of Engineers, The, Post College. (Bennett)	310
Effect of Color of Tank on Temperature. (Montsinger and Wetherill)	821

- Surges on Transformer Windings. (Hodnette) November, 829
- Transient Voltages on Power Transformer Design. (Palueff) May, 357
- Electric Heating Elements. (Fleischmann) September, 665
- Power in South. August, 634
- Welding Committee Report. (Candy) July, 526
- Electrical Aids to Navigation. (Marriott) March, 195
- Communication Committee Report. (Drake) October, 747
- Engineering of Sound Picture Systems, The. (Morgan and Shea) October, 766
- Equipment of Bar Plate and Hot Strip Mills. (Ink) May, 353
- Features of the Kansas City New Water Works. (Maillard) May, 386
- Instruments Used in the Measurement of Flow. (Pratt) February, 142
- Machinery Committee Report. (Foster) November, 825
- Wave Analyzers for Power and Telephone Systems. (McCurdy and Blye) June, 461
- Electricity Applied to Strip Coal Mining. December, 871
- Electrification of Oil Pipe Lines. (Levy) June, 434
- the Mexican Railway, The. (Cox) August, 629
- Electrified Railway Substation, An. (Duer) June, 431
- Electrochemistry and Electrometallurgy Committee Report (Vinal) December, 878
- Electrodeposition and Corrosion. April, 280
- Electromagnetic Induction in Closed Circuits, Flux Linkages and. (Bewley) March, 216
- Electrophysics Committee Report. (Karapetoff) November, 833
- Engineer, Practical Idealist, The, President's Address. (Schuchardt) August, 611
- Engineers Review Progress. August, 628
- ### F
- Fabrication of Large Rotating Machinery. (Putman) May, 382
- Faraday Centenary in 1931. April, 307
- Field Tests of the Deion Circuit Breaker. (Jamieson) February, 101
- Flames from Electric Arcs. (Slepian) September, 661
- Flow, Electrical Instruments Used in the Measurement of. (Pratt) February, 142
- Flux Linkages and Electromagnetic Induction in Closed Circuits. (Bewley) March, 216
- Flying Field and Airway Lighting. (Ogden) July, 555
- Forces on Magnetically Shielded Conductors. (Morecroft and Turner) January, 25
- Foundry Costs Reduced. July, 546
- Four-Thousand Lb. Telescope Disk, A. November, 841
- Fundamental Plan of Power Supply. (Kehoe) August, 600
- Theory of the Capacitor Motor, The. (Specht) February, 134
- Fuses, High-Voltage Low-Current Fuses and Switches. (Wilkins) September, 692
- Future of Higher Steam Pressures. (Moulthrop) December, 875
- ### G
- General Power Applications Committee Report. (Gaskill) December, 896
- Generator, Calorimeter Test on 68,750-Kv-A. Turbine. (Calvert) November, 842
- , Higher Voltages for. February, 100
- , The Diverter Pole. (Smith) January, 11
- Generators, Design Features that Make Large Turbine Generators Possible. (Foster and Savage) October, 733
- , Iron Losses in Turbine. (Laffoon and Calvert) May, 370
- Graphic Solution of A-C. Transmission Line Problems, The. January, 49
- Graphical Theory of Traveling Electric Waves, A. (Karapetoff) February, 113
- Guarding and Shielding for Dielectric Loss. (Salter) June, 444
- ### H
- Heating Elements, Electric. (Fleischmann) September, 665
- High-Accuracy Current Transformer, A New. (Wilson) March, 179
- High-Frequency Currents, The Transmission for. (Boddie and Curtis) January, 37
- Portable Tools and Equipment. (Coates) July, 521
- High-Voltage Circuits, Automatic Reclosing of. (Robinson and Spurgeon) September, 707
- Interborough Cables. February, 121
- Low-Current Fuses and Switches. (Wilkins) September, 692
- Phenomena in Thunderstorms. (Lissman) January, 45
- Higher Voltages for Generator. February, 100
- How Far Does a Kilowatt-Hour Travel? October, 765
- ### I
- ILLUMINATION ITEMS
- Advances in Industrial Lighting Practise. April, 318
- Aviation Lighting. July, 560
- Center Fixture in Residence Lighting, The. April, 317
- Device for Measuring Average Voltage, A. May, 397
- Electrical Engineer and Light Therapy, The. (Kalb) December, 917
- International Commission on Illumination. February, 150
- Light and Architecture. July, 561
- Sound Sign, A. May, 398
- Therapy. June, 477
- Light's Golden Jubilee Celebration. October, 777
- Mobile Color Lighting at Barcelona Exposition. (Stahl) December, 918
- Motor Vehicle Light Testing Laboratory of Minnesota. (Ryan) December, 919
- New Laboratory of Applied Lighting. October, 776
- Present Status of Light Sources and Window Material in Light Therapy. May, 397
- Report of Use of Incandescence Lamps in Motion Picture Photography. June, 478
- Traffic Control. April, 317
- Twenty-Ampere Series Circuits for Street Lighting. November, 842
- Wiring for Adequate Lighting in Commercial and Industrial Building. October, 775
- Impulse Insulation Characteristics of Wood-Pole Lines. (Melvin) November, 813
- Induction Motor Operation with Non-Sinusoidal Impressed Voltage. (Doggett and Queer) October, 759
- Influence of Temperature on Large Commutator Operation. (Hague and Penney) June, 473
- Institute Meeting, A Fruitful. March, 235
- Instruments and Measurements Committee Report. (Lee) September, 698
- Insulation, Purified Textile for Telephone Central Office Wiring. (Glenn and Wood) February, 146
- Tests of Electrical Machinery. (Gilt and Barns) March, 228
- The Opportunity for Research. (Whitehead) January, 27
- Insulator Strings, Sixty-Cycle Flashover of Long Suspension. (Angus) November, 837
- Insulators, Radio Interference from Line. (Van Atta and White) September, 682
- , Reactions between. April, 260
- , The Predominating Influence of Moisture and Electrolytic Material upon Textiles as. (Williams and Murphy) April, 289
- Integraph, The Interconnected. (Glover and Plumb) September, 695
- Interconnection in the Southwest. (Mills) June, 469
- Interference, Arcing Line Connectors Caused. April, 292
- Ionization Studies in Paper Insulated Cables—II. (Dawes, Reichard, and Humphries) January, 3
- Iron and Steel Committee Report. (Fowler) August, 635
- Losses in Turbine Generators. (Laffoon and Calvert) May, 370
- ### L
- Light Up House Numbers Abroad. May, 385
- Lighting Airways in Hudson and Mohawk Valleys Proposed. February, 104
- of Airways and Airports. (Mahan) May, 379
- Twenty-Ampere Series Circuits for Street Lighting. November, 842
- Lightning. (Peck) April, 303
- Lightning Experience on the 132-Kv. Transmission Lines of the A. G. & E. Co. 1927. (Sporn) February, 122
- Studies of Transformer. (Brand and Palueff) July, 542
- , Theoretical and Field Investigations of. (Fortescue, Atherton, and Cox) April, 277
- , Traveling Waves Due to. (Bewley) October, 729
- Light's Golden Jubilee. October, 727
- Line-Start Induction Motors. (Koch) March, 232
- Looking Backward. January, 31
- Losses in A-C. Generators, Separation of Stray Load. (Holmes) March, 224
- Armored Single-Conductor Lead-Covered A-C Cables. (Schurig, Kuehni, and Buller) March, 206

M

Magnetic Analysis. (Sanford).....	January,	7
— Fields, Analytical Determination of. (Robertson and Terry).....	August,	619
— Shielding. (Gokhale).....	October,	770
Master Reference System for Telephone Transmission. (Martin and Gray).....	July,	513
Measurements, Precautions against Stray-Field Errors in. (Silsbee).....	June,	447
Meeting Long Distance Telephone Problems. (Fritz and Lawther).....	July,	547
Meter, Speed Indicator and Frequency. (Greibach).....	August,	633
Mills, Electrical Equipment of Bar Plate and Hot Strip. (Ink).....	May,	353
Moisture and Electrolytic Material upon Textiles as Insulators, The Predominating Influence of. (Williams and Murphy).....	April,	289
More Efficient Hydro Plants.....	May,	385
Motion Picture Camera in Electrical Testing.....	November,	799
Motor Control for Wind Tunnel. (Lewis).....	September,	686
—, The Condenser. (Bailey).....	April,	273
—, — Fundamental Theory of the Capacitor. (Specht).....	February,	134
—, — Revolving Field Theory of the Capacitor. (Morrill).....	March,	190
Motors, A-C. Elevator Motors of the Squirrel-Cage Type. (Dreese).....	January,	32
—, Line-Start Induction. (Koch).....	March,	232
Movements of Overhead Line Conductors during Short Circuits. (Peterson and McCracken).....	February,	138

N

Navigation, Electrical Aids to. (Marriott).....	March,	195
Network, An A-C. Low-Voltage. (Gamble and Baughn).....	October,	742
—, Operating Experience with Low-Voltage A-C. (Pinckard).....	May,	349
—, Standard Voltage A-C. (Oram).....	June,	436
—, Systems and Equipment, Developments in. (Brosnan and Kelly).....	July,	551
Networks, Telephone Transmission. (Shea and Lane).....	August,	624
New Automatic Synchronizer, A. (Gulliksen).....	October,	751
— Sources of Energy Still Sought.....	October,	728
— Type of Hot Cathode Oscillograph, A. (George).....	July,	534
Noises in Electrical Apparatus, Study of. (Spooner and Foltz).....	March,	199
No-Load Induction Motor Core Losses. (Spooner and Kincaid).....	April,	285
NOTES AND ANNOUNCEMENTS		
The Institute Publications.....	January,	2

O

Oils, Development of Insulating. (Skinner).....	August,	589
132-Kv. Shielded Potentiometer. (Weller).....	April,	312
Operating Experience with Low-Voltage A-C. Network. (Pinckard).....	May,	349
Oscillograph, A New Type of Hot Cathode. (George).....	July,	534
— for Measuring Non-Electrical Quantities, Use of the. (Miner and Batten).....	February,	126
— Study, Cathode Ray. (McEachron and Goodwin).....	May,	374
Oscillographs for Recording Transient Phenomena. (Marrison).....	April,	261
Outdoor Hydrogen-Ventilated Synchronous Condensers. (Wieseman).....	July,	530

P

Parallel Operation of Transformers. (Mac Ferran).....	November,	809
Patent Court, An Unofficial.....	March,	178
Peak, Carrying Peak Loads.....	January,	2
Photoelectric and Glow Discharge Devices, Some. (Breisky and Erickson).....	February,	118
— Tube Counts Traffic Passing through Holland Tunnel. (Hinson).....	July,	559
Physics, 1928 Progress in.....	February,	92
Pipe Lines, Electrification of Oil. (Levy).....	June,	434
Population as an Index to Electrical Development. (Hinson).....	August,	593
Potentiometer, 132-Kv. Shielded. (Weller).....	April,	312

Power Factor and Dielectric Constant in Viscous Dielectrics. (Kitchin).....	April,	281
— Generation Committee Report. (Allner).....	September,	702
— Limit Tests. (Jones and Treat).....	January,	56
— Plants, Rehabilitation of Steam. (Hirshfeld).....	November,	817
— Supply, Fundamental Plan of. (Kehoe).....	August,	600
Precautions against Stray-Field Errors in Measurements. (Silsbee).....	June,	447
Precision Regulator for Alternating Voltage, A. (Stoller and Power).....	February,	110
Predominating Influence of Moisture and Electrolytic Material upon Textiles as Insulators, The. (Williams and Murphy).....	April,	289
President's Message.....	January, 1; February, 91; March, 177; April, 259; May, 347; June, 429; July, 511; August, 587; September, 659; October, 725; November, 793; December,	863
Production and Application of Light Committee Report. (Shackelford).....	December,	913
Progress in Physics, 1928.....	February,	92
— the Study of System Stability. (Summers and McClure).....	December,	891
Protective Devices Committee Report. (Hester).....	September,	673
Purchased Power for Railways.....	April,	318
Purified Textile Insulation for Telephone Central Office Wiring. (Glenn and Wood).....	February,	146

Q

Quick-Response Generator Voltage Regulator. (Burnham, North, and Dohr).....	June,	465
---	-------	-----

R

Radio as an Aid to Air Navigation. (Dellinger).....	February,	105
— Interference from Line Insulators. (Van Atta and White).....	September,	682
— Permits Talking from Moving Train.....	June,	446
Railroads, Contact Wire Wear on Electric. (Landhy).....	October,	756
Railway, The Electrification of the Mexican. (Cox).....	August,	629
— Train Signal Practise. (Gault).....	June,	457
Reactions between Insulators.....	April,	260
Recent Developments in Telephone Construction Practises. (Wagner and Burroway).....	May,	366
Recording Torque Indicator, A. (Anderson).....	December,	865
Reduction of Sheath Losses in Single-Conductor Cables. (Halperin and Miller).....	January,	20
Regulator, Precision for Alternating Voltage. (Stoller and Power).....	February,	110
—, Quick-Response Generator Voltage. (Burnham, North, and Dohr).....	June,	465
Regulators, Application of Induction. (Wolfert and Brosnan).....	September,	669
Rehabilitation of Steam Power Plants. (Hirshfeld).....	November,	817
Research as a Business Help.....	February,	109
— Committee Report. (Peek).....	October,	762
—, Insulation, The Opportunity for. (Whitehead).....	January,	27
Revolving Field Theory of the Capacitor Motor, The. (Morrill).....	March,	190
Rule for D-C. Machine Relationship, A.....	March,	189

S

Safe Loading of Oil-Immersed Transformers. (Norris).....	August,	615
Separation of Stray Load Losses in A-C. Generators. (Holmes).....	March,	224
Series Synchronous Condensers. (Morgan).....	December,	872
Shielding and Guarding Electrical Apparatus. (Curtis).....	June,	453
— in High-Frequency Measurements. (Ferguson).....	July,	517
Short-Circuit Testing on Alabama Power Company System. (Scholz and Hawkins).....	April,	264
— Torque in Synchronous Machines. (Penney).....	October,	738
Simplified Practise.....	March,	214
Sixty-Cycle, Flashover of Long Suspension Insulator Strings, The. (Angus).....	November,	837
SOME LEADERS OF THE A. I. E. E.		
Howel H. Barnes, Jr.....	February,	92
Frederick Bedell.....	July,	512
Bernard Arthur Behrend.....	May,	348
Morgan Brooks.....	March,	178

William A. Del Mar	October,	726	Protective Devices, Committee on	September,	673
Paul Milton Downing	August,	588	Research, Committee on	October,	702
W. B. Jackson	December,	864	Transmission and Distribution, Committee on	November,	804
P. Junkersfeld	November,	794	Transportation Committee on	December,	888
Severn D. Sprong	June,	430	Telemetering. (Linder, Stewart, Rex, and Fitzgerald)	March,	183
Charles Waterman Stone	April,	260	Telephone Cable, Transatlantic	August,	635
Norman Willson Storer	September,	660	—, Carrier Systems for Short Toll Circuits. (Blauk, Almquist, and Hgenfritz)	January,	15
Some Problems in Dielectric Loss Measurements. (Dawes, Hoover, and Reichard)	June,	450	—, Circuits for Program Transmission. (Cowan)	July,	538
— High-Voltage Cable Development. (Davis and Eddy)	January,	52	—, Construction Practices, Recent Developments in. (Wagner and Burroway)	May,	366
Sound Picture Systems, Electrical Engineering of. (Morgan and Shea)	October,	766	—, Dial Telephone System. (Whoolock)	November,	800
Southeastern Power & Light System. (Hutchins)	April,	293	—, Problems, Meeting Long Distance. (Fritz and Lawther)	July,	547
Speed Indicator and Frequency Meter. (Greibach)	August,	633	—, Transmission, Master Reference System for. (Martin and Gray)	July,	513
Spray and Fog Tests on 220-Kv. Insulators. (Wood)	December,	900	—, Networks. (Shea and Lane)	August,	624
Square Root, Easy Method of Approximating the Stability, System as a Design Problem. (Park and Bancker)	January,	60	Temperature, Effect of Color of Tank on. (Montsinger and Wetherill)	November,	821
Standard Voltage A-C. Network. (Oram)	June,	436	Testing, Motion Picture Camera in Electrical	November,	799
Star Heat Measured by Electricity	October,	746	Theoretical and Field Investigations of Lightning. (Fortescue, Atherton, and Cox)	April,	277
Stray Loss Measurements, Correspondence	July,	529	Theory of Electrical Conductivity, The. (Houston)	November,	795
Street Lighting Forms Airway Marker	July,	525	— the Deion Circuit Breaker. (Slepian)	February,	93
— Railway Power Economics. (Noertker)	May,	361	Tools and Equipment, High-Frequency Portable. (Coates)	July,	521
Structural Development of the Deion Circuit Breaker, The. (Dickinson and Baker)	February,	96	Totalizing of Electric System Loads. (Lincoln)	February,	129
Student Engineers Should Study Psychology	June,	439	Transatlantic Telephone Cable	August,	635
Substation, An Electrified Railway. (Duer)	June,	431	Transformer, A New High-Accuracy Current	March,	179
—, Automatic Mercury Rectifier in Chicago. (Garrett)	April,	301	— Design Effect of Transient Voltages on Power. (Paluett)	May,	357
—, Transformer. (Edson)	June,	440	—, Lightning Studies of. (Brand and Paluett)	July,	542
— for the Chicago Terminal Electrification, D-C. Railway. (Garrett)	September,	678	—, Windings, Effect of Surges on. (Hodnette)	November,	829
Switches, High-Voltage Low-Current Fuses and. (Wilkins)	September,	692	Transformers for Metering, Bushing-Type Current. (Boyajian and Skeats)	April,	308
Synchronized at the Load, Symposium. (Kehoe, Griscom, Searing, and Milne)	August,	607	—, Parallel Operation of. (MacFerran)	November,	809
Synchronizer, A New Automatic. (Gulliksen)	October,	751	—, Safe Loading of Oil-Immersed. (Norris)	August,	615
Synchronous Condensers, Outdoor Hydrogen-Ventilated. (Wieseman)	July,	530	Transient Analysis of A-C. Machinery. (Ku)	April,	269
— Machines, Short-Circuit Torque in. (Penney)	October,	738	— Phenomena, Oscillographs for Recording. (Marrison)	April,	261
—, Two-Reaction Theory of. (Park)	March,	194	Transmission and Distribution, Committee Report (1927-1928). (Wallau)	March,	210
System Performance, Calculations of. (Griscom)	August,	603	— (1928-1929). (Woodrow)	November,	804
— Stability as a Design Problem. (Park and Bancker)	January,	41	—, Graphic Solution of A-C. Transmission Line Problems. (Denton)	January,	49
— Tests and Operating Connections. (Searing and Milne)	August,	607	— of High-Frequency Currents, The. (Boddie and Curtis)	January,	37
T					
Technical Changes in Industry	June,	430	Transportation Committee Report. (Vandersluis)	December,	888
TECHNICAL COMMITTEE ANNUAL REPORTS—1928-1929.					
Applications to Marine Work, Committee on	December,	895	Traveling Waves Due to Lightning. (Bewley)	October,	729
— Mining Work, Committee on	December,	905	Two-Reaction Theory of Synchronous Machines. (Park)	March,	194
Automatic Stations, Committee on	August,	596;			
	December,	911	V		
Education, Committee on	September,	677	Vector Presentation of Broad-Band Wave Filters. (Mallina and Knackmuss)	April,	265
Electric Welding, Committee on	July,	526			
Electrical Communication, Committee on	October,	747	W		
— Machinery, Committee on	November,	825	Water Works, Electrical Features of the New Kansas City. (Maillard)	May,	386
Electrochemistry and Electrometallurgy, Committee on	December,	878	Wave Filters, Vector Presentation of Broad-Band. (Mallina and Knackmuss)	April,	265
Electrophysics, Committee on	November,	833	Waves, A Graphical Theory of Traveling Electric. (Karapetoff)	February,	113
General Power Applications, Committee on	December,	896	Wind Tunnel, Motor Control for. (Lewis)	September,	686
Instruments and Measurements, Committee on	September,	698	Wood-Pole Lines, Impulse Insulation Characteristics of. (Melvin)	November,	813
Iron and Steel, Committee on	August,	635			
Power Generation, Committee on	September,	702			
Production and Application of Light, Committee on	December,	913			

INDEX OF INSTITUTE AND RELATED ACTIVITIES

A

American Electric Railway Association Convention	September, 712
AMERICAN ENGINEERING COUNCIL	
A. S. C. E. Joins Council	May, 403
Administrative Board Spring Meeting	June, 484
Advisors for Rosenwald Museum	December, 924
Anniversary of Birth of First Engineer President	December, 923
Annual Meeting at Washington, D. C.	February, 155; December, 923
Appointment to the Assembly	October, 780
Colorado River Project Progresses	August, 646
Conference of Engineering Secretaries at Chicago	May, 403
Consulting Engineers for Government Service	December, 924
Council Appoints Committee on Dams	June, 484
Engineering and Allied Technical Professions	July, 567; September, 713
Communication Committee	July, 567
Opposes Movement to Transfer Geodetic Work to Department of the Interior	January, 71
Publishes Roster	September, 713
Cruiser Bill Passes Senate	March, 239
Engineers in Public Life	May, 403
Fall Meeting of Administrative Board	October, 780
Government Employees Compensation Bill	March, 239
Hydraulic Laboratory Bill	March, 239
Legislative Measures of Interest to Engineers	January, 70
Mapping Program	December, 923
Meeting of Administrative Board	July, 567
National Hydraulic Laboratory Bill	February, 156
New Edition of Constitution and By-Laws	September, 713
Nicaraguan Interoceanic Canal Board Appointed	August, 646
Plea for Mapping Appropriation	August, 646
Recommends Engineers for International Joint Commission	December, 923
Relief of Engineers from Duty with Combat Forces	December, 924
Report on Street Signs, Signals, and Marking	April, 326
Special Committee to Work with Congress and Federal Administration	August, 645
St. Lawrence Waterway	December, 924
State Interested in Water Resources	May, 404
Street Traffic Report Distribution Progressing	May, 403
Study of Airports Considered	December, 924
Water Resources Division Needs Help	August, 646
AMERICAN INSTITUTE OF ELECTRICAL ENGINEERS	
Addresses Wanted	March, 244; November, 851
Committees	January, 85; September, 721
Convention, Pacific Coast	June, 482; July, 563; August, 642; September, 712; October, 779
Report of Technical Discussion	November, 846
Summer	March, 237; April, 321; May, 399; June, 479; July, 563; August, 637
Winter (1929)	January, 61; February, 152; March, 237; (1930) December, 920
Report of Technical Discussion	April, 323
Directors Meeting	January, 65; March, 240; May, 407; June, 488; August, 647; September, 713; November, 847
District Award Paper Prizes	June, 486
Honorary Members Elected	August, 647
Meeting, Annual	May, 399; August, 640
Chicago District	June, 482; August, 641; October, 778; November, 712, 843; December, 921
Cincinnati Regional	February, 152; March, 236; May, 405
Dallas Regional	February, 153; March, 237; April, 319; May, 399; June, 485; July, 569
Meetings for 1929	January, 64; February, 153
Meetings, Future Section	January, 72; February, 158; March, 244; April, 328; May, 409; June, 491; July, 571; October, 783; November, 852; December, 929
Past Section	January, 73; February, 159; March, 245; April, 328; May, 411; June, 493; August, 651; October, 784; November, 853; December, 930
Members Going Abroad	April, 325
Membership, Applications, Elections, Transfers, etc.	January, 82; February, 168; March, 253; April, 339; May, 423; June, 503; July, 580; August, 655; September, 720; October, 788; November, 858; December, 939

National Prizes Awarded for Papers	June, 485; December, 928
Regional Prizes	February, 155
Nominations	January, 67; October, 728
Obituary	January, 72; February, 157; March, 243; April, 327; May, 409; June, 490; July, 570; August, 649; September, 716; October, 782; November, 850; December, 925
Officers, A. I. E. E.	January, 85; February, 173; March, 253; April, 343; May, 425; June, 505; July, 583; August, 656; September, 724; October, 789; November, 859; December, 944
Personal Mention	January, 71; February, 157; March, 243; April, 327; May, 408; June, 489; July, 569; August, 649; September, 715; October, 782; November, 850; December, 924
Report of Tellers of Election	July, 566
SECTION ACTIVITIES: Annual Student Program of	
Portland Section	July, 571
Communication Group of New York Section Organized	June, 491
Competition Held by Seattle Section	July, 571
Contacts between Engineers and Public	May, 410
Discussed in Schenectady	June, 492
Electrical Developments of 1928 Reviewed at St. Louis Section	March, 245
First Power Group Meeting, Chicago Section	December, 930
Fourth Student Branch Convention North Eastern District	June, 495
Group Activities Proposed in New York Section	April, 328
Institute Affairs Discussed by Washington Section	June, 492
Iowa Section Organized	November, 852
Joint Meeting Held in Virginia	March, 245
of Virginia Sections of National Societies	February, 159
Joint Section and Branch Meeting held in Akron	June, 492; Cleveland, May, 411; Columbus, June, 492; Louisville, February, 159; Milwaukee, May, 411; Nebraska, June, 492; Seattle, June, 492; Urbana, June, 492; University of Idaho, June, 491
Louisville Section Meeting	June, 492
Meeting of Executive Committee of Middle Eastern District	November, 852
Midwinter Dinner of Pittsburgh Section	February, 158
New Developments in Electrothermics and Electrochemistry	March, 244
New York Section	July, 571
Elects Officers for 1929-30	June, 491
Meeting	February, 158
Devoted to International Communication	March, 245
on Wonders of Sound Transmission	November, 852; December, 930
New Expansion Activities	May, 410
Power, Transportation, and Communication Groups Meet	December, 929
Recent Meetings	May, 411
Student Branch Convention	June, 495
To Get Statistics on "How Much Light"	December, 929
Transportation and Communication Groups	November, 852
North Carolina Section Organized	June, 491
Recent Developments in Electrical Industry	February, 159
Section Organized at Birmingham, Ala.	August, 651
Sections, List of	January, 87; February, 173; March, 255; April, 343; May, 425; June, 507; July, 583; August, 656; September, 724; October, 790; November, 860; December, 944
Speaking Contest Held at Los Angeles Section	February, 158
Twenty-fifth Anniversary Meeting of Seattle Section	March, 245
STUDENT ACTIVITIES: Affiliated Student Society	
Annual College Branch Night of Denver Section	March, 257; April, 345; June, 496

----- Joint Meeting of Los Angeles Section with Student Branches	April, 331	Visit of Prof. van Hecke	December, 922
----- Meeting of San Francisco Section	June, 496	Engineering Societies Employment Service	January, 81; February, 167; March, 252; April, 338; May, 421, 422; June, 502; July, 579; August, 654; September, 719; October, 787; November, 857; December, 938
----- Utah Section	June, 496	----- Excerpts from Letters of Appreciation	March, 205; April, 284; August, 623
----- at Dallas Regional Meeting	June, 495	ENGINEERING SOCIETIES LIBRARY	
----- Pacific Coast Convention	October, 784	Annual Report	May, 407
----- Branch at Southern Methodist University	November, 854	Book Notices	January, 79; February, 164; March, 250; April, 335; May, 418; June, 500; July, 576; August, 652; September, 718; October, 785; November, 856; December, 936
----- at University of Mexico	November, 854	Engineering Societies Secretaries Meeting	July, 568
----- Branch Conference at Pittsburgh	February, 161	Eye Sight Conservation Council Officers 1929	May, 407
----- Convention and New York Section Meeting	April, 330	F	
----- Organized at Cornell University	March, 247	Faraday Electromagnetic Centenary	December, 923
----- Michigan College Mining and Technology	October, 785	----- Medal to Dr. Semenza	July, 565
----- in North Dakota	July, 574	Federal Power Commission, Changes in	June, 486
----- Branches List of	January, 88; February, 174; March, 256; April, 344; May, 426; June, 508; July, 584; August, 656; September, 724; October, 792; November, 860; December, 945	Ferntagung Meeting by Long Distance Telephone	August, 651
----- Conference on District No. 2	May, 413	Fritz, John, Medal to Mr. Hoover	May, 404
----- District No. 6	May, 414	----- Dr. Modjeski	November, 848
----- Conference on in Great Lakes District	February, 161	G	
----- Convention at Troy	May, 414	Government Reorganization	June, 488
----- Convention Held in Philadelphia	April, 330	Grand Rapids Elects Engineer	June, 487
----- Convention of, in Ohio	January, 75; December, 932	H	
----- Discussed at Cincinnati Regional Meeting	February, 161	Hague, Dr., Visiting Professor at Brooklyn Polytechnic Institute	October, 781
----- Electric Show at Montana State College	January, 75; December, 932	Highway Research Board to Meet in December	August, 645
----- Electrical Engineering Exhibition at Yale University Branch	February, 161	Highway Safety Campaign, A	October, 781
----- Electrical Show at Michigan State College	May, 414	I	
----- Joint Meeting of Oklahoma Section and Neighboring Branches	July, 573	I. E. C. Investigates Resistivity of Aluminum	March, 241
----- Montana State College Branch has Rhodes Scholar	April, 331	Illuminating Engineers N. Y. Section Meetings	December, 922
----- Paper on Student Branch Activities	April, 330	----- To Meet in Philadelphia	September, 712
----- Past Branch Meetings	January, 75; February, 162; March, 247; April, 332; May, 415; June, 496; July, 574; August, 652; October, 785; November, 854; December, 932	Industry to Cooperate with Electrochemists	September, 712
----- Program in Cincinnati	July, 573	International Conference on Large High-Voltage Electric Systems	January, 64
----- Vancouver Section Holds Annual Student Meeting	April, 331	----- Congress on Steel Construction	May, 404
----- Year Book	April, 325	----- High-Tension Conference, Fifth Session	May, 402
American Mathematical Society Meeting	November, 845; December, 922	----- Illuminating Congress	March, 242
----- Welding Society, Annual Meeting	April, 321	K	
B		Kelvin Medal Awarded to André Blondel	August, 648
Berresford, Death of Mrs.	March, 244	L	
Book Review	April, 326; June, 488; November, 849	Lamme Medal	February, 154; June, 483; August, 641, 648
Boulder Canyon Dam Legislation	February, 156	M	
----- Engineers Named by Wilbur	June, 487	Massachusetts Institute Hears Hydraulic Engineer	November, 845
Gen. Lytle Brown Appointed Chief of Engineers	November, 848	Land Grant Colleges Survey	June, 487
C		Louvain Memorial	January, 71
Carnegie Institute Special Courses	May, 408	Midwest Power Engineering Conference	February, 153
Census Bill to Pass	July, 568	Mississippi Flood Control	June, 488; July, 568
Chemical Industry Exposition	March, 241; April, 322; May, 402	Montefiore Prize	February, 155; July, 569
Columbia University Scholarship in Electrical Engineering	March, 242	Muscles Shoals Again before Congress	July, 569
Cuban Engineers Extend Invitation	March, 241	N	
D		National Electric Code, The	September, 715
Debuchi, Ambassador, Guest of Engineers	June, 482	National Fuel Meeting to be Outstanding, The	October, 779
Diesel and Oil Engine Course at Brooklyn Polytechnic Institute	September, 715	National Research Council Advisory Aid Solicited from Engineers and Scientists	September, 713
Current Industrial News Digest	January, 90; February, 176; March, 258; April, 346; May, 428; June, 510; July, 586; August, 658; September, 726; October, 792; November, 862; December, 956	----- Three-Day Insulation Conference at M. I. T.	November, 844
E		Naval Architects and Marine Engineers Meeting	November, 846
Edison Medal	January, 65; March, 238	New York Electrical Society to Hear about Hudson River Bridge	October, 779
Electrochemists to Discuss Aviation Materials	August, 641	P	
Empire State Gas and Electric Association Electric Section Meets	January, 66	Patton New Director U. S. Coast and Geodetic Survey	June, 487
Engineering Experiment Station Record	July, 563	Plea for Forest Conservation	December, 924
Engineering Fellowship at University of Wisconsin	April, 322	Polytechnic Institute Extends "Open House" Invitation	January, 66
ENGINEERING FOUNDATION		Power Circuit Analysis Colloquium	April, 322; June, 486; August, 648
Alloys of Iron Research	March, 243; October, 781	R	
Annual Report	May, 408	Radio Commission Membership Confirmed	June, 486
Research Narratives, Vol. III	October, 782	----- Engineers Meeting	April, 321

Reactive Power	May,	402
Rehbock, Dr. T., on Lecture Tour	June,	487
Research Graduate Assistantship at University of Illinois	March,	242
— Narratives Available	September,	715
Rosenwald Industrial Museum	October,	781
Rudenberg, Prof., to Lecture at M. I. T.	February,	153

S

S. A. E. Transportation Meeting	November,	846
Safety, Nation-Wide Radio Hook-up on	May,	406
Schuchardt, Death of Mrs.	January,	72
Scientific Conquest of 1928	January,	66
Secretaries' Fourth Conference	September,	714
Harold B. Smith, President-Elect	July,	564
Elmer A. Sperry now President of A. S. M. E.	January,	66

STANDARDS

Abbreviations for Scientific and Engineering Terms	July,	566
A. I. E. E. Standards Approved as American Standards	January,	66
A. I. E. E. Test Codes Suggested	February,	153
American Standards Association	August,	645
— for Electric Welding to be Developed	September,	713
— — — Oil Circuit Breakers and Horn-Gap Switches and for Disconnecting	September,	713
Bureau of Standards to Publish All Letter Symbols	April,	322
Code for Protection against Lightning Becomes American Standard	June,	484
Constant Current Transformers	July,	565
Definition of Breakdown Voltage and Dielectric Strength	June,	484
— — Distortion Factor	June,	483
Dry Cells	August,	645
Electrical Definitions	July,	565
For Heating Devices	April,	322
— Relays	September,	712
Graphical Symbols for Radio	April,	322
Measurement of Core Losses	June,	483
Measuring Temperature of Secondarily Ventilated Motors	February,	153
Methods of Test for Determining Distortion Factor	June,	483
National Electric Code Approved	December,	923
Navigational and Topographical Symbols	October,	779; December,
New Index Now Available	February,	153

— Standards Binder Available	October,	779
Proposed Model of Standard for Adequacy of Wiring of Commercial and Industrial Buildings	November,	845
— Standards for Constant Current Transformers	June,	484
Protection of Electrical Circuits and Equipment	December,	923
Revision of Illuminating Engineering Nomenclature and Photometric Standards	March,	239
Specifications for Weatherproof Wires and Cables	August,	644
Standard Dimensions for Polyphase Induction Motors	October,	779
Switchboard and Switching Equipment for Power and Light	July,	566
Symbols for Hydraulics	October,	779
— — Mechanics, Structural Engineering, and Testing Materials	November,	845
— — Photometry and Illumination	August, 645; December,	922
Test Codes for Electrical Machines	April, 322; June,	483
Three New American Standards	September,	712
— — Reports on A. I. E. E. Standards Available	August,	644
Values of A-C. Test Voltage for Household Devices Cancelled	April,	322

T

Thoma, Dr. D., Visits America	October,	780
-------------------------------------	----------	-----

U

United Engineering Society Annual Report	March,	240
University of Pennsylvania New Evening Course	November,	848

V

J. H. Van Wagenen Appointed Boundary Commissioner	June,	487
---	-------	-----

W

Washington Award	February, 155; November,	845
Welding Code for Building Construction	June,	486
Welfare Medal, Engineers to Award First	July,	564
World Engineering Congress, Tokio	January, 64; May,	402; July, 563; September, 712; October, 778; November,
World Power Conference	October, 781; November, 845; December,	921
	December,	922

INDEX OF AUTHORS

A			
Allner, F. A.	September,	702	
Almquist, M. L., Ilgenfritz, L. M., and Black, H. S.	January,	15	
Anderson, G. R.	December,	865	
Angus, R. H.	November,	837	
B			
Bailey, Benj. F.	April,	273	
Baker, B. P. and Dickinson, R. C.	February,	96	
Bancker, E. H. and Park, R. H.	January,	41	
Barns, B. L. and Gilt, C. M.	March,	228	
Batten, W. B. and Miner, D. F.	February,	126	
Baughn, E. and Gamble, L. R.	October,	742	
Bennett, Edward	September,	677	
Bewley, L. V.	March, 216, October,	729	
Black, H. S., Almquist, M. L., and Ilgenfritz, L. M.	January,	15	
Blye, P. W. and McCurdy, R. G.	June,	461	
Boddie, C. A. and Curtis, R. C.	January,	37	
Brand, F. F. and Palueff, K. K.	July,	542	
Breisky, J. V. and Erickson, E. O.	February,	118	
Brosnan, T. J. and Kelly, R.	July,	551	
Brosnan, T. J. and Wolfert, E. R.	September,	669	
Buller, F. H., Schurig, O. R., and Kuehni, H. P.	March,	206	
Burnham, E. J., North J. R., and Dohr, I. R.	June,	465	
Burroway, A. C. and Wagner, B. S.	May,	366	
C			
Calvert, J. F. and Laffoon, C. M.	May,	370	
Calvert, J. M.	November,	842	
Candy, A. M.	July,	526	
Coates, C. B.	July,	521	
Cowan, F. A.	July,	538	
Cox, J. B.	August,	629	
Curtis, H. L.	June,	453	
Curtis, R. C. and Boddie, C. A.	January,	37	
D			
Davis, E. W. and Eddy, W. N.	January,	52	
Dawes, C. L., Hoover, F. L., and Reichard, H. H.	June,	450	
Dawes, C. L., Reichard, H. H., and Humphries, P. H.	January,	3	
Dellinger, J. H.	February,	105	
Denton, F. M.	January,	49	
Dickinson, R. C. and Baker, B. P.	February,	96	
Doggett, L. A. and Queer, E. R.	October,	759	
Dohr, I. R., Burnham, E. J., and North, J. R.	June,	465	
Drake, H. W.	October,	747	
Dreese, E. E.	January,	32	
Duer, J. V. B.	June,	431	
Dwight, H. B.	July,	559	
E			
Eddy, W. N. and Davis, E. W.	January,	52	
Edson, W. W.	June,	440	
Erickson, E. O. and Breisky, J. V.	February,	118	
F			
Ferguson, J. G.	July,	517	
Fitzgerald, A. S., Linder, C. H., Stewart, C. E., and Rex, H. B.	March,	183	
Fleischmann, E.	September,	665	
Foltz, J. P. and Spooner, T.	March,	199	
Fortescue, C. L., Atherton, A. L., and Cox, J. H.	April,	277	
Foster, W. J.	November,	825	
Foster, W. J. and Savage, M. A.	October,	733	
Fowler, M. M.	August,	635	
Fritz, H. R. and Lawther, H. P., Jr.	July,	547	
G			
Gamble, L. R. and Baughn, E.	October,	742	
Garrett, A. M.	September,	678	
Gaskill, J. F.	December,	896	
Gault, P. M.	June,	457	
George, R. H.	July,	534	
Gilt, C. M. and Barns, B. L.	March,	228	
Glenn, H. H. and Wood, E. B.	February,	146	
Glover, R. E. and Plumb, H. H.	September,	695	
Gokhale, S. L.	October,	770	
Goodwin, V. E. and McEachron, K. B.	May,	374	
Gray, C. H. G. and Martin, W. H.	July,	513	
Greibach, E. H.	August,	633	
Griscom, S. B.	August,	603	
Gulliksen, F. H.	October,	751	
H			
Hague, F. T. and Penney, G. W.	June,	473	
Halperin, Herman, and Miller, K. W.	January,	20	
Hawkins, C. B. and Scholz, H. J.	April,	264	
Hester, E. A.	September,	673	
Hinson, N. B.	August,	593	
Hirshfeld, C. F.	November,	817	
Hodnette, J. K.	November,	829	
Holmes, M. C.	March,	224	
Hoover, F. L., Reichard, H. H., and Dawes, C. L.	June,	450	
Houston, W. V.	November,	795	
Humphries, P. H., Dawes, C. L., and Reichard, H. H.	January,	3	
I			
Ilgenfritz, L. M., Black, H. S., and Almquist, M. L.	January,	15	
Ink, J. B.	May,	353	
J			
Jamieson, B. G.	February,	101; May,	392
Jones, S. Murray and Treat, Robert	January,	56	
K			
Kalb, W. C.	December,	917	
Karapetoff, Vladimir	February, 113, November,	833	
Kehoe, A. H.	August,	600	
Kelly, R. and Brosnan, T. J.	July,	551	
Kelly, W. G.	December,	881	
Klev, P., Jr. and Shirley, D. W., Jr.	December,	907	
Koch, C. J.	March,	232	
Ku, Yu H.	April,	269	
Kuehni, H. P., Buller, F. H., and Schurig, O. R.	March,	206	
L			
Laffoon, C. M. and Calvert, J. F.	May,	370	
Landhy, I. T.	October,	756	
Lane, C. E. and Shea, T. E.	August,	624	
Langguth, P. O. and Marshall, D. E.	December,	884	
Lawtner, H. P., Jr., and Fritz, H. R.	July,	547	
Lee, Carl	December,	905	
Lee, E. S.	September,	698	
Levy, D. H.	June,	434	
Lewis, W. A.	September,	686	
Lincoln, P. M.	February,	129	
Linder, C. H., Stewart, C. E., Rex, H. B., and Fitzgerald, A. S.	March,	183	
Lissman, Marcel A.	January,	45	
M			
MacFerran, M.	November,	809	
Mahan, H. E.	May,	379	
Maillard, A. L.	May,	386	
Mallina, R. F. and Knackmuss, O.	April,	265	
Marriott, R. H.	March,	195	
Marrison, W. A.	April,	261	
Marshall, D. E. and Langguth, P. O.	December,	884	
Martin, W. H.	March,	223	
Martin, W. H. and Gray, C. H. G.	July,	513	
Marvin, R. H. and Whitehead, J. B.	March,	186	
McClure, J. B. and Summers, I. H.	December,	891	
McCracken, H. J. Jr., and Peterson, Wm. S.	February,	138	
McCurdy, R. G. and Blye, P. W.	June,	461	
McEachron, K. B. and Goodwin, V. E.	May,	374	
McKibben, F. P.	May,	393	
Melvin, H. L.	November,	813	
Millan, W. H.	August, 596; December,	911	
Miller, K. W. and Halperin, Herman	January,	20	
Miller, M. C.	June,	471	
Milne, G. R. and Searing, H. R.	August,	607	
Miner, D. F. and Batten, W. B.	February,	126	

Montsinger, V. M. and Wetherill, L. November, 821
 Morecroft, J. H. and Turner, Alva. January, 25
 Morgan, K. F. and Shea, T. E. October, 766
 Morgan, T. H. December, 872
 Morrill, W. J. March, 190
 Moulthrop, I. E. December, 875

N

Noertker, J. A. May, 361
 Norris, E. T. August, 615
 North, J. R., Dohr, I. R., and Burnham, E. J. June, 465

O

Ogden, H. R. July, 555
 Oram, John June, 436

P

Palueff, K. K. May, 357
 Palueff, K. K. and Brand, F. F. July, 542
 Park, R. H. March, 194
 Park, R. H. and Bancker, E. H. January, 41
 Peek, F. W. October, 762
 Penney, G. W. October, 738
 Penney, G. W. and Hague, F. T. June, 473
 Peterson, Wm. S. and McCracken, H. J. Jr. February, 138
 Pinckard, F. E. May, 349
 Plumb, H. H. and Glover, R. E. September, 695
 Power, J. R. and Stoller, H. M. February, 110
 Pratt, W. H. February, 142
 Putman, H. V. May, 382

Q

Queer, E. R. and Doggett, L. A. October, 759

R

Reichard, H. H., Dawes, C. L., and Hoover, F. L. June, 450
 Reichard, H. H., Humphries, P. H. and Dawes, C. L. January, 3
 Rex, H. B., Fitzgerald, A. S., Linder, C. H., and Stewart, C. E. March, 183
 Robertson, B. L. and Terry, I. A. August, 619
 Robinson, E. W. and Spurgeon, S. J. September, 707
 Robinson, E. W. and Woodcock, W. I. March, 215
 Ryan, W. T. December, 919

S

Salter, E. H. June, 444
 Sanford, R. L. January, 7
 Savage, M. A. and Foster, W. J. October, 733
 Scholz, H. J. and Hawkins, C. B. April, 264

Schuchardt, R. F., President's Address August, 611
 Schurig, O. R., Kuehni, H. B., and Buller, F. H. March, 206
 Searing, H. R. and Milne, G. R. August, 607
 Shackelford, B. E. December, 913
 Shea, T. E. and Lane, C. E. August, 624
 Shea, T. E. and Morgan, K. F. October, 766
 Shirley, D. W., Jr. and Klev, P., Jr. December, 907
 Silsbee, F. B. June, 447
 Skinner, C. E. August, 589
 Slepian, J. September, 661
 Slepian, J. S. February, 93
 Smith, E. D. January, 11
 Specht, H. C. February, 134
 Spooner, T. and Foltz, J. P. March, 199
 Sporn, Philip February, 122
 Spurgeon, S. J. and Robinson, E. W. September, 707
 Stahl, C. J. December, 918
 Stewart, C. E., Rex, H. B., Fitzgerald, A. S., and Linder, C. H. March, 183

Stewart, P. May, 390
 Stoller, H. M. and Power, J. R. February, 110
 Summers, I. H. and McClure, J. B. December, 891

T

Terry, I. A. and Robertson, B. L. August, 619
 Thau, W. E. December, 895
 Thompson, L. W. and Walton, P. J. December, 868
 Treat, Robert and Jones, S. Murray January, 56
 Turner, Alva, and Morecroft, J. H. January, 25

V

Van Atta, E. and White, E. L. September, 682
 Vandersluis, W. M. December, 888
 Vinal, G. W. December, 878

W

Wagner, B. S. and Burroway, A. C. May, 366
 Wallau, H. L. March, 210
 Walton, P. J. and Thompson, L. W. December, 868
 Wetherill, L. and Montsinger, V. M. November, 821
 Wheelock, F. O. November, 800
 White, E. L. and Van Atta, E. September, 682
 Whitehead, J. B. January, 27
 Whitehead, J. B. and Marvin, R. H. March, 186
 Wieseman, R. W. July, 530
 Wilkins, Roy September, 692
 Wilson, M. S. March, 179
 Wolfert, E. R. and Brosnan, T. J. September, 669
 Wood, E. B. and Glenn, H. H. February, 146
 Wood, R. J. C. December, 900
 Woodcock, W. I. and Robinson, E. W. March, 215
 Woodrow, H. R. November, 804

DIGEST OF CURRENT INDUSTRIAL NEWS

NEW CATALOGUES AND OTHER PUBLICATIONS

Mailed to interested readers by issuing companies

Mercury Arc Rectifiers.—Bulletin GEA-1151, 20 pp. Describes mercury arc rectifiers for railway service. General Electric Company, Schenectady, N. Y.

Chain Grate Stoker.—Catalog GND-2, 28 pp. Describes the Green Natural Draft Chain Grate Stoker, applicable to boilers of all types where the load and operating conditions are such that a natural draft chain grate stoker is suitable. It is stated that this is one of the pioneer stokers of its type and is installed under boilers of more than 1,200,000 rated boiler horsepower. Combustion Engineering Corporation, 200 Madison Avenue, New York.

Motor Maintenance Equipment.—Catalog B-829, 58 pp. Describes motor maintenance equipment and electrical specialties. The equipment includes commutator resurfacers, grinders, mica undercutters, slotting files, blowers, etc. The catalog contains instructions for the operation of d-c. generators, a chapter which treats in detail of some fifty commutator troubles and remedies; definitions of electrical terms; and tables on the current-carrying capacity of solid and stranded wires, as well as tables on fusing, wiring and full load current data. Ideal Commutator Dresser Co., Sycamore, Ill.

Electrical Distribution Systems.—Bulletin 31-C-62, 16 pp. Describes Bull Dog "Bus-DUCT" and "Trolley-DUCT." The latter is a flexible system of electrical control for portable electrical tools as used on moving assembly lines in automobile and other mass production plants. Bus-DUCT is a bus bar system of electrical power distribution for industrial plants employing mass production methods, where frequent and repeated changes in location of machines, motors and sometimes whole departments are desired on short notice. It displaces, to some extent, the older method of distribution by conduit, wires and power panels. Bull Dog Electric Products Co., 7610 Jos. Campau Avenue, Detroit, Mich.

NOTES OF THE INDUSTRY

The Wagner Electric Corporation, St. Louis, has appointed D. O. Reardon as representative for part of Iowa, with headquarters in Des Moines, Iowa.

The Ohio Brass Company, Mansfield, Ohio, announces that its Boston office in charge of Harvey H. Hoxie, has been removed from its former location in the Little Building to Room 1001, Statler Building, 20 Providence Street.

The Kuhlman Electric Company, Bay City, Mich., manufacturers of power, distribution and street lighting transformers, announces the appointment of Frank C. Fassett, 15 East Jackson Street, Phoenix, Arizona, as its representative in that territory.

The Allis-Chalmers Manufacturing Company, Milwaukee, Wis., has appointed T. B. Wood's Sons Company, Chambersburg, Pa., as special distributors of Texrope drives. A large stock of Texrope drives and Texrope belts will be carried so as to render prompt and efficient service.

The Inca Manufacturing Corporation has announced the construction of a large addition to the new factory at Fort Wayne, Ind., trebling the capacity of the present plant. The structure will be completed shortly after the first of the year. The plant, which was founded by George A. Jacobs and associates, manufactures copper wire products for the radio, electrical and automotive industries.

Paul Stauffer has been appointed eastern manager of the company with headquarters at Newark, N. J., and R. A. Connor has joined the sales and engineering staff at Fort Wayne.

Westinghouse Builds Large Synchronous Converters.—The Roessler and Haslach Chemical Company, of Niagara

Falls, has recently ordered two 16,000 ampere, 340 volt d-c. synchronous converters from the Westinghouse Electric & Manufacturing Company. These machines will have the largest current rating of any converting equipment in electrolytic service, increasing by 60% the current rating of any previously installed converter used for this purpose. Switching equipment for the converters and two 5800 k-v-a., 3-phase transformers with tap changers were also included in the order.

New Small Motor Starter.—A new counter E. M. F. type automatic starter has been developed by Cutler-Hammer, Inc., 163 12th St., Milwaukee, Wis. This new, small motor starter incorporates a number of new and important features such as: small size, reduced voltage starting, thermal overload protection, low voltage protection and renewable silver contacts. It is rated up to 2 hp., 115 or 230 volts. The contactors are designed especially for direct current service and the renewable silver contacts insure long life. Each starter is supplied with a separate pushbutton master switch providing three-wire remote control. Two wire control can be furnished, if desired.

Electric Ships for the Pacific.—Two vessels over 600 feet long, with turbine-electric propulsion and otherwise completely electrically equipped are to be constructed by the Newport News Shipbuilding and Dry Dock Company for the Dollar Steamship Line. The vessels will be sister ships of twin-screw design and built for a speed of 20 knots. The first one to be constructed will be completely electrified by the General Electric Company. It will have accommodations for 450 passengers and a crew of more than 300. The power plant on the first boat will consist of two 11,000 shaft-horsepower turbines running at 2500 r. p. m. and driving two alternating-current generators each having a continuous rating of 10,100 kilowatts, 3-phase, 4800 volts. These main propulsion generators will supply electricity for driving two 13,250 horsepower, synchronous-induction motors, each connected to one of the two propeller shafts which will turn at the rate of 133 r. p. m. Excitation and power for operating auxiliaries and lighting will be furnished by four 500-kilowatt, 240-volt, compound-wound, direct-current turbine generators of the geared type. Electrification of the auxiliaries will be practically complete, even to the extent of the general use of electric heat.

Soviet Russia Employs American Engineers.—Several score engineers and foremen have recently been engaged to work in Soviet industrial and agricultural organizations, according to announcement of the Amtorg Trading Corporation. The American engineers who have either left or will leave shortly for work in the Soviet Union, include experts in the metal industries, construction, irrigation, mining, etc. While a large number of technical assistance contracts, providing for sending about 200 American engineers to the Soviet Union, have been concluded within the past year with American firms, no contracts with individual engineers were made until recently. In view of the announced policy of the Soviet government to employ foreign technical talent to a greater degree, it is expected that a number of additional American engineers will be engaged for work in industrial and agricultural enterprises of the U. S. S. R. Among the individual American engineers who have been retained by Soviet organizations are seven hydraulic engineers headed by Arthur P. Davis, formerly chief of the United States Reclamation Service, who will supervise the irrigation projects in Central Asia and Transcaucasia. A number of other Soviet industrial organizations have announced the intention of inviting foreign engineers, foremen and supervisors for work in their enterprises. The employment of American engineers and other technical personnel is done through the Amtorg Trading Corporation, 261 Fifth Avenue, New York, representatives in this country of a number of the principal Soviet industrial enterprises.

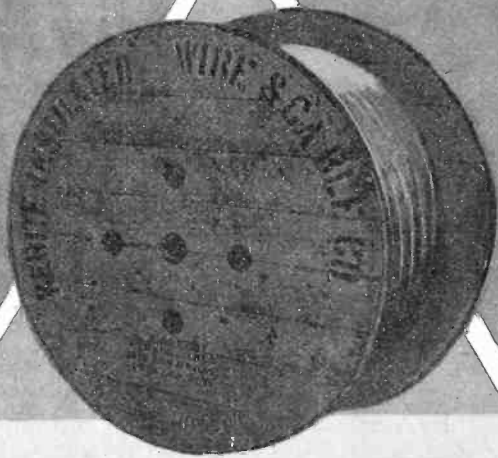

The careful investor judges a security by the history of its performance.

KERITE

in a half-century of continuous production, has spun out a record of performance that is unequalled in the history of insulated wires and cables.

Kerite is a seasoned security.

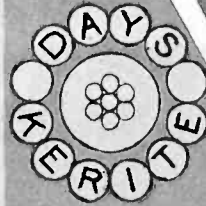
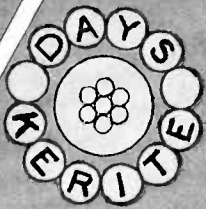

THE KERITE INSULATED WIRE & CABLE **COMPANY INC**
 NEW YORK SAN FRANCISCO CHICAGO

McClure 80-668

Builders of Transformers for every laboratory and industrial application



Speed in Production— with the delicate touch of the Craftsman—

THE Amerweld Electric Spot Welding Machine was designed by American Transformer Company engineers for fusing small metal parts, such as the elements in radio tubes and electric light bulbs, in the manufacture of jewelry, dental supplies, novelties, and for small spot welding of all kinds.

It is simple, quick, reliable, safe, and economical of current—hence inexpensive. Equipped with a Ward Leonard Vitrohm rheostat and adjustable within a useful range, both for intensity of heat and the period

of application, Amerweld fills a long felt need. As many welds as required can be made with no loss of time, giving maximum productivity and minimum waste of materials. A battery of fifty Amerwelds can be accommodated on a bench one hundred feet long and six inches deep, reclaiming valuable floor space for other operations.

The machine can be supplied for operations on circuits of any frequency, and voltages up to 550 volts. Standard units are carried in stock for 220 and 110 volts—60 cycles.

For further information write for Bulletin 1125.

Representatives

Atlanta, Ga.—H. Douglas Starr, 101 Marietta Street

Chicago, Ill.—L. C. Hermann, 4435 North Richmond Street, Ravenswood Station

Knoxville, Tenn.—Arthur L. Pollard

Minneapolis, Minn.—Elliott Equipment Co., 708 Sixth Avenue, South

Montreal, Canada—W. O. Taylor & Co., Ltd., 415 Canada Cement Bldg.

Philadelphia, Pa.—L. D. Joralemon, 117 South 16th Street

San Francisco, Calif.—James H. Southard, 687 Mission Street

St. Louis, Mo.—J. W. Jones, 432 Pennant Building

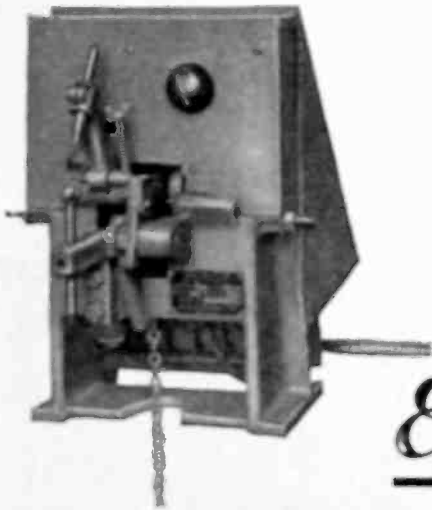

AMERWELD

Electric SPOTWELDER

AMERICAN TRANSFORMER COMPANY

178 EMMET STREET

NEWARK, N. J.

Please mention the JOURNAL of the A. I. E. E. when writing to advertisers.

On your
resistance
problems
consult these
Resistance
Specialists

THE manufacturers of DURHAM Metallized Resistors place at the service of electrical engineers the facilities of a broadly experienced staff of resistance specialists together with probably the most complete experimental laboratory of its kind in existence.

Whatever your resistance problem may be, the utilization of this service should not only save time and money in bringing about a proper solution, but will also provide you the highest degree of accuracy in design and manufacture, together with minimum costs for the finished products.

Probably the best indication of the value of this service lies in the fact that our engineers are constantly cooperating with electrical engineers of many of the largest manufacturers and experimental laboratories and are continually developing new ideas, new designs and new uses for DURHAM Resistance Units. The facilities of our experimental laboratories plus the experience of our specialist staff are

available to all engineers. We cordially invite you to consult with us on your resistance problems.



A standard Durham Metallized resistance unit, made in a wide variety of ranges and used by the millions in the radio industry.

DURHAM
METALLIZED

RESISTORS & POWEROHMS
INTERNATIONAL RESISTANCE CO.
2006 Chestnut Street, Philadelphia, Pa.

Please mention the JOURNAL of the A. I. E. E. when writing to advertisers.

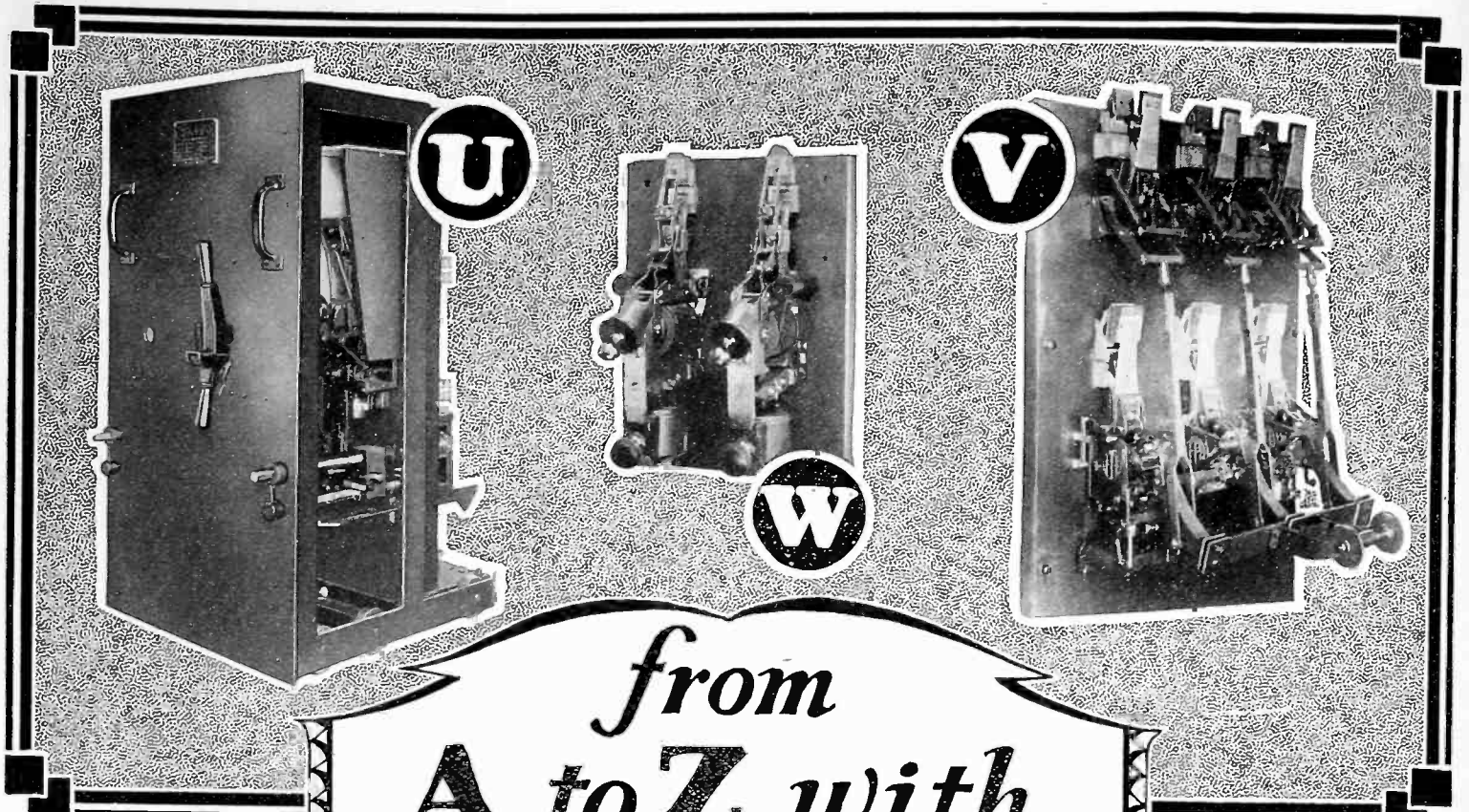

from A to Z with I.T.E.

Coming Attractions

- X** Type LG circuit breaker—2000 amperes at 220 volts A. C. 2 phase 4 wire—4 poles—4 direct-acting overload coils with 4 direct-acting time limits (Dalites)—non-closable on overload or short circuit (Autoite).
- Y** Type S circuit breaker—150 amperes at 250 volts D. C.—2 direct-acting overload coils with 2 direct-acting time limits (Dalites)—poles close independently, but trip together.
- Z** Padlocked U-Re-Lite—to prevent unauthorized changes of overload setting and also to protect men working on the line.

For complete information on dependable protection for any circuit up to 750 volts D. C. or 550 volts A. C. write or call our nearest office.

U

Type LL air circuit breaker truck—1600 amperes at 550 volts A.C.—fitted with wheels, racking in gear and separable contacts for easy removal from switchboard—mechanically interlocked so truck cannot be removed while breaker is closed. Truck can be racked out to 6" inspection position without breaking auxiliary control circuits.

V

I-T-E semi-automatic transfer switch—400 amperes at 480 volts A. C.—automatically connects load to emergency source when normal fails—reconnected to normal source by operator. Also made in full automatic form where switch returns instantly and automatically to normal source when normal is restored.

W

Type J circuit breaker—40 amperes at 250 volts D.C.—2 poles—2 direct-acting overload coils with 2 direct-acting time limits (Dalites)—poles are closed and tripped independently.

I-T-E CIRCUIT BREAKER COMPANY
19th and HAMILTON STS., PHILADELPHIA

Birmingham, American-Traders Bank Building; Boston, 201 Devonshire; Buffalo, Ellcott Sq. Bldg.; Chicago, 333 N. Michigan Ave.; Cincinnati, Union Trust Bldg.; Cleveland, 439 Terminal Tower Bldg.; Dallas, 1810 Allen Bldg.; Denver, Tramway Bldg.; Detroit, Penobscot Bldg.; Duluth, 611 Providence Bldg.; Kansas City, Midland Bldg.; Los Angeles, 106 W. 3rd; Minneapolis, Plymouth Bldg.; Montreal, 151 LaGauchetiere St. West; New Orleans, Hibernia Bank Bldg.; New York, 12 E. 41st St.; Omaha, Electric Bldg.; Philadelphia, 1505 Race St.; Pittsburgh, Park Bldg.; St. Louis, Bank of Commerce Bldg.; San Francisco, Russ Bldg.; Seattle, 802 33rd Ave.; Toronto, 149 Adelaide Street East; Vancouver, 500 Beatty Street.

"Almost to the end of my little show, only three more to go—but remember the new I-T-E catalog contains 66 pages of descriptions, dimension drawings, photographs and prices of I-T-E equipment. Great help to you in your daily work, Brother—better write my company for your copy."

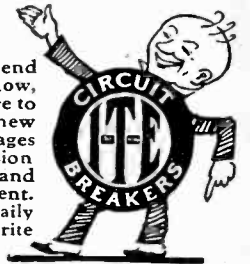

I-T-E PROTECTION

URELITES — I-T-E CIRCUIT BREAKERS

Please mention the JOURNAL of the A. I. E. E. when writing to advertisers.

SHUNT WOUND

BATTERY CHARGER

THE DIVERTER POLE GENERATOR

CONSTANT VOLTAGE INHERENT

RUNS AS MOTOR SAFELY

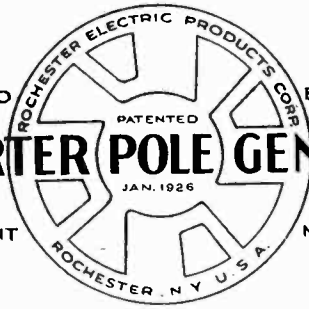

For All Kinds of Battery Charging

(Floating—Trickle—Constant Potential—Modified Constant Potential—Cycle)

With Safety and Economy

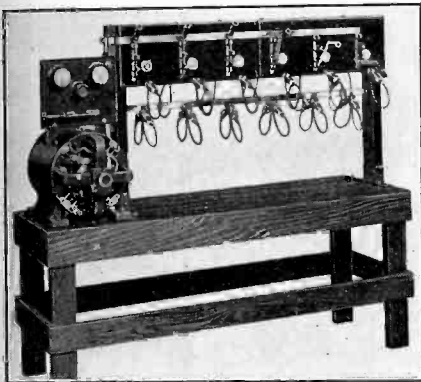

A Diverter Pole Generator charging outfit that assures every battery of getting the right charge.

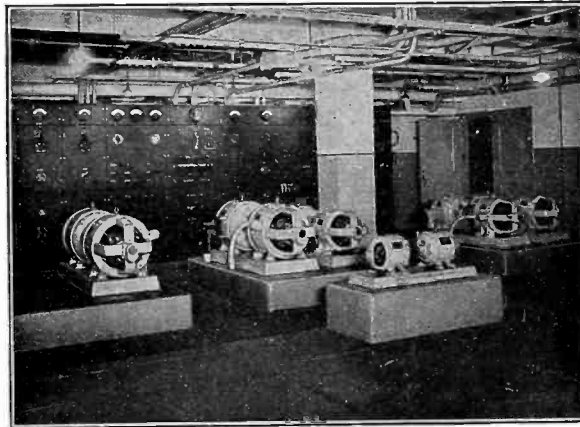

Diverter Pole Generators floating with storage batteries in a telephone repeater station.



A Diverter Pole Generator floating with a bus control battery in an automatic substation.

Some recent comments—

"The Diverter Pole Generators in our substations go for months at a time without touching the field rheostat." (There are ten 5-kw. generator sets in this group.)

"The Diverter Pole Generator is the only thing for telephone batteries."

"The two 500-watt Generator Sets are giving wonderful results and are ideal for use with the Automatic Fire Alarm System."

"The average life of our industrial truck batteries has been doubled since the installation of your Diverter Pole charging set."

While not at liberty to officially give the names of these endorsers, we will gladly give you names and addresses on request that will enable you to either verify or get similar statements to those above.

Send for descriptive bulletin

ROCHESTER ELECTRIC PRODUCTS CORP.

87 Allen Street

Rochester, N. Y.

BUILDERS OF D. C. MOTORS AND GENERATORS FOR 30 YEARS

G-E Type FK-139

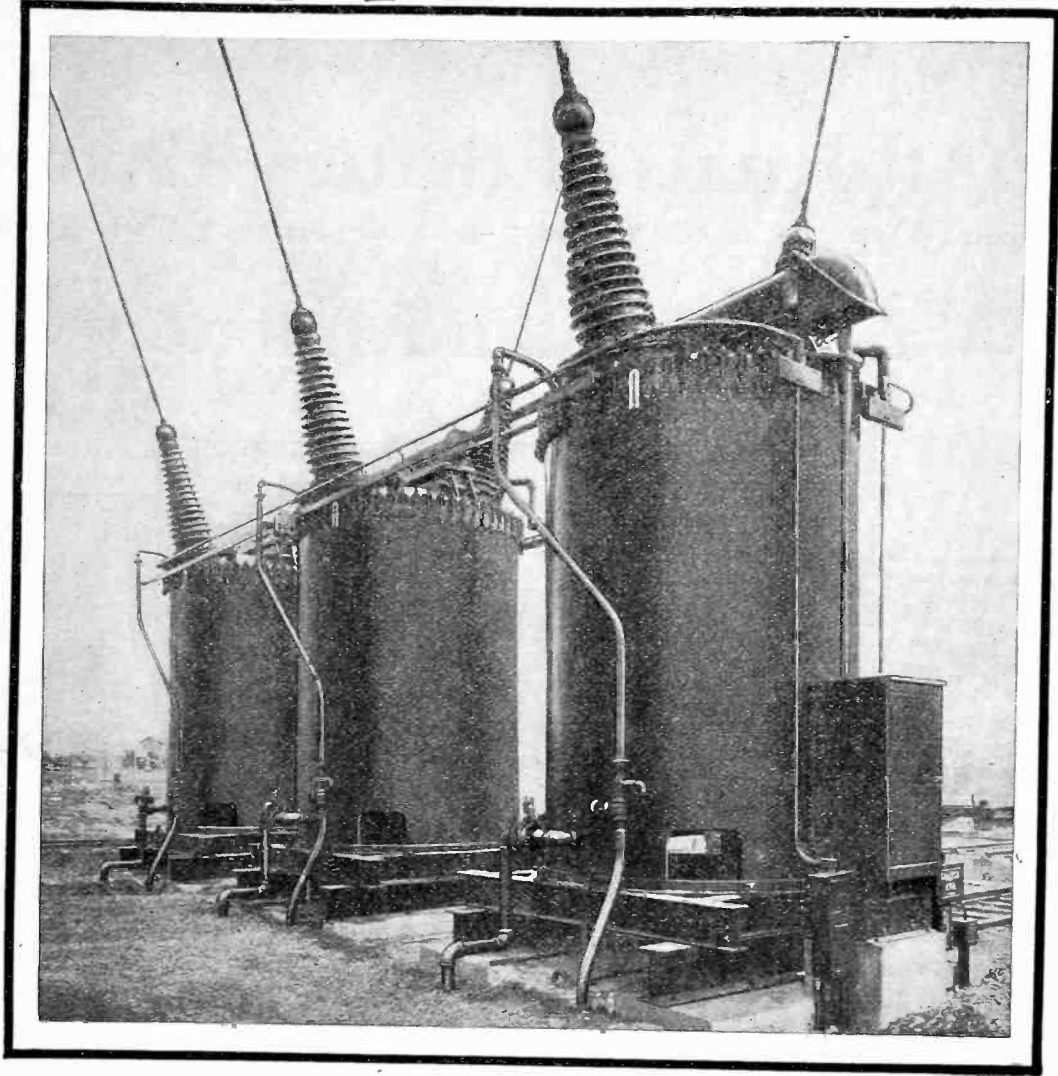

G-E Type FK-139 Oil Circuit Breakers

A complete line of heavy-duty breakers — Indoor or outdoor service — 7500 to 220,000 volts — 600 to 2000 amperes — Interrupting ratings, 350,000 to 2,500,000 kv-a. — Conservatively rated — Proved by rigid tests and operating experience.

GENERAL

GENERAL ELECTRIC COMPANY, SCHENECTADY, N. Y.

Please mention the JOURNAL of the A. I. E. E. when writing to advertisers.

Oil Circuit Breakers

Strong steel-plate construction ~ Internal mechanism ~ Rust-resisting pins ~ Bronze bushings in bearings ~ Explosion chambers on higher-duty breakers ~ Large break distances ~ High insulation ~ Separating chambers and emergency vents on all breakers ~ Bushing transformers ~ Bushing potential devices for 110 kv. and above.

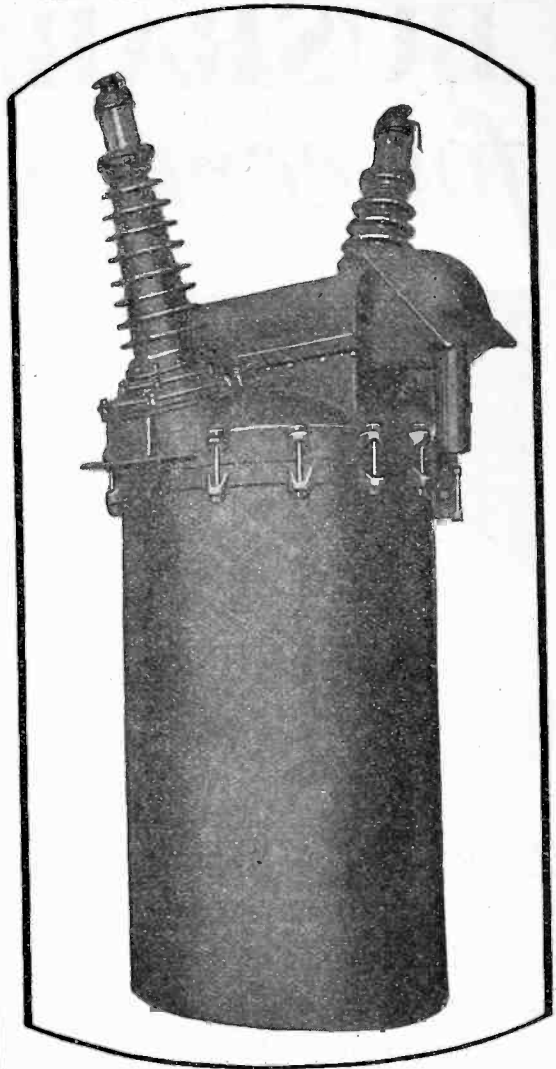

JOIN US IN THE GENERAL
ELECTRIC HOUR, BROADCAST
EVERY SATURDAY AT 9 P.M.,
E.S.T. ON A NATION-WIDE
N.B.C. NETWORK.



For complete information
about G-E Type FK-139
oil circuit breakers, write
to the nearest G-E office
for a copy of GEA-925.

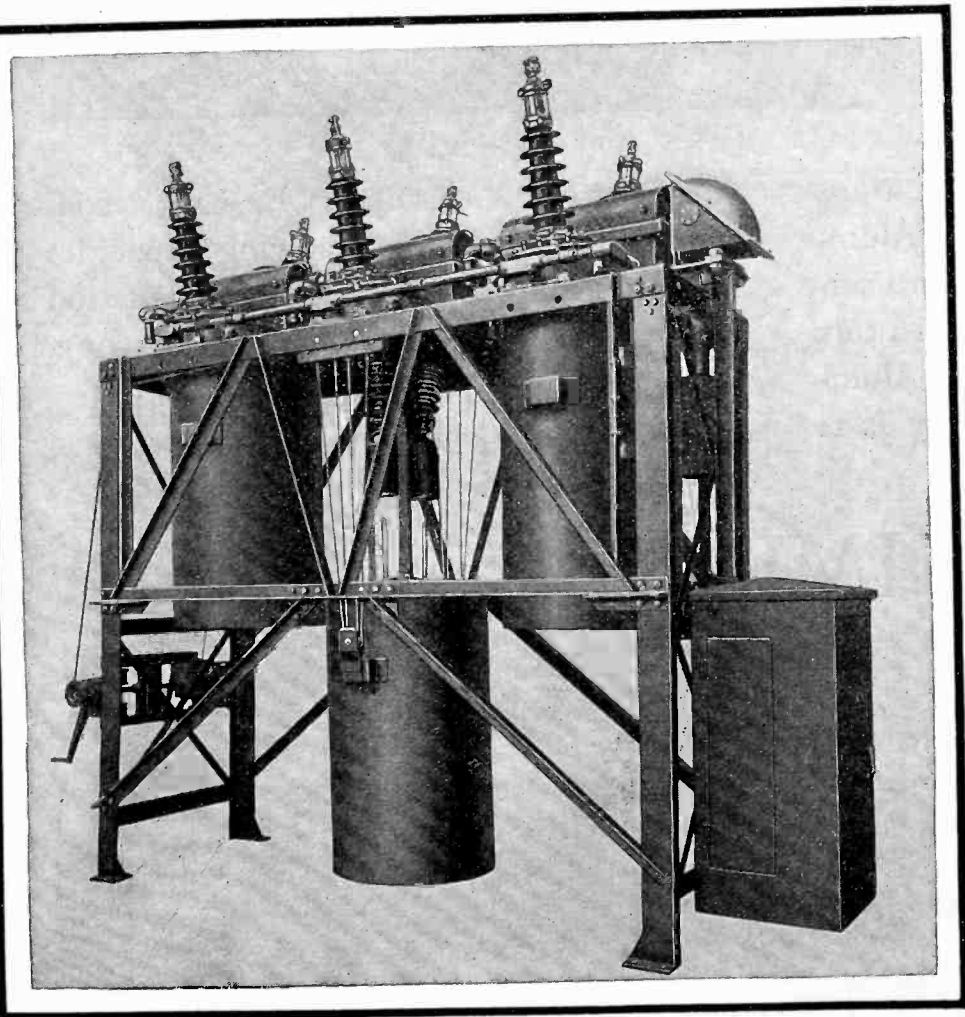

ELECTRIC
SALES OFFICES IN PRINCIPAL CITIES

470-14

ALUMINUM BUSBARS *for economy*

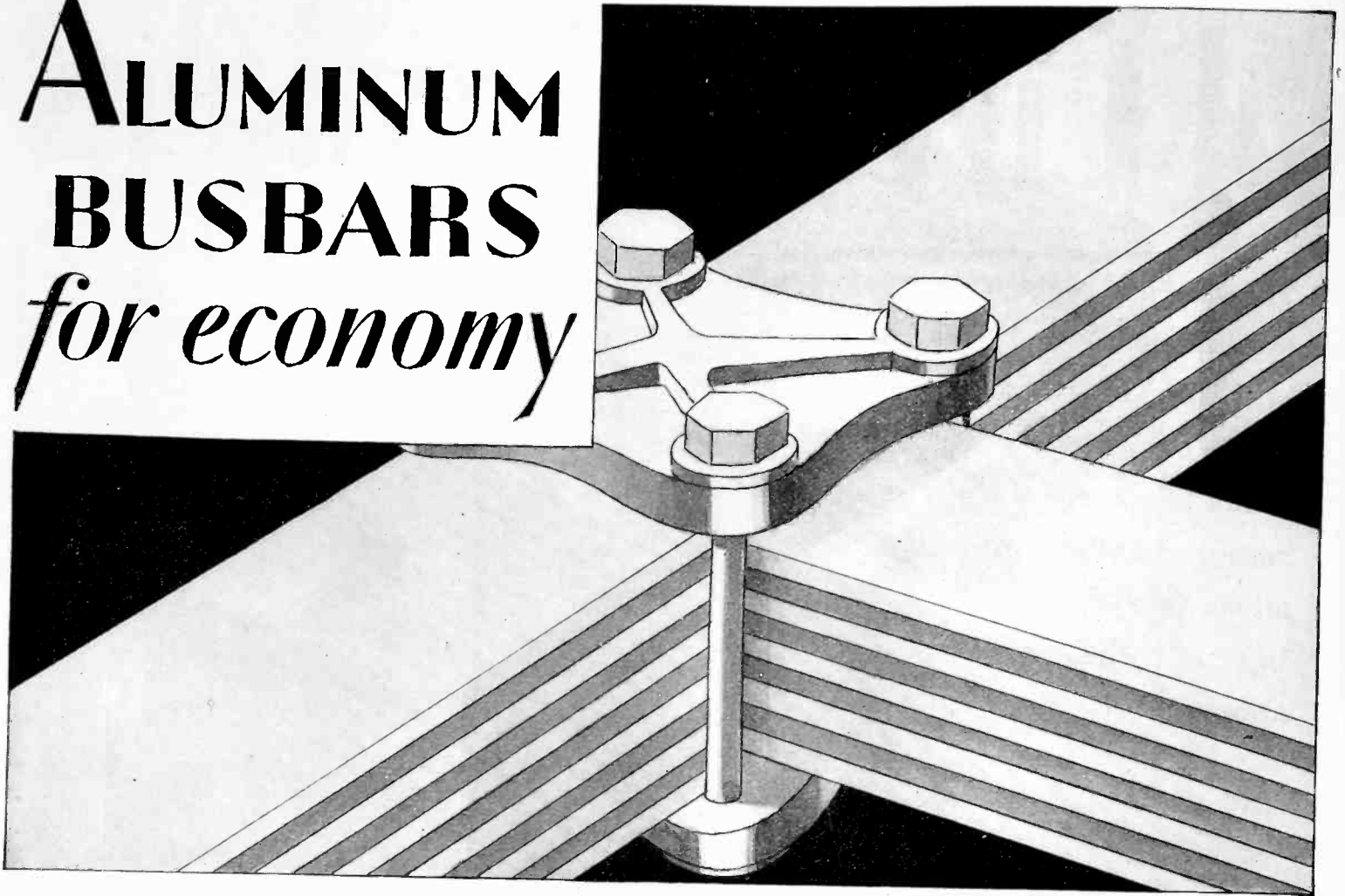

FOR years the most important nations of Europe have standardized on Aluminum Busbars as most economical and satisfactory for transmission purposes. In this country the steadily widening use of Aluminum Busbar clearly shows the way it is regarded by American engineers.

The booklet, "Aluminum Busbars," contains tables of weights, carrying capacities and physical properties, with installation photographs. Please send for your copy.

ALUMINUM COMPANY OF AMERICA
2448 Oliver Bldg., Pittsburgh, Pa.
Offices in 19 Principal American Cities

ALUMINUM



Busbar

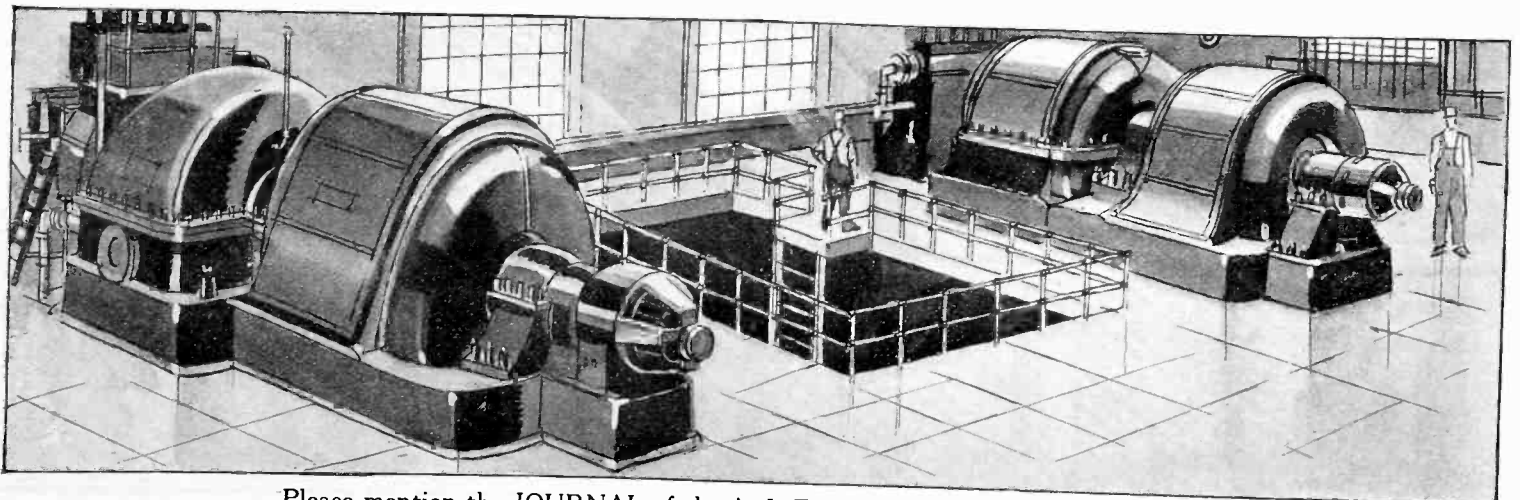

Please mention the JOURNAL of the A. I. E. E. when writing to advertisers.

dependable

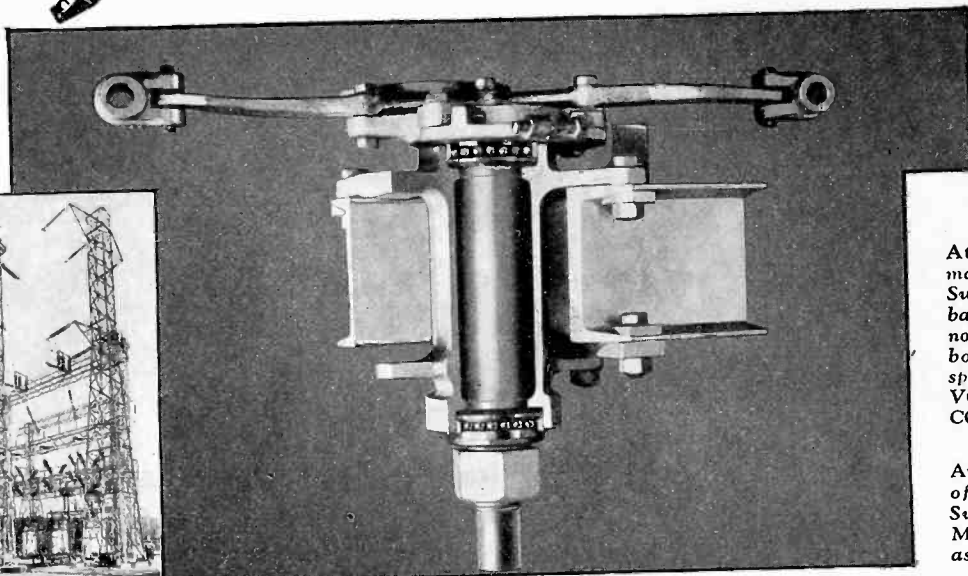
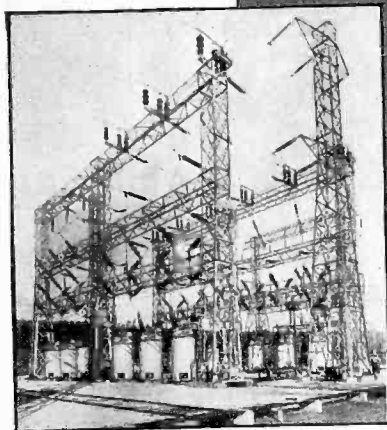

At left: Sectional view of main bearing of Hi-Voltage Switch showing Monel Metal ball bearings which require no lubrication. Monel Metal bolts are also supplied if specified. Mfg. by THE HI-VOLTAGE EQUIPMENT CO., Cleveland, Ohio.

At extreme left: Installation of Hi-Voltage Air Break Switches which are built with Monel Metal ball bearings as standard equipment.

HI-VOLTAGE

switches have ball bearings of...

MONEL METAL

The Monel Metal ball bearings used in all Hi-Voltage switches eliminate the need for any lubrication.

Monel Metal is used for these ball bearings and many other important parts of well-known outdoor switching equipment because it affords a combination of properties not found in any other material.

Monel Metal will not rust. It is free from corrosion-cracking. It retains its high strength through extremes in temperatures. It is not subject to fatigue failures.

To insure the dependability of outdoor electrical equipment, specify Monel Metal bolts, nuts, springs, pins—for parts which must not fail.

SEND FOR BOOKLET—"BOLTS THAT WILL NOT FAIL"

Monel Metal is a technically controlled Nickel-Copper alloy of high Nickel content. It is mined, smelted, refined, rolled and marketed solely by The International Nickel Company, Inc. The name "Monel Metal" is a registered trade mark.



THE INTERNATIONAL NICKEL COMPANY, INC., 67 WALL STREET, NEW YORK, N. Y.



Please mention the JOURNAL of the A. I. E. E. when writing to advertisers.



Delegation of prominent New Yorkers on an inspection tour of New York's first subway in 1904.



THE high conductivity and uniform quality of Anaconda Metals are the result of the coordinated supervision by a single organization of every process from ore to finished product. Seven wire mills offer a coast-to-coast service unequalled for promptness and dependability.

This
Paper Insulated
**LEAD SHEATHED
POWER CABLE**

has helped to transport billions
of subway passengers
during 25 years

MUCH of the lead power cable installed in New York's first subway, back in 1904, was produced by the National Conduit & Cable Company, of Hastings-on-Hudson, N. Y.—now the Hastings Mill of Anaconda Wire & Cable Company. That most of this cable is still in service despite the most exacting of service conditions, is striking evidence of its quality.

The Hastings Mill is now being completely re-equipped for the production of high voltage cable as well as low and medium voltage cable for which it has long been well known.

The new equipment will include stranding and insulation machinery of the latest type—drying and impregnating apparatus incorporating desirable new features—lead presses capable of producing the highest quality of lead sheath covering, and a most complete high voltage testing laboratory.

Constant scientific investigation will also be an important phase of the work at the Hastings Mill. The Company will be glad to receive inquiries concerning the plant and its products.

ANACONDA WIRE & CABLE CO.

General Offices: 25 Broadway, New York

Chicago Office: 111 West Washington Street

Exclusive Selling Agent for Wire and Cable Products of
THE AMERICAN BRASS COMPANY

ANACONDA WIRE PRODUCTS

Please mention the JOURNAL of the A. I. E. E. when writing to advertisers.

**- for High Voltage
or Low Voltage
in any Climate!**

*Always
Dependable!*



MINERALLAC ELECTRIC CO.
25 NORTH PEORIA ST. CHICAGO

Please mention the JOURNAL of the A. I. E. E. when writing to advertisers.

LOCKE

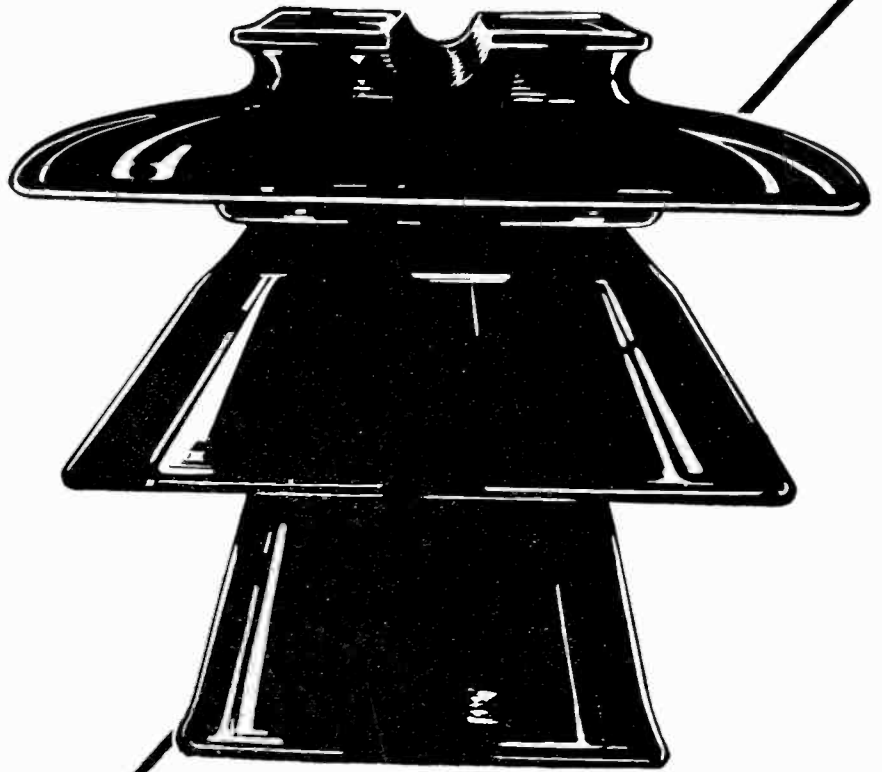

Locke 1066 insulator is an outstanding example of the perfect balance which is characteristic of all Locke designs.

The record which these insulators have established is the natural outcome of consistent research and study, in both laboratory and field, extending over a period of more than thirty-five years. Refinements in design have been paralleled by improvements in manufacturing methods and materials, stricter standards and more exact factory control. Today—as the fruit of this—Locke offers you insulators which will give unequalled performance under any service conditions.

When service counts, specify **LOCKE**.

LOCKE INSULATOR CORPORATION
BALTIMORE MARYLAND

PORCELAIN INSULATORS

Please mention the JOURNAL of the A. I. E. E. when writing to advertisers.



“Keyed”
to meet YOUR
needs

THIS organization is alert to the changing needs of the electrical industry. For over fifty years Standard engineers have been of vital assistance in the development of the industry. Today our whole organization is keyed to the task of progress as never before.

When our representative calls, *or is called in*, you will find him quick to grasp your particular needs. He is experienced as a liaison officer between your engineers and ours. His training summarizes Standard's experience and achievements, enabling him readily to interpret your problems to our technical staff.

Standard products include all types and sizes of wires and cables—aerial, underground and submarine. For the unusual, our manufacturing facilities and engineering counsel are always “at your service”.

We will welcome your inquiry for specifications or prices or, just as gladly, an opportunity to apply our experience in assisting you to solve your troublesome problems.

STANDARD UNDERGROUND CABLE COMPANY

Division of General Cable Corporation

Perth Amboy, N. J.

STANDARD
UNDERGROUND
* CABLE COMPANY *

Please mention the JOURNAL of the A. I. E. E. when writing to advertisers.

A Lineman's View of **DOSSERTS**

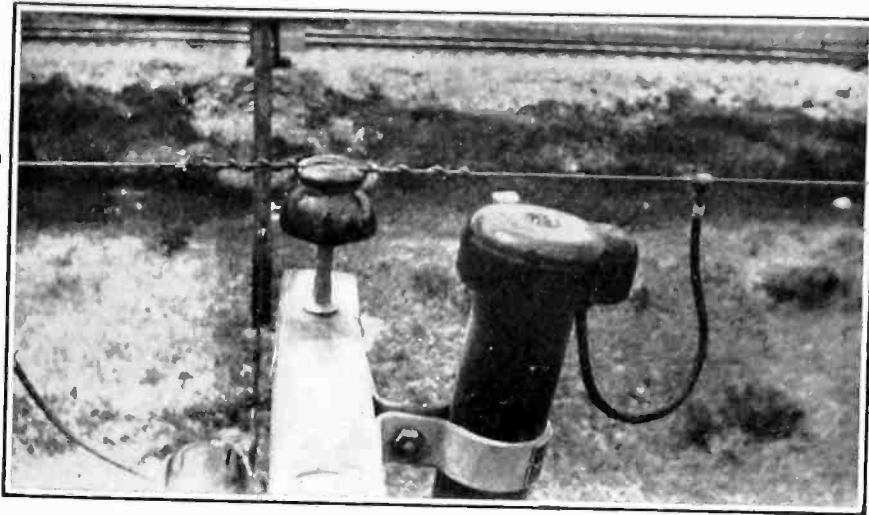

This view taken from the top cross arm shows one of 1500 DOSSERTS installed on lines of Los Angeles and Salt Lake Railroad Company (Union Pacific System).

This Dossert year book gives data on dozens of connections on which linemen and wiremen can save time and provide dependable joints.

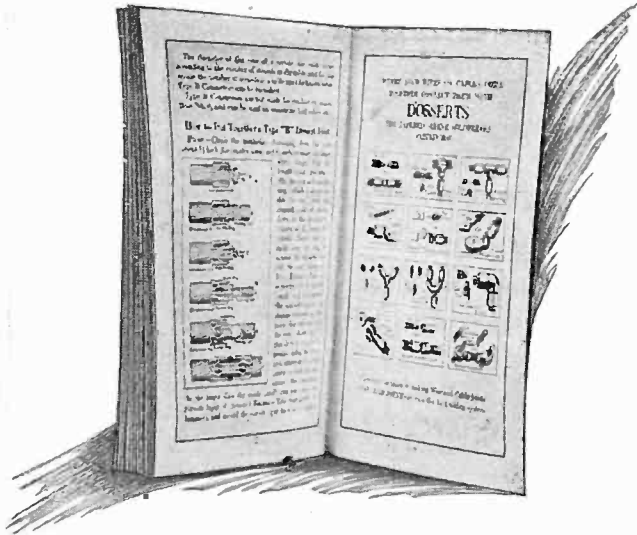

FOR 20 years engineers have found DOSSERTS a means for economical and dependable connections and terminals for wires, cables, rods or tubing.

The reason for the choice of Dosserts is purely an engineering one i. e.—the Dossert tapered sleeve principle.

But the lineman's view of the Dossert is always that it saves time and labor in the effort to make good connections.

DOSSERT & COMPANY, H. B. LOGAN, President, 242 West 41st St., New York

DOSSERTS

Please mention the JOURNAL of the A. I. E. E. when writing to advertisers.

After 18 Years of Dependable Service

Records Show That Present Day Suspension Clamp Requirements are Fully Met by Original O-B Design

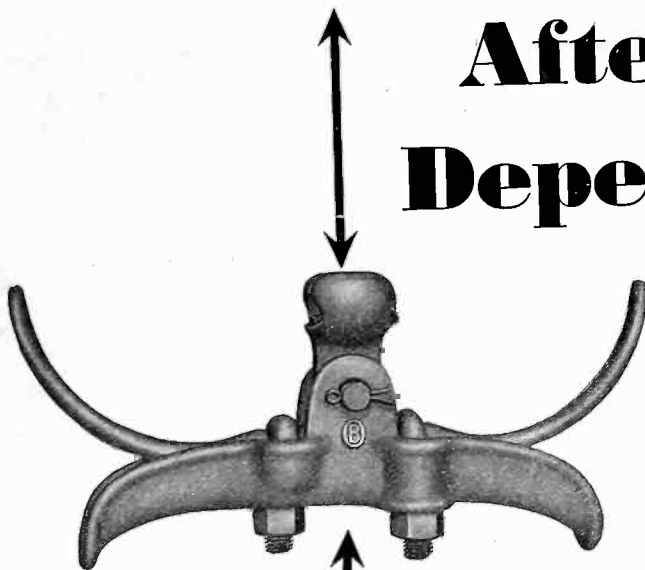

IN 1911, O-B introduced Suspension Clamp No. 11538. Its basic design has guided the design of all O-B Suspension Clamps since that time.

It was the first closed seat clamp—the first to overcome the hazard accompanying the loosening of the conductor in the clamp, caused by vibration. The closed seat clamp will not drop the conductor. Despite the fact that the higher voltages and heavier conductors have required larger and heavier clamps, this basic design is still the outstanding leader.

Such a record proves the correctness of the design. It also proves that the material used in this clamp is the best for the purpose, for eighteen years ago O-B Suspension Clamps were cast from *malleable iron*. Today, three-fourths of all O-B clamps are still cast from *malleable iron*—employing the Flecto process.

Eighteen years ago malleable iron served best. Today, malleable iron—improved by the Flecto process—continues as the leader, as evidenced by the fact that transmission engineers specify O-B Suspension Clamps of a design and material which has proved best through years of service.

Ohio Brass Company, Mansfield, Ohio
Canadian Ohio Brass Company, Limited
Niagara Falls, Canada
1143H

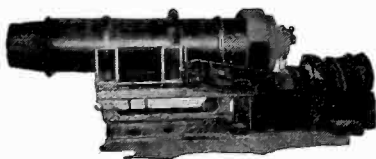

O-B Flecto Iron

The Flecto process of treating malleable iron has definitely established a higher standard of malleable iron quality. Not only by eliminating embrittlement after hot-dip galvanizing, but by preventing breakage due to embrittlement of castings during extremely cold weather, the Flecto process saves users of O-B Hardware thousands of dollars and insures them of more reliable service.

3,354,654 tested castings, with less than one per cent defective after galvanizing and no failures in service during zero temperatures, prove the effectiveness of the Flecto process.

Ohio Brass Co.

NEW YORK PITTSBURGH PHILADELPHIA BOSTON

CHICAGO CLEVELAND ST. LOUIS ATLANTA SAN FRANCISCO LOS ANGELES DALLAS

PORCELAIN INSULATORS
LINE MATERIALS
RAIL BONDS
CAR EQUIPMENT
MINING MATERIALS
VALVES

Please mention the JOURNAL of the A. I. E. E. when writing to advertisers.

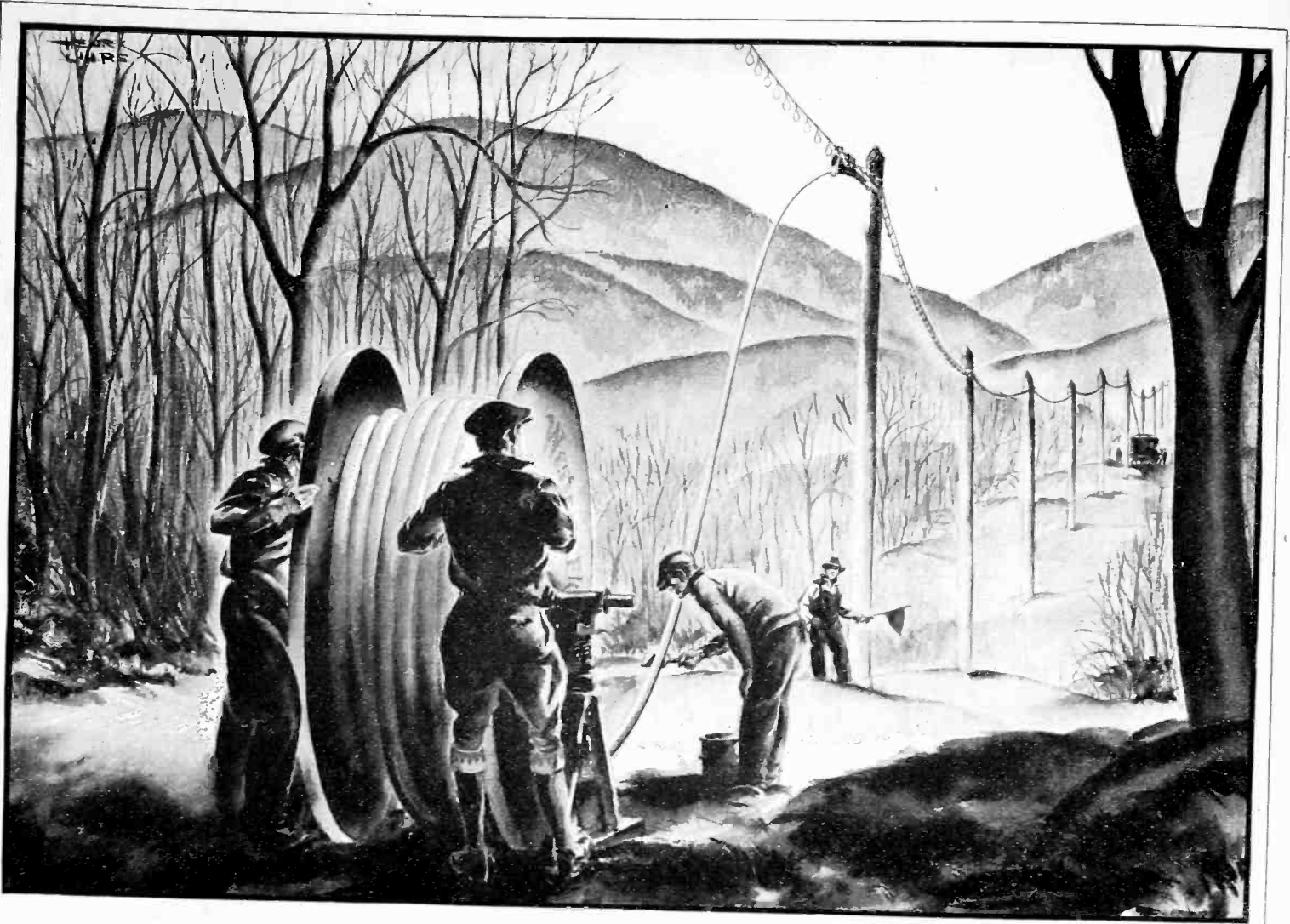

BIG AND LITTLE, RICH AND POOR, CAN PROJECT THEIR PERSONALITIES OVER THE WIDE NETWORK OF ITS WIRES

In the service of all the people

*An Advertisement of the
American Telephone and Telegraph Company*

THE Bell System is owned by 450,000 stockholders and operated by more than 400,000 workers for the service of the people of the nation.

It is a democratic instrument of a democracy. Big and little, rich and poor, can project their personalities over the wide network of its wires. For friendship or business, pleasure or profit, the telephone is indispensable to our modern civilization.

This year the Bell System is erecting new telephone buildings in more than



200 cities. It is putting in thousands of miles of cable, thousands of sections of switchboard and hundreds of thousands of new telephones. Its expenditure for plant and improvements in service in 1929 will be more than 550 millions of dollars—half again as much as it cost to build the Panama Canal.

This program is part of the telephone ideal that anyone, anywhere, shall be able to talk quickly and at reasonable cost with anyone, anywhere else. There is no standing still in the Bell System.



Greetings

from
American Steel & Wire Company

Again the Yuletide, with its inspirations of good cheer is with us—the New Year approaches—and we sincerely extend to you our very best wishes for a very **MERRY CHRISTMAS** and a **HAPPY, PROSPEROUS NINETEEN THIRTY** » » »

ELECTRICAL WIRES
Manufactured by
 AMERICAN STEEL & WIRE COMPANY
 Rubber Covered
 Weatherproof
 Bare Copper—Magnet
 Annunciator and Office Wires
 Lamp Cords—Trolley Wire
 Automobile Cables
 Submarine Cables
 Park and Suburban Cables
 Power Cables
 Either Rubber, Cambric or
 Paper Insulated

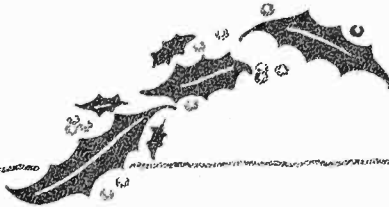

American Steel & Wire Company

SUBSIDIARY UNITED STATES STEEL CORPORATION

208 S. La Salle Street, Chicago 30 Church Street, New York
 Other Sales Offices: Atlanta Baltimore Birmingham Boston Buffalo Cincinnati Cleveland
 Dallas Denver Detroit Kansas City Memphis Milwaukee Minneapolis-St. Paul
 Oklahoma City Philadelphia Pittsburgh Salt Lake City St. Louis Wilkes-Barre Worcester
 U. S. Steel Products Co.: San Francisco, Los Angeles, Portland, Seattle, Honolulu
 Export Distributors: United States Steel Products Co., 30 Church St., New York City

FERRANTI LTD.

ETN/ML.

DEPARTMENTAL MEMORANDUM.

From Mr. E.T. Norris. Date 7th October, 1929.
 File F.11. To Mr. Vincent de Ferranti.
Mr. R.H. Schofield.
Sales Department.

FERRANTI SURGE ABSORBERS.

Damage caused by Lightning.

An investigation has recently been carried out on a large scale into the damage caused by lightning surges, together with the effects of lightning arresters in the United States. The results are extremely interesting, and are published in the Technical News Bulletin of the United States Bureau of Standards for July 1929.

The investigation covered two calendar years and summarises the experience of 240 Supply Companies scattered over thirty States in the west and middle west.

The total amount of damage caused in this period was valued at \$631,000. Considering damage to transformers only, 91% of the breakdowns occurred in transformers protected by lightning arresters, whereas only 80% of the transmission lines were protected by lightning arresters.

These figures indicate that on the average 2.44 times as many transformer breakdowns occurred on each protected line as on each unprotected line. Although arrester protection is probably more prevalent in lightning areas, it would appear from these figures that the lightning arresters do considerably more harm than good.

All lightning arresters under consideration operate by discharging the surge to earth, and therefore the power arcs and disturbance to the supply thus set up are probably responsible for many breakdowns that would not otherwise have occurred.

The report states that 3673 breakdowns occurred to Station apparatus, and of these cases, 3171 or 86%, were inductive apparatus such as transformers, rotating machinery, etc. These figures show quite clearly that the principal damage caused by lightning surges is to inductive apparatus, such as transformers which are affected by the steepness of the wave front rather than by the amplitude. The fact that existing lightning arresters have been so useless is evidently because they operate on the amplitude of the wave instead of on its steepness of wave front. The surge absorber essentially operates on the steepness of wave front.

The prevalence of lightning varied widely over the areas covered, some areas reporting an average of seven instances of damage per 100 miles of transmission line per season, and others only .05 instances of damage.

The voltages of the various systems varied from 60 to 125,000, and most of the damages recorded occurred on lines of low or medium voltage.

It should be emphasized that the report referred to above is published by the United States Bureau of Standards, and is therefore presumably accurate and authoritative.

(sgd.)

E. T. Norris.

The Effective Surge Absorber

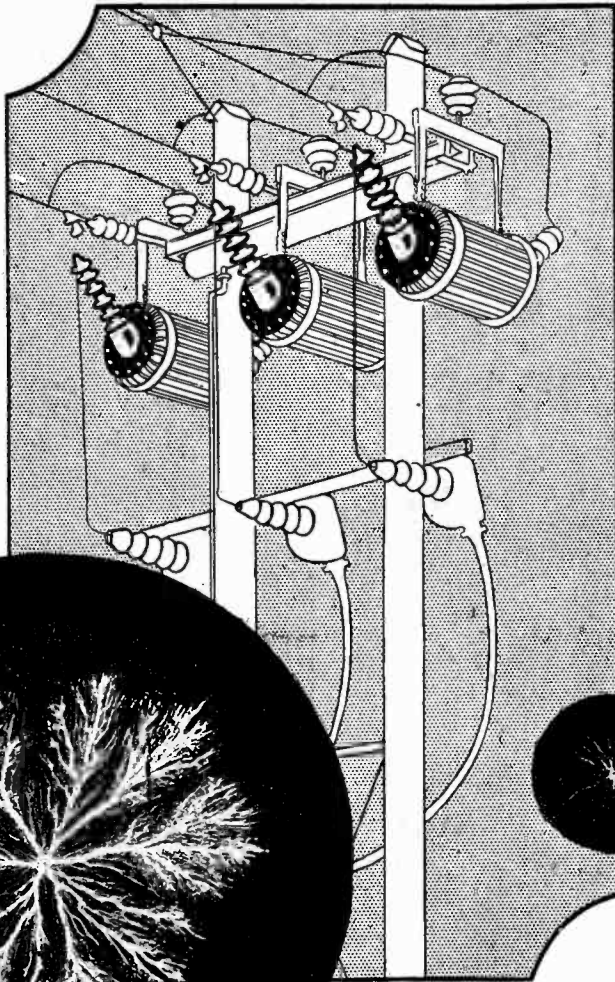

THERE is no time lag in the operation of the Ferranti Surge Absorber.

THE steeper the wave-front of any transient voltage (with consequent increase in danger to inductive apparatus) the more effective the Absorber.

Suitable for connecting in cables and transmission lines of voltages from 220 to 220,000

Klydonograph records of the voltage across

the end turns of transformer at terminal of transmission line.

- a. Without Surge Absorber in circuit.
- b. With Surge Absorber in circuit.

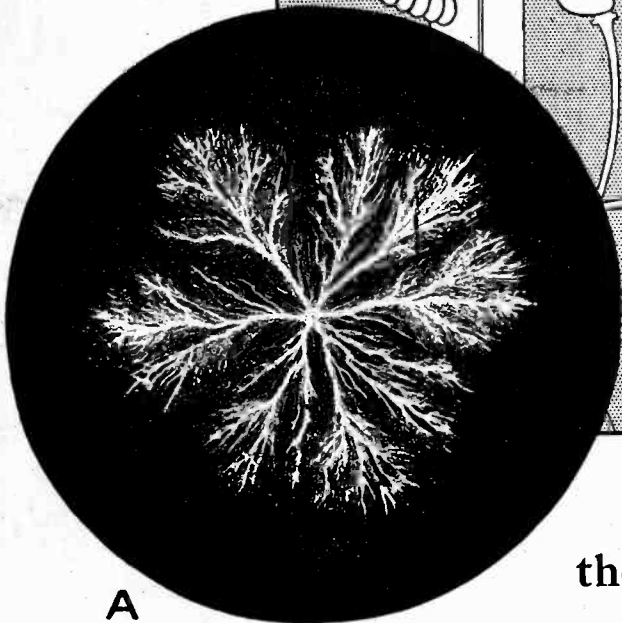

A

NOTE.—The amplitude of the surge voltage is approximately proportional to the diameter of the figure.



B

FERRANTI SURGE ABSORBER

Ferranti, Inc.
130 West 42nd Street
New York, U. S. A.

Ferranti, Ltd.
Hollinwood
Lancashire, England

Ferranti Electric Limited
26 Noble Street
Toronto, Canada

Load Ratio

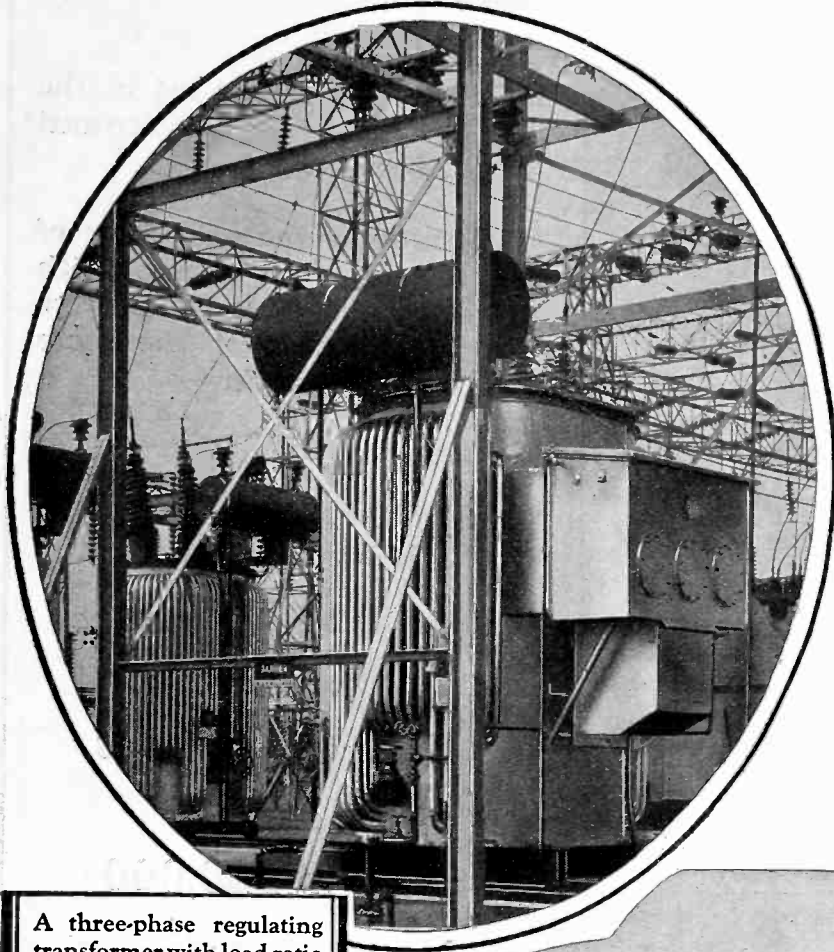

A three-phase regulating transformer with load ratio control at the Gadsden Substation of the Alabama Power Company. Rated 10,000/20,000 kv-a. (output), 46,000 volts

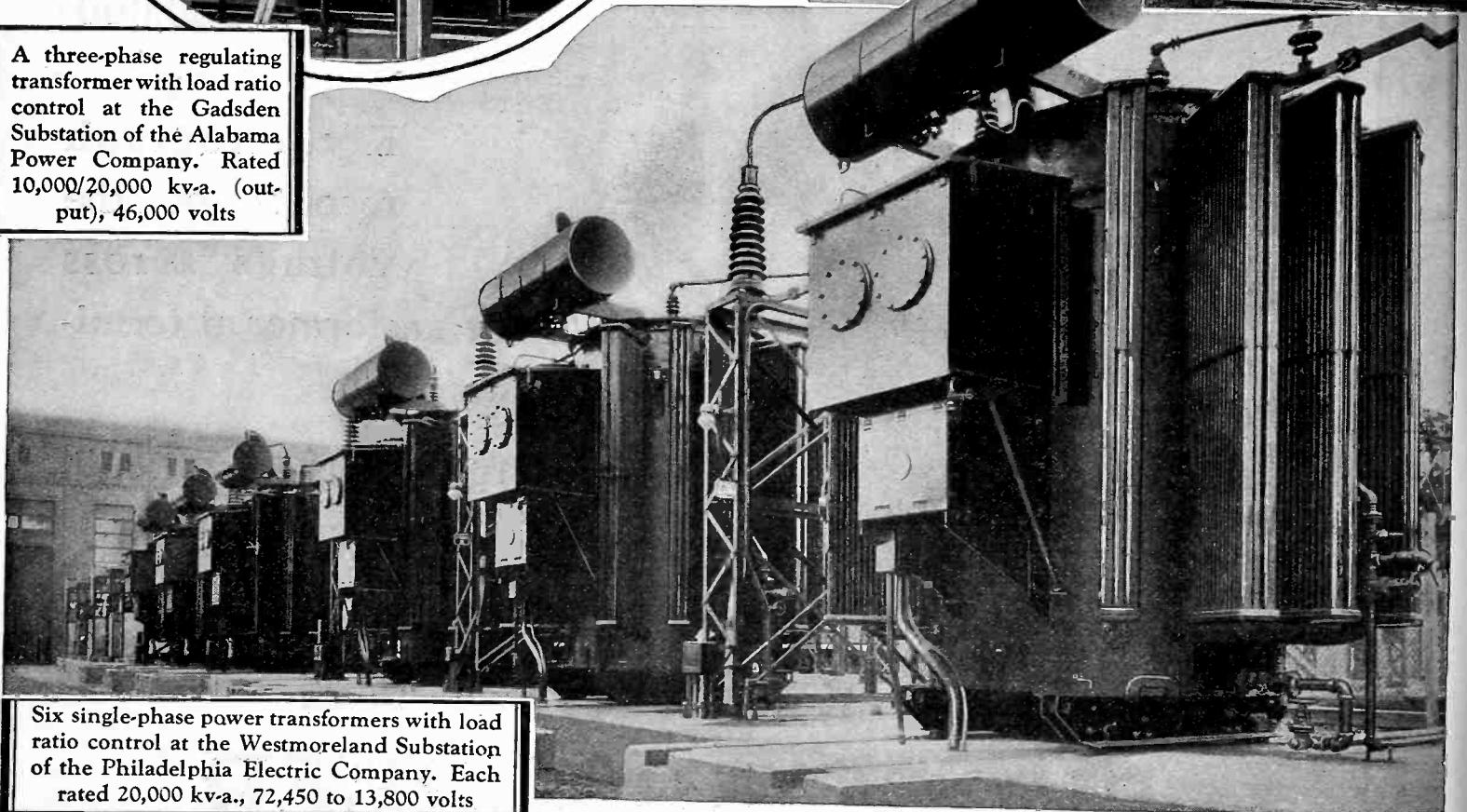
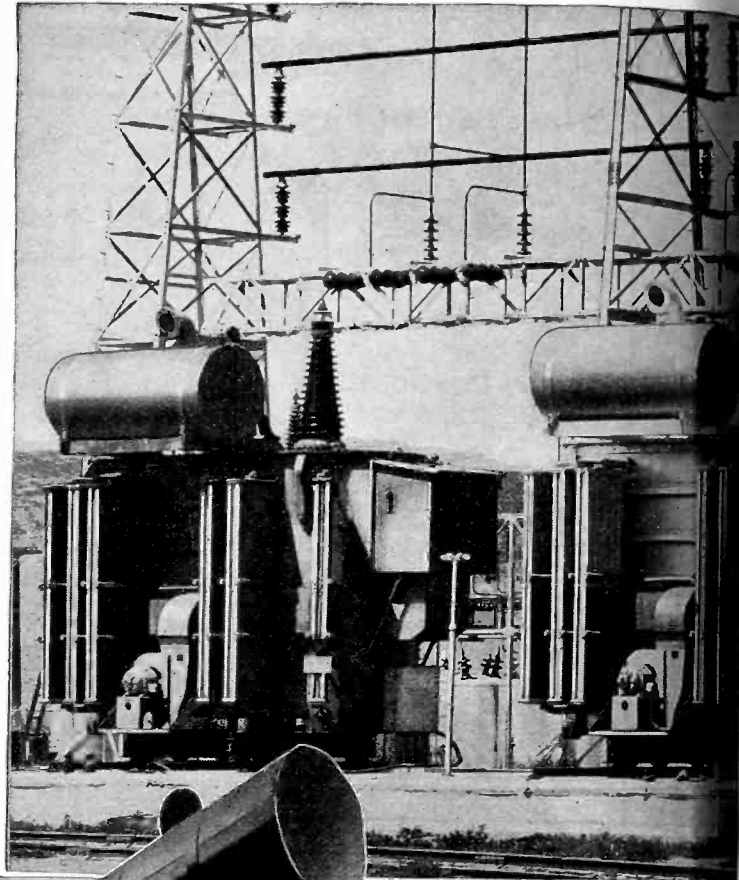

Six single-phase power transformers with load ratio control at the Westmoreland Substation of the Philadelphia Electric Company. Each rated 20,000 kv-a., 72,450 to 13,800 volts

GENERAL
 GENERAL — ELECTRIC COMPANY, SCHENECTADY, N. Y.

Please mention the JOURNAL of the A. I. E. E. when writing to advertisers.

Control —

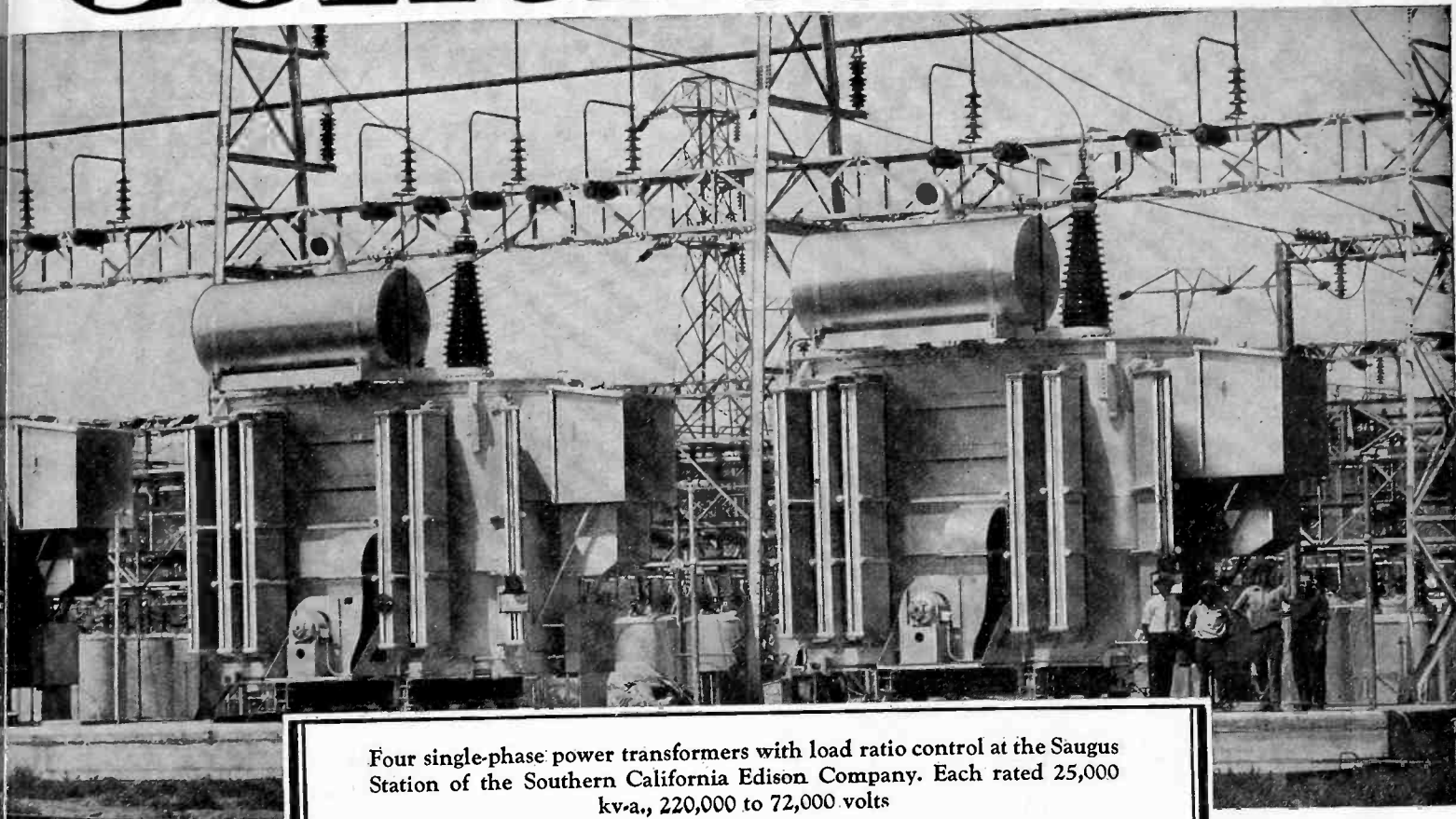

Four single-phase power transformers with load ratio control at the Saugus Station of the Southern California Edison Company. Each rated 25,000 kv-a., 220,000 to 72,000 volts

now used by practically every large operating company

IN the comparatively short period of seven years, G-E equipment for changing transformer ratio under load has been applied almost universally. It has been so generally accepted that the power thus regulated totals millions of kv-a. This attests the comprehensive experience of General Electric in the production of load ratio control and demonstrates the unqualified success of the G-E method and design.

Features of General Electric Design

The voltage steps are uniform regardless of load or power-factor, because each ratio is obtained directly from a separate tap.

Complete oil immersion, so important in the successful operation of high-voltage apparatus, affords the necessary high degree of reliability.

The usual nine ratios are obtained with only two current-interrupting contacts per phase, requiring but one inspection annually.

Extreme compactness is an important feature of G-E design; in some cases no additional floor space is required.

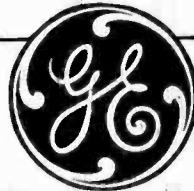

JOIN US IN THE GENERAL ELECTRIC HOUR, BROADCAST EVERY SATURDAY AT 9 P.M., E.S.T. ON A NATION-WIDE N.B.C. NETWORK

410-22

ELECTRIC

SALES OFFICES IN PRINCIPAL CITIES

Please mention the JOURNAL of the A. I. E. E. when writing to advertisers.

PURIFYING TRANSFORMER OIL

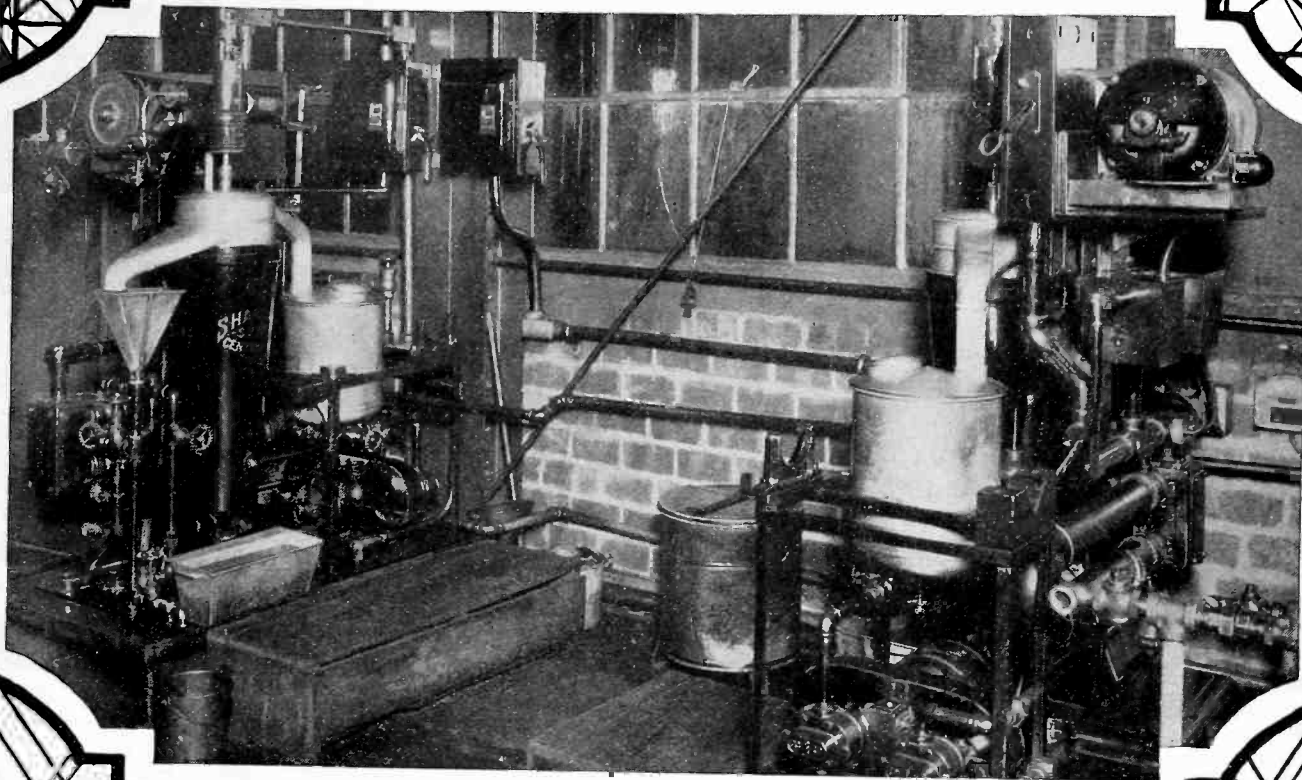

THESE Sharples Portable Units—one installed five years ago and the other two years ago—centrifuge transformer oil for the Moloney Electric Company of St. Louis. Approximately four thousand gallons of transformer oil are purified daily, the Super Centrifuge removing all dirt, water and sludge and restoring the dielectric strength of the oil to well above the specification requirements of new oil.

THE SHARPLES SPECIALTY COMPANY,
2324 WESTMORELAND STREET, PHILADELPHIA,
Boston, New York, Baltimore, Pittsburgh, Chicago, Detroit, Tulsa,
New Orleans, San Francisco, Los Angeles, Toronto, London, Paris,
Tokio; Henry W. Peabody & Company, Sydney and Melbourne,
Australia.

SHARPLES

A GREAT FORCE

Please mention the JOURNAL of the A. I. E. E. when writing to advertisers.

New Small Sized Bristol's Recording Voltmeters and Ammeters

TO those responsible for the routine checking of central station, substation and automatic substation operating efficiency, this Bristol's New Small Sized Electrical Instrument should have an instant appeal.

The small sized rectangular form recording instrument adapts itself admirably to panel board mounting. It requires only a minimum amount of space and presents a very trim and pleasing appearance. In keeping with this idea of economizing space the door is so designed that it can be opened even when the instrument cases are mounted with practically no space between them.

Records Simplify Control

Operating records obtained with Bristol's Recording Voltmeters and Ammeters assist in locating overloaded feeders, overloaded stations and over capacity stations.

The Voltage record gives a continuous check on the uniformity of regulation, and warns of impending faults before they grow to an extent that customers complain. The individual AMPERE METER records of each phase show clearly whether or not the three phases are balanced.

Voltage and ampere records taken together, provide an excellent means of checking voltage in conjunction with changes in load.

Charts used are but 6 inches in diameter. Where a great many records must be examined periodically, these small charts can be accurately and speedily checked. Furthermore, they are all uniform in size—can be handled almost as easily as a deck of cards, and require very little space for filing.

Complete information in Bulletin #373, a copy of which will be sent to any interested person.

The Bristol Company
Waterbury
Conn.

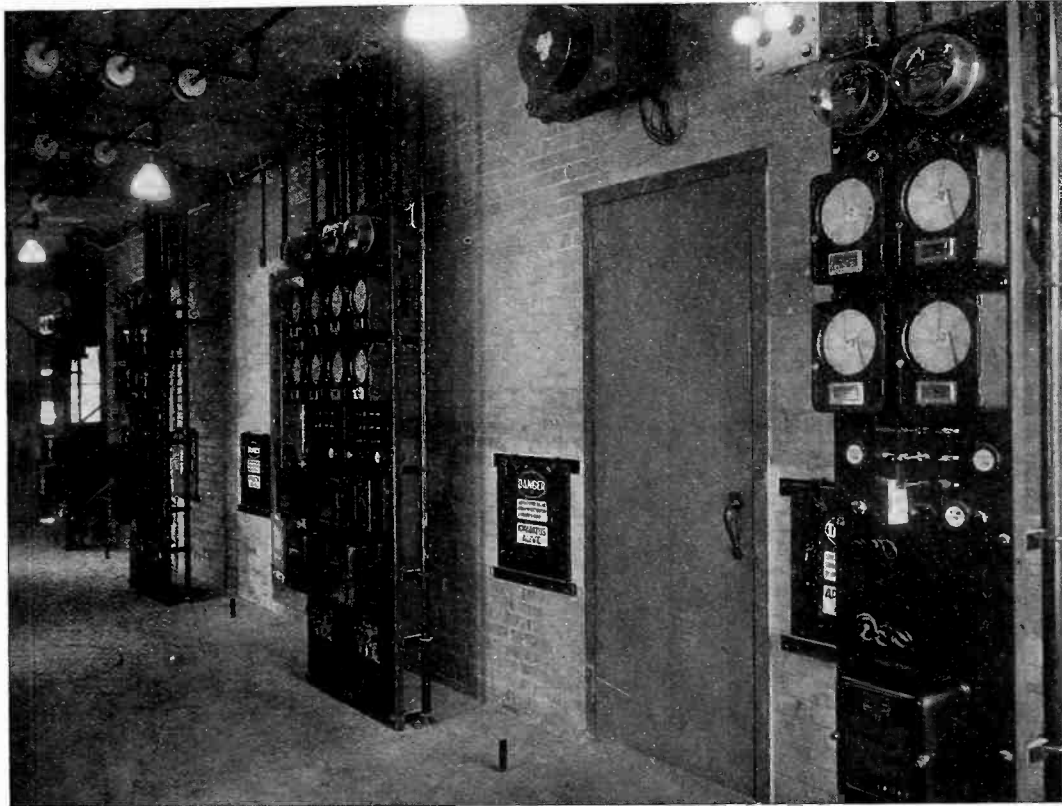

Above are shown several panels of Bristol's small size recording Voltmeters and Ammeters installed in unattended substation of The Detroit Edison Company, Detroit, Michigan.



At left is a close up view of one of the instrument panels. Note how admirably these small size instruments lend themselves to board mounting. Outside case dimensions are 8" wide x 10½" high x approximately 4½" deep.

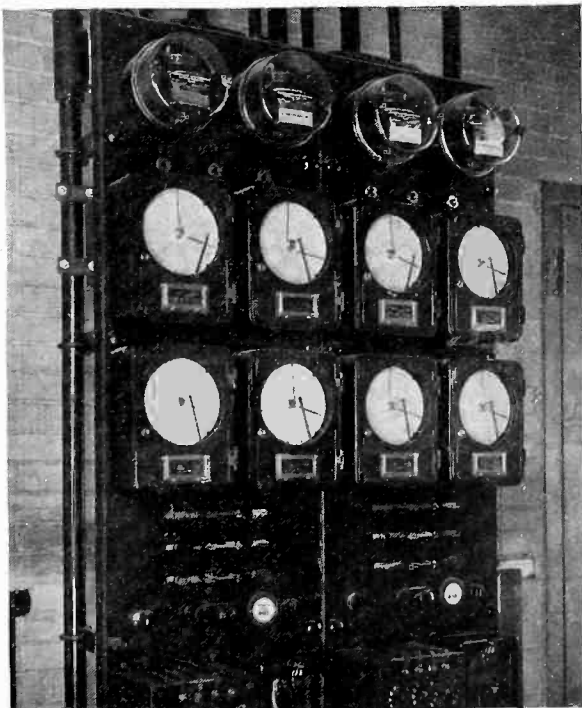

Chandeysson

Generators
25 to 25,000 Amperes

Direct Connected to



Motors

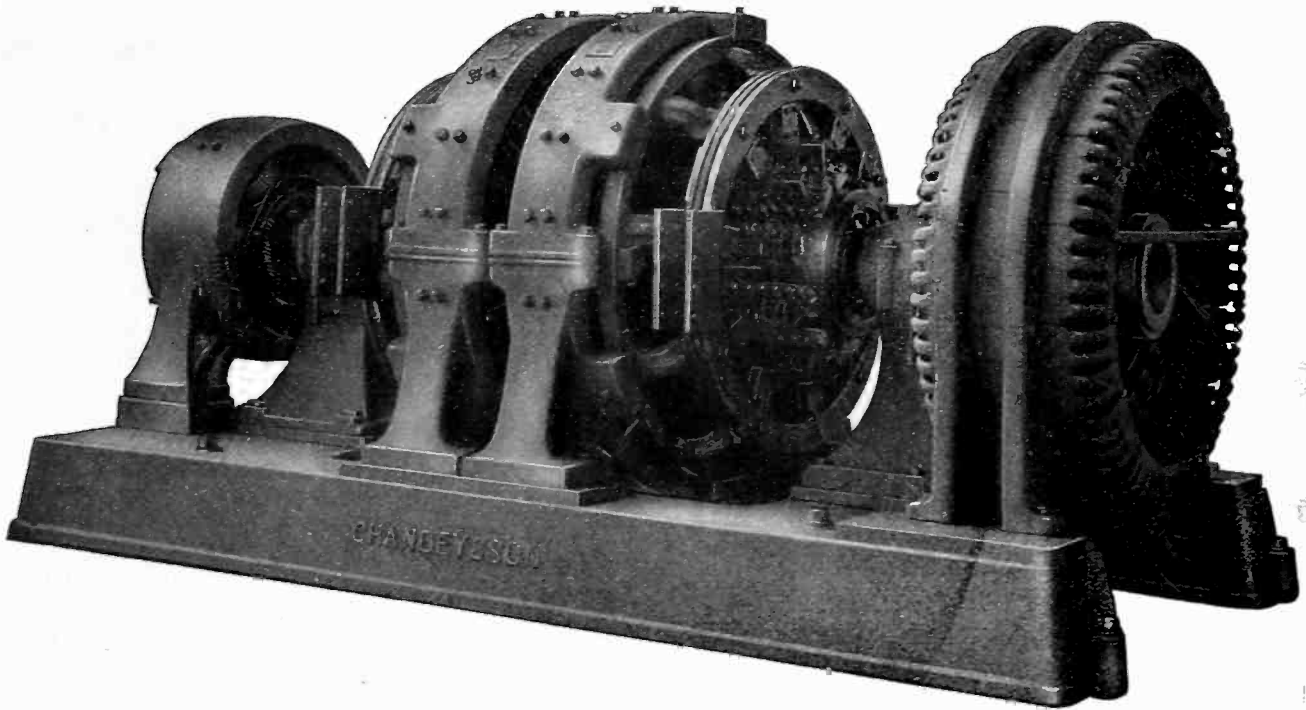

TWIN GENERATOR TYPE

- 1 Greater Flexibility
- 2 Higher Efficiency
- 3 Floor Economy
- 4 Lower Cost

Write for Bulletin 114

CHANDEYSSON ELECTRIC CO., St. Louis, U. S. A.

Chandeysson

Generators
25 to 25,000 Amperes

Direct Connected to



Motors

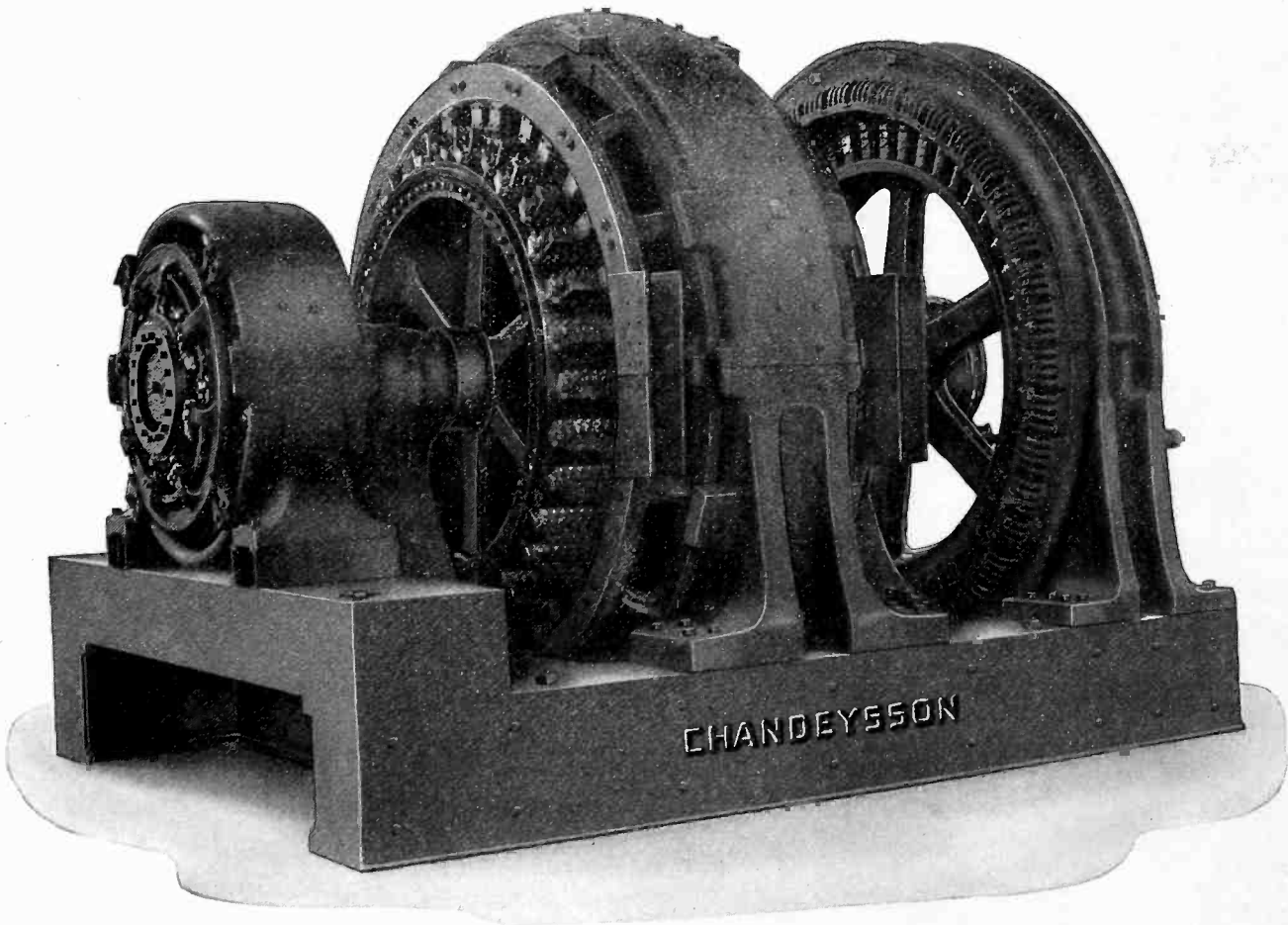

20,000 AMPERES 12 VOLTS UNIT

WEIGHT 85,600 POUNDS
FABRICATED STEEL SUB-BASE

CHANDEYSSON ELECTRIC CO., St. Louis, U. S. A.

Please mention the JOURNAL of the A. I. E. E. when writing to advertisers.

Clean... Cool

 In many applications motors fail due to external conditions such as corrosive fumes, dust or moisture. Wagner makes a complete line of enclosed motors cooled by a fast moving jacket of air produced by an external blower (in small sizes the blower is on one end, in the larger sizes on both). In the illustration the casings are removed from one of the motors to show the position of the two blowers.

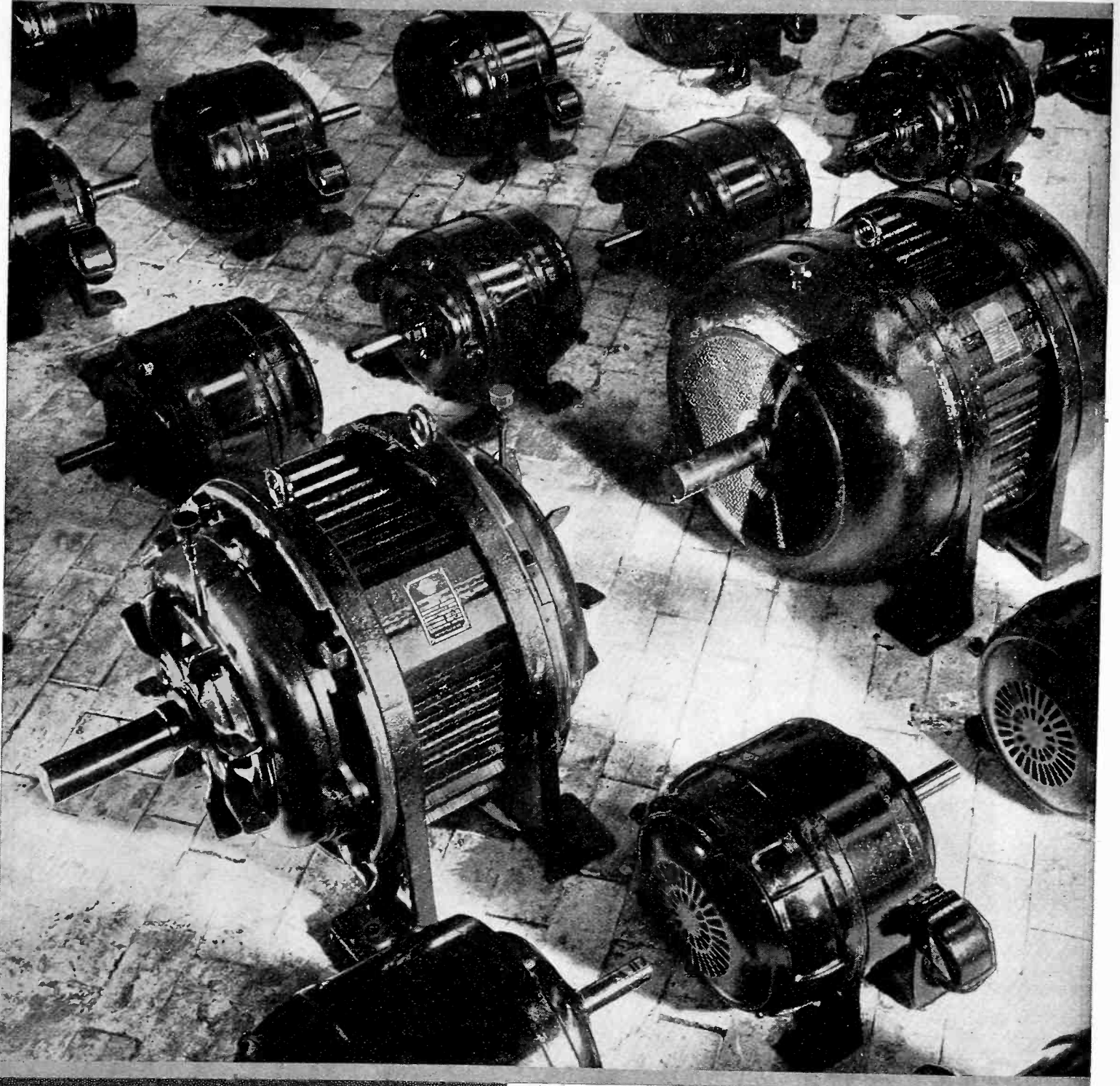

Wagner, Quality

 Wagner motor advice is unbiased because Wagner makes every commercial type of alternating-current motor.
 Literature on Request
WAGNER ELECTRIC CORPORATION
 6400 Plymouth Ave., St. Louis
 Sales and Service in 25 Principal Cities
PRODUCTS . . . FANS . . . DESK . . . WALL . . . CEILING
TRANSFORMERS . . . POWER . . . DISTRIBUTION . . . INSTRUMENT
MOTORS . . . SINGLE-PHASE . . . POLYPHASE . . . DIRECT CURRENT

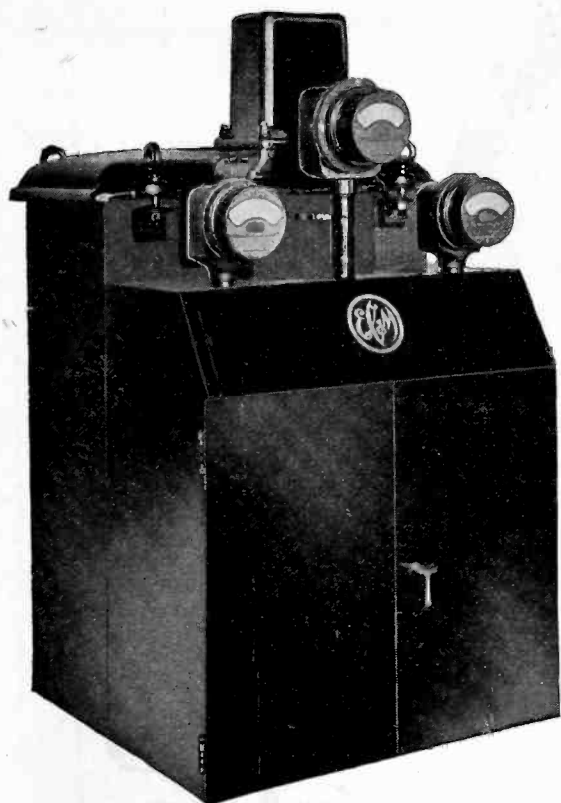

A NEW DESIGN OF AUTOMATIC SYNCHRONOUS MOTOR STARTERS

A SMALL compact unit, requiring a minimum amount of floorspace and headroom, is the feature of this new design EC&M Automatic Starter for controlling a 1100 HP, 2300 volt synchronous motor-generator set.

Although very compact for a reduced voltage compensator-type starter of such a large horsepower rating, accessibility to all parts is in no way sacrificed. The compensator mechanism is arranged in two sections, so that a minimum headroom is required to lift it out of the case.

Likewise is the automatic field panel containing a graphic watt-hour meter and numerous protective features so designed that it may be tilted forward to permit easy access to the wiring on the back of the panel.

Mines and similar places where a few inches in reduced headroom means a real saving appreciate the economy of these compact EC&M Automatic Synchronous Motor Starters. Write to our nearest branch office for a copy of the leaflet showing how many of these starters are installed in cramped and isolated places.

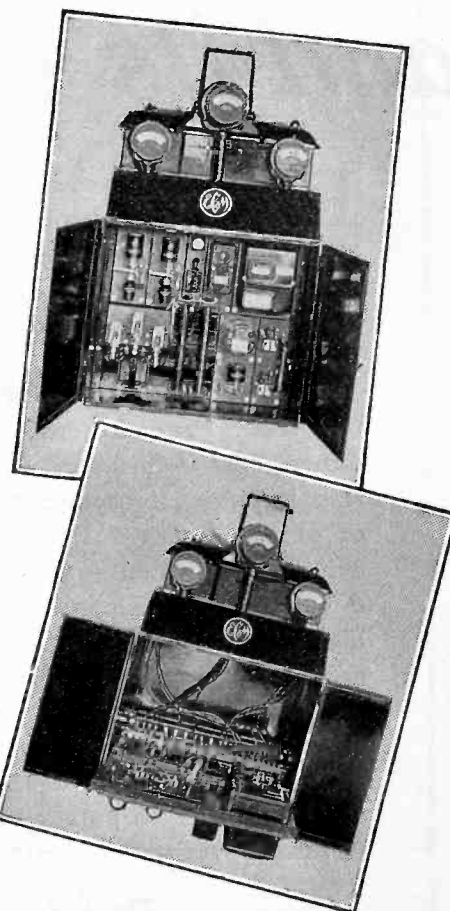

The above illustrations show how the removal of two top bolts allows the automatic field panel to be easily swung forward to permit access to the wiring in the rear.



THE ELECTRIC CONTROLLER & MFG. CO.

NEW YORK-50 CHURCH ST.
CHICAGO-CONWAY BLDG.
DETROIT-DIME BANK BLDG.
BIRMINGHAM-BROWN-MARK BLDG.
CINCINNATI-1ST NATIONAL BANK BLDG.
DENVER-KITTREDGE BLDG.

CLEVELAND, OHIO

LOS ANGELES-912 E. THIRD ST.
HOUSTON-1006 WASHINGTON AVE.
TORONTO-REFORD BLDG.

PHILADELPHIA-WITHERSPOON BLDG.
PITTSBURGH-OLIVER BLDG.
SAN FRANCISCO-CALL BUILDING
MONTREAL-CASTLE BLDG.
TULSA-217 E. ARCHER ST.
SEATTLE-ALASKA BLDG.



Please mention the JOURNAL of the A. I. E. E. when writing to advertisers.

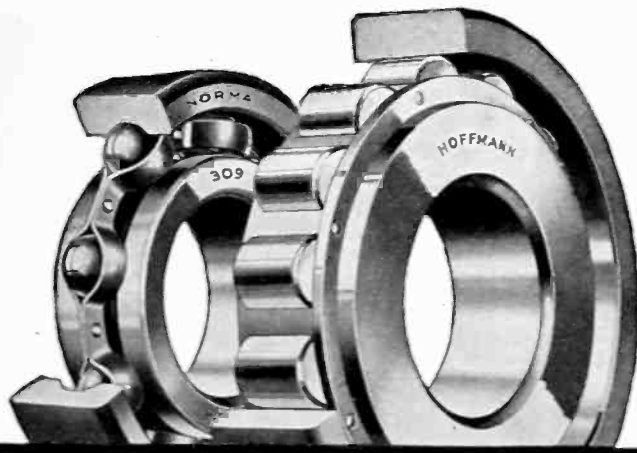

PRECISION

*its meaning
and its commercial value*

PRECISION, as commonly used, is a term defining extreme refinement of dimension and finish. But as describing an outstanding quality of *NORMA-HOFFMANN Precision Bearings*, the word has a far more comprehensive meaning.

To Norma-Hoffmann engineers and production men, *Precision* means the ultimate in dimensional refinement. Above and beyond this, however, it means bearing design worthy of expression in a finished product of this extreme refinement—selected materials well deserving of special treatments and of highly refined machining processes—standards of production which permit no deviation from absolute uniformity, regardless of quantity.

Precision, as thus described, is the foundation quality upon which the Norma-Hoffmann reputation rests, upon which its

business has been built, and upon which it must continue to grow.

But what does all this mean to the buyer and user of *NORMA-HOFFMANN Precision Ball and Roller Bearings*? What, in other words, is the commercial value of *Precision*?

Briefly stated, *Precision* stands for that combination of qualities which manifests itself in higher anti-friction efficiency, longer life, greater speedability, better performance, lower costs for replacements, increased production. These are the distinct and concrete advantages which accrue to the user of *NORMA-HOFFMANN Precision Bearings*.

Obviously, *Precision* is costly to produce and to maintain. But it has been the uniform experience of those who have availed themselves of its advantages, that its price is repaid a hundred fold in the lower after-costs which inevitably follow.

The long, varied experience of Norma-Hoffmann engineers is offered without obligation to machine users and builders facing bearing problems.

NORMA-HOFFMANN PRECISION BEARINGS

NORMA-HOFFMANN BEARINGS CORPN.—STAMFORD CONN. U.S.A.

Please mention the JOURNAL of the A. I. E. E. when writing to advertisers.

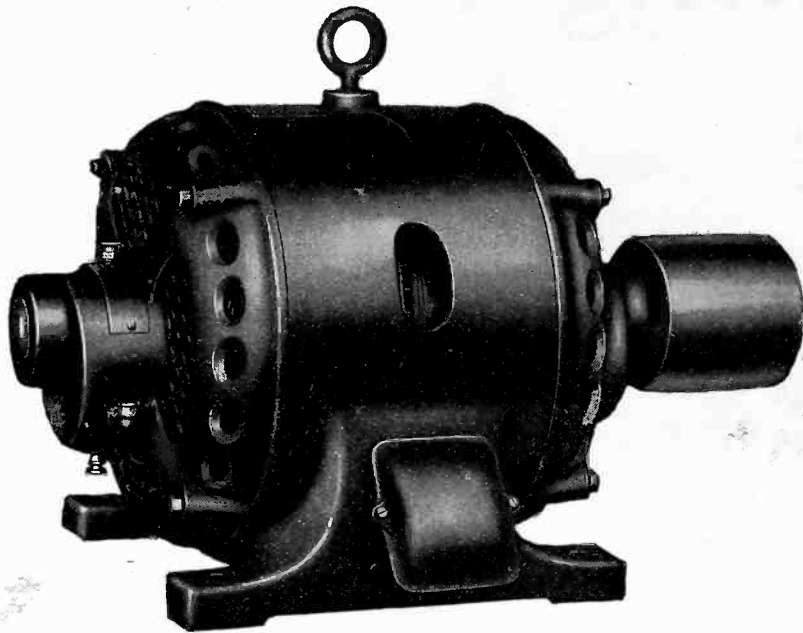

20 Horse Power Century Type SC
Multi-Speed Constant Torque Squirrel Cage Induction
3 and 2 Phase Motor

MULTISPEED

Constant Torque Motors

Constant Horse Power Motors

Variable Torque Motors

Multiple speeds from a squirrel cage motor, with push button or drum control, offer a solution of many drive problems—among machine tools, woodworking machinery, mixers, blowers, stokers, conveyors, etc.

They are built regularly for 2, 3 and 4 speeds, with wide or narrow speed ranges like 1800-1200 or 1800-600 down to 900-450 r. p. m. (60 cycle). Special speed combinations available as described in bulletin 13-1.

CENTURY ELECTRIC COMPANY

1806 Pine St.

St. Louis, Mo.

40 U. S. and Canadian Stock Points and more than 75 outside thereof



“THEY KEEP A-RUNNING”

Please mention the JOURNAL of the A. I. E. E. when writing to advertisers.

Speaking of severe service—

Allis-Chalmers Type "ARZ" Totally-Enclosed Fan-Cooled Motor installed in pit on mixer in iron foundry.

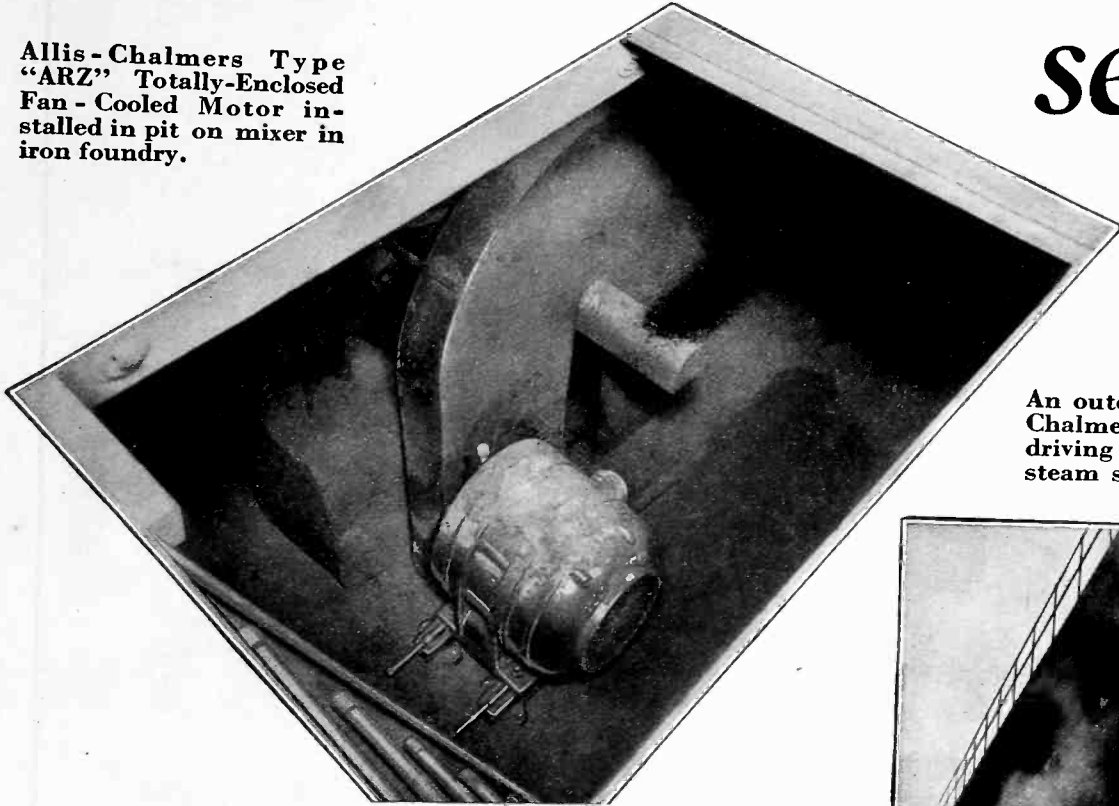

An outdoor installation of Allis-Chalmers Type "ARZ" Motors driving cooling tower fans. Note steam surrounding motors.

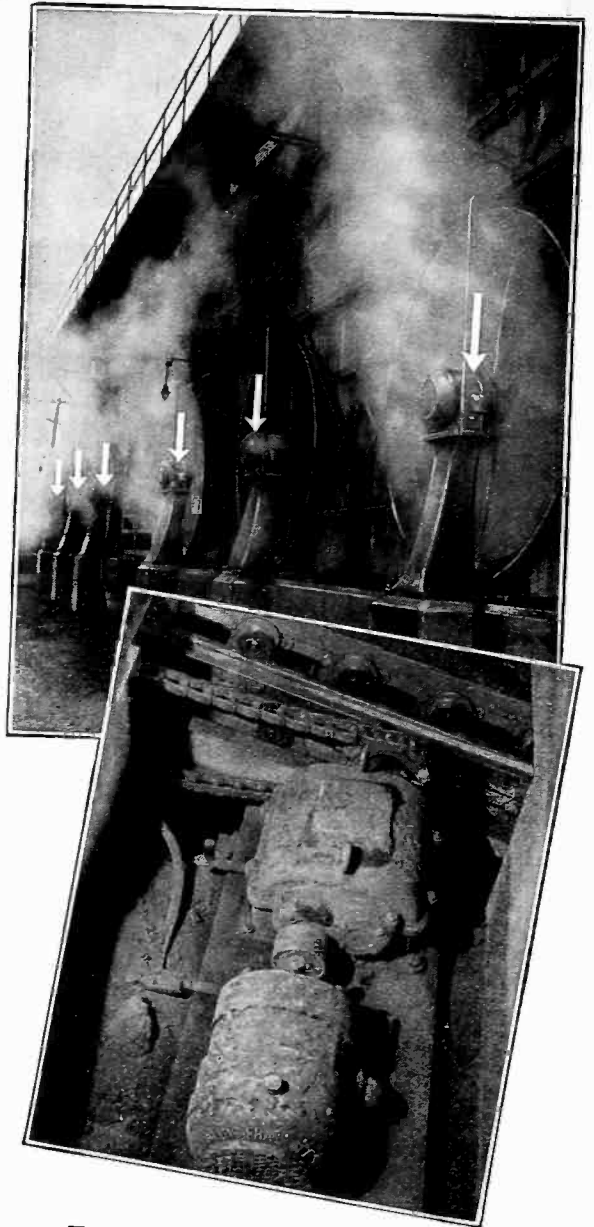

WHERE are the "severe service" jobs for motors in your plant? Wherever they are, and whatever the motor problem presented, there is an Allis-Chalmers Motor to efficiently handle it.

The illustrations show some of the jobs the Allis-Chalmers Type ARZ Totally-Enclosed Fan-Cooled Motors are handling.

The solid cast iron bearing housings are designed as complete enclosures in these motors. These housings carry the rotor and are fitted with apertures for taking air gap measurements. By means of this design the separately attached coil enclosing devices with their auxiliary seals are avoided. The grease-packed bearings are the only shaft seals against the interchange of inside and outside air.

The stator windings and rotor and all parts subject to destruction are thus sealed against the entrance of dirt or dust.

These Allis-Chalmers Totally-Enclosed Fan-Cooled Motors will remove the "grief" from your motor operation where severe conditions exist. Maintenance becomes negligible and the uninterrupted service required in the modern industrial plant is assured.

ALLIS-CHALMERS MFG. COMPANY

Milwaukee, Wis.

District Offices in all Principal Cities

Type "ARZ" Motor driving an apron conveyor under a shake-out pit in a large steel mill.

ALLIS-CHALMERS MOTORS

Please mention the JOURNAL of the A. I. E. E. when writing to advertisers.

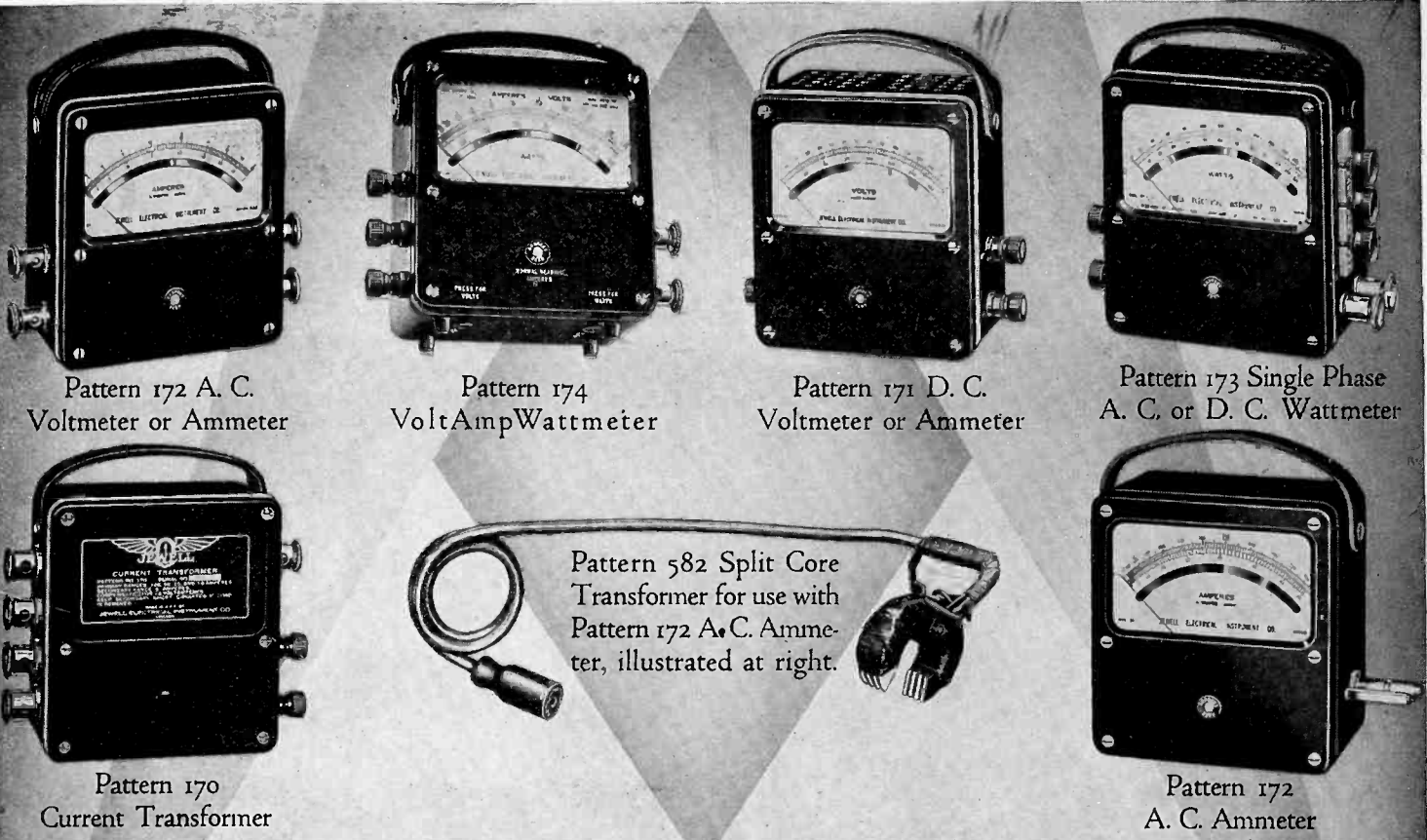

Pattern 172 A. C. Voltmeter or Ammeter

Pattern 174 VoltAmpWattmeter

Pattern 171 D. C. Voltmeter or Ammeter

Pattern 173 Single Phase A. C. or D. C. Wattmeter

Pattern 170 Current Transformer

Pattern 582 Split Core Transformer for use with Pattern 172 A.C. Ammeter, illustrated at right.

Pattern 172 A. C. Ammeter

Every Industrial Plant can afford JEWELL Master Instruments

IN the maintenance of plant electrical equipment; in the inspection of electrical products; in the design of electrical apparatus; and in the service of electrically operated machinery, reliable electrical testing instruments are the basis of scientific operation.

The Jewell Line of Master Instruments in intermediate size bakelite cases of uniform dimensions meets every requirement of electrical testing. Their 1/2 of 1% accuracy guarantee is more than adequate for the great majority of uses. Their compact, uniform size makes it easy to carry a complete group in a small case.

No expense has been spared in making Jewell

Masters the best intermediate size instruments that can be made. Yet, through the use of quantity production methods and die made parts that are completely interchangeable, Jewell Master Instruments come to you at a very moderate cost.

Bakelite cases of uniform size; large scale openings protected by non-shatterable glass; long, hand-drawn scales; and knife-edge pointers of seamless aluminum, are features that suggest the quality of Jewell Master Portables.

You should know all about Jewell Master Instruments. Ask the nearest Jewell Representative to tell you about them, or mail the coupon, today.

The Jewell Electrical Instrument Company makes a complete line of high grade A. C. and D. C. instruments for every purpose, including switchboard instruments from 2 inches to 9 inches in diameter, and portable instruments from small pocket sizes to laboratory precision standards. Catalog sent on request.

29 YEARS MAKING GOOD INSTRUMENTS
JEWELL

Master Instruments

Please mention the JOURNAL of the A. I. E. E. when writing to advertisers.

Jewell Electrical Instrument Company
1650 Walnut Street, Chicago, Illinois

Of course I want to know about the most complete line of intermediate size instruments. Mail your bulletin.

Name.....

Company.....

Address.....

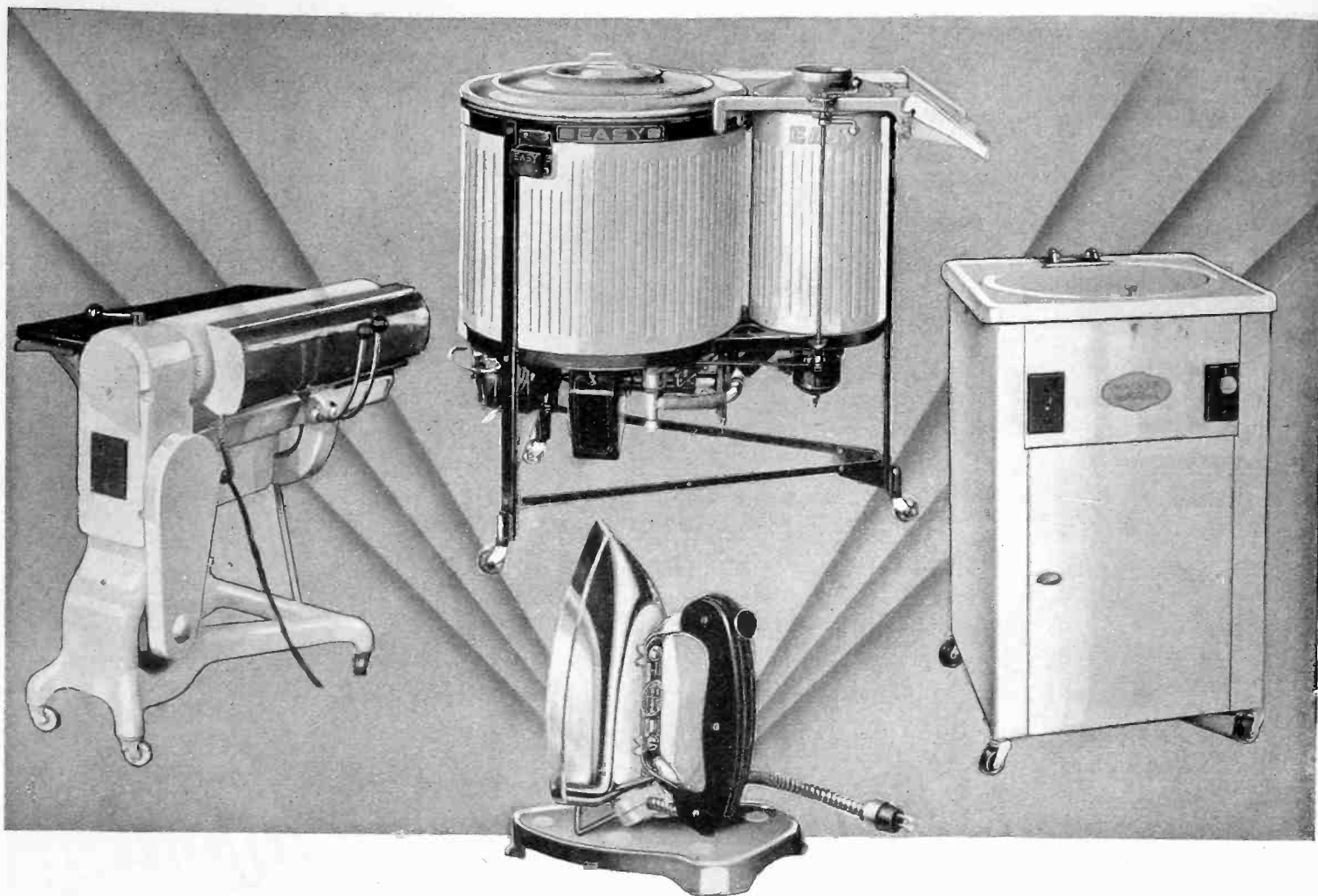

Laundry moisture and kitchen steam cannot impair Bakelite Insulation

When the numerous labor-saving appliances were first developed, many manufacturers thought that an insulation material which would prevent current leakage met every reasonable requirement. The high cost of servicing quickly demonstrated the need for a dependable insulation, which would retain its dielectric and mechanical strength unimpaired by steam, moisture and long service.

Leading manufacturers of irons, ironers, washers and dish washers have found the desired dependability in Bakelite Materials. From long experience, they know that these

materials possess high insulation value and rugged mechanical strength. Exposure to dampness cannot cause Bakelite Insulation to swell or shrink, and through years of weather extremes it will not crack, split or crumble.

Both Bakelite Molded and Bakelite Laminated are widely used for insulation purposes. Each of these Bakelite Materials possesses many distinct advantages for the manufacturer of electrical appliances and devices. Our booklets 3M, "Bakelite Molded" and 3L, "Bakelite Laminated" are descriptive of these materials and their applications, and copies will be sent you upon request.

BAKELITE CORPORATION

247 Park Avenue, New York, N. Y. Chicago Office, 635 West 22nd Street
BAKELITE CORP. OF CANADA, LTD., 163 Dufferin Street, Toronto, Ont., Can.

BAKELITE

REGISTERED

U. S. PAT. OFF.



THE MATERIAL OF A THOUSAND USES

"The registered Trade Mark and Symbol shown above may be used only on products made from materials manufactured by Bakelite Corporation. Under the capital "B" is the numerical sign for infinity, or unlimited quantity. It symbolizes the infinite number of present and future uses of Bakelite Corporation's products."

Please mention the JOURNAL of the A. I. E. E. when writing to advertisers.

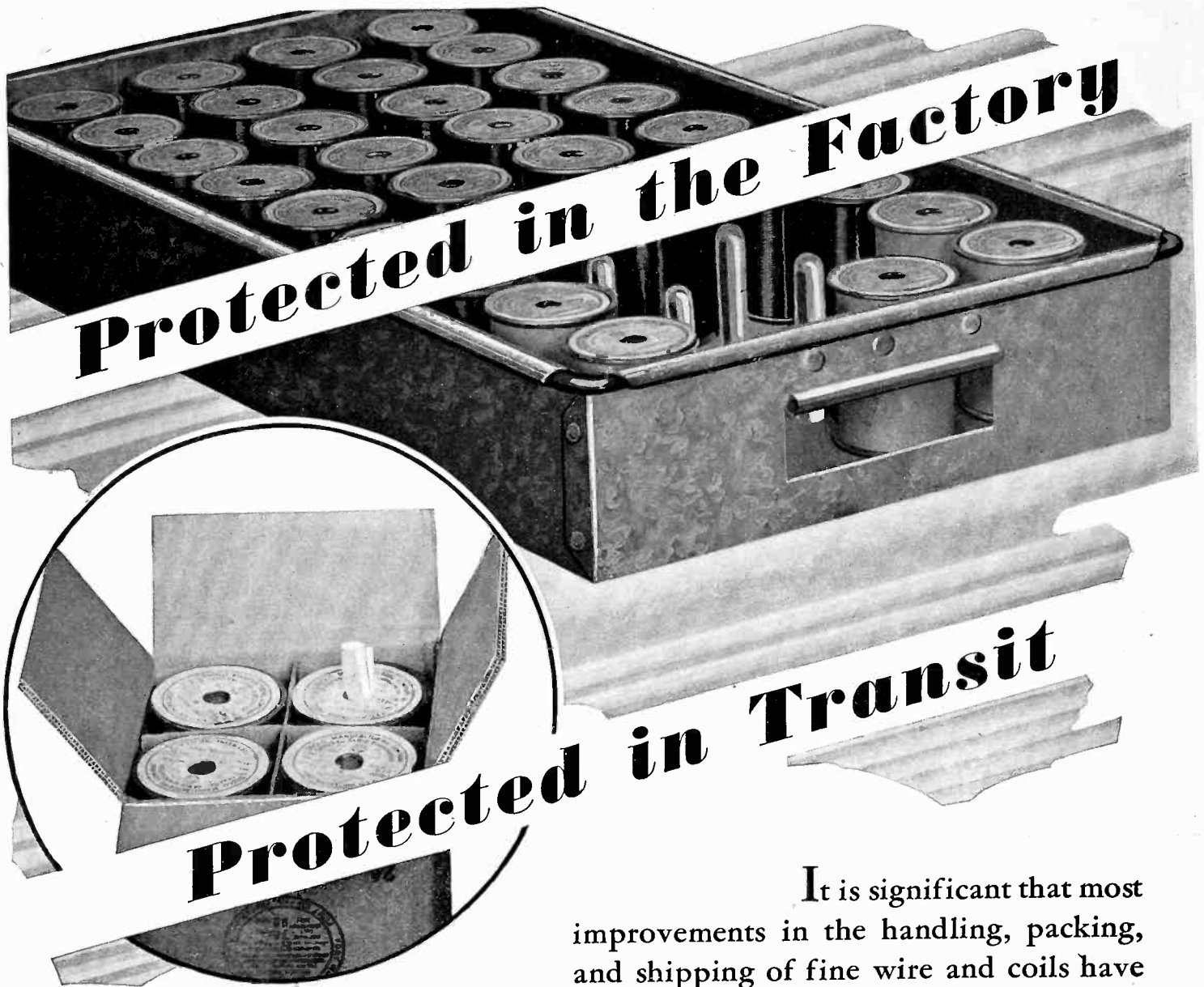

Factory trays fitted with vertical pegs protect the spools from contact with each other, thus preventing any possibility of damage to the insulation. These trays are another Dudlo development.

Spools are shipped in double-strength boxes, and are separated by heavy fibre-board partitions forming an individual compartment for each tier. No possibility of damage in transit.

It is significant that most improvements in the handling, packing, and shipping of fine wire and coils have found their origin in the Dudlo plant.

The final buyer of your product wants quality. With this end in view, it is our purpose to see that your wire arrives in perfect condition. No precaution on Dudlo's part is too painstaking when your interests as a manufacturer are involved.

Dudlo handling and packing methods are just one more reason why Dudlo wire is the choice of the country's leading manufacturers.

DUDLO

DUDLO MANUFACTURING COMPANY, FORT WAYNE, INDIANA
Division of General Cable Corporation

Please mention the JOURNAL of the A. I. E. E. when writing to advertisers.

ELECTRITE

**A high grade fibre board
for electrical insulation.**

**A material of quality pos-
sessing high tensile and
dielectric strength.**

**Tested and approved by
the Underwriters' Labora-
tories.**

Pulp Products Department

**WEST VIRGINIA
PULP & PAPER COMPANY**

230 Park Avenue
New York, N. Y.

35 East Wacker Drive
Chicago, Ill.

MICABOND
THE STANDARD MICA INSULATION

for COMMUTATOR INSULATION

Faulty commutator insulation is the cause of a large percentage of motor and generator failures with the consequent loss of thousands of dollars annually in interrupted production.

For this reason leading manufacturers in all lines of industry are vitally concerned about the matter of insulation.

For 30 years Micabond has been known for its uniform dependable quality—its high dielectric strength—its resistance to heat—and its reliability under the most severe conditions.

Micabond has become the standard mica insulation and its use means the elimination of insulation failure and consequent shut-downs and losses.

*Write for further details or send your
specifications for samples and prices.*

CHICAGO MICA COMPANY
482 Campbell Street
VALPARAISO INDIANA

FIBROC

FIBROC INSULATING PARTS READY FOR ASSEMBLY

The Fibroc Insulation Company maintains a large battery of specially designed and equipped punch presses that quickly and economically supply Fibroc punched parts to meet practically any specification.

Engineering and production departments of large electrical manufacturing plants quickly recognize the economy and production advantages of Fibroc Ready Punched and Inspected insulating parts.

Recent exhaustive tests disclose the following Fibroc characteristics:

1. High dielectric strength 600-1,100 volts per mil.
2. Chemically stable—unaffected by ordinary solvents.
3. Non-hygroscopic, does not swell, warp or shrink.
4. Great mechanical strength, compact and light in weight.
5. Resists heat, constant 225° F. intermittent up to 275° F.

*Send your specifications or blue prints for
samples and quotations. Our engineering
department will be glad to work with you.*

FIBROC INSULATION COMPANY
Licensed Bakelite Laminators since 1922
510 Lincoln Ave. VALPARAISO, IND.



INSULATORS made of LAVA

Electrical appliance manufacturers have found in lava parts the solution of their problems of insulation.

Each part made to special design. The material strong in dielectric and heat resistant properties.

**AMERICAN
LAVA CORPORATION**

27-67 Williamson Street
CHATTANOOGA, TENN.

Manufacturers of Heat Resistant Insulators

SUPER-MICANITE RINGS AND SEGMENTS

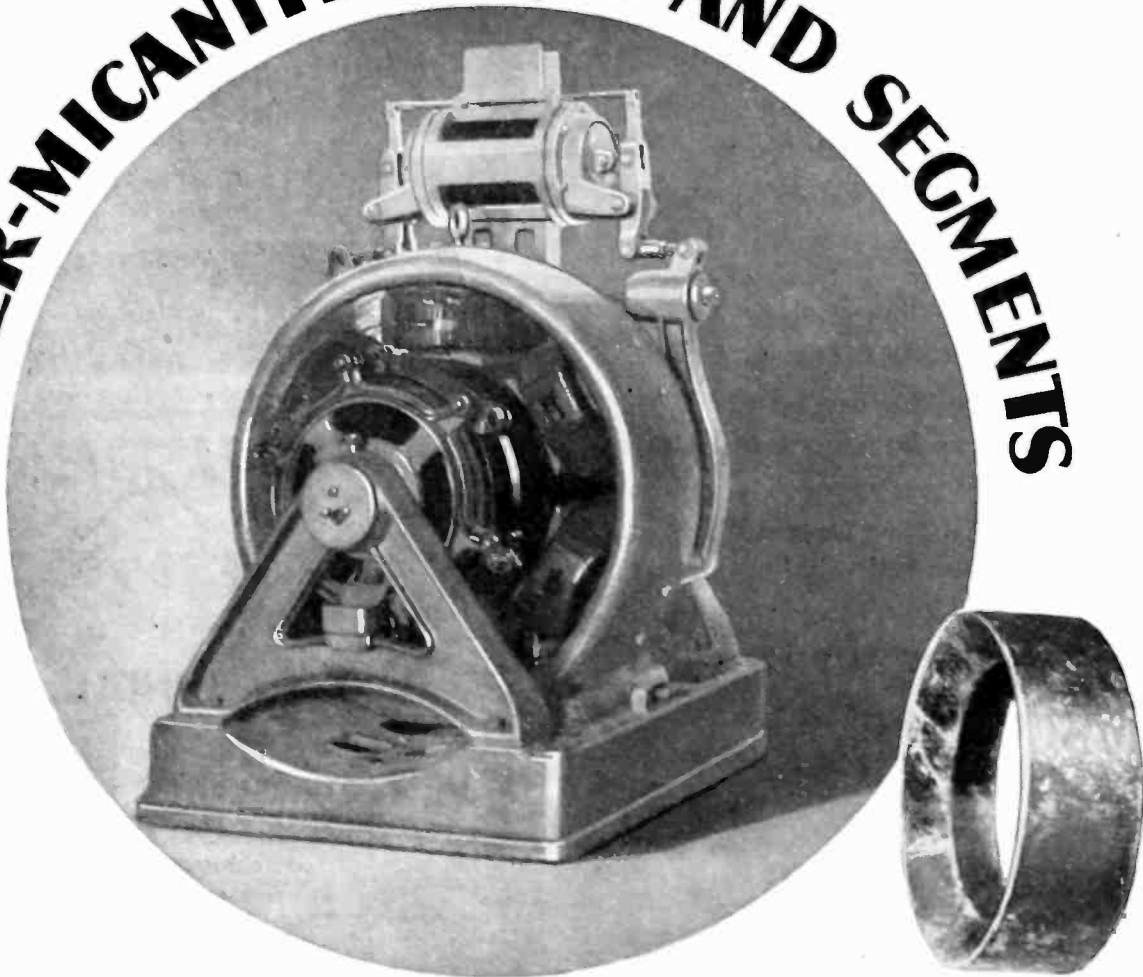

for A.B. See Elevator motors

HERE in the heart of an elevator Super-Micanite plays an important part in assuring smooth, uninterrupted service. High dielectric strength and low surface leakage so essential for this service, are characteristics of Super-Micanite that are unequalled in any other built up mica insulation.

Super-Micanite has the added advantage of not slipping under temperatures and pressures encountered in commutator assembly. Firmer and better commutators result—a fact that Super-Micanite users are unanimous in acclaiming.

Subject Super-Micanite to all the tests you consider essential. We want you to be the judge. We will gladly furnish samples.

MICA INSULATOR COMPANY

New York: 200 Varick St.

Chicago: 542 So. Dearborn St.

Works: Schenectady, N. Y.

London, England

Cleveland Pittsburgh Cincinnati Birmingham Seattle San Francisco Los Angeles Toronto Montreal



REG. U.S. PAT. OFF.

Electrical INSULATION



REG. U.S. PAT. OFF.

MICA INSULATION

OILED CLOTH INSULATION

Please mention the JOURNAL of the A. I. E. E. when writing to advertisers.

ACME WIRE PRODUCTS

Magnet Wire — All Insulations

Coils—Magnet Wire Wound

Varnished Insulations

Parvolt Filter and By Pass Condensers

All products made to Recognized Commercial Standards including those of:

National Electric Mfrs. Assn.

Radio Manufacturers Assn.

American Society for Testing Materials

For 25 years manufacturers and suppliers to the largest and most discriminating users.

THE ACME WIRE CO.

New Haven, Conn.

Branch Offices

New York
52 Vanderbilt Ave.

Chicago
842 N. Michigan Ave.

Cleveland
Guardian Bldg.

Roebbling

Electrical Wires and Cables

High in Conductivity
and Reliability

John A. Roebblings' Sons Company
Trenton, New Jersey



Elevator Control Cable

SUNDH ELECTRIC COMPANY

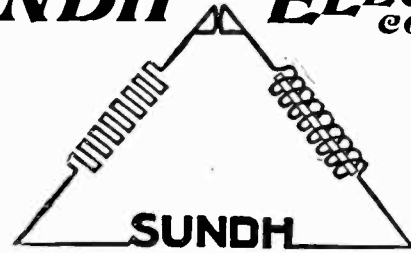

Automatic Starters
Circuit Breakers
Float Switches
Hand Starters
Magnet Switches

Pressure Regulators
Remote Switches
Speed Regulators
Transfer Switches
Valve Control

SUNDH ELECTRIC CO., INC.

Parkhurst St. at Ave. C

NEWARK, N. J., U. S. A.

Branch Offices or Sales Representatives in Principal Cities

Science Abstracts

ALL electrical engineers actively engaged in the practice of their profession should subscribe to "Science Abstracts."

Published monthly by the Institution of Electrical Engineers, London, in association with the Physical Society of London, and with the cooperation of the American Institute of Electrical Engineers, the American Physical Society and the American Electrochemical Society, they constitute an invaluable reference library.

Through "Science Abstracts" engineers are enabled to keep in touch with engineering progress throughout the world, as one hundred and sixty publications, in various languages, are regularly searched and abstracted. "Science Abstracts" are published in two sections, as follows:

"A"—PHYSICS—deals with electricity, magnetism, light, heat, sound, astronomy, chemical physics.

"B"—ELECTRICAL ENGINEERING—deals with electrical plant, power transmission, traction, lighting, telegraphy, telephony, wireless telegraphy, prime movers, engineering materials, electrochemistry.

Through special arrangement, members of the A.I.E.E. may subscribe to "Science Abstracts" at the reduced rate of \$5.00 for each section, and \$10 for both. Rates to non-members are \$7.50 for each section and \$12.50 for both.

Subscriptions should start with the January issue. The first volume was issued in 1898. Back numbers are available, and further information regarding these can be obtained upon application to Institute headquarters.

American Institute of Electrical Engineers
33 West 39th Street, New York



Please mention the JOURNAL of the A. I. E. E. when writing to advertisers.

The best
cable
shop
in the
country

....

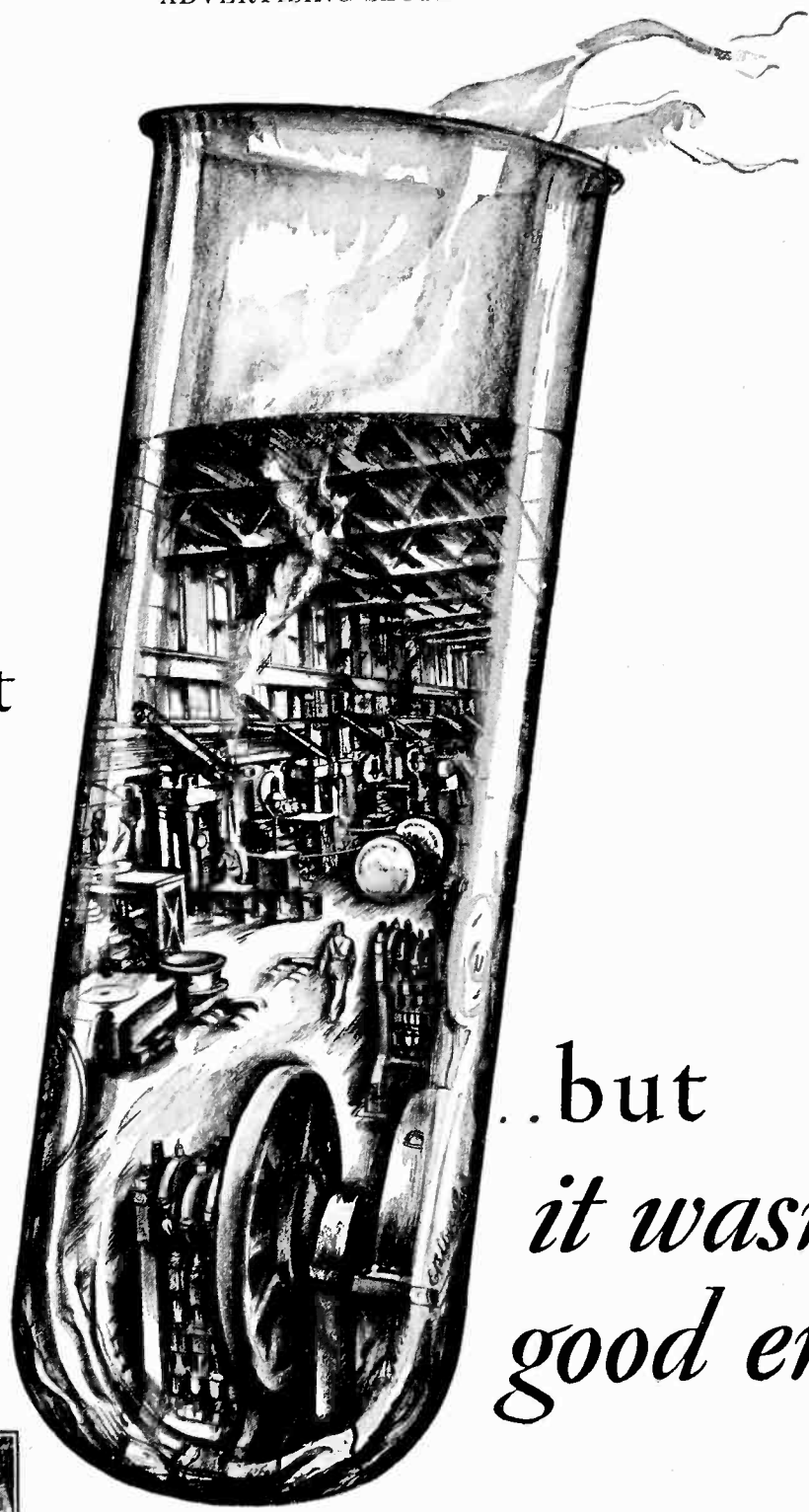

..but
*it wasn't
good enough*

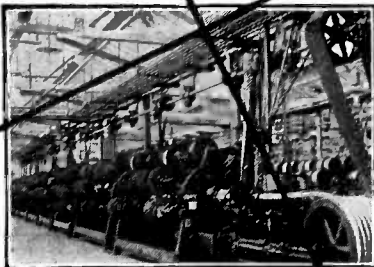

The old way. This machine for stranding cable was the best in the country, but—

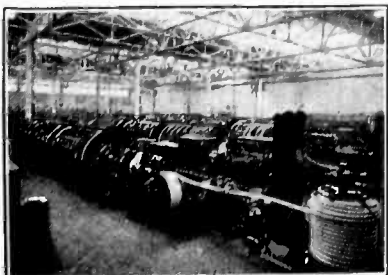

Western Electric engineers worked out a new way, stranding cable more quickly, more safely, more economically.

IN equipment and methods the Western Electric telephone cable plant of 1927 set the pace. But that didn't satisfy the company's manufacturing engineers. They put the plant in the test tube of critical judgment—and they came out with something even better.

It meant revising processes, re-designing machines, rebuilding a

factory which occupied sixteen huge structures. But it was worth it!

Whether making cable or any of the 10,000 items of telephone apparatus, Western Electric seeks till it finds the better and more efficient and more economical way. As manufacturer for the Bell System this is its share in good telephone service.

Western Electric

MAKERS OF YOUR TELEPHONE

Please mention the JOURNAL of the A. I. E. E. when writing to advertisers.

For *hard-to-get-at*
assemblies
Self-tapping Screws
are easier to use
than rivets and bolts



SHEET metal assemblies and fastenings to sheet metal or slate, aluminum, die castings, ebony asbestos, Bakelite, etc., are easily made in unhandy and hard-to-get-at places with Hardened Self-tapping Sheet Metal Screws. No fumbling with nuts or washers. No tapping. No riveting.

Just turn a Self-tapping Screw into a drilled or pierced hole with a screw driver—from the outside. One man can do the job.

As the Screw is turned in, it taps its own thread in the material, drawing the sections firmly together.

Scores of prominent electrical manufacturers have tested these Screws and adopted them because they proved to be the easiest, quickest and cheapest means of making secure fastenings. Self-tapping Screws hold under vibration and severe service conditions.

Write for free samples of Self-tapping Screws. Test them on your own work—see what these unique Screws will save you in time, labor and money. Send us a brief description of your assembly so that we can provide proper samples for a test.

PARKER-KALON CORPORATION
198 Varick Street New York, N. Y.

Distributed in Canada by
Aikenhead Hdw., Ltd., 19-21 Temperance St., Toronto

PARKER-KALON
HARDENED ^{TYPE} **Z** SELF-TAPPING
Sheet Metal Screws

PATENTED
APR. 1, 1919—No. 1299232 — MAR. 20, 1922—No. 1411184
AUG. 14, 1923—No. 1455149 — FEB. 10, 1925—No. 1520182
OTHERS PENDING

Please mention the JOURNAL of the A. I. E. E. when writing to advertisers.

Trade "ESCO" Mark

ELECTRIC SPECIALTY CO.

Engineers and Manufacturers



DESIGN —
DEVELOP —
PRODUCE —

TYPE NA AIRPLANE GENERATOR

Small Motors, Generators, Dynamotors,
Motor Generators, Rotary Converters, Etc.

FOR SPECIAL PURPOSES—Send Us Your Problems

222 South Street, STAMFORD, CONN., U.S.A.

To Engineers Manufacturers & Inventors

We possess exceptional facilities for doing your experimental work . . . models, dies, tools, instruments, light machinery . . . general manufacturing . . . inventions developed. Customer's supervision in machine shop permitted. Over thirty years' specialized experience. Clients include Bell Telephone Laboratories, All-America Cables, Inc., and other well known organizations.

MANUFACTURERS' & INVENTORS' ELECTRIC CO.

Incorporated 1897

228 West Broadway, New York

(Smith Building at Franklin St.)

Tel. Walker 8687-8688

Cable Address "MANDIELECO"

The Pioneer Manufacturer

— of —

Interpole & Ball Bearing Motors

½ to 1000 H. P. D. C. and A. C.

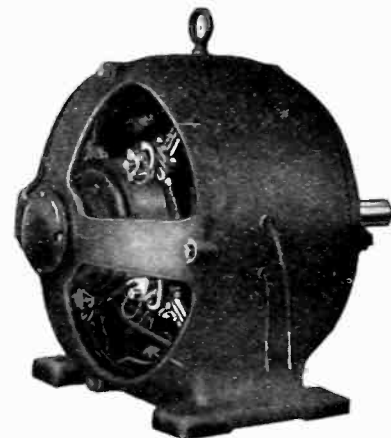

Type "S" Ball Bearing Motor

ELECTRO DYNAMIC COMPANY

Manufacturers of Ball Bearing Motors Since 1904

BAYONNE, N. J.

Sales Offices in Principal Cities

"Quality for Half a Century"

IT'S THE TWISTED TEETH THAT LOCK

TANGLEPROOF

Pack them together—bunch them as much as you like—Shakeproof Lock Washers can't link or tangle. Manufacturers are finding that the time saved in this one feature alone oftentimes pays their entire washer bill. Speed up your production line—stop delays—adopt Shakeproof Lock Washers, designed to prevent linking.

MULTIPLE LOCKING

Twisted teeth of steel set around the circumference of the washer. Tighten down the nut and each tooth bites in with a grip of steel—they can't let go. For sure locking demand Shakeproof.

SPREADPROOF

No matter how much pressure is applied you just can't spread a Shakeproof Lock Washer. This eliminates breaking of washers, too, and saves you time and money. With its multiple advantages, it is no wonder that manufacturers, large and small alike, the country over are adopting Shakeproof.

PRODUCTION SPEED

Slip them onto the bolt as fast as the hand can move. Easy to handle—just as easy to apply. Shakeproof will win new friends in your production department and speed up their work for you.

The roll call of American manufacturers is the roll call of Shakeproof users. Pick any car on the road—the radio in your home—the cash register in your neighborhood store—the vacuum cleaner your wife uses—the typewriter on your stenographer's desk—it is a hundred to one they are all locked with Shakeproof.

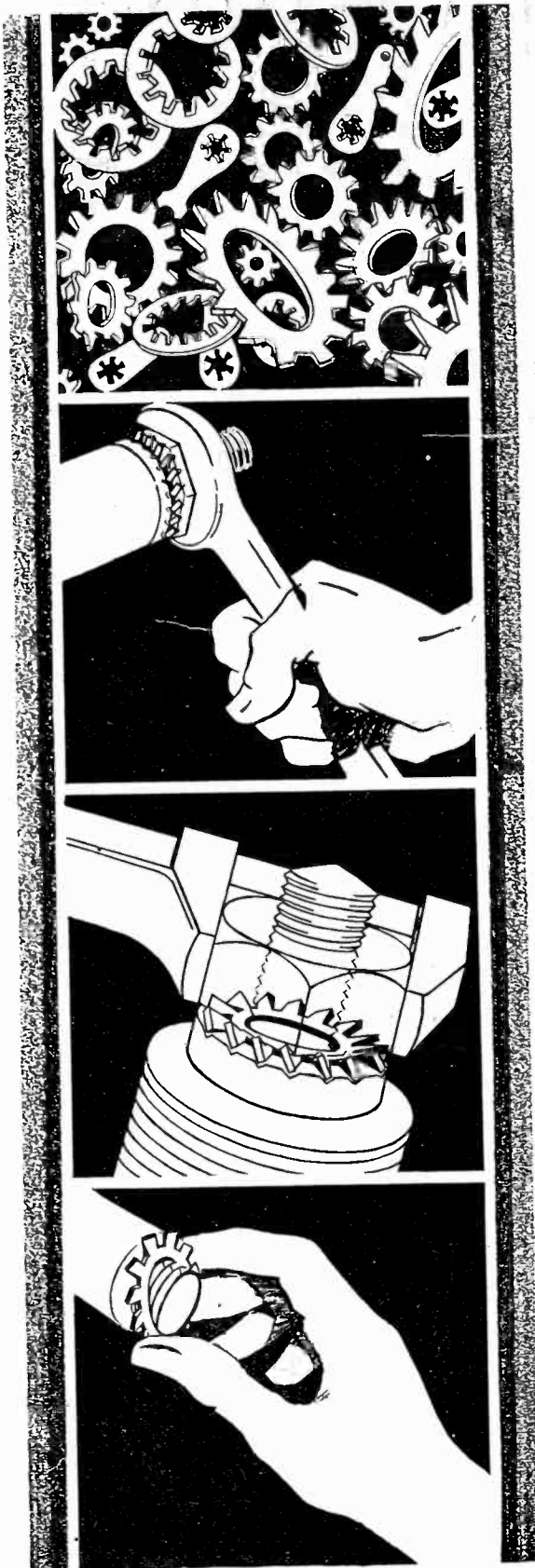

U. S. Patents
1,419,564; 1,604,122;
1,697,954. Other
Patents Pending.
Foreign Patent.



Type 20 Terminal



Type 12 Internal



Type 20 Terminal

FREE SHOP TEST SAMPLES

SHAKEPROOF LOCK WASHER CO.
2517 North Keeler Ave., Chicago, Ill.
Please send me samples of

- Shakeproof Locking Terminals Size.....
- Shakeproof Lock Washers to fit bolt size.....

Firm Name.....

Address..... Town.....

State..... By.....

SHAKEPROOF Lock Washer Company

[Division of Illinois Tool Works]

2517 North Keeler Avenue

Chicago, Illinois

Please mention the JOURNAL of the A. I. E. E. when writing to advertisers.

CHAMPION SWITCH CO.

KENOVA, W. VA.

SWITCHES  BUS SUPPORTS

HEAVY DUTY OUTDOOR AND INDOOR EQUIPMENT

→ CATALOGUES UPON REQUEST ←

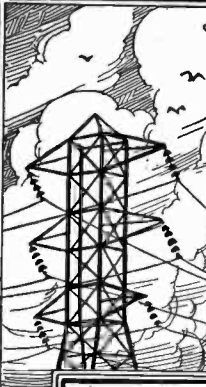

Thomas Quality
 PORCELAIN INSULATORS
 LINE HARDWARE
 WIRING PORCELAINS
 and
 Porcelain Specialties
An American Standard since '73

THE R. THOMAS & SONS CO.
 New York Boston Lisbon, Ohio Chicago London

INSULATORS



CANADIAN PORCELAIN CO., Ltd.
 Hamilton—Ontario—Canada

Quebec District Office
 612 Transportation Bldg.
 Montreal, Qu.

London Office
 343 Abbey House, 4 Victoria Street
 London, S. W. 1.



PYREX
 A MARK OF CORNING GLASS WORKS
INDUSTRIAL WARE

Write for literature

CORNING GLASS WORKS
 Dept. 61, Industrial and Laboratory Division
 CORNING, N. Y.

HEMINGRAY

GLASS INSULATORS

The transparency of Hemingray Glass Insulators makes line inspection very simple. The lineman can tell at a glance whether the insulator is intact or not. Hemingray insulators are mechanically and dielectrically dependable, non-porous and uniform in structure. They defy moisture and age.

Send for Bulletin No. 1.

HEMINGRAY GLASS COMPANY
 Muncie, Indiana

Reconditioned and Tested A.I.E.E. Standard 5,000 Transformers ready for shipment—at low prices

Every one a safe buy for the most strenuous service. Sizes range from 1 to 1,000 kva.—voltages from 110 to 66,000. Modern equipment that has no superior. Many nationally prominent public utility companies

are our regular customers. We satisfy the users. The savings are between 30 and 60 per cent. Ask your electrical engineer to inspect our shop and testing laboratory. Send for our free Monthly Bulletin.



WE BUY MODERN TYPE TRANSFORMERS—ANY SIZE—ANY QUANTITY

The **ELECTRIC SERVICE CO. Inc.**
 America's Used Transformer Clearing House
 212 Walnut Street Cincinnati, Ohio



Please mention the JOURNAL of the A. I. E. E. when writing to advertisers.

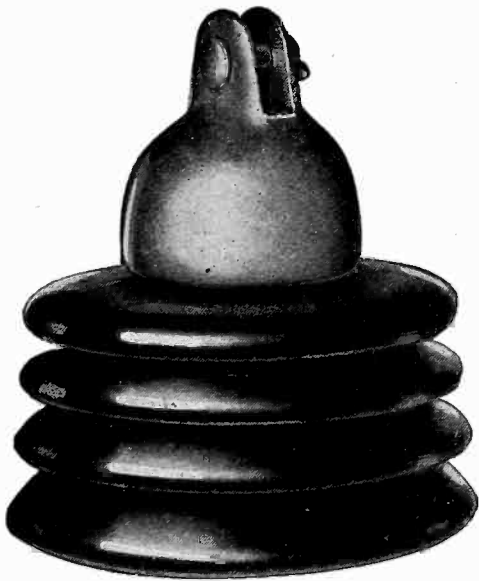

LAPP

INSULATORS

Lapp Fog Type Suspension Insulator, No. 5805. Test voltage, 116,000. Minimum Mechanical and M. & E. strength 12,000 lbs. Flashover wet and dry much higher in strings than standard 10' units.

How They Stand Up!

UNDER salt spray deposition, eight Lapp Fog Type Suspension Units hold in while 12 or more standard 10-inch units flash over. This superiority is due to difference in design. And these designs are made possible by Lapp Vacuum Process porcelain (patented).

As on all Lapp Suspension Insulators, the metal parts are *drop-forged* copper-bearing steel, excellently hot-dip galvanized.

Lapp Fog Type Insulators are carrying 220,000 volts for Southern California Edison Company. At the other extreme, they are now setting new standards in telegraph service. Lapp Fog Types can probably cite cures under conditions similar to those now menacing your own operations.

Their short petticoats reduce breakage. Cleaning is required only under the most exceptional conditions. Per year of service, they cost less than standard types, while initial cost is only slightly higher.

Lapp Insulators reduce maintenance costs

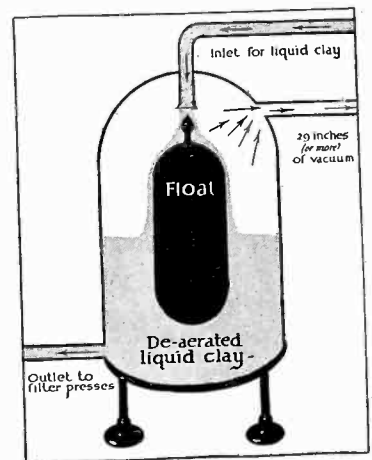

Here's a diagram of the Lapp Vacuum Process (patented). Mechanical and dielectric faults are usually due to air occluded in the liquid clay—"slip." The Vacuum Process actually boils the air right out. The resulting porcelain has unique homogeneity and permanence.

LAPP INSULATOR CO. INC. LEROY, N.Y. U.S.A.

Principal A. I. E. E. Publications

JOURNAL. Published monthly.

An engineering periodical containing in full or in abstract engineering and theoretical papers as presented before meetings of the Institute and its Sections and Branches; descriptions of new developments characterized by notable advances, and items relating to the activities of the Institute and other organizations.

Subscription price \$10.00 per year. Agents, publishers and dealers are allowed 20 per cent discount; a special discount of 50 per cent is allowed on single subscriptions received directly from college or public libraries. Postage to Canada on annual subscription \$0.50 additional, and to foreign countries, \$1.00. (Postage should not be included when computing discounts).

JOURNAL BINDERS. A loose leaf binder, especially designed for the JOURNAL of the A. I. E. E. is now available. The new binder is attractively finished in a long-wearing, processed material, resembling brown leather. From one to six copies of the JOURNAL can be inserted. The name of the publication is embossed in gold on the front cover and backbone. The binders are sold in sets of two at \$2.25 or \$1.25 for one.

TRANSACTIONS. Published quarterly.

Contains such of the technical papers and reports published by the Institute in the JOURNAL and elsewhere as are selected and authorized by the Publication Committee; also the discussions on the technical papers. The TRANSACTIONS form a permanent record of the progress of electrical engineering.

The subscription price to A. I. E. E. members is \$2.00 per year for pamphlet binding and \$4.00 for cloth binding. To non-members the cost is \$10.00 per year for pamphlet binding, and \$12.00 for cloth binding.

Available volumes of the TRANSACTIONS published prior to 1921 may be obtained at reduced prices. The volumes in stock and prices will be supplied upon request.

Discounts allowed on the current volume are as follows: 20 per cent to publishers and subscription agents 50 per cent to college and public libraries upon direct subscription to Institute headquarters.

INDEX TO TRANSACTIONS. Published every ten years. Vol. III of the TRANSACTIONS Index (Jan. 1, 1911 to Jan 1, 1922) is a practical bibliography (168 pp.) of all A. I. E. E. papers and discussions printed during the period 1911-1922. Price to members and non-members \$2.00, with dealers' discount of 20 per cent.

A. I. E. E. STANDARDS.

The work of revision of the A. I. E. E. Standards which has been in progress for several years has now reached a stage where a large number of sections of the Standards have been approved by the Board of Directors and are available in pamphlet form, as follows:

1—General Principles Upon Which Temperature Limits are Based in the Rating of Electrical Machinery, (.20); 4—Measurement of Test Voltages in Dielectric Tests, (.30); 5—Direct-Current Generators and Motors and Direct-Current Commutator Machines in General, (.40); 7—Alternators, Synchronous Motors and Synchronous Machines in General, (.40); *8—Synchronous Converters, (.40); 9—Induction Motors and Induction Machines in General, (.40); 10—Direct-Current and Alternating-Current Fractional Horse Power Motors, (.30); *11—Railway Motors, (.30); 13—Transformers, Induction Regulators and Reactors, (.40); *14—Instrument Transformers, (.30); *15—Industrial Control Apparatus, (.40); *16—Railway Control and Mine Locomotive Control Apparatus, (.40); *17—Mathematical Symbols, (.30); *17g1—Letter Symbols for Electrical Quantities, (.20); 17g6—Graphical Symbols for Telephone and Telegraph Use, (.20); 19—Oil Circuit Breakers, (.30); 22—Disconnecting and Horn Gap Switches, (.30); 26—Automatic Stations, (.30); 30—Wires and Cables, (.40); 33—Electrical Measuring Instruments, (.30); 34—Telegraphy and Telephony, (.30); *36—Storage Batteries, (.20); *37—Illumination, (.30); 38—Electric Arc Welding Apparatus, (.40); 39—Electric Resistance Welding Apparatus, (.30); 41—Insulators, (.30); *42—Symbols for Electrical Equipment of Buildings, (.20); 45—Recommended Practice for Electrical Installations on Shipboard, (1.50); *46—Hard Drawn Aluminum Conductors, (.20); *60—Specifications for Tinned Soft or Annealed Copper Wire; *61—Specifications for Soft or Annealed Copper Wire, (No. 60 and 61 published as one pamphlet), (.30); *63—Specifications for 30 Per Cent Rubber Insulation for Wire and Cable for General Purposes, (.30); *69—Specifications for Cotton Covered Round Copper Magnet Wire; *70—Specifications for Silk Covered Round Copper Magnet Wire; *71—Specifications for Enameled Round Copper Magnet Wire, (No. 69, 70 and 71 published as one pamphlet), (.30).
*Approved as American Standard.

A discount of 50% is allowed to Institute members. Numbers of the Standards Sections should be given when ordering.

NEW STANDARDS BINDERS. A new and different binder is now available which will hold all the present Standards pamphlets and reports, and still have room for additional sections. Price \$1.75.

YEAR BOOK OF THE A. I. E. E.

A directory, published annually in March, of the membership of the A. I. E. E. Gives in alphabetical order, the names, occupations and addresses of all members. The membership is also listed in geographical order. The Year Book contains general information regarding the scope and activities of the Institute, including the Constitution and By-Laws, lists of Sections and Branches, the various committees, governing body, etc. Single copies will be supplied to members without charge upon application.

American Institute of Electrical Engineers
33 West Thirty-ninth Street, New York, N. Y.

The Condit D-Line

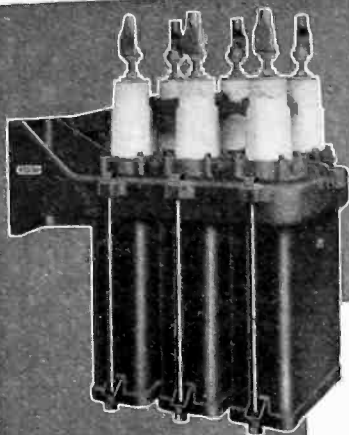

Type D-123

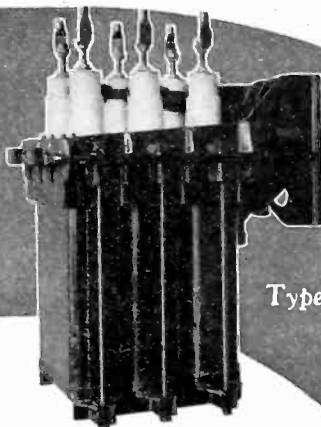

Type D-118

“D” for Dependability

Inverted laminated brushes; exceptionally heavy arcing contacts designed to minimize arcing; massive, rigid frames; deeper tank per pole construction; oversize one-piece wet-process porcelain bushings—the Condit Type D Oil Circuit Breakers have *everything* for safe, dependable, efficient service.

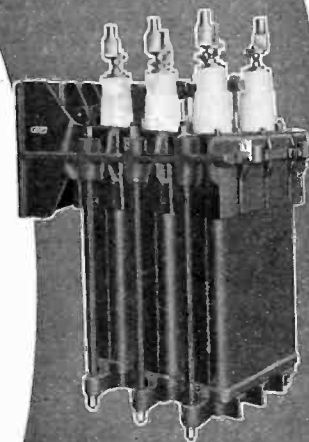

Type D-128

“*Get in touch with Condit*”

CONDIT ELECTRICAL MFG. CORPORATION
Manufacturers of Electrical Protective Devices
BOSTON, MASS.

Northern Electric Company
LIMITED

Distributor for the Dominion of Canada

Type D-127

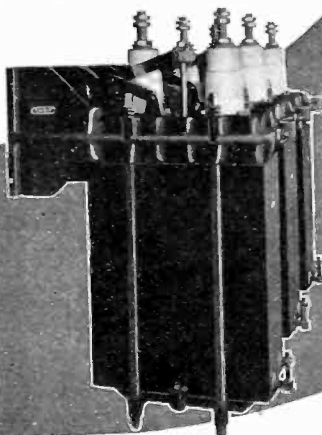
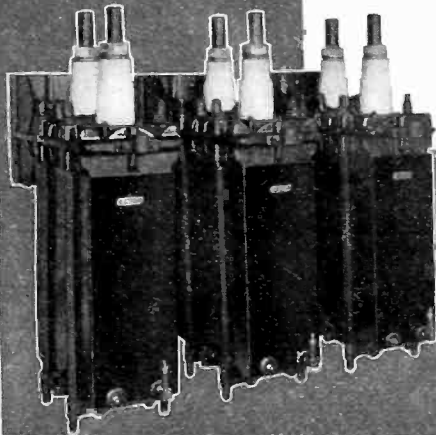

Type D-117

SPECIFICATIONS: 1200 amperes or less, 15,000 volts; 1600 amperes, 7500 volts; estimated interrupting capacity at 15,000 volts. Type D-123, 2500 amperes. Type D-118, 3500 amperes. Type D-128, 5000 amperes. Type D-117, 5000 amperes. Type D-127, 7000 amperes.



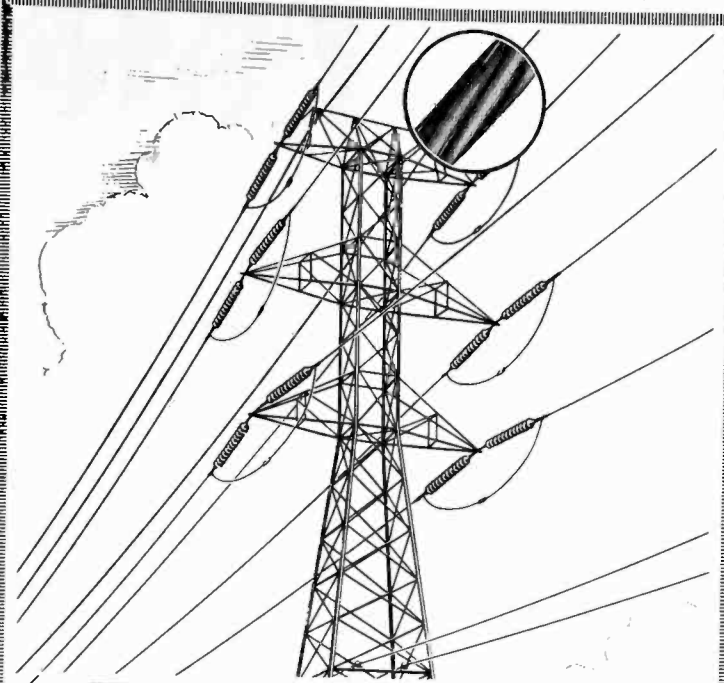

Improve the reliability of
your transmission lines with
"COPPERWELD"
Overhead Ground Wire

Copperweld Steel Company
Glassport, Penna.

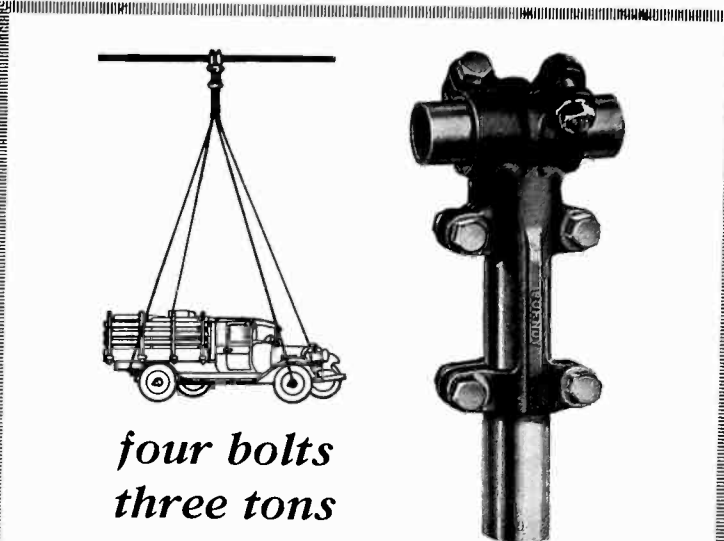

*four bolts
three tons*

INTENDED to grip and connect 1 1/4" IPS Copper Tube this Burndy Clamp T-Connector has held a suspended weight of 6100 pounds. How was it done? By correct design and proper materials; for the pressure of Everdur bolts on a similar connector has produced a contacting pressure of 20 tons! Would you like to examine the test reports?

Other interesting test reports are shown on pages 15 and 16 of "The High Tension Bus" Catalog of

BURNDY
ENGINEERING CO. INC
10 EAST 43RD STREET · NEW YORK



BURKE
Positive Grip
Connectors

The only connector
which can be
partially assembled
on the ground.

Made from high
conductivity copper
Tobin Bronze or
Monel Metal Bolts.

Bulletin on Request.

BURKE ELECTRIC CO.
ERIE, PA.

Offices in Principal Cities
Pacific Coast—JONES-LYMAN, INC., San Francisco, Los Angeles

MEMCO

- Insulator Clamps
- Copper Fittings
- Splicing Sleeves
- Disconnects
- Choke Coils
- Fuse Mountings
- Substation Combinations
- Air Break Switches
- Bus Supports

Memco builds this equipment in all standard and special sizes—ask for bulletins of interest to you.

Memco Engineering & Manufacturing Company, Inc.
381 Hamilton Street, Long Island City, N. Y.

KEARNEY
Manufacturers of

Screw Anchors; Hi-Tension 4-in-1 Expansion Anchors; Solderless Service Connectors; Double Duty Fuse Cutouts; 7500, 12,000 and 15,000 volt Fuse, Disconnect and Fuse-Choke Coil Switching Equipment; Fuse Pullers; Plug Cutouts; Guy Wire Clips; Sleeve Twisters with Interchangeable Dies; Hot Tap Clamps; Yokes; Economy Cable Clamps; Live Line Maintenance Tools and Accessories, previously Tip's Tools.

A Complete Catalog Will be Sent on Request

JAMES R. KEARNEY CORPORATION
4220 Clayton Avenue ST. LOUIS, MO.

Please mention the JOURNAL of the A. I. E. E. when writing to advertisers.

CABLE TERMINAL DEVICES



- POTHEADS
- UNDERGROUND CABLE BOXES
- AUTOMATIC TRANSFER SWITCHES
- OIL and AIR BREAK DISCONNECTS
- SERIES CUTOUPS
- GROUND PIPE CAPS
- CONDUIT BELLS
- CABLE HEADS
- CABLE COUPLINGS
- CABLE SUPPORTS
- INSULATING SLEEVES
- INSULATING COMPOUND

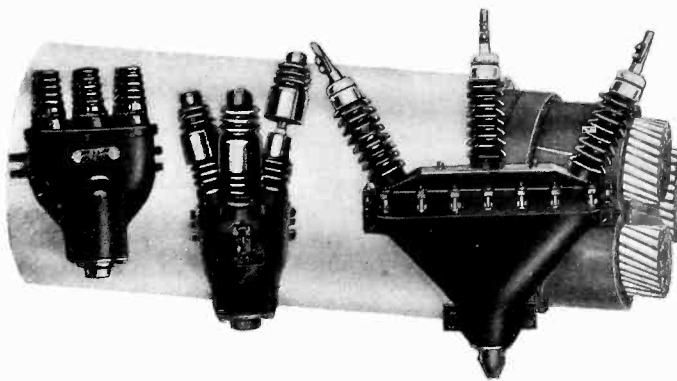

By concentrating on cable terminal devices for twenty-five years The G & W Electric Specialty Co. has developed many practical designs which have been widely accepted. Why not benefit from this experience and concentration?

LET US KNOW WHAT YOU WANT

CABLE TERMINAL DEVICES

G&W Electric Specialty Co.

7780 DANTE AVENUE, CHICAGO, ILLINOIS.

REPRESENTATIVES IN PRINCIPAL CITIES



CONDUITS ARE UNNECESSARY IF
CONDEX
PARK CABLE
 IS USED



CONDEX Park Cable eliminates the necessity of outside conduits and other methods of protection.

The feature of this type of cable is a specially constructed steel tape armor which offers unusual resistance to crushing and protects against outside disturbances.

As the steel tape is applied over the lead sheath it overlaps and interlocks, forming a flexible conduit. This type of protection was

originated by us and during the past few years has met with the approval of public utility engineers throughout the United States.

CONDEX Park Cable is ideal on series lighting circuits for municipal street lighting, white way installations, and for park or playground illuminating systems.

Further information, a sample and prices will be sent on request.

SIMPLEX WIRE & CABLE CO

MANUFACTURERS

201 DEVONSHIRE ST., BOSTON

BRANCH SALES OFFICES

CHICAGO, 564 W. Monroe St. SAN FRANCISCO, 390 Fourth St.
 NEW YORK, 1328 B'way CLEVELAND, 2019 Union Trust Bldg.
 JACKSONVILLE, 1010 Barnett Nat'l Bank Bldg.

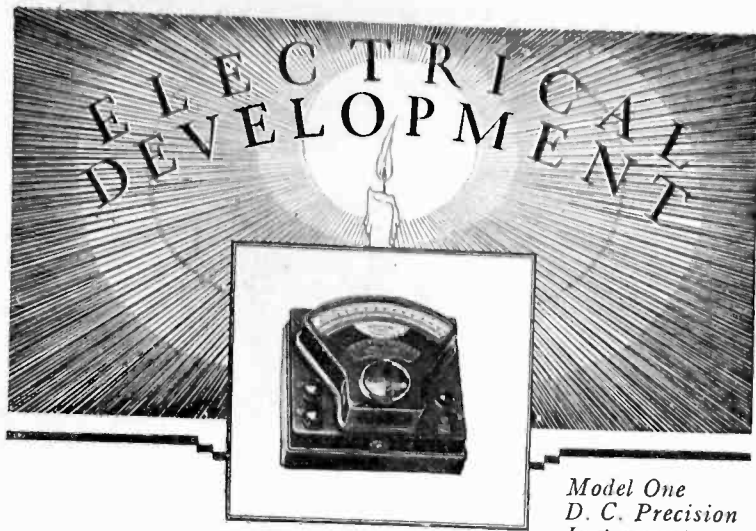

Model One
D. C. Precision
Instrument.

Can we throw some light on *your* problems?

NO single swallow makes a summer—nor does a single instrument go farther than a candle's feeble glow to lighten the problems of Electrical Development.

Take any Weston Instrument—any model or range. The most complete description possible would fail to convey a full conception of its probable uses. The needs of electrical measurement are too numerous and varied for even an attempt at classification with respect to the application of a single instrument or, for that matter, Weston's complete line of instruments.

It is a case where the mountain should come to Mohammed! For more than forty years the Electrical Industry has come to Weston for the solution of its measurement problems. With the tremendous increase in scientific developments, involving the use of new instruments and special requirements as to design, electrical characteristics and ranges, it is becoming a problem in itself to sense the exact needs in all branches of industry.

But Weston research, manufacturing and consultation facilities are available to all. Engineering and sales representation in all the principal cities of the world affords convenient points of contact with instrument headquarters, so that your problems *can be brought to us* for study and solution. If the abridged listing in our catalog does not cover the instruments you require, we shall be glad to receive your communication and will give it prompt attention.

Weston
PIONEERS
SINCE 1888
INSTRUMENTS

WESTON ELECTRICAL INSTRUMENT CORP.
584 Frelinghuysen Avenue Newark, N. J.

Cambridge Magnet Tester

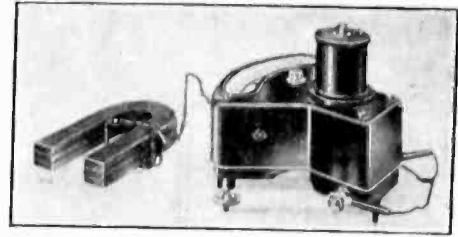

Size
8"x7"x7"
Weight
11 1/2 lbs.

A BALLISTIC, suspended coil galvanometer, used in conjunction with an exploring coil, for the testing of magnets of any kind. Its indications are determined solely by the total discharge through the coil, regardless of the speed of discharge.

With this, robust but sensitive instrument, measurements may be made of

1. Strength of Magnetic Field
2. Pole strength and distribution of magnetism in a bar magnet
3. Determination of B.H. curve in samples of iron
4. Coefficient of mutual induction in a pair of coils
5. Discharge through a non-inductive shunt

Fully described in List No. 167

CAMBRIDGE
INSTRUMENT CO INC

Pioneer Manufacturers of Precision Instruments
3510 Grand Central Term., New York

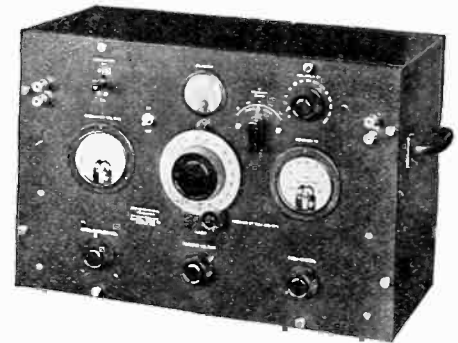

Standard-Signal Generator

The Type 403-B Standard-Signal Generator is a calibrated oscillator for delivering known radio-frequency voltages which are localized between two terminals. Its principal use is in measuring radio field intensity (field strength) and in taking sensitivity, selectivity, and fidelity characteristics on radio receivers. It may be used either with or without modulation; a 400-cycle modulating oscillator is contained in the instrument and there is provision for supplying modulating voltages from an external oscillator.

Its range is from 500 to 1500 kilocycles, but others can be built to cover other bands on special order.

GENERAL RADIO COMPANY

Manufacturers of Electrical and Radio Laboratory Apparatus
30 State Street CAMBRIDGE, MASSACHUSETTS

A New Oil Circuit Breaker

SPEED

These new breakers have the elements you know, by experience, are essential—speed of operation, good mechanical design, high electrical and mechanical strength. Why not investigate and if favorably impressed—buy a few.

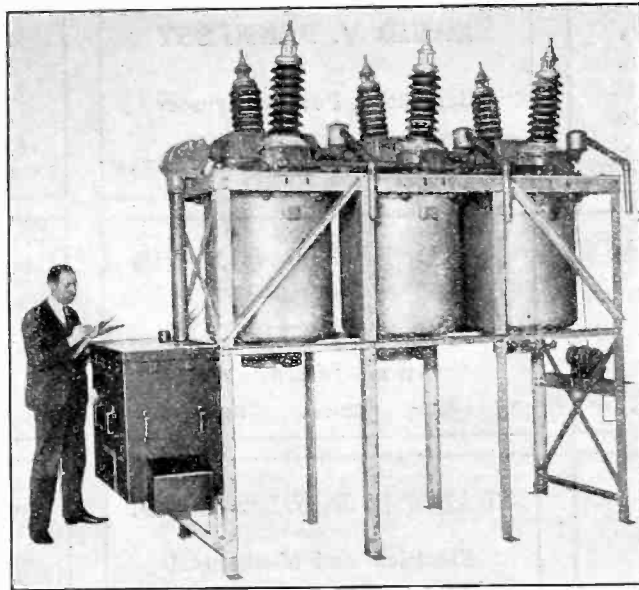

WE INVITE YOU

For years leading public utilities have used DELTA-STAR outdoor substations and air break switching equipment with interchangeable parts. Now we invite you to send an engineer to inspect this latest UNIT TYPE product.

For Canada:
MONARCH ELECTRIC,
LTD.
St. Johns, Que.

Delta

MAKERS OF
UNIT  TYPE
EQUIPMENT

Star

For Canada:
MONARCH ELECTRIC,
LTD.
St. Johns, Que.

DELTA-STAR ELECTRIC COMPANY, 2400 BLOCK, FULTON ST, CHICAGO, ILLINOIS.

Specify **Instruments
and
Circuit Breakers**



by



ROLLER-SMITH COMPANY
Electrical Measuring and Protective Apparatus

MAIN OFFICE:
12 Park Place, NEW YORK



WORKS:
Bethlehem, Penna.

Offices in Principal Cities in U. S. and Canada
Representatives in Australia, Cuba, Japan and Philippine Islands

COMPLETE SWITCHING EQUIPMENT
OIL CIRCUIT BREAKERS STEEL STRUCTURES
AIR BREAK SWITCHES FUSE CUTOUTS
FUSES CHOKE COILS

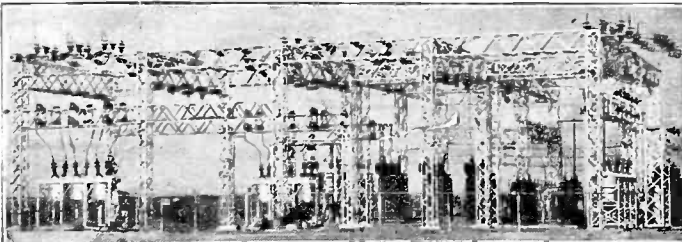

Pacific Electric Manufacturing Corp.

5815 THIRD STREET, SAN FRANCISCO, CALIF.
Representatives in Principal Cities



Faradon

ELECTROSTATIC
CONDENSERS

for All Purposes



The Accepted Standard
for Exacting Service as well as
General Application on
Land and Sea and
in the Air

**WIRELESS SPECIALTY
APPARATUS COMPANY**

Est. 1907

Jamaica Plain

Boston

Please mention the JOURNAL of the A. I. E. E. when writing to advertisers.

PROFESSIONAL ENGINEERING DIRECTORY

For Consultants in the Fields of Engineering, and Related Arts and Sciences

AMBURSEN DAMS
Hydroelectric Developments
Water Supply and Irrigation Dams
DAMS ON DIFFICULT FOUNDATIONS
AMBURSEN CONSTRUCTION CO.
Incorporated
Grand Central Terminal, New York
Kansas City, Mo. Atlanta, Ga.

DAVID V. FENNESSY
Consulting Power Engineer
MILLS BUILDING EL PASO, TEXAS

N. J. NEALL
Consulting Engineer
for
Electrical and Industrial Properties
12 Pearl Street BOSTON, MASS 100 Broadway NEW YORK CITY

W. S. BARSTOW & COMPANY
Incorporated
Engineering Design
Construction
50 Pine Street, New York
412 Washington St., Reading, Pa.

FORD, BACON & DAVIS
Incorporated
ENGINEERS
115 Broadway, New York
Philadelphia Chicago San Francisco

NEILER, RICH & CO.
Electrical and Mechanical
Engineers
Consulting, Designing and
Supervising
431 So. Dearborn St. — — — Chicago

BATTEY & KIPP
Incorporated
ENGINEERS
Complete Industrial Plants
Power Plants & Electrical Installations
Engineering Reports, Analyses & Appraisals
231 South LaSalle Street CHICAGO

FRANK F. FOWLE & CO.
Electrical and Mechanical
Engineers
MONADNOCK BUILDING CHICAGO

To appear in the following
issue, cards must be re-
ceived not later than the
20th day of the month.

BLACK & VEATCH
Consulting Engineers
Water, Steam and Electric Power Investiga-
tions, Design, Supervision of Construction,
Valuation and Tests.
Mutual Building KANSAS CITY, MO.

FREYN ENGINEERING COMPANY
Industrial Electric Power
Generation—Application—Purchase
Combustion Engineering
Electric Furnace Installations
310 South Michigan Ave. CHICAGO

OPHULS & HILL, INC.
ENGINEERS AND CONSTRUCTORS
Steam Generating and Electric Power Plants
Ice Making and Refrigerating Plants
112 WEST 42nd ST.
NEW YORK CITY

ROBERT C. BURT, E. E., Ph. D.
DONALD H. LOUGHRIDGE, Ph.D.
Consulting Physicists
Designers and Makers of
Scientific Instruments
327 So. Michigan Ave. PASADENA California

HOOSIER ENGINEERING CO.
Erectors of
Transmission Lines and Substations
100 W. Monroe Street
CHICAGO
NEW YORK INDIANAPOLIS
31 Nassau Street 5 E. Market Street

FARLEY OSGOOD
Consultant
Design, Construction, Operation
Inter-Connection
of
PUBLIC UTILITIES
National Bank of Commerce Building
31 Nassau Street, New York, N. Y.
Tel.: Rector 7878 Cable Address: Fargood

BYLLESBY
ENGINEERING AND MANAGEMENT
CORPORATION
231 S. La Salle Street
CHICAGO
New York San Francisco

Dugald C. Jackson
Edward L. Moreland
JACKSON & MORELAND
CONSULTING ENGINEERS
31 St. James Ave. Boston, Mass.

G. R. SACKMAN, M. E.
Assoc. A. I. E. E.
Counsellor at Law
PATENT ATTORNEY
1860 BROADWAY NEW YORK CITY
Suite 1715-16 Phone: Columbus 8945

EDWARD E. CLEMENT
Fellow A. I. E. E.
Attorney and Expert
in Patent Causes
Soliciting, Consultation, Reports,
Opinions
McLachlen Bldg. Washington, D. C.
700 10th St., N. W.

ROBERT S. KRUSE
Consultant for Radio
Stations and Manufacturers
103 Meadowbrook Road Telephone
West Hartford, Conn. Hartford 4-5327

SANDERSON & PORTER
ENGINEERS
PUBLIC UTILITIES & INDUSTRIALS
Design Construction Management
Examinations Reports Valuations
Chicago New York San Francisco

When you require technical advice —
Or a solution to an engineering problem —

CONSULT THIS DIRECTORY

PROFESSIONAL ENGINEERING DIRECTORY

For Consultants in the Fields of Engineering, and Related Arts and Sciences

SARGENT & LUNDY

Incorporated

Mechanical and Electrical
Engineers

1412 Edison Bldg., 72 West Adams Street
CHICAGO ILLINOIS

STEVENS & WOOD

INCORPORATED

Engineers and Constructors

60 JOHN STREET, NEW YORK
Youngstown, O. Jackson, Mich.
Chicago, Ill.

PERCY H. THOMAS

Consulting Engineer

ELECTRIC POWER

Generation—Transmission
Applications

120 BROADWAY NEW YORK

SCOFIELD ENGINEERING CO.

CONSULTING ENGINEERS

Utility and Industrial Plants
Design, Construction, Operation
Valuations and Appraisals

PHILADELPHIA

STOCKBRIDGE & BORST

Patent Law

41 PARK ROW NEW YORK CITY

THE J. G. WHITE

ENGINEERING CORPORATION

Engineers—Constructors

Oil Refineries and Pipe Lines,
Steam and Water Power Plants
Transmission Systems, Hotels, Apartments,
Offices and Industrial Buildings, Railroads
42 EXCHANGE PLACE NEW YORK

JOHN A. STEVENS, INC.

Established 1909

CONSULTING ENGINEERS

Power Plants Paper Mills
Dye Houses Surveys

LOWELL, MASSACHUSETTS

STONE & WEBSTER

Incorporated

DESIGN AND CONSTRUCTION

EXAMINATIONS APPRAISALS REPORTS

INDUSTRIAL AND PUBLIC SERVICE
PROPERTIES

New York Boston Chicago

J. G. WRAY & CO.

Engineers

J. G. Wray, Fellow A. I. E. E. Cyrus G. Hill

Utilities and Industrial Properties

Appraisals Construction Rate Surveys
Plans Organizations Estimates
Financial Investigations Management

2130 Bankers Bldg., Chicago

YOUR CARD in each issue of this publication—12 times a year, will keep your name and specialized service constantly before the electrical industry. Qualified advertisers in the Professional Engineering Directory are invited to send for rates.

ELECTRICAL TESTING LABORATORIES

80th Street and East End Ave.
NEW YORK

Inspections — Tests — Research

Tests may be used by the purchaser for the following purposes:

- (1) To determine the quality of competing samples. This enables the purchase of the best quality for the money.
- (2) To make sure that shipments comply with specifications. This makes possible the assurance to the customer that shipments match buying samples.
- (3) To furnish an impartial decision in case of disputes between purchaser and manufacturer.

Testing places the whole buying problem on a sound basis.

ENGINEERING SOCIETIES EMPLOYMENT SERVICE

WALTER V. BROWN, Manager

31 West 39th Street, New York City

Chicago Office: 205 W. Wacker Drive

San Francisco Office: 57 Post Street

UNDER THE AUSPICES OF

American Society of Civil Engineers
American Society of Mechanical Engineers

American Institute of Mining and Metallurgical Engineers
American Institute of Electrical Engineers

You are invited to use this service, representing over fifty thousand members, to supply your needs for all classes of engineers, executives and assistants.

Kindly be specific regarding requirements, salary, location, nature of work, etc.

Employers wishing to withhold their identity will be sent records of candidates meeting requirements specified, otherwise, qualified applicants will be sent in person.

Please mention the JOURNAL of the A. I. E. E. when writing to advertisers.

Classified Advertiser's Index for Buyers

Manufacturers and agents for machinery and supplies used in the electrical and allied industries.

Note: For reference to the advertisements see the Alphabetical List of Advertisers on page 56.

- AIR COMPRESSORS**
Allis-Chalmers Mfg. Co., Milwaukee
General Electric Co., Schenectady
- AMMETER COMPENSATING COILS**
Minerallac Electric Co., Chicago
- AMMETER, VOLTMETERS**
(See INSTRUMENTS, ELECTRICAL)
- ANCHORS, GUY**
Copperweld Steel Co., Glassport, Pa.
Kearney Corp., Jas. R., St. Louis
Matthews Corp., W. N., St. Louis
- BATTERY CHARGING APPARATUS**
Electric Specialty Co., Stamford, Conn.
General Electric Co., Schenectady
Rochester Electric Products Corp., Rochester, N. Y.
Wagner Electric Corp., St. Louis
Westinghouse Elec. & Mfg. Co., E. Pittsburgh
- BEARINGS, BALL**
Norma-Hoffmann Bearings Corp., Stamford, Conn.
- BOXES, FUSE**
General Electric Co., Schenectady
Kearney Corp., Jas. R., St. Louis
Metropolitan Device Corp., Brooklyn, N. Y.
Westinghouse Elec. & Mfg. Co., E. Pittsburgh
- BOXES, JUNCTION**
G & W Elec. Specialty Co., Chicago
Metropolitan Device Corp., Brooklyn, N. Y.
Standard Underground Cable Co., Pittsburgh
- BRUSHES, COMMUTATOR**
Carbon
Morganite Brush Co., Inc., L. I. City, N. Y.
National Carbon Co., Inc., Cleveland
Westinghouse Elec. & Mfg. Co., E. Pittsburgh
Copper Graphite
Morganite Brush Co., Inc., L. I. City, N. Y.
National Carbon Co., Inc., Cleveland
Westinghouse Elec. & Mfg. Co., E. Pittsburgh
- BUS BARS, ALUMINUM**
Aluminum Co. of America, Pittsburgh
- BUS BAR FITTINGS**
Burndy Engineering Co., Inc., New York
Champion Switch Co., Kenova, West Va.
Delta-Star Electric Co., Chicago
General Electric Co., Schenectady
Memco Engg. & Mfg. Co., L. I. City, N. Y.
Ohio Brass Co., Mansfield, O.
Westinghouse Elec. & Mfg. Co., E. Pittsburgh
- BUSHINGS, PORCELAIN**
Ohio Brass Co., Mansfield, O.
- CABLE ACCESSORIES**
Champion Switch Co., Kenova, West Va.
Delta Star Electric Co., Chicago
Dossert & Co., New York
G & W Electric Specialty Co., Chicago
General Electric Co., Schenectady
Minerallac Electric Co., Chicago
Standard Underground Cable Co., Pittsburgh
- CABLE RACKS**
Metropolitan Device Corp., Brooklyn, N. Y.
- CABLES**
SEE WIRES AND CABLES
- CABLEWAYS**
American Steel & Wire Co., Chicago
Roebing's Sons Co., John A., Trenton, N. J.
- CARRIER CURRENT TELEPHONE EQUIPMENT**
Wireless Specialty Apparatus Co., Boston
- CASTINGS, ALUMINUM**
Aluminum Co. of America, Pittsburgh
- CIRCUIT BREAKERS**
Air—Enclosed
Condit Elec. Mfg. Corp., Boston
I-T-E Circuit Breaker Co., The, Philadelphia
Roller-Smith Co., New York
Sundh Electric Co., Newark, N. J.
Oil
Condit Electrical Mfg. Corp., Boston
General Electric Co., Schenectady
Pacific Electric Mfg. Corp., San Francisco
Roller-Smith Co., New York
Westinghouse Elec. & Mfg. Co., E. Pittsburgh
- CLAMPS, INSULATOR**
Champion Switch Co., Kenova, West Va.
Memco Engg. & Mfg. Co., L. I. City, N. Y.
- CLAMPS, GUY & CABLE**
Burndy Engineering Co., Inc., New York
Kearney Corp., Jas. R., St. Louis
Matthews Corp., W. N., St. Louis
- COILS, CHOKE**
Burke Electric Co., Erie, Pa.
General Electric Co., Schenectady
Kearney Corp., Jas. R., St. Louis
Memco Engg. & Mfg. Co., L. I. City, N. Y.
Westinghouse Elec. & Mfg. Co., E. Pittsburgh
- COILS, MAGNET**
Acme Wire Co., New Haven, Conn.
Belden Mfg. Co., Chicago
Dudlo Mfg. Corp., Ft. Wayne, Ind.
General Electric Co., Schenectady
Westinghouse Elec. & Mfg. Co., E. Pittsburgh
- COMMUTATOR SEGMENTS AND RINGS**
Mica Insulator Co., New York
- CONDENSATION PRODUCTS**
Bakelite Corporation, New York
- CONDENSERS, COUPLING**
For Carrier Current Telephone
Wireless Specialty Apparatus Co., Boston
- CONDENSERS, RADIO**
General Radio Co., Cambridge, Mass.
Sangamo Electric Co., Springfield, Ill.
Wireless Specialty Apparatus Co., Boston
- CONDENSERS, STEAM**
Allis-Chalmers Mfg. Co., Milwaukee
General Electric Co., Schenectady
Westinghouse Elec. & Mfg. Co., E. Pittsburgh
- CONNECTORS, SOLDERLESS**
Champion Switch Co., Kenova, West Va.
Dossert & Co., New York
Kearney Corp., Jas. R., St. Louis
Westinghouse Elec. & Mfg. Co., E. Pittsburgh
- CONNECTORS AND TERMINALS**
Belden Mfg. Co., Chicago
Burke Electric Co., Erie, Pa.
Burndy Engineering Co., Inc., New York
Dossert & Co., New York
G & W Electric Specialty Co., Chicago
Westinghouse Elec. & Mfg. Co., E. Pittsburgh
- CONTACTS, TUNGSTEN**
General Electric Co., Schenectady
- CONTROLLERS**
Electric Controller & Mfg. Co., Cleveland
General Electric Co., Schenectady
Sundh Electric Co., Newark, N. J.
Westinghouse Elec. & Mfg. Co., E. Pittsburgh
- CONVERTERS—SYNCHRONOUS**
Allis-Chalmers Mfg. Co., Milwaukee
Electric Specialty Co., Stamford, Conn.
Wagner Electric Corp., St. Louis
Westinghouse Elec. & Mfg. Co., E. Pittsburgh
- COPPER CLAD WIRE**
Belden Mfg. Co., Chicago
Standard Underground Cable Co., Pittsburgh
- COPPERWELD WIRE**
Copperweld Steel Co., Glassport, Pa.
- CUT-OUTS**
Condit Electrical Mfg. Corp., S. Boston
General Electric Co., Schenectady
G & W Electric Specialty Co., Chicago
Kearney Corp., Jas. R., St. Louis
Metropolitan Device Corp., Brooklyn, N. Y.
Wagner Electric Corp., St. Louis
Westinghouse Elec. & Mfg. Co., E. Pittsburgh
- DIVERTER POLE GENERATORS**
Rochester Electric Products Corp., Rochester, N. Y.
- DYNAMOS**
(See GENERATORS AND MOTORS)
- DYNAMOTORS**
Burke Electric Co., Erie, Pa.
Electric Specialty Co., Stamford, Conn.
Rochester Electric Products Corp., Rochester, N. Y.
- ELECTRIFICATION SUPPLIES, STEAM ROAD**
General Electric Co., Schenectady
Ohio Brass Co., Mansfield, Ohio
Westinghouse Elec. & Mfg. Co., E. Pittsburgh
- ENGINEERS, CONSULTING AND CONTRACTING**
(See PROFESSIONAL ENGINEERING DIRECTORY)
- ENGINES**
Gas & Gasoline
Allis-Chalmers Mfg. Co., Milwaukee
Oil
Allis-Chalmers Mfg. Co., Milwaukee
Steam
Allis-Chalmers Mfg. Co., Milwaukee
- EXPERIMENTAL WORK**
Manufacturers' and Inventors' Electric Co.
228 West Broadway, New York
- FANS, MOTOR**
Century Electric Co., St. Louis
General Electric Co., Schenectady
Wagner Electric Corp., St. Louis
Westinghouse Elec. & Mfg. Co., E. Pittsburgh
- FIRE EXTINGUISHING APPARATUS**
Walter Kidde & Co., Inc., New York
- FLOW METERS**
General Electric Co., Schenectady
- FURNACES, ELECTRIC**
General Electric Co., Schenectady
Westinghouse Elec. & Mfg. Co., E. Pittsburgh
- FUSES**
Enclosed Refillable
General Electric Co., Schenectady
Westinghouse Elec. & Mfg. Co., E. Pittsburgh
Enclosed Non-Refillable
General Electric Co., Schenectady
Open Link
General Electric Co., Schenectady
Metropolitan Device Corp., Brooklyn, N. Y.
High-Tension
Delta-Star Electric Co., Chicago
Metropolitan Device Corp., Brooklyn, N. Y.
- FUSE MOUNTINGS**
Champion Switch Co., Kenova, West Va.
Memco Engg. & Mfg. Co., L. I. City, N. Y.
- FUSE PULLERS**
Kearney Corp., Jas. R., St. Louis



Is your name on our mailing list for bulletins and catalog?

Morganite Brushes

Morganite Brush Co., Inc.
3302-3320 Anable Ave.,
Long Island City,
N. Y.

Please mention the JOURNAL of the A. I. E. E. when writing to advertisers.



ALERT

Throughout nature, alertness is one of the basic requirements for existence—in the business world it is also the sine qua non of progress.

It has long been the policy of the Kuhlman Electric Company to anticipate improvements in transformer design and construction, and also in service to the electrical industry . . . Kuhlman Transformers are being used in rapidly increasing numbers by light and power companies throughout the country.

KUHLMAN ELECTRIC COMPANY, Bay City, Mich.

KUHLMAN TRANSFORMERS

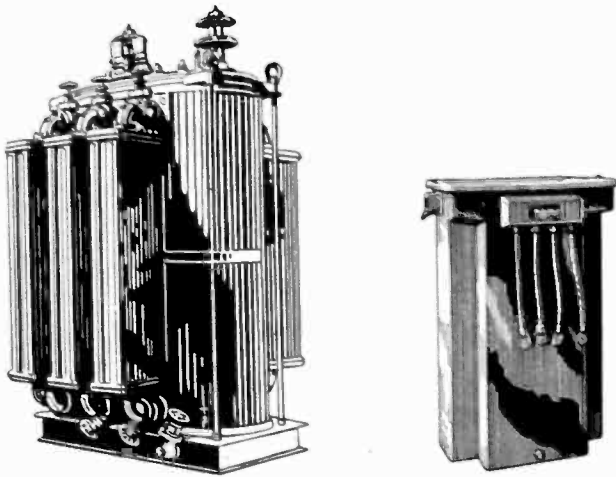

Offices:

Akron, Ohio
Electric Motor & Repair Co.
High and Barges Sts.

Atlanta, Georgia
E. K. Higginbottom
1431 Healy Bldg.

Baltimore, Md.
Industrial Power Equip. Co.
421 W. Camden St.

Boston, Mass.
Geo. H. Wahn Co.
69-71 High Street

Buffalo, N. Y.
John E. Hoffman
280 Carolina St.

Chicago, Ill.
John R. Smith
844 Rush St.
Cincinnati, Ohio
S. L. Currier
833 Union Trust Bldg.
Cleveland, Ohio
Public Service Supply Co.
627 Union Trust Bldg.

Dallas, Texas
F. T. Morrissey & Co.
1408 Allen Bldg.

Denver, Colo.
Joy & Cox, Inc.
314 Tramway Bldg.

Detroit, Michigan
Richard P. Johnson
10-230 General Motors Bldg.

Indianapolis, Indiana
Scott Jacqua Co., Inc.
202 Indiana Terminal Whse.
Lincoln, Neb.
Enterprise Electric Co.
1425-35 M. St.

Los Angeles, Cal.
Thomas Machinery Co.
912 E. 3rd St.

Milwaukee, Wis.
Wm. H. Fernholz
1031 Clybourn St.

Minneapolis, Minn.
Joseph L. Barnard
2101 Blaisdell Ave.

Montreal, Quebec
W. O. Taylor & Co.
415 Canada Cement Bldg.

New Orleans, La.
Lyman C. Reed
1230 Hibernia Bank Bldg.

New York, N. Y.
D. F. Potter, Jr.
Graybar Bldg.

New York (Export)
Parr Electric Export Corp.
77 Warren St.

Omaha, Neb.
J. H. Nicholson
6315 N. 33rd St.

Philadelphia, Pa.
J. Edward Bolich
1015 Chestnut St.

Phoenix, Arizona
Frank C. Fassett
15 East Jackson St.

Pittsburgh, Pa.
Continental Sales & Eng. Co.
839 Oliver Bldg.

San Francisco, Cal.
C. F. Henderson
Call Building

Seattle, Wash.
Equipment Sales Co.
514 Lloyd Bldg.

Toledo, Ohio
Howard J. Wittman
319 Spitzer Bldg.

York, Pa.
Harry W. Motter
25 N. Duke St.

Classified Advertiser's Index for Buyers—Continued

- GEARS, FIBRE**
Fibroc Insulation Co., Valparaiso, Ind.
General Electric Co., Schenectady
- GENERATORS AND MOTORS**
Allis-Chalmers Mfg. Co., Milwaukee
Burke Electric Co., Erie, Pa.
Century Electric Co., St. Louis
Chandeysson Electric Co., St. Louis
Electric Specialty Co., Stamford, Conn.
Electro-Dynamic Co., Bayonne, N. J.
General Electric Co., Schenectady
Rochester Electric Products Corp., Rochester, N. Y.
Wagner Electric Corp., St. Louis
Westinghouse Elec. & Mfg. Co., E. Pittsburgh
- GENERATING STATION EQUIPMENT**
Allis-Chalmers Mfg. Co., Milwaukee
Burke Electric Co., Erie, Pa.
General Electric Co., Schenectady
Westinghouse Elec. & Mfg. Co., E. Pittsburgh
- GROUND RODS**
Copperweld Steel Co., Glassport, Pa.
- HARDWARE, POLE LINE AND INSULATOR**
Ohio Brass Co., Mansfield, O.
Westinghouse Elec. & Mfg. Co., E. Pittsburgh
- HEADLIGHTS**
Ohio Brass Co., Mansfield, O.
Westinghouse Elec. & Mfg. Co., E. Pittsburgh
- HEATERS, INDUSTRIAL**
General Electric Co., Schenectady
Westinghouse Elec. & Mfg. Co., E. Pittsburgh
- INDICATORS, REMOTE, WATER LEVEL**
Bristol Co., The, Waterbury, Conn.
- INDICATORS, SPEED**
Bristol Co., The, Waterbury, Conn.
Roller-Smith Co., New York
- INSTRUMENTS, ELECTRICAL**
Graphic
Bristol Co., The, Waterbury, Conn.
Cambridge Instrument Co., New York
Ferranti, Ltd., Hollinwood, England
Ferranti, Inc., New York
Ferranti Electric, Ltd., Toronto, Ont.
General Electric Co., Schenectady
Roller-Smith Co., New York
Westinghouse Elec. & Mfg. Co., E. Pittsburgh
Indicating
Bristol Co., The, Waterbury, Conn.
Cambridge Instrument Co., New York
Ferranti, Ltd., Hollinwood, England
Ferranti, Inc., New York
Ferranti Electric, Ltd., Toronto, Ont.
General Electric Co., Schenectady
Jewell Elec. Instrument Co., Chicago
Roller-Smith Co., New York
Sangamo Electric Co., Springfield, Ill.
Westinghouse Elec. & Mfg. Co., E. Pittsburgh
Weston Elec. Inst. Corp., Newark, N. J.
Integrating
Ferranti, Ltd., Hollinwood, England
Ferranti, Inc., New York
Ferranti Electric, Ltd., Toronto, Ont.
General Electric Co., Schenectady
Sangamo Electric Co., Springfield, Ill.
Westinghouse Elec. & Mfg. Co., E. Pittsburgh
Radio
Cambridge Instrument Co., New York
General Radio Co., Cambridge, Mass.
Jewell Elec. Instrument Co., Chicago
Roller-Smith Co., New York
Repairing and Testing
Cambridge Instrument Co., New York
Electrical Testing Laboratories, New York
Jewell Elec. Instrument Co., Chicago
Roller-Smith Co., New York
Scientific Laboratory, Testing
Cambridge Instrument Co., New York
General Electric Co., Schenectady
Jewell Elec. Instrument Co., Chicago
Metropolitan Device Corp., Brooklyn, N. Y.
Roller-Smith Co., New York
Westinghouse Elec. & Mfg. Co., E. Pittsburgh
Weston Elec. Inst. Corp., Newark, N. J.
- INSULATING MATERIALS**
Board
Acme Wire Co., New Haven, Conn.
General Electric Co., Bridgeport, Conn.
West Va. Pulp & Paper Co., New York
Cloth
Acme Wire Company, New Haven, Conn.
General Electric Co., Bridgeport, Conn.
Mica Insulator Co., New York
Minerallac Electric Co., Chicago
Westinghouse Elec. & Mfg. Co., E. Pittsburgh
- INSULATING MATERIALS—Continued**
Composition
American Lava Corp., Chattanooga
Bakelite Corporation, New York
Belden Mfg. Co., Chicago
Fibroc Insulation Co., Valparaiso, Ind.
General Electric Co., Bridgeport, Conn.
Westinghouse Elec. & Mfg. Co., E. Pittsburgh
Compounds
General Electric Co., Bridgeport, Conn.
Mica Insulator Co., New York
Minerallac Electric Co., Chicago
Standard Underground Cable Co., Pittsburgh
Westinghouse Elec. & Mfg. Co., E. Pittsburgh
Fibre
Belden Mfg. Co., Chicago
Fibroc Insulation Co., Valparaiso, Ind.
General Electric Co., Bridgeport, Conn.
West Va. Pulp & Paper Co., New York
Lava
American Lava Corp., Chattanooga, Tenn.
Mica
Mica Insulator Co., New York
Westinghouse Elec. & Mfg. Co., E. Pittsburgh
Paper
Acme Wire Company, New Haven, Conn.
General Electric Co., Bridgeport, Conn.
Mica Insulator Co., New York
Westinghouse Elec. & Mfg. Co., E. Pittsburgh
Silk
Acme Wire Company, New Haven, Conn.
General Electric Co., Bridgeport, Conn.
Tape
Belden Mfg. Co., Chicago
General Electric Co., Bridgeport, Conn.
Mica Insulator Co., New York
Minerallac Electric Co., Chicago
Okonite Co., The, Passaic, N. J.
Westinghouse Elec. & Mfg. Co., E. Pittsburgh
Varnishes
Acme Wire Company, New Haven, Conn.
General Electric Co., Bridgeport, Conn.
Mica Insulator Co., New York
Minerallac Electric Co., Chicago
Westinghouse Elec. & Mfg. Co., E. Pittsburgh
- INSULATORS, HIGH TENSION**
Composition
General Electric Co., Schenectady
Glass
Hemingray Glass Co., Muncie, Ind.
Porcelain
Canadian Porcelain Co., Ltd., Hamilton, Ont.
Champion Switch Co., Kenova, West Va.
General Electric Co., Schenectady
Lapp Insulator Co., Inc., LeRoy, N. Y.
Locke Insulator Corp., Baltimore
Ohio Brass Co., Mansfield, O.
Thomas & Sons Co., R., Lisbon, O.
Westinghouse Elec. & Mfg. Co., E. Pittsburgh
Post Type
Delta-Star Electric Co., Chicago
Ohio Brass Co., Mansfield, O.
- INSULATORS, TELEPHONE & TELEGRAPH**
Hemingray Glass Co., Muncie, Ind.
Ohio Brass Co., Mansfield, O.
- INSULATOR PINS**
Ohio Brass Co., Mansfield, O.
Thomas & Sons Co., R., Lisbon, O.
- LAMP GUARDS**
Matthews Corp., W. N., St. Louis
- LAVA**
American Lava Corp., Chattanooga
- LIGHTNING ARRESTERS**
Delta-Star Electric Co., Chicago
General Electric Co., Schenectady
Westinghouse Elec. & Mfg. Co., E. Pittsburgh
- LOCOMOTIVES, ELECTRIC**
General Electric Co., Schenectady
Westinghouse Elec. & Mfg. Co., E. Pittsburgh
- LUBRICANTS**
Texas Co., The, New York
- MAGNETIC SEPARATORS**
Electric Controller & Mfg. Co., Cleveland
- METERS, ELECTRICAL**
(See INSTRUMENTS ELECTRICAL)
- METER SEALS**
Metropolitan Device Corp., Brooklyn, N. Y.
- MICA PRODUCTS**
Mica Insulator Co., New York
Westinghouse Elec. & Mfg. Co., E. Pittsburgh
- MOLDED INSULATION**
Bakelite Corporation, New York
Belden Mfg. Co., Chicago
Burke Electric Co., Erie, Pa.
Westinghouse Elec. & Mfg. Co., E. Pittsburgh
- MOTORS**
(See GENERATORS AND MOTORS)
- OHMMETERS**
Jewell Elec. Instrument Co., Chicago
Roller-Smith Co., New York
Weston Elec. Instr. Corp., Newark, N. J.
- OIL SEPARATORS & PURIFIERS**
Sharples Specialty Co., The, Philadelphia
Westinghouse Elec. & Mfg. Co., E. Pittsburgh
- PANEL BOARDS**
(See SWITCHBOARDS)
- PATENT ATTORNEYS**
(See PROFESSIONAL ENGINEERING DIRECTORY)
- PLATING GENERATORS**
Burke Electric Co., Erie, Pa.
Chandeysson Elec. Co., St. Louis
Electric Specialty Co., Stamford, Conn.
Rochester Electric Products Corp., Rochester, N. Y.
- PLUGS**
Delta-Star Electric Co., Chicago
General Electric Co., Schenectady
Westinghouse Elec. & Mfg. Co., E. Pittsburgh
- POLE LINE HARDWARE**
Ohio Brass Co., Mansfield, O.
- POTHEADS**
G & W Electric Specialty Co., Chicago
Ohio Brass Co., Mansfield, O.
Standard Underground Cable Co., Pittsburgh
- PULLERS, SLACK**
Matthews Corp., W. N., St. Louis
- PUMPS**
Allis-Chalmers Mfg. Co., Milwaukee
- RADIO LABORATORY APPARATUS**
General Radio Co., Cambridge, Mass.
Westinghouse Elec. & Mfg. Co., E. Pittsburgh
- RAILWAY SUPPLIES, ELECTRIC**
General Electric Co., Schenectady
Ohio Brass Co., Mansfield, O.
Westinghouse Elec. & Mfg. Co., E. Pittsburgh
- REACTORS**
General Electric Co., Schenectady
Metropolitan Device Corp., Brooklyn, N. Y.
- RECTIFIERS**
General Electric Co., Schenectady
Wagner Electric Corp., St. Louis
Westinghouse Elec. & Mfg. Co., E. Pittsburgh
- REELS, PAYOUT AND TAKEUP**
Matthews Corp., W. N., St. Louis
- REGULATORS, VOLTAGE**
Burke Electric Co., Erie, Pa.
General Electric Co., Schenectady
Westinghouse Elec. & Mfg. Co., E. Pittsburgh
- RELAYS**
Condit Elec. Mfg. Corp., Boston
Electric Controller & Mfg. Co., Cleveland
General Electric Co., Schenectady
Roller-Smith Co., New York
Westinghouse Elec. & Mfg. Co., E. Pittsburgh
- RESISTOR UNITS**
General Electric Co., Schenectady
International Resistance Co., Philadelphia
Westinghouse Elec. & Mfg. Co., E. Pittsburgh
- RHEOSTATS**
General Electric Co., Schenectady
Sundh Electric Co., Newark, N. J.
Westinghouse Elec. & Mfg. Co., E. Pittsburgh

Please mention the JOURNAL of the A. I. E. E. when writing to advertisers.

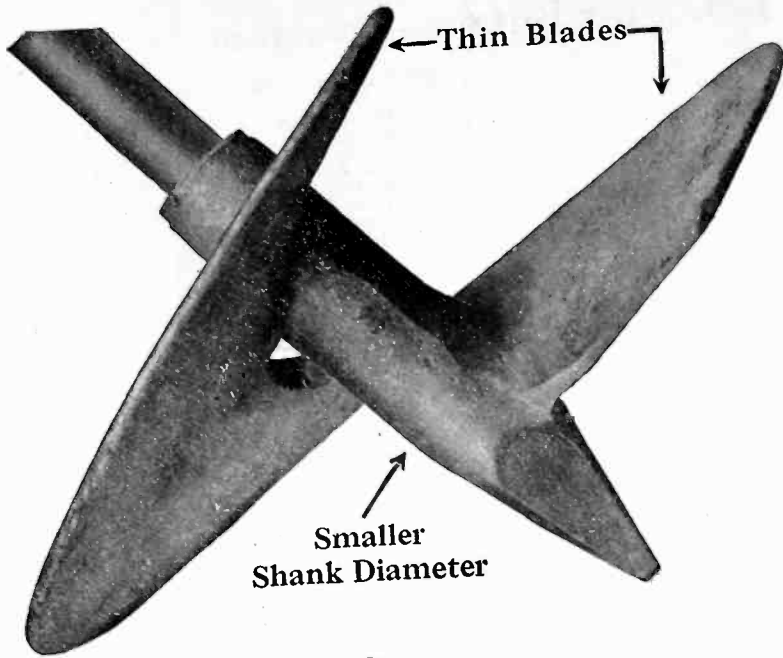

SEE HOW the new Matthews Scrulix Anchors get their tremendous holding power

50% greater holding power guaranteed!



Any Other
Screw Anchor

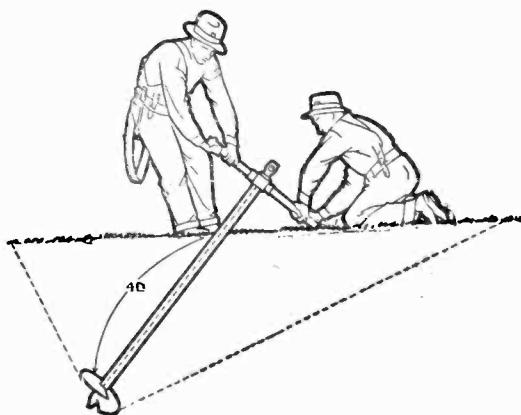

Note difference
in size of cones
of earth

Size for size the new Matthews Scrulix Anchors can be put down two feet deeper than any other screw anchor in the same length of time. The new Matthews Wrench permits the men to stand in upright comfortable positions during entire installation—even when end of rod is down to ground level—as the handle can be moved up and down the extra long wrench.

With any other screw anchor the wrench handle catches on the ground while the anchor rod is still two feet out of the ground—yet the anchor is down as far as the wrench can put it unless the men dig the ground away or use a ratchet handle; it has always been difficult, if not impossible, to get them to do this. Compare the size of the cones of earth on the two illustrations at the left. The extra depth of the new Scrulix is what gives it the tremendous holding power. Tests show 100% greater—we guarantee 50%.

In extra hard clay or disintegrated rock drill a pilot hole with the 381 Matthews Auger. This will make installation easy and enable you to get anchorages up to strength of the rod at less cost than with any other anchor. Ask for circular that tells all. W. N. Matthews Corporation, Engineers and Manufacturers 3706 Forest Park Blvd., St. Louis, Mo.

THE NEW PREHEATED CERTIFIED MALLEABLE
**MATTHEWS
SCRULIX ANCHORS**

Patents Applied for

Please mention the JOURNAL of the A. I. E. E. when writing to advertisers.

Classified Advertiser's Index for Buyers—Continued

ROPE, WIRE

American Steel & Wire Co., Chicago
Roebling's Sons Co., John A., Trenton, N. J.

SCREWS

Drive Hardened Metallic
Parker-Kalon Corp., New York
Self-Tapping Hardened
Parker-Kalon Corp., New York
Sheet Metal, Hardened Self-Tapping
Parker-Kalon Corp., New York

SEARCHLIGHTS

General Electric Co., Schenectady
Westinghouse Elec. & Mfg. Co., E. Pittsburgh

SLEEVE TWISTERS

Kearney Corp., Jas. R., St. Louis

SLEEVES, SPLICING

Memco Engg. & Mfg. Co., L. I. City, N. Y.

SOCKETS AND RECEPTACLES

General Electric Co., Schenectady
Westinghouse Elec. & Mfg. Co., E. Pittsburgh

SOLENOIDS

Acme Wire Company, New Haven, Conn.
Belden Mfg. Co., Chicago
Dudlo Mfg. Co., Ft. Wayne, Ind.
Electric Controller & Mfg. Co., Cleveland
General Electric Co., Schenectady
Roebling's Sons Co., John A., Trenton, N. J.
Sundh Electric Co., Newark, N. J.
Westinghouse Elec. & Mfg. Co., E. Pittsburgh

SPRINGS

American Steel & Wire Co., Chicago

STARTERS, MOTORS

Condit Electrical Mfg. Corp., Boston
Electric Controller & Mfg. Co., Cleveland
General Electric Co., Schenectady
Roller-Smith Co., New York
Sundh Electric Co., Newark, N. J.
Westinghouse Elec. & Mfg. Co., E. Pittsburgh

STOKERS, MECHANICAL

Westinghouse Elec. & Mfg. Co., E. Pittsburgh

SUB-STATIONS

Champion Switch Co., Kenova, West Va.
Delta-Star Electric Co., Chicago
General Electric Co., Schenectady
Memco Engg. & Mfg. Co., L. I. City, N. Y.
Westinghouse Elec. & Mfg. Co., E. Pittsburgh

SWITCHBOARDS

Allis-Chalmers Mfg. Co., Milwaukee
Bull Dog Electric Products Co., Detroit
Condit Electrical Mfg. Corp., Boston
General Electric Co., Schenectady
Metropolitan Device Corp., Brooklyn, N. Y.
Westinghouse Elec. & Mfg. Co., E. Pittsburgh

SWITCHES

Automatic Time
General Electric Co., Schenectady
Minerallac Electric Co., Chicago
Sundh Electric Co., Newark, N. J.
Westinghouse Elec. & Mfg. Co., E. Pittsburgh

Disconnecting
Burke Electric Co., Erie, Pa.
Champion Switch Co., Kenova, West Va.
Condit Electrical Mfg. Corp., Boston
Delta-Star Electric Co., Chicago
General Electric Co., Schenectady
Kearney Corp., Jas. R., St. Louis
Matthews Corp., W. N., St. Louis
Memco Engg. & Mfg. Co., L. I. City, N. Y.
Pacific Elec. Mfg. Corp., San Francisco
Roller-Smith Co., New York
Westinghouse Elec. & Mfg. Co., E. Pittsburgh

Fuse
Bull Dog Electric Products Co., Detroit
General Electric Co., Schenectady
Kearney Corp., Jas. R., St. Louis
Matthews Corp., W. N., St. Louis
Metropolitan Device Corp., Brooklyn, N. Y.

Knife
Electric Controller & Mfg. Co., Cleveland
General Electric Co., Schenectady
Matthews Corp., W. N., St. Louis
Westinghouse Elec. & Mfg. Co., E. Pittsburgh

Oil
Condit Electrical Mfg. Corp., Boston
General Electric Co., Schenectady
Pacific Elec. Mfg. Corp., San Francisco
Roller-Smith Co., New York
Westinghouse Elec. & Mfg. Co., E. Pittsburgh

Remote Control
Condit Electrical Mfg. Corp., Boston
General Electric Co., Schenectady
Roller-Smith Co., New York
Sundh Electric Co., Newark, N. J.
Westinghouse Elec. & Mfg. Co., E. Pittsburgh

TELEPHONE CONNECTORS

Kearney Corp., Jas. R., St. Louis

TESTING LABORATORIES

Electrical Testing Labs., New York

TRANSFORMERS

Allis-Chalmers Mfg. Co., Milwaukee
American Transformer Co., Newark, N. J.
Duncan Elec. Mfg. Co., Lafayette, Ind.
Electric Service Co., Cincinnati
Ferranti, Ltd., Hollinwood, England
Ferranti, Inc., New York
Ferranti Electric, Ltd., Toronto, Ont.
General Electric Co., Schenectady
Kuhlman Electric Co., Bay City, Mich.
Moloney Electric Co., St. Louis
Sangamo Electric Co., Springfield, Ill.
Wagner Electric Corp., St. Louis
Westinghouse Elec. & Mfg. Co., E. Pittsburgh

Factory
American Transformer Co., Newark, N. J.
Kuhlman Electric Co., Bay City, Mich.
Moloney Electric Co., St. Louis
Wagner Electric Corp., St. Louis

Furnace
Allis-Chalmers Mfg. Co., Milwaukee
American Transformer Co., Newark, N. J.
Moloney Electric Co., St. Louis
Westinghouse Elec. & Mfg. Co., E. Pittsburgh

Metering
American Transformer Co., Newark, N. J.
Ferranti, Ltd., Hollinwood, England
Ferranti, Inc., New York
Ferranti Electric, Ltd., Toronto, Ont.
Roller-Smith Co., New York
Sangamo Electric Co., Springfield, Ill.

Radio
American Transformer Co., Newark, N. J.
Ferranti, Ltd., Hollinwood, England
Ferranti, Inc., New York
Ferranti Electric, Ltd., Toronto, Ont.

Street Lighting
Kuhlman Electric Co., Bay City, Mich.

TRANSFORMERS, USED

Electric Service Co., Cincinnati

TROLLEY LINE MATERIALS

General Electric Co., Schenectady
Ohio Brass Co., Mansfield, O.
Westinghouse Elec. & Mfg. Co., E. Pittsburgh

TURBINES, HYDRAULIC

Allis-Chalmers Mfg. Co., Milwaukee

TURBINES, STEAM

Allis-Chalmers Mfg. Co., Milwaukee
General Electric Co., Schenectady
Westinghouse Elec. & Mfg. Co., E. Pittsburgh

TURBO-GENERATORS

Allis-Chalmers Mfg. Co., Milwaukee
Westinghouse Elec. & Mfg. Co., E. Pittsburgh

VALVE CONTROL, ELECTRIC

Bristol Company, The, Waterbury, Conn.

VALVES, BRASS

Gas, Water, Steam
Ohio Brass Co., Mansfield, O.

VARNISHES, INSULATING

General Electric Co., Bridgeport, Conn.
Mica Insulator Co., New York
Minerallac Electric Co., Chicago
Westinghouse Elec. & Mfg. Co., E. Pittsburgh

WASHERS, LOCK

Shakeproof Lock Washer Co., Chicago

WELDING MACHINES, ELECTRIC

General Electric Co., Schenectady
Ohio Brass Co., Mansfield, O.
Westinghouse Elec. & Mfg. Co., E. Pittsburgh

WELDING WIRES & RODS

Aluminum Co. of America, Pittsburgh
American Steel & Wire Co., Chicago
Ohio Brass Co., Mansfield, O.

WIRES AND CABLES and A. C. S. R.

Aluminum
Aluminum Co. of America, Pittsburgh
Armored Cable
American Steel & Wire Co., Chicago
Belden Mfg. Co., Chicago
General Electric Co., Schenectady
Kerite Ins. Wire & Cable Co., New York
Okonite Company, The, Passaic, N. J.
Roebling's Sons Co., John A., Trenton, N. J.
Simplex Wire & Cable Co., Boston
Standard Underground Cable Co., Perth Amboy, N. J.

Asbestos Covered
American Steel & Wire Co., Chicago
Belden Mfg. Co., Chicago
General Electric Co., Schenectady
Rockbestos Products Corp., New Haven, Conn.
Rome Wire Company, Rome, N. Y.

WIRES AND CABLES—Continued

Automotive
American Steel & Wire Co., Chicago
Belden Mfg. Co., Chicago
General Electric Co., Schenectady
Kerite Ins. Wire & Cable Co., New York
Roebling's Sons Co., John A., Trenton, N. J.
Rome Wire Company, Rome, N. Y.
Simplex Wire & Cable Co., Boston
Standard Underground Cable Co., Perth Amboy, N. J.

Bare Copper
American Steel & Wire Co., Chicago
Anaconda Wire & Cable Co., New York
Belden Mfg. Co., Chicago
Roebling's Sons Co., John A., Trenton, N. J.
Rome Wire Company, Rome, N. Y.
Standard Underground Cable Co., Perth Amboy, N. J.

Copper Clad
Belden Mfg. Co., Chicago
Standard Underground Cable Co., Perth Amboy, N. J.

Copperweld
Copperweld Steel Co., Glassport, Pa.

Flexible Cord
American Steel & Wire Co., Chicago
Belden Mfg. Co., Chicago
General Electric Co., Schenectady
Okonite Company, The, Passaic, N. J.
Roebling's Sons Co., John A., Trenton, N. J.
Rome Wire Company, Rome, N. Y.
Simplex Wire & Cable Co., Boston
Standard Underground Cable Co., Perth Amboy, N. J.

Heavy Duty Cord
American Steel & Wire Co., Chicago
Belden Mfg. Co., Chicago
Okonite Company, The, Passaic, N. J.
Rome Wire Company, Rome, N. Y.
Simplex Wire & Cable Co., Boston

Fuse
Aluminum Co. of America, Pittsburgh
American Steel & Wire Co., Chicago
General Electric Co., Schenectady
Roebling's Sons Co., John A., Trenton, N. J.

Lead Covered (Paper and Varnished Cambric Insulated)
American Steel & Wire Co., Chicago
Anaconda Wire & Cable Co., New York
General Electric Co., Schenectady
Kerite Ins. Wire & Cable Co., New York
Okonite Company, The, Passaic, N. J.
Okonite-Callender Cable Co., The, Inc., Passaic, N. J.
Roebling's Sons Co., John A., Trenton, N. J.
Rome Wire Company, Rome, N. Y.
Simplex Wire & Cable Co., Boston
Standard Underground Cable Co., Perth Amboy, N. J.

Magnet
Acme Wire Company, New Haven, Conn.
Aluminum Co. of America, Pittsburgh
American Steel & Wire Co., Chicago
Anaconda Wire & Cable Co., New York
Belden Mfg. Co., Chicago
Dudlo Mfg. Corp., Fort Wayne, Ind.
General Electric Co., Schenectady
Roebling's Sons Co., John A., Trenton, N. J.
Rome Wire Company, Rome, N. Y.
Standard Underground Cable Co., Perth Amboy, N. J.

Rubber Insulated
American Steel & Wire Co., Chicago
Belden Mfg. Co., Chicago
General Electric Co., Schenectady
Kerite Ins. Wire & Cable Co., New York
Okonite Company, The, Passaic, N. J.
Roebling's Sons Co., John A., Trenton, N. J.
Rome Wire Company, Rome, N. Y.
Simplex Wire & Cable Co., Boston
Standard Underground Cable Co., Perth Amboy, N. J.

Tree Wire
Okonite Company, The, Passaic, N. J.
Roebling's Sons Co., John A., Trenton, N. J.
Simplex Wire & Cable Co., Boston

Trolley
American Steel & Wire Co., Chicago
Anaconda Wire & Cable Co., New York
Copperweld Steel Co., Glassport, Pa.
Roebling's Sons Co., John A., Trenton, N. J.
Rome Wire Company, Rome, N. Y.
Standard Underground Cable Co., Perth Amboy, N. J.

Weather proof
American Steel & Wire Co., Chicago
Anaconda Wire & Cable Co., New York
Copperweld Steel Co., Glassport, Pa.
General Electric Co., Schenectady
Kerite Ins. Wire & Cable Co., New York
Okonite Company, The, Passaic, N. J.
Roebling's Sons Co., John A., Trenton, N. J.
Rome Wire Company, Rome, N. Y.
Simplex Wire & Cable Co., Boston
Standard Underground Cable Co., Perth Amboy, N. J.

Please mention the JOURNAL of the A. I. E. E. when writing to advertisers.

TUNE IN JANUARY 1st

THE ROMANCE

OF ELECTRICAL DEVELOPMENT

Westinghouse invites you to tune in . . . 7:30 p. m., Eastern Standard Time, for one of a series of radio programs of a new type . . . a "Westinghouse Salute" to Electrical Development, January 1st. Complete cast of actor-stars from the legitimate stage . . . magnificent mixed chorus of 40 voices . . . complete symphony orchestra, 50 instruments . . . through a coast-to-coast NBC network of 34 stations, including KDKA, WBZ, WBZA and KYW.



The Studio Cast of a "Westinghouse Salute"

Westinghouse



Please mention the JOURNAL of the A. I. E. E. when writing to advertisers.

MOLONEY

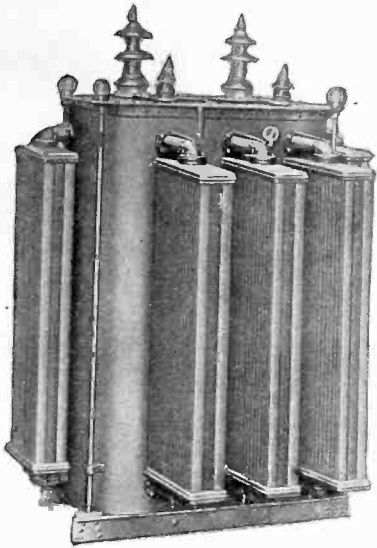

Satisfactory Service

Under all conditions and in any service —that's the guarantee you get with Moloney Quality—it's the reason Moloney Transformers are being used more and more by both large and small power and light companies throughout the country.

MOLONEY ELECTRIC COMPANY

Main Office and Factories: ST. LOUIS, MO.

Sales Offices in Principal Cities

TRANSFORMERS

ALPHABETICAL LIST OF ADVERTISERS

	PAGE		PAGE		PAGE
Acme Wire Company	36	Fennessy, David V.	47	Ohio Brass Company	15
Allis-Chalmers Manufacturing Company	30	Ferranti, Incorporated	18, 19	Okonite Company, The	Third Cover
Aluminum Company of America	8	Fibroc Insulation Company	34	Okonite-Callender Cable Co., Inc.	Third Cover
Ambursen Construction Company, Inc.	48	Ford, Bacon & Davis, Inc.	47	Ophuls & Hill, Inc.	48
American Lava Corporation	34	Fowle & Company, Frank F.	47	Osgood, Farley	48
American Steel & Wire Company	17	Frey Engineering Company	47		
American Telephone & Telegraph Co.	16				
American Transformer Company	2				
Anaconda Wire & Cable Company	10				
Bakelite Corporation	32	G & W Electric Specialty Company	45	Pacific Electric Mfg. Corporation	47
Barstow & Company, Inc., W. S.	48	General Electric Company	6, 7, 20, 21	Parker-Kalon Corporation	38
Battey & Kipp, Inc.	48	General Radio Company	46	Publications, A. I. E. E.	42
Belden Manufacturing Company	Fourth Cover				
Black & Veatch	48	Hemingray Glass Company	40	Rochester Electric Products Corp.	5
Bristol Company, The	23	Hoosier Engineering Company	48	Roebling's Sons Company, John A.	36
Burke Electric Company	44			Roller-Smith Company	47
Burdny Engineering Company, Inc.	44	International Nickel Company, Inc., The	9		
Burt, Dr. Robert C.	48	International Resistance Company	3		
Byllesby Engineering & Management Corp.	48	I-T-E Circuit Breaker Company	4		
		Jackson & Moreland	48	Sackman, G. R.	48
Cambridge Instrument Company	46	Jewell Electrical Instrument Company	31	Sanderson & Porter	48
Canadian Porcelain Company, Ltd.	40			Sargent & Lundy, Inc.	49
Century Electric Company	29	Kearney Corporation, James R.	44	Science Abstracts	36
Champion Switch Company	40	Kerite Insulated Wire & Cable Co., Inc.	1	Scofield Engineering Company	49
Chandeysson Electric Company	24, 25	Kruse, Robert S.	48	Shakeproof Lock Washer Company	39
Chicago Mica Company	34	Kuhlman Electric Company	51	Sharples Specialty Company, The	22
Clement, Edward E.	48			Simplex Wire & Cable Company	45
Condit Electrical Manufacturing Corp.	43	Lapp Insulator Company, Inc.	41	Standard Underground Cable Company	13
Copperweld Steel Company	44	Locke Insulator Corporation	12	Stevens, Inc., John A.	49
Corning Glass Works	40			Stevens & Wood, Inc.	49
		Manufacturers' & Inventors' Elec. Co.	38	Stockbridge & Borst	49
Delta-Star Electric Company	47	Mathews Corporation, W. N.	53	Stone & Webster, Inc.	49
Dossert & Company	14	Memco Engineering & Mfg. Co., Inc.	44	Sundh Electric Company, Inc.	36
Dudlo Manufacturing Company	33	Metropolitan Device Corporation	58		
		Mica Insulator Company	35	Texas Company, The	57
Electric Controller & Mfg. Co., The	27	Minerallac Electric Company	11	Thomas, Percy H.	49
Electric Service Company, Inc., The	40	Moloney Electric Company	56	Thomas & Sons Company, The R.	40
Electric Specialty Company	38	Morganite Brush Company, Inc., The	50		
Electrical Testing Laboratories	49				
Electro Dynamic Company	38	Neall, N. J.	48	Wagner Electric Corporation	26
Engineering Directory	49, 50	Neiler, Rich & Company	48	West Va. Pulp & Paper Company	34
Engineering Societies Employment Service	49	Norma-Hoffmann Bearings Corporation	28	Western Electric Company	37
				Westinghouse Elec. & Mfg. Company	55
				Weston Electrical Instrument Corp.	46
				White Engineering Corp., The J. G.	49
				Wireless Specialty Apparatus Company	47
				Wray & Company, J. G.	49

(For classified list of Advertisers see pages 50, 52 and 54)

Please mention the JOURNAL of the A. I. E. E. when writing to advertisers.

...with Texaco Algol Oil

- ⊛ *Lower bearing temperature*
- ⊛ *Lower oil consumption*
- ⊛ *Perfect lubrication*
- ⊛ *No carbon trouble*
- ⊛ *No sticking piston rings*

THESE are the five points which lead to the endorsement of Texaco Algol Oil for the Fairbanks-Morse Diesel Engines in the power plant of one well known southeastern utility company.

The chief engineer of the plant highly recommends Texaco Algol Oil for Diesel lubrication. Two other oils had been tried out. Both were excellent oils made especially for the work, but Texaco Algol Oil proved so superior

that it is the *one* lubricant now used exclusively at this installation.

Texaco Algol Oil is the effective lubricant for all Fairbanks-Morse and other engines of the Diesel and semi-Diesel type. Its high lubricating qualities and uniformity are recognized everywhere—and Texaco Lubrication Service is always available to cooperate in securing the most effective lubricating practices.

TEXACO LUBRICANTS

THE TEXAS COMPANY
Texaco Petroleum Products



17 Battery Place, New York City
Offices in Principal Cities

There is a Texaco Lubricant for every purpose

WHERE

can you get a light weight inexpensive ladder rig that will go on a Ford Chassis and do the work cheaper and better



Low first cost and low maintenance are outstanding investment features of the Murray P S Light Ladder.

A pamphlet on this inexpensive ladder rig for street lighting will be mailed upon request.

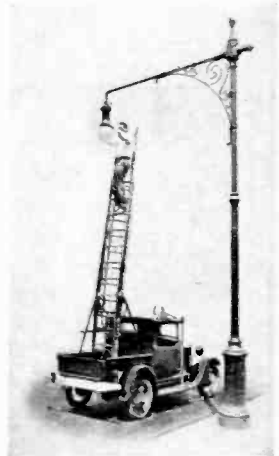
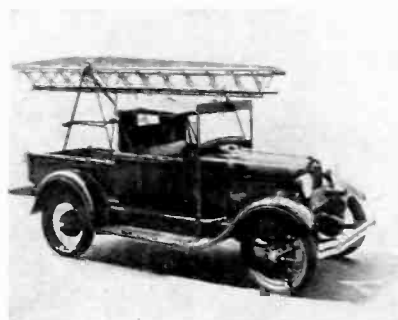
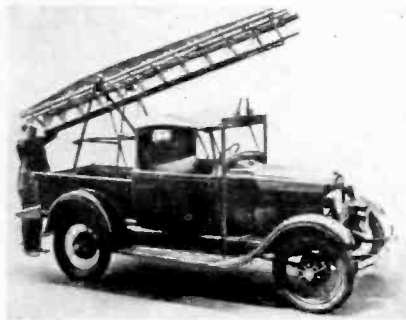
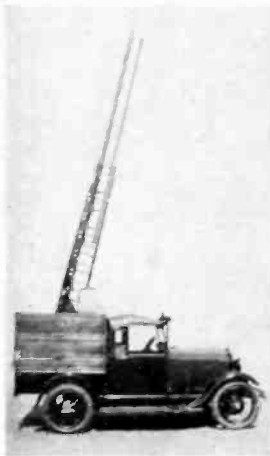

Metropolitan Device Corporation
1250 Atlantic Ave., Brooklyn, N. Y.

27971

Please mention the JOURNAL of the A. I. E. E. when writing to advertisers.

Back of it all is OKONITE

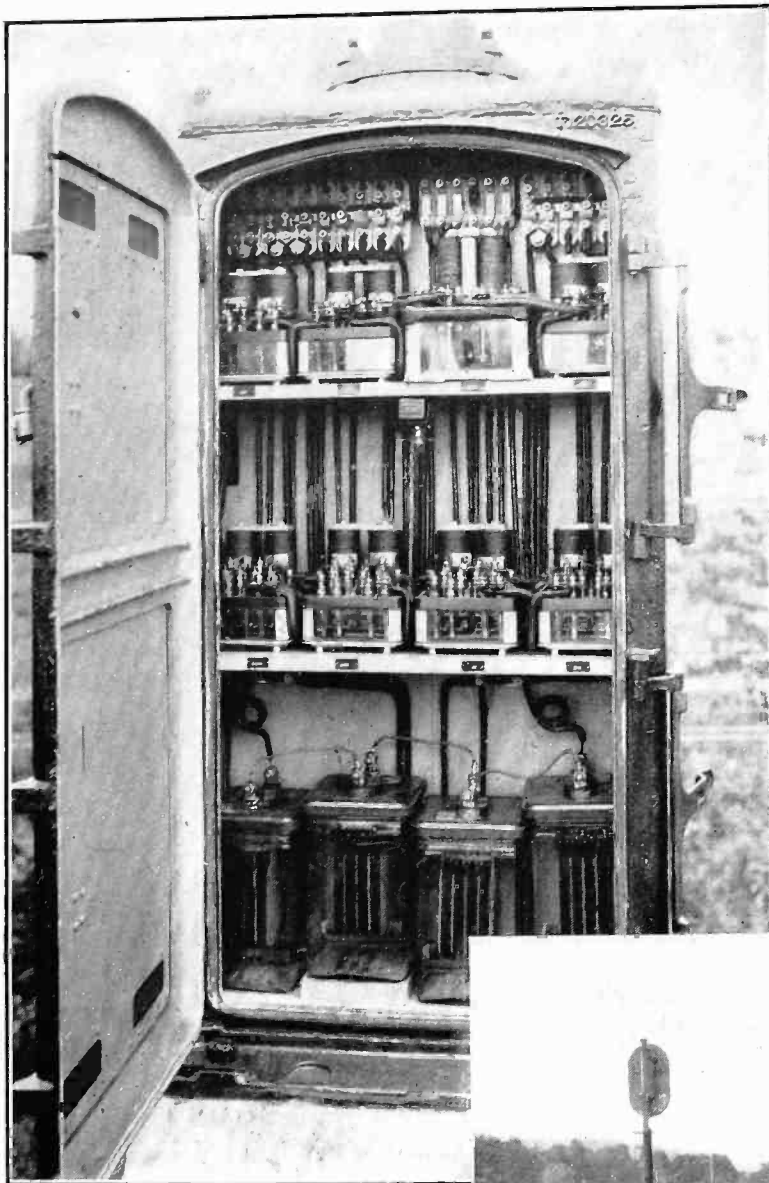

EVERY feature of the recently completed signaling installation on the Erie between Meadville, Pa., and Salamanca, N. Y., bears testimony to the extreme care used to get perfect results. Even the wiring of the cases has been done with rare skill and an eye to finished appearance.

Back of the elaborate system of interlocking controls for the 106 mile section was the demand for the best possible equipment. OKONITE was used exclusively for all circuits.



Okonite Products
 OKONITE
 INSULATED
 WIRES AND
 CABLES
 VARNISHED
 CAMBRIC
 CABLES
 OKONITE
 INSULATING
 TAPE
 MANSON & DUNDEE
 FRICTION TAPE
 OKONITE
 CEMENT
 OKOCORD
 OKOLOOM

*Okonite-Callender
 Products*
 IMPREGNATED
 PAPER CABLES
 SUPER-TENSION
 CABLES
 SPLICING
 MATERIALS

THE OKONITE COMPANY

Founded 1878

THE OKONITE-CALLENDER CABLE COMPANY, INC.

Factories: Passaic, N. J.

Paterson, N. J.

SALES OFFICES: NEW YORK CHICAGO PITTSBURGH ST. LOUIS BOSTON ATLANTA
 BIRMINGHAM SAN FRANCISCO LOS ANGELES SEATTLE DALLAS
 Novelty Electric Co., Philadelphia, Pa. F. D. Lawrence Electric Co., Cincinnati, O.
 Canadian Representatives: Engineering Materials, Limited, Montreal
 Cuban Representatives: Victor G. Mendoza Co., Havana



OKONITE QUALITY CANNOT BE WRITTEN INTO A SPECIFICATION

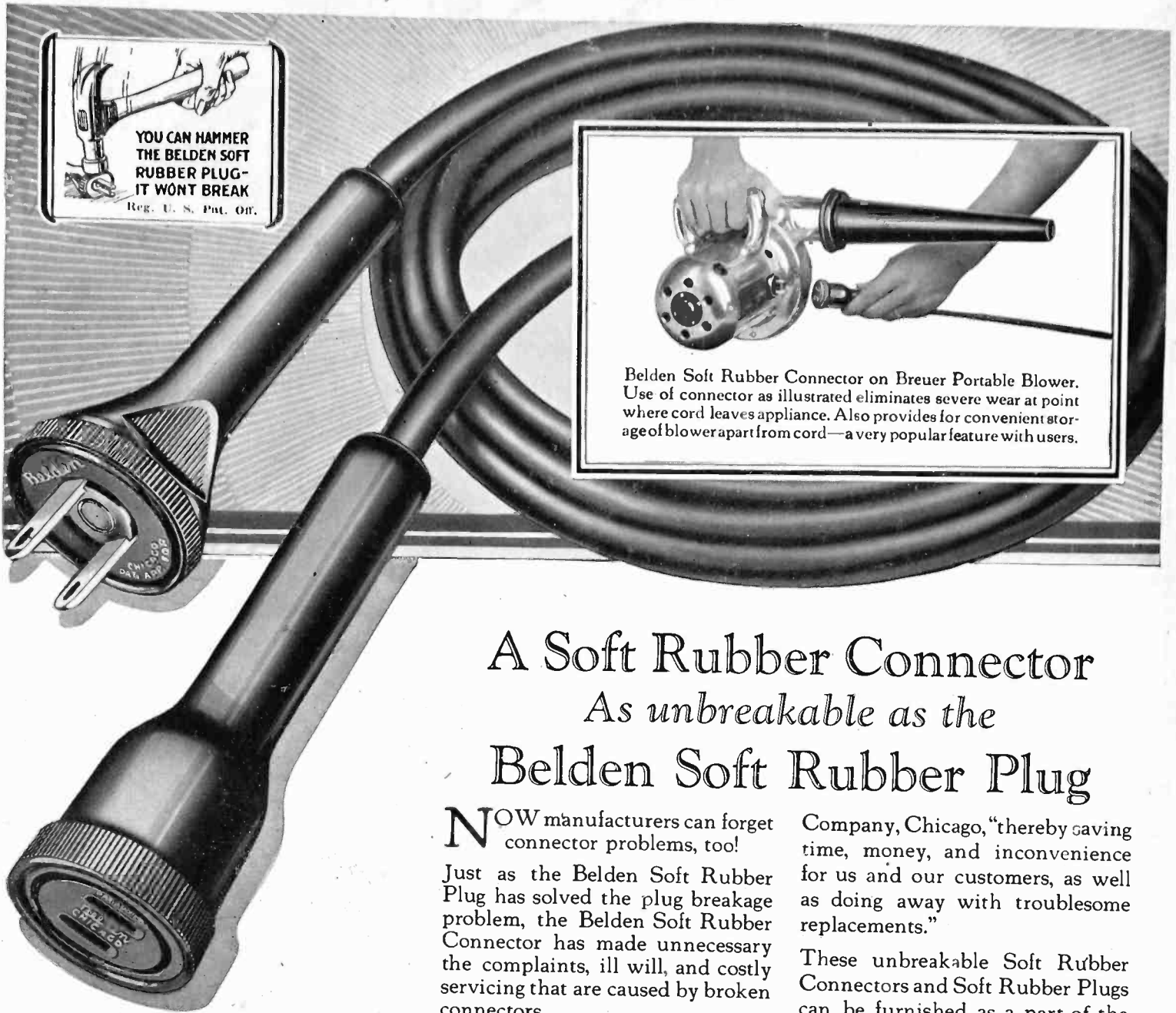

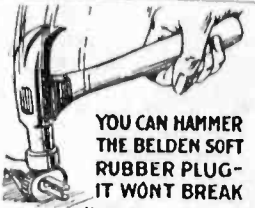

**YOU CAN HAMMER
 THE BELDEN SOFT
 RUBBER PLUG—
 IT WON'T BREAK**
 Reg. U. S. Pat. Off.

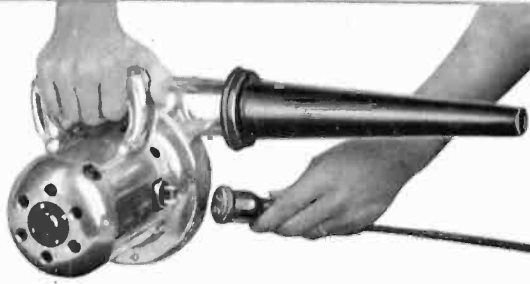

 Belden Soft Rubber Connector on Breuer Portable Blower. Use of connector as illustrated eliminates severe wear at point where cord leaves appliance. Also provides for convenient storage of blower apart from cord—a very popular feature with users.

A Soft Rubber Connector As unbreakable as the Belden Soft Rubber Plug

NOW manufacturers can forget connector problems, too!

Just as the Belden Soft Rubber Plug has solved the plug breakage problem, the Belden Soft Rubber Connector has made unnecessary the complaints, ill will, and costly servicing that are caused by broken connectors.

"By adopting the Belden All-Rubber Extension Link with Soft Rubber Connector and Soft Rubber Plug, we have eliminated breakage," writes A. A. Breuer, of the Breuer Electric Manufacturing

Company, Chicago, "thereby saving time, money, and inconvenience for us and our customers, as well as doing away with troublesome replacements."

These unbreakable Soft Rubber Connectors and Soft Rubber Plugs can be furnished as a part of the Belden Cut Cord Service on cords in a variety of sizes and insulations (including textile as well as all-rubber) lengths to your specifications.

Send cord specifications and sample will be furnished.

BELDEN PRODUCTS

**Beldenamel and Textile
 Magnet Wire**
Coil Windings
Beldenmold
 (Molded Bakelite Products)
Automotive Wires and Cables
Airplane Assemblies
**Radio Wires, Cords
 and Cables**
Rubber Covered Wires
Armored Cables
Flexible Armature Wires
Motor Lead Wires
**Braided and Stranded
 Copper Cables**
Cotton Sleaving

Belden Manufacturing Company

2316-B South Western Ave.

Chicago, Ill.

*Specify
 Belden*