

*Engl. Bauer*

# JOURNAL OF THE A. I. E. E.

NOVEMBER 1929



PUBLISHED MONTHLY BY THE  
AMERICAN INSTITUTE OF ELECTRICAL ENGINEERS  
33 WEST 39TH ST.  
NEW YORK CITY

# MEETINGS

of the

American Institute of Electrical Engineers

---

DISTRICT MEETING, Great Lakes District No. 5,  
Chicago, Illinois, December 2-4, 1929

WINTER CONVENTION, New York, N. Y., January  
27-31, 1930



## MEETINGS OF OTHER SOCIETIES

American Mathematical Society, Annual Meeting, Lehigh  
University, Bethlehem, Pa., December 27-28, 1929

Naval Architects and Marine Engineers, Engineering Societies  
Building, November 14-15, 1929

Society of Automotive Engineers, Toronto, Canada, November  
12-15, 1929

The American Society of Mechanical Engineers, Engineering  
Societies Building, New York, N. Y., December 2-6, 1929

The American Society of Refrigerating Engineers, New York,  
N. Y., December 4-7, 1929. (D. L. Fiske, 37 West 39th St.,  
New York, N. Y.)



# JOURNAL of the A. I. E. E.

PUBLISHED MONTHLY BY THE AMERICAN INSTITUTE OF ELECTRICAL ENGINEERS  
33 West 39th Street, New York

## PUBLICATION COMMITTEE

W. S. GORSUCH, *Chairman*, H. P. CHARLESWORTH, F. L. HUTCHINSON, DONALD McNICOL, E. B. METER

GEORGE R. METCALFE, *Editor*

Changes of advertising copy should reach Institute headquarters by the 15th day of the month for the issue of the following month.  
Subscription: \$10.00 per year to United States, Mexico, Cuba, Porto Rico, Hawaii and the Philippines, \$10.50 to Canada, Central America, South America, Haiti, Spain and Colonies, and \$11.00 to all other countries.  
Single copies \$1.00.

Entered as matter of the second class at the Post Office, New York, N. Y., May 10, 1905, under the Act of Congress, March 3, 1879.  
Acceptance for mailing at special rate of postage provided for in Section 1103, Act of October 3, 1917, authorized on August 3, 1918.

Vol. XLVIII

NOVEMBER 1929

Number 11

## TABLE OF CONTENTS

### Papers, Discussions, Reports, Etc.

The Presidents Message.....	793	Effect of Color of Tank on Temperature (Abridged), by V. M. Montsinger and L. Wetherill.....	821
Some Leaders of the A. I. E. E.....	794	Report of Committee on Electrical Machinery (Abridged), W. J. Foster, Chairman.....	825
The Theory of Electrical Conductivity, by W. V. Houston.....	795	Effect of Surges on Transformer Windings (Abridged), by J. K. Hodnette.....	829
Motion Picture Camera in Electrical Testing.....	799	Report of Committee on Electrophysics (Abridged), V. Karapetoff, Chairman.....	833
Dial Telephone System (Abridged), by F. O. Wheelock.....	800	The Sixty-Cycle Flashover of Long Suspension Insulator Strings, by R. H. Angus.....	837
Report of Committee on Transmission and Distribution (Abridged), H. R. Woodrow, Chairman.....	804	A 4000-Lb. Telescope Disk.....	841
Chain Drives for Factories.....	808	Illumination Items	
Parallel Operation of Transformers (Abridged), by M. MacFerran.....	809	Twenty-Ampere Series Circuits for Street Lighting.....	842
Impulse Insulation Characteristics of Wood-Pole Lines (Abridged), by H. L. Melvin.....	813	Calorimeter Test on 68,750-Kv-A. Turbine Generator, by J. M. Calvert.....	842
Rehabilitation of Steam Power Plants (Abridged), by C. F. Hirshfeld.....	817		

### Institute and Related Activities

The Chicago District Meeting.....	843	Addresses Wanted.....	851
En Route to the World Engineering Congress.....	844	A. I. E. E. Section Activities	
National Research Council		New York Section Meeting on Wonders of Sound Transmission.....	852
Three-Day Insulation Conference at M. I. T.....	844	New York Section Transportation and Communication Groups.....	852
Annual Meeting of the American Mathematical Society.....	845	Future Section Meetings.....	852
Massachusetts Institute hears Hydraulic Engineer	845	Iowa Section Organized.....	852
The Washington Award.....	845	Meeting of Executive Committee of Middle Eastern District.....	852
Standards		Past Section Meetings.....	853
Symbols for Mechanics, Structural Engineering and Testing Materials.....	845	A. I. E. E. Student Activities	
Proposed Model of Standard for Adequacy of Wiring of Commercial and Industrial Buildings.....	845	Student Branch at University of Mexico.....	854
World Power Conference—American Committee Appointed.....	845	Student Branch at Southern Methodist University.....	854
Meeting of Naval Architects and Marine Engineers.....	846	Past Branch Meetings.....	854
S. A. E. Transportation Meeting.....	846	Engineering Societies Library	
Report of Technical Discussion at Pacific Coast Convention.....	846	Book Notices.....	856
A. I. E. E. Directors Meeting.....	847	Engineering Societies Employment Service	
A New Evening Course at the University of Pennsylvania.....	848	Positions Open.....	857
General Lytle Brown Appointed Chief of Engineers.....	848	Men Available.....	857
The John Fritz Medal to Doctor Modjeski.....	848	Membership	
Book Review.....	849	Applications, Elections, Transfers, Etc.....	858
Personal Mention.....	850	Officers A. I. E. E.....	859
Obituary.....	850	List of Sections.....	860
		List of Branches.....	860
		Order for Reprints of Papers Abridged in JOURNAL.....	861
		Digest of Current Industrial News.....	862

A REQUEST FOR CHANGE OF ADDRESS must be received at Institute headquarters at least ten days before the date of issue with which it is to take effect. Duplicate copies cannot be sent without charge to replace those issues undelivered through failure to send such advance notice. With your new address, be sure to mention the old one, indicating also any changes in business connections.

Copyright 1929. By A. I. E. E.

Printed in U. S. A.

Permission is given to reprint any article after its date of publication, provided proper credit is given,  
(The Journal of the A. I. E. E. is indexed in Industrial Arts Index.)

# MEETINGS

of the

American Institute of Electrical Engineers

---

DISTRICT MEETING, Great Lakes District No. 5,  
Chicago, Illinois, December 2-4, 1929

WINTER CONVENTION, New York, N. Y., January  
27-31, 1930



## MEETINGS OF OTHER SOCIETIES

American Mathematical Society, Annual Meeting, Lehigh  
University, Bethlehem, Pa., December 27-28, 1929

Naval Architects and Marine Engineers, Engineering Societies  
Building, November 14-15, 1929

Society of Automotive Engineers, Toronto, Canada, November  
12-15, 1929

The American Society of Mechanical Engineers, Engineering  
Societies Building, New York, N. Y., December 2-6, 1929

The American Society of Refrigerating Engineers, New York,  
N. Y., December 4-7, 1929. (D. L. Fiske, 37 West 39th St.,  
New York, N. Y.)



# JOURNAL of the A. I. E. E.

PUBLISHED MONTHLY BY THE AMERICAN INSTITUTE OF ELECTRICAL ENGINEERS  
33 West 39th Street, New York

## PUBLICATION COMMITTEE

W. S. GORSUCH, *Chairman*, H. P. CHARLESWORTH, F. L. HUTCHINSON, DONALD McNICOL, E. B. MEYER

GEORGE R. METCALFE, *Editor*

Changes of advertising copy should reach Institute headquarters by the 15th day of the month for the issue of the following month.  
Subscription: \$10.00 per year to United States, Mexico, Cuba, Porto Rico, Hawaii and the Philippines, \$10.50 to Canada, Central America, South America, Haiti, Spain and Colonies, and \$11.00 to all other countries.  
Single copies \$1.00.

Entered as matter of the second class at the Post Office, New York, N. Y., May 10, 1905, under the Act of Congress, March 3, 1879. Acceptance for mailing at special rate of postage provided for in Section 1103, Act of October 3, 1917, authorized on August 3, 1918.

Vol. XLVIII

NOVEMBER 1929

Number 11

## TABLE OF CONTENTS

### Papers, Discussions, Reports, Etc.

The Presidents Message.....	793	Effect of Color of Tank on Temperature (Abridged), by V. M. Montsinger and L. Wetherill.....	821
Some Leaders of the A. I. E. E.....	794	Report of Committee on Electrical Machinery (Abridged), W. J. Foster, Chairman.....	825
The Theory of Electrical Conductivity, by W. V. Houston.....	795	Effect of Surges on Transformer Windings (Abridged), by J. K. Hodnette.....	829
Motion Picture Camera in Electrical Testing.....	799	Report of Committee on Electrophysics (Abridged), V. Karapetoff, Chairman.....	833
Dial Telephone System (Abridged), by F. O. Wheelock.....	800	The Sixty-Cycle Flashover of Long Suspension Insulator Strings, by R. H. Angus.....	837
Report of Committee on Transmission and Distribution (Abridged), H. R. Woodrow, Chairman.....	804	A 4000-Lb. Telescope Disk.....	841
Chain Drives for Factories.....	808	Illumination Items	
Parallel Operation of Transformers (Abridged), by M. MacFerran.....	809	Twenty-Ampere Series Circuits for Street Lighting.....	842
Impulse Insulation Characteristics of Wood-Pole Lines (Abridged), by H. L. Melvin.....	813	Calorimeter Test on 68,750-Kv-A. Turbine Generator, by J. M. Calvert.....	842
Rehabilitation of Steam Power Plants (Abridged), by C. F. Hirshfeld.....	817		

### Institute and Related Activities

The Chicago District Meeting.....	843	Addresses Wanted.....	851
En Route to the World Engineering Congress.....	844	A. I. E. E. Section Activities	
National Research Council		New York Section Meeting on Wonders of Sound Transmission.....	852
Three-Day Insulation Conference at M. I. T.....	844	New York Section Transportation and Communication Groups.....	852
Annual Meeting of the American Mathematical Society.....	845	Future Section Meetings.....	852
Massachusetts Institute hears Hydraulic Engineer	845	Iowa Section Organized.....	852
The Washington Award.....	845	Meeting of Executive Committee of Middle Eastern District.....	852
Standards		Past Section Meetings.....	853
Symbols for Mechanics, Structural Engineering and Testing Materials.....	845	A. I. E. E. Student Activities	
Proposed Model of Standard for Adequacy of Wiring of Commercial and Industrial Buildings	845	Student Branch at University of Mexico.....	854
World Power Conference—American Committee Appointed.....	845	Student Branch at Southern Methodist University.....	854
Meeting of Naval Architects and Marine Engineers.....	846	Past Branch Meetings.....	854
S. A. E. Transportation Meeting.....	846	Engineering Societies Library	
Report of Technical Discussion at Pacific Coast Convention.....	846	Book Notices.....	856
A. I. E. E. Directors Meeting.....	847	Engineering Societies Employment Service	
A New Evening Course at the University of Pennsylvania.....	848	Positions Open.....	857
General Lytle Brown Appointed Chief of Engineers.....	848	Men Available.....	857
The John Fritz Medal to Doctor Modjeski.....	848	Membership	
Book Review.....	849	Applications, Elections, Transfers, Etc.....	858
Personal Mention.....	850	Officers A. I. E. E.....	859
Obituary.....	850	List of Sections.....	860
		List of Branches.....	860
		Order for Reprints of Papers Abridged in JOURNAL.....	861
		Digest of Current Industrial News.....	862

A REQUEST FOR CHANGE OF ADDRESS must be received at Institute headquarters at least ten days before the date of issue with which it is to take effect. Duplicate copies cannot be sent without charge to replace those issues undelivered through failure to send such advance notice. With your new address, be sure to mention the old one, indicating also any changes in business connections.

Copyright 1929. By A. I. E. E.

Printed in U. S. A.

Permission is given to reprint any article after its date of publication, provided proper credit is given, (The Journal of the A. I. E. E. is indexed in Industrial Arts Index.)

# AMERICAN INSTITUTE OF ELECTRICAL ENGINEERS

## —Some Activities and Services Open to Members—

**Attendance at Conventions.**—Taking part in the Institute conventions is one of the most useful and helpful activities which membership in the Institute affords. The advantages offered lie in two distinct channels, technical information and personal contacts. The papers presented are largely upon current problems and new developments, and the educational advantages of hearing and taking part in the discussion of these subjects in an open forum cannot but broaden the vision and augment the general knowledge of those who participate. Equally advantageous is the opportunity which conventions afford to extend professional acquaintances and to gain the inspiration which grows out of intimate contact with the leaders in electrical engineering. These conventions draw an attendance of 1000 to 2000 people and constitute milestones in the development of the electrical art.

**Presentation of Papers.** An important activity of the Institute is the preparation and presentation of papers before meetings of the Institute. Opportunity is offered for any member to present a paper of general interest to engineers at an Institute meeting, or of having shorter contributions published in the JOURNAL without verbal presentation. In preparing a paper for presentation at a meeting, the first step should be to notify the Meetings and Papers Committee about it so that it may be tentatively scheduled. Programs for the meetings are formulated several months in advance, and unless it is known well in advance that a paper is forthcoming, it may be subject to many months delay before it can be assigned to a definite meeting program. Immediately upon notification, the author will receive a pamphlet entitled "Suggestions to Authors" which gives in brief form instructions in regard to Institute requirements in the preparation of manuscripts and illustrations. This pamphlet contains many helpful suggestions and its use may avoid much loss of time in making changes to meet Institute requirements.

Manuscripts should be in triplicate and should be sent to Institute headquarters at least three months in advance of the date of the meeting for which they are intended. They are then submitted first to the members of the technical committee covering the subject of the paper, and if approved will next go to the Meetings and Papers Committee for final disposal. After final acceptance, the paper goes to the Editorial department for printing which requires usually from two to three weeks. Advance copies are desired about ten days prior to the meeting in order to distribute the paper to members desiring to discuss it. Considering the routine through which all papers must pass, the advantage of prompt notification and early submission of manuscripts will be apparent.

**Publications of the A. I. E. E.**—The chief publications of the Institute are the JOURNAL, QUARTERLY TRANSACTIONS, A. I. E. E. STANDARDS, and the YEAR-BOOK.

The JOURNAL, a monthly publication which every member receives, contains two sections, one devoted to technical papers, and the other to current activities of the Institute and other related subjects of engineering interest. The technical section consists largely of rather complete abridgments of the papers presented at conventions and meetings of the Institute. These are brief enough to enable the reader to keep posted in the various fields of engineering which the papers cover; and complete copies of any paper are sent gratis to the reader who wishes to specialize on any subject. The second section of the JOURNAL is designed to keep members acquainted with the activities of the Institute and with the news of the engineering world in general.

The QUARTERLY TRANSACTIONS contain the papers and discussions at Institute meetings and are the only publications in which they are printed in full. These volumes are designed principally for reference books, and are furnished to members at a very nominal cost. These volumes practically constitute the history of the art of electrical engineering, as they contain papers covering every major electrical development.

The A. I. E. E. STANDARDS which were formerly published in a single book have so increased in volume that they are now divided into more than thirty individual sections and the number is constantly growing. This arrangement gives greater latitude in publishing revisions of any sections promptly, and convenient binders are furnished for filing all the individual sections under one cover. An index for the complete set is also available. The standards are supplied to members at a very small cost.

The YEAR-BOOK is published annually and contains an alphabetical and a geographical list of members corrected to January first each year. It also includes a section giving general information about the Institute, the Constitution, By-laws, Code of Principles of Professional Conduct and the Annual Report of the Board of Directors. The Year-Book is sent free to members on request.

# JOURNAL OF THE A. I. E. E.

DEVOTED TO THE ADVANCEMENT OF THE THEORY AND PRACTISE OF ELECTRICAL ENGINEERING AND THE ALLIED ARTS AND SCIENCES

*The Institute is not responsible for the statements and opinions given in the papers and discussions published herein.  
These are the views of individuals to whom they are credited and are not binding on the membership as a whole.*

Vol. XLVIII

NOVEMBER, 1929

Number 11

*A Message From the President.*

## The Centralizing and Coordinating Agencies in the Interrelationships of the Institute

SEVERAL of the more important interrelationships pertaining particularly to the functioning of various internal activities of the Institute have been outlined briefly on these pages in the last three issues of the Journal. With increased growth and scope of the Institute, new external connections requiring coordination likewise have arisen. Therefore, with extension of these contacts, two natural and important influences have been at work. One, due to internal relations, is both centralizing and decentralizing. The other, due to external association, is necessarily centralizing.

With the broader geographical distribution of its membership, a decentralizing influence within the Institute has been recognized, and met, by the establishment of the ten district organizations, each provided with its own executives and committees. Each of these ten district units, and possibly others yet to be established, are charged with the responsibility of furthering the best interests of its particular district through District meetings, prizes, Section and Branch activities, etc. Each one has also the important duty of coordinating its own effort and activity with the centralizing, controlling and coordinating efforts of the Institute's Board of Directors and Headquarters. This obligation whereby each part be cognizant of the whole and the whole cognizant of all its parts has become a most important task. This condition is full of opportunity for both service and experience in the interests of both. Upon mutual effort and ability to meet these problems depends much of the success of both the District and the Institute as a whole.

Upon the Board of Directors, through the executive work of Institute Headquarters, devolves the duty not only of cooperating with and assisting the District organizations but also of centralizing and coordinating the latter's effort to give to the Institute the most efficient organization possible.

Acting for the Board of Directors, the Institute Headquarters, therefore, becomes not only the centralizing, coordinating agent of internal relationships, but also the coordinating unit of the Institute's external activities. As such, it reaches, here and there, for all that is best for the advancement of the theory and application of electrical engineering; the profession of electrical engineering itself, in this and other countries. Thus only can the Institute achieve its purpose. The Board of Directors and National Headquarters with the many ramifications of their work constitute more than the centralizing, coordinating agency of the Institute. As representing the membership of the Institute, they become the centralizing body, in this country, of the entire profession. This position has been won for the Institute through years of earnest devotion to the development of all that pertains to that profession. The recognition of this position carries the added responsibility of cooperation with "the allied arts and sciences" here and abroad.

*Harold B. Smith*

*President*



### Some Leaders of the A. I. E. E.

P. Junkersfeld, Vice-President of the Stone and Webster Corporation, Associate Member of the Institute 1901, Fellow 1912, and Vice-President 1916-18, was born near Sadorous, Illinois, October 17, 1869. In 1895 he obtained a B. S. degree at University of Illinois, and in 1907, E. E. He has engaged in engineering and construction ever since 1895.

Soon after graduation in 1895, Mr. Junkersfeld entered the employ of the Chicago Edison Company and its successor, with which interests he remained for nearly 24 years. Beginning with two years in power plant operation, he rose in the organization until, in 1899, he became head of the Engineering Department, and in 1909, Assistant Vice-President, supervising the contracting, operating, construction, and electrical departments. He was intimately identified with the Fisk, Quarry, Northwest, and other steam power plants (aggregating over 600,000 kv-a. when he resigned in 1919), and corresponding transmission lines, substations, distributing system and other physical properties; he has also engaged in commercial activities, particularly electric service and power rating and negotiations resulting in supplying power required by all elevated and surface electric railways of Chicago. He served also in the capacity of consultant, and for five years was chairman of a monthly engineering, constructing, and operating conference of various Insull public utilities in several states. In 1916 he became President of the Association of Edison Illuminating Companies. By Josephus Daniels, Secretary of the Navy, he was appointed to the Board of Directors for Industrial Preparedness in Illinois, and was made an Associate Member of the Naval Consulting Board.

He became a member of the Officers' Reserve Corps in February 1917, and on June 7, 1917 began active service in the World War, continuing until March 4, 1919 in the successive ranks of Major, Lieutenant-Colonel and Colonel, engaged in the construction of cantonments, camps, hospitals, port terminals, warehouses, munition plants and other war construction. On July 15th, 1919 Newton D. Baker, Secretary of War, presented him with the Distinguished Service Medal.

In April 1919 he resigned from the Commonwealth Edison Company to become associated with Stone & Webster, Inc., of Boston, as Engineering Manager and executive of the Construction and Engineering Division. During the following three years, this Division constructed about 300,000 kv-a. in 14 steam and four hydroelectric plants and extensions, and about 20,000 boiler horsepower in six industrial and steam heating boiler plants; he also engaged in industrial work including a complete sugar refinery, five rubber works, fabric and hosing works, and other industrial and general construction developments.

In February 1922, he resigned from Stone & Webster, Inc., to become a partner in the firm McClellan & Junkersfeld, Inc., Engineers and Constructors, whose

first important work was the design and construction of the Cahokia power plant for the Union Electric Light & Power Co. of Illinois, near East St. Louis, Ill. With extensions and commitments authorized, this plant has a capacity of about 340,000 kw., and a probable ultimate capacity of 450,000 kw. It was the second large public utility electric plant designed to burn exclusively pulverized coal. Engineering service was rendered also for the Cleveland Electric Illuminating Company on its Avon and East 70th Street plants, and engineering and construction service for the new San Francisco steam plant of the Great Western Power Co. in California. In six years, beginning 1922, his firm did engineering, construction, and report work in a total of 21 States and three Provinces of Canada, including about 1,200,000 kv-a. in steam-electric plants, and pulverized coal installations totaling over 110,000 boiler horsepower, exclusive of various industrial installations.

On July 19, 1928 the firm of McClellan & Junkersfeld, Inc., was merged with the Division of Construction and Engineering of Stone & Webster, Inc., to form the Stone & Webster Engineering Corporation, with Mr. Junkersfeld Vice-President.

He has written many technical papers, among them "Multiple vs. Independent Operation of Power Plants" (1901); "Periodic Inspection of Steam Turbines" (1907); "Effect of Load Factor on Steam Station Costs" (1921); "Obsolescence as a Factor in Design of Steam Generating Stations" (1923); "General Review of Current Practice in Steam Power Stations" (1924); (The last presented before the First World Power Conference in London jointly by Mr. Junkersfeld and Mr. G. A. Orrok), as well as other articles and discussions before engineering and technical associations and printed in various publications.

He was first President of the Construction Division Association; is a Past-President of Association of Edison Illuminating Companies, and Past Vice-President of Western Society of Engineers. He is also a member of The American Society of Mechanical Engineers; American Society of Civil Engineers; National Electric Light Association; Edison Pioneers; Engineers' Clubs of Chicago and New York; Western Universities Club of New York; the Lawyers' Club; and the Scarsdale Golf Club.

The Year Book of the Czechoslovak Electric Association shows that of a total of 457 electric power stations in that country 311 are owned by power companies and 146 by manufacturers. The power companies generated 719,000,000 kw.-hr. in 1927 with an installed capacity of 396,700 kw. The total energy generated in Czechoslovakia in 1927 amounted to 1,700,000,000 kw.-hr., which gives an average of 125 kw.-hr. annually per capita. This is an increase by 12.5 per cent compared with 1926.

There are 13,000 miles of high-tension transmission lines in Czechoslovakia and the mileage is increasing at the rate of 17.5 per cent a year.

# The Theory of Electrical Conductivity

## Recent Developments

BY WILLIAM V. HOUSTON\*

Non-member

*Synopsis.*—This paper explains the electrical conductivity of metals in light of recent discoveries regarding the behavior of electrons. It is claimed that these discoveries have made possible a satisfactory theory of conduction. The more important discovery is that of the wave nature of the electrons. The other new discovery is known as Pauli's "exclusion principle" which states that no two electrons in a wire can have exactly the same velocity and direction of motion. In working out the theory, the

statistical method of the Fermi distribution function is employed.

The paper shows that the theory satisfactorily explains how there may be emissions of electrons from a hot wire in spite of the fact that very little energy is put into the electrons by raising the temperature, it explains relative resistances of metals and their alloys, the contact potential between metals, the thermoelectric effect, the Peltier effect and the change in resistance due to a magnetic field.

\* \* \* \* \*

FOR the past 30 or 40 years the attempt has been made in the study of physics to explain all of the properties of matter on the basis of ultimate electrical particles. It has been assumed that a piece of material is made up of a very large number of positively charged particles called protons, and of negatively charged particles called electrons. This assumption is based on the experimental fact that it is possible to separate positive and negative particles from all kinds of matter. The numerical value of the charge on one particle is found to be the same as that on the other. Furthermore, the total numbers of protons and electrons are the same, so that there is no electrical charge on the body; but the mass of a proton is some 1840 times as large as that of an electron, so that the weight of a body is essentially that of the protons. It is found that all of the protons and about half of the electrons are gathered together into small clusters which are the atomic nuclei. These nuclei then have a resultant positive charge, and are surrounded by enough negative electrons to make a neutral atom. The number of positive charges on the nucleus, which is the same as the number of electrons around the nucleus, is equal to the atomic number of the element and determines its position in the periodic system of the elements. This method of interpreting experimental facts has had such tremendous success in so many fields that it seems almost certain that, in its broad outline, it represents correctly the constitution of matter.

With this picture, it is relatively easy to account qualitatively for the electrical conductivity of metals. When the atoms are packed as closely together as they are in a metal, the outer and more loosely attached electrons come under the influence of more than one atom and become free. In other words, they cannot be identified as belonging to one atom or another, and they move about between the atoms with very little restraint. Under these conditions, the application

of e. m. f. causes these electrons to filter between the fixed atoms, and so, to constitute a current. On the other hand, an insulator is a substance in which all of the electrons are tightly bound to individual atoms.

This idea was given a quantitative treatment by Drude,<sup>1</sup> Lorentz,<sup>2</sup> and others. They started out by treating the free electrons as though they were alone in the metal and behaved exactly as gas molecules, moving about with energy due to temperature. Thus we come to speak of the group of free electrons as an electron gas. If an e. m. f. is applied to such an electron gas, it starts of course an average motion of all the electrons in one direction. If there were nothing to interfere with the motion, the electrons would move faster and faster, and the current would continue to increase without limit. The limit is set, however, by the presence of the atoms themselves, or more strictly speaking, of the positive ions, which form the crystal lattice. When an electron collides with an ion which is more or less tightly bound to its position in the crystal, the electron loses the extra energy which it has acquired from the field. On this account, its velocity cannot increase indefinitely. Thus the collisions of the electrons with the fixed ions are observed as a resistance, and the resistance is proportional to the number of collisions per second.

It is perhaps desirable to look at the relative magnitudes of some of the quantities involved in this picture. If we make the very reasonable assumption that there is one free electron for every atom, there will be about  $6 \times 10^{22}$  free electrons per cu. cm. When there is no e. m. f. applied, these electrons will be moving with fairly high speeds in all directions, but the average velocity will be zero, so that the electron gas as a whole will not move. This distinction between the velocity of a single electron, and the average velocity of all electrons, which latter is the current, is the same as the distinction between the velocity of the molecules of air and the velocity of the air as a whole. The velocity of the molecules we recognize as heat, while the velocity of the whole we call wind. Now the velocity of a single electron will be of the order of  $10^8$  cm. per sec., while if

\*Assistant Professor of Physics, California Institute of Technology, Pasadena, California.

1. For references see Bibliography.

Presented at the Pacific Coast Convention of the A. I. E. E., Santa Monica, Calif., Sept. 3-6, 1929. Printed complete herein.

the average velocity of the whole is as great as only one cm. per sec. there will be the tremendous current of about 8000 amperes per sq. cm. or about 50,000 amperes per sq. in. This shows that the applied e. m. f. produces only a *very minute* change in the velocities of the electrons.

All this, of course, has nothing to do with the propagation of the e. m. f. along the wire. That is governed by Maxwell's equations and can be explained as a result of the mutual repulsions of the electrons. This mutual repulsion can be neglected except, perhaps, in the finer details of the theory of conductivity.

Qualitatively, this picture is very satisfactory; but there are very serious difficulties with the quantitative treatment. In the first place, if there is at least one free electron for each atom in the metal, the electron gas should have a specific heat about half as large as that due to the vibration of the ions which make up the crystal. But the observed specific heat is merely that of the ions themselves. This constitutes a very serious objection to the classical theory, since it indicates that not enough energy is put into the metal when the temperature is raised to account for the assumed increased energy of the electrons. In the second place, the number of free electrons which must be assumed to explain the different electrical properties of a metal varies between such wide limits that the theory, is evidently inconsistent. Another difficulty is that when the resistance is calculated by means of this theory it is found to be proportional to the square root of the temperature, which is not at all in accord with the observed facts.

On account of these difficulties, many attempts have been made to give other pictures of the behavior of the electrons in a metal. Some of these have been based on the idea that the electrons do not become free from the atoms, but remain attached and under the influence of an applied e. m. f. occasionally pass from one atom to the next. In this case, of course, the electrons need have no specific heat, since they do not move independently of the atom. But it is just this lack of an independent motion which makes it difficult to explain the emission of electrons from hot wires which we use in thermionic vacuum tubes. It is usually thought that this is due to the fact that certain electrons acquire a very high velocity and so are able to pass through the retaining wall of potential which bounds the metal. If there is no motion due to temperature energy, this could not be the case.

Thus, until recently, the theory of the electrical properties of metals contained a number of conflicting hypotheses, and it seemed impossible to form a consistent theory with a few simple assumptions. Within the last few years, two important discoveries have changed the whole aspect of the situation. Perhaps the more important of these discoveries has been the discovery of *the wave nature of the electrons*.

For several centuries there have been two rival explanations of the phenomena of light,—the wavetheory and the corpuscular theory. During the nineteenth century, the weight of evidence became almost overwhelmingly in favor of the wave theory, but with the discovery of the photoelectric effect in 1888, it became necessary to use the corpuscular theory, (which has been called the quantum theory), to explain the phenomena of the interaction of light with matter. But although there have been two theories of light, there has been only one theory of the nature of electrons. Since the very early experiments on cathode rays, there has been practically no doubt as to the nature of electrons. They seemed in every way to satisfy the requirements of corpuscles of electricity. No one ever thought of investigating the wave properties of electrons until it was accidentally discovered in 1927 that a stream of electrons produces a diffraction pattern in the same way as a beam of X-rays.<sup>3</sup> Many theoretical considerations had been pointing toward the necessity of treating electrons as waves under some circumstances. Through this experimental confirmation of the theory, *we have now just as good evidence for saying that a stream of electrons is a train of waves as we have for saying the same thing about a beam of light*. The quantum theory, which was so called because it seemed to require that light should be propagated in corpuscles or quanta, has now come to include the requirement that electrons should have the properties of waves. This duality of nature, of both light and electrons, is now a firmly fixed experimental fact. It is one of the discoveries which has made possible a satisfactory theory of electrical conduction.

The other essentially new feature in the present theory is known as Pauli's exclusion principle. Applied to the problem in hand, this states that no two electrons in a wire can be in the same quantum state, *i. e.*, they cannot have exactly the same velocity and direction of motion. At first this seems an outrageous restriction, and yet there is a great deal of experimental evidence in favor of it. It is the basis of the theory of the periodic system of the chemical elements, as well as the very extensive and satisfactory theory of spectra. This principle, combined with the fact of the wave nature of the electrons, makes it necessary to revise the statistics with which we treat the electron gas in a metal.

On account of the large number of electrons with which we have to deal, it is necessary to use the methods of statistical mechanics. There are several different varieties of statistics, each one adapted to dealing with a certain kind of object. It is perhaps easiest to characterize the different types of statistics by giving their distribution functions. These functions give the number of electrons which may be expected to have velocities in a given range.

The classical statistics were developed largely by Maxwell and Boltzmann, and are adapted to the treat-



ment of material particles. The distribution function for these is

$$dn = A e^{-mv^2/2kT} d\xi d\eta d\zeta \quad (1)$$

This means that  $dn$  is the number of electrons, on the average, whose velocity components in the  $x$ ,  $y$ , and  $z$  directions lie between  $\xi$  and  $\xi + d\xi$ ,  $\eta$  and  $\eta + d\eta$ ,  $\zeta$  and  $\zeta + d\zeta$ .  $v$  is the total velocity,  $k$  is the molecular gas constant,  $m$  the mass of the electron, and  $T$  is the absolute temperature. The curve of this function for two different temperatures is shown in Fig. 1. It is evident from Equation (1), as well as from

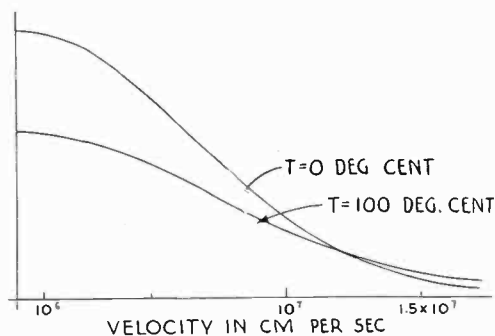

FIG. 1—THE MAXWELL OR CLASSICAL DISTRIBUTION PLOTTED AS A FUNCTION OF VELOCITY

Fig. 1 that as the temperature increases, the curve becomes more and more spread out, so that more electrons are found with high velocities.

The theory of quantum statistics with which we are concerned was developed by the Italian Fermi,<sup>4</sup> and independently by the Englishman Dirac. It is based on assumptions which make it applicable to wave motions when the Pauli exclusion principle applies. Thus, according to our latest knowledge concerning the nature of electrons, it should apply to electrons. The distribution function in this case is

$$dn = \frac{2m^3}{h^3} \frac{1}{\frac{1}{A} e^{mv^2/2kT} + 1} d\xi d\eta d\zeta \quad (2)$$

where the letters have the same significance as in Equation (1);  $h$  is known as Planck's constant of action and characterizes all equations in the quantum theory. The constant  $A$  in both functions is determined so that the integral of  $dn$  over all possible values of  $v$  gives the total number of electrons present. In the Maxwell distribution function in Equation (1),  $A$  is merely a constant by which the exponential function is multiplied, but in the Fermi distribution, the size of  $A$  determines the nature of the function. If  $A$  is very much smaller than 1, the first term in the denominator is so large that the other may be neglected. The function then becomes the same as the Maxwell function. But in the opposite case, the functions are entirely different. The value of  $A$ , when  $A$  is large, can be determined from the equation

$$\log A = (h^2/2mkT) (3n/8\pi)^{2/3} \quad (3)$$

where  $n$  is the number of electrons per cu. cm. Because of the very large number of free electrons when it is assumed that there is one per atom,  $A$  for ordinary metals is about  $10^{90}$ . Thus, only the case where  $A$  is very large need be considered. Fig. 2 shows the curve of the Fermi distribution function for two different temperatures when  $A$  is given this value. A gas for which the constant  $A$  is greater than unity is called degenerate, and the size of  $A$  is a measure of the degeneracy.

It is evident from the curve and from Equation (2) that in the case of the highly degenerate electron gas, the temperature has only a very slight effect on the velocities of most of the electrons. Only the relatively few which have the higher velocities are affected at all. Since the temperature has very little effect upon the motion of the electrons, it follows that the specific heat of the electron gas is very small; in fact it is given by

$$C_v = (\pi^2 m k/h^2) (8\pi/3n)^{2/3} R T \quad (4)$$

where  $R$  is the gas constant for one gram molecular weight. For room temperature,  $C_v$  is less than 1 per cent of the value to be expected with the Maxwell distribution. This is one of the important successes of the present electron theory of metals and was pointed out by Sommerfeld<sup>5</sup> who developed the statistical

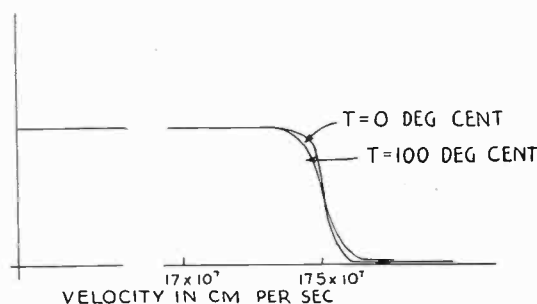

FIG. 2—THE FERMI DISTRIBUTION FUNCTION PLOTTED AS A FUNCTION OF VELOCITY

The scale of this figure is not at all comparable with that of Fig. 1.

phase of the theory. Now it can be understood why the electron gas makes practically no contribution to the specific heat of the metal.

But although the free electrons have a very low specific heat, they do not have a low energy of agitation. It is merely that this energy is not given up when the metal is cooled, but is retained and exists at the absolute zero of temperature. The average velocity of a free electron in a metal is of the order of  $10^8$  cm. per sec. This high velocity and the accompanying energy produces a pressure on the surface of the metal which amounts to something like  $2 \times 10^5$  atmospheres. Even with this pressure, however, the majority of the electrons are unable to escape from the metal because of the strong electric field which exists at the surface. But there will always be a few with extra large velocities, which can penetrate this surface layer and escape

from the metal, and the number of these increases with the temperature.

In Fig. 3, the Fermi distribution function for the degenerate electron gas is plotted with the energy instead of the velocity, for the horizontal axis.  $W_i$  represents the energy at which the function has dropped to  $\frac{1}{2}$ , while  $W_a$  represents the energy which an electron must have to escape from the metal. The electrons which escape are those represented by the part of the curve to the right of  $W_a$ . By calculating the number of electrons represented by this part of the curve, and taking account of the various directions in which they are traveling, Sommerfeld has shown that the current per sq. cm. coming from a hot wire is given by

$$I = (4 \pi e m / h^3) k^2 T^2 e^{-(W_a - W_i)/kT} \quad (5)$$

The equation derived by Dushman and others is:

$$I = B T^2 e^{-b/T} \quad (6)$$

In Equation (5)  $(W_a - W_i)/k$  takes the place of  $b$  in Equation (6). This shows that the  $b$  which is usually measured and called the work function, is not really the energy necessary for an electron to have in order to escape from the metal, but is the difference between

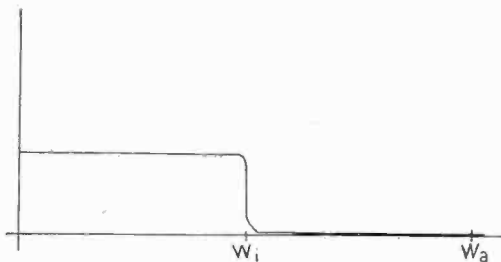

FIG. 3—THE FERMI DISTRIBUTION FUNCTION PLOTTED AS A FUNCTION OF ENERGY

this energy and an energy which represents the pressure of the electrons inside the metal. In this way, the theory explains completely why we can get emission of electrons from hot wires in spite of the fact that very little energy is put into the electrons by raising the temperature.

The outstanding electrical property of a metal is that of conductivity. It was mentioned above that a current is a relatively slow drift of all the electrons under the influence of an applied e. m. f. This drift would become faster and faster if it were not for the fact that the electrons collide with the metal atoms and so lose the acceleration they have gained from the field. Thus, the average gain in speed and the current is proportional to the time for which an electron can travel without a collision. The average distance which the electron can travel without making a collision is called the mean free path, and this quantity is generally used for calculation instead of the mean time between collisions. Sommerfeld has shown that when the Fermi statistics is used to describe the velocity distribution of the electrons, the specific conductivity in electrostatic units is given by

$$\gamma = (8 \pi e^2 / 3 h) (3 n / 8 \pi)^{2/3} l \quad (7)$$

In this equation  $e$  is the charge on one electron,  $h$  is Planck's constant of action,  $n$  is the number of free electrons per cu. cm., and  $l$  is the mean free path for those electrons whose energy is equal to the  $W_i$  of Equation (6);  $l$  is of the order of  $5 \times 10^{-6}$  cm. The mean free path is, of course, a function of the velocity, but only the length of the mean free path at this particular velocity is essential in the conductivity.

In Equation (7) all of the quantities except  $l$  are independent of the temperature, and so we must explain the fact that resistance increases with temperature by the fact that  $l$  decreases with temperature. It is here that the wave nature of the electron becomes directly apparent. The wavelength of an electron wave is determined by the velocity of the electron through the relation

$$\lambda = h / m v \quad (8)$$

This shows that the faster electrons have the shorter waves. From the Fermi statistics, it can be shown that the free electrons in a metal have such velocities that practically all of the wavelengths are greater than about 5 A or  $5 \times 10^{-8}$  cm. They are longer than most X-rays. This fact is of importance when we study the effect of a crystal upon these waves.<sup>6</sup> The behavior of an electron in a crystal can be considered from two points of view which correspond to the two natures of the electron. From the corpuscular point of view, the electron makes collisions with the atoms in the crystal and so is deflected from its path. From the wave point of view, the electron wave is diffracted by the crystal in the same way that a light wave is diffracted from an optical grating. In the case of electrons in a metal, the wave point of view is the correct one to use. Hence, the problem of determining the resistance of a metal is the same as the problem of determining the scattering of the electron waves by the atoms which form the lattice of the metallic crystal.

It is possible to calculate this scattering effect by the methods used for calculating the diffraction of X-rays by a crystal, when proper allowance is made for the difference in wavelength. The electron waves are longer than the distances between the atoms of most crystals, so that if the atoms were really stationary and regularly arranged, there would be no scattering at all, and hence, no resistance whatever. This is not the explanation, however, of the phenomenon of superconductivity, nor of the fact that the resistance becomes zero when the absolute temperature becomes zero, for there is very good evidence that the atoms in a crystal are not stationary, even at the absolute zero of temperature. There are still other ways in which the resistance may become zero, although if there were no motion of the atoms in the lattice, it would certainly be zero.

The thing that produces the diffraction of the electron waves and consequently the resistance is an irregularity in the arrangement of the metallic atoms. This ir-

regularity may come about either through the presence of impurities which distort the arrangement of the atoms, or through the motion due to the temperature energy. This latter effect produces the resistance in pure metals, while the first effect explains why the resistance of an alloy is always greater than the resistance of at least one of its constituents. It is easy to understand from this the reason for Matthiessen's rule which states that a small amount of impurity causes a small added resistance which is independent of temperature. This is explained by the fact that the irregularity in the crystal due to the impurity is essentially independent of temperature.

It is possible to calculate the resistance due to the heat motion of the metal atoms. This kind of calculation shows that the resistance, in its dependence on temperature, may be closely approximated by

$$R \text{ is proportional to } 1/x_0 \int_0^{x_0} \frac{x^4 dx}{(e^x - 1)(x^2 + a x_0^2)^2} \quad (9)$$

$x_0 = \theta/T$ , where  $\theta$  is a function of the elastic constants of the metal and  $T$  is the absolute temperature;  $a$  is a measure of the scattering power of a single atom and so is characteristic of the metal. Equation (9) shows that for ordinary temperatures, the resistance is proportional to the absolute temperature, while for lower temperatures, it falls off more rapidly than would be indicated by the simple proportionality with temperature.

The agreement of Equation (9) with the observations shows that the knowledge of the wave nature of the electron has made it possible for the first time to give a satisfactory explanation of the way in which the resistance depends on the temperature.

In addition to the phenomena already mentioned, there are several others which are explained in a satisfactory manner by the present theory. The sudden increase of resistance, which always appears when a pure metal is melted, is due to the destruction of the regularity of the crystal by the metal. The atoms in the solid have a regular arrangement, to a certain extent, while the atoms in the liquid are moving about at random. This loss of regularity causes a large increase in the scattering of the electron waves and a correspondingly large increase of resistance.

The fact that the resistance of a non-cubical metallic crystal is different in different directions can be attributed to the fact that the atoms in the non-cubical crystals can vibrate more easily in one direction than in the others. This causes the diffraction of the electron waves to vary with the direction. The corresponding difference in resistance, calculated on this basis, agrees very well with the observed differences.

A number of other effects, such as the contact potential between different metals, the thermoelectric effect, the Peltier effect, and the change in resistance due to a magnetic field, receive a consistent and satisfactory explanation on the basis of the Fermi statistics and the wave nature of the electron.

The study of atomic structure, which has engaged the

attention of physicists for the past 30 years, has now come to the stage where it is possible to treat not only single atoms, but molecules and those very large molecules which we know as solid bodies.

The first extensive application to solids has been the electron theory of metal which has been developed by Sommerfeld, Houston, Frenkel, Nordheim and Bloch.<sup>7</sup> This brief outline has sought to indicate the degree of success with which the modern theory of the electron has provided a unified treatment of this baffling physical problem.

### Bibliography

1. P. Drude, *Ann. der Physik*, 1900, 1, 566.
2. H. A. Lorentz, "The Theory of Electrons," pp. 267-273.
3. C. J. Davisson and L. H. Germer, *Phys. Rev.* 1927, 30, 705.
4. G. P. Thomson, *Proc. Roy. Soc.*, 1928, 117, 600.
5. E. Fermi, *Zeitsch. f. Physik*, 1926, 36, 902. P. A. M. Dirac, *Proc. Roy. Soc.*, 1926, 112, 661.
6. A. Sommerfeld, *Zeitsch. f. Physik*, 1928, 47, 1.
7. W. V. Houston, *Zeitsch. f. Physik*, 1928, 48, 449. J. Frenkel, *Zeitsch. f. Physik*, 1928, 47, 819.
8. F. Bloch, *Zeitsch. f. Physik*, 1929, 52, 555. L. Nordheim, *Zeitsch. f. Physik*, 1928, 46, 833.

### MOTION PICTURE CAMERA IN ELECTRICAL TESTING

The following brief résumé of an article describing the use of a motion picture camera in making certain electrical tests is given through the courtesy of Mr. Frank E. Fisher, of Chicago.

There appears in the February, 1929 issue of *The Transactions* of the South African Institute of Electrical Engineers an interesting article describing the use of a moving picture camera in connection with certain tests where meters of the oscillograph or recording variety are not applicable.

The general method is to mount the meters, which vary with the type of test to be run, on a panel and then take moving pictures of the instruments. Thus, the data taken by an ampere-hour meter, voltmeter, wattmeter, frequency-meter, speed indicator, etc., are accurately recorded on the film and can be studied at leisure. This method obviates the use of a man to read each instrument, thus avoiding the inaccuracy of the human element.

The readings may be taken on 16 mm. or 35 mm. standard film and many of the cameras on the market which have a fairly wide range, can be used. A spring-operated camera has been tried with good results.

The author of the article, who is also the originator of the method of test, suggests various uses for the scheme and illustrates the set-up which was used in studying the operation of the skip in a metal mine. In this case eleven instruments were mounted. The scheme was originated by Mr. L. B. Woodworth of the Central Mining and Investment Corporation of South Africa, and the experiments were conducted at the No. 14 Shaft of Crown Mine, and were eminently successful. The method is also being experimented with by the Victoria Falls Power Company.



# Abridgment of Dial Telephone System Serving Small Communities of Southern California

BY F. O. WHEELOCK<sup>1</sup>

Member, A. I. E. E.

*Synopsis.*—This paper briefly reviews the history of the step-by-step dial telephone system in small communities of metropolitan areas, and notes some of the reasons for its recent, rapidly growing use in small towns and communities apart from metropolitan areas. The wider appreciation of improved service by the public in the last

three years is noted, and requirements of the service now being rendered are discussed. The equipment is described, and the methods of operation and maintenance are given. The affect on outside plant, building design, and other incidentals is discussed, as are also the results obtained in the use of this telephone system.

## INTRODUCTION

**I**N rendering telephone service, two systems are in general use; the manual system and the dial system.

As the names imply, the fundamental difference between these two systems is that in the manual system, the principal central office operations for completing telephone calls are made by hand, and in the dial system they are made by machine. Today, dial telephone systems are in use in a great many places, chiefly in exchanges of considerable size with equipment arranged as a single unit having a capacity of ten thousand terminals or multiples thereof. The idea of providing telephone service for the smaller community by means of dial system equipment housed in small buildings and normally unattended is by no means new but its use in this manner has been limited for reasons explained later on.

It is the purpose of this paper to describe the small

operation and maintenance. The exchanges specifically referred to are located in the area shown in Fig. 1.

## REASONS FOR ADOPTING PRESENT SYSTEM

More than 15 years ago, there were several small dial offices of the step-by-step type serving portions of the Los Angeles and San Diego exchanges. Then these were known as "branch offices" and "automatic sub-offices." Each was in fact a part or an extension of the large dial office to which it was directly connected. Fig. 2



FIG. 1—MAP OF SOUTHERN CALIFORNIA

step-by-step dial telephone system. First, a brief history of its development is given, followed by a discussion of some of the considerations which led to its rather wide use in Southern California. Then a description is given of the equipment employed and its

1. Southern California Telephone Co., Los Angeles, Calif.

Presented at the Pacific Coast Convention of the A. I. E. E., Santa Monica, Calif., September 3-6, 1929. Complete copies upon request.

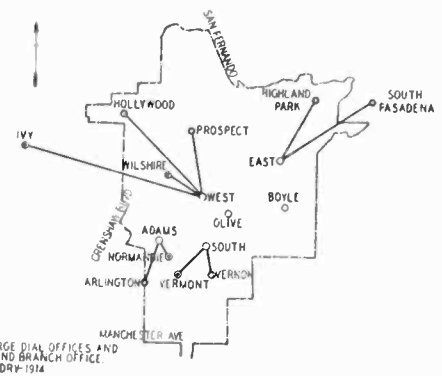

FIG. 2—MAP OF LOS ANGELES, SHOWING SMALL DIAL OFFICES IN 1914

shows the location of these offices in the Los Angeles exchange at that time. The branch office was fully attended, and while the sub-office was smaller and more of a complete unit in itself, it also required rather constant attendance.

The recent growing demand for full 24-hour service in progressive communities, and an effort to secure greater economy and efficiency in giving better service, were probably the motivating forces exerted in promoting in 1926 the idea of using dial equipment for serving the small community with equipment operating independent of the larger or nearby exchange except for trunking and for trouble alarm signals.

A study was made in the latter part of 1926, and plans were formulated for installing a modern small dial telephone system in the rapidly growing new town of San Clemente, California. Other installations have since been completed so that at the close of 1929, fourteen towns are similarly equipped. These are shown in Fig. 3 and include the following exchanges:

Arcadia, Buena Park, Dana Point, Fontana, Imperial, La Mesa, Ojai, Pacific Beach, Piru, Rancho Santa Fe, Reseda, San Clemente, San Ysidro, Vista.

In addition, the following other small communities in the same area are now served by step-by-step dial telephone systems, each including some of the features described herein:

Artesia, Barstow, Beaumont, Bellflower, Downey, Hynes, Indio, La Habra, Lynwood, Mar Vista, Norwalk, Palm Springs, Rivera, Victorville.

#### SERVICE REQUIREMENTS

A fundamental requirement in rendering universal telephone service is to have an operator readily available to the user in case assistance is necessary in completing a connection. This precludes the use of a telephone system that is mechanically operated in its entirety. In the small dial telephone system, this feature is taken care of by operators located at a center serving usually more than one exchange.

To insure satisfactory operation when called upon



FIG. 3—SMALL DIAL OFFICES, MANUAL OPERATING CENTERS, AND MAINTENANCE SERVICE CENTERS

by the subscriber while dialing a number, the equipment requires routine supervision of its operation at various periods. It also requires attention to predetermine defects, potential and actual, that may cause trouble. Therefore, from the standpoint of maintenance, also, it is not entirely unattended.

In addition, successful operation of a dial telephone system depends upon a third human factor,—the subscriber. The equipment may be designed, installed, and maintained properly with an operator readily available, but its operation will not be a success unless the subscriber uses his telephone properly.

#### DESCRIPTION OF THE EQUIPMENT

The outstanding items of improved central office equipment used are line finders rather than line switches; self-protecting apparatus which permits of omitting heat coils in the battery supply leads; reverting call selectors; 10-party code ringing connectors; choice of postpayment dial or postpayment manual coin box equipment; trouble alarm signals extending to the center from which the dial office is supervised; power plants with start and stop of charging current

automatically controlled; and ringing machines automatically controlled by selectors for the smaller exchange and continuously running for the larger exchange.

The regular subscribers' line equipment consists principally of line and cut-off relays. Dial coin box subscribers' line equipment consists of similar relays and associated equipment to furnish the necessary tone to indicate to the subscriber when to deposit a coin. Manual coin box subscribers' line equipment consists of a concentrating switch of the rotary type to connect the line to a trunk leading directly to the manually-operated center, and relays similar to those in the regular subscribers line.

In appearance, the line finder is similar to an ordinary selector, but in addition, it has a commutator and associated wiper for level hunting; it is a part of the call originating equipment and is used to connect the line of a calling subscriber to a first selector.

Local selectors are of the usual two-wire type universally used for local or incoming service. Toll selectors also are of the type used in the larger dial office. They are equipped with contacts that close with the vertical operation of the switch to operate a relay for controlling the start of the ringing machine in the offices where continuously run ringing machines are not employed.

Connectors are of the type used for the various classes of service, including one-bell, two-bell, rotary hunting, 10-party code ringing and toll.

Where transmission is satisfactory over the local train, toll selectors and toll connectors are not provided.

Repeaters are of the usual type.

Long line equipment consists of the usual relay, resistance, repeating coil, and condenser equipment to increase the normal impulsing and signaling range of the subscribers line.

The arrangement of the trouble alarm equipment includes visual and audible alarms which are extended to the adjacent manual operating center.

Ample testing equipment, for all central office equipment and for subscribers' line and station equipment, is furnished.

Distributing frames are of the floor or wall type, the protector usually terminating the outside cable.

The relay rack is of the usual channel iron type, and on it are mounted the long line, alarm, and other miscellaneous relay equipment.

The power plant includes storage batteries of either the portable or stationary type, and arrangements for facilitating maintenance, such as automatic voltage regulators, Tungar rectifiers, ampere-hour meters for the automatic starting and stopping of the charging current, and ringing machines, either continuously running or those controlled by selectors.

When the present movement toward the wider use of dial equipment for the small community was started, it was with a thought that by omitting operators rest

rooms, facilities for preparing lunches, etc., the central office quarters could be provided at much less expense than for manual equipment.

So far, use has been made of the standard 11-ft. 6-in. frames and racks, as in the large dial exchanges. Frames of heights 9 ft. 1¼ in. and 8 ft. 5¾ in. also have been used in some offices. These have required rooms with a fairly good ceiling height. As previously mentioned, however, it is expected that within a short time there will be available an equipment using

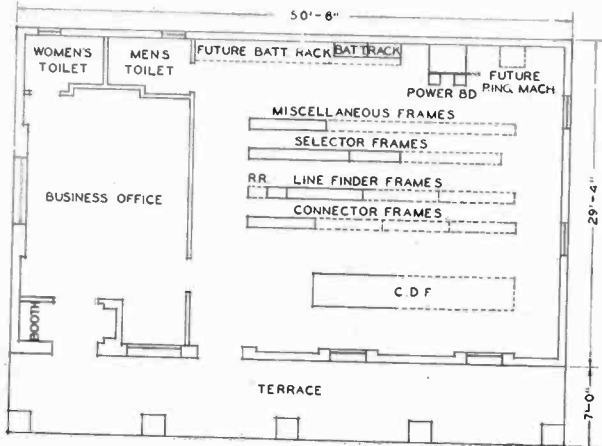

FIG. 6—FLOOR PLAN, OJAI

frames and racks limited to 7 ft., together with self-contained units for the mounting of line finders, selectors, and connectors which will permit of installing equipment in rooms 9 ft. in height.

The arrangement and floor space occupied by the equipment for one of the exchanges is shown in Fig. 6.

Some of the earlier offices were not provided with heating apparatus. It has been found necessary, how-

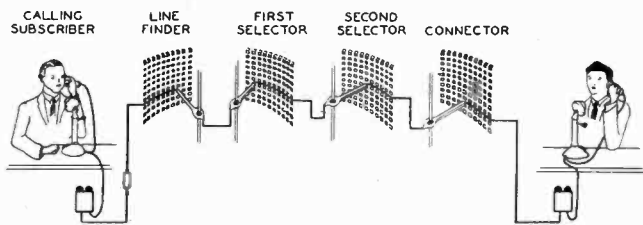

FIG. 7—PATH OF LOCAL CALL—SMALL DIAL OFFICE

ever, to place either gas or electric heaters in the majority of the small dial offices. When in use, these are regulated by thermostatic control and during cold or damp weather are operated continuously.

METHOD OF OPERATION

On an ordinary call, when a dial system subscriber removes his receiver, the line finder automatically connects the line to an idle first selector. The subscriber hears the dial tone, which indicates that he is connected to a first selector and that he may dial the number. The first digit of the desired number is dialed. The selector responding to the dial impulse is raised to the desired level, and, finding an idle trunk,

cuts the line through to the connector. In offices where the total terminals exceed 1000, a second selector is inserted in the circuit between the first selector and the connector. With the dialing of the last two digits, the connector steps up vertically and around horizontally until the dialed number is reached, at which time, if the line is not busy, the ringing starts. The ringing tone is heard by the calling party until the called party answers. If the line called tests busy, a busy signal is heard by the calling party. Fig. 7 shows the path of the call for a completed connection. If the called number is on a 10-party line, an additional digit is assigned. When this final digit is dialed, a minor switch, which is part of the connector, operates in a rotating motion and upon completion of the dialing, completes a circuit to relay equipment which sends out the required number of rings on the tip or ring side of the called line. The above method of operation is nearly identical with the method of operation in use in large exchanges where the line finder step-by-step type of equipment is employed.

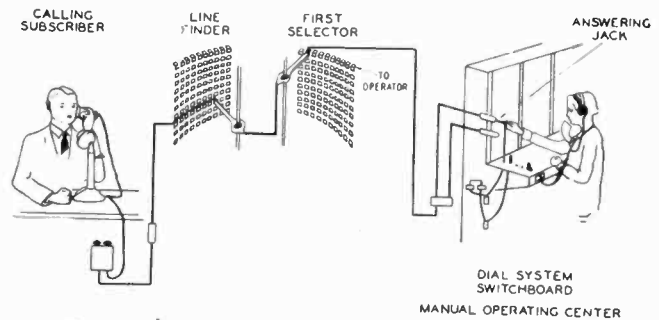

FIG. 8—PATH OF CALL FROM SMALL DIAL OFFICE TO MANUAL OPERATING CENTER

Numbering plans consisting of three and four digits are used in smaller exchanges, and those of four and five digits are used in the larger exchanges. As previously stated, where code ringing is used, the last digit indicates the code ring.

On out of town calls and assistance calls the subscriber dials "0" to connect with the operator at the manual center, as shown in Fig. 8, and the operator completes the call to the distant toll point. In handling assistance calls from the small dial exchange, the operator may dial the desired number over the regular paths to test for "busy" or "don't answer". Fig. 9 shows the path of an incoming call through the manually operated center to a dial system subscriber.

Where rotary hunting connectors are not provided, private branch exchange service is given by listing all the trunk numbers in the directory. In most small dial exchanges, no intercepting service is given for changed numbers, disconnected numbers, and vacant terminals; failure to hear the audible ringing signal is an indication to the subscriber that he has selected a vacant level or terminal.

Reverting calls,—i. e., calls to other stations on the same line,—are obtained by calling a three-digit number, first dialing nine, then the last digit of the calling sub-



scriber's number, followed by the last digit of the called subscriber's number.

No special provision is made for absorbing false preliminary impulses other than that level No. 1 of first selectors is not ordinarily assigned, but is used initially as a vacant level.

Coin box stations are of the multi-slot postpayment type. Local numbers are dialed from dial coin box stations in the same manner as from any other dial station. When the called party removes his receiver from the hook, a distinctive tone is heard by both parties, which is an indication to the calling party to deposit a coin. When the coin is deposited, the tone is removed, clearing the circuit and connecting it through for the conversation.

#### MAINTENANCE

In the operation of any telephone plant, some maintenance effort is necessary to keep the equipment in good workable condition. The proper amount to give a good balance between maintenance effort and the quality of service rendered is desirable. In the larger central offices this is accomplished through systematic methods

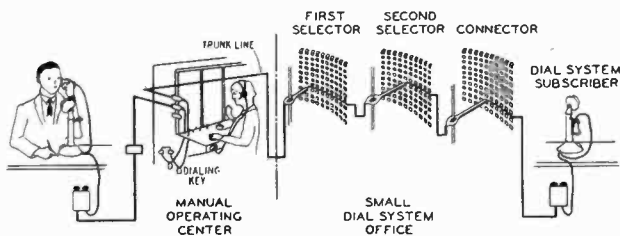

FIG. 9—PATH OF INCOMING CALL THROUGH MANUAL OPERATING CENTER TO SMALL DIAL OFFICE

whereby the equipment is made to function on test on a somewhat more stringent margin than would normally be met with under the worst operating condition. Tests are made through the medium of test circuits designed to simulate the various conditions under which the apparatus is designed to function.

While the equipment specified for small dial offices is practically the same as that used in large dial offices and requires the same treatment, the amount of maintenance effort necessary to keep the apparatus functioning, due principally to the low calling rate, is considerably less than that required for the large office. The routine methods employed in a great many instances are identical, but include some special tests for apparatus peculiar to this type of equipment.

These routine tests are made at intervals in proportion to the importance of the apparatus.

In addition to routine testing, the trouble signals and alarms facilitate maintenance of the equipment. The alarm signals are made common and are routed over trunks or individual circuits to the operating center to inform the operator of trouble during periods when no one is present at the dial office.

For the purpose of making routine operation and observation of the equipment, visits to the small dial

office by the maintenance men were first scheduled weekly. Later it was found possible to extend the frequency without causing service reaction, so that the minimum period between visits is two weeks. For the Reseda Exchange, the equipment routines require the attention of a central office repairman for about five hours every two weeks. Considering the amount of equipment involved, the number of cases of trouble recorded as a result of routine tests has been negligible.

Outstanding in conditions noted is the adaptability of the central office and outside repairmen, who have been trained and have had their experience principally in the manual system, to handle quickly the equipment of the step-by-step dial system.

#### RESULTS OBTAINED

Some of the results obtained that have caused additional study and action, as well as those that are favorable, are recorded in the following matter.

*Outside Plant.* Some trouble has been experienced from low insulation on open-wire trunk circuits which are in operation between San Clemente and San Juan Capistrano, a distance of approximately  $7\frac{1}{2}$  mi. This trouble occurs only in dry climates where there is considerable dust accumulation and where rains are not sufficiently frequent to keep the insulators washed clean. Salt spray on the insulators from the ocean which is nearby also aggravates the situation. This condition has been under careful observation and has been cared for tentatively by scrubbing the insulators with brushes and water at intervals. While final conclusions have not yet been reached as to the most practical way to permanently care for this condition, it is thought that the installation of cable for a portion or the entire distance may be warranted.

At Fontana, one of the small communities first provided with dial equipment, rather serious service conditions existed during the first few months of operation due to various outside plant conditions. Winds of great velocity are frequent and several of the open-wire leads pass through trees. These lines, swinging together, operated line finders nearly continuously, causing unnecessary wear and at times tying up the available paths for traffic in the office to an unsatisfactory degree. This condition was met by rather extensive rebuilding of outside plant and the service has been improved to a grade comparable to that of large dial offices. In general the small dial system does not require any better grade of outside plant than the manual system.

*Buildings.* The introduction of the small dial office has involved the construction of many new buildings for the small exchange, thus offering an opportunity to improve their appearance. Considerable thought has been given to beautifying the outside as well as the inside of the structure. These small dial exchange buildings are scattered over a wide area and all conditions of topography and climate are met.

*Simplicity of Equipment.* The avoidance of a multiplication of refinements in service and in ways of performing one and the same service are essentials to be kept in mind and closely controlled in the continued success of the small dial system. An open-minded public and company, both ready to waive the nonessentials for the essentials, have made it possible to omit, in most cases, features such as intercepting service on unconnected terminals, to permit of simplification of the plant.

The small dial system must give satisfactory service at low cost and a careful course must be pursued to keep down the investment to permit of operating economically.

*Psychological Aspect.* Visitors to these small offices, who know of the quality of the service in these ex-

changes, have been impressed with the fact that notwithstanding the doors being locked; yet as they enter, they view in fitting surroundings a clean nearly perfect machine which is functioning continuously with very little human aid to give this service.

Today, the maintenance man is sure in his own mind of what the equipment does and will do in the future; he therefore goes about his work expecting the proper performance of the system and it functions accordingly. Before experience was gained by actual use, it was the natural thing for all to be looking for causes that would prevent proper operation. Now, however, skepticism is a thing of the past, the system has proved satisfactory and its permanent use is assured. Pessimism has changed to constructive suggestion which can only result in improvement.

## Abridgment of Transmission and Distribution ANNUAL REPORT OF COMMITTEE ON TRANSMISSION AND DISTRIBUTION\*

*To the Board of Directors:*

The work of the Committee on Power Transmission and Distribution covers a wide field and may logically be divided into the following classifications:

- Lightning and surge problems on overhead lines
- Insulator design for overhead lines
- Design of towers and poles for overhead systems
- Cable development for underground systems
- System connections and stability factors
- Standardization activity
- Research activity.

The work carried on this year has been confined to the lightning and insulator problems handled by a subcommittee under the leadership of Mr. Sporn, cable development handled by a subcommittee under the direction of Mr. Peterson, and system connections and stability factors handled by a subcommittee under the direction of Mr. Evans, with Mr. Farmer coordinating the standardization activities and the research work carried on under the direction of a joint research com-

**\*COMMITTEE ON POWER TRANSMISSION AND DISTRIBUTION:**

H. R. Woodrow, Chairman,		
R. E. Argersinger,	E. W. Dillard,	E. R. Northmore,
Geo. M. Armbrust,	R. E. Doherty,	L. L. Perry,
R. W. Atkinson,	L. L. Elden,	T. F. Peterson,
E. T. J. Brandon,	R. D. Evans,	D. W. Roper,
V. Bush,	F. M. Farmer,	A. E. Silver,
P. H. Chase,	Harland C. Forbes,	L. G. Smith,
C. V. Christie,	C. L. Fortescue,	H. C. Sutton,
D. D. Clarke,	K. A. Hawley,	Percy H. Thomas,
W. H. Cole,	V. L. Hollister,	Philip Torchio,
R. N. Conwell,	J. P. Jollyman,	Theodore Varney,
M. T. Crawford,	A. H. Kehoe,	H. L. Wallau,
W. A. Del Mar,	A. H. Lawton,	H. S. Warren,
Herbert H. Dewey,	W. E. Mitchell,	R. J. C. Wood,

*Presented at the Summer Convention of the A. I. E. E., Swampscott, Mass., June 24-28, 1929. Complete copies upon request.*

mittee working under the auspices of the N. E. L. A. Underground Systems Committee, Association of Edison Illuminating Companies' Committee on High Tension Cable, and the Power Transmission and Distribution Committee of the A. I. E. E.

The problems arising under the above activities are so closely related with similar problems handled by other committees of the Institute and other organizations that considerable attention has been given to coordinating this work so as to eliminate unnecessary duplication and at the same time insure the proper handling of all subjects. In light of this condition, your committee has not initiated any work on inductive coordination and any consideration of the interference aspect of such subjects is being tied in with the work of the Joint General Committee and the activity of the work on stability factors and interconnection has been referred to the Committee on Coordination of Institute Activities for assistance in subdividing this work between the various committees.

A summary of the developments and problems arising during the year is covered in the following reports from the subcommittees:

### SUBCOMMITTEE ON LIGHTNING AND INSULATORS

PHILIP SPORN, CHAIRMAN

#### GENERAL ASPECTS OF THE LIGHTNING PROBLEM

Lightning disturbances on electric circuits have always been a problem; the importance of these disturbances becomes greater with the increase of interconnecting high-voltage lines transmitting large blocks of power, which now form the backbone of intercon-

tion and in many cases, the basis of economic generation. The transmission line therefore becomes a vital link in the electric circuit, and lightning, by its adverse effect on its operation, its worst enemy. The demand for more reliable line operation, from a lightning standpoint, has started investigation and research, beginning with isolated field investigations with crude and limited instruments, next laboratory research with the lightning generator, and then to field investigation with the klydonograph and surge recorder; and finally, to the cathode ray oscillograph in both the laboratory and field.

Both the laboratory and field have contributed to the solution of the lightning problem. The laboratory by offering complete and easy control of the lightning wave has, of course, rendered investigations far more simple than field research.

Theory, too, has contributed its part in studying the mechanism of cloud formation and lightning discharges, the breakdown of the discharge path, the influence of ground wires, the characteristics of the electrostatic field, the effect of traveling waves on electric circuits, and the shape and effect of different shapes of traveling waves on the insulation strength of the line and the connected apparatus. A noteworthy contribution to the study by the field is the record of lightning disturbances and trouble on lines as encountered in actual service, together with complete storm data where available.

Finally, an extension of the development has been made in combining the laboratory and field in the form of artificially created lightning imposed on actual transmission lines. Certain problems that prove difficult of solution, such as wave propagation, can best be handled that way.

With this background, it is clear that the solution of the lightning problem has received progression acceleration the past few years, and a large amount of lightning data has been secured and many of the results published in the technical press. Even with considerable theoretical analysis and the laboratory and field data available, the lightning problem is not solved. Some phases of lightning are only partly known, others are in dispute, and some are definitely not known.

#### COMMITTEE PROGRAM PLANNED

An attempt will be made to coordinate a program of determining more definitely what is known about lightning as affecting electric circuits. A careful correlation of lightning data and theories which may appear to be conflicting should bring forth information that is needed in the solution of many of our problems.

The lightning problem of electric circuits is primarily an insulating problem and consequently requires not only a study of voltage stresses but the installation characteristics necessary to withstand these stresses or at least localize the trouble to the least damaging point.

#### LIGHTNING PROGRESS DURING 1928

A large amount of data has been provided to indicate the magnitude of lightning voltages and attenuation of this voltage and characteristics of traveling waves as result of the three cathode ray oscillographs and the numerous klydonographs and surge recorders which have been connected to the systems during the past year. Artificial lightning surges have been placed on transmission lines, making it possible to observe with a cathode ray oscillograph the behavior of the lines under various conditions which have considerably accelerated the establishment of data of this character.

Extension in the use of ground wires and the use of grading shields on insulator strings has been made during the past year, and the practise of reducing the line insulation for a mile or so out from the substation to protect station equipment has been extended.

#### RESEARCH WORK IN PROGRESS

Surge investigation installations are in progress on transmission lines of a number of operating companies. Some ten or twelve cathode ray oscillographs are planned to be in operation on actual lines during the coming summer. Two or more additional installations to record the performance of artificial lightning are also planned for this summer. It is expected that this extensive program will be very effective in obtaining greater amount of information on lightning and surge characteristics.

#### SUBCOMMITTEE ON CABLE DEVELOPMENT

T. F. PETERSON, CHAIRMAN

#### GENERAL STATEMENT

The portion of last year's Power Transmission and Distribution Committee Report dealing with cable developments included descriptions of what might be considered remarkable advances and great strides in the transmission art. Of these, the design, installation, and operation of 132-kv. oil-filled cable were most notable. This year, nothing so sensational is to be noted. Practically all development and improvement seem to have been characterized by a tendency toward review and analysis of existing practises, stabilization, and reduction of known methods and principles to economic and practical feasibility. These have apparently constituted the bases for such crucial investigations of paper insulated cable of the so-called solid type, sheath corrosion, sheath current mitigation, temperatures of conduits, etc., as have been reported in the technical press throughout the year. The fine cooperation and coordination of results evidenced by various organizations, utilities, and manufacturers engaged in the improvement of cable bids fair toward hastening the day of our profound understanding of cable and its operation.

#### RESEARCH

The annual report of the Impregnated Paper Insulated Cable Research Subcommittee gives a compre-

hensive picture of the extent of the research activities which have been greatly expanded during the last few years and indicates the spirit of cooperation which is now displayed in the industry.

At Massachusetts Institute of Technology, an extensive investigation of the rate of deterioration of wood-pulp paper for cable insulation when subjective to heat alone has been concluded. It appears from this investigation that impregnated wood pulp paper will withstand temperatures at least as high as manila paper and that the permissible operating temperatures of high-tension cable could be considerably increased above the present prescribed values.

At Johns Hopkins University the investigation of the effects of residual air and moisture in the insulation indicates that the difficulties with commercial cables are due largely to extended areas of entrapped air and gases resulting from imperfect impregnation, distortion in handling, or expansion of the lead sheath rather than the lack of extremely low pressure of impregnation.

The study of the laws governing ionization characteristics of cable insulation has progressed at Harvard University to the point where simple empirical equations have been established for the experimental curves.

The accelerated life tests on cable carried on by the Brooklyn Edison Company and the test of insulation of the solid type carried on by the Detroit Edison Company are adding valuable data to this problem. The Commonwealth Edison Company is conducting an elaborate theoretical study of the fundamental nature of insulation under the auspices of Utilities Research Commission.

#### DEVELOPMENTS IN PRACTISE

The 132-kv. lines installed last year in Chicago and New York have continued to operate without electrical failures, and an additional circuit is being installed this year in New York. This year's development shows important advancement in the method of installation in that it is possible to install the cable filled with oil, thereby eliminating the field impregnation required on the first development.

The several installations of 45-kv. and 66-kv. single-conductor cable of the solid insulation type have continued to give satisfactory service, and during the past year, a pioneer installation of three-conductor oil-filled cable for 33-kv. operation has been made in Chicago. The satisfactory operation of the oil-filled cable indicates that similar construction can be used for higher voltages up to at least 66-kv. The improved regulation of the three-conductor cables and the elimination of sheath losses, together with the other features of superiority, make this type of construction appear attractive as compared with three single-conductor cables.

The shielded or Hochstadter type of construction continues to find favor for three-conductor cables in the 22- to 33-kv. class. The use of oil reservoirs on the joints has proved very beneficial and thus far the pos-

sible trouble which some engineers feared from the expansion of cable sheath has not been manifested. For the lower voltages of 11-kv. to 15-kv., three-conductor cables and single-conductor cables installed three per duct have been used more or less indiscriminately with advantages being claimed for both.

It has long been felt that our present method of rating cables, based on temperature limit of insulation, was, to say the least, unsound. The lack of a suitable alternative has accounted for the retention of the present method, but with the coordinated investigations now in hand, it may be expected that data will be available before long to set up a rational method of rating cables.

During the past year, considerable interest has been exhibited in sheath corrosion, and several companies have observed the formation on lead sheath of various red, orange, and white compounds. Inasmuch as these, especially the red lead oxide, made their appearance on cable installed in monolithic concrete duct, which is coming into very general use, they gave rise to considerable alarm among those operating and extending such systems. Almost coincidentally, there was reported considerable corrosion of lead sheath in creosoted wood ducts.

Through the concerted investigation of the Utility companies and the Portland Cement Association it was found that the presence of calcium hydroxide from the concrete, water and a-c. electrolysis conspired to produce the oxide. The elimination of the water or electrolysis will prevent the formation, or if the concrete is allowed to stand for approximately twenty-eight days, thereby allowing the calcium hydroxide to change to calcium carbonate, the cables should be relatively free from corrosion of this type.

The corrosion in wood ducts was found to be due to acetic acid evolved from the Douglas fir used for the conduit and the remedial measure applied in this case was the introduction of ammonia gas into the duct, thus neutralizing the acid.

#### SPECIFICATIONS, TESTING, AND OPERATION OF CABLE

There has been no important change in cable inspection and testing practise during the year. Specifications remain practically unchanged except for an increase in test voltages for single-conductor and shielded type multiple conductor cables, as well as a decrease in the allowable ionization factor in high-voltage cables. As in previous years, a survey of the test results obtained shows a general trend in the direction of improvement. This is indicated by the percentage of deficiencies and the uniformity of insulation resistance, power factor, and ionization factor. This consistent trend toward improvement is now being reflected in decidedly better operation of cable as revealed in annual reports of operation which have been compiled. Analytical studies of the mass of data that is collected annually in connection with acceptance inspection and testing



of cable and of failures of cable which occur in service, have been carried on for several years. The value of these studies as an aid in improving cable having been demonstrated, more effective means of carrying them on has been developed under the cooperative auspices of the National Electric Light Association and the Association of Edison Illuminating Companies. This development is another indication of the cooperation which exists in the industry and which cannot help but be a great aid to progress.

### STANDARDIZATION ACTIVITY

F. M. FARMER, CHAIRMAN

The following is a brief summary of standardization activities which have been consummated during the year.

1. Section No. 30 of the Standards of the A. I. E. E. dealing with wires and cables has been submitted to the American Standards Association for ratification as an American Standard (minus certain items which are now under discussion).

2. Specifications for annealed copper wire, both bare and tinned, were approved as American Standard by the American Standards Association June 12, 1928.

3. Specifications for 30 per cent rubber insulation for wire and cable for general purposes were approved by the American Standards Association as tentative American Standard April 2, 1928.

4. Specifications for magnet wire were approved by the American Standards Association as tentative American Standard April 2, 1928.

A number of matters dealing with wires and cables is in the course of development to the standardization stage. Specifications for impregnated paper insulation, specifications for varnished cloth insulation, and specifications for weatherproof heat resisting and other coverings are being developed by the Sectional Committee on Wires and Cables of the American Standards Association. Similarly, progress is being made with the development of a standard stranding table for stranded conductors by the same committee.

Informal arrangements have been made between the appropriate committees of the National Electric Light Association and the Association of Edison Illuminating Companies for the coordinated collection and study of cable failures on a standardized basis.

### SUBCOMMITTEE ON INTERCONNECTION AND STABILITY FACTORS

R. D. EVANS, CHAIRMAN

Interconnection of power systems has been brought about as a natural result of consolidation under a common management or as a measure to reduce investment or operating expense of systems under separate managements. The general advantages, such as those arising from load diversity, generating reserve, and utilization of stream flow plants, have been recognized for some time. The problems at hand have to do with the determination of the economy of a particular under-

taking and the selection of the best method of carrying out the interconnection.

One of the most important aspects is the reliability of the power supply obtained from the interconnection. Reliability depends to a large extent on the vulnerability and stability of the system, *i. e.*, its capacity to maintain the machines in synchronism at times of system disturbances. These problems are very prominent in the field of power transmission, as the means of interconnection consist of transmission lines or ties with the associated transformers and switching equipment, and as the location, number, and character of these ties largely determine the serviceability of the interconnection.

The study of system connections is a development whose importance has recently become generally recognized. While it is true that different power system connections have developed in different parts of the country, these differences could largely be explained because of the difference in the local situation as to the transmission distance, the density, and the distribution of the load. Increase in the extent of systems and of interconnection has made it necessary to give consideration to what are commonly called "system problems," of which stability may be cited as an example. Stability was first carefully analyzed in connection with long-distance power transmission. More recently, these principles are being applied in the study of the closely-connected systems.

The plan of operation of interconnected systems may be premised on either the maintenance of synchronism at times of system disturbances or upon the separation of the systems. In the latter case, the system may be split at fixed points or at variable points to coordinate connected load and generating capacity. At the present time it is not possible to draw any general conclusions as to the proper field of application of these different methods of operation.

In the design of systems to maintain stability, several distinct methods are recognizable. Synchronism may be maintained (1) by measures which increase the synchronizing power which may be transferred between the machines, as by the use of low reactance tie lines or the application of quick response excitation; (2) by measures which limit the severity of the shocks to the system occasioned by faults, as may be affected by the use of individual lines of high reactance or by quicker fault isolation; or (3) by a system layout which causes the shock to be distributed to the various machines in such a way as to accelerate or decelerate them as a unit.

In order to improve stability, special attention is being given to the characteristics of apparatus to be used on extensive systems and interconnections. From the standpoint of stability, governors should operate quickly and should possess anti-hunting features tending to reduce oscillations after disturbances. Governor operation in direct response to fault indications may prove advantageous. Field test to indicate perform-

ance of governors under transient conditions would be very desirable.

In generators, high short-circuit ratio and low transient reactance are of benefit in improving the power limits. The use of the proper kind of excitation system extends the power limit under both steady state and transient conditions and may largely overcome the disadvantages of low short-circuit ratio. Low transient reactance will improve the stability conditions at times of system fault. In general, a study should be made to determine in each case the proper value of machine transient reactance which depends upon line and transformer as well as generator costs.

Consideration is being given to the use of damper windings in waterwheel generators. Damper windings tend to improve stability by virtue of their damping action and to decrease stability because of the increase in fault current due to the reduction in negative phase sequence reactance of the generator. Investigations have indicated that in certain cases, damper windings may be advantageous provided they are of the proper characteristics.

Excitation systems capable of quick response are effective in improving stability under steady state and particularly under transient conditions. In special cases the use of synchronous condensers, wholly or principally as an aid to stability, will be found desirable. The stabilizing effect of such condensers will be increased by the application of suitable quick response excitation systems.

During the past year, active field tests and investigations have been made regarding quick response excitation systems, increased insulation of lines, the speedy disconnection of a defective circuit from the system and the introduction of ground resistor or reactance (Peterson coil).

The extension of systems and interconnections have introduced operating problems important from the standpoint of stability. The greater complication of systems has temporarily required the human element to a greater extent which is being offset by the further development of automatic features such as control of frequency, voltage, and switching.

The theoretical investigation of stability has proceeded to a point where fundamental operating data are urgently needed. Information as to the operation of systems has been obtained in the past principally from indicating and graphic instruments which have been provided for the convenience of the operators. During the past few years a number of instruments with speed-up devices has been used, but the general results have not been entirely satisfactory because of the delay in starting the device and the inaccuracies in the measuring elements. Recently these objections have been reduced by the use of an oscillographic type of instrument, and the tendency is to use such devices where transient records of disturbances are desired.

The importance of records of this nature is becoming more apparent in reconstructing the nature and extent of system disturbances, particularly where considerable power is being transmitted over some distance. With such data available, it will be possible to place the design requirements upon a sounder basis; for example, it should be possible to determine whether the basis for maintaining stability should be predicted upon a single fault to ground as is commonly done at present, or upon the less frequent double fault to ground. Such data will also make it possible in many cases to estimate from oscillation with existing loads, the probable system disturbance with future loads.

#### GENERAL CONCLUSION

The expansion of the interconnection of systems has brought numerous problems to the engineer for solution and it is to be noted in the foregoing subcommittee reports and the several papers presented before the Institute that fundamentally different ideas of system developments have been brought out to meet the ever increasing demand for higher continuity of service and greater flexibility of supplying relatively large blocks of load from a network system. Your committee expects rapid strides to be made within the next few years in handling distribution problems and predicts radical departures from old methods and practises.

#### CHAIN DRIVES FOR FACTORIES

Chain drives have been developed during the present generation into a practicable means for transmitting power in industry. They have established themselves as a most satisfactory and trouble-free way of transmitting power from an electric motor to a line shaft or directly to a machine tool. The positive nature of the drive prevents loss from belt slippage, and such loss is loss of production, not merely loss of power, writes A. C. Woodbury, in the October issue of the *S. A. E. Journal*, an official publication of the Society of Automotive Engineers.

A silent chain drive that is intelligently selected for the job and installed in good alignment will operate for years with no attention other than lubrication, periodic inspection and possibly two or three adjustments of center distance.

The silent chain drive has been found to fill a great need in power transmission, because it furnishes a positive drive that is much more compact than a belt drive and much more flexible than a gear drive, according to the author. The compactness makes it available in individual drives from motors to machine tools with little or no additional floor space required for the motor. Motors can often be mounted directly on the tool, to make a self-contained unit that can be moved about and placed as required for convenience in manufacturing, without reference to anything like a line shaft.

# Abridgment of Parallel Operation of Transformers Whose Ratios of Transformation are Unequal

BY MABEL MACFERRAN\*

Associate, A. I. E. E.

**Synopsis.**—An equation is developed for use in meeting emergency conditions which necessitate the paralleling of transformer banks whose impedances expressed in percentage are not equal. This equation makes it possible to calculate what change should be made in the ratio of transformation of the bank with the lower percentage impedance in order to prevent its being overloaded when the total load approaches the combined capacity of the two banks.

*It is pointed out that such an expedient is a makeshift justifiable only when maintenance of service is the paramount consideration and efficiency is for the time being of secondary importance. When conditions arise which do justify such a temporary arrangement, the method developed in the present paper affords a simple yet accurate means of solving the problem.*

\* \* \* \* \*

## INTRODUCTION

**E**MERGENCIES sometimes arise in which it becomes desirable to operate in parallel transformer banks whose characteristics are not ideally suited to such a procedure. It is well known that unless the impedances of the two banks, expressed in percentage form, are approximately equal, one bank will assume too much load in proportion to its rating; the other too little. The question then arises whether it is possible so to change the ratio of transformation of one bank that under the most severe load conditions which are to be imposed on the combination, neither bank will be overloaded.

The purpose of the present paper is to derive an equation whereby the change in ratio necessary to accomplish the desired result may be calculated. Such an equation is very much needed, as the only method which, to the writer's knowledge, is now extant for attacking the problem is based on the regulation curves of the two banks and involved errors which make it, in many cases, somewhat inaccurate.

It should be clearly understood that the expedient of changing the ratio of transformation of one bank relative to that of the other is not being advocated as a permanent measure, as it results in marked inefficiency of operation. It is justifiable only as a temporary step to be adopted under emergency conditions which require a certain peak load to be carried, no matter what the cost in efficiency at lighter loads.

## FUNDAMENTAL EQUATIONS FOR PARALLEL OPERATION

Since the principles governing the parallel operation of two three-phase banks are exactly the same as those governing the parallel operation of two transformers in a single-phase circuit, the discussion will be based on the simple case of two single-phase transformers in parallel.

It will be assumed throughout the discussion that the load is connected to the low-tension side of the paralleled transformers.

\*Operating Department, Southern California Edison Company. Presented at the Pacific Coast Convention of the A. I. E. E., Santa Monica, Calif., Sept. 3-6, 1929. Complete copies upon request.

The fundamental considerations which control the behavior of two transformers operating in parallel are very simple. They are:

1. The voltage impressed on the high-tension winding of one transformer is equal to, and in phase with, that impressed on the high-tension winding of the other transformer.
2. The voltage appearing at the low-tension terminals of one transformer is equal to, and in phase with, that appearing at the low-tension terminals of the other transformer.

From the first consideration it follows that the low-tension open-circuit voltages of the two transformers are in phase with each other.\* The reason is that neglecting the very small phase displacement caused by the exciting current, the low-tension open-circuit



FIG. 1—TRANSFORMERS OF UNLIKE RATIO IN PARALLEL OPEN-CIRCUIT CONDITION

voltage of each transformer is in phase with the voltage impressed on its high-tension winding. The two low-tension open-circuit voltages are not equal in magnitude, however, unless the ratios of transformation are equal in the two transformers. The vector diagram for open-circuit conditions is shown in Fig. 1. In this diagram,  $\bar{E}_1$  represents the low-tension open-circuit voltage of Transformer 1, and  $\bar{E}_2$ , that of Transformer 2.

When a load is applied to the low-tension side of the paralleled transformers, the impedance drop in each transformer must be of such magnitude and direction that the second consideration is satisfied, as shown in Fig. 2.

In expressing these relations mathematically, the following symbols will be used:

$\bar{E}_1$  = low-tension open-circuit voltage of Transformer 1  
 $\bar{E}_2$  = low-tension open-circuit voltage of Transformer 2

\*"Parallel Operation of Transformers," Waldo V. Lyon, *Elec. World*, Vol. 63, No. 6, February 7, 1914, p. 315 ff.

- $\bar{V}_1$  = low-tension terminal voltage of Transformer 1  
 $\bar{V}_2$  = low-tension terminal voltage of Transformer 2  
 $\bar{I}_1$  = current in low-tension winding of Transformer 1  
 $\bar{I}_2$  = current in low-tension winding of Transformer 2  
 $\bar{I}_L$  = current flowing to the load  
 $\theta_L$  = angle between load current and voltage impressed on the load  
 $\phi$  = angle between voltage impressed on high-tension side of the transformers and voltage appearing at low-tension terminals  
 $D$  = arithmetical difference between  $\bar{E}_1$  and  $\bar{E}_2$   
 $Z_1$  = equivalent ohmic impedance of transformer 1, referred to low-tension side  
 $Z_2$  = equivalent ohmic impedance of transformer 2, referred to low-tension side.

From Fig. 2, the following equations may be written:

$$\bar{V}_1 = \bar{E}_1 - \bar{I}_1 Z_1 \quad (1)$$

$$\bar{V}_2 = \bar{E}_2 - \bar{I}_2 Z_2 \quad (2)$$

$$\bar{V}_1 = \bar{V}_2 \quad (3)$$

The simultaneous solution of these equations gives:

$$\bar{E}_1 - \bar{E}_2 = \bar{I}_1 Z_1 - \bar{I}_2 Z_2 \quad (4)$$

Since  $\bar{E}_1$  and  $\bar{E}_2$  are in phase with each other, if

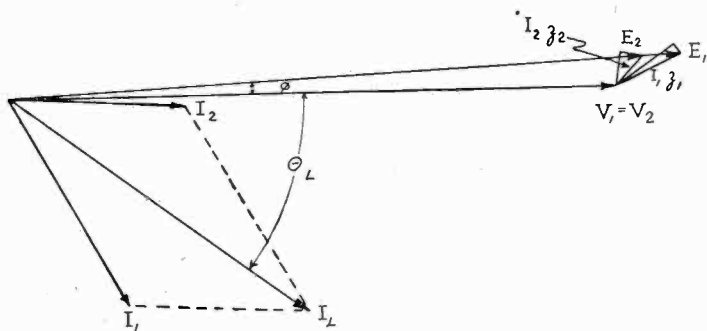

FIG. 2—TRANSFORMERS OF UNLIKE RATIO IN PARALLEL LOAD CONDITION

$\bar{V}_1 = \bar{V}_2$  be selected as the reference axis, we may write:

$$\bar{E}_1 - \bar{E}_2 = D/\phi \quad (5)$$

Equation (4) may then be written as follows:

$$\bar{I}_1 Z_1 - \bar{I}_2 Z_2 = D/\phi \quad (4a)$$

It is also necessarily true that:

$$\bar{I}_1 + \bar{I}_2 = \bar{I}_L \quad (6)$$

Equations (4a) and (6), if solved simultaneously, give the following result:

$$\bar{I}_1 = \frac{\bar{I}_L Z_2 + D/\phi}{Z_1 + Z_2} \quad (7)$$

$$\bar{I}_2 = \bar{I}_L - \bar{I}_1 \quad (8)$$

It should be noted that the use of the specific vector  $D/\phi$  in place of the general vector expression  $(\bar{E}_1 - \bar{E}_2)$  ties Equations (7) and (8) definitely to  $\bar{V}_1 = \bar{V}_2$  as a reference axis.

Equations (7) and (8) make it possible, given the difference existing between the ratios of transformation of the two transformers, to calculate the division of current for any specified total load. It must be borne

in mind that *the solution will be correct for only the one load*, and that the currents will shift in relative magnitude and in relative phase position as the magnitude and power factor of the load are changed.

It will be seen at once that there is one difficulty in the way of obtaining a direct solution for Equation (7). This difficulty is that since the phase position of  $\bar{V}_1 = \bar{V}_2$  depends upon the magnitude and phase position of  $\bar{I}_1$  and  $\bar{I}_2$ , the value of  $\phi$  is not known until  $\bar{I}_1$  and  $\bar{I}_2$  are known. Fortunately, this difficulty is of little practical importance, since the angle  $\phi$  is usually so small that it may be set equal to zero with only a slight resulting error in the solution. If it is desired to carry the calculation to greater accuracy, the method of successive approximations may readily be applied; that is,  $\phi$  may first be set equal to zero, the solution made, and the position of  $\bar{V}_1 = \bar{V}_2$  calculated. Then, with the value of  $\phi$  obtained from this calculation, a new solution of Equation (7) may be made.

The impedances substituted in Equations (7) and (8) should be in the form of complex quantities, having both resistance and reactance components. The values used should be those applying to the taps on which the transformers are operating. This requirement will be found to offer something of a stumbling-block in practice, as the data ordinarily available give information only on the full-winding impedance values. It is beyond the scope of the present paper to discuss ways of estimating the tap values of impedance other than to point out that as the transformer is placed on lower and lower taps, the impedance values referred to the winding on which the taps are situated generally decrease quite slowly, whereas the impedance values referred to the other winding *increase* rather rapidly. The exact mode of variation depends on the type of core, type of winding, and location of the taps. There is urgent need of published data on this subject. Such data being at present lacking, the engineer confronted with a problem in parallel operation must either rely upon estimates based on his own experimental tests, or neglect the variation of impedance with taps altogether. If only an approximate solution is required, the latter course may be adopted.

If the problem at hand involves three-phase transformer banks, the application of Equations (7) and (8) is permissible, providing the ordinary rules for working with one phase of a three-phase circuit are followed. In Appendix A will be found a more detailed discussion of this subject, with especial reference to the case in which one bank is delta-Y and the other, Y-delta.

#### RATIO CHANGE TO GIVE A DESIRED CURRENT DIVISION

It is now easily possible to derive an equation which will give  $D$  in terms of the anticipated load current and the desired division of current between the transformers. It is only necessary to specify that

$$\bar{I}_2 = \bar{A} \bar{I}_1 \quad (9)$$

In this relation,  $\bar{A}$  is a vector quantity. Its magni-



tude will ordinarily be taken such as to make the ratio of the currents the same as the ratio of the transformer ratings. Preferably its angle would be zero, placing  $\bar{I}_1$  and  $\bar{I}_2$  in phase with each other; but it will be shown that it is not possible to specify both the magnitudes and the angle of  $\bar{A}$ .

By substituting condition (9) in Equation (8), there is obtained the relation

$$\bar{I}_1 = \frac{\bar{I}_L}{\bar{A} + 1}$$

Substituting this in turn in Equation (7), there results:

$$D/\phi = \frac{\bar{I}_L (Z_1 - \bar{A} Z_2)}{\bar{A} + 1} \quad (10)$$

Since  $D$  is by definition a pure arithmetical quantity, it is necessary that the expression on the right of Equation (10) come out as some quantity at an angle  $\phi$ . In general, for a specified magnitude of  $\bar{A}$ , there is only one angle of  $\bar{A}$  that will result in a vectorially correct solution to Equation (10). This means that it is possible to dictate the proportion between the currents  $\bar{I}_1$  and  $\bar{I}_2$ , but it is not possible simultaneously to dictate the angle that shall exist between them.

The correct angle for the vector  $\bar{A}$  must be found by trial and error. It is usually sufficiently accurate to assume  $\phi$  approximately equal to zero. Then, having selected the desired magnitude for  $\bar{A}$ , it is necessary to try different angles for  $\bar{A}$  until one is found which makes the right-hand side of Equation (10) come out to some quantity at an angle within two or three degrees of zero.  $D$  is then equal to this quantity. If greater accuracy is desired, the method of successive approximations may be applied to fix the value of  $\phi$  more closely. However, in practical work, it is not necessary to make an extremely accurate solution for  $D$ , because the anticipated load conditions are usually somewhat vague; and furthermore, there is seldom a tap available to conform exactly to the calculated value of  $D$ .

If  $D$  comes out positive, the open-circuit voltage of the transformer which was assigned, the designation "2" is the one to be lowered, since Equation (7) from which Equation (10) is derived is based on the assumption that  $\bar{E}_1$  is greater than  $\bar{E}_2$ . If  $D$  comes out negative, then the open-circuit voltage of Transformer 2 is to be raised above that of Transformer 1. In starting a solution, it is a good plan to assign the designation "2" to the transformer with the lower percentage impedance, because this will be the one whose open-circuit voltage will have to be lowered in order to prevent its taking too much load. Thus the inconvenience of working with a negative  $D$  will be avoided.

If the angle which it is necessary to assign to  $\bar{A}$  in order to obtain a solution for  $D$  is of the order of 90 deg. or more, it is probable that the solution will be of little practical value, since even though the currents divide in proportion to the ratings, each will have to be so large (in order that their vector sum

may equal  $\bar{I}_L$  despite the large angle between them) that the transformers will in all likelihood be overloaded.

If it seems impossible to find an angle for  $\bar{A}$  that works out satisfactorily, some other magnitudes for  $\bar{A}$  will have to be tried. Of course there is no use trying magnitudes which differ markedly from the ratio of the ratings unless there is a very wide leeway between the load to be carried and the sum of the ratings of the transformers.

A minor difficulty presents itself in assigning the correct values to  $Z_1$  and  $Z_2$ . Their values will depend on what taps are employed on the transformers, and these in turn will depend on the value of  $D$ . Here, if desired, the method of successive approximations may be applied. First solve for  $D$ , using the full-winding values of  $Z_1$  and  $Z_2$ . Then, if to obtain the required  $D$  it is necessary to place one or both transformers on taps, estimate the values of  $Z_1$  and  $Z_2$  on these taps and solve again for  $D$ . Repeat if necessary until little change occurs in  $D$  on the successive solutions. For practical work it is probable that the first value of  $D$  will be quite accurate enough, especially since the actual taps available may be such as to make it impossible to use the exact value of  $D$  obtained from the solution.

The reasonable procedure in attacking a practical problem is to make a solution for  $D$ , using the full-winding impedance values and assuming  $\phi = 0$ . Ascertain what taps come nearest to giving the required difference in ratio. Then assume the transformers placed on these taps and check the current division by Equations (7) and (8); using the values of  $Z_1$  and  $Z_2$  appropriate to the taps employed, and still assuming  $\phi = 0$ . Finally, when  $\bar{I}_1$  and  $\bar{I}_2$  have been found, check the value of  $\phi$  by graphic construction or calculation, and if it differs from zero by more than two or three degrees, make a new solution based on this corrected value of  $\phi$ .

In most practical cases, the magnitude and power factor of the load are a little hard to predict. The best procedure is to select a value of  $D$  to fit the most severe load conditions which are anticipated. Then in order to be sure that there is no possibility of overload occurring on one of the transformers, check the current division not only for this but for several other possible values of load and power factor.

If  $D$  is selected to give the best possible current division conditions when the total load is of a magnitude approaching the combined capacities of the transformers, it will be found that as the load decreases the current vectors tend to swing further and further apart, until at no-load they are 180 deg. apart and constitute a pure circulating current. On account of this increasing predominance of the circulating component at light loads, it is usually advisable to take the smaller transformer out of service when the total load drops to a value within the capacity rating of the larger transformer.

#### CONCLUSIONS

Equations have been derived which, for a specified

total load at a specified power factor, determine the division of current between transformer banks which differ not only in impedance but also in ratio of transformation.

A formula has been developed for use in meeting emergency conditions which necessitate the paralleling of transformer banks whose impedances expressed in percentage form are not equal. This formula makes it possible to calculate what change, if any, can be made in the ratio of transformation of the bank with the lower percentage impedance in order to prevent its being overloaded when the total load approaches the combined capacity of the two banks.

It has been shown that when the ratio of transformation of one bank is changed in order to produce approximately correct load division under peak conditions, very inefficient operation results when the load drops below the peak value. Therefore, the expedient of ratio change is justifiable only when maintenance of service is the paramount consideration and efficiency is, for the time being, of secondary importance.

When emergency conditions arise which do justify a change of ratio, the method developed in the present paper affords a simple and yet accurate means of solving the problem.

### Appendix A

#### APPLICATION OF EQUATIONS TO THREE-PHASE TRANSFORMER BANKS

If the banks which are to be operated in parallel are both Y-connected on the low-tension side, Equations (7), (8) and (10) may be applied by using the low-tension line-to-neutral voltage and the impedance of one transformer in each bank. The currents to be used are the line currents flowing in the low-tension side of each bank and in the load.

If the banks are both delta-connected on the low-tension side, the equations may be applied by using the low-tension line-to-line voltage and the impedance of one transformer in each bank. In this case, the currents to be used are the low-tension line currents divided by the square root of three.

If one bank is Y-connected on the low-tension side and the other delta, the simplest procedure is to convert the delta connection into a fictitious Y connection which will have the same percentage impedance as the actual delta-connected bank. In order to derive an expression for the ohmic impedance of each transformer in the fictitious bank, it will be convenient to adopt the following symbols.

$\bar{V}_a$  = Rated voltage across low-tension side of each transformer in actual bank

$\bar{V}_f$  = Rated voltage across low-tension side of each transformer in fictitious bank

$\bar{I}_a$  = Rated current in low-tension winding of each transformer in actual bank

$\bar{I}_f$  = Rated current in low-tension winding of each transformer in fictitious bank

$Z_a$  = Equivalent ohmic impedance of each transformer in actual bank (referred to low-tension side)

$Z_f$  = Equivalent ohmic impedance of each transformer in fictitious bank (referred to low-tension side)

Since the actual bank is delta on the low-tension side, while the fictitious bank is Y, it follows that:

$$\bar{V}_f = \frac{\bar{V}_a}{\sqrt{3}}$$

$$\bar{I}_f = \sqrt{3} \times \bar{I}_a$$

$$Z_a = \frac{\text{Rated voltage} \times \text{per cent impedance}}{\text{Rated current} \times 100}$$

$$= \frac{\bar{V}_a}{\bar{I}_a} \times \frac{\text{Per cent impedance}}{100}$$

$$Z_f = \frac{\bar{V}_f}{\bar{I}_f} \times \frac{\text{Per cent impedance}}{100}$$

$$= \frac{\bar{V}_a}{\sqrt{3} \times \sqrt{3} \times \bar{I}_a} \times \frac{\text{Per cent impedance}}{100} = \frac{Z_a}{3}$$

That is, if the equivalent ohmic impedance (referred to the low-tension side) of each transformer in the fictitious bank is taken equal to one-third that of each transformer in the actual bank for which it substituted, the per cent impedance of the fictitious bank will be the same as that of the actual bank. The same reasoning applies of course to the resistance and reactance components of the impedance.

When the calculation of equivalent ohmic impedance referred to the low-tension side is based directly upon data giving the per cent impedance of the transformer, the ratio of transformation does not enter the problem, and so it makes no difference whether the high-tension winding of the fictitious bank is Y or delta. However, the ratio of transformation does enter the calculation when it is desired to ascertain the taps to give a specified value of  $D$ . Here it is necessary to remember the rules as to what types of three-phase connection can and cannot be paralleled, in fixing the ratio of transformation of the fictitious bank. For example, if one bank is Y-Y and the other delta-delta, the fictitious bank which replaces the delta-delta bank must be Y-Y, *not* delta-Y. Or, if one bank is delta-Y and the other Y-delta, the fictitious bank which replaces the Y-delta bank must be delta-Y, *not* Y-Y. The ratio of transformation of the fictitious bank should be fixed accordingly.

In Appendix B of the complete paper an example is worked out which illustrates the method of forming a fictitious delta-Y bank to replace an actual Y-delta bank.

### Bibliography

1. "Parallel Operation of Transformers," Waldo V. Lyon, *Elec. Wld.*, Vol. 63, No. 6, February 7, 1914, p. 315 ff.
2. "The Parallel Operation of Transformers," J. Murray Weed, *Elec. Wld.*, Vol. 52, No. 21, November 21, 1908, p. 1117 ff.

# Abridgment of Impulse Insulation Characteristics of Wood-Pole Lines

BY H. L. MELVIN\*

Member, A. I. E. E.

*Synopsis.*—This paper gives the results of a rather comprehensive series of tests on the impulse insulation characteristics of wood, combinations of insulators and wood as used in wood-pole trans-

mission line construction and methods of protecting wood from damage; also a brief discussion on applications of the data.

\* \* \* \* \*

## I. INTRODUCTION

THE tests, results of which are covered by this paper, were made for the purpose of obtaining some fundamental data on the impulse insulation characteristics of wood as used in the construction of transmission lines. Quantitative values were desired, even though they might be only relative, on the insulation strength of poles, crossarms, combinations of insulators and wood, variations between different species of wood, influence of moisture and contamination, and methods of protecting wood from damage due to lightning flash-over. These data should make it possible to use wood in a more intelligent manner in design and also supplement the lightning research investigations.

## II. TEST IMPULSE WAVE

Impulse voltages ranging from 400 kv. to 3000 kv. were employed. The voltage wave used for all tests can be described as one reaching its crest in approximately one-fourth of a microsecond and then decreasing to one-half of its maximum value in approximately 20 microseconds.

While the sparkover voltage values would vary with the type of impulse wave used, and this wave may not necessarily be representative of actual lightning, the results obtained should be comparative, and indicative of performance under lightning conditions.

The test points were, of course, rather erratic but sufficiently consistent to plot the average curves shown by the figures. The dashed portions are interpolations and extensions.

## III. IMPULSE SPARKOVER VOLTAGES

*General.* Sparkover voltage tests were made on cedar, chestnut, and treated pine poles; fir and treated pine crossarms; treated hardwood and pine sticks; combinations of insulators and crossarms; insulators and poles; insulators, crossarms and poles; air-gaps; and insulators alone. The combinations corresponded to those which might be used for 66-kv. to 132-kv. construction.

\*Engineering Department Electric Bond and Share Company, New York, N. Y.

Presented at the Pacific Coast Convention of the A. I. E. E., Santa Monica, Calif., Sept. 3-6, 1929. Complete copies upon request.

Samples of each of the varieties of poles, crossarms, and sticks were tested dry, surface wet, tap water soaked for about two weeks and salt water soaked (about one-fourth as salty as sea water) for two weeks. Wet cement was also applied to samples to simulate contamination.

*Poles, Crossarms, and Sticks.* In testing the poles, crossarm, and sticks it was learned that the variety of wood, treatment, moisture content, contamination or salt water soaking had little influence on the sparkover voltage values. The results are shown by Figs. 3 and 4. The poles and crossarms were taken from service or stock and the sticks were five to ten square inches in

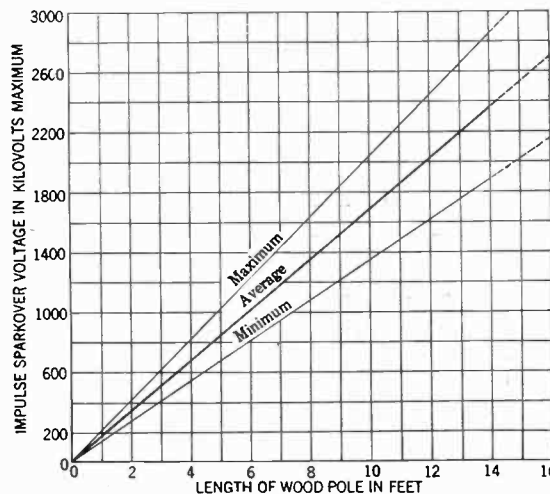

FIG. 3—SPARKOVER VOLTAGE OF WOOD POLES

cross-section, of selected quality, considered suitable for use as long wood guy insulators.

*Air-Gaps.* Sparkover voltage measurements were made for air-gaps such as obtain between conductors and guys or grounded parts of structures and across horn-gaps, the results being given by the curve in Fig. 5.

*Insulators.* Fig. 6 gives the sparkover voltages for 10-in. diameter 5 $\frac{3}{4}$ -in. spaced suspension units of the ordinary design for the 20-microsecond wave, as taken from the recent paper *Lightning* by F. W. Peek, Jr.\* All tests were made with this type of unit with the exception of those using a 70-kv. pin type insulator of usual design.

\*See Bibliography for references.

*Combinations of Insulators, Crossarms, and Poles.* Figs. 7, 8 and 9 give the average sparkover voltages for combinations of insulators with varying length of cross-arm, insulators with varying length of pole, and insulators with sections of crossarm with varying length of pole respectively. The sparkover voltage values of the

moisture content or conductivity of the pole or cross-arm. The intensity of the partial sparkover arc was very much lower than that for normal discharge of the lightning generator.

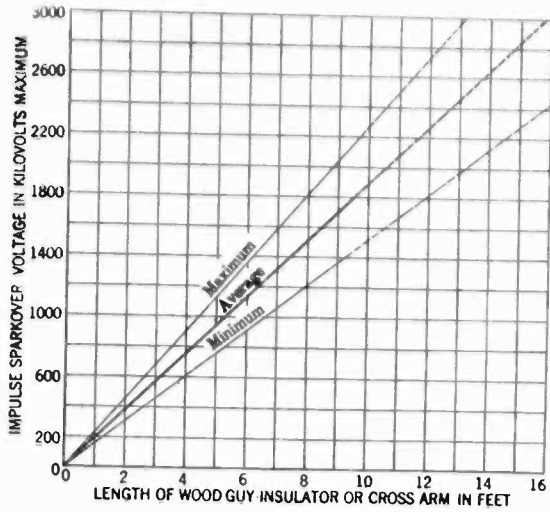

FIG. 4—SPARKOVER VOLTAGE OF WOOD GUY INSULATORS AND WOOD CROSSARMS

component parts cannot be added directly, (as will be noted) on account of the differences in the characteristics of porcelain and wood insulation and their physical relations.

If sparkover values are desired for combinations dif-

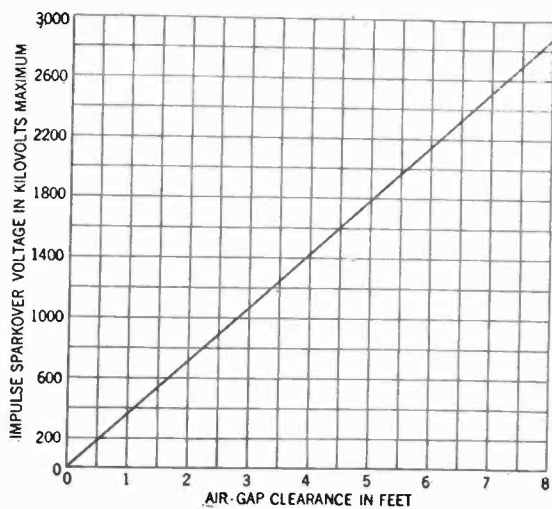

FIG. 5—SPARKOVER VOLTAGE OF AIR-GAPS

ferent than those shown or with suspension insulators with spacings other than  $5\frac{3}{4}$ -in., values can be interpolated by shifting the starting point of the curves or estimating from the combinations covered.

*Partial Sparkover of Combinations of Insulators, Crossarms, and Poles.* Sparkover of the insulators only may occur with impulse voltages applied to combinations of insulators, crossarms, and poles, at lower values than are required to completely spark over the combinations. The voltages at which these partial sparkovers occurred seemed to be primarily a function of the

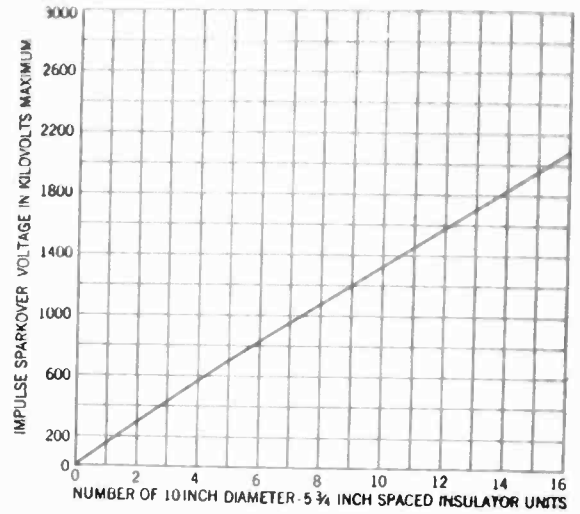

FIG. 6—SPARKOVER VOLTAGE OF SUSPENSION INSULATORS

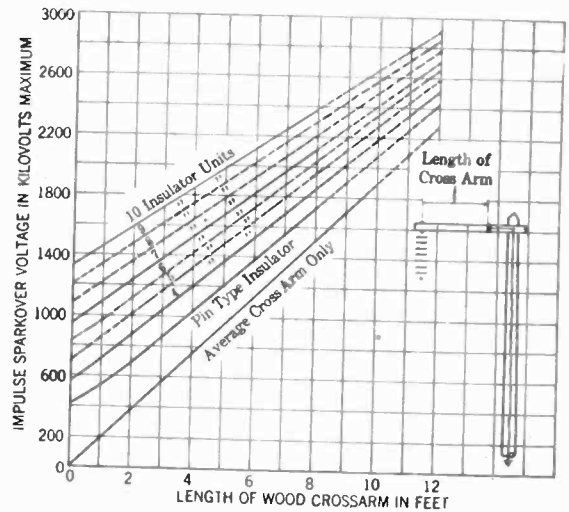

FIG. 7—SPARKOVER VOLTAGE OF INSULATORS AND WOOD CROSSARM

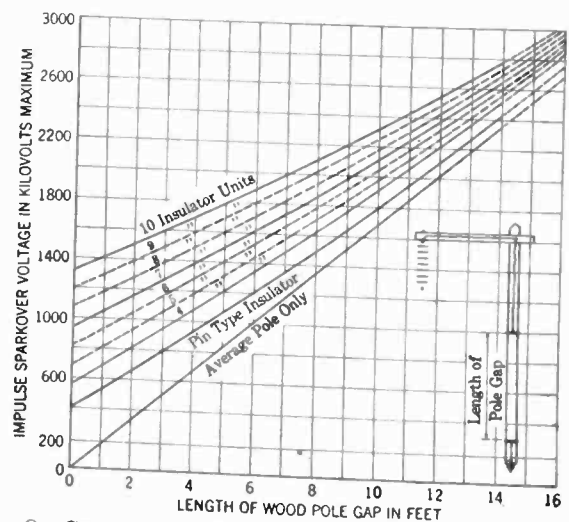

FIG. 8—SPARKOVER VOLTAGE OF INSULATORS AND WOOD POLE

The results of these tests are not included in curve form as they were very erratic, also direct practical application could not be made of the data. They did,



however, indicate possible limitations in the effective use of poles to increase the insulation of all three power conductors from ground on account of the possibility of phase to phase flashovers.

IV. PROTECTION OF WOOD FROM DAMAGE

A by-pass air-gap having a lower sparkover value than the section of wood being protected would seem

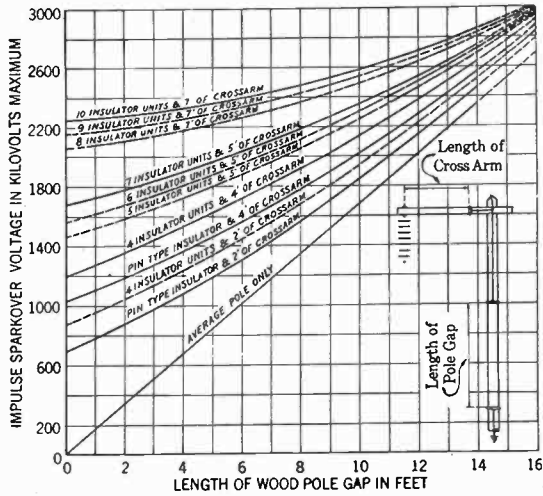

FIG. 9—SPARKOVER VOLTAGE OF INSULATORS, WOOD CROSS-ARM, AND WOOD POLE

to be an effective method of protecting wood from damage due to lightning flashover. The controlling dimensions for designing protecting horn-gaps for poles and sticks are given by Figs. 10 and 11 respectively. The "safe" air-gap dimensions are such that their sparkover values are equivalent to that of poles or

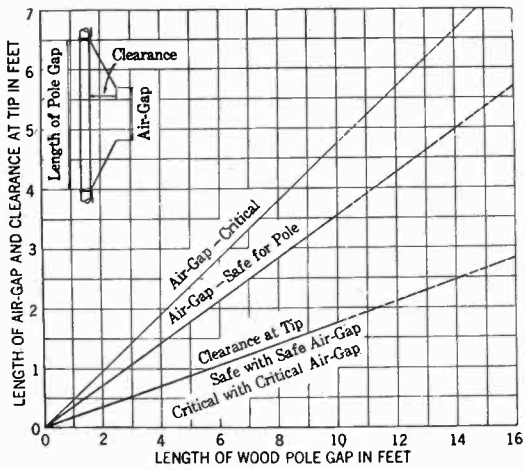

FIG. 10—HORN-GAP PROTECTION OF WOOD POLES

sticks having insulation strengths equivalent to the minimum samples tested so the factors of safety obtained are dependent upon the characteristics of the particular specimens of wood. Not only must the air-gap be of proper relative length, but the clearances from all points of the horns to the wood must be such that arcs will not occur from the horns to the wood and then along its surface.

Instead of applying horns directly to guy insulators, the tests indicated that protection could be obtained

by providing the by-pass gap on the pole as illustrated by Fig. 12. If damage to the pole from lightning flashover can be accepted, the "safe" curve should be used and if horn-gaps are to be applied the "critical" curve.

Protecting gaps for crossarms must be designed for each combination of insulators and crossarm length as the voltage appearing on the crossarm is dependent upon the relations in the particular combination and the

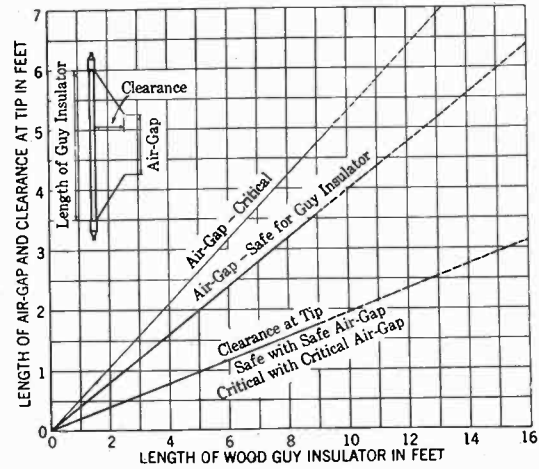

FIG. 11—HORN-GAP PROTECTION OF WOOD-GUY INSULATORS

protecting air-gap must be so proportioned that it will have a sparkover value lower than the voltage appearing on the crossarm. Actual tests were not made to determine controlling dimensions; however, a suggested procedure is as follows: From Fig. 7 obtain the spark-

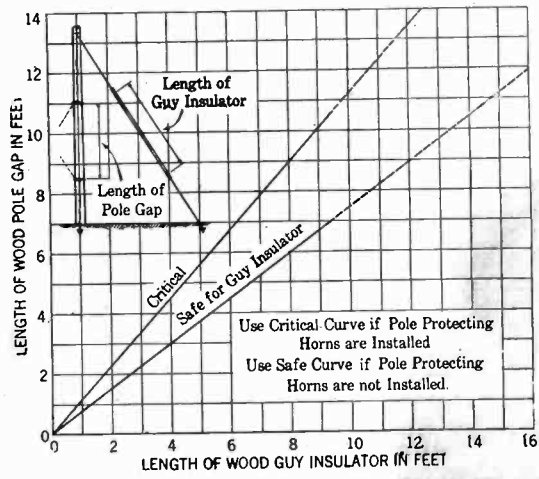

FIG. 12—RATIO OF WOOD-POLE GAP TO WOOD-GUY INSULATOR FOR GUY INSULATOR PROTECTION

over voltage of the particular insulator and crossarm combination,—interpolating, if necessary; then determine the increase in sparkover voltage effected by the crossarm by subtracting the sparkover voltage of the insulators alone; take 80 per cent of the resulting value to allow for variations in crossarms, determine the air-gap length from Fig. 5, and then obtain the clearance between the horn tip and crossarm directly from Fig. 11, using the clear length of crossarm to be protected as the abscissa.

Whether protecting horns for poles, wood-guy insu-

lators, and crossarms designed with these dimensions, will be effective for actual lightning must be demonstrated by field application, or, when more is learned about lightning, including direct strokes, it may be possible to simulate more nearly the conditions in the laboratory and devise improved methods for protecting wood or modify the dimensions given by the curves.

#### V. APPLICATION OF DATA

*General.* This investigation should not be interpreted as a general recommendation that wood be used to increase the impulse insulation strength of lines, as it is not practicable to use wood in all localities on account of the possibility of crossarm and pole fires; it may not be desirable or effective to increase the strength of the lines materially above that of terminal equipment in all cases; the value of increased insulation as reflected in line performance has not been determined, and the use of these data must be regarded as experimental.

Several lines are now in operation, in localities where lightning is regarded as severe, on which the results of these tests have been applied. Their performance is being observed very closely and they are already yielding some interesting information. It must be remembered, however, that considerable time may be required to obtain conclusive confirming results from operating experience.

*Present Conventional Designs.* The data can be used for the purposes of comparing and checking the impulse insulation strengths of designs utilizing wood, correcting inconsistencies such as inadequate clearances to guys and insufficient insulation at structures where the hardware is grounded; also schemes for protecting wood may be devised for structures particularly subject to damage.

*Modified Designs.* Where it is practicable to have wood in the insulating circuit, and desirable to increase the impulse insulation strength of lines, the crossarms and poles may be employed to advantage in varying degrees in combination with the insulators. The crossarms can be used in designs where conventional overhead ground wires or pole grounding wires are installed. Protection from damage may be provided if there is a probability of crossarm splitting with the particular combination of insulators and crossarm. It is necessary to give particular attention to guy clearances and the insulation at special structures in order that the desired minimum insulation strength be maintained throughout the line.

The insulation strength of lines without overhead ground wires may be increased materially by the use of long wood guy insulators for increasing the insulation strengths of the guyed structures. An experimental design which has been used for 66-kv. to 132-kv. H-frame lines employs wood guy insulators about 20-ft. long. Protection for the guy insulators is provided by a horn-gap on the pole; the crossarm is protected by

horn-gaps or a bonding wire is installed along the end sections of the arm to prevent splitting. It is desirable to utilize the crossarm, or at least a part of it, in order to increase the insulation between phases. All bonding and grounding may be omitted from the unguyed structures, or pole gaps with or without horn-gap protection may be installed similar to those on the guyed structures. Such designs will have impulse insulation strengths of from 2500 kv. to 3000 kv., though there is no reason why the insulation strength to ground cannot be increased considerably above these values. Ten-foot wood guy insulators have been used on several 66-kv. single-pole lines.

Insulation strengths of this order are, of course, not immune to lightning flashover nor is it possible to state the degree of improvement in service which may be realized. Surge-voltage records which have been obtained on one of the 66-kv. lines have indicated several lightning voltages in the order of the values obtained in the tests; also the schemes for protecting guy insulators have been quite successful. When more operating experience has been obtained on the experimental lines, it may be possible to make more definite statements regarding the value of wood and its protection when used as insulation for lightning voltages.

*Substation Protection.* Substation and apparatus impulse insulation strengths will usually be lower than that of connecting wood-pole transmission lines which have been designed to utilize the wood and therefore should be protected from surges originating on the lines. Reduced insulation, adjacent to the substations, spillway, or protective gaps, lightning arresters or combinations of these, if properly coordinated should provide the desired protection.

#### CONCLUSIONS

Wood has quite definite and reasonably uniform impulse insulation strength which is not materially affected by usual amounts of moisture or contamination.

It should be practicable to utilize wood to increase the impulse insulation strength of lines in many situations where there is little danger of crossarm or pole fires from leakage currents. Wood should not be used, however, as a means of reducing the amounts of porcelain insulation required to successfully insulate the normal line voltage.

Wood can evidently be protected from damage due to lightning discharges by providing a parallel air-gap of lower sparkover voltage value than the section of wood being protected.

The impulse sparkover voltages of combinations of insulators and wood are not equal to the sum of the sparkover values of the component parts.

Partial sparkover of the insulators only may occur at lower lightning voltages than are required for complete sparkover to ground, particularly when the wood is wet.

Application of these data must be regarded as experimental; also the voltage values given are for the particu-

lar test-voltage wave. Further tests would be very desirable, particularly when more has been learned about the characteristics of actual lightning and additional operating experience has been obtained from the application of the results of these tests.

#### ACKNOWLEDGMENTS

The tests which form the basis of this paper were conducted in the High-Voltage Laboratory of the General Electric Company under the direction of the engineering department of the Electric Bond & Share Company for the Carolina Power & Light, Florida Power & Light, and Texas Power & Light Companies.

Messrs. A. E. Silver, C. A. Jordan, and L. B. Cowgill of the Electric Bond & Share Company par-

ticipated in the planning of the tests and preparation of the paper. Mr. Cowgill also assisted at the laboratory and in the analysis of the data.

The cooperation of the General Electric Company and valuable suggestions from Mr. F. W. Peek, Jr., in planning and arranging the tests as well as the assistance of Mr. W. L. Lloyd, Jr. in conducting the laboratory work are very much appreciated.

#### Bibliography

1. *Lightning—Progress in Lightning Research in the Field and in the Laboratory*, F. W. Peek, Jr., A. I. E. E. Quarterly TRANS., Vol. 48, 1929, p. 436.
2. "The Advantages and Limitations of Wood in Transmission Structures," A. O. Austin, Presented before International High-Tension Congress, Paris, June 23, 1927.

### Abridgment of

# Rehabilitation of Steam Power Plants

BY C. F. HIRSHFELD<sup>1</sup>

Associate, A. I. E. E.

*Synopsis.*—Certain pertinent history of recent development in the field of power generation is given in graphic form. The problem of rehabilitation of steam power plants is shown to arise from the great rapidity of this development. While no simple rule can be given to indicate when, if at all, rehabilitation is justifiable, certain guiding criteria which may serve as aids in analysis are

stated. These are followed by brief accounts of the various methods available for rehabilitating plants to different extents.

Finally, it is suggested that the possibility of later rehabilitation be taken into account when designing plants for systems in which history or argument indicate that such action is to be expected.

\* \* \* \* \*

THE exceedingly rapid evolution of the art of generating electric power is known in a general way to all who have more than a casual contact with it. However, even those whose daily business consists of power generation frequently fail to appreciate the speed with which we have advanced, or the significance thereof. Among the items important in picturing the development over the past quarter century are: (1) Increase in steam pressures; (2) increase in total steam temperatures; (3) increase in physical size of boiler units; (4) increase in steaming capacity of boiler units; (5) increase in main unit turbine sizes; (6) increase in thermal economy of plants, and (7) increase in kilowatt-hours per man hour.

The decrease in the average number of heat units utilized in the generation of a kilowatt-hour represents a remarkable procession in the direction of lower thermal costs, but we appear to be approaching the place where further improvement will be much less rapid.

Of course the decreased thermal consumption is not self-justifying, as it may have been obtained with more than a compensating increase of fixed charges.

1. Chief of Research Department, The Detroit Edison Co., Detroit, Mich.

Presented at the Summer Convention of the A. I. E. E., Swampscott, Mass., June 24-28, 1929. Complete copies upon request.

Unfortunately, experience is not yet sufficiently extensive to make possible a complete analysis. One can reason only from the reports of the few who have actually built and operated the thermally efficient plants. On such a basis and under certain conditions, they at least seem to be justified.

The kilowatt-hour generated per man hour is a subject to which little attention has been given in the literature of this subject. The increasing output per man hour is in line with the general movement throughout the industrial world. In this case, it is brought about largely through improved load factor, combined with the use of boilers and turbines of ever increasing capacity per unit. There has also been a conscious effort to design stations in such a way as to facilitate operation and maintenance and thus decrease the number of men required.

From the executive's point of view the rapid advance indicated by a study of the items listed above has had two opposing results. On one hand, the total cost of producing power has been decreased; on the other hand, the rate of obsolescence has been high, and invested capital has therefore been impaired. The net result of all the forces concerned has been a gradual but consistent lowering of the selling price of power. But the decrease in this price has naturally not been so great as it would have been had it been possible in

some magic way to wipe out of existence the older and less efficient plants as more modern ones became available.

The situation from one point of view is shown in Fig. 8. The solid line represents the thermal performance for a typical metropolitan system in which the rate of growth has been rapid. In drawing the line, certain liberties have been taken with facts, in that the effects of variables other than those here under consideration have been omitted. The dotted line shows what the values would have been if at the time of each improvement, all earlier equipment could have been junked and the required capacity obtained with equipment similar to that just installed. One of the problems of the executive of light and power companies is to determine from time to time just how far he is justified in moving values such as those shown by the solid lines nearer to those shown by the dotted ones. Putting it in another way, the problem is to determine from time to time that balance between production and

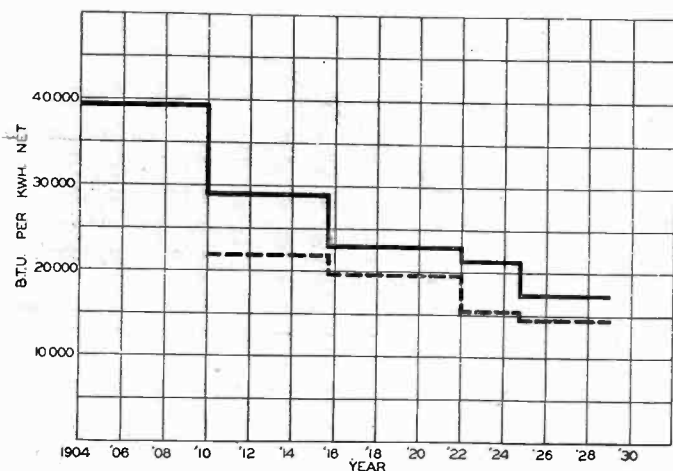

FIG. 8—THE EFFECT OF ADDITIONS TO GENERATING CAPACITY ON THERMAL ECONOMY OF A REPRESENTATIVE GENERATING SYSTEM

The solid line indicates actual conditions while the dotted line shows the thermal economy which would be attained if the older parts of the system were replaced by equipment on a par with the most modern section

capital charges which will represent the best compromise for all concerned. It is out of this problem that we get rehabilitation and reconstruction of power plants.

It is self-evident that no simple rule can be set as a criterion of the advisability of such operations. There are too many variables of divergent nature. It is of course true that the old simple rule, to the effect that in the limit an improvement must at least so reduce production costs as to balance resultant capital costs, holds in a general way. But it is equally true that the effect of improvement upon both sets of costs is in general so complicated that exact calculation is very difficult, if at all possible, in any given case; and a universally applicable formula is practically non-existent. Moreover, there are frequently many almost immeasurable, although very tangible, factors that enter the problem, so that judgment must to some extent take the place of exact calculation.

There is one very interesting aspect of this problem which should be mentioned at this point. It is the

difference between conditions which arise in the case of rapid and slow growth respectively. It happens that most of the light and power companies of this country have had a very rapid growth. This is a situation very favorable to the maintenance of high standards and low costs, whereas with a lesser rate of growth, the problems involved are far more complicated.

Consideration may now be given to some of the things which cause rehabilitation or even complete replacement of power plants. The more important of these are listed below:

1. The plant may be thermally inefficient in comparison with current standards of performance.
2. The plant may be inefficient in the use of man power.
3. The plant may be inefficient in its use of ground area.
4. The plant may be inefficient in its use of invested capital; such as occupying a larger building than necessary, operating boilers at low steaming rates, etc.

These simple statements should not be understood to indicate that figuratively, one can stand off to one side of the problem of rehabilitation and decide offhand with regard to the significance of these controlling factors in any given case. In each case, certain rather rough calculations will usually indicate the relative magnitudes of investments, water quantities, and areas and volumes required to obtain certain approximately determined capacities, investments, and thermal performances. Such preliminary calculations will then indicate the impracticability or even the absolute impossibility of certain solutions, leaving a much restricted field for more intense study.

It is practically impossible to set down definite rules or even guides regarding the rehabilitation of steam power plants. A few outstanding facts may, however, be indicated.

In most cases, both improvement of thermal efficiency and increased capacity will be possible, and it is necessary at the start of the problem to consider which of these possibilities, if either, is to be favored. In general, increase of capacity beyond certain limits will be attainable only by sacrificing certain thermal possibilities and a clear picture of the relative importance of the two will assist greatly in steering a reasonable course through the maze of things that might be done. Usually, the possibility of increased capacity should be given first consideration because certain limits to such increase are so easily discovered.

Thus, it would naturally be foolish to consider increase of capacity if the increased output could not be transmitted or distributed from the site in question. In many cases the available number of routes is limited and these may be found to be used to the limits of their respective capacities. Naturally this is logically the first matter for study.

If the power could be got away if generated, the next logical step is a study of those things which may limit ability to generate on that particular site. These



would be primarily the quantity of water available for condensing purposes and the possibility of delivering the required amount of fuel. If all available water is now being used, as determined either by the supply or the size of canals that must be used, increased output can be obtained only as the steam rate can be reduced, or as the vacuum is permitted to become poorer and the thermal efficiency proportionately sacrificed.

If the water and fuel supply appear adequate, the area of the site and area and cubical content of buildings come into consideration. Any of these may place unfortunate limitations on increase of capacity, but they are in general not so controlling as the other factors just considered.

Finally, the adequacy of existing switching equipment should be given attention. Any scheme which will permit the use of existing equipment would naturally stand a better chance of financial justification than one which required complete rebuilding of the electrical end of the plant.

With such possible limitations clearly evaluated, the most important decision in the average case, and that on which all else may be said to hang is whether the boilers are to be retained or scrapped. If they are to be retained, the operating steam pressure is limited to its earlier value except in those cases where a high-pressure unit is installed as an addition to existing equipment. If the boilers are to be retained, there is definite restriction of choice as to what may be done; on the other hand, there is the certainty of a smaller expenditure.

There has been much misunderstanding of the significance of high steam pressure. It so happens that a very rapid improvement in the thermal efficiency of power plants has occurred during the same time that we have been stepping up steam pressures. As a result, many who are not familiar with all the details have come to assume that the first is entirely the result of the second. This is really far from a complete statement of the facts.

During the same interval, we have increased the boiler room efficiency from values falling between 70 and 78 per cent up to values falling between 84 and 89. A change from 78 to 88 represents a fuel saving of over 11 per cent.

We have also adopted the regenerative cycle of operation, that is, heating of the feed-water in steps by means of steam bled from the turbine. This represents a saving varying from 5 per cent to 11 per cent when referred to the coal pile.

It should also be noted that, in addition, we have increased the total steam temperature. In a period of about 15 years we have gone from a total temperature of about 600 deg. fahr. to a total temperature of about 725 deg. fahr. This change of temperature is equivalent to a thermal improvement of between 4 and 5 per cent for the plant as a whole. During all this time the design of the steam turbine itself has been so improved as to result in a material reduction in heat con-

sumption at any given pressure, temperature, and vacuum.

It is therefore apparent that it is not correct to attribute all of the improvement in the thermal performance of the past ten years or so to increasing steam pressures since many other factors have contributed. As a corollary, it follows that in the rehabilitation of a station, it may be possible to do much that will result in improvement of the thermal efficiency even though the original steam pressure must be retained.

The decision with respect to the use of higher steam pressure is not confined entirely to its effect upon the thermal efficiency, because increased capacity can be obtained in this way through the use of comparatively small high-pressure turbines discharging into the old turbines, utilizing the old condensers. Therefore, while the boiler room investment would necessarily be high, this may be balanced by a comparatively small turbine room investment. Also, the use of the old generators would make it possible in general, to use the old switching equipment, although there would naturally have to be additions to take care of the generators of the new high-pressure turbines.

Thus far the majority of cases of rehabilitation have fallen in the class in which the old boilers are retained, thus accepting the limitations set by the original steam pressure. At present, these are the more interesting and probably the more important.

The following methods of attack are available in such cases:

1. The boiler room efficiency may be greatly improved without materially increasing the steam generating capacity. This can be done by the use of more modern fuel burning equipment of one sort or another, by the addition of economizers or preheaters, or both, and occasionally, by improved baffling of the boilers.

2. The boiler room efficiency may be greatly improved, and at the same time, the steam generating capacity may be increased to a very great extent. It is not at all impossible to double or more than double the steam output of an old boiler room by using improved combustion equipment of greater fuel burning capacity, while at the same time bettering the boiler room thermal efficiency through the use of economizers or air preheaters, or both. It will be found generally advisable to use a certain amount of furnace wall cooling in such extreme cases so as to gain the increased output most easily and hold in check the tendency toward increased furnace maintenance. In this connection it should be noted that frequently it is possible to obtain greatly increased furnace volume by ignoring existing floor levels and utilizing modern ash handling equipment which requires little height for its installation.

3. The turbine room efficiency may be increased by raising the steam temperature. This will naturally involve more superheater surface, or at least differently located surface. In most cases the use of some sort of

radiant superheater in series with the older superheaters will be found advantageous, but a careful study of pressure drop through superheaters and connections must always be made. This is of particular importance when the steaming capacity of the boilers is also increased. The adoption of higher superheat will usually involve minor rebuilding of the high-pressure end of the turbine, and in some cases, major rebuilding of that end.

4. The turbine room efficiency and capacity may be increased by several different methods. The most obvious but usually the most expensive is by the installation of new, larger, and more efficient turbines taking steam at higher temperature from a boiler room of increased steaming capacity. When this method is adopted, it becomes comparatively easy to introduce regenerative feed heating, because the new turbine casings will be supplied with bleeder outlets. Therefore the improvement of thermal efficiency from regenerative heating can readily be obtained. Larger condensers or additions to existing condensers may have to be provided. The old electrical switchgear can sometimes be used by adopting a double winding on the generators so that the capacity per switch is held within the old limitations.

A less obvious but very effective method of obtaining increased capacity and efficiency is found in the compounding of old turbines with new turbines. At first glance this would appear to be practically impossible without raising the steam pressure, but this is not the case; two old turbines may be rebuilt to receive steam at lower pressure and temperature than they did before, and thus serve as low-pressure elements to a single new turbine taking steam at boiler pressure. In such cases, the extent to which regenerative heating of feed is obtainable will depend upon the design of the casings of the original turbines; naturally the new turbine can be designed for bleeder nozzles, and the exhaust connection between it and the older units can be tapped for feed heating. This general method can be made to yield an increased generating capacity of at least 50 per cent and a marked improvement of over-all efficiency as well.

Even when neither of the methods just considered is available, it is still frequently possible to obtain increased output by rebuilding the old turbines and generators. No exact values can be given, but increases of the order of 15 to 20 per cent, and occasionally even more, can be obtained in this way, while at the same time materially improving the over-all thermal performance of the station.

5. Even though it may prove economically undesirable to replace or to rebuild the old turbines, it is still frequently possible to gain marked thermal improvement over that which is to be obtained in the boiler room. This can be done through modification of the auxiliary power supply and the heat balance of the station. One is inclined to think of regenerative feed heating as necessarily tied to the bleeding of each

main unit. In fact, to a certain extent it is obtained whenever that steam which is used for heating feed water has done useful work before being used for this purpose. From the thermal standpoint, it is most perfectly obtained when the steam has done the greatest amount of work before being used for heating, and when the heating is done in the greatest number of temperature steps. Practically two, or at the most three, steps will ordinarily prove economically the best with moderate steam pressures, such as one would expect in plants now being rehabilitated.

The fact that comparatively small turbo generators can now be obtained with steam rates which compare very favorably with those of their larger brothers opens up possibilities of effective regenerative feed heating, even when the main units are not equipped with bleeder nozzles. Thus, a new unit equipped for bleeding very great quantities of steam may be used to supply auxiliary energy and such part of the station output as may be necessary to produce the required amount of steam. The steam bled and exhausted from this unit may then be used for regenerative heating of the condensate from all main units. Thermally, the result would be the same as that attainable through bleeding of the main units if the steam rate of the small unit were the same as that of the larger. Practically, the result will generally not be quite so good because of the higher steam rate of the small unit.

It is worthy of note that rehabilitation of the sort which greatly increases station capacity will generally result in a radical reduction of investment per unit of capacity. It is not at all uncommon to obtain the increment capacity at from four to six tenths of the investment characteristic of the original station. On the other hand, the rebuilt station is generally more crowded than the original, and operating facility may have been sacrificed to a certain extent in producing it. The reduction of man hours per unit of station send-out which should follow the increased capacity may therefore be partly counterbalanced through having to use more men than would be used in a new station of similar unit sizes.

It is true that some executive engineers do not accept rehabilitation as economically justifiable in their own systems. Therefore, it is not legitimate in all cases to predicate original station design on the assumption that rehabilitation will be a necessary part of the history of the plant. However, such rebuilding to a greater or lesser extent appears to be becoming more general than it once was and the history of any given system with respect to such practises should be given serious study when designing new plants for that particular system. If it has been one in which rehabilitation has been found economically desirable it is obviously the part of wisdom to design rather generously with respect to ground area, floor area, cubical contents, and clearances, so that if and when rehabilitation becomes necessary there may be the greatest degree of flexibility.

# Abridgment of Effect of Color of Tank on the Temperature of Self-Cooled Transformers under Service Conditions

BY V. M. MONTSINGER\*  
Fellow, A. I. E. E.

and

L. WETHERILL\*  
Associate, A. I. E. E.

**Synopsis.**—The effect of color on the temperature of oil-immersed self-cooled transformers under service conditions has been a mooted question for a great many years. Based upon the relative absorption powers of the various colors often used in painting transformer tanks, the lighter colors should give appreciably lower temperatures in hot climate sections. The results of three series of field tests conducted on actual transformers are given in the paper. The results, however, do not show the advantages for the light colors that would be expected, based solely upon the absorption powers of the colors.

A method of calculation is used to check the test results, taking into consideration the various factors which apply to a transformer and do not apply to, say, a piece of metal painted and exposed to the

sun's rays; i. e. the ratio of the area of the surface exposed to the sun to the total surface dissipating heat, the difference in thermal capacities, and the condition where in one case the test piece is dissipating heat as well as receiving heat from the sun, whereas in the other case it only receives heat from the sun. It is shown that when all the factors are taken into consideration, the calculated results check the observations very closely. Finally, it is shown that the selection of color for repainting transformer tanks exposed to the sunshine should be based primarily on durability and appearance rather than upon color, since the difference in temperature resulting from a tank painted black and aluminium, or even white, will seldom exceed one or two deg. cent.

## I. GENERAL

THE predetermination of the ultimate temperature rise of a transformer operating in the shade with constant load and ambient conditions is a comparatively simple problem.

Also, the effect of color on the temperature rise under these conditions can be calculated, knowing the emissivity of the color and the percentage of losses dissipated by radiation and convection for a given color.

In service, however, we have a more complicated set of conditions to deal with, making it more difficult to predict the effect of color on the temperature of transformers. For example, only a part of the tank's surface is exposed to the sun's rays. The part exposed is absorbing heat while the part unexposed is not affected by the sun's rays. The tank is exposed only a part of the time—during the day,—while at night conditions may be altered; i. e., some surfaces that are advantageous in the sunshine are disadvantageous in the shade. Also, the solar intensity varies during the day, which complicates the problem still further.

The impression is prevalent that a transformer tank, if painted with a light color, will operate at an appreciably lower temperature in the sunshine than if painted black. This impression is based upon either the relative absorption powers of the colors or tests made on apparatus under conditions not applicable to transformer conditions.

All tests which have been made on transformers under service conditions show, however, that the gain resulting from painting the case a light color is hardly worth considering.

The objects of this paper are, (1) to give the results of the available field tests, and (2) to reconcile the results of

\*Both of the General Electric Company, Pittsfield, Mass.

Presented at the Pacific Coast Convention of the A. I. E. E., Santa Monica, Calif., Sept. 3-6, 1929. Complete copies upon request.

these tests with theoretical results; in other words, to show by a method of calculations that we should not expect an appreciable gain from the light colors for conditions under consideration.

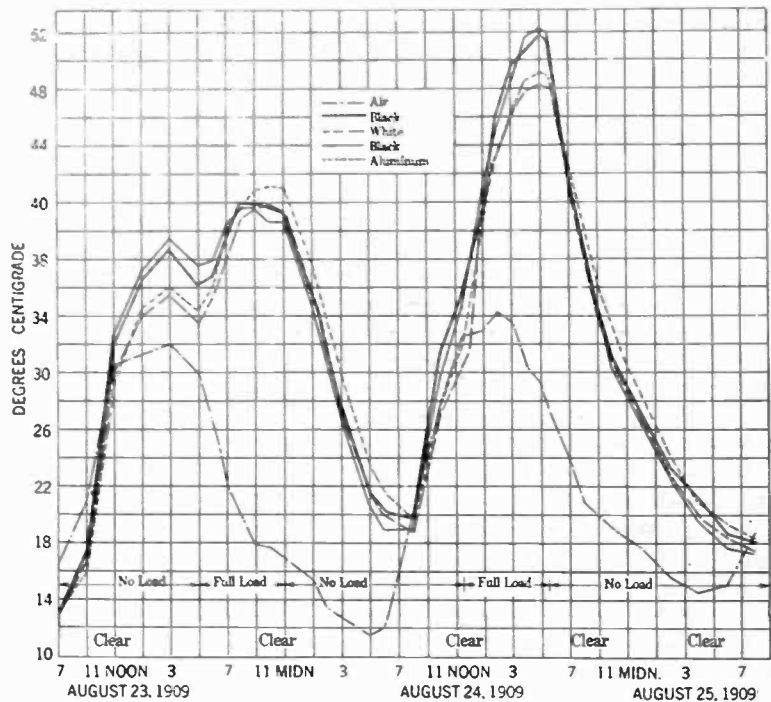

FIG. 3—EFFECT OF SUN UPON HEATING OF TRANSFORMERS OF DIFFERENT COLORS

Normal excitation—six-hour full-load  
5-kv-a. transformers with plain tanks. Temperature by thermometer in top oil. Tests made in Pittsfield

## II. RESULTS OF TESTS MADE UNDER SERVICE CONDITIONS

Three series of tests made under service conditions (at Pittsfield, Mass., Fresno, Calif., and Dallas, Texas) are given and analyzed:

**Pittsfield Tests.** In 1909 a series of tests was made

at Pittsfield, Mass. Some 5- and 50-kv-a. lighting transformers were tested in an exposed location. Tests were made with tanks painted black, white, and aluminum. The transformers were loaded by the

and 11:30 a. m. The effect of the color is not very great, the maximum difference occurring at 4 p. m. showing only 3 deg. cent. in favor of white paint over black.

Fig. 5 shows the result of a continuous full-load run. The difference in temperature is still less, the maximum difference being about 2 deg. cent.

*Fresno Tests.* In 1922 Messrs. Moore and Moulton

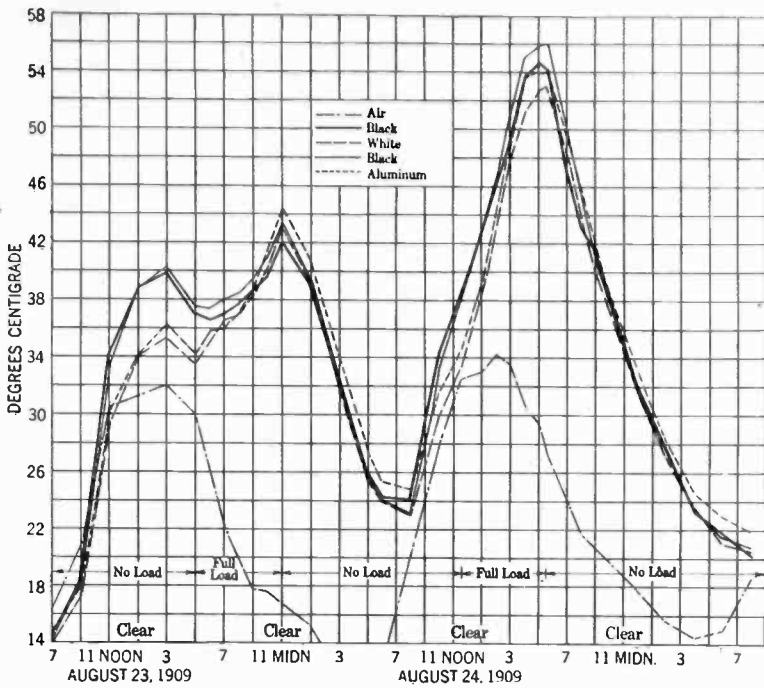

FIG. 4—EFFECT OF SUN UPON HEATING OF TRANSFORMERS OF DIFFERENT COLORS

Normal excitation—six-hour full-load  
50-kv-a. transformers with cast iron corrugated tanks. Temperature by thermometer in top oil. Tests made in Pittsfield

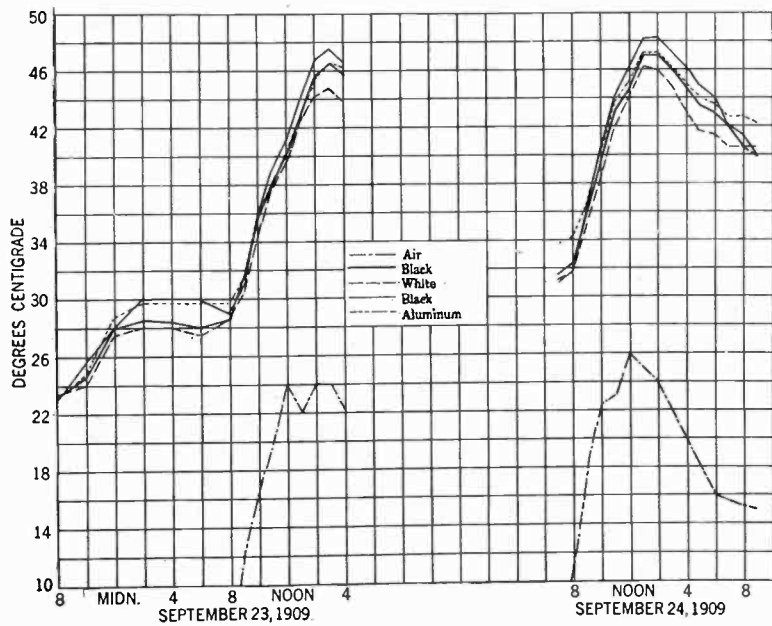

FIG. 5—EFFECT OF SUN UPON HEATING OF TRANSFORMERS OF DIFFERENT COLORS

Continuous full load  
5-kv-a. transformers with plain tanks. Temperature by thermometer in top oil. Tests made in Pittsfield

“loading back” method, which insured equal loads on all pairs.

Figs. 3 and 4 show the results of tests made with six-hour full load following normal excitation at 5 p. m.

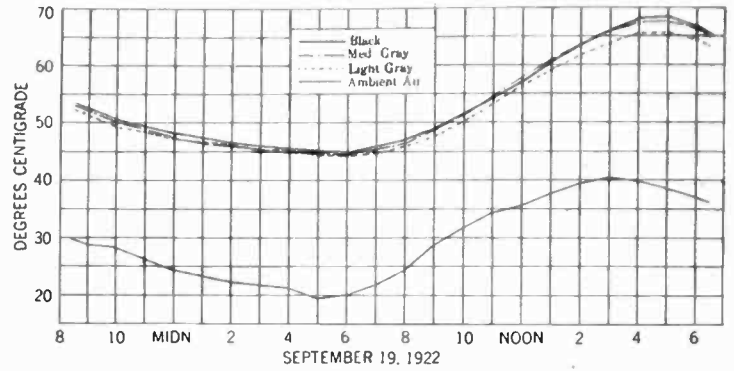

FIG. 8—EFFECT OF SUN UPON HEATING OF TRANSFORMERS OF DIFFERENT COLORS

Normal excitation—normal load  
Three-kv-a. transformers with plain cases. Temperature by thermometer in top oil. Tests made in Fresno, California

of the San Joaquin Light and Power Corporation conducted a long series of tests<sup>1</sup> on several 3-kv-a. lighting transformers, in the sunshine at Fresno, Calif., where the air reached a maximum temperature of 38.8 deg. cent. (102 deg. fahr).

Fig. 8 shows data for full-load runs. The following average temperatures were observed during a 24-hr. period starting at 8 p. m., September 19.

Color of case	Average ambient		Transformers with normal load temperature rise over air			
	Deg. fahr.	Deg. cent.	Deg. fahr.		Deg. cent.	
			Avg.	Max.	Avg.	Max.
Black.....	85.5	29.7	43.3	53.2	24.	29.5
Medium gray.....	85.5	29.7	42.5	52.1	23.4	29.0
Light gray.....	85.5	29.7	41.0	48.6	22.8	27.0

Many more tests were made than shown above. However, the general results were the same.

The following comments are from the report by Moore and Moulton on these tests. They will be of interest since they were made by operating engineers who have transformers operating in one of the warmest sections of the United States.

“The number of successive days during which tests were made and the consistency of the results leaves little doubt as to the accuracy of the full-load tests. The fact that a gray paint will not reduce the oil temperature more than 3 or 4 deg. fahr. or 1 or 2 deg. cent. during the extremely hot weather encountered in the San Joaquin Valley seems established. This was a disappointment in view of the seemingly prevalent

1. See Bibliography for references.



belief that a much larger reduction for gray paint would be found.

"We have reached the conclusion, after a very careful study of the results herein recorded, that any additional expenditure to procure a gray case instead of black would not be justified. This is in view of the fact that the differences in temperature under full load conditions do not vary any more than the difference obtained from various makes operating under identical conditions. Assuming that gray or black tanks are available at equal cost, and that experience shows that gray paint stands up in service as satisfactorily as the black, we should be inclined to favor the medium gray tank. We feel very strongly however, that any expenditure to repaint black cases now in service would not in any way be justified."

*Dallas Tests.* Through the courtesy of O. S. Hockaday of the Texas Power and Light Company, the writers are enabled to give the results of a series of tests conducted in 1924 on three 150-kv-a. transformers with corrugated tanks painted different colors and exposed to the sun's rays. To calibrate the transformers with reference to each other, temperature of each transformer was recorded every day to 6:00 p. m. for about a month with the standard paint (aluminum with black top and bottom) on all three tanks. The average reading for each transformer showed that the northeast unit ran 1 deg. cent. cooler than the middle one and the southwest unit ran 0.3 deg. cent. cooler than the middle one.

The northeast unit was then painted all aluminum, the middle unit all black, and the southwest unit left with aluminum with black trimmings. The average results of the readings taken from July 25 to September 17 are given below; as in the calibrating run, one reading was taken at 6 p. m. each day; fair weather occurred during 80 per cent of the test period.

From July 25 to September 17 inclusive the average temperatures were:

	Northeast all aluminum	Middle all black	Southwest alum. black trim.
Observed temperature.....	47.7	49.6	49.1
Correction from calibrating run	1.0	0	0.3
Corrected temp. (deg. cent.)..	48.7	49.6	49.4

Thus the all-aluminum runs 0.9 deg. cent. cooler than the black.

That the 20 per cent of cloudy or rainy weather has not had any great effect can be seen from the following set of figures, based on seven consecutive days of fair weather.

From August 6 to 12 inclusive the average temperatures were:

	Northeast all aluminum	Middle all black	Southwest alum. black trim
Observed temperature.....	49.1	50.4	50.1
Average correction from calibrating run.....	1.0	0	0.3
Corrected relative temp.....	50.1	50.4	50.4

In this case, the all aluminum runs 0.3 deg. cent. cooler than the black.

Table I gives the results of reading taken October 1 every half hour from 10 a. m. to 6 p. m. Based on the

TABLE I  
TESTS MADE BY TEXAS POWER AND LIGHT COMPANY  
Three Transformers-150 Kv-a., Corrugated Tanks, Bank Capacity 450 Kv-a.

Time	Kv-a.	Ambient temperature	Transformer temperature		
			Aluminum	Black	Alum. black trim.
10:00 a. m.	394	23	31	33	32
10:30	394	23	31	34	33
11:00	396	23	32	34	33
11:30	425	24	33	35	34
12:00 m.	445	25	34	36	35
1:00 p. m.	360	27	36	37	37
1:30	343	28	36	38	37
2:00	373	29	37	38	38
2:30	370	29	37	38	38
3:00	365	29	38	39	38
3:30	357	29	38	39	39
4:00	324	28	39	40	40
4:30	321	27	39	40	40
5:00	376	26	38	40	39
5:30	384	24	38	40	39
6:00	374	22	37	39	39

Data furnished through the courtesy of O. S. Hockaday of the Texas Power and Light Company.

average readings corrected, the all aluminum tank ran 0.7 deg. cent. cooler and the aluminum-black trim ran 0.5 deg. cent. warmer than the all black tank. This last set of readings is perhaps the most reliable since it took account of the entire day and afternoon when the aluminum color shows up to best advantage.

*Pittsfield Tests on Aluminum Tanks.* The preceding tests showed a slight advantage for aluminum but they were made under circumstances favorable to aluminum. Tests made with the tanks shaded from the sun show the disadvantages of aluminum.

Some tests were made in Pittsfield in 1925 to show the effect of aluminum paint on operation in the shade (indoors) on two standard 25-kv-a. transformers, having plain cases.

Two units having the same losses were first tested with their tanks painted black. The two tanks were then painted aluminum and the test repeated with results shown below.

Transf. No.	Room temp. deg. cent.	Top oil rise deg. cent.		Max. tank surf. rise deg. cent.	
		Black	Alum.	Black	Alum.
1	20	37.2	46.3	32.5	41.0
2	20	36.7	47.6	32.0	41.6
Average	20	37.	47.	32.3	41.3

The oil rise of the aluminum tank was 126.5 per cent of the black tank. The maximum tank surface rise of the aluminum tank was 126 per cent of the black tank. This checks very well the estimated percentage of about 130 per cent, assuming a low temperature emissivity of 0.55 for aluminum paint.

The effect of aluminum paint in increasing the temperature indoors is lessened on radiator and tubular tanks, but may still be appreciable. A tank with four rows of tubes will run by calculation about 12 per cent hotter with aluminum paint when operating in the shade. Even on the largest tanks with radiators as close to each other as possible, it is estimated that aluminum paint will increase the temperature rise about 7 per cent when operating in the shade.

III. CALCULATION OF EFFECT OF COLOR

The thermal behavior of a transformer operating in the sun under variable conditions can be calculated

\*TABLE II  
LOW TEMPERATURE TOTAL EMISSIVITIES

Silver, highly polished	0.02
Platinum " "	0.05
Zinc " "	0.05
Aluminum " "	0.08
†Monel metal, polished	0.09
Nickel " "	0.12
Copper " "	0.15
Stellite " "	0.18
Cast iron " "	0.25
Monel metal, oxidized	0.43
Aluminum paint	0.55
Brass, polished	0.60
Oxidized copper	0.60
Oxidized steel	0.70
Bronze paint	0.80
Black gloss paint	0.90
White lacquer	0.95
White vitreous enamel	0.95
Asbestos paper	0.95
Green paint	0.95
Gray paint	0.95
Lamp black	0.95

\*These data are the result of investigations made by the Bureau of Standards, the British National Physical Laboratory, General Electric Research Laboratories, and several eastern universities, and were collected by W. J. King of the General Electric Co.

†Questionable because of scant or inconsistent data.

\*TABLE III  
COEFFICIENT OF ABSORPTION OF SOLAR RADIATION

Silver, highly polished	0.07
Platinum " "	0.10
Nickel " "	0.15
†Aluminum " "	0.15
Magnesium carbonate	0.15
Zinc oxide	0.15
†Steel	0.20
Copper	0.25
White lead paint	0.25
Zinc oxide paint	0.30
Stellite, polished	0.30
Light cream paint	0.35
Monel metal, polished	0.40
Light yellow paint	0.45
Light green paint	0.50
Aluminum paint	0.55
Zinc, polished metal	0.55
Gray paint	0.75
Black matte	0.97

\*These data are the result of investigations made by the Bureau of Standards, the British National Physical Laboratory, General Electric Research Laboratories, and several eastern universities, and were collected by W. J. King of the General Electric Co.

†Questionable because of scant or inconsistent data.

quite accurately using a point by point solution. Two cases are worked out in the complete paper. The results of the first case are shown in Fig. 12. The behavior of the black transformer was used as a base to determine the effect of the sun, for use in calculating the behavior of the white transformer.

IV. CONCLUSIONS

A. *In Shade.* 1. The temperature rise of a transformer in a tank painted with a non-metallic paint is practically independent of the color.

2. Metallic paints radiate less heat than non-metallic paints and may cause a transformer to overheat.

3. A plain aluminum painted tank will run approximately 30 per cent higher temperature rise\* than if painted with a non-metallic paint.

4. Thirty per cent represents the maximum increase of temperature rise caused by painting a tank with aluminum instead of a non-metallic paint. If a plain tank is finished with a surface having a lower emissivity than aluminum the temperature increase naturally will be more than 30 per cent, increasing to about 75 per

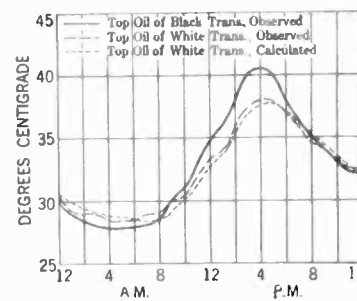

FIG. 12—COMPARISON OF TOP OIL TEMPERATURE OF 50-KV-A. TRANSFORMERS OPERATING IN SUN

cent\* where the emissivity is very low such as for polished silver, nickel, etc.

5. As the surface of a tank becomes more and more convoluted, (with tubes and externally connected radiators) the effect of a metallic paint in increasing the temperature rise becomes less and less, in extreme cases getting as low as 7 per cent.\*

B. *In Sunshine.* 1. The improvement resulting from using special paint on self-cooled transformer tanks, either plain or with convoluted surfaces, is in service very small, hardly enough to be worth considering. Even under the most favorable conditions (white lead paint, smooth tank surface, and a hot, sunny day) the gain is not more than 2 deg. cent. average during a 24-hr. period and in some cases less than 2 deg. cent.

2. The repainting of transformer tanks in the field for operating in the warmer sections of the country should be based upon the consideration of durability and appearance rather than upon color.

Bibliography

1. "Effects of Various Colored Cases on Oil Temperatures of Distribution Transformers," by E. J. Moore and J. H. Moulton, *Jl. of Elec. and Western Ind.*, June 1923.

\*Refers to oil rise. The winding rise over room will be increased the same number of degrees as the oil rise is increased.

2. *Predetermination of Self-Cooled Oil-Immersed Transformer Temperatures before Conditions are Constant*, by W. H. Cooney, A. I. E. E. TRANS., Vol. 44, p. 611.

3. "Effect of Solar Radiation upon Balloons," Bureau of Standards No. 8.

4. *Temperature Rise of Stationary Electrical Apparatus as Influenced by Radiation, Convection, and Altitude*, by V. M. Montsinger and W. H. Cooney, A. I. E. E. TRANS., Vol. 43, p. 13.

5. *Free Convection of Heat in Gases and Liquids—II*, by Chester W. Rice, A. I. E. E. TRANS., Vol. 43, p. 131.

## Abridgment of Electrical Machinery

### ANNUAL REPORT OF COMMITTEE ON ELECTRICAL MACHINERY\*

*To the Board of Directors:*

The Committee on Electrical Machinery has functioned under an organization similar to that of last year; that is, with subcommittees commissioned to handle all the matters of a particular type of equipment that properly belong to this committee.

After reviewing the proposed standards of the I. E. C. on "Rating of Electrical Machinery", the committee recommended agreement with the International Standards in a number of items, but recommended against the adoption of higher temperature rise for organic insulation,—particularly for transformers,—and against a few other features in which European practises differ radically from those in America.

In the new report for transformer standards there is included an appendix designed to outline operation by temperature rather than rating, which reduces hot-spot temperature from 105 deg. to 95 deg. whenever the ambient is 30 deg. cent. or less. Standards for constant-current transformers have been completed and presented for review.

There is evidence of a misunderstanding of "conventional" efficiencies and losses that are neglected in slow-speed engine-driven machines, on the part of engine builders who sometimes charge against the generator much larger losses than actually exist. Steps have been initiated to clarify this situation and to modify the standards to include these small losses.

Work has been started on the development of standards for a-c. commutator motors, and studies have been undertaken to establish a reasonable allowance for no-load losses when these are not determined by test.

Mercury arc rectifiers have been actively studied and records of their performance assembled. Ground work for the preparation of standards for this equipment and

the special transformer requirements has been well laid.

The committee has been commissioned with the preparation of a test code for certain types of apparatus, and it is expected that this will be the beginning of the development of an extensive test code outlining generally accepted methods of test.

No radical departure in the size or design of apparatus has been evident during the past year, but there has been a gradual upward tendency in ratings and efficiencies. In some lines, factory methods are rapidly being changed by the substitution of structural and rolled steel parts for castings and it is expected that these changes will be reflected more obviously in designs as advantageous modifications become evident. While the maximum nominal operating voltage has not been extended beyond 220 kv., the upward trend in voltage has been evident in large equipment. More specifically, some of the trends and typical examples of recent developments are outlined in the following paragraphs.

#### TRANSFORMERS

While apparently well stabilized in types of construction, transformers have increased in size, and their small margin of losses has been further reduced. Efficiencies have been obtained as high as 99.71 per cent in a 60-cycle auto-transformer with 2—1 voltage ratio and 99.54 per cent in a 60-cycle two-winding transformer. Manufacturer's testing facilities have been increased until the General Electric Company can secure 5,000,000 volts with its lightning generator at Pittsfield, and the Westinghouse Company Laboratory is capable of producing over 3,000,000 volts.

The General Electric Company has developed a new type of transformer which has been called "non-resonating." Published tests indicate that in the "non-resonating" transformer the voltage distribution is approximately uniform and the same for high-frequency impulses as it is for operating frequencies. These results are obtained by the use of special shields connected to line terminals but external to the windings so that the necessary charging current can be supplied directly to the various coils rather than indirectly through line end coils. The first of the "non-resonating" transformers has been in operation about two years.

The use of load-ratio control has materially increased

#### \*COMMITTEE ON ELECTRICAL MACHINERY:

W. J. Foster, Chairman,

E. B. Paxton, Secretary,

P. L. Alger,

B. L. Burns,

A. B. Cooper,

W. M. Dann,

C. M. Gilt,

W. S. Gorsuch,

Stuart L. Henderson,

B. G. Jamieson,

J. Allen Johnson,

A. H. Kehoe,

C. W. Kincaid,

R. O. Louis,

A. M. MacOutcheon,

O. K. Marti,

V. M. Montsinger,

F. D. Newbury,

J. M. Olliver,

A. M. Rossman,

R. B. Williamson,

H. L. Zabriske.

*Presented at the Summer Convention of the A. I. E. E., Swampscott, Mass., June 24-28, 1929. Complete copies upon request.*

and the manufacturers have reduced dimensions so that they may now be secured on the transformer tanks extending but little beyond the radiators. The same type of equipment in conjunction with regulating transformer windings may be used to obtain phase control.

Forced air ventilation supplementing self-cooling is particularly effective in large self-cooled units in decreasing the radiator surface required for maximum rating without requiring blower losses on moderate ratings. Two types of equipment are furnished, one of which consist of a single blower, piped to all radiators, and the other, small individual blowers and housings with one attached to each radiator.

Three-winding transformers have continued in popularity, and the Westinghouse Company reports that nearly half the power transformers ordered of its company in 1928 were of this type.

Typical of the most notable installations of large units may be mentioned the following:

An 83,333-kv-a. output, three-phase, 25-cycle water-cooled auto-transformer was installed by the Buffalo General Electric Company, (furnished by the General Electric Company) and probably concentrates in one unit the largest kv-a. output so far undertaken. The high-voltage windings consist of two windings, each of which is connected to a separate bus section and so arranged that a short circuit on one winding tends to raise the voltage of the other.

The largest self-cooled transformer reported consists of 40,000-kv-a. three-phase 60-cycle transformers supplied to the United Electric Light and Power Company of New York by the Westinghouse Company.

Six single-phase 15,000-kv-a. water-cooled 25-cycle transformers, with a voltage ratio of 220/110/132 kv. with both low-voltage windings of full capacity, were supplied to the Hydro Electric Power Commission of Ontario by the Canadian Westinghouse Company and are probably physically the largest 25-cycle units yet supplied.

Single-phase self-cooled transformers, with ratings of 33,333 kv-a. per transformer, self-cooled and 43,333-kv-a., with auxiliary air blast, have been installed at the Plymouth Metering Substation of the Philadelphia Electric Company and were supplied by the Westinghouse Company. They are three-winding transformers with 220-kv. high voltage and are equipped with load ratio control.

Low cost, small power supply from high-voltage lines, has been made available by the standard "substation" for use on 66,000-volt grounded neutral system with a capacity of 15 to 50 kw.-single-phase. The unit consists of an over-insulated single-bushing transformer with cut-outs, metering equipment, etc.

#### SYNCHRONOUS MACHINES

The tendency toward larger machines has continued in the field of waterwheel generators, but there has been

no increase in size of turbo generators beyond those previously reported. The use of fabricated construction has been extended considerably, and the frames, bearing brackets, and rotor spiders of practically all machines are built up from steel plates and rolled members.

The use of quick-response excitation has increased, and the rates of changes of exciter voltage that are now available are in excess of those required for most operating conditions. More experience has been obtained with hydrogen-cooled condensers, to which type of machine this method of cooling is particularly applicable. The designs of high-voltage machines has been advanced, and several generators have been built by the General Electric Company to operate at 22,000 volts; the Westinghouse Company also is now building a 75,000-kv-a. 23,000-volt generator. The scheme of using two independent parallel windings has been supplied by the General Electric Company in two large alternators allowing each winding to be connected to different bus sections so that the reactance between the windings acts as a bus reactor between bus sections.

#### HYDRAULIC GENERATORS

Four waterwheel generators, larger than any yet built, were ordered from the General Electric Company by the Dnieprostroy Hydro-Electric Development of Russia. Fabricated construction will be used in all principle parts of the units.

The following lists the more important machines ordered or installed during the past year:

Purchaser	No.	Kv-a.	Speed	Manufacturer
Dnieprostroy Hydro-Electric Dev.....	4	77,500	88.2	G. E.
Lexington Power Co.....	4	40,625	138	West
Phila. Elect. Co.....	4	40,000	81.8	G. E.
	3	40,000	81.8	West
New England Power Co...	4	39,000	138	West
Brazilian Hydro-Electric	1	33,000	125	G. E.
Southern Calif. Edison...	1	35,000	375/450	G. E.
Alabama Power Co.....	2	29,000	100	West
Norwood Electric Co.....	2	27,500	90	A. C.
City of Los Angeles.....	1	25,000 (Hor)	143	A. C.
Montana Power Co.....	2	25,000	81.8	West
Norwood Electric Co.....	1	22,500	71	A. C.

The vertical Westinghouse and Allis Chalmers units are of the so called "umbrella" or "overhung type" with the guide and thrust bearings located under the generator rotor. This scheme is especially suited to machines whose diameter is large compared to the height. The Conowingo units have been installed since last Spring. Tests on the General Electric Company units showed an efficiency of 97.99 per cent.

Westinghouse has brought a new line of small generators with structural steel parts in ratings from 62.5 kv-a. to 3000 kv-a. at speeds from 100 to 400 rev. per min.



STEAM TURBINE GENERATORS

There were no orders placed this year for any exceptionally large units although a number of orders were received for machines ranging from 60,000 to 75,000 kw.

The use of fabricated parts has been extended and some units have been designed so that the change to hydrogen cooling may be added at a later date. Some of the units mentioned in last year's report have been installed and are in operation. Among more notable installations are the following:

Purchaser	Kv-a.	Speed	Voltage	Shaft	Manufacturer
State Line Gen. Co.....	235,000	1800	22,000	3	G. E.
United Elec. Lt. & Pr. Co..	188,400	1800	13,000	2	West
United Elec. Lt. & Pr. Co..		LP 1200			
	188,250	HP 1800	13,800	2	A. B. B.
Amer. Gas & Elec. Co....	187,000	1800	11,000	3	G. E.
N. Y. Edison Co.....	160,000	1500	11,400	1	G. E.
Brooklyn Edison Co.....	137,500	1800	13,800	2	West
So. Calif. Edison Co.....	100,000	1500	16,500	1	G. E.
Union Elec. Lt. & Pr. Co.	83,333	1800	13,800	1	G. E.

The Westinghouse Company has built a 12,500-kv-a., 3600-rev. per min. generator with self-contained double-entrance fans, which design is said to materially increase its efficiency.

SYNCHRONOUS MOTORS

The design of synchronous motors has been advanced in securing higher efficiency and better torque characteristics and there has been an increase in the use of these machines for industrial purposes.

The Westinghouse Company has built two 1000-hp., 180-rev. per min. motors for cement mill drive, which, while of the salient pole construction, have polyphase damper windings connected through slip-rings to external resistors for starting.

The first two-speed synchronous motors which have previously been described by General Electric Company have been put in service.

SHIP PROPULSION SYNCHRONOUS MOTORS

Two ships having a displacement of a little over 30,000 tons have been placed in service and are propelled at a speed of 18 knots by two 8500-hp. synchronous motors furnished by the General Electric Company. Work has been started on electrical equipment for other large vessels.

SYNCHRONOUS CONDENSERS

The Westinghouse Company has built two 30,000-kv-a. condensers at 720 rev. per min. for the Philadelphia Electric Company, which are the largest units so far constructed at that speed.

The first commercial application of hydrogen cooling for electrical machines was made on a General Electric 12,500-kv-a. outdoor synchronous condenser at the Pawtucket Substation of the New England Power Company. A larger unit of similar design, rated 20,000

kv-a., is in operation at the Turner Substation of the Appalachian Electric Power Company. In addition to reducing losses and increasing the rating, it is believed that the hydrogen cooling increases the insulation life, and decreases the windage noises and the fire risk.

D-C. MACHINES

The fabrication of parts without the use of castings has been extended lately, particularly as to the rotating parts. The development of the arc-welded fabricated construction has given flexibility, and still permitted the standard part principle which is adaptable to machines of different designs and ratings.

Several installations have been made of a new scheme of ventilation in which a special volute housing is arranged to make use of the windage of the machine to force heated air through ducts out of station.

MOTOR-GENERATOR SETS

The Allis Chalmers has furnished a 7000-hp. double-unit reversing mill motor to the Illinois Steel Company and a 6000-kw. flywheel induction motor-generator set for driving it. The General Electric Company has furnished some 4000-kw., 5500-kw., and 6000-kw. motor-generator sets for electrolytic work. These sets were built with one motor and two generators. The Cleveland Terminal electrification has adopted 3000-volt, 3000-kw. motor-generator sets for power supply. The General Electric sets consist of two 1500-volt generators driven by one motor having an overload capacity of 50 per cent for two hours and 200 per cent for five minutes.

MOTORS

An interesting application consists of five motors mounted on a common bedplate with a distance between centers of 7 ft. furnished by the Westinghouse Company to the American Steel and Wire Company for rolling mills. While this requires extreme accuracy in the speed control it permits a better product.

Gearless traction elevator motors are gaining in use for high-speed service and have been supplied as large as 140-hp. at 85 rev. per min. by General Electric Company.

The use of d-c. motors and generators for Diesel-electric ship propulsion has increased. The largest is a 4000-hp. motor supplied by two 800-kw. Diesel-engine-driven generators.

EXCITERS

Quick change of excitation has been applied in a number of installations to increase system stability during disturbances. Rates of voltage rise of 6400 volts per sec. with a maximum of 950 volts for a 250-volt exciter have been obtained.

INDUCTION MOTORS

During the past year the most interesting developments have been in the line of small motors. The need for small single-phase motors of the highest quality

for domestic service brought renewed activity to the capacitor motor. Reliable low-cost capacitors have become available through the progress of the radio art and made capacitor motors economically feasible. The Howell Electric Company has developed a line of this type and the General Electric Company has put several thousand on electric refrigerators. The use of single-phase repulsion-start induction motors in sizes up to 10-hp. has grown steadily and a general improvement of characteristics has been obtained. The General Electric Company has brought out a new motor of this type, with square punchings and graded slots, to obtain more efficient utilization of steel.

Practically all American motor manufacturers are building an extensive line of motors designed for full-voltage starting. The great majority of these are of sizes between 7½- and 30-hp.

The use of small induction frequency-changer sets to supply moderately high-frequency power to drive high-speed motors has grown steadily.

Two induction synchronous frequency-changer sets built for the Niagara Lockport and Ontario Power Company by Westinghouse were placed in operation in 1928. Each synchronous machine is rated 25,000 kv-a., and each induction motor, 28,000 hp., making these the largest variable-ratio frequency changers in the world.

The General Electric Company is building a similar 25,000-kv-a., 27,500-hp. set for the Buffalo General Electric Company.

Enclosed fan-cooled motors have grown remarkably popular. The initial temperature rise of an open motor is not greatly increased by these features, and the accumulation of dirt in service of an open motor, with the consequent increase in temperature rise, is eliminated.

The trend towards the development of large capacity high-speed motors is indicated by some orders recently placed with the Westinghouse Company for eight 1250-hp., 3600-rev. per min. induction motors, to be used for driving high-pressure boiler-feed pumps.

MERCURY ARC RECTIFIERS

Mercury arc rectifiers continue to hold the interest in the d-c. railroad and street railway field. Since January 1, 1928, a total of 28 sets have been installed or placed on order in this country, having a total kilowatt rating of 48,975. The majority of these sets consist of single tanks. The same general trend appears to be current in Europe as over 40 rectifiers with current ratings of 4000 to 6000 amperes were installed or placed on order.

The deleterious effects and frequency of arc-backs have been materially decreased due to more ample auxiliaries, the addition of arc suppressors and other modifications.

Graphitic anodes have given good account of themselves during the past twelve months, and confidence in metallic anodes is indicated by their continued use in

the largest rectifiers now in service in this country.

The outstanding installations during the past year were two 5000-ampere, 625-volt automatic railway outfits installed on the Commonwealth Edison Company's system for railway service, having an overload capacity of 7500-ampere for two hours and 10,000 amperes for one minute. The units are six-phase, twelve-anode type with arc suppressors supplied by the Brown Boveri Company. This company has developed a new type of rectifier for 3000 kw., which is about 30 per cent smaller than the original units of this capacity. Another type with normal rating as high as 16,000 amperes has been developed showing improved efficiency and reduced weight.

MERCURY ARC RECTIFIERS IN RAILWAY INSTALLATIONS INSTALLED OR ON ORDER SINCE 1927

	No. of sets	Tanks per set	D-c. voltage	Kw per set	Total kw.	Control
Commonwealth Edison Company, Chicago, Maypole	1	1	600	3000	3000	Auto
Commonwealth Edison Company, Chicago, West Lawn	1	1	600	3000	3000	Auto
Toronto Hydro Electric System, Toronto Casington	1	1	600	1100	1100	Auto
Southern Public Utilities Corp., Charlotte, N. C., Eliza Ave	1	1	600	750	750	Manual
City of Calgary, Calgary, Portable	1	1	575	600	600	Auto
Union Railway of New York City, New York, St. Peters Ave	1	1	625	1000	1000	Auto
Toronto Hydro Electric System	1	1	600	1100	1100	Auto
American Gas & Electric New York	2	1	600	1000	2000	Auto
Cons. Mining & Smelting Co. of Canada, Electro-litic	3	2	460/560	5600	16800	Manual
City of Edmonton			575		1325	Manual
City of Calgary			575		1200	Auto
City of Halifax	1	1	600	1100	1100	
Chicago & Joliet	1	1	600	500	500	Auto
Columbus Railway Power & Light Co.	1	2	600	500	1000	Manual
Columbus Railway Power & Light Co.	1	1	600	500	500	Auto
Columbus Railway Power & Light Co.	1	1	600	500	500	Auto
Eastern Mass. St. Ry.	1	2	600	1000	3000	Manual
Chicago So. Shore & So. Bend Ry.	1	2	1500		1500	Auto
Chicago So. Shore & So. Bend Ry.	1	2	1500		1500	Auto
Chicago So. Shore & So. Bend Ry.	1	2	1500		1500	Auto
Philadelphia Rapid Transit	3	1	600	1000	3000	Auto
Sacramento Northern Railway	1	1	1500	500	500	Auto
Piedmont & Northern	2	2	1500	750	1500	Auto
British Columbia Elec. Ry.	1	1	600	1000	1000	Manual
					48975	

Bibliography

An extensive bibliography of pertinent developments has been compiled and was published with the complete report.

# Abridgment of Effect of Surges on Transformer Windings

BY J. K. HODNETTE<sup>1</sup>

Associate, A. I. E. E.

**Synopsis.**—A study has been made of the reaction of transformer windings in grounded neutral systems when subjected to transient voltage surges such as exist on normally insulated lines. Measurements of the voltage distribution throughout the windings between various elements and to ground were effected by means of a cold cathode type cathode ray oscillograph and sphere-gaps.

An estimate of the stresses occurring in transformers due to the voltages occurring on transmission systems is made, basing them on the most recent data obtainable. The data indicate that the worst stresses, both within the winding and to ground, are in the vicinity of the line coil.

\* \* \* \* \*

## I. INTRODUCTION

WITH the rapid growth of transmission systems and their interconnection to larger systems, continuity of service is becoming increasingly more important. This has prompted a great amount of study on the subject of increased reliability of all component parts of the system. Such studies have been conducted on transmission lines and connected apparatus. The power transformer constitutes a vital link in such systems. Due undoubtedly to the unceasing research and study conducted during their rapid growth in size and voltage in the past few years, these transformers have shown an excellent record.

Transient voltage surges have long been recognized as one of the chief sources of trouble, and during the past five years, the klydonograph has yielded much information on the magnitude and frequency of occurrence of these surges on transmission systems under service conditions. More recently, the cathode ray oscillograph has been perfected, making it possible to record accurately voltage-time relationships occurring in a small fraction of a second. By means of this instrument it has been possible to obtain actual photographs of surges.

The voltage surges occurring on transmission systems, and, of necessity, those with which we are concerned as affecting transformers, can be divided into three general classes according to their origin; namely, arcing grounds, switching surges, and electrostatic or lightning surges. It is the purpose of this paper to analyze various types of these surges, and afford a common basis of studying their effects, particularly on grounded neutral systems.

*Relative Importance of Arcing Grounds, Switching Surges, and Lightning Surges.* Arcing grounds are discharges to ground, usually from one phase or line of a transmission system. In case the neutral of the system is grounded, the maximum voltage developed would be approximately two and one-half times the normal volt-

age to neutral.<sup>2</sup> For an isolated neutral system, the maximum voltage may be as great as six times normal.

Reviewing literature<sup>3</sup> on the subject, we find the data obtained on a number of systems covering the whole operating range of transmission-line voltages indicate that approximately 50 per cent of switching operations cause no appreciable voltage surge. The maximum voltage recorded on any system was six times normal, and that was caused by deenergizing a line.

As a rule, switching surges do not cause flashover of the line insulation. They must of necessity be of short duration in order to obtain excessive values, and may rise to a maximum in the order of a few microseconds. On the other hand, lightning surges attain values of many times normal line voltages. In many of the cases recorded by the klydonograph, flashover of the line insulation is known to have occurred. By virtue of the fact that the line insulation was flashed over, the magnitude of the voltage is much greater than for arcing grounds or switching surges. In Fig. 1 is shown a comparison of the voltages to be expected from the several sources, together with the normal voltages of the system, the transformer test voltages, and the 60-cycle dry flashovers of normally insulated lines. From this it may be seen that surges produced by lightning are of most serious consequence, and for very short surges with lower values for surges of longer duration may be as great as 14 times normal.

*Factors Limiting Lightning Surge Voltages.* The principal factor limiting the voltage on a transmission line is the spark over of the line insulation. The flashover of a string of insulators depends both upon the magnitude and the shape of the impressed surge, and in the case of lightning surges, is always greater than the 60-cycle flashover voltage. We may assume that failure commences as the 60-cycle spark-over voltage is approached, and that spark-over is a function of time and the voltage above this value. The tail of the surge, as well as the front, affects spark-over, and the more abrupt each is, the higher the voltage necessary to produce arc-over.

From experimental data<sup>4,5</sup> for the flashover of line insulators, it is estimated that the maximum voltage

1. Engineer, Westinghouse Electric & Mfg. Co., Sharon, Pa.

2. For all references see Bibliography.

Presented at the Pacific Coast Convention of the A. I. E. E., Santa Monica, Calif., Sept. 3-6, 1929. Complete copies upon request.

which could exist on a line as a result of a direct stroke would be in the neighborhood of 2.5 to 2.7 times the 60-cycle crest sparkover. The curve for the probable maximum voltage, curve G, Fig. 1, is based on this computation. Points of this curve agree approximately with the maximum voltages recorded by the klydonograph.

In this connection, reduced line insulation, ground wires, protective gaps, and lightning arresters should be mentioned. Each tends to limit the voltage on the system, particularly lightning arresters.

The second factor limiting the potential surges on apparatus is attenuation.<sup>6</sup> Where the voltage of the

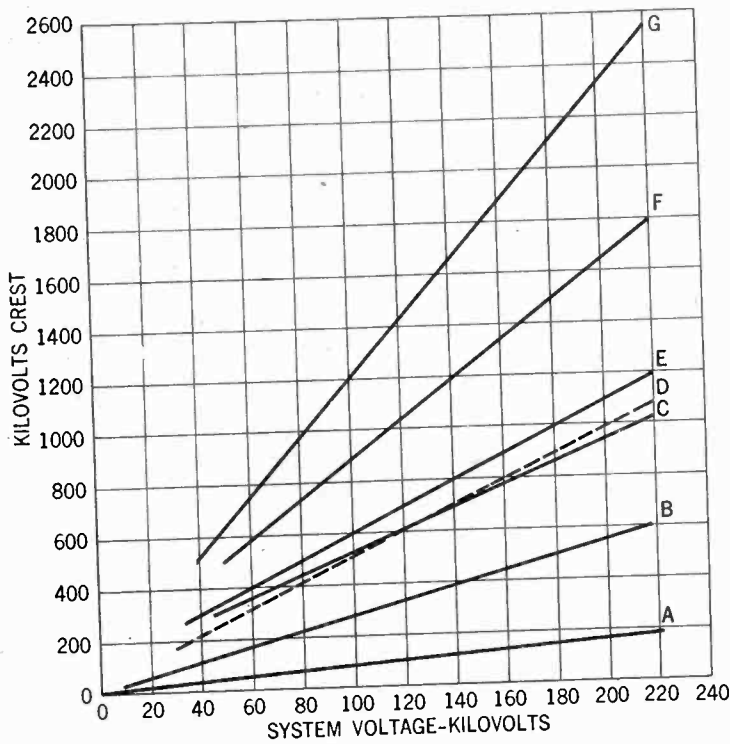

FIG. 1—COMPARISON OF SURGE VOLTAGES AND TRANSFORMER AND TRANSMISSION LINE INSULATION VOLTAGES (ESTIMATED)

- A. Normal voltage of transformer (line to neutral)
- B. Transformer test voltage
- C. 60-cycle dry flashover of normally insulated transmission line
- D. Probable maximum switching surges
- E. Probable maximum voltage for 60-microsecond surge not causing flashover
- F. Probable maximum voltage for 5-microsecond surge not causing flashover
- G. Probable maximum lightning voltage possible (flashover on rise)

surge is very high, the attenuation is very great. To this property of traveling waves much protection to connected apparatus is due.

II. GENERAL CONSIDERATIONS

(A section of the unabridged paper is devoted to this matter)

III. EXPERIMENTAL RESULTS

The circuit used in conducting these tests is shown in Fig. 5. The capacitance C was charged from an alternating source by means of kenotron rectifiers and discharged through an inductance L and resistance R. The potential drop across the resistance was impressed upon the transformer terminal. A lumped impedance

Zs, of approximately 500 ohms, was connected between the transformer terminal and the source of voltage supply. The terminals of the secondary winding were connected to ground through similar impedances.

Waves rising to a maximum in less than a microsecond and decaying to one-half value in 5 and 60 microseconds were considered representative of fairly short and long lightning surges and these, together with waves chopped while rising, were used principally in this

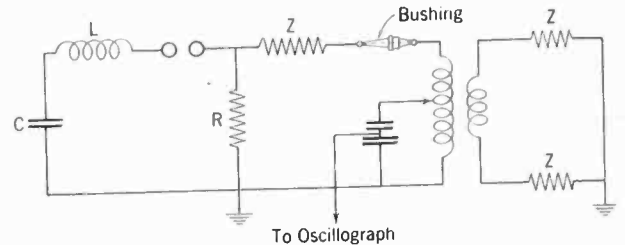

FIG. 5—SCHEMATIC DIAGRAM OF TESTING CIRCUIT

investigation. Waves of approximately 5- and 30-microsecond fronts were also used.

The effect of surges on the windings of the following transformers was studied in the course of this investigation:

3000-kv-a., 140,000- to 5000-volt single-phase, shell type transformer with the high-voltage winding divided into three groups.

667-kv-a., 66,000- to 7200-volt core type transformer

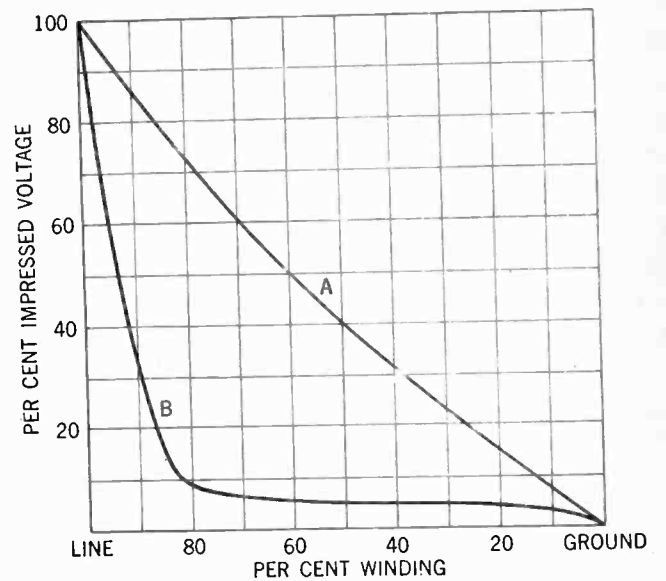

FIG. 7—COMPARISON OF VOLTAGE DISTRIBUTION IN LONG AND SHORT STACKS OF COILS

- A. Short stack of wide coils
- B. Long stack of narrow coils

with cylindrical low-voltage coils and circular pancake high-voltage coils. The winding was arranged on two legs with a reentry in the middle of each leg.

The Effect of the Proportions of Winding on the Distribution of Voltage. Fig. 7 illustrates the difference in the voltage to ground in a short stack of wide coils and a long stack of narrow coils when subjected to a five-microsecond surge. These values represent approximately the initial voltage distribution and are



indicative of the worst stresses occurring in the stacks. Curve A represents what occurs in the line group of a well proportioned wide stack of coils and Curve B represents what occurs in a narrow stack of coils when short steep waves are impressed upon them.

When the windings are interleaved or broken up into

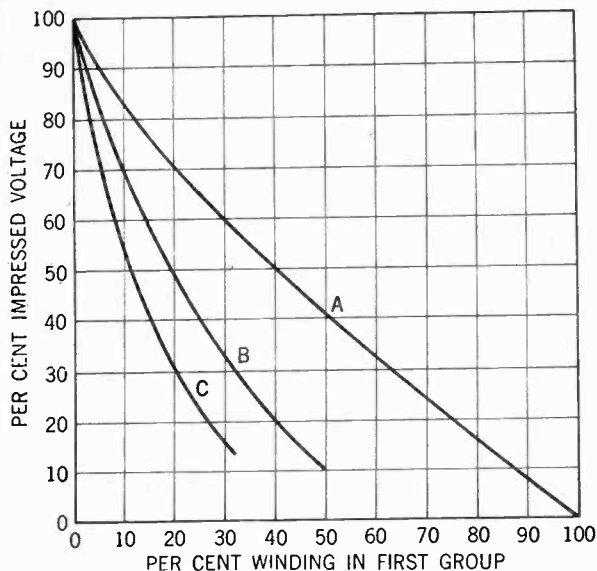

FIG. 8—THE EFFECT OF INTERLEAVED WINDINGS ON THE VOLTAGE DISTRIBUTION  
 A. Voltage distribution with one group  
 B. Voltage distribution with two groups  
 C. Voltage distribution with three groups

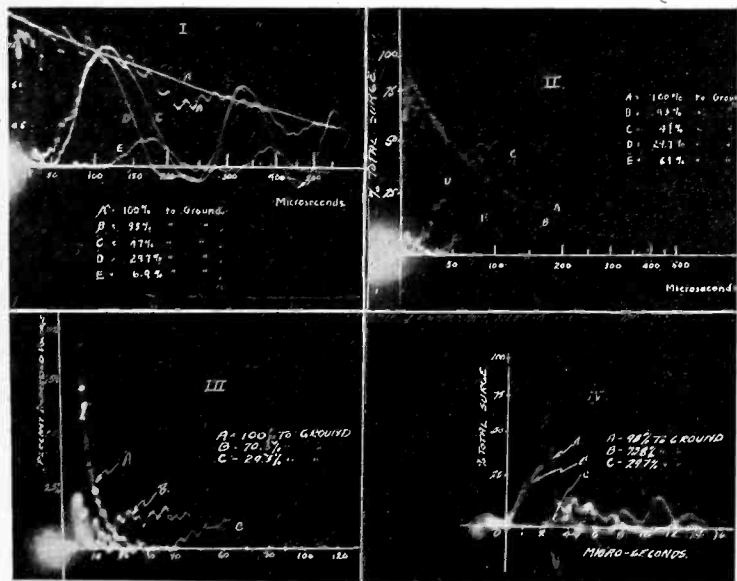

FIG. 9—OSCILLOGRAMS SHOWING VARIATION IN INTERNAL OSCILLATIONS OF 3000-KV-A. TRANSFORMER WITH DIFFERENT LENGTH SURGES

1. Very long surge, 250 microseconds to half value
2. Long surge, 60 microseconds to half value
3. Short surge, 5 microseconds to half value
4. Chopped surge

groups, the line group absorbs most of the surge voltage. Data were taken on the 3000-kv-a. transformer first by impressing a surge across the total winding; then across two groups, and finally across a single group of the winding. A five-microsecond surge was used and measurements of voltage were made to ground. Referring to Fig. 8, the three curves were seen to be of similar shape,

or the distribution of voltage in the line group is practically unchanged by varying the number of groups. The discontinuous points in the curves indicate the division of voltage across the group.

*Internal Oscillations and Voltage to Ground.* When a steep-front surge strikes a transformer, oscillations are set up in the winding. The values attained by these oscillations depend largely upon the shape of the surge. Referring to the oscillograms, Fig. 9, the oscillations are seen to be higher for the longer tail waves. A point in the winding 29.7 per cent above ground reaches a maximum value of approximately 75 per cent of the total applied voltage for the extremely long wave,

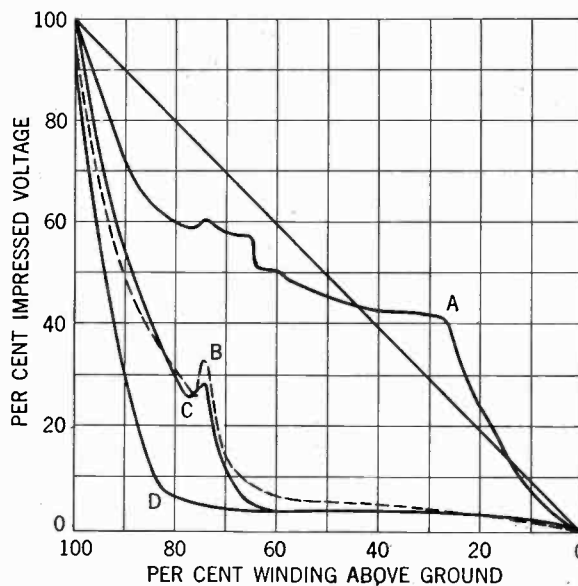

FIG. 11—MAXIMUM VOLTAGES TO GROUND FOR DIFFERENT TYPES OF SURGES

- A. Voltage distribution in 3000-kv-a. transformer with 60-microsecond surge
- B. Same with chopped surge
- C. Same with five-microsecond surge
- D. Voltage distribution in 667-kv-a. transformer with five-microsecond surge

approximately 47 per cent for the long or 60-microsecond wave, 10 per cent for the short or five-microsecond wave and 5 per cent for the chopped wave.

Thus it may be seen that if the surge is sufficiently short, the voltage by oscillation does not rise above the initial voltage acquired from the front of the wave. On the other hand, a measurement of the voltage above ground for longer waves would indicate the maximum values reached by oscillation. This is confirmed by the agreement between the curves (Fig. 11), and the oscillograms.

The natural frequency of the shell type transformer investigated was approximately 5000 cycles and that of the core 6700 cycles. It is believed that the order of these fundamental frequencies is representative of that of power transformers in general.

Referring again to Fig. 11, a very close agreement between the voltage to ground for the five-microsecond and chopped waves is observed. This follows the explanation just given that the initial distribution and not the oscillatory portion of the transient was the factor determining the voltage to ground.

The breaks or departures from continuous smooth curves were caused by taps in the winding.

The voltage to ground for the 667-kv-a. transformer subjected to a five-microsecond surge is also given. A basis for comparing the two transformers is not simple. However, the curves show for the same surges that 86 per cent of the voltage drop occurs across 15 per cent of the winding of the 667-kv-a. transformer as against 57 per cent of the voltage for the same percentage of the 3000-kv-a. winding.

#### IV. MAGNITUDE OF STRESSES IN TRANSFORMERS AS DETERMINED BY THE LINE CONDITIONS

*Stresses within the Windings.* Referring to Fig. 11, from which the stress along the length of the wind-

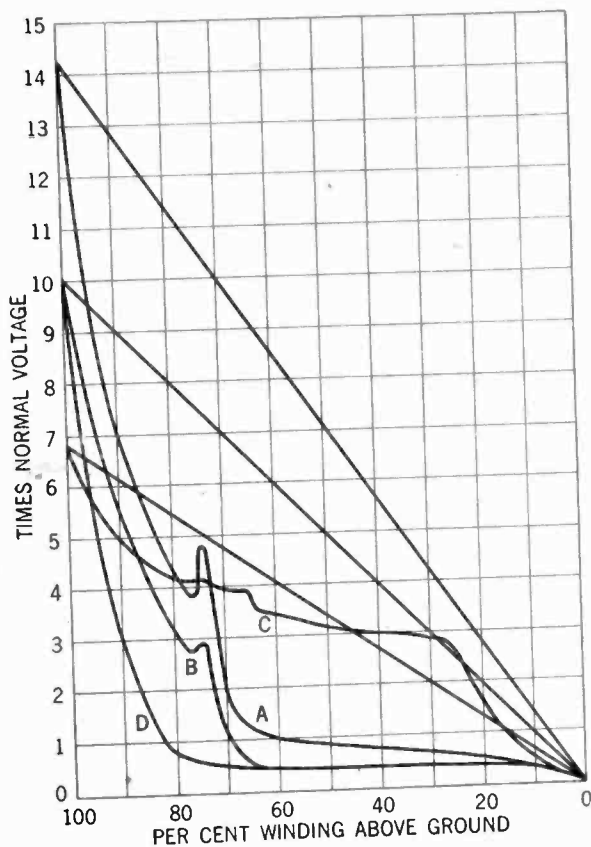

FIG. 14—PROBABLE MAGNITUDE OF INTERNAL VOLTAGES ABOVE GROUND

- A. Chopped surge, 3000-kv-a. transformer
- B. Five-microsecond surge, 3000-kv-a. transformer
- C. 60-microsecond surge, 3000-kv-a. transformer
- D. Five-microsecond surge, 667-kv-a. transformer

ing can be estimated, and to the probable maximum potentials on transmission line as given in Fig. 1, the following may be deduced:

The highest stresses are evidently those caused by surges with very steep fronts, as these give the worst initial distribution of voltage and attain the highest values which, in the case of surges limited by flashover of the line insulation may be of the order of 14 to 15 times normal. Surges of this character cause no fundamental oscillations on transformers having periods of the order of those investigated herein; therefore, the initial distribution is the only factor necessary to consider. This distribution is largely a function of the physical properties of the winding. By reference to the

above curves it may be seen that the greatest stresses occur near the line end, where the winding is made of the simplest possible form of construction, free from taps, which lends itself for providing adequate insulation.

*Stresses to Ground.* The voltages to ground as expressed in the curves of Fig. 11 have been multiplied by the ratios of the probable maximum surge voltages of Fig. 1 and are plotted with respect to their relative values in Fig. 14. On this basis, the latter curves represent the maximum voltage stresses to ground obtained in the various parts of the transformer winding, either through internal oscillation or by the initial electrostatic induction. In recording these values, measurements by oscillograph and sphere-gap are in agreement within experimental accuracy. Obviously these stresses are placed upon the major insulation of transformers, and for uninterrupted service must be withstood. Since in this case, as in the previous case, the highest stresses are produced by the very short surges, the transformer major insulation may be subjected to 14 to 15 times normal voltage in the vicinity of the line end. In the mid-section of the transformer, the highest voltages are produced by the long surges and are three to five times normal. Their value is fixed by the amplitude of oscillation. The amplitude of oscillation is a function of the initial distribution which in turn is a function of the physical proportions of the winding. Transformers insulated sufficiently to withstand the maximum stresses at the line end should without difficulty withstand the stresses imposed at any internal portion, even though the insulation there is reduced.

The above conditions refer to the maximum surges expected in service. For longer surges such as represented by curves E and F, Fig. 1, or for surges removed a considerable distance from the transformer, the stresses would be diminished.

#### ACKNOWLEDGMENTS

The author is pleased to acknowledge the valuable assistance rendered by Messrs. F. J. Vogel, J. F. Peters, J. M. Blackhall, and others of his associates in the Engineering Department of the Westinghouse Electric and Manufacturing Company in obtaining the experimental data and preparing this paper.

#### Bibliography

2. J. F. Peters and J. Slepian, *Arcing Grounds*, A. I. E. E. TRANS., Vol. 41, p. 478.
3. J. H. Cox, P. H. McAuley, and L. G. Huggins, *Klydonograph Surge Investigations*, A. I. E. E. TRANS., Vol. 46, 1927, p. 315.
4. F. W. Peek, Jr., *Lightning*, A. I. E. E. QUARTERLY TRANS., Vol. 48, April 1929, p. 436.
5. C. L. Fortescue, A. L. Atherton and J. H. Cox, *Theoretical and Field Investigation of Lightning*, A. I. E. E. QUARTERLY TRANS., Vol. 48, April 1929, p. 449.
6. J. J. Torok and W. Ramberg, *Impulse Flashover of Insulators*, A. I. E. E. QUARTERLY TRANS., Vol. 48, Jan. 1929, p. 239.
7. W. W. Lewis, *Surge Voltage Investigation on Transmission Lines*, A. I. E. E. QUARTERLY TRANS., Vol. 47, Oct. 1928, p. 1111.

# Abridgment of Electrophysics

## ANNUAL REPORT OF THE ELECTROPHYSICS COMMITTEE\*

To the Board of Directors:

One of the Committee's principal functions has been to serve as a connecting organization between the world of physics and the Institute. We have been trying to serve this purpose by encouraging papers which bring in new concepts, phenomena, and terminology from working physicists, and discouraging contributions which are results of "inbreeding." Dielectric phenomena and dielectric theory are two particularly live topics, and there is a constant danger of unnecessarily burdening the Institute publications with contributions which contain more undigested data and unfounded speculations, and which do not bring us any nearer to a rational understanding of the underlying molecular phenomena.

### DIELECTRICS

A large percentage of papers submitted to the Committee on Electrophysics has to do with dielectrics and their behavior. One of the sessions at the Winter Convention was devoted chiefly to this topic, and papers were presented on anomalous conduction, dielectric absorption, dielectric constant, power loss, and corona. Several other papers have been since approved for publication or for presentation at future meetings.

Much work on dielectrics is being done under the auspices of the Committee on Electrical Insulation of the National Research Council and also by the American Society for Testing Materials. Their reports and publications should be consulted in addition to the material found in the *A. I. E. E. TRANSACTIONS*. There is also a Government Research Committee on this subject in England. Many valuable articles on dielectrics will be found in the *Archiv für Elektrotechnik*, and in some recent British and German books on different phases of dielectric behavior.

Under the auspices of the above mentioned Committee on Electrical Insulation, several subcommittees were formed in 1928, among others a Subcommittee on Physics, V. Karapetoff, Chairman, and a Subcommittee on Chemistry, F. M. Clark, Chairman. Both subcommittees are already functioning, and through them many prominent physicists and chemists have

#### \*COMMITTEE ON ELECTROPHYSICS:

V. Karapetoff, Chairman,

Carl Kinsley, Secretary,

O. E. Buckley,

V. Bush,

John R. Carson,

F. M. Clark,

W. D. Coolidge,

W. F. Davidson,

O. J. Ferguson,

C. L. Fortescue,

A. Hund,

W. B. Kouwenhoven,

K. B. McEachron,

R. A. Millikan,

R. H. Parks,

L. J. Peters,

J. Slepian,

F. E. Terman.

Liaison Representatives of American Physical Society

Dr. W. F. G. Swann, Prof. A. P. Wills.

Presented at the Summer Convention of the A. I. E. E., Swampscott, Mass., June 24-28, 1929. Complete copies upon request.

been drawn into the study of scientific aspects of dielectrics.

### HIGH-VOLTAGE RESEARCH

Using the principle of charging capacitors in parallel and discharging them in series, very high impulse voltages have been generated for test purposes. A voltage of 5,000,000 has been produced in this way and even higher voltages have been applied to transmission lines. The phenomena of attenuation, reflection, etc., of traveling waves have been studied by means of the cathode ray oscillograph. This work is being continued on a larger scale. The cathode ray oscillograph was used also to record impulses on lines due to natural lightning. Only two records were obtained in this first attack on this problem, but a start has been made and more extensive data should be collected this summer. The cathode ray oscillograph was used for a laboratory study of a number of interesting and important phenomena, such as the impulse flashover of insulators and the distribution of transient voltages in transformers.

The year's work at the Ryan Laboratory, Stanford University, California, resulted in three papers. One, by Lissman<sup>1</sup> analyzes lightning phenomena in the light of laboratory experience, and gives a detailed picture of what actually goes on in a lightning stroke. The second paper by Carroll and Cozzens<sup>2</sup> reports results on sphere-gap sparkover voltages up to and over one million to ground. It was found that the voltage per inch required to break down gaps in excess of 9 ft. decreased so rapidly with increased spacing that it established an approximate economic limit of high voltage for power transmission. The final paper, by Dr. J. T. Lusignan<sup>3</sup> gives the probable history of an a-c. flashover, as obtained from oscillographic and spectroscopic evidence.

### DIELECTRIC CONSTANT, MOLECULAR STRUCTURE, AND MOLECULAR MOMENT

During the past year, considerable research has been carried out on the subject of molecular moment and its relation to dielectric constant and molecular structure. The work has centered chiefly around the Debye theory. In general, this theory is becoming more and more accepted, although a large number of the researchers find that the theory does not fit in with experimental behavior in a great many instances.

In a study of the variation of the dielectric constant of gases with temperature and pressure, Magdalene Forro finds in the *Zeitsch f. Physik*, 1928, 47, 430 that the constants of the Debye equation,  $(\epsilon - 1)/(\epsilon + 2)$

1. A. I. E. E. TRANS., Vol. 48, Jan. 1929, p. 146.
2. A. I. E. E. TRANS., Vol. 48, Jan. 1929, p. 1.
3. A. I. E. E. TRANS., Vol. 48, Jan. 1929, p. 246.

$(T/d) = \alpha T + b$ , change with temperature and pressure. For hydrogen, nitrogen and air,  $\alpha$  (which is the optical contribution to the dielectric constant) is of constant value, while  $b$  (which is the permanent dipole contribution) is zero. For carbon monoxide the value of  $b$  varies with pressure at constant temperature. The temperature coefficient of  $b$  for carbon monoxide indicates a dipole moment of  $0.108 \times 10^{-18}$  at one atmosphere to  $0.147 \times 10^{-18}$  at six atmospheres of pressure. The variation of the permanent dipole contribution to the dielectric constant can be expressed as either a linear or as a quadratic function. For carbon dioxide, however, this permanent dipole effect varies with the density as a quadratic function, the dipole moment varying from  $0.192 \times 10^{-18}$  at one atmosphere to  $0.217 \times 10^{-18}$  at 6.53 atmospheres.

Study of the molecular moment and dielectric constant in organic and inorganic solutions has been a particularly favored field of investigation during 1928. In general, the work has been in agreement with the results obtained by G. Rock and S. Klosky published in the *Journal of Physical Chemistry*, 33, p. 143 (1929). They found that the dielectric constant of silver sols is essentially that of the dispersion medium.

#### FERROMAGNETISM

Heisenberg has been partially successful in explaining the origin of ferromagnetism on the basis of the spinning electron and the Fermi-Dirac statistical theory. His theoretical deduction is that a material cannot be ferromagnetic unless it is composed of atoms which have three-quantum electrons and which are symmetrically surrounded by at least eight neighbors.

Honda suggests that the electrons in the nucleus are responsible for the origin of ferromagnetism. His picture avoids the difficulty of the Larmor precession of extra-nuclear electron orbits.

Weiss and Forrer have redetermined the value of the Weiss magneton in iron and nickel, and reviewed the literature to show that the magneton is the unit in all magnetic materials.

The increase in specific heat, due to loss of magnetism near the magnetic transformation temperature, has been measured by Bates for manganese arsenide and compared with the values calculated according to Weiss from the magnetization-temperature curve, with good agreement.

Elmen has reported the remarkable magnetic properties which he has found in some alloys of iron, cobalt, and nickel. These alloys, called "perminvars," when properly heat treated, have permeabilities which are unusually constant up to fields of several gauss. They have therefore very small hysteresis losses for low flux densities.

#### EXPERIMENTAL INVESTIGATION OF THERMAL RELATIONS OF ENERGY OF MAGNETIZATION

Walter B. Ellwood, graduate student at Columbia University, working on hysteresis in iron, has succeeded in his attempt to a solution of an outstanding

problem in magnetism which has hitherto defied attack. The following note, which is a first report on this work, was received from Professor A. P. Wills, under whose direction the investigation was carried on.

Experiments were undertaken for the purpose of determining the mechanism of the degradation of energy which accompanies magnetization in ferromagnetic substances. The experimental method consists in observing the change in temperature of a test specimen produced by a change in the magnetizing force at consecutive intervals in a single cycle of magnetization.

#### PROPAGATION OF ELECTROMAGNETIC WAVES IN SPACE

The subject of wave propagation has been studied theoretically and experimentally and the existence of the Kennelly-Heaviside layer can be regarded as a fact. The resultant signal received at any point is the vector sum of the ground wave and the indirect wave coming down from the ionized layer. The waves radiated from a normal aerial have their electric vectors vertical to the surface of the ground, and almost so at the receiving end. This means in the optical language that the received ground wave is horizontally polarized. The downcoming wave is generally elliptically polarized and the resultant field of both waves is usually complex. This gives rise to bearing errors in direction finding and causes the well-known fading.

Hollingworth finds that downcoming waves which are longer than 10,000 meters are usually plane polarized. The direction of the plane is approximately constant during the day but during the sunset and sunrise periods it varies in a manner depending on the distance between the sender and the receiver. At some distances the plane is turned clockwise and at other distances, counter-clockwise.

For waves of 400 meters at distances of 100 miles the downcoming components are circularly polarized. This means that both the electric and magnetic vectors have constant amplitude but rotate synchronously, the direction of rotation depending on the direction of the earth's magnetic field. This would mean a right handed rotation in all parts of the Southern hemisphere.

For 15 and 50-meter waves, T. L. Eckersley finds the downcoming waves almost plane polarized, the plane rotating slowly with the period of a few seconds. This should produce fading when a vertical or a horizontal aerial is used for receiving. But fading seems mostly due to a change in intensity of the downcoming waves rather than to a change of phase with respect to the ground wave.

#### PHYSICS OF RADIO COMMUNICATION

In Europe, much attention has been given to the effect of trees, buildings, built up areas, etc., on the attenuation of radio waves. Examples of such studies are those of Barfield (*Inst. of Elec. Eng. Jl.*, 1928 and 1929).

Among the important investigations of short-wave



propagation are those of Heising (*I. R. E.* 17, 75, Jan., 1928), Taylor and Young (*I. R. E.* 16, 562, May, 1928), Mesny (*L'Onde Elec.* 7, 130, April, 1928) Meissner and Rothe (*I. R. E.* 17, 35, Jan., 1929) and others.

Our present knowledge of static is summarized in a paper by Watson Watt (*E. W. and W. E.* p. 619, Nov., 1928). Carson has shown that it is impossible to eliminate static disturbances in receivers by audio frequency balancing schemes (*I. R. E.* 16, p. 966, 1928).

Advances have been made in the production of oscillations having wavelengths of less than 1 meter. Important publications on this subject are by Yagi (*I. R. E.* p. 715, June, 1928), Hollmann (*I. R. E.* p. 229, Feb. 1929), and Okabe (*Journ. Inst. of E. E. Japan*, March, 1928, p. 284).

An excellent summary of the status of direction finding was recently published in the *I. R. E. Proceedings* (March, 1929, p. 425) by Smith-Rose.

The Bureau of Standards has developed a successful aircraft radio beacon (*I. R. E.* 16, p. 890, July, 1928). An extensive bibliography on aircraft radio has been published by Joliffe and Zandoninini (*I. R. E.* 16, p. 985, July, 1928).

In the field of vacuum tubes, Hull<sup>4</sup> has developed a high-voltage two-element gaseous rectifier, and a three-element gas tube, both of remarkable characteristics. Four-element double grid commercial tubes have been developed, and five-element tubes are now in the experimental stage.

The most remarkable discovery that has been made recently in short-wave propagation is the discovery by Stormer and Hals of echo signals with time delays as great as 15 seconds after reception of the original signals (*Nature*, Vol. 122, Nov. 3, 1928, p. 681). Similar echoes have also been observed by van der Pol (*Nature*, Vol. 122, Dec. 8, 1928, p. 878). These Stormer-Hals echoes have aroused great interest, and several explanations have been advanced concerning their origin.

#### SUBCOMMITTEE ON REACTIVE POWER

In October 1928 the A. I. E. E. published an English edition of the "Questionnaire on the Problem of Reactive Power," prepared by the National Roumanian Institute for the Study of the Development and Utilization of Sources of Energy, for the Advisory Committee for the Improvement of Power Factor of the International Conference on Large High-Voltage Systems.

This is a 21-page 9 by 12-in. pamphlet with an introduction by Doctor C. O. Mailloux. The questionnaire treats in great detail of the theoretical and practical aspects of the subject, with an extensive list of references appended.

The questionnaire has been referred by the Standards Committee of the Institute to the Committee on Electrophysics for an opinion. Since most of the members of this committee are following entirely different lines of work, it was deemed advisable to form a special subcommittee. Dean O. J. Ferguson of the University of Nebraska kindly

consented to serve as chairman of the subcommittee.

#### SOME ACTIVE TOPICS IN PHYSICS

One of the purposes of the committee being to act as a connecting link between the Institute and the field of pure physics, the following list of topics will be of interest. It represents some of the subjects on which physicists are working and on which papers are being regularly presented and articles written by the leading investigators. It will be noticed in particular that the old division into mechanics, heat, light, electricity, and sound, has been more or less obliterated, the electron theory and the quantum mechanics being the dominant foundation of most of the researches, except in acoustics.

Scattering of electrons by gases, liquids, and solids.

Diffraction of electrons by thin films and by crystals.

Absorption of electrons by vapors.

Effect of electrostatic and magnetic fields upon electrons, ions, and neutral molecules.

Spectra of various substances under different conditions, as bearing upon the nature of their atomic and molecular structure.

Energy distribution, attenuation, and absorption of radiation at different wavelengths.

Photoelectricity and photoelectric cells.

Effect of electric and magnetic fields upon spectra, and correlation of these effects with the atomic and molecular structure.

X-rays; their wavelength, electron levels, diffraction, fine structure, polarization, ejection of photoelectrons.

Characteristics of sparks and other discharges, including their spectra.

Thermionic emission and properties of triode valves.

Compton effect; Raman effect.

Behavior of electrons like waves and behavior of light quanta like particles; bridging the gap between matter, electricity, and energy.

Nature of light waves and of electrons.

Conduction in metals from the point of view of the new quantum mechanics.

Nature of magnetism.

Magnetic properties of crystals.

Experimental and theoretical study of atmospheric electricity and terrestrial magnetism, in terms of moving ions and of radiations.

Structure of the universe in terms of astronomical and spectroscopic evidence, assisted by Einstein's generalized theory of relativity.

New statistical mechanics, wave mechanics, quantum relations, indetermination principle, etc.

Quantum mechanics of chemical reactions.

Atomic structure and chemical valency.

NOTE. Attention is directed to Doctor M. I. Pupin's Editorial on *1928 Progress in Physics*.<sup>5</sup>

#### A GENERAL TREND IN PHYSICAL CONCEPTS

The present day period in physics may be said to have begun with the discovery of the electron in the closing years of the nineteenth century. This meant a new

4. A. I. E. E. Quarterly TRANS., Vol. 47, July 1928, p. 753.

5. A. I. E. E. JOURNAL, February 1929, Vol. 48, p. 92.

atomic concept of electricity. The introduction of the idea of quantum of energy, as the smallest amount of energy in a "chunk" of radiation of a given frequency, meant another new concept; namely, the atomicity of energy, at least in one of its forms. Einstein's relativity followed in 1905, and has brought in another new idea; namely, that a physical "law" may be different depending upon the size of the continuum to which it is applied and the magnitude of the velocities which come into play. In the Bohr-Sommerfeld theory of the atom (1913-1915), the three new concepts; namely those of electron, quantum, and relativity, were brought together in a masterly way to explain the observed complex structure of various spectra. Later, similar ideas were extended to molecular spectra and to the theory of specific heats, as being due to different forms of motion of the parts of a molecule relatively to one another.

Thus, an area of "picture theories" of the atomic structure was ushered in. Electrons were endowed with various forms of motion about a central nucleus to explain this or that phenomena; atoms were endowed with suitable forms of motion within a molecule to explain some other phenomena; and when a particular feature of a spectrum could not be accounted for, new motions were invented to explain it—for example, the spinning electron. In other cases, the observed spectra did not show all the lines predicted by the theory, and certain "principles" or "postulates" were introduced to exclude such lines *a priori* as not being in accord with one of these principles.

However, the picture-theory period was only short-lived, partly because the pictures themselves became unduly complex, especially for heavier atoms, partly because the theory proved to be inadequate on some essential points, and partly because in the very nature of the phenomena statistical results were desired, rather than an actual orbit of this or that electron in a particular atom. But a statistical problem, where billions of atoms are to be considered simultaneously, and where only the probability of a certain event is sought, rather than its certainty for a given atom, hardly lends itself to a picture. Just as an extreme advocacy of graphical methods on a branch of engineering usually leads to a reaction in favor of an analytical method, so the picture-theory period yielded its place almost overnight to a "mathematical-function" period in the midst of which we are now laboring.

Several brilliant European mathematical physicists, such as Heisenberg, Born, Jordan, Pauli, de Broglie, Dirac, Fermi, and Schrödinger, have developed various aspects of this new point of view, and while it would be entirely out of place to go into the details here, the following few remarks may indicate the general trend.<sup>6</sup>

6. A symposium on Quantum Mechanics was held under the joint auspices of the American Physical Society and American Mathematical Society in New York City on December 31, 1928. Most of the papers and discussions may be found in the April 1929 issue of the *Franklin Institute Journal*.

Ideas are more general than objects or phenomena, and we are apt to come nearer the true interpretation of the universe by adhering as closely as possible to general ideas rather than by evolving specific pictures, especially if the latter have been borrowed from the big world of every day experience and transferred without change into the unknown intra-atomic world. But quantitative ideas are best expressed by mathematical formulas and operations, and so the problem is reduced to devising such formulas and operations and using them to describe and to predict phenomena, even though we may not be able to construct corresponding pictures within the atom. There is no contradiction in this because an individual atom is not yet susceptible to direct observation. The principal point to achieve is to make the mathematical theory agree with the observed phenomena in the minutest amounts of matter and energy with which an experimentalist deals.

As Haas correctly points out,<sup>7</sup> should the new point of view persist for any length of time, it cannot fail to affect our whole attitude towards physical laws and interpretation of nature. According to it, matter and radiant energy are both atomic, and do not differ radically from each other. Under certain circumstances, electrons behave like waves and waves behave like chunks of matter. Energy is converted into matter, and vice versa, and this process is going on in the universe continually, creating new worlds and destroying the old. A physical law does not dominate an event but merely establishes probabilities for this or that percentage, just as a statistical law does not affect births or deaths in a species of living beings. In the big visual world we may speak of an instantaneous position of a material point and at the same time of its instantaneous velocity. In the sub-atomic world, according to Heisenberg's principle of indeterminateness, such a statement would be absurd. If the coordinates of an electron are given we can only ask about the probability of a certain velocity, and vice versa. In the big world of interstellar spaces, other laws reign supreme; Euclidean geometry and ordinary mechanics hold no more, and what we observe in our every day life (or even in our best equipped laboratories) is but a very narrow aspect of the real laws of nature. We do not see the bigger relativity aspects of the fundamental laws of nature, because our distances are too small and our velocities too low. We do not see the fine-structure aspects of the same laws because of the crudity of our apparatus which permits our observing the microcosm only statistically.

The new attitude is one of humility, and if it is an attempt to free the laws of nature from an anthropocentric point of view, future generations will welcome it as a step in the right direction.

7. Arthur Haas, "Materiewellen und Quantenmechanik," *Akademische Verlags-gesellschaft*, 1929, Chapter 19. See also V. Karapetoff, "Picture Theories Inadequate," an article to be published in the *Electrical World* during 1929.

# The Sixty-Cycle Flashover of Long Suspension Insulator Strings

BY R. H. ANGUS\*

Student Member, A. I. E. E.

**Synopsis.**—This is a study of the 60-cycle flashover of strings up to voltages of 1100 kv., undertaken at the Ryan High-Voltage Laboratory, Stanford University. Investigation was made of the variations in flashover voltage for similar horizontal and vertical

strings, with and without shields and lower members. An attempt has been made to correlate these flashover voltages with the point-to-point and point-to-grounded-plane arc-over voltages established in 1928 at the Laboratory.<sup>1</sup>

## INTRODUCTION

THE dry 60-cycle flashover voltage of long strings of cap-and-pin porcelain insulators, is of some importance in the design and selection of the insulation for any particular project. There are authorities who advocate the adoption of a wet flashover as the criterion;<sup>2</sup> but the difficulties which have been encountered in the standardization of a suitable "rain" or "mist" make it inadvisable to accept this as the only test of insulator strings.<sup>3</sup> Further, if Dr. L. B. Loeb's<sup>4</sup> theory of breakdown is established, it may be that power frequency arc-over voltages will be a measure of impulse voltage flashover of insulator strings, provided arcing-rings are designed and fitted to prevent cascading arcs.<sup>5</sup>

In all the publications dealing with the flashover of insulator strings, which the writer has seen, no reference was found to tests on strings in a horizontal position. Judging by the large numbers of strain strings in any high-voltage line, this would appear to be an important omission, which may be filled by the tests on horizontal strings to be described in this paper. Only one article mentioned flashovers of more than 750 kv.<sup>6</sup> Because deviations from a straight line flashover-distance relation only begin to appear above 600 kv., the experimental work was continued up to flashovers of 1100 kv., which is the maximum voltage to ground available at the Ryan High-Voltage Laboratory.

Doubt has been expressed as to the necessity of increasing the number of insulators in strain strings, by one or two, over the number in a normal suspension string. This seems to be standard practise to attempt to overcome the deterioration of insulation due to the accumulation of dirt and the heating effects of sunlight. But the flashover of similar clean strings in the two positions was not thought to be different,<sup>2</sup> although the form of the electrostatic field about vertical and horizontal strings cannot be the same.

## THE NATURE OF FLASHOVER

The flashover of an insulator string is the breakdown

\*Commonwealth Fund Fellow at Stanford University, Palo Alto, Calif.

1. For reference see Bibliography.

Presented at the Pacific Coast Convention of the A. I. E. E., Santa Monica, Calif., Sept. 3-6, 1929. Printed complete herein.

of the surrounding air, and consequently follows the laws of conduction of electricity through gases, which have been formulated by Paschen, J. J. Thomson, J. S. Townsend, L. B. Loeb, F. W. Peek, and others. The process of breakdown is thought to consist of ionization of the air and disturbance of the electronic orbits, consequent on the applied voltage gradient, till the air attains a conducting or chemically reactive state. When this occurs a sharp spark takes place, the spark having many of the characteristics of a condenser discharge. The power arc immediately follows. In the preparation for breakdown, ionization is dependent on voltage gradient and therefore on the form of the electrostatic field. Previous to power-frequency point-gap arc-overs of above 500 kv., long "streamers" sparks reach out from the electrodes. The air in the paths of these sparks is conducting and their presence must influence the distribution of the field. It is conceivable that their influence is the main cause of the widely varying arc-over values which are observed.<sup>7</sup>

The field about an insulator string is, as is well known, by no means uniform. The equal capacities of the units, as they are in series, give a higher stress at the line end of the string than at any other place. Equalizing shields do much to unify the distribution of stress along a string, but they and grounded tower structures complicate the form of the field, so that the effect of their presence on the flashover of a string can hardly be accurately anticipated for any particular case. All that can be done is to discover the variations in flashover values due to surrounding objects, for some extreme cases.

## THE TEST INSULATORS

Only two types of insulators were used in the tests. Both were standard ball-and-socket cap-and-pin porcelain insulators, whose principal dimensions are; insulator "A", diameter 10 in., pitch 5.75 in.; insulator "B" diameter 10 in., pitch 5.0 in.

It is hoped that the selection of this type of insulator will in no way prejudice the possibilities of other types, including that evolved by Dr. H. B. Smith.<sup>8</sup> Only ring shields at the line end and arcing-rings at the ground end of the strings were used, as arcing horns appear unsatisfactory.<sup>5</sup> The shields were to attempt

to equalize the electrostatic stress on individual units, and the arcing rings were to insure that the arc clears the string at the ground end. The dimensions are below.

*Shields.* Single String; a circular torus, internal diameter 22 in. of 2.5-in. circular metal material, mounted from the line clamp so that the central plane of the torus was one inch below the top of the cap of the line unit. The whole shield was in metallic contact with the high-voltage line.

*Double String;* an oval ring, internal diameters 33 and 20 in., of oval material 1 in. by 0.5 in., mounted in a similar way to the single string shield with the 33-in. diameter in the plane containing the axes of the two strings. The 1-in. diameter of the material was parallel to the axes of the strings.

*Arcing-rings.* Single String; circular ring, internal diameter 20 in. of 1-in. by 0.25-in. flat material, mounted in metallic connection to ground, the 1-in. dimension parallel to the axis of the string. The ring was level with the porcelain of the ground unit.

*Double String;* similar in every way to the double string shield.

Flashover voltages of vertical and horizontal strings of both types of insulators, were measured for the following cases:

1. Strings without shields or arcing-rings.
2. Strings fitted with shields and arcing-rings.
3. Strings fitted with shields and arcing-rings, tower structures being present at the ground end of the string.

In each case the nearest object, other than these mentioned above together, with the high-voltage and ground cables was over 18 ft. from the string.

#### METHOD OF CONDUCTING TESTS

As the flashover of any gap is dependent on ionization, the maximum voltage reached before spark-over is the value that must be measured. With an alternating voltage, the required value is that of the crest immediately previous to spark-over. Thus, a satisfactory method of measuring this value must be devised; either the crest value or the wave form must be known, and the use of an oscillograph is obviously desirable. The technique of voltage measurement by means of an oscillographic record of the current through a water resistor, as developed in 1928 at the Ryan High-Voltage Laboratory,<sup>1</sup> proved to be invaluable. This method was used to calibrate the voltmeter coil of the high-voltage transformers, for each type of set-up, as differing capacities to ground and differing corona loads affect the constancy of the voltmeter coil's transformation ratio.

Five separate oscillograph measurements were made for each of a number of typical set-ups. The results so obtained were compared with voltmeter coil readings of other flashovers of the same strings. This led to a calibration curve for each type of string, so that volt-

meter coil readings could be used for similar strings of different lengths.

Results were thus achieved more quickly than if an oscillograph had been used for every measurement.

No temperature or pressure connections of flashover voltages were made, as at no time during the tests were the conditions sufficiently far from the standard of 760 mm. and 25 deg. cent. to warrant such connections.

#### COMPARISON OF FLASHOVER VOLTAGES

There are certain principles which must be accepted before flashover values of different strings may be compared; these are:

1. Flashover values should be referred to the arc-over distance and not to the number of units in the string. The arc-over distance is the length of the shortest path in air which arc can take from the line to the ground end of the string.

2. Comparison of the flashovers of complete strings

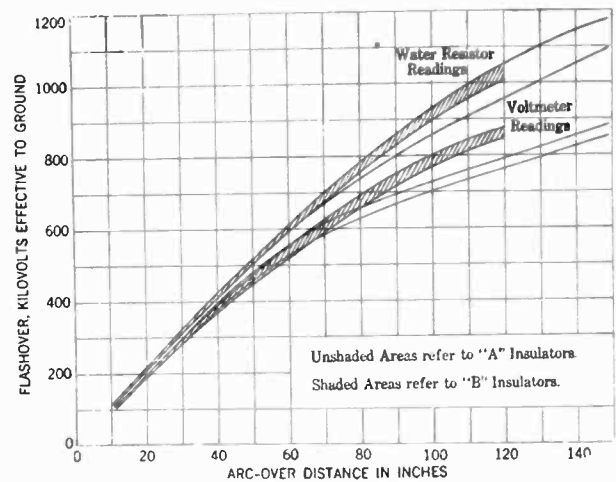

FIG. 1—FLASHOVER OF SUSPENSION INSULATORS, STRAIN POSITION, UNSHIELDED

under working conditions should be made only with each other, or some standard, and not with the flash-over value of one unit of the string.<sup>9</sup>

3. The lowest observed flashover is the important value. Proceeding on these lines, an attempt has been made to relate the lowest flashovers of suspension and strain strings with the standards of the point-to-point and point-to-grounded-plane arc-overs.

#### DISCUSSION OF RESULTS

As the flashover of a string of insulators to a certain extent is dependent upon the initial state of ionization of the surrounding air, a constant flashover voltage cannot be expected, and the values may be represented rather by an area than by a line curve. This is done in Fig. 1. The areas denote the range within which the flashover of a strain string may occur, for the two types of insulators which were tested. A comparison is also made between the values derived by the water resistor method and the direct voltmeter readings. This shows the necessity for calibration of any particular arrangement of apparatus.



With "B" insulators, the calibration ratio increases steadily with the string length, which is a result of the increasing corona load as the flashover voltages grow larger. With "A" insulators a greater change in the ratio sets in at 550 kv. This is due, first, to the increasing corona, and second, to priming which occurs with more than six of this type of unit. "Priming" is a term applied to the short, snapping sparks over the

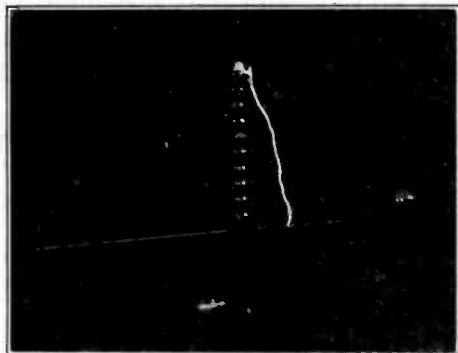

FIG. 2—NON-CASCADING FLASHOVER OF VERTICAL STRING OF 10 "A" INSULATORS

line units, occurring before arc-over. It is the direct translation of the French expression for this phenomenon,<sup>9</sup> and should, in the opinion of the writer, be used in preference to "cascading," which should de-

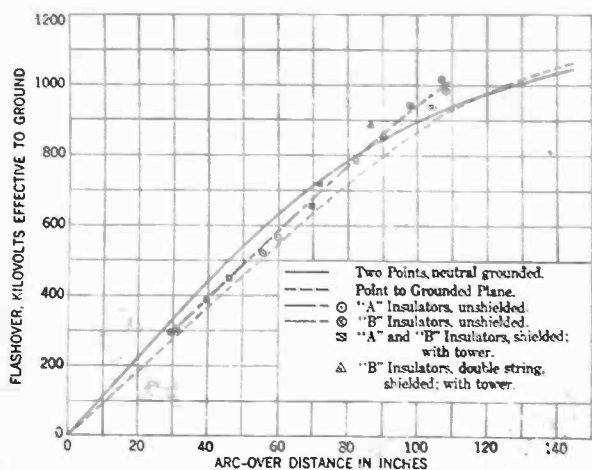

FIG. 3—FLASHOVER OF SUSPENSION INSULATORS, VERTICAL POSITION, LOWEST OBSERVED VALUES

scribe only the type of arc that clings close to the porcelain in its passage from one cap to the next.

LOWEST OBSERVED VALUES

1. Strings in the Vertical Position.

(a). "A" and "B" insulators, unshielded.

In this position, the conductor has a very considerable shielding effect on the string; so much so that no priming took place, and only 108 in. could be arced over with the 1100 kv. available. There was some cascading with "A" insulator strings of above ten units. Fig. 2 is a typical non-cascading arc-over.

(b). "A" and "B" insulators, with shields, arcing-rings, and tower members.

The lowest flashover voltages for the same arc-over distances are very similar to those for unshielded strings; the effect of the conductor is nearly as much as that of the shields in equalizing the stresses on individual units and preventing both priming and cascading. This is specially noticeable with the smaller pitched "B" insulators.

The values for shielded and unshielded strings are so equal that one curve serves for both sets. (Fig. 3.) The curve is approximately midway between the point-to-point and point-to-plane curves; the deviation from this position at above 750 kv. is due to the effect of the capacity-to-ground on a vertical gap, which causes about 20 per cent increase in the arc-over value of a 110-in. point-gap when the lower point is moved from ground level to 15 ft. above it.<sup>1</sup>

In order to discover any effect of the vertical part of

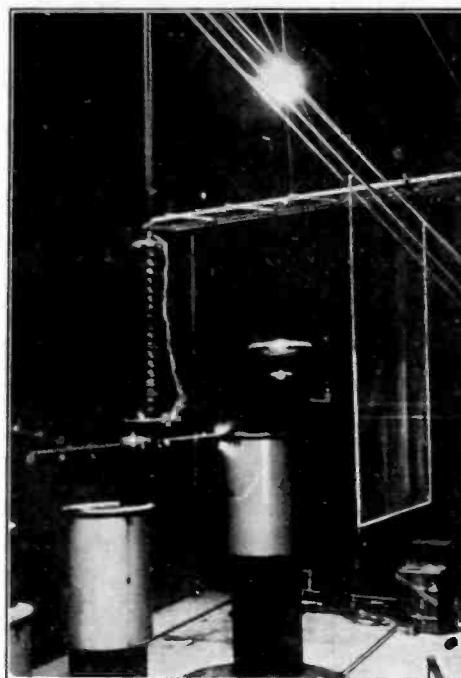

FIG. 4—FLASHOVER OF 20 "B" INSULATORS, WITH SHIELDS AND TOWER MEMBERS IN POSITION

towers on flashover values, a large wire screen was erected 10 ft. 10 in. from the nearest point of the shield of a string of 20 "B" insulators, and the screen was connected to ground. (Fig. 4.) Voltmeter readings of flashovers were taken with and without the screen in place. The averages of the two sets of readings were equal, showing that the voltmeter coil calibrations of the two set-ups were the same. But the lowest observed values were 900 kv. with the screen and 930 kv. without. It is probably safe to infer that the exploring streamer sparks were influenced by the presence of the screen, resulting in a 3 per cent lower flashover. This is barely greater than the limits of experimental error. Consequently it may be said that the important part of the tower, as regards flashovers, is the member at the ground end of the insulators.

The flashover voltage of a double string when

shielded, is sufficiently near to that of a similar single string to assume that they are equal, provided they have equal arc-over distances, (Fig. 3).

2. *Strings in the Horizontal Position.*

In the horizontal position the conductor provides no shielding effect. In actual transmission lines, the jumper at anchor towers would give some shielding; but it was decided to use an extreme case, as might be found at a terminal point, where the lead to the trans-



FIG. 5—FLASHOVER OF 25 "A" INSULATORS, STRAIN POSITION

formers or switchgear is in such a position as to shield the insulators but little.

(a) "A" insulators, unshielded.

The lowest flashover voltages of unshielded strings of "A" insulators are mid-way between the point-to-point and point-to-plane values, up to about 750 kv. Above this, both priming and cascading (Fig. 5) become very marked, and the curve runs below those of the two

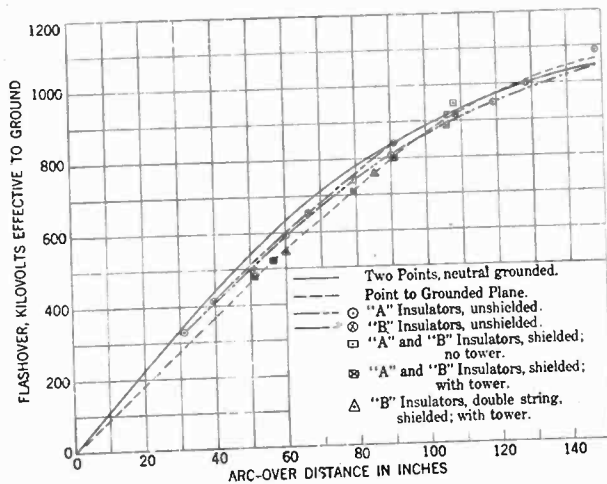

FIG. 6—FLASHOVER OF SUSPENSION INSULATORS, STRAIN POSITION, LOWEST OBSERVED VALUES

standards. (Fig. 6.) It should be noted that 25 "A" units were arced over only because priming and cascading occurred. The flashover of 25 of the closer pitched "B" units was beyond limits of the high-voltage transformers, for with them there was less priming and cascading. (Fig. 7.)

Fig. 8 is interesting, as it visibly demonstrates the need of shields and arcing-rings; corona from the high-voltage lead has shielded the first nine units, but cascading has occurred on the ground unit.

(b) "B" insulators, unshielded.

The smaller amount of priming with "B" insulators results in a higher flashover for a given arc-over distance than with the "A" insulators, although there is hardly any difference between the flashovers of the two types for strings of less than 15 units.

(c) "A" and "B" insulators, with shields, arcing-rings, and tower members.

Fig. 9 shows a typical arc-over. An arc to the tower sometimes occurred, and the flashover was frequently below the string but in every case the arc cleared the units.

The flashover voltages were the lowest of all those

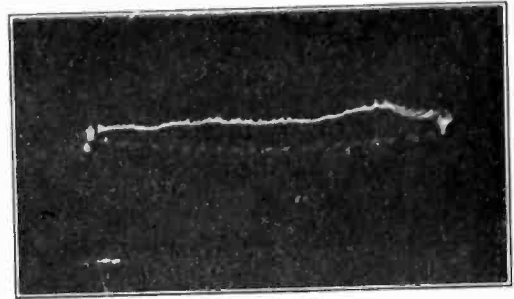

FIG. 7—FLASHOVER OF 22 "B" INSULATORS, STRAIN POSITION

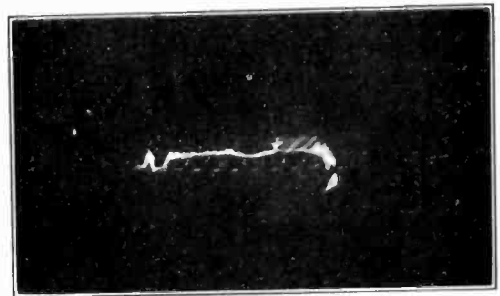

FIG. 8—FLASHOVER OF 10 "A" INSULATORS, STRAIN POSITION

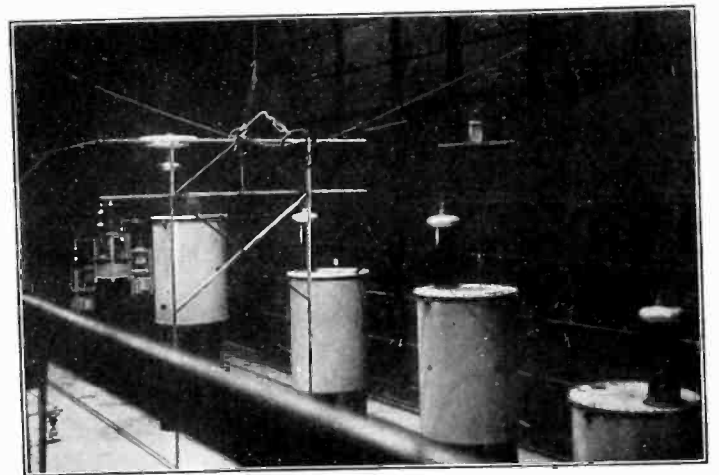

FIG. 9—FLASHOVER OF 20 "A" INSULATORS, WITH SHIELDS AND TOWER MEMBERS IN POSITION. WATER COLUMN RESISTOR IN FOREGROUND

measured. They agree very closely with the point-to-grounded-plane values, as might have been anticipated from the position of the high-voltage lead with respect to the grounded tower.

CONCLUSIONS

1. *Variation in Pitch.* With strings in any position which are shielded (either by the conductor or by

shields) a 15 per cent variation in pitch does not affect the arc-over.

With strings which are not shielded cascading and priming may result on an increase in pitch. This will lower the flashover value.

The 5-in. pitch of the "B" insulators seems to be as large as a 10-in. diameter unit will stand without cascading. This is in close agreement with the results of G. Viel<sup>9</sup> for cap-and-pin insulators 11.4 in. in diameter and 5.9 in. pitch. In other words, for unshielded strings the pitch should not be more than about half the diameter of the unit.

2. *Shielding.* All strings (except perhaps those below 15 in. long) should be shielded. With vertical strings the conductor may provide sufficient shielding if the pitch and therefore the variation in stress on individual units, is not too great; though to be certain that the flashovers clear the string, arcing-rings should be used.<sup>5</sup> In other positions the conductor may not provide sufficient shielding, then ring shields must be fitted.

3. *The Flashover Voltage-Distance Relation* is not straight line, but lies between the point-to-point and point-to-ground-plane curves.

4. *The Lowest Flashovers* are obtained with strain strings. But these values are not below the point-to-grounded-plane arc-overs for the same distances.

5. *Length of Strain Strings.* These need not be more than five per cent longer than suspension strings; that is, one unit in twenty should be added to the normal vertical string to guard against the capacity effect of the strain towers. Additional units may also be necessary to overcome special local atmospheric or dirt conditions.

6. *Double Strings* have the same flashover as single strings of the same length, if both are adequately shielded.

7. *Calibration of Voltmeter.* Voltmeter-coil (or potential-transformer) readings should be calibrated by some suitable method for each particular type of set-up.

#### ACKNOWLEDGMENTS

The author is deeply indebted to Dr. H. J. Ryan for his helpful criticisms and to Professor J. S. Carroll and the other members of the Laboratory staff whose experience and assistance, both mental and physical, were invaluable.

#### Bibliography

1. J. S. Carroll and B. Cozzens, *Sphere-Gap and Point-Gap Arc-Over Voltages*, A. I. E. E. TRANS., Vol. 48, January 1929, p. 1.
2. T. B. Fleming, "The Application of High-Tension Insulators," *Electric Jl.*, Vol. 21, 1924, p. 217.
3. R. T. Fleming, "Testing of Insulators under Artificial Rain," *Electric Rev. (Lond.)*, Vol. 98, 1926, pp. 612 and 651.

Note. As reported on page 260 of Volume 48 of the A. I. E. E. JOURNAL for April 1929, it seems as though Viel advocates the increased separation of both cap-and-pin and link type insulators. Actually these remarks apply only to the link type with which he experimented; he says that his cap-and-pin type should not have a greater separation.

4. L. B. Loeb, "Theory of Electrical Breakdown of Gases at Atmospheric Pressure," *Franklin Inst. Jl.*, Vol. 205, 1928, p. 305, and *Science*, Vol. 69, 1929, p. 509.

5. J. J. Torok and H. Ramberg, *Impulse Flashover of Insulators*, A. I. E. E. TRANS., Vol. 48, January 1929, p. 239.

6. E. Marx, "Die Stromaufnahme von Hängisolatoren und ihr Einfluß auf die Spannungsverteilung an Isolatorenketten," *E. T. Z.* Vol. 46, 1925, p. 81.

7. J. T. Lusignan, *A Study of High-Voltage Flashovers*, A. I. E. E. TRANS., Vol. 48, January 1929, p. 246.

8. H. B. Smith, *The Development of a Suspension-Type Insulator*, A. I. E. E. TRANS., Vol. 43, 1924, p. 1263.

9. G. Viel, "Resultats d'essais effectués sur des isolateurs suspendus; étude de l'influence de la longueur des attaches," *Rev. Gén. Elec.*, Vol. 24, 1928, p. 945. Abstract in *World Power*, Vol. 11, 1929, No. 63, and in A. I. E. E. J., Vol. 48, 1929, p. 260.

#### A 4000-LB. TELESCOPE DISK

The most serious difficulties met in producing large pieces of glass include properly melting the amount of glass required, transferring it to a mold to produce the desired shape while maintaining the necessary quality, and finally, cooling it at such a rate that it does not crack and is free from disturbing internal stresses.

Because of the lack of definite information on methods of making satisfactory pieces of glass which could be used for large telescope reflectors, the Bureau of Standards undertook to produce a 70-in. disk.

It was first necessary to make pots sufficiently large to hold the amount of glass required. The pots were "cast" in a plaster of Paris mold by a method developed at the Bureau. A hole was provided near the base of the pot which could be plugged during the melting of the glass and through which the glass could be tapped.

The combined mold and annealing furnace into which the glass was tapped consisted of four essential parts: the metal forms, the lining, the heating elements, and the insulation.

The temperatures of the melting furnace and of the annealing furnace were controlled electrically. The pot was burned very slowly, 30 days being required to reach a temperature of 1425 deg. cent., at which the glass would be melted.

When all arrangements were completed for tapping the pot, the water-cooled plug was removed and the molten glass began to flow. When practically all the glass was in the mold, the lid was put in place. The glass was cooled to 600 deg. cent. as rapidly as the furnace structure would permit. During the next two months the heating current was gradually reduced until the temperature for annealing was reached. The glass was annealed for 41 days at 461 deg. cent.

Four and a half months after the cooling from annealing temperature started, the furnace and its contents were practically at room temperature. The glass was found to be in satisfactory condition.

The disk was 69.75 in. in diameter, 11 in. thick, and weighed approximately 4000 lb. The maximum strain detected was well within the limit permissible for optical instruments of the highest precision.

## ILLUMINATION ITEMS

Submitted by  
The Committee on Production and Application of Light

### TWENTY-AMPERE SERIES CIRCUITS FOR STREET LIGHTING

C. J. STAHL<sup>1</sup>

Wherever lamps are to be installed on a fairly close spacing, there is a growing tendency to use 20-ampere straight series street lighting circuits in preference to 6.6-ampere circuits, which have been so generally used in the past. Several 20-ampere systems have been in use for more than a year, and reports of operation are very favorable.

Those who advocate the use of 20-ampere circuits maintain that the 6.6-ampere practise is a heritage of the days when arc lamps were in general use for street lighting service. It is pointed out that on underground circuits, either No. 6 or No. 8 copper conductors are used, and that these have a current-carrying capacity considerably in excess of 6.6 amperes. When this current-carrying capacity is not properly utilized, a share of the copper investment is going to waste. Furthermore, insulation costs are unnecessarily increased, since at the lower current rating for a given load, the total circuit voltage is higher than for the 20-ampere circuit. On the 20-ampere straight series circuits the use of individual auto-transformers or series transformers at the lamps is unnecessary. This somewhat improves the efficiency and power factor and naturally the investment cost is less, due to the omission of these items.

There appears to be no element of the equipment, installation or maintenance carrying a higher cost for the 20-ampere circuit than for the 6.6-ampere circuits but there are several items in which the cost is considerably reduced.

For a given circuit load it is obvious that the total circuit voltage is reduced approximately 66 per cent. In this case the cost of underground cables is substantially less. On the other hand, for a given cable voltage rating, it is possible to supply approximately three times as many units on a single circuit when operated at 20 amperes.

The use of 20 amperes, however, does make necessary the omission of steel tapes from underground cables. During the past two or three years, this has brought about the development of the so-called "non-inductive" cables, in which the steel tapes have been entirely omitted or replaced by non-magnetic fibrous material. In duct systems, in which the ducts are of non-magnetic material, naturally no difficulties are experienced from the standpoint of excessive reactance losses.

The advantages of the 20-ampere system seem to apply either to ornamental or overhead types of street lighting, providing that the spacing between the units does not much exceed 150 ft. In the case of

<sup>1</sup> Westinghouse Electric & Manufacturing Co., South Bend, Ind.

abnormally long spacings, the conductor losses reach the point of balance as against the savings in other factors.

### CALORIMETER TEST ON 68,750-KV-A. TURBINE GENERATOR

J. M. CALVERT<sup>1</sup>

ALTHOUGH a number of calorimeter tests have been made in this country and abroad to determine the loss in turbine generators when operating at the full-load full-voltage 0 per cent power over exciter condition, very little if anything has been published on tests at 80 per cent power factor, and the idea has always lurked in the minds of engineers that possibly the load loss under these conditions might be of a different magnitude.

Recently two duplicate 68,750-kv-a. turbine genera-

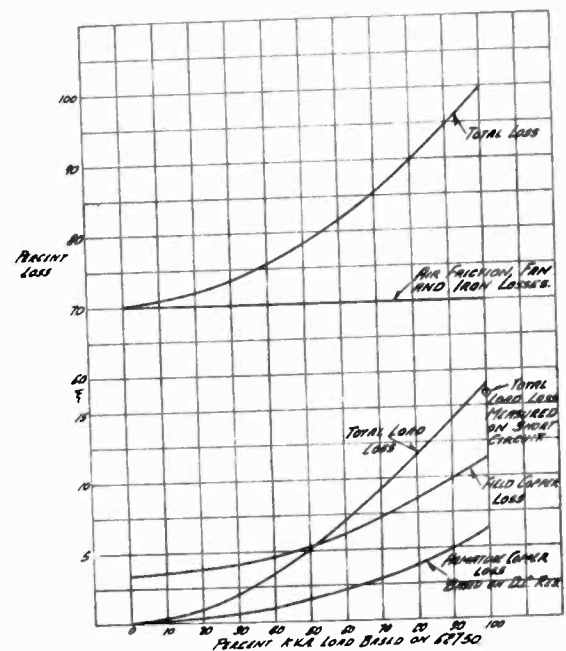

FIG. 1

tors were coupled electrically and mechanically, and the losses of the machine which was operating at 80 per cent power factor as an over-excited generator were measured by the calorimeter method; that is, the kilowatts to the air stream, which comprised about 98 per cent of the total loss occurring within the frame, were computed from measurements of the volume and temperature rise of the air passing through the machine. The remaining loss was estimated from temperature measurements at various points on the frame and the air velocities over the outside surface.

The data obtained showed that the full value of load loss as measured on short circuit was practically equal to the load loss at the full-load full-voltage 80 per cent power-factor condition as determined by the calorimeter tests. This test furnishes a verification of the present A. I. E. E. standard method of measuring stray-load loss for commercial guarantees.

<sup>1</sup> Westinghouse E. & M. Co.



# INSTITUTE AND RELATED ACTIVITIES

## The District Meeting in Chicago

Some of the most vital of recent developments in electrical engineering will be discussed at the District Meeting of the Institute which will be held December 2 to 4 at the Drake Hotel, Chicago, Ill. Inspection trips of special interest have been arranged and a banquet and dance will be enjoyed.

Two Student Sessions form another important part of the program. The schedule of all events is as follows:

### PROGRAM OF CHICAGO MEETING

(All sessions will be held in the Ballroom)

#### MONDAY, DECEMBER 2

- 9:00 a. m. Registration.
- 9:30 a. m. **Session on Student Branch Activities.**  
J. H. Kuhlmann, presiding.  
A series of reports by Branch chairmen will be presented. A prize of \$10.00 will be awarded for the best report.
- 2:00 p. m. Formal Opening of Meeting by President H. B. Smith.  
Address of Welcome by Chicago Association of Commerce.
- Session on Communication.**  
W. O. Kurtz, presiding.  
*Recent Developments in Telephone Toll Service*, by W. H. Harrison, American Telephone & Telegraph Co.  
*The Chicago Long Distance Toll Board*, by E. O. Neubauer and G. A. Rutgers, Illinois Bell Telephone Co.  
*Manufacture of Telephone Carrier and Repeater Apparatus*, by R. C. Glasier, Western Electric Co.  
*Air Transport Communication*, by E. L. Jones and F. M. Ryan, Bell Telephone Laboratories.

#### TUESDAY, DECEMBER 3

- 9:30 a. m. **Session on Power Plants.**  
F. H. Lane, presiding.  
*The Future of Higher Steam Pressures*, by I. E. Moulthrop, Edison Electric Illuminating Company of Boston.  
*Use and Design of Fault Ground Bus*, by R. M. Stanley and F. C. Hornibrook, Byllesby Engg. and Mgt. Corp.  
*Increased Voltages for Synchronous Machines*, by C. M. Laffoon, Westinghouse Elec. & Mfg. Co.  
*Double Windings for Turbine Alternators*, by P. L. Alger, E. H. Freiburghouse and D. D. Chase, General Electric Co.  
*A 40,000-kw. Variable-Ratio Frequency Converter Installation*, by E. S. Bundy, Niagara Lockport and Ontario Power Co. and A. Van Niekirk and W. H. Rodgers, Westinghouse Elec. & Mfg. Company.
- 2:00 p. m. **Student Technical Session.**  
J. H. Kuhlmann, presiding.  
*Relation Between the Branches and the Institute*, by H. H. Henline, Assistant National Secretary, A. I. E. E.  
*What I Expect to Find When I Get Into Industry*, by H. W. Hasse, Marquette University.  
*Personnel Selection in Public Utilities*, by A. O. Alstadt, Marquette University.

- Electric Power Transmission in Iowa*, by E. M. Ellingson, The State University of Iowa.  
*Experiences with Single-Phase Condenser Motors*, by S. E. Burgduff, Marquette University.  
*Headlight Testing*, by J. C. Newhouse, University of Minnesota.  
*Testing of Reduction Gear Units*, by G. P. Maurer, Marquette University.  
*Determination of the Temperature of Underground Power Cables from Load*, by J. E. Dean, Michigan State College.  
*Cooperative Engineering*, by R. J. Abele and F. J. O'Keefe, University of Detroit.  
*A Discussion of the Recent Public Utility Investigation at Washington*, by E. G. Conroy, University of Notre Dame.

3:30 p. m. **Board of Directors' Meeting (Room D).**

6:45 p. m. **Banquet and Dance (Ballroom).**

#### WEDNESDAY, DECEMBER 4

- 9:30 a. m. **Session on Transmission and Distribution.**  
H. W. Eales, presiding.  
*Theory of a New Valve Type Lightning Arrester*, by J. Slepian, R. Tanberg and C. E. Krause, Westinghouse Elec. and Mfg. Company.  
*Low-Voltage A-C Networks*, by R. M. Stanley and C. T. Sinclair, Byllesby Engg. and Mgt. Corp.  
*An Economic Study of an Electrical Distributing Station*, by W. G. Kelley, Commonwealth Edison Co.  
*Experience with Carrier-Current Communication on a High-Tension Interconnected Transmission System*, by Philip Sporn and R. H. Wolford, American Gas & Electric Co.  
*Automatic Regulation for Synchronous Condensers Equipped with Super-speed Excitation*, by L. W. Thompson and P. J. Walton, General Electric Co.
- 2:00 p. m. **Session on Research and Development.**  
A. H. Lovell, presiding.  
*Polyphase Induction Motors*, W. J. Branson, Robbins & Myers, Inc.  
*Recording Torque Indicator*, by G. R. Anderson, Fairbanks, Morse & Co.  
*Effect of Armature Resistance on Stability of Synchronous Machines*, by C. A. Nickle and C. A. Pierce, General Electric Co.  
*Ionization Currents and the Breakdown of Insulation*, by J. J. Torok and F. D. Fielder, Westinghouse Elec. & Mfg. Co.  
*Heat Radiation in Inter-Reflection Cases*, by A. D. Moore, University of Michigan.

#### INSPECTION TRIPS

There will be quite a number of attractive inspection trips, including those to the New State Line Generating Station, Crawford Avenue Generating Station, a typical electrified steel mill, a high-capacity transmission substation, the Western Electric factory, an automatic telephone exchange, and several others.

Members should register as soon as possible for trips they wish to take. Complete information will be available at the registration desk at the opening of the meeting.

## LADIES' ENTERTAINMENT

The Ladies' Entertainment Committee is planning a very interesting program, including trips to the Art Institute, the Live Stock Show, and the Field Museum—also a bridge party and tea. A shopping service will also be available.

## REDUCED RAILROAD RATES

Railroad tickets from certain territories to Chicago may be purchased at reduced rates, available to anyone who visits Chicago during the International Live Stock Show, which will be in progress at the time of the meeting. The round trip rate will be one and one-half times one way fare for those starting east of Chicago. It will be one and one-third times one way fare for those starting from west of Chicago. Local ticket agents should be consulted regarding territories, restrictions in dates, and other details.

## HOTEL RESERVATIONS

Reservations for hotel rooms should be made by application direct to the hotel. Rates for the headquarters hotel, the Drake, as well as for other hotels are given in the following tabulation. Reservations should be made early in view of the expected large attendance at the Live Stock Show.

Hotel	Room rates per day (minimum)	
	Without bath	With bath
Drake .....	—	\$5.00 4.00*
Pearson .....	\$3.50	
McCormick .....	3.00	
Knickerbocker .....	2.50	
Maryland .....	2.50	
Allerton .....	2.50	3.00
Eastgate .....	2.50	
Alexandria .....	1.50	2.00
Ontario .....	1.50	2.00

\*Special rate for Students only.

## COMMITTEES

The District Meeting Committee which is arranging the meeting is as follows: W. T. Ryan (Vice-President in District No. 5) *Chairman*; T. G. LeClair, *Vice-Chairman*; A. G. Dewars, *Secretary*; J. H. Kuhlmann, M. A. Faucett, Oscar Gaarden, L. F. Hickernell, P. B. Juhnke and F. H. Lane. The chairmen of the other committees are: *Technical Program*, F. H. Lane; *Hotel and Registration*, J. E. Kearns; *Finance*, K. A. Auty; *Trips and Transportation*, H. E. Wulfing; *Publicity*, F. R. Innes; *Entertainment and Banquet*, H. W. Eales; *Ladies*, Miss Helen Norris; and *Student Activities*, J. H. Kuhlmann.

## En Route to World Engineering Congress

On October second the principal group of American and European engineers en route to Tokio to attend the World Engineering Congress left New York on a special train via the Baltimore and Ohio Railroad. About 80 were aboard the train and this number was considerably increased by accessions at various places in the taking on of the foreign engineers who had arrived in New York during August and September and who left earlier for the purpose of visiting places of engineering interest on their way to San Francisco.

When the train reached Washington, it was met by a well organized local committee, and the entire party was taken to the Mayflower Hotel, selected as headquarters.

Upon the evening of their arrival, His Excellency, Katsuji Debuchi, Japanese Ambassador to the United States, entertained more than 150 engineers in a most hospitable manner. Ambassador Debuchi, in a short appropriate address following the banquet, welcomed the delegates and their friends and wished

them a happy journey. Elmer A. Sperry, Chairman of the American Delegation, responded to this address. The occasion was an exceedingly enjoyable one and afforded a much appreciated opportunity for American, European, and Japanese delegates in attendance to become better acquainted.

Upon completion of the sightseeing trip about Washington, (which included Mr. Vernon,—the home of the first engineer President,—the Bureau of Printing and Engraving, the Pan American Union, Museums, the Capitol, Library of Congress, Arlington National Memorial, the embassies, legations, and even the zoological gardens), the delegation called at the White House and paid its respects to President Hoover who was one of the early sponsors of this movement for a World Engineering Congress in Tokio. He shook hands warmly with each member of the delegation, wished them a pleasant journey, and stood for his photograph with the delegation.

The special train bearing the delegates away from Washington left at 3:55 p. m., on the third, scheduled to stop at Chicago, Los Angeles and San Francisco, and in each place the delegates were met by the local engineering societies; thence, on to Hawaii.

The train arrived in Chicago early October fourth and the acting local committee ably conducted the visitors upon the various excursions of interest; at noon the Western Society of Engineers entertained the entire group at luncheon.

Leaving Chicago late on the afternoon of October fourth, the special train stopped a whole day at the Grand Canyon, and another day at Pasadena and Los Angeles. The local committee of engineers provided enjoyable events at Los Angeles and San Francisco, the latter city being reached the morning of October ninth.

About 300 engineers and members of their families sailed October tenth from San Francisco on the *Korea Maru* of the Nippon Yusen Kaisha and the *President Jackson* of the Dollar Line. Some of those unable to obtain accommodations on these two ships were obliged to embark on steamers from Seattle and Vancouver.

After a stop of two days in Honolulu, the two steamers left, scheduled to reach Yokohama October 27th, the Congress to open on the 28th and to terminate on November 10th. After this, various excursions in Japan and elsewhere have been scheduled by the Japanese committees in charge of the arrangements for the Congress.

## NATIONAL RESEARCH COUNCIL

## THREE-DAY INSULATION CONFERENCE AT M. I. T.

The Committee on Electrical Insulation, Division of Engineering and Industrial Research, National Research Council, of which Doctor J. B. Whitehead is Chairman, will hold an Annual Meeting and three-day Conference at the Massachusetts Institute of Technology, November 14-16, inclusive. The first day will be devoted to meetings of the subcommittees. On Friday, November 15, the conference will be welcomed by Doctor Stratton, President of the Massachusetts Institute of Technology, and the conference will be opened by the address of Doctor J. B. Whitehead. Technical sessions will follow and there will be discussion of the research work now under way in the laboratories of the M. I. T. Saturday morning, the 16th, will be devoted to a technical session at which will be presented progress reports of research work in laboratories of the Universities of Illinois, Harvard, Johns Hopkins, and Massachusetts Institute of Technology. The conference will be the guests of M. I. T. at luncheon each day. Other social features are also being arranged.

Among those to present papers are Messrs. W. F. Davidson, Brooklyn Edison Co., C. F. Hirshfeld, Detroit Edison Company, D. W. Roper, Commonwealth Edison Co., R. W. Atkinson, General Cable Corporation; Professors E. B. Paine, University of

Illinois, C. L. Dawes, Harvard University, J. B. Whitehead, Johns Hopkins University, P. H. Moon, Massachusetts Institute of Technology, and others.

### Annual Meeting of the American Mathematical Society

The American Mathematical Society, for its Annual Meeting December 27-28, 1929, to be held at Lehigh University, Bethlehem, Pa., is arranging that Friday be given to the presentation of the usual type of papers and that Saturday be devoted to a symposium on the mathematics of engineering. The general topic chosen for the Saturday sessions is *Differential equations of engineering*, and it is proposed tentatively that, both morning and afternoon, three half-hour papers be given by men eminent in their fields. This part of the program is being arranged because of a wish expressed by some members of each of the two groups—mathematicians and research engineers—for closer cooperation.

All interested are cordially invited to attend. Headquarters for the meeting will be at the Hotel Bethlehem, and further details are being planned by the Committee on Arrangements, Professor Tomlinson Fort of Lehigh University, Chairman. Printed program will be sent upon request to the Secretary, R. G. D. Richardson, 501 W. 116th Street, New York, (after December 7), who will gladly furnish other desired information.

The sessions will be held in the new Packard Laboratory for electrical and mechanical engineering.

Those participating in the program are H. W. March, Department of Mathematics, University of Wisconsin; Vannevar Bush, Department of Electrical Engineering, Massachusetts Institute of Technology; T. H. Gronwall, Department of Physics, Columbia University; A. Nadai, Research Laboratory, Westinghouse Electric and Manufacturing Company, (formerly of the University of Göttingen); R. H. Park, Engineering Department, General Electric Company; and S. Timoshenko, Department of Mathematics, University of Michigan, (formerly with the Westinghouse Electric and Manufacturing Company).

### Massachusetts Institute Hears Hydraulic Engineer

Starting October 2, Doctor Dieter Thoma, Director of the Hydraulic Institute of the Technical University of Munich, Germany, gave a series of lectures at Massachusetts Institute of Technology, Cambridge, on the following subjects:

Development of the design of Kaplan Turbines and some recent installations, including Rybourg-Schworstadt Plan; cavitation in hydraulic turbines and pumps; methods of improving the shape of blades of turbines and centrifugal pumps; the hydraulic storage of energy; dissipation of energy in fluids; experimental determination of losses in pipe fittings and experiments with various devices; the hydroelectric plants of the Mittlere Isar A. G. and experimental researches for them; stability problems involved in governing hydraulic turbines; self-supporting pipes of large diameter with thin walls; effect of scale in model tests and general remarks about hydraulic laboratories for turbine research illustrated by moving and still pictures.

Doctor Thoma has consented to lecture before the Washington Society of Engineers on November 6, at which time he will deliver an illustrated lecture on the Kaplan turbine. By special request, he will also treat, in a limited time, the subject of cavitation.

### The Washington Award

Members of the Institute are reminded that through Secretary F. L. Hutchinson, as representative, they may participate in the Washington Award.

This prize,—a bronze plaque,—is presented annually to an engineer for accomplishment which "preeminently promotes the

happiness, comfort, and well-being of humanity." Although the prize is sponsored by the Western Society of Engineers, which holds a fund now amounting to \$10,000 donated by its member John W. Alvord, the award is made by a Commission representing the American Society of Civil Engineers, the American Institute of Mining and Metallurgical Engineers, the American Society of Mechanical Engineers, the American Institute of Electrical Engineers and the Western Society of Engineers.

The proceeds of the fund are used to provide the annual token, and to entertain the guest of honor at the annual presentation.

Although previous recipients of the award included famous men, such as Herbert C. Hoover and Orville Wright, it is the purpose of the Award Commission to bestow the award, when merited, upon comparatively little known instances of public and professional devotion. It is intended to cover all the various branches of engineering in the broadest sense, and is not limited to residents of the United States or membership in any society or organization. Members of the Institute possessed of information which they believe will be helpful to the Washington Award Commission should communicate such information to Mr. Hutchinson at Institute headquarters.

## STANDARDS

### Symbols for Mechanics, Structural Engineering and Testing Materials

A report on a proposed Tentative American Standard "Symbols for Mechanics, Structural Engineering and Testing Materials," is now being circulated for purposes of criticism and comment. This report has been prepared by the Subcommittee on Mechanics of the Sectional Committee on Scientific and Engineering Symbols and Abbreviations of which the Institute is one of five joint sponsors. Those interested in obtaining copies of this report should address C. B. Le Page, A. S. M. E., 29 West 39th Street, New York, N. Y.

### Proposed Model or Standard for Adequacy of Wiring of Commercial and Industrial Buildings

The Commercial National Section of the N. E. L. A. is working to establish a model or standard of adequacy, for the wiring of commercial and industrial buildings. Certain model specification paragraphs have been prepared and are intended for insertion in architects' electrical specifications. Their purpose is to provide sufficient capacity so as to permit of suitable electric lighting to meet probable demands, and avoid expense of future reconstruction. Heretofore it has been a common practise to use the National Wiring Code as a guide to adequacy, resulting in a large number of wiring installations becoming out of date shortly after completion, so that fuses are blown or the wiring drop is so excessive that lighting units fall far short of rated light output. For further details, copies of the specification paragraphs, etc. address the N. E. L. A. headquarters, 420 Lexington Ave., New York, N. Y.

### World Power Conference

#### AMERICAN COMMITTEE APPOINTED

The engineering profession and the power developing and using industries of the United States have planned an elaborate program of papers for discussion in the sessions of the World Power Conference to be held in Berlin, June 16-25, 1930.

The papers program will stress the economic and financial problems involved in the generation, distribution and utilization of power, and focus the attention of the world upon the increasing importance of this tremendous agency in building up of civilization.

The American Committee appointed has been formulating the program, which it closed on October 21st. It is expected that

General Reports of all the papers will be available in French, German, and English, well in advance of the Congress.

The address of the World Power Conference Program Committee is Room 818, 29 West 39th Street, New York, N. Y.

### Meeting of Naval Architects and Marine Engineers

The Thirty-seventh General Meeting of the Society of Naval Architects and Marine Engineers will be held in the Engineering Societies Building, 29 West 39th St., New York, N. Y., November 14-15 inclusive. A technical program of approximately fourteen papers by eminent authorities on the various subjects introduced will be presented, followed by opportunity for open discussion.

On Friday evening, November 15th, the Annual Banquet will be held in the Ball Room of the Pennsylvania Hotel, 33rd St. and Seventh Avenue preceded by a reception at 6:30 p. m. All interested should communicate promptly with Daniel H. Cox, Secretary-Treasurer, Engineering Societies Building.

### S. A. E. Transportation Meeting

The Society of Automotive Engineers will hold a Transportation Meeting, November 12-15 inclusive, at Toronto, Canada. Joint sessions with the Motor Transport Division of the American Railway Association are scheduled for November 13.

### Report on Technical Discussion at Pacific Coast Convention

A summarized report of the main points in the technical discussion at the Pacific Coast Convention held in Santa Monica, Calif., September 3 to 6, is given below. The papers presented in each session are listed and followed by the discussion report. Complete discussion will be published with the respective papers in the TRANSACTIONS:

#### FIRST SESSION

*Radio Interference for Line Insulators*, E. Van Atta and E. L. White.

This paper discusses the phenomenon of brush discharge on pin type and suspension insulators, from the point of view of radio interference. It describes the various attempts at eliminating such discharge, and offers some suggestions for the future.

J. P. Jollyman stated that interference is caused by 60-kv. transformer bushings which are solid porcelain with a hole larger than the conductor. In order to eliminate the interference, his company proposes to fill the hole with metal filings or screen. Mr. Kalb stated that he has reduced such interference by installing a wire-screen sleeve between the bushing and the conductor. He said he had not been able to eliminate interference from pin type insulators by any method. He suggested that corona due to use of too small a conductor might be responsible for some interference. F. B. Doolittle stated that he has eliminated interference caused by large bushing holes by employing a brass tubing sleeve. Mr. Van Atta agreed with some of the speakers that excessive dampness minimizes interference. He stated that interference from loose bushings may be prevented by filling the open spaces with insulating compound or tape.

*Spray and Fog Tests on 220-Kv. Insulators*, R. J. C. Wood.

In this paper are given results of two and one-half years of tests at 150 kv. to ground under field conditions at a location near the ocean. Ten different types of insulators are compared, and a basis of comparison is suggested.

G. A. Fleming stated that his experience agreed with the contentions in Mr. Wood's paper that frequent washing of insulators is desirable in localities exposed to salt spray and sand.

*The 60-Cycle Flashover of Long Suspension Insulator Strings*, R. H. Angus.

This paper gives the results of an investigation covering the

variations in flashover voltage for similar horizontal and vertical insulator strings with and without shields and tower members.

In commenting on Mr. Angus' paper, Bradley Cozzens pointed out that double suspension strings of insulators have a higher mortality rate than single strings of the same length.

*Impulse Insulation Characteristics of Wood-Pole Lines*, H. L. Melvin.

This paper gives the results of a rather comprehensive series of tests on the impulse insulation characteristics of wood and of combinations of insulators and wood used in wood-pole transmission line construction; and suggests methods of protecting wood from damage due to lightning discharges.

#### SECOND SESSION

*Development of Insulating Oils*, C. E. Skinner.

This paper traces the difficulties which have arisen during the development of insulating oils and details the precautions which are necessary during manufacture and in subsequent handling.

In discussing Mr. Skinner's paper, President H. B. Smith stated that he had raised the insulation strength of a 40,000-gallon open tank of oil by operating continuously in the bottom of the tank a 3-kv-a. electric heater. In two months, the breakdown voltage in the standard gap increased from 38,000 volts to 48,000 volts. For two months longer, it remained at 48,000 volts. Mr. Wilcox pointed out that oil which contains acid cannot be completely purified by a centrifuge or a filter press; a chemical process must also be introduced. For such oil, he advocated the use of water glass and Fuller's Earth in connection with a centrifuge. The method, he said, is simple and easily learned. D. W. Proebstel stated that he has successfully used a method of recovering used oil which employs a mixing tank, a vacuum pump and Fuller's Earth.

*Effect of Tank Color on Temperature Under Service Conditions*, V. M. Montsinger and L. Wetherill.

This paper outlines the results of field tests conducted on transformers, and a method of calculation to check the test results, taking into consideration the various factors which apply to a transformer. Figures are given to show that the calculated results check very closely with the observations, while the outstanding conclusion is that the color of the tanks has very little effect on the performance of transformers located outdoors, though indoors, a dark color is desirable.

In commenting on the paper, J. F. Dunn pointed out that although a black transformer tank gives an internal temperature only about 2 to 4 deg. cent. higher than a white tank, this difference is worthy of careful consideration. A difference of 2 deg., he said, may amount to 5 per cent in the loading of the transformer. He pointed out also that the temperature differences might be considerably greater in climates warmer than that of Pittsfield where the tests of the paper were conducted. J. S. Moulton stated that experiments made by him in California caused him to agree with the authors' conclusion that the color of paint is of little importance.

*Population as an Index to Electrical Development*, N. B. Hinson.

The value of population studies to determine the probable future electrical demand of a given community is pointed out in this paper, and a number of cases are given to show the results of such a basis of prediction.

*Flames from Electric Arcs*, J. Slepian.

The origin and properties of flames from electric arcs are discussed in this paper. Means for reducing and dissipating such flames are considered, and application of such means described.

*Design Features That Make Large Turbine Generators Possible*, W. J. Foster and M. A. Savage.

This paper discusses the modern features of electric designs which permit the development of machines having a capacity of 100,000 kv-a., or greater.



## THIRD SESSION

*Effects of Surges on Transformer Windings*, J. K. Hodnette.

This paper describes a study of the reaction of transformer windings when subjected to transient voltage surges. Measurements of the voltage distribution to ground and between parts of windings were effected, using a cathode ray oscillograph and sphere-gaps. Stresses in the windings were estimated on the basis of surges expected on normally insulated transmission systems.

Mr. Hodnette's paper was discussed at some length by K. K. Palueff, who claimed that the shell type transformer is affected by transient voltage in the same way as the core type and that the grading of major insulation in the order of low frequencies is not a safe practise. F. W. Peek mentioned the development of a "non-resonating" transformer which, through use of electrostatic shields, is designed to make the voltage distribution uniform across a transformer winding at any frequency.

*An A-C. Low-Voltage Network Without Network Protectors*, L. R. Gamble and Earl Baughn.

The development of an a-c. low-voltage network eliminating the usual form of network protector is described, together with the operating experience obtained up to this time.

In discussing the paper, V. B. Wilfley pointed out that with the system described, two kinds of fault might possibly fail to clear themselves; namely, a secondary fault near a transformer bank and a phase-to-phase feeder fault. Mr. Gamble said that in his opinion, although tests under these particular conditions have not been made, such faults will clear satisfactorily.

*Development of Low-Current High-Voltage Fuses*, Roy Wilkins.

This paper covers the results of investigations and tests of a number of different forms of high-voltage fuses, together with certain comments concerning their use and limitations.

*Electrical Control Features of Wind Tunnel at California Institute of Technology*, W. A. Lewis, Jr.

The special electrical control features described in this paper were developed for use under conditions which must be met in making experiments with a wind tunnel having a number of unusual features.

In answer to some questions on Mr. Lewis' paper Dr. Klein stated that the closed type of wind tunnel had been selected because it requires less space; the efficiency, he said, has exceeded that of any open tunnel.

## FOURTH SESSION

*The Electrical Engineering of Sound Picture Systems*, T. E. Shea and K. F. Morgan.

The paper describes the technique and apparatus of sound picture recording and reproduction, with emphasis on their electrical engineering aspects. The various steps in the process of disk and film recording, and the changes required in theater equipment to provide for sound production, are outlined. The laboratory developments and studies out of which recording and reproduction methods have grown are given brief mention.

In discussing the paper on sound pictures, D. H. Loughran pointed out the usefulness of the cathode ray oscillograph with linear time axis.

*Dial Telephone System Serving Small Communities of Southern California*, F. O. Wheelock.

This paper deals with the history, use, and service of the step dial telephone system. The equipment is described and the methods of operation and maintenance are given.

*Parallel Operation of Transformers Whose Ratios of Transformation Are Unequal*, Mabel Macferran.

A formula is developed for use when emergency conditions necessitate the paralleling of transformer banks of unequal percentage impedance. By this formula, it is possible to calculate how far "off ratio" one bank should be placed in order to make the banks divide an anticipated peak load in proportion to their ratings.

*Progress in the Study of System Stability*, I. H. Summers and J. B. McClure.

This paper gives simplified methods of making transient stability calculations and includes examples demonstrating the methods used. The relation of system connections and apparatus to stability is also discussed in detail.

V. B. Wilfley, in discussing this paper, stated that he had found that excitation rises of 400 to 600 volts per sec. are more desirable and only slightly more costly than speeds of 200 volts per sec., as advocated in the paper. He warned against the possibility of preventing stability troubles only at the expenses of increasing circuit-breaker troubles. L. R. Gamble stated that in case of a particular station of the Washington Water Power Company, quick excitation had been found to be ineffectual. Mabel Macferran suggested caution in applying high-speed excitation to synchronous condensers. J. P. Jollyman stated that tests prove that short-circuit currents increase during many cycles after their start and that quick-acting circuit breakers are therefore desirable and less liable to trouble than slower breakers. He stated that high-speed excitation is desirable, particularly for generators with direct-connected exciters.

*Synchronous Generation of Voltage Consumed by Line Inductance*, T. H. Morgan.

A new plan is presented for compounding the inductive effects on transmission lines. A system of series compensation by the use of electric machinery is described. This includes an explanation of the method of producing the required voltage and inserting it into the line.

## A. I. E. E. Directors Meeting

The regular meeting of the Board of Directors of the American Institute of Electrical Engineers was held at Institute headquarters, New York, on Friday, October 18, 1929.

There were present: President Harold B. Smith, Worcester, Mass.; Past-President Bancroft Gherardi, New York, N. Y.; Vice-Presidents E. B. Merriam, Schenectady, N. Y.; H. A. Kidder, New York, N. Y.; W. T. Ryan, Minneapolis, Minn.; W. S. Rodman, Charlottesville, Va.; C. E. Sisson, Toronto, Ont.; Directors I. E. Moulthrop, Boston, Mass.; H. C. Don Carlos, Toronto, Ont.; E. B. Meyer, Newark, N. J.; J. Allen Johnson, Niagara Falls, N. Y.; A. M. MacCutcheon, Cleveland, Ohio; W. S. Lee, Charlotte, N. C.; J. E. Kearns, Chicago, Ill.; C. E. Stephens, New York, N. Y.; Assistant National Secretary Henry H. Henline, New York, N. Y.

The minutes of the Directors' meeting of August 6, 1929, were approved.

A report of the meeting of the Board of Examiners held September 25, 1929, was presented, and the actions taken at that meeting were approved. Upon the recommendation of the Board of Examiners, the following actions were taken upon pending applications: 31 Students were enrolled; 89 applicants were admitted to the grade of Associate; six applicants were elected to the grade of Member; one applicant was elected to the grade of Fellow; 32 applicants were transferred to the grade of Member; three applicants were transferred to the grade of Fellow.

The Board ratified the action of the Finance Committee on approving for payment monthly bills amounting to \$31,071.10. The budget for the appropriation year beginning October 1, 1929, was adopted as submitted by the Finance Committee.

The secretary reported 1020 members (950 Associates, 69 Members, and one Fellow) in arrears for dues for the fiscal year which ended April 30, 1929, and was authorized to remove from the membership list on December 1, 1929, all those whose dues remain unpaid at that time and who have not requested an extension of time for the payment of the dues.

As provided in Sec. 22 of the Constitution, Messrs. James S. Fitzmaurice, J. W. Kirkland, and Frederick G. Strong, were

added to the list of "Members for Life" by exemption from future dues.

Approval was given to the location and dates selected by the Pacific Coast members for the already authorized Pacific Coast Convention in 1930; namely, Portland, Oregon, September 2-5.

A petition from the Kansas City Section for an extension of territory was granted.

As required by the By-laws, five members of the Board of Directors were selected to serve on the National Nominating Committee, as follows: Messrs. H. C. Don Carlos, B. Gherardi, J. E. Kearns, A. M. MacCutecheon, and C. E. Stephens.

The Board confirmed the appointment by the President, of Mr. H. P. Charlesworth as a member of the Edison Medal Committee to fill the unexpired term of Mr. E. B. Craft, deceased.

The following appointments of representatives were made: Mr. H. P. Charlesworth was reappointed to the Board of Trustees, United Engineering Society, for the three-year term beginning in January 1930; Mr. W. A. Del Mar was appointed to fill the unexpired term of E. B. Craft, deceased, on the Library Board of the U. E. S., and Professor W. I. Slichter was reappointed to the Library Board for the four-year term beginning January 1, 1930; Mr. John C. Parker was reappointed a representative of the Institute on the Standards Council, American Standards Association, for the three-year term beginning January 1, 1930, and Messrs. H. H. Henline, H. M. Hobart, and H. S. Osborne were reappointed alternates on this body for the calendar year 1930.

Upon the recommendation of the Standards Committee, approval by the Institute as one of five joint sponsors was given to (1) Report of Sectional Committee on Scientific and Engineering Symbols and Abbreviations, dealing with navigational and topographical symbols, and (2) revision of American Standard for Illuminating Engineering Nomenclature and Photometric Standards, reported by the Sectional Committee on Scientific and Engineering Symbols and Abbreviations.

An invitation to send delegates to the Fiftieth Anniversary of the Elektrotechnischer Verein e. V., January 24-27, 1930, was accepted and the appointment of delegates referred to the President.

It was understood that the next meeting of the Board of Directors will be held in Chicago, December 3, during the Chicago District Meeting.

Other matters were discussed, reference to which may be found in this and future issues of the JOURNAL.

## A New Evening Course at the University of Pennsylvania

A new evening course in Electrical Engineering, which will lead to the degree of Master of Science in Electrical Engineering, has been announced by Doctor Harold Pender, Dean of the Moore School of Electrical Engineering of the University of Pennsylvania. All sessions in the course will be held in the Moore School Building, Thirty-third and Walnut streets.

The course opened during the week of October 21, and any student holding a Bachelor of Arts or a Bachelor of Science degree is eligible, provided he has had the necessary preliminary instruction in mathematics and physics during his undergraduate days.

To receive the degree of Master of Science in Electrical Engineering, students must have completed an undergraduate course equivalent to that given in the Moore School, and must obtain credit within a period of four years in all subjects required for the Master of Science degree in the regular day course offered in the Moore School.

The courses required, according to Dean Pender, will be Introduction to Mathematical Physics, Advanced Electric Circuit Theory, Electron Theory and its Engineering Applications, Thesis, Fundamentals of Physical Theories, and either Atomic Structure, Electro Dynamics, or High-Frequency Alternating

Current, the student having the privilege of selecting any one of the latter three.

Already eleven engineers from nearby industrial plants have signified their intention of taking the new evening course, and these men, together with others interested in the course, will be given an opportunity to discuss its various details with Moore School faculty members at a preliminary meeting for registration and consultation to be held in Room 212 of the Moore School Building, October 18.

Further information may be obtained from the Office of the Dean, Moore School.

## General Lytle Brown Appointed Chief of Engineers

Of interest to almost every engineering organization in the United States is the recent selection of a new Chief of Engineers to succeed Lieutenant-General Edgar Jadwin who retired August 7. After careful investigation, lasting over a month, in which he reviewed the advice and recommendations of almost every shade of opinion interested in the selection of the chief, President Hoover appointed Brigadier-General Lytle Brown Chief of Engineers, U. S. Army, and the Senate promptly confirmed the appointment.

General Brown is a graduate of Vanderbilt University, West Point and the General Staff College at Fort Leavenworth. He is also a Charter Member of the Society of American Military Engineers.

In accordance with plans which President Hoover had announced at the same time of General Brown's appointments, a slight reorganization is taking place in the Corps of Engineers. Eight geographic divisions have been formed, several of the old engineering districts having been regrouped and reassigned. The geographic divisions, their chiefs, with headquarters and fields of operation are:

Lower Mississippi Valley Division, System and flood control in the Alluvial Valley, Chief, Brigadier-General T. H. Jackson, Vicksburg, Miss.

Upper Mississippi Valley Division, (Upper Mississippi System, including the Missouri, Illinois and Ohio River) Chief, Lt. Col. G. R. Spalding, St. Louis, Mo.

Great Lakes Division, (harbors and channels on the Great Lakes; waterway from Great Lakes to the Atlantic) Chief, Col. E. M. Markham, Cleveland, Ohio.

North Atlantic Division, (harbors and channels along the North Atlantic Coast, Cape Cold Canal, Delaware and Chesapeake Canal, harbors and channels in Porto Rico), Chief, Col. William J. Barden, New York City.

South Atlantic Division, (harbors and channels along the South Atlantic Coast, intracoastal waterways from Norfolk, Va. to Jacksonville, Fla), Chief, Col. H. B. Ferguson, Norfolk, Va.

Gulf of Mexico Division, (harbors and channels along Gulf Coast and in Florida, intracoastal waterways from New Orleans, La. to Corpus Christi, Texas), Chief, Lt.-Col. Mark Brooke, New Orleans, La.

South Pacific Division, (harbors and channels along California coast and in Hawaii, Sacramento River flood control), Chief, Lt.-Col. J. Franklin Bell, San Francisco, Calif.

North Pacific Division, (harbors and channels along the coast of Oregon, Washington and Alaska, Columbia River system), Chief, Col. Gustave R. Lukesb, Portland, Ore.

Col. Edward H. Schulz, Corps of Engineers, has been assigned to the command of the Engineer Post and School at Fort Humphreys, Va., succeeding Col. E. M. Markham.

## The John Fritz Medal to Doctor Modjeski

Ralph Modjeski, a native of Poland, and son of the late Helen Modjeska, noted tragedienne, was awarded the 1929 John Fritz Gold Medal, at the regular annual meeting of the Board, Sep-

tember 27, 1929, "For notable achievement as an engineer of great bridges combining the principles of strength and beauty."

The choice of Doctor Modjeski was unanimous with the Board of Award, composed of sixteen past-presidents of the four national societies of civil, mining and metallurgical, mechanical, and electrical engineers, representing a combined membership of nearly 60,000.

"In recognition of the increasing contribution of bridge builders to the progress of humanity, and in appreciation of the distinguished scientific and industrial achievements of Doctor Modjeski as one of America's foremost bridge builders, this award was made."

Born in Cracow in 1861, Doctor Modjeski came to this country with his parents in 1876. He obtained his engineering education at the Ecole des Ponts et Chaussees in Paris. As designer, construction engineer, and consultant, he has been identified with many of America's most notable bridges, among them the McKinley Bridge over the Mississippi at St. Louis, Columbia River Bridge at Celilo, Oregon, Keokuk Bridge over the Mississippi, Ohio River Bridge at Cincinnati, Thames River Bridge at New London, Quebec Bridge, Poughkeepsie Bridge, Philadelphia-Camden Bridge, and Manhattan Bridge, New York.

Members of the Board making the award were; Robert Ridgway, George S. Davison, John F. Stevens, and Lincoln Bush, of the American Society of Civil Engineers; J. V. W. Reynders, Samuel A. Taylor, E. De Golyer, George Otis Smith, of the American Institute of Mining and Metallurgical Engineers; D. S. Jacobus, Dexter S. Kimball, Charles M. Sewab, and Alex Dow, of the American Society of Mechanical Engineers, and M. I. Pupin, C. C. Chesney, Bancroft Gherardi, and R. F. Schuchardt, Past-Presidents of the Institute.

### Book Reviews

**TELEVISION.** By H. Horton Sheldon and Edgar N. Grisewood. New York, D. Van Nostrand Company, Inc. 194 pages,  $5\frac{1}{2} \times 8\frac{3}{4}$  in., cloth, illustrated, 1929. Price \$2.75.

The authors describe in language easily understood the developments and present limitations of this newest branch of the electrical communication art. Under a broad definition of television, which consists of reducing an object to a series of light signals which are converted into electric signals, transmitted to a distance, and converted back into light signals, the authors include in their work both the transmission of pictures and the scanning of objects. The transmission of photographs, or telephotography, which is described, has attained a commercial status, and this service is now regularly supplied by the large telegraph companies. The various systems of scanning, which are also described, are still in the experimental laboratory stage and the future of television, while seeming assured, is still problematical. This book, which comes as the first American work on this subject, gives a historical outline of developments and explains the essential elements of television. It also describes and illustrates the apparatus used by different inventors in this field. The book is addressed particularly to amateurs in the belief that widespread amateur interest will prove of great help in the development of the art.

**PROCEEDINGS, INTERNATIONAL CONGRESS ON ILLUMINATION, 1928.** Chemical Publishing Company, Easton, Pa. 1458 pages,  $6\frac{1}{2} \times 9\frac{1}{4}$  in., cloth, illustrated. Price \$10.00. Apply for copies to Illuminating Engineering Society, 29 West 39th Street, New York, N. Y.

The Proceedings of the International Congress on Illumination, 1928, includes the proceedings of the Seventh Plenary Session of the International Commission on Illumination held at Saranac Inn, N. Y., September, 1928, and also selected papers presented at the Twenty-third Annual Convention of the Illuminating Engineering Society. Theme subjects treated at length are Street Lighting, Glare Research, Motor Vehicle Headlighting,

Distribution of Luminous Flux, Precision Photometry and Standards, Heterochromatic Photometry, Natural Lighting, Decorative Lighting, Vocabulary, Definitions and Symbols, School and Factory Lighting, Illumination Research, Colored Signal Glasses, Diffusing Materials, Motion Picture Lighting, the I. C. I. Tour, general sessions reports and the results of an international survey on show-window lighting, home lighting, lighting education and aviation lighting practise. In all, the volume contains sixty-nine papers and reports by authors recognized as the leaders in illumination throughout the world.

The vast amount of authoritative information contained in the Proceedings will prove an invaluable reference source to those who wish to continue research along these lines and also to illuminating engineers whose daily activities bring them into close touch with many problems in lighting practise.

The volume is indexed and cross-indexed as to contents and personnel, and is profusely illustrated with line-cut and half-tone engravings and color plates. The scope of the contents and the manner in which the most involved subjects are reported serve to illustrate the present status and the broad scope of the art and science of illumination.

**ELEMENTARY DIFFERENTIAL EQUATIONS.** By Thornton Foy. New York, N. Y., D. Van Nostrand Company, Inc. 255 pages,  $6\frac{1}{4} \times 9\frac{1}{4}$  in., cloth, illustrated, 1929. Price \$2.50.

This text is the outgrowth of several mimeographed editions used by the author in the out-of-hour courses at the Bell Telephone Laboratories, and has been written primarily for engineering students. It deals with the solution of ordinary differential equations, especially those linear equations commonly encountered in the study of physics. In order to help visualize abstract mathematical expressions, the fundamental ideas are interpreted in geometrical illustrations which will be found very helpful. A large number of practical problems is given and, being written especially for engineers, subjects of purely mathematical interest have been omitted.

**INDUSTRIAL STANDARDIZATION.** Published by the National Industrial Conference Board, New York, N. Y. 306 pages,  $6 \times 8\frac{3}{4}$  in., cloth. Price \$3.50.

The purpose of this book is to establish a popular understanding of industrial standardization and the extent and manner in which it is being advanced. The recent rapid industrial growth in the United States is attributed largely to the influence of standardization in almost every branch of American business. Part I covers the historical background of standardization and gives a picture of the issues involved in the adoption of standard practises and devices and the procedure followed by companies, technical societies, trade associations and other standardizing bodies. Part II deals with the advantages and business savings resulting from standardization. While the full effects of standardization cannot yet be evaluated, the cumulative evidence points to the conclusion that it is an important factor in increasing industrial efficiency and that it suggests unlimited possibilities for future achievements. While the technical literature on standardization is extensive, this is perhaps the only work which considers the entire subject in a broad, popular, and non-technical manner.

**INTRODUCTION TO COLLEGE PHYSICS.** By C. M. Kilby. New York, N. Y., D. Van Nostrand Company, Inc. 349 pages,  $5\frac{3}{4} \times 8\frac{3}{4}$  in., cloth, illustrated, 1929. Price \$3.00.

The fundamentals of physics are arranged in a concise and accurate manner in this textbook which is designed for use as a first year college course, and the subject is covered in a way which comprises a good foundation for future study. The contents are divided into five major parts; *viz.*, mechanics, magnetism and electricity, heat, sound, and light. The book is liberally illustrated with diagrams, and special stress is laid on the solution

added to the list of "Members for Life" by exemption from future dues.

Approval was given to the location and dates selected by the Pacific Coast members for the already authorized Pacific Coast Convention in 1930; namely, Portland, Oregon, September 2-5.

A petition from the Kansas City Section for an extension of territory was granted.

As required by the By-laws, five members of the Board of Directors were selected to serve on the National Nominating Committee, as follows: Messrs. H. C. Don Carlos, B. Gherardi, J. E. Kearns, A. M. MacCutecheon, and C. E. Stephens.

The Board confirmed the appointment by the President, of Mr. H. P. Charlesworth as a member of the Edison Medal Committee to fill the unexpired term of Mr. E. B. Craft, deceased.

The following appointments of representatives were made: Mr. H. P. Charlesworth was reappointed to the Board of Trustees, United Engineering Society, for the three-year term beginning in January 1930; Mr. W. A. Del Mar was appointed to fill the unexpired term of E. B. Craft, deceased, on the Library Board of the U. E. S., and Professor W. I. Slichter was reappointed to the Library Board for the four-year term beginning January 1, 1930; Mr. John C. Parker was reappointed a representative of the Institute on the Standards Council, American Standards Association, for the three-year term beginning January 1, 1930, and Messrs. H. H. Henline, H. M. Hobart, and H. S. Osborne were reappointed alternates on this body for the calendar year 1930.

Upon the recommendation of the Standards Committee, approval by the Institute as one of five joint sponsors was given to (1) Report of Sectional Committee on Scientific and Engineering Symbols and Abbreviations, dealing with navigational and topographical symbols, and (2) revision of American Standard for Illuminating Engineering Nomenclature and Photometric Standards, reported by the Sectional Committee on Scientific and Engineering Symbols and Abbreviations.

An invitation to send delegates to the Fiftieth Anniversary of the Elektrotechnischer Verein e. V., January 24-27, 1930, was accepted and the appointment of delegates referred to the President.

It was understood that the next meeting of the Board of Directors will be held in Chicago, December 3, during the Chicago District Meeting.

Other matters were discussed, reference to which may be found in this and future issues of the JOURNAL.

## A New Evening Course at the University of Pennsylvania

A new evening course in Electrical Engineering, which will lead to the degree of Master of Science in Electrical Engineering, has been announced by Doctor Harold Pender, Dean of the Moore School of Electrical Engineering of the University of Pennsylvania. All sessions in the course will be held in the Moore School Building, Thirty-third and Walnut streets.

The course opened during the week of October 21, and any student holding a Bachelor of Arts or a Bachelor of Science degree is eligible, provided he has had the necessary preliminary instruction in mathematics and physics during his undergraduate days.

To receive the degree of Master of Science in Electrical Engineering, students must have completed an undergraduate course equivalent to that given in the Moore School, and must obtain credit within a period of four years in all subjects required for the Master of Science degree in the regular day course offered in the Moore School.

The courses required, according to Dean Pender, will be Introduction to Mathematical Physics, Advanced Electric Circuit Theory, Electron Theory and its Engineering Applications, Thesis, Fundamentals of Physical Theories, and either Atomic Structure, Electro Dynamics, or High-Frequency Alternating

Current, the student having the privilege of selecting any one of the latter three.

Already eleven engineers from nearby industrial plants have signified their intention of taking the new evening course, and these men, together with others interested in the course, will be given an opportunity to discuss its various details with Moore School faculty members at a preliminary meeting for registration and consultation to be held in Room 212 of the Moore School Building, October 18.

Further information may be obtained from the Office of the Dean, Moore School.

## General Lytle Brown Appointed Chief of Engineers

Of interest to almost every engineering organization in the United States is the recent selection of a new Chief of Engineers to succeed Lieutenant-General Edgar Jadwin who retired August 7. After careful investigation, lasting over a month, in which he reviewed the advice and recommendations of almost every shade of opinion interested in the selection of the chief, President Hoover appointed Brigadier-General Lytle Brown Chief of Engineers, U. S. Army, and the Senate promptly confirmed the appointment.

General Brown is a graduate of Vanderbilt University, West Point and the General Staff College at Fort Leavenworth. He is also a Charter Member of the Society of American Military Engineers.

In accordance with plans which President Hoover had announced at the same time of General Brown's appointments, a slight reorganization is taking place in the Corps of Engineers. Eight geographic divisions have been formed, several of the old engineering districts having been regrouped and reassigned. The geographic divisions, their chiefs, with headquarters and fields of operation are:

Lower Mississippi Valley Division, System and flood control in the Alluvial Valley, Chief, Brigadier-General T. H. Jackson, Vicksburg, Miss.

Upper Mississippi Valley Division, (Upper Mississippi System, including the Missouri, Illinois and Ohio River) Chief, Lt. Col. G. R. Spalding, St. Louis, Mo.

Great Lakes Division, (harbors and channels on the Great Lakes; waterway from Great Lakes to the Atlantic) Chief, Col. E. M. Markham, Cleveland, Ohio.

North Atlantic Division, (harbors and channels along the North Atlantic Coast, Cape Cold Canal, Delaware and Chesapeake Canal, harbors and channels in Porto Rico), Chief, Col. William J. Barden, New York City.

South Atlantic Division, (harbors and channels along the South Atlantic Coast, intracoastal waterways from Norfolk, Va. to Jacksonville, Fla), Chief, Col. H. B. Ferguson, Norfolk, Va.

Gulf of Mexico Division, (harbors and channels along Gulf Coast and in Florida, intracoastal waterways from New Orleans, La. to Corpus Christi, Texas), Chief, Lt.-Col. Mark Brooke, New Orleans, La.

South Pacific Division, (harbors and channels along California coast and in Hawaii, Sacramento River flood control), Chief, Lt.-Col. J. Franklin Bell, San Francisco, Calif.

North Pacific Division, (harbors and channels along the coast of Oregon, Washington and Alaska, Columbia River system), Chief, Col. Gustave R. Lukesh, Portland, Ore.

Col. Edward H. Schulz, Corps of Engineers, has been assigned to the command of the Engineer Post and School at Fort Humphreys, Va., succeeding Col. E. M. Markham.

## The John Fritz Medal to Doctor Modjeski

Ralph Modjeski, a native of Poland, and son of the late Helen Modjeska, noted tragedienne, was awarded the 1929 John Fritz Gold Medal, at the regular annual meeting of the Board, Sep-



tember 27, 1929, "For notable achievement as an engineer of great bridges combining the principles of strength and beauty."

The choice of Doctor Modjeski was unanimous with the Board of Award, composed of sixteen past-presidents of the four national societies of civil, mining and metallurgical, mechanical, and electrical engineers, representing a combined membership of nearly 60,000.

"In recognition of the increasing contribution of bridge builders to the progress of humanity, and in appreciation of the distinguished scientific and industrial achievements of Doctor Modjeski as one of America's foremost bridge builders, this award was made."

Born in Cracow in 1861, Doctor Modjeski came to this country with his parents in 1876. He obtained his engineering education at the Ecole des Ponts et Chaussees in Paris. As designer, construction engineer, and consultant, he has been identified with many of America's most notable bridges, among them the McKinley Bridge over the Mississippi at St. Louis, Columbia River Bridge at Celilo, Oregon, Keokuk Bridge over the Mississippi, Ohio River Bridge at Cincinnati, Thames River Bridge at New London, Quebec Bridge, Poughkeepsie Bridge, Philadelphia-Camden Bridge, and Manhattan Bridge, New York.

Members of the Board making the award were; Robert Ridgway, George S. Davison, John F. Stevens, and Lincoln Bush, of the American Society of Civil Engineers; J. V. W. Reynders, Samuel A. Taylor, E. De Golyer, George Otis Smith, of the American Institute of Mining and Metallurgical Engineers; D. S. Jacobus, Dexter S. Kimball, Charles M. Sewab, and Alex Dow, of the American Society of Mechanical Engineers, and M. I. Pupin, C. C. Chesney, Bancroft Gherardi, and R. F. Schuchardt, Past-Presidents of the Institute.

### Book Reviews

**TELEVISION.** By H. Horton Sheldon and Edgar N. Grisewood. New York, D. Van Nostrand Company, Inc. 194 pages,  $5\frac{1}{2} \times 8\frac{3}{4}$  in., cloth, illustrated, 1929. Price \$2.75.

The authors describe in language easily understood the developments and present limitations of this newest branch of the electrical communication art. Under a broad definition of television, which consists of reducing an object to a series of light signals which are converted into electric signals, transmitted to a distance, and converted back into light signals, the authors include in their work both the transmission of pictures and the scanning of objects. The transmission of photographs, or telephotography, which is described, has attained a commercial status, and this service is now regularly supplied by the large telegraph companies. The various systems of scanning, which are also described, are still in the experimental laboratory stage and the future of television, while seeming assured, is still problematical. This book, which comes as the first American work on this subject, gives a historical outline of developments and explains the essential elements of television. It also describes and illustrates the apparatus used by different inventors in this field. The book is addressed particularly to amateurs in the belief that widespread amateur interest will prove of great help in the development of the art.

**PROCEEDINGS, INTERNATIONAL CONGRESS ON ILLUMINATION, 1928.** Chemical Publishing Company, Easton, Pa. 1458 pages,  $6\frac{1}{2} \times 9\frac{1}{4}$  in., cloth, illustrated. Price \$10.00. Apply for copies to Illuminating Engineering Society, 29 West 39th Street, New York, N. Y.

The Proceedings of the International Congress on Illumination, 1928, includes the proceedings of the Seventh Plenary Session of the International Commission on Illumination held at Saranac Inn, N. Y., September, 1928, and also selected papers presented at the Twenty-third Annual Convention of the Illuminating Engineering Society. Theme subjects treated at length are Street Lighting, Glare Research, Motor Vehicle Headlighting,

Distribution of Luminous Flux, Precision Photometry and Standards, Heterochromatic Photometry, Natural Lighting, Decorative Lighting, Vocabulary, Definitions and Symbols, School and Factory Lighting, Illumination Research, Colored Signal Glasses, Diffusing Materials, Motion Picture Lighting, the I. C. I. Tour, general sessions reports and the results of an international survey on show-window lighting, home lighting, lighting education and aviation lighting practise. In all, the volume contains sixty-nine papers and reports by authors recognized as the leaders in illumination throughout the world.

The vast amount of authoritative information contained in the Proceedings will prove an invaluable reference source to those who wish to continue research along these lines and also to illuminating engineers whose daily activities bring them into close touch with many problems in lighting practise.

The volume is indexed and cross-indexed as to contents and personnel, and is profusely illustrated with line-cut and half-tone engravings and color plates. The scope of the contents and the manner in which the most involved subjects are reported serve to illustrate the present status and the broad scope of the art and science of illumination.

**ELEMENTARY DIFFERENTIAL EQUATIONS.** By Thornton Foy. New York, N. Y., D. Van Nostrand Company, Inc. 255 pages,  $6\frac{1}{4} \times 9\frac{1}{4}$  in., cloth, illustrated, 1929. Price \$2.50.

This text is the outgrowth of several mimeographed editions used by the author in the out-of-hour courses at the Bell Telephone Laboratories, and has been written primarily for engineering students. It deals with the solution of ordinary differential equations, especially those linear equations commonly encountered in the study of physics. In order to help visualize abstract mathematical expressions, the fundamental ideas are interpreted in geometrical illustrations which will be found very helpful. A large number of practical problems is given and, being written especially for engineers, subjects of purely mathematical interest have been omitted.

**INDUSTRIAL STANDARDIZATION.** Published by the National Industrial Conference Board, New York, N. Y. 306 pages,  $6 \times 8\frac{3}{4}$  in., cloth. Price \$3.50.

The purpose of this book is to establish a popular understanding of industrial standardization and the extent and manner in which it is being advanced. The recent rapid industrial growth in the United States is attributed largely to the influence of standardization in almost every branch of American business. Part I covers the historical background of standardization and gives a picture of the issues involved in the adoption of standard practises and devices and the procedure followed by companies, technical societies, trade associations and other standardizing bodies. Part II deals with the advantages and business savings resulting from standardization. While the full effects of standardization cannot yet be evaluated, the cumulative evidence points to the conclusion that it is an important factor in increasing industrial efficiency and that it suggests unlimited possibilities for future achievements. While the technical literature on standardization is extensive, this is perhaps the only work which considers the entire subject in a broad, popular, and non-technical manner.

**INTRODUCTION TO COLLEGE PHYSICS.** By C. M. Kilby. New York, N. Y., D. Van Nostrand Company, Inc. 349 pages,  $5\frac{3}{4} \times 8\frac{3}{4}$  in., cloth, illustrated, 1929. Price \$3.00.

The fundamentals of physics are arranged in a concise and accurate manner in this textbook which is designed for use as a first year college course, and the subject is covered in a way which comprises a good foundation for future study. The contents are divided into five major parts; *viz.*, mechanics, magnetism and electricity, heat, sound, and light. The book is liberally illustrated with diagrams, and special stress is laid on the solution

of problems which are given in considerable numbers. Many complete solutions of problems are given as guides. While it is elementary in scope, it offers a very good groundwork for the beginner in the study of physics.

**FORTY YEARS WITH GENERAL ELECTRIC.** By John T. Broderick. Albany, N. Y., Fort Orange Press. 218 pages, 5¼ x 7¾ in., cloth, illustrated, 1929. Price \$2.50.

The book contains a rather sketchy history of the General Electric Company, combined with many biographical references to the men who have been leaders in the development of the organization. The author's long connection with the company has enabled him to produce a human interest story of people and events with which he has been intimately associated. The author designates as fathers of the General Electric Co., Elihu Thomson, C. A. Coffin and E. W. Rice, Jr. who, surrounded by able and brilliant colleagues, established business ideals which comprise the spirit of a great corporation. Many of the company's notable achievements in research are described and numerous incidents in connection with the business are narrated in interesting style.

**AN INTRODUCTION TO CRYSTAL ANALYSIS.** By Sir William Bragg. New York, N. Y., D. Van Nostrand Company, Inc. 168 pages, 5¾ x 9 in., cloth, illustrated, 1929. Price \$4.25.

This is an American edition of an English book which describes the methods of examining the crystalline structure of solid matter. The development of X-rays for this purpose was the outgrowth of experiments to prove that X-rays and light waves were of the same nature. The crystalline structure of materials is of importance to many sciences and since a method of crystal analysis has become available great progress has been made in this field. The contents includes reflection by the crystal lattice, description of methods of analysis, simple inorganic crystals, space groups or crystal arrangements, some complex crystals, and a final chapter devoted to X-ray analysis of the structure of metals and alloys.

## PERSONAL MENTION

**WILLARD A. LANING, JR.**, has been appointed Research Graduate Assistant at the Engineering Equipment Station, University of Illinois, Urbana, Ill.

**R. BIGLAND DICKINSON**, who for four years was with the Duke Price Power Company, Limited, in Arvida and Isle Maligne, P. Q., has engaged as Assistant Superintendent on construction work with the Canadian Comstock Company in Montreal.

**A. ANDREW DOUGLAS**, for the past three years an instructor for the Brooklyn Edison Company Educational Bureau, is now at the State University of Iowa, Iowa City, Iowa, taking graduate work in electricity and mathematics.

**CLAIR F. BOWMAN** has resigned his position as Instructor in Electrical Engineering at Purdue University to accept the position of Assistant Professor in Electrical Engineering at Montana State College, Bozeman, Mont.

**JUSTIN J. McCARTHY**, formerly Research Engineer of the Cleveland Railway, is now connected with the engineers, Parsons, Klapp, Brinckerhoff & Douglas, of Cleveland, Ohio, as Signal Engineer.

**JOHN E. S. THORPE**, heretofore General Superintendent of the Knoxville Power Company, Calderwood, Tennessee, has accepted the office of President of the Nantahala Power & Light Company, Bryson City, N. C.

**THOMAS A. FAWELL** has recently severed his connection as manufacturers representative of the Martindale Electric Com-

pany and other manufacturers and is associated with the Hoffman Specialty Company, Inc., with headquarters at 557 Market Street, San Francisco, Calif.

**CLARENCE L. COLLENS**, President of the Reliance Electric and Engineering Company and Associate of the Institute, has been elected President of the National Electrical Manufacturers Association for the ensuing year. Mr. Collens received the McGraw Award for his part in bringing about the organization of NEMA three years ago and has been Governor of the Association and Vice-President of the Policies Division ever since its inception.

**A. W. BERRESFORD**, President of the American Engineering Council, Past-President of the Associated Manufacturers of Electrical Supplies, Electrical Manufacturers Club, and the American Institute of Electrical Engineers, was appointed Managing Director of NEMA, effective at once, to succeed Mr. Alfred E. Waller resigned. Mr. Berresford was formerly Vice-President and General Manager of the Cutler-Hammer Mfg. Co. and Vice-President of what is now the Kelvinator Corporation.

## Obituary

**Henry C. Houck**, Manager of the Merchandise Department of the General Electric Company, died at his home in Bridgeport, Conn., on October 15, after a long illness. Educated at Phillips Exeter Academy and the University of Pennsylvania, from which he was graduated in Electrical Engineering in 1899, he entered the employ of the General Electric Company in the fall of that year. In his thirty years of service with the company, Mr. Houck filled many important positions at Schenectady, Cleveland, and Cincinnati, as well as at Bridgeport, where he became Manager of the Merchandise Department in December, 1925. He was made an Associate of the Institute in 1907.

**Bedford Jethro Brown**, Superintendent of the Meter Department of the Duke Power Company, Charlotte, N. C., died October 2, 1929. He was a native of Charlotte, and received his public school education there. He was graduated with the degree of B. E. in Electrical Engineering from the N. C. A. & M. College, Raleigh, N. C. in 1901, after which he completed an apprentice course in engineering with the Westinghouse Electric & Manufacturing Company. From the latter part of 1903 to March 1904 he was in the Testing Department of the Westinghouse Company and then became a Meter Expert in the Company's Chicago District. He was compelled to leave this position because of ill health, and did not resume his work again until 1906 when he accepted a position in the Meter Testing Department of the Southern Power Company, at Charlotte, N. C.

Mr. Brown's work led to extensive travel in the United States, notwithstanding the fact that for eleven years he was Superintendent of the Testing Department and Instrument Testing Laboratory of the Westinghouse Company. He joined the Institute as an Associate in 1910 and became a Member in 1918.

**Charles Shelly Lawson**, Assistant Manager of the Transformer Engineering Department of the Sharon plant of the Westinghouse Electric and Manufacturing Co., died at the Buhl Hospital, Saturday, October twelfth, following an operation.

Mr. Lawson was taken suddenly ill on Monday, at the Sharon Country Club links.

Born on a farm near Montgomery, Ala., February 8, 1879, he was graduated from University of Alabama with an M. S. degree, and in 1902 he received a B. S. in Electrical Engineering from Massachusetts Institute of Technology. He then took the Student Course of the General Electric Company and later became associated with the Atlanta Water and Power Company. In 1905 Mr. Lawson accepted a position as Insulation Engineer in the Transformer Engineering Department of the East Pittsburgh Plant of the Westinghouse Company, and from that time his rise was rapid, ultimately becoming assistant mana-

ger. He came to Sharon in 1925. He was a Fellow of the Institute, which he joined in 1906; was a member of the Sharon Rotary and Country Clubs and the Sharon Chamber of Commerce.

**N. Govindraj**, Mains Superintendent, Simla Municipal Electricity Department, Simla, North India, died September 21 at Simla, of pneumonia.

He was a graduate in Electrical Engineering from the Victoria Jubilee Technical Institute, at Bombay, and was the recipient of the Lord Reay Gold Medal of the Institute. He had served with the Tatas at Bombay as an apprentice, and after a short term of service with the Bombay Tramways, he was appointed Mains Superintendent of the Simla Municipality in 1920, an office which he has filled with highest efficiency.

Mr. Govindraj was thirty-eight years of age and a native of Madras, India. In his early training he was a student of physics, chemistry and natural science at Madras University, and in his preliminary electrical work he was with the maintenance and operation departments of a receiving station, inspecting transformers, high-voltage motors and other switching apparatus. He later was made superintendent of erection and maintenance of extra high-tension aerial mains and the laying and maintaining of high- and low-tension cables. He joined the Institute as an Associate in 1922.

**Wallace S. Clark**, for many years head of the Wire and Cable Division of the General Electric Company, died suddenly at his home in Schenectady, N. Y., on October 11. Mr. Clark was one of the pioneers of the electrical industry, and his service in it began in September, 1885, when, shortly after his graduation from Sheffield Scientific School with the degree of Ph. B., he entered the commercial and engineering offices of the Edison Electric Light Company at 65 Fifth Avenue, New York.

He went to the Schenectady Works of the Edison General Electric Company in February, 1887; the company had moved to that city the previous fall. He entered the Wire and Cable Department of the Company in 1891, and in 1903 was made superintendent of the wire and cable, underground tube and varnish departments. In July, 1904, he was made engineer of the wire and cable department, and was also in charge of sales for the department. With the formation of the central station department in 1924, he was made manager of the wire and cable division. During the entire period of the participation of the United States in the World War, Mr. Clark served on the war service committee of the insulated wire industry. He joined the Institute in 1902.

**James Thomas Watson** of the Westinghouse Electric & Mfg. Co., and with residence at Wilkes Baire, died September 17, 1929. He was born at Fallston, Harford County, Maryland, and after one year in the Waynesboro Business College, Waynesboro, Va., and three and a half years at the Fishburne Military School, (also at Waynesboro,) he became a student of the International Correspondence School at Scranton, graduating from a course in Electric Power and Lighting, and further pursuing his study of Electrical Engineering with the American School of Correspondence at Chicago.

From 1897 to 1899 he was Electrician in Charge of the Waynesboro Electric Light & Power Company, Waynesboro, Va. He then became Foreman of Interior Wiring for Charles B. Scott, Electrical Contractor at Scranton, Pa., where he remained until 1900, when he was chosen Chief Foreman of Electricians by the Delaware and Hudson Company Scranton, Pa. remaining there eight years. The last three years of his period of service he was Assistant to the Electrical Engineer. Later in the year 1908 he became Superintendent of the Blue Ridge Light & Power Company, Staunton, Va. and then Electrical Engineer of the Tennessee Copper Company, Copperhill, Tenn. Mr. Watson became an Associate of the Institute in 1910 and was transferred to the grade of Member in 1913.

**David L. Huntington**, President of the Washington Water Power Company, Spokane, Washington, to which office he rose from General Manager and Chief Engineer in 1902, died at his home September 27 after a confinement of two years. He was born in New London, Connecticut, received his public school education in Washington, D. C. and afterward attended Yale University. Upon leaving Yale, he joined the Thomson-Houston Electric Company, Lynn, Mass. and when the General Electric Company was organized, he was sent to the Philadelphia District. He resigned from this work to become Treasurer of the Washington Water Power Company.

Mr. Huntington was prominently identified with electrical developments of the Northeast and was an important factor in the growth of the Spokane utility movement. His last big undertaking was as head of the Washington Water Power Company in building the Chelan hydroelectric plant in connection with which he made several trips to New York, personally supervising the purchase of the site, the awarding of contracts and the formulation of the financial program. Although taken ill before the completion of the work, through the agency of an electric button, he placed this first unit in operation. He joined the Institute as an Associate in 1902 and was elected a Fellow in 1913. In commenting upon his death, the *Spokesman Review* of Spokane said, "Mr. Huntington might be said to have anticipated the public policy, now the rule rather than the exception among public utility corporations of foresight and aggressiveness, that service is the yardstick of usefulness."

### Addresses Wanted

A list of members whose mail has been returned by the postal authorities is given below, together with the addresses as they now appear on the Institute records. Any member knowing the present address of any of these members is requested to communicate with the Secretary at 33 West 39th St., New York.

All members are urged to notify Institute Headquarters promptly of any changes in mailing or business address, thus relieving the member of needless annoyance and assuring the prompt delivery of Institute mail through the accuracy of our mailing records, and the elimination of unnecessary expense for postage and clerical work:

- C. A. Baer, 1330 Pine St., Philadelphia, Pa.
- J. B. Bakker, 440 Hyde St., San Francisco, Calif.
- Marcel A. Collinot, c/o F. W. V. Rm. 1050, 11 W. 42nd St., New York, N. Y.
- H. H. DeCamp, 414 Ella St., Wilkesburg, Pa.
- F. S. Degener, 1015 Casgrain Ave., Detroit, Mich.
- Ernest Fick, A. T. & T. Co., 412 S. Market St., Chicago, Ill.
- Henry W. Harbison, R. F. D. 1, Merriam, Kans.
- John Ernest Hardey, Box 1055, Wellington, N. Z.
- H. U. Hedeby, P. O. Box 414, Sharon, Pa.
- Eric David Howells, Westinghouse Club, Wilkesburg, Pa.
- Edgar A. James, 912 S. Poplar St., Allentown, Pa.
- H. Kirkland, Jr., 6701 Cregier Ave., Chicago, Ill.
- A. Klein, 1215 Locust St., Philadelphia, Pa.
- Charles Max, Companhia Electrica, Catumbela, Angola, W. Africa.
- John T. Mooney, 4547 N. Leavitt St., Chicago, Ill.
- Julius M. Naiman, 1703 15th Ave., South, Birmingham, Ala.
- H. L. Perkins, 129 Marshall St., Petersburg, Va.
- W. M. Philip, 433 Morrison St., Niagara Falls, Ont., Can.
- H. D. Rives, 298 Central Ave., Lynbrook, L. I., N. Y.
- Carl Schwartz, c/o Int'l. Combustion Engg. Corp., New York, N. Y.
- Robert H. Singer, 2214 Auburn Ave., Cincinnati, Ohio.
- Gerhard Svensson, c/o American Express Co., 65 Broadway, New York, N. Y.
- C. H. Willis, 184 Prospect Ave., Princeton, N. J.

# A. I. E. E. Section Activities

## WONDERS OF SOUND TRANSMISSION

New York Section to hear S. P. Grace of Bell Telephone Laboratories

On the evening of Friday, November 8th, the New York Section members will have the privilege of attending a lecture and demonstration by S. P. Grace, Asst. Vice-President of the Bell Telephone Laboratories, Inc. disclosing some of the most recent wonders of science in the field of sound transmission. Just a glance over the modern marvels to be illustrated and explained will reveal the electric ear, scrambled speech, delayed speech, double-ended short wave high power radio tubes, amplified muscle noises, translation of mechanical impulses into speech, the artificial larynx, and so on down the list of the latest work in sound transmission—the results of organized effort to extend the range of the human voice. Mr. Grace has shown that he can entertain audiences of every type, scientists and laymen. The Program Committee feels that this is an unusual opportunity to spend not only a particularly interesting and instructive evening, but it is as sure that all will go away with a fuller realization of the place of science in American progress. The meeting will be held at 8 p. m. in the Engineering Auditorium, 33 West 39th Street, New York, N. Y.

## NEW YORK SECTION TRANSPORTATION COMMUNICATION GROUPS HOLD MEETINGS

The group activities within the New York Section for the year 1929-30 are now well under way. Of the four groups which have been organized to date, the Power Group met on October 30th, the Transportation and Communication Groups are scheduled for November 4th and November 13th, respectively. The Illumination Group is arranging its first meeting for January 7, 1930. The general details of the November 4th and 13th meetings, which will be held in the Engineering Societies Building, 33 West 39th St., New York, N. Y., follow:

*Transportation Group:* Meeting Monday, November 4, 1929 at 7:30 p. m., Room 1, 5th Floor, Engineering Societies Building. Subject—*How the Electric Railways are Meeting the Demand for Modern Transportation.* Speakers: Guy C. Hecker, General Secretary, A. E. R. A. and B. O. Austin, Control Engineer, Westinghouse Elec. & Mfg. Co. The speakers will outline the many technical developments of interest to engineers that have occurred recently.

*Communication Group:* Meeting Wednesday, November 13, 1929 at 7:30 p. m., Room 2, 5th Floor, Engineering Societies Building. Subject—*Materials of Communication.* Speakers: W. W. Brown, General Electric Co. on *Micalex. Its properties and Application to Radio Equipment.* I. R. Smith, Westinghouse Elec. & Mfg. Co. on *Copper Oxide. Its Use and Performance in Rectifiers.* W. Fondiller, Bell Telephone Laboratories on *Developments in Communication Materials.* The work done on insulating materials and metals, including duralumin, permalloy, brasses and bronzes. D. Levinger, Western Electric Co. on *Manufacturing Problems in Communication Materials.* Problems in introducing some of the newer materials into manufacture.

There will be open discussion at all group meetings, which will all be scheduled for 7:30 p. m. sharp with adjournment at 9:30 to enable the commuting members to get early trains.

## FUTURE SECTION MEETINGS

### Akron

November 8, 1929 at Canton. *Heavy Duty Mercury Arc Rectifiers*, by O. K. Marti, Chief Engineer, American Brown Boveri Electric Corporation.

December 31, 1929. *Railway Electrification*, by J. V. B. Duer, Electrical Engineer, Pennsylvania Railroad Company.

### Cleveland

November 21, 1929. Subject: *Social and Economic Results of Power and Machinery.* Speaker: C. M. Ripley, General Electric Co.

December 12, 1929. Subject: *Anti-Aircraft Artillery.* Speaker: Major C. M. Barnes, Ordnance Dept., United States Army.

### Detroit-Ann Arbor

November 12, 1929. Hayes Hotel, Jackson, Michigan. Subject: *Power System Planning.* Speaker: L. W. W. Morrow, Editor, *Electrical World*, New York.

December 10, 1929. The Detroit Edison Auditorium. Joint meeting with the Detroit Engineering Society. Subject: *Power House Design.* Speaker: Alex Dow, President of the Detroit Edison Co. Inspection trip through the New Delray Power House in the afternoon.

### Lynn

November 6, 1929. Technical Lecture by L. A. Hawkins, Executive Engineer of Research Laboratory, General Electric Co. Subject: "Today's Science, Tomorrow's Engineering."

November 20, 1929. Popular Lecture "With Allenby in Palestine and Lawrence in Arabia" by the noted lecturer Lowell Thomas. Ladies invited.

December 4, 1929. Technical Lecture by H. D. Brown (*Mercury Arc Rectifiers*).

### Pittsburgh

November 19, 1929. *What's Coming in Aviation*, W. B. Stout, Stout Metal Airplane Company, Division Ford Motor Company.

December 10, 1929. *Latest Developments in Supervisory Control*, R. J. Wensley, Westinghouse Electric & Mfg. Company, Mansfield, Ohio.

## IOWA SECTION ORGANIZED

At a meeting held on June 25, 1929, the Board of Directors authorized the organization of the Iowa Section. C. L. Sampson, Engineer of Transmission, Protection, and Foreign Wire Relations of the Northwestern Bell Telephone Company, Des Moines, Iowa, was elected Chairman and Professor J. K. McNeely, Iowa State College, Ames, Iowa, was chosen as Secretary.

The Iowa Section includes as its territory the entire state of Iowa.

## MEETING OF EXECUTIVE COMMITTEE OF MIDDLE EASTERN DISTRICT

A meeting of the Executive Committee of the Middle Eastern District, No. 2, held at the Keystone Athletic Club, Pittsburgh, Pa., on October 7, was attended by a large majority of the members of the Committee, and ten of the twelve Sections in the District were represented.

After the completion of the business before the meeting, there was an extended discussion of Section activities and methods by which they may be made more effective. Some of the more important topics were; the desirability of affording to as many members as possible opportunities for participating in the activities; use of cards to keep records of attendance at meetings; developing better speaking ability among the members; methods of making special appeal to enrolled Students of the Institute; stimulation of discussion; policies regarding local membership; meetings of certain technical groups within a Section; the types of social meetings which are most helpful; civic affairs; and publicity.



## PAST SECTION MEETINGS

**Boston**

Meeting of Executive Board. Election of Membership, Program and Entertainment Committee Chairmen. Voted to hold the regular monthly meetings on the first Tuesday of each month. The Secretary announced the plans for the October meeting, an inspection trip of the Boston Harbor on the City Steamship, Saturday afternoon, Oct. 5. Discussion of membership policy for the coming year. Approval of tentative budget for the year. September 19.

**Chicago**

Joint meeting with Western Society of Engineers held during celebration of Light's Golden Jubilee. L. A. Ferguson, Vice-President, Commonwealth Edison Co., read his speech at the commemoration of the 50th anniversary of the laying of the Atlantic cable made in N. Y. twenty years ago. Speech by W. L. Abbott, Chief Operating Engineer, Commonwealth Edison Co. on the old days in Chicago. The meeting was preceded by a dinner. September 23. Attendance 385.

**Cincinnati**

Minutes of annual meeting and Treasurer's report read and approved. Professor A. M. Wilson, head of the Department of Electrical Engineering at the University of Cincinnati, gave a brief analysis of color projection and color filters, with demonstrations. September 17. Attendance 76.

**Denver**

"The Quest of the Unknown," by Professor Harold B. Smith, President of the Institute, illustrated with lantern slides. A dinner preceded the meeting. September 11. Attendance 46.

Talk by F. C. Hanker, Manager Central Station Engineering, Westinghouse E. & M. Co., "Recent Studies in Generation and Distribution of Power." Talk was illustrated and discussed by Professor W. C. DuVall, Counselor of the University of Colorado Branch. The meeting was preceded by a dinner. October 4. Attendance 47.

**Detroit-Ann Arbor**

Chairman L. F. Hicknell reported on the Executive Committee meeting of the Great Lakes District (No. 5) held in Chicago. J. J. Shoemaker, Chairman of the Meetings and Papers Committee, presented the complete program of the 1929-1930 meetings. Talk by John T. Millen, Director of the Detroit Zoological Park, on the subject, "Wild Animal Experiences." Annual dinner meeting at the Lee Plaza Hotel. September 17. Attendance 91.

**Erie**

Discussion of proposed amendments to Erie Section Constitution. Talk by H. M. Towne, Engineer in charge of Design and Development of Lightning Arresters for General Elec. Co. at Pittsfield, Mass., on "Lightning Problems." Dinner preceded the meeting. September 24. Attendance 60.

**Houston**

Hezzie Clark, Humble Pipe Line Co., gave a talk on electrification in the petroleum industry. Discussion followed and M. E. Montrose of General Elec. Co. presented figures in reference to the cost of using electricity instead of steam for the drilling of wells. Also talks by J. H. Dubendorf, Shell Petroleum Co., on electrification of oil refineries and D. A. Keirn of the Westinghouse Co. on the photoelectric cell. Discussion followed. September 26. Attendance 63.

**Iowa**

First meeting of this newly authorized Section of the Institute. Election of officers as follows: C. L. Sampson, Chairman, J. K. McNeely, Secretary-Treasurer, John M. Drabelle and G. T. Shoemaker, members of the Executive Committee. Address by President Harold B. Smith on "The Quest of the Unknown." September 13. Attendance 44.

**Kansas City**

"The Quest of the Unknown" delivered by Professor Harold B. Smith, President of the A. I. E. E. An informal dinner preceded the meeting at which the executive committees and presiding officers of each of the technical societies as well as the leading men from the Westinghouse, General Electric, Western Electric, Allis-Chalmers, the large utilities of the Middle West, and the Deans of the Engineering Schools in the vicinity, were present. September 16. Attendance 126.

**Lehigh Valley**

Annual meeting. At 10:00 a. m. inspection trip through No. 5 Breaker of the Jeddo-Highland Coal Co. 12:00 noon

Luncheon at the Altamont. 2:00 p. m. business meeting, election of officers. Paper by A. O. Austin of the Ohio Brass Co. on *Power Transmission and High Voltage Insulators*. Moving pictures at the Service Depot on "Formation of Coal During the Ages Past." 6:30 p. m. dinner at Hotel Altamont. Address by Stephen Q. Hayes of the Westinghouse Company on "Electrifying South America." June 1. Attendance 101.

**Los Angeles**

First meeting of fiscal year. New officers and members of the Executive Committee were introduced. H. L. Caldwell gave a report of the Swampscott convention. E. R. Northmore gave a report of the Pacific Coast Convention. Past-President R. F. Schuchardt, H. B. Gear, Asst. to the Vice-President, Commonwealth Edison Co. and O. C. Merrill, Chairman of the American Committee of the World Power Conference, who were passing through Los Angeles enroute to the World Engineering Congress at Tokio, Japan, gave a few remarks. Professor R. W. Sorensen, California Institute of Technology talked on the subject "A Western Engineer's Experience in the East." Professor Sorensen also briefly discussed the paper which he presented before the meeting of the Society for the Promotion of Engineering Education, outlining certain phases of the work at the California Institute of Technology. The meeting was preceded by a dinner at the Engineers' Club. October 8. Attendance 78.

**Louisville**

General Section matters discussed. W. H. Stilwell, Signal Engineer of the Louisville and Nashville Railroad Co., talked on "Centralized Traffic Control Developed by the General Railway Signal Co." Four reels of motion pictures taken of the Centralized Traffic Control installed on the Ohio Central Lines were shown. October 8. Attendance 60.

**Madison**

Proposed new By-laws of Section distributed among members. Professor Edward Bennett spoke on "The Inadequacy of the Public Utilities Law of Wisconsin." Dinner at the Memorial Union preceded the meeting. October 9. Attendance 44.

**Mexico**

Election of officers as follows: G. Solis Payan, Chairman; E. Leonarz, Jr., Secretary; E. F. Lopez, Treasurer. Executive Committee: F. Aubert, H. Olmedo, G. Obregon, B. M. Antipovitch.

**Minnesota**

First meeting of the season. John Lapham of the North Central Electric Association spoke on "Edison and Light's Golden Jubilee." Several slides were shown. Two moving pictures entitled, "The Benefactor" and "The Light of a Race" were presented. October 3. Attendance 45.

**Pittsburgh**

Inspection trip to the Bell Telephone Plant. Refreshments were served at the conclusion of the inspection. September 18. Attendance 275.

**Portland**

"The Quest of the Unknown," by Professor Harold B. Smith, President of the Institute, illustrated with lantern slides. The meeting was preceded by a dinner. At the conclusion of the evening meeting a buffet lunch was served. August 26. Attendance 95.

Executive business: Chairman H. H. Cake announced that the Executive Committee of the Section made a formal request through Vice-President G. E. Quinan of District No. 9 that the date of holding the 1930 Pacific Coast Convention be Sept. 2-5, inclusive. H. H. Schoolfield was selected as general convention chairman. Mr. Schoolfield reported briefly on the success of the Santa Monica Convention. I. H. Summers of the Central Station Engg. Dept. of the General Electric Co., Schenectady, N. Y. gave a resumé of a paper presented at the Pacific Coast Convention entitled, *System Stability*. Buffet lunch followed the meeting. September 24. Attendance 69.

**Rochester**

Dr. Phillips Thomas and Dr. C. K. Lee, both of the Westinghouse E. & M. Co., East Pittsburgh, Pa., spoke on "Recent Developments in the Research Departments of the Westinghouse Elec. & Mfg. Co." Meeting was held jointly with the Rochester Engineering Society. The meeting was preceded by a dinner given to welcome the speakers. October 4. Attendance 283.

# A. I. E. E. Section Activities

## WONDERS OF SOUND TRANSMISSION

New York Section to hear S. P. Grace of Bell Telephone Laboratories

On the evening of Friday, November 8th, the New York Section members will have the privilege of attending a lecture and demonstration by S. P. Grace, Asst. Vice-President of the Bell Telephone Laboratories, Inc. disclosing some of the most recent wonders of science in the field of sound transmission. Just a glance over the modern marvels to be illustrated and explained will reveal the electric ear, scrambled speech, delayed speech, double-ended short wave high power radio tubes, amplified muscle noises, translation of mechanical impulses into speech, the artificial larynx, and so on down the list of the latest work in sound transmission—the results of organized effort to extend the range of the human voice. Mr. Grace has shown that he can entertain audiences of every type, scientists and laymen. The Program Committee feels that this is an unusual opportunity to spend not only a particularly interesting and instructive evening, but it is as sure that all will go away with a fuller realization of the place of science in American progress. The meeting will be held at 8 p. m. in the Engineering Auditorium, 33 West 39th Street, New York, N. Y.

## NEW YORK SECTION TRANSPORTATION COMMUNICATION GROUPS HOLD MEETINGS

The group activities within the New York Section for the year 1929-30 are now well under way. Of the four groups which have been organized to date, the Power Group met on October 30th, the Transportation and Communication Groups are scheduled for November 4th and November 13th, respectively. The Illumination Group is arranging its first meeting for January 7, 1930. The general details of the November 4th and 13th meetings, which will be held in the Engineering Societies Building, 33 West 39th St., New York, N. Y., follow:

*Transportation Group:* Meeting Monday, November 4, 1929 at 7:30 p. m., Room 1, 5th Floor, Engineering Societies Building. Subject—*How the Electric Railways are Meeting the Demand for Modern Transportation.* Speakers: Guy C. Hecker, General Secretary, A. E. R. A. and B. O. Austin, Control Engineer, Westinghouse Elec. & Mfg. Co. The speakers will outline the many technical developments of interest to engineers that have occurred recently.

*Communication Group:* Meeting Wednesday, November 13, 1929 at 7:30 p. m., Room 2, 5th Floor, Engineering Societies Building. Subject—*Materials of Communication.* Speakers: W. W. Brown, General Electric Co. on *Micalex. Its properties and Application to Radio Equipment.* I. R. Smith, Westinghouse Elec. & Mfg. Co. on *Copper Oxide. Its Use and Performance in Rectifiers.* W. Fondiller, Bell Telephone Laboratories on *Developments in Communication Materials.* The work done on insulating materials and metals, including duralumin, permalloy, brasses and bronzes. D. Levinger, Western Electric Co. on *Manufacturing Problems in Communication Materials.* Problems in introducing some of the newer materials into manufacture.

There will be open discussion at all group meetings, which will all be scheduled for 7:30 p. m. sharp with adjournment at 9:30 to enable the commuting members to get early trains.

## FUTURE SECTION MEETINGS

### Akron

November 8, 1929 at Canton. *Heavy Duty Mercury Arc Rectifiers*, by O. K. Marti, Chief Engineer, American Brown Boveri Electric Corporation.

December 31, 1929. *Railway Electrification*, by J. V. B. Duer, Electrical Engineer, Pennsylvania Railroad Company.

### Cleveland

November 21, 1929. Subject: *Social and Economic Results of Power and Machinery.* Speaker: C. M. Ripley, General Electric Co.

December 12, 1929. Subject: *Anti-Aircraft Artillery.* Speaker: Major C. M. Barnes, Ordnance Dept., United States Army.

### Detroit-Ann Arbor

November 12, 1929. Hayes Hotel, Jackson, Michigan. Subject: *Power System Planning.* Speaker: L. W. W. Morrow, Editor, *Electrical World*, New York.

December 10, 1929. The Detroit Edison Auditorium. Joint meeting with the Detroit Engineering Society. Subject: *Power House Design.* Speaker: Alex Dow, President of the Detroit Edison Co. Inspection trip through the New Delray Power House in the afternoon.

### Lynn

November 6, 1929. Technical Lecture by L. A. Hawkins, Executive Engineer of Research Laboratory, General Electric Co. Subject: "Today's Science, Tomorrow's Engineering."

November 20, 1929. Popular Lecture "With Allenby in Palestine and Lawrence in Arabia" by the noted lecturer Lowell Thomas. Ladies invited.

December 4, 1929. Technical Lecture by H. D. Brown (*Mercury Arc Rectifiers*).

### Pittsburgh

November 19, 1929. *What's Coming in Aviation*, W. B. Stout, Stout Metal Airplane Company, Division Ford Motor Company.

December 10, 1929. *Latest Developments in Supervisory Control*, R. J. Wensley, Westinghouse Electric & Mfg. Company, Mansfield, Ohio.

## IOWA SECTION ORGANIZED

At a meeting held on June 25, 1929, the Board of Directors authorized the organization of the Iowa Section. C. L. Sampson, Engineer of Transmission, Protection, and Foreign Wire Relations of the Northwestern Bell Telephone Company, Des Moines, Iowa, was elected Chairman and Professor J. K. McNeely, Iowa State College, Ames, Iowa, was chosen as Secretary.

The Iowa Section includes as its territory the entire state of Iowa.

## MEETING OF EXECUTIVE COMMITTEE OF MIDDLE EASTERN DISTRICT

A meeting of the Executive Committee of the Middle Eastern District, No. 2, held at the Keystone Athletic Club, Pittsburgh, Pa., on October 7, was attended by a large majority of the members of the Committee, and ten of the twelve Sections in the District were represented.

After the completion of the business before the meeting, there was an extended discussion of Section activities and methods by which they may be made more effective. Some of the more important topics were; the desirability of affording to as many members as possible opportunities for participating in the activities; use of cards to keep records of attendance at meetings; developing better speaking ability among the members; methods of making special appeal to enrolled Students of the Institute; stimulation of discussion; policies regarding local membership; meetings of certain technical groups within a Section; the types of social meetings which are most helpful; civic affairs; and publicity.

## PAST SECTION MEETINGS

**Boston**

Meeting of Executive Board. Election of Membership, Program and Entertainment Committee Chairmen. Voted to hold the regular monthly meetings on the first Tuesday of each month. The Secretary announced the plans for the October meeting, an inspection trip of the Boston Harbor on the City Steamship, Saturday afternoon, Oct. 5. Discussion of membership policy for the coming year. Approval of tentative budget for the year. September 19.

**Chicago**

Joint meeting with Western Society of Engineers held during celebration of Light's Golden Jubilee. L. A. Ferguson, Vice-President, Commonwealth Edison Co., read his speech at the commemoration of the 50th anniversary of the laying of the Atlantic cable made in N. Y. twenty years ago. Speech by W. L. Abbott, Chief Operating Engineer, Commonwealth Edison Co. on the old days in Chicago. The meeting was preceded by a dinner. September 23. Attendance 385.

**Cincinnati**

Minutes of annual meeting and Treasurer's report read and approved. Professor A. M. Wilson, head of the Department of Electrical Engineering at the University of Cincinnati, gave a brief analysis of color projection and color filters, with demonstrations. September 17. Attendance 76.

**Denver**

"The Quest of the Unknown," by Professor Harold B. Smith, President of the Institute, illustrated with lantern slides. A dinner preceded the meeting. September 11. Attendance 46.

Talk by F. C. Hanker, Manager Central Station Engineering, Westinghouse E. & M. Co., "Recent Studies in Generation and Distribution of Power." Talk was illustrated and discussed by Professor W. C. DuVall, Counselor of the University of Colorado Branch. The meeting was preceded by a dinner. October 4. Attendance 47.

**Detroit-Ann Arbor**

Chairman L. F. Hicknell reported on the Executive Committee meeting of the Great Lakes District (No. 5) held in Chicago. J. J. Shoemaker, Chairman of the Meetings and Papers Committee, presented the complete program of the 1929-1930 meetings. Talk by John T. Millen, Director of the Detroit Zoological Park, on the subject, "Wild Animal Experiences." Annual dinner meeting at the Lee Plaza Hotel. September 17. Attendance 91.

**Erie**

Discussion of proposed amendments to Erie Section Constitution. Talk by H. M. Towne, Engineer in charge of Design and Development of Lightning Arresters for General Elec. Co. at Pittsfield, Mass., on "Lightning Problems." Dinner preceded the meeting. September 24. Attendance 60.

**Houston**

Hezzie Clark, Humble Pipe Line Co., gave a talk on electrification in the petroleum industry. Discussion followed and M. E. Montrose of General Elec. Co. presented figures in reference to the cost of using electricity instead of steam for the drilling of wells. Also talks by J. H. Dubendorf, Shell Petroleum Co., on electrification of oil refineries and D. A. Keirn of the Westinghouse Co. on the photoelectric cell. Discussion followed. September 26. Attendance 63.

**Iowa**

First meeting of this newly authorized Section of the Institute. Election of officers as follows: C. L. Sampson, Chairman. J. K. McNeely, Secretary-Treasurer, John M. Drabelle and G. T. Shoemaker, members of the Executive Committee. Address by President Harold B. Smith on "The Quest of the Unknown." September 13. Attendance 44.

**Kansas City**

"The Quest of the Unknown" delivered by Professor Harold B. Smith, President of the A. I. E. E. An informal dinner preceded the meeting at which the executive committees and presiding officers of each of the technical societies as well as the leading men from the Westinghouse, General Electric, Western Electric, Allis-Chalmers, the large utilities of the Middle West, and the Deans of the Engineering Schools in the vicinity, were present. September 16. Attendance 126.

**Lehigh Valley**

Annual meeting. At 10:00 a. m. inspection trip through No. 5 Breaker of the Jeddo-Highland Coal Co. 12:00 noon

Luncheon at the Altamont. 2:00 p. m. business meeting, election of officers. Paper by A. O. Austin of the Ohio Brass Co. on *Power Transmission and High Voltage Insulators*. Moving pictures at the Service Depot on "Formation of Coal During the Ages Past." 6:30 p. m. dinner at Hotel Altamont. Address by Stephen Q. Hayes of the Westinghouse Company on "Electrifying South America." June 1. Attendance 101.

**Los Angeles**

First meeting of fiscal year. New officers and members of the Executive Committee were introduced. H. L. Caldwell gave a report of the Swampscott convention. E. R. Northmore gave a report of the Pacific Coast Convention. Past-President R. F. Schuchardt, H. B. Gear, Asst. to the Vice-President, Commonwealth Edison Co. and O. C. Merrill, Chairman of the American Committee of the World Power Conference, who were passing through Los Angeles enroute to the World Engineering Congress at Tokio, Japan, gave a few remarks. Professor R. W. Sorensen, California Institute of Technology talked on the subject "A Western Engineer's Experience in the East." Professor Sorensen also briefly discussed the paper which he presented before the meeting of the Society for the Promotion of Engineering Education, outlining certain phases of the work at the California Institute of Technology. The meeting was preceded by a dinner at the Engineers' Club. October 8. Attendance 78.

**Louisville**

General Section matters discussed. W. H. Stilwell, Signal Engineer of the Louisville and Nashville Railroad Co., talked on "Centralized Traffic Control Developed by the General Railway Signal Co." Four reels of motion pictures taken of the Centralized Traffic Control installed on the Ohio Central Lines were shown. October 8. Attendance 60.

**Madison**

Proposed new By-laws of Section distributed among members. Professor Edward Bennett spoke on "The Inadequacy of the Public Utilities Law of Wisconsin." Dinner at the Memorial Union preceded the meeting. October 9. Attendance 44.

**Mexico**

Election of officers as follows: G. Solis Payan, Chairman; E. Leonarz, Jr., Secretary; E. F. Lopez, Treasurer. Executive Committee: F. Aubert, H. Olmedo, G. Obregon, B. M. Antipovitch.

**Minnesota**

First meeting of the season. John Lapham of the North Central Electric Association spoke on "Edison and Light's Golden Jubilee." Several slides were shown. Two moving pictures entitled, "The Benefactor" and "The Light of a Race" were presented. October 3. Attendance 45.

**Pittsburgh**

Inspection trip to the Bell Telephone Plant. Refreshments were served at the conclusion of the inspection. September 18. Attendance 275.

**Portland**

"The Quest of the Unknown," by Professor Harold B. Smith, President of the Institute, illustrated with lantern slides. The meeting was preceded by a dinner. At the conclusion of the evening meeting a buffet lunch was served. August 26. Attendance 95.

Executive business: Chairman H. H. Cake announced that the Executive Committee of the Section made a formal request through Vice-President G. E. Quinan of District No. 9 that the date of holding the 1930 Pacific Coast Convention be Sept. 2-5, inclusive. H. H. Schoolfield was selected as general convention chairman. Mr. Schoolfield reported briefly on the success of the Santa Monica Convention. I. H. Summers of the Central Station Engg. Dept. of the General Electric Co., Schenectady, N. Y. gave a resumé of a paper presented at the Pacific Coast Convention entitled, *System Stability*. Buffet lunch followed the meeting. September 24. Attendance 69.

**Rochester**

Dr. Phillips Thomas and Dr. C. K. Lee, both of the Westinghouse E. & M. Co., East Pittsburgh, Pa., spoke on "Recent Developments in the Research Departments of the Westinghouse Elec. & Mfg. Co." Meeting was held jointly with the Rochester Engineering Society. The meeting was preceded by a dinner given to welcome the speakers. October 4. Attendance 283.



**St. Louis**

Past Chairman C. P. Potter called the 212th meeting of the Section to order and gave a report covering his term of office. G. H. Quermann, Chairman for the year 1929-1930, made a few remarks covering his policies and also his attendance at the Summer Convention. Chairmen of the Standing Committees were announced. Professor Harold B. Smith, President of the Institute then gave an address on "The Quest of the Unknown." Attendance prizes were awarded. Sandwiches and coffee were served. September 17. Attendance 85.

**San Francisco**

"The Quest of the Unknown," delivered by President Harold B. Smith. An informal dinner preceded this meeting. Plans for the September meeting were announced. August 29. Attendance 145.

**Seattle**

Annual banquet. Reading of the minutes was postponed. J. Hellenthal, Secretary District No. 9 gave a short report of the Pacific Coast Convention at Santa Monica, Calif. Sept. 17. Attendance 46.

**Sharon**

F. D. Newbury and R. S. Marthens, both of the Westinghouse Elec. & Mfg. Co., East Pittsburgh, Pa., spoke on the subject, "The Problem of Designing Fabricated D. C. Motors and

Generators." Two motion picture reels preceded the talks. October 1. Attendance 124.

**Springfield**

General Section matters reviewed. Hans Passburg, Engineer of the United Electric Light Co., Springfield, Mass., spoke on the subject "Muscle Shoals." Mr. Passburg went into detail regarding the Muscle Shoals development and illustrated his talk with many lantern slides. September 9. Attendance 23.

**Toledo**

The minutes of the previous meeting were read and approved. The Program Committee reported regarding its activities. Mr. Paul Gravelle, Results Engineer of the Toledo Edison Co., spoke on "Modern Steam Plant Economies." A large drawing of the Acme Station was used to trace out the heat cycles in the turbines, boilers and auxiliaries. Discussion followed. September 24. Attendance 28.

**Toronto**

Annual Get-Together meeting. Review of general Section matters after which the remainder of the evening was of a social character with music, entertainment, and refreshments. September 27. Attendance 73.

**Utah**

"The Quest of the Unknown," by Professor Harold B. Smith, President of the A. I. E. E. September 9. Attendance 44.

## A. I. E. E. Student Activities

**A STUDENT BRANCH AT UNIVERSITY OF NEW MEXICO**

At its meeting held on May 22, 1929, the Board of Directors authorized the formation of a Student Branch at the University of New Mexico, Albuquerque, New Mexico. The Branch has organized and selected the officers named below:

F. A. Stortz, Jr., Chairman  
R. D. Jenkins, Vice-Chairman  
W. Irving Abbott, Secretary-Treasurer

Professor F. M. Denton has been appointed Counselor of the Branch.

**STUDENT BRANCH AT SOUTHERN METHODIST UNIVERSITY**

At its meeting held on May 22, 1929, the Board of Directors authorized the formation of a Student Branch at the Southern Methodist University, Dallas, Texas. The branch has organized and selected the officers named below:

Willard Cox, Chairman  
J. V. Melton, Vice-Chairman  
Porter Lindsley, Jr., Secretary-Treasurer

Dean E. H. Flath has been appointed Counselor of the Branch.

**PAST BRANCH MEETINGS****Alabama Polytechnic Institute**

First meeting of the season. Professor Hill, Counselor of the Branch, discussed the plans for the convention to be held in November. Several announcements of local interest were made. September 26. Attendance 20.

**University of Arizona**

Professor J. C. Clark, Counselor and Barney Shehane, Chairman of the Branch, gave reports of the Pacific Coast Convention. September 20. Attendance 10.

Barney Shehane and Otto Mangum presented papers on Summer experiences with the New State Electric Co. and the Miami Copper Co. September 27. Attendance 12.

**Bucknell University**

E. C. Metcalf read a paper on *Automatic Railway Substations* which was illustrated. Discussion followed. October 7. Attendance 22.

**University of California**

As this meeting was in the form of a banquet there was no executive business discussed. Three papers were presented:

*The Engineer of Tomorrow*, by V. T. Johnson, Student; *Why I Took Up Engineering*, by Norman H. Adams, Student; *Design of Automatic Substations*, by R. B. Kellogg, Pacific Gas & Electric Co. A brief description of the Pacific Coast Convention was given by F. R. Norton. September 13. Attendance 70.

Executive Business. Two papers presented: *Descriptions of Sound Motion Pictures*, by Frank R. Norton; *Description of an Electrical System of Television*, by H. R. Lubeke, Television Engineer. Refreshments served. September 25. Attendance 45.

**Carnegie Institute of Technology**

Professors W. R. Work and B. C. Dennison spoke on the benefits of Student enrolment and also membership in the National organization. October 1. Attendance 64.

**Clarkson College**

Reports of various committees presented. Professor A. R. Powers, Counselor of the Branch, gave a talk on the plans for the coming season. Coffee and cake served after the meeting. October 8. Attendance 20.

**Clemson Agricultural College**

Two papers presented as follows: *The Making of an Engineer*, by G. W. Sackman, Student; and *Psychology of Getting On*, by W. C. Snyder, Student. Luncheon served after meeting. October 3. Attendance 38.

**University of Denver**

A discussion took place as to the best method of obtaining the interest of non-members. Plans for the coming membership campaign were discussed. September 30. Attendance 7.

**University of Detroit**

Talk on "Things We Don't Think About," by Raymond J. Abele. Two reels of moving pictures presented on "Hydro-Electric Power Production in the New South." Short talks by new officers and some of the faculty members. October 9. Attendance 32.

Election of officers: Wm. F. Haldeman, Chairman; R. J. Abele, Vice-Chairman; W. R. Moyers, Secretary; R. L. Sailer, Treasurer. September 10.

**University of Idaho**

The meeting was held for the purpose of organizing the year's work. Talk by Professor J. H. Johnson, Counselor of the Branch, on the benefits of the Institute. October 1. Attendance 34.



**Lafayette College**

Election of officers as follows: Earl C. Albert, Chairman; Murray G. Clay, Vice-Chairman; William F. Titus, Secretary-Treasurer. September 29.

**Lewis Institute**

Election of officers as follows: G. W. Malstrom, Chairman; E. R. Borden, Secretary. October 2. Attendance 13.

**Mississippi A. & M. College**

Election of officers. Professor L. L. Patterson, Counselor, gave a talk on the advantage of Student membership. October 3. Attendance 21.

**Montana State College**

Papers presented by Messrs. Murray Davidson and Eitaro Etow. Discussion followed regarding the electrical show which was to be held on October 21. October 9. Attendance 56.

**University of Nebraska**

Student talks given by R. R. Dysart, F. V. Peterson and B. R. Robinson on their experiences during the past summer. Chairman Schneider made a few explanatory remarks regarding the benefits of Student enrolment. October 9. Attendance 48.

**The Newark College of Engineering**

Committee members appointed. Three propositions were explained concerning a proposed change in the By-laws for the transfer from Student to Associate membership. October 7. Attendance 31.

**The College of the City of New York**

Election of officers as follows: Robert Fassnacht, Chairman; Frank J. Wodicka, Secretary. September 26. Attendance 15.

**University of North Dakota**

Talk by Professor H. F. Rice, Counselor, on the benefits of the A. I. E. E. A still film on "Train Radio" was shown. Doughnuts and cider served. October 3. Attendance 19.

**University of Notre Dame**

Professor J. A. Caparo, Counselor, reviewed the past success of the Branch and urged future publicity. Smokes and refreshments served. September 23. Attendance 60.

**Ohio Northern University**

President McGahan welcomed new Students. Professor Campbell, Counselor, discussed the value of membership in the A. I. E. E. Dean Needy, Head of the Engg. Dept. gave illustrations explaining the great engineering age we are living in. Smokes and refreshments served. September 26. Attendance 57.

**Oklahoma A. & M. College**

Professor Naeter, Head of the Elec. Engg. Dept., presented a paper on *The Use of the Pendulum in the Measurement of Electrical Energy*. September 22. Attendance 18.

**University of Oklahoma**

Professor F. G. Tappan, Counselor, gave a discussion on Light's Golden Jubilee and the banquet which will be held on October 21. This Branch is providing several attractions for the banquet, the most notable being the so-called "talking electric sign." This sign was designed and built by the Branch. Discussion followed concerning the advantages of Institute membership and the relation of the University of Oklahoma Branch to the Oklahoma City Section. Refreshments served. October 10. Attendance 50.

**University of Pittsburgh**

Talk by Professor H. E. Dyeche, Counselor. October 26. Attendance 42.

Talk by E. S. McClelland on "History of the Westinghouse Elec. & Mfg. Co." October 3. Attendance 81.

**Rensselaer Polytechnic Institute**

Committee appointments. Several Students gave talks on their work during the past summer. October 8. Attendance 75.

**Rhode Island State College**

Talks as follows: "History of Radio," by George E. Arnold, Student. "Recent Developments," by Charles Pagella, Student. October 9. Attendance 17.

**Rose Polytechnic Institute**

Election of officers as follows: D. E. Henderson, Chairman; J. H. Corp, Secretary; C. A. Lotze and E. A. Johnson members Program Committee. September 27. Attendance 15.

J. H. Corp reviewed the By-laws relating to Student enrolment. D. E. Henderson gave a talk on the meeting to be held in Chicago in December. Professor C. C. Knipmeyer spoke about the Branch and gave suggestions as to how meetings should be conducted in the future. October 2. Attendance 34.

**University of South Carolina**

First meeting of the season. Voted to hold three meetings each month. Election of Executive Committee members. October 4. Attendance 14.

Three papers presented by students, *Short Transmission Lines*, by J. D. Bell; *Sketch on Aeronautics*, by H. W. Farnam; *Development of Communication*, by C. A. Riley. October 11. Attendance 26.

**South Dakota School of Mines**

Professor J. O. Kammerman, Counselor, gave a talk on the activities of the Institute. Professor E. E. Clark spoke about his summer travels. October 3. Attendance 28.

**University of Southern California**

N. B. Hinson, Chairman of the Los Angeles Section, spoke regarding the By-laws concerning Student enrolment. He also spoke on the industrial development of Southern California. September 25. Attendance 50.

**Syracuse University**

Election of officers as follows: D. A. MacGregor, Chairman; M. J. Wright, Secretary. October 9. Attendance 10.

**University of Tennessee**

Discussion of plans for future meetings. October 11. Attendance 16.

**Texas A. & M. College**

Discussion of general Branch activities. September 27. Attendance 34.

**University of Utah**

Plans for the year were discussed. Counselor J. H. Hamilton spoke on the advantages of being an enrolled Student. A film showing the building of the Panama Canal was shown. October 8. Attendance 20.

**Virginia Military Institute**

Committee appointed to draw up new set of By-laws. Papers presented by students: *Application of Electricity to Modern Transportation*, by J. T. Brodnax; *The Benefits Derived from the A. I. E. E.*, by H. B. Blackwood; *Why Brookland Adopted the Low Voltage A. C. Network*, by A. F. Black. September 27. Attendance 43.

**Virginia Polytechnic Institute**

Appointment of Executive Committee. Discussion of coming student convention in Charlottesville. Talk on Branch activities by Professor Cladius Lee, Counselor. October 2. Attendance 22.

**West Virginia University**

Election of officers as follows: C. E. Moyers, President, G. H. Hollis, Secretary; E. M. Hansford, Treasurer. September 23. Attendance 38.

Student papers presented as follows: *The Diesel Aircraft Motor*, by W. S. McDaniels; *Arc Welding in the Shops of the Northern Pacific Ry. Co.*, by A. F. Fervier; *Recent Developments in Telephone Construction Practises*, by G. H. Hollis; *The Reason for and Meaning of S. A. E. Viscosity Number*, by W. H. Rose; *Hydrogen—The Successor to Air*, by E. M. Hansford; *The Roof Steam Accumulator*, by G. S. Garrett; *Economics of Distribution Systems*, by G. C. Barnes. September 30. Attendance 38.

A film on Electrical Measuring Instruments was presented. October 7. Attendance 40.

# Engineering Societies Library

The Library is a cooperative activity of the American Institute of Electrical Engineers, the American Society of Civil Engineers, the American Institute of Mining and Metallurgical Engineers and the American Society of Mechanical Engineers. It is administered for these Founder Societies by the United Engineering Society, as a public reference library of engineering and the allied sciences. It contains 150,000 volumes and pamphlets and receives currently most of the important periodicals in its field. It is housed in the Engineering Societies Building, 29 West Thirty-ninth St., New York.

In order to place the resources of the Library at the disposal of those unable to visit it in person, the Library is prepared to furnish lists of references to engineering subjects, copies or translations of articles, and similar assistance. Charges sufficient to cover the cost of this work are made.

The Library maintains a collection of modern technical books which may be rented by members residing in North America. A rental of five cents a day, plus transportation, is charged.

The Director of the Library will gladly give information concerning charges for the various kinds of service to those interested. In asking for information, letters should be made as definite as possible, so that the investigator may understand clearly what is desired.

The library is open from 9 a. m. to 10 p. m. on all week days except holidays throughout the year except during July and August when the hours are 9 a. m. to 5 p. m.

## BOOK NOTICES, SEPTEMBER 1-30, 1929

Unless otherwise specified, books in this list have been presented by the publishers. The Societies do not assume responsibility for any statement made; these are taken from the preface or the text of the book.

All books listed may be consulted in the Engineering Societies Library.

### ANALYSE DILATOMETRIQUE DES MATERIAUX.

By Pierre Chevenard. Paris, Dunod, 1929. 90 pp., illus., diags., 11 x 9 in., paper. 25,50 fr.

Professor Chevenard discusses the value of the dilatometric method in the study of thermal changes in metals, describes the apparatus and methods that he has evolved at the Imphy steel-works, and gives some of the interesting results that he has obtained in studying the quenching of aluminum bronze, the graphitization of cast iron, the firing of refractories, and other industrial processes.

### APPLIED GEOPHYSICS IN THE SEARCH FOR MINERALS.

By A. S. Eve and D. A. Keys. Cambridge, Eng., University Press; N. Y., Macmillan Co., 1929. 253 pp., illus., diags., 9 x 6 in., cloth. \$4.50.

A review of the various methods—magnetic, electrical, gravitational, seismic, etc.—that have been proposed for geological exploration and prospecting. The authors discuss both the theoretical and practical sides of the schemes of exploration now available, in the light of varied personal experience in the field.

### BARRAGES CONJUGUES ET BASSINS DE COMPENSATION.

By Georges Laporte. Paris, Dunod, 1929. 116 pp., diags., 10 x 7 in., paper. 35,50 fr.

Discusses the effect upon each other of two neighboring power developments upon the same river. The author treats of the equipment appropriate in these circumstances, the rules for using the water that become necessary, and the reserves and compensating reservoirs required to maintain a flow in the river which will satisfy the owners of its banks. The discussion is illustrated by concrete examples taken from the author's practical experience.

### DIE DAUERPRUFUNG DER WERKSTOFFE.

By O. Föppl, E. Becker and G. v. Heydekampf. Berlin, Julius Springer, 1929. 124 pp., illus., diags., 10 x 7 in., paper. 9,50 r. m.

A discussion of apparatus and methods for determining the fatigue of metals subjected to vibration. A variety of testing machines is described, their uses explained and methods of testing given, together with some results.

### FESTSCHRIFT PROF. DR. A. STODOLA.

Edited by E. Honegger. Zürich u. Lpz., Orell Füsseli Verlag, 1929. 602 pp., illus., diags., port., 10 x 7 in., paper. 24.-r. m.

Professor Stodola's friends and former pupils have commemorated his seventieth birthday and approaching retirement by issuing this handsome volume. It contains, in addition to a biographical sketch of Stodola and a bibliography of his writings, sixty-three papers by eminent engineers and scientists, upon various problems of engineering and physics, particularly of the steam turbine. The list of contributors is an imposing one.

### FIELD ENGINEERING.

By William H. Searles. 20th edition revised and enlarged by H. C. Ives. N. Y., John Wiley & Sons, 1929. 2 v. in 1, diags., tables, 7 x 4 in., fabrikoid. \$4.00.

The first volume of the new edition of this well-known manual differs from the last edition chiefly by the addition of a concise chapter on highway curves, which makes the book useful to highway engineers, as well as railroad engineers. The second volume has many changes and additions. Seven-place tables of the natural trigonometric functions replace the former five-figure tables. Tables of natural secants and cosecants have been added. The table of trigonometric formulas has been rearranged and extended.

### HANDBOOK OF FORMULAS AND TABLES FOR ENGINEERS.

By Clarence A. Peirce, Walter B. Carver and Charles E. O'Rourke. 3rd edition. N. Y., McGraw-Hill Book Co., 1929. 228 pp., 8 x 5 in., fabrikoid. \$2.50.

The aim of the compilers has been to produce a small book, of really convenient size for the pocket, containing the most useful tables and formulas. In this edition, some of the more essential civil engineering data have been added, enlarging the field of usefulness of the book. Several sections have also been enlarged and revised.

HYDRAULIC LABORATORY PRACTICE; trans. revised to 1929, of Die Wasserbaulaboratorien Europas, by V. D. I. Edited by John R. Freeman. N. Y., American Society of Mechanical Engineers, 1929. 868 pp., illus., 12 x 9 in., cloth. \$10.00.

Some years ago Dr. John R. Freeman urged the German Society of Engineers to publish a volume describing the hydraulic laboratories of Europe and the principal research work of each of them. The result of this suggestion was "Die Wasserbaulaboratorien Europas," which appeared in 1926, and which now appears in English under Dr. Freeman's editorship.

The English edition will be of interest to every hydraulic engineer. To the professor of hydraulics it affords descriptions of the important laboratories of the world, of their equipment, organization, management, and of the work which they have carried out. The engineer in practice will find many helpful data in the text and in the numerous bibliographies. No such general survey of experimental activities in this science has hitherto existed.

The translation contains much more material than the original. Appendixes describing other European laboratories, and some American ones, have been added. Biographies of the directors of the various laboratories have been inserted, as well as several monographs on important general subjects.

### MOTOR VEHICLES AND TRACTORS.

By P. M. Heldt. Nyack, N. Y., P. M. Heldt, 1929. 678 pp., illus., diags., tables, 9 x 6 in., cloth. \$8.00.

A textbook on design, covering all the elements of the automobile and tractor except the engine and electrical equipment. The book is intended to replace the former second volume of the author's "Gasoline Automobile" and repeats some of that material, but is principally a new work. The book is suited for class or home study; uses only simple mathematics and has much practical information.

## RADIOTECHNIK, VI; Die Elektrischen Wellen.

By F. Kiebitz. Ber. u. Lpz., Walter de Gruyter & Co., 1929. 125 pp., diags., 6 x 4 in., cloth. 1,50 r. m.

A brief text on Herzian waves, especially the waves used in radio. Their characteristics, radiation and reception, diffusion and directing are discussed with a minimum of mathematics. A simple introduction to the subject for students and operators of radio telegraphy.

## RELAIS UND SCHUTZSCHALTUNGEN IN ELEKTRISCHEN KRAFTWERKEN UND NETZEN.

Edited by Reinhold Rüdenberg. Berlin, Julius Springer, 1929. 281 pp., illus., diags., tables, 9 x 6 in., bound. 25,50 r. m.

Contains a course of lectures upon protective relays given at Berlin during 1927 and 1928 by seven prominent engineers, under the auspices of the Electrical Engineering Society and the Technical High School. Discusses the importance of relays as safety devices, the failures that occur in networks and the principles of protection; the basic principles of relay action and construction, current relay construction, use and testing, the protection of generating and transmission equipment, and bases for further developments.

## RENFORCEMENT DES SOUDURES, COUVRE-JOINTS DISCONTINUS SOUDES.

By E. Hoehn. Paris et Liège, Ch. Béranger, 1929. 103 pp., diags., tables, 9 x 6 in., paper. 20.-fr.

A study of the value of welded buttstraps as a reinforcement of welded joints in boilers and other pressure vessels. The results of tests are given and the distribution of stresses discussed. Data are given for use by designers.

## SIMPLIFICATION OF HIGHWAY TRAFFIC.

By William Phelps Eno. Saugatuck, Conn., Eno Foundation for Highway Traffic Regulation, Inc., 1929. 206 pp., illus., diags., 9 x 7 in., cloth. \$5.00; paper, \$3.00.

Mr. Eno has devoted his life to the study of highway traffic regulation. In the present book, which is to a certain extent a revision and rearrangement of material selected from his former books, he discusses particularly the selection and use of traffic guides, systems of regulation, methods of accelerating traffic and increasing safety. Many practical questions are handled on the basis of wide experience. Professor C. J. Tilden has prepared an appendix giving an account of Mr. Eno's activities and of the development of traffic regulation since they began.

## STEAM AND GAS ENGINEERING.

By Thomas E. Butterfield. N. Y., D. Van Nostrand Co., 1929. 481 pp., illus., diags., tables, 9 x 6 in., cloth. \$4.50.

An introductory text for engineers by the Professor of Heat Power Engineering at Lehigh University. The entire field of power production from steam and gas is covered, with emphasis upon the natural laws involved and upon the various kinds of apparatus used to apply them in practise. Several chapters are devoted to descriptions of engines, boilers, gas producers and other apparatus. Many problems are given.

## UBERTRAGUNGSTECHNIK.

By Rudolf Winzheimer. Mün. u. Ber., R. Oldenbourg, 1929. 233 pp., illus., diags., 9 x 6 in., cloth. 12.-r. m.

A text-book presenting the general principles of the electrical transmission of speech, either by telephone or radio, and intended for students of these subjects. The book first discusses the electrical and acoustical principles involved in telephony, the theory of telephone lines, amplifiers, networks and telephone cables. The specific variations of radio transmission are then discussed. A basic knowledge of electrical transmission theory is assumed.

## Engineering Societies Employment Service

*Under joint management of the national societies of Civil, Mining, Mechanical and Electrical Engineers cooperating with the Western Society of Engineers. The service is available only to their membership, and is maintained as a cooperative bureau by contribution from the societies and their individual members who are directly benefited.*

Offices:—31 West 39th St., New York, N. Y.,—W. Y. Brown, Manager.

1216 Engineering Bldg., 205 W. Wacker Drive, Chicago, Ill., A. K. Krauser, Manager.

57 Post St., San Francisco, Calif., N. D. Cook, Manager.

**MEN AVAILABLE.**—Brief announcements will be published without charge but will not be repeated except upon requests received after an interval of one month. Names and records will remain in the active files of the bureau for a period of three months and are renewable upon request. Notices for this Department should be addressed to **EMPLOYMENT SERVICE, 31 WEST 39th Street, New York City**, and should be received prior to the 15th day of the month.

**OPPORTUNITIES.**—A Bulletin of engineering positions available is published weekly and is available to members of the Societies concerned at a subscription of \$3 per quarter, or \$10 per annum, payable in advance. Positions not filled promptly as a result of publication in the Bulletin may be announced herein, as formerly.

**VOLUNTARY CONTRIBUTIONS.**—Members obtaining positions through the medium of this service are invited to cooperate with the Societies in the financing of the work by contributions made within thirty days after placement, on the basis of one and one-half per cent of the first year's salary: temporary positions (of one month or less) three per cent of total salary received. The income contributed by the members, together with the finances appropriated by the four societies named above will it is hoped, be sufficient not only to maintain, but to increase and extend the service.

**REPLIES TO ANNOUNCEMENTS.**—Replies to announcements published herein or in the Bulletin, should be addressed to the key number indicated in each case, with a two cent stamp attached for reforwarding, and forwarded to the Employment Service as above. Replies received by the bureau after the positions to which they refer have been filled will not be forwarded.

### POSITIONS OPEN

**ELECTRICAL ENGINEER**, Canadian, college graduate, 25-28. Power transmission line construction experience desirable. Work of general nature at Canadian plant of electrical manufacturer. May lead to sales engineering work. Apply by letter giving full information. X-9594.

**ELECTRICAL ENGINEER**, thoroughly familiar with the requirements of the paper mill industry. Must be able to design, layout, install and supervise entire electrical system, wiring, apparatus and equipment pertinent to construction and operation of modern paper mills. Apply by letter giving full information, such as age, technical training, previous experience, present salary, references, etc. Location, South. X-9625-CS.

**VACUUM TUBE ENGINEER**, familiar with tube measurement work, quality control of tubes,

and the tube side of circuit work. Apply by letter. Location, New Jersey. X-9671-C.

**LOUD SPEAKER ENGINEER**, capable of doing development work on speakers and making speaker performance measurements. Apply by letter only. Location, New Jersey. X-9672-C.

**ENGINEER**, with engineering and test experience in paper condenser work. Apply only by letter. Location, New Jersey. X-9673-C.

**SWITCHBOARD ENGINEER**, capable of laying out small switchboards for controlling battery charging motor generator sets, small alternators, etc. Man with two or three years' experience testing or designing preferred. Must be technical school or college graduate. Apply by letter stating training, experience, and salary desired. Location, New York State. X-9679-C.

**TRANSFORMER ENGINEER**, with two or three years' experience in testing or designing transformers. Must be technical school or

college graduate. Apply by letter stating training, experience, and salary desired. Location, New York State. X-9680-C.

**RECENT GRADUATE ELECTRICAL ENGINEER**, for research work. Apply by letter. Salary \$30 a week. Location, New England X-8464.

**ELECTRICAL ENGINEER**, preferably with postgraduate schooling in the electrical branches of physics and a few years' experience in industrial research or development, for development and research work with a growing firm in varied fields embracing control apparatus and vacuum-tube applications. Apply by letter. Location, New England. X-9387.

**ELECTRICAL ENGINEER**, experienced in the manufacture of vacuum tubes for radio work. Apply by letter. Location, New Jersey. X-9067.

**SALES ENGINEER**, 1927-1928, graduate in electrical engineering, for commercial side of a

manufacturing organization; traveling sales work. Opportunity. Apply by letter. Location, Middle West. X-7062-C.

RECENT GRADUATE, electrical engineer, willing to locate in eastern territory near Philadelphia, and to enter traveling sales work, handling a-c. motors and fans. Must have clean-cut personality. Apply by letter. Headquarters, Middle West. X-3172-C.

#### MEN AVAILABLE

ELECTRICAL ENGINEER, 34, single; 11 years' experience in development, application, and testing of railway and industrial control equipments including five years heavy traction work. Available upon one month's notice. Location, immaterial. C-6506.

ELECTRICAL ENGINEER, 28, single, B. S., 1929, graduated with high honors, desires connection with manufacturer of electrical machinery or utility company. Preferably production, management, or design. Opportunity for advancement considered most important. Two years' test floor experience. Location, Eastern States or abroad. Excellent knowledge of Russian. Available on short notice. C-6526.

ELECTRICAL ENGINEER, with seven years' experience in the electrical field including: telephone work, developments in instruments and measuring methods; also meter, protection and apparatus testing in the field. Desires position here or abroad. Available January, 1930. C-3911.

SALES ENGINEER, 28, single, M. I. T., 1925, B. S. in E. E. degree. One year electric locomotive and transmission design. One year assembly and test work with large electrical company. Two years industrial and utility sales engineer. Desires sales engineer position requiring technical background with a concern affording good opportunity. Located at present in New York. C-1415.

ELECTRICAL ENGINEER, 30, single, college graduate, London. General Electric Co. and British Thomson Houston Co. Test courses. Seven years' experience in Australia and the United States of America, on hydroelectric and steam power plants, transmission lines, and substations. Location optional. Short notice. References. C-6518.

POWER OR MECHANICAL SUPERINTENDENT, 41, experienced steam, gas, air, hydraulic, electric power plant construction and

operation; institutional, industrial, and building mechanical design and maintenance. Now employed Middle Northwest. Desires good industrial connection, 30 days' notice. Specialty, straightening out, revamping and coordinating power services. C-987.

ELECTRICAL ENGINEER, single, 38, desires position in engineering or sales department. Seven years' experience with one small company manufacturing standard and special rotating machinery, d-c. and a-c. ratings up to 500 kw. or hp. Was successively in charge of testing, service, engineering, correspondence and sales. Location, immaterial. C-6543.

ELECTRICAL ENGINEER, twelve years' experience electrical design of power houses, substations, transmission lines, industrial plants, in all branches and details of work. Also eight years' other electrical, mechanical engineering experience including power plant testing, machinery design. E. E. degree. Age 43, location, vicinity New York City. Available at once. C-6542.

ELECTRICAL ENGINEER, university graduate, seven years' experience on transmission and distribution planning, design of transmission lines and substations, construction, operation. Utility cadet course. Speaks foreign languages. Desires position with utility, export firm or consulting engineers. Now employed. Europe or South America considered. B-8043.

GRADUATE ELECTRICAL ENGINEER, E. E., wide experience in construction, operation, maintenance, generating, transmission at 100,000 volts, underground transmission, 6600 and 22,000 volts, outdoor and indoor substations, mill installations. Has sales and managing experience, Latin, America, and India. Speaks English, Spanish, German, French, and Hindustani. Location, immaterial. Now employed. C-4222.

ELECTRICAL ENGINEER, 27, married, five years' experience in powerhouse and substation construction, operating, general maintenance, specializing in relay and meter work. Desires position abroad. C-6548.

HYDROELECTRIC ENGINEER, 37, estimating engineer for the Big Creek Project, desires connection for field work on budgets, estimates, appraisals or cost accounting. Has the basic construction experience in generation and distribution necessary for such analyses. B. S. in

E. E. from the California Institute of Technology. C-6498.

ENGINEER, ELECTRICAL-MECHANICAL, age, 41; married, speaks Portuguese and Spanish; with 25 years' experience on construction and maintenance of steam, hydroelectric, and electrical plants, seeks a situation on the construction, or maintenance of a power station, mine or industrial plant abroad. C-6553.

JUNIOR ELECTRICAL ENGINEERING GRADUATE, 1928. Desires position with private professional concern doing consulting and construction engineering. Four years' practical experience, energetic, ambitious, and willing to work hard. C-6446.

ELECTRICAL ENGINEERING GRADUATE with two years' experience in construction and maintenance of electric locomotives and multiple-unit cars, both a-c. and d-c. Desires position in electric railway or subway construction or operation. C-6513.

GRADUATE ELECTRICAL ENGINEER, 28, married, nine years' experience engineering, construction and operation of underground and overhead transmission and distribution systems. Last three years as division engineer for large metropolitan utility. Desires position in engineering or construction division of a large holding company or industry. Location immaterial. B-9408.

PERSONNEL IMPROVEMENT SYSTEM, new and original application of natural laws develop, multiply and indicate the instinctive efforts of ambitious employees and likewise minimize negative influence. This system is available to organization heads and will be developed to fit your specific application without any interference, by an engineer of wide experience. C-1867.

ELECTRICAL ENGINEER, age 29, five years' varied experience: test floor, application, design, construction and maintenance. Now in charge of electrical department for mining company. Desires position as assistant plant engineer or assistant electrical engineer with large industrial plant. Good personality and very well recommended. B-9001.

ELECTRICAL ENGINEER, 33, married, now located Western New York, seven years sales engineering, two years instructor, two years distribution and central station drafting. Able to design and sell induction motors. Available on 30-day notice. B-3853.

## MEMBERSHIP—Applications, Elections, Transfers, Etc.

### APPLICATIONS FOR ELECTION

Applications have been received by the Secretary from the following candidates for election to membership in the Institute. Unless otherwise indicated, the applicant has applied for admission as an Associate. If the applicant has applied for direct admission to a grade higher than Associate, the grade follows immediately after the name. Any member objecting to the election of any of these candidates should so inform the Secretary before November 30, 1929.

Andersson, A., General Electric Co., Pittsfield, Mass.

Ando, K., Texas Power & Light Co., Dallas, Tex.

Barcus, E. D., Southern California Telephone Co., Los Angeles, Calif.

Barter, P. A., Buchans Mining Co., Ltd., Buchans, Newfoundland

Bathe, C. E., Oklahoma Gas & Electric Co., Oklahoma City, Okla.

Beck, L. E., Purdue University, W. Lafayette, Ind.

Brown, C. J., Samson Electric Co., New York, N. Y.

Buitrago, E. J., Jr., Westinghouse Elec. & Mfg. Co., Sharon, Pa.

Burkholder, J. C., (Member), Canadian National Telegraphs, Toronto, Ont., Can.

Carey, P. C., (Member), Runyon & Carey, Newark, N. J.

Carter, H. B., General Electric Co., Fort Wayne, Ind.

Chase, D. D., General Electric Co., Schenectady, N. Y.

Coldwell, K. I., Texas Creosoting Co., Orange, Tex.

Creedy, F., (Member), Lehigh University, Bethlehem, Pa.

Danner, R. F., Oklahoma Gas & Electric Co., Oklahoma City, Okla.

Davis, C., Michigan Bell Telephone Co., Detroit, Mich.

Davis, F. F., International Tel. & Tel. Co., New York, N. Y.

Driscoll, J. E., Western Mass. Co., Springfield, Mass.

Eppard, C. M., Union Electric Light & Power Co., St. Louis, Mo.

Falkenberg, R. T., Westinghouse Elec. & Mfg. Co., Houston, Tex.

Ferris, F. S., 649 S. Main St., Akron, Ohio

Hague, B., (Member), Brooklyn Polytechnic Institute, Brooklyn, N. Y.

Haycock, O. C., University of Utah, Salt Lake City, Utah

Hemphill, L. F., General Electric Co., Fort Wayne, Ind.

Hendeberg, H., Sargent & Lundy, Chicago, Ill.

Hessler, V. P., Iowa State College, Ames, Iowa

High, T. L., Pacific Electric Mfg. Corp., Portland, Ore.

Hudson, A. R., Board of Education, Louisville, Ky.

Johannsen, E., Pacific Electric Mfg. Co., San Francisco, Calif.

Jones, E. C., West Virginia University, Morgantown, W. Va.

Jones, J. L., Kentucky Electric Development Co., Louisville, Ky.

Katz, L. S., Grove Hall Radio Co., Roxbury, Mass.

Lukens, A. F., General Electric Co., Pittsfield, Mass.

Mailey, R. D., (Fellow), Cooper Hewitt Electric Co., Hoboken, N. J.

McLean, C., Northwestern Electric Co., Portland, Ore.

McQuillen, J. V., Westinghouse Elec. & Mfg. Co., Sharon, Pa.

McRae, H. T., New Jersey Bell Telephone Co., Newark, N. J.

Moreno, V. G., Border Telephone & Light Co., Tijuana, B. Cal., Mexico



Mullowney, T. F., New York Telephone Co., New York, N. Y.  
 Murphy, L. K., Brooklyn Edison Co., Inc., Brooklyn, N. Y.  
 Nicolaisen, R. J., Gibbs & Hill, New York, N. Y.  
 Odarenko, T. M., New York Telephone Co., New York, N. Y.  
 Oldenburg, P. R., Duquesne Light Co., Pittsburgh, Pa.  
 Parker, L. F., British Columbia Electric Railway Co., Vancouver, B. C., Can.  
 Petersen, F. C., New York Edison Co., New York, N. Y.  
 Pirkey, J. W., (Member), Arcturus Radio Tube Co., Newark, N. J.  
 Prince, R. W., (Member), Chesapeake & Potomac Telephone Co., Washington, D. C.  
 Pringle, W. A., General Electric Co., Fort Wayne, Ind.  
 Rankin, L. R., Carnegie Steel Co., Farrell, Pa.  
 Rhael, R. J., Bell Telephone Laboratories, Inc., New York, N. Y.  
 Roloson, G. B., (Member), California School of Mechanical Arts, San Francisco, Calif.  
 Rose, H. B., 55 Hanson Place, Brooklyn, N. Y.  
 Rudolph, W. J., (Member), Electrical Testing Laboratories, New York, N. Y.  
 Russell, C., Jr., University of New Mexico, Albuquerque, N. M.  
 Shoch, W. N., Philadelphia Electric Co., Philadelphia, Pa.  
 Shoffner, J. R., Markle-Bullers Coal Co., Inc., Dora, Pa.; C. E. Ringgold Coal Co., Inc.; C. E. Katukas Coal Co., Inc., Timblin, Pa.  
 Skonberg, E. A., (Member), Electric Motor Repair Co., Springfield, Mass.

Smith, E. A. H., New Jersey Bell Telephone Co., Newark, N. J.  
 Snow, B. H., "Electrical West," Portland, Ore.  
 Stanton, J. M., Electrical Research Products, Inc., Seattle, Wash.  
 Stickley, G. W., Aluminum Co. of America, Massena, N. Y.  
 Taylor, J. A., Tallassee Power Co., Badin, N. C.  
 Tiedemann, D. P., Purdue University, Lafayette, Ind.  
 Tiernan, T. F., National District Telegraph Co., New York, N. Y.  
 Underhill, J. E., British Columbia Electric Railway Co., Ltd., Vancouver, B. C., Can.  
 Watchorn, C. W., Pennsylvania Water & Power Co., Baltimore, Md.  
 Wilhelm, H. T., Bell Telephone Laboratories, Inc., New York, N. Y.  
 Young, R. C., Kuhlman Electric Co., Bay City, Mich.  
**Total 68**

**Foreign**

Bateman, W. T., (Member), Ferguson, Pailin Ltd., Manchester, England  
 Burton, W., Shropshire, Worcestershire & Staffordshire Electric Power Co., Halesowen, Eng.  
 Dean, G. H., (Member), Allen West & Electric Control, Ltd., Brighton, Sussex, Eng.  
 Edmondson, F. C., (Member), City of Perth Electricity & Gas Dept., Perth, Western Australia  
 Phatak, R. K., Tata Hydro-Electric Supply Co., Bombay, India  
**Total 5**

**STUDENTS ENROLLED**

Brown, George H., University of Wisconsin  
 Burnett, Carlos E., Southern Methodist University

Bush, Arthur E., University of Detroit  
 Byrne, Howard E., University of Detroit  
 Cox, Willard J., Southern Methodist University  
 Frauman, Issie, Southern Methodist University  
 Griffith, Arthur F., Lehigh University  
 Griffith, David P., Lehigh University  
 Headley, Francis B., University of Nevada  
 Johnson, Henry W., Drexel Institute  
 Krumm, Harold F., Engineering School of Milwaukee  
 Larose, Victor A., Engineering School of Milwaukee  
 Lindsley, Robert P. Jr., Southern Methodist University  
 Lyon, Stern A., Northeastern University  
 Melton, J. V., Southern Methodist University  
 Nash, Floyd M., University of California  
 O'Donnell, James T., Northeastern University  
 Robertson, George M., University of Southern Calif.

Rogers, James H., Southern Methodist University  
 Rosen, Sidney, University of Southern California  
 Rotter, Cyril F., Engineering School of Milwaukee  
 Sailer, Roman L., University of Detroit  
 Santos, Bartolome, University of Detroit  
 Schley, Woodruff H., Southern Methodist University  
 Sinclair, Donald B., Mass. Institute of Technology  
 Stortz, Frank A. Jr., University of New Mexico  
 Swart, Berry G., Michigan College of Mining & Technology  
 Talbot, Thomas, Southern Methodist University  
 Taylor, Wesley D., University of Minnesota  
 Tsang, Isaac H., Engineering School of Milwaukee  
 Tucker, D. J., Southern Methodist University  
**Total 31**

**OFFICERS A. I. E. E. 1929-1930**

**President**  
 HAROLD B. SMITH

**Junior Past Presidents**  
 BANCROFT GHERARDI

R. F. SCHUCHARDT

**Vice-Presidents**

E. B. MERRIAM  
 H. A. KIDDER  
 W. T. RYAN  
 B. D. HULL  
 G. E. QUINAN

**Directors**

I. E. MOULTROP  
 H. C. DON CARLOS  
 F. J. CHESTERMAN  
 F. C. HANKER  
 E. B. MEYER  
 H. P. LIVERSIDGE

**National Treasurer**  
 GEORGE A. HAMILTON

**Honorary Secretary**  
 RALPH W. POPE

HERBERT S. EVANS  
 W. S. RODMAN  
 C. E. FLEAGER  
 E. C. STONE  
 C. E. SISSON

J. ALLEN JOHNSON  
 A. M. MACCUTCHEON  
 A. E. BETTIS  
 W. S. LEE  
 J. E. KEARNS  
 C. E. STEPHENS  
**National Secretary**  
 F. L. HUTCHINSON

**General Counsel**  
 PARKER & AARON  
 30 Broad Street, New York

**LOCAL HONORARY SECRETARIES**

T. J. Fleming, Calle B. Mitre 519, Buenos Aires, Argentina, S. A.  
 H. W. Flashman, Aus. Westinghouse Elec. Co. Ltd., Cathcart House, 11 Castlereagh St., Sydney, N. S. W., Australia.  
 F. M. Servos, Rio de Janeiro Tramways, Light & Power Co., Rio de Janeiro, Brazil.  
 A. P. M. Fleming, Metropolitan Vickers Elec. Co., Trafford Park, Manchester, England.  
 A. S. Garfield, 45 Bd. Beausejour, Paris 16 E., France.  
 F. W. Willis, Tata Power Company, Bombay House, Bombay, India.  
 Guido Semenza, 39 Via Monte Napoleone, Milan, Italy.  
 P. H. Powell, Canterbury College, Christchurch, New Zealand.  
 M. Chatelain, Lesnoi Polytechnic Institute, Apt. 27, Leningrad, U. S. S. R.  
 Axel F. Enstrom, 24a Grefteuregatan, Stockholm, Sweden.  
 W. Eldson-Dew, P. O. Box 4563 Johannesburg, Transvaal, Africa.

**A. I. E. E. COMMITTEES**

(A list of the personnel of Institute committees may be found in the September issue of the JOURNAL.)

**GENERAL STANDING COMMITTEES AND CHAIRMEN**

EXECUTIVE, Harold B. Smith  
 FINANCE, E. B. Meyer  
 MEETINGS AND PAPERS, A. E. Knowlton  
 PUBLICATION, W. S. Gorsuch  
 COORDINATION OF INSTITUTE ACTIVITIES, H. A. Kidder  
 BOARD OF EXAMINERS, E. H. Everit  
 SECTIONS, W. B. Kouwenhoven  
 STUDENT BRANCHES, W. H. Timbie  
 MEMBERSHIP, J. Allen Johnson  
 HEADQUARTERS, R. H. Tapscott  
 LAW, L. F. Morehouse  
 PUBLIC POLICY, D. C. Jackson  
 STANDARDS, F. D. Newbury  
 EDISON MEDAL, Samuel Insull  
 LAMME MEDAL, Charles F. Scott

CODE OF PRINCIPLES OF PROFESSIONAL CONDUCT, F. B. Jewett  
 COLUMBIA UNIVERSITY SCHOLARSHIPS, W. I. Slichter  
 AWARD OF INSTITUTE PRIZES, A. E. Knowlton  
 SAFETY CODES, A. W. Berresford

**SPECIAL COMMITTEE**

ADVISORY COMMITTEE TO THE MUSEUMS OF THE PEACEFUL ARTS, J. P. Jackson

**TECHNICAL COMMITTEES AND CHAIRMEN**

AUTOMATIC STATIONS, F. Zogbaum  
 COMMUNICATION, G. A. Kositzky  
 EDUCATION, Edward Bennett  
 ELECTRICAL MACHINERY, Philip L. Alger  
 ELECTRIC WELDING, A. M. Candy  
 ELECTROCHEMISTRY AND ELECTROMETALLURGY, P. H. Brace  
 ELECTROPHYSICS, O. E. Buckley  
 GENERAL POWER APPLICATIONS, J. F. Gaskill  
 INSTRUMENTS AND MEASUREMENTS, Everett S. Lee  
 APPLICATIONS TO IRON AND STEEL PRODUCTION, M. M. Fowler  
 PRODUCTION AND APPLICATION OF LIGHT, George S. Merrill  
 APPLICATIONS TO MARINE WORK, W. E. Thau  
 APPLICATIONS TO MINING WORK, Carl Lee  
 POWER GENERATION, F. A. Allner  
 POWER TRANSMISSION AND DISTRIBUTION, H. R. Woodrow  
 PROTECTIVE DEVICES, E. A. Hester  
 RESEARCH, S. M. Kintner  
 TRANSPORTATION, Sidney Withington

**A. I. E. E. REPRESENTATION**

(The Institute is represented on the following bodies; the names of the representatives may be found in the September issue of the JOURNAL.)

ALFRED NOBLE PRIZE COMMITTEE, A. S. C. E.  
 AMERICAN ASSOCIATION FOR THE ADVANCEMENT OF SCIENCE, COUNCIL  
 AMERICAN BUREAU OF WELDING  
 AMERICAN COMMITTEE ON ELECTROLYSIS  
 AMERICAN ENGINEERING COUNCIL ASSEMBLY  
 AMERICAN MARINE STANDARDS COMMITTEE  
 AMERICAN STANDARDS ASSOCIATION  
 AMERICAN YEAR BOOK, ADVISORY BOARD  
 BOARD OF TRUSTEES, UNITED ENGINEERING SOCIETY  
 CHARLES A. COFFIN FELLOWSHIP AND RESEARCH FUND COMMITTEE  
 COMMITTEE OF APPARATUS MAKERS AND USERS, NATIONAL RESEARCH COUNCIL  
 COMMITTEE ON ELIMINATION OF FATIGUE, SOCIETY OF INDUSTRIAL ENGINEERS  
 COMMITTEE ON HEAT TRANSMISSION, NATIONAL RESEARCH COUNCIL  
 ENGINEERING FOUNDATION BOARD  
 JOHN FRITZ MEDAL BOARD OF AWARD  
 JOINT COMMITTEE ON WELDED RAIL JOINTS  
 JOINT CONFERENCE COMMITTEE OF FOUR FOUNDER SOCIETIES  
 LIBRARY BOARD, UNITED ENGINEERING SOCIETY  
 NATIONAL FIRE PROTECTION ASSOCIATION, ELECTRICAL COMMITTEE  
 NATIONAL FIRE WASTE COUNCIL  
 NATIONAL RESEARCH COUNCIL, ENGINEERING DIVISION  
 NATIONAL SAFETY COUNCIL, ELECTRICAL COMMITTEE OF A. S. S. E.—ENGINEERING SECTION  
 THE NEWCOMEN SOCIETY  
 RADIO ADVISORY COMMITTEE, BUREAU OF STANDARDS  
 SOCIETY FOR THE PROMOTION OF ENGINEERING EDUCATION, BOARD OF INVESTIGATION AND COORDINATION  
 U. S. NATIONAL COMMITTEE OF THE INTERNATIONAL COMMISSION ON ILLUMINATION  
 U. S. NATIONAL COMMITTEE OF THE INTERNATIONAL ELECTROTECHNICAL-COMMISSION  
 WASHINGTON AWARD, COMMISSION OF

## LIST OF SECTIONS

Name	District	Chairman	Secretary	Name	District	Chairman	Secretary
Akron	(2)	W. A. Hillebrand	R. R. Krammes, The Ohio Power Co., Canton, O.	New York	(3)	H. P. Charlesworth	T. F. Barton, General Elec. Co., 120 Broadway, New York
Atlanta	(4)	H. L. Wills	W. F. Bellinger, Electric & Gas Bldg., Atlanta, Ga.	Niagara Frontier	(1)	Raymond T. Henry	E. P. Harder, Buffalo General Elec. Co., 205 Electric Bldg., Buffalo, N. Y.
Baltimore	(2)	W. B. Kouwenhoven	G. S. Diehl, Pa. Water & Pwr. Co., 1611 Lexington Bldg., Baltimore, Md.	North Carolina	(4)	E. P. Coles	Marshall E. Lake, Duke Pr. Co. Power Bldg., Charlotte, N. C.
Birmingham	(4)	W. E. Bare	O. E. Charlton, Alabama Power Co., Birmingham, Ala.	Oklahoma City	(7)	C. Walker Mier	C. T. Almquist, Univ. of Oklahoma, Norman, Okla.
Boston	(1)	W. H. Colburn	G. J. Crowdes, Simplex Wire & Cable Co., Sidney St., Cambridge, Mass.	Panama Philadelphia	(3) (2)	R. H. Silbert	J. L. MacBurney, Elec. Storage Battery Co., 1955 Hunting Park Ave., Philadelphia, Pa.
Chicago	(5)	T. G. LeClair	F. R. Innes, c/o Electrical World, 7 So. Dearborn St., Chicago, Ill.	Pittsburgh	(2)	J. A. Cadwallader	C. T. Sinclair, Byllesby Engg. & Mngmt. Corp., 435 Sixth Ave., Pittsburgh, Pa.
Cincinnati	(2)	T. C. Reed	L. L. Bosch, Columbia Engg. & Mgmt. Corp., 314 West 4th St., Cincinnati, O.	Pittsfield	(1)	L. F. Blume	L. H. Burnham, General Electric Co., Pittsfield, Mass.
Cleveland	(2)	T. D. Owens	Wm. H. LaMond, Simplex Wire & Cable Co., 2019 Union Trust Bldg., Cleveland, O.	Portland, Ore.	(9)	H. H. Cake	A. H. Kreul, Portland Elec. Pr. Co., Hawthorne Bldg., Portland, Ore.
Columbus	(2)	R. A. Brown	W. C. Johnson, Ohio Bell Tel. Co., 42 E. Gay St., Columbus, Ohio	Providence	(1)	F. W. Smith	O. W. Briden, Blackstone Valley Gas & Elec. Co., Pawtucket, R. I.
Connecticut	(1)	Sidney Withington	R. G. Warner, Yale Univ., New Haven, Conn.	Rochester	(1)	Virgil M. Graham	Charles F. Estwick, General Railway Signal Co., Rochester, N. Y.
Dallas	(7)	J. B. Thomas	A. Chetham-Strode, Dallas Pwr. & Light Co., Interurban Bldg., Dallas, Tex.	St. Louis	(7)	G. H. Quermann	O. J. Rotty, Union Elec. Lt. & Pr. Co., 315 No. 12th Blvd., St. Louis, Mo.
Denver	(6)	W. H. Bullock	N. R. Love, 807 Tramway Bldg., Denver, Colo.	San Francisco	(8)	L. F. Fuller	G. Ross Henninger, Electrical West, 883 Mission St., San Francisco, Cal.
Detroit-Ann Arbor	(5)	L. F. Hickernell	T. N. Lacy, Michigan Bell Tel. Co., 1365 Cass Ave., Detroit, Mich.	Saskatchewan	(10)	J. R. Crowley	A. B. Coward, Light & Power Dept., Regina, Sask., Canada
Erie	(2)	W. H. Pelton	Geo. I. Le Baron, General Electric Co., Erie, Pa.	Schenectady	(1)	R. Treat	E. E. Johnson, Rm. 435, Bldg. 2, General Electric Co., Schenectady, N. Y.
Fort Wayne	(5)	F. W. Merrill	E. J. Schaefer, General Electric Co., Ft. Wayne, Ind.	Seattle	(9)	L. N. Robinson	George S. Smith, Elec. Engg. Dept., University of Washington, Seattle, Wash.
Houston	(7)	L. K. Del'Homme	C. D. Farman, Southwestern Bell Tel. Co., Houston, Texas	Sharon	(2)	J. B. Gibbs	S. S. Cook, Westinghouse E. & M. Co., Sharon, Pa.
Indianapolis-Laf.	(5)	J. B. Bailey	H. M. Stradling, 353 Mass Ave., Indianapolis, Ind.	Southern Virginia	(4)	H. C. Leonard	Cecil Gray, Westinghouse E. & M. Co., 912 Electric Bldg., Richmond, Va.
Iowa	(5)	C. L. Sampson	J. K. McNeely, Iowa State College, Ames, Iowa	Spokane	(9)	Earl Baughn	Loren A. Traub, 215 Symons Bldg., Spokane, Wash.
Ithaca	(1)	W. C. Ballard, Jr.	W. E. Meserve, 614 E. Buffalo St., Ithaca, N. Y.	Springfield, Mass.	(1)	Fred L. Hunt	B. V. K. French, American Bosch Magneto Corp., Springfield, Mass.
Kansas City	(7)	A. B. Covey	J. S. Palmer, Kansas City Pr. & Lt. Co., 1330 Grand Ave., Kansas City, Mo.	Syracuse	(1)		F. E. Verdin, 1206 Hills Bldg., Syracuse, N. Y.
Lehigh Valley	(2)	A. J. Althouse	E. F. Weaver, Pa. Pr. & Lt. Co., 901 Hamilton St., Allentown, Pa.	Toledo	(2)	E. B. Featherstone	Max Neuber, 1257 Fernwood Ave., Toledo, O.
Los Angeles	(8)	N. B. Hinson	H. W. Hitchcock, So. Cal. Tel. Co., 740 So. Olive St., Los Angeles, Cal.	Toronto	(10)	F. F. Ambuhl	W. F. Sutherland, Toronto Hydroelec. Sys., 225 Yonge St., Toronto, Ont., Canada
Louisville	(4)	H. W. Wischmeyer	Philip P. Ash, Louisville & Nashville Rd. Bldg., 9th & B'way Ave., Louisville, Ky.	Urbana	(5)	M. A. Faucett	C. E. Skroder, Univ. of Ill., Urbana, Ill.
Lynn	(1)	I. F. Kinnard	H. K. Nock, General Elec. Co., West Lynn, Mass.	Utah	(9)	A. C. Kelm	L. B. Fuller, Utah Pr. & Lt. Co., Salt Lake City, Utah
Madison	(5)	R. E. Purucker	L. C. Larson, Univ. of Wisconsin, Madison, Wis.	Vancouver	(10)	J. Teasdale	D. Robertson, Canadian Gen. Elec. Co., Ltd., Vancouver, B. C., Canada
Mexico	(3)	G. Solis-Payan	E. Leonar, Jr., Ap. Postal 206, Monterrey, N. L. Mexico	Washington	(2)	W. A. E. Doying	G. L. Weller, Chesapeake & Potomac Tel. Co. & Assoc. Cos., 725-13th St., N. W., Washington, D. C.
Milwaukee	(5)	E. W. Seeger	R. C. Siegel, Wisconsin Tel. Co., 418 Broadway, Milwaukee, Wis.	Worcester	(1)	H. H. Newell	R. P. Bullen, General Elec. Co., 704 State Mutual Bldg., Worcester, Mass.
Minnesota	(5)	V. E. Engquist	Oscar Gaarden, Northern State Pr. Co., 15 S. 5th St., Minneapolis, Minn.				
Nebraska	(6)	D. H. Braymer	W. O. Jacobi, Omaha & Council Bluffs St. Ry. Co., 19 & Farnam Sts., Omaha, Neb.				

Total 57

## LIST OF BRANCHES

Name and Location	District	Chairman	Secretary	Counselor (Member of Faculty)
Akron, Municipal Univ. of, Akron, Ohio	(2)	Glenn O. Hite	G. G. Clark	J. T. Walther
Alabama Polytechnic Inst., Auburn, Ala.	(4)	T. S. Winter	O. T. Allen	W. W. Hill
Alabama, Univ. of, University, Ala.	(4)			
Arizona, Univ. of, Tucson, Ariz.	(8)	Barney Shehane	F. F. Denney	J. C. Clark
Arkansas, Univ. of, Fayetteville, Ark.	(7)	D. J. Morrison		W. B. Stelzner
Armour Inst. of Tech., 3300 Federal St., Chicago, Ill.	(5)	J. Dollenmaier	S. Janiszewski	E. H. Freeman
Brooklyn Poly. Inst., 99 Livingston St., Brooklyn, N. Y.	(3)	F. J. Mullen	R. G. O'Sullivan	Clyde C. Whipple
Bucknell University, Lewisburg, Pa.	(2)	E. C. Metcalf	R. G. Tingle	W. K. Rhodes
Calif. Inst. of Tech., Pasadena, Calif.	(8)	E. C. Lee		R. W. Sorensen
Calif., Univ. of, Berkeley, Calif.	(8)	C. W. Mors	R. W. Hollis	L. E. Reukema
Carnegie Inst. of Tech., Pittsburgh, Pa.	(2)	J. R. Britton	S. A. Bottonari	B. C. Dennison
Case School of Applied Science, Cleveland, Ohio	(2)	R. B. McIntosh	H. L. Brouse	H. B. Dates
Catholic Univ. of America, Washington, D. C.	(2)			Thos. J. MacKavanaugh
Cincinnati, Univ. of, Cincinnati, Ohio	(2)	V. G. Rettig		W. C. Osterbrock
Clarkson College of Tech., Potsdam, N. Y.	(1)	R. N. Roberts	F. W. Truesdell	A. R. Powers
Clemson Agri. College, Clemson College, S. C.	(4)	G. W. Sackman	Walter C. Snyder	Sam. R. Rhodes
Colorado State Agri. College, Ft. Collins, Colo.	(6)	G. R. Branch	P. H. Lindon	H. G. Jordan
Colorado, University of, Boulder, Colo.	(6)	Wm. J. Dowis	E. E. Stoeckly	W. C. DuVall
Cooper Union, New York, N. Y.	(3)	W. Henschel	H. H. Reuter	A. J. B. Fairburn
Cornell University, Ithaca, N. Y.	(1)	Alexander B. Credle	J. D. McCurdy	
Denver, Univ. of, Denver, Colo.	(6)	L. J. Wright	R. B. Convery	R. E. Nyswander
Detroit, Univ. of, Detroit, Mich.	(5)	Wm. F. Haldeman	W. R. Moyers	H. O. Warner
Drexel Institute, Philadelphia, Pa.	(2)	D. M. Way	O. L. Eichna	E. O. Lange
Duke University, Durham, N. C.	(4)	W. E. Cranford	C. W. Berglund, Jr.	W. J. Seeley
Florida, Univ. of, Gainesville, Fla.	(4)	J. W. McKay	A. L. Webb	J. M. Weil
Georgia School of Tech., Atlanta, Ga.	(4)	B. Mann	K. W. Mowry	T. W. Fitzgerald
Idaho, University of, Moscow, Idaho	(9)	Wayne McCoy	C. E. Conway	J. H. Johnson
Iowa State College, Ames, Iowa	(5)	H. H. Stahl	H. Kirk	F. A. Fish
Iowa State University of, Iowa City, Iowa	(5)	D. MacDougal		E. B. Kurtz
Kansas State College, Manhattan, Kansas	(7)	L. N. Lydick	L. C. Paslay	R. M. Kerchner
Kansas, Univ. of, Lawrence, Kansas	(7)	M. W. Hammond	H. W. Yenzer	G. C. Shad
Kentucky, Univ. of, Lexington, Ky.	(4)	Wm. F. Steers	R. I. Port	W. E. Freeman
Lafayette College, Easton, Pa.	(2)	E. C. Albert	Wm. F. Titus	Morland King
Lehigh University, Bethlehem, Pa.	(2)	B. O. Steinert	J. E. Zeaser	J. L. Beaver
Lewis Institute, Chicago, Ill.	(5)	G. W. Malstrom	E. R. Borden	F. A. Rogers
Louisiana State University, Baton Rouge, La.	(4)	J. C. Bice	J. J. Bridges, Jr.	M. B. Voorhies

LIST OF BRANCHES—Continued

Name and Location	District	Chairman	Secretary	Counselor (Member of Faculty)
Louisville, University of, Louisville, Ky.	(4)	H. T. Clark	O. M. Arehart	D. C. Jackson
Maine, University of, Orono, Maine	(1)	A. E. Crockett	H. R. Mayers	Wm. E. Barrows, Jr.
Marquette University, 1200 Sycamore St., Milwaukee, Wis.	(5)	H. W. Haase	G. C. Reichert	J. F. H. Douglas
Massachusetts Institute of Technology, Cambridge, Mass.	(1)	R. H. Swingle		W. H. Timbie
Michigan College of Mining and Technology, Houghton, Michigan	(5)	Charles F. Sawyer	B. G. Swart	G. W. Swenson
Michigan State College, East Lansing, Mich.	(5)	R. L. Clark	G. A. Whitfield	L. S. Foltz
Michigan, University of, Ann Arbor, Mich.	(5)	W. R. Hough	H. L. Scofield	B. F. Bailey
Milwaukee, School of Engineering of, 163 East Wells St., Milwaukee, Wis.	(5)	T. J. Coleman, Jr.	K. O. Werwath	Oscar Werwath
Minnesota, University of, Minneapolis, Minn.	(4)	R. W. Fenton	W. M. Taylor	J. H. Kuhlmann
Mississippi Agricultural & Mechanical College, A. & M. College, Miss.	(5)	W. F. Barksdale	A. H. Peale	L. L. Patterson
Missouri School of Mines & Metallurgy, Rolla, Mo.	(7)	F. B. Beatty	E. J. Gregory	I. H. Lovett
Missouri, University of, Columbia, Mo.	(7)	L. G. Weiser		M. P. Weinbach
Montana State College, Bozeman, Mont.	(9)	E. B. Wilson	O. Van Horn	J. A. Thaler
Nebraska, University of, Lincoln, Neb.	(6)	D. E. Schneider	H. G. Wiltse	F. W. Norris
Nevada, University of, Reno, Nevada	(8)	A. McCullom	A. B. Chace	S. G. Palmer
Newark College of Engineering, 367 High St., Newark, N. J.	(3)	H. Harrison	A. L. Davis	J. C. Peet
New Hampshire, University of, Durham, N. H.	(1)	P. Nudd	D. Googins	L. W. Hitchcock
New Mexico, The University of, Albuquerque, New Mexico.	(7)	F. A. Stortz, Jr.	W. I. Abbott	F. M. Denton
New York, College of the City of, 139th St. & Convent Ave., New York, N. Y.	(3)	R. Fassnacht	F. J. Wodicka	Harry Baum
New York University, University Heights, New York, N. Y.	(3)	N. G. Schutt	T. S. Humphrey	J. Loring Arnold
North Carolina State College, Raleigh, N. C.	(4)	H. W. Horney	E. R. Price	R. S. Fouraker
North Carolina, University of, Chapel Hills, N. C.	(4)	J. J. Alexander	F. R. Toms	J. E. Lear
North Dakota Agricultural College, State College Station, Fargo, N. D.	(6)	L. C. Langaunet	R. W. Scott	H. R. Rush
North Dakota, University of, University Station, Grand Forks, N. D.	(6)	R. W. Olson	G. E. Glass	H. F. Rice
Northeastern University, 316 Huntington Ave., Boston 17, Mass.	(1)	R. W. Littlefield	R. J. Edwards	Wm. L. Smith
Notre Dame, University of, Notre Dame, Ind.	(5)	E. G. Conroy	Ben South	J. A. Caparo
Ohio Northern University, Ada, Ohio	(2)	J. D. McGahan	R. I. Hartshorn	I. S. Campbell
Ohio State University, Columbus, Ohio	(2)	W. M. Webster	R. C. Moser	F. C. Caldwell
Ohio University, Athens, Ohio	(2)	C. Kenney	H. W. Giesecke	A. A. Atkinson
Oklahoma A. & M. College, Stillwater, Okla.	(7)	H. V. Anderson	E. F. Neal	D. S. Donnell
Oklahoma, University of, Norman, Okla.	(7)	E. E. Brady	C. W. Anthony	F. G. Tappan
Oregon State College, Corvallis, Oregon	(9)	B. G. Griffith	D. C. Gillanders	F. O. McMillan
Pennsylvania State College, State College, Pa.	(2)	W. C. Mason		L. A. Doggitt
Pennsylvania University of, Philadelphia, Pa.	(2)	R. R. Creighton	N. Smith	C. D. Fawcett
Pittsburgh, University of, Pittsburgh, Pa.	(2)	W. A. Aeberlie	G. L. Bolender	H. E. Dyche
Princeton University, Princeton, N. J.	(2)	C. F. Nesslage	N. T. Humphrey	Malcolm MacLaren
Purdue University, Lafayette, Indiana	(5)	P. C. Sandretto	R. T. Orth	A. N. Topping
Rensselaer Polytechnic Institute, Troy, N. Y.	(1)	Wm. Mayott	R. N. Palmer	F. M. Sebast
Rhode Island State College, Kingston, R. I.	(1)	K. K. Sperl	C. Pagella	Wm. Anderson
Rose Polytechnic Institute, Terre Haute, Ind.	(5)	D. E. Henderson	J. H. Corp	C. C. Knipmeyer
Rutgers University, New Brunswick, N. J.	(3)	G. E. Weglener		Paul S. Creager
Santa Clara, University of, Santa Clara, Calif.	(8)	T. L. Selna	J. D. Gillis	L. J. Neuman
South Carolina, University of, Columbia, S. C.	(4)	G. H. Preacher	B. F. Karick	E. F. Ball
South Dakota State School of Mines, Rapid City, S. D.	(6)	H. E. Sattler	B. Hagmann	J. O. Kammerman
South Dakota, University of, Vermillion, S. D.	(6)	E. Johnson	E. E. Lovejoy	B. B. Brackett
Southern California, University of, Los Angeles, Calif.	(8)	Del Mar Wright	G. M. Robertson	Philip S. Biegler
Southern Methodist University, Dallas, Texas.	(7)	W. Cox	P. Lindsley, Jr.	E. H. Flath
Stanford University, Stanford University, Calif.	(8)	D. H. Ring	H. E. Hill	T. H. Morgan
Stevens Institute of Technology, Hoboken, N. J.	(3)	F. C. Gilman	G. Habach	F. C. Stockwell
Swarthmore College, Swarthmore, Pa.	(2)	D. B. Spangler	B. C. Algeo	Lewis Fussell
Syracuse University, Syracuse, N. Y.	(1)	D. A. MacGregor	M. J. Wright	C. W. Henderson
Tennessee, University of, Knoxville, Tenn.	(4)	F. P. Elam	A. M. Howery	Joseph G. Tarboux
Texas, A. & M. College of, College Station, Texas	(7)	S. L. Moseley	T. M. Sowell	H. C. Dillingham
Texas, University of, Austin, Texas.	(7)	C. B. Norris	R. W. Chase	J. A. Correll
Utah, University of, Salt Lake City, Utah	(9)	L. A. Moore	S. Blomquist	J. H. Hamilton
Vermont, University of, Burlington, Vt.	(1)	F. E. Beckley	A. E. Merrill	L. P. Dickinson
Virginia Military Institute, Lexington, Va.	(4)	W. T. Saunders	A. S. Britt, Jr.	S. W. Anderson
Virginia Polytechnic Institute, Blacksburg, Va.	(4)	L. Backer	C. V. West	Claudius Lee
Virginia, University of, University, Va.	(4)	H. R. Holt	C. H. Dickinson	W. S. Rodman
Washington, State College of, Pullman, Wash.	(9)	T. Mathison	J. Livie	R. D. Sloan
Washington University, St. Louis, Mo.	(7)	Wm. L. Knaus		H. G. Hake
Washington, University of, Seattle, Wash.	(9)	K. E. Hammer		G. L. Hoard
Washington & Lee University, Lexington, Va.	(4)			R. W. Dickey
West Virginia University, Morgantown, W. Va.	(2)	C. E. Moyers	G. H. Hollis	A. H. Forman
Wisconsin, University of, Madison, Wis.	(5)	G. H. Brown	A. N. O'Neill	C. M. Jansky
Worcester Polytechnic Institute, Worcester, Mass.	(1)	E. C. Milde	C. S. Greco	E. W. Starr
Wyoming, University of, Laramie, Wyoming	(6)	E. C. Moudy		G. H. Sechrist
Yale University, New Haven, Conn.	(1)	F. H. Eastman	A. K. Wing, Jr.	R. G. Warner
Total 104				

AFFILIATED STUDENT SOCIETY

Brown Engineering Society, Brown University, Providence, R. I.

GEOGRAPHICAL DISTRICTS

- |   |                              |
|---|------------------------------|
| No. 1—North Eastern District                    | No. 5—Great Lakes District   |
| No. 2—Middle Eastern District                   | No. 6—North Central District |
| No. 3—New York City                             | No. 7—South West District    |
| Also all foreign countries<br>(Canada excepted) | No. 8—Pacific District       |
| No. 4—Southern District                         | No. 9—North West District    |
|   | No. 10—Canada                |

ORDER FORM FOR REPRINTS OF PAPERS ABRIDGED IN THE JOURNAL\*

(November 1929)

Number	Author	Title
<input type="checkbox"/> 29-81	C. F. Hirshfeld	Rehabilitation of Steam Power Plants
<input type="checkbox"/> 29-96	H. R. Woodrow, Chairman	Report of Committee on Transmission and Distribution
<input type="checkbox"/> 29-93	V. Karapetoff	Report of Committee on Electrophysics
<input type="checkbox"/> 29-109	W. J. Foster, Chairman	Report of Committee on Electrical Machinery
<input type="checkbox"/> 29-128	F. O. Wheelock	Dial Telephone System
<input type="checkbox"/> 29-131	J. K. Hodnette	Effect of Surges on Transformer Windings
<input type="checkbox"/> 29-137	H. L. Melvin	Impulse Insulation Characteristics
<input type="checkbox"/> 29-138	M. MacFarren	Parallel Operation of Transformers
<input type="checkbox"/> 29-140	V. M. Montsinger and L. Wetherill	Effect of Color of Tanks on Temperature

\*Members, Enrolled Students, and JOURNAL subscribers are entitled to one complete copy of each paper free of charge; additional copies, at 25 cents each.

Name .....

Address .....

Please order reprints by number. Address Order Department A. I. E. E., 33 West 39th Street, New York, N. Y.

# DIGEST OF CURRENT INDUSTRIAL NEWS

## NEW CATALOGUES AND OTHER PUBLICATIONS

*Mailed to interested readers by issuing companies*

**Motors.**—Bulletin 508, 12 pp. Describes "explosion-proof," self-ventilated, squirrel-cage motors for use in explosive atmospheres. The Louis Allis Company, Milwaukee, Wis.

**Theatre Cooling Equipment.**—Bulletin, 16 pp. Describes conventional theater cooling systems and illustrates theaters in which such installations have been made. The Ideal Electric & Manufacturing Co., Mansfield, Ohio.

**Gas Electric Drive For Autos.**—Bulletin GEA-149C, 12 pp. Describes the G-E gas electric drive for buses and other vehicles. General Electric Company, Schenectady, N. Y.

**Electroplating Generators.**—Bulletin, 16 pp. Describes Columbia generators for electroplating, electrotyping and electrochemical processes. Columbia Electric Manufacturing Co., 1292 East 53rd Street, Cleveland, O.

**Electric Heat In Industry.**—Bulletin GEA-261A, 48 pp. Illustrates the application of electric heat to groups of basic operations commonly found in industrial plants. General Electric Company, Schenectady, N. Y.

**Ball Bearings.**—"The Gurney Ball Bearing Manual," 202 pp. A comprehensive treatment of the subject describing numerous types of bearings and their proper applications. Prices are included. Marlin-Rockwell Corporation, Jamestown, N. Y.

**Silver Solder.**—Bulletin, 20 pp., on "The Proper Selection and Use of Silver Solder." According to the manufacturer there are many uses of silver solder in electrical manufacturing, and silver compositions that have been especially developed and perfected for the electrical industry are described in the bulletin. Handy & Harman, 57 William Street, New York.

## NOTES OF THE INDUSTRY

**Champion Switch Company Appointments.**—R. J. Stewart, formerly with the West Penn Power Company, is now head of the inspection department, and J. A. Dudley, formerly of the Chrysler Corporation, has been appointed to take charge of production for the Champion Switch Company, Kenova, West Virginia.

**The Wagner Electric Manufacturing Corporation, St. Louis,** announces the removal of two branch sales offices. The Milwaukee sales office and service station has been moved from 501 Broadway to 525-27 Broadway. The St. Louis sales office has been removed from 505 Shell Building to 909 Plaza Olive Building. Those removals were necessitated by the increased business requiring more space.

**Increased Orders for G-E.**—Orders received by the General Electric Company for the three months ended September 30th amounted to \$116,688,014, compared with \$90,328,666 for the corresponding quarter of 1928, an increase of 29 per cent, President Gerard Swope has announced. For the nine months ended September 30th orders received amounted to \$337,404,470, compared with \$260,686,463 for the first nine months of last year, also an increase of 29 per cent.

**A New Oil Purifier.**—The largest portable combination centrifuge and filter press on the market is now being offered through the Westinghouse Electric and Manufacturing Company. It is the Sharples combination portable super-centrifuge and filter press, and is made by the Sharples Specialty Company. A Sharples super-centrifuge is combined with Westinghouse filter press equipment and mounted on a truck. The following advantages are claimed for it: Thoroughly cleans 1200 gallons of oil per hour continuously. Purification is complete in one operation. Operation is simple and clean. Practically no oil is lost in handling. Construction is sturdy and simple. Maintenance is remarkably low. Occupies very little floor space—only a space 54 inches by 106 inches. Can be easily moved from place to place.

**Great Northern Electrification.**—Increased passenger travel following the opening of the Great Northern's 8-mile tunnel under the Cascades is reflected by the purchase from the General Electric Company of four additional 3000-horsepower electric locomotives for use on passenger trains on the electrified division. The new locomotives will cost about \$250,000 each. With the completion of the 8-mile Cascade tunnel last January, the railway's entire route through the Cascades was changed from steam to electrical operation. The saving in time afforded by these and other improvements enabled the Great Northern to cut nearly seven hours from the time of its transcontinental trains. The new locomotives will be the same type as those now handling the railway's passenger trains. They weigh approximately 530,000 pounds each and are 75 feet long. They are built so they can be operated in multiples, each unit being capable of handling a 1000-ton train on any of the grades. Each locomotive has six traction motors which deliver power to six axles. The driving wheels are nearly 5 feet in diameter.

**New High-Capacity Oil Breakers.**—The Pacific Electric Manufacturing Corporation, San Francisco, announces the addition of two more sizes to their "JC" type oil circuit breakers, now available in voltages from 11,000 to 37,000. The JC-17 breaker is rated to interrupt 100,000 kv-a. at 15 kv. and has exceeded this rating in actual test. Types JC-22 and 26 have a rating of 125,000 kv-a. at 25 kv. and 37 kv. respectively. Features of this type of oil circuit breaker include: One cast top member for all three phases, with individual tanks per phase. All operating parts are fastened to the one piece top member and assembled at the factory and shipped without disturbing the factory adjustment. The rotating unit that carries the contacts is composed of Bakelite, insuring positive mechanical strength and a wide safety factor in dielectric strength. Ample oil capacity with high operating speed gives these breakers an interrupting capacity greater than other breakers of comparable size. These breakers may be motor or solenoid operated. Either type of control can be mounted on the end or side of the breaker without the use of additional parts, and the two styles of control are interchangeable as far as mountings are concerned.

**Electrical Equipment for Ford.**—A turbine generator rated at 110,000 kilowatts, is to be installed by the Ford Motor Company in the power generating station of its River Rouge plant at Fordson, Michigan. This machine, far exceeding the rating of any existing prime mover used for industrial purposes, and involving many novel and unusual features of design, will be used in the manufacture of Ford automobiles. This apparatus, now being built at the Schenectady Works of the General Electric Company, represents interesting departures in design and construction. It is a vertical compound unit and is the first large machine to be made to this design. The high-pressure turbine and generator will be mounted directly on top of the low-pressure turbine and generator, resulting in the most compact unit yet proposed. Each element has a capacity of 55,000 kilowatts. Steam will be used at a pressure of 1200 pounds exclusively. One of the important features of the design—of particular value in the Ford plant, where floor space is at a premium—is the small amount of space which will be taken up by the new unit. The general dimensions include a length of 57 feet 6 inches, a maximum width of 23 feet and a little less than 21 feet overall height from the floor. The approximate weight is 2,000,000 pounds. The space to be occupied is less than a quarter of a cubic foot per kilowatt of output.

The Ford Motor Company has also ordered one 600 hp. and one 300 hp. oil-electric locomotive from the Ingersoll-Rand Company for the River Rouge Plant. These locomotives will be furnished with General Electric equipment and will be built at their Erie Works.





**KERITE**

In 1752 Franklin invented the Lightning Conductor and identified lightning and electricity. A century later, Day invented

**KERITE**

Over half a century of experience has identified it as the most reliable and permanent insulation for Electrical Conductors



THE KERITE INSULATED WIRE & CABLE COMPANY INC  
NEW YORK CHICAGO SAN FRANCISCO

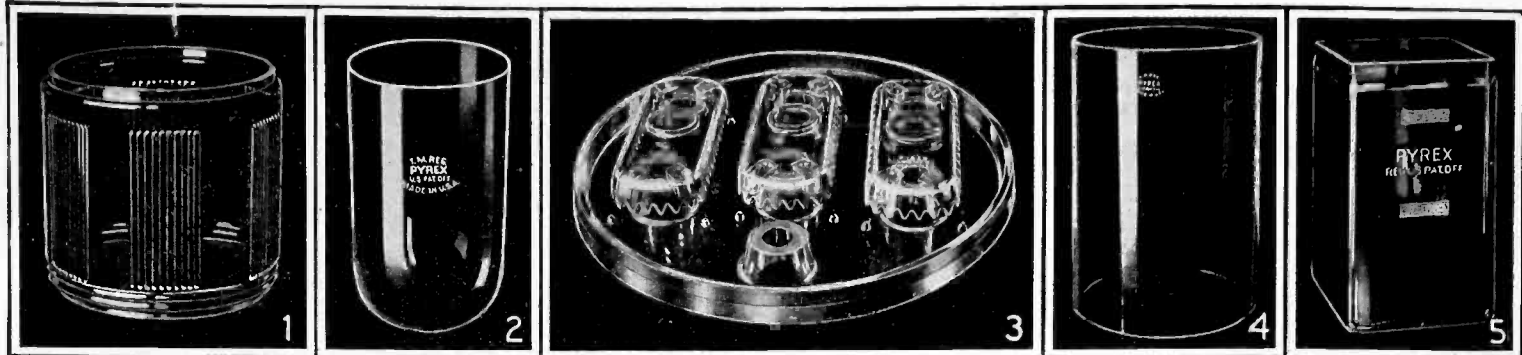

1. Stove jacket. 2. Vacuum bottle blank. 3. Distilling column plate. 4. Gasoline filling station pump cylinder. 5. Battery jar. 6. Pulley. 7. Sight glass. 8. Silk reel. 9. Glass pipe lines and fittings. 10. Socket base for radio tubes.

## The solution of your problem may well be glass

**M**ANY an experienced engineer has been astonished at the manifold industrial purposes which glass now serves. The extraordinary properties of the special glasses developed by Corning Glass Works frequently permit substitution of these glasses for other materials as the solution of troublesome problems. Invariably the result is economy in first cost or maintenance, or both.

Illustrated here are a few PYREX parts developed by Corning Glass Works engineers. The properties of the glass from which these PYREX parts are fabricated may very possibly be the solution of your problem:

Transparency for visual inspection—High surface and internal hardness—Homogeneity of structure—Low expansion co-efficient—High mechanical strength—High electrical resistivity—Pleasing surface contour and finish—Resistance to sudden heat change—High chemical stability—Freedom from disintegration—Non-adherence of surface deposits of foreign material—Care-free service.

Corning Glass Works has long been the pioneer in adapting glass to industrial usage. The experience and vast facilities of our research staff are at your disposal. Put your problem up to us.

## CORNING GLASS WORKS

Dept. 61, Industrial and Laboratory Division, Corning, New York

New York Office: 501 Fifth Avenue

World's largest makers of Technical Glassware

*A booklet "Pyrex Industrial Products" illustrates a variety of unusual glass products that have solved stubborn problems for others. Write for it.*

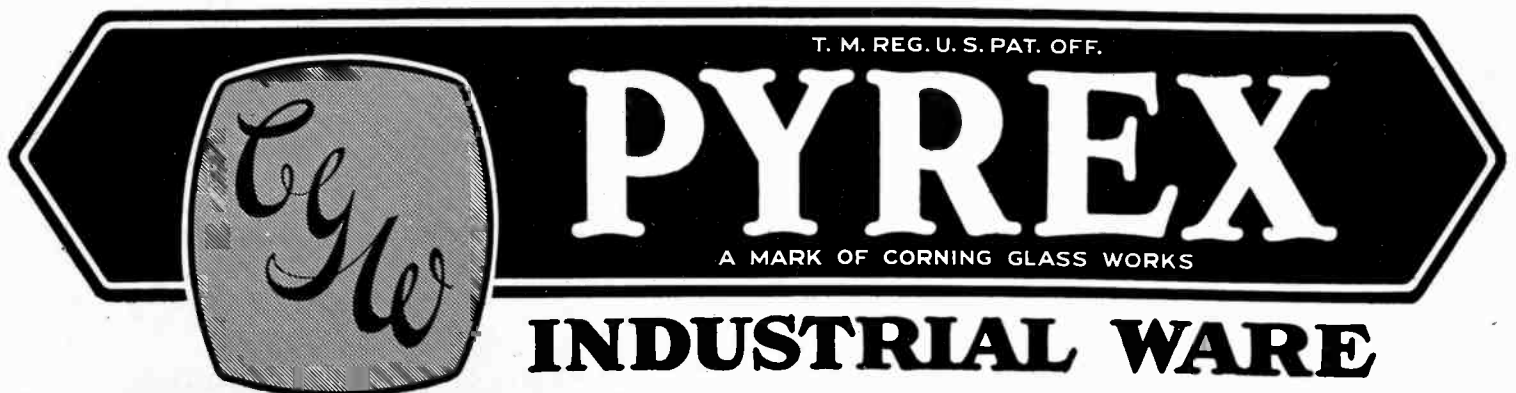

Please mention the JOURNAL of the A. I. E. E. when writing to advertisers.

# Co. operating with electrical engineers on RESISTANCE PROBLEMS

This complete staff of  
resistance specialists  
at your service.



*A standard Durham Metallized resistance unit, made in a wide variety of ranges and used by the millions in the radio industry.*

**W**E mean "at your service" in the broadest sense of the term, for our staff of resistance engineers are glad to extend the full facilities of our laboratory to help solve any resistance problem in connection with any type of electrical work.

This organization has long been recognized as the leading producers of resistance units in the country for radio, television, sound amplification, talkie-movie apparatus, X-ray and other work requiring precise design and manufacture.

**DURHAM RESISTANCES** are now standard equipment with many of America's foremost manufacturers of radio and allied equipment and are also used and endorsed by various departments of the United States Government.

We are constantly working in cooperation with the engineers of large manufacturing companies and experimental laboratories and now wish to take this opportunity to invite *all* engineers to take full advantage of our broad service, which encompasses an equally wide experience.

# DURHAM RESISTORS & POWEROHMS

INTERNATIONAL RESISTANCE CO., 2006 Chestnut Street, Philadelphia, Pa.

Please mention the JOURNAL of the A. I. E. E. when writing to advertisers.



# A Transformer for Every Job



For every job...large or small...indoors, outdoors or in wet subways...Wagner has a transformer that is electrically and mechanically correct. Wagner Motors fed from Wagner Transformers furnish a complete service that will assure continual, safe and economical operation. Wagner Transformers are thoroughly modern in every detail.

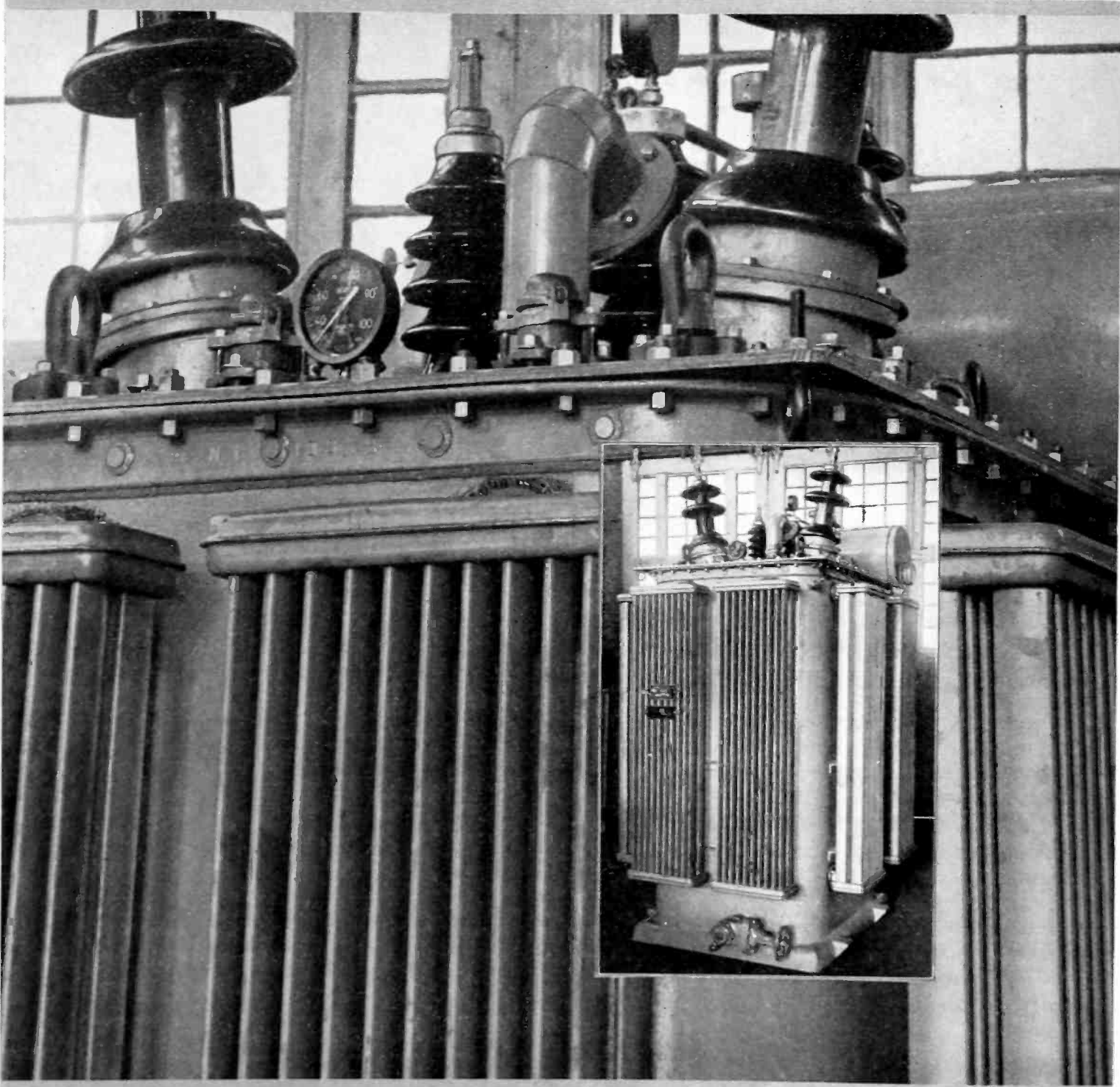

# Wagner, Quality



Write for performance data and description of Wagner Power Distribution and Subway Transformers.

Literature on Request

**WAGNER ELECTRIC CORPORATION**

6400 Plymouth Ave., St. Louis

Sales and Service in 25 Principal Cities

**PRODUCTS** . . . FANS . . . DESK . . . WALL . . . CEILING  
 TRANSFORMERS . . . POWER . . . DISTRIBUTION . . . INSTRUMENT  
 MOTORS . . . SINGLE-PHASE . . . POLYPHASE . . . DIRECT CURRENT



# Reduce capital investment with Aluminum Busbars

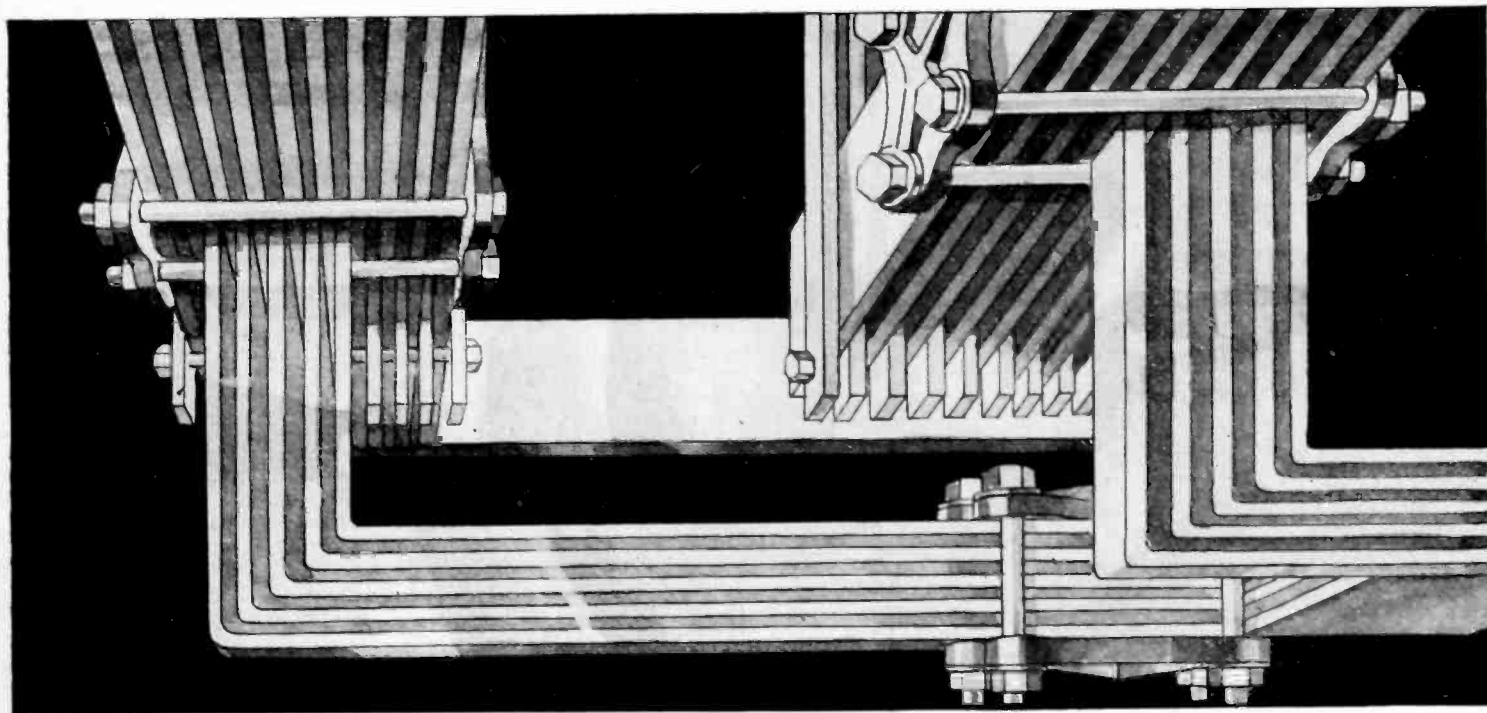

**M**ORE than twenty years ago an important street railway company in this country equipped twelve of its power stations with Aluminum Busbar.

Through all of the intervening years Aluminum Busbar has given that company reliable, dependable service.

Today, the use of Aluminum Busbar develops a far greater saving than it did at that time.

And both in this country and abroad Aluminum is now recognized as a splendid material for that purpose.

The booklet, "Aluminum Busbars" sent on request, contains useful tables of weights, carrying capacities and physical properties, with photographs of various characters of installation. Please ask for your copy.

ALUMINUM COMPANY OF AMERICA  
2448 Oliver Bldg., Pittsburgh, Pa.  
*Offices in 19 Principal American Cities*

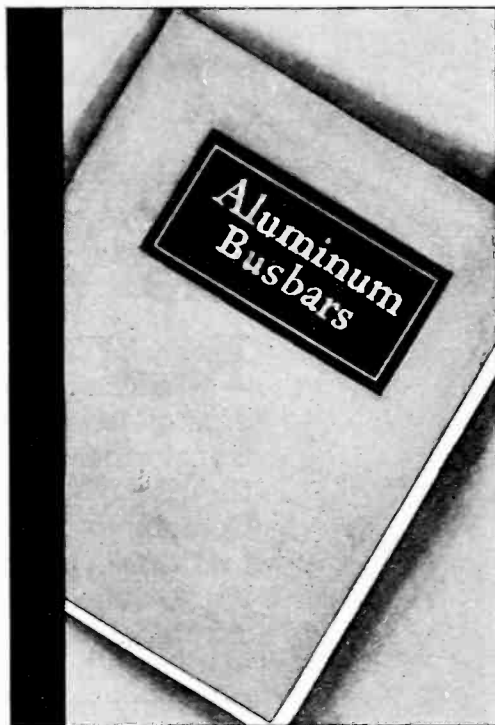

## ALUMINUM



## Busbar

Please mention the JOURNAL of the A. I. E. E. when writing to advertisers.

# BLAZING TRAILS

in the transformer field --

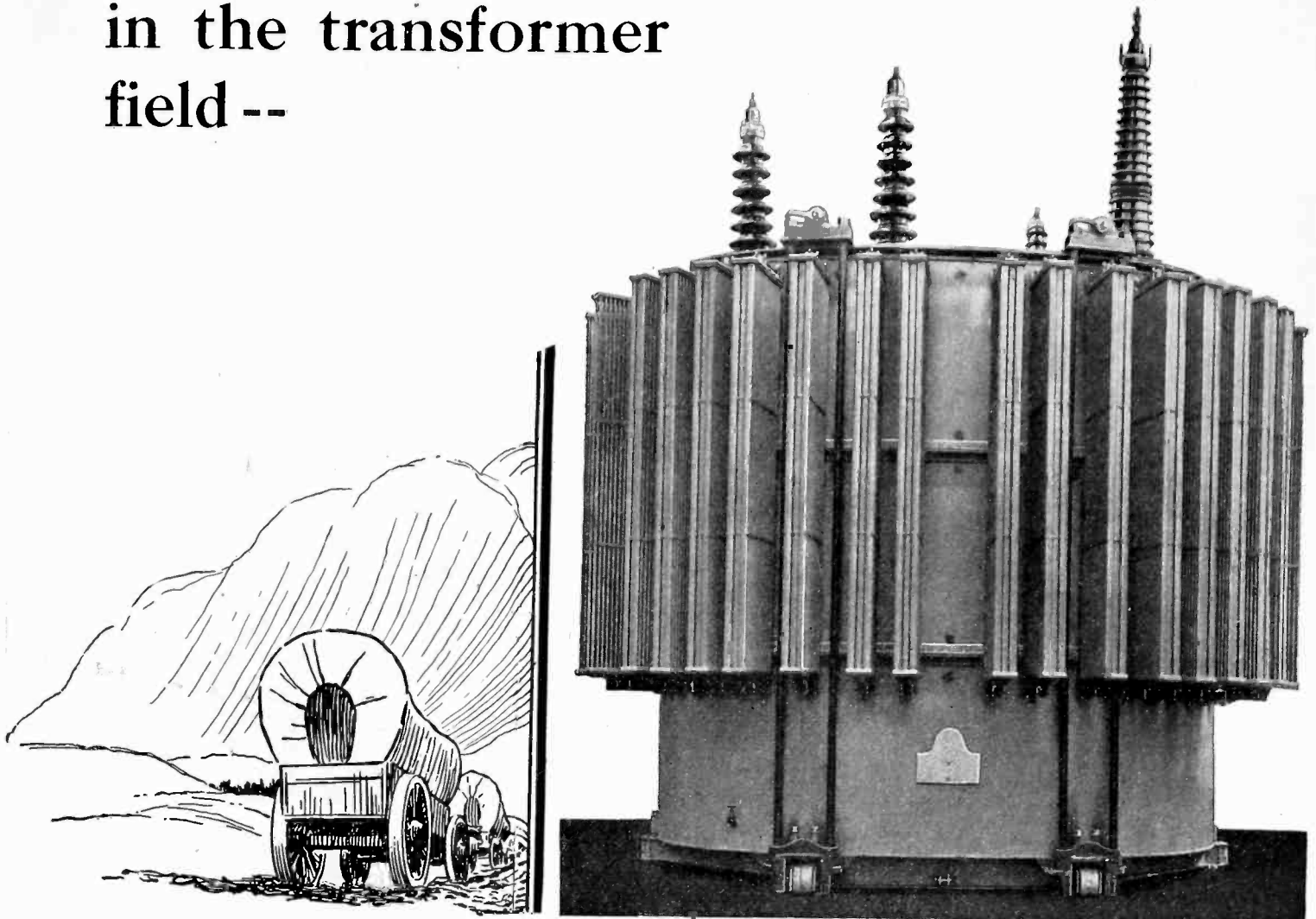

## Again Westinghouse builds the World's Largest Transformers

RECENTLY, the Public Service Electric and Gas Company of New Jersey needed four 30,000-kv-a. transformers to transfer power from the Pennsylvania Power and Light Company's plant at Bushkill, Pa., to their own lines at their Roseland, N. J. substation. Westinghouse was selected for the task of building these huge transformers—transformers larger than any ever before built.

Each transformer is 35 feet high, occupies a floor space 22 by 23 feet and uses more than 32 miles of wire. Although they

are rated at 220,000 volts, these huge transformers were tested at 570,000 volts—the highest test voltage ever applied to a power transformer.

This is but another example of the leadership of Westinghouse in the field of power transformers, a leadership based upon constant research and close association with all phases of modern power distribution.

WESTINGHOUSE ELECTRIC & MFG. COMPANY  
SHARON WORKS SHARON, PENNSYLVANIA

SALES OFFICES AND SERVICE SHOPS IN ALL  
PRINCIPAL CITIES OF THE UNITED STATES



# Westinghouse

T 30775

Please mention the JOURNAL of the A. I. E. E. when writing to advertisers.

# dependable



Single pole, 220 K. V. Edison type switch mfd. by ELECTRIC POWER EQUIPMENT CO. of Philadelphia, Pa., fitted with Monel Metal bolts and installed at Plymouth Meeting Station of the Philadelphia Electric Company.



## Equipment with Monel Metal bolts

### Specified by Philadelphia Electric Company

With the open-mindedness that is characteristic of leaders in the electrical industry, the Philadelphia Electric Co. has been quick to recognize the advantages offered by Monel Metal bolts.

For outdoor switching equipment, where bolts must have a combination of

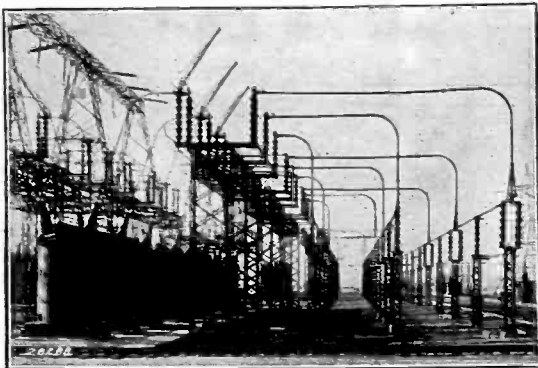

Plymouth Meeting Station of PHILADELPHIA ELECTRIC COMPANY showing installations of Elpeco Monel Metal fitted switches.

high tensile strength with corrosion-resistance, this well known company has specified Monel Metal bolts.

The properties of Monel Metal which make it so desirable for this type of service are:

1. Its high tensile strength (well over 100,000 p. s. i.).
2. Its immunity to rust and its resistance to corrosion-cracking.
3. Its freedom from fatigue failure.
4. Its dependable, rolled uniformity.

In specifying for installations you are naturally desirous of insuring utmost dependability. The record of Monel Metal in outdoor electrical service gives ample proof that Monel Metal bolts will solve some of your troublesome problems.

Write for booklet—"BOLTS THAT WILL NOT FAIL"

## MONEL METAL

Monel Metal is a technically controlled Nickel-Copper alloy of high Nickel content. It is mined, smelted, refined, rolled and marketed solely by The International Nickel Company, Inc. The name "Monel Metal" is a registered trade mark.



THE INTERNATIONAL NICKEL COMPANY, INC., 67 WALL STREET, NEW YORK, N. Y.

Please mention the JOURNAL of the A. I. E. E. when writing to advertisers.

# Strength

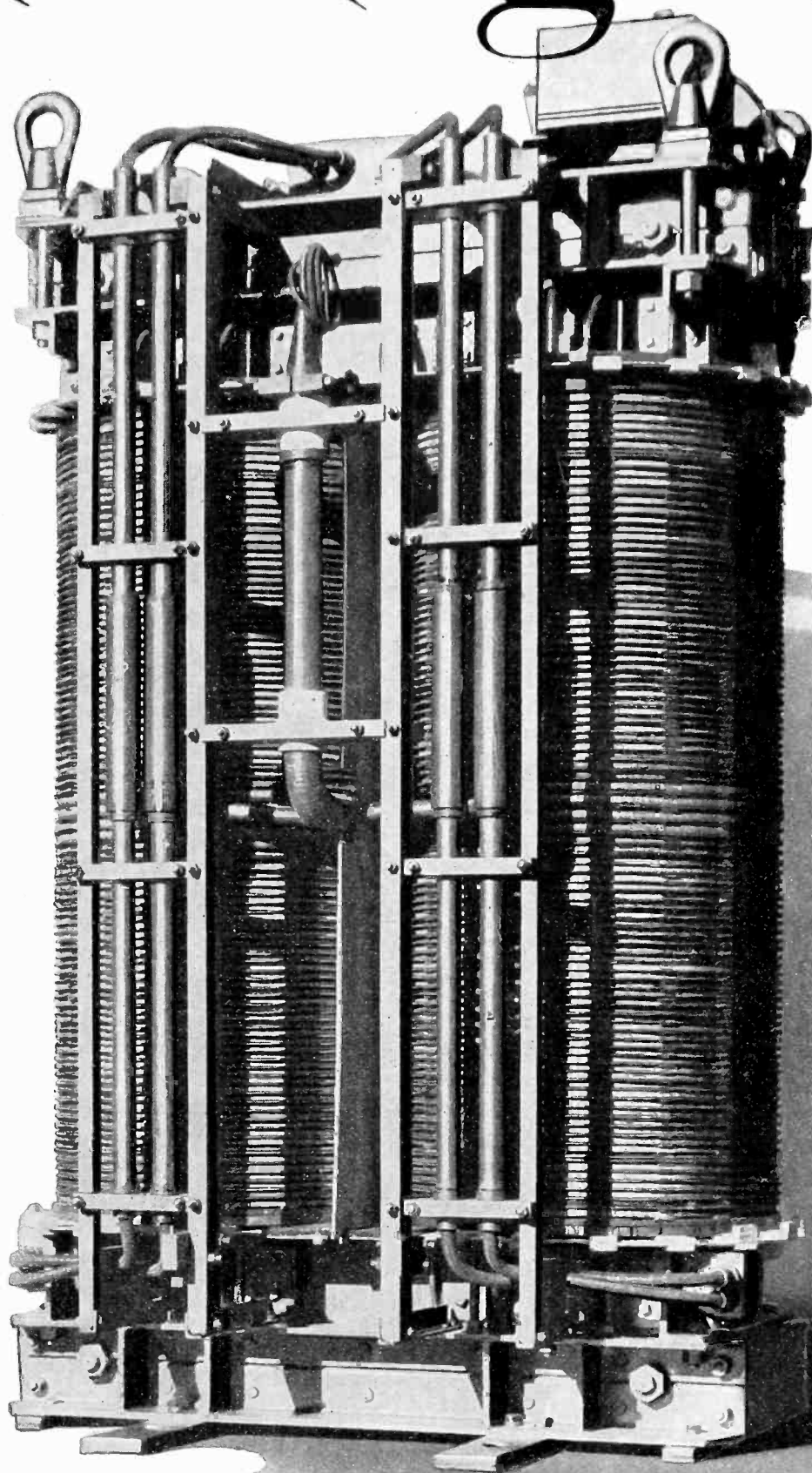

**GENERAL**  
GENERAL ELECTRIC COMPANY, SCHENECTADY, N. Y.

Please mention the JOURNAL of the A. I. E. E. when writing to advertisers.



# *—is inherent in* G-E Circular-Coil Transformers

—and strength in abundance is essential if a transformer is to be relied on for continuous service, unremitting, year after year.

Circular coils, arranged concentrically as in G-E transformers, represent the best design to withstand unusual—

## Electrical Stresses

- because abnormal surge voltages are more evenly distributed on account of the low and uniform capacitance between sections of circular-coil windings and to ground.
- because a simplified type of insulation is used, in the form of cylinders, plates, and flange collars. The material is Herkolite, which has extraordinary strength.
- because the dielectric strength of the turn insulation is not impaired either during winding or in service. The compression forces are low and uniform and, as the coils expand and contract uniformly with changes in temperature, there is no abrasion of the insulation.
- because proper reënforcement of end turns and end coils is more easily and effectively accomplished

## Mechanical Forces

- because all turns are rigidly supported by spacers perpendicular to the conductor. These spacers form a continuous column, transmitting the forces directly to the clamping structure.
- because the short-circuit forces against the high-voltage winding are uniformly distributed and do not tend to distort it.
- because the short-circuit forces against the low-voltage winding are uniform and are easily resisted by the Herkolite cylinder, which is supported by the core leg.
- because requirements of design such as different insulation thickness and taps can be provided with minimum asymmetry and resulting distorting forces.

G-E circular-coil construction makes possible, economically, the highest factors of safety against lightning and short circuits. It makes unnecessary any sacrifice in quality of service to obtain the desired operating characteristics.

Moreover, on account of the superior ventilation obtained with this construction, there are no hot spots to deteriorate the insulation. The original strength is maintained throughout the life of the transformers.

410-18

# E L E C T R I C

S A L E S   O F F I C E S   I N   P R I N C I P A L   C I T I E S

# Transformers

## *Pittsburgh Type*

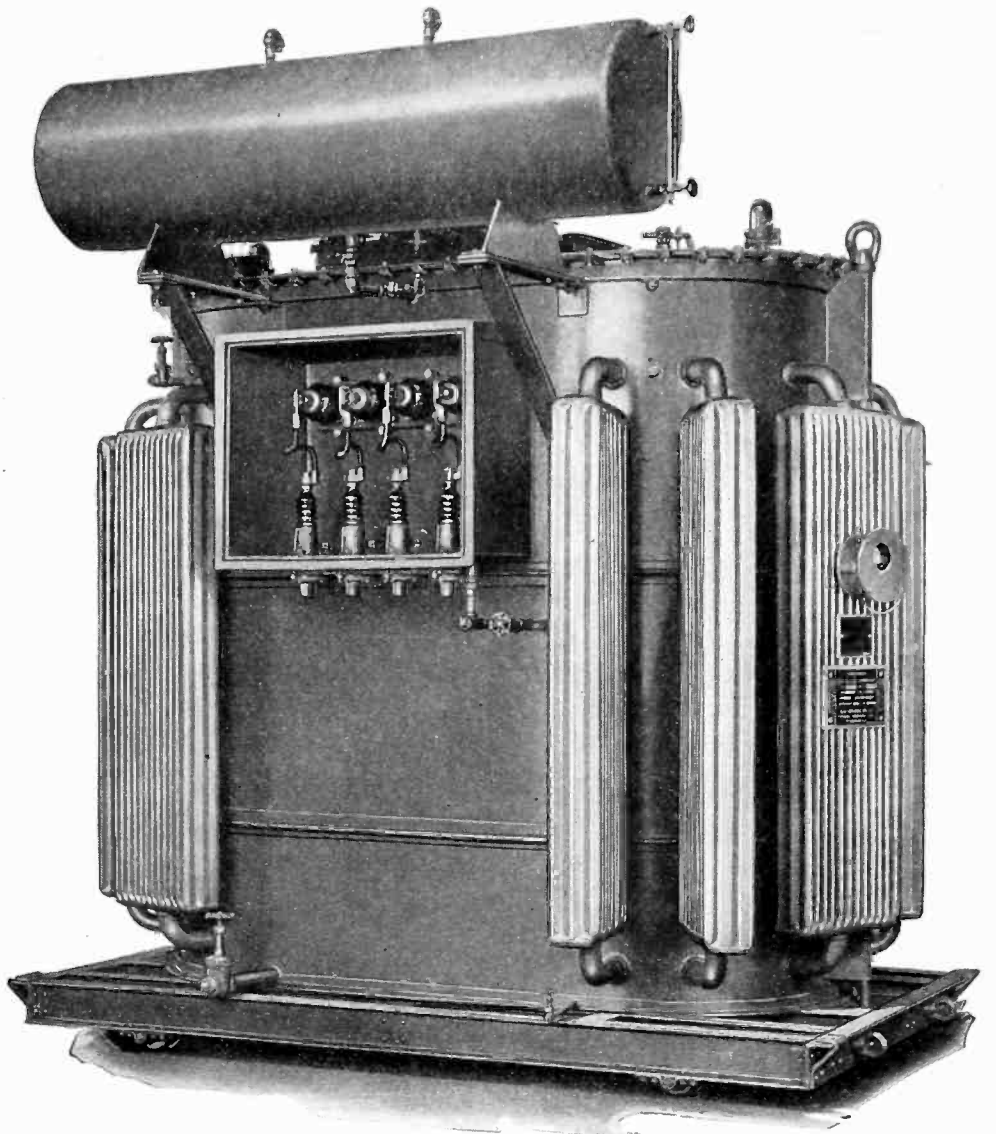

### PRODUCTS

Allis-Chalmers Electrical Machinery includes—Motors for all purposes; A.C. and D.C. Generators; Motor Generator Sets; Transformers; Frequency Changers; Balancers; Boosters; Equalizing Sets; Synchronous Motors and Condensers; Armored Switchgear; and Motor Starters. Power Equipment includes Prime Movers of all types, Condensers, Centrifugal Pumps, and Texrope Drives. Industrial Machinery is built for many basic industries.

**T**HIS 2000-kva., 3 phase, self cooled, outdoor type transformer was built for Union Gas and Electric Company, Cincinnati, Ohio. The high voltage side is rated at 13,200 volts delta and the low voltage side at 2500-4325 volts Y connected. High and low voltage terminals are equipped with potheads for cable connections. Provision is made on tank top for future installation of outdoor type bushings. Other Pittsburgh features include double magnetic circuit core construction, elliptical coils, and rectangular structural steel base.

**ALLIS-CHALMERS MANUFACTURING COMPANY**  
PITTSBURGH TRANSFORMER WORKS—PITTSBURGH, PA.

# ALLIS-CHALMERS

PITTSBURGH TRANSFORMER WORKS

Please mention the JOURNAL of the A. I. E. E. when writing to advertisers.

# Line Reliability and Station Efficiency Demand *Safe* Bushings

WHEN a bushing punctures the system is out. Consequently, it is of utmost importance to see that the bushings on transformers and circuit breakers are capable of performing *safely* when subjected to surges and impacts at abnormal frequencies as well as disturbances at normal frequency.

O-B Bushings give the necessary *safety*, for they do not puncture in service. Let the surge gnaw away at the bushing—for seconds at a time and at relatively high voltages—and after the trouble is over the O-B Bushing will be as *safe* and reliable as before. An O-B bushing will not break down—it will not puncture. Nearly twenty years of service have proved that.

Correctly *balanced design*—the ability to guard against overstress on the inside of the bushing—to provide adequate flashover, and *safety* from puncture—to incorporate ample mechanical strength—that is the outstanding advantage in O-B Bushings.

As a consequence more O-B Bushings are going into service today than ever before. The Manufacturer of Station Equipment and the System Engineer both recognize the extreme importance of *safe* bushings—of O-B Bushings.

Ohio Brass Company, Mansfield, Ohio  
Canadian Ohio Brass Co., Limited  
Niagara Falls, Canada  
1124H

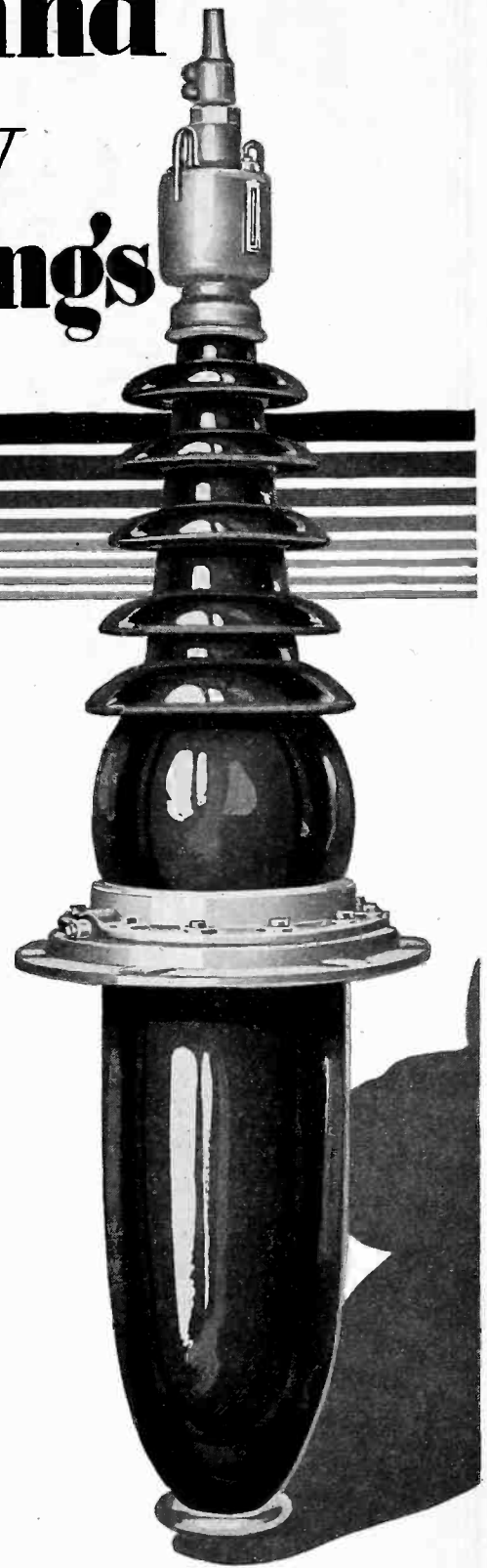

O-B Bushing No. 26720, illustrated above is representative of the complete O-B line of both oil-filled and dry type bushings which are listed on pages 314 to 373 of O-B Catalog No. 20.

# Ohio Brass Co.

NEW YORK PITTSBURGH  
PHILADELPHIA BOSTON

CHICAGO CLEVELAND ST. LOUIS ATLANTA  
SAN FRANCISCO LOS ANGELES DALLAS

PORCELAIN  
INSULATORS  
LINE MATERIALS  
RAIL BONDS  
CAR EQUIPMENT  
MINING  
MATERIALS  
VALVES

Please mention the JOURNAL of the A. I. E. E. when writing to advertisers.

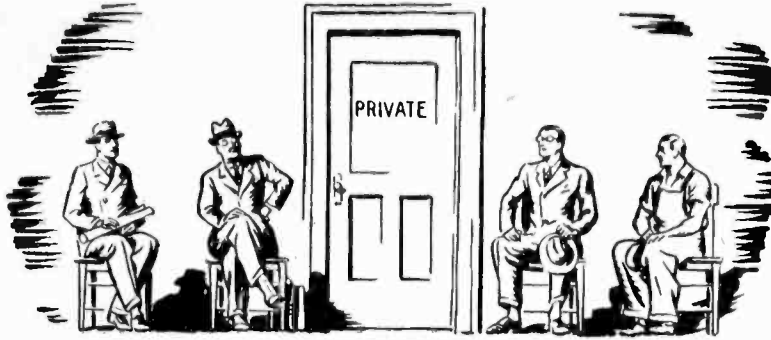

# Our service "at your door"

WHEN our trained field representatives call, *or are called in*, they come to you fully prepared. They are trained to grasp your problem or needs quickly. They are thoroughly versed in the experience and capacity of Standard's engineering and manufacturing facilities.

Standard representatives do not waste your time by asking for unnecessary explanations. Your concise statement of your needs enables them to set our whole organization to work on your requirements.

Quality is assured. Everyone in our organization is impressed with the vital need for quality in every wire and cable. And by maintaining an unvarying high quality, Standard products have established an enviable record.

May we tell you more about our company and its products? We will be glad to have your inquiry for engineering service, for specifications, or for prices, on all types of wires and cables—*aerial, underground or submarine.*

STANDARD UNDERGROUND CABLE COMPANY

*Division of General Cable Corporation*

Perth Amboy, N. J.

# STANDARD UNDERGROUND \* CABLE COMPANY \*

Please mention the JOURNAL of the A. I. E. E. when writing to advertisers.



# A Lineman's View of DOSSERTS

$\frac{E}{I} = R$

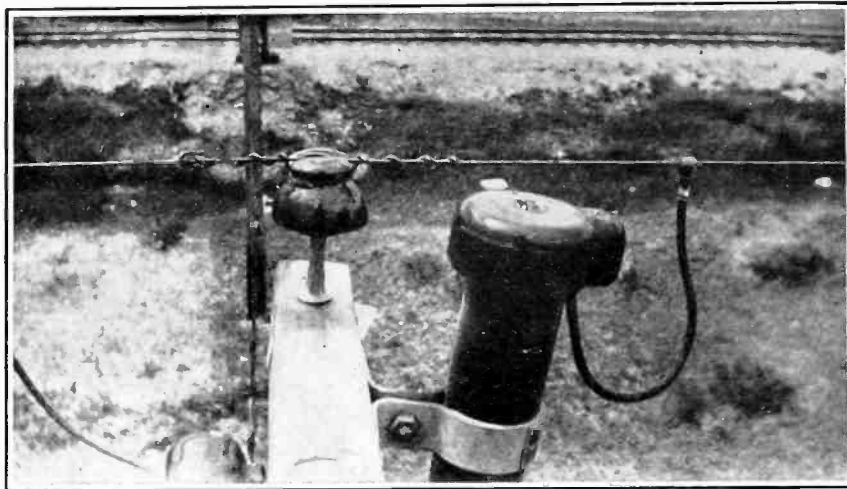

This view taken from the top cross arm shows one of 1500 DOSSERTS installed on lines of Los Angeles and Salt Lake Railroad Company (Union Pacific System).

This Dossert year book gives data on dozens of connections on which linemen and wiremen can save time and provide dependable joints.

FOR 20 years engineers have found DOSSERTS a means for economical and dependable connections and terminals for wires, cables, rods or tubing.

The reason for the choice of Dosserts is purely an engineering one i.e.—the Dossert tapered sleeve principle.

But the lineman's view of the Dossert is always that it saves time and labor in the effort to make good connections.

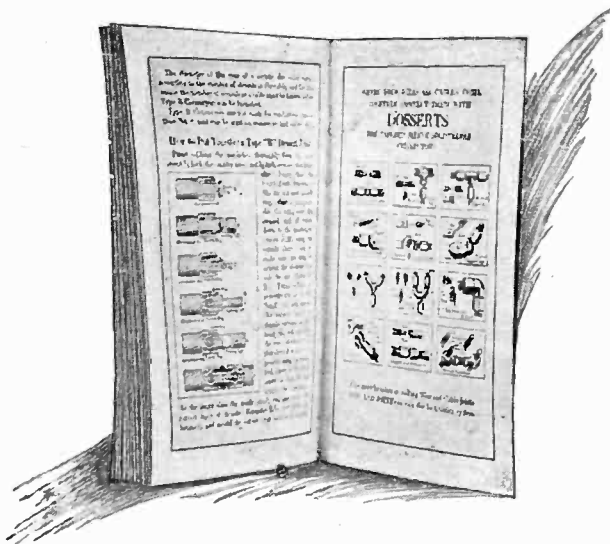

DOSSERT & COMPANY, H. B. LOGAN, *President*, 242 West 41st St., New York

# DOSSERTS

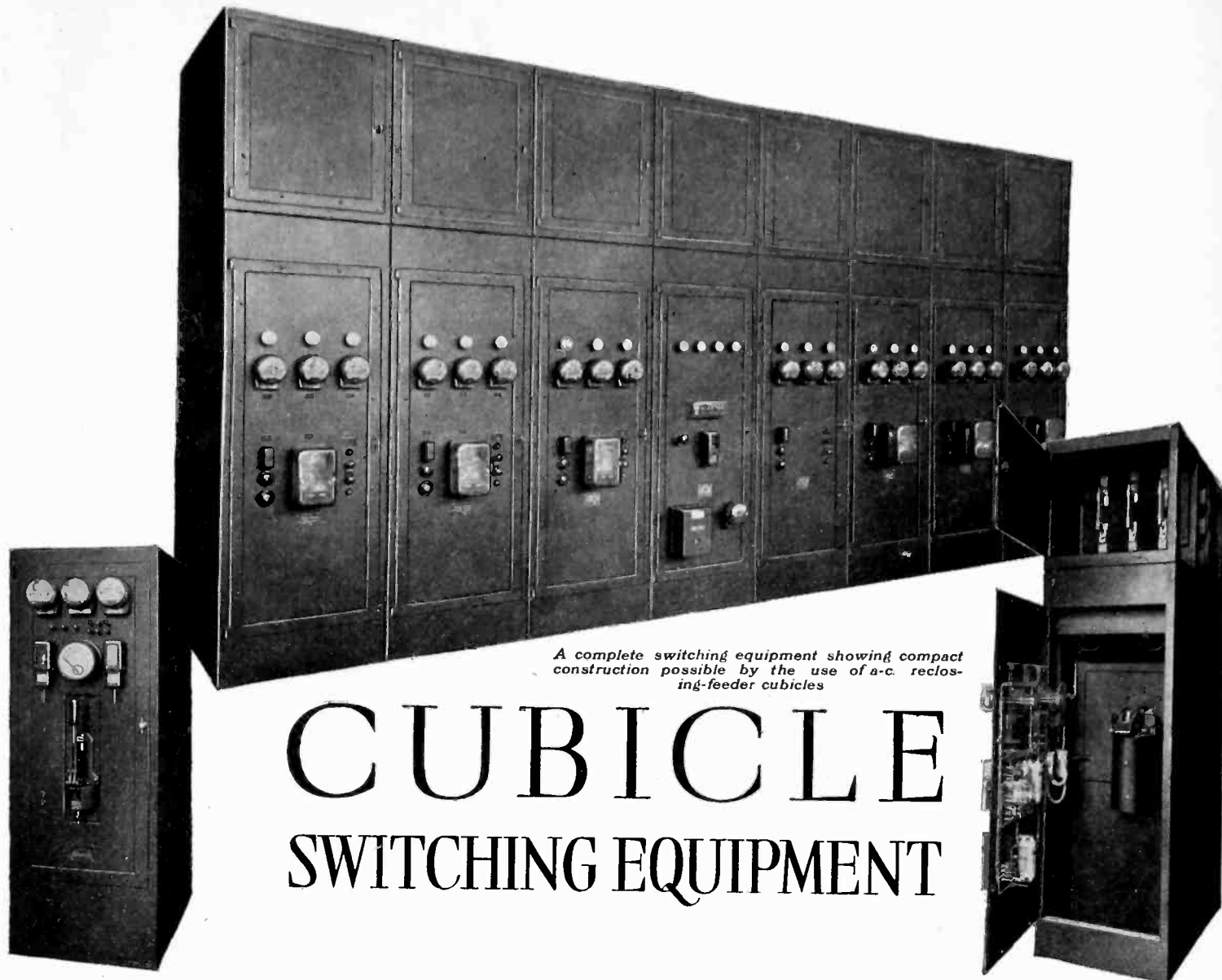

*A complete switching equipment showing compact construction possible by the use of a-c. reclosing-feeder cubicles*

# CUBICLE SWITCHING EQUIPMENT

*A complete unit without superstructure, ready for installation*

**S**ELF-SUPPORTING indoor steel cubicles for housing a-c. switching equipment are rapidly gaining in favor. They are easy to install and occupy only a small amount of floor space. Each unit is constructed of flanged sheet steel with doors front and rear, which give full access to all wiring devices. They are dust- and vermin-proof. Units can be mounted in a row to form a complete switching equipment.

*A cubicle with superstructure showing accessibility of wiring*

These cubicles are available for voltages up to 7500 and are suitable for both machine and feeder control. They are shipped completely assembled and ready to install. For further information, write to the nearest G-E office for a copy of GEA-1137.



460-41

JOIN US IN THE GENERAL ELECTRIC HOUR, BROADCAST EVERY SATURDAY AT 9 P.M., E.S.T. ON A NATION-WIDE N.B.C. NETWORK

# GENERAL ELECTRIC

GENERAL ELECTRIC COMPANY, SCHENECTADY, N. Y., SALES OFFICES IN PRINCIPAL CITIES

Please mention the JOURNAL of the A. I. E. E. when writing to advertisers.

# 44 KV Cable Transmission Efficiency

(Cable Buried in 1,000-ft. Lengths)

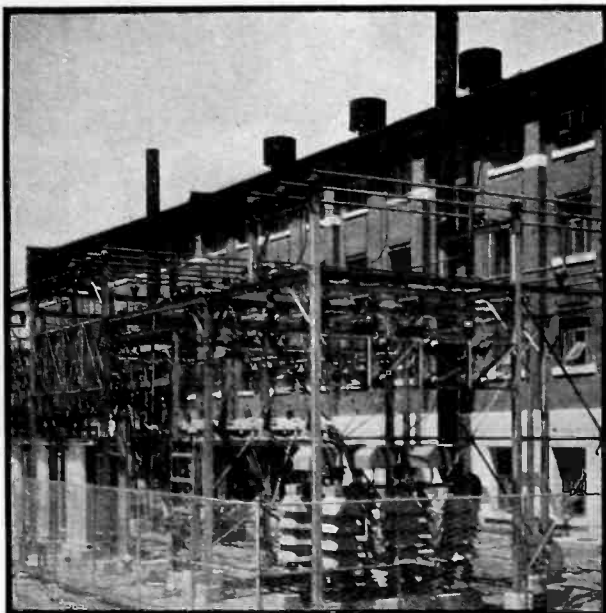

Tennessee Coal, Iron & Railroad Company Power Station, Birmingham, Ala.



A pamphlet illustrating and describing details of this installation awaits your request. Write office nearest you.

Individually Leaded Three-Conductor Paper Insulated Underground Power Cable for 44,000 Volt 3-Phase Operating Potential, made by American Steel & Wire Company.



Single Conductor Pothead—Three at end of each cable.

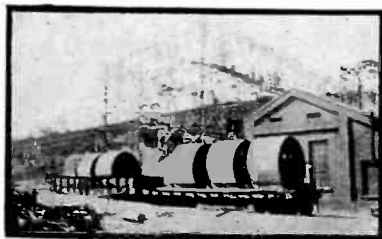

Cable Reels arriving at the Tennessee Power House.

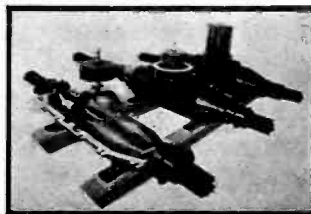

Single Conductor Joints with Oil Reservoirs and Cast Iron Housing.



Cables in ground prior to back filling.

The above illustrations point the way to securing (over all) transmission economy and high efficiency by: (a) *Eliminating conduits and manholes*—using American Steel and Wire Buried Cable. (b) *Cutting down number of joints*—installing cable in 1000 ft. lengths. (c) *Transmitting at high voltage*—44KV carried by three-conductor American Steel and Wire Buried Cable.

## American Steel & Wire Company

Subsidiary of United States Steel Corporation

208 South La Salle St., Chicago

30 Church St., New York

Other Sales Offices: Atlanta Baltimore Birmingham Boston Buffalo Cincinnati Cleveland Dallas Denver Detroit Kansas City  
Memphis Milwaukee Minneapolis-St. Paul Oklahoma City Philadelphia Pittsburgh Salt Lake City St. Louis Wilkes-Barre Worcester  
U. S. Steel Products Co.: San Francisco Los Angeles Portland Seattle Honolulu  
Export Distributors: United States Steel Products Co., 30 Church St., New York City

Please mention the JOURNAL of the A. I. E. E. when writing to advertisers.



800,000 ADDITIONAL TELEPHONES ARE GOING INTO USE THIS YEAR

## A million and a half dollars a day

*An Advertisement of the  
American Telephone and Telegraph Company*

MORE than 200 new Bell telephone buildings are going up this year in the United States, 800,000 additional telephones are going into use and new switchboards to care for 3,000,000 additional calls a day.

Thousands of miles of new cable, millions of miles of wire, new carrier systems, vacuum tubes and loading coils. These are a few of the things in the 1929 construction and improvement program of the Bell System which will cost more than 550 million dollars—a million and a half a day.

Telephone growth is essential to the new American civilization of better opportunity for the average man. The Bell System employs more than 400,000 workers,



is owned by 450,000 stockholders, and serves the people of the nation.

Every day the Bell System is extending its lines to more people, increasing the speed and accuracy of its service, giving greater comfort and convenience in telephone use. All of this is done that each individual may get the most from this means of all inclusive and instantaneous communication and that the nation may be one neighborhood.

This is part of the telephone ideal that anyone, anywhere, shall be able to talk quickly and at reasonable cost with anyone, anywhere else. There is no standing still in the Bell System.





THE high conductivity and uniform quality of Anaconda Metals are the result of the co-ordinated supervision by a single organization of every process from ore to finished product. Seven wire mills offer a coast-to-coast service unequalled for promptness and dependability.

# This Paper Insulated Lead Sheathed Power Cable was installed in 1897

*1929 finds it still operating*

LEAD power cable, to serve thirty-two years, despite service conditions undreamed of at the time of its installation, must be well made. There's one in Minneapolis with such a service record. The Twin City Rapid Transit Company, of that city, has some one hundred and six miles of 13 KV paper-insulated cable, much of which has been in daily operation for thirty-two years.

This is a tribute to the manufacturing skill of the National Conduit & Cable Company, Hastings-on-Hudson, N. Y., now the Hastings Mill of Anaconda Wire & Cable Company.

This plant, prominent for many years in the field of cable manufacture, is now being completely re-equipped with modern facilities for the production and testing of low, medium and high tension cables.

The new equipment will include stranding and insulation machinery of the latest type—drying and impregnating apparatus incorporating desirable new features—lead presses capable of producing the highest quality of lead sheath covering and a most complete high voltage testing Laboratory.

Constant scientific investigation will also be an important phase of the work at the Hastings Mill. The Company will be glad to furnish complete information concerning the plant and its products.

**ANACONDA WIRE & CABLE CO.**

General Offices: 25 Broadway, New York

Chicago Office: 111 West Washington Street

Exclusive Selling Agent for Wire and Cable Products of  
THE AMERICAN BRASS COMPANY

# ANACONDA WIRE PRODUCTS

Please mention the JOURNAL of the A. I. E. E. when writing to advertisers.



*Handwritten signature or initials, possibly 'F. K. ...' and '1929'.*

# STONE & WEBSTER

I N C O R P O R A T E D

STONE & WEBSTER ENGINEERING CORPORATION

STONE & WEBSTER AND BLODGET, INCORPORATED

STONE & WEBSTER SERVICE CORPORATION

STONE & WEBSTER ASSOCIATES CORPORATION

STONE & WEBSTER INVESTING CORPORATION

---

Organization—Financing

---

Underwriting and  
Distribution of Securities

---

Design—Construction

---

Management

---

Reports—Appraisals

# ..Continuous Power

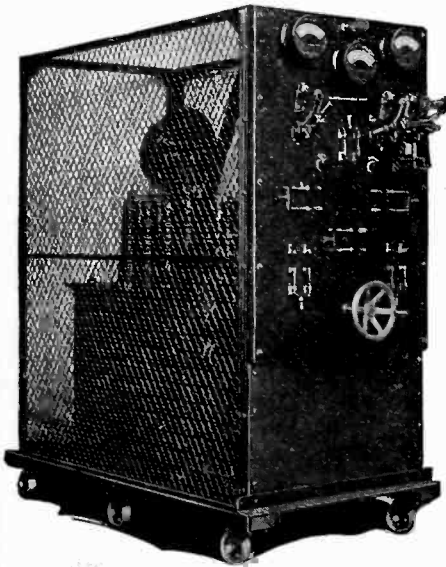

TS-10A Test Set

5 to 25 KVA, 220 primary, 60 cycle; 12,500 / 25,000/50,000/5,000/2,500/1,250 secondary. This set has two high voltage transformers (one a main testing transformer, the other an auxiliary testing transformer). Controlled by induction regulator.

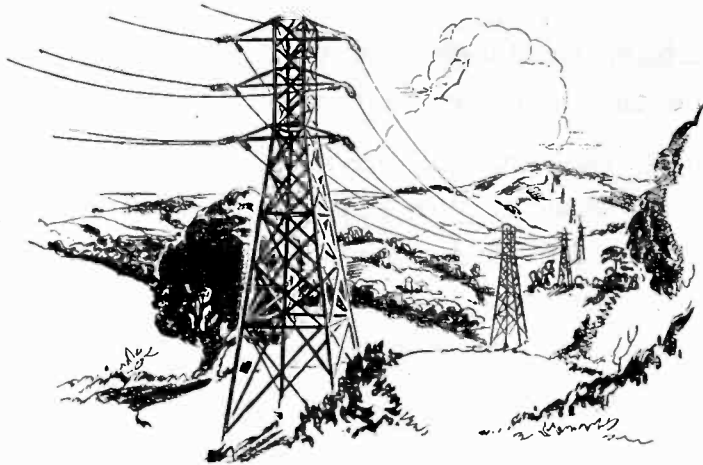

*—the reward of  
constant testing  
of materials*

The TS-10A Transformer is a complete testing set for all commercial and laboratory tests from 500 to 50,000 volts. Originally it was designed by American Transformer engineers for one\* of the world's largest cable manufacturers. With modifications and improvements suggested by experience in operation it has become standard equipment for makers of cable, insulation, electrical apparatus, and for power company laboratories.

Quickly and easily adjusted to all voltage requirements ranging from 500 to 50,000 volts, the TS-10A Test Set saves valuable time, and, often, the cost of additional testing apparatus.

For a smaller range of voltage requirements the TS-2 Set is equal in performance to the larger TS-10A. We recommend the TS-2 for testing from 10,000 to 50,000 volts as less expensive and fully as satisfactory.

Complete information about these and other special industrial transformers is contained in our Bulletin 1130, which will be mailed to you on request.

There is an American Transformer for every laboratory and industrial application.

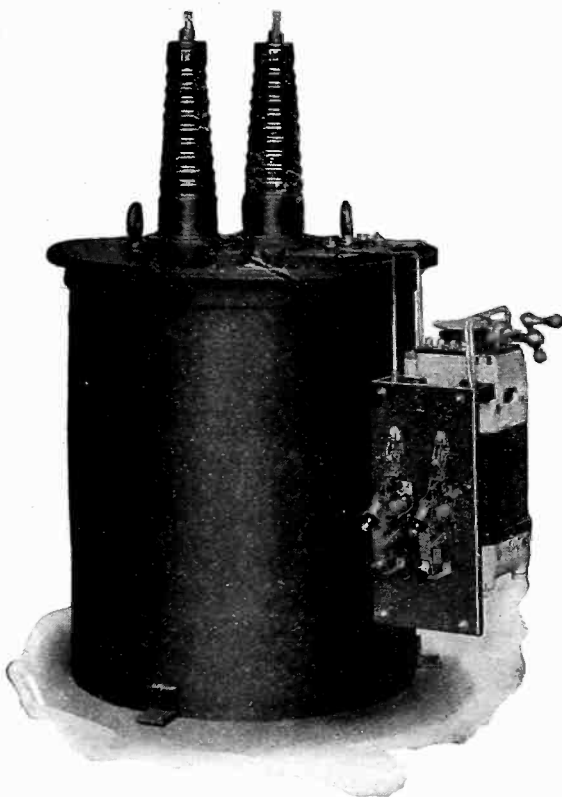

TS-2 Test Set

2 to 5 KVA, 110/220 primary, 60 cycle; 50,000 volts secondary. Controlled by induction regulator.

## AMERICAN TRANSFORMER COMPANY

178 Emmet Street

Newark, N. J.

\*Name given on request.

### Representatives

Atlanta, Ga.—H. Douglas Stier, 101 Marietta Street

Chicago, Ill.—L. C. Hermann, 4433 North Richmond Street, Ravenswood Station

Knoxville, Tenn.—Arthur L. Pollard

Minneapolis, Minn.—Elliott Equipment Co., 708 Sixth Avenue, South

Montreal, Canada—W. O. Taylor & Co., Ltd., 415 Canada Cement Bldg.

Philadelphia, Pa.—L. D. Joralemon, 112 South 16th Street

San Francisco, Calif.—James H. Southard, 682 Mission Street

St. Louis, Mo.—J. W. Jones, 432 Pehnant Building

# AMERICAN TRANSFORMER

Please mention the JOURNAL of the A. I. E. E. when writing to advertisers.

# What...and How Much?

**I**nstrument transformers affect directly the performance of meters and the safety of operators. If they give trouble on important lines they may even interfere with the continuity of service.

Some installations require practically perfect accuracy . . . Sangamo two-stage is in order. Some require ability to withstand heavy surges . . . Sangamo Type LA. Many require high accuracy with extra heavy burden . . . Sangamo Types F and G. In some cases relays are operated from the same transformer . . . Sangamo double secondary separates the meters from the relays.

Sangamo engineers recognize the commercial requirements of the various classes of service, power and super-power stations, substations, industrial plants, and transformers meeting all these requirements are included in the Sangamo line.

Write for Bulletin 65 for complete description of performance characteristics.

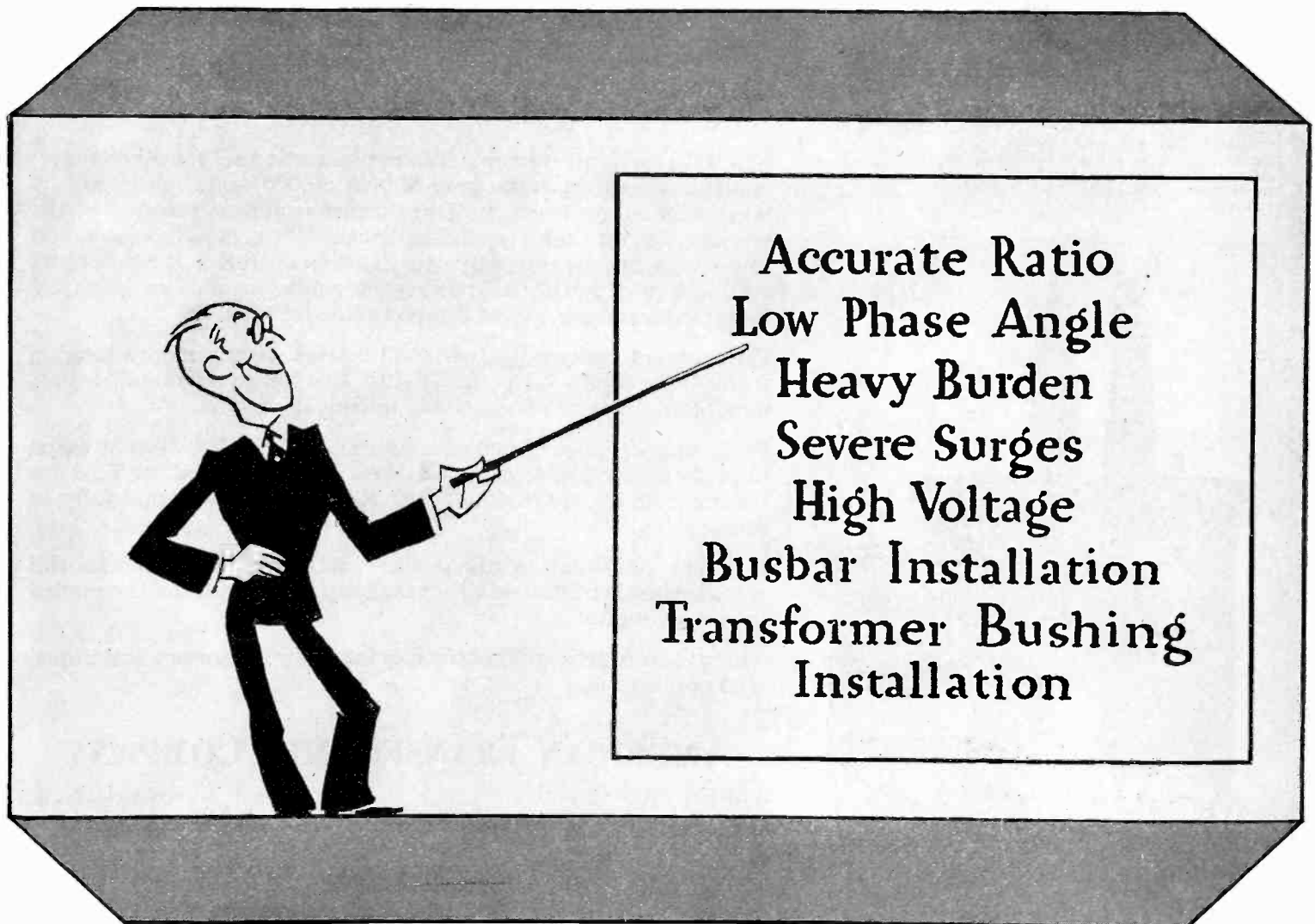

# SANGAMO

**ELECTRIC COMPANY • • • SPRINGFIELD, ILLINOIS** 86-8331-15

Please mention the JOURNAL of the A. I. E. E. when writing to advertisers.



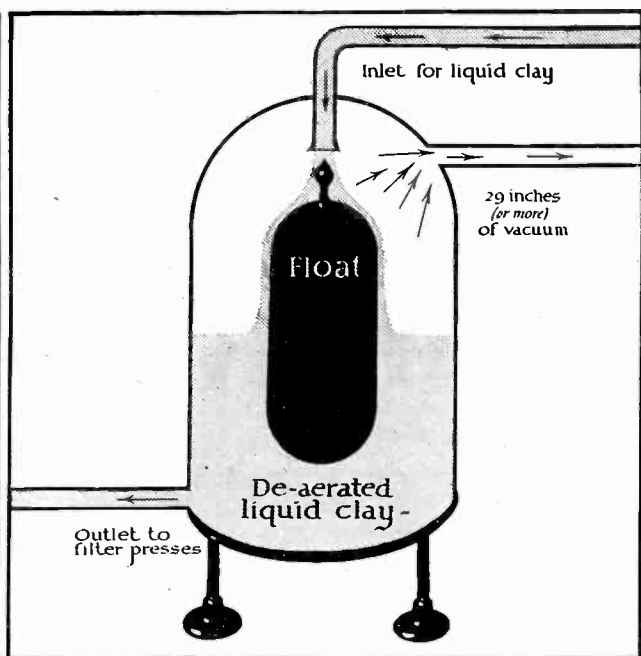

Here's how the Lapp Vacuum Process acts

## Permanence ex Vacuo

**W**ATER contains dissolved air. Water is mixed with clay for making insulators. Therefore the clay mixture contains dissolved and occluded air. By the heat of mixing and fabricating, minute air-bubbles are generated and mixed into the clay. Result: weaknesses which ultimately may cause insulator cracking and failure.

Now note how simply this is overcome by the Lapp Vacuum Process (patented). The liquid clay is subjected to a high vacuum. The air actually boils out—all of it. In two seconds the clay is aged more than by 100 years of the old method.

Insulators made of such clay are free from laminations, blebs, checks, lack of plastic bond and other ills. They carry up to 220,000 volts indefinitely, regardless of atmospheric conditions, without failure or trouble of any kind. Such porcelain excels in uniformity and electrical and mechanical strength.

*With Lapp Insulators line maintenance costs  
come down and stay down*



No. 6173  
66,000 volts  
Standard Pin Type



**LAPP INSULATOR CO. INC. LEROY, N.Y. U.S.A.**

# FERRANTI TRANSFORMERS



30,000 K. V. A., 132,000 Volts, three phase transformer  
supplied for the British Super Power System

**FERRANTI, INC.**  
130 W. 42nd Street  
New York

**FERRANTI, LTD.**  
Hollinwood  
England

**FERRANTI ELECTRIC  
Limited**  
Toronto, Canada

# LOCKE

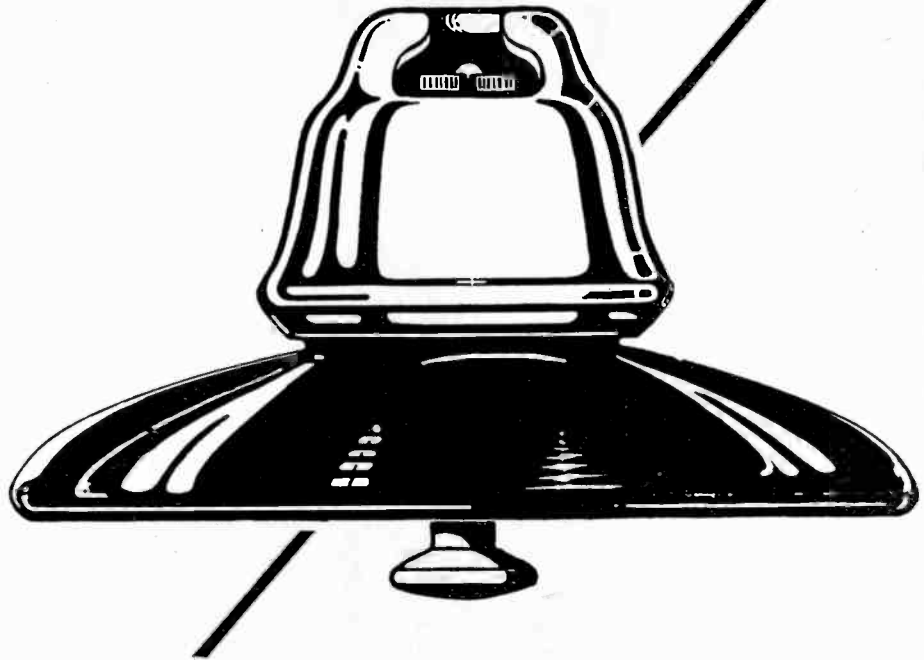

In nineteen hundred and four Locke made and catalogued the first cap and pin type insulator. Since then tremendous strides, both in design and materials, have kept Locke Suspension Type Insulators in the forefront for high quality and utmost reliability.

Locke 18400 Insulator is a combination of ample mechanical strength, high electrical values and extreme ruggedness. Construction engineers readily appreciate the quicker, easier handling which Locke design makes possible. It is nothing unusual for an entire transmission line using Locke insulators to be erected without a single case of insulator breakage. And trouble after installation is unknown.

LOCKE INSULATOR CORPORATION  
BALTIMORE MARYLAND

# PORCELAIN INSULATORS

Please mention the JOURNAL of the A. I. E. E. when writing to advertisers.

# Chandeysson

## Generators 25 to 25,000 Amperes

Direct Connected to



## Motors

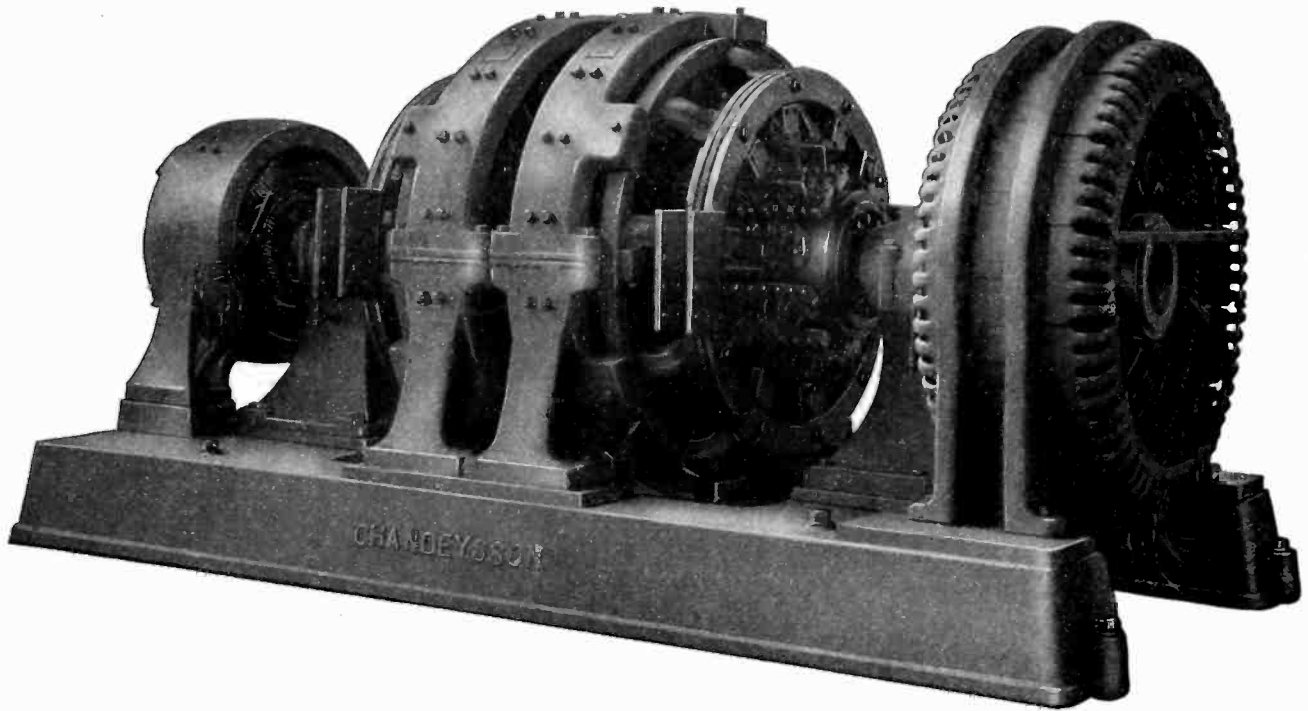

## TWIN GENERATOR TYPE

- 1 Greater Flexibility
- 2 Higher Efficiency
- 3 Floor Economy
- 4 Lower Cost

Write for Bulletin 114

CHANDEYSSON ELECTRIC CO., St. Louis, U. S. A.



*Chandeysson*

**Generators**  
25 to 25,000 Amperes

Direct Connected to



**Motors**

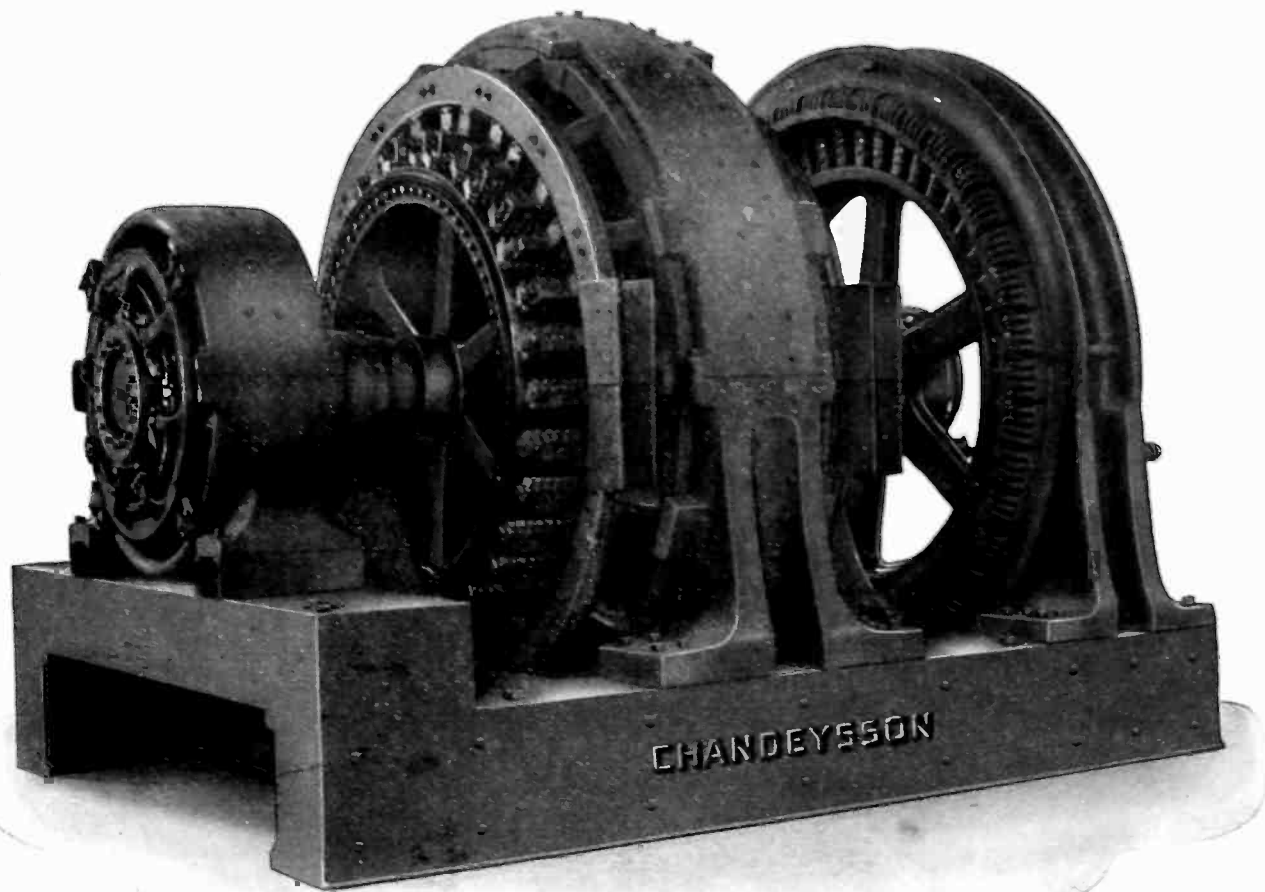

**20,000 AMPERES 12 VOLTS UNIT**

**WEIGHT 85,600 POUNDS**  
**FABRICATED STEEL SUB-BASE**

CHANDEYSSON ELECTRIC CO., St. Louis, U. S. A.

# The *Efficiency* of Permanent Wiring with the *Speed* of Temporary Wiring

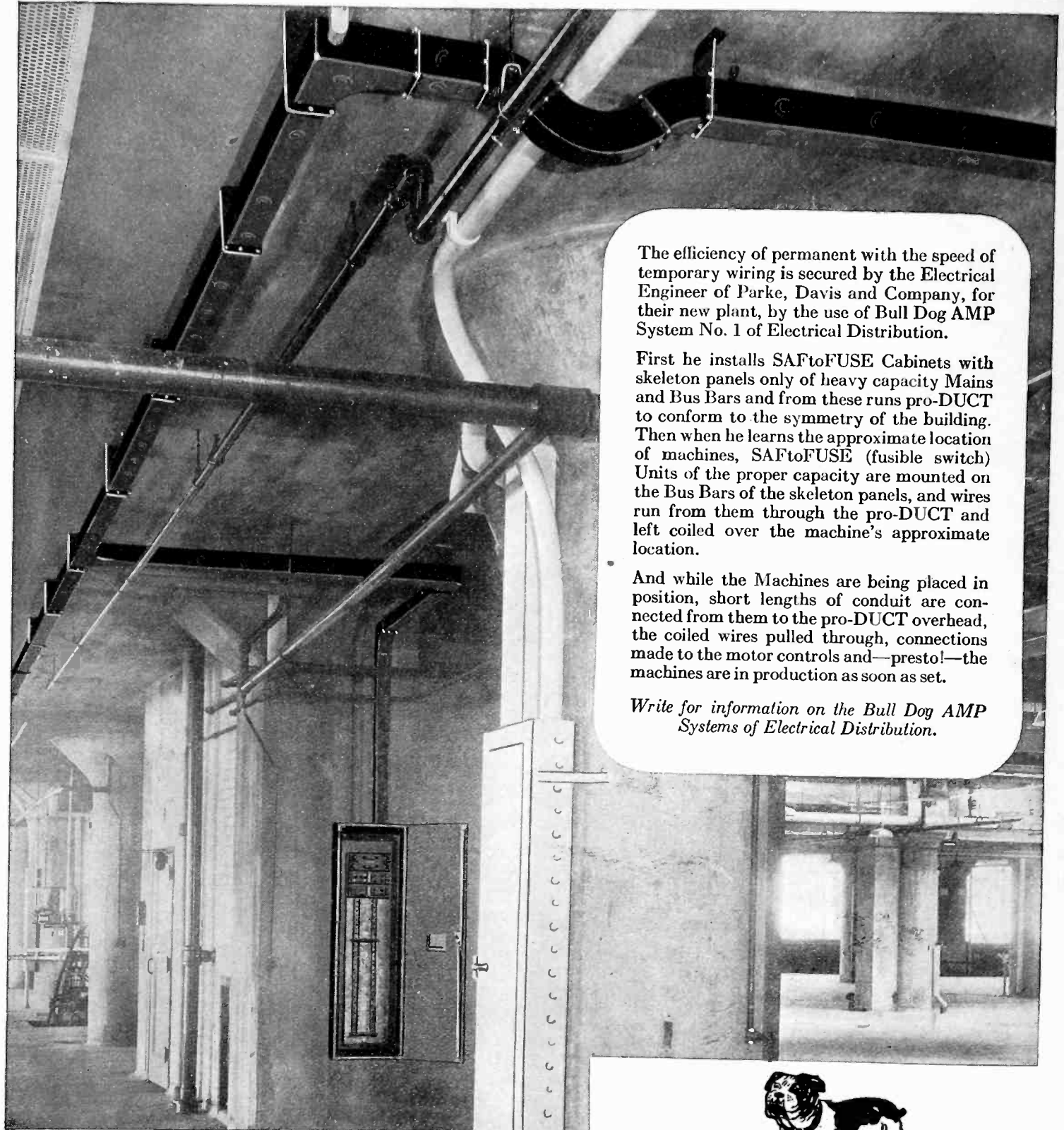

The efficiency of permanent with the speed of temporary wiring is secured by the Electrical Engineer of Parke, Davis and Company, for their new plant, by the use of Bull Dog AMP System No. 1 of Electrical Distribution.

First he installs SAFtoFUSE Cabinets with skeleton panels only of heavy capacity Mains and Bus Bars and from these runs pro-DUCT to conform to the symmetry of the building. Then when he learns the approximate location of machines, SAFtoFUSE (fusible switch) Units of the proper capacity are mounted on the Bus Bars of the skeleton panels, and wires run from them through the pro-DUCT and left coiled over the machine's approximate location.

And while the Machines are being placed in position, short lengths of conduit are connected from them to the pro-DUCT overhead, the coiled wires pulled through, connections made to the motor controls and—presto!—the machines are in production as soon as set.

*Write for information on the Bull Dog AMP Systems of Electrical Distribution.*

BULL DOG ProDUCT, SAFtoFUSE feeder and Unit-Versal Lighting panels, as installed in Parke, Davis & Co. plant, Detroit, Michigan. John G. Plasko, Electrical Engineer.

BULL DOG ProDUCT is the original duct. It was first designed by BULL DOG and miles of it sold over 5 years ago.

**BULL DOG ELECTRIC PRODUCTS CO.**  
DETROIT, MICH.

Please mention the JOURNAL of the A. I. E. E. when writing to advertisers.



**BULL DOG**  
**AMP**  
APPARATUS for MASS PRODUCTION  
Patents applied for

# ROCKBESTOS

*-the asbestos covered wire*

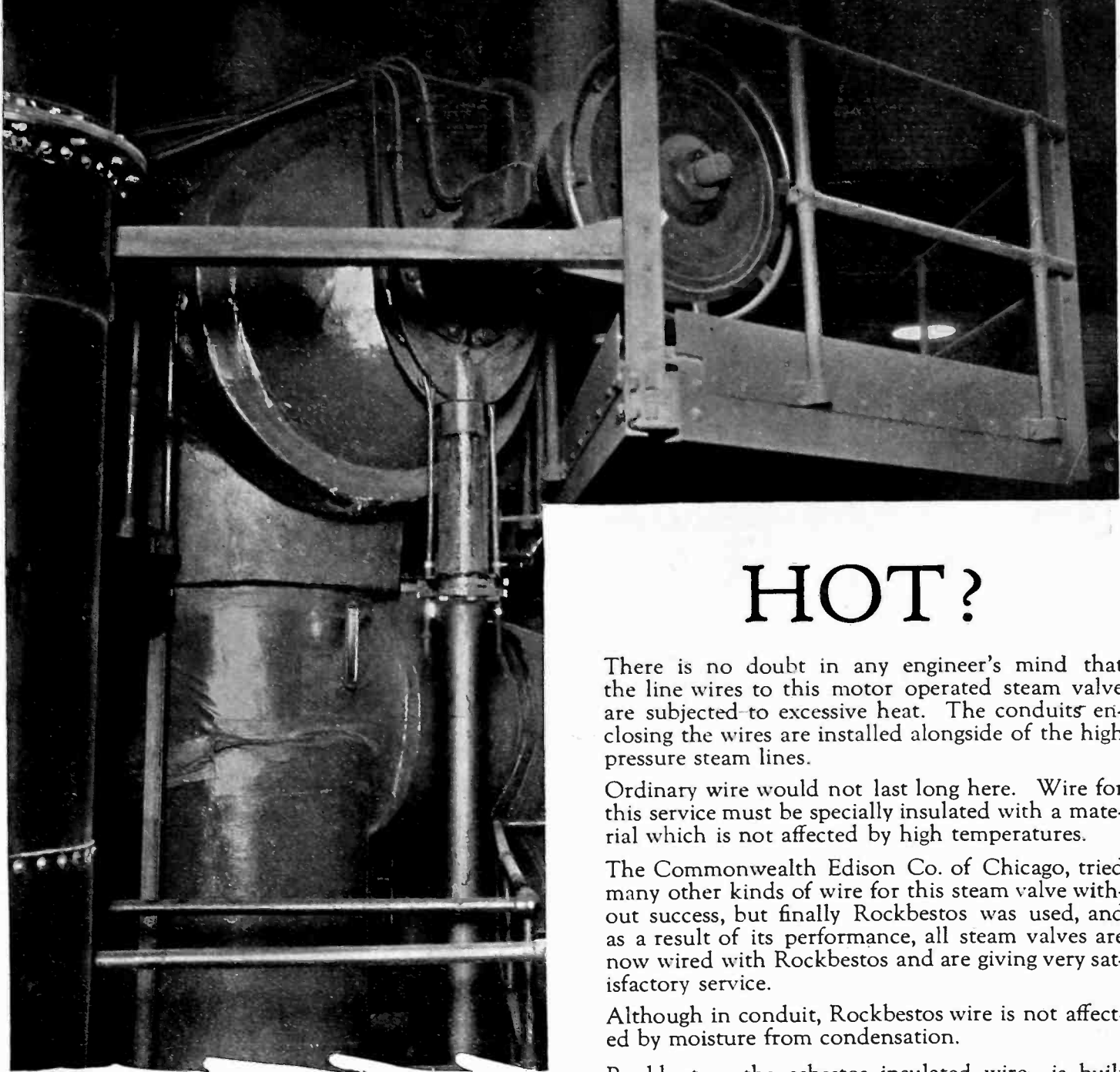

## HOT?

There is no doubt in any engineer's mind that the line wires to this motor operated steam valve are subjected to excessive heat. The conduits enclosing the wires are installed alongside of the high pressure steam lines.

Ordinary wire would not last long here. Wire for this service must be specially insulated with a material which is not affected by high temperatures.

The Commonwealth Edison Co. of Chicago, tried many other kinds of wire for this steam valve without success, but finally Rockbestos was used, and as a result of its performance, all steam valves are now wired with Rockbestos and are giving very satisfactory service.

Although in conduit, Rockbestos wire is not affected by moisture from condensation.

Rockbestos—the asbestos insulated wire—is built by specialists, and they can help you to solve your problems.

*Rockbestos wires and cables are now accepted by many Industrial Plants as standard for high temperature applications.*

*Bulletins covering our asbestos insulated wires sent on request.*

**ROCKBESTOS PRODUCTS**  
C O R P O R A T I O N  
NEW HAVEN, CONN.

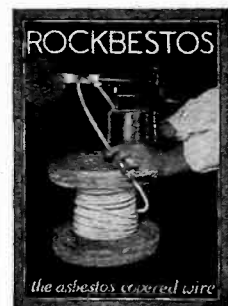

5942 Grand Central Term. Bldg., New York

903 Clark Bldg., Pittsburgh, Pa.

224 Madison Term Bldg., Chicago

On the Pacific Coast—Anaconda Wire & Cable Co.

Please mention the JOURNAL of the A. I. E. E. when writing to advertisers.

◆◆ BEHIND THE PYRAMIDS—11 ◆◆



# Ready to fill your orders on receipt



*Sawing and grinding room*

WHEN the furnaces are opened after the graphitizing process, the brush blocks are taken out and cleaned. These are now the semi-finished material from which brushes are made, by sawing and grinding to accurate dimensions.

But before these blocks are put into stock, they are tested thoroughly, for electrical resistance, density and hardness, undergoing the same scientific scrutiny that has been applied to all previous manufacturing operations.

Stocks of these blocks, in all grades, are carried in all our factories. Thus, on receipt of an order, finished brushes can be produced quickly by taking brush blocks from these stores, sawing them to approximate

dimensions with special carborundum saws and then grinding to tolerances of a few thousandths of an inch on accurate automatic grinding machines.

Where shunts are required additional machinery operations are necessary, before the brushes are ready to receive the copper cable attachment.

Over 60 days have passed since the lampblack was first manufactured for these brush blocks and brushes. About 36 major operations have been carried out, and innumerable minor ones. Scientific tests and controls have been applied at every step. The brush blocks that have been approved by our laboratory and inspection staff are now put into stock awaiting your orders.

*An interesting moving picture film illustrating in detail the processes used in the manufacture of carbon brushes will gladly be shown on request to any organization of engineers, or students.*

**NATIONAL CARBON COMPANY, INC.**

Unit of Union Carbide  and Carbon Corporation

Carbon Sales  
Division



Cleveland, Ohio

*Branch Offices and Factories*

New York Pittsburgh Chicago Birmingham San Francisco

Please mention the JOURNAL of the A. I. E. E. when writing to advertisers.





$\frac{3}{4}$  Horse Power Century Type SC  
Squirrel Cage Induction 3 and 2 Phase Motor

## **Long Life Bearings Protected Against Abrasive Wear**

The long bearing life of Century Fractional horse power 3 and 2 Phase Motors is due to their being equipped with tight-fitting dust cap and dust collars, which make the bearing housings as nearly dust-tight as it is possible to build them. They remain so throughout the life of the motor . . . Flying particles of dust and dirt cannot reach the bearing surfaces through the oil wells, because of the filtering action of the continuous strands of pure wool yarn used in the Century Wool-yarn System of Lubrication . . . There is no drain plug at the bottom of the oil well.

Built in standard sizes from  $\frac{1}{4}$  to 250 horse power.  
Temperature rating, 40° C.

**CENTURY ELECTRIC COMPANY**  
1806 Pine St. St. Louis, Mo.

*40 U. S. and Canadian Stock Points and more than 75 outside thereof*



**“THEY KEEP A-RUNNING”**

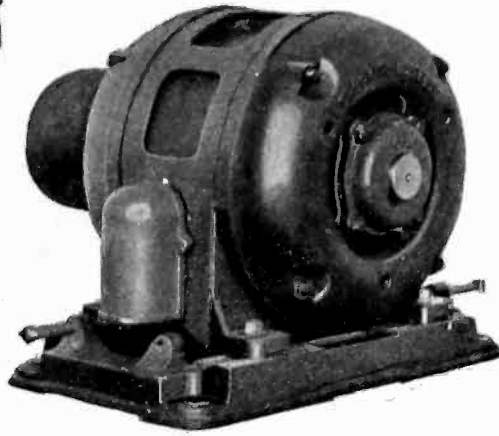
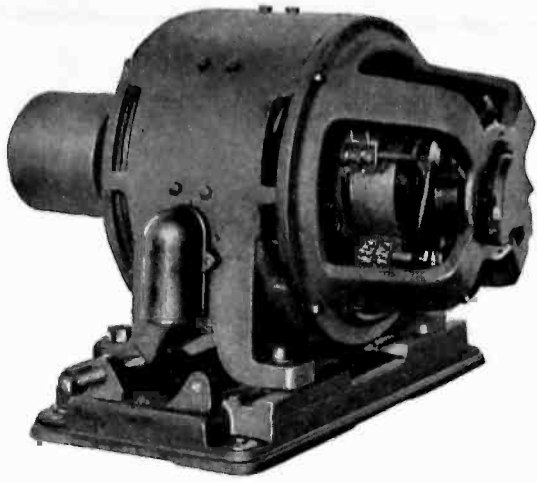

*The three Crocker-Wheeler Motors shown—75, 50, and 5 H. P. respectively—use Norma-Hoffmann Precision Bearings—Crocker-Wheeler Electric Manufacturing Co., Amberg, New Jersey*

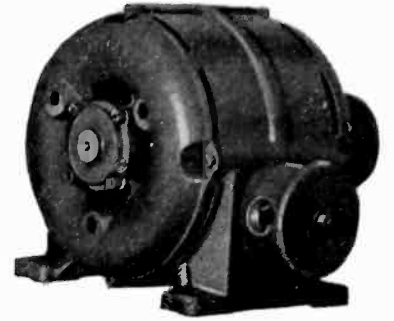

# Adding "PLUS" to "MOTOR VALUE"

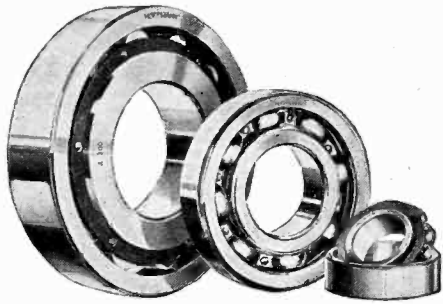

*Our engineers will be glad indeed to give you the aid of their specialized experience.*

A MOTOR failure is costly to the motor owner—but its indirect effects may be far more costly to the motor builder. Motors, by their performance, must maintain the builder's reputation.

Motors seldom fail electrically; most "motor failures" are "motor bearing failures," really—just as most "motor troubles" are "motor bearing troubles."

That extra-dependability which PRECISION Quality imparts explains the ever-growing recognition accorded NORMA-HOFFMANN Precision Bearings by motor builders who seek to make their motors mechanically, as well as electrically, better.

## NORMA-HOFFMANN PRECISION BEARINGS

**NORMA-HOFFMANN BEARINGS CORPORATION STAMFORD, CONN., U.S.A.**

Please mention the JOURNAL of the A. I. E. E. when writing to advertisers.



# Repairs — Less than 1% on! 1073 EC&M Motor Starters •

The remarkable low upkeep cost of EC&M Motor Starters is well demonstrated by the 1073 units working in a large chemical process plant, where the yearly cost for repair parts is less than 7/10 of one per cent of the original cost of the equipment. This cost is an average figure based on an eight year period, or ever since the first starter was installed.

Operating, not only under a very corrosive acid condition which is destructive to insulation, current carrying parts and all the operating mechanism, the majority of these starters are used on very severe service. Many times during a day's operation, they handle heavy currents, being used on plugging service and still they work with such a low maintenance cost under these adverse conditions.

Even more important is the uninterrupted production that is made possible with EC&M rugged construction and liberal design combined with the oil-immersed feature, which makes EC&M Motor Starters flame-proof, corrosion-proof, and weather-proof.

We invite you to personally check the above figures with your own maintenance costs. Write to our nearest branch office for further figures in various other plants.



## THE ELECTRIC CONTROLLER & MFG. CO.

NEW YORK-50 CHURCH ST.  
CHICAGO-CONWAY BLDG.  
DETROIT-DIME BANK BLDG.  
BIRMINGHAM-BROWN-MARX BLDG.  
CINCINNATI-INTERNATIONAL BANK BLDG.  
DENVER-KITTREDGE BLDG.

### CLEVELAND, OHIO

LOS ANGELES-912 E. THIRD ST.  
HOUSTON-1006 WASHINGTON AVE.  
TORONTO-REFORD BLDG.

PHILADELPHIA-WITHERSPOON BLDG.  
PITTSBURGH-OLIVER BLDG.  
SAN FRANCISCO-CALL BUILDING  
MONTREAL-CASTLE BLDG.  
TULSA-217 E. ARCHER ST.  
SEATTLE-ALASKA BLDG.



Please mention the JOURNAL of the A. I. E. E. when writing to advertisers.

# LOCK IT WITH SHAKEPROOF

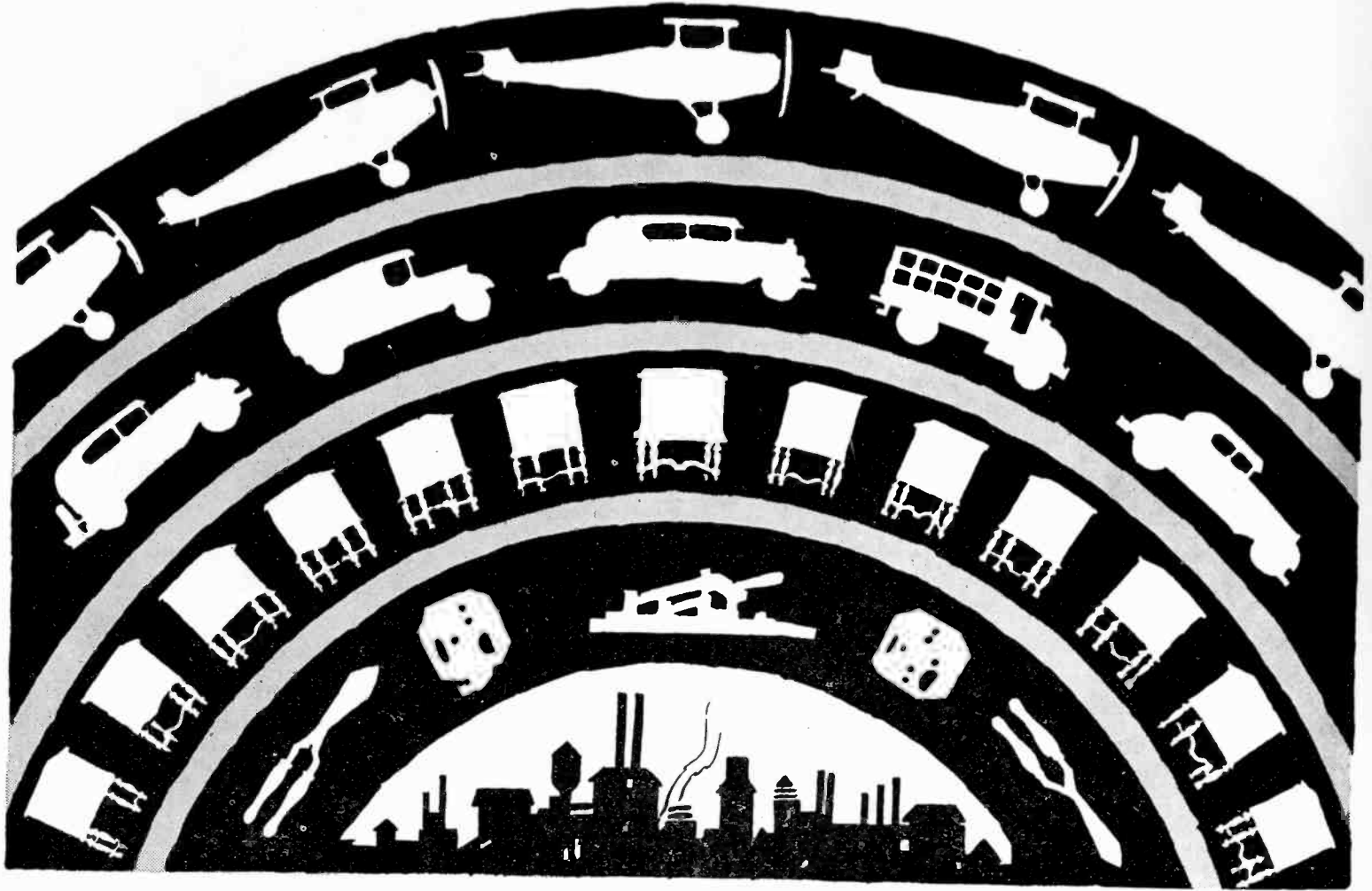

Type 20 Terminal



Type 12 Internal



Type 11 External

ON the modern line of production, whether it's airplanes or automobiles, radios or office appliances—no matter what the product, manufacturers are finding that SHAKEPROOF Lock Washers bring an easy, ready solution to all locking problems. SHAKEPROOF is the modern lock washer. Its twisted teeth bite in and won't let go, holding nuts firmly in a grip of steel. Easy to apply, SHAKEPROOF actually speeds up production, saving time and money. The list of SHAKEPROOF users is the Blue Book of American manufacturers.

Write today for free samples of SHAKEPROOF Lock Washers. Test them out in your own shop.

**SHAKEPROOF LOCK WASHER COMPANY**

*(Division of Illinois Tool Works)*

2517 North Keeler Avenue

Chicago, Illinois

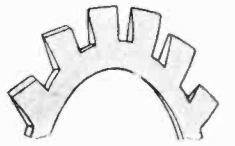

Twisted steel teeth set around the circumference of the washer bite in when the nut is tightened down—only applied pressure can loosen their tenacious hold.

# SHAKEPROOF

Please mention the JOURNAL of the A. I. E. E. when writing to advertisers.





## Good insulation keeps appliances in service

All along the line, and particularly in wiring devices, are small insulation parts—bushings, washers, strips—that carry the burden of keeping appliances in use. Insulation breakdown in a plug, switch or outlet usually puts an appliance or a lamp out of use—often for days. Good insulation keeps them in service.

For the better class of wiring devices, the use of Bakelite Laminated insulation has come to be accepted practice. Experience has shown that this material possesses the requisite

insulation value, and retains it unimpaired through years of service. When Bakelite Laminated is used in wiring devices, insulation failures are practically unknown.

Bakelite Laminated is available in sheets, rods and tubes in a wide range of sizes. It is readily die-cut, punched, sawed or machined. It is strong, does not deteriorate with age or use, and is non hygroscopic. It is obtainable only under the following trade-names:

**Dilecto** **PHENOLITE** **FIBROC** **Spanfling** **Textolite** **Micarta** **FORMICA** **SYNTHANE**  
BAKELITE SHEETS TUBES RODS

Write for Booklet 3L, "Bakelite Laminated"

### BAKELITE CORPORATION

247 Park Avenue, New York, N. Y. Chicago Office, 635 West 22nd Street  
 BAKELITE CORP. OF CANADA, LTD., 163 Dufferin Street, Toronto, Ont., Can.

# BAKELITE

REGISTERED U. S. PAT. OFF.



THE MATERIAL OF A THOUSAND USES

"The registered Trade Mark and Symbol shown above may be used only on products made from materials manufactured by Bakelite Corporation. Under the capital "B" is the numerical sign for infinity, or unlimited quantity. It symbolizes the infinite number of present and future uses of Bakelite Corporation's products."

Please mention the JOURNAL of the A. I. E. E. when writing to advertisers.



# Healing by Music

*Modern hospitals put the Western Electric Public Address System on staff*

Music hath charms—and healing powers. Lucky is the hospital patient whose convalescence is cheered and hastened by entertainment through the Western Electric Public Address System.

It amplifies and distributes sound to all parts of the hospital by means of loud speakers in private rooms and telephone headsets in wards. And patients can listen to radio broadcast, or entertainment put into a microphone in the building, or phonograph records played on the Western Electric Music Reproducer.

Here then is a soothing bedside visitor always on hand at the right moment.

The Western Electric System has many advantages which appeal to progressive hospital managements. Architects and engineers value it because it is electrically reliable, made by the makers of your telephone.

To hospitals, hotels, schools, amusement parks and communities, it offers new opportunities for service to their public.



*The Western Electric Music Reproducer, ever ready to provide entertainment from phonograph records.*

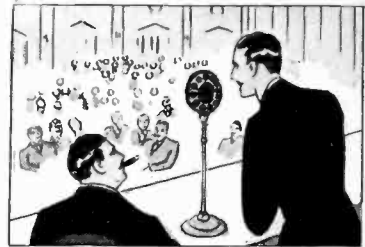

*Now all can hear in the hotels' large meeting rooms.*



*Dancing to the Music Reproducer at restaurant or country club.*

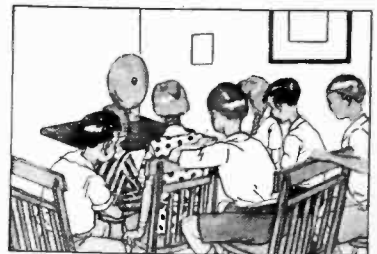

*The school principal can, by loud speaker, address all rooms at once.*

# Western Electric

PUBLIC ADDRESS AND MUSIC REPRODUCTION SYSTEMS

DISTRIBUTED BY *Graybar Electric Company* / / / / OFFICES IN 72 PRINCIPAL CITIES

Please mention the JOURNAL of the A. I. E. E. when writing to advertisers.



# DUDLO

## Nation-Wide Service

**T**HE fact that Dudlo has become the nation's headquarters for coils and magnet wire has made necessary the organization of a vast, nation-wide service which stretches from Atlantic to Pacific.

Dudlo's modern factory facilities at Fort Wayne, Ind., have made possible production methods that are unparalleled, and Dudlo engineers, with their years of experience, will help you solve the most complex coil and wire problems which may be peculiar to your product.

DUDLO MANUFACTURING COMPANY  
FORT WAYNE, INDIANA  
*Division of General Cable Corporation*

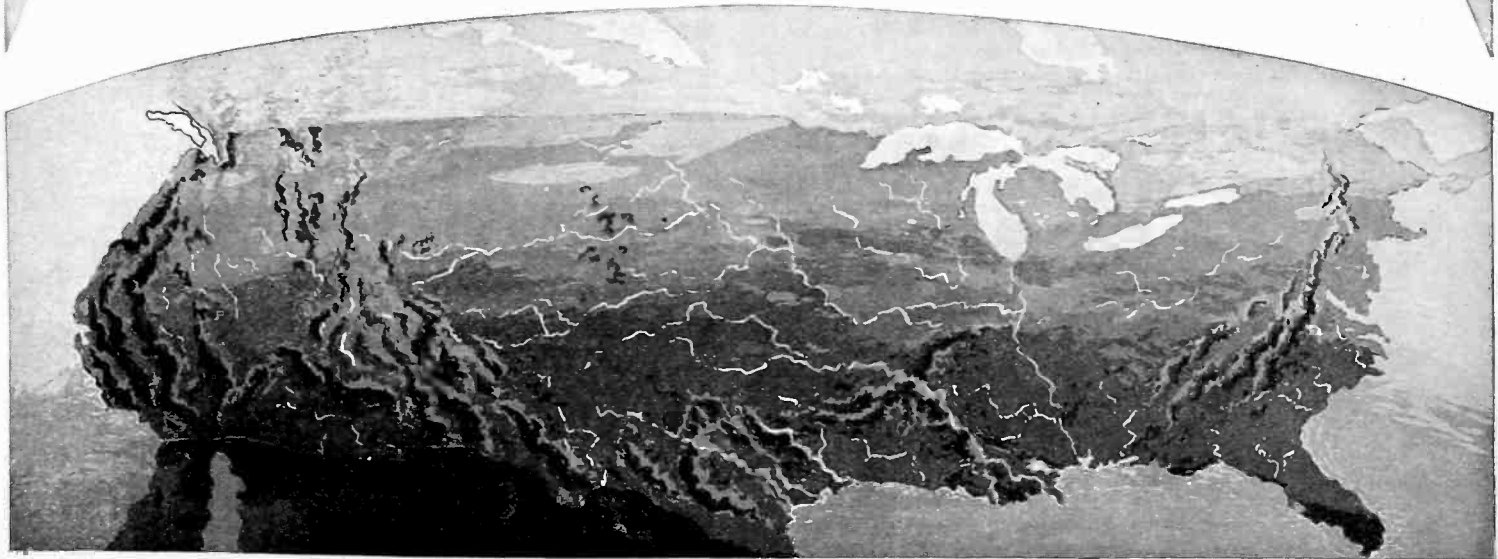

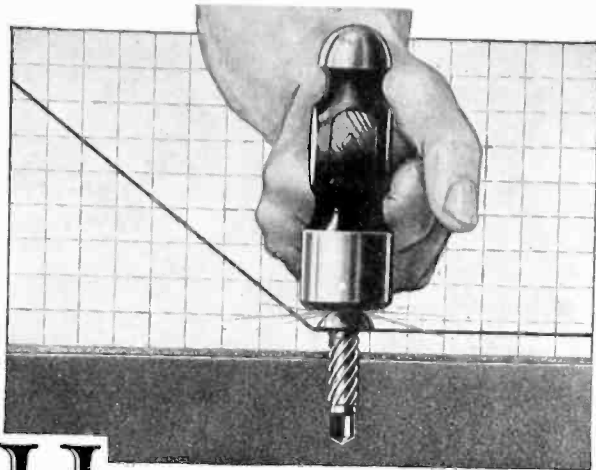
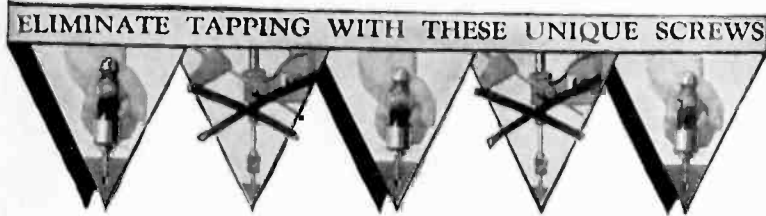

# Hammer down metal assembly costs

*... by hammering in this Screw that makes secure fastenings without tapping . . . . .*

When Hardened Metallic Drive Screws are adopted for an assembly, the costly, time-wasting items that make assembly costs climb are banished.

Tapping is eliminated. So are broken taps, tapping plates, tapping machinery maintenance, and the stripped and crossed threads that result in scrapped materials.

No need for skilled workmen. Anyone can make permanent fastenings to iron, brass and aluminum castings, steel, Bakelite, etc., with Hardened Metallic Drive Screws.

Just hammer the Screw into a drilled or molded hole. It forms its own thread in the material and binds the sections so securely that the fastening holds under vibration and severe service.

Most prominent electrical manufacturers have tested and adopted these Screws. We want you to try them, too. Describe your assembly—we'll furnish samples for a test.

**PARKER-KALON CORPORATION**  
 198 Varick Street New York, N. Y.  
*Distributed in Canada by*  
*Aikenhead Hdw., Ltd., 19-21 Temperance St., Toronto*

**PARKER-KALON**  
TRADE MARK  
**HARDENED METALLIC**  
REG. U. S. PAT. OFF.  
**DRIVE SCREWS**  
 PAT. JAN. 29, 1924 No. 1482151 - OTHERS PENDING



**For Making Fastenings to Iron, Brass and Aluminum Castings, Steel, Bakelite, etc.**

## ACME WIRE PRODUCTS

Magnet Wire — All Insulations  
 Coils—Magnet Wire Wound  
 Varnished Insulations  
 Parvult Filter and By Pass Condensers

All products made to Recognized Commercial Standards including those of:

- National Electric Mfrs. Assn.
- Radio Manufacturers Assn.
- American Society for Testing Materials

For 25 years manufacturers and suppliers to the largest and most discriminating users.

**THE ACME WIRE CO.**  
 New Haven, Conn.

**Branch Offices**  
 New York 52 Vanderbilt Ave.  
 Cleveland Guardian Bldg.  
 Chicago 842 N. Michigan Ave.



What better gift than good health?

BUY CHRISTMAS SEALS

The National, State and Local Tuberculosis Associations of the United States



**Belden**  
Soft Rubber Plugs  
are now standard  
equipment on  
the following:

- 20 Washing Machines
- 19 Radio Units
- 14 Medical Equipments
- 11 Electrical Tools
- 4 Refrigerators
- 3 Paint Sprayers
- 3 Business Machines
- 2 Vacuum Cleaners
- 2 Floor Machines
- 2 Portable Saws
- 2 Grinders
- 18 Miscellaneous Machines

Available on a wide selection of Belden Rubber Covered and Braided Wire. Lengths and end trimming to your specifications.

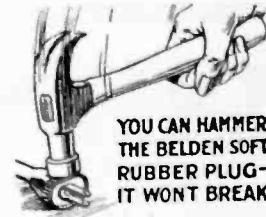

YOU CAN HAMMER  
THE BELDEN SOFT  
RUBBER PLUG -  
IT WON'T BREAK

## Industry Has Adopted the Belden Soft Rubber Plug

**M**ANUFACTURERS of appliances such as electrical tools, on which cords and plugs are subjected to extremely hard service, have been quick to appreciate the unbreakable feature of Belden Soft Rubber Plugs.

Today, manufacturers of equipment which is seldom moved, such as electrical refrigerators, are also rapidly equipping their machines with the Belden Soft Rubber Plug, because it prevents trouble calls, complaints, and

payment delays that occur due to breakage that is inherent in ordinary plugs.

The Belden Unbreakable Soft Rubber Plug is furnished as part of the Belden Cut Cord Service, in black and brown, with or without the long handle.

You should have the facts that have caused so many manufacturers to adopt the Belden Unbreakable Soft Rubber Plug. Write for them today.

**Belden Manufacturing Company**  
2316-B South Western Ave. Chicago, Ill.

### BELDEN PRODUCTS

*Beldenamel and Textile  
Magnet Wire*

*Coil Windings*

*Beldenmold*

*(Molded Bakelite Products)*

*Automotive Wires and Cables*

*Airplane Assemblies*

*Radio Wires, Cords  
and Cables*

*Rubber Covered Wires*

*Armored Cables*

*Flexible Armature Wires*

*Motor Lead Wires*

*Braided and Stranded*

*Copper Cables*

*Cotton Sleaving*

*Specify*  
**Belden**

# ELECTRITE

**A high grade fibre board  
for electrical insulation.**

**A material of quality pos-  
sessing high tensile and  
dielectric strength.**

**Tested and approved by  
the Underwriters' Labora-  
tories.**

*Pulp Products Department*

**WEST VIRGINIA  
PULP & PAPER COMPANY**

230 Park Avenue  
New York, N. Y.

35 East Wacker Drive  
Chicago, Ill.

# FIBROC

## FIBROC INSULATING PARTS READY FOR ASSEMBLY

The Fibroc Insulation Company maintains a large battery of specially designed and equipped punch presses that quickly and economically supply Fibroc punched parts to meet practically any specification.

Engineering and production departments of large electrical manufacturing plants quickly recognize the economy and production advantages of Fibroc Ready Punched and Inspected insulating parts.

Recent exhaustive tests disclose the following Fibroc characteristics:

1. High dielectric strength 600-1,100 volts per mil.
2. Chemically stable—unaffected by ordinary solvents.
3. Non-hygroscopic, does not swell, warp or shrink.
4. Great mechanical strength, compact and light in weight.
5. Resists heat, constant 225° F. intermittent up to 275° F.

*Send your specifications or blue prints for samples and quotations. Our engineering department will be glad to work with you.*

**FIBROC INSULATION COMPANY**  
*Licensed Bakelite Laminators since 1922*  
510 Lincoln Ave. VALPARAISO, IND.

# MICABOND

THE STANDARD MICA INSULATION

for

## COMMUTATOR INSULATION

Faulty commutator insulation is the cause of a large percentage of motor and generator failures with the consequent loss of thousands of dollars annually in interrupted production.

For this reason leading manufacturers in all lines of industry are vitally concerned about the matter of insulation.

For 30 years Micabond has been known for its uniform dependable quality—its high dielectric strength—its resistance to heat—and its reliability under the most severe conditions.

Micabond has become the standard mica insulation and its use means the elimination of insulation failure and consequent shut-downs and losses.

*Write for further details or send your specifications for samples and prices.*

**CHICAGO MICA COMPANY**  
482 Campbell Street  
VALPARAISO INDIANA

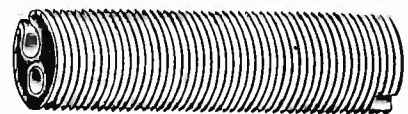

# LAVA INSULATORS

Strong in dielectric properties, heat resistant, and maintaining accurate dimensions, Lava has been accepted as the ideal insulating medium by manufacturers who require dependable insulators.

**AMERICAN LAVA  
CORPORATION**

27-67 Williamson St. Chattanooga, Tenn.

*Manufacturers of Heat Resistant Insulators*

# Extremes *in size....* Duplicates *in quality!*

This 130" Micanite tube with an outside diameter of 10" and weighing 350 lbs. dwarfs the fractional inch Micanite tubes—but only in size.

In the quality of workmanship all Micanite tubes, all Micanite products are duplicates. They are made to one inflexible standard—the highest.

For motors, generators, controls, condensers and innumerable other electrical devices, Micanite has been a standard electrical insulation for years. Many of the common applications as well as detailed characteristics of Micanite are given in the new Catalog No. 87. Send for a copy.

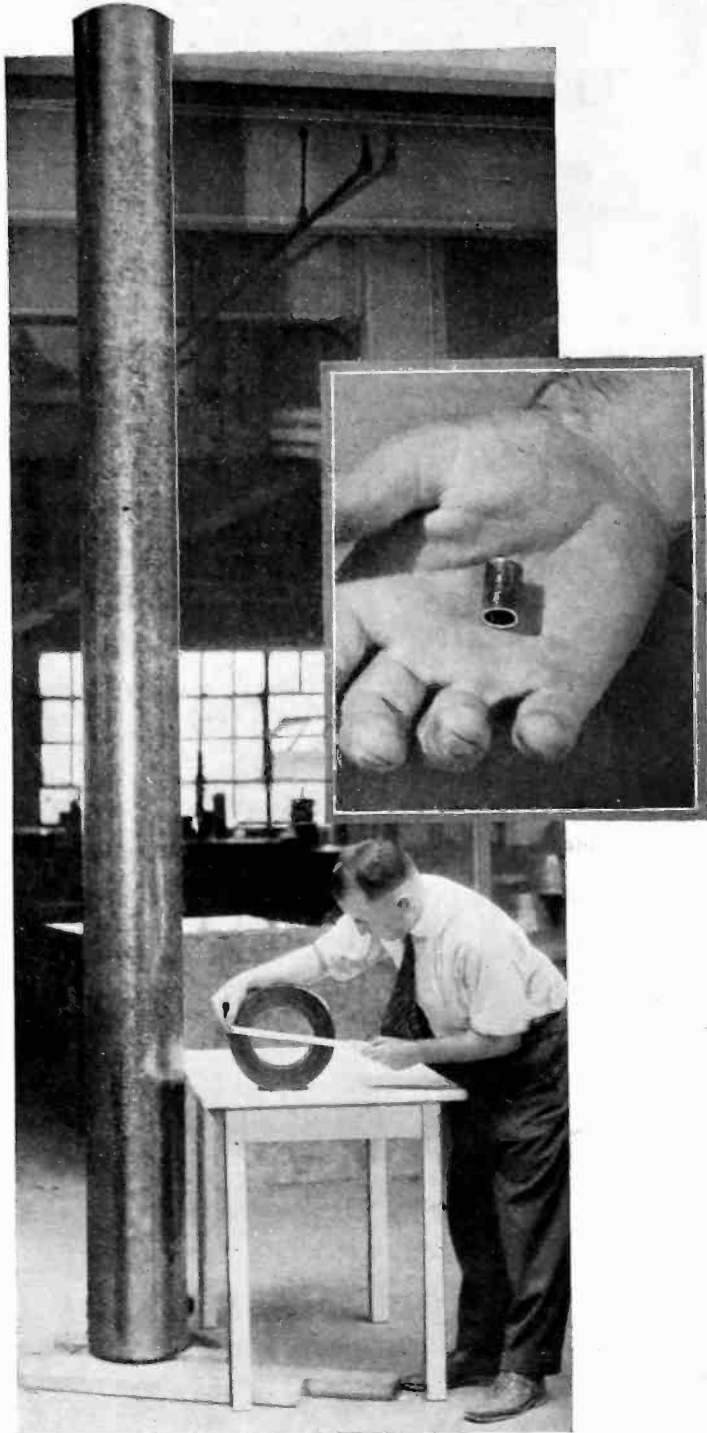

MICA INSULATOR COMPANY  
 New York 200 Varick St.  
 Chicago 542 So. Dearborn St.  
 Cleveland Pittsburgh Cincinnati  
 Birmingham Seattle San Francisco  
 Los Angeles Toronto Montreal  
 Works: Schenectady, N. Y. London, Eng.



*Electrical*  
INSULATION



MICA INSULATION

OILED CLOTH INSULATION

Please mention the JOURNAL of the A. I. E. E. when writing to advertisers.

Trade "ESCO" Mark  
**ELECTRIC SPECIALTY CO.**  
 Engineers and Manufacturers



TYPE NA AIRPLANE GENERATOR

DESIGN —  
 DEVELOP —  
 PRODUCE —

Small Motors, Generators, Dynamotors,  
 Motor Generators, Rotary Converters, Etc.  
 FOR SPECIAL PURPOSES—Send Us Your Problems  
 222 South Street, STAMFORD, CONN., U.S.A.

To . . . . . Engineers  
 Manufacturers ✦ Inventors

We possess exceptional facilities for doing your experimental work . . . models, dies, tools, instruments, light machinery . . . general manufacturing . . . inventions developed. Customer's supervision in machine shop permitted. Over thirty years' specialized experience. Clients include Bell Telephone Laboratories, All-America Cables, Inc., and other well known organizations.

**MANUFACTURERS' & INVENTORS' ELECTRIC CO.**  
 Incorporated 1897  
 228 West Broadway, New York  
 (Smith Building at Franklin St.)  
 Tel. Walker 8687-8688 Cable Address "MANDIELECO"

'Tis the usual thing—

when faced with the task of filling a position, to turn to friends for friends they may recommend.

Your best friend from whom to seek this help is The Engineering Societies Employment Service. They will refer you to the best available talent for your particular need. The service is free to employers.

Send your requirements to the nearest office of

**THE ENGINEERING SOCIETIES  
 EMPLOYMENT SERVICE**

31 West 39 St. 205 W. Wacker Dr. 57 Post St.  
 New York Chicago San Francisco

*The Pioneer Manufacturer*  
 — of —  
**Interpole & Ball Bearing  
 Motors**

½ to 1000 H. P. D. C. and A. C.

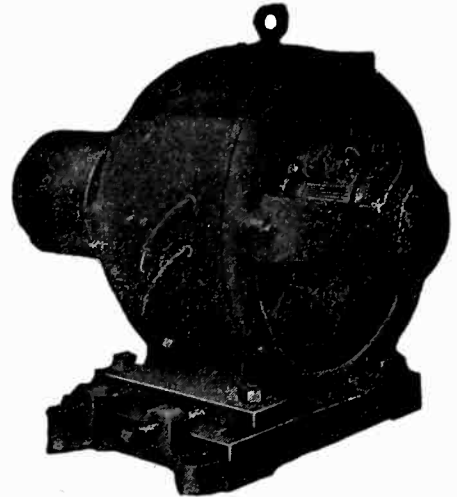

Type "S" Ball Bearing Motor with base and pulley

**ELECTRO DYNAMIC COMPANY**  
 Manufacturers of Ball Bearing Motors Since 1904  
 BAYONNE, N. J.  
 Sales Offices in Principal Cities  
 "Quality for Half a Century"

SHUNT WOUND BATTERY CHARGER  
**THE DIVERTER POLE GENERATOR**  
 CONSTANT VOLTAGE INHERENT RUNS AS MOTOR SAFELY  
 PATENTED JAN. 1926  
 ROCHESTER, N. Y. U. S. A.

**MOST ECONOMICAL  
 FOR ALL KINDS OF BATTERY CHARGING**

Ask Us for the Name of a User in Your Vicinity

**Rochester Electric Products Corp.**  
 87 Allen Street Rochester, N. Y.

**SUNDH ELECTRIC COMPANY**

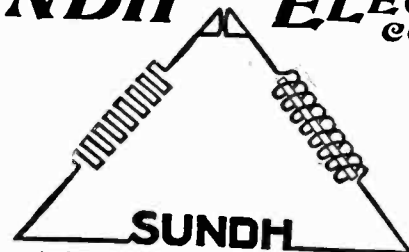

Automatic Starters  
 Circuit Breakers  
 Float Switches  
 Hand Starters  
 Magnet Switches

Pressure Regulators  
 Remote Switches  
 Speed Regulators  
 Transfer Switches  
 Valve Control

**SUNDH ELECTRIC CO., INC.**  
 Parkhurst St. at Ave. C  
 NEWARK, N. J., U. S. A.

Branch Offices or Sales Representatives in Principal Cities



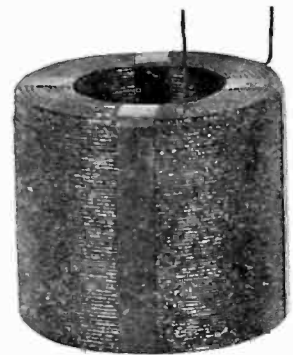

## Useless Space in Coils is Expensive

Rome is prepared to produce a wide variety of coils to meet the most exacting specifications. You will be particularly interested in the exclusive Rome Process of Winding that produces heavy wire coils in which a given number of turns occupies less space than has heretofore been practicable.

Aside from the economies affecting the coils themselves, consider the value of possible savings through reduction in size of the device to take the coils.

This double saving is frequently sufficient reason for the specification of Rome Precision Coils.

But it is by no means the only reason. For the Rome Process results in greater

accuracy and uniformity both physically and electrically. It enables the designer to work within closer limits. It facilitates speedy assembly. It improves thermal characteristics.

The sum of these advantages puts the coil factor of any product in an entirely new light. Rome Engineers are ready to demonstrate specifically, with sample coils built to meet electrical requirements, HOW important these advantages are in relation to YOUR product.

**ROME WIRE COMPANY**  
 Division of General Cable Corporation  
 R O M E ,        N E W   Y O R K

# ROME PRECISION COILS

Please mention the JOURNAL of the A. I. E. E. when writing to advertisers.

*When*  
**THOR'S  
HAMMER  
STRIKES**

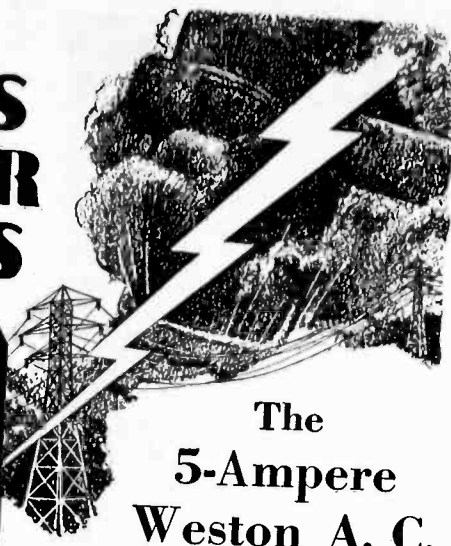
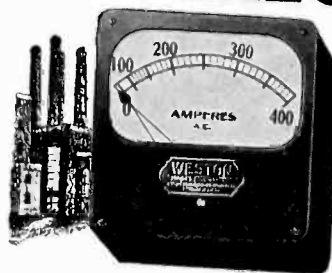

The  
**5-Ampere  
Weston A. C.  
RECTANGULAR**

*easily withstands a Current of*  
**ONE HUNDRED TIMES NORMAL  
— or MORE!**

**L**IGHTNING discharges—steep wave fronts and other abnormal disturbances—mighty forces clashing with the enormous power of vast interconnecting systems—calling for stout resistance and instant coordination of line equipment—the ability of relays, current transformers and instruments to withstand the terrific “bumps” of instantaneous energy surges—the necessity for quickly and safely clearing lines and apparatus from these violent and destructive shocks—such are the problems which follow in the wake of super-power, problems of serious concern to operating engineers who must depend for their solution entirely on the performance of station, transmission and distribution equipment.

In present day operation, ammeters are often called upon to withstand sudden excessive overloads. Only those instruments which provide for an exceptionally high heat storage capacity can hope to cope with these conditions. One of the outstanding characteristics of Weston Rectangular Ammeters is that they are designed to accommodate a stress of momentary duration amounting to at least a hundred times normal rating, or even double this value, so rugged and resilient are the movements, so light the mass and so beautifully proportioned with respect to the proper distribution of forces.

Weston Rectangulares are made as a complete line for every switchboard need. For constructional details and ranges write to our nearest office, or direct to the factory.

**WESTON ELECTRICAL INSTRUMENT CORP.**  
584 Frelinghuysen Avenue Newark, N. J.

**Weston**  
PIONEERS  
SINCE 1888  
**INSTRUMENTS**

Please mention the JOURNAL of the A. I. E. E. when writing to advertisers.

*Faradon*

**ELECTROSTATIC  
CONDENSERS**  
*for All Purposes*

*The Accepted Standard  
for Exacting Service as well as  
General Application on  
Land and Sea and  
in the Air*

**WIRELESS SPECIALTY  
APPARATUS COMPANY**

Est. 1907

Jamaica Plain

Boston

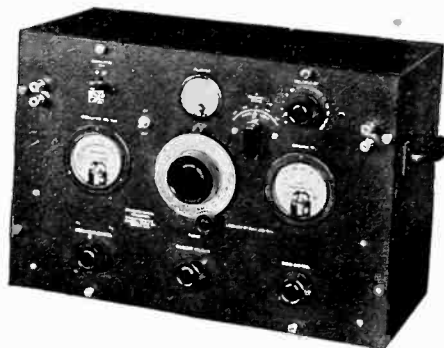

## Standard-Signal Generator

The Type 403-B Standard-Signal Generator is a calibrated oscillator for delivering known radio-frequency voltages which are localized between two terminals. Its principal use is in measuring radio field intensity (field strength) and in taking sensitivity, selectivity, and fidelity characteristics on radio receivers. It may be used either with or without modulation; a 400-cycle modulating oscillator is contained in the instrument and there is provision for supplying modulating voltages from an external oscillator.

Its range is from 500 to 1500 kilocycles, but others can be built to cover other bands on special order.

**GENERAL RADIO COMPANY**

*Manufacturers of Electrical and Radio Laboratory Apparatus*  
30 State Street CAMBRIDGE, MASSACHUSETTS

# From A to Z with I.T.E.

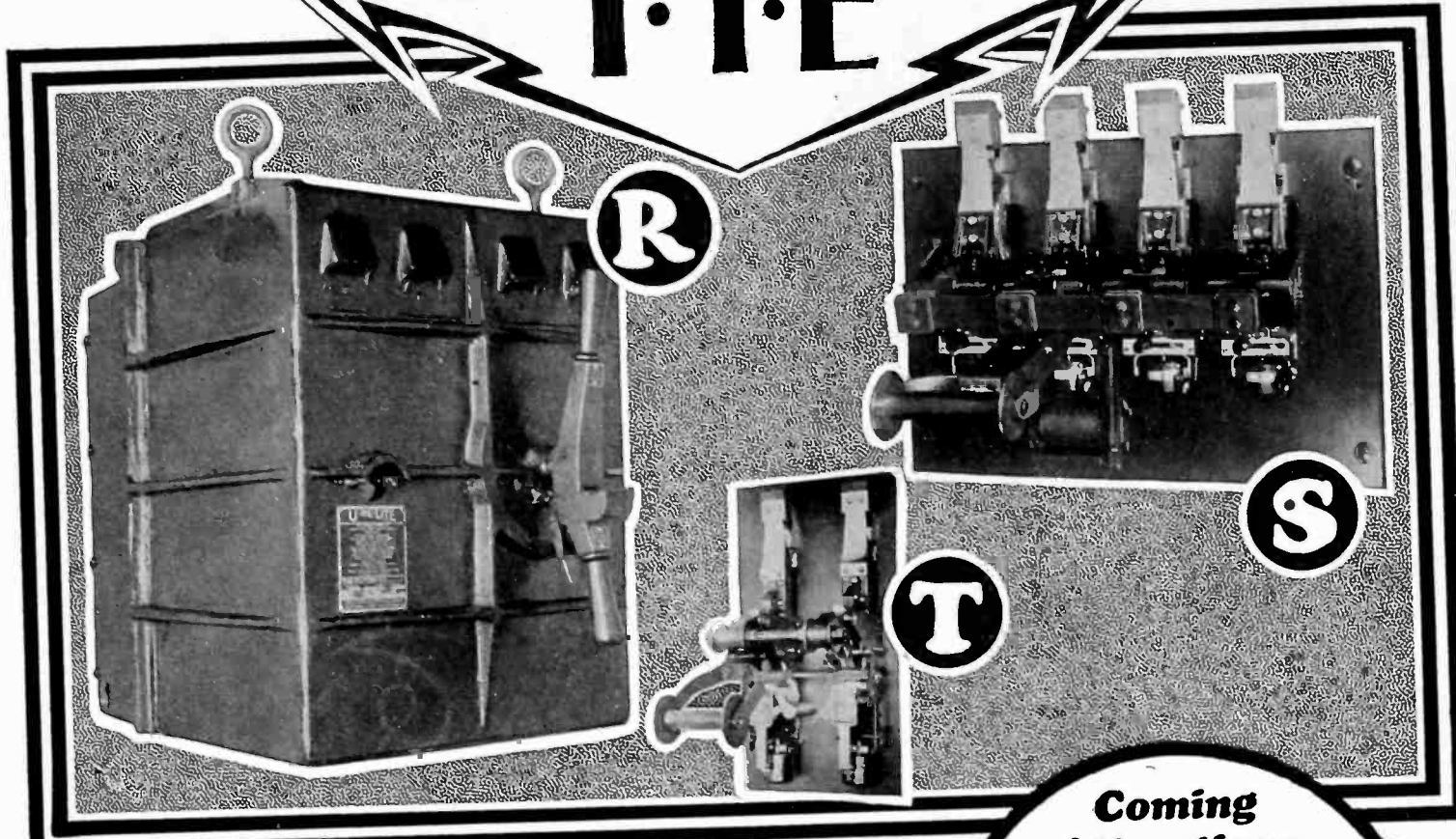

## Coming Attractions

**R** Weatherproof Auto U-Re-Lite—400 amperes at 115 volts A. C.—type W Auto U-Re-Lite in cast iron box—can also be furnished with aluminum front box.

**S** Type LL circuit breaker—1000 amperes at 220 volts A. C. 2 phase 4 wire—4 poles—4 direct-acting time limits (Dalites)—non-closable against overload or short circuit (Autoite)—shunt trip at right of handle.

**T** Type W circuit breaker—200 amperes at 250 volts D. C.—2 poles—2 direct-acting overload coils with 2 direct-acting time limits (Dalites)—non-closable against overload or short circuit (Autoite).

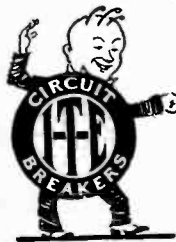

“Say, Mr. Electrical Engineer, have you seen the new I-T-E catalog? Send for your copy and get the dope on dependable protective equipment for 750 volts D. C. and 550 volts A. C. and less—takes the strain off the old bean, I says!”

I-T-E CIRCUIT BREAKER COMPANY  
19th and HAMILTON STS., PHILADELPHIA

**U**

Type LL air circuit breaker truck—1600 amperes at 550 volts A. C. fitted with wheels, racking gear and separable contacts for easy removal from switchboard.

**V**

I-T-E semi-automatic transfer switch—400 amperes at 480 volts A. C.—automatically connects load to emergency source—reconnected to normal source by operator.

**W**

Type J circuit breaker—40 amperes at 250 volts D. C.—2 poles with direct-acting overload coils and time limits (Dalites).

**X**

Type LG circuit breaker—2000 amperes at 220 volts A. C. 2 phase 4 wire—4 poles—4 direct-acting overload coils with 4 direct-acting time limits (Dalites)—non-closable on overload or short circuit (Autoite).

**Y**

Type S circuit breaker—150 amperes at 250 volts D. C.—2 direct-acting overload coils with 2 direct-acting time limits (Dalites)—poles close independently, but trip together.

**Z**

Padlocked U-Re-Lite—to prevent unauthorized changes of overload setting and also to protect men working on the line.

Birmingham, American-Traders Bank Building; Boston, 201 Devonshire; Buffalo, Ellcott Sq. Bldg.; Chicago, 333 N. Michigan Ave.; Cincinnati, Union Trust Bldg.; Cleveland, 439 Terminal Tower Bldg.; Dallas, 1810 Allen Bldg.; Denver, Tramway Bldg.; Detroit, Penobscot Bldg.; Duluth, 611 Providence Bldg.; Kansas City, Midland Bldg.; Los Angeles, 106 W. 3rd; Minneapolis, Plymouth Bldg.; Montreal, 151 Lagachetiere St. West; New Orleans, Hibernia Bank Bldg.; New York, 12 E. 41st St.; Omaha, Electric Bldg.; Philadelphia, 1505 Race St.; Pittsburgh, Park Bldg.; St. Louis, Bank of Commerce Bldg.; San Francisco, Russ Bldg.; Seattle, 802 33rd Ave.; Toronto, 149 Adelaide Street East; Vancouver, 500 Beatty Street.

For complete information on dependable protection for any circuit up to 750 volts D. C. or 550 volts A. C. write or call our nearest office.

# I-T-E PROTECTION

URELITES — I-T-E CIRCUIT BREAKERS

# Moloney Transformers

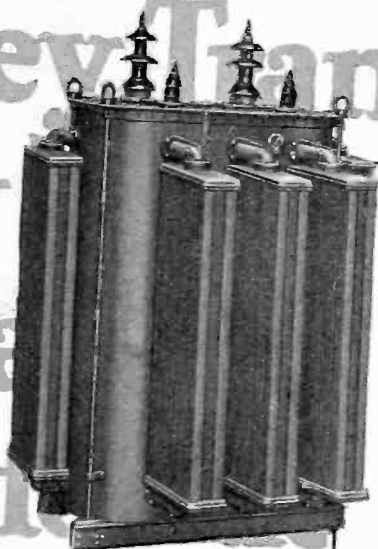

By past performance  
Moloney transformers  
have earned their  
present nation-wide  
approval.

**MOLONEY ELECTRIC CO.**

Main Office and Factories:  
ST. LOUIS, MO.

Sales Offices in Principal Cities

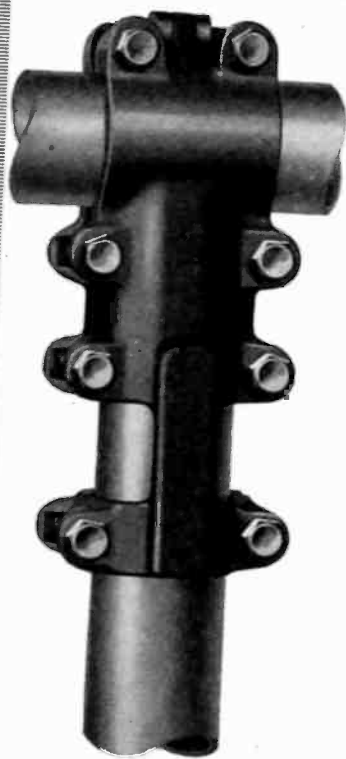

## BURKE Positive Grip Connectors

The only connector  
which can be  
partially assembled  
on the ground.

Made from high  
conductivity copper  
Tobin Bronze or  
Monel Metal Bolts.

*Bulletin on Request.*

**BURKE ELECTRIC CO.**  
ERIE, PA.

Offices in Principal Cities

Pacific Coast—JONES-LYMAN, INC., San Francisco, Los Angeles

## Engineering Societies Library

A reference library for engineers—contains  
150,000 volumes—receives over 1,300 technical  
journals and periodicals on all branches of  
engineering.

Searches are made upon engineering subjects,  
translations from foreign publications, photostats  
made, etc.

Books may be borrowed by members of the  
A. I. E. E. For information address, The  
Engineering Societies Library, 33 West 39th St.,  
New York.

At Your Service

# KEARNEY

Manufacturers of

Screw Anchors; Hi-Tension 4-in-1 Expansion Anchors; Solderless Service Connectors; Double Duty Fuse Cutouts; 7500, 12,000 and 15,000 volt Fuse, Disconnect and Fuse-Choke Coil Switching Equipment; Fuse Pullers; Plug Cutouts; Guy Wire Clips; Sleeve Twisters with Interchangeable Dies; Hot Tap Clamps; Yokes; Economy Cable Clamps; Live Line Maintenance Tools and Accessories, previously Tip's Tools.

A Complete Catalog Will be Sent on Request

**JAMES R. KEARNEY CORPORATION**  
4220 Clayton Avenue . . . . . ST. LOUIS, MO.



# Pacific Electric Six Break Oil Circuit Breakers

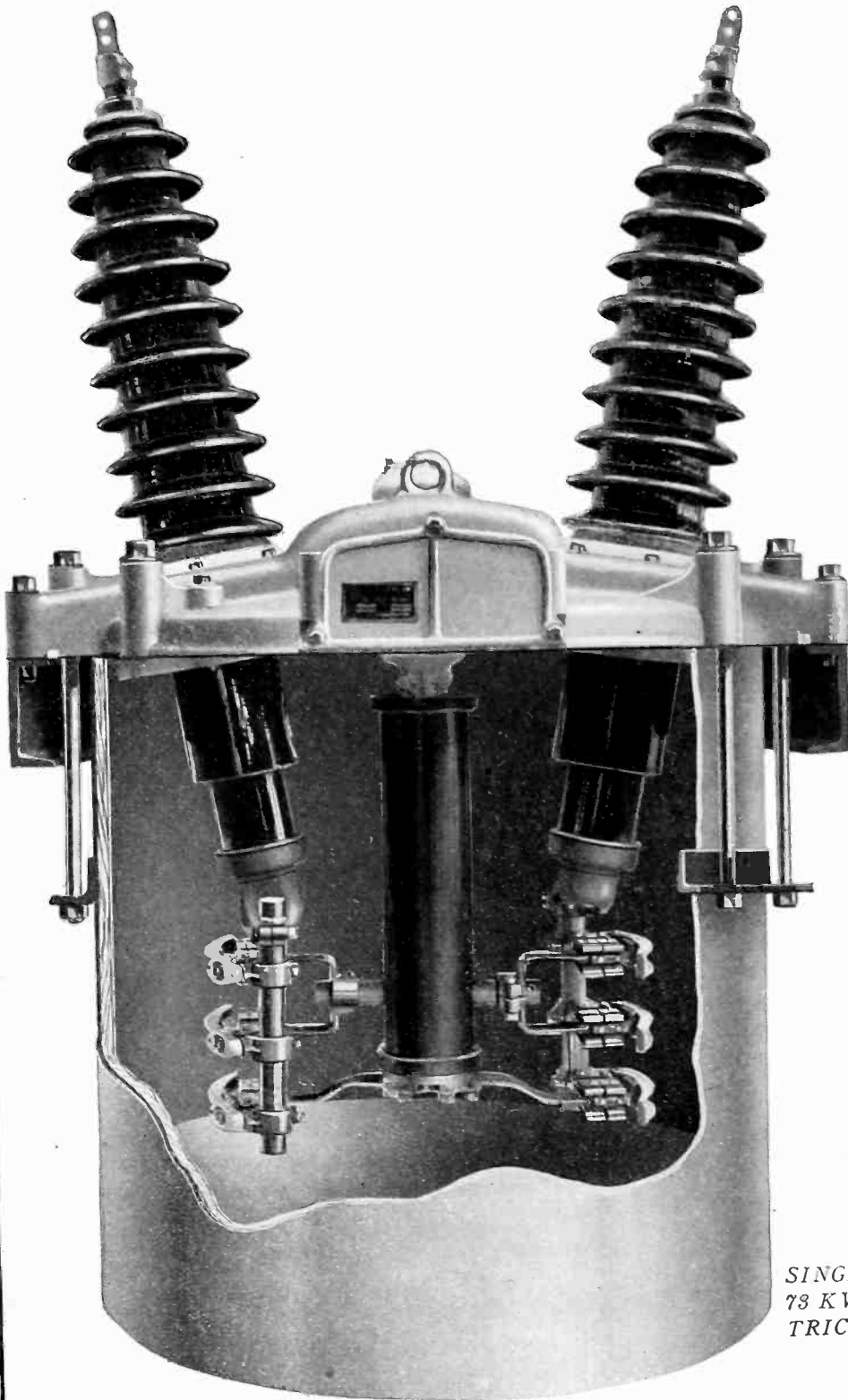

## FEATURES:

1. SIX BREAKS PER PHASE IN SERIES WITH NO ADDED SUPPORTING INSULATION.
2. HORIZONTAL BREAKS WHICH DRAW ARCS THROUGH OIL AWAY FROM THEIR NATURAL COURSE.
3. ONE MAIN ROTATING ELEMENT OF BAKELITE SIMPLE IN DESIGN AND OF VERY RUGGED CONSTRUCTION.
4. FULL FLOATING SELF-ALIGNING CONTACTS AND OVERSIZE ARCING TIPS THAT ARE EASILY REMOVED.

Send for a copy of  
Bulletin No. 11

*SINGLE POLE UNIT, TYPE R-45—  
73 KV., 400 AMP., PACIFIC ELECTRIC OIL CIRCUIT BREAKER.*

## Pacific Electric Manufacturing Corp.

5815 THIRD STREET, SAN FRANCISCO, CALIF.  
P. O. BOX 1214, GARY, IND.  
*Representatives in Principal Cities*

# UNDERGROUND CABLE BOXES FOR A-C NETWORKS

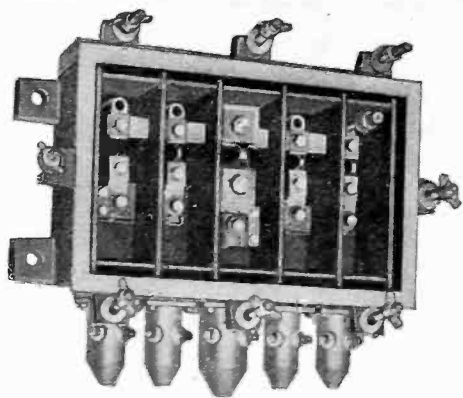

TYPE "FB" BOTTOM ENTRANCE BOX  
1500Mcm main—4-500Mcm branches



TELL US WHAT YOU WANT

Tying in solid may be all right in some cases but many operating men now want the additional safety and system flexibility provided by G & W Underground Cable Boxes.

G&W Boxes are made up of simplified unit parts to suit any local conditions. They are easy to install and operate. They are watertight on the job because they are air tested at the factory.

CABLE TERMINAL DEVICES

**G & W ELECTRIC SPECIALTY CO.**

7780 DANTE AVE., CHICAGO, ILL.

AGENTS IN PRINCIPAL CITIES

## "COPPERWELD"

Messenger Strand and  
Cable Rings

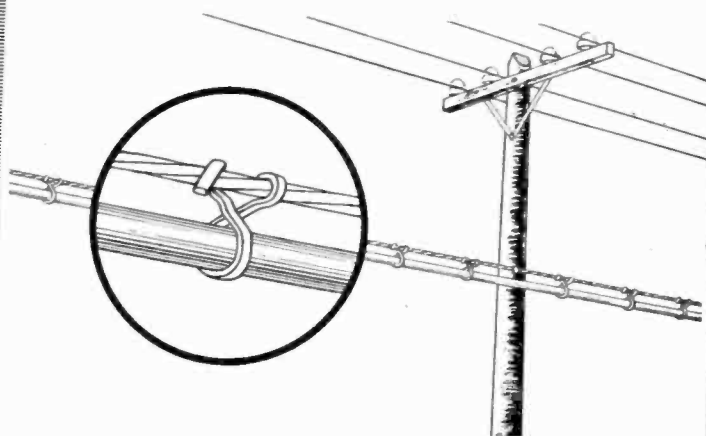

Eliminate  
Replacement Costs

**Copperweld Steel Company**

General Offices and Mills  
Glassport, Penna.

## INSULATORS



CANADIAN PORCELAIN CO., Ltd.  
Hamilton—Ontario—Canada

Quebec District Office  
612 Transportation Bldg.  
Montreal, Qu.

London Office  
343 Abbey House, 4 Victoria Street  
London, S. W. 1.

Specify  
**Thomas  
Quality  
Insulators**  
for  
Permanently  
Dependable  
SERVICE

**THE R. THOMAS & SONS CO.**  
Lisbon, Ohio  
New York Boston Chicago London

Please mention the JOURNAL of the A. I. E. E. when writing to advertisers.

Akron, Ohio  
Electric Motor & Repair Co.  
High and Barges Sts.

Atlanta, Georgia  
E. K. Higginbottom  
411 Glenn Bldg.

Baltimore, Md.  
Industrial Power Equip. Co.  
421 W. Camden St.

Boston, Mass.  
Geo. H. Wahn Co.  
69-71 High Street

Minneapolis, Minn.  
Joseph L. Barnard  
1727 Lagoon Ave.

Montreal, Quebec  
W. O. Taylor & Co.  
415 Canada Cement Bldg.

New Orleans, La.  
Lyman C. Reed  
1230 Hibernia Bank Bldg.

New York, N. Y.  
D. F. Potter, Jr.  
Graybar Bldg.

# Another KUHLMAN Installation

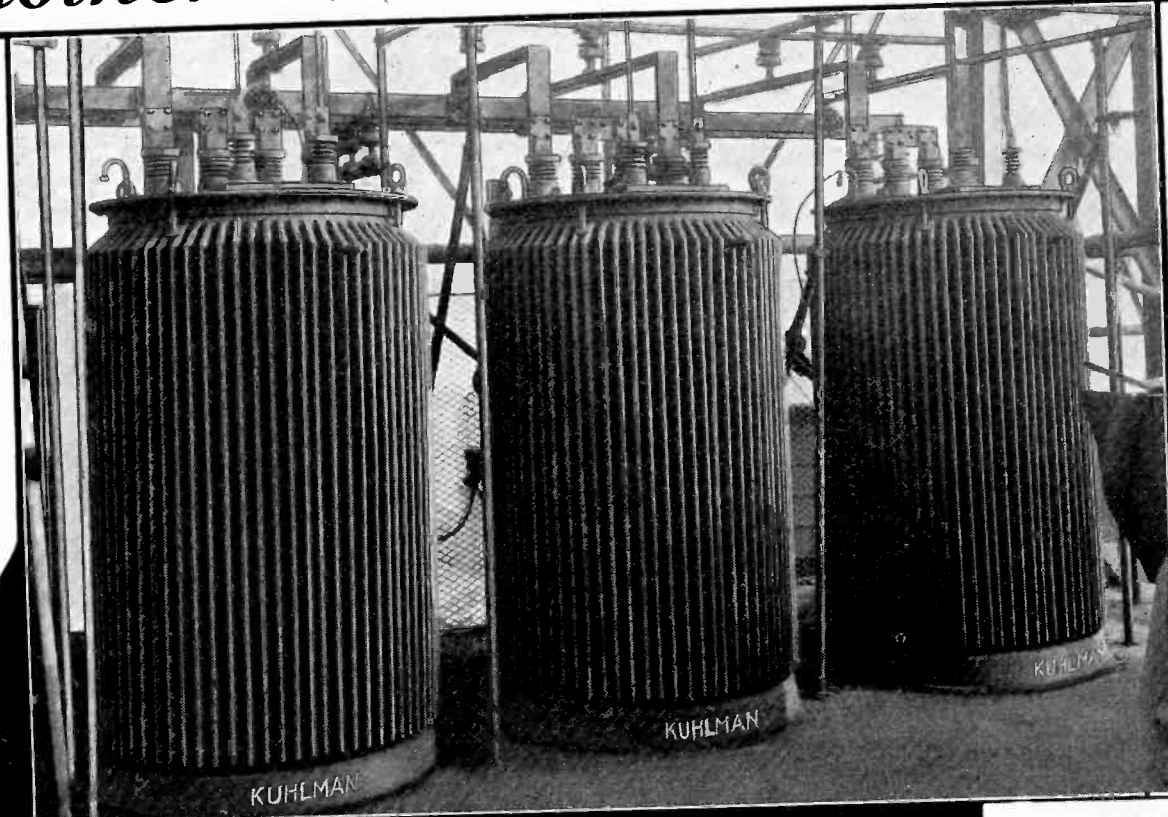

Buffalo, N. Y.  
John E. Hoffman  
280 Carolina St.

Chicago, Ill.  
John R. Smith  
844 Rush St.

Cincinnati, Ohio  
S. L. Currier  
833 Union Trust Bldg.

Cleveland, Ohio  
Public Service Supply Co.  
627 Union Trust Bldg.

Dallas, Texas  
F. T. Morrissey & Co.  
1408 Allen Bldg.

Denver, Colo.  
Joy & Cox, Inc.  
314 Tramway Bldg.

Detroit, Michigan  
Richard P. Johnson  
10-230 General Motors Bldg.

Indianapolis, Indiana  
Scott Jacqua Co., Inc.  
202 Indiana Terminal Whse.

Lincoln, Neb.  
Enterprise Electric Co.  
1425-35 M. St.

Los Angeles, Cal.  
Thomas Machinery Co.  
912 E. 3rd St.

Milwaukee, Wis.  
Wm. H. Fernholz  
1031 Clybourn St.

New York (Export)  
Parr Electric Export Corp.  
77 Warren St.

Omaha, Neb.  
J. H. Nicholson  
6315 N. 33rd St.

Philadelphia, Pa.  
J. Edward Bolich  
1015 Chestnut St.

Pittsburgh, Pa.  
Continental Sales & Eng. Co.  
839 Oliver Bldg.

Rochester, N. Y.  
Geo. W. Foote  
601 Temple Bldg.

Saint Paul, Minn.  
E. H. Heins  
4179 Blair St.

San Francisco, Cal.  
C. F. Henderson  
Call Building

Seattle, Wash.  
Equipment Sales Co.  
514 Lloyd Bldg.

Tampa, Fla.  
Tampa Hardware Co.  
Polk & Morgan Sts.

Toledo, Ohio  
Howard J. Wittman  
319 Spitzer Bldg.

York, Pa.  
Harry W. Motter  
25 N. Duke St.

**T**HIS is one of three banks of Kuhlman Power Transformers installed in a foundry of one of the world's largest manufacturing organizations. The selection of Kuhlman Transformers for the second and third banks is significant . . . it is another indication of the reliable and efficient performance of Kuhlman Transformers.

It is an interesting fact that since the first installation of Kuhlman Power Transformers, this plant has also placed in service approximately 1100 kva. of small Kuhlman Distribution Transformers.

When you are in the market for distribution and power transformers, it will be to your interest to get in touch with the nearest Kuhlman office.

KUHLMAN ELECTRIC CO., BAY CITY, MICH.

## KUHLMAN TRANSFORMERS

# LONG EAR AND SHORT EAR PIPE FITTINGS

## Something New

There are but five parts from which any combination you want can be made.

Each fitting has two ears, one long and one short—a new idea.

The long ear of one clamp always fits over the short ear of the other.

The clamp assemblies will unfold into strings in one plane when laid out.

Your storeroom investment, storage space, lost time and layout costs will be reduced.

Ask for Bulletin 70

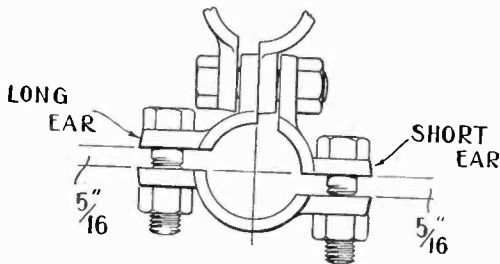

Showing How Parts Fit Together

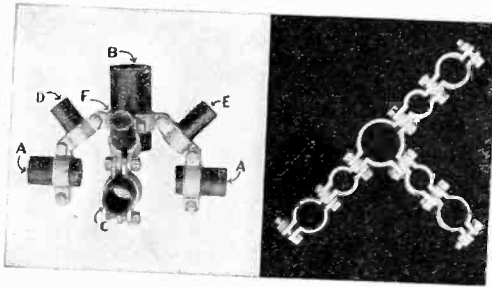

THREE STANDARD BRACES  
(For Unequal Sizes of Pipe)

## New Possibilities

These new clamps open new possibilities in the field of pipe construction.

Easy to install. No more hurrying to secure the last and missing link on the job.

They are forged from mild steel and hot galvanized by electric heat.

Our bulletin contains much useful information for designers of pipe structures.

There are 36 pages with pictures, tables, charts and up-to-date engineering data.

Ask for Bulletin 70

For Canada:  
MONARCH ELECTRIC,  
LTD.  
St. Johns, Que.

# Delta

MAKERS OF  
UNIT  TYPE  
EQUIPMENT

# Star

For Canada:  
MONARCH ELECTRIC,  
LTD.  
St. Johns, Que.

DELTA-STAR ELECTRIC COMPANY, 2400 BLOCK, FULTON ST, CHICAGO, ILLINOIS.

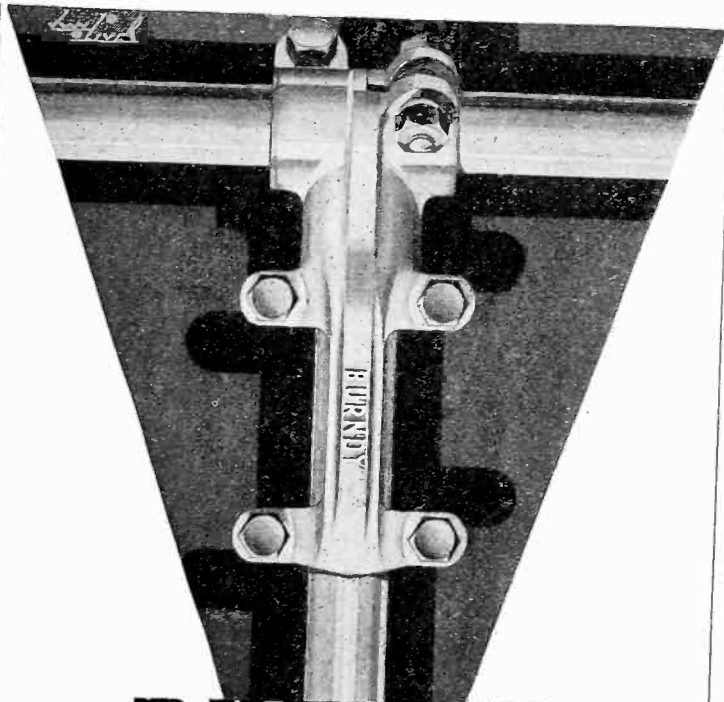

# BURNDY CONNECTORS

For Tubing, Cable and Bar

**BURNDY ENGINEERING CO.,**  
Incorporated  
10 East 43rd Street, New York

# MEMCO

- Insulator Clamps
- Copper Fittings
- Splicing Sleeves
- Disconnects
- Choke Coils
- Fuse Mountings
- Substation Combinations
- Air Break Switches
- Bus Supports

*Memco builds this equipment in all standard and special sizes—ask for bulletins of interest to you.*

Memco Engineering & Manufacturing Company, Inc.  
381 Hamilton Street, Long Island City, N. Y.

# Roebbling

Electrical Wires and Cables  
High in Conductivity and Reliability

John A. Roebblings' Sons Company  
Trenton, New Jersey



Elevator Control Cable

Please mention the JOURNAL of the A. I. E. E. when writing to advertisers.





CONDUITS ARE UNNECESSARY IF  
**CONDEX**  
**PARK CABLE**  
 IS USED

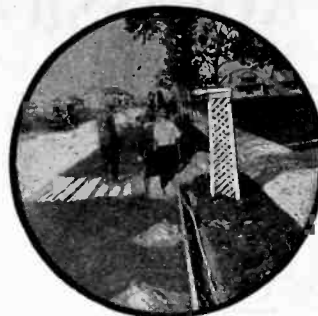

CONDEX Park Cable eliminates the necessity of outside conduits and other methods of protection.

The feature of this type of cable is a specially constructed steel tape armor which offers unusual resistance to crushing and protects against outside disturbances.

As the steel tape is applied over the lead sheath it overlaps and interlocks, forming a flexible conduit. This type of protection was

originated by us and during the past few years has met with the approval of public utility engineers throughout the United States.

CONDEX Park Cable is ideal on series lighting circuits for municipal street lighting, white way installations, and for park or playground illuminating systems.

Further information, a sample and prices will be sent on request.

**SIMPLEX WIRE & CABLE CO**

MANUFACTURERS

201 DEVONSHIRE ST., BOSTON

BRANCH SALES OFFICES

CHICAGO, 564 W. Monroe St. SAN FRANCISCO, 390 Fourth St.  
 NEW YORK, 1328 B'way CLEVELAND, 2019 Union Trust Bldg.  
 JACKSONVILLE, 1010 Barnett Nat'l Bank Bldg.

**MINERALLAC 150**

A Cable-Pulling Compound

that

Saves the wear and tear

on the

Cable Sheath

*Write for Bulletin 120*

**MINERALLAC ELECTRIC COMPANY**

25 North Peoria St., Chicago, Illinois

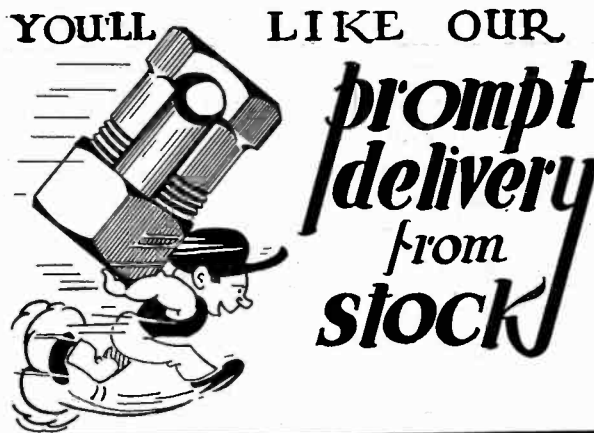

on PENN-UNION Connectors for all standard needs

Because of volume production, we are able to ship from stock all types and sizes of PENN-UNION Connectors, for conductors up to and including 500,000 CM.

And we make prompt delivery on the larger sizes, too.

Positive mechanical and electrical connections without solder

The permanent tightness of PENN-UNION Connectors prevents damage from overcharges. Unique lock-nut action—can't loosen and burn out. Equalized pressure on main and branch conductors.

Extreme simplicity—only four parts. Saves time and labor. Write for Bulletin "E."

PENN-UNION ELECTRIC CORPORATION  
 Erie, Pa.

**PENN-UNION CONNECTORS**

HOLD TIGHT  REALLY SOLDERLESS

# PROFESSIONAL ENGINEERING DIRECTORY

For Consultants in the Fields of Engineering, and Related Arts and Sciences

**AMBURSEN DAMS**  
Hydroelectric Developments  
Water Supply and Irrigation Dams  
DAMS ON DIFFICULT FOUNDATIONS  
AMBURSEN CONSTRUCTION CO.  
Incorporated  
Grand Central Terminal, New York  
Kansas City, Mo. Atlanta, Ga.

**DAVID V. FENNESSY**  
Consulting Power Engineer  
MILLS BUILDING EL PASO, TEXAS

**N. J. NEALL**  
Consulting Engineer  
for  
Electrical and Industrial Properties  
12 Pearl Street BOSTON, MASS 100 Broadway  
NEW YORK CITY

**W. S. BARSTOW & COMPANY**  
Incorporated  
Engineering Design  
Construction  
50 Pine Street, New York  
412 Washington St., Reading, Pa.

**FORD, BACON & DAVIS**  
Incorporated  
ENGINEERS  
115 Broadway, New York  
Philadelphia Chicago San Francisco

**NEILER, RICH & CO.**  
Electrical and Mechanical  
Engineers  
Consulting, Designing and  
Supervising  
431 So. Dearborn St. — — — Chicago

**BATTEY & KIPP**  
Incorporated  
ENGINEERS  
Complete Industrial Plants  
Power Plants & Electrical Installations  
Engineering Reports, Analyses & Appraisals  
231 South LaSalle Street CHICAGO

**FRANK F. FOWLE & CO.**  
Electrical and Mechanical  
Engineers  
MONADNOCK BUILDING CHICAGO

To appear in the following  
issue, cards must be re-  
ceived not later than the  
20th day of the month.

**BLACK & VEATCH**  
Consulting Engineers  
Water, Steam and Electric Power Investiga-  
tions, Design, Supervision of Construction,  
Valuation and Tests.  
Mutual Building KANSAS CITY, MO.

**FREYN ENGINEERING COMPANY**  
Industrial Electric Power  
Generation—Application—Purchase  
Combustion Engineering  
Electric Furnace Installations  
310 South Michigan Ave. CHICAGO

**OPHULS & HILL, INC.**  
ENGINEERS AND CONSTRUCTORS  
Steam Generating and Electric Power Plants  
Ice Making and Refrigerating Plants  
112 WEST 42nd ST.  
NEW YORK CITY

**ROBERT C. BURT, E. E., Ph. D.**  
**DONALD H. LOUGHRIDGE, Ph.D.**  
Consulting Physicists  
Designers and Makers of  
Scientific Instruments  
327 So. Michigan Ave. PASADENA  
California

**HOOSIER ENGINEERING CO.**  
Erectors of  
Transmission Lines and Substations  
100 W. Monroe Street  
CHICAGO  
NEW YORK INDIANAPOLIS  
31 Nassau Street 5 E. Market Street

**FARLEY OSGOOD**  
Consultant  
Design, Construction, Operation  
Inter-Connection  
of  
PUBLIC UTILITIES  
National Bank of Commerce Building  
31 Nassau Street, New York, N. Y.  
Tel.: Rector 7878 Cable Address: Fargoood

**BYLLESBY**  
ENGINEERING AND MANAGEMENT  
CORPORATION  
231 S. La Salle Street  
CHICAGO  
New York San Francisco

Dugald C. Jackson  
Edward L. Moreland  
**JACKSON & MORELAND**  
CONSULTING ENGINEERS  
31 St. James Ave. Boston, Mass.

**G. R. SACKMAN, M. E.**  
Assoc. A. I. E. E.  
Counsellor at Law  
PATENT ATTORNEY  
1860 BROADWAY NEW YORK CITY  
Suite 1715-16 Phone: Columbus 8945

**EDWARD E. CLEMENT**  
Fellow A. I. E. E.  
Attorney and Expert  
in Patent Causes  
Soliciting, Consultation, Reports,  
Opinions  
McLachlen Bldg. Washington, D. C.  
700 10th St., N. W.

**ROBERT S. KRUSE**  
Consultant for Radio  
Stations and Manufacturers  
103 Meadowbrook Road Telephone  
West Hartford, Conn. Hartford 4-5327

**SANDERSON & PORTER**  
ENGINEERS  
PUBLIC UTILITIES & INDUSTRIALS  
Design Construction Management  
Examinations Reports Valuations  
Chicago New York San Francisco

When you require technical advice —  
Or a solution to an engineering problem —

CONSULT THIS DIRECTORY

# PROFESSIONAL ENGINEERING DIRECTORY

For Consultants in the Fields of Engineering, and Related Arts and Sciences

**SARGENT & LUNDY**  
Incorporated  
Mechanical and Electrical  
Engineers  
1412 Edison Bldg., 72 West Adams Street  
CHICAGO ILLINOIS

**STEVENS & WOOD**  
INCORPORATED  
Engineers and Constructors  
60 JOHN STREET, NEW YORK  
Youngstown, O. Jackson, Mich.  
Chicago, Ill.

**PERCY H. THOMAS**  
Consulting Engineer  
**ELECTRIC POWER**  
Generation—Transmission  
Applications  
120 BROADWAY NEW YORK

**SCOFIELD ENGINEERING CO.**  
CONSULTING ENGINEERS  
Utility and Industrial Plants  
Design, Construction, Operation  
Valuations and Appraisals  
PHILADELPHIA

**STOCKBRIDGE & BORST**  
  
Patent Law  
41 PARK ROW NEW YORK CITY

**THE J. G. WHITE**  
ENGINEERING CORPORATION  
Engineers—Constructors  
Oil Refineries and Pipe Lines,  
Steam and Water Power Plants  
Transmission Systems, Hotels, Apartments,  
Offices and Industrial Buildings, Railroads  
42 EXCHANGE PLACE NEW YORK

**JOHN A. STEVENS, INC.**  
Established 1909  
CONSULTING ENGINEERS  
Power Plants Paper Mills  
Dye Houses Surveys  
LOWELL, MASSACHUSETTS

**STONE & WEBSTER**  
Incorporated  
DESIGN AND CONSTRUCTION  
EXAMINATIONS REPORTS  
APPRAISALS  
INDUSTRIAL AND PUBLIC SERVICE  
PROPERTIES  
New York Boston Chicago

**J. G. WRAY & CO.**  
Engineers  
J. G. Wray, Fellow A. I. E. E. Cyrus G. Hill  
Utilities and Industrial Properties  
Appraisals Construction Rate Surveys  
Plans Organizations Estimates  
Financial Investigations Management  
2130 Bankers Bldg., Chicago

**YOUR CARD** in each issue of this publication—12 times a year, will keep your name and specialized service constantly before the electrical industry. Qualified advertisers in the Professional Engineering Directory are invited to send for rates.

**ELECTRICAL TESTING LABORATORIES**  
80th Street and East End Ave.  
NEW YORK

*Inspections — Tests — Research*  
Tests may be used by the purchaser for the following purposes:  
(1) To determine the quality of competing samples. This enables the purchase of the best quality for the money.  
(2) To make sure that shipments comply with specifications. This makes possible the assurance to the customer that shipments match buying samples.  
(3) To furnish an impartial decision in case of disputes between purchaser and manufacturer.  
Testing places the whole buying problem on a sound basis.

**Leading Public Utility Companies are our Transformer repair customers**  
Our shops are manned by experienced men, under supervision of transformer specialists. Transformers rewound and re-conditioned by us are equal in performance to new equipment. The work done is of the highest quality A. I. E. E. standard and deliveries are prompt. We can save you from 30 to 60 per cent in your transformer replacement cost.  
We also carry a stock of nearly 5,000 rebuilt transformers, ranging from 1 to 1,000 kva. capacity and primary voltages up to 66,000. Every one guaranteed.



Send for our Monthly Bulletin—contains complete stock and prices.  
WE BUY MODERN TYPE TRANSFORMERS—ANY SIZE—ANY QUANTITY

*The* **ELECTRIC SERVICE CO. Inc.**  
America's Used Transformer Clearing House  
212 Walnut Street Cincinnati, Ohio



Please mention the JOURNAL of the A. I. E. E. when writing to advertisers.

# Classified Advertiser's Index for Buyers

Manufacturers and agents for machinery and supplies used in the electrical and allied industries.

Note: For reference to the advertisements see the Alphabetical List of Advertisers on page 58.

- AIR COMPRESSORS**  
Allis-Chalmers Mfg. Co., Milwaukee  
General Electric Co., Schenectady
- AMMETER COMPENSATING COILS**  
Minerallac Electric Co., Chicago
- AMMETER, VOLTMETERS**  
(See INSTRUMENTS, ELECTRICAL)
- ANCHORS, GUY**  
Copperweld Steel Co., Glassport, Pa.  
Kearney Corp., Jas. R., St. Louis  
Matthews Corp., W. N., St. Louis
- BATTERY CHARGING APPARATUS**  
Electric Specialty Co., Stamford, Conn.  
General Electric Co., Schenectady  
Rochester Electric Products Corp., Rochester, N. Y.  
Wagner Electric Corp., St. Louis  
Westinghouse Elec. & Mfg. Co., E. Pittsburgh
- BEARINGS, BALL**  
Norma-Hoffmann Bearings Corp., Stamford, Conn.
- BOXES, FUSE**  
General Electric Co., Schenectady  
Kearney Corp., Jas. R., St. Louis  
Metropolitan Device Corp., Brooklyn, N. Y.  
Westinghouse Elec. & Mfg. Co., E. Pittsburgh
- BOXES, JUNCTION**  
G & W Elec. Specialty Co., Chicago  
Metropolitan Device Corp., Brooklyn, N. Y.  
Standard Underground Cable Co., Pittsburgh
- BRUSHES, COMMUTATOR**  
*Carbon*  
Morganite Brush Co., Inc., L. I. City, N. Y.  
National Carbon Co., Inc., Cleveland  
Westinghouse Elec. & Mfg. Co., E. Pittsburgh  
*Copper Graphite*  
Morganite Brush Co., Inc., L. I. City, N. Y.  
National Carbon Co., Inc., Cleveland  
Westinghouse Elec. & Mfg. Co., E. Pittsburgh
- BUS BARS, ALUMINUM**  
Aluminum Co. of America, Pittsburgh
- BUS BAR FITTINGS**  
Burdny Engineering Co., Inc., New York  
Delta-Star Electric Co., Chicago  
General Electric Co., Schenectady  
Memco Engg. & Mfg. Co., L. I. City, N. Y.  
Ohio Brass Co., Mansfield, O.  
Westinghouse Elec. & Mfg. Co., E. Pittsburgh
- BUSHINGS, PORCELAIN**  
Ohio Brass Co., Mansfield, O.
- CABLE ACCESSORIES**  
Delta Star Electric Co., Chicago  
Dossert & Co., New York  
G & W Electric Specialty Co., Chicago  
General Electric Co., Schenectady  
Minerallac Electric Co., Chicago  
Standard Underground Cable Co., Pittsburgh
- CABLE RACKS**  
Metropolitan Device Corp., Brooklyn, N. Y.
- CABLES**  
SEE WIRES AND CABLES
- CABLEWAYS**  
American Steel & Wire Co., Chicago  
Roebbling's Sons Co., John A., Trenton, N. J.
- CARRIER CURRENT TELEPHONE EQUIPMENT**  
Wireless Specialty Apparatus Co., Boston
- CASTINGS, ALUMINUM**  
Aluminum Co. of America, Pittsburgh
- CIRCUIT BREAKERS**  
*Air—Enclosed*  
I-T-E Circuit Breaker Co., The, Philadelphia  
Roller-Smith Co., New York  
Sundh Electric Co., Newark, N. J.  
*Oil*  
Condit Electrical Mfg. Corp., Boston  
General Electric Co., Schenectady  
Pacific Electric Mfg. Corp., San Francisco  
Roller-Smith Co., New York  
Westinghouse Elec. & Mfg. Co., E. Pittsburgh
- CLAMPS, INSULATOR**  
Memco Engg. & Mfg. Co., L. I. City, N. Y.
- CLAMPS, GUY & CABLE**  
Burdny Engineering Co., Inc., New York  
Kearney Corp., Jas. R., St. Louis  
Matthews Corp., W. N., St. Louis
- COILS, CHOKE**  
Burke Electric Co., Erie, Pa.  
General Electric Co., Schenectady  
Kearney Corp., Jas. R., St. Louis  
Memco Engg. & Mfg. Co., L. I. City, N. Y.  
Westinghouse Elec. & Mfg. Co., E. Pittsburgh
- COILS, MAGNET**  
Acme Wire Co., New Haven, Conn.  
Belden Mfg. Co., Chicago  
Dudlo Mfg. Corp., Ft. Wayne, Ind.  
General Electric Co., Schenectady  
Westinghouse Elec. & Mfg. Co., E. Pittsburgh
- COMMUTATOR SEGMENTS AND RINGS**  
Mica Insulator Co., New York
- DENSATION PRODUCTS**  
Bakelite Corporation, New York
- CONDENSERS, COUPLING**  
*For Carrier Current Telephone*  
Wireless Specialty Apparatus Co., Boston
- CONDENSERS, RADIO**  
General Radio Co., Cambridge, Mass.  
Sangamo Electric Co., Springfield, Ill.  
Wireless Specialty Apparatus Co., Boston
- CONDENSERS, STEAM**  
Allis-Chalmers Mfg. Co., Milwaukee  
General Electric Co., Schenectady  
Westinghouse Elec. & Mfg. Co., E. Pittsburgh
- CONNECTORS, SOLDERLESS**  
Dossert & Co., New York  
Kearney Corp., Jas. R., St. Louis  
Penn-Union Electrical Corp., Erie, Pa.  
Westinghouse Elec. & Mfg. Co., E. Pittsburgh
- CONNECTORS AND TERMINALS**  
Belden Mfg. Co., Chicago  
Burke Electric Co., Erie, Pa.  
Burdny Engineering Co., Inc., New York  
Dossert & Co., New York  
G & W Electric Specialty Co., Chicago  
Westinghouse Elec. & Mfg. Co., E. Pittsburgh
- CONTACTS, TUNGSTEN**  
General Electric Co., Schenectady
- CONTROLLERS**  
Electric Controller & Mfg. Co., Cleveland  
General Electric Co., Schenectady  
Sundh Electric Co., Newark, N. J.  
Westinghouse Elec. & Mfg. Co., E. Pittsburgh
- CONVERTERS—SYNCHRONOUS**  
Allis-Chalmers Mfg. Co., Milwaukee  
Electric Specialty Co., Stamford, Conn.  
Wagner Electric Corp., St. Louis  
Westinghouse Elec. & Mfg. Co., E. Pittsburgh
- COPPER CLAD WIRE**  
Belden Mfg. Co., Chicago  
Standard Underground Cable Co., Pittsburgh
- COPPERWELD WIRE**  
Copperweld Steel Co., Glassport, Pa.
- CUT-OUTS**  
Condit Electrical Mfg. Corp., S. Boston  
General Electric Co., Schenectady  
G & W Electric Specialty Co., Chicago  
Kearney Corp., Jas. R., St. Louis  
Metropolitan Device Corp., Brooklyn, N. Y.  
Wagner Electric Corp., St. Louis  
Westinghouse Elec. & Mfg. Co., E. Pittsburgh
- DIVERTER POLE GENERATORS**  
Rochester Electric Products Corp., Rochester, N. Y.
- DYNAMOS**  
(See GENERATORS AND MOTORS)
- DYNAMOTORS**  
Burke Electric Co., Erie, Pa.  
Electric Specialty Co., Stamford, Conn.  
Rochester Electric Products Corp., Rochester, N. Y.
- ELECTRIFICATION SUPPLIES, STEAM ROAD**  
General Electric Co., Schenectady  
Ohio Brass Co., Mansfield, Ohio  
Westinghouse Elec. & Mfg. Co., E. Pittsburgh
- ENGINEERS, CONSULTING AND CONTRACTING**  
(See PROFESSIONAL ENGINEERING DIRECTORY)
- ENGINES**  
*Gas & Gasoline*  
Allis-Chalmers Mfg. Co., Milwaukee  
*Oil*  
Allis-Chalmers Mfg. Co., Milwaukee  
*Steam*  
Allis-Chalmers Mfg. Co., Milwaukee
- EXPERIMENTAL WORK**  
Manufacturers' and Inventors' Electric Co.  
228 West Broadway, New York
- FANS, MOTOR**  
Century Electric Co., St. Louis  
General Electric Co., Schenectady  
Wagner Electric Corp., St. Louis  
Westinghouse Elec. & Mfg. Co., E. Pittsburgh
- FIRE EXTINGUISHING APPARATUS**  
Walter Kidde & Co., Inc., New York
- FLOW METERS**  
General Electric Co., Schenectady
- FURNACES, ELECTRIC**  
General Electric Co., Schenectady  
Westinghouse Elec. & Mfg. Co., E. Pittsburgh
- FUSES**  
*Enclosed Refillable*  
General Electric Co., Schenectady  
Westinghouse Elec. & Mfg. Co., E. Pittsburgh  
*Enclosed Non-Refillable*  
General Electric Co., Schenectady  
*Open Link*  
General Electric Co., Schenectady  
Metropolitan Device Corp., Brooklyn, N. Y.  
*High-Tension*  
Delta-Star Electric Co., Chicago  
Metropolitan Device Corp., Brooklyn, N. Y.
- FUSE MOUNTINGS**  
Memco Engg. & Mfg. Co., L. I. City, N. Y.
- FUSE PULLERS**  
Kearney Corp., Jas. R., St. Louis



Is your  
name on our  
mailing list  
for bulletins  
and catalog?

# Morganite Brushes

Morganite  
Brush Co., Inc.  
3302-3320 Anable Ave.,  
Long Island City,  
N. Y.

Please mention the JOURNAL of the A. I. E. E. when writing to advertisers.



# SOMETHING NEW In Circuit Breaker Design

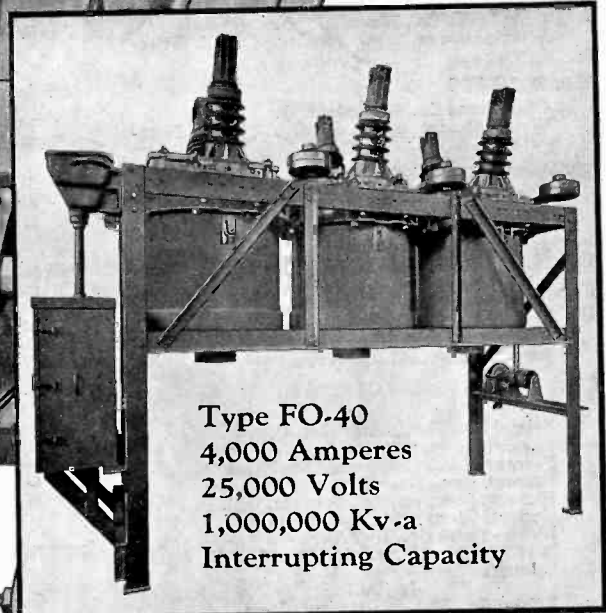

Here's a close-up of the contact system of the new 4000 ampere, 25,000 volt type FO-40 Oil Circuit Breaker.

Observe the inverted laminated brushes; multi-breaks in series; heavy cylindrical arcing contacts of large thermal absorption capacity; and above all, the sturdy construction throughout.

It's such features that make the type FO-40 supreme for outdoor distribution service.

*"Get in touch with Condit"*

**CONDIT ELECTRICAL MFG. CORPORATION**  
Manufacturers of Electrical Protective Devices  
BOSTON, MASS.  
Northern Electric Company  
LIMITED  
Distributor for the Dominion of Canada



# Classified Advertiser's Index for Buyers—Continued

- GEARS, FIBRE**  
Fibroc Insulation Co., Valparaiso, Ind.  
General Electric Co., Schenectady
- GENERATORS AND MOTORS**  
Allis-Chalmers Mfg. Co., Milwaukee  
Burke Electric Co., Erie, Pa.  
Century Electric Co., St. Louis  
Chandeysson Electric Co., St. Louis  
Electric Specialty Co., Stamford, Conn.  
Electro-Dynamic Co., Bayonne, N. J.  
General Electric Co., Schenectady  
Rochester Electric Products Corp., Rochester, N. Y.  
Wagner Electric Corp., St. Louis  
Westinghouse Elec. & Mfg. Co., E. Pittsburgh
- GENERATING STATION EQUIPMENT**  
Allis-Chalmers Mfg. Co., Milwaukee  
Burke Electric Co., Erie, Pa.  
General Electric Co., Schenectady  
Westinghouse Elec. & Mfg. Co., E. Pittsburgh
- GROUND RODS**  
Copperweld Steel Co., Glassport, Pa.
- HARDWARE, POLE LINE AND INSULATOR**  
Ohio Brass Co., Mansfield, O.  
Westinghouse Elec. & Mfg. Co., E. Pittsburgh
- HEADLIGHTS**  
Ohio Brass Co., Mansfield, O.  
Westinghouse Elec. & Mfg. Co., E. Pittsburgh
- HEATERS, INDUSTRIAL**  
General Electric Co., Schenectady  
Westinghouse Elec. & Mfg. Co., E. Pittsburgh
- INDICATORS, REMOTE, WATER LEVEL**  
Bristol Co., The, Waterbury, Conn.
- INDICATORS, SPEED**  
Bristol Co., The, Waterbury, Conn.  
Roller-Smith Co., New York
- INSTRUMENTS, ELECTRICAL**  
*Graphic*  
Bristol Co., The, Waterbury, Conn.  
Cambridge Instrument Co., New York  
Ferranti, Ltd., Hollinwood, England  
Ferranti, Inc., New York  
Ferranti Electric, Ltd., Toronto, Ont.  
General Electric Co., Schenectady  
Roller-Smith Co., New York  
Westinghouse Elec. & Mfg. Co., E. Pittsburgh  
*Indicating*  
Bristol Co., The, Waterbury, Conn.  
Cambridge Instrument Co., New York  
Ferranti, Ltd., Hollinwood, England  
Ferranti, Inc., New York  
Ferranti Electric, Ltd., Toronto, Ont.  
General Electric Co., Schenectady  
Jewell Elec. Instrument Co., Chicago  
Roller-Smith Co., New York  
Sangamo Electric Co., Springfield, Ill.  
Westinghouse Elec. & Mfg. Co., E. Pittsburgh  
Weston Elec. Inst. Corp., Newark, N. J.  
*Integrating*  
Ferranti, Ltd., Hollinwood, England  
Ferranti, Inc., New York  
Ferranti Electric, Ltd., Toronto, Ont.  
General Electric Co., Schenectady  
Sangamo Electric Co., Springfield, Ill.  
Westinghouse Elec. & Mfg. Co., E. Pittsburgh  
*Radio*  
Cambridge Instrument Co., New York  
General Radio Co., Cambridge, Mass.  
Jewell Elec. Instrument Co., Chicago  
Roller-Smith Co., New York  
*Repairing and Testing*  
Cambridge Instrument Co., New York  
Electrical Testing Laboratories, New York  
Jewell Elec. Instrument Co., Chicago  
Roller-Smith Co., New York  
*Scientific Laboratory, Testing*  
Cambridge Instrument Co., New York  
General Electric Co., Schenectady  
Jewell Elec. Instrument Co., Chicago  
Metropolitan Device Corp., Brooklyn, N. Y.  
Roller-Smith Co., New York  
Westinghouse Elec. & Mfg. Co., E. Pittsburgh  
Weston Elec. Inst. Corp., Newark, N. J.
- INSULATING MATERIALS**  
*Board*  
Acme Wire Co., New Haven, Conn.  
General Electric Co., Bridgeport, Conn.  
West Va. Pulp & Paper Co., New York  
*Cloth*  
Acme Wire Company, New Haven, Conn.  
General Electric Co., Bridgeport, Conn.  
Mica Insulator Co., New York  
Minerallac Electric Co., Chicago  
Westinghouse Elec. & Mfg. Co., E. Pittsburgh
- INSULATING MATERIALS—Continued**  
*Composition*  
American Lava Corp., Chattanooga  
Bakelite Corporation, New York  
Belden Mfg. Co., Chicago  
Fibroc Insulation Co., Valparaiso, Ind.  
General Electric Co., Bridgeport, Conn.  
Westinghouse Elec. & Mfg. Co., E. Pittsburgh  
*Compounds*  
General Electric Co., Bridgeport, Conn.  
Mica Insulator Co., New York  
Minerallac Electric Co., Chicago  
Standard Underground Cable Co., Pittsburgh  
Westinghouse Elec. & Mfg. Co., E. Pittsburgh  
*Fibre*  
Belden Mfg. Co., Chicago  
Fibroc Insulation Co., Valparaiso, Ind.  
General Electric Co., Bridgeport, Conn.  
West Va. Pulp & Paper Co., New York  
*Lava*  
American Lava Corp., Chattanooga, Tenn.  
*Mica*  
Mica Insulator Co., New York  
Westinghouse Elec. & Mfg. Co., E. Pittsburgh  
*Paper*  
Acme Wire Company, New Haven, Conn.  
General Electric Co., Bridgeport, Conn.  
Mica Insulator Co., New York  
Westinghouse Elec. & Mfg. Co., E. Pittsburgh  
*Silk*  
Acme Wire Company, New Haven, Conn.  
General Electric Co., Bridgeport, Conn.  
*Tape*  
Belden Mfg. Co., Chicago  
General Electric Co., Bridgeport, Conn.  
Mica Insulator Co., New York  
Minerallac Electric Co., Chicago  
Okonite Co., The, Passaic, N. J.  
Westinghouse Elec. & Mfg. Co., E. Pittsburgh  
*Varnishes*  
Acme Wire Company, New Haven, Conn.  
General Electric Co., Bridgeport, Conn.  
Mica Insulator Co., New York  
Minerallac Electric Co., Chicago  
Westinghouse Elec. & Mfg. Co., E. Pittsburgh
- INSULATORS, HIGH TENSION**  
*Composition*  
General Electric Co., Schenectady  
*Glass*  
Hemingray Glass Co., Muncie, Ind.  
*Porcelain*  
Canadian Porcelain Co., Ltd., Hamilton, Ont.  
General Electric Co., Schenectady  
Lapp Insulator Co., Inc., LeRoy, N. Y.  
Locke Insulator Corp., Baltimore  
Ohio Brass Co., Mansfield, O.  
Thomas & Sons Co., R., Lisbon, O.  
Westinghouse Elec. & Mfg. Co., E. Pittsburgh  
*Post Type*  
Delta-Star Electric Co., Chicago  
Ohio Brass Co., Mansfield, O.
- INSULATORS, TELEPHONE & TELEGRAPH**  
Hemingray Glass Co., Muncie, Ind.  
Ohio Brass Co., Mansfield, O.
- INSULATOR PINS**  
Ohio Brass Co., Mansfield, O.  
Thomas & Sons Co., R., Lisbon, O.
- LAMP GUARDS**  
Matthews Corp., W. N., St. Louis
- LAVA**  
American Lava Corp., Chattanooga
- LIGHTNING ARRESTERS**  
Delta-Star Electric Co., Chicago  
General Electric Co., Schenectady  
Westinghouse Elec. & Mfg. Co., E. Pittsburgh
- LOCOMOTIVES, ELECTRIC**  
General Electric Co., Schenectady  
Westinghouse Elec. & Mfg. Co., E. Pittsburgh
- LUBRICANTS**  
Texas Co., The, New York  
Texas Co., The, New York
- MAGNETIC SEPARATORS**  
Electric Controller & Mfg. Co., Cleveland
- METERS, ELECTRICAL**  
(See INSTRUMENTS ELECTRICAL)
- METER SEALS**  
Metropolitan Device Corp., Brooklyn, N. Y.
- MICA PRODUCTS**  
Mica Insulator Co., New York  
Westinghouse Elec. & Mfg. Co., E. Pittsburgh
- MOLDED INSULATION**  
Bakelite Corporation, New York  
Belden Mfg. Co., Chicago  
Burke Electric Co., Erie, Pa.  
Westinghouse Elec. & Mfg. Co., E. Pittsburgh
- MOTORS**  
(See GENERATORS AND MOTORS)
- OHMMETERS**  
Jewell Elec. Instrument Co., Chicago  
Roller-Smith Co., New York  
Weston Elec. Instr. Corp., Newark, N. J.
- OIL SEPARATORS & PURIFIERS**  
Sharples Specialty Co., The, Philadelphia  
Westinghouse Elec. & Mfg. Co., E. Pittsburgh
- PANEL BOARDS**  
(See SWITCHBOARDS)
- PATENT ATTORNEYS**  
(See PROFESSIONAL ENGINEERING DIRECTORY)
- PLATING GENERATORS**  
Burke Electric Co., Erie, Pa.  
Chandeysson Elec. Co., St. Louis  
Electric Specialty Co., Stamford, Conn.  
Rochester Electric Products Corp., Rochester, N. Y.
- PLUGS**  
Delta-Star Electric Co., Chicago  
General Electric Co., Schenectady  
Westinghouse Elec. & Mfg. Co., E. Pittsburgh
- POLE LINE HARDWARE**  
Ohio Brass Co., Mansfield, O.
- POTHEADS**  
G & W Electric Specialty Co., Chicago  
Ohio Brass Co., Mansfield, O.  
Standard Underground Cable Co., Pittsburgh
- PULLERS, SLACK**  
Matthews Corp., W. N., St. Louis
- PUMPS**  
Allis-Chalmers Mfg. Co., Milwaukee
- RADIO LABORATORY APPARATUS**  
General Radio Co., Cambridge, Mass.  
Westinghouse Elec. & Mfg. Co., E. Pittsburgh
- RAILWAY SUPPLIES, ELECTRIC**  
General Electric Co., Schenectady  
Ohio Brass Co., Mansfield, O.  
Westinghouse Elec. & Mfg. Co., E. Pittsburgh
- REACTORS**  
General Electric Co., Schenectady  
Metropolitan Device Corp., Brooklyn, N. Y.
- RECTIFIERS**  
General Electric Co., Schenectady  
Wagner Electric Corp., St. Louis  
Westinghouse Elec. & Mfg. Co., E. Pittsburgh
- REELS, PAYOUT AND TAKEUP**  
Matthews Corp., W. N., St. Louis
- REGULATORS, VOLTAGE**  
Burke Electric Co., Erie, Pa.  
General Electric Co., Schenectady  
Westinghouse Elec. & Mfg. Co., E. Pittsburgh
- RELAYS**  
Electric Controller & Mfg. Co., Cleveland  
General Electric Co., Schenectady  
Roller-Smith Co., New York  
Westinghouse Elec. & Mfg. Co., E. Pittsburgh
- RESISTOR UNITS**  
General Electric Co., Schenectady  
International Resistance Co., Philadelphia  
Westinghouse Elec. & Mfg. Co., E. Pittsburgh
- RHEOSTATS**  
General Electric Co., Schenectady  
Sundh Electric Co., Newark, N. J.  
Westinghouse Elec. & Mfg. Co., E. Pittsburgh

Please mention the JOURNAL of the A. I. E. E. when writing to advertisers

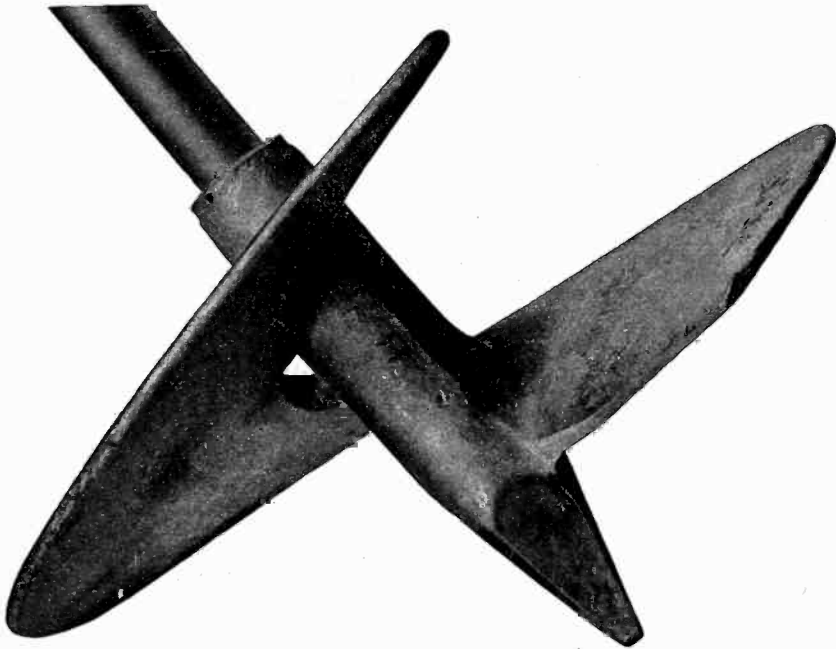

actual tests  
show double  
holding power  
*50% greater guaranteed!*

Companies testing these new Preheated Certified Malleable Matthews Scrulix Anchors have proved time and again that in all types of ground or loose shale, they have double the holding power of ordinary screw anchors. We guarantee 50% greater holding power. By using the new Matthews Wrench these new anchors can be installed two feet deeper. This is the reason for their superior holding power. Ask for circular that tells all. W. N. Matthews Corporation, 3716 Forest Park Boulevard, St. Louis, Mo.

The New Preheated Certified Malleable

**MATTHEWS  
SCRULIX ANCHORS**

Patents Applied for

Please mention the JOURNAL of the A. I. E. E. when writing to advertisers.

# Classified Advertiser's Index for Buyers—Continued

## ROPE, WIRE

American Steel & Wire Co., Chicago  
 Roebling's Sons Co., John A., Trenton, N. J.

## SCREWS

*Drive Hardened Metallic*  
 Parker-Kalon Corp., New York  
*Self-Tapping Hardened*  
 Parker-Kalon Corp., New York  
*Sheet Metal, Hardened Self-Tapping*  
 Parker-Kalon Corp., New York

## SEARCHLIGHTS

General Electric Co., Schenectady  
 Westinghouse Elec. & Mfg. Co., E. Pittsburgh

## SLEEVE TWISTERS

Kearney Corp., Jas. R., St. Louis

## SLEEVES, SPLICING

Memco Engg. & Mfg. Co., L. I. City, N. Y.

## SOCKETS AND RECEPTACLES

General Electric Co., Schenectady  
 Westinghouse Elec. & Mfg. Co., E. Pittsburgh

## SOLENOIDS

Acme Wire Company, New Haven, Conn.  
 Belden Mfg. Co., Chicago  
 Dudlo Mfg. Co., Ft. Wayne, Ind.  
 Electric Controller & Mfg. Co., Cleveland  
 General Electric Co., Schenectady  
 Roebling's Sons Co., John A., Trenton, N. J.  
 Sundh Electric Co., Newark, N. J.  
 Westinghouse Elec. & Mfg. Co., E. Pittsburgh

## SPRINGS

American Steel & Wire Co., Chicago

## STARTERS, MOTORS

Condit Electrical Mfg. Corp., Boston  
 Electric Controller & Mfg. Co., Cleveland  
 General Electric Co., Schenectady  
 Roller-Smith Co., New York  
 Sundh Electric Co., Newark, N. J.  
 Westinghouse Elec. & Mfg. Co., E. Pittsburgh

## STOKERS, MECHANICAL

Westinghouse Elec. & Mfg. Co., E. Pittsburgh

## SUB-STATIONS

Delta-Star Electric Co., Chicago  
 General Electric Co., Schenectady  
 Memco Engg. & Mfg. Co., L. I. City, N. Y.  
 Westinghouse Elec. & Mfg. Co., E. Pittsburgh

## SWITCHBOARDS

Allis-Chalmers Mfg. Co., Milwaukee  
 Bull Dog Electric Products Co., Detroit  
 Condit Electrical Mfg. Corp., Boston  
 General Electric Co., Schenectady  
 Metropolitan Device Corp., Brooklyn, N. Y.  
 Westinghouse Elec. & Mfg. Co., E. Pittsburgh

## SWITCHES

*Automatic Time*  
 General Electric Co., Schenectady  
 Minerallac Electric Co., Chicago  
 Sundh Electric Co., Newark, N. J.  
 Westinghouse Elec. & Mfg. Co., E. Pittsburgh

*Disconnecting*  
 Burke Electric Co., Erie, Pa.  
 Condit Electrical Mfg. Corp., Boston  
 Delta-Star Electric Co., Chicago  
 General Electric Co., Schenectady  
 Kearney Corp., Jas. R., St. Louis  
 Matthews Corp., W. N., St. Louis  
 Memco Engg. & Mfg. Co., L. I. City, N. Y.  
 Pacific Elec. Mfg. Corp., San Francisco  
 Roller-Smith Co., New York  
 Westinghouse Elec. & Mfg. Co., E. Pittsburgh

*Fuse*  
 Bull Dog Electric Products Co., Detroit  
 General Electric Co., Schenectady  
 Kearney Corp., Jas. R., St. Louis  
 Matthews Corp., W. N., St. Louis  
 Metropolitan Device Corp., Brooklyn, N. Y.

*Knife*  
 Condit Electrical Mfg. Co., Boston  
 Electric Controller & Mfg. Co., Cleveland  
 General Electric Co., Schenectady  
 Matthews Corp., W. N., St. Louis  
 Westinghouse Elec. & Mfg. Co., E. Pittsburgh

*Oil*  
 Condit Electrical Mfg. Corp., Boston  
 General Electric Co., Schenectady  
 Pacific Elec. Mfg. Corp., San Francisco  
 Roller-Smith Co., New York  
 Westinghouse Elec. & Mfg. Co., E. Pittsburgh

*Remote Control*  
 Condit Electrical Mfg. Corp., Boston  
 General Electric Co., Schenectady  
 Roller-Smith Co., New York  
 Sundh Electric Co., Newark, N. J.  
 Westinghouse Elec. & Mfg. Co., E. Pittsburgh

## TELEPHONE CONNECTORS

Kearney Corp., Jas. R., St. Louis

## TESTING LABORATORIES

Electrical Testing Labs., New York

## TRANSFORMERS

Allis-Chalmers Mfg. Co., Milwaukee  
 American Transformer Co., Newark, N. J.  
 Duncan Elec. Mfg. Co., Lafayette, Ind.  
 Electric Service Co., Cincinnati  
 Ferranti, Ltd., Hollinwood, England  
 Ferranti, Inc., New York  
 Ferranti Electric, Ltd., Toronto, Ont.  
 General Electric Co., Schenectady  
 Kuhlman Electric Co., Bay City, Mich.  
 Moloney Electric Co., St. Louis  
 Sangamo Electric Co., Springfield, Ill.  
 Wagner Electric Corp., St. Louis  
 Westinghouse Elec. & Mfg. Co., E. Pittsburgh

*Factory*  
 American Transformer Co., Newark, N. J.  
 Kuhlman Electric Co., Bay City, Mich.  
 Moloney Electric Co., St. Louis  
 Wagner Electric Corp., St. Louis

*Furnace*  
 Allis-Chalmers Mfg. Co., Milwaukee  
 American Transformer Co., Newark, N. J.  
 Moloney Electric Co., St. Louis  
 Westinghouse Elec. & Mfg. Co., E. Pittsburgh

*Metering*  
 American Transformer Co., Newark, N. J.  
 Ferranti, Ltd., Hollinwood, England  
 Ferranti, Inc., New York  
 Ferranti Electric, Ltd., Toronto, Ont.  
 Roller-Smith Co., New York  
 Sangamo Electric Co., Springfield, Ill.

*Radio*  
 American Transformer Co., Newark, N. J.  
 Ferranti, Ltd., Hollinwood, England  
 Ferranti Inc., New York  
 Ferranti Electric, Ltd., Toronto, Ont.

*Street Lighting*  
 Kuhlman Electric Co., Bay City, Mich.

## TRANSFORMERS, USED

Electric Service Co., Cincinnati

## TROLLEY LINE MATERIALS

General Electric Co., Schenectady  
 Ohio Brass Co., Mansfield, O.  
 Westinghouse Elec. & Mfg. Co., E. Pittsburgh

## TURBINES, HYDRAULIC

Allis-Chalmers Mfg. Co., Milwaukee

## TURBINES, STEAM

Allis-Chalmers Mfg. Co., Milwaukee  
 General Electric Co., Schenectady  
 Westinghouse Elec. & Mfg. Co., E. Pittsburgh

## TURBO-GENERATORS

Allis-Chalmers Mfg. Co., Milwaukee  
 Westinghouse Elec. & Mfg. Co., E. Pittsburgh

## VALVE CONTROL, ELECTRIC

Bristol Company, The, Waterbury, Conn.

## VALVES, BRASS

*Gas, Water, Steam*  
 Ohio Brass Co., Mansfield, O.

## VARNISHES, INSULATING

General Electric Co., Bridgeport, Conn.  
 Mica Insulator Co., New York  
 Minerallac Electric Co., Chicago  
 Westinghouse Elec. & Mfg. Co., E. Pittsburgh

## WASHERS, LOCK

Shakeproof Lock Washer Co., Chicago

## WELDING MACHINES, ELECTRIC

General Electric Co., Schenectady  
 Ohio Brass Co., Mansfield, O.  
 Westinghouse Elec. & Mfg. Co., E. Pittsburgh

## WELDING WIRES & RODS

Aluminum Co. of America, Pittsburgh  
 American Steel & Wire Co., Chicago  
 Ohio Brass Co., Mansfield, O.

## WIRES AND CABLES and A. C. S. R.

*Aluminum*  
 Aluminum Co. of America, Pittsburgh  
*Armored Cable*  
 American Steel & Wire Co., Chicago  
 Belden Mfg. Co., Chicago  
 General Electric Co., Schenectady  
 Kerite Ins. Wire & Cable Co., New York  
 Okonite Company, The, Passaic, N. J.  
 Roebling's Sons Co., John A., Trenton, N. J.  
 Simplex Wire & Cable Co., Boston  
 Standard Underground Cable Co., Perth Amboy, N. J.

*Asbestos Covered*  
 American Steel & Wire Co., Chicago  
 Belden Mfg. Co., Chicago  
 General Electric Co., Schenectady  
 Rockbestos Products Corp., New Haven, Conn.  
 Rome Wire Company, Rome, N. Y.

## WIRES AND CABLES—Continued

*Automotive*  
 American Steel & Wire Co., Chicago  
 Belden Mfg. Co., Chicago  
 General Electric Co., Schenectady  
 Kerite Ins. Wire & Cable Co., New York  
 Roebling's Sons Co., John A., Trenton, N. J.  
 Rome Wire Company, Rome, N. Y.  
 Simplex Wire & Cable Co., Boston  
 Standard Underground Cable Co., Perth Amboy, N. J.

*Bare Copper*  
 American Steel & Wire Co., Chicago  
 Anaconda Wire & Cable Co., New York  
 Belden Mfg. Co., Chicago  
 Roebling's Sons Co., John A., Trenton, N. J.  
 Rome Wire Company, Rome, N. Y.  
 Standard Underground Cable Co., Perth Amboy, N. J.

*Copper Clad*  
 Belden Mfg. Co., Chicago  
 Standard Underground Cable Co., Perth Amboy, N. J.

*Copperweld*  
 Copperweld Steel Co., Glassport, Pa.

*Flexible Cord*  
 American Steel & Wire Co., Chicago  
 Belden Mfg. Co., Chicago  
 General Electric Co., Schenectady  
 Okonite Company, The, Passaic, N. J.  
 Roebling's Sons Co., John A., Trenton, N. J.  
 Rome Wire Company, Rome, N. Y.  
 Simplex Wire & Cable Co., Boston  
 Standard Underground Cable Co., Perth Amboy, N. J.

*Heavy Duty Cord*  
 American Steel & Wire Co., Chicago  
 Belden Mfg. Co., Chicago  
 Okonite Company, The, Passaic, N. J.  
 Rome Wire Company, Rome, N. Y.  
 Simplex Wire & Cable Co., Boston

*Fuse*  
 Aluminum Co. of America, Pittsburgh  
 American Steel & Wire Co., Chicago  
 General Electric Co., Schenectady  
 Roebling's Sons Co., John A., Trenton, N. J.

*Lead Covered (Paper and Varnished Cambric Insulated)*

American Steel & Wire Co., Chicago  
 Anaconda Wire & Cable Co., New York  
 General Electric Co., Schenectady  
 Kerite Ins. Wire & Cable Co., New York  
 Okonite Company, The, Passaic, N. J.  
 Okonite-Callender Cable Co., The, Inc., Passaic, N. J.  
 Roebling's Sons Co., John A., Trenton, N. J.  
 Rome Wire Company, Rome, N. Y.  
 Simplex Wire & Cable Co., Boston  
 Standard Underground Cable Co., Perth Amboy, N. J.

*Magnet*  
 Acme Wire Company, New Haven, Conn.  
 Aluminum Co. of America, Pittsburgh  
 American Steel & Wire Co., Chicago  
 Anaconda Wire & Cable Co., New York  
 Belden Mfg. Co., Chicago  
 Dudlo Mfg. Corp., Fort Wayne, Ind.  
 General Electric Co., Schenectady  
 Roebling's Sons Co., John A., Trenton, N. J.  
 Rome Wire Company, Rome, N. Y.  
 Standard Underground Cable Co., Perth Amboy, N. J.

*Rubber Insulated*  
 American Steel & Wire Co., Chicago  
 Belden Mfg. Co., Chicago  
 General Electric Co., Schenectady  
 Kerite Ins. Wire & Cable Co., New York  
 Okonite Company, The, Passaic, N. J.  
 Roebling's Sons Co., John A., Trenton, N. J.  
 Rome Wire Company, Rome, N. Y.  
 Simplex Wire & Cable Co., Boston  
 Standard Underground Cable Co., Perth Amboy, N. J.

*Tree Wire*  
 Okonite Company, The, Passaic, N. J.  
 Roebling's Sons Co., John A., Trenton, N. J.  
 Simplex Wire & Cable Co., Boston

*Trolley*  
 American Steel & Wire Co., Chicago  
 Anaconda Wire & Cable Co., New York  
 Copperweld Steel Co., Glassport, Pa.  
 Roebling's Sons Co., John A., Trenton, N. J.  
 Rome Wire Company, Rome, N. Y.  
 Standard Underground Cable Co., Perth Amboy, N. J.

*Weather proof*  
 American Steel & Wire Co., Chicago  
 Anaconda Wire & Cable Co., New York  
 Copperweld Steel Co., Glassport, Pa.  
 General Electric Co., Schenectady  
 Kerite Ins. Wire & Cable Co., New York  
 Okonite Company, The, Passaic, N. J.  
 Roebling's Sons Co., John A., Trenton, N. J.  
 Rome Wire Company, Rome, N. Y.  
 Simplex Wire & Cable Co., Boston  
 Standard Underground Cable Co., Perth Amboy, N. J.



# Principal A. I. E. E. Publications

## JOURNAL. Published monthly.

An engineering periodical containing in full or in abstract engineering and theoretical papers as presented before meetings of the Institute and its Sections and Branches; descriptions of new developments characterized by notable advances, and items relating to the activities of the Institute and other organizations.

Subscription price \$10.00 per year. Agents, publishers and dealers are allowed 20 per cent discount; a special discount of 50 per cent is allowed on single subscriptions received directly from college or public libraries. Postage to Canada on annual subscription \$0.50 additional, and to foreign countries, \$1.00. (Postage should not be included when computing discounts).

**JOURNAL BINDERS.** A loose leaf binder, especially designed for the JOURNAL of the A. I. E. E. is now available. The new binder is attractively finished in a long-wearing, processed material, resembling brown leather. From one to six copies of the JOURNAL can be inserted. The name of the publication is embossed in gold on the front cover and backbone. The binders are sold in sets of two at \$2.25 or \$1.25 for one.

## TRANSACTIONS. Published quarterly.

Contains such of the technical papers and reports published by the Institute in the JOURNAL and elsewhere as are selected and authorized by the Publication Committee; also the discussions on the technical papers. The TRANSACTIONS form a permanent record of the progress of electrical engineering.

The subscription price to A. I. E. E. members is \$2.00 per year for pamphlet binding and \$4.00 for cloth binding. To non-members the cost is \$10.00 per year for pamphlet binding, and \$12.00 for cloth binding.

Available volumes of the TRANSACTIONS published prior to 1921 may be obtained at reduced prices. The volumes in stock and prices will be supplied upon request.

Discounts allowed on the current volume are as follows: 20 per cent to publishers and subscription agents 50 per cent to college and public libraries upon direct subscription to Institute headquarters.

**INDEX TO TRANSACTIONS.** Published every ten years. Vol. III of the TRANSACTIONS Index (Jan. 1, 1911 to Jan 1, 1922) is a practical bibliography (168 pp.) of all A. I. E. E. papers and discussions printed during the period 1911-1922. Price to members and non-members \$2.00, with dealers' discount of 20 per cent.

## A. I. E. E. STANDARDS.

The work of revision of the A. I. E. E. Standards which has been in progress for several years has now reached a stage where a large number of sections of the Standards have been approved by the Board of Directors and are available in pamphlet form, as follows:

1—General Principles Upon Which Temperature Limits are Based in the Rating of Electrical Machinery, (.20); 4—Measurement of Test Voltages in Dielectric Tests, (.30); 5—Direct-Current Generators and Motors and Direct-Current Commutator Machines in General, (.40); 7—Alternators, Synchronous Motors and Synchronous Machines in General, (.40); \*8—Synchronous Converters, (.40); 9—Induction Motors and Induction Machines in General, (.40); 10—Direct-Current and Alternating-Current Fractional Horse Power Motors, (.30); \*11—Railway Motors, (.30); 13—Transformers, Induction Regulators and Reactors, (.40); \*14—Instrument Transformers, (.30); \*15—Industrial Control Apparatus, (.40); \*16—Railway Control and Mine Locomotive Control Apparatus, (.40); \*17f—Mathematical Symbols, (.30); \*17g1—Letter Symbols for Electrical Quantities, (.20); 17g6—Graphical Symbols for Telephone and Telegraph Use, (.20); 19—Oil Circuit Breakers, (.30); 22—Disconnecting and Horn Gap Switches, (.30); 26—Automatic Stations, (.30); 30—Wires and Cables, (.40); 33—Electrical Measuring Instruments, (.30); 34—Telegraphy and Telephony, (.30); \*36—Storage Batteries, (.20); \*37—Illumination, (.30); 38—Electric Arc Welding Apparatus, (.40); 39—Electric Resistance Welding Apparatus, (.30); 41—Insulators, (.30); \*42—Symbols for Electrical Equipment of Buildings, (.20); 45—Recommended Practice for Electrical Installations on Shipboard, (1.50); \*46—Hard Drawn Aluminum Conductors, (.20); \*60—Specifications for Tinned Soft or Annealed Copper Wire; \*61—Specifications for Soft or Annealed Copper Wire, (No. 60 and 61 published as one pamphlet), (.30); \*63—Specifications for 30 Per Cent Rubber Insulation for Wire and Cable for General Purposes, (.30); \*69—Specifications for Cotton Covered Round Copper Magnet Wire; \*70—Specifications for Silk Covered Round Copper Magnet Wire; \*71—Specifications for Enameled Round Copper Magnet Wire, (No. 69, 70 and 71 published as one pamphlet), (.30).  
\*Approved as American Standard.

A discount of 50% is allowed to Institute members. Numbers of the Standards Sections should be given when ordering.

**NEW STANDARDS BINDERS.** A new and different binder is now available which will hold all the present Standards pamphlets and reports, and still have room for additional sections. Price \$1.75.

## YEAR BOOK OF THE A. I. E. E.

A directory, published annually in March, of the membership of the A. I. E. E. Gives in alphabetical order, the names, occupations and addresses of all members. The membership is also listed in geographical order. The Year Book contains general information regarding the scope and activities of the Institute, including the Constitution and By-Laws, lists of Sections and Branches, the various committees, governing body, etc. Single copies will be supplied to members without charge upon application.

**American Institute of Electrical Engineers**  
33 West Thirty-ninth Street, New York, N. Y.

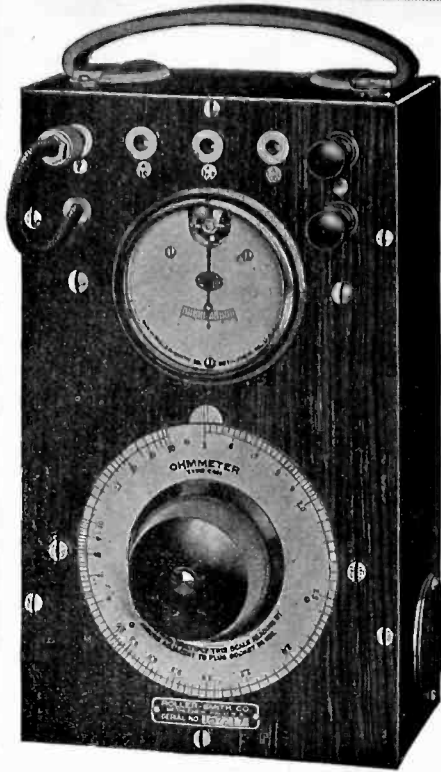

## COM OHMMETER

Portable, direct reading, small, compact, light, rugged, accurate, entirely self-contained. Measures resistance values from .5 ohm to 50,000 ohms. List price \$70.00, subject to discount. Send for new Bulletin No. AE-300.

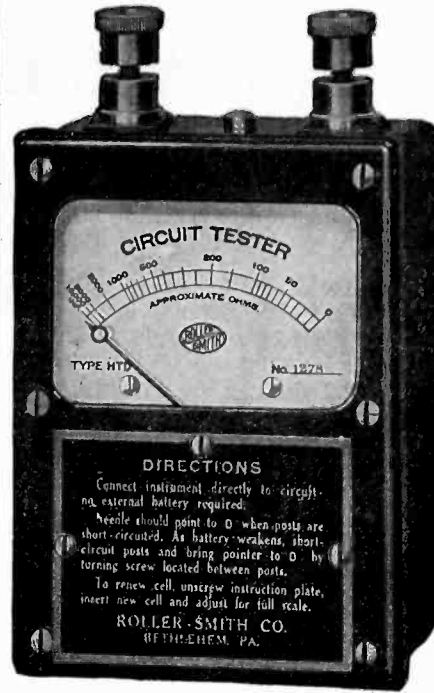

## HTD CIRCUIT TESTER

Instantly locates open circuits in coils and circuits. Shows approximate resistance up to 10,000 ohms. Small, compact, rugged and dependable. List price \$21.00, subject to discount. Send for new Bulletin No. AE-300.

*"Over thirty years' experience is back of ROLLER-SMITH"*

Offices in Principal  
Cities in the  
United States  
and Canada

# ROLLER-SMITH COMPANY

Electrical Measuring and Protective Apparatus

MAIN OFFICE  
12 Park Place, NEW YORK



WORKS  
Bethlehem, Penna.

Representatives in  
Australia, Cuba  
and Japan

## ALPHABETICAL LIST OF ADVERTISERS

	PAGE		PAGE		PAGE
Acme Wire Company	36	Fennessy, David V.	50	Ohio Brass Company	11
Allis-Chalmers Manufacturing Company	10	Ferranti, Incorporated	22	Okonite Company, The	Third Cover
Aluminum Company of America	5	Fibroc Insulation Company	38	Okonite-Callender Cable Co., Inc.	Third Cover
Ambursen Construction Company, Inc.	50	Ford, Bacon & Davis, Inc.	50	Ophuls & Hill, Inc.	50
American Lava Corporation	38	Fowle & Company, Frank F.	50	Osgood, Farley	50
American Steel & Wire Company	15	Frey Engineering Company	50		
American Telephone & Telegraph Co.	16			Pacific Electric Mfg. Corporation	45
American Transformer Company	19	G & W Electric Specialty Company	46	Parker-Kalon Corporation	36
Anaconda Wire & Cable Company	17	General Electric Company	8, 9, 14	Penn-Union Electrical Corporation	49
		General Radio Company	42	Publications, A. I. E. E.	57
Bakelite Corporation	33				
Barstow & Company, Inc., W. S.	50	Hoosier Engineering Company	50	Rochester Electric Products Corp.	40
Batley & Kipp, Inc.	50			Rockbestos Products Corporation	27
Belden Manufacturing Company	37	International Nickel Company, Inc., The	7	Roebing's Sons Company, John A.	48
Black & Veatch	50	International Resistance Company	3	Roller-Smith Company	58
Bull Dog Electric Products Company	26	I-T-E Circuit Breaker Company	43	Rome Wire Company	41
Burke Electric Company	44				
Burdry Engineering Company, Inc.	48	Jackson & Moreland	50	Sackman, G. R.	50
Burt, Dr. Robert C.	50			Sanderson & Porter	50
Byllesby Engineering & Management Corp.	50	Kearney Corporation, James R.	44	Sangamo Electric Company	20
		Kenite Insulated Wire & Cable Co., Inc.	1	Sargent & Lundy, Inc.	51
Canadian Porcelain Company, Ltd.	46	Kidde & Company, Inc., Walter	Fourth Cover	Scofield Engineering Company	51
Century Electric Company	29	Kruse, Robert S.	50	Shakeproof Lock Washer Company	32
Chandeysson Electric Company	24, 25	Kuhlman Electric Company	47	Simplex Wire & Cable Company	49
Chicago Mica Company	38			Standard Underground Cable Company	12
Christmas Seals	36	Lapp Insulator Company, Inc.	21	Stevens, Inc., John A.	51
Clement, Edward E.	50	Locke Insulator Corporation	23	Stevens & Wood, Inc.	51
Condit Electrical Manufacturing Corp.	53			Stockbridge & Borst	51
Copperweld Steel Company	46	Manufacturers' & Inventors' Elec. Co.	40	Stone & Webster, Inc.	18, 51
Corning Glass Works	2	Mathews Corporation, W. N.	55	Sundh Electric Company, Inc.	40
		Memco Engineering & Mfg. Co., Inc.	48		
Delta-Star Electric Company	48	Metropolitan Device Corporation	60	Texas Company, The	59
Dossert & Company	13	Mica Insulator Company	39	Thomas, Percy H.	51
Dudlo Manufacturing Company	35	Minerallac Electric Company	49	Thomas & Sons Company, The R.	46
		Moloney Electric Company	44		
Electric Controller & Mfg. Co., The	31	Morganite Brush Company, Inc., The	52	Wagner Electric Corporation	4
Electric Service Company, Inc., The	51			West Va. Pulp & Paper Company	38
Electric Specialty Company	40	National Carbon Company, Inc.	28	Western Electric Company	34
Electrical Testing Laboratories	51	Neall, N. J.	50	Westinghouse Elec. & Mfg. Company	6
Electro Dynamic Company	40	Neiler, Rich & Company	50	Weston Electrical Instrument Corp.	42
Engineering Directory	50, 51	Norma-Hoffmann Bearings Corporation	30	White Engineering Corp., The J. G.	51
Engineering Societies Library	44			Wireless Specialty Apparatus Company	42
Engineering Societies Employment Service	40			Wray & Company, J. G.	51

(For classified list of Advertisers see pages 52, 54 and 56)

Please mention the JOURNAL of the A. I. E. E. when writing to advertisers.

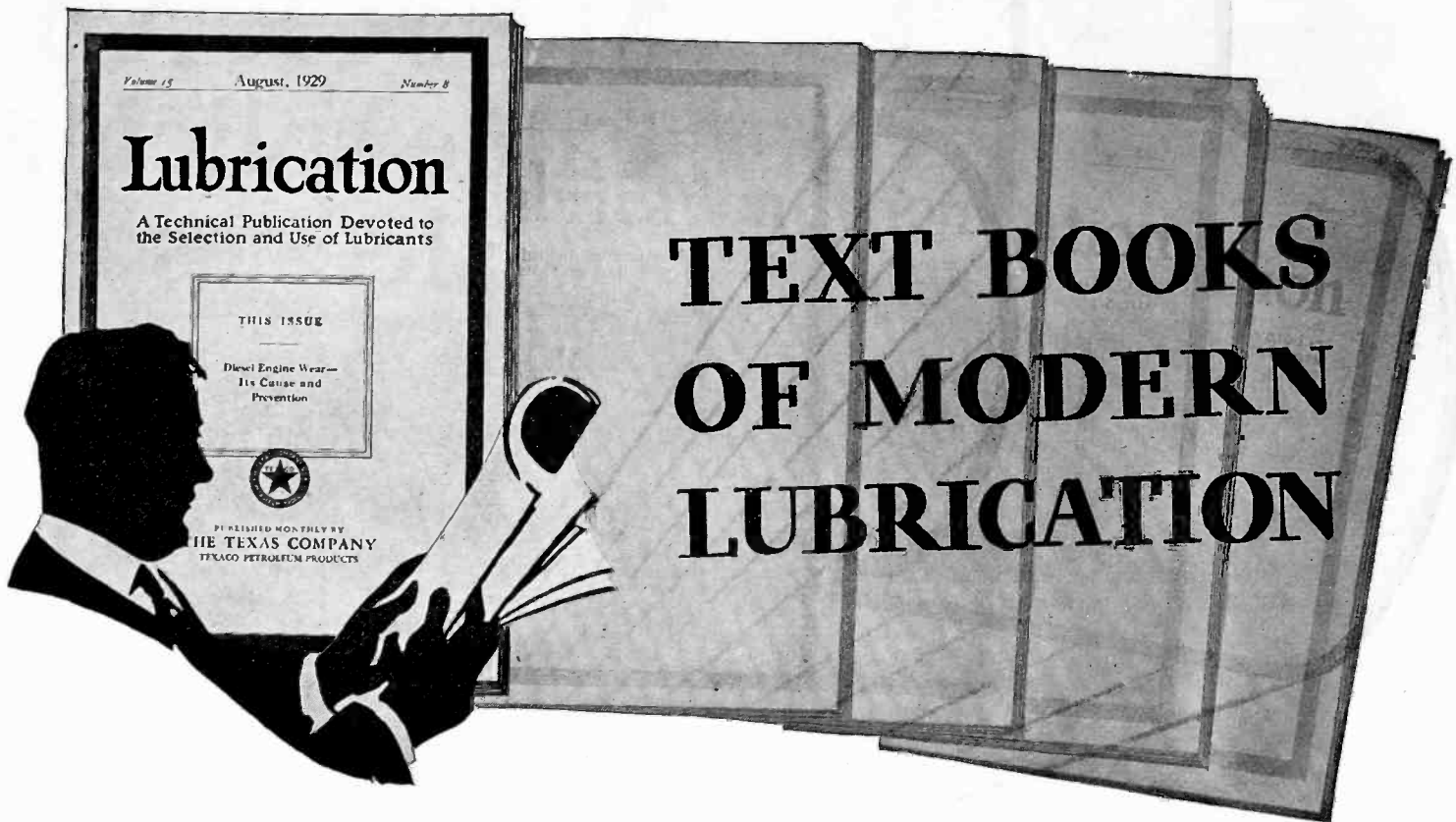

**H**AVE you a question concerning effective lubrication? Are you interested in the trend of modern lubrication practices—in meeting the lubricating needs of the latest machinery in your plant?

These text-books of modern lubrication will help you.

“Lubrication” is issued monthly by The Texas Company. It is the leader in its field. No other publication covers the subject so thoroughly. Each issue is a complete treatise on some phase of lubrication.

The Texas Company since its inception has been deeply interested in effective lubrication. There is a Texaco Lubricant for every purpose and each has been developed to meet specific requirements. Millions have been saved—in power consumption, maintenance and lubricating costs through Texaco Lubricants and Lubrication Service in all parts of the globe. Write the Texas Company and ask to have your name placed on the list to receive “Lubrication” regularly. There is no cost.

# TEXACO LUBRICANTS

THE TEXAS COMPANY, 17 BATTERY PLACE, NEW YORK CITY  
OFFICES IN PRINCIPAL CITIES



Please mention the JOURNAL of the A. I. E. E. when writing to advertisers.



# MURRAY cable splicing sleeves

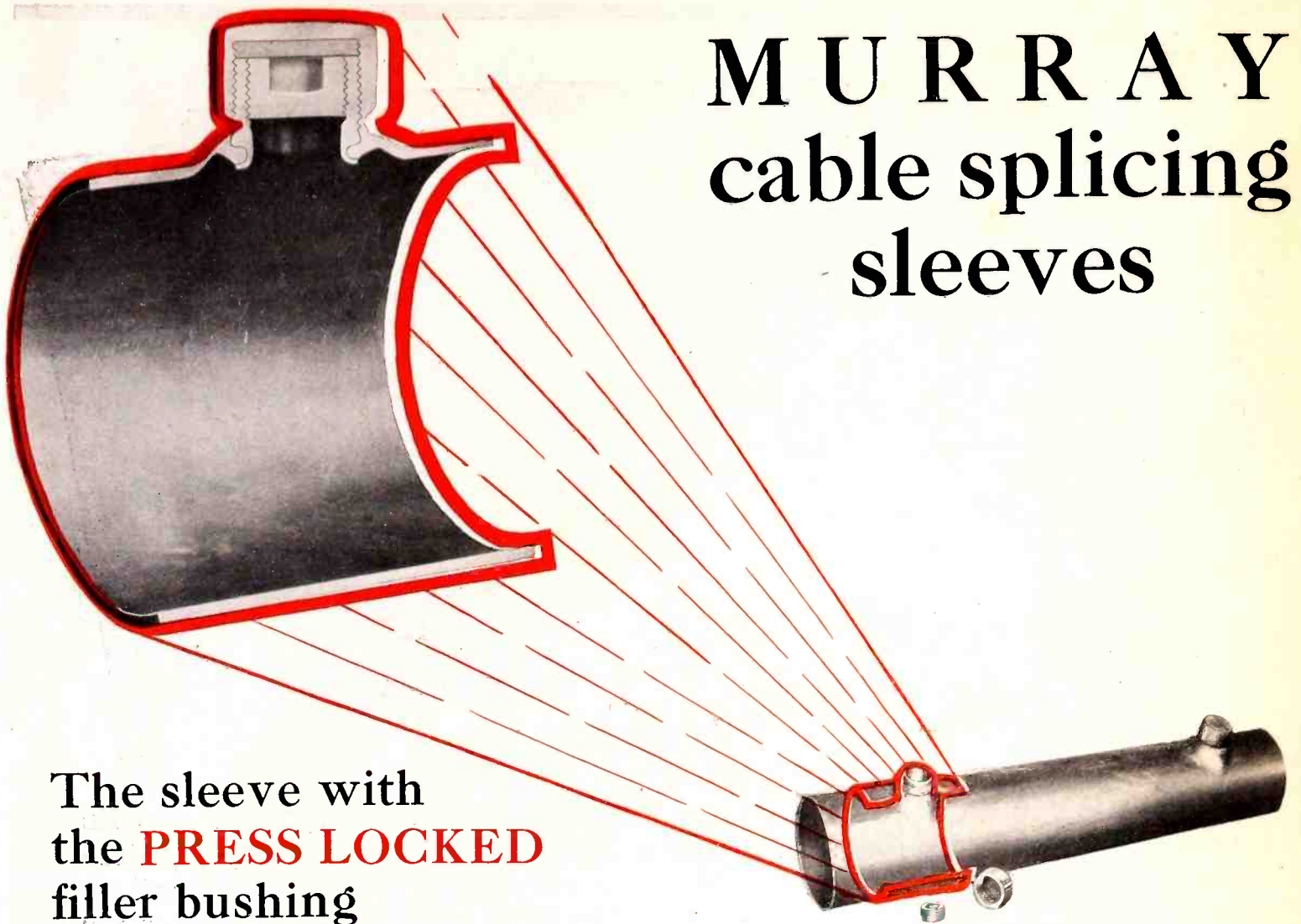

The sleeve with  
the **PRESS LOCKED**  
filler bushing

The filler bushings on the Murray Cable Splicing Sleeve are not merely soldered to the sleeve. The bottom section of the bushing passes through the wall of the sleeve and is flanged over to firmly grip the lead wall of the sleeve. Filler bushings are mechanically tight on the sleeve. After the pressing and flanging operation, the filler bushing is soldered on the outside of the sleeve to further strengthen the joint between bushing and sleeve and to insure a pressure tight joint.

Also Standard Package Joints for both type H and belted cables

**METROPOLITAN DEVICE CORPORATION**  
1250 ATLANTIC AVENUE      BROOKLYN, N. Y.



*An installation of the Murray Cable Splicing Sleeve described above.*  
Please mention the JOURNAL of the A. I. E. E. when writing to advertisers.



# Meeting New Developments

For example: 20,000 kva.  
**INCREASED CAPACITY**  
was added to the pole line  
shown in the picture by  
installing the two 26 kv.  
aerial power cables.



## With Aerial Power Cables

Telephone cables on poles are a familiar sight to all. It is just as easy to install aerial power cables.

This practice is a modern development and is increasing because aerial power cables afford such simple means of adding capacity to transmission lines; of repairing open wire circuits without shutting down a whole line; and of relieving crowded pole tops.

Aerial power cables are often the best means of taking on heavy power loads; of bridging gaps in system expansion; and of postponing underground or other impending changes.

Aerial power cables will frequently be found the best way to care for special situations: Right-of-way difficulties; joint occupancy on poles; complicated crossings; bridges and trestles; congested districts; and for other specific uses.

We have made exhaustive studies of field problems and our factories specialize in the manufacture of all types of cables suitable for aerial work.

*A copy of our booklet AERIAL POWER CABLE will be mailed upon request.*

### THE OKONITE COMPANY

*Founded 1878*

THE OKONITE-CALLENDER CABLE CO., INC.

Factories: Passaic, N. J. Paterson, N. J.

Sales Offices: New York Chicago Pittsburgh  
St. Louis Los Angeles Atlanta Birmingham  
San Francisco Seattle Dallas Boston

Novelty Electric Co., Philadelphia, Pa.  
F. D. Lawrence Electric Co., Cincinnati, O.

Canadian Representatives:

Engineering Materials

Limited, Montreal

Cuban Representatives:

Victor G. Mendoza Co.,

Havana



#### Okonite Products

OKONITE  
INSULATED  
WIRES AND  
CABLES  
VARNISHED  
CAMBRIC  
CABLES  
OKONITE  
INSULATING  
TAPE  
MANSON &  
DUNDEE  
FRICTION TAPE  
OKONITE  
CEMENT  
OKOCORD  
OKOLOOM

#### Okonite-Callender Products

IMPREGNATED  
PAPER CABLES  
SUPER-TENSION  
CABLES  
SPLICING  
MATERIALS

OKONITE QUALITY CANNOT BE WRITTEN INTO A SPECIFICATION



## This Blanket Makes TRIFLES of OIL SWITCH FIRES

**S**ERIOUS interruptions do not occur after Lux is used to snuff out fire. There is no delay to dry out windings...no time lost to clean off equipment.

Lux gas—carbon dioxide—acts like a blanket. It kills fire rapidly and without after effects. It is clean, dry, non-corrosive and a non-conductor.

After use, Lux leaves your equipment just as good as before. All damage is limited to that by the fire itself...all repairs are limited to the fire damage.

Lux Extinguishers have been proved to be good fire protection—both by test and by actual use. The Underwriters' Laboratories have rated them B-1, C-1; higher than any other hand device for power plant hazards. And over 15,000 units, installed on public utility properties to-day, are equally strong evidence of their effectiveness in actual service. More than 12,000 of these have replaced other extinguishers, not worn out but made obsolete by the more efficient Lux Extinguisher.

We shall gladly send you complete information about the Lux Extinguisher.

**Walter Kidde & Company, Inc.**  
140 Cedar Street  
New York

