

# JOURNAL OF THE A. I. E. E.

AUGUST 1927



PUBLISHED MONTHLY BY THE  
AMERICAN INSTITUTE OF ELECTRICAL ENGINEERS  
33 WEST 39TH ST. NEW YORK CITY

# MEETINGS

of the

American Institute of Electrical Engineers

(See Announcements This Issue)

---

PACIFIC COAST CONVENTION, Del Monte, Calif.,  
September 13-16

REGIONAL MEETING, Great Lakes District,  
Chicago, November 28-29 and 30



## MEETINGS OF OTHER SOCIETIES

Association of Electrologists International, Hotel Chase, St. Louis,  
Aug. 8-12. (L. W. Davis, 15 W. 37th St., New York)

National Electric Light Association

*New England Division*, New London, Conn., Sept. 12-15

*Rocky Mountain Division*, Colorado Springs, Oct. 17-20

American Electric Railway Association, Cleveland, Oct. 3-7

Illuminating Engineering Society, Edgewater Beach Hotel, Chicago,  
October 11-14

# JOURNAL

OF THE

## American Institute of Electrical Engineers

PUBLISHED MONTHLY BY THE AMERICAN INSTITUTE OF ELECTRICAL ENGINEERS  
33 West 39th Street, New York

Subscription. \$10.00 per year to United States, Mexico, Cuba, Porto Rico, Hawaii and the Philippines, \$10.50 to Canada and \$11.00 to all other Countries. Single copies \$1.00.

Entered as matter of the second class at the Post Office, New York, N. Y., May 10, 1905, under the Act of Congress, March 3, 1879. Acceptance for mailing at special rate of postage provided for in Section 1103, Act of October 3, 1917, authorized on August 3, 1918.

Vol. XLVI

AUGUST, 1927

Number 8

### TABLE OF CONTENTS

#### Papers, Discussions, Reports, Etc.

Notes and Announcements .....	761	A Study of Transverse Armature Reaction in Synchronous Machines, by R. A. Schaefer .....	811
The Use of High-Frequency Currents for Control, by C. A. Boddie .....	763	Mechanical Forces in Transformers, by J. E. Clem .....	814
Present Status of the International Electrical Units, by E. C. Crittenden .....	769	Nitrogen Fixation to be Used Extensively by British .....	817
Report of Committee on Electrical Transportation, J. V. B. Duer, Chairman .....	775	Mercury Arc Power Rectifiers, by O. K. Marti and H. Winograd .....	818
The Nature of Cold Light .....	778	Country is Always Hungry for More Electric Power .....	826
Report of Committee on Protective Devices, F. L. Hunt, Chairman .....	779	Discussion at Winter Convention Synchronous Machines III (Doherty and Nickle) .....	827
A. I. E. E. Outstanding Features, (President's Address), C. C. Chesney .....	786	Starting Performance of Synchronous Motors (Putman) .....	830
Report of Committee on Electrochemistry and Electrometallurgy, G. W. Vinal, Chairman .....	791	Discussion at Kansas City A 21,000-Kv-a. Automatic Substation (Ellyson) .....	832
Starting Performance of Synchronous Motors (Abridged), by H. V. Putman .....	794	Discussion at Bethlehem Recent Developments in Electric Drive for Rolling Mills (Umansky) .....	834
A 21,000-Kv-a. Automatic Substation, by D. W. Ellyson .....	802	Illumination Items	
New Cement Resists Acid .....	804	Checking Up an Industry on Its Lighting .....	836
Electricity in the Drilling of Oil Wells, by L. J. Murphy .....	805	Bright Lights Lure Tent Caterpillars .....	836

#### Institute and Related Activities

Program for Pacific Coast Convention .....	838	Student Activities	
A Great Summer Convention .....	839	Conference of Student Activities at Summer Convention .....	847
A. I. E. E. Directors Meeting .....	843	Branch Meetings .....	848
Exposition of Chemical Industries .....	844	Engineering Societies Library	
John Scott Medal Awarded to Grid-Glow Tube Inventor .....	844	Book Notices .....	849
Revision of Transformer Standards Suggested .....	844	Engineering Societies Employment Service	
A Useful Library on Electric Communication .....	846	Positions Open .....	852
Engineering Foundation		Men Available .....	852
Vice-President Dobson Visits Institute Sections .....	846	Membership	
Orville Wright Recipient of Washington Award .....	846	Applications, Elections, Transfers, etc. ....	853
Mr. Flinn Receives Honorary Degree .....	846	Officers, A. I. E. E. ....	854
Personal Mention .....	847	List of Sections .....	854
Past Sections Meetings .....	847	List of Branches .....	855
		Digest of Current Industrial News .....	856

A REQUEST FOR CHANGE OF ADDRESS must be received at Institute headquarters at least ten days before the date of issue with which it is to take effect. Duplicate copies cannot be sent without charge to replace those issues undelivered through failure to send such advance notice. With your new address be sure to mention the old one, indicating also any change in business connections.

Copyright 1927. By A. I. E. E.

Printed in U. S. A.

Permission is given to reprint any article after its date of publication, provided proper credit is given.  
(The Journal of the A. I. E. E. is indexed in Industrial Arts Index.)

# **Current Electrical Articles Published by Other Societies**

**American Society For Testing Materials, June 1927**

Report of Committee A-6 on Magnetic Properties. Preprint No. 13

Report of Committee D-9 on Electrical Insulating Materials. Preprint  
No. 65

**The Institute of Radio Engineers, Proceedings, June 1927**

Short-Wave Commercial Long Distance Communication, by H. E. Hallborg,  
L. A. Briggs and C. W. Hansell

Some Practical Aspects of Short-Wave Operation at High Power, by H. E.  
Hallborg

Maximization Methods for Functions of a Complex Variable, by W. VanB.  
Roberts

A Mathematical Study of Radio Frequency Amplification, by Victor G. Smith

# Journal of the A. I. E. E.

Devoted to the advancement of the theory and practise of electrical engineering and the allied arts and sciences

Vol. XLVI

AUGUST, 1927

Number 8

## A. I. E. E. National and Regional Prizes

A system of National and Regional Prizes for Institute papers was inaugurated by the Board of Directors in 1926 and has been administered by a special Committee on Award of Institute Prizes. After two years' experience, this committee found the system of award to be extremely difficult, owing to the fact that comparison between papers dealing with entirely different branches of the art cannot logically be made. It was also found necessary to establish some basis for rating and judging the papers in order to make the awards in a satisfactory manner. After a careful study of the whole situation, this committee submitted a new plan to serve as a basis of awards for Institute papers, and the Board of Directors, at a meeting held in Detroit on June 23rd, adopted the committee's report as given below. The following plan is therefore now in effect as applying to prizes for papers presented in 1927.

The principal changes included in the report consist of increasing the number of first prize awards to three, each applying to a broad classification of engineering work; the adoption of a standard method of grading papers; and the omission of the National Prize for the best Regional paper, as prizes are available for the best papers in each Geographical District. The report follows:

### NATIONAL PRIZES

The following National Prizes may be awarded each year at the discretion of the Committee on Award of Institute Prizes:

1. *First Prizes*  
Engineering Practise  
Theory and Research  
Public Relations and Education
2. *Prize for Initial Paper*
3. *Prize for Branch Paper*

1. The *First Prizes* in each of the three classes, — namely; "Engineering Practise," "Theory and Research," and "Public Relations and Education" — consisting of \$100.00, and a certificate may be awarded to the author or authors of the best original paper presented at any National, Regional, or Section Meeting of the Institute.

2. The *Prize for Initial Paper*, consisting of a certificate and \$100.00 in cash, may be awarded to the author or authors of the most worthy paper presented

at any National, Regional or Section Meeting of the Institute, provided the author or authors have never previously presented a paper which has been accepted by the Meetings and Papers Committee.

3. The *Prize for Branch Paper*, consisting of a certificate and \$100.00 in cash, may be awarded to the author or authors of the best paper presented at a Branch or other Student Meeting of the Institute, provided the author or authors are Enrolled Students of an Institute Branch.

a. *Consideration of Papers.* All papers approved by the Meetings and Papers Committee and presented at any meeting will be considered by the Committee on Award for the Best Paper Prizes without being formally offered for competition. Papers other than those presented to the Meetings and Papers Committee, and all "Initial" papers, must be submitted in triplicate, with a written communication to the National Secretary on or before February 15th of the year following the calendar year in which they were presented. This may be done by the author or authors, by an officer of the Institute, or by the Executive Committees of Sections or Geographical Districts.

All papers submitted for prizes, (excepting for the Branch Paper Prize), must be written by members of the Institute, and when papers are written jointly, at least one of the authors must be a member of the Institute, and the cash award shall be divided.

Consideration of papers for prizes for a given year shall include only those papers presented during the calendar year.

b. *Time of Award.* All National Prizes for a given calendar year shall be awarded prior to May 1 of the succeeding year by the Committee on Award of Institute Prizes. This committee shall consist of the past and present chairman of the Meetings and Papers Committee, (covering the calendar year during which the papers were presented), and of such other members as the Board of Directors may designate.

All prizes shall be presented at the Annual Summer Convention of the Institute during the year following the year in which the papers were presented.

c. *Conditions of Award.* For the *First Prizes*, the Meetings and Papers Committee shall indicate to the Committee on Award of Institute Prizes the class under which each paper for First Prize is to be considered.

The considerations which shall govern the grading

of papers for purposes of making awards shall be as follows:

<i>Analysis of Subject</i>	<i>Grade</i>
The paper shall present a clear outline of the situation out of which arises the need for the preparation of a paper on the particular subject, explaining the point of view assumed in the presentation.....	10 per cent
<i>Logical Presentation</i>	
The presentation should include an analysis of the difficulties encountered, the methods of attack and the solution of the problem.....	15 per cent
<i>Unity</i>	
While brevity and conciseness are important, they should not be attained at the sacrifice of unity and completeness of presentation.....	10 per cent
<i>Value in its Field</i>	
The value of the paper as a contribution to the literature in its own field should receive particular consideration.....	35 per cent
<i>Value to Electrical Engineering</i>	
The paper should be considered from the standpoint of the quality of its contribution to the advancement of electrical engineering and its value to civilization.....	30 per cent

At the discretion of the Committee on Award of Institute Prizes, a single paper may be awarded more than one of the prizes available and honorable mention may be made of papers which do not receive prize awards.

Papers awarded prizes shall be published in full or in abstract in the JOURNAL, in the TRANSACTIONS, or in pamphlet form.

#### REGIONAL PRIZES

The following Regional Prizes may be awarded each year, in each Geographical District of the Institute:

1. *First Prize*
2. *Prize for Initial Paper*
3. *Prize for Branch Paper*

1. The *Regional First Prize*, consisting of a certificate of award issued by the officers of the Geographical District and \$25.00 in cash, may be awarded to the author or authors of the best paper presented at any Regional, Section or Branch Institute meeting in the Geographical District during the calendar year.

2. The *Regional Prize for Initial Paper*, consisting of a certificate of award issued by the officers of the Geographical District and \$25.00 in cash, may be awarded to the author or authors of the best paper presented at an Institute meeting in the District provided the author or authors have never before presented a paper before the Institute at any National, Regional, or Section meeting.

3. The *Regional Prize for Branch Paper*, consisting of a certificate of award issued by the officers of the Geographical District and \$25.00 in cash, may be awarded to the author or authors of the best paper presented at any Branch or other Student Meeting of the Institute, provided the author or authors are Enrolled Students of an Institute Branch.

a. *Consideration of Papers.* All papers to be considered in competition for Regional Prizes must be submitted in duplicate by the authors or by the officers of the Branch, Section or District concerned, to the District Committee on Awards, on or before January 10th of the year following the calendar year in which the papers have been presented.

All papers submitted for prizes, (excepting for the Branch Paper Regional Prize), must be written by members of the Institute; and when papers are written jointly, at least one of the authors must be a member of the Institute and the cash value of the prize shall be divided.

b. *Time of Award.* All Regional Prizes for a given calendar year shall be awarded prior to May 1 of the succeeding year by the District Executive Committee or by a committee appointed by the District Executive Committee and authorized to make such awards.

c. *Conditions of Award.* The considerations which shall govern the grading of papers for the purposes of making awards shall be the same as those governing the awarding of National Prizes.

#### Engineering Developments Surveyed at Summer Convention

Engineers in the electrical industry have glanced over all aspects of their art and have recorded great progress, outlining definite things to accomplish in the near future. This status of engineering was indicated at the noteworthy convention of the Institute held in Detroit. It is a notable occasion when more than 1200 electrical engineers gather under the auspices of their professional society. Their work is fundamental to industrial progress, and the industry may well be proud of the Institute and its accomplishments. It could commendably do more to encourage Institute activities, for the contributions of professional engineers deserve unstinted support.

At the Detroit convention a series of technical committee reports of great value and importance was presented. Every phase of the art was carefully surveyed and many new developments recorded. Sound engineering opinions and suggestions deserving of serious consideration by all branches of the industry were presented in these reports. Attention was called to the rapid trend of research away from the colleges to industry, not considered good for the colleges, the art or for industry. Definite suggestions were made for needed dielectric researches as well as similar proposals regarding cognate matters. On the whole, these committee reports indicated very satisfactory conditions in engineering and research.

Unity, enthusiasm and family spirit have been manifested at Institute conventions, bespeaking a healthy condition in this large engineering group. The Detroit meeting was outstanding, and all who attended voted it a great success.—*Electrical World*.

# The Use of High-Frequency Currents for Control

BY C. A. BODDIE<sup>1</sup>

Associate, A. I. E. E.

THE rapid development of radio has given rise to a parallel development in the art of remote control. Remote and supervisory control is being applied to an ever increasing variety of problems. This control is now commonly effected by the use of special wires connecting the apparatus under control with the point from which control is exercised.

Wires suitable for control purposes are often difficult to obtain. If they are supported for any considerable distance on the same towers as the power line, induction from the power line may seriously reduce their value unless special measures are adopted. If the wires are carried on separate poles on a separate right of way, the cost becomes a formidable item. The other alternative is to lease the necessary circuits from the telephone company. In this case, the rentals are always so high as to be a serious burden on the whole project.

The expense of obtaining and difficulty in operation of special wire circuits have directed attention to the possibilities in the use of alternating currents of moderate or high frequency for control purposes. The object has been to utilize the existing power conductors as a control circuit. This has been accomplished by superimposing on the live power circuit a frequency sufficiently different from the power frequency to permit its being easily separated from the power frequency by suitable tuned circuits. Although this current flows in the power system together with the power current, it is independent of it. It may therefore be used for control purposes.

The application of alternating current to control problems opens up many new fields. The development of apparatus is already quite well advanced. Some of the equipment has been in commercial service for over two and one-half years and has given good account of itself. The applications already developed provide for the control of large main line oil circuit breakers, substation apparatus and street lights. It is expected that this type of control will be used quite generally for all classes of control now requiring special circuits, where these circuits introduce a serious burden on the project as a whole.

The development has been carried out along two rather distinct lines. The apparatus may be classed according to the frequencies employed as

1. Medium-frequency systems,
2. High-frequency systems.

The medium-frequency system employs frequencies of the order of 500 cycles. This control frequency is so low that it passes through transformers just like power

frequencies. The control frequency is generated by a motor-generator set and is fed into the circuit usually by means of condensers. The special advantage of this system is that the line losses are low on account of the moderate frequency used. It is possible to transmit sufficient energy to the receiving devices to directly actuate a relay magnet. This relay is tuned to the control frequency and therefore responds only to this frequency. The relay is simple and sturdy and requires no vacuum tube amplifier. The system is very flexible and is well adapted to quite a variety of applications.

The high-frequency system employs frequencies of the order of 50,000 cycles. Frequencies of this order are most readily produced by vacuum tubes. The energy employed in the high-frequency system is much less than that required in the medium-frequency system. Vacuum tube amplifiers are necessary to amplify the control frequency at the receiving point in order to get sufficient energy to operate a relay satisfactorily. On account of its requiring vacuum tubes, the receiving equipment is much more bulky and more complex than the corresponding equipment of the medium-frequency system. Currents of this frequency do not pass readily through transformers. Its application is therefore limited mainly to operation over high voltage power lines, but it is well adapted to this class of service.

## HIGH-FREQUENCY SYSTEM INSTALLED AT TIPTON, INDIANA

Sporadic attempts at control utilizing radio or high-frequency currents over wires date back over a period of 10 or 15 years. These attempts assumed more of a spectacular than of a practical trend. Perhaps the first definite attempt to control the apparatus of a power system by high-frequency currents was made just previous to the opening of the Dresser Power Station of the Central Indiana Power Co. There was then in operation a high-frequency system controlling two 66-kv. circuit breakers at Tipton, Indiana. The control point was Kokomo, Indiana, some 20 miles distant. The 66-kv. line loops through the substation at Tipton. An oil circuit breaker is installed in each branch of the line as it connects to the high-tension bus at Tipton. This is indicated in Fig. 1.

The local power plant which previously supplied the town of Tipton was shut down shortly after the transmission line was built between Indianapolis and Kokomo and power was supplied from the line. The substation at Tipton is about a mile out of town. An operator is not maintained at this point. The object of installing the circuit breakers and the control system was to insure continuous service to the town from either of two power sources, namely, Indianapolis

<sup>1</sup> Westinghouse Elec. & Mfg. Co., East Pittsburgh, Pa.

Presented at the Summer Convention of the A. I. E. E., Detroit, Mich., June 20-24, 1927.

and Kokomo. In case of line trouble on either side of Tipton, the section in trouble could be cut clear by operating the proper breaker at Tipton and the town supplied with power from the remaining section of line. The absence of an operator at Tipton necessitated the installation of the control system.

At the time it became apparent that supervisory control of the Tipton breakers would be desirable, an

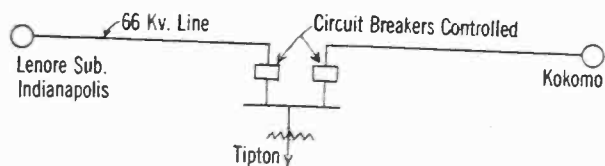

FIG. 1—SCHEMATIC DIAGRAM OF CIRCUIT BREAKER INSTALLATION AT TIPTON INDIANA

efficient high-frequency telephone system was already in regular operation over the Indianapolis-Kokomo lines. It was decided to use the transmitter then installed at Kokomo and to install one of the standard receivers and calling selectors at Tipton for the operation of the Tipton circuit breakers. A special frequency was selected so that there could be no interference between the telephone system and the control system. This special frequency could be readily produced since the Kokomo transmitter was already

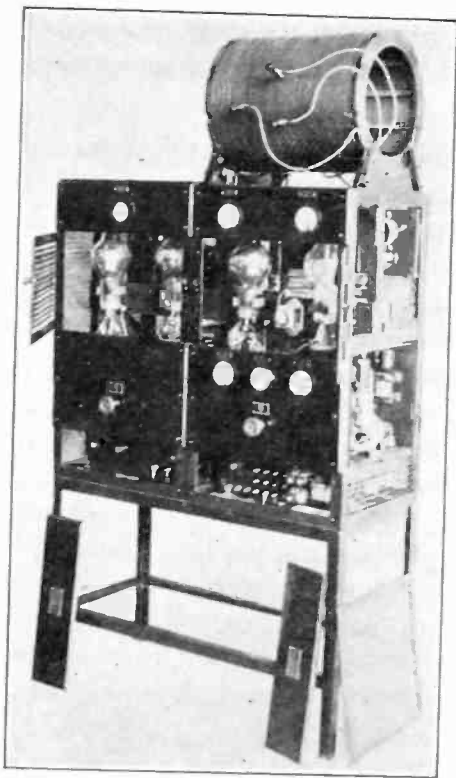

FIG. 2—TYPE OF TRANSMITTER INSTALLED AT KOKOMO

This transmitter is rated at 250 watts and is used for both control and telephone communication

provided with a wave-change switch as a regular part of the equipment, whereby its frequency could be changed from the normal frequency used in telephone service to any other desired frequency. The operation of changing frequencies was accomplished by the operation of the automatic calling dial.

### HETERODYNE RECEPTION

The receiver was of the usual coupled circuit type as shown in Fig. 3. The receiver circuits employed were exactly the same as used regularly in the telephone calling system. This utilizes the well-known heterodyne method invented by Fessenden for radio telegraph reception. Because of its superior efficiency and a remarkable ability to ride through serious radio static, it soon displaced all other methods for radio telegraph reception. It was for these same reasons that it was selected as the basis of the calling system for power line telephone communication. The heterodyne method was of course retained for the application to supervisory control.

In the heterodyne system, the incoming high-frequency signal is combined with a frequency generated locally. In this application, it is customary to adjust the locally generated frequency to within about 1000 cycles of the incoming signal frequency. This difference of frequency gives rise to a third frequency equal to the difference between the two main frequencies. This third frequency is commonly called the beat fre-

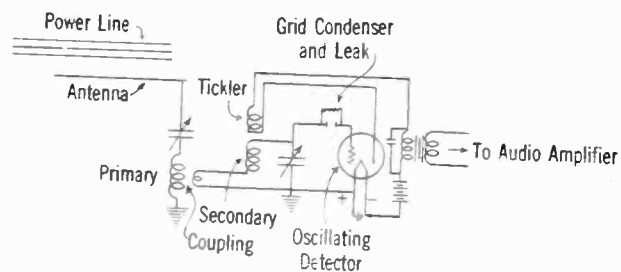

FIG. 3—SCHEMATIC OF RECEIVER USED FOR HIGH FREQUENCY CONTROL

The sector is kept in a state of continuous oscillation and heterodynes the incoming signal

quency. The second or locally generated frequency is in this case produced by maintaining the receiving detector in a state of continuous oscillation. The beat frequency of 1000 cycles is amplified by a two-step amplifier, the second step of which is adjustable and the output used to operate a polarized relay. This is accomplished by connecting two vacuum tubes in parallel as shown in Fig. 4 and supplying their plate circuit through a polarized relay having a suitable winding. The tubes are provided with a grid leak and condenser just as in the case of an ordinary radio detector. When the amplified 1000-cycle beat frequency is applied to the grids of the relay tubes, a negative charge is built upon the grid condenser in the usual way which gives the grids a large negative bias. This greatly reduces the plate current drawn through the winding of the polarized relay and allows the tension of a spring to close the relay contacts.

When the control frequency is put on the power line by the Kokomo transmitter, a beat is produced between the oscillating detector and the incoming frequency which, as described above, causes the relay contacts to close. When the flow of current from the Kokomo transmitter is interrupted, the relay contacts auto-



matically open. The calling dial of the sending transmitter is arranged to interrupt the flow of high-frequency current so as to produce a series of impulses. At each interruption, the contacts of the control relay close and thus give a corresponding series of impulses to the selector which it controls.

SELECTOR

The type of selector used is that commonly employed in automatic telephone systems and now so widely used for supervisory control. It consists essentially of

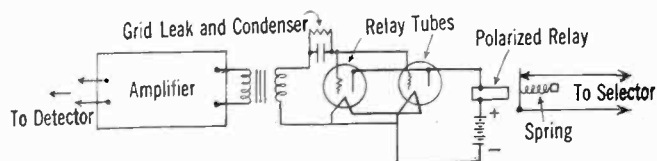

FIG. 4—SCHEMATIC SHOWING METHOD OF OPERATING POLARIZED RELAY

Two vacuum tubes are used in parallel to ensure ample mechanical pull at contacts

an electromagnet commonly called a motor magnet which drives a contact arm over a bank of contacts by means of a ratchet and pawl, as shown in Fig. 5. At each impulse of the radio or control relay, the motor magnet advances its contact arm one step. By a combination of fast and slow relays associated with the motor magnet, the circuit through the contact arm is held open until the proper code sequence is received. After the final pause in the series of code impulses, a slow relay drops out and completes the circuit to perform the desired operation if the correct code sequence has been received. The relay combination is such that during the advance of the selector contact arm a pause must be made at two predetermined points and there must be no interruption, in each group of impulses between the pauses. The total number of impulses must also add up to a predetermined total. Unless all of these conditions are fulfilled, the operating circuit cannot be closed. This interlocking combination is more elaborate than that commonly used in the calling system of standard power line telephone equipment.

The installation at Tipton is perhaps the oldest practical installation of supervisory control using high-frequency currents transmitted over a power line. In its initial stage it involved merely the application of a standard power line telephone system to the service of controlling oil service breakers. It was but a short step from this to the full system with answer-back applying all the well-known functions of modern supervisory control.

ANSWER-BACK WITH INDICATING LAMPS

In order to provide for an answer-back signal, a small transmitting set was installed at Tipton and an additional receiver was added to the equipment at Kokomo. Controllers similar to those used for controlling oil circuit breakers replaced the automatic calling dial of the desk telephone set. These were mounted on a small panel and provided with the usual

red and green indicating lamps. Automatic impulse senders were provided at Kokomo for sending the proper code impulses. The code sent out by the impulse sender was determined by the oil switch controller. Thus, to operate one of the Tipton breakers, the Kokomo operator was required to perform only the usual function of operating the controller of a standard oil circuit breaker. This started the automatic impulse sender which sent out a code of impulses corresponding to the particular controller operation performed.

When the code impulses were received at Tipton, the proper control circuits were completed and the desired breaker operation effected. At the completion of any circuit breaker operation a small transmitter was automatically started by means of a similar automatic impulse sender and a code was sent back to Kokomo corresponding to the breaker operation which had occurred. These impulses being received at Kokomo on selectors caused the proper indicating lamps to show on the Kokomo control board. The equipment was also arranged so that in case of doubt the operator could always check the position of the breakers.

IMPROVEMENTS IN MECHANICAL DESIGN

The mechanical arrangement and form of mounting used in the Tipton installation has been changed in later designs. The receiving equipment, instead of being built as a number of independent units and mounted on a table, has been changed to the arrangement shown in

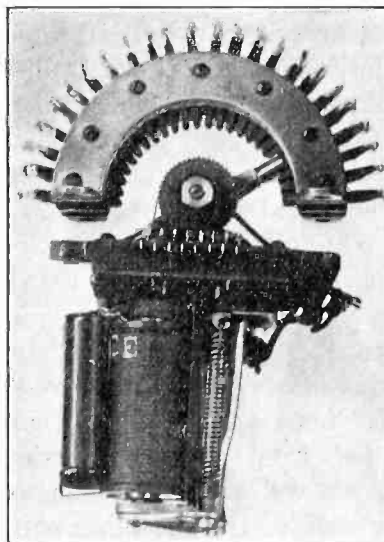

FIG. 5—VIEW OF SELECTOR SHOWING MOTOR MAGNET AND BANK OF CONTACTS

Fig. 6A-6B. The equipment is all mounted on panels which are accessible front and rear. The unit construction is still retained. The top panel carries the entire high-frequency equipment. A second panel carries all vacuum tubes and associated apparatus. The third panel carries the rectifier supplying the plate current to the vacuum tube system and the lower panel carries all relay and selective equipment together with the terminal board.

For work over short stretches of power line or over

sections of badly exposed telephone line, a small unit has been developed. This is a complete transmitter and receiver and also carries with it sufficient selective equipment for some simple applications. The unit is

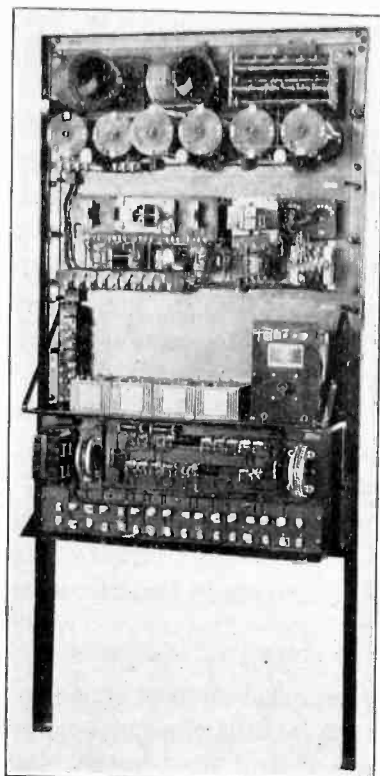

FIG. 6A—FRONT AND REAR VIEW OF PANEL TYPE RECEIVER SHOWING SELECTOR AND TERMINAL BOARD

adapted to either telephone service or supervisory control. The transmitter tubes are shown at the top. A master oscillator and four  $7\frac{1}{2}$ -watt tubes are mounted so that they may be tied all four in parallel as oscillators for control work, or two may be used as oscillators and two for modulators for telephone service. The lower three tubes constitute the receiver. The unit is supplied with 500 volts of direct current from a dynamotor running on current furnished by a 24-volt storage battery.

The high-frequency system is well adapted for control using high voltage power conductors as a circuit. The system has also been applied to the control of series street lights fed from pole type regulating transformers. It is not well adapted to this class of service because of the bulk of the receiving equipment which must be hung on a pole and more or less exposed to the weather. It is not suitable to the control of multiple street lights. This is again owing to the bulk and cost of the receiving equipment and to the fact that frequencies of the order of 50,000 cycles do not readily pass through transformers. The system is thus limited to service on high-tension lines.

#### MEDIUM-FREQUENCY SYSTEM

As early as 1901, Mr. Rhodes of the New York Edison Co. proposed to turn multiple street lights on and off by superimposing a 500-cycle control current on the power circuits. The early work did not show much

promise and the project was dropped for some years. About four years ago the project was reopened and promising results obtained from preliminary work on the overhead system at Yonkers, New York. Subsequent development was carried out on the underground system of the Fordham substation of the New York Edison Co.

While the system was developed primarily for the control of multiple street lights, it has been found applicable to a wide variety of control problems. It is being applied to the control of street lights both series and multiple and to supervisory control of all kinds. Its simplicity is one of its principal points of merit. In addition, its receiving unit is very small in bulk and quite inexpensive. These features were essential to its success in the field of street light control.

The moderate-frequency system may possibly be best understood by discussing its application to street light control. Fig. 7 is a schematic diagram of a substation showing the method of energizing a single feeder. Feeders may be energized one at a time as in the schematic diagram, or in groups, or the entire bus may be energized according to the method of operation preferred. The control frequency is produced by the generator G. This is a rotating machine of a standard type, driven by a two-speed induction motor whose synchronous speeds are 1200 and 1800 rev. per min.

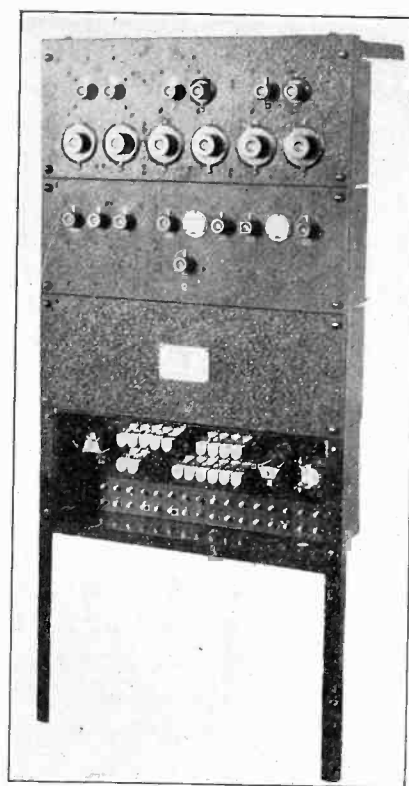

FIG. 6B—FRONT AND REAR VIEW OF PANEL TYPE RECEIVER SHOWING SELECTOR AND TERMINAL BOARD

This gives control frequencies of 440 and 660 cycles at synchronism. The motor is especially designed for low slip which is approximately  $1\frac{1}{2}$  per cent. Condensers of the oil-filled type similar to those regularly used for power factor correction are employed to couple the

generator to the line. Inductance coils are provided to tune the circuit as a whole. The power circuit presents a low impedance when viewed from the generator terminals. Hence a coupling transformer of suitable ratio is interposed between the generator and the tuned circuit to enable the generator to deliver its full output into the power system.

**METHOD OF ENERGIZING FEEDER**

When energizing a single feeder, it is preferable to connect on to the feeder just beyond the feeder regulator and reactor, as indicated in Fig. 7. This will be apparent

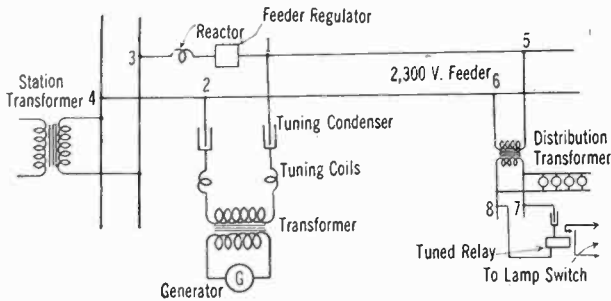

FIG. 7—SCHEMATIC DIAGRAM SHOWING METHOD OF ENERGIZING FEEDER FOR MEDIUM FREQUENCY CONTROL

when it is observed that current delivered by the generator through the tuned circuit to the feeder has two paths in which to flow. It may flow out along the feeder through the numerous distributing transformers and it may also flow back into the station bus and through the large station transformers. If the generator is connected beyond the reactor and feeder regulator,

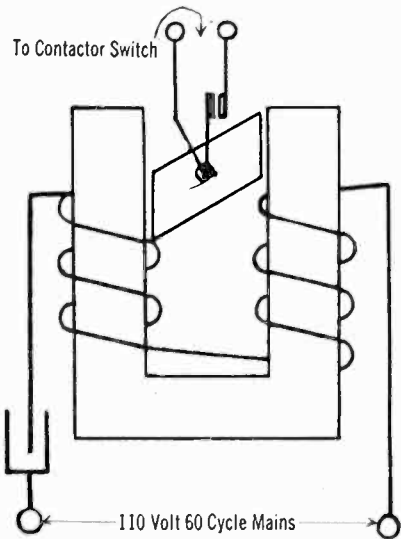

FIG. 8—SCHEMATIC DIAGRAM OF RESONANT RELAY

the impedance of these two elements is interposed in the path of the current flowing back through the station bus and less generator current is required to energize the feeder.

The control currents flow along the conductor just as though the power currents were not present. Sufficient current is fed into the system to establish a control frequency potential of approximately 100 volts

at the outgoing terminals of the feeder. This control frequency potential acts throughout the whole length of the feeder in the same manner as the power frequency but it is quite independent of it. The various distribution transformers supplied by the feeder, step this control voltage down in the same ratio as they do the power voltages. Thus, with 100 volts of control frequency on the high side of a 2200-volt distribution transformer, five volts are delivered on the 110-volt side. It is this voltage which is available for the operation of the control relays.

At any point on the system where control is desired, a control relay is located as indicated in Fig. 7 and connected to the 110-volt side of a distribution transformer. It consists of a simple U-shaped magnet acting on a balanced armature as shown more clearly in schematic diagram, Fig. 8. A contact is mounted on the armature shaft and arranged to close when the relay is energized. A condenser is placed in series with the relay winding. The inductance of the winding is designed so that the inductive reactance of the relay is

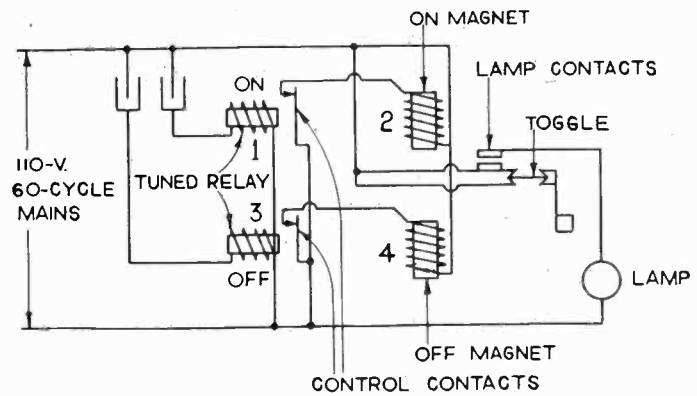

FIG. 9—SCHEMATIC DIAGRAM OF STREET LIGHT CONTROL UNIT USING RESONANT RELAYS

exactly equal to the capacity reactance of the condenser at the frequency the relay is intended to operate on. The total reactance of the relay circuit including its condenser is therefore zero, and the control current passing through the relay is governed by Ohm's law, thus:

$$I = \frac{E}{R}$$

where  $E$  is the value of the control voltage impressed across the relay circuit,  $R$  is the effective resistance of the relay circuit, and  $I$  is the current flowing through the relay winding. When a circuit is adjusted so that its reactance is zero, it is said to be in tune or in resonance for this particular frequency.

**APPLICATION TO STREET LIGHT CONTROL**

In its application to street light control, it is clear that the lower the effective resistance of the relay circuit, the more energy will be available for its operation. This is owing to the low impedance of the supply circuits; the principal difficulty encountered in the

development of the relay was in keeping its losses sufficiently low. By careful selection of materials and proper proportioning of the magnetic circuit, these losses were cut well under the values necessary for commercial operation. It was the successful development of these low loss relays which made it possible to draw sufficient energy from the power system to operate a pair of contacts by the direct magnetic pull of the control current itself.

It will be apparent from the foregoing that when the feeder is excited by the control generator, all relays tuned to the control frequency will close their contacts.

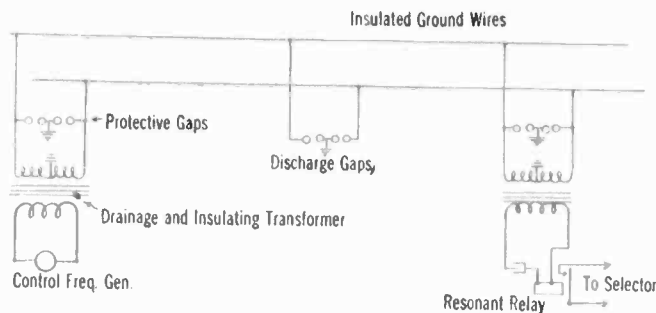

FIG. 10—SERIES STREET LIGHTS CONTROLLED BY MEDIUM FREQUENCY SYSTEM

By interrupting the flow of current from the control generator, the contacts of the resonant relays can be made to follow. Thus code impulses from the control frequency generator are reproduced by the contacts of the resonant relays. The system may therefore be used for control purposes of any kind.

In applying the system to street light control, two control frequencies are employed, one for turning the lights on and one for turning them off. Selection by using different frequencies is preferred in this case because of its simplicity. This requires two relays at each control point, one resonant to each control frequency. The contacts of the resonant relays are not required to carry the lamp current, but merely to throw a toggle switch which is provided with heavier contacts to carry the lamp current. Fig. 9 shows a schematic diagram of the two resonant relays and toggle switch as used in street light control. These elements are assembled in a weather proof case. The whole control unit is small enough to permit its being installed on the base of most ornamental street light posts.

In its application to the control of series street lights, the control unit governs the position of an oil switch in the primary side of a pole type regulating transformer as in Fig. 10. In this case, the feeder potential is usually 2300 volts and a potential transformer is necessary to supply 110 volts to the control unit. This transformer furnishes power frequency energy to operate the oil switch and control frequency energy to operate the resonant relays.

#### APPLICATION TO SUPERVISORY CONTROL

Supervisory control by means of moderate-frequency currents and resonant relays has recently been applied

to a rather new problem. This is to provide for the control of numerous sectionalizing switches and some oil circuit breakers on a long 110-kv. line. The circuit over which the control system operates is rather novel. This circuit is obtained by insulating the ground wires ordinarily provided on a long high-tension line. The protective feature of the ground wires is not sacrificed appreciably owing to the installation of spark gaps at frequent intervals which provide a discharge path to ground. The sectionalizing switches to be controlled are installed at 15-mile intervals. At each point where a sectionalizing switch is located, a drainage transformer is provided with its middle point grounded in addition to the spark-gaps.

The control frequency is produced by a  $\frac{1}{2}$ -kw. generator. This is connected to the line by a step-up insulating and drainage transformer. The generator voltage is 100 volts and the transformer is provided with taps to permit the use of line voltages of 300 to 500 volts.

The current supplied by the control generator is controlled by a standard system of supervisory control. The output of the generator is thus broken up into impulses and these impulses are received by resonant relays at the points where switches are to be controlled. The line voltage of 500 volts is stepped down to 10 volts by the insulating drainage transformer at each sectionalizing switch. This voltage is used to operate the resonant relays. The contacts of the resonant relays

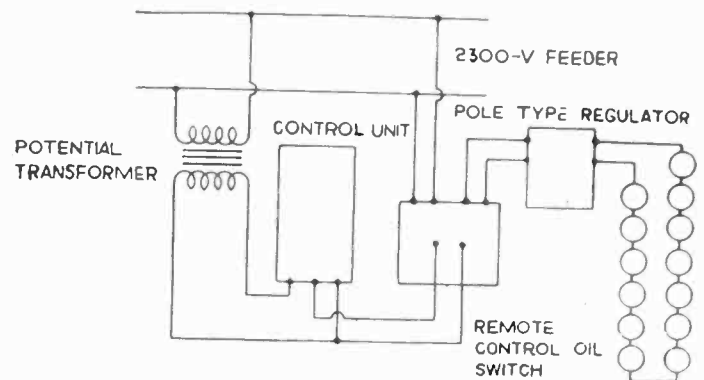

FIG. 11—SCHEMATIC DIAGRAM SHOWING SYSTEM OF MEDIUM FREQUENCY CONTROL USING CIRCUIT CONSISTING OF INSULATED GROUND WIRES

are connected in a circuit to repeat the impulses received from the control generator into the selector system.

The selector system employs a combination of fast and slow relays together with associated motor magnets and contact banks as ordinarily used in automatic telephony and now adopted as standard practise for supervisory control. The complete supervisory system and resonant control relays are mounted on a switch-board section one panel wide. The type of line construction and the location of the spark-gaps and drainage transformers is shown in Fig. 11.

This application of medium-frequency alternating currents to the control of sectionalizing switches is likely to find wide application on long transmission lines where conditions will not justify a double-circuit line. By this means it is expected to reduce very

greatly the interruptions to service arising from the use of a single-circuit line. The system may also have important applications on double-circuit lines and assist materially in the solution of control problems of all kinds.

## Present Status of the International Electrical Units\*

BY E. C. CRITTENDEN†

Member, A. I. E. E.

*Synopsis.*—This paper summarizes the present legal standing and practical usage of the international electrical units, particularly as maintained in the United States. The international agreement reached in 1910 was provisional and requires some revision. Further investigations of the international standards, as well as of the absolute units, are urgently needed to put the system on a satisfactory basis for work of high precision.

Legal authority to deal with electrical units has now been given the International Committee on Weights and Measures. This provides a permanent working organization through which international agreements can be reached and can be made effective throughout the world.

When the committee takes up the question of electrical units for

formal international adoption, it will have to decide whether to maintain as nearly as is practicable the values accepted at present or to revise them so as to accord with the fundamental c. g. s. system. With regard to primary standards, it will have to choose between the mercury ohm and silver voltameter, on the one hand, as against direct determination of the units by methods based on mechanical dimensions.

The Bureau of Standards has under way several investigations planned to give a better technical basis for final decisions on these questions. It is desirable also that they be discussed by those interested in making precise and accurate electrical measurements in order that all the advantages and disadvantages of the changes proposed may be given adequate consideration.

### INTRODUCTION

WHILE many systems of electrical units have been proposed, the leaders in electrical science and engineering since the time of Weber have almost invariably adhered to the principle that fundamental electrical measurements should be based on the mechanical effects of electricity, and thus be made concordant with measurements in other fields of science and engineering. The metric system has also been generally accepted as the basis for the electrical units.

Even though this general principle is accepted, there are many sets of alternatives between which a choice must be made. For example, one may start with the mechanical forces between electric charges at rest, or on the other hand, first consideration may be given to the magnetic effects which are of so much greater importance in connection with electric currents. In other words, the basis of the system of units may be either electrostatic or electromagnetic effects.

In fact, systems of both kinds are used, and each has special advantages for particular cases. The greater importance of electromagnetic relations in the practical use of electricity, and the facility with which precise

measurements of electric current can be made by the use of magnetic effects, have combined to give the electromagnetic system a predominating position. It is nevertheless worth noting that developments of recent years, especially in high voltage work and in electronics, have made electrostatic effects more prominent than they formerly were. It has been established beyond reasonable doubt that all material is composed of constellations of electric charges. The numerical values of these elementary charges have been determined with precision. In numerous devices they already serve us, and the future importance of their direct uses no one can foretell. In this great and growing field of science and practise, essential values are naturally determined in absolute electrostatic units.

It would be beside the point to discuss here the various combinations of units which have been proposed for the purpose of simplifying the numerical relations between quantities and thus making computations easier. These proposed systems are treated at some length in Bureau of Standards Circular No. 60, "Electric Units and Standards,"<sup>1</sup> and Scientific Paper No. 292, "International System of Electric and Magnetic Units."<sup>2</sup> In brief, the view set forth in those publications is that in the "practical" electromagnetic system, as modified by the adoption of the present international units, there has been developed a set of units more generally satisfactory than any of the systems proposed on a theoretical basis. Consequently, it is concluded that there is no good reason to incur the confusion which

\*Approved by the Director of the Bureau of Standards, Department of Commerce.

†Physicist, Chief of Electrical Div., Bureau of Standards, Washington, D. C.

Presented at the Summer Convention of the A. I. E. E., Detroit, Mich., June 20-24, 1927.

would result from an attempt to change the units now ordinarily used.

During the last 10 years there has been no agitation for radical changes in the present system, and certainly no such proposals would now be received with favor. No one would seriously propose to do away with the ohm, the ampere, or any of the important units derived from them. It is, however, an open question whether the values of these units as now accepted should not be adjusted to make them accord more closely with the general system of measurements. Furthermore, we may well inquire whether the methods of determining these values have not reached such a stage of perfection that the old expedients for maintaining constancy of the units can be safely discarded. If any such changes of units or of fundamental standards are to be made, they must, of course, be thoroughly considered in advance in order that the advantages and disadvantages resulting from the change may be fully weighed. The purpose of this paper is therefore to set forth the present status of the units and to ask for discussion of the changes which might logically be made if found expedient.

#### LEGAL BASIS OF THE UNITS IN THE UNITED STATES

The legal basis for the electrical units used in the United States is still the Act of July 12, 1894. This accepted the international ohm, ampere, volt, coulomb, farad, joule, watt, and henry, as adopted at the International Electrical Congress held at Chicago in 1893, and incorporated definitions paraphrasing without essential changes the resolutions adopted by that Congress. The definitions given in the Act for the ohm, ampere, and volt were as follows:

1. The unit of resistance shall be what is known as the international ohm, which is substantially equal to one thousand million units of resistance of the c. g. s. system of electromagnetic units, and is represented by the resistance offered to an unvarying electric current by a column of mercury at the temperature of melting ice, 14.4521 g. in mass, of a constant cross-sectional area, and of the length of 106.3 cm.

2. The unit of current shall be what is known as the international ampere, which is one-tenth of the unit of current of the c. g. s. system of electromagnetic units, and is the practical equivalent of the unvarying current, which, when passed through a solution of nitrate of silver in water in accordance with standard specifications, deposits silver at the rate of 0.001118 of a gram per second.

3. The unit of electromotive force shall be what is known as the international volt, which is the electromotive force that, steadily applied to a conductor whose resistance is one international ohm, will produce a current of an international ampere,

and is practically equivalent to  $\frac{1000}{1434}$  of the electro-

motive force between the poles or electrodes of the voltaic cell known as Clark's cell, at a temperature of 15 deg. cent., and prepared in the manner described in the standard specifications.

It will be seen that these definitions do not draw a sharp distinction between the basic c. g. s. units and those defined in terms of concrete standards. If taken literally, the law is inconsistent with regard to the relations between the two sets of units. The exact value of the ohm is to be that obtained from the mercury column, the absolute unit being mentioned merely as a substantial equivalent, while in the case of the ampere this condition is reversed.

Section 2 of the same act provided,

That it shall be the duty of the National Academy of Sciences to prescribe and publish, as soon as possible after the passage of this Act, such specifications of detail as shall be necessary for the practical application of the definitions of the ampere and volt hereinbefore given, and such specifications shall be the standard specifications herein mentioned.

This section has become a dead letter, since it was necessary to depart from the National Academy specifications in order to obtain consistent results and to obtain international agreement. Except in this detail, however, it has been possible to follow the terms of the law literally and still to put into effect the international agreements which have been reached. The differences between the absolute and the accepted international unit of current have been negligible, and the terms in which the Clark cell were referred to were not such as to require its use, so that there has been no legal obstacle to the adoption of the Weston normal cell as a substitute for the Clark.

#### THE PRESENT UNITS

The values of the units now accepted for practical use throughout the world were established, in principle, by the International Conference on Electrical Units and Standards, held in London in 1908. This conference made a clear distinction, so far as definitions are concerned, between the absolute units and those which were called international. The Conference used the term "fundamental" for the units here called absolute, that is, those derived from the basic units of length, mass, and time. With reference to these units, the following resolution was adopted:

The Conference agrees that as heretofore the magnitudes of the fundamental electrical units shall be determined on the electromagnetic system of measurement with reference to the centimetre as the unit of length, the gramme as the unit of mass and the second as the unit of time.

These fundamental units are:

1. The *Ohm*, the unit of electric resistance which has the value of 1,000,000,000 ( $10^9$ ) in terms of the centimetre and second,

2. The *Ampere*, the unit of electric current, which has the value of one-tenth (0.1) in terms of the centimetre, gramme, and second,

3. The *Volt*, the unit of electromotive force which has the value of 100,000,000 ( $10^8$ ) in terms of the centimetre, gramme, and second,

4. The *Watt*, the unit of power which has the value of 10,000,000 in terms of the centimetre, the gramme, and the second.

As a system of units representing the above and sufficiently near to them to be adopted for the purpose of electrical measurements and as a basis for legislation, the conference recommended the adoption of the international ohm, ampere, volt, and watt, defined as follows:

The *International Ohm* is the resistance offered to an unvarying electric current by a column of mercury at the temperature of melting ice, 14.4521 grammes in mass, of a constant cross-sectional area and of a length of 106.300 centimetres. (The procedure to be followed in setting up mercury ohms was prescribed in detail in specifications attached to the resolutions.)

The *International Ampere* is the unvarying electric current which, when passed through a solution of nitrate of silver in water, in accordance with the Specification II attached to these Resolutions, deposits silver at the rate of 0.00111800 of a gramme per second.

The *International Volt* is the electrical pressure which, when steadily applied to a conductor the resistance of which is one international ohm, will produce a current of one international ampere.

The *International Watt* is the energy expended per second by an unvarying electric current of one international ampere under an electric pressure of one international volt.

It is perhaps worth noting that the units of mass and length included in these definitions occur in the description of the apparatus by which the units are to be established, and are not involved in the real definitions of the units themselves. That is, these dimensions could be stated in any other mechanical units desired without affecting the value of the electrical units; the latter are essentially defined in terms of the properties of mercury and of silver without any reference to systems of measurement. They therefore become independent, fundamental units which, joined with the centimeter and the second, constitute the basis of a complete system from which even mechanical units including the gram might be derived.

While these definitions were thus made in form quite independent of the absolute electrical units defined in terms of the centimeter, gram, and second, the intention of the conference was to make the units adopted represent very closely the value of the absolute units. In fact, one reason advanced for choosing the ampere, instead of the volt, as a fundamental unit was the

possibility of direct determination of the absolute value of the ampere by several methods independently of any assumed value for the ohm or other electrical units.

The definition adopted for the ampere carried the value to six significant figures although it was recognized that the specifications for the voltameter were incomplete and therefore indefinite. An International Committee on Electrical Units and Standards was created to complete the work of the conference and to carry it on until another conference should be convened. Among other duties, this committee was to secure agreement on precise specifications for the voltameter and to establish a standard value for the electromotive force of the average Weston normal cell consistent with the international ohm and the ampere as defined by these specifications. The accomplishment of an important part of this task was made possible by the generous support of four American societies, the American Institute of Electrical Engineers, Association of Edison Illuminating Companies, Illuminating Engineering Society and National Electric Light Association. These societies contributed funds to bring representatives of Great Britain, France, and Germany to America for joint experiments with the Bureau of Standards upon the silver voltameter and the standard cell. The Technical Committee thus created worked at Washington for nearly two months in 1910. It did not agree on formal specifications for the voltameter, but it did bring the experimental results with different types of voltameters nearly enough into accord so that the value of 1.0183 at 20 deg. cent. for the Weston normal (saturated) cell was established and accepted internationally.

#### VALUES OF THE OHM

When the Technical Committee met in 1910, it had at hand wire standards calibrated in terms of the mercury ohms at the German Physikalisch-Technische Reichsanstalt and the British National Physical Laboratory. The two values for the ohm were found to differ by only one part in 100,000, and the mean value was accepted by the Technical Committee in the following resolution:

The committee decides to choose, for the present and until there are other mercury ohms prepared, as the value of the international ohm, to be recommended to all countries for general use, the mean of the values of the units realized at the Physikalisch-Technische Reichsanstalt and at the National Physical Laboratory. Although the international ohm as defined by the London Conference has not yet been strictly realized, the committee believes that its value has been attained in two laboratories independently with a good degree of precision, and that future work is not likely to change it by more than two or three parts in 100,000.

It will be seen that this acceptance of a mean value

to be called the International Ohm was really provisional. The International Committee never succeeded in completing the full and formal establishment of the unit, and no machinery was provided for the distribution and maintenance of a common unit. The work of the committee did, however, show that the resistance standards of the several national laboratories were already in fairly good agreement. Since the standards were thus reasonably concordant, in general each laboratory considered it best to maintain the continuity of its own values rather than to make small changes in advance of a complete international acceptance of a precise value.

In fact, a mercury ohm determination completed at the Bureau of Standards a few years later<sup>3</sup> gave a value differing from the international ohm accepted in 1910 by 25 parts in a million. This was considered to be a check within the limits of certainty of the mercury ohm, and the values assigned to the Bureau's wire standards were not changed. Since 1915 no mercury ohm determinations have been made at the Bureau. The unit has been preserved by sets of wire standards whose relative values have been found to be very stable. The unit has been maintained on the assumption that the mean resistance of a group of 10 one-ohm manganin wire standards remains constant. The ten standards included in the reference group are, however, not always the same. Intercomparisons with a considerably larger group are made from time to time, and those standards which have apparently been most stable are chosen for the reference group which is the custodian of the unit until the next intercomparison is made. Since 1910, 17 different standards have thus at various times been included in the reference group.

Comparisons of the ohm as maintained in different countries have been made only irregularly, but the results have indicated that all the national laboratories have remained in satisfactory agreement. The differences found have seldom been greater than two parts in 100,000, which is about the limit of accuracy obtainable in the establishment of the international ohm.

In recent years an entirely unexpected complication has arisen which makes the old definition of the international ohm indefinite. This is the discovery that mercury is not a simple element but includes several isotopes. If completely separated, these would presumably differ in density by as much as 3 per cent, although they have the same resistivity on the basis of volume. This difficulty is not a serious one, however, since mercury from many sources as ordinarily produced has been shown to have the same density within a few parts in a million. At any rate, the difficulty can be met by specifying the density of the mercury to be used in the ohm tubes or by prescribing the cross-section instead of the mass of the mercury column.

Although the mercury ohm affords a means, however, of checking the value of the unit to a few parts in

100,000, determinations of the absolute value of the international ohm have shown that this unit differs by a considerable amount from the basic unit with which it was intended to be practically equivalent. Two very careful determinations have been made since 1910 by entirely different methods, one at the National Physical Laboratory,<sup>4</sup> with an apparatus of the Lorenz disk type, the other at the Reichsanstalt<sup>5</sup> by comparison of resistance standards with the calculated self-inductance of a coil. The two results agree within one part in 100,000. This close agreement must be considered as partly accidental, since the relative values of the reference standards used in the two laboratories could not be depended upon to such a high degree of accuracy. Expressed in terms of the length of a column of mercury of the same cross-section as the international standard, these two determinations indicated that the absolute ohm would be represented by a column 106.245 or 106.246 cm. long instead of 106.300. It appears certain, therefore, that the absolute ohm is smaller than the international ohm by about five parts in 10,000, and incidentally that determinations of the absolute ohm can be made with the same degree of precision as the international ohm can be established and checked with mercury ohm tubes.

#### VALUES OF THE AMPERE

The present international ampere represents the value obtained by the Technical Committee of 1910 as an average of the results found with several different types of voltameter. Since current is transitory, the average result was recorded and is concretely expressed by the value assigned to the Weston normal cell. The international volt being the potential drop in the accepted international ohm with a current flowing which deposited 1.11800 mg. per sec. in the *average* voltameter, the committee found that the average cell had a voltage of 1.0183, and this has since been used as the standard value. Standard cells used in conjunction with resistance standards calibrated in international ohms presumably reproduce ampere values as then obtained.

The voltameters operated by the Bureau of Standards at that time would have established an ampere larger than the average by three parts in 100,000. That is, in these voltameters the deposits of silver were smaller, probably because they were more nearly pure silver. As a result of researches carried out over a period of several years<sup>6</sup> following the London Conference, the precision of the voltameter as a measuring instrument was materially improved, but since these improvements in procedure reduced the deposits they would increase the value of the ampere as measured by the silver deposited. Seven series of measurements made in five different countries since 1910 have shown an average deviation of only one part in 100,000 from their mean, but the mean is three parts in 100,000 different from the 1910 value. That is, these voltameter measurements



would have made the standard cell value 1.01827 instead of 1.0183.

As has been remarked above, the ultimate value of the international ampere as defined by the silver voltameter is as yet indefinite because no precise specifications for the operation of the voltameter have been adopted. The Bureau of Standards has proposed specifications which are believed to assure the highest attainable degree of purity in the deposit. In voltameters used according to these specifications, the absolute ampere as measured by the Bureau's current balance was found to deposit 1.11804 or 11.1805 mg. per sec., of which about 0.004 per cent was foreign matter included with the silver. Consequently, according to these measurements, if the international ampere were based on *pure silver* deposited, it would be identical with the absolute unit within the limits of accuracy of these measurements.

This allowance for inclusions was not made, however, when the accepted value for the standard cell was established in 1910. Since it has to be added to the difference of three parts in 100,000 mentioned above, the "international ampere" then set up was smaller than the absolute by seven or eight parts in 100,000, according to the measurements made at the Bureau of Standards. Taking into account also measurements at the British National Physical Laboratory<sup>7</sup> and at the University of Groningen, Holland<sup>8</sup>, it has been estimated<sup>1</sup> that the best value for the international ampere of 1910 was 0.99991 absolute ampere, and this conversion factor has been commonly used.

There are several distinctly different methods by which the absolute ampere can be found. Since the 1908 London Conference, good determinations have been made by the tangent galvanometer<sup>8</sup>, the electro-dynamometer<sup>9</sup>, and several forms of current balance<sup>7,10</sup>. It is not possible, in most cases, to compare the results exactly because there have been no common standards of sufficient accuracy to preserve and express the values obtained by these experiments. The differences have been a few parts in 100,000, and it is a question how much of these differences is due to the errors in establishing the absolute ampere and how much to variations between the voltameters (or the standard cells and resistance coils) used to represent the international ampere. Certainly it is possible to establish the absolute value within two or three parts in 100,000 with a single instrument like the current balance. If several laboratories were to set up different types of absolute instruments and systematically compare the results, it should be possible to establish and maintain the ampere to one part in 100,000.

#### VALUES OF THE VOLT AND OTHER UNITS

Although the ampere is the second fundamental unit adopted, the unit actually maintained for practical measurements is the volt, as represented in the standard cell. Since 1910 the Bureau of Standards has main-

tained this unit by groups of reference cells in a manner closely analogous to that described above for the ohm. With a few substitutions of stable cells for some which showed a relative decrease in electromotive force, it is believed that these reference groups of selected cells have remained substantially constant for many years, some of them since 1906. A few new cells have been made recently, and these have agreed with the older groups within one part in 100,000. Results of comparisons with other laboratories in this country and abroad have also generally supported the belief that the Bureau's cells have maintained their values. During the last year, however, differences of several parts in 100,000 have arisen between the Bureau's measurements and those of the National Physical Laboratory, and no complete explanation for them has yet been found.

The absolute value of the international volt and of other international units is, of course, dependent on that of the ohm and of the ampere. On the basis of the estimates given above for the two fundamental units as established in 1910, the various international units have the following values<sup>1</sup>:

1 international ohm	= 1.00052 absolute ohm
1 international ampere	= 0.99991 absolute ampere
1 international volt	= 1.00043 absolute volt
1 international watt	= 1.00034 absolute watt
1 international joule	= 1.00034 absolute joule
1 international coulomb	= 0.99991 absolute coulomb
1 international farad	= 0.99948 absolute farad
1 international henry	= 1.00052 absolute henry
1 international gilbert	= 0.99991 absolute gilbert
1 international maxwell	= 1.00043 absolute maxwell

#### FUTURE UNITS AND STANDARDS

There are few applications in which a change of one-twentieth of one per cent (the maximum discrepancy existing between the two sets of units) would now be of any practical importance. The demands of industry for precise measurements have grown with surprising speed, however, and if the discrepancy is ever to be removed, it would be well to perform the operation before the change does become significant in industry. For those laboratories which carry on work of high precision, the changes involved in going over to the absolute units would undoubtedly be troublesome for a time, particularly because so much apparatus is precisely adjusted to values in the international units. The easier course at present would be to retain the old units, making such minor adjustments as may be found necessary for better international agreement, and to establish accurately the necessary conversion factors for those who must transfer from electromagnetic quantities to electrostatic and to heat or other mechanical units. When one considers, however, that this probably means laying up trouble in increasing amounts for decades to come in order to avoid some temporary inconvenience, it would appear that the logical course is to adopt the absolute units in the near future rather

than to make merely minor adjustments in the international units.

Before the absolute units could be thus adopted for practical use, it would be necessary to have more laboratories set up apparatus to give these units and to find whether these newer determinations agreed satisfactorily with those which have been mentioned above. If such apparatus is set up in the several national laboratories and gives concordant results with a certainty as great as that of the mercury ohm and silver voltameter, the need for these inconvenient custodians of the units will have vanished. This will be true even if the present international units should be continued in use.

In the enactment of legal definitions, the concreteness of the standards representing the present international units offers some advantage, but in those countries having national laboratories there should be no serious difficulties in securing the legal recognition of units defined in terms of the centimeter, gram, and second, to be established and maintained by the national laboratory in cooperation with the International Committee on Weights and Measures. Other countries could define the units similarly and provide for obtaining copies of standards through the International Committee.

Although this Committee has never heretofore dealt with electrical standards, it was empowered to do so by an amendment to the international convention on weights and measures which was ratified by the United States in 1923. In accordance with its enlarged authority, the Committee is now inaugurating a series of systematic intercomparisons between the national standardizing laboratories, and it will consider eventually what steps shall be taken to coordinate more effectively electrical measurements as made in different countries.

Whatever course is followed, it is obvious that there is urgent need for comprehensive experimental studies, including the reexamination and further development of the fundamental standards whereby the units are established and maintained. This, of course, is primarily a problem for the national standardizing laboratories. In general, however, such laboratories in recent years have been pressed with problems of more immediate and obvious industrial usefulness, or their means available for fundamental scientific work have been otherwise curtailed.

#### PRESENT WORK AT THE BUREAU OF STANDARDS

In view of the long period over which the units have been maintained at the Bureau by means of secondary standards, coils and cells, it would be desirable to check their values by new mercury-ohm and silver-voltameter determinations. It has been believed, nevertheless, that a revival of the researches on fundamental units is still more important, and that if successfully carried out, these researches would in effect give also as accurate

a check on the international units as could be got by the use of the mercury column and the voltameter. Since it has not been practicable to take up work on both types of standards, attention has been given first to the development of apparatus for establishing the fundamental units. Of these units, the ohm has been given priority because the Bureau has never made any determinations of its value, and very few accurate determinations have ever been made. Two independent schemes for accomplishing this purpose are being developed. Both will use stationary inductance coils designed for calculation of the inductance from dimensions. One method, devised some years ago by Dr. Frank Wenner, will use mutual inductances so arranged that the electromotive force induced in the secondaries can be balanced against the potential drop in a resistance of which the value is to be determined. The other procedure is planned to make use of the experience of the Inductance Laboratory under the charge of Dr. H. L. Curtis. It will consist essentially of the comparison, by a-c. bridge methods, of a self-inductance of calculated value with the resistance to be measured. In each project, it is desired to carry the results to an accuracy approaching one part in 100,000, and this requires a theoretical and experimental study of many details which are neglected in ordinary measurements. Fair progress is being made, but it is impossible to predict when final results will be obtained.

For absolute measurements of current, the balance used by Dr. E. B. Rosa<sup>10</sup> and his associates has been reassembled and is being studied for possible improvements. It is hoped that this will soon give results which, in conjunction with the wire ohm standards, will serve to check the Bureau's standard cell values.

Whatever primary standards are used, the cells always serve as one of the essential secondary standards, and studies of their behavior are being made. This work, as well as the maintenance of the reference group of cells, is under the direction of Mr. G. W. Vinal.

#### CONCLUSION

This summary of the present situation in regard to the electrical units and standards has been offered because the Bureau of Standards has a large responsibility for their maintenance and improvement which in recent years it has not been able to meet to its own satisfaction. The kind of work necessary to give the accuracy desired in the basic standards can not be done hastily, and it will require several years of work on the part of all the national laboratories to provide a good technical basis for a final decision on the type of standards and on the units to be adopted for international use. Detailed results of the several investigations mentioned will be published as they become available. In the light of these results and those of similar work abroad, the International Committee on Weights and Measures will have to reach a decision. In the meantime, it is desired that those whose interests will be affected by

this decision study the situation and make known their views as to the course which should be chosen.

### Bibliography

1. "Electric Units and Standards," Bur. of Stds., Circular 60.
2. "International System of Electric and Magnetic Units," J. H. Dellinger, *Bul. Bur. of Stds.*, **13**, p. 599, 1916, (Sci. Paper 292).
3. "Construction of Primary Mercurial Resistance Standards," Wolff, Shoemaker and Briggs, *Bul. Bur. of Stds.*, **12**, p. 375, 1915, (Sci. Paper 256).
4. "Absolute Measurements of a Resistance by a Method Based on That of Lorenz," F. E. Smith, *Proc. Royal Soc. London*, **89**, p. 525, 1914, *Phil. Trans. (A)*, **214**, p. 27, 1914.
5. "Eine neue Bestimmung der absoluten elektrischen

Widerstandseinheit," E. Grüneisen and E. Giebe, *Ann. d. Physik*, **63**, p. 179, 1920.

6. "The Silver Voltmeter as an International Standard for the Measurement of Electric Current," E. B. Rosa and G. W. Vinal, *Proc. Nat. Acad. Sci.*, **3**, p. 59, 1917.

7. "Current Balance and Silver Voltmeter Experiments," F. E. Smith, *Nat. Phys. Lab. Report for 1910*, p. 31.

8. "The Electromotive Force of the Weston Normal Cell," H. Haga and J. Boerema, *Konink. Akad. Wetensch. Amsterdam Proc.*, **13**, p. 587, 1910, *Arch. Neerland, Sci.* **3A**, **3**, p. 324, 1913.

9. "A Determination of the Electromotive Force of the Weston Normal Cell in Semi-absolute Volts," A. N. Shaw and H. L. Callendar, *Phil. Trans. Royal Soc.*, **214**, p. 147, 1914.

10. "A Determination of the International Ampere in Absolute Measure," Rosa, Dorsey, and Miller, *Bul. Bur. of Stds.*, **8**, p. 269, 1911, (Sci. Paper 171).

# Electrical Transportation

## Annual Report of Committee on Transportation\*

### To the Board of Directors:

During the past year the application of electrical means to the various branches of transportation continued at an accelerated pace. The major division of the transportation industry, namely, steam railroads, added to its electrified lines and, although the mileage electrified is still a small percentage of the total, it is steadily increasing and is rapidly becoming an important factor in railroad operation. Into the field of city and suburban railways, improvements are constantly being introduced. On the water, electric drives are being adopted more and more, with either steam turbines or oil engines as prime movers. Bus transportation is adopting, extensively, gas-electric propulsion. The oil-electric locomotive and the gas-electric motor rail car are being introduced in certain phases of railroad operation.

### STEAM RAILROAD ELECTRIFICATION

The year 1926 has seen the completion of two major electrification projects, that of the suburban lines of the Illinois Central Railroad out of Chicago and the line of the Virginian Railway between Mullens, West Virginia, and Roanoke, Virginia. The Detroit & Ironton Railroad completed 17 mi. of electrification between Fordson and Flat Rock, Michigan.

The New York Central opened a new electrified section between High Bridge and Yonkers, New York.

Of the principal uncompleted projects, the Great Northern Railway is electrifying 80 continuous mi. of its line between Wenatchee and Skykomish, Washington. The Pennsylvania Railroad is extending electric

suburban operation on its main line between Philadelphia and Wilmington, and also from Philadelphia to West Chester. The New York, Westchester & Boston Railway is continuing its extension of electrified line between Larchmont and Port Chester, New York. The Long Island Railroad is installing freight electrification on its Bay Ridge division.

*Illinois Central Railroad.* The first step in the electrification of the Illinois Central out of Chicago was completed during July of last year when the suburban service was placed in electric operation over 28 mi. of the main line and 8.9 mi. on two branch lines. The ordinance under which this project was carried out calls for electrification of freight service within the city limits by 1935 and electrification of through-passenger service on both the Illinois Central and Michigan Central by 1940, provided a certain portion of the tenant roads then using the passenger station on East Roosevelt Boulevard are electrically operated at the time.

The 1500-volt, d-c. system with overhead contact wire was chosen since there is no immediate prospect for extension over main line divisions.

Power supply is secured at the railroad's right-of-way from substations owned and operated by outside power companies. The conversion from 60-cycle power to 1500-volt direct current is accomplished by means of synchronous converters and mercury arc rectifiers. One of the reasons for purchasing power rather than building a generating plant was the fact that the power companies can supply power from several plants over various routes and thus aid in securing continuity of service.

The distribution system of the railroad is so laid out that the wires over each track are separate electrically and can be sectionalized at substations and interlocking plants by automatic high-speed circuit breakers. Normally, the wires are tied together over all tracks.

### \*Committee on Transportation:

J. V. B. Duer, Chairman	H. A. Kidder,	N. W. Storer,
E. R. Hill,	John Murphy,	W. M. Vandersluis,
W. K. Howe,	W. S. Murray,	Richard H. Wheeler,
D. C. Jackson,	W. B. Potter,	

Presented at the Summer Convention of the A. I. E. E., Detroit, Mich., June 20-24, 1927.

No feeders are required external to the catenary system. Trolley feeder switches in all substations and tie stations are operated from the railroad company's power supervisor's office by supervisory control. The power supervisor has electrical indication from each substation and tie station and, in case of trouble, he can cooperate with the train dispatcher who occupies a joint office.

The catenary system, which provides the entire current-carrying capacity, has an average conductivity over each track of about 790,000 cir. mils, copper equivalent. This figure takes into consideration average wear on the contact wire. The catenary system is completely non-ferrous, with a double contact wire. Chord construction is used on curves with the aid of shortened pole spacing. The rail bond, adopted as a final standard, is a U-type gas-weld bond consisting of two No. 1 A. w. g. flexible conductors.

The 260 multiple-unit cars for this service are built in two-car units. Two pantographs and four 250-h. p. nominal-rating, self-ventilated, series railway motors are located on each motor car to which a trailer car is semi-permanently attached. Normally, only one pantograph on each motor car is in operation. Each pantograph exerts a pressure of about 20 lb. against the contact wires. Automatic couplers couple the cars together mechanically, electrically and pneumatically with full automatic operation between the two-car units.

*Virginian Railway.* Heavy electric freight operation over the entire electrified zone of the Virginian Railway started in September, 1926. The electrification is now complete from Mullens, West Virginia, to Roanoke, Virginia, a route of 133 mi.

An 11,000-volt, 25-cycle, single-phase, a-c. system is installed. The problem of taking a heavy tonnage train down a long grade was a large factor in deciding upon the a-c. system in order to use split-phase locomotives for regenerative braking.

The power plant, owned and operated by the railway, contains four 12,500-kv-a., 25-cycle, single-phase turbo generators and five water tube boilers each rated at 1521 b. h. p. Pulverized fuel is used and has been found to be peculiarly well adapted to the rapidly fluctuating power load.

Electric power is transmitted from the plant at 88,000 volts over twin transmission lines. There are seven transformer substations along the right-of-way. They contain three-coil transformers in which the low-voltage winding is divided into two parts. One part of the winding supplies 11,000 volts between the trolley and rail, while the other part supplies 22,000 volts between a feeder and the rail. This gives a potential between trolley and feeder of 33,000 volts. Transformer windings are so constructed that reconnection for 22,000 volts from trolley to ground can be made when traffic demands require this to be done. Balancer stations containing auto-transformers are located between the

main transformer stations in order to connect the feeder circuit to the trolley and rail.

The catenary system is completely non-ferrous with a copper and bronze composite messenger and a bronze contact wire. Inclined catenary is used in general, but on account of the great number and high degree of curves, pull-offs have also been employed.

The 12 road locomotives are each built in three units which are electrically identical. They receive power from the single-phase trolley through a transformer and phase converter, and are driven by three-phase traction motors at running speeds of 14 and 28 mi. per hr. Each complete locomotive weighs 637 tons.

*Detroit & Ironton Railway.* During 1926, the Detroit and Ironton Railway started electric operation on 17 mi. of line from Fordson to Flat Rock, Michigan.

Power is supplied at 44,000 volts, 25-cycle, single-phase, between feeder and contact wire, with 22,000 volts between contact wire and ground.

The catenary system is non-ferrous, composed of 4/0 bronze contact wire and a 1/2-in., seven-stand bronze messenger wire. The supports for the catenary are unique in that they are pre-cast reinforced concrete arches bolted together and placed on concrete foundations. Inclined catenary is used on curves. A 1/2-in. stranded copper feeder, together with auto-transformers, is used to secure three-wire feed.

The locomotives, two in number, are of the motor-generator type. In these locomotives, alternating current is stepped down to 1240 volts to drive a synchronous motor which, in turn, drives a 600-volt d-c. generator. Eight traction motors, of the d-c. type, rated at 225 h. p., are mounted on each power unit which is articulated into two wheel bases of four axles each. The complete locomotive consists of the two power units. It has 32 driving wheels on which the total weight of 372 tons is carried.

*Great Northern Railway.* The line of the Great Northern Railway between Wenatchee and Skykomish, Washington, involving about 80 mi. of route, is being electrified with 11,000-volt, single-phase, alternating current. Twenty-six miles of the old line (from Cascade to Skykomish) is now in operation. A new tunnel 7 3/4 mi. long is being constructed to improve the route and to replace the old Cascade tunnel which was electrified in 1909 with 6600 volts, three-phase.

Two motor-generator type locomotives with two cabs each have been placed in service, which convert the 25-cycle power into 600-volt direct current to operate the traction motors. These two locomotives have a continuous rating of 3660 h. p. at 15 1/2 mi. per hr. with a tractive force of 88,500 lb.

Two single cab motor-generator type locomotives are now being built. They will convert the 25-cycle power to 1500-volt direct current to operate the motors with two motors in series. These locomotives will

have a continuous rating of 3000 h. p. at 18.6 mi. per hr. with a tractive force of 60,500 lb.

*Pennsylvania Railroad.* The Pennsylvania Railroad has under way the electrification of its main line for suburban service between Philadelphia and Wilmington, a distance of 27 mi. After this is completed, the suburban line between Philadelphia and West Chester will also be electrified. The design is laid out with due regard to the possibility of future extensions.

Electric power will be purchased, stepped up and transmitted along the right-of-way at 132,000 volts, 25-cycle, single-phase, 66,000 volts to ground, over duplicate transmission lines to the transformer substations where it will be converted to 11,000 volts for the trolleys.

The catenary system will be completely non-ferrous. A bronze messenger wire with copper auxiliary wire and a single bronze contact wire will be used. The inclined type of catenary is to be installed on curves. The catenary supports are principally back guyed tubular poles with cross-span catenary to support the main catenary.

Multiple-unit cars of the type in the existing suburban electrification to Paoli and Chestnut Hill will be used.

*New York, Westchester & Boston Railway.* The New York, Westchester and Boston Railway has built an extension of its line to Harrison, New York, and will continue on to Port Chester. Much of this extension adjoins the trackage of the New York, New Haven and Hartford Railroad. Multiple-unit suburban service is operated with an 11,000-volt, single-phase system.

*Long Island Railroad.* The Long Island Railroad is electrifying its freight line to Bay Ridge for 11,000 volts, single-phase, with overhead catenary construction. This involves about 100 mi. of trackage. Seven 150-ton locomotives for operation on this line have been delivered.

The extension of the third rail d-c. electrification over the West Hempstead passenger branch was completed last October.

*New York Central Railroad.* During 1926, the New York Central opened electric operation for multiple-unit service on the Putnam division, extending from Sedgwick Avenue Station, New York City, to Yonkers, New York, a distance of seven mi.

#### CITY AND SUBURBAN RAILWAYS

New car equipment being placed in service on electric railways is now confined, in most cases, to the light-weight type of car, in order to secure reduced operating costs.

Articulated train units are now in operation in street-car and subway service. Three-car articulated units for heavy subway and elevated service have been installed by the Brooklyn-Manhattan Transit Corporation. These units consist of three-car-bodies mounted on four trucks.

The most radical development is a car on which

high-speed motors, entirely spring-supported, drive the axles through worm gears and a differential. Light weight and absence of noise are the outstanding characteristics of this car.

#### MARINE PROPULSION

Diesel-electric drive has been introduced on large tankers, suction and dipper dredges, ferries and tug-boats. Double-end operation has been successfully introduced on tug-boats as well as on ferries.

Turbo-electric drive has been used on ferries in addition to its past application to large boats.

#### BUS TRANSPORTATION

Simplicity, ease of control and durability are among the advantages which are causing the rapid introduction of gas-electric drive on buses.

#### RECENT DEVELOPMENTS

*Diesel Electric Locomotive.* The Diesel engine prime mover with electric drive is finding an increasing field in moderate sized locomotives up to 1000 h. p., on account of its high efficiency, ease and flexibility of operation and the absence of stand-by losses.

*Gas-Electric Cars.* Many of the gasoline-propelled rail cars now being placed in operation are equipped with electric drive.

*Automatic Substations and Supervisory Control.* The automatic substation is now finding its way into the electric railway field. The New York Central Railroad is installing three such substations to supply additional power for its New York Terminal electrification.

Supervisory control has been introduced by several of the recently completed railway electrifications, notably the suburban electrification of the Illinois Central, out of Chicago.

*High-Speed D. C. Circuit Breaker.* The high-speed d. c. circuit breaker, on account of the fact that it is opened by the rate of increase of the current rather than by the current value, has two distinct advantages in railroad electrification. First, the breaker will open before the current has reached a damaging value in any abnormal condition, such as motor flashovers, severe wheel slipping, or slight grounds. Second, the rapid rate of rise of current in a short circuit of any value makes the breaker more susceptible to short circuits than to heavy power loads and thus aids in securing selectivity between these two conditions.

*Mercury Arc Rectifiers.* The installation of mercury arc rectifiers for the Illinois Central is one of the first instances in which these rectifiers have been used in this country for a steam railroad electrification.

*Motor-Generator Locomotives.* Motor-generator locomotives are being placed in service by the Detroit and Ironton, Great Northern, and New York, New Haven & Hartford Railroads. This type of locomotive can be built to give regenerative braking down to a very low speed. Speed control is flexible and the a-c. synchronous motor operates at a high power factor while the

d-c. traction motors are developed to a high degree of efficiency.

*Test Plant for Single-Phase Locomotives and Cars.* In order to test electric locomotives and multiple-unit cars, the Pennsylvania Railroad, during 1925, equipped its Locomotive Test Plant at Altoona with a motor-generator set to convert 11,000-volt, three-phase, 60-cycle power into 11,000-volt, 25-cycle, single-phase power. A 204-ton freight and passenger locomotive was tested in 1925. During the year 1926, a complete test was made with a multiple-unit car.

*New Single-Phase Induction Motor.* A single-phase traction motor without a commutator has been built in Germany. It consists of two rotors on the same axis, one inside the other. The outer rotor is synchronous, excited by direct current. The inner rotor is a slip-ring motor which drives the shaft. According to the builders, power factor can be maintained at unity with this motor, and it is their hope that the motor will compete successfully with the a-c. commutator motor.

#### TECHNICAL PAPERS

The committee has been fortunate in securing some excellent papers for presentation at the Summer Convention in Detroit. They are as follows:

*Current Collection from an Overhead Contact System Applied to Railroad Operation*, S. M. Viele, Pennsylvania Railroad.

*Catenary Design for Overhead Contact Systems*, H. F. Brown, N. Y., N. H. & H. R. R.

*Catenary Construction for Chicago Terminal Electrification of Illinois Central Railroad*, J. S. Thorp, Illinois Central Railroad Co.

*Collection of Current from Overhead Contact Wires*, R. E. Wade and J. J. Linebaugh, General Electric Co.

*Railway Inclined-Catenary Standardized Design*, O. M. Jorstad, Westinghouse Electric & Manufacturing Co.

J. V. B. DUER, *Chairman.*

### THE NATURE OF COLD LIGHT

Among the multitude of questions asked of Mr. Edison on the occasion of his eightieth birthday, the following, with its answer, indicates that the search for the sources of "cold light" has a practical bearing on the developments of the future.

Q. Do you look for any radical changes in the present system of manufacturing and distributing electricity?

A. Not unless we solve the problem of cold light.

It is unfortunate in this regard that so many misconceptions have arisen concerning the nature of "cold light" as distinguished from other forms of natural and artificial light, because the matter is so simple when stripped of the mystery that seems to surround it.

What is "cold light"? In a critical sense it has no existence for so-called "cold light" if intercepted and absorbed is converted into heat, but as the energy or

mechanical equivalent of this light is very small, the heat thus produced is insignificant.

We all know that white light can be split up by a prism into rays of many colors from red at one end of the spectrum to violet at the other end. Its mechanical equivalent appears as a maximum at the red end and drops to a minimum at the violet end, so that its average value may probably exist in the yellow-green region, which is the color of the light produced by the firefly and the glow-worm; typical producers of "cold light."

Why then is not all light "cold light"? For the reason that sunlight and almost all forms of artificial light are produced by incandescence of solid materials, and many octaves of invisible heat waves, which precede and accompany the single octave (nearly) of visible light waves, are superposed on the latter. It is thus unavoidable total of invisible heat waves and visible light waves mixed together that is known by the common term of light. It is evident that light cannot be produced in this way without being accompanied by heat, the development of which generally consumes 98 or 99 per cent of the total radiant energy.

When light is produced by means other than incandescence, as in the case of the firefly for example, it is not thus accompanied by the undesirable heat waves. It is therefore termed "cold light" and it is, in fact, practically cold, as compared with other forms of light in general use.

A saturated solution of alum in water is fairly transparent to visible light, but opaque to heat rays. Therefore, if sunlight, or artificial light produced by incandescence, is filtered through a glass cell filled with this solution, the heat will be arrested and absorbed, and only "cold light" transmitted.

There is no mystery about this: "cold light" is just plain visible light *by itself*, without any admixture of unnecessary and undesirable heat rays. The mystery only exists in the question of how to produce it artificially in an economical way, and of sufficient intensity to be commercially useful.—*General Electric Review.*

Each year the country demands more strongly that the light it uses shall be directed where it will do the most good. This is indicated by the government figures on the number of lighting fixtures of all kinds made in the United States during 1924 and 1926. There was a general increase of 16.8 per cent, raising the total value of such products from \$205,000,000 made in 1924 to \$240,000,000 in 1926. The variations by classes offer some interesting sidelights.

Theater and stage lighting fixtures increased 13 per cent, indicating improved illumination in that proportion. The lighting of banks, public buildings and office buildings in 1926 improved over 1924 by 115 per cent.

# Protective Devices

## Annual Report of Committee on Protective Devices\*

To the Board of Directors:

This committee in its report last year gave a rather complete survey of the present state of the art in the field of protective devices for power systems. As many of the principal features of that report still describe the present practise in these various lines, the committee will report at this time more especially its activities during the past year.

The principal work of the committee this year has been, first, in the arranging for and the actual preparation of papers for presentation at meetings of the Institute, of which about 15 have been presented as listed in the reports of the subcommittees following, and second, in the work of standardization in connection with which during the year there were issued two reports on standards, one for lightning arresters and one for automatic stations.

The work of the committee has been carried on by subcommittees, each under the direction of its own chairman, and after the first organization meeting of the main committee, held at Chicago, in October, the further meetings have been held by the subcommittees individually. The subjects covered and the chairmen in charge of the subcommittees are as follows:

Automatic Stations, W. H. Millan, Union Electric Light & Power Co., St. Louis, Mo.

Current Limiting Reactors, E. A. Hester, Duquesne Light Co., Pittsburgh, Pa.

Lightning Arresters, J. A. Johnson, Niagara Falls Power Co., Niagara Falls, N. Y.

Oil Circuit Breakers, J. M. Oliver, Alabama Power Co., Birmingham, Ala.

Protective Relays, H. P. Sleeper, Public Service Electric & Gas Co., Newark, N. J.

Reports of the individual subcommittees follow.

### SUBCOMMITTEE ON AUTOMATIC STATIONS

Four papers have been arranged for by this subcommittee during the year:

*Carrier-Current Selector Supervisory Equipment*, by C. E. Stewart and C. F. Whitney.

*Testing, Inspection and Maintenance of Automatic Stations*, by Chester Lichtenberg.

*Automatic Substations*, by D. W. Ellyson.

\*Committee on Protective Devices:

F. L. Hunt, Chairman

H. R. Summerhayes, Vice-Chairman

E. A. Hester, Secretary

Raymond Bailey,

W. S. Edsall,

H. Halperin,

F. C. Hanker,

J. Allen Johnson,

M. G. Lloyd,

H. C. Louis,

W. B. Kirke,

K. B. McEachron,

W. H. Millan,

L. J. Moore,

J. M. Oliver,

E. J. Rutan,

H. P. Sleeper,

E. C. Stone,

A. H. Sweetnam,

A. Royal Wood.

Presented at the Summer Convention of the A. I. E. E., Detroit, Mich., June 20-24, 1927.

*Development of Automatic Switching Equipments in United States and Europe*, by A. H. de Goede.

In the matter of standardization, this subcommittee has prepared and circulated Report No. 26 on Standards for Automatic Stations. Criticism of this report is invited and it is hoped that many engineers to whom the report will be sent will respond with such suggestions as will permit adjustment of the substance of the report into a final set of standards.

In the matter of research work it has been suggested that the application of automatic control has a direct influence on the degree of service actually rendered, and that a study should be made of the subject, with a view to determining to what extent, if any, automatic control of station equipment has improved service.

### SUBCOMMITTEE ON CURRENT LIMITING REACTORS

Since there has been no marked progress in design, and since no very unusual installations have been called to the attention of the subcommittee, the subject of development will be passed with just a word. The fact that practically all new reactors now being installed are of the insulated conductor type shows that it is to be preferred over the older type with bare conductors. The superiority of insulated conductors has also been rather definitely proven by exhaustive tests. There seems to be some hesitancy on the part of operating engineers to go to the use of reactors of a higher voltage than 33,000 volts, although there are some successful installations of higher voltages, and manufacturers express their confidence in being able to produce satisfactory high-voltage equipment.

In last year's report, certain recommendations were made covering subjects to be studied this year. These were for the most part problems which have been considered by previous subcommittees and to which no solution has yet been discovered. Chief among these is the question of the value of resistance shunted reactors. It was hoped that the extended use of the klydonograph and Dufour oscillograph would shed some light on this much mooted question, but nothing conclusive has been obtained.

Another suggestion was that some work be done in an effort to reduce the variety of reactors with respect to voltage, current, and reactance values. The idea was that they might be standardized, with respect to their various characteristics, in steps in much the same way as has been done on oil circuit breakers. This was discussed at one of the Main Committee meetings and a decision handed down that this problem properly belongs to the N. E. L. A. rather than to the A. I. E. E.

Further study of possible standardization for reactors is now under way.

## SUBCOMMITTEE ON LIGHTNING ARRESTERS

March 24, 1927

*Papers and Research.* Last year's report described in considerable detail two new tools which have become available for the study of lightning and other transient electric phenomena; namely, the klydonograph and the Dufour cathode ray oscillograph. That report also suggested three items of further work to be done; namely:

1. Standardization of technique for using lightning generators for testing lightning arresters,
2. Determination of voltage time characteristics of lightning arresters including rate of discharge, and the dielectric spark lag,
3. Statistical data of operating experience on high-voltage lines.

During the past year, substantial progress has been made along these lines by the use of the two devices above mentioned. This progress is recorded in the following papers presented before the Institute during the past year:

1. *Lightning and Other Experiences with 132-Kv. Steel Tower Transmission Lines*, by M. L. Sindeband and P. Sporn, JOURNAL, Vol. XLV, No. 7, p. 641.
2. *Measurement of Transients by the Lichtenberg Figures*, by K. B. McEachron, JOURNAL, Vol. XLV, No. 10, p. 934.
3. *Lightning—A Study of Lightning Rods and Cages with Special Reference to the Protection of Oil Tanks*, by F. W. Peek, jr., JOURNAL, Vol. XLV, No. 12, p. 1246.
4. *Measurement of Surge Voltages on Transmission Lines Due to Lightning*, by Everett S. Lee and C. M. Foust, JOURNAL, Vol. XLVI, No. 2, p. 149.
5. *Transmission Line Voltage Surges*, by J. H. Cox, JOURNAL, Vol. XLVI, No. 3, p. 263.
6. *Klydonograph Surge Investigation*, by J. H. Cox, P. H. McAuley, and L. Gale Huggins, JOURNAL, Vol. XLVI, No. 5, p. 459.

Since the progress in research during the year in general is summed up in the conclusions of these papers, it seems worthwhile to restate these conclusions here in so far as they throw light on the nature and magnitude of lightning surges and the characteristics of the devices being used to investigate them.

Mr. McEachron's paper concludes as follows:

"As a result of this investigation, it can be definitely stated that the size and appearance of both positive and negative Lichtenberg figures are dependent on the wave front as well as on the crest voltage.

Throughout the range of wave fronts probably found in service, the size of the positive figure is not much changed by a change in wave front only, except at voltages close to the upper limit of potential where a decrease in the size of figure is indicated with very abrupt fronts.

The positive figures may be divided into three type forms which are partly determined by wave front and partly by the value of the crest voltage. It is possible

to gain some idea of the steepness of the front from the appearance of the positive figure.

The size and appearance of the negative figures are considerably affected by changes in wave front, the steepest waves always giving the largest figures. The percentage change with a constant crest voltage applied is greatest for the lower voltages. The change seems to be great enough so that it cannot be neglected. The negative figures change in appearance with increasing steepness of wave front, but the changes are so indefinite that it is only possible to state that a particular negative figure probably represents a fast wave or a slow wave."

The paper by Lee and Foust contains field klydonograph records showing surge voltages on a transmission line as high as 1500 to 2100 kv. In one case this was a highly damped oscillatory surge predominantly negative; in another case it was a unidirectional surge with positive polarity.

Practically all figures obtained on transmission lines were of the type II class (paper by McEachron) and may be placed, therefore, within the wide range of wave fronts which vary roughly from that of a slow 60-cycle wave to a surge which comes to its maximum value in a fraction of a microsecond.

The maximum surge voltages obtained compare favorably with the laboratory results of insulator flash-over tests; the value 1800 kv. for the lightning spark-over of a 14-unit insulator string seems to be close to the upper limit of voltages actually measured on the line by means of recorders. The authors summarize this paper as follows:

"It has been shown that surge voltage recorders using the positive photographic Lichtenberg figures have given essentially the same calibration data under a variety of conditions; also that the accuracy of such an instrument is in the order of 25 per cent, with a somewhat better value possible for those measurements wherein several similar observations may be obtained.

"An extension of instrument design has been described wherein two recorders are used together, which allows the use of the positive figure as a voltage measure of all surge voltages, thus insuring greater certainty of result. A more comprehensive analysis of the figure characteristics is also possible, since both positive and negative figures are available.

"A means of connecting the surge voltage recorder to a transmission line of higher than instrument voltage has been described which has been proved in service to be simple, reliable, and easy to calibrate. Calibration data are presented to show that with such connection, reasonable accuracy may be obtained in recording voltages up to values in the order of 2000 kv. A specimen record of such voltages obtained in the field is shown.

"The records which can be obtained from surge voltage recorder instruments connected as desired along a transmission line will allow the facts regarding surge voltages on transmission lines to be determined with reasonable exactness."



Mr. Cox's paper concludes as follows with respect to lightning:

"1. Positive lightning strokes are frequent but weak. They are slow, of the order of 0.01 sec., and hence do not induce surges on transmission lines.

"2. Positive strokes, even though slow, may produce surges of importance on isolated low-voltage lines, such as communication lines.

"3. Negative lightning strokes are less frequent but more violent. They discharge in about *three microseconds* and hence produce high-voltage surges on transmission lines.

"4. The field gradient is often as high as 60 kv. per ft. and may reach 100 kv. per ft. Thus a surge of over 2000 kv. might be induced upon a line of ordinary height with sufficiently high insulation. *Eighteen hundred kv. has been recorded by the klydonograph.*

"5. The time lag of an insulator flashover is less than the time of discharge of a negative stroke and thus the impulse flashover voltage of the insulators limits the possible potential.

"6. The stroke of lightning itself is unidirectional. If an oscillatory surge due to lightning is recorded, it is a line oscillation resulting from a flashover."

The paper by Cox, McAuley and Huggins contains the following conclusions with respect to lightning:

"1. Surge voltage due to lightning is unidirectional. The clouds which produce surges are of negative polarity, resulting in positive induced voltages and negative direct-stroke voltages.

"2. The maximum values, reached by lightning surges on transmission lines, are limited by the flashover of the insulators. It is believed that the flashover voltage of 220-kv. transmission line insulation, at the steepnesses of wave front of lightning surges, is comparable to the maximum potentials ordinarily induced by lightning.

"3. The flashover voltage of the average insulation of lines up to 140 kv. is about seven times normal for lightning impulses.

"4. Seldom more, and often less than two surges, comparable in magnitude to the insulator flashover voltage, appear at a given point of a line during a storm.

"5. The frequency of occurrence of the higher surges does not seem to be greater for low-voltage than for high-voltage lines.

"6. High-voltage surges are damped below the corona voltage in traversing a few miles of line. At low magnitudes they may travel long distances.

"7. The quantitative measurements with the klydonograph agree with the theories regarding induced voltages and the protection against these afforded by the ground wire.

\* \* \* \* \*

"13. Except for lightning surges and arcing grounds, no high-voltage disturbances of particular importance to the operating engineer appear on transmission lines.

\* \* \* \* \*

"18. In the investigations of the performance of lightning arresters in actual service, it was found that arresters in general give satisfactory operation, that is, they relieve all surge voltages above the standard test voltages for equipment insulation. Discharge currents up to 2500 amperes occur in practise. From these tests it is concluded that the field performances of arresters confirm predictions based on laboratory tests.

"19. Lightning arresters do not protect a line against flashovers at distant points."

It is desired to call particular attention to Fig. 12 of the paper by Lee and Foust which shows results of klydonograph calibrations reported by Messrs. Cox and Legg, Mr. McEachron, and Messrs. Lee and Foust. "These results show remarkable agreement for the work of the different observers in different laboratories, with different instruments and circuits, and give added weight and certainty to the calibrations of the Lichtenberg figures in regard to magnitude of voltage."

As for the determination of wave shape from Lichtenberg figures, the following excerpt from the paper by Messrs. Lee and Foust is significant:

"At the present time, the determination of wave shape from the Lichtenberg figure characteristics is not as definite or as certain as the determination of the magnitude from the figure size, and herein there is room for added study. Further study along these lines tending toward greater exactness in the interpretation of figure characteristics is desirable."

From the foregoing results of the researches of the several investigators, the following significant summary of present knowledge may be made:

1. Lightning strokes are unidirectional.
2. Positively charged clouds discharge in about one one-hundredth of a sec.; negatively charged, in about three microsec.
3. Surge voltages due to lightning are usually unidirectional. The clouds which produce surges are of negative polarity, resulting in positive induced voltages and negative direct-stroke voltages. Oscillatory surges are the result of flashovers and are highly damped.
4. The wave front steepness, or time required for a lightning surge to reach its crest, lies within the broad range between about one one-hundredth of a second and one microsec. The steepest waves probably reach their crest in a time of the same order as that required for the discharge of a negatively charged cloud, namely, about three microsec.
5. The maximum potential of lightning surges agrees with theory and laboratory tests and is limited by the flashover value of the line insulators.
6. Lightning arrester performance in service confirms laboratory tests.

With the foregoing facts reasonably well established, it would appear that the establishment of standards for lightning arresters and lightning arrester test apparatus and procedure may now be undertaken upon a rational scientific basis.

*Standards.* The progress which has been made during the past year is bringing nearer the time when rational standards for lightning arresters can be formulated. Since the lightning arrester is a device for dealing with transient voltages, the standardization of arrester characteristics and testing devices and procedure upon a rational basis demands the adoption of a *standard transient potential or lightning surge*. Such a standard transient or lightning surge should resemble as nearly as laboratory limitations will permit, the most destructive surges which natural lightning produces on transmission circuits. Sufficient evidence is now available to indicate that such natural surges reach their crest values in a time on the order of three to four microsec. It is believed that the demand of the art at the present time for the adoption of a standard transient for lightning arrester testing is sufficient to justify the adoption at this time of a tentative standard. Therefore, in the formulation of standards for lightning arresters, in which work the subcommittee is now actively engaged, it is proposed to establish a standard lightning surge for laboratory use which it is proposed to define as follows:

"The standard lightning surge shall be one which rises to its crest value in four microsec. and which does not decrease more than 2 per cent in the following 10 microsec."

For the purposes of lightning arrester standardization, it is proposed to fix the maximum value of the standard lightning surge at 100 kv. in order to limit the size of the necessary laboratory equipment.

It is felt that the accelerated progress which will result from the agreement upon a standard transient is sufficient justification for the adoption of such a standard at the present time, even though further experience may indicate that the exact form of the standard adopted may have to be changed. The Institute has a standard for cyclic voltages, namely, the sine wave. There would seem to be no reason why it should not likewise have a standard for transient voltages. Possibly more than one such standard may be required for different purposes.

Since the entire matter of standardization of test procedure for lightning arresters depends upon the adoption of a standard transient, the matter is mentioned here in order that the committee may have the benefit of open discussion of the matter in the work of formulating standards on this most difficult subject.

It is also desired to point out here that the cathode ray oscillograph is rapidly supplanting the use of sphere-gaps in determining the voltage and current characteristics of lightning arresters, and that consequently such terms as "equivalent sphere-gap," "discharge rate," and "dielectric spark lag" are rapidly being left behind, and are being replaced by actual voltage and current curves obtained with the cathode ray oscillograph. Such cathode ray oscillograms can be interpreted in terms of actual volts, amperes and times, even down to fractions of a microsecond, and conse-

quently give far more comprehensive information regarding the performance of lightning arresters than ever was or ever could be possible from the use of sphere-gaps.

It is hoped that the standards now under preparation, in connection with which a considerable amount of research is also under way, may be sufficiently advanced for presentation sometime within the next few months.

#### SUBCOMMITTEE ON OIL CIRCUIT BREAKERS

There was presented at the Winter Convention, a paper entitled *Tests on High- and Low-Voltage Oil Circuit Breakers Conducted by the American Gas & Electric Company*, prepared by Philip Sporn and Harry P. St. Clair. This paper may properly be classed as research work, since it gives valuable information on the subject of rupturing capacity of oil circuit breakers and methods which may be used in determining what these capacities are. This is the most important problem in the matter of oil circuit breaker design, and needs much additional research work of this class. Several other companies are arranging for similar oil circuit tests, and most of these tests are being conducted according to the recommendation of uniform test procedure, which will insure comparative results and much valuable data.

Arrangements have also been made for and work is now progressing on the preparation of a joint paper, *Rating and Selection of Oil Circuit Breakers*, which will bring up to date information presented some years ago in a paper of the same title by Messrs. Burnham, Hewlett and Mahoney.

In the matter of standards, certain changes have been recommended, and are now under consideration by the Standards Committee, in Standards No. 19 and No. 22. Further work on standardization is necessary, in the opinion of the subcommittee, in connection with the temperature rating on switch and circuit breaker contacts and other parts. This work is being carried on as rapidly as possible with other interests that are involved.

We believe that further work in standardization can be accomplished by the study of factors which determine the interrupting duty on oil circuit breakers. This is recommended for future study.

#### SUBCOMMITTEE ON PROTECTIVE RELAYS

During the past year there have been presented under the auspices of this subcommittee, five papers, including:

*Automatic Network Relays*, by W. K. Bullard,  
*A-C. Network Relay Characteristics*, by D. K. Blake,  
*Evolution of the Automatic Relay Unit*, by J. S. Parsons,  
*Design and Application of Automatic A-C. Network Units*, by G. G. Grissinger,

*Ground Relay Protection of Transmission Systems* by B. M. Jones and G. B. Dodds.

In studying the question of standardization, there has been prepared a report on current and potential transformer characteristics. The result of this study is presented herewith, and it is recommended that

further consideration be given the subject, with a view to standardizing the limitations of use of current transformers of various characteristics.

*Report of the Subcommittee on Current and Potential Transformer Characteristics*

BY H. M. RANKIN, CHAIRMAN

1. The purpose of this subcommittee investigation was to determine the effect of very high currents on the characteristics of current and potential transformers, and to specify the nature and extent of information which is necessary to their application to protective relaying. It was the opinion of the members of the subcommittee that the characteristics of potential transformers were not sufficiently affected by high current conditions to warrant investigation from a relaying standpoint. This report, therefore, deals exclusively with current transformers, including both the "instrument type" with multiple primary turns and the "bushing type" with single turn primary.

2. Characteristic ratio curves for current transformers should have a lower limit of one ampere secondary current and an upper limit determined by any one of the following three conditions:

- 10,000-amperes primary current,
- 20 times normal rated current,
- 2 times nominal ratio.

3. Characteristic ratio curves should be furnished for both "instrument" and "bushing" type current transformers for inductive burdens, power factor 0.5, as follows:

15	Volt-amperes
25	" "
50	" "
100	" "
200	" "

All values of volt-amperes given are based on five amperes, 60 cycles. The various loads are also to be specified in ohms resistance and henries inductance.

4. Until further experience may demonstrate that more narrow limits may be adhered to, the manufacturers should furnish, for each type and ratio of current transformer, a characteristic curve which shall be correct within the following limits:

- a.  $\pm 2\frac{1}{2}$  per cent deviation from standard curve up to 1.1 times nominal ratio.
- b.  $\pm 10$  per cent deviation from standard curve at 2 times nominal ratio.
- c. The deviations at points between 1.1 and 2 times nominal ratio shall be interpolated on a straight line basis.

The manufacturers will, in future, keep a close check on current transformer tests to determine whether the above limits are reasonable or can be decreased. If greater accuracy than the above is required, pending the result of further investigation on the part of the manufacturers, it should be the subject of special request.

5. Change in phase angle under high-current conditions. Some change in phase angle undoubtedly

does occur, especially with "bushing" type current transformers in connection with large non-inductive secondary burden. It is thought that under conditions normally met in operation with secondary burdens approximating 0.5 power factor, this change in phase angle will have no serious effect on relaying. Information is lacking, however, on this point and it is recommended that more complete tests be made.

6. Change in wave form under high-current conditions. The following oscillograms show plainly the wave distortion at high currents:

7. Comparison of relay test methods. The following illustrations H-3601624, shows a comparison of the primary-secondary method to the shunt method of testing relays with "bushing" type current transformers. The curve marked "1-Turn Primary" represents, of course, the actual operating condition of the "bushing" type current transformer. For the curve marked "Shunt Method," the primary ampere-turns

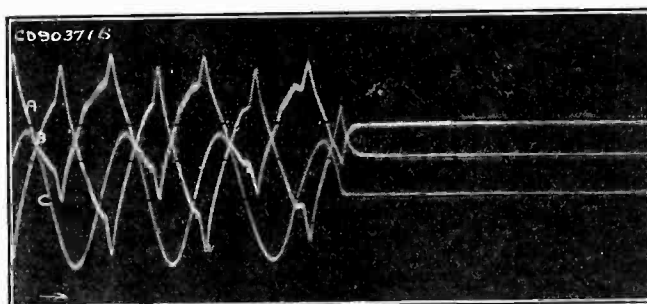

FIG. 1

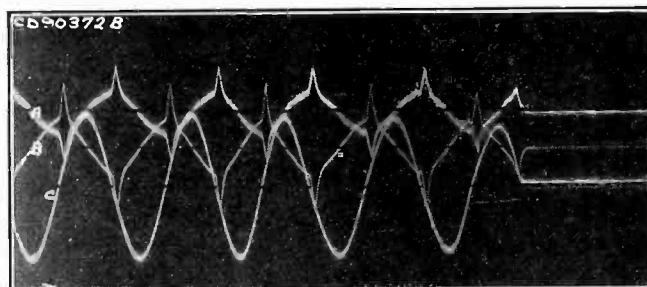

FIG. 2

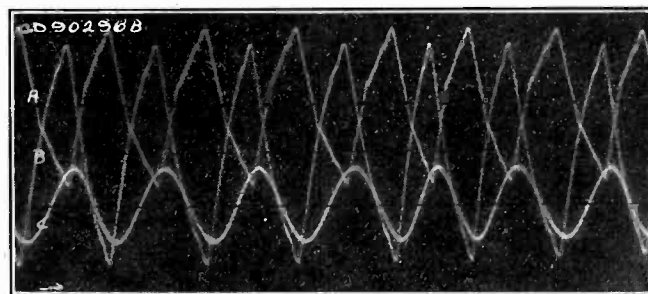

FIG. 3

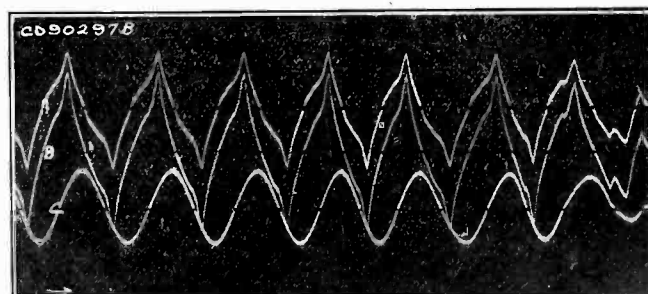

FIG. 4

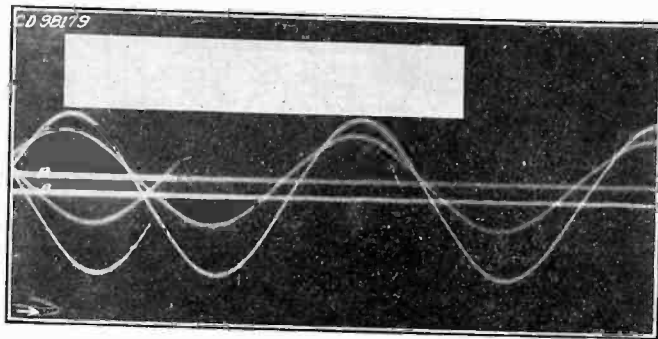

FIG. 5

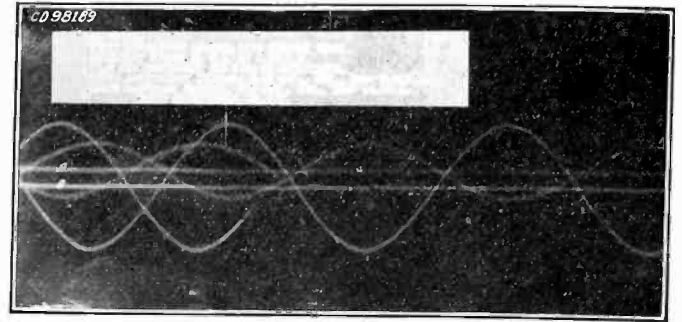

FIG. 9

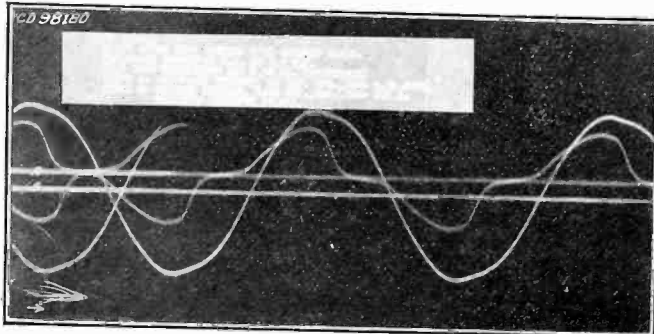

FIG. 6

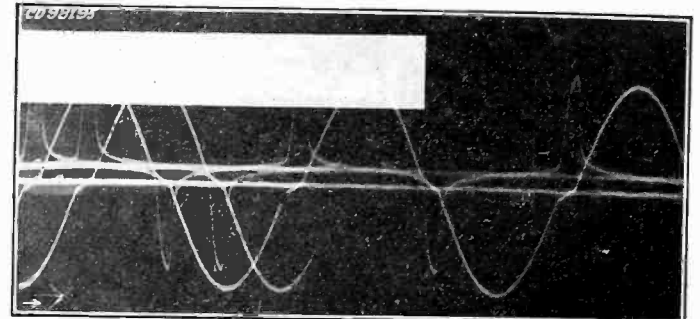

FIG. 10

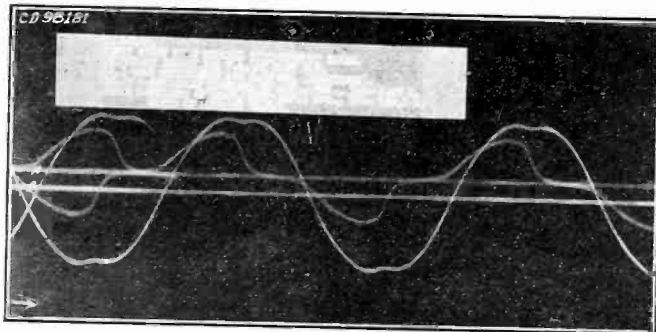

FIG. 7

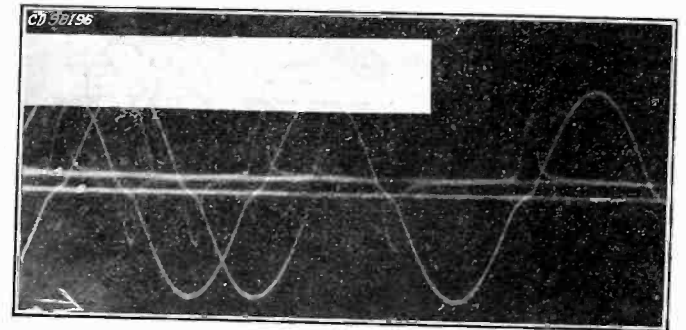

FIG. 11

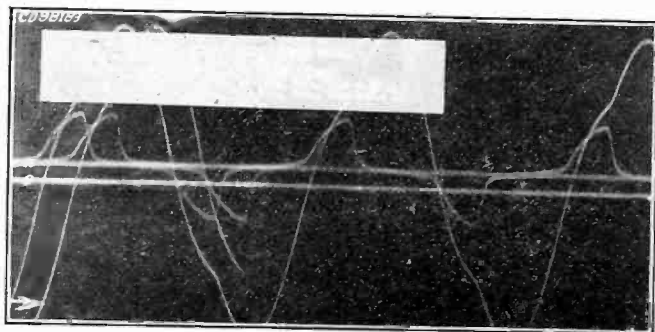

FIG. 8

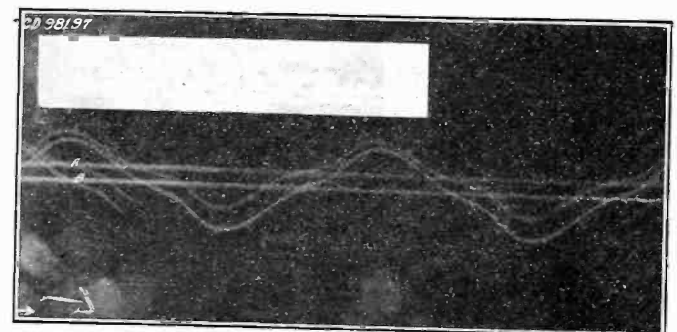

FIG. 12

Oscillogram number	Current transformer	Secondary burden		R. M. S. amperes final		Ratio
		Ohms resist.	M. H. induct.	Primary	Secondary	
CD-90371	A W-12 60/5 A	0.5		6.800	220	30.6:1
CD-90372	A W-12 60/5 A	1.4		6.800	145	49.0:1
CD-90296	B K-48 60/5 A	0.5		6.150	310	19.8:1
CD-90297	B K-48 60/5 A	1.4		6.150	175	35.1:1
CD-98179	57-turn bushing type	0.5	3.09	4.050	65	62.3:1
CD-98180	" " " "	2.5	3.09	4.442	66	67.3:1
CD-98181	" " " "	4.5	3.09	2.760	37	74.6:1
CD-98183	" " " "	6.5	3.09	4.260	34	125:1
CD-98189	" " " "	0.5	3.09	200	3.25	61.5:1
CD-98195	13-turn bushing type	4.5	3.09	11,000	16.7	660:1
CD-98196	" " " "	2.5	3.09	11,120	29.7	375:1
CD-98197	" " " "	0.5	3.09	556	40	13.9:1

The first four apply to "instrument" transformers and the remainder to "bushing" type transformers. It will be noted that though the distortion occurring under conditions of primary currents and secondary burdens within the range of ordinary operation may not be great enough to seriously affect relay performance, the imposition of excessive secondary burdens may have a decidedly bad effect.

are calculated by multiplying the input current by the number of secondary turns on the "bushing" transformer. The "4-Turn Primary" curve shows the discrepancy which may be involved when testing with one-fourth of the primary current through four turns wound on the core. The "bushing" type current transformer chosen in this test was one having a very low ratio and with the secondary turns bunched in a

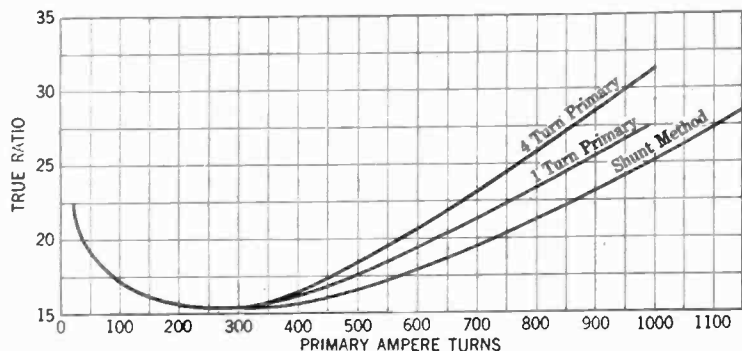

FIG. 13

small space on the core, in order to exaggerate the errors involved. With a higher ratio transformer in which the secondary turns would be more evenly distributed around the core, the discrepancies would probably be much reduced.

8. Error due to eccentric location of primary conductor. The following illustration H-3601623, which is self-explanatory, shows the effect of eccentric location of the primary lead of a "bushing" type current transformer, combined with the effect of a bunched secondary winding. From a relaying standpoint, the discrepancy is so small as to be negligible.

The attention of the subcommittee for the past year has also been given to the matter of relay test specifications and standards. It has been found difficult to unify the varying practises of the many operating companies, as well as the test methods of the various manufacturers. It is not considered advisable at this time to undertake to offer a final and complete form, but the following data are given as the basis of tentative recommendations by this subcommittee.

1. Nameplate Data.
  - a. Descriptive name of relay.
  - c. Nominal operating current or voltage, or both.
  - c. Frequency.
  - d. Calibration curve.
  - e. Time setting chart.
  - f. Volt-ampere consumption and power factor or resistance and reactance of various coils.
  - g. Manufacturer's type or model designation.
  - h. Manufacturer's name or mark.
  - i. Interrupting capacity of tripping contacts.
  - j. Polarity of directional relays.
2. Allowable Temperature Rise.
  - a. Coils.
  - b. Contacts.

3. Insulation Resistance or Dielectric Strength Test.
  - a. Insulation resistance test made with a megger of either 500- or 1000-volt rating.
  - b. Dielectric strength test voltage, frequency, and duration of test.
4. Permissible Minimum Contact Separation.
5. Allowable Discrepancy from Nominal Value Given on Taps. (Current or voltage or both).
6. Zero Torque Test on Zero Power Factor, Current Alone, Voltage Alone, Etc.
7. Chattering Test at High Current.
8. Vibration Tests.

It is hoped that the interested members will comment to the subcommittee, on the above suggestion and that by another year, the report may be in the form of a recommended standard. The work of this committee should continue, therefore, for another 12-month period.

It is further recommended that the attention of this subcommittee be directed toward the establishment of other relay standards. This is a subject which deserves considerable attention as there are few phases of the art in general which are really standardized, and the need is great. Other suggested subjects are: Standardization of characteristic curves, standardization of descriptive nomenclature, standardization of relay symbols for single-line diagrams, standardization of relay symbols for wiring diagrams, and standardization of relay operation nomenclature.

It is recommended that a subcommittee be appointed on "Relay Handbook Revisions and Amendments." The book has now been published about two years, and it is believed that sufficient advances and improvements

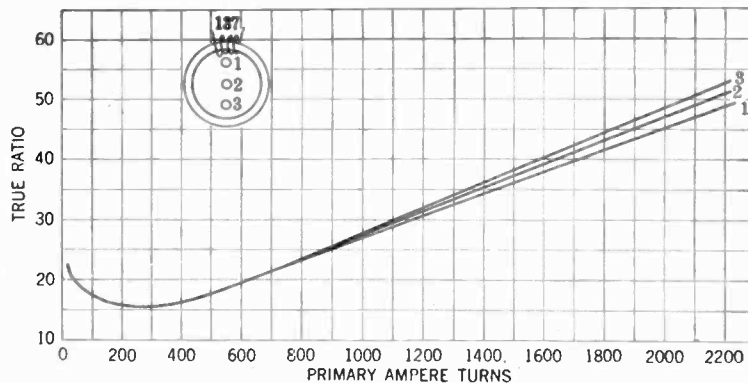

FIG. 14

in the art have occurred to warrant their inclusion in the "Relay Handbook." It is the belief of this subcommittee that such action will be justified every two or three years. Otherwise, the value of the book will disappear in a few years' time by reason of obsolescence.

In the matter of future papers, it is recommended that papers be prepared on the following subjects:

- Operating Experience with Impedance Relaying
- Operating Experience with Parallel Line Relay, Protection.

F. L. HUNT, *Chairman.*

# A. I. E. E. Outstanding Features of the Past Year

## President's Address

BY CUMMINGS C. CHESNEY

THE fact that the provision of the Constitution of the American Institute of Electrical Engineers which assigns the address of the President to the close rather than to the beginning of his term, seems to me to indicate a desire on the part of the Institute to have this address include in some measure, the ideas of the retiring President, acquired during his term on matters of general concern to the Institute, and to review those problems of procedure, organization and policy, which may assist the Institute to grow and develop in a way, which is healthy and for the best interests of its members, for the engineering profession as a whole, for the good of the electrical industry and the communities which we represent. It seems fitting therefore at this time to bring to your attention several outstanding features of the year just past.

It has been my privilege as your President to have visited many of the more remote Sections of the Institute, for instance Salt Lake City, Los Angeles, San Francisco, Portland, Seattle, Spokane, and all of the Sections in Canada, together with many of the Sections located in the eastern cities and in the central West. I had in mind visiting all of those Sections, which, on account of their geographical location, have either never been visited by a national officer, or have been visited very infrequently. I am sure that it will be gratifying to all to learn of the increasing interest and activity in Institute affairs all over the country which it was my pleasure to find; and also to learn of the greater appreciation of the value of the Institute professionally and practically; but I have also noted many times in meeting with the officers of these Sections and discussing their problems, what an important part of our Institute activities these Sections constitute and how much of the future growth and vitalizing power of the Institute is dependent upon their success.

The Institute and its Sections can well be likened to a hydroelectric power system, where the Sections may be represented as so many small rivers reaching out in all directions, bringing their supply of power through the main artery to the central power house which converts their combined energy into a total useful effort.

At the regional meetings held by the Institute in various Sections of the country, out of a total membership of 19,000, several hundred national members may attend. For instance, at the regional meeting held at Madison, Wis., 180 were registered; at Niagara Falls 580 were registered; at New York 700; at Kansas City 225; at Bethlehem, Pa., 400. On the other hand, at the Sections meetings held during the year thousands

of members get together and carry on in the many sections the real development work of the Institute. There are 95 Student Branches, which held 842 meetings last year, at which 42,650 members were registered. There are 52 of the regular Sections which held 432 meetings last year, at which 60,708 were registered; in other words there were over 100,000 members total of local Sections and Branches that attended meetings last year.

It is through the regular meetings of Sections that the young engineer makes his first contacts and receives, in many instances, the inspiration that influences the character of his life's work.

What the meetings of the Institute really mean to the members has been ably pointed out by President Scott in 1902, at the time of his presidency, when the Institute was developing at a rapid pace. A committee was formed on local Sections at this time with the authority to make arrangements for the holding of local meetings. There had been a few Sections operating at the time but active steps were then taken to develop broadly the Section idea. As Professor Scott so ably said, "In a profession, whose interests are so diversified and extended, workers should be brought together; they should have a common meeting place where discoveries may be announced, inventions discussed, engineering schemes criticized and new undertakings presented and discussed. Here the student and professor, the investigator, the manufacturer, the operator and consulting engineer may meet upon common ground. The professor who regards lightly the work of the designing or construction engineer may find that his own cherished formulas are derived from rules and contain the constants, which the practical man has determined for himself. Association leads to mutual understanding, it curbs eccentricity and one-sided development, promoting symmetrical advancement."

During the year, I have been especially interested in watching the growth and accomplishments of all Sections of the Institute, and as might be expected, have been particularly interested in the growth and development of the Pittsfield Section, my home Section. This Section, the largest in the Institute, has a combined national and local membership of 1000 members, and it is not uncommon to have at the meetings more than 800 in attendance. This Section is not only a common meeting ground for all ambitious young engineers in the community, but at the same time it represents a definite part of the city and community life. A large number of people interested in the general meetings purchase a membership ticket and attend the popular

*Presented at the Summer Convention of A. I. E. E., Detroit, Mich., June 20-24, 1927.*

meetings at which important investigators, scientists, and explorers give talks and demonstrations covering their experiences. The Institute Section is the leading dignified engineering group in the community and, being interested in the community's growth, all the leading citizens feel honor-bound to belong to it. The local papers report the meetings in an elaborate way, sometimes half a page being given to a single meeting. This publicity spreads the work of the Institute beyond the city limits so that the effectiveness of the Institute as an educational and social influence is far-reaching.

In addition to the large general meetings, discussion or round-table technical meetings are held, at which the more ambitious young engineer meets on a common ground, and can engage in oral discussion, with the senior engineers of the community upon subjects of vital interest to him. Such discussion develops self-confidence, attracts attention to the younger engineer, creates the desire on his part to present papers at regional meetings, and affords an outlet for his latent energy, his enthusiasm, and his creative ability.

As he gains in experience he is placed on committees and given an opportunity to do organization work. After he has served for several years in a minor capacity, further responsibilities are added and the extent to which he continues his efforts in the interest of his Section aids his progress in securing a higher office as a reward. Simultaneously with such progress he becomes identified with the national organization, taking an active part on the main committees.

This opportunity for self-expression and growth afforded the younger engineers through the local Section is vital, for here he learns one of the fundamentals of life—that progress comes only through constant effort. The methods, which have been followed by the Pittsfield Section, develop the activities of the Section and have resulted directly in the growth and development of the individual member; they have been followed to some extent by other Sections, and while the Pittsfield idea is worth copying there are other similar successful experiences in other Sections of the Institute that are equally entitled to thorough study and consideration by the national officers.

I believe there is need for outlining a more definite policy for Section activities based on the opportunities for training and growth afforded the younger members. Such a policy would include more specific plans for lectures and round-table discussions than have heretofore been the practise, and gives a chance for development of organizing and managerial ability. It should, of course, include the opportunity to prepare papers, to engage in oral discussions, and to take a more intimate part in community work.

An engineer, because of his education, is accustomed to analyze conditions and arrive at basic truths, and if his special abilities which invite confidence could be adapted to our community problems it would have

a very direct bearing on the future progress and efficiency of our industry and our country.

The Speaker Bureau idea came into effect this year, in a limited way. Through this bureau it is expected the Sections may more readily get talented speakers and lecturers. The idea is sound and should become more and more valuable each year and should be given special consideration in the future.

The Committee on Public Relations, by formulating a definite plan of procedure based, of course, on the experience of the older sections, can greatly aid in extending more rapidly the influence in their several communities of the younger or more newly organized sections.

For the purpose of the study of the section idea and the ready exchange of ideas between them, and for the purpose of extending the sections' local and national influence, our new Assistant Secretary, Mr. Henline, was added to the national executive staff last January, and while he has not authorized me to speak for him, coming from the Golden West, I know his progressive spirit makes him ever ready to render any assistance within his power to any section. May I also at this point commend the work of Prof. Harold Smith during the past several years as Chairman of the Sections Committee. The Institute is under a deep debt of gratitude to him. We cannot too much emphasize the fact that without the help of the Sections, through their vigorous and helpful growth the usefulness and future stability and the influence of the Institute will be seriously handicapped; whereas with the constructive and vitalizing work which the Sections are able to contribute to the Institute's affairs there will be every reason to expect that the past effectiveness of the Institute will continue indefinitely.

During the past year, your executive officers and your Board of Directors have given more than usual attention to the subject of Electrical Standardization. It is a subject that has had the particular attention of practically every Board of Directors since the appointment of the first Committee of Standardization by the Institute in 1898.

There has been intense interest in standardization through the older engineering organizations and also through the newer trade associations, both national and international, which has brought forth recent statements from prominent writers, such as, "Standardization is the outstanding note of this present century. It ramifies to the remotest details of our industrial regime. Its trends are highly significant. They tap all sources of scientific knowledge and affect every phase of design, production and utilization." From another author—"Standardization is a new and outstanding influence in modern industry. It is based on an economic conception of utility, and its trends and ramifications affect every aspect of design, production and utilization."

These are excellent and general statements of fact, but submit no reason for this recent great activity in this line, which is now so generally recognized. It is, in my opinion, largely the direct outcome of the scarcity of labor since the great war and the passage of our new immigration law, and the laudible desire to maintain and extend the high standard of living which, in this country, we have enjoyed for the past quarter of a century, and during which tens of millions of people have attained standards of comfort and of culture far higher than those of any other country in the world, and immensely in excess of anything hitherto known in the world's history.

All this argues for the maintenance and increase of the present earnings of the worker and at the same time requires the lowering of the cost of production. Standardization—which permits more readily repetitive methods of production—stimulates the invention of machines to do more rapid, more accurate and more skilled work. It stimulates the increased use of conveyors and other mechanical means for reducing the amount of labor required for handling and transportation, all of which makes for the increase of the productivity of the individual and thus directly for the increase of the national wealth.

Standardization and mass production contribute to decreased cost, not only through the economies effected in the manufacture of the product but also in the economies effected—

1. In calculations and designs.
2. In the preparation of drawings and specifications.
3. In making propositions in response to requests from customers.
4. In selling costs.

(1) Economies are effected in design largely through savings in time of engineers by the elimination of odd types and designs, thus freeing the engineers for other work. Standardization of circuit voltage and periodicity and of permissible limits of variation of these in service, permit the manufacturer to reduce the number of varieties of machines. Furthermore, by standardized working limits, such as dielectric strength and temperature rise and other characteristics such as regulations, stalling load, starting torque, etc., the engineer can more quickly complete the engineering work on a given design by reason of his knowledge of the results which are usually obtained by working to a single standard and by the familiarity and facility he has attained through the working out of many similar designs. If he has different limits to work to in different cases obviously he must employ more variables in his calculations.

As an example consider that an engineer has been accustomed to designing a given kind of electrical machine for a high potential insulation test of a given severity and that suddenly he must design a similar machine of the same rating but for a higher insulation test. He must employ more space for insulation

(granting that a better kind of insulation cannot be obtained) and this will leave him less space for iron and copper. Immediately his whole design must be changed.

(2) The standardization of material and parts and the reduction of number of varieties, leads to less and simpler drawings and specifications so that a given staff of engineers and draftsmen can deal with a much larger volume of business.

(3) By the standardization of certain requirements, the buyer and seller become accustomed to specifying machines on these bases; useless or relatively unimportant tests are less likely to be demanded by the buyer; printed specification forms may be provided which simplify the labor of making up a specification and knowledge and familiarity with similar cases (based on the same standards) enable an estimate of cost to be made more quickly and easily. These, and many other considerations which will suggest themselves to any one investigating the matter, serve to reduce the cost of the preparation of specifications and making of tenders.

(4) Standardization makes cataloging possible. The greater the degree of standardization, the greater is the simplicity and the usefulness of the catalogue. Information which can be brought to the customer through the medium of the catalogue and handbook requires less effort on the part of the sales force; or, conversely, a given sales force can deal with a larger volume of business. A salesman to be fully informed needs to carry less in his head, consequently he can handle more work in one special subject or a greater number of special subjects than would otherwise be the case.

With the less variety of sizes of a product, the less is the value of the stock which has to be carried by various distributors and products.

Thus, costs, associated with engineers, draftsmen, salesmen and some components of overhead, are, with modern mass production, materially decreased by standardization. This is in addition to the decrease in the strictly production costs. All together these combine to increase the growth and influence of the electrical industry which is primarily our concern.

The first standards for electrical machinery generally followed by the American electrical industry were those prepared by the original Institute committee, and adopted by the Institute in June 1899. A review of the proceedings of each successive Committee of Standardization since that date indicates that all of these committees were fully aware of the flux and changes that were taking place in industry, and while these committees consisted entirely of engineers—who, by nature and training, loved law and order and who might be supposed, on that account, to be ultra-conservative and possibly timid—they were, however, endowed with the spirit of progress which collectively turned their hopes and aspirations to the future; they saw the world of industry not as a still tableau but as a moving picture



and in consequence the accomplishments of each year were progressively better than the year before.

They recognized that no standard could be final—since science was continually advancing and more effective equipment was steadily being introduced into industry—but they also recognized that changes must not be made so frequently as to unduly disturb the industry and only when a serviceable gain justified the change.

These committees to date have taken the initiative in the formulation of all electrical standards of America, and their work has been recognized as being authoritative throughout the entire world. Their procedure and their resulting standards during this period of more than a quarter of a century have been acceptable to the manufacturing and consuming interests, as well as to the general public. The industry has learned to value and to depend upon the A. I. E. E. Standards in commercial transactions covering matters of interest to all sections of the electrical industry. There has been no attempt to dictate to the industry but standards on any particular line have been introduced only when it is clear that all interested agree that the step is wise and desirable.

In the Institute Standards Committee, or in its sub-committees, the manufacturer and purchaser and the general interests came together and developed the required standards in a way which has been generally satisfactory in the past to all the interested sections of the industry. The electrical standards so issued always have been identified with the name of the Institute. It is well known that the Institute as an organization has no interest other than one of public service, which duty the Institute has always performed at its own expense. The Institute in performing this service, although voluntary, has assumed obligations during the past 28 years to the electrical industry and the public which would make it now embarrassing, if not impossible, to discontinue the present practise or lessen its responsibilities until a more simple and direct method has been devised and demonstrated.

For fear that some who have not had the opportunity to study in an intimate way the subject of Standards and Standardization, may not understand what the terms mean—I quote from my February 7th address:

“In this country and in Great Britain the term ‘standardization’ has grown to mean, in the minds of engineers, not only a simplification in the number of types and sizes and the securing of interchangeability, but also the laying down of performance rules or codes for all types of apparatus, including measuring instruments, prime movers, generators, transformers and motors. Thus broadly the term ‘Standard’ in addition to being a measure of quality of standards of comparison, means a common unified practise, method or dimension, which it is to the interest of industry and the community to adopt. Back of any policy of standardization is primarily the purpose to furnish the public a

better article or to render it a better service at a lower cost.”

“In 1916 the need for a National Clearing House for engineering standards became apparent, in order to prevent duplication in standardization work and in promulgation of conflicting standards. To formulate a method of cooperation, a special joint committee—made up of representatives from the American Institute of Electrical Engineers, American Institute of Mining Engineers, American Society of Civil Engineers, American Society of Mechanical Engineers, and American Society for Testing of Materials—held its first meeting January 17, 1917. The result of this meeting and subsequent meetings was the organization of the American Engineering Standards Committee. This Committee initially consisted of representatives of these five institutions. Shortly after its organization, government representatives were admitted; and in 1919 the Constitution was broadened to permit the representation from other national bodies. The Committee now includes representatives from seven departments of the Federal Government, nine national engineering societies and nineteen national industrial associations.

“The American Engineering Standards Committee, as at present organized, is a coordinating committee, and not a standards-making body. All standards are to be formulated and published by the respective societies, making the standard a function of great value and scope to industry. This intention is clearly expressed in the Constitution, and the American Engineering Standards Committee is primarily an administrative and policy-forming committee.

“As stated by its Secretary, perhaps the most important accomplishment of the American Engineering Standards Committee has been the actual launching of the work, setting up machinery and securing the official cooperation of some three hundred national organizations, that is the fundamental job of breaking ground. Ninety-seven standards have been approved for the engineering and building trade—ten have to do with the electrical industry. In my opinion this is a very excellent record of accomplishments to date. The Secretary also states that everyone who has examined the work before the American Engineering Standards Committee, agrees that the whole movement of making American standards is being seriously crippled by the lack of adequate financial support. The total annual budget is \$58,000. The American Institute of Electrical Engineers as such contributes to the American Engineering Standards Committee \$1500 annually. Due to legal restrictions the government departments are unable to pay dues, and a special provision is made exempting them from such payments.

“The Secretary also expresses the opinion that inertia, lack of interest and understanding of the standardization method as a whole, and of its economic relations to their business on the part of executives and industrial groups, has been one of the greatest difficulties

encountered in the successful accomplishment of the committee's work. It is now proposed, by the process of amendment, to make a material and fundamental change in the Constitution of the American Engineering Standards Committee. This can only be done by the unanimous consent, notwithstanding the general provision in the Constitution, providing for its amendment by a lesser vote. Such provisions only apply to incidental amendments made to carry out the purpose of the organization, and not to fundamental changes—any amendment that aims to convert the American Engineering Standards Committee into a standards-making body, or into a body that would interfere in the autonomy, in standardization work, of the representative societies would be unconstitutional.

"On February 9, 1926 during Dr. Pupin's administration, the Board of Directors authorized a brief statement of its policy to its representatives on committees, or on joint bodies, dealing with the formulation of standards;

1. To continue to develop, publish and maintain in the name of the Institute electrical standards as it has done for the past 25 years.

2. That in doing this work the Institute will continue as it has in the past to avail itself to the fullest degree of the assistance of others—both individuals and organizations—with a view to serving the interests of all who may be properly concerned in the work.

3. That Standards, after having been developed by the Institute in accordance with 1 and 2, and adopted by the Board of Directors as Institute Standards, will be presented to the American Engineering Standards Committee for approval by it as American Standards when, in the opinion of the Institute, such a step is proper.

4. That such presentation to the American Engineering Standards Committee for their consideration for approval as American Standard will be done in full conformity with the Constitution, By-laws and Rules of Procedure of the American Engineering Standards Committee, which Committee the Institute was instrumental in initiating and has continued to and does now endorse and support.

5. That when and if Standards of the A. I. E. E. have been further advanced to the stage of being designated as 'Approved as American Standard by the American Engineering Standards Committee,' they shall continue to be printed as standards of the A. I. E. E. with a statement of approval by the American Engineering Standards Committee added to the title page of each particular standard."

This statement I understand to mean that the American Institute of Electrical Engineers is in sympathy with the American Engineering Standards Committee as it is now organized, but that any changes affecting the fundamental character of the committee may not be acceptable to it.

Something over a year ago, a movement was under-

taken to form an International Standards Association. The proposed organization to have a national committee in each country. In America, the national committee was to be the American Engineering Standards Committee. As it has been stated heretofore, its (A. E. S. C.) principal constitutional object is to supervise standardization work, but it is expressly stated in its constitution that it shall not formulate standards. There is, however, a clause in its constitution which states that one of the objects of the American Engineering Standards Committee shall be "to act as the authoritative channel of cooperation in international engineering standardization."

The Institute has subscribed to the American Engineering Standards Committee constitution. It is also a member of the United States National Committee of the International Electrotechnical Commission, which has been and is at present the body through which the electrical industry of America is conducting its international standardization work. The Institute is thus faced with a conflict of obligations. The most reasonable course is for it to go before the American Engineering Standards Committee with a frank statement of the case, and ask the American Engineering Standards Committee for its support for the course which the Institute considers, to be in the best interest of the electrical industry of this country, at the present time. Under the procedure of the International Electrotechnical Commission much of value has been accomplished in establishing international electrical engineering standards. This field alone is a very large one, and it would appear unwise to abandon the present successful plan for the untried plan of an International Standards Association which does not appear to be based on such sound fundamental principles. The success of the International Electrotechnical Commission has been so considerable that it could well be duplicated in other engineering fields such as mechanical, civil and mining fields, etc. If this were done, then we should, in addition to the International Electrotechnical Commission have an International Mechanical Commission, and International Civil Commission, etc. At some future time it might become desirable to tie these international organizations into an international technical commission, but it would at this time be premature to try to decide whether this last step would be desirable and when it should be undertaken.

It would appear that if the electrical industry is a unit in desiring to continue the International Electrotechnical Commission, and in believing that its interests would be seriously endangered by going over to a new plan, representations to this effect should be made in proper form and on the proper occasion to the American Engineering Standards Committee. While the International Electrotechnical Commission recognizes that its field is electrical, and that the desired international accomplishments in that field alone constitute an

enormous task, it is also recognized that its 20 years of experience constitutes a considerable asset. The International Electrotechnical Commission has never taken advantage of this asset in a selfish way. In cases where in other fields of engineering, it should be desired to make use of the International Electrotechnical Commission's organization and experience, either temporarily or permanently, for work in other lines, the International Electrotechnical Commission is prepared, as in certain cases in the past, to offer its facilities and to adapt them to include the added work. In such cases the International Electrotechnical Commission could arrange with the organization in whose field the work belongs for additional representatives from that organization's membership. If at a later time the co-operating organization, through the establishment of its own international organization, or from any other reason for change of policy, should decide to discontinue the arrangement, this without doubt should and would

meet with the hearty agreement of the International Electrotechnical Commission.

Three open problems on standardization thus confront the Institute and their importance justifies a prompt solution; but not a hasty one.

First: The internal routine to be followed through its Committee on Standards for the handling of standards and standardization should be revised. This has to do primarily with the A. I. E. E. Standards.

Second: The present and future status of the American Engineering Standards Committee should be determined.

Third: The relation of the American Institute of Electrical Engineers to the United States National Committee of the International Electrotechnical Commission.

These I repeat are important and vital problems and need, for the best interest of the Institute and the industry, a prompt solution.

## Electrochemistry and Electrometallurgy

### Annual Report of the Committee on Electrochemistry and Electrometallurgy\*

*To the Board of Directors:*

The Committee on Electrochemistry and Electrometallurgy makes its annual report as follows:

About two years ago, this committee brought to the attention of the Standards Committee the desirability of revising the Institute Standards for storage batteries. A special working committee was then appointed to undertake this task and a tentative standard has been formulated defining the terms and conditions which characterize the rating and behavior of storage batteries. This report is now in the hands of the Standards Committee. It is believed that the work accomplished at the suggestion of this committee will be of value to the storage battery industry, which is an important unit in the electrochemical field.

Standards for the international electrical units are again receiving much attention at the various national standardizing laboratories. These fundamental standards which furnish a basis of measurement for both the physicist and the electrical engineer fall within the field of electrochemistry. Seventeen years have elapsed since the International Technical Committee met in Washington to carry out a joint investigation on the silver voltammeter and the standard cell. At the conclusion of its work the value 1.0183 international

volts at 20 deg. cent. was adopted for the Weston Normal cell, and by international agreement, this value became effective on January 1, 1911. The various countries, therefore, started out on this date with identical values for the international volt, which, together with standards of resistance, served to fix the measurement of current, also. Since that time, the basis of reference has been carried forward by means of groups of standard cells and resistances. It is a matter of importance, therefore, that we should determine how accurately these standards have been maintained. Several new groups of standard cells have recently been prepared at the Bureau of Standards, which indicate a very close agreement with the Bureau's existing basis of reference. The results obtained, so far, cannot be considered as conclusive but indicate that our standard for voltage has been maintained over a long period within a few millionths of a volt. Comparisons have also been made with the standards of several other countries and reasonably close agreement has been found in most cases. The necessity still remains, however, for checking the standard for the international volt by means of the silver voltammeter and by the absolute current balance for the measurement of current. Progress is being made in absolute measurement of resistance. As pointed out in last year's report, it is apparent that a considerable difference exists between the international ohm and the absolute ohm.

In reviewing the progress during any particular year, it is always difficult to evaluate the definite advances within so limited a period. New methods, when first tried, are experimental and it is impossible to say

\*Committee on Electrochemistry and Electrometallurgy:

G. W. Vinal, Chairman,	Salford K. Colby,	Magnus Unger,
Lawrence Addicks,	F. A. J. Fitzgerald,	J. B. Whitehead,
A. N. Anderson,	Walter E. Holland,	J. L. Woodbridge,
T. C. Atchison,	F. A. Lidbury,	J. L. McK. Yardley,
Farley G. Clark,	C. G. Schluederberg,	

*Presented at the Summer Convention of the A. I. E. E., Detroit, Mich., June 20-24, 1927.*

whether or not they constitute an advance. Development in electrochemistry and electrometallurgy as well as in other lines is necessarily gradual. It is possible, however, to mention certain developments which appear to distinguish the past year as one of considerable progress in this field.

The introduction of the high-frequency furnace into electric steel foundries is a notable step. The high-frequency furnace has been regarded in the past as a laboratory instrument but now it is rapidly finding favor in the industry as a whole.

Arc furnaces have increased in size and power input largely as a result of the development of three-voltage switching. The principle of this development is based upon the fact that the cold charge within the furnace is capable of absorbing heat at a higher rate than after the charge has become molten. It is possible, therefore, to supply energy very rapidly at the beginning and decrease this as the charge is melted. In the final step, only enough energy is supplied to meet the furnace losses and whatever may be required for chemical reactions during the slagging period. It has been stated that nearly all of the large electric steel-melting installations made during the past year have utilized this principle.

The trend of electric furnace development, however, differs somewhat from that during the period of the World War. The economic limitations to its application are recognized, and the electric furnace is being used now in processes where quality of product is of importance. In this respect, it has been largely responsible for the rapid development in high grade alloys and tool steels. American manufacturers are still importing special steels and pure iron that should be produced here. According to recent reports, a great research campaign on steel is being instituted by one of the large manufacturers,

The advance in the application of electric furnaces in the steel and brass industries has been pointed out in papers presented at the 25th Anniversary Meeting of the Electrochemical Society. The electric steel industry began in this country about 1909, with a half-dozen furnaces producing 13,000 tons. Since then the number of furnaces has increased to over 500 and the product for 1925 was in excess of 600,000 tons. The proportion of electrically melted metal is much greater in the brass industry than in the steel industry. About 625 electric furnaces for brass melting are in use in the United States and Canada. It has been estimated that they used \$3,000,000 worth of electrical energy in 1926. A notable saving of fuel compared with that which would have been used in fuel-fired furnaces was accomplished. A still greater economy was achieved by saving over 13,000 tons of metal valued at \$2,500,000, which would have been lost in the fuel-fired furnaces.

Comprehensive studies of electric heating are being made by some power companies with a view to analyzing the load possibilities within surrounding territory. In connection with one of these surveys it is interesting

to note that a rather definite line of demarcation between ovens and furnaces is made at the temperature of 1000 deg. Fahr. Immersion types of electrical heating units are being utilized in existing fuel-fired, stereotype pots having capacities up to six tons.

The use of chromium, both as an electrodeposit and in certain alloys, again occupies a prominent part in the development of electrochemical industry. The previous predictions regarding the usefulness of chromium plating have been largely verified. At present, chromium plating is being applied successfully in the automobile industry, especially on such parts as radiator shells, where its hardness, high luster, and freedom from tarnish are advantageous. It is being used on gages because of its extreme hardness and resistance to abrasion. It is also being applied to plumbing supplies and to a great variety of metal products where good appearance and durability are desirable. The chief obstacle to the more general adoption of chromium plating is the poor "throwing power" that renders difficult the plating of recessed articles. Experience and mechanical ingenuity have frequently led, however, to the successful plating of rather irregular shapes.

A chromium surface affords a valuable protection to steel against corrosion as well as furnishing a high lustrous finish. It is unique in being particularly resistant to the action of sulphur compounds such as seriously impair silvered and other polished metal articles. Large molds for automobile tires, stills used in oil refining, and plates for engraving bank notes are all examples of articles whose life has been greatly extended by the use of chromium plating.

A method has been worked out for producing an exceedingly smooth chromium plating on mirror surfaces. The reflecting power of chromium is not as high as that of silver, but may perhaps be improved by plating with other metals. It is probable that a high average reflecting power of a chromium surface can be maintained over a long period of time, since the chromium surface is not subject to tarnish, discoloration or scratching from cleaning operations. From the military standpoint, there is considerable advantage in a chromium plated mirror for search lights since such a mirror is free from shattering, if struck by a bullet, and it is better adapted to withstand the high temperature of the arc.

The use of chromium in iron and steel alloys has created widespread interest. There is a variety of these alloys and the properties depend upon the composition, as might readily be supposed. Up to 5 per cent of chromium, high strength, ductility, and hardness are obtained in the presence of at least one other element as, for example, nickel. Higher percentages of chromium impart notable resistance to oxidation, even at high temperatures. Above 20 per cent of chromium, the steels have in addition to oxidation resistance a marked resistance to the action of nitric acid and nitrates.

There have been few marked developments in the

process of electrodepositing other metals than chromium, but there has been an increased interest in the theory and mechanism of making such deposits. Commercial processes are being conducted more and more on a scientific basis and it is interesting to find that the application of the hydrogen electrode to the control of refining and plating solutions is teaching the workers to understand the significance of the  $pH$  values of their solutions and how these may be used as a guide in the control of their product.

An industrial achievement during the past year has been the commercial development of the electrodeposition of rubber. Rubber is deposited anodically. Rubber deposits can be made quickly in forms corresponding to the shape of the anode. It is reported that wire can be insulated by passing it through the latex solution, the wire serving as the anode and the rubber being deposited on the wire as it passes through. The rubber on the wire then passes through a vulcanizer for the completion of the process.

The development of power devices for use with radio sets has been a matter of interest and concern to battery manufacturers. It seems probable that the inroads of such devices have been more in the field of storage batteries than in the field of dry cells. From the standpoint of the power company, it is interesting to estimate the electrical energy consumed by the use of some of these devices. Recent calculations have shown that a device operating a radio set of five tubes and charging a small storage battery when the set was not in use for a period of approximately 18 hr. per day, required one kilowatt-hour in each 24 hr. Charges for power in this particular case were estimated at \$1.80 per month which, in view of the possible use of a large number of such devices, indicate a considerable revenue to be derived from them.

The development of small rectifiers has been stimulated by the growth of the radio industry. The life and efficiency of the aluminum rectifier has been materially increased. The use of tantalum has been extended not only to the radio field but to other important uses, as in railway signalling. So-called electronic rectifiers, including those having elements of copper oxide and copper sulphide, have become available commercially during the past few months. Such rectifiers are, however, subject to the limitation of a relatively low voltage across each element. They have not been in use for a sufficiently long time to obtain definite data as to their life but it seems likely that they will become of increasing importance. Alloys high in silicon are also being used as valve metals in electrolytic rectifiers.

The development of the Hoopes process for the preparation of a very pure aluminum, was described two years ago. This aluminum, which possesses somewhat different physical and chemical properties from those associated with the ordinary aluminum, is finding commercial use in collapsible tubes and also in metallurgical work where the aluminum may be studied unhampered

by the presence of detrimental impurities. Remarkable results in heat-treated castings of the pure metal have been reported. New uses for this material are still being sought. There has been a large increase in the consumption of aluminum alloys, particularly that known as duralumin. Among the novel uses for these alloys may be mentioned the manufacture of aluminum furniture. The attractive finishes in browns, reds, and greens, together with the light weight, have been important factors in promoting the sale of this material.

In the field of rare metals the electrolytic production of pure beryllium may be noted. Some investigation has been made of alloys of aluminum and beryllium but as yet there is no definite information to show whether these will be commercially valuable. Pure thorium is also being made by electrolytic methods. The use of thorium has arisen from its exceptional thermionic properties. Amounts of vanadium sufficiently large for careful experimental investigation have also been produced.

The highly sensitive potassium photoelectric cell has largely displaced the selenium cell. The potassium cell possesses extreme sensitivity and responds instantly to a beam of light. Among the many possible applications for such a cell may be mentioned a recently developed method for television.

At the Anniversary Meeting of the American Electrochemical Society, held in Philadelphia at the close of the month of April, a number of interesting papers were presented reviewing the progress of electrochemistry during the 25 years since the society was founded. One session at this meeting was devoted to the electrochemistry of concentrated solutions. A new theory is rapidly setting aside the old theory of Arrhenius, and Professor Peter Debye, of the University of Zurich, one of the chief exponents of this new theory, was present to present his views. The interest in this matter is shown by the fact that a similar symposium was held at almost the same time by the Faraday Society in England. Industrial engineers found papers of interest in the session devoted to gaseous reduction of ores. Gaseous reduction of iron ores, followed by electric melting of sponge iron, may open up a further field for electrothermics.

The fall meeting of the Electrochemical Society is expected to take the form of a trip through the north-western part of the United States with stops at numerous points of electrochemical and electrometallurgical interest. Such a trip should result in a better understanding of the work that is being done in this important region and at the same time focus the attention of electrochemists and electrical engineers on the power requirements and possibilities of this region.

The committee wishes to acknowledge with thanks the cooperation of Dr. William Blum, Dr. Colin G. Fink, and Dr. H. W. Gillett, members of the Electrochemical Society, who have furnished valuable information used in preparing this report.

GEORGE W. VINAL, *Chairman*

# Abridgment of Starting Performance of Synchronous Motors

BY H. V. PUTMAN<sup>1</sup>

Associate, A. I. E. E.

*Synopsis.*—This paper deals with the theory underlying the starting performance of the salient pole synchronous motor equipped with damper windings. The theory, while involving some approximations, is accurate enough for practical engineering calculations. Formulas are developed for the starting torque, pull-in torque and inrush. A method is also given for calculating the speed torque curve from standstill to synchronous speed.

Due to the fact that the damper winding is not continuous around the periphery and due to the presence of the single-phase field winding, the rotor circuit is not a perfect polyphase secondary but is unbalanced to some extent. In order to take care of this unbalance, it is necessary, in addition to the usual system of positively rotating vectors, to employ a second system of negatively

rotating vectors as is done in unbalanced three-phase problems.

The stator resistance has been disregarded in working out the general case of the unbalanced or partial polyphase secondary in order to obtain a torque formula which will be simple and at the same time accurate enough for practical calculations. Mr. Q. Graham is working on this problem and expects to present in an Institute paper, in the near future, the general solution including the stator resistance.

The use of the double squirrel-cage type of damper winding in salient pole machines has been examined both theoretically and experimentally. Other methods of obtaining unusual starting performance are suggested and the results of some actual calculations presented.

## INTRODUCTION

PROBABLY the earliest published work on the starting performance of synchronous motors was done by Carl J. Fechheimer in 1912<sup>2</sup>. This was a paper of great merit and a valuable contribution to the art. Not only did it give much valuable experimental data concerning the synchronous motor but it added much to our knowledge of the calculation of reactance. The discussion which followed the presentation of this paper showed clearly that the synchronous motor was well understood experimentally in 1912. Engineers knew *what* the motor would do under various conditions but the "why" was often in doubt. The theory developed in the present paper explains some of the "whys." Mr. Fechheimer limited his theoretical work to the conditions at standstill. In this paper the starting conditions are examined not only at standstill but through the whole starting period up to the pull-in point.

## NOTATION

The following notation will be used throughout the paper. The subscript  $p$  used with a vector quantity denotes that the vector belongs to the positive system of vectors, while the subscript  $n$  denotes that the vector belongs to the negative system. For instance:

$E_{ip}$  = Induced voltage, positively rotating.

$E_{in}$  = Induced voltage, negatively rotating.

In a similar manner the subscripts  $p$  and  $n$  may appear with any of the vectors.

$E_0$  = Impressed voltage,

$I_1$  = Stator current,

$I_{00}$  = Magnetizing current,

$I_2$  = Rotor current,

$I_b$  = Rotor bar current,

$I_f$  = Rotor current in the field winding,

$I_{2np}$  = Negatively rotating rotor current due to  $E_{ip}$ .

1. Westinghouse Electric & Mfg. Co., East Pittsburgh, Pa.

2. TRANS. A. I. E. E., 1912, Vol. 31, Part I, p. 529.

Presented at the Winter Convention of the A. I. E. E., New York, N. Y., February 7-11, 1927. Complete copies are available upon request.

(The subscript 2 indicates rotor current. The first subscript  $n$  indicates that the vector is a negatively rotating vector. The last subscript  $n$  indicates that the current is produced by the negatively rotating induced voltage  $E_{in}$ .)

Similarly

$I_{2np}$  = Negatively rotating rotor current due to  $E_{ip}$ ,

$I_{2pp}$  = Positively rotating rotor current due to  $E_{ip}$ ,

$I_{2pn}$  = Positively rotating rotor current due to  $E_{in}$ ,

$V = x_2 + j r_{2s}$ ,

$V = Z_{bs} Z_f$ ,

$a$  = Half the depth of double squirrel-cage damper bar (App. II),

$b$  = Width of double squirrel-cage damper bar (App. II),

$B = 1/x_1 + b_{00}$ ,

$b_{00}$  = Magnetizing admittance,

$f$  = Frequency in cycles per second,

$j = \sqrt{-1}$ , indicates the imaginary term in vector expressions,

$K = \text{Ratio } \frac{\text{N. R. V.}}{\text{P. R. V.}} = \frac{\sin \theta}{\theta}$  (see equation (14)),

$K_c$  = Value of  $K$  corrected for effect of closed field circuit,

$$K^2 = \frac{4 \pi p}{\sigma} \text{ (App. II)}$$

$p$  = Operator  $\frac{d}{dt}$  and denotes differentiation with

respect to time (App. II),

$r_1$  = Stator resistance,

$r_2$  = Rotor resistance,

$r_b$  = Rotor bar resistance,

$r_{2s} = r_2 S$ ,

$r_f$  = Field circuit resistance,

$r_{fs} = r_f S$ ,

$r_0 = r_1 + r_2$ ,

$S$  = Slip,

Apr. 1927

- $t$  = Time in seconds,
- $T$  = Motor torque due to positively rotating flux and positively rotating rotor current,
- $v$  = Ratio  $Z_{bs}/Z_{fs}$ ,
- $x_s$  = Stator reactance,
- $x_r$  = Rotor reactance,
- $x_1$  = Rotor bar reactance,
- $x_f$  = Field winding reactance,
- $x_2$  =  $x_1 + x_2$ ,
- $z$  =  $\sqrt{1 + 2Bx_2 + B^2Z_{2s}^2}$
- $Z$  = Rotor impedance =  $\sqrt{r_2^2 + S^2x_2^2}$
- $Z_s$  =  $\sqrt{r_{2s}^2 + x_2^2}$
- $Z_b$  =  $\sqrt{r_{bs}^2 + x_b^2}$
- $Z_f$  =  $\sqrt{r_{fs}^2 + x_f^2}$
- $Z_0$  =  $\sqrt{r_0^2 + x_0^2}$ ,
- $Z$  = Stator impedance =  $\sqrt{r_1^2 + x_1^2}$ ,
- $\theta$  = Bar span in electrical radians (Part I),
- $\theta = \tan^{-1} \frac{x_b}{r_{bs}} + \alpha = \text{phase angle of rotor circuit}$

with field closed (Part IV),

$$\alpha = \tan^{-1} \frac{v \cos \varphi}{1 + v \sin \varphi}$$

$$\varphi = \tan^{-1} \frac{x_b}{r_{bs}} + \tan^{-1} \frac{r_{fs}}{x_f}$$

- $\Phi$  = M. m. f. (Part I),
- $\Phi$  = Self-inductive flux (App. II),
- $\omega$  = Angular velocity in radians per sec.,
- $\rho$  = Specific resistance of material used in double squirrel-cage damper bar (Abohms per cu. cm.).

### Part I. Theory of the Partial Polyphase Rotor Circuit

The expression,

$$\cos \omega t + j \sin \omega t \tag{1}$$

represents a vector of unit length rotating forward in the positive direction with angular velocity  $\omega$  and start-

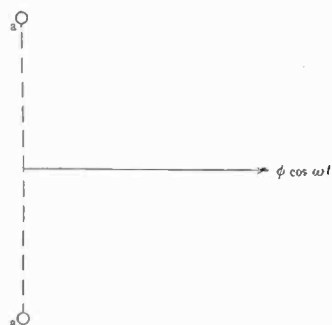

FIG. 1—M. M. F. PRODUCED BY A SINGLE COIL, PULSATING IN TIME, UNIDIRECTIONAL IN SPACE

ing at the zero position at the instant of counting time. Similarly,

$$\cos \omega t - j \sin \omega t \tag{2}$$

represents a vector rotating backwards or in the negative direction with angular velocity  $\omega$ .

The sum of these two rotating vectors is

$$2 \cos \omega t \tag{3}$$

which is simply a pulsating quantity in one direction in space.

If, now, equation (3) represents the m. m. f. due to a single-phase winding, it follows from the above that this m. m. f., which is unidirectional in space and pulsating in time, can be represented by, or split up into, two vectors constant in time but rotating in space, one

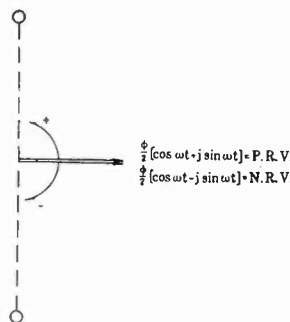

FIG. 2—M. M. F. PRODUCED BY A SINGLE COIL, RESOLVED INTO TWO ROTATING VECTORS

rotating in the positive direction and the other in the negative direction.

As an example of the above, let the field produced by a coil  $a - a$ , Fig. 1, be  $\Phi \cos \omega t$ .

In Fig. 2 the equivalent rotating vectors are shown.

$$\frac{\Phi}{2} [\cos \omega t + j \sin \omega t] = \text{positively rotating vector.}$$

$$\frac{\Phi}{2} [\cos \omega t - j \sin \omega t] = \text{negatively rotating vector.}$$

It should be noted that the length of each rotating

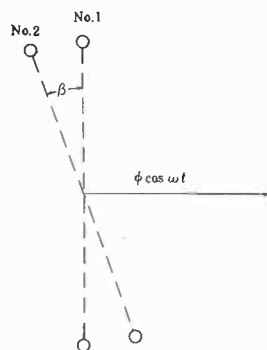

FIG. 3—M. M. F. PRODUCED BY TWO COILS SEPARATED BY ANGLE  $\beta$ , RESOLVED INTO TWO ROTATING VECTORS

vector is only half the maximum value of the stationary vector. In Fig. 1, when  $t = 0$ ,  $\Phi \cos \omega t$  is maximum and the current in the coil is, therefore, a maximum. In Fig. 2, then, time is counted from the instant the current in the coil is maximum, and at this instant it should be particularly noted that the positively rotating vector and negatively rotating vector are together in space.

### THE PARTIAL POLYPHASE SECONDARY PRODUCED BY DAMPER BARS IN THE POLE FACE

Consider now the m. m. f. produced by two coils or pairs of bars shown in Fig. 3, as No. 1 and No. 2. Let time be counted from the instant the current in coil No. 1 is a maximum. Let the current in coil No. 2 lag behind that of No. 1 by an angle  $\beta$  equal to the space angle between the coils, as this would be the case with damper bars.

The m. m. f. due to coil No. 1 is

$$\left. \begin{aligned} \frac{1}{2} \Phi [\cos \omega t + j \sin \omega t] &= \text{positively rotating vector} \\ \frac{1}{2} \Phi [\cos \omega t - j \sin \omega t] &= \text{negatively rotating vector} \end{aligned} \right\} \quad (4)$$

To find the m. m. f. due to No. 2 coil, proceed as follows: Assume temporarily that the current in No. 2 is in time phase with that in No. 1. On this assumption the rotating vectors would be

$$\left. \begin{aligned} \frac{1}{2} \Phi \{ \cos (\omega t + \beta) + j \sin (\omega t + \beta) \} \\ &= \text{positively rotating vector} \\ \frac{1}{2} \Phi \{ \cos (\omega t - \beta) - j \sin (\omega t - \beta) \} \\ &= \text{negatively rotating vector} \end{aligned} \right\} \quad (5)$$

But the current in No. 2 lags behind that in No. 1 by an angle  $\beta$ . Hence it is necessary to substitute  $(\omega t - \beta)$  for  $\omega t$  in (5). This gives for the rotating vectors for coil No. 2 under the conditions specified above:

$$\left. \begin{aligned} \frac{1}{2} \Phi \{ \cos \omega t + j \sin \omega t \} \\ &= \text{positively rotating vector} \\ \frac{1}{2} \Phi \{ \cos (\omega t - 2\beta) - j \sin (\omega t - 2\beta) \} \\ &= \text{negatively rotating vector.} \end{aligned} \right\} \quad (6)$$

It should be noted that the positively rotating vectors for both coils No. 1 and No. 2 are in phase with each other. The negatively rotating vectors are, however, out of phase by an angle  $2\beta$ .

To get the combined m. m. f. due to both coils No. 1 and No. 2 it is only necessary to add equations (4) and (6) together.

This gives:

$$\left. \begin{aligned} \text{Positively rotating vector} &= \Phi (\cos \omega t + j \sin \omega t) \\ \text{Negatively rotating vector} &= \Phi \cos \beta \{ \cos (\omega t - \beta) \\ &\quad - j \sin (\omega t - \beta) \} \end{aligned} \right\} \quad (7)$$

It is seen that the negatively rotating vector has been shortened by  $\cos \beta$  factor. This is due to the fact that the two coils constitute a partial or imperfect polyphase field. For a perfect polyphase field the negatively

rotating vector would disappear entirely. The positively rotating vector and negatively rotating vector are not together in space when  $t = 0$ . This is because time was counted from the instant the current in coil No. 1 was maximum. If, now, time had been counted from the instant the current in coil No. 2 was maximum, the rotating vectors would have been:

$$\left. \begin{aligned} \text{Positively rotating vector} &= \Phi (\cos \omega t + j \sin \omega t) \\ \text{Negatively rotating vector} &= \Phi \cos \beta \{ \cos (\omega t + \beta) \\ &\quad - j \sin (\omega t + \beta) \} \end{aligned} \right\} \quad (8)$$

The phase angle of the negatively rotating vector thus depends upon the instant from which time is counted.

Consider, now, the m. m. f. produced by a number of coils uniformly distributed over an arc or angle  $\theta$ , Fig. 4. Thus:

Let

$\Delta \beta$  = angle between coils

$\Phi$  = m. m. f. per radian periphery. The m. m. f. of each coil is then  $\Phi \Delta \beta$  and there are

$$\frac{\theta}{\Delta \beta} = n \text{ coils.}$$

Count time from the instant the current in coil No. 1

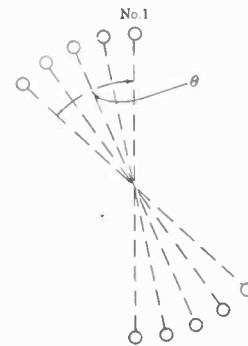

FIG. 4—M. M. F. PRODUCED BY A NUMBER OF COILS DISTRIBUTED OVER ANGLE  $\theta$  TO THE LEFT OF COIL NO. 1

is maximum. Since the positively rotating vectors are all in phase and each has a magnitude of  $\frac{\Phi \Delta \beta}{2}$ ,

and there are  $\frac{\theta}{\Delta \beta}$  coils, the

$$\text{positively rotating vector} = \frac{\Phi \theta}{2} (\cos \omega t + j \sin \omega t) \quad (9)$$

The negatively rotating vectors are all out of phase and the sum of them is:

$$\begin{aligned} \text{Negatively rotating vector} \\ &= \frac{\Phi \Delta \beta}{2} \left\{ \sum_{n \text{ terms}} \cos \omega t + \cos (\omega t - 2 \Delta \beta) \right. \\ &\quad \left. + \cos (\omega t - 4 \Delta \beta) + \dots - j \sum_{n \text{ terms}} \sin \omega t \right. \\ &\quad \left. + \sin (\omega t - 2 \Delta \beta) + \sin (\omega t - 4 \Delta \beta) + \dots \right\} \quad (10) \end{aligned}$$



$$= \frac{\Phi \Delta \beta}{2} \left\{ \sum_{r=1}^{r=n} \cos \{ \omega t - 2 (r - 1) \Delta \beta \} - j \sum_{r=1}^{r=n} \sin \{ \omega t - 2 (r - 1) \Delta \beta \} \right\} \quad (11)$$

Now let  $\Delta \beta \rightarrow 0$  and  $n \rightarrow \infty$

The  $\Sigma$ 's then become integrals as follows:

Negatively rotating vector

$$= \frac{\Phi}{2} \left\{ \int_{x=0}^{x=\theta} \cos (\omega t - 2x) dx - j \int_{x=0}^{x=\theta} \sin (\omega t - 2x) dx \right\} \quad (12)$$

$$= \frac{\Phi}{2} \sin \theta [\cos (\omega t - \theta) - j \sin (\omega t - \theta)] \quad (13)$$

which is the negatively rotating field.

The ratio of the magnitude of the negative field to that of the positive field is from (9) and (13),

$$\text{Ratio} \frac{\text{Negatively rotating vector}}{\text{Positively rotating vector}} = K = \frac{\sin \theta}{\theta} \quad (14)$$

$K$  is really a measure of the single-phase action in the rotor. It shows how nearly the rotor circuit

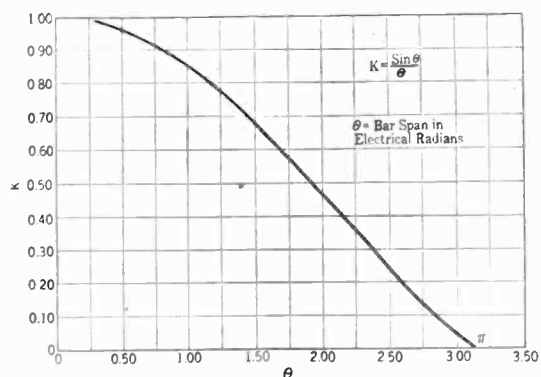

FIG. 5—CURVE SHOWING VALUES OF  $K$  AS FUNCTION OF THE DAMPER BAR SPAN.  $K$  IS A MEASURE OF THE SINGLE-PHASE ACTION PRODUCED BY THE DAMPER WINDING

approaches the perfect polyphase condition. If, in equation (14),  $\theta$  is put equal to zero for the case of the single-phase rotor,  $K = 1$ , since  $\lim_{\theta \rightarrow 0} \frac{\sin \theta}{\theta} = 1$ , so

that the negatively rotating field is equal to the positively rotating field which is correct for the single-phase rotor. But if in (14)  $\theta$  is made equal to  $\pi$  corresponding to a damper winding which is continuous around the periphery as in a squirrel-cage induction motor, then  $K = 0$ , and there is no negatively rotating field. Fig. 5 shows a curve which gives values of  $K$  corresponding to different values of the bar span  $\theta$ .

It should be noted that the magnitude of the positive field is always equal to  $\frac{1}{2}$  the m. m. f. in the whole winding, assuming all currents in phase.

It can be shown in a similar manner that for a group

of coils as shown in Fig. 6 covering an angle to the right of coil No. 1 (instead of to the left as in the previous case) that the vectors are:

Positively rotating vector

$$= \frac{\Phi \theta}{2} [\cos \omega t + j \sin \omega t] \quad (15)$$

Negatively rotating vector

$$= \frac{\Phi \sin \theta}{2} [\cos (\omega t + \theta) - j \sin (\omega t + \theta)] \quad (16)$$

Here again time was counted from the instant the current in coil No. 1, Fig. 6, was maximum.

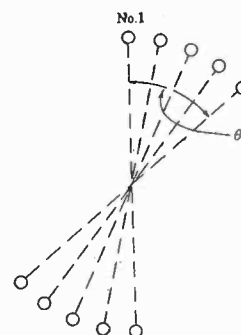

FIG. 6—M. M. F. PRODUCED BY A NUMBER OF COILS DISTRIBUTED OVER ANGLE  $\theta$  TO THE RIGHT OF COIL NO. 1

Combining the results of Figs. 4 and 6 gives the m. m. f. for the arrangement of coils shown in Fig. 7, time being counted from the instant the current is maximum in coil No. 1, which is the middle coil of the group.

The angle or arc covered by the winding is in this

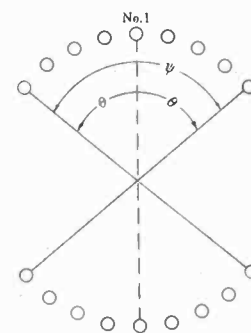

FIG. 7—M. M. F. OF A SYMMETRICAL ARRANGEMENT OF COILS

case  $\psi = 2 \theta$ . To get the positively rotating vector it is only necessary to add (9) and (15)

$$\text{Positively rotating vector} = \Phi \theta [\cos \omega t + j \sin \omega t] \quad (17)$$

To get the negatively rotating vector add equations (13) and (16) which gives:

Negatively rotating vector

$$= \frac{\Phi}{2} \sin \theta \{ \cos (\omega t - \theta) + \cos (\omega t + \theta) \}$$

$$= \Phi \sin \theta \cos \theta [\cos \omega t - j \sin \omega t] - j [\sin (\omega t - \theta) + \sin (\omega t + \theta)] \quad (18)$$

Substituting  $2\theta = \psi$  in (17) and (18) gives  
Positively rotating vector

$$= \frac{\Phi \psi}{2} [\cos \omega t + j \sin \omega t]$$

Negatively rotating vector

$$= \frac{\Phi}{2} \sin \psi [\cos \omega t - j \sin \omega t] \quad (19)$$

Hence it is seen that if time is counted from the instant that the current is maximum in the middle of the belt of conductors, the positively rotating vector and negatively rotating vector are in phase with each other; that is, they are together in space. Or, more generally, it may be stated that regardless of the instant from which time is counted, the positively rotating vector and negatively rotating vector are together in space at the instant the current is maximum in the middle bar in the pole face.

### Part II. Construction of the Vector Diagram of a Synchronous Motor With Partial Polyphase Rotor Circuit

It is well known, of course, that the ordinary vector diagram of a polyphase induction motor represents not only the time relation of the various quantities but the actual space relation in the machine as well. The same will be true of the vector diagram of a motor with a partial polyphase rotor circuit. It will be found convenient to represent by the vector for the rotor bar current the current in the bar in the middle of the pole.

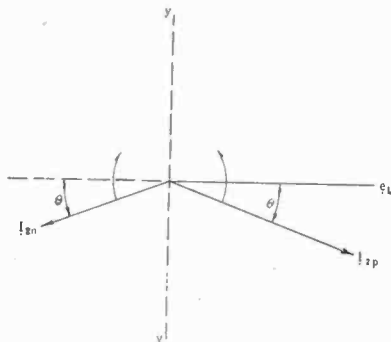

FIG. 8—DIAGRAM SHOWING SIMPLE POSITIVE AND NEGATIVE ROTATING SYSTEMS

#### RELATION BETWEEN NEGATIVELY ROTATING SYSTEM AND POSITIVELY ROTATING SYSTEM

It has been shown above that if, due to a positively rotating sine wave of flux in the gap, there is induced a voltage in each of the rotor bars which causes a sine wave of current to flow in each of the bars, the resultant m. m. f. may be represented by two rotating vectors, one rotating positively and the other negatively. In Fig. 8, let  $e_i$  be the voltage induced in each of the bars.

Two current vectors are produced, the positively rotating vector which is  $I_{2p}$  and lags behind the induced

voltage by angle  $\theta$ , the phase angle of the damper bar circuit, and the negatively rotating vector which is  $I_{2n}$  and which lies along the reflection of  $I_{2p}$  about the  $y$  axis. Now, how does one know for sure the position of  $I_{2n}$ ? It has been shown very clearly that  $I_{2n}$  must be so located that  $I_{2n}$  and  $I_{2p}$  will come together in space at the instant the current in the middle bar of the pole is maximum. Since the projection of any of

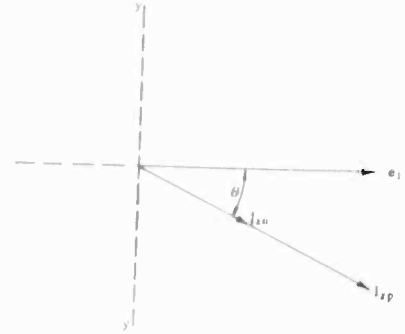

FIG. 9—DIAGRAM ILLUSTRATING THE PRINCIPLE OF REFLECTION

the vectors on the  $y$  axis as they rotate gives their instantaneous values in time, this will occur when  $I_{2p}$  comes in line with the  $y$  axis. Since  $I_{2n}$  is rotating negatively, it will come in line with the  $y$  axis at the same time as does  $I_{2p}$ . Hence, it is seen that by making  $I_{2n}$  lie along the reflection of  $I_{2p}$  about the  $y$  axis, the condition that the positively rotating vector and negatively rotating vector shall be together in space at the instant the current is maximum, is fulfilled.

#### PRINCIPLE OF REFLECTION OF THE NEGATIVE SYSTEM

It is evident that the conventional system of vector notation cannot be applied directly to the condition existing in Fig. 8. In fact, it cannot be applied to a vector diagram in which there are vectors rotating in opposite directions, so that, for the purpose of mathematical analysis it is necessary to construct the diagram in such a manner that the actual vectors in the diagram rotate in the positive direction. Such a diagram is shown in Fig. 9.

This diagram is obtained from that in Fig. 8, by applying the principle of reflection which may be stated as follows: If the negative system of vectors (in this case only the single vector  $I_{2n}$ , Fig. 8) be reflected about the  $y$  axis and made to rotate positively, the instantaneous values of the quantities represented by the vectors of the negative system remain unchanged. In other words, if in Fig. 9  $I_{2n}$  rotates positively, it produces the same projections on the  $y$  axis (which projections are the instantaneous values) as does  $I_{2n}$  in Fig. 8 when rotating negatively. Now, the diagram in Fig. 9 has the advantage that it lends itself to analysis by regular vector equations. It has the disadvantage that it is a time diagram only and does not represent the space relations in the machine as does the diagram in Fig. 8. Either diagram can, of

course, be obtained from the other by simply reflecting the negative system.

VECTOR DIAGRAM OF SYNCHRONOUS MOTOR WITH PARTIAL POLYPHASE ROTOR CIRCUIT IN FIG. 10

Fig. 10 gives the complete vector diagram of a motor. It is of the same type as Fig. 8, giving space as well as time relations. It is similar to the ordinary diagram of an induction motor except more complicated because of the negative system. All dotted vectors are actually rotating negatively in this diagram.

In the machine there are two fluxes in the gap, one rotating positively, the other negatively. The positive flux generates a positive induced voltage  $E_{ip}$  in the damper bars.<sup>3</sup> This, as has been described, produces two current vectors:  $I_{2pp}$ <sup>4</sup> which is the positively rotating vector and  $I_{2np}$  which is the negatively rotating vector and which lies along the reflection of  $I_{2pp}$  about the  $y$  axis.

In a similar manner the negatively rotating flux

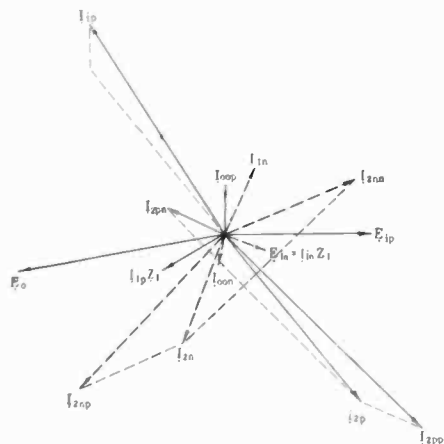

FIG. 10—MOTOR VECTOR DIAGRAM AT STANDSTILL WITH PARTIAL POLYPHASE ROTOR CIRCUIT

Dotted lines represent negatively rotating vectors.

generates a negative induced voltage  $E_{in}$  in the damper bars which again sets up two current vectors. The larger of these in this case is the negatively rotating vector which is  $I_{2nn}$  and lags behind  $E_{in}$  by the phase angle of the damper bars. The other is  $I_{2pn}$  which is the positively rotating vector and lies along the reflection of  $I_{2nn}$  about the  $y$  axis.

The total positive m. m. f. in the rotor is represented by  $I_{2p}$  and is the sum of  $I_{2pp}$  and  $I_{2pn}$ . Similarly, the total negative m. m. f. in the rotor is  $I_{2n}$  and is the sum of  $I_{2nn}$  and  $I_{2np}$ .

The positive m. m. f. in the stator is the sum of

3. It is easier, in describing the diagram, to forget about the field winding. Its effect is discussed later. The diagram is perfectly general, applying to any machine with a partial polyphase rotor of any type.

4.  $I_{2pp}$  is read as follows: Secondary current positively rotating produced by the positively rotating induced voltage. The 2 means secondary. The first  $p$  means positively rotating and the last  $p$  means due to the positive induced voltage.

$-I_{2p}$  and the magnetizing current  $I_{00p}$ ,<sup>5</sup> which produces the positive flux in the gap. Similarly, the negative m. m. f. in the stator is the sum of  $-I_{2n}$  and the negative magnetizing current  $I_{00n}$  which produces the negative flux in the gap.

The impressed voltage on the motor is the sum of  $-E_{ip}$  and the  $I_{1p}Z_1$  drop. Since there is no negatively rotating impressed voltage (if the phases are balanced as assumed) the negative induced voltage  $E_{in}$  is equal to the  $I_{1n}Z_1$  drop, as shown in the diagram.

Part III. Vector Equations—Derivation of the Torque Formula

In writing these equations the stator resistance will be disregarded. This leads to many simplifications which are impossible if it is included.

The positive secondary current is

$$I_{2p} = I_{2pp} + I_{2pn} \tag{20}$$

or

$$I_{2p} = \frac{E_{ip}}{Z_2} + \frac{K E_{in}}{Z_2} \tag{21}$$

where  $K$  is the ratio of the  $\frac{\text{negatively rotating vector}}{\text{positively rotating vector}}$  given by equation (14).

$$\text{Actually } K = \frac{\text{Magnitude of } I_{2pn}}{\text{Magnitude of } I_{2nn}} = \frac{\text{Magnitude of } I_{2np}}{\text{Magnitude of } I_{2pp}}$$

or

$$I_{2p} = \frac{E_{ip} + K E_{in}}{S Z_{2s}^2} (r_{2s} - j x_2) \tag{22}$$

where  $r_{2s} = \frac{r_2}{S}$  and  $Z_{2s}^2 = x_2^2 + r_{2s}^2$

The positive magnetizing current is

$$I_{00p} = j b_{00} \frac{E_{ip}}{S}$$

The  $S$  enters in the denominator because  $E_{ip}$  was taken as the voltage induced in the rotor bars, not in the stator.

$$I_{1p} = -I_{2p} + I_{00p}$$

or

$$I_{1p} = \frac{-E_{ip}}{S Z_{2s}^2} [r_{2s} - j(x_2 + b_{00} Z_{2s}^2)] - \frac{K E_{in}}{S Z_{2s}^2} (r_{2s} - j x_2) \tag{23}$$

5. It is, of course, not entirely correct to represent the magnetizing current by a simple vector on account of the non-uniformity of the air-gap in a synchronous motor. To take care of this correctly would probably involve the introduction of harmonics of higher order than fundamental. The error is probably not large, although it is a fact that the magnetizing admittance in a synchronous machine is large, the exciting current usually being greater than the normal full load current of the machine. Possibly this point is worthy of further study and investigation.

$$I_{1p} Z_1 = j I_{1p} x_1 = \frac{-E_{ip} x_1}{S Z_{2s}^2} [x_2 + b_{00} Z_{2s}^2 + j r_{2s}] - \frac{K E_{in} x_1}{S Z_{2s}^2} (x_2 + j r_{2s}) \quad (24)$$

but

$$E_0 = \frac{-E_{ip}}{S} + I_{1p} Z_1$$

or

$$E_0 = \frac{-E_{ip} x_1}{S Z_{2s}^2} [x_2 + B Z_{2s}^2 + j r_{2s}] - \frac{K E_{in} x_1}{S Z_{2s}^2} (x_2 + j r_{2s}) \quad (25)$$

where

$$B = \left( \frac{1}{x_1} + b_{00} \right)$$

Similarly for the negative current,

$$I_{2n} = \frac{E_{in} + K E_{ip}}{S Z_{2s}^2} (r_{2s} - j x_2) \quad (26)$$

The negative magnetizing current is

$$I_{00n} = j b_{00} \left( \frac{2S-1}{S} \right) E_{in} \frac{1}{(2S-1)} = j b_{00} \frac{E_{in}}{S} \quad (27)$$

To understand this equation clearly it must be

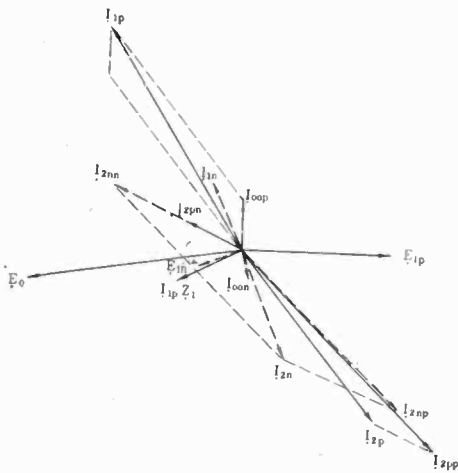

FIG. 11—MOTOR VECTOR DIAGRAM AT STANDSTILL, ALL VECTORS ROTATING POSITIVELY IN THE DIAGRAM

Vector equations are based on this diagram.

remembered that this magnetizing current is assumed to flow in the stator<sup>6</sup>; that the magnetizing admittance is

6. This assumption is not necessary. The point of view could be taken that the negative magnetizing current flows in the rotor and precisely the same result reached. Actually, the negative magnetizing current does flow in the rotor bars as can be seen from either diagram, Fig. 10 or Fig. 11. It will be noted that  $I_{2n}$  is larger than  $I_{1n}$ , which simply means that since the negative m. m. f. in the rotor is greater than that in the stator, it must supply the magnetization. Of course, just the opposite is true of the positive m. m. fs.  $I_{1p}$  is always greater than  $I_{2p}$  so that the positive magnetizing current is carried in the stator.

inversely proportional to the frequency; and that  $b_{00}$  is given per unit volt in the stator while  $E_{in}$  is the voltage generated in the rotor bars. Since the negative flux actually moves backward on the rotor at a speed  $S$ , while the rotor moves forward at a speed  $(1-S)$ , the negative flux really cuts the stator at a frequency of  $(2S-1)$ , while it cuts the rotor bars at a frequency  $S$ . The exciting admittance in the stator for this negative flux is then

$$b_{00} \left( \frac{1}{2S-1} \right)$$

since it is inversely proportional to the frequency and

the voltage induced in the stator is  $\left( \frac{2S-1}{S} \right) E_{in}$ .

The stator negative current is

$$I_{1n} = -I_{2n} + I_{00n}$$

or

$$I_{1n} = \frac{-E_{in}}{S Z_{2s}^2} [r_{2s} - j(x_2 + b_{00} Z_{2s}^2)] - \frac{K E_{ip}}{S Z_{2s}^2} (r_{2s} - j x_2) \quad (28)$$

$$I_{1n} Z_1 = j I_{1n} x_1 (2S-1) \quad (29)$$

$$= \frac{-E_{in} x_1 (2S-1)}{S Z_{2s}^2} (x_2 + b_{00} Z_{2s}^2 + j r_{2s})$$

$$- \frac{K E_{ip} x_1 (2S-1)}{S Z_{2s}^2} (x_2 + j r_{2s}) \quad (29)$$

But

$$I_{1n} Z_1 = E_{in} \frac{(2S-1)}{S} \quad (30)$$

Equating (29) and (30), reducing and solving for  $E_{in}$  gives:

$$E_{in} = -K E_{ip} \frac{V}{V + B Z_{2s}^2} \quad (31)$$

where

$$V = x_2 + j r_{2s}$$

Substituting (31) in (25) and putting  $x_2 + j r_{2s} = V$  gives:

$$E_0 = \frac{-E_{ip} x_1}{S Z_{2s}^2} \left[ \frac{(V + B Z_{2s}^2)^2 - K^2 V^2}{V + B Z_{2s}^2} \right] \quad (32)$$

In Appendix I, it is shown that the numerical value of the bracket is:

$$\frac{Z_{2s}}{z} \sqrt{(z^2 - K^2)^2 - (2KB r_{2s})^2} \quad (33)$$

where

$$z = \sqrt{1 + 2B x_2 + B^2 Z_{2s}^2}$$

Substituting (33) for the bracket in (32) and making  $E_{ip}$  zero vector, (32) may be solved for the positive induced voltage.

$$\frac{E_{ip}}{S} = \frac{E_0 Z_{2s} z}{x_1 \sqrt{(z^2 - K^2)^2 - (2KB r_{2s})^2}} \quad (34)$$

The positive torque which is due to the positive flux in the gap reacting on the positive current in the rotor bars is

$$T_p = \frac{E_{ip}}{S} \times \text{real part of } I_{2p} \quad (35)$$

From (31)

$$I_{ip} + K E_{in} = E_{ip} \left[ \frac{V(1 - K^2) + B Z_{2s}^2}{V B + Z_{2s}^2} \right] \quad (36)$$

Substituting (36) in (22) gives:

$$I_{2p} = \frac{E_{ip}}{S Z_{2s}^2} \left[ \frac{V(1 - K^2) + B Z_{2s}^2}{V B + Z_{2s}^2} \right] (r_{2s} - j x_2) \quad (37)$$

Now, the rationalizing factor in the denominator is  $r_{2s} + B Z_{2s}^2 - j x_2$ , so that the problem of finding the real part of  $I_{2p}$  resolves itself into that of finding the real part of

$$x_2 + B Z_{2s}^2 - j r_{2s} [x_2 + B Z_{2s}^2 + j r_{2s} - K^2(x_2 + j r_{2s})] (r_{2s} - j x_2) \quad (38)$$

Multiplying this out and reducing the real part is found to be

$$Z_{2s}^2 r_{2s} [z^2 - K^2(1 + 2B x_2)] \quad (39)$$

The real part of  $I_{2p}$  is, therefore,

$$I_{2p} \text{ (real part only)} = \frac{E_{ip} r_{2s}}{S Z_{2s}^2 z^2} [z^2 - K^2(1 + 2B x_2)]$$

Substituting in (35) gives the positive torque,

$$T_p = \left( \frac{E_{ip}}{S} \right)^2 \frac{r_{2s}}{Z_{2s}^2 z^2} [z^2 - K^2(1 + 2B x_2)] \quad (41)$$

Substituting (34) in (41) and reducing gives,

$$T_p = \frac{E_0^2}{x_1^2} r_{2s} \frac{[(z^2 - K^2) - 2K^2 B x_2]}{[(z^2 - K^2)^2 + (2BK r_{2s})^2]} \quad (42)$$

In this formula,

$$z^2 = 1 + 2B x_2 + B^2 Z_{2s}^2$$

and

$$B = \frac{1}{x_1} + b_{00}$$

This is the torque of the motor produced by the positively rotating flux in the gap and by the positive current in the rotor bars. On the assumption of no stator resistance this is the total motor torque, since if there is no stator resistance there is no component of  $I_{2n}$  in phase with  $E_{in}$ . (See vector diagram Fig. 10). In other words, there is no current in time phase with the negatively rotating flux in the gap, so there can be no torque due to this flux.

If in (42)  $K$  is put equal to 1 for the case of a single phase rotor circuit, the torque is

$$T = \frac{r_{2s}}{x_1^2 \{ B^2 r_{2s}^2 + (2 + B x_2)^2 \}} \quad (43)$$

By differentiating this expression with respect to slip, it is easily seen that maximum torque occurs at

$$S = \frac{B r_{2s}}{2 + B x_2} \quad (44)$$

and the maximum torque is

$$T_{max} = \frac{.5}{B x_1^2 (2 + B x_2)} \quad (45)$$

Formulas (44) and (45) are useful in studying the conditions at pull-in as will be seen later.

By substituting the numerical values of the several constants of the machine in equation (42) for different values of slip, a speed torque curve could be made for the case of open field circuit. This is of little practical value as machines are almost never started with the field open and even if they are started with the field open, it is usually closed before the motor reaches the pull-in point. This is necessary because a motor has very little pull-in torque with open field. Hence, it is necessary, before one can make a speed torque curve with closed field circuit, to study the effect of closing the field circuit on the other constants of the machine.

The balance of the paper, which is too long for JOURNAL publication, consists of Part IV, The Effect of Field Winding on the Characteristics of the Rotor Circuit; Part V, The Speed-Torque Curve—Pull-in Torque and Inrush; Part VI, Characteristics of Double Squirrel-Cage Windings in Salient Pole Synchronous Motors; and Part VII, Possibilities of External Damper Bar Circuit. There are two appendixes, the first deducing the numerical value of the vector equations derived in Part III, and the second, on Resistance and Reactance of an Inverted T- or L-Shaped Damper Bar.

Complete copies of the paper are available in pamphlet form, and will be furnished free of charge to anyone interested, on request.

## HUGE RADIO TUBE IS BUILT LIKE A BRIDGE

Real horse power, and a good deal of it, is required for radio broadcasting nowadays. One of the largest vacuum power tubes used by a sending station;—rated at 100 kilowatts—is 7½ ft. high and thicker than a man's arm. The grid alone is 3 ft. 5 in. long and is supported within its glass housing and tubular copper envelope by bracing resembling that of a steel bridge. To heat the filament requires 11 h. p. of electrical energy. The high-frequency output of the gigantic tube is enough to light 2500 lamps of 40-watt capacity. Such a huge tube, when in operation, is cooled by a water jacket.—*Elec. Dev.*, 6-5-27.

# A 21,000-Kv-A. Automatic Substation

BY D. W. ELLYSON<sup>1</sup>

Member, A. I. E. E.

*Synopsis.*—The present practise in the design of distribution substations shows a tendency towards the more extensive use of automatically controlled equipment to replace the older manually-operated type. This paper is of interest therefore as an example of the type of equipment used by one company, and also for some of the reasons why this type was decided upon. The paper includes a

summary of the apparatus and control equipment, general scheme of operation, together with floor plans of the building, one-line diagrams illustrating the operation, and a view of a portion of the single-phase regulator equipment. It also includes a summary showing the total kv-a. capacity of apparatus that is automatically controlled.

## INTRODUCTION

THE subject of automatically controlled equipment is becoming of greater interest each year, due not only to the success obtained in the operation of many such equipments, but also to the better designed and built equipment that may be purchased at the present time. This company has had an extensive and varied experience with automatically controlled equipment, both d-c. and a-c. systems. It is operating an entire Edison, three-wire system with automatically controlled equipment and without the use of a standby storage battery, a number of city stations with 13,200-volt incoming feeders and 2300/4400-volt outgoing circuits, and also some outdoor transformer substations with reclosing oil circuit breakers. Many different types of equipment are in use, and they have all operated successfully.

The chief element of interest in the substation described in the following article is in this company's method of handling the 2300/4400-volt load, and the automatic features required to take care of these conditions. The 2300/4400-volt bus is so arranged that, by means of bus tie oil circuit breakers, it can be handled as one, two or three sections, depending upon the station load. A separate transformer bank is used to feed each section of the bus, so that in case of light load the three sections are tied together and fed from one bank, while as the load increases a second bank is cut in and the bus split into two sections, and upon still further increase in load, the third bank is cut in and the bus is split into three sections. As the load decreases the busses are tied together and the transformer banks are cut out. By splitting the busses, the amount of power that can be fed from the power house into a fault in or beyond the substation is limited.

The method of operation of this station has proven so successful that it was decided to use a similar scheme for controlling the last two manually operated substations, and this equipment is being installed at the present time. Upon the completion of this work, the entire 2300/4400-volt city load will be handled by automatically controlled equipment, and Kansas City will then be truly automatic.

1. Kansas City Power & Light Co., Kansas City, Mo.

Presented at the Regional Meeting of District No. 7, of the A. I. E. E., Kansas City, Mo., March 17-18, 1927.

Modern practise in the design of automatic substations for serving residential districts is exemplified in the 21,000-kv-a. substation of the Kansas City Power & Light Company. This station, known as Substation E, is located at 31st & Cherry Streets, Kansas City, Missouri, and furnishes 2540/4400Y-volt, three-phase, four-wire power for a residential district, with comparatively little motor load.

When first installed, the power was supplied chiefly to private homes, there being comparatively few apartments and stores. In recent years there have been a great number of apartments and hotels and a considerable number of stores built in this district, so that the load has become heavily concentrated.

During the winter of 1922 and 1923 the load reached a value where it was necessary to consider either increasing the capacity of the present substation or building a new substation in some other locality to take care of part of the load. It was finally decided to increase the capacity of the existing station, as it was felt that the additional expense that would be required for a new station was unwarranted.

After this decision had been reached, the question arose as to whether the station should be left manually operated or whether it should be equipped with automatic control. In determining the type of control, a comparison of the interest and depreciation of the increased cost of the automatic control was checked against the cost of the station operators and the reliability of service was considered also. From a standpoint of cost, the automatic control proved more economical than the manually operated, and from the success which the company obtained from two other automatically controlled substations that had been in service since the middle of 1922, it was decided that better service would be rendered to the customer with the automatically controlled than with the manually operated substation.

Order was placed, therefore, for an additional transformer bank and for automatic equipment to control both the high- and low-voltage transformer oil circuit breakers and the outgoing 2540/4400Y, three-phase, four-wire circuits.

## STATION EQUIPMENT

There are four transformer banks as follows:  
Line I 1—7500-kv-a., three-phase, 60-cycle, 13,200-volt transformer.

- Line II 1—7500-kv-a., three-phase, 60-cycle, 13,200-volt transformer.
- Line III. 2—3000-kv-a., three-phase, 60-cycle, 13,200-volt transformers.
- Line IV 2—3000-kv-a., three-phase, 60-cycle, 13,200-volt transformers.

“DISTRIBUTION CIRCUITS”

- 20—200-ampere, 2540/4400Y-volt, three-phase, four-wire outgoing circuits, or a total of 60 single-phase circuits.
- 1—200-ampere, 2540/4400Y-volt, three-phase, four-wire, street lighting circuit, total of three single-phase.
- 1—200-ampere, 2540/4400Y-volt, three-phase, four-wire, transfer circuit, total of three single-phase.

Fig. 1 is a plan of the first floor, showing the location of the three 2540/4400-volt busses and the 4400-volt oil circuit breakers. It will be noted that the trans-

When there is a change in operating conditions, a system of relays operate and start a motor driven master switch to rotating, which in turn makes a series of contacts in the proper order to close or open the necessary oil circuit breakers.

The general scheme of operation is that there are three normal (Lines I, II & III) and one emergency (Line IV), 13,200-volt, three-phase, 60-cycle incoming feeders, each feeding a separate bank of transformers.

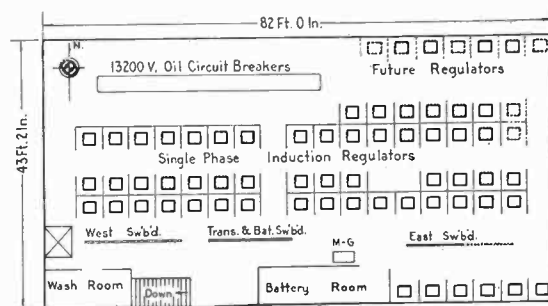

FIG. 2—SECOND FLOOR PLAN OF AUTOMATIC SUBSTATION “E”, KANSAS CITY POWER & LIGHT CO.

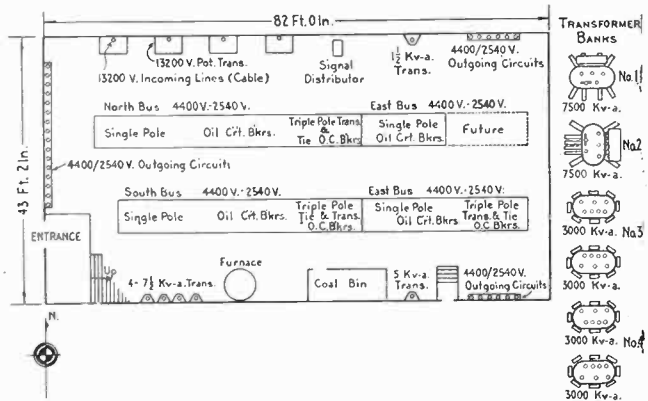

FIG. 1—FIRST FLOOR PLAN OF AUTOMATIC SUBSTATION “E”, KANSAS CITY POWER & LIGHT CO.

formers are installed out of doors. Fig. 2 is the second floor plan, showing location of the 13,200-volt breakers, single-phase regulators and switchboard panels. Fig. 3 shows the method of installing the single-phase induction regulators with concrete barriers, and some of the panels for the reclosing oil circuit breaker equipment.

AUTOMATIC EQUIPMENT FOR SWITCHING TRANSFORMERS

Fig. 4 is a single-line diagram of the incoming 13,200-volt feeders, transformer banks, high- and low-voltage oil circuit breakers, and the 2540/4400Y-volt, busses.

Lines I, II, III, refer to the three 13,200-volt incoming feeders and their transformer banks, and are the normal operating lines. Line IV and its transformer is used for emergency service only to take the place of a cable or transformer bank that has failed or is out of service.

It is also to be noted that the transformers are connected in parallel on the low-voltage side only during the time necessary to perform the proper switching to take care of the change in operating conditions. In other words the 4400/2540-volt bus is operated in one, two, or three sections, depending upon whether one, two, or three transformers are in service.

Lines I, II & III, with their corresponding transformer banks, are used for normal operation, the number of transformers cut into service being dependent upon the load demand. Line IV and its transformer bank is used for emergency service to take the place of one or more normal lines (or transformer banks) that are in trouble or out of service.

NORMAL OPERATION

Fig. 4 (Nos. 1, 2 & 3) show the three normal operating conditions as follows:

1. Light Load.—One transformer only required.

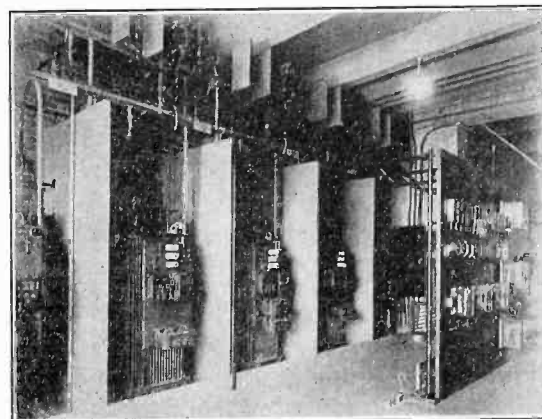

FIG. 3—SECTION OF SINGLE-PHASE REGULATORS AND PANEL FOR RECLOSING OIL CIRCUIT BREAKER EQUIPMENT

The three sections of the 2540/4400-volt bus are tied together and fed by Line I.

2. Increased Load.—Two transformers required. Line I feeding bus 1, busses 2 and 3 tied together and fed by Line II.

3. Heavy Load.—Three transformers required. Line I feeds bus 1, Line II feeds bus 2, and Line III feeds bus 3.

Relays connected to current transformers giving total

station load are used to operate the control to cut in or cut out the transformer banks, so that the proper number of transformers to carry the station load are always in service.

### EMERGENCY SERVICE

In case any incoming feeder or its transformer should develop trouble, then the high- and low-tension breakers for that transformer bank are automatically tripped, the emergency Line IV is connected to the bus of the line that has failed and the other normal lines remaining in service are connected to their respective bus sections and the tie breakers opened. If two normal lines

the corresponding transformer bank, and a suitable system of relays will start the necessary switching operations to connect in the Emergency Line IV to pick up the load of the line or lines that have failed.

Upon the restoration of voltage to the line that has failed, this line is automatically cut back into service and the emergency line taken out.

For control of 2540/4400Y-volt outgoing circuits. Each single-phase circuit is equipped with an overload relay that will trip its breaker in case of overload or short circuit, and automatic equipment will reclose the breaker after a predetermined time delay. If the breaker should trip three times within a certain time interval, then it is locked out and prevented from further reclosing until an inspector has reached the station and reset the lockout device by hand. In other words, when a breaker trips from overload or short circuit, it is closed back on the line three times, and then if it trips again it is locked open.

### OPERATING EXPERIENCE

This station was placed in automatic service in January 1924, and has given excellent service since that date. There have been three cases where there have been momentary interruptions of service, lasting from 5 to 15 seconds, due to failure of some of the automatic equipment. The cause of these interruptions have been determined and measures taken to prevent a recurrence.

The operation of both the transformer switching for the transformer banks and also the reclosing features of the outgoing circuits has been so successful that at the present time the company is equipping the two remaining manually operated city substations with automatic control, so that by the early part of 1927 all of the 2540/4400Y-volt city load as well as the d-c. Edison system will be handled by automatically controlled equipment.

In conclusion, it might be of interest to note that this company has in service or under construction the following automatically controlled substations:

5 D-c. Edison substations.....	17,400 kv-a.
7 A-c. indoor substations with 4400/2540Y-volt distribution ..	105,400 kv-a.
9 A-c. outdoor substations with re- closing oil circuit breakers.....	9,100 kv-a.
TOTAL	131,900 kv-a.

### NEW CEMENT RESISTS ACID

A new form of cement has been developed by a British firm and is reported upon by the Department of Commerce. This plastic material resists acid and is therefore valuable for use in constructing chimneys, sewer pipes, culverts, storage tanks, etc.

The process is patented in the United States and it is contemplated that it will be manufactured here in the near future. A description of the product in complete detail can be obtained from the Chemical Division, Department of Commerce by request.

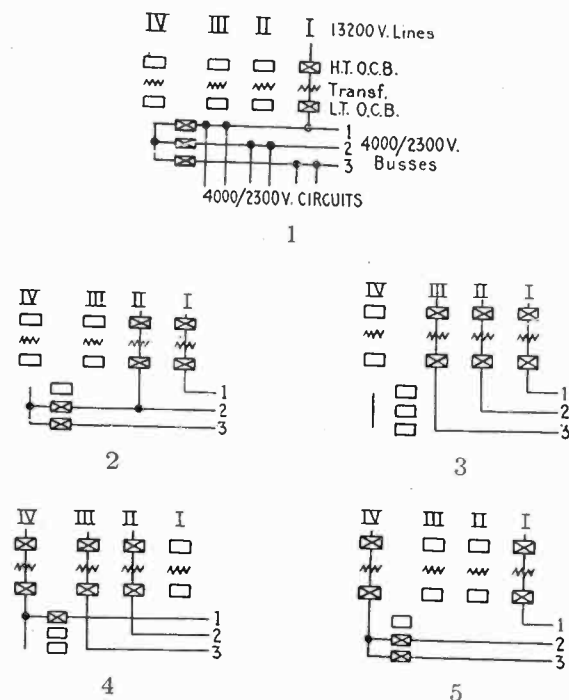

FIG. 4—SINGLE-LINE DIAGRAM OF TRANSFORMER SWITCHING FOR AUTOMATIC SUBSTATIONS "E," KANSAS CITY POWER & LIGHT CO.

should fail, the emergency Line IV would carry the load of the two busses.

The following examples of emergency operation are given:

4. Line I de-energized, Lines II, III & IV energized. Line I breakers are tripped, Emergency Line IV is connected to bus 1, Line II feeds bus 2, Line III feeds bus 3.

5. Lines II & III de-energized, Lines I & IV energized. Line IV carries busses 2 & 3, Line I bus 1.

Upon restoration of voltage to the line that has failed, this line is automatically cut back into service and the emergency line taken out.

No overload relays are used in the substation for protection of the transformer equipment, as the relays on the outgoing 13,200-volt feeders at the power house are used for this purpose. The transformers are protected from continued overload, however, by temperature relays, and differential relays are used to trip the breakers in case of internal trouble.

The failure of an incoming 13,200-volt feeder will trip the breakers on the high- and low-voltage side of



# Electricity in the Drilling of Oil Wells

BY L. J. MURPHY<sup>1</sup>

Non-Member

*Synopsis.*—As in other industries, electricity has taken the lead in the petroleum industry in putting the drilling of oil wells on an engineering basis and as a result of numerous installations it can be said that oil companies in general at the present time have a very receptive attitude toward electric drilling. Satisfied drillers, easy

operation, low maintenance, low power bills, fewer shut downs, perfect motion, faster drilling, heavier pulling, no stand-by losses—all these factors have contributed to make electricity the coming accepted standard by which all other forms of oil-well drilling will be judged.

\* \* \* \* \*

## CABLE-TOOL DRILLING

THERE are two forms of drilling practise in common use in the United States today, *i. e.*, cable-tool and rotary. The cable-tool or percussion system was the original method and is the one most extensively employed at the present time. It is used exclusively in the Pennsylvania, Ohio, Illinois and Kentucky fields and to a very large extent in the mid-continent and western fields.

In drilling with this system, the drilling tools are suspended from a steel cable or manila rope and moved in an up-and-down motion with the speed of the walking beam, which supports the tools, corresponding to the natural period of the string of tools. Naturally this period becomes greater as the depth of the hole increases and, in order to obtain maximum drilling speed, the motor driving the rig must be capable of very delicate adjustment over quite a wide range of speed. It can be seen readily that this method is better adapted to hard solid formations than to soft formations on account of the fact that repeated jarring of the earth will loosen soft structures and cause cave-ins which necessitate fishing jobs and no end of trouble.

There are four principal operations in the drilling of oil wells by the cable-tool system, namely, spudding-in, drilling, hoisting tools, and bailing, each operation necessitating distinct requirements of the electrical equipment operating the rig.

The "spudding" operation consists of raising the drilling tools through a vertical distance of three or four ft. and allowing them to fall. The operation is accomplished by means of a jerk line one end of which is attached to the crank on the band wheel and the other end through a sliding shoe to the cable which supports the drilling tools. The tools are supported usually by a steel or manila cable which passes over a sheave wheel on top of the derrick and then is spooled on a hoisting drum or bull wheel. The tools are fed downward by releasing the brake on the bull wheel. Near the top of the hole the band wheel is operated at a speed of 42 to 45 rev. per min. to give most satisfactory operation and the speed must be very closely controllable. This operation requires approximately 30 to 40 h. p.

1. General Engineering Department, Westinghouse Electric and Mfg. Company, East Pittsburgh, Pa.

Presented at the Regional Meeting of District No. 7 of the A. I. E. E., Kansas City, Mo., March 17 and 18, 1927.

After a 200- to 400-ft. length of hole has been drilled by the spudding operation the remainder of the drilling is done on the beam. Drilling on the beam requires that the speed of the driving motor or motors be very closely regulated and that the motors have relatively small fly-wheel effect in order to permit rapid variation in speed in response to variations in torque throughout the drilling cycle. The range of speed throughout the drilling of a well runs from 40 to 45 strokes per min. at the top of the hole down to as low as 14 to 20 strokes per min. at the bottom.

The average speed of the drilling equipment must be adjustable at all times to correspond exactly to the

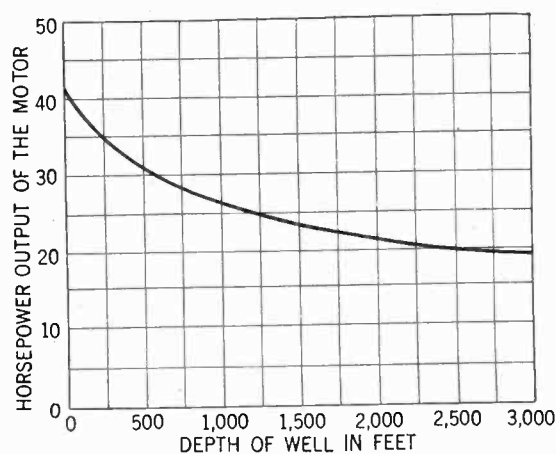

FIG. 1—POWER REQUIREMENTS FOR OIL WELL DRILLING BY THE CABLE-TOOL METHOD

natural period of the drilling tools and drilling line, if maximum progress is to be obtained. If the speed of the drilling tool is set too low, the bit does not strike a sharp blow and the progress is slow; while if the speed is set too fast, excessively high stresses are set up in the drilling cable, drilling is slow and fishing jobs are to be expected.

The horse power required will be found to vary but in general it can be said to decrease somewhat as the depth increases. If the hole is free of water, the horse power required to swing the tools will be comparatively light, the beam will operate at a larger number of strokes and the drilling will progress faster than if water in appreciable quantity is encountered in the hole.

Fig. 1 is a curve showing how the horse power output of the motor varies with the depth of the well. As no two wells are exactly alike and as conditions will vary

considerably throughout different parts of the country, the above mentioned curve can be considered as representative only of the general trend of the power requirements with increase in depth.

After every six-foot length of hole has been drilled, it is necessary to remove the cuttings from the hole and before this can be done the drilling tools must be hoisted. In this operation heavy ropes are slipped into a large grooved pulley on the bull wheel and into similar grooves on a tug rim bolted to the band wheel. Thus, the same motor equipment that is used for drilling is used for hoisting also. The pulley ratios between the motor equipment and the band wheel are such that a maximum speed of 80 to 90 rev. per min. is possible at the band wheel and approximately 90 to 100 rev. per min. at the bull wheel. The tools are accordingly hoisted out of the well at a rate of 350 to 700 ft. per min., the speed increasing as the bit nears the surface, due to the increasingly larger effective drum diameter. As the effective drum diameter is increasing, however, the weight to be lifted is decreasing, so that for a given

probably around 25 to 30 kw. The operation of hoisting the tools shows that considerable power is required to accelerate the load to full speed but that as soon as the motor has come up to full speed the load remains practically constant. Since the motor is already up to full speed at the time the bailing operation commences, the peaks at the start of this operation can be attributed to pulling the bailer loose from the mud at the bottom of the hole and accelerating it to full speed. It will be noted that the first bailer was evidently more fully loaded than the second.

In order to take care of all the operations incident to the drilling of an oil well by the cable-tool method, there are two equipments in common use in the United States at the present time, one involving two two-speed motors and the other involving one larger single-speed motor. The former method employs two standard two-speed, 15/35-h. p., oil-well pumping motors belted to a common counter shaft whereby the drilling is accomplished on the low-speed, low-horsepower connections and the hoisting taken care of on the high-

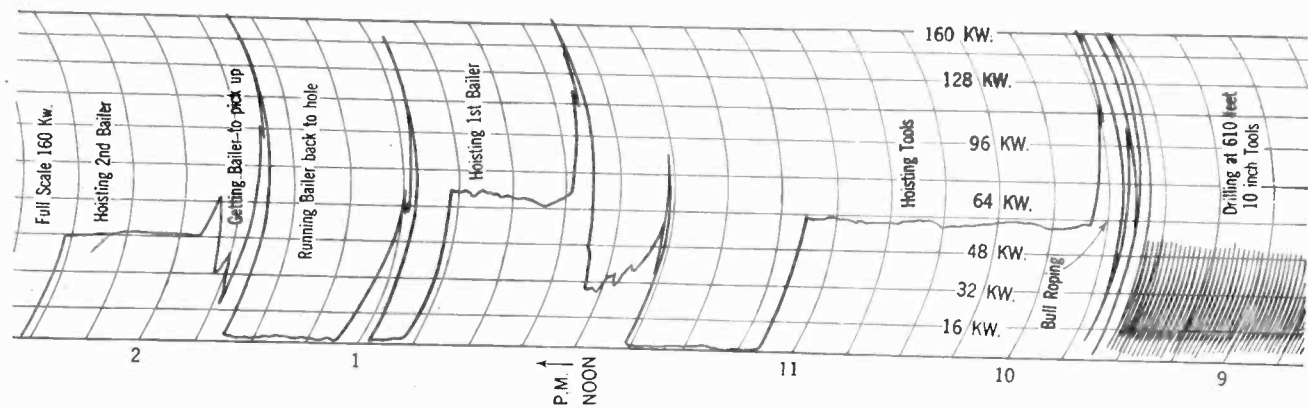

FIG. 2—TYPICAL GRAPHIC CHART SHOWING VARIOUS OPERATIONS IN CABLE-TOOL DRILLING

condition the horse power remains practically constant from bottom to top. At the start of the drilling, the hoisting of the tools is not exceptionally heavy duty, but as the hole becomes deeper this load is likely to become as high as 150 h. p., especially if the rig is not very efficient.

As soon as the drilling tools have been hoisted out of the hole, the bailer is lowered several times to remove the cuttings. The bailer, which consists of a piece of pipe with a dart valve at the bottom, is operated by a sand reel, friction-driven from the band wheel. The speed of hoisting the bailer is approximately 2 to 2½ times as fast as the speed of hoisting tools, but because of the lighter weight of the bailer the load on this operation is practically the same as that of hoisting tools.

Fig. 2 represents a section of a drilling chart, showing the various operations when drilling at a depth of approximately 600 ft., using a 15-in. bit. It will be noted that for a considerable portion of the drilling cycle, the load is approximately 16 kw. but that at the peak the meter registered 53 kw. with an average

speed, high-horsepower connections. Each motor has nine points of speed control on each speed connection and by operating one controller on one point and the other on any one of its nine points, a total of 45 speeds on each speed connection is available. The latter method employs a standard 75-h. p., single-speed motor in which the low drilling speeds are obtained by the insertion of slip resistance in the secondary circuit of the motor. A main controller takes care of acceleration and reversing and an auxiliary controller gives fine speed adjustment by subdividing one of the steps of resistance into a number of smaller steps.

In regard to power consumption, the kilowatt-hours per foot will vary considerably with the location and formation but in general it can be said to vary from 4 to 10 kw.-hr. per ft. for a 2000-ft. well with an average of 7 and from 5 to 12 kw.-hr. per ft. for a 3000-ft. well with the average correspondingly increased. The two-motor scheme will be found, as a rule, to be the more economical of the two, due to the fact that during the major part of the drilling operation the two motors are operating at more nearly their synchronous speed and

therefore little power is lost in secondary resistance. Fig. 3 shows an installation of this kind.

Fig. 4 shows a typical power curve for cable-tool drilling in the mid-continent field and indicates that the total power consumed tends to increase slightly faster than the increase in depth, due, no doubt, to the greater power consumption in the hoisting and bailing operations.

### ROTARY DRILLING

In certain sections of the country where the formations are, for the most part, of unconsolidated material

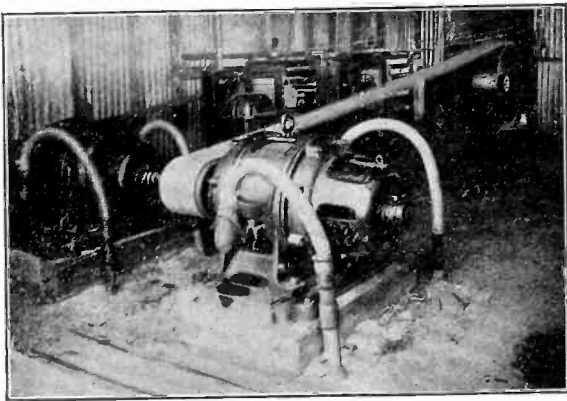

FIG. 3—INSTALLATION OF TWO 15/35-H. P. PUMPING MOTORS FOR CABLE-TOOL DRILLING

such as sand, gravel and boulders, considerable difficulty was encountered in endeavoring to apply the cable-tool system as the jarring of the tools would loosen the earth and cause cave-ins with resulting fishing jobs. To handle these formations successfully, the rotary system of drilling was developed.

In this system a hollow drill pipe with a suitable bit, usually shaped like a fish tail, fastened to the bottom of it, is rotated at a speed of 60 to 90 rev. per min. and gradually fed downward. At the same time plunger pumps force mud down through the drill pipe, through two small holes or eyes in the bit, and up on the outside of the drill pipe. The combination of the scraping action of the bit with the jetting action of the mud through the holes, actually drills the well, but in addition to assisting in drilling the mud functions also to carry the cuttings continuously to the surface. The high hydrostatic head forces this mud into the soft formations and the rotating pipe trowels it into place and thus the walls of the hole are built up rather solidly. The amount of casing required with this system is thereby reduced to a minimum.

The equipment involved in an electrically-driven rotary drilling rig consists essentially of a motor, a suitable single reduction gear unit, a draw works, a rotary table, and two motor-driven mud pumps. The draw works comprises a line shaft chain-driven from the gear unit and a drum shaft on which is mounted a hoisting drum so arranged with a number of sprockets and jaw clutches, chain-driven from the line shaft, that

two or three hoisting speeds can be obtained. The rotary table is also chain-driven from the line shaft with a jaw clutch on the latter whereby the rotary table can be disengaged at any time.

The operation to be performed in rotary drilling may be segregated into three distinct classes: drilling, hoisting and lowering drill pipe, and circulating, each requiring certain fundamental features in the design of the electrical equipment. The drilling operation requires from 30 to 100 kw., depending on the depth, size of hole, and the formation, and, as mentioned previously, the table speed ranges normally from 60 to 90 rev. per min., although under some conditions this speed may be as low as 30 rev. per min. Certain formations require as high as 100 kw. at a speed of 70 rev. per min. which is probably the worst condition encountered, while in other formations the most satisfactory progress of the bit will occur at 90 rev. per min. with loads as light as 30 kw. When special types of rock bits are employed, the speed of rotation of the drill pipe will be as low as 30 rev. per min. and the power drawn from the line will seldom exceed 30 kw. Thus it can be seen readily that the ranges of power and speed for satisfactory penetration of the bit vary considerably with the formations and the location.

There is still another feature to take into consideration and that is the ultimate torsional strength of the drill pipe. With the necessity for excessively high torques in hoisting, as will be described later, it is found

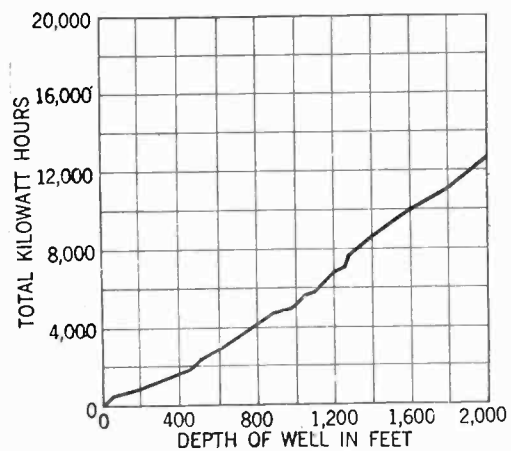

FIG. 4—TYPICAL CURVE OF POWER CONSUMPTION OF A WELL DRILLED IN KANSAS BY THE CABLE-TOOL SYSTEM

highly desirable when drilling to insert a certain amount of permanent resistance in the secondary circuit of the motor which will not only limit the maximum strain that can be applied to the drill pipe but which will also give the motor a drooping speed-torque characteristic. This drooping characteristic offers a cushioning effect between the motor and the drill pipe, a feature particularly desirable when drilling through boulders or hard shells where the equipment is frequently subjected to very severe shocks.

After drilling has progressed for four or five hours, the bit has usually become dull and out of gage and it is therefore necessary to replace it with a fresh bit. To

do so means removing all the drill pipe from the hole and standing it up in the derrick in "fourbels" or approximately 85-ft. lengths. As the well becomes deeper this operation requires an ever increasing percentage of the total time and as a result it is highly desirable to have equipment which will take care of extremely high overloads for short periods of time in order that as much of the drill pipe as possible can be hoisted in high gear. Records show that when handling

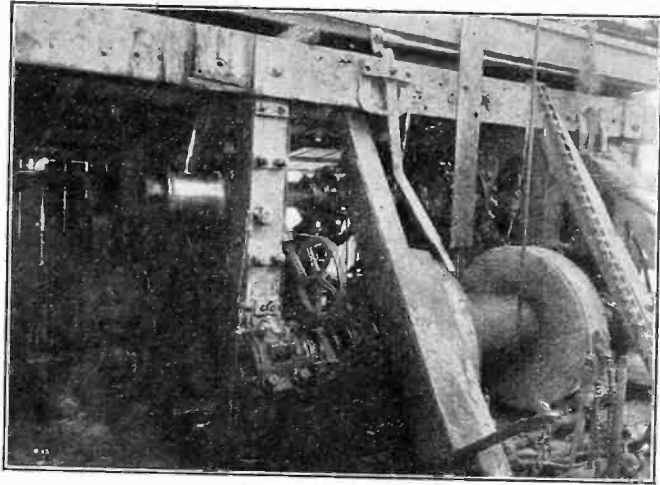

FIG. 5—INSTALLATION OF 100-H. P. ROTARY DRILLING EQUIPMENT SHOWING RELATIVE LOCATION OF MOTOR, CONTROL GEAR UNIT AND DRAW WORKS

3500 ft. of 6-in. diameter drill pipe, representing approximately 42 tons, the hoisting loads are as high as 300 h. p. but inasmuch as the load lasts only for a period of 40 to 50 sec., this load can be handled very conveniently by a 100-h. p. motor, providing the motor has been designed with ample pull-out torque. After hoisting the entire string of drill pipe approximately

required by friction, the weight of the blocks and one stand of pipe.

After the worn bit has been replaced, the pipe is put back in the hole, and during this operation very little work is required of the motor other than lifting the 85-ft. sections into place for coupling together and running the blocks up light to the top of the derrick.

Circulating is an operation in which the drill pipe is held off bottom and rotated very slowly at a speed seldom exceeding 15 rev. per min. The purpose of circulating is to allow the pump to force mud through the drill pipe and build up the walls of the hole. Since the load is exceptionally light and the speed extremely low, a considerable amount of secondary resistance is required to accomplish the desired results. Rotating the drill pipe at too high a speed in this operation will cause the bit to become out of gage.

For extremely shallow wells it has been found that a 15/35-h. p., two-speed pumping motor has sufficient capacity to do the work, but for the average wells a 100-h. p. or 125-h. p. motor is required, with the possibility of utilizing a 75-h. p. motor on moderately light wells in some territories where oil is reached at a depth not in excess of 3000 ft. It is interesting to note that the deepest well in the world, 8046 ft. deep, was recently completed in California and electric motors were used throughout, both for driving the drilling machinery and for operating the mud pumps.

Fig. 6 is a typical graphic chart showing the load on a 100-h. p. drilling motor for the various operations.

The power consumption per foot of hole will vary considerably with the location, with the ultimate depth, and with the diameter of the hole. In the Gulf Coast district for wells around 850 to 950 ft. deep, the kw-hr.-per-ft.-range from 1.5 to 4 with an average around 2.5.

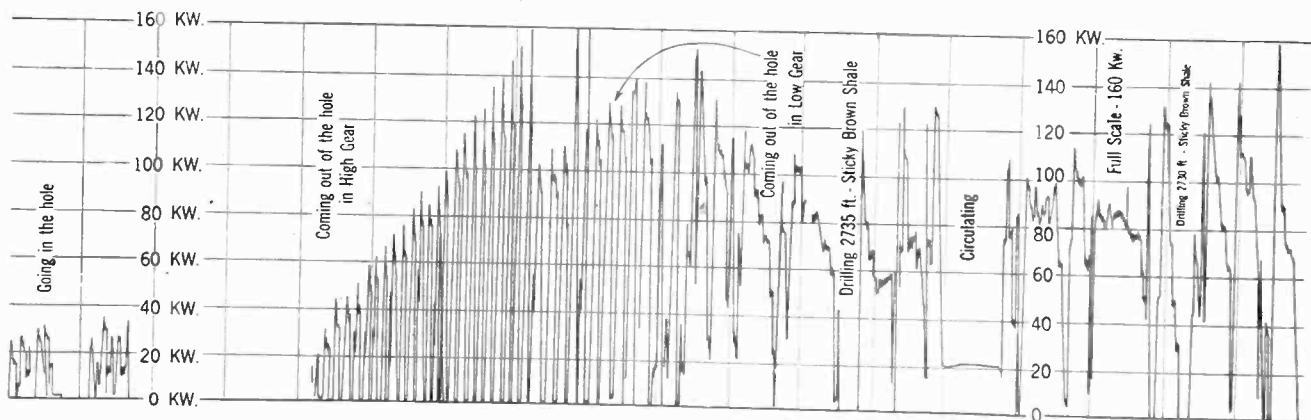

FIG. 6—GRAPHIC WATTMETER CHART OF 100-H. P. ROTARY DRILLING EQUIPMENT OPERATING AT A DEPTH OF 2730 FT.

85 ft., one stand or fourbel is uncoupled and stood in the derrick, the elevators are lowered, a new hold taken on the drill pipe, and the hoisting operation repeated. Thus there is an interval of about one minute when the motor is required to do little or no work. Each succeeding hoisting operation means less load on the motor until, when the last length of pipe is drawn out of the hole, the load is a minimum, amounting only to that

Deeper wells in this same territory require from 8 to 14 kw-hr. per ft. with an average of 9.5, the great increase over the shallower wells being due primarily to the larger diameter hole, the harder formations at the greater depths, the high power consumption during hoisting, and the extra horse power to maintain mud circulation at the greater depths. In the California fields, for 3500- to 4000-ft. wells, the power consump-

tion runs as high as 25 kw-hr. per ft., although, with the general adoption of more efficient bits, this figure has been reduced considerably. It is therefore apparent that no definite figures can be given as to the power consumption for various depths of hole as conditions vary in different fields and even in the same field the formation varies to a great extent.

**AUTOMATIC ROTARY DRILLING**

A large proportion of the difficulties in rotary drilling are fundamentally caused by improper feed of the drill.

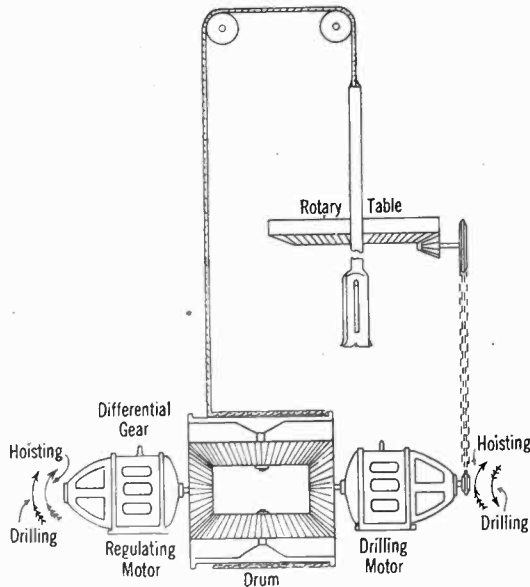

FIG. 7—SCHEMATIC DIAGRAM SHOWING PRINCIPLE OF OPERATION OF THE HILD DIFFERENTIAL DRIVE FOR AUTOMATIC ROTARY DRILLING.

SPEED (REV. PER MIN.) OF DIFFERENT PARTS OF AUTOMATIC DRILLER

Operation	Reg. motor	Differential	Drilling motor
Drilling, no progress	1000 Forward	0	1000 Forward
Drilling progress	990 Forward	5 Down	1000 Forward
Drilling progress	990 Forward	2 Down	996 Forward
Retrieval	990 Forward	45 Up	990 Forward
Hoisting	1000 Forward	1000 Up	1000 Reverse

The feed is in the hands of an individual operator and the regulation of proper feed depends upon the personal equation of this individual, his judgment, his experience, his desire to do good work, etc. Errors of the individual are responsible for many such accidents as twist-offs, balled bits, and crooked holes. If the feed of the bit could be made scientifically proportional to the resistance it encounters, and if this feed could be cared for automatically and independent of any personal equation, many of the accidents and errors due to incorrect drill feed would be eliminated, the speed of drilling would be increased, delays would be decreased, and costs would be reduced. The Hild Differential Drive was developed with this idea of providing a scientifically regulated feed for the drill bit in the place of haphazard manual feed dictated by personal judgment and inclination.

The fundamental principle of the Hild Differential Drive is that the downward feed of the drill pipe is varied according to the power required to revolve the bit on bottom. This relationship between the feed and the power required for drilling is not only adjustable but is fixed for any given adjustment due to the inherent characteristics of induction motors and the principle of the differential gear drive. In operation, if the formation changes so that the load on the drill pipe increases, the downward progress of the drill pipe is automatically retarded. Thus the device not only tends to keep the load on the drill pipe constant for any given setting but also tends to hold the pipe on bottom at all times and at a constant pressure. Furthermore, if the load on the drill pipe suddenly becomes excessive, as would be the case in encountering boulders, the drill pipe is raised until the bit is free of the obstruction, after which downward progress is again resumed.

Briefly, the equipment makes use of a differential gear unit and two motors. The drilling motor drives one-half of the differential, and also the rotary table, direct through gears and chains; while the regulating motor is connected to the other half of the differential. The hoist drum is connected to the central portion or floating part of the differential gear unit.

Referring to Fig. 7, it will be seen that if the two motors are rotating in opposite directions as indicated by the arrows, with the drilling motor having the slightly higher speed, there will be a slight downward feed of the bit. Now if the load on the drill pipe increases, the increase is reflected in a slowing down of

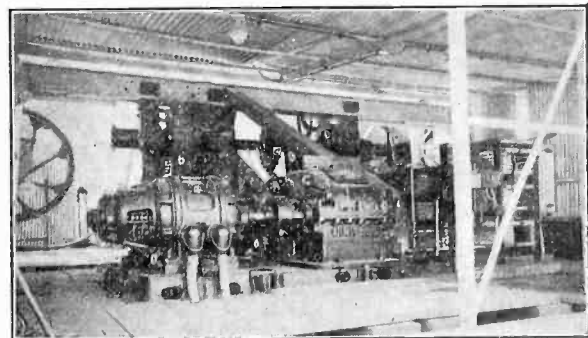

FIG. 8—INSTALLATION OF HILD DIFFERENTIAL DRIVE FOR AUTOMATIC ROTARY DRILLING

the drilling motor and a resultant decrease in the rate of feed. If the speed of the drilling motor is reduced below the speed of the regulating motor, the feed reverses and the bit is raised off bottom. Thus the device tends to maintain a constant predetermined pressure of the bit on bottom, at the same time limiting the torsional stresses in the drill pipe. By reversing the drilling motor, the equipment is used for hoisting with the maximum power of both motors available. Fig. 8 shows an installation of this type of drive.

In the operation of this equipment, the drilling, the hoisting and the other minor operations are all per-

formed in the same manner as with the hand-fed equipment.

In Fig. 9 are shown two typical parallel graphic wattmeter charts representing the loads on the drilling and regulating motors when drilling at depths of 1460

hoisting load is divided evenly between the two machines. A comparison of the charts in Fig. 9 with those in Fig. 6 demonstrates conclusively the advantages of the automatic feeding of the bit over the hand-fed method, both from an economic and from an

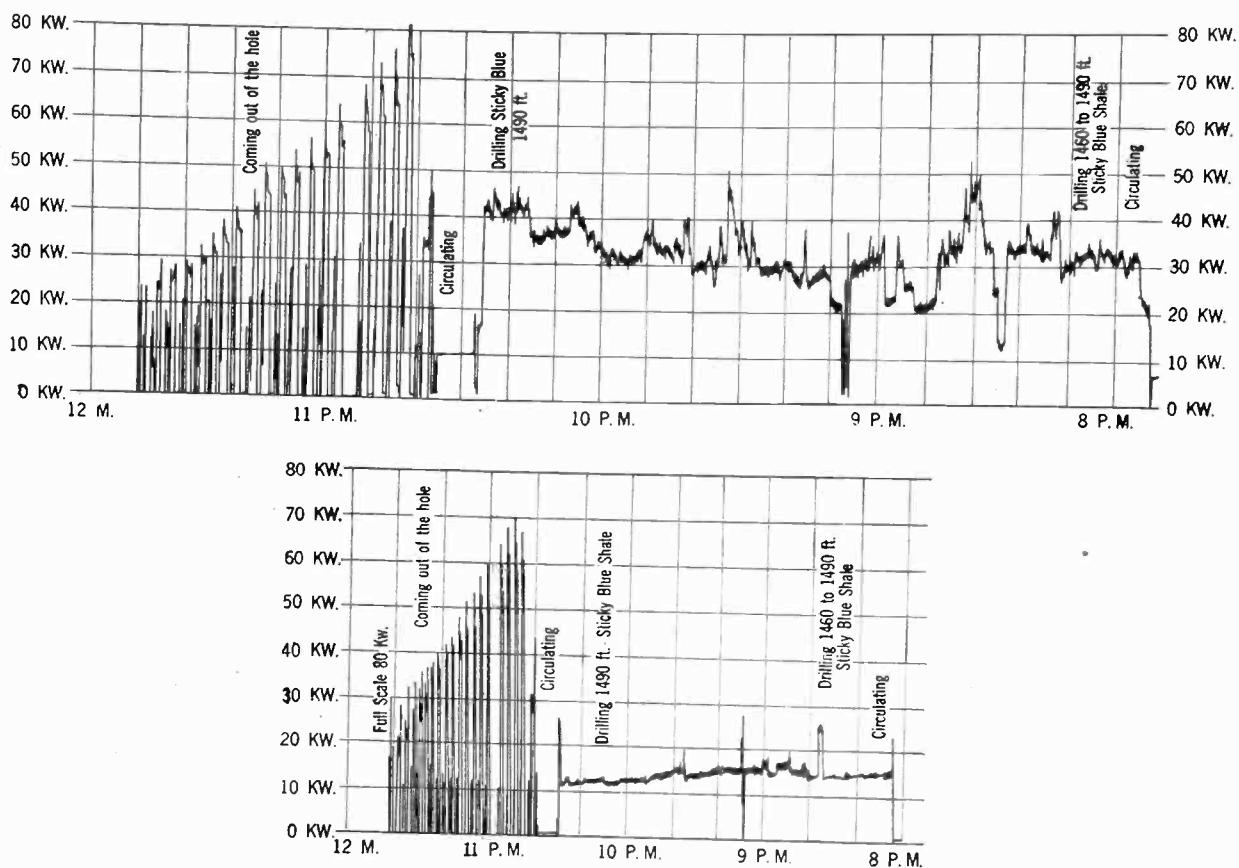

FIG. 9—PARALLEL GRAPHIC WATTMETER CHARTS OF LOAD ON DRILLING AND REGULATING MOTORS

Upper—Drilling motor  
Lower—Regulating motor

Note the comparison between the loads for automatic drilling and hand fed drilling as shown in Fig. 6

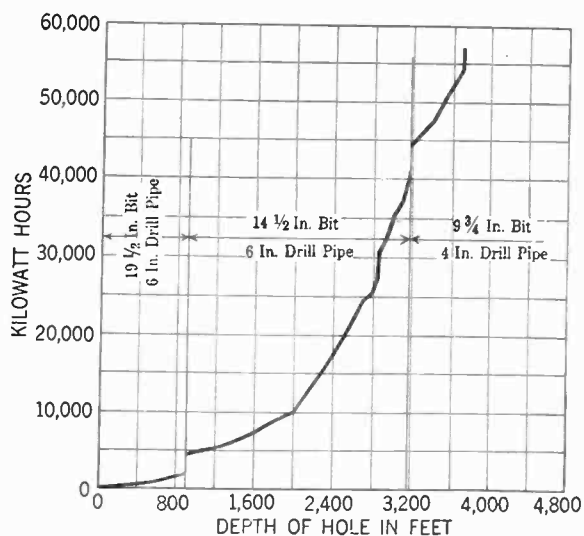

FIG. 10—TYPICAL CURVE OF POWER CONSUMPTION FOR A WELL DRILLED BY THE HILD DIFFERENTIAL DRIVE IN CALIFORNIA

to 1490 ft., using 6-in. diameter drill pipe and 14½-in. fish-tail bits. The total drilling load is represented by the sum of the loads on the two motors. During hoisting both motors are pulling together and the total

engineering standpoint. The absence of peaks during the drilling operation with the automatic feed lessens the strains in the equipment as well as in the drill pipe and the steady uniform load insures that the bit is on bottom the maximum possible portion of the time, resulting naturally in much faster drilling.

Fig. 10 shows how the total power consumption varies with the depth of the hole in the drilling of a 3700-ft. well in the California fields with the Hild Differential Drive. It will be noticed that in this particular case the power consumption amounted to 15.5 kw-hr. per ft., while for other wells in the same field using the same drive the consumption has run as low as 6.6 kw-hr. per ft. The general shape of the curve appears to be a slight modification of a parabola which differs from the shape of the curve for wells drilled by the cable-tool method as shown in Fig. 4.

The past three years have demonstrated the success of the automatic drive and, in the opinion of quite a few operating men, this drive constitutes the greatest advance in the art of oil-well drilling since the advent of the rotary system.

Everywhere in the oil fields, the operator is in a very receptive mood towards electrification as a result of the success of the pumping and drilling drives. The possibilities are unlimited, especially when it is considered that the industry is at the present time less than 10 per cent electrified and the central stations have only

just recently realized the desirability of the oil field load. The drilling load in itself is not so desirable but wherever a well is drilled electrically, it is pumped by the same power and the pumping load with practically a 100 per cent load factors represents the ideal load for any central station.

# A Study of Transverse Armature Reaction in Synchronous Machines

By Means of a Second Machine with an Adjustable Stator\*

BY R. A. SCHAEFER

Non-Member

## INTRODUCTION

IT is well known that synchronous machines, when operated under certain conditions, do not behave as theory would lead us to believe. These differences from predicted results are not of serious consequences under normal operating conditions, but are widely in error when operation on charging a long unloaded transmission line, synchronizing power, and pull-out torque, are computed from the design constants. These things lead us to believe that certain changes in the theories of synchronous machines would be advantageous, and it is with this fact in mind that we make this study of transverse armature reaction.

By transverse armature reaction is meant the effect that the magnetic flux produced by the armature has upon the field flux, when the armature reaction is entirely cross magnetizing. This occurs when the current reaches its maximum value in a conductor located under the center of the pole. This reaction may be expressed numerically as a constant, which when multiplied by the transverse component of armature current gives the armature reaction expressed in field amperes.

It can be seen that, in a generator, the armature reaction is not entirely cross magnetizing when the machine is delivering a current at unity power factor, because the flux produced by the armature strengthens the flux on one side of the pole and weakens it on the other, and thus producing a considerable phase angle between the voltage at no-load and the voltage at full load.

It can also be seen that the effect produced by the current in a cross magnetizing position can not be obtained from a zero power-factor run. At zero power factor the flux produced by the armature current is acting directly on the poles. It does not seem logical to suppose that the effect of a current in this position, acting on a region composed chiefly of iron, is of the same magnitude as the effect produced by a current in a cross-magnetizing position, which acts upon a region

composed chiefly of air. Therefore, to determine accurately the effect of transverse reaction, it becomes necessary to test a machine so that the current reaches its maximum value in a conductor located at the center of the pole.

The method used previously in our laboratory (described in a paper by J. F. H. Douglas, presented at the Winter Convention) required that in loading the machine, the full power be taken from the line. The machine was operated as a motor and means had to be provided to absorb the power produced. Another machine of the same number of poles also had to be available. In the method of test to be described the second machine is still required, but the amount of power supplied is only equal to the losses in the two machines.

## TEST

The machines used for this test were two 15-kw., 1200-rev. per. min. Westinghouse machines built for experimental purposes. With the three-phase star connection the rating is 220 volts, 40 amperes. The machines have 6 poles and are designed to operate at 60 cycles. Additional design data can be obtained from a description of the machine by Q. Graham<sup>1</sup>. One of the machines is so mounted that it is possible to turn the stator through a considerable angle by means of a hand wheel. The two machines are coupled together and driven as one unit by a d-c. motor. This motor supplies all the losses. A source of alternating current of a variable voltage and of the proper frequency must also be available. The apparatus is wired as shown in Fig. 1. It will be noted that polyphase switchboards are provided to measure the current in each machine and the current and power supplied by the line. This is done so that the current in each of the three lines may be checked for any unbalance in the three-phase system.

The set is started by starting the d-c. motor. The a-c. machines are connected in the proper phase rotation with each other and with the line by phasing out with lamps and a voltmeter. The two machines are con-

\*National Prize Paper presented at Marquette University Branch, December 30, 1926.

1. A. I. E. E. Journal, May, 1925, p. 542-543.

connected together and synchronized with the line as one unit. The controls are as follows: Turning the hand wheel which adjusts the stator position of one machine causes a circulating current to flow between the machines. The current taken from the a-c. line is varied by the induction regulator and by changing taps on the auto transformers. The reading on the wattmeter in the a-c. line is controlled by means of the field rheostat of the d-c. motor. The relation between the

netizing. First, the currents in the two machines must be equal. Second, the line current must be equal to  $2 I \sin \frac{1}{2} \theta$ , where  $I$  is the current in either machine, and  $\theta$  is the angle by which the poles are displaced as shown on the scale attached to the stator. Third, the power factor of the line current must be zero.

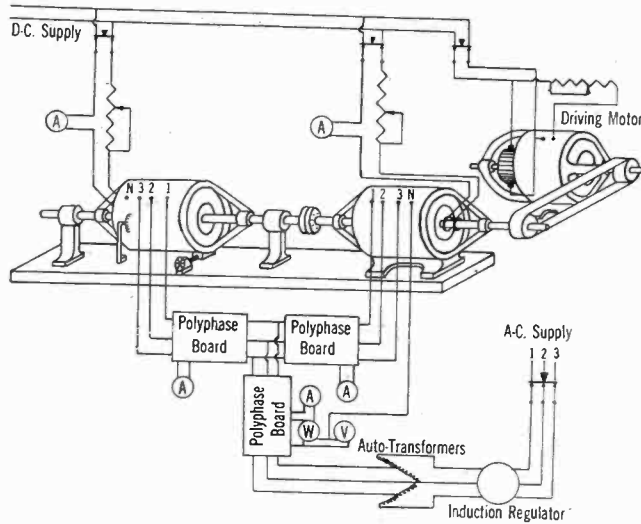

FIG. 1—INDUCTION REGULATOR

currents in the two a-c. machines can be varied within wide limits by adjusting the field currents of the two a-c. machines. Shifting the stator of the one machine separates the pole axes by an electrical angle which can be read directly on a scale attached to the machine.

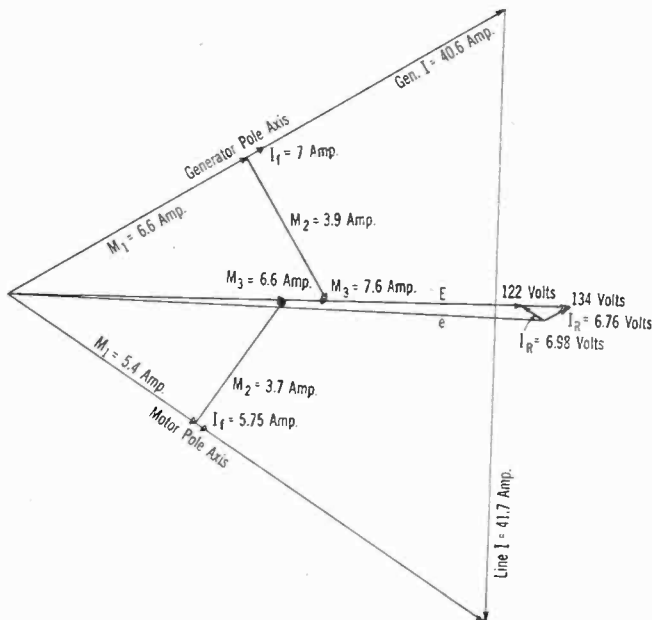

FIG. 2—COMPLETE SOLUTION BY VECTOR DIAGRAM

By a study of the vector relations in Fig. 2, it is possible to see what conditions must be fulfilled in order that the current may be in phase with the pole axis in each machine, and hence be wholly cross mag-

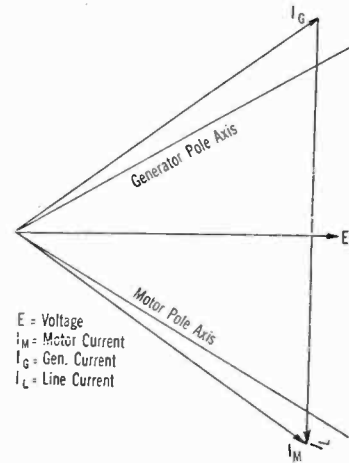

FIG. 3

When all conditions are satisfied all instruments are read and recorded.

It may be of interest to note at this point what the results would be if the conditions outlined above were not fulfilled. Fig. 3 illustrates the effect on the vector diagram if the line current is not of the proper mag-

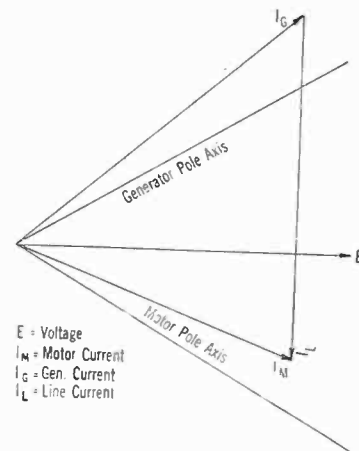

FIG. 4

nitude. It is obvious that the current in the machines is not wholly cross magnetizing.

Fig. 4 illustrates the effect of unequal currents in the two machines. Again the current is not wholly cross magnetizing.

If the wattmeter does not read zero, the current may be cross magnetizing, or it may not be. To determine whether it is, or is not, would involve a more detailed solution of the vector diagram, taking into account the power factor of the line current. It is a far simpler matter to adjust the wattmeter to zero by means of the field rheostat of the driving motor.



CALCULATIONS

As magnetic conditions in the two machines are similar, and the loads on the motor and the generator are equal, it seems logical to assume that the terminal voltage vector lies midway between the pole axes of the two machines.

Fig. 2 illustrates the vector relations.  $E$  is the terminal voltage drawn at an angle of  $\frac{1}{2}\theta$  to the pole axis of either machine.  $E$  is the induced voltage in the machine.  $M_3$  represents the magnetomotive force which induces this voltage. This m. m. f. is obtained by taking  $E$  to the saturation curve and reading the field amperes. This m. m. f. may be resolved into two components. One component along the pole axis, produced by the field coils of the machine, the other transverse to it, the transverse component being due to armature reaction. The reaction  $M_2$  expressed in field amperes, divided by the armature current which produced this reaction is, by definition, the constant which we set out to determine. It is well to note that, in determining the induced voltage  $E$ , the terminal voltage was not corrected for  $I X$  drop. When the current in a conductor reaches its maximum directly over the pole, any flux produced by that conductor has an effect upon the flux in the pole. All the effect is reaction. There is no effect which is proportional to the current and independent of saturation, and therefore no  $I X$  drop. This assumption seems to be

justified because the value  $\frac{M_2}{I}$  is a fairly constant quantity.

We will next consider the solution of a typical case. The following data are observed.

Pole displacement	=	64.5 deg.
Motor field current	=	5.75 amperes
Generator field current	=	7.0 amperes
Motor Current		
avg. of 3 phases	=	41.8 amperes
Generator Current		
avg. of 3 phases	=	40.6 amperes
Line Current		
avg. of 3 phases	=	41.7 amperes
Total line watts	=	40 watts
Volts to neutral		
avg. of 3 phases	=	128.3 volts
Arm of Resist	=	1667 ohms

The graphical solution is as follows: (See Fig. 2).

The pole axis of motor and generator are drawn 64.5 deg. apart. The terminal voltage vector is drawn midway between the pole axis, length 128.3 volts.  $I R$  drop for motor, 6.98 volts.  $I R$  drop for generator, 6.67 volts. The induced voltage vectors are drawn and when scaled are found to be 134 volts for the generator and 122 volts for the motor. The saturation curve shows an m. m. f. equivalent to 7.6 and 6.6 field amperes for generator and motor respectively. These field currents are laid off on a line in phase with the

induced voltage vectors and from their ends perpendiculars are dropped to the respective pole axis. The transverse component of the m. m. f. is measured, and in the motor is equivalent to 3.7 field amperes. This gives a transverse reaction constant equal to

$$C = \frac{3.7}{41.8} = 0.0886$$

The transverse component of m. m. f. as measured for the generator is equivalent to 3.9 field amperes. This gives a transverse reaction constant of

$$C_i = \frac{3.9}{40.6} = 0.0961$$

It may be of further interest to note that, in the vector diagram the component of m. m. f. along the pole axis in the case of the motor is 5.4 amperes. The observed field current is 5.75 amperes. In the generator the vector diagram shows 6.6 amperes on the pole axis, while the observed field current is 7 amperes.

In some cases, the value of field current as shown on

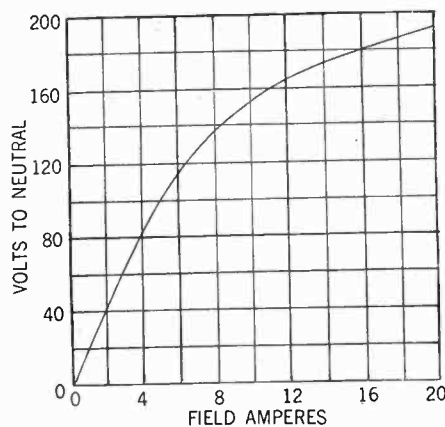

FIG. 5—SATURATION CURVE

the vector diagram was larger than the observed field current, but in general the observed field current was larger. It is believed that if very accurate meters are provided and suitable care is taken in the observations the observed current will always be larger.

This might be explained in the following way. As armature reaction shifts the flux to one side of the pole, the one side is weakened more than the other side is strengthened, due to the curvature of the saturation curve. While there is no direct reaction on the pole, yet the result is slightly demagnetizing. This effect has long been recognized in the design of d-c. machines.

Nine series of data were taken on this pair of machines, varying the field current from 3.58 amperes to 16.6 amperes, with armature currents from 18.4 amperes to 46.9 amperes, and with pole displacements ranging from 30 deg. to 64.5 deg. The average constant computed from these series of data was  $0.09300 \pm 0.00911$ . The result obtained by J. F. H. Douglas (described in the paper referred to above) is  $0.092 \pm 0.005$ . The fact that these results agree so closely leads

us to believe that there is no constant error in either method.

#### CONCLUSION

The above test is of too technical a nature, and is of little value as a routine test to determine whether a machine meets a purchaser's specifications. It may however, be useful for the designer to check the design constants in a machine.

There is one disadvantage in the test as described, that is, one machine requires an adjustable stator.

There does not seem to be any reason why the tests could not be made by slipping the coupling a few degrees for each series of data, and taking readings for various field and armature currents.

The test requires a source of alternating current approximately equal to the kv-a. capacity of one machine if tests at near 60 degree pole displacements are to be made. As the current is wattless, no power is drawn from the a-c. line. The rating of the d-c. motor must be equal to the losses in the two machines.

## Mechanical Forces in Transformers

BY J. E. CLEM<sup>1</sup>

Associate, A. I. E. E.

*Synopsis*—In this paper a method of calculating the mechanical forces in transformers, based on mutual reactance between coils, is presented. A formula for the mutual inductance between coaxial solenoids is developed and from this expression the formula for the mechanical force between concentric cylindrical transformer coils is

derived. The same method is followed to obtain the formula giving the mechanical force between individual coaxial coils. The method is checked by calculations of reactance of complicated arrangements of coils. Tables are given to facilitate calculations.

IN the design of transformers it is essential that the mechanical forces set up on short circuit be predetermined so that the bracing structure may be proportioned properly. This feature becomes increasingly important as the size of the transformer and the extent of the power systems increase. In this paper there is developed a method, fundamental and analytical, by means of which the total axial force and the force on separate coils of a transformer having concentric cylindrical windings may be calculated easily and quickly. The method is simple, being based on the fact that the reactance of a transformer may be calculated from formulas of self- and mutual-inductance.

#### MUTUAL INDUCTANCE OF COAXIAL SOLENOIDS

This development is similar to other developments of the same problem but the result is given in a form that

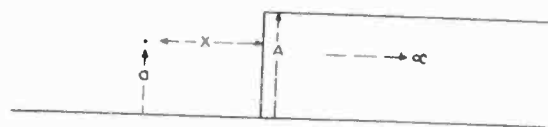

FIG. 1

is more convenient for calculation than heretofore available.

It has been shown elsewhere<sup>2</sup> that the mutual inductance between a circle of radius  $a$  and a coaxial solenoid of radius  $A$ , Fig. 1, extending to infinity from a

1. Central Station Engg. Dept., General Electric Co., Schenectady, N. Y.

2. Bul. No. 169, Bureau of Standards.

Presented at the Regional Meeting of District No. 1 of the A. I. E. E., Pittsfield, Mass., May 25-28, 1927.

point  $X$  distant from the plane of the circle is given by an expression which becomes on transformation

$$M = 2 \pi^2 a^2 N \left[ 1 - \frac{x}{r} F \right] \quad (1)$$

$$F = F_0 + \frac{a^2}{r^2} F_2 + \frac{a^4}{r^4} F_4 + \frac{a^6}{r^6} F_6 + \text{etc.}$$

$$F_0 = 1$$

$$F_2 = \frac{3}{8} \frac{A^2}{r^2}$$

$$F_4 = \frac{5}{64} \frac{A^2}{r^2} \left( 7 \frac{A^2}{r^2} - 4 \right)$$

$$F_6 = \frac{35}{1024} \frac{A^2}{r^2} \left( 33 \frac{A^4}{r^4} - 36 \frac{A^2}{r^2} + 8 \right) \text{etc.}$$

$$r = \sqrt{A^2 + x^2}$$

Equation (1) has been transformed from those usually given to obtain a series for the quantity  $F$  in which the variables are always less than unity. This makes the calculations easier and extends the working range of the equation by keeping the value of the series for each component part of  $F$  down to a small figure throughout the entire range of the variable  $A^2/r^2$ .

In this expression  $M$  is the number of lines passing through the circle due to the semi-infinite solenoid which has a winding of  $N$  turns per cm. The mutual inductance between the finite solenoid, Fig. No. 2, of radius  $a$  and length  $S$  having  $n$  turns per cm. and the semi-infinite solenoid may be obtained by integrating the expression of (1) over the range from  $x = x_1$  to  $x = x_2$ . This gives

$$M = 2 \pi^2 a^2 n N [x_3 - r_3 B^{III} - x_1 + r_1 B^I] \quad (2)$$

$$B = B_0 - \frac{a^2}{r^2} B_2 - \frac{a^4}{r^4} B_4 - \frac{a^6}{r^6} B_6 - \text{etc.}$$

$$B_0 = 1$$

$$B_2 = \frac{1}{8} \frac{A^2}{r^2}$$

$$B_4 = \frac{1}{64} \frac{A^2}{r^2} \left( 5 \frac{A^2}{r^2} - 4 \right)$$

$$B_6 = \frac{5}{1024} \frac{A^2}{r^2} \left( 21 \frac{A^4}{r^4} - 28 \frac{A^2}{r^2} + 8 \right) \text{ etc.}$$

By reference to Fig. No. 3 it can be seen that the mutual inductance of the finite solenoid *S* and a second

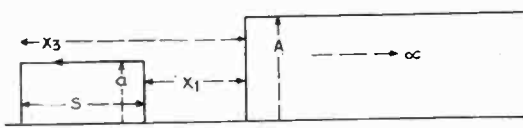

FIG. 2

semi-infinite solenoid extending to infinity but starting *P* further away from the solenoid *S* than the the first semi-infinite solenoid is given by a similar expression involving *x*<sub>2</sub> and *x*<sub>4</sub> in place of *x*<sub>1</sub> and *x*<sub>3</sub> as follows:

$$M = 2 \pi^2 a^2 n N [x_4 - r_4 B^{IV} - x_2 + r_2 B^{II}] \quad (3)$$

It follows naturally that the mutual inductance of coils *S* and *P* with centers *x* cm. apart as in Fig. No. 4 is the difference between (2) and (3), *i. e.*, (2) - (3) which gives as the final formula for the mutual inductance between two concentric coaxial solenoids

$$M = 2 \pi^2 a^2 n N [r_1 B^I - r_2 B^{II} - r_3 B^{III} + r_4 B^{IV}] \quad (4)$$

- M* = Mutual inductance in centimeters
- a* = Smaller radius of solenoids in centimeters
- A* = Larger radius of solenoids in centimeters
- S* = Length of *a* solenoid in centimeters
- P* = Length of *A* solenoid in centimeters
- n* = Turns per centimeter of *a* solenoid
- N* = Turns per centimeter of *A* solenoid
- r* =  $\sqrt{x^2 + A^2}$  for each value of *x*
- B* = Function of the ratios  $A^2/r^2$  and  $a^2/r^2$  for each value of *x* as defined in equation (2). Values of *B* may be taken from Table 3.

$$x_1 = x - \frac{S + P}{2} \quad x_3 = x + \frac{S - P}{2}$$

$$x_2 = x - \frac{S - P}{2} \quad x_4 = x + \frac{S + P}{2}$$

SELF-INDUCTANCE OF SOLENOIDS

In order to calculate the net inductance of a pair of solenoids it is necessary to calculate the self-inductance of each. One of the most convenient methods of doing this is that given by Nagaoka as follows:

$$L = 4 \pi^2 a^2 n^2 S K \quad (5)$$

which gives the inductance in centimeters. The factor *K* is a function of the ratio of the diameter to the length of the coil and the values of *K* are available<sup>3</sup> in any book that treats on inductance.

AXIAL FORCE IN TWO COAXIAL SOLENOIDS

When the magnetic centers of two coaxial solenoids coincide there will be no axial force tending to move the coils as a whole. But if the magnetic centers of the coils do not coincide there will be a force tending to

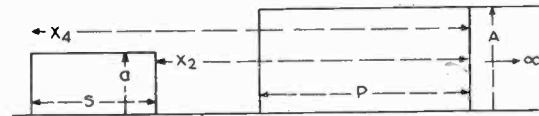

FIG. 3

cause a still greater separation of the magnetic centers. This force will depend upon the stored magnetic energy and the rate at which the energy is changed by the differential motion of the coil, *i. e.*,

$$f = - \frac{d W}{d x}$$

$$W = \frac{1}{2} L I^2$$

- W* = stored magnetic energy in joules  
= 10<sup>7</sup> ergs or dyne-centimeters
- L* = inductance of circuit in henrys
- I* = maximum value of currents

$$f = - \frac{10^7}{2} I^2 \frac{d L}{d x} \text{ dynes} \quad (6)$$

In the pair of solenoids or transformer coils being considered

$$L = L_p + L_s - 2 M_{ps} \quad (7)$$

- L* = Net inductance or leakage reactance of transformer

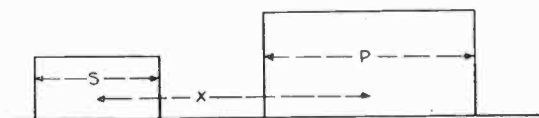

FIG. 4

- L<sub>p</sub>* = Self-inductance of primary
- L<sub>s</sub>* = Self-inductance of secondary
- M<sub>ps</sub>* = Mutual inductance between primary and secondary

Since the self-inductance of neither the primary nor secondary coil will be affected by any change in their relative position, there results

$$\frac{d L}{d x} = - 2 \frac{d M}{d x} \quad (8)$$

3. Bul. No. 169, Bureau of Standards.

Since  $M$  is given by equation (4),  $\frac{dM}{dx}$  is given by the derivative of this equation. Rewriting (4) for inches and henrys,

$$M = 2.54 : \frac{2 \pi^2 a^2 n N}{10^9} \sum r B$$

there results

$$\frac{dM}{dx} = 2.54 : \frac{2 \pi^2 a^2 n N}{10^9} \sum \frac{x}{r} F$$

and

$$\frac{dL}{dx} = - 2.54 \frac{4 \pi^2 a^2 n N}{10^9} \sum \frac{x}{r} F \quad (9)$$

When (9) is substituted in (6), the force, after changing from dynes to pounds, is found to be

$$f = 444 I^2 a^2 n N 10^{-9} \sum \frac{x}{r} F$$

In this expression,  $I$  is the maximum value of current and to use the usual effective value we must write

$$f = 0.888 I^2 a^2 n N 10^{-6} \sum \frac{x}{r} F \quad (10)$$

This expression gives the force in pounds when the dimensions are in inches and  $F$  is defined as in equation (1). The value of  $F$  may be taken from Table II.

FORCE ON INDIVIDUAL COILS

To find an expression for the force between a solenoid and a single coil we proceed as above, *i. e.*, integrate to find the mutual inductance between the coil and the solenoid and then differentiate this expression to find the force. The mutual inductance between two circles, Fig. 5, is given by

$$M = 8 \pi \sqrt{a} A \frac{F - E}{\sqrt{K}} \quad (11)$$

In this expression  $F$  and  $E$  are elliptic integrals, avail-

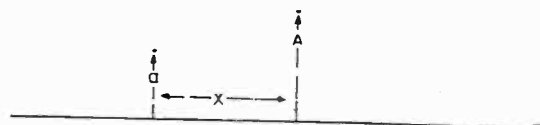

FIG. 5

able from published data in works on inductance,<sup>4</sup> to the modulus  $K$  which is defined as

$$K = \frac{4 a A}{(r_2 + r_1)^2}$$

$$r_2^2 = (A + a)^2 + x^2$$

$$r_1^2 = (A - a)^2 + x^2$$

4. Bul. No. 169, Bureau of Standards.

The mutual inductance between one of the circles and a solenoid is obtained by integrating (11) over the range  $S$  from  $x = x_1$  to  $x = x_2$  which gives

$$M = 8 \pi n N \sqrt{a} A \int_{x_1}^{x_2} \frac{F - E}{\sqrt{K}} dx$$

$$= 8 \pi n N \frac{\sqrt{a} A}{S} \left[ \int D \right]_{x_1}^{x_2}$$

Upon differentiating this and substituting in the force equation there results

$$f = 0.698 n N \frac{\sqrt{a} A}{S} [D'' - D'] \quad (12)$$

- $f$  = Force in pounds
- $n$  = Turns per inch of solenoidal coil
- $N$  = Turns in single coil
- $a$  = Radius of solenoid inches
- $A$  = Radius of coil inches
- $S$  = Length of solenoid inches

TABLE I  
COMPARISON OF CALCULATED AND MEASURED VOLTAGES FOR WINDINGS SHOWN IN FIG. 6

Connection	Fig. 6A		Fig. 6B	
	Test	Calc.	Test	Calc.
P - S	3350	3850	4023	3820
P - T	2130	1954	4530	4665
P - Q	660	665	1471	1318
S - T	5110	5344	4865	4770
S - Q	1520	1460	1464	1364
P/S - T	6048	5844	5264	5560
P/S - Q	1975	1725	1862	1725
T - Q	468	529	466	409
Ave.....	100	100.6	100	95.6

TABLE II  
VALUES OF F

$A^2/r^2$	$a^2/r^2 = 1.$	0.9	0.8	0.7	0.6
1.	(2.2955)	1.9280	1.6833	1.5090	1.3803
0.95	1.7660	1.6280	1.5089	1.4076	1.3211
0.9	1.5369	1.4731	1.4058	1.3395	1.2767
0.85		1.3887	1.3405	1.2910	1.2416
0.8		1.3310	1.2921	1.2524	1.2131
0.7			1.2212	1.1944	1.1665
0.6				1.1497	1.1304
					1.1005
	$a^2/r^2 = 0.5$	0.4	0.3	0.2	0.1
1.	1.2816	1.2036	1.1397	1.0860	1.0400
0.95	1.2471	1.1835	1.1283	1.0802	1.0377
0.9	1.2187	1.1658	1.1179	1.0746	1.0354
0.85	1.1948	1.1500	1.1081	1.0692	1.0332
0.8	1.1739	1.1358	1.0990	1.0640	1.0310
0.7	1.1389	1.1106	1.0823	1.0542	1.0267
0.6	1.1102	1.0891	1.0673	1.0451	1.0226
0.5	1.0858	1.0702	1.0538	1.0365	1.0185
0.4	1.0646	1.0534	1.0413	1.0284	1.0146
0.3		1.0382	1.0299	1.0208	1.0108
0.2			1.0192	1.0135	1.0071
0.1				1.0071	1.0035

TABLE III  
VALUES OF B

$A^2/r^2$	$a^2/r^2 = 1.$	0.9	0.8	0.7	0.6
1.	(0.8506)	0.8689	0.8861	0.9024	0.9179
0.9	0.8845	0.8956	0.9071	0.9187	0.9304
0.8		0.9149	0.9227	0.9317	0.9411
0.8					
0.7			0.9357	0.9430	0.9505
0.6				0.9530	0.9590
0.5					0.9669
	$a^2/r^2 = 0.5$	0.4	0.3	0.2	0.1
1.	0.9328	0.9471	0.9609	0.9743	0.9873
0.9	0.9422	0.9540	0.9657	0.9772	0.9887
0.8	0.9506	0.9603	0.9701	0.9800	0.9900
0.7	0.9582	0.9662	0.9744	0.9828	0.9913
0.6	0.9652	0.9717	0.9784	0.9854	0.9926
0.5	0.9718	0.9769	0.9823	0.9880	0.9939
0.4	0.9780	0.9819	0.9861	0.9905	0.9951
0.3		0.9867	0.9897	0.9930	0.9964
0.2			0.9933	0.9954	0.9976
0.1				0.9977	0.9988

TEST APPLICATION

The method has been checked by the calculation of reactance for complicated arrangements of windings, on

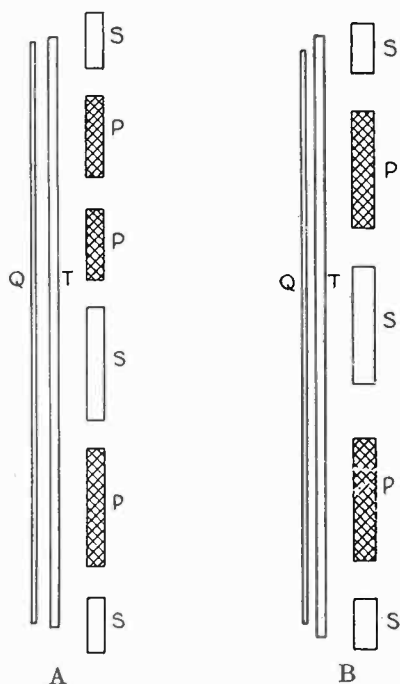

FIG. 6

the basis that if the voltage can be calculated accurately then the force calculation as based on the differential of the voltage equation will be established as reliable. This was done because the voltages can be measured much more easily than forces.

In Figs. 6A and 6B are shown diagrams of two transformers for which voltage calculation was made. The agreement of calculated and measured voltage shown in Table I is reasonably close. These are high voltage transformers having extra insulated end turns so that the turns are not distributed uniformly over the high-voltage coils. This has an effect which is greater as the portion of the winding considered is less, but these

calculations have been made as for a uniform distribution.

Forces for a representative transformer have been calculated and the results are shown in Figs. 7 and 8. The coil forces in Fig. 8 are for a displacement of

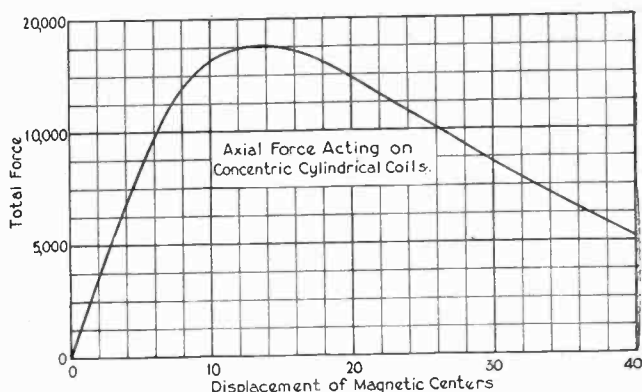

FIG. 7

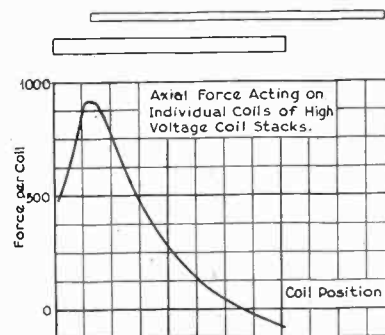

FIG. 8

about 14 in. and the sum of the individual coil forces totals to the value on the curve in Fig. 7. In this case the forces are relatively low on account of the rather high reactance of the transformer for which these calculations are made. The displacement which gives the maximum is higher than would ever occur in a well designed transformer.

NITROGEN FIXATION TO BE USED EXTENSIVELY BY BRITISH

According to one of the directors of the Imperial Chemical Industry, Ltd., the fixation of atmospheric nitrogen, through the intermediate stage of ammonia, seems to have established itself as definitely superior to other methods of fixation. This statement was transmitted through our trade commissioner at London.

In the opinion of British authorities, the natural nitrate of soda from Chile has the greatest difficulty in competing with fixed nitrogen of synthetic origin.

It is pointed that Great Britain has made considerable progress in the development of the nitrogen industry and that the output of fixed nitrogen will be greatly increased over present production by the end of next year.

The Department of Commerce states that the demand for nitrogen is increasing at the rate of 100,000 tons of fixed nitrogen per annum and that there is no expectation of any lower rate of increase in sight.

# Mercury Arc Power Rectifiers Their Applications and Characteristics

BY O. K. MARTI<sup>1</sup> and H. WINOGRAD<sup>1</sup>

Associate, A. I. E. E.

Associate, A. I. E. E.

*Synopsis.*—Steel-enclosed mercury arc rectifiers, due to their advantages over rotary converters in efficiency, ease and reliability of operation, and ability to produce high d-c. voltages, are gradually replacing other forms of converters in all fields of application. There are at present 600,000 kw. of rectifier installations, distributed over different parts of the world. Statistical data are given showing the growth of installed rectifier capacity since 1911, the distribution of rectifiers over various fields of application, and their increasing use at higher voltages for railways. The high efficiency and reliability of rectifiers at high voltages will undoubtedly influence the selection of systems and voltages for main-line electrification. Comparative operating figures are given for rectifiers and motor-generator

sets at 3000 volts d-c. Several types of Brown Boveri rectifiers and their load curves are shown. Due to the fact that the d-c. voltage of a rectifier consists of portions of sine waves, the voltage wave is somewhat undulated. The magnitude of the undulations depends on the number of phases and varies with the load. The effect of the undulations in the voltage wave on the shape of the current wave for various types of loads is discussed, and oscillograms of the voltage and current waves of a rectifier feeding a railway load under various conditions are shown. The effects of the undulations on different kinds of load—batteries, lighting, and power circuits—and on communication circuits paralleling the d-c. feeders are discussed briefly.

**D**IRECT current, in spite of the many advantages of alternating current, has its own numerous and valuable characteristics and uses. Among these might be mentioned trolley and other city railway lines, interurban and main-line railroads, rolling mills, special drives requiring the facility of control made available only by the use of direct current, electrochemical applications, and so forth. The generation of d-c. power at ordinarily used voltages would be very uneconomical due to the small power involved for particular requirements. Furthermore, at the voltages at which it is at present generated and used, transmission of the d-c. power over long distances could be accomplished only with considerable losses. The only solution of this problem, therefore, is to generate alternating current, transmit it at high voltages to the site of its application, and there convert it by the best means available into the desired d-c. voltages. Rotating converters have been the only means commercially available for this purpose, until the comparatively recent advent of the steel-enclosed mercury arc power rectifier.

On account of its newness in the commercial field, there was at first a lack of confidence in the rectifier. This, however, has been dispelled by its advantages and successful operation in all parts of the world and in every field of application. Contrary to the rotating conversion apparatus, the electrical energy is not first changed into a mechanical form and then changed back again to the electrical form, but the conversion occurs directly with no intermediate stages. The losses and other disadvantages accompanying conversion by means of rotating machinery are either greatly reduced or eliminated entirely. In a rectifier there are no iron, windage, friction, or ventilation losses, and those which do occur (losses due to the voltage drop in the arc)

do not vary as in the usual electrical machines and apparatus, as the square of the current, but only as a linear function and independent of the voltage. Two important properties of the rectifier are dependent on this last mentioned fact: the efficiency remains practically constant at all loads, and since the losses in the rectifier proper are practically constant at all operating voltages, the efficiency increases as the operating voltage is increased. This characteristic of the rectifier—a high efficiency at partial loads—is of particular importance in cases when the conversion machinery has to be operated under conditions which impose a low annual load factor, as in the supply of d-c. power to rolling mills, dredges, elevators, and especially for traction motors. For the last mentioned application, the simplicity and rapidity of the starting operation are also outstanding advantages. These advantages, together with others, have proved the rectifier to be superior to the rotary converter, and have contributed to the great popularity which rectifiers have gained during recent years.

As an example of the superiority of the mercury arc rectifier, it may be mentioned that the chief reason for not using d-c. voltages above 1500 volts for traction lies in the fact that this value is already close to the maximum which can reliably and safely be applied to one commutator of rotating converters. For higher d-c. voltages, two machines must be connected in series, which greatly reduces the efficiency, appreciably increases the initial cost of the installation, and introduces further operating difficulties. With rectifiers, this is not the case, as a single cylinder is capable of producing many times this voltage.

The fact that today there are in service throughout the world steel-enclosed rectifiers with a total capacity of more than 600,000 kw. is without doubt a proof of the soundness of the basic design of these devices. In Fig. 1 are shown the total installed capacities from year to year, and the fact that the steepness of the rise becomes greater year by year indicates the possibility that

1. Both of the American Brown Boveri Electric Corp., Camden, N. J.

Presented at the Regional Meetings of the A. I. E. E., Kansas City, Mo., March 18, 1927 and Bethlehem, Pa., April 21-23, 1927.

this device will soon largely replace all other forms of converters.

The field of application of the steel-enclosed mercury arc power rectifier is already very wide, as is clearly illustrated in Fig. 2. Mercury arc rectifiers are naturally used with greater advantage where their peculiar qualities meet the requirements of the service in question. To these classes of service belong installations subjected to large fluctuations in load and to heavy and short current peaks, such as main-line railways, street cars, subway and elevated railroads, rolling mills and the like. A comparison of the shaded areas in Fig. 2 shows that the use of rectifiers for street car and railroad service is twice as great as for all other purposes combined. The next largest field of application is for power and light. Then follow motors for rolling mills, special drives, shovels, dredges, elevators, and mining locomotives. The smallest application of rectifiers,

with Fig. 4, showing the relative sizes of the different types of rectifiers made at present by the Brown Boveri companies. Inspection of Fig. 3 and Type C in Fig. 4 reveals that the relative dimensions and arrangement of the various elements are practically identical in the 1914 and the present designs. In spite of the fact that there has been no great change in the basic structure of the rectifier, many refinements have nevertheless been

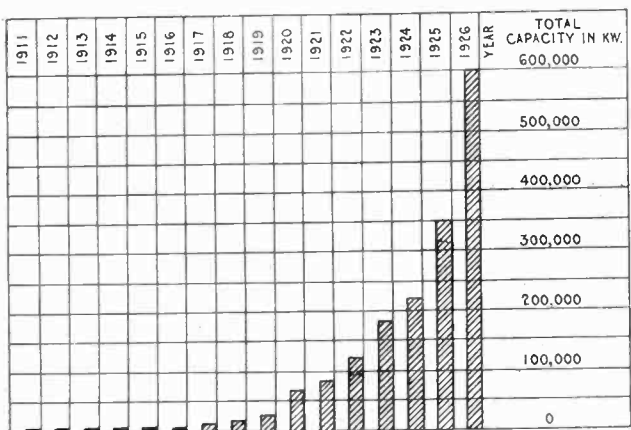

FIG. 1—GROWTH OF TOTAL CAPACITY IN KW. OF RECTIFIERS INSTALLED

because it is the newest, is for electrochemical purposes. Successful load tests have been carried out with rectifiers at d-c. voltages of 5000 volts and 8000 volts for special electrolytic purposes. Considerable study is being devoted to this field, and attention has naturally been given to assure safety of operation at the high voltages mentioned. These tests have shown that the limits of d-c. voltages for which rectifiers can be used are still unknown.

Installations on a commercial scale were begun in Europe in the year 1912, and then only in capacities of 100 kw. One of the earliest installations is shown in Fig. 3, which is for a municipal lighting plant, the direct current being employed for power and lighting purposes. This plant consists of four 6-anode rectifiers, each rated for 150 kw. at 220 volts. The supply current is three-phase, 50-cycle, 5250-volt. This installation was made in 1914 with three cylinders, the fourth being added later on.

Attention may be called to the fact that the principal elements in the design of the Brown Boveri type of rectifier have changed little during the past twelve years. This is evident at once when Fig. 3 is compared

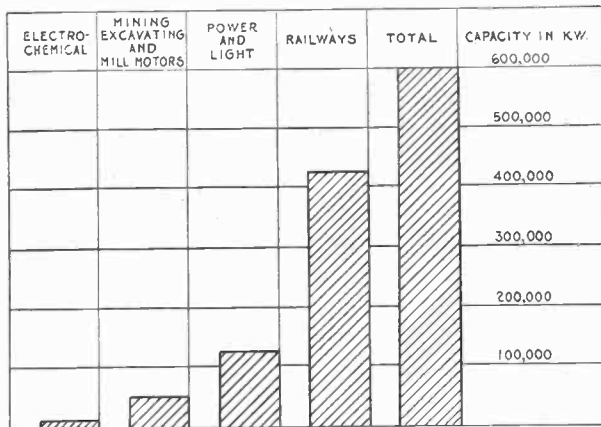

FIG. 2—DISTRIBUTION OF RECTIFIERS INSTALLED ACCORDING TO CLASSES OF SERVICE

made in the design of such details as cooling, anodes, seals, etc., and in the development of more suitable material. Improvements have also been made in the auxiliaries, which, together with the improvements in the rectifier proper, allow a far better utilization of the

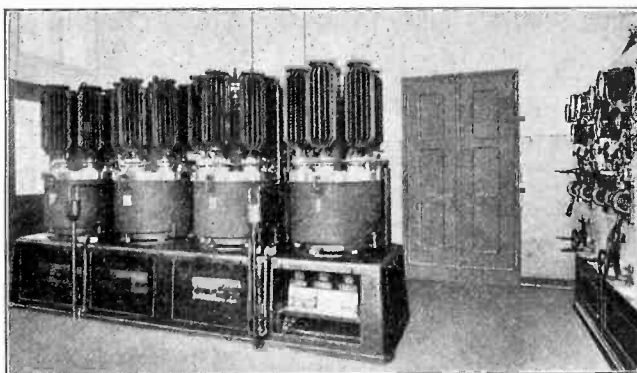

FIG. 3—ONE OF THE EARLIEST RECTIFIER INSTALLATIONS

device. These facts are mentioned merely to remove any possible impression which may exist that the mercury arc power rectifier is still an unfinished product in its first stages of development.

OPERATING FEATURES

The following figures might be of interest in connection with the operation of rectifiers.

The number of rectifiers operating in parallel with rotary converters and batteries, either in substations or over feeders, is about 900, distributed over approximately 450 installations, with a total rated capacity of more than 450,000 kw. Parallel operations of rectifiers with each other, with rotary converters, d-c. generators,

or batteries, is governed by the same principles as govern the parallel operation of d-c. generators. In accordance with the fundamental principles on which the operation of the rectifier depends, energy cannot flow from the d-c. to the a-c. network, since the current can pass only from the anode to the cathode. This fact is of considerable importance because a satisfactory parallel operation of rectifiers connected to two independent a-c. networks is thereby possible. The

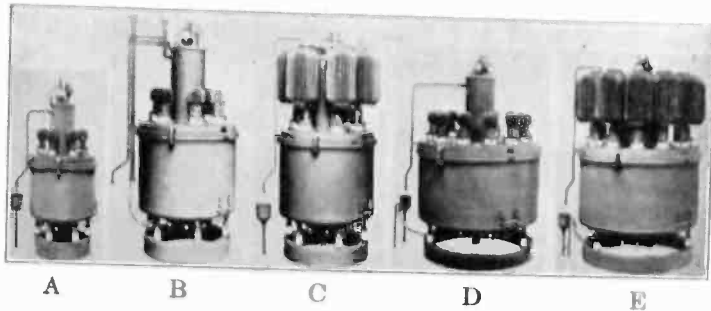

FIG. 4—RELATIVE SIZE OF A SERIES OF BROWN BOVERI TYPE RECTIFIERS

two networks are not restricted, in that they must have the same frequency, nor does a change in frequency affect safe operation, because a change in the frequency in one network will not cause motoring or other troublesome and dangerous occurrences in the rectifier, as would be the case in synchronous converters should they be connected to independent networks.

In regard to the adaptability of the rectifier to full automatic control, the fact that the total number of fully automatic substations reaches the appreciable figure of 100 may be of interest. Due to the simplicity

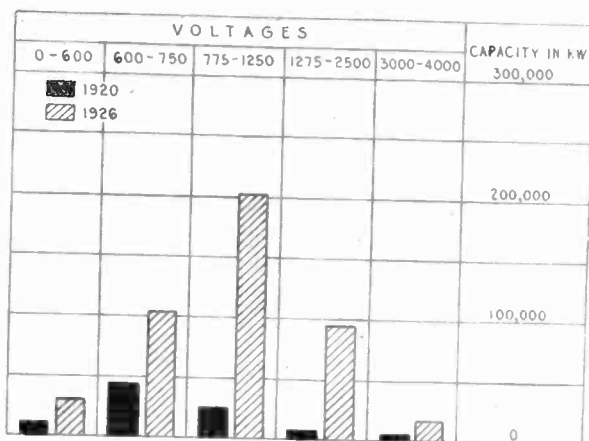

FIG. 5—DISTRIBUTION OF RECTIFIERS INSTALLED FOR RAILWAY SERVICE ACCORDING TO VOLTAGE

and speed of starting and stopping a mercury arc rectifier, this device lends itself to automatic control much more readily than a synchronous converter.

Another outstanding feature of the characteristics of the rectifier may be brought out here. As can be seen from Fig. 2, the application of rectifiers for railway service is far greater in respect to total capacity than for any other field; in fact, twice as much as for all other applications together. A most interesting fact in relation to railway service is illustrated in Fig. 5, in which the total capacity

rating of rectifier installations for railway service—including city, interurban, and main-line—at different voltages is given, for the years 1920 (solid areas) and 1926 (shaded areas), respectively. The solid areas show that the voltages most frequently used in 1920 lay between 600 and 750 volts, while the shaded areas show that in 1926 the average choice lay between 775 and 1250 volts. It is unquestionably true that the influence of the outstanding rectifier characteristics, consisting of reliable and safe operation at voltages above 600 volts and increased efficiency at the higher voltages, accounts in great part for this fact. The authors firmly believe that an even more pronounced effect of these characteristics on the selection of voltages for the electrification of railroads will soon be noticeable, and thus the mercury arc power rectifiers will soon exert an influence on the question of d-c. versus a-c. systems.

In support of this, the following figures, which show the advantages of a 2000-kw. mercury arc rectifier as compared to a 2000-kw. motor-generator set at 3000 volts d-c., both at nominal rating, may be adduced. Assuming a load factor of 40 per cent, which is common in railway service (800 kw. for 24 hours), a total of 19,200 kw-hr. is obtained, and, assuming a load characteristic of two hrs. at 150 per cent load, eight hrs. at 50 per cent load, eight hrs., at 30 per cent load, four hours at five per cent load, and two hrs. at no-load, the table below will illustrate the large saving which can be effected by employing a rectifier in place of a motor-generator set for this particular load characteristic.

Time (hrs.)	Load kw.	Efficiencies		Losses in kw-hr.	
		Rectifier	M. G.	Rectifier	M. G.
2	3000	97.0	90.8	185	600
8	1000	96.8	86.4	264	1260
8	600	95.5	81.8	266	1070
4	100	82.5	46	82	470
2	0			38	232
				795	3632

Hence, the saving effected during 24 hrs. amounts to 2837 kw-hr., and per year to 1,035,000 kw-hr. Assuming the cost of power to be one cent per kw-hr., an annual saving of about \$10,000.00 would be obtained, which would pay for the substation in a few years.

Additional savings in the annual costs would result from the use of a rectifier of the above rating in place of a motor-generator set on account of the lower initial cost of the rectifier, which is about 55 per cent of the cost of the motor-generator set, and on account of the lower cost of the substation, since the building required by the rectifier would be smaller, and would not need special foundations nor cooling ducts.

#### LOAD CHARACTERISTICS

The mercury arc rectifier is inherently a machine with a continuous rating, due to the very small masses



which can absorb and store up the heat produced during its operation. Due principally to the absence of all rotating parts, however, it has a high momentary overload capacity and can respond very quickly to these overloads due to the absence of the inertia of a magnetic field. Standard types of Brown Boveri rectifiers are shown in Fig. 4; their current and kilowatt ratings at various voltages, up to 5000 volts, are given by the curves in Fig. 6. At present they are built for voltages from 220 volts to 5000 volts d-c., and in capacities from 220 kw. to 2700 kw. The ratings given in Fig. 6 are

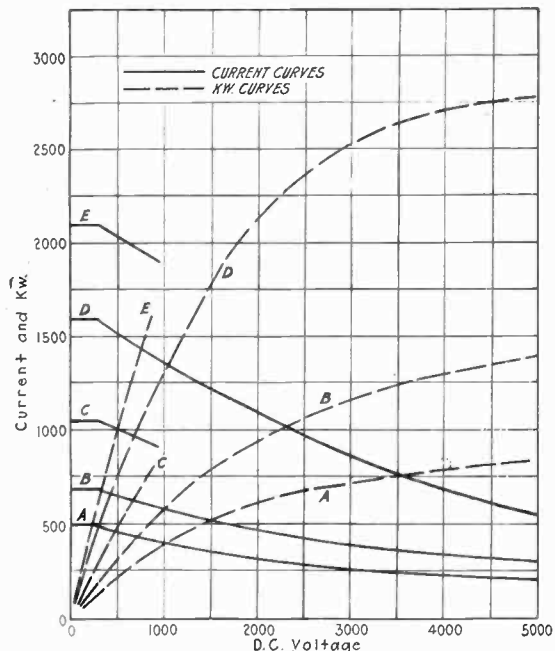

FIG. 6—LOAD CURVES OF BROWN BOVERI RECTIFIERS SHOWN IN FIG. 4

reduced somewhat if overloads of appreciable duration are required. In order to give a picture of the overloads which can be cared for by rectifiers, the following figures have been noted: Type D, shown in Fig. 4, has a continuous capacity of 1500 kw. at 1500 volts, with an overload capacity of 2250 kw. for 15 min., 3000 kw. for five min., and 4500 kw. for one minute. The significance of these figures may be better appreciated if it is realized that it would be possible to start and run a train of average size with one such unit, since it does not take more than 5 to 10 minutes to bring such a train up to speed.

It can be seen from Fig. 6 that the output for a given cylinder increases with the voltage. In spite of this fact, rectifiers are at present rated on the basis adopted for the rating of electrical apparatus and machinery before the advent of the mercury arc power rectifier. The authors believe that, in view of the fact that the field of application of rectifiers is constantly enlarging, it would be justifiable to take steps to work out standards of rating for rectifiers based on their peculiar characteristics rather than on those of rotating machinery. The curves for Types D and E show the characteristic fact that with increasing voltage the

kilowatt output increases in a straight line at first, but that the rate of rise decreases with further increases in the voltage.

The rectifier transformer serves the same purpose as the transformer for a synchronous converter; namely, to obtain the proper d-c. voltage and to split the primary power into the desired number of secondary phases. As is illustrated in Fig. 8, the d-c. voltage, during conversion, retains the caps of the sine wave of the a-c. supply voltage. It will be shown later that, in consequence of this, the amplitude and the frequency of the ripples depend on the number of phases, and that increasing the number of phases reduces the magnitude of the undulations. This is one of the reasons why the number of phases employed with rectifiers is relatively large: usually not less than six, and often as high as twelve. As the number of phases is increased, however, many complications enter into the design of the transformer, and its utilization decreases. This latter fact can easily be realized from a consideration of Fig. 8. The interval per cycle, during which the arc is maintained between the cathode and any one anode, decreases with a larger number of phases so that the time of utilization of each phase is shortened. During the other intervals, the phases are not under load and hence not fully utilized. Therefore, for a given d-c. output, the rating of the transformer will increase with the number of phases (see curve 3, Fig 9) which necessitates limiting the number of phases for economic reasons, at a reduction in the smoothness of the d-c. voltage wave. It is

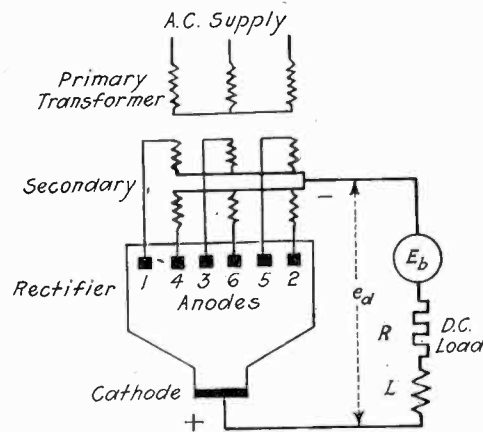

FIG. 7—SIX-PHASE RECTIFIER WITH GENERALIZED D-C. LOAD

therefore necessary to take into account a certain amount of undulation in the voltage wave of all rectifiers, and accordingly we shall look into this question more thoroughly in the next part of this paper.

The various applications and present status of steel-enclosed mercury arc rectifiers have been dealt with in the first part of this paper. We shall consider now the characteristics of the rectifier as affected by the character of the load and electrical conditions on the d-c. side, for the various applications.

## VOLTAGE WAVE

In a preceding paper by one of the present authors<sup>2</sup>, the current and voltage relations in circuits of polyphase rectifiers were derived with the assumption that the direct-current wave is a straight line. While this assumption leads to sufficiently accurate results, for all practical purposes, insofar as the relations of voltage, current and power on the d-c. and a-c. sides of the rectifier are concerned, and is entirely justified when there is a considerable amount of inductance on the d-c. side, yet in some cases the undulations in the d-c. current and voltage waves become a factor worth considering, as will be brought out later on.

In a polyphase rectifier, the load current at any

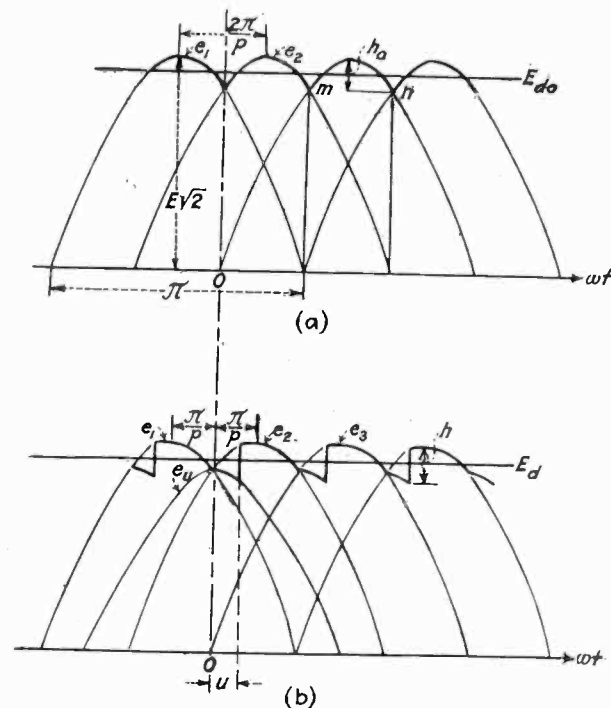

FIG. 8—RECTIFIER D-C. VOLTAGE WAVE AT (A) NO LOAD, AND (B) FULL LOAD

instant is carried by the anode having the highest positive potential with respect to the neutral of the transformer secondary. The d-c. voltage wave at no-load has the form shown in Fig. 8A. The undulation of the (voltage) wave is formed by the caps of sine waves of the transformer secondary phase voltages. As each phase assumes a maximum positive potential once during every cycle, the number of pulsations per cycle must be equal to the number of phases, and the frequency of pulsation or the number of pulsations per second must be equal to the product of the frequency of the a-c. supply and the number of secondary phases.

If the transformer, the a-c. line, and generator supplying the rectifier were free of reactance, each anode of a  $p$ -phase rectifier would carry the whole d-c. current during  $\frac{2\pi}{p}$  part of a cycle only; thus, in Fig. 8, the

whole load current would be transferred instantly from phase 2 to phase 3 at  $m$  and from phase 3 to phase 4 at  $n$ . Under such conditions, the d-c. voltage wave under load would have the same form as at no load.

Due to the unavoidable reactance present in the transformer, the current cannot die down nor build up instantly in any phase. As a result, there are intervals during which two adjoining phases carry current simultaneously, as the current in one phase is dying down and the current in the other is building up. This period of overlapping between two adjoining phases begins at the intersection of their respective sine waves and continues until the current in the leading phase becomes zero. The angle of overlap  $u$  is given by the expression

$$\cos u = 1 - \frac{IX}{E\sqrt{2}\sin\frac{\pi}{p}} \quad (1)$$

in which  $I$  is the direct current,  $X$  the reactance per phase of transformer secondary<sup>3</sup> at the primary frequency,  $E$  the effective value of phase voltage, and  $p$  the number of secondary phases.<sup>4</sup>

The d-c. voltage during the period of overlapping is equal to the mean of the overlapping phase voltages.

Using the point of intersection of phase voltages  $e_1$  and  $e_2$  (Fig. 8B) as the origin, these voltages may be expressed by

$$e_1 = E\sqrt{2}\cos\left(\omega t + \frac{\pi}{p}\right) \quad (2)$$

$$e_2 = E\sqrt{2}\cos\left(\omega t - \frac{\pi}{p}\right) \quad (3)$$

The d-c. voltage during the period of overlapping is

$$e_u = \frac{e_1 + e_2}{2} = E\sqrt{2}\cos\frac{\pi}{p}\cos\omega t \quad (4)$$

When the period of overlapping is over, the d-c. voltage is equal to the voltage of the working phase.

The average d-c. voltage  $E_d$  (including the constant drop in the arc), is given by the expression

$$E_d = \frac{E\sqrt{2}\sin\frac{\pi}{p}}{\pi/p} - \frac{IX}{2\pi/p} \quad (5)$$

The first term to the right of eq. (5) is the average d-c. voltage at no-load; the second term is the voltage drop at load current,  $I$ . The rectifier d-c. voltage wave under load is shown in Fig. 8B. Oscillograms Nos. 1 and 2, Fig. 13, show rectifier voltage waves at no-load and full load, respectively.

The magnitude of the angle of overlap, and therefore

3. Including equivalent reactance of transformer primary and line.

4. For derivation of eqs. (1) and (5) see paper mentioned in footnote 2.

2. Rectification of Alternating Currents, by O. K. Marti, A. I. E. E., JOURNAL, Sept. 1926, Vol. 45, pp. 832-846.

the shape of the d-c. voltage wave under load depend somewhat on the nature of the load. Eq. (1) was derived on the assumption that the current curve is a straight line. The angle  $u$  will be greater or less than that given by eq. (1) depending on whether the current during the period of overlap is greater or less than the average current. The difference, however, is negligible, and the voltage wave is assumed to be independent of the character of the load.

The total height,  $h$ , of the ripple in the voltage wave is equal to the difference between the maximum and minimum ordinates of the wave. From Fig. 8B, it is readily seen that for values of  $u < \frac{\pi}{p}$ , the maximum

ordinate is equal to the amplitude of  $e_2$ , while the minimum ordinate is equal to the value of  $e_u$  for  $\omega t = u$ .

Therefore,

$$\begin{aligned}
 h &= E\sqrt{2} - E\sqrt{2} \cos \frac{\pi}{p} \cos u \\
 &= E\sqrt{2} \left( 1 - \cos \frac{\pi}{p} \cos u \right) \quad (6)
 \end{aligned}$$

Expressing  $h$  as a fraction  $a$  of the average d-c. voltage at no-load (see eq. (5)),

$$\begin{aligned}
 a &= \frac{h}{E\sqrt{2} \sin \frac{\pi}{p} / \frac{\pi}{p}} \\
 &= \frac{E\sqrt{2} \left( 1 - \cos \frac{\pi}{p} \cos u \right)}{E\sqrt{2} \sin \frac{\pi}{p} / \frac{\pi}{p}} \\
 &= \frac{1 - \cos \frac{\pi}{p} \cos u}{\sin \frac{\pi}{p} / \frac{\pi}{p}} \quad (7)
 \end{aligned}$$

For values of  $u > \frac{\pi}{p}$ , the maximum ordinate is equal to the value of  $e_2$  for  $\omega t = u$ , and the minimum ordinate to the value of  $e_u$  for  $\omega t = u$ . Therefore

$$\begin{aligned}
 h &= E\sqrt{2} \cos \left( u - \frac{\pi}{p} \right) - E\sqrt{2} \cos \frac{\pi}{p} \cos u \\
 &= E\sqrt{2} \sin \frac{\pi}{p} \sin u \quad (8)
 \end{aligned}$$

$$a = \frac{E\sqrt{2} \sin \frac{\pi}{p} \sin u}{E\sqrt{2} \sin \frac{\pi}{p} / \frac{\pi}{p}} = \frac{\pi}{p} \sin u \quad (9)$$

The variation of the ripple in the d-c. voltage wave

with the number of phases, at no load, is shown by Curve 1 in Fig. 9. In the same figure are plotted the frequency of the main ripple and the ratio of the transformer rating to d-c. load, to show the effect of the number of phases used on these quantities. The magnitude of the ripple naturally decreases as the number of phases is increased; but to counterbalance that, the size of the transformer increases with the number of phases. Furthermore, the frequency of the ripple increases with the number of phases, which is often objectionable.

In Fig. 10 are shown the variations of the voltage ripple of a six-phase rectifier with the load on the

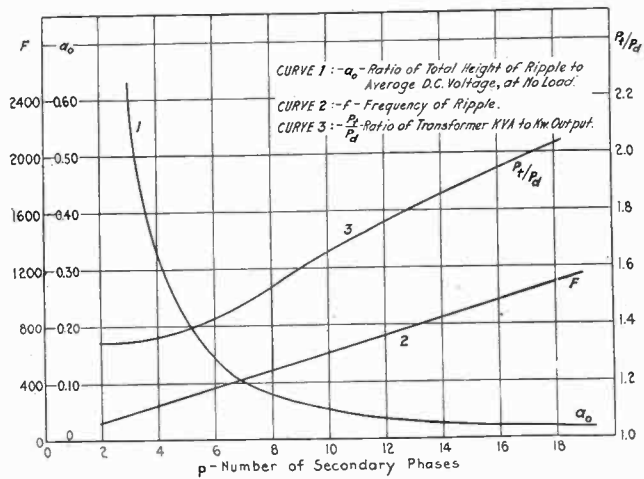

FIG. 9—CURVES SHOWING VARIATION IN RIPPLE HEIGHT, RIPPLE FREQUENCY AND TRANSFORMER KV-A. WITH THE NUMBER OF PHASES USED.

rectifier. The curves have been plotted from eqs. (7) and (9). The load is expressed as a ratio,  $I/I_s$ . This ratio is deduced by rewriting eq. (1) as follows:

$$\cos u = 1 - \frac{I}{\frac{E\sqrt{2}}{X} \sin \frac{\pi}{p}} = 1 - \frac{1}{\sin \frac{\pi}{p}} \cdot \frac{I}{I_s} \quad (10)$$

(7) where  $I_s = \frac{E\sqrt{2}}{X}$ .

The point on the abscissa corresponding to full-load current of a rectifier is determined by the value of  $X$ , and therefore depends upon the design of the transformer. The smaller the value of  $X$  for a given transformer rating, the larger is  $I_s$ , and therefore the smaller the ratio  $I/I_s$  at full load. The value of  $I/I_s$  corresponding to full load is approximately 0.05.

CURRENT WAVE

It was shown above that the form of the rectifier d-c. voltage wave depends on the number of phases used and on the design of the transformer, and that it varies with the magnitude of the load; but is practically independent of the nature of the load. The wave consists of a d-c. component equal to the average value of the voltage, on which is superimposed an alternating component

made up of the upper portions of sinusoidal waves. The alternating component is irregular in shape and cannot be expressed by a continuous function. It may be resolved into harmonic components by means of a Fourier series. The first harmonic has a frequency equal to the product of the frequency of the a-c. supply and the number of phases used; it is therefore the  $p$ th harmonic with respect to the a-c. voltage supplied to the rectifier. The frequencies of the higher harmonics are multiples of the frequency of the first harmonic and since the positive and negative portions of the wave are not symmetrical, there are even multiples as well as odd. Thus, the d-c. voltage wave of a six-phase rectifier supplied by a 60-cycle system has an alternating component consisting of sinusoidal waves of frequencies 360, 720, 1080, etc., cycles.

The general equation of the d-c. voltage of a  $p$ -phase rectifier, expressed in a Fourier series, is

$$e_d = E_d + A_{p1} \sin p \omega t + A_{p2} \sin 2 p \omega t + A_{p3} \sin 3 p \omega t + \dots + A_{pn} \sin n p \omega t + \dots + B_{p1} \cos p \omega t + B_{p2} \cos 2 p \omega t + B_{p3} \cos 3 p \omega t + \dots + B_{pn} \cos n p \omega t + \dots \quad (11)$$

The voltage curve may be analyzed to determine the amplitudes of the various harmonics by any one of the well-known methods of analysis.

A typical analysis of the alternating component in the d-c. voltage wave of a 60-cycle 6-phase rectifier under load, with and without a series reactor on the d-c. side, is given in the table below:

Order of harmonic	Frequency in cycles per sec.	Per cent amplitude of harmonic to d-c. voltage	
		Without reactor	With reactor
First	360	8.46	2.36
Second	720	1.70	0.40
Third	1080	0.95	0.28
Fourth	1440	1.05	0.17
Fifth	1800	0.71	0.12
Sixth	2160	0.58	0.10
Seventh	2520	0.45	0.09
Eighth	2880	0.39	0.08

When the voltage wave with its d-c. and a-c. components is known, the shape of the current wave may readily be determined when the constants of the load are known.

A six-phase rectifier with a generalized d-c. load is shown in Fig. 7. The load may consist of one of the following combinations.

1. Resistance only ( $R$ ).
2. Resistance and back-e. m. f. ( $R + E_b$ ).
3. Resistance and inductance ( $R + L$ ).
4. Resistance, inductance, and back-e. m. f. ( $R + L + E_b$ ).

1. *Resistance only.* With a load consisting of resistance only, such as a lighting or heating load, the current wave has the same shape as the voltage wave; *i. e.*, the

harmonic components in the ripple bear the same ratios to the average value of current as in the voltage wave.

2. *Resistance and back-e. m. f.* With a load consisting of resistance and a constant back-e. m. f., such as a battery, the shape of the current wave depends upon the relative magnitude of the average d-c. voltage,  $E_d$ ,

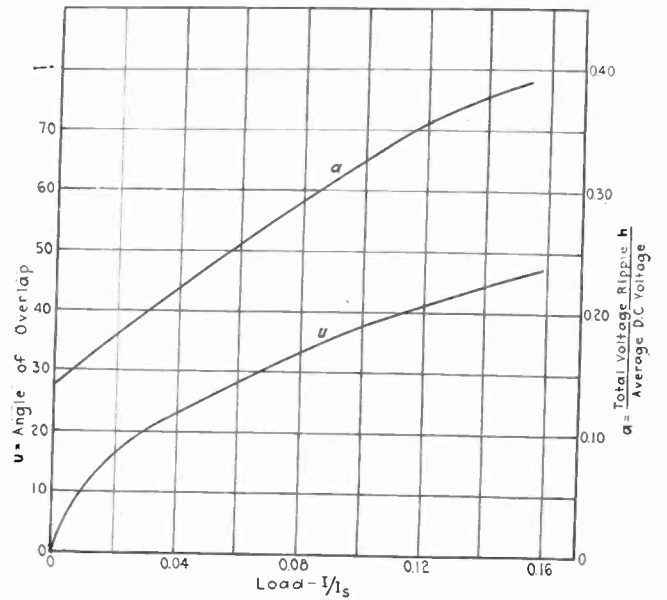

FIG. 10—CURVES SHOWING VARIATION OF THE ANGLE OF OVERLAP AND HEIGHT OF RIPPLE WITH THE LOAD

and the back-e. m. f.,  $E_b$ . The conditions are shown in Fig. 11. The current is produced by the portion of the voltage wave lying above the line  $b b'$ , the average value of which is  $E_d - E_b$ . The ratio of the height  $h$  of the ripple to this voltage is greater than its ratio

to  $E_d$  (eqs. 7 and 9) in the proportion of  $\frac{E_d}{E_d - E_b}$ . The

ripple in the current wave, therefore, has the same shape as that of the voltage wave; but the percentage of

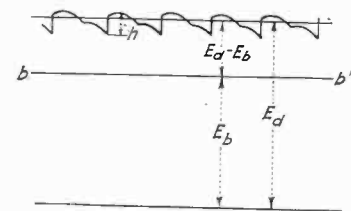

FIG. 11—VOLTAGE CONDITIONS OF RECTIFIER SUPPLYING A LOAD HAVING A BACK ELECTROMOTIVE FORCE

the current ripple is greater than that of the voltage

ripple in the ratio,  $\frac{E_d}{E_d - E_b}$ .

3. *Resistance and inductance.* With a load consisting of resistance and inductance, such as a lighting or heating load fed over a line having a certain amount of inductance, or with a series reactor connected into the d-c. circuit for smoothing out the wave, the average d-c. current is equal to the ratio of average d-c. voltage to the resistance:  $I_d = E_d/R$ . The amplitude of the  $n$ th

harmonic in the current ripple, however, is equal to the height of the corresponding harmonic in the voltage ripple divided by the impedance of the circuit to that harmonic:

$$I_n = E_n / \sqrt{R^2 + X_n^2}$$

From the above,

$$\begin{aligned} \frac{I_n}{I_d} &= \frac{R}{\sqrt{R^2 + X_n^2}} \cdot \frac{E_n}{E_d} \\ &= \frac{1}{\sqrt{1 + X_n^2/R^2}} \cdot \frac{E_n}{E_d}, \end{aligned} \tag{12}$$

i. e., the percentage of the  $n$ th harmonic in the current wave is less than that of the corresponding harmonic

in the voltage wave by the ratio of  $\frac{1}{\sqrt{1 + \frac{X_n^2}{R^2}}}$ , in

which  $X_n = p n L$  is the reactance of the circuit to the  $n$ th harmonic. It is seen from the above that the inductance has a smoothing effect upon the current wave, and the smoothing action is greater for the higher harmonics.

4. *Resistance, inductance, and back-e. m. f.* This type of load is by far the most common load supplied by rectifiers, as it is characteristic of all d-c. motors. While starting, when the speed of the motor is zero, the back e. m. f. is also zero, and the load conditions are as given under 3. When the motor is running, a back e. m. f. is generated, in opposition to the applied e. m. f.; the voltage conditions are then as shown in Fig. 11. The current is produced by the portion of the voltage curve lying above line  $b b'$ , as for load 2. The load here, however, is inductive and the current wave is consequently smoothed. The average d-c. current,

$$I_d = \frac{E_d - E_b}{R}$$

The amplitude of the  $n$ th harmonic in the current wave,

$$\begin{aligned} I_n &= E_n / \sqrt{R^2 + X_n^2} \\ \frac{I_n}{I_d} &= \frac{R}{\sqrt{R^2 + X_n^2}} \cdot \frac{E_n}{E_d - E_b} \\ &= \frac{1}{\sqrt{1 + \frac{X_n^2}{R^2}} \cdot \left(1 - \frac{E_b}{E_d}\right)} \cdot \frac{E_n}{E_d} \end{aligned} \tag{13}$$

From eq. (13) it is seen that the percentage of the  $n$ th harmonic in the current wave is smaller than the corresponding harmonic of the voltage wave in the proportion of

$$\frac{1}{\sqrt{1 + \frac{X_n^2}{R^2}} \cdot \left(1 - \frac{E_b}{E_d}\right)}$$

the symbols having the same meaning as in eq. (12).

The series d-c. motor, used for railways, hoists, etc., is the most common motor fed by rectifiers; in fact, it is the favorable characteristics of the series, d-c. motor for traction purposes which have brought about the present large scale conversion from a-c. to d-c. The series motor is also the most favorable load for smoothing out the ripples in the current wave, due to the inductance of the series field of the motor. In oscillogram No. 3, Fig. 13, are shown the voltage and current waves of a rectifier supplying a railway load. The oscillogram was taken on a 1500-volt rectifier at 200 per cent of the rated load when the voltage ripple is greater than at rated load, and shows the smoothing effect of the series motor on the current wave.

A further smoothing out of the current, and also of the voltage wave supplied to the line can be realized by connecting a reactor into the d-c. lead of the rectifier. The smoothing of the voltage wave is produced by the a-c. voltage drop across the reactor, due to the ripple in the current. The effect of the reactor on the current

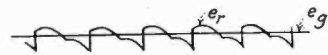

FIG. 12—VOLTAGE CONDITIONS OF RECTIFIER OPERATING IN PARALLEL WITH ROTARY CONVERTER OR D-C. GENERATOR

and voltage waves supplied to the line by a rectifier is shown in oscillogram No. 4, Fig. 13. The oscillogram was taken at approximately the same load and under the same conditions as oscillogram No. 3, except that a series reactor of approximately 3 millihenrys was connected into the circuit when oscillogram No. 4 was taken.

When a rectifier operates in parallel with a rotary converter or a d-c. generator which has a smoother voltage wave than the rectifier, the resultant line voltage and current waves are smoother than those of a rectifier alone. This condition is shown in Fig. 12. In this sketch,  $e_r$  is the voltage wave of the rectifier and  $e_g$  that of the rotary machine. For the sake of simplicity, the commutator ripples of the rotary machine are not shown. The smoothing of the voltage wave is produced by the interchange of a small alternating current between the rectifier and the rotary machine.

The interchange current is produced by the alternating component in the difference of the two voltage waves. The a-c. voltage drop in the reactance of the rectifier transformer, produced by the a-c. current component flowing between the rectifier and rotary machine, reduces the ripple in the voltage wave of the rectifier. In this respect, the rotary acts somewhat as a shunt

condenser across the rectifier in that it absorbs an alternating component.

When a series reactor is connected into the d-c. lead of a rectifier operating in parallel with a rotary, the wave of line voltage is improved on account of the additional drop in the reactor due to alternating interchange current.

The above conditions are clearly shown in oscillo-

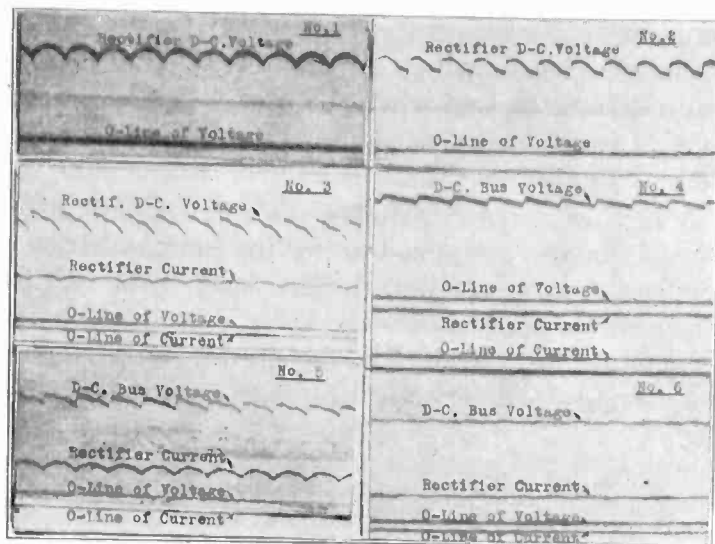

FIG. 13—OSCILLOGRAMS OF VOLTAGES AND CURRENTS OF A 1500-Kw., 1500-VOLT RECTIFIER

- No. 1. D-c. voltage wave at no load.
- No. 2. D-c. voltage wave under load.
- No. 3. Waves of voltage and current supplied to railway load, rectifier working alone.
- No. 4. Waves of voltage and current supplied to railway load, rectifier working alone with a series reactor.
- No. 5. Waves of voltage and current supplied to railway load, rectifier working in parallel with rotary converter in the same station.
- No. 6. Waves of voltage and current supplied to railway load, rectifier working in parallel with rotary converter in the same station and with a series reactor in the rectifier circuit.

grams 5 and 6, Fig. 13. Oscillogram No. 5 was taken with a rectifier operating in parallel with a rotary in the same station. Oscillogram No. 6 was taken at about the same current and under the same conditions as oscillogram No. 5, except that there was a series reactor in the rectifier circuit.

The effect of various load conditions on the wave form of rectifier voltage and current having been discussed, it might be of interest to mention here that extensive tests have been carried out to determine the effect of the undulations in the waves upon the load connected to a rectifier. For this purpose, batteries and shunt-wound and series-wound motors were connected, first to a battery (*i. e.*, a constant d-c. voltage supply), then to a rectifier fed, respectively, by a single-phase, three-phase, and six-phase a-c. supply. With six-phase operation, no difference in the efficiency as compared to operation on a battery could be noticed in the case of either motor; nor did the undulations have any effect upon commutation.

It can readily be seen that the undulations in the d-c.

voltage will have no effect upon the usual lighting circuits, since the frequency of the undulations is high and their magnitude small as compared to the 60-cycle a-c. voltage used for lighting.

The presence of these ripples in the d-c. voltage wave of a rectifier, particularly the harmonics lying within the audible frequency band, has raised the question of their influence upon neighboring communication circuits. This influence has been detected in connection with about 5 per cent of all installations and was found to be due either to close spacing between communication circuits and rectifier feeders, to bad insulation conditions, or to a grounded method of operation on part of the communication system for certain types of service. The cause of the interference is similar to that which results in disturbances in communication or signaling circuits which parallel high-voltage supply lines at small separations and for long distances; *i. e.*, induced or leakage currents and voltages due to harmonics in the voltage wave. When, as in the case of street railway systems, one side is permanently grounded, the ripples may appear in the communication circuits, especially when the method of operation or interconnection involves grounded equipment, wet soil conditions aggravating the case materially. The problem may be solved by the elimination of the exposure, the employment of a non-grounded method of operation or interconnection, or the utilization of a so-called filter, which consists of a combination of inductance and capacitance, so arranged in the circuit as to smooth out the high-frequency ripples in the voltage wave of the rectifier. To the knowledge of the authors, such filters have been found necessary in but few cases. The subject is merely mentioned here, as a thorough discussion of the question would lead beyond the scope of this paper.

## COUNTRY IS ALWAYS HUNGRY FOR MORE ELECTRIC POWER

The United States is continuing its steady increase in demand for electricity. The government figures for power production for the month of May have just been issued showing that the country in that month used 6,515,570 kw-hr. of current. This is almost exactly 11 per cent greater than the May power consumption a year ago, and 1 per cent ahead of April of this year.

The usual balance was maintained as between power generated by falling water and power generated by fuel-burning plants. In May, waterpower produced 2,632,333 kw-hr. of energy and fuel 3,883,197 kw-hr. In the fuel plants were consumed 3,234,000 tons of coal, 510,000 barrels of oil and 4,829,000,000 cu. ft. of gas.

The nation's power plants use more coal and gas and less oil than they did. Coal consumption during May jumped from 85,000 tons to 104,000 tons a day and gas from 62,000,000 cu. ft. to 155,000 cu. ft. per day, but oil has dropped from 23,000 barrels to 16,800 barrels.

## Discussion at Winter Convention

### SYNCHRONOUS MACHINES—III

(DOHERTY AND NICKLE)

NEW YORK, N. Y., FEBRUARY 7, 1927

**J. F. H. Douglas:** I wish to ask a question regarding the paragraph which reads, "It will be observed that the slope of the dotted line is still positive beyond the maximum power point of stable, steady-state operation. This means that if a machine were operating beyond the angle corresponding to maximum, steady-state power, say at 100 electrical degrees, the machine would be stable under sudden changes, although the steady-state characteristics at that point indicate instability." I am somewhat curious to know under what operating conditions, if any, this becomes of interest?

The curve in Fig. 7 involves not only  $\sin \delta$  but also  $\sin 2\delta$ ; that is, it quite obviously contains a second harmonic. I believe this is fully recognized in the paper, and I simply wish to call attention to the fact that most textbooks do not recognize the existence of this second component, and that it is very important that it should be recognized inasmuch as it greatly increases torques in the stable operating range.

**R. D. Evans:** I was much interested in the question raised about the increased power limit obtainable by means of automatic control of excitation. I interpret the answer given by Mr. Nickle as giving essentially the same idea as what was incorporated in the term "artificial stability," a term coined by Mr. Shand in 1924. At that time it was thought impossible in actual operation to obtain a condition of increased power limits by that process.

Subsequently we made tests of a somewhat similar nature to that described by Mr. Nickle. These test results given in the closing discussion<sup>1</sup> on the Evans and Wagner paper at the 1926 Midwinter Convention, were the first experimental verification of the fact that increased power limits were actually obtainable. I might liken the condition of increased stability by control of the excitation to the process of maintaining equilibrium by the *artificial* process of juggling. Up to 90 deg., or actually somewhat less, it is possible to obtain stable operation *inherently*. Beyond that point, equilibrium may be maintained *artificially* but it is necessary to use automatic devices. This corresponds to the action of a juggler in making a corrective action after the system has started to pull out. This action on a power system is possible because of the time required for the system to pull out of step.

In the presentation Mr. Nickle described a mechanical system. We, too, have found such a system to be very good for the purpose of visualizing the actions taking place during the transients. Analytically, the actions are quite complicated, but they can be understood by a suitable mechanical model by adding inertia to the vector arms, and a spring connecting them. Mr. Griscom described a system of this general character in an article entitled "A Mechanical Analogy to the Problem of Transmission Stability" *Electric Journal*, May 1926. I notice that Mr. Nickle has described the addition of a dashpot to the arrangement which makes it possible to simulate the condition of the demagnetizing action in a machine, which changes the internal e. m. f. and brings about the change of machine reactance from leakage to synchronous reactance.

**W. V. Lyon:** Mr. Doherty and Mr. Nickle have presented in this paper an ingenious method for analyzing, what I believe to be, a very difficult problem. They have founded their analysis on what seem to be a reasonable set of premises. These premises have been so well chosen that in the subsequent mathematical work it is necessary to make but one simplifying assumption in order to arrive at a final result that is not unduly complicated. Whether or not this method of analysis produces accurate

results can be determined only by laboratory experiment, and it is to be regretted that such data are not available at the present time. In fact we have at the Massachusetts Institute of Technology measured the torque-angle characteristic of a small synchronous motor when the load torque varies cyclicly. To be more exact we measured the power-angle characteristic, although there is but little difference between the two. Unfortunately I have had no opportunity to compare these results with Mr. Doherty's calculations.

In the third part of their paper where they consider the question of synchronizing out of phase, I should much prefer to see them follow the methods that have already been developed for computing the transient currents in a three-phase synchronous generator. The first shock on the machine, coming as it does within the time of one cycle, would probably occur before the rotor has swung more than a negligible amount. The methods to which I refer are based on the differential equations which apply to synchronous machines, whereas Messrs. Doherty's and Nickle's treatment has no such fundamental background. Since, however, the differential equations assume certain ideal conditions that do not exist, it is possible that their method will actually give better results. Here, again, laboratory experience only can decide.

I should like to suggest another method of attacking this problem. The premises upon which it is based are much the same as the authors have chosen. Briefly the assumption is that the vector diagrams which are used to explain the steady-state operation may also be used when the angular velocity of the rotor is not constant. The actual condition of operation can be resolved into two component conditions of operation as follows. First, consider that the armature is short-circuited and that normal excitation voltage is impressed on the field. The determination of the armature and field currents is a simple process even if the angular velocity of the rotor is slowly changing. Next, consider that the field winding is short-circuited and that normal polyphase voltage is impressed on the armature. Here we have an induction motor with an unsymmetrical rotor winding. The determination of the armature and field currents is again a fairly simple process which is well understood. It is only necessary to assume that the currents are determined by the actual angular velocity of the rotor and are not affected by its acceleration. Laboratory experiments alone can determine whether this assumption is reasonable. Under the actual condition of operation both of these components of current exist simultaneously and the resultant torque can be computed without much difficulty. We can then set up the differential equation which equates the electromagnetic torque developed equal to the sum of the torques acting on the shaft and that due to the acceleration of the rotor. Although I have had no opportunity to make this solution in detail I have gone far enough to see that there are no insurmountable difficulties in the path.

**H. V. Putman** (communicated after adjournment): It would seem that the damping torque calculated by the authors is not the actual damping torque of the motor. Actually, the damping torque is proportional to the rate of change of only that part of the displacement between the pole and the electrical field, while the damping torque calculated by the authors is proportional to the rate of change of the total displacement. Such a radical departure from the accepted ideas about this problem, is at least, worthy of further explanation.

There is another peculiar thing about this damping torque  $T_d$  calculated by the authors. It was obtained by substituting in a formula for the synchronizing torque derived under the assumption of steady-state conditions. They state that equation (11) which is the synchronizing torque under steady conditions, gives the torque not merely for the steady state but for any conditions within the premises when the actual values of the nominal

1. A. I. E. E. JOURNAL, September, 1926, p. 887.

voltages and the displacement existing at the moment under consideration, are substituted. Substituting these values for the oscillatory condition in this formula, for the synchronizing torque, gives a vector expression of which one term is the synchronizing torque, and the other, so the authors claim, is the damping torque. It at least seems peculiar that one could obtain a damping torque by substituting in a formula for the synchronizing torque, derived under steady-state conditions and one would be inclined to question the premises which could lead to these conclusions.

If I understand the paper correctly, it seems to me that the fundamental assumption made by the authors, is unjustifiable. They assume that the whole phenomenon discussed in part A can be handled as the result of two transformer actions, one taking place in line with the pole, and the other in line with the inter-polar space. The armature current has been resolved into two components, one in line with the average position of the field pole, the other in line with the average position of the inter-polar space. The modulation of these components of current causes the armature reactions produced by them to pulsate in magnitude. So the armature reaction produced by the direct component of current, for instance, pulsates in magnitude in line with the average position of the field pole. It is not in line with the field pole at every instant of time, as assumed by the authors, and hence, it would seem that the phenomenon can not be calculated as a simple transformer action if the damping torque is to be obtained correctly. If this assumption is not made, the problem might become more complicated but the damping torque, would, in all probability be found to depend on only that part of the displacement between the pole and the electrical field.

I think that the mathematical work from equation (14) to (21) could be much simplified as follows:

$\Delta T$  is the pulsating motor torque resulting from an oscillation  $\Delta\delta$  which was shown to be a harmonic function of  $st$  that is  $\Delta\delta$  is a function of the type

$$A \sin st + B \cos st \quad (1)$$

and the total motor torque is of the form

$$\Delta T = T_s \Delta\delta + T_d \Omega \quad (2)$$

but since  $\Delta\delta$  is an harmonic function of  $st$ , it is evident that:

$$\Delta\delta = -\frac{j}{s} \frac{d}{dt} \Delta\delta \text{ or } \Delta\delta = -\frac{j}{s} \Omega \quad (3)$$

substituting (3) in (2) gives  $\frac{\Delta T}{\Omega} = T_d - \frac{j}{s} T_s$

which is the author's equation (21).

I found the explanation given in the paper for this part of the work, more confusing than clarifying, because of the confusion of the units involved. For instance, the well-known equation for torque consumed in any mechanical system, which is the authors' equation (16) involves torque in foot-pounds, and time in seconds and angular velocity in mechanical radians per second. Also equation (17) involves time in seconds and when

one puts  $\frac{d}{dt} = j\omega$ , the differentiation is with respect to time in seconds.

I have been much interested in this percentage representation of the time unit, but it seems to me that the use of time expressed as a fraction of the time corresponding to one electrical radian at normal frequency, is actually somewhat cumbersome. For instance, if time is in seconds, one obtains the damping torque in units of torque per radian per second, and one can mark his answer exactly what it is. But how does one express damping torque in the time units used by the authors? They define it as "the damping constant, torque corresponding to unit electrical angular velocity." Unit electrical angular velocity is the angular velocity in electrical radians per second, divided by  $\omega$  so that when one obtains the damping torque in the units used by the

authors, he is rather puzzled as to how it is to be used until it has been transferred into electrical radians per second or some other tangible unit which can be defined.

**R. H. Park:** Mr. Putman states in his discussion that "Actually, the damping torque is proportional to the rate of change of only that part of the displacement between the pole and the electrical field, while the damping torque calculated by the authors is proportional to the rate of change of the total displacement. Such a radical departure from the accepted ideas about this problem, is at least, worthy of further explanation."

The explanation of this phenomenon is as follows: At any given frequency of motion of the rotor there will exist a harmonic electrical torque on the rotor of the same frequency and proportional to the amplitude of oscillation, the constant of proportionality depending in general on the frequency of oscillation. In general, there will be a difference in the time phase of the torque and the displacement. The total harmonic torque, however, may be broken up into two components, one in time phase and one in time quadrature with the displacement of the rotor. The component in time phase with the total displacement is referred to as the synchronizing component of torque. The component in time quadrature is referred to as the damping component of torque, because it is in time phase with the rate of change of displacement—i. e., in time phase with the velocity. Therefore it is quite clear that at any given frequency of oscillation the electrical torque is capable of being expressed as

$$(a \text{ constant}) \times (\text{total displacement}) + a \text{ constant} \\ \times (\text{rate of change of total displacement}).$$

It is also true, as shown below, that at any given frequency of oscillation the torque may be expressed as

$$(a \text{ constant}) \times (\text{relative displacement of magnetic field and pole}) + (a \text{ constant}) \times (\text{rate of change of relative displacement of magnetic field and pole}).$$

Since, at any given frequency the relative displacement of the field and pole is in constant relation to the total displacement of the rotor provided that the oscillations are small as was assumed.

Mr. Putman also raises a question as to the reasonableness of the process by which the synchronizing and damping components of torque were calculated by substituting in the steady-state formula for synchronizing torque. The legitimacy of this method of calculation is explained most simply from the following considerations.

1. The electrical torque on the rotor depends only on the instantaneous distributions of flux and current in the machine.
2. Neglecting armature resistance, the distribution of flux and current in a machine, and therefore also the magnitude of torque, are known uniquely when the magnitude of the direct and quadrature nominal e. m. fs., terminal e. m. f., and the displacement angle between the rotor and the terminal e. m. f. are known. (It is to be noted that nominal voltage is to be interpreted as the percent armature flux linkages due to the direct component of field current, quadrature nominal voltage similarly and terminal voltage as the percent total armature linkages).

3. Although the formula in question was originally derived in the study of the magnetic torque under steady conditions of operation, and was therefore expressed in terms of the nominal and terminal voltages and the displacement angle, nevertheless, since the torque, at any instant, actually depends only upon the instantaneous values of these quantities, it follows, as stated in the paper, that the formula may be extended in scope so as to cover variable conditions of operation.

Since the formula expressed the electrical torque completely, it must contain all component torques; thus it must contain both synchronizing and damping components. As shown in the paper, this is found to be the case. The correctness of the torque formula employed can, moreover, be demonstrated in a



more explicit manner than given above. I propose to give such a demonstration in a paper to be presented before the A. I. E. E. in the near future.

**C. F. Wagner** (communicated after adjournment): During the discussion of this paper the question of the efficacy of voltage regulators and exciters in increasing the amount of power has arisen. This brings up the question as to whether the improvement so obtained could be attributed to the regulator or to the exciter. It is apparent that both must be sufficiently rapid; a long time lag in either regulator or exciter being approximately equivalent to conditions under hand regulation. It has been the experience of the Westinghouse Company with which I am associated that their standard vibrating voltage regulator, which is used with standard exciters, is sufficiently rapid even for quick-response exciters. This becomes apparent when it is known that the contacts of such a regulator close in a fraction of a cycle (at 60 cycles) under reduced potential. In light of these facts one must conclude that the improvement in power limits are due to improvements in exciters rather than improvements in regulators, the regulators as already developed being sufficiently satisfactory.

**C. A. Nickle:** Mr. Douglas has asked about the operation of synchronous machines above the steady-state power limit. In answering this question, a simple case with a cylindrical-rotor generator connected to an infinite bus will be considered. If the terminal voltage of the infinite bus is  $e$ , and  $e_1$  is the nominal voltage of the generator, the power interchange between the generator and the bus is given by

$$P = \frac{e e_1}{x} \sin \delta$$

where  $x$  is the synchronous reactance of the machine. Evidently, when  $e_1$ ,  $e$ , and  $x$  are constant, this expression has a maximum when  $\delta = \pi/2$ . If, however,  $e_1$  is caused to vary in such a manner as to become a definite function of  $\delta$ , the expression for power may have its maximum for values of  $\delta$  greater than  $\pi/2$  and the maximum power is increased. Operation beyond the steady-state power limit thus depends upon applying the proper excitation at the proper time.

By means of a new voltage regulator which we have developed, such requirements are fulfilled and machines have been caused to operate beyond the steady-state power limit by a considerable amount. To illustrate this, the following test may be cited. Two 435-kv-a. synchronous machines were connected to the same bus, one being driven as a generator and the other running as a motor. The rated voltage of these machines was 4000 volts and since, at this voltage, the possible power transfer would seriously overload the direct-connected, direct-current machines, all tests were run at a reduced voltage; *i. e.*, 2200 volts. The maximum power obtained in tests where the terminal voltage was held by hand-controlled rheostats and also by standard regulators, was 180 kw. The use of the new regulator increased this power to 480 kw. or almost triple the value which could be obtained by ordinary methods. The angular displacement between the rotors of the two machines when operating at these loads was considerably beyond 90 deg. as was verified by means of stroboscopic observations. The torque-angle characteristics for angular displacements beyond the steady-state limit thus have a physical significance as well as a theoretical one.

**R. E. Doherty:** Mr. Evans has referred to the term, "artificial stability," coined by Mr. Shand, as applying to operation beyond the "static" stability limit. Why coin a new term, since classical usage has long since specified such a state as "dynamic" stability, in contra-distinction to "static" stability? It is the distinction between the stability of a boy riding a tricycle in one case and a bicycle in the other.

He refers also the discussion which took place at the Philadelphia Convention in 1924<sup>2</sup>, regarding power transmission, and

states that "at that time it was thought impossible in actual operation to obtain a condition of increased power limits by that process," that is, by dynamic stability. There were a number of opinions expressed at that meeting regarding stability. I remember that I expressed this particular one: that, considering the then present stage of electrical engineering art, and the extent to which the studies under consideration projected beyond the limits of experience, we should "neither gamble that a voltage regulator will be able to insert a supporting prop under an otherwise falling system, nor depend for stability during load transients, upon possible, momentary, favorable conditions due to momentum and field transients. These may add up in the right direction, but engineers had better keep them up their sleeves . . . ." Mr. Nickle's investigation since that time has demonstrated that synchronous operation far beyond the steady-state limit is possible. Thus the mechanical momentum can be utilized in this connection to a much greater degree than was thought possible at that time.

I hope that the importance of Mr. Nickle's tests may not be overlooked. The greatest increase above the steady-state power limit which Mr. Evans and his associates state that they have obtained on test is about 20 per cent. I wish to call attention to the fact that in Mr. Nickle's test, the steady-state limit was 180 kw., and that, by the use of a new regulator which he has developed and which applies excitation not merely quickly, (*i. e.* not merely "high-speed excitation" but at the right time phase), it was possible to raise the power from 180 to 480 kw. And, in my opinion, he has written a new chapter in the story of long-distance power transmission.

Mr. Wagner refers to test results given in the closing discussion of the Evans and Wagner paper at the last Midwinter Convention, both as being "similar" to those mentioned by Mr. Nickle, and as being "the first experimental verifications that increased power limits were actually obtainable."

How similar? They showed an increase of 20 per cent. Mr. Nickle's test showed an increase of 160 per cent beyond the power corresponding to the steady-state limit—*i. e.* from 180 to 480 kw.

Over a year before, the paper by Doherty and Dewey, at the Pacific Coast Convention, September, 1925<sup>3</sup>, has test results showing a 28 per cent increase in power above the steady state limit.

We are pleased to note that Professor Lyon considers the authors' premises to be reasonable; also that M. I. T. expects to make some experiments along these lines. Prof. Lyon mentions another possible method of attack which is interesting, and I hope that he may have an opportunity to carry this through.

Mr. Putman has raised some interesting points which the authors are glad to have the opportunity to clear up. Mr. Park has answered the question regarding the damping torque, and the particular angular velocity on which it depends; also he has shown why the torque formula referred to is applicable in general, and therefore in the present case. The authors acknowledge that there should have been further explanation regarding this point in the paper.

With reference to his proposal to simplify the mathematics: both ways are now available, so the reader may choose to his liking.

Mr. Putman's statement regarding the authors' alleged assumption relating to the reference axes is interesting and requires detailed comment. The basic conception is a synchronous machine connected to an "infinite bus," and experiencing a periodic angular oscillation. Under such conditions the magnitude of the space fundamental component of armature m. m. f. will pulsate periodically. Moreover, on account of the variation of power factor during each oscillation of the rotor, the position of the m. m. f. wave with respect to synchronous space

2. A. I. E. E. TRANS., 1924, p. 71.

3. TRANS., A. I. E. E., 1925, p. 972.

will vary periodically—at the same period as the pulsation in magnitude.

The question is, how shall these phenomena be expressed? One may choose the premises which the authors have actually chosen, or those which Mr. Putman understands that they have chosen, and the result will be the same; that is, one may assume the component of the fundamental m. m. f. wave over the pole (*i. e.* the direct component) and likewise the quadrature component, to vary harmonically; or, as Mr. Putman suggests, that the components in line with the *average* positions of the pole axis and the quadrature axis, vary harmonically. In the first case it is tacitly assumed by the authors that those variations of the m. m. f. *in line with the pole* other than the harmonic variations, are negligible, being second-order differences under the assumed extremely small oscillations. And it is these negligible differences to which Mr. Putman has apparently assigned an undue importance, as shown in the following:

Referring to the accompanying figure, let  $\delta_1$  be the angular displacement between the average position of armature m. m. f. wave and the average position of the direct axis of the rotor, both of which positions are fixed references in synchronous

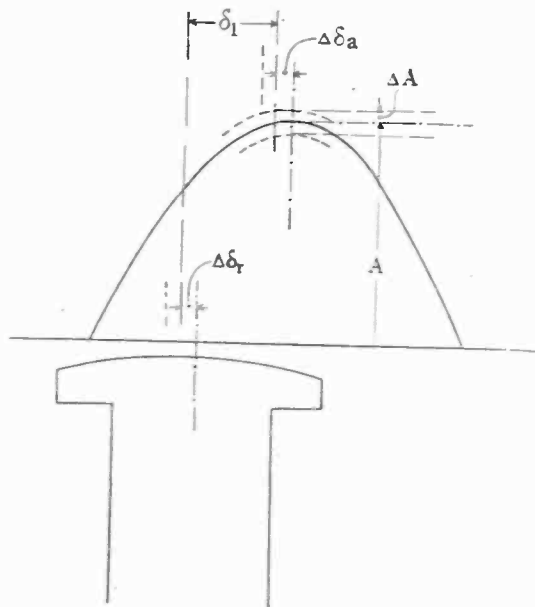

FIG. 1

space. Also, let the total armature m. m. f. wave vary harmonically in amplitude according to the expression.

$$a = A + \Delta A \cos st$$

and let the position of the m. m. f. wave vary harmonically about its average position according to

$$\Delta\delta_a = \Delta\delta_2 \cos(st + \beta)$$

The harmonic oscillation of the direct axis about its average position is

$$\Delta\delta_r = \Delta\delta_3 \cos(st + \beta_1)$$

The total angular displacement between the armature m. m. f. wave and the direct axis of the rotor at any instant is then

$$\delta = \delta_1 + \Delta\delta_2 \cos(st + \beta) - \Delta\delta_3 \cos(st + \beta_1)$$

Thus the component of m. m. f. which exists in the direct axis at all instants is

$$A_d = (A + \Delta A \cos st) \cos [\delta_1 + \Delta\delta_2 \cos(st + \beta) - \Delta\delta_3 \cos(st + \beta_1)]$$

Expanding, and taking advantage of the close approximation that for small angles

$$\cos x = 1 - \frac{x^2}{2}$$

$$\sin x = x$$

$$A_d = [A + \Delta A \cos st]$$

$$\left[ \cos \delta_1 \left\{ 1 - \frac{< \Delta\delta_2 \cos(st + \beta) - \Delta\delta_3 \cos(st + \beta_1) >^2}{2} \right\} - \sin \delta_1 \{ \Delta\delta_2 \cos(st + \beta) - \Delta\delta_3 \cos(st + \beta_1) \} \right]$$

Neglecting second order terms,

$$A_d = A \cos \delta_1 + [\Delta A \cos \delta_1 \cos st - A \sin \delta_1 \{ \Delta\delta_2 \cos(st + \beta) - \Delta\delta_3 \cos(st + \beta_1) \}]$$

Likewise for  $A_q$ .

Hence the m. m. f. in the direct axis, that is over the pole, or in the quadrature axis, at all instants comprises a constant term plus a harmonically varying increment—which is the form taken by the authors.

It is recognized generally that the problem of bringing about a quick change in the exciter voltage is important. The point which does not yet appear to be recognized in Mr. Wagner's discussion, is the very important part which the regulator plays. From his discussion, one is clearly led to the conclusion that his sole criterion regarding the efficacy of the regulator is whether its contacts close promptly on the occasion of a sudden voltage disturbance. Thoughtful consideration must nevertheless surely indicate that the subsequent behavior of the regulator is of equal importance. However, such questions as he has raised cannot be effectively settled by verbal discussion. Mr. Wagner's view would be immensely more convincing if, instead of submitting the time required for the regulator contacts to close, he had adduced some test results obtained by the use of the standard vibrating regulator which he mentions, such test results showing an increase in power over the steady-state limit comparable with those brought out in Mr. Nickle's and my discussion.

### STARTING PERFORMANCE OF SYNCHRONOUS MOTORS<sup>1</sup>

(PUTMAN)

NEW YORK, N. Y., FEBRUARY 7, 1927

**R. H. Park:** In the treatment of a complex problem such as the starting performance of a synchronous motor, it is necessary to employ simplifying assumptions to facilitate the calculation. At the same time, it is desirable to keep in mind just what assumptions have been employed.

On studying Mr. Putman's paper, I listed the assumptions that I found in it as follows: First, that the machine has a uniform air-gap. Second, that rotor bar reactance and resistance is equal for all rotor bars. Third, that only space fundamental of air-gap flux is considered. Actually, the rotor currents will produce a considerable amount of flux that is not space fundamental. This flux will be leakage reactance flux and will have a good deal to do in the determination of the distribution of rotor-bar currents. Fourth, the numerical value of all rotor-bar currents is assumed equal, even with the field closed. Fifth, the electrical phase angle in time of the rotor bar currents is assumed equal to their electrical space separation. This would be true in an induction motor, but actually, on account of the non-space fundamental air-gap flux, that is, leakage reactance flux, the phase angles will be different. Sixth, the effect of armature resistance is neglected. The effect of armature resistance will be important in determining the torque at half speed. In view of the approximations involved in these assumptions, it is, I think, particularly interesting that Mr. Putman is able to secure results which check tests.

**P. L. Alger:** Mr. Putman's ways of taking into account the width of pole arc of the machine, and the single-phase reaction of the field winding, are very interesting. And, the close checks he gets with test results indicate that his method is at least approximately correct.

However, I feel that some of the bold approximations he has

<sup>1</sup> A. I. E. E. JOURNAL, August, 1927, p. 794.

made, seriously limit the generality of his conclusions. For example, he assumes the stator resistance to be zero, and thus entirely neglects the dip in torque at half speed which occurs with any unbalanced rotor. Also, he assumes the current in every squirrel-cage bar to be the same, whereas, as a matter of fact, we know that the outside bars of a squirrel cage always carry more current during the starting period than the middle bars. Finally, he has combined the effects of the field and the squirrel cage by entirely neglecting the action of the squirrel cage in the field axis. That is, he has assumed the field winding to have such low impedance in the direct axis that the squirrel-cage current in this axis is negligible. These approximations are in addition to those he has mentioned in the paper.

Mr. Putman concludes from his study of double squirrel-cage synchronous motors that they are of no practical importance. While there is a measure of truth in this conclusion, there is much to be said on the opposite side of the argument. The difficulty of getting enough space in the pole tip to insert a satisfactory type of double squirrel-cage is the most fundamental part of the problem. The L-bar type of squirrel-cage Mr. Putman employed is not the best for this purpose, since the impedance cannot be made high enough to reduce appreciably the starting current with the field closed. By using an open-circuited, or idle, steel bar above the squirrel cage proper, a higher impedance can be obtained in the same space, and thus a material reduction of starting current can be secured. However, the reduction possible is not great enough to warrant the extended use of this construction.

The primary object of a double squirrel-cage is to reduce the starting current on full voltage sufficiently to avoid the use of a starting compensator. Therefore, all those machines whose starting currents are only about 20 per cent higher than permissible for full-voltage starting can be brought within the permissible class, and so can be made considerably cheaper by the use of the special construction. When the torques are compared on the basis of the same starting current, the two types then give comparable results.

**Quentin Graham:** I made an experimental investigation several years ago which showed a number of interesting facts concerning synchronous-motor starting performance. Chief among these was the enormous effect of the field winding on the

the field winding is closed on itself the torque characteristics are as shown by Curve B. It will be seen that the torque at low speed is about the same but that it increases greatly for low values of slip. Curve C shows that with resistance in the field circuit the cusp is almost entirely removed although the torque is changed very little at the extremities of the curve. By making use of these characteristics, determined first experimentally, we have been able to use relatively high-resistance cage windings with consequent high starting torque and low starting current. The field winding takes care of the torque at low values of slip and the judicious selection of a field starting resistor prevents a dip in the curve at intermediate speeds. While these characteristics have been known and have been explainable in a general way by induction motor theory, Mr. Putman has published the first adequate mathematical treatment of the problem.

Another result of our experimental work was that we obtained an entirely new conception of the pull-in problem. A number of investigators, both in this country and in Europe, have attacked this problem but in nearly every case they have been concerned with the oscillation which takes place when the field current is applied. They have attempted to find the maximum slip at which the motor could operate and still pull into step during the surge that takes place when the field is excited. The solution of this problem requires a knowledge of the inertia of the rotor and its connected load and depends also upon the point on the slip cycle at which excitation is applied. Our investigations, however, showed that we need not concern ourselves with this aspect of the pull-in problem except in rare cases. We found that if the motor could be brought to the upper branch of the speed—torque curve, that is, to a speed above the pull-out or unstable point on the curve, the application of excitation would always bring the rotor into synchronism. The problem thus became one of finding the induction motor characteristics rather than one dealing with the purely pull-in phenomenon.

Mr. Alger, in his discussion, has called attention to Mr. Putman's omission of the stator resistance and has pointed out that this may give an error in the torque at half speed. I have developed the equation for torque including the stator resistance and have substituted values for a few cases. While there is a slight dip in the curve at half speed, I have concluded that it is of negligible importance.

**H. V. Putman:** Before this theoretical investigation was started at all, the company with which I am associated (thanks to the painstaking efforts of Mr. Quentin Graham), has, for a number of years, accumulated a vast amount of experimental data on the starting performance of synchronous motors. These data were of great assistance in building a theoretical structure on which to base calculations of starting performance.

Both Mr. Alger and Mr. Park mentioned the fact that I neglected the stator resistance and Mr. Alger says that I did this without saying anything about it in the paper. I stated very clearly that this assumption was being made in order to simplify the theory. We were well aware of the effect of the stator resistance at half speed and I stated that Mr. Graham had worked out the theory taking the stator resistance into account. He has calculated curves on this basis which show the dip at half speed. However, a review of a great many speed-torque curves which we have made, disclosed the fact that none of them shows a distinct dip or cusp at half speed. At half speed there are usually a few test points which appear erratic. Sometimes there is a point above the curve, sometimes one below, but we have never been able to obtain a test curve which showed distinctly a dip at half speed. The dip does exist, but the fact that it can't be obtained experimentally shows that it is so small as to be negligible. This is also borne out by the fact that since we have been building real damper windings, we have never had a case of trouble where a motor stuck at half speed and refused to come up to full speed. If there were any appreciable dip in the torque at half speed, it seems likely that, with the

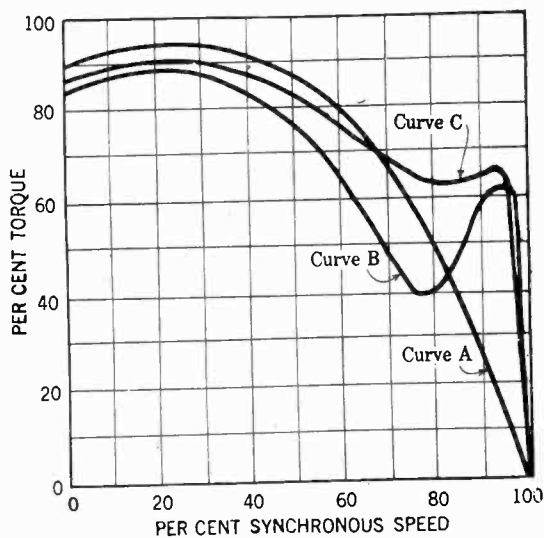

FIG. 1

speed—torque curve, a fact which is clearly shown in Mr. Putman's paper, and which, I believe, has not been appreciated fully by designing engineers. A typical set of curves illustrating this point is shown in Fig. 1 herewith. Curve A is the speed—torque characteristic of the motor with its field winding open-circuited so that the squirrel-cage winding furnishes all the torque. If

increased severity of synchronous-motor applications and hence more severe starting duty, we would have had some cases of sticking at half speed.

Both Mr. Alger and Mr. Park say I assume the same current in each bar and Mr. Alger says that I neglect the effect of the squirrel-cage in the axis of the field winding. This shows that both Mr. Alger and Mr. Park do not clearly understand the theory of the symmetrical-coordinate method and they have not read my paper carefully. They have this theory mixed up with Blondel's two-reaction theory. One speaks of the direct and transverse axes in the two-reaction theory, but not when dealing with the symmetrical-coordinate method.

What I did assume, was this: There are two fluxes rotating in the gap, one in the positive direction and one in the negative. Both cut the damper bars. Due to the positive flux, there are damper-bar currents set up which are all equal, provided the damper bars all have the same resistance and reactance, and are apart in time phase by the space angle between the bars. These produce a positively rotating m. m. f. which I represent by  $I_{2pp}$  and a negatively rotating m. m. f. represented by  $I_{2np}$ . Similarly, the negative flux in the gap produces additional damper-bar currents all of which are equal and which in turn produce two more m. m. fs., a negative m. m. f. represented by  $I_{2nn}$  and a positive m. m. f. represented by  $I_{2pn}$ . Since  $I_{2pp}$  and  $I_{2pn}$  rotate in the same direction, they combine to make the resultant  $I_{2p}$  which is the positively rotating rotor m. m. f. Similarly,  $I_{2np}$  and  $I_{2nn}$  combine to form the negatively rotating rotor m. m. f. From this point on I deal only with m. m. fs. But if one combines the bar currents due to the positive flux, with those due to the negative flux, the combined currents which result are not equal in each bar; neither are they apart in time by the space angle of the bars.

Mr. Alger's statement that I neglect the effect of the damper bars in the axis of the field winding, amounts to the same thing as saying that in an induction-motor diagram, if one represents the rotor-bar current by a single vector  $I_b$ , he is neglecting the effect of the bars which constitute a phase at right angles to  $I_b$ . But we all know that a polyphase m. m. f. or current can be represented by a single vector and the problem handled as though it were a single-phase, but because we handle it as single-phase it doesn't mean that we neglect the phase at right angles to it. If Mr. Alger will read my paper carefully he will see that I have made no such approximation.

Mr. Park says that my theory assumes that all bars have the same resistance and reactance. This is not necessarily true. My theory begins on the basis of a rotor having a definite rotor resistance, rotor reactance and single-phase action factor,  $K$ . It is true that it may be a little more difficult to get the rotor-bar resistance, reactance, and  $K$ , if the bars are all different, than it is when they are all alike. I showed in my paper how the value of  $K$  is obtained when they are all alike to give a general idea of the problem, however, I did not include in my paper any explanation of the calculation of the several motor constants as ex-

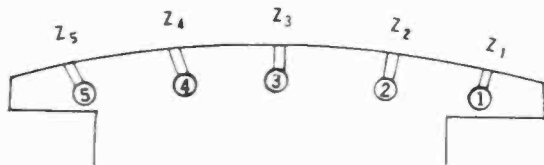

FIG. 2—SYMMETRICAL GROUP OF DAMPER BARS

plained in one of the foot notes in my paper. The handling of cases where damper bars of different resistances and reactances are used in the same field pole, is simply a problem in calculating the values of rotor resistance, rotor reactance and  $K$ . We often build machines with bars of at least two different materials and usually the bars at the tip of the pole are nearer the surface and

have less reactance than those in the middle. In all such cases, it is only necessary to calculate an equivalent bar and then proceed as if all bars were like the equivalent bar.

An example calculation of this kind, is as follows: In the accompanying Fig. 2, let  $Z_1$  equal the impedance of bars No. 1 and No. 5. Let  $\beta_1$  equal phase angle of bars No. 1 and No. 5,

that is,  $\beta_1 = \tan^{-1} \frac{X_1}{r_1}$  where  $Z_1 = \sqrt{x_1^2 + r_1^2}$ . Similarly,

let  $Z_2$  equal the impedance of bars No. 2 and No. 4 and let  $\beta_2$  be the corresponding phase angle. Let  $Z_3$  be the impedance of the middle bar and  $\beta_3$  its phase angle.

Calculate

$$\begin{aligned}\varphi_1 &= \beta_3 - \beta_1 \\ \varphi_2 &= \beta_3 - \beta_2\end{aligned}$$

Then calculate

$$\begin{aligned}X &= \left( 2 \frac{Z_3}{Z_1} \sin \varphi_1 + 2 \frac{Z_3}{Z_2} \sin \varphi_2 \right) \\ Y &= \left( 1 + 2 \frac{Z_3}{Z_1} \cos \varphi_1 + 2 \frac{Z_3}{Z_2} \cos \varphi_2 \right)\end{aligned}$$

Then calculate  $B = \sqrt{X^2 + Y^2}$  and  $\beta^1 = \tan^{-1} \frac{X}{Y}$

The equivalent bar has an impedance of  $\frac{5}{B} Z_3$  and a phase angle of  $\beta_3 - \beta^1$ .

Small differences in the impedances of the several bars make only a very slight change in  $K$ . When it is thought necessary to calculate a new  $K$ , we have a fairly elaborate formula involving the several bar impedances, phase angles, and the space angle between the bars. Usually, this is not necessary.

I did not mean to say that the double-squirrel-cage synchronous motor has no practical value. What I did say, is that it is more desirable to limit the inrush by the use of a high-resistance damper rather than by the use of high reactance because this method gives a higher average torque per kv-a. In higher-speed motors where there is a greater depth of pole head, the double squirrel cage can be used to greater advantage and, as Mr. Alger says, is of use in bringing many ratings within the full-voltage starting class.

## Discussion at Kansas City

A 21,000-Kv-a. AUTOMATIC SUBSTATION<sup>1</sup>

(ELLYSON)

KANSAS CITY, MO., MARCH 17, 1927

**W. H. Millan:** Mr. Ellyson's paper outlines the converting of an old manually operated station to modern automatic control.

It might be well to point out that some of the things which were done in this station, while they appear at first glance out of order, are justified because the old manual equipment could be used again in the redesign of the station.

The major thing coming under this category is the oil breakers in the high-voltage side of the main transformers. In a new station the cost of these oil switches could probably not be justified, but as we see Mr. Ellyson's station, we realize that these oil breakers referred to were already installed and a very small amount of control applied to them resulted in a refinement that was well worth it.

A very prominent point in the operation of this station is the fact that upon the failure of a transformer, or even its supply feeder, a portion of the substation's distribution load is deliberately dropped and the automatic gear depended upon

1. A. I. E. E. JOURNAL, August, 1927, p. 802.

to restore service to that portion of the load very quickly. This is being done in a large number of places in this country with particular reference however to transformer failures.

I know of no other case where the failure of a transformer cable is permitted to cause an outage of a portion of the station's load. Exceptions to this, however, are stations where the total supply is over a single transmission circuit with a reserve circuit available but not closed on the station bus.

In certain substations of the St. Louis system, the entire substation load is dropped upon failure of the transmission-cable. This applies, however, only to stations where the growth is not sufficiently advanced to permit installation of a second preferred supply circuit.

Initially, these St. Louis substations are started out with a single 33-kv. supply cable which originates on the secondary side of a step-up transformer located at the power plant. The oil switch controlling the transmission circuit is on the power-plant side; *i. e.*, the 13.8-kv. side, the high side being switched only by air-brake, hand-operated switch units.

The circuit thus led out of the power plant arrives at the substation and is switched to the 33-kv. bus through an oil breaker with ordinary protective equipment. A second similar circuit is carried from the power plant to this substation but, by means of tap connections, runs also to one or two other similar substations. This second circuit acts as a reserve at the two or three stations and the oil switches on each of the ends are normally in "open" position, the cable of course being charged from the power-plant end.

The failure of a preferred transmission circuit relays the circuit on the 13.8-kv. side at the power plant, thus de-energizing the entire substation. A preferred emergency transfer equipment at the substation opens the oil breaker on the defective line and closes the emergency supply line (if alive) on the bus, thus restoring the service. The entire performance of restoration is carried out in something under 10 sec.

A substation whose load increases above the prescribed limit of a single transmission circuit, (7500 kv-a.), acquires a second preferred transmission circuit, at which period in its life, the transfer equipment is so altered as to permit parallel operation of the two preferred circuits at all times with the emergency circuit normally open.

Directional relays are installed on the substation ends of the transmission circuits. The failure of a preferred transmission circuit after this period in the life of the substation does not cause an outage, but the circuit relays at the power-plant end on overload and at the substation end on reverse current. This performance of course throws double load on the remaining preferred transmission circuit.

In this case, the function of the transfer device is to parallel the emergency circuit with the remaining operative preferred circuit, which is done in about 10 sec. and after automatic check for synchronism.

If, for any reason, the preferred circuit which has relayed is again made alive, the transfer equipment restores conditions to normal; *i. e.*, the preferred circuit which is open checks for synchronism, closes and, upon closing the emergency circuit, is opened.

The foregoing description may tend to qualify Mr. Ellyson's arrangement in his station.

In the matter of transformers, the St. Louis stations do not actually carry a spare, but transformers which have water coils are used adding approximately 50 per cent to their capacity. As a complete substation usually embodies four transformer units, it follows that so long as all four units are available, the self-cooled rating is used, but that upon the failure of one of the four units, the application of cooling water to the remaining three, (and this is done automatically), will permit operation of the station without abnormal loads on any unit.

I should like to ask Mr. Ellyson to indicate why he finds it

necessary to have so large a ratio of ampere capacity in outgoing feeders to ampere capacity of transformers. It is noted that the ampere capacity of all transformers in this station excluding emergency transformers, is 2760 amperes, while the total capacity based on the rating of the regulators of his outgoing distribution is 4000 amperes. This ratio is so much wider than we are compelled to use in the St. Louis system that I feel an explanation is warranted.

A 15,000-kv-a. station in St. Louis has a total ampere capacity in transformers of approximately 1950 amperes at 4500 volts. We find that these transformers cannot supply more than ten distribution circuits rated at 250 amperes each, or a total of 2500 amperes.

In connection with the general arrangement of regulators, whenever we can we attempt to keep down the number of regulators in a row or the number of regulators which may face each other across a narrow aisle.

Mr. Lichtenberg's picture may give some idea of what we have attempted to do along these lines in St. Louis. So far as possible we use a unit structure; that is, we attempt to assemble in a single set of barriers isolated from everything else, all of the equipment connected with a three-phase distribution circuit.

An exception to this is the control panel, which we mount as near to this structure unit as possible without actually exposing to danger the man who attempts to manipulate the equipment on the panel.

In the past several serious regulators fires in St. Louis have demonstrated that in spite of the use of barriers between regulators, one loses almost the total number of units in the row.

**C. M. Gilt:** In Brooklyn we have no completely automatic stations at the present time. We have from two points of view a problem ahead of us in our d-c. Edison system. The land is becoming so valuable that we cannot afford to keep some of our stations and it appears that we can't change all of their load completely to alternating current. We shall have to abandon the old stations and scatter them about in some small automatic stations.

Then there is another thing ahead of us; in some sections where we are changing this direct current to alternating current, there may be two or three large customers who have such expensive equipment that it may be impossible to change them over. The solution seems to be to have some small automatic stations located on these premises.

We are not entirely non-automatic, because eight out of ten a-c. stations have automatic reclosing devices. These vary in capacity from 30,000 to 50,000 kv-a. each. The two that are non-automatic are so because the feeder breakers installed do adequate rupturing capacity to stand the reclosing duty cycle, particularly as we like to have the first re-closure instantaneous, feeling that gives the best service we possibly can to our customers.

The question might arise as to why we couldn't make entirely automatic the stations in which we have alternating current automatic re-closing feeders. The reason is, I think, our policy of restoring feeders in case a feeder goes out. Most of these feeders are three-pole. In case a feeder is locked out, we put it over on our transfer bus, which is fed by single-pole breakers and see if one or two of the phases won't stay in and maintain a large proportion of the lighting load.

The other thing is that after a feeder has gone through its automatic re-closing cycle and is locked out, we immediately get our distribution people on the circuit and close our breakers as fast as we can when they think they have found the trouble. In other words, we keep a man in the station to close the breakers as fast as the distribution people think they have found the trouble and cleared it up.

Our station layout is a little different from any shown so far. We have feeder busses fed directly from 10,000-kv-a. transformers

at 27,000 volts and no high-tension breakers. These are connected through reactors to a tie bus with a transformer feeding this, the ring transformer being the only one that has any high-tension breakers. These are put in to save feeder cable. We do not run the cable from the ring transformer back to the generating station but connect the transformer in a cable ring running from one station to the next. These transformers are of the same capacity as the cable, that is, 10,000-kv-a. We rate a station of that kind (three main one-ring transformers) as of 30,000-kv-a. capacity, with the spare transformer connected at all times, each feeder being regulated.

We can't seem to run quite as high a load factor on our feeders as in Kansas City. We run 24,200-ampere 30,000-kv-a. stations. On some of our stations where we have a large percentage of power load, we can't even quite load up to 30,000 kv-a. on 24,200-ampere feeders.

We are entirely satisfied that automatic equipment gives us better service than we can get with purely manual control and that is the reason for putting it in. We use entirely truck-type breakers, which we think have a considerable advantage.

**C. W. Place:** The thing that appeals to me is that each operating company gives its particular view on the operation. The disagreements, as I see them, in the way things are done indicate the compromise between management, money and engineering practise, the human element applied on top.

Each city's particular equation must be considered and the proper equipment to meet the limitations given.

**C. A. Butcher:** In working out the three-wire a-c. distribution system in metropolitan systems, which is being carried out now to restrict as much as possible the growth of the Edison three-wire systems, they are using man-hole transformers and three-wire a-c. network at 110 and 220 volts.

In order to operate the network efficiently and to isolate the faulty sections and the transformers which are lightly loaded, a three-pole network protector controlled by single relay has been perfected and is in operation on a great many networks.

For example, the secondaries of distribution transformers supplied through radial primary feeders are connected in parallel on the 110/220-volt network through these protectors so that a fault on the a-c. network isolates the faulty section automatically, and in the event that the primary circuit to any particular group of transformers is opened, the automatic network protector on the low-voltage side operating on the exciting current taken by the transformers from the low-side isolates the transformers and thus saves light-load losses during off-peak periods.

In reality, it is a small automatic substation in a man-hole and they have been built so they can be submerged and still be operated. They are of the submarine as well as of the station type.

**B. J. George:** We have had demand instruments with charts which indicate when the customer is operating off or on peak. If some of you engineers can impress carrier currents upon our regular power circuits and operate a sort of auxiliary relay and arm on the demand meter so as to indicate exactly to the customer when the on-peak period starts and when it ends you will assist greatly in showing some individuals why they do or do not operate on the peak.

**D. W. Ellyson:** Regarding Mr. Millan's comments with regard to the possibility of load being dropped because of cable outage to a substation. There are several reasons for selecting the radial system of distribution rather than the parallel or multiple system of distribution to these substations.

(a) By using a single cable with its transformer to supply a section of 4000-volt bus the short-circuit current through any induction regulator is limited to the guaranteed value without the addition of 4000-volt reactors. These reactors were not only an item of expense and added loss but were an item detrimental to the system power factor.

(b) The history of cable operation on our system indicates

that there is a probability of only one outage on any supply feeder once in 5 to 15 years, depending upon the length of such supply feeder. The added complication in relay arrangement by arranging parallel operation of the supply feeders would in itself cause a probability of total substation interruption due to misadjustment, etc. of the relays equal to the present probable partial outage.

(c) The simplification of switching by radial supply feeders rather than parallel supply feeders allowed a less expensive total supply equipment; *i. e.*, the saving in fewer high-voltage oil switches paid for complete spare transformer equipment connected ready for service, etc.

Regarding the apparent discrepancy between the ratio of total ampere rating of regulators and the ampere rating of normal supply transformers in the Kansas City substations as compared to the St. Louis substations: In the Kansas City setup each regulator is rated to enable it to carry some emergency overload so as to enable the lighting peak load to be transferred from any outgoing feeder that may be in trouble to the mains of outgoing feeders carrying adjacent load. If the normal expected load on individual regulators is used instead of the rated load, Kansas City compares with St. Louis. Since the 200-ampere regulators have no overload rating, their normal load is slightly more than 150 amperes and the overload limit of the outgoing feeder is 200 amperes.

In regard to Mr. Millan's remarks concerning the trouble he has experienced with d-c. breakers, I might state that when our station was first put in, we had considerable trouble with our own breakers and it took us about one year or more to learn how to take care of them properly. The chief trouble is, that these breakers were designed for hand operation and were not the best type for automatic control as they have too many delicate parts that get out of adjustment very easily. We look over every d-c. breaker once a week and overhaul it thoroughly. By this method, we have been able to run for over a year without a breaker failing in service. However, until the manufacturers design a better type of breaker for automatic service there will always be either numerous breaker failures or an excessive amount of maintenance to prevent such failures. We have been able to prevent failures by going to the time and expense of thoroughly overhauling these breakers every week.

## Discussion at Bethlehem

### RECENT DEVELOPMENTS IN ELECTRIC DRIVE FOR ROLLING MILLS

(UMANSKY)

BETHLEHEM, PA., APRIL 22, 1927

**D. M. Petty:** In reading the introduction to this paper, I noted that there was just one rather important point which Mr. Umansky did not cover. I think it is a rather vital point and is becoming more vital every day. That is, the relation of the power generated in steel plants to that which is purchased. A number of steel plants are making it a point to buy a certain proportion of their power and with the advent of interconnections of large power companies, I think the interchanging of power between steel companies and power companies becomes increasingly important. The power companies themselves, naturally, having a wider range of load, are now able to absorb waste-gas and waste-heat energy better than they otherwise could have done had their system been limited to a small territory, it being understood, of course, that the steel plant has this power available as a by-product.

Immediately I imagine the problem arises in the minds of a good many of the central station men that most steel plants are 25-cycle and the power companies are 60-cycle. This has for a long time apparently offered an almost insurmountable barrier to an interchange of power agreement, but I find in talking to some of the power engineers, that as these super-power systems grow

and their lines extend over greater distances, the use of synchronous condensers becomes a considerable factor in the regulation of voltages at different points.

It has occurred to me that possibly some of these synchronous condensers at different points could have a 25-cycle generator connected to the big, 60-cycle synchronous condensers. It might look, in a good many cases, like an exciter connected to the synchronous condenser. However, it might be big enough to provide a means of interchange of power in sufficient quantities to provide for the needs of the steel plant when it wanted to buy power and also to provide an outlet for a maximum amount of power which the steel plant might have available at any particular time in its operations.

The various rolling-mill layouts which Mr. Umansky showed, I think, are very typical of the modern trend of steel-mill design and rolling-mill design. There is just one thought that I should like to mention in this connection, for fear that possibly some one who is not a steel-mill engineer might be a little misled. The big thing in rolling-mill practise is to obtain tonnage from the mill, and, with the various Kraemer and Scherbius drives as illustrated, it must always be borne in mind that the first consideration is that the particular electrical drive to be hooked to the mill must enable the millman to deliver from the mill the maximum amount of tonnage at the lowest possible cost, and cost in a rolling mill hinges almost always around production more than any other factor. So that when you think of cost in a rolling mill, you are almost saying "reliability," since a drive that is not reliable, either because of complications or anything else, would immediately run the cost up by virtue of the fact that it would reduce the tonnage. The actual dollars and cents expended on labor and material in repairs might be negligible but the reduction in tonnage would be a serious matter. So that while we like to feel that we are going after all the efficiency we can get in mill drives, we should not hesitate to throw out 3 or 4 per cent of efficiency if there was a thought that a d-c. drive might produce more tonnage on a mill than either a Kraemer or a Scherbius or any other system of a-c. drive. In other words, production is the most important factor, especially where the product of the mill is not determined at the time it is laid out.

Of course, if it is known beforehand that the mill is never going to roll anything else but a particular product, it is comparatively easy to make the layout. So that while we want to do everything we can to make the drives more efficient, the big point is always reliability and flexibility, whenever flexibility means more tonnage. That, to my mind, is the big factor in the matter of drives.

I wish also to emphasize further the point that you cannot say that one drive, because it has worked out excellently in one mill, will always work out so well in the next mill. Each mill must necessarily be laid out for itself and for the purposes which the product of the mill demands. In some cases two mills may look alike in the number of stands, but the product may be different and consequently it may be necessary to have an entirely different type of drive. I feel that that particular point is one of the best points brought out by Mr. Umansky.

**A. J. Standing:** The mills should be so designed that the mill layout may not be the limiting factor; in other words, the mill shall be so laid out from the heating and the furnace end of it that steel can be delivered to the drive as fast as the drive can roll it, and that, at the other end of the drive, steel can be taken care of at the finishing and disposal end fast enough to take care of the drive. The reason I mention this is because oftentimes the mill is laid out for the production of one product, and later we find that the mill has undergone considerable change from the time when original product was got out. So that in putting a drive on a mill, the past experience has a great deal of weight due to the fact that information has been obtained as to the speed with which we can handle steel both before it enters

the drive and especially after it leaves the mill. With that in view, I think the steel manufacturers each year are gaining more experience with various installations so that those who are installing electrical drives from now on will be able to profit by the actual applications and the improvements which have been made in the tonnages, especially from the standpoint of cost per ton.

**R. H. Wright:** Under present-day business conditions, it is essential that any organization, to be successful, must be quick to adopt new methods and equipment. Steel plant engineers and executives for years have been pioneers in the application of electrical equipment to heavy mechanical operations and, through continual expansion of their electrical power systems, they have effected great economies of operation.

One of the chief advantages of the electric motor drive in the steel industry, in addition to the inherent economy, is the extreme flexibility and the ease with which it can be applied to new processes and labor-saving devices. Through liberal use of electric motors and automatic control in the modern steel plant, the output per man has been increased many times and the accident hazard reduced to a minimum. That the advantages of electrification can be obtained without sacrificing plant production during installation of new equipment is illustrated by a project recently completed in the Philadelphia district. All the steam engines in this plant were replaced by electric drives operating on purchased power in less than three years with no appreciable loss in production during the changeover period. The saving in power cost and operating labor will, in three years, cover the cost of the installation.

To meet the peculiar needs in the industry, the electrical manufacturers have developed complete lines of equipment for steel mill service. One of the first main-roll drives was a reversing motor, installed twenty years ago to drive a plate mill. Since the initial installation reversing motors have been increasing in size until units rated 7000 h. p. at 50 rev. per min. are now quite common and one motor has been built for 8000 h. p. at 40 rev. per min.

Up to a few years ago all reversing motors above 5000-h. p. rating were built with two armatures on a common shaft. Direct-current power was supplied to the motor through a motor-generator set having two generators. In order to keep the voltage to ground from exceeding the potential of one generator, a sandwich scheme of electrical connections was employed in the circuit between the generator armatures and the double-armature motor. Motor-generator sets with two generators are used with the more recent equipments, but the double-unit armature construction of the motors has been abandoned, and one 8000-h. p. and six 7000-h. p. motors have been built with single-unit armatures by the Westinghouse Company.

It will be obvious that the single-unit motor has one-half the armature end windings of a double-unit motor of the same rating and diameter and that the number of cross connections for the commutating pole and compensating windings is also reduced to half that required for a double-unit motor. The copper loss of the single-unit motor is therefore about 25 per cent less than the copper loss of a double-unit motor of the same rating and the efficiency is higher.

When two generators are used in the motor-generator set they are connected in parallel. Equal division of the rapidly varying load to which such generators are subjected is obtained by means of special field connections. As shown in the accompanying figure, each generator has a differential series winding and a cumulative series winding. These windings are identical and under balanced load conditions, they neutralize each other. However, if No. 1 generator, for example, should tend to take more than its share of the load, the differential series field of the No. 1 generator would be stronger than the cumulative series field and the voltage; consequently, the load on the No. 1 genera-

tor would be reduced. At the same time, the excess of current from the No. 1 generator would strengthen the cumulative

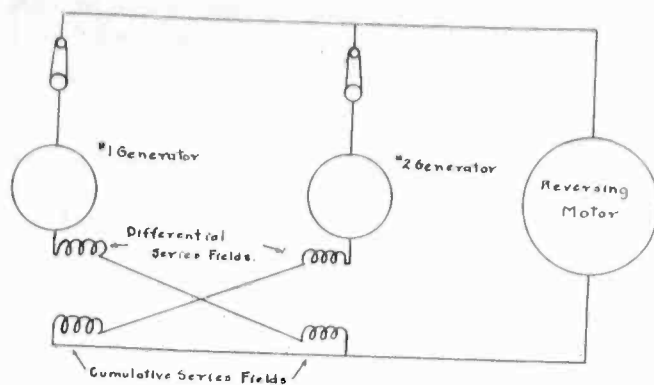

winding of the No. 2 generator, causing it to take more load. Any tendency for unequal division of load is therefore corrected very quickly.

**W. E. Lloyd:** I should like to include one question. How is it controlled? Do you have a dozen men or one man with a push button?

**L. A. Umansky:** This paper was not intended to cover the very interesting point just brought up by Mr. Petty; namely, the interchange of power between the steel plants and the public utilities. It is very fortunate, however, that this problem has been mentioned here as it is a very vital one and will undoubtedly grow in importance as time goes on. Whenever the steel plant operates at a frequency of 25 cycles, while the purchased power is available at 60 cycles, the two systems will be undoubtedly tied-in by means of special frequency-changer sets. Their purpose will be not only to convert the 60-cycle to 25-cycle power, or vice versa, but also to control the flow of power between the two systems. It means that while one unit, presumably at the 60-cycle end of the set, will be of a synchronous type, the 25-cycle unit is likely to be an induction motor with a speed-regulating equipment attached to it. The latter may be similar to the Scherbius, Kraemer, or similar systems outlined in this paper. The actual speed of the frequency-changer set is not changed as long as the frequencies remain fixed, but, by controlling the frequency applied to the secondary circuit of the induction machine, the latter may be given a tendency to operate either as a motor or as a generator; in this manner the interchange of power between the two systems may be readily controlled. The synchronous motor of the set, if suitably designed, may also act as a synchronous condenser on the 60-cycle line.

We all agree with Mr. Petty that the question of reliability and flexibility is just as important in selecting electric drives for rolling mills as is the question of efficiency. So many of both a-c. and d-c. drives are in successful operation for many years that their reliability certainly should be considered on a par.

No reversing drives were mentioned in my discussion as there were no radical changes made in this line for the last ten or fifteen years. Many details were undoubtedly improved, as pointed out by Mr. Wright, but the method of operation of the machines remains substantially unchanged. A single-unit armature of a, say, 7000-h. p. reversing motor, is an improvement of size rather than of kind. When two generators are supplying power to a single-armature reversing motor, means should be provided, of course, to divide the load automatically and evenly between the two generators. The scheme mentioned by Mr. Wright is very effective for this purpose; as a matter of fact, the same scheme is used for a number of years on the double-unit, d-c. motors shown on Figs. 3 and 4 of my paper. It should be borne in mind, however, that if we equip each of the two machines with two series fields, one cumulative and one differential, then the load balance is maintained at the expense of crowding the main poles of the machine with a double amount of series field turns; the

latter carry the full current but, in the ideal case, do not produce any flux. In other words, the balance is obtained magnetically and not electrically. By causing the current to circulate through two series fields, the copper losses are increased and the efficiency is, therefore, reduced.

The reversing drives usually give an excellent opportunity to apply a simpler but an equally effective scheme which, at the same time, is devoid of the above shortcoming. A relatively small potential winding may be mounted on the main poles of each generator and these auxiliary fields of the two machines are then connected in series with each other. They are so wired that, when one of them acts cumulatively with the main field of its generator, the other auxiliary winding acts differentially with the main field of the second generator. The free ends of the auxiliary fields are connected to terminals of the two generators of the same polarity. The current of each generator is carried separately to the reversing motor, where the two circuits are joined together. When the load is evenly divided between the two generators the  $IR$  drop in each circuit is equal and, therefore, no current is flowing through the auxiliary fields. If, for any reason, one generator carries less than its proper share of the load, the  $IR$  drops in the two circuits will differ and therefore a current will flow through the auxiliary fields, strengthening the main field of this particular generator and weakening the field of the second generator, thereby re-establishing the balance. It will be seen that the results are obtained directly by means of an electrical balance; in other words, the auxiliary field does not carry any current in case the load is evenly divided. The copper losses are lower than in the scheme described by Mr. Wright and the main poles are less crowded.

This scheme has been in successful operation for a number of years. It will be of interest to note that just a few days ago a large rolling mill was started at the Lackawanna Plant of the Bethlehem Steel Company. This mill includes five reversing drives, of which three are 7000-h. p., single-armature motors, each furnished with power from two generators connected in multiple. The division of load is maintained in a perfect manner by means of the scheme just described.

Once the reversing drives are discussed, I wish to mention one other point which may eventually change in one respect the conventional form of these equipments. It has been commonly understood that any reversing drive requires a motor-generator set equipped with a heavy flywheel to equalize the load on the incoming line. This is still true for the larger reversing drives, but, as the power systems grow, the question of limiting the instantaneous peak load will acquire relatively less importance. Just recently, a reversing drive which will include a synchronous motor-generator set was ordered. The power in this case was purchased from a public utility and the question was put squarely before the power company: Did it prefer to take on its system a heavier instantaneous peak load, not smoothed out by any flywheel, or to reduce this peak load and contend with the lagging power factor of the induction-motor-driven set. The answer was in favor of the synchronous motor drive. While this particular reversing drive is of a moderate size, (4200-kv-a. synchronous motor), I believe that it is a forerunner of larger equipments provided with synchronous motor-generator sets. Maybe in ten or fifteen years from now, even the 7000-h. p., reversing blooming-mill drives will lose one of their typical features,—the flywheel set.

Mr. Lloyd inquired as to how many operators usually control a large continuous mill with individual drives. The motors and the motor-generator sets are usually fully protected by automatic devices, and, strictly speaking, no attendant is required in the motor room. The actual starting speed adjustment and stopping of each drive is controlled by one man in the operating pulpit having within his easy reach the necessary master switches, push buttons, rheostats, etc. One man is usually sufficient to do this work; a second man would be comparatively useless.



## ILLUMINATION ITEMS

By Committee on Production and Application of Light.

### CHECKING UP AN INDUSTRY ON ITS LIGHTING

At a recent convention of the Association of Iron and Steel Electrical Engineers,<sup>1</sup> Mr. Ward Harrison<sup>2</sup> presented in a paper entitled "Fifteen Years of Steel Mill Illumination—What Change?" a study of what such lighting was, is, and should be.<sup>3</sup> In terms of the cost of steel, the cost of light from 1912 to 1927 has gone down in the ratio of 16 to 1. If one foot-candle was the illumination provided in the earlier day, the same ratio of cost of light to cost of steel would today provide sixteen foot-candles.

There is really no excuse whatever for a steel mill to be poorly lighted with cost of power so relatively cheap, but the fact remains that many of them are very badly lighted. In this respect they are almost without exception on a decidedly lower basis than other progressive industries.

The steel industry has improved a little more in average efficiency than industry as a whole. Two industries which stand out as conspicuous examples of improved efficiency, as measured by the value given to the public for the dollars it spends, are also conspicuous as being the best lighted industries in America. Even though it is not assumed that good lighting is responsible for this increased efficiency, it is interesting to see that the executives who guide two of the most progressive and important of our industries today believe that good lighting is worth its cost and will return a profit. One of these industries is the motor car industry; the other is the electrical industry.

In the former, we find long lanes in which work is illuminated to 60 foot-candles with the energy consumption of 10 watts per sq. ft. of floor area; press rooms where lamps mounted 40 ft. above the floor produce an average of 20 foot-candles; other work rooms where large areas are lighted to 45 foot-candles at an expenditure of four watts per sq. ft. In the large shops and assembly rooms of motor car factories, the present standard of illumination is from 20 to 30 foot-candles obtained with 300-watt lamps on from 8- to 10-ft. centers. How does the steel industry compare with this?

In the General Electric Company plants, wiring for standard lighting installation can now supply three watts per sq. ft., with a line drop from not exceeding 1.5 volts panel board. (Branch circuits will carry five watts per sq. ft. with a drop not greater than 2.5 volts). Lighting fixtures have been standardized to provide levels of illumination as high as those mentioned above.

These industries have found that light aids production, and carefully conducted tests involving various kinds of work have been made toward correcting pre-

vious conditions. Increases in production ranging from 10 to 35 per cent have been obtained when lighting was improved; ordinarily an increase of approximately 15 per cent is obtained by the installation of a system which provides light at a cost of about two per cent of the payroll. Other advantages,—improved quality, decreased spoilage, better supervision, greater order and neatness and, even more important than these, reduction of accidents—are obtained simultaneously. Many accidents in steel mills cannot be prevented by the use of safety devices, but carelessness is of course responsible for many others. In almost every mill, there are unprotected machine parts in motion, obstacles in aisles and passage ways, and shadows that hide sharp cutting edges. In this particular field, there are extreme and blinding contrasts created by incandescent metals which, unless alleviated by good lighting, are too great for the eyes to stand.

Although at one time among the leaders, the steel industry is now far behind the practise of others in the lighting field. Specific suggestions for the improvement of lighting in various parts of the plant are given by Mr. Harrison in an appendix<sup>3</sup> that discusses both interior and exterior lighting in detail.

### BRIGHT LIGHTS LURE TENT CATERPILLARS

According to the State Experiment Station at Geneva, New York, trial tests indicate that tent caterpillars, most ravenous of all insect pests, will forsake succulent young apple twigs any time to gather about a yellow electric lamp where there is plenty of light but not much bug fodder.

As a part of a study of the reactions of insects to various colored light, apple branches were arranged radially from a central point toward lights of different colors. The insects were placed at the hub and permitted to choose their own path to the light which attracted them most. Hungry caterpillars that could see a pale yellow light didn't stop for so much as a wayside bite, but dusted right along the twigs to the lamps. Some chose a light of deeper yellow and some even left the twigs to gather on the glass behind which the light shown. The red light appeared to appeal to only a few.

The study of insect control by means of electricity, thus undertaken, will include not only the reactions of insects to different types and colors of light, but will also test the possible effects of radio waves as well as the trapping of insects with lights as bait.

Because of eye strain in schools due to improper lighting, the Illuminating Engineering Society has framed a lighting code for schools and the authorities consider it adequate. The only states in which schools are reported as having conformed to this code, however, are New York, Michigan, Minnesota and Wisconsin. Other states and territories are studying the code with the idea of applying it.

1. Twenty-third Annual Convention, Pittsburgh, June 1927.

2. Director of Illuminating Engineering National Lamp Works of G. E. Co.

3. Paper printed in *Iron and Steel Engineer*, June 1927.

# JOURNAL OF THE American Institute of Electrical Engineers

**PUBLISHED MONTHLY BY THE A. I. E. E.**  
33 West 39th Street, New York  
Under the Direction of the Publication Committee

BANCROFT GHERARDI, *President*  
GEORGE A. HAMILTON, *National Treasurer*      F. L. HUTCHINSON, *National Secretary*

**PUBLICATION COMMITTEE**  
L. F. MOREHOUSE, *Chairman*  
F. L. HUTCHINSON, *Member*      E. B. MEYER, *Member*  
DONALD McNICOL, *Member*      I. E. MOULTROP, *Member*  
GEORGE R. METCALFE, *Editor*

Subscription: \$10.00 per year to United States, Mexico, Cuba, Porto Rico, Hawaii and the Philippines; \$10.50 to Canada and \$11.00 to all other countries. Single copies \$1.00. Volumes begin with the January issue.

Changes of advertising copy should reach this office by the 15th day of the month for the issue of the following month.

*The Institute is not responsible for the statements and opinions given in the papers and discussions published herein. These are the views of individuals to whom they are credited and are not binding on the membership as a whole.*

## Program for Pacific Coast Convention at Del Monte, September 13-16

A very profitable and enjoyable four-days meeting is planned for the coming Pacific Coast Convention of the Institute which will be held in Del Monte, Calif., September 13 to 16, with headquarters at the Hotel Del Monte. The technical papers are of highest quality and will cover some such timely subjects as application of intermediate synchronous condensers to transmission lines, transients and oscillations in transmission lines, oscillographic recording of transients, corona, the sphere-gap voltmeter, high-voltage circuit breakers, carrier-current protection, carrier-current communication on power lines, long-distance and toll telephony and lightning protection for oil tanks. The number of papers on the program has been kept low so that there will be ample time for discussion. In addition to the technical papers there will be addresses by President Bancroft Gherardi and Dr. Harris J. Ryan. Further information on the events is given in the accompanying tentative program.

A feature of the Convention will be the Student and Branch program held on the first day. There will first be a luncheon and then a conference of Branch Counselors and Chairmen and this will be followed by a session devoted to technical papers written by the students. All members are invited to attend these meetings.

In addition to the excellent technical program to be presented, there will be numerous entertainment features and sporting events. Probably outstanding in the latter will be the annual golf tournament with the J. B. Fiskien cup as the prize. Other sports include swimming, tennis and boating. Special entertain-

ment features will be provided for women guests and will include bridge parties, motor trips, golf, swimming, tennis and similar activities.

The annual banquet to be held on Thursday evening will be the largest general social affair. Here again the Entertainment Committee has provided numerous interesting features.

Inspection trips will be arranged for the purpose of enabling delegates to visit important projects of an engineering nature. In addition to the points of interest near San Francisco, there are available from Del Monte, the Pit River and Melones projects of the Pacific Gas and Electric Company, the Kings River project of the San Joaquin Light & Power Corporation, and the Big Creek development of the Southern California Edison Company. Inspection trips will be arranged by the entertainment committee as desired. One trip in particular that will be of more than usual interest will be the visit to the Ryan High-Voltage Laboratory at Stanford University where Dr. Harris J. Ryan himself will be the host.

The location of the Convention headquarters, the Hotel Del Monte on the Monterey Peninsula, is most fortunate. This is an ideal spot for pleasure, offering as it does a combination of

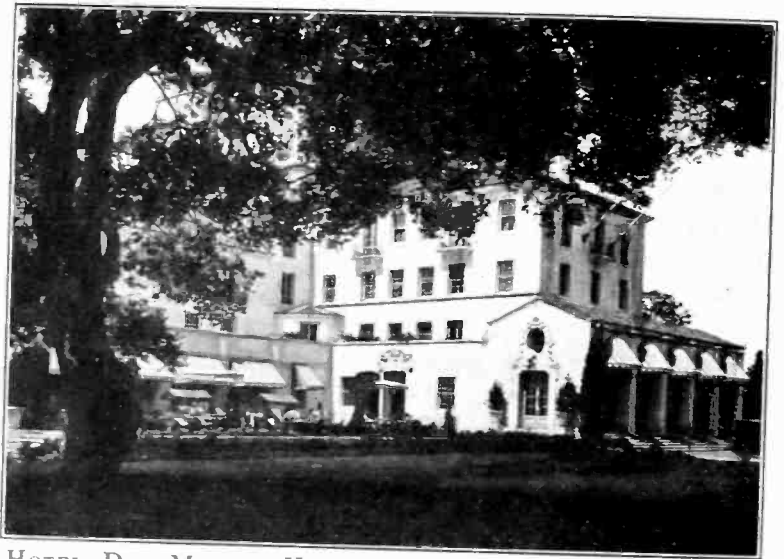

HOTEL DEL MONTE—HEADQUARTERS FOR THE A. I. E. E. PACIFIC COAST CONVENTION

mountains, forest and ocean. By special arrangement with the hotel, the following rates will be offered for the convention:

### HOTEL DEL MONTE DAILY RATES INCLUDING MEALS

Room	No. of persons	Price per person
Single, without bath	1	\$ 8.00
Double, without bath	2	7.50
Single, with bath	1	10.00
Double, with bath	2	9.00
Two singles, bath bet.	2	9.50
Two doubles, bath bet.	4	8.50

All plans for the meeting are being ably handled by the following general committee: P. M. Downing, Chairman; D. I. Cone, Vice-Chairman; G. H. Hagar, E. A. Crellin, W. L. Winter, W. R. Van Bokkelen and A. G. Jones.

### TENTATIVE PROGRAM

TUESDAY, SEPTEMBER 13

Morning Registration  
12:00 m. Student Branch Counselors' and Leaders' Luncheon.  
2:00 p. m. Student Branch Conference.  
3:00 p. m. Student Technical Meeting.  
Evening Open.

WEDNESDAY, SEPTEMBER 14

9:30 a. m. Technical Session.

*The Relation between Frequency and Spark-Over Voltage in a Sphere-Gap Voltmeter*, L. E. Reukema, University of California.

*The Space Charge that Surrounds a Conductor in Corona*, J. S. Carroll and J. T. Lusignan, Jr., Stanford University.

*Electric Oscillations in the Double-Circuit Three-Phase Transmission Line*, Y. Satoh, Stanford University.

Afternoon Recreation.

8:00 p. m. General Meeting.

Address by President Bancroft Gherardi.

Address by Dr. H. J. Ryan on Phases of Future Electrical Development.

THURSDAY, SEPTEMBER 15

9:30 a. m. Technical Sessions.

*Advance Planning of the Telephone Toll Plant*, J. N. Chamberlin, Pacific Tel. & Tel. Co.

*Tandem System of Handling Toll Calls in and About Los Angeles*, E. Jacobson, American Tel. & Tel. Co., and F. O. Wheelock, So. California Telephone Co.

*Coupling Capacitors for Carrier-Current Communication over Power Lines*, T. A. E. Belt, General Electric Co.

*A Carrier-Current Pilot System of Transmission-Line Protection*, A. S. Fitzgerald, General Electric Co.

1:30 p. m. Technical Session.

*Transients Due to Short Circuits*, R. J. C. Wood and L. F. Hunt, Southern California Edison Co., and S. B. Griscom, Westinghouse Elec. & Mfg. Co.

*Equipment for 220-Kv. Systems*, J. P. Jollyman, Pacific Gas and Elec. Co.



THE GOLF COURSE

*Static Stability Limits and the Intermediate Condenser Station*, R. D. Evans and C. F. Wagner, Westinghouse Elec. & Mfg. Co.

*Synchronous Condensers*, P. L. Algor, General Electric Co.

7:00 p. m. Banquet.

FRIDAY, SEPTEMBER 16

9:30 a. m. *Oscillographic Recording Apparatus for Transmission-Line Studies*, J. W. Legg, Westinghouse Elec. & Mfg. Co.

*High-Voltage Oil Circuit Breakers for Transmission*

*Networks*, Roy Wilkins and E. A. Crellin, Pacific Gas & Elec. Co.

*Lightning Protection for Oil-Storage Tanks and Reservoirs*, R. W. Sorensen, J. H. Hamilton and C. D. Hayward, California Institute of Technology.

*Lightning Protection for Oil Tanks*, E. R. Schaeffer, Johns-Manville, Inc.

Friday afternoon and Saturday—open for recreation and trips.

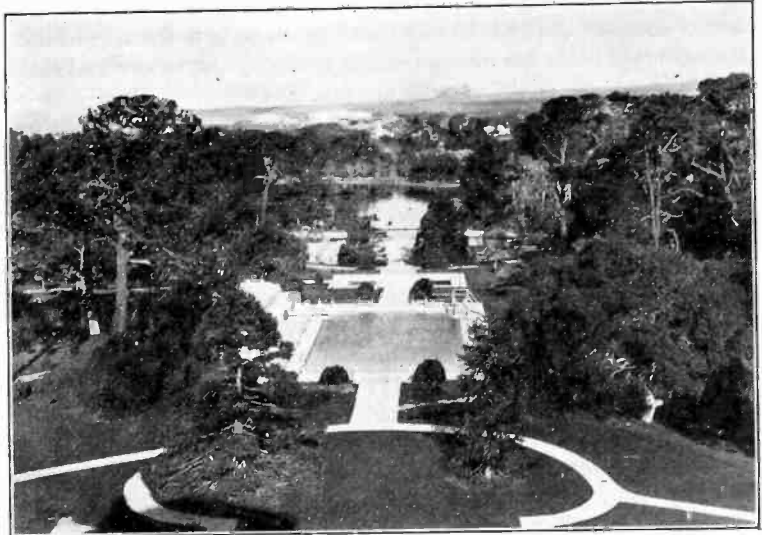

A SWIMMING POOL AT THE DEL MONTE HOTEL

## A Great Summer Convention Held in Detroit

The 1200 members and guests of the Institute who attended the forty-third Summer Convention held at the Book-Cadillac Hotel, Detroit, June 20-24, were amply repaid by a most excellent program of valuable technical contributions and many enjoyable entertainment features. Eight technical sessions as well as conferences of Section delegates and Branch counselors were held; also a meeting of the Board of Directors and a number of committee meetings. There were, too, numerous trips and a number of social and sports events.

The Convention was officially opened on Tuesday morning, June 21, by Alex Dow, Chairman of the General Convention Committee. Mr. Dow, representing also the Mayor of the City of Detroit, extended a hearty welcome to all in attendance.

President C. C. Chesney then delivered his presidential address which created no little interest, and is published in this issue of the JOURNAL. President-elect Bancroft Gherardi was introduced and responded with a brief and appropriate talk.

Following, came the presentation of the Institute prizes for 1926 convention papers of which full details were published in the June issue of the JOURNAL, p. 638.

### TECHNICAL SESSIONS

In the following paragraphs are given the titles of the papers presented at the various technical sessions, and also some of the important points of the discussions. Many of the papers have already been published in the JOURNAL and copies of any of individual interest may be obtained from Institute headquarters. Full discussion will be published in later issues of the JOURNAL.

*Power Plants, Transmission and Relays—Tuesday Session.*

In the first technical session, held on Tuesday morning, (W. S. Gorsuch, Chairman), the following papers were presented: *Hollywood Steam Plant, Design and Operation in Coordination with Water Power*, F. A. Allner; *Auxiliary Power at Richmond Station*, J. W. Anderson and A. C. Monteith; *Recent Investigations of Transmission-Line Operation*, J. G. Hemstreet; *Ground-Relay Protection for Transmission Systems*, B. M. Jones and G. B.

Dodds; *Directional Ground-Relay Protection*, J. V. Breisky, G. W. King and J. R. North.

In the discussion following these papers, ground relays and insulator flashovers were the principal topics. H. P. Sleeper said that ground-relay protection is justified because (1) it minimizes danger at the fault and (2) it reduces the voltage drop on the system. He stated that the relay scheme described by Messrs. Jones and Dodd had been very effective for his system, having cleared a conductor-to-sheath ground in a 26-kv. joint so quickly that no outward sign of the fault was evident. With a 75-ohm resistance in the neutral, a voltage dip of 2 to 4 per cent occurs compared with a 10 to 20 per cent drop with a solid ground. He uses line loads very successfully to check the relays and does not believe actual field grounds are justified.

B. M. Jones said that he believes actual grounding is desirable and also stated that in applying 305 grounds to check 484 relay installations, 17 errors in connections and settings were found.

E. E. George stated that directional ground relays are necessary for high-voltage systems. He employs relays operated by two currents, (over-current and directional), actuating one disk. He strongly favored testing with field grounds.

H. A. P. Langstaff pointed out the value of ground relays in reducing the duty on oil circuit breakers. His company has discarded the watt-operated relay for the current-operated. He most always favored testing with line loads.

G. H. Doan stated that his company had been using a mechanically balanced differential relay with almost perfect success. Its operation is very rapid. He spoke also in favor of more powerful relays. Test transformers are employed by him in place of actual grounds.

L. H. Crichton pointed out that the ground relays employed on a system having a neutral resistance might be employed on a system grounded without neutral resistance, provided a phase-shifting device is added to the relay.

H. M. Trueblood pointed out that a ground resistance is desirable on grounded-neutral systems to minimize inductive disturbances on exposed communication lines.

In commenting upon Mr. Hemstreet's paper, E. E. George agreed that increasing the ground resistance increases the number of insulator flashovers.

G. H. Doan corroborated Mr. Hemstreet's statement that the top wire is most susceptible to flashovers. He reported that in the Detroit Edison Company, 77 per cent of the flashovers on 120-kv. lines occurred on the upper conductor. He also reported that since the installation of a ground wire, switch openings, due to lightning, had decreased about 94 per cent; at the same time the number of storms per year had decreased about 50 per cent. He emphasized the fact that high ground resistance results in a large number of flashovers.

R. L. McCoy agreed in recommending longer-spaced insulators to decrease the number of flashovers. He stated that grading shields increase from 15 to 20 per cent the flashover value of insulators.

A. O. Austin also supported the value of a well installed ground wire. He pointed out that higher transmission lines have more flashovers in proportion to height than might be expected. He then drew attention to the advantages of wood poles and mentioned the fact that counter-poise ground wires are being investigated with an offer of advantages.

#### *The Electric Arc—Tuesday-Evening Lecture.*

One of the most valuable Technical contributions was the lecture by Dr. K. T. Compton of Princeton University on "The Physical Nature of the Electric Arc," on Tuesday evening. The meeting was presided over by Prof. V. Karapetoff, and some interesting discussion developed.

Joseph Slepian mentioned a number of experiments which he had performed and which had proved that arcs may be formed which cannot be attributed to thermionic emission.

J. C. Lincoln described a novel phenomenon which he called an

"electric torch" and which demonstrated an unusual type of arc.

Professor Karapetoff drew attention to the fact that Dr. Compton's lecture dealt mainly with the simplest form of arc, with which the electrical engineer is usually not concerned. He pointed out, however, that Dr. Compton's theories and reasoning would be of great value in the study of the types of arc found in practical use.

#### *Technical Committee Reports—Wednesday, Session A.*

The technical program on Wednesday morning consisted of the presentation of fourteen Technical Committee Reports, and a report of the Standards Committee. These reports were presented in two sessions. In Session A, at which H. B. Smith presided, the following reports were given: *Research*, J. B. Whitehead, Chairman, (presented by F. W. Peek); *Electrophysics*, Vladimir Karapetoff, Chairman; *Standards*, J. F. Meyer, Chairman (presented by H. A. Kidder); *Instruments and Measurements*, A. E. Knowlton, Chairman; *Communication*, H. P. Charlesworth, Chairman; *Production and Application of Light*, P. S. Millar, Chairman; *Electrical Machinery*, H. M. Hobart, Chairman, (presented by H. S. Barns).

In the ensuing discussion on the report of the Committee on Research, C. E. Magnusson and R. W. Sorensen both differed with the report's statement that only a small amount of research is being done in the colleges. They stated that extensive and valuable research is being done in many colleges. They pointed out the difficulty, financially, of supporting college research and suggested that the industries which benefit from such research should contribute much more freely of financial assistance. F. C. Caldwell, R. E. Hellmund, F. A. Brownell and J. C. Clark also contributed to the discussion of these reports.

#### *Technical Committee Reports—Wednesday, Session B.*

In Session B on Wednesday morning, at which D. W. Roper presided, the following Technical Committee Reports were presented: *Power Generation*, W. S. Gorsuch, Chairman; *Power Transmission and Distribution*, Philip Torchio, Chairman; *Protective Devices*, F. L. Hunt, Chairman (presented by E. C. Stone); *Applications to Iron and Steel Production*, A. G. Pierce, Chairman; *Applications to Mining Work*, W. H. Lesser, Chairman; *Transportation*, J. V. B. Duer, Chairman; *Electric Welding*, J. C. Lincoln, Chairman; *Electrochemistry and Electrometallurgy*, G. W. Vinal, Chairman (presented by E. C. Crittenden).

In discussing the Report of the Committee on Power Generation, Philip Torchio said that manufacturers evidently have not reached the limit in generator sizes. He pointed out that the present coal economies are being obtained at the expense of increased capital investment.

F. A. Scheffler said that the coal used in pulverized form is approximately 17 per cent of the total coal consumption in public utility plants in this country.

In commenting upon the Report of the Committee on Protective Devices, Alfred Herz cautioned against the use of unsuitable film in the klydonograph and the varying effects of atmospheric conditions.

J. Allen Johnson suggested the need for defining a standard lightning surge or transient voltage which should be used for comparative tests of lightning arresters.

The discussion on the Report of the Committee on Applications to Mining Work dealt mainly with the subject of "permissible" equipment.

J. C. Lincoln in answering questions on his report stated that, although the Boiler Code does not permit electric welding of fire pressure vessels, the railroads have been successfully repairing locomotive boilers by electric welding for a number of years. Other discussors were S. J. Rosch, E. J. Gealy, A. M. MacCutecheon, E. C. Crittenden and F. W. Funk.

#### *Telegraphy, Phonographs and Television—Thursday, Session A.*

Telegraphy, phonographic reproduction and television were the topics of Session A Thursday morning. H. P. Charlesworth

was Chairman at this session. The following papers were presented: *Printing Telegraphs on Non-Loaded Ocean Cable*, Herbert Angel; *A Non-Rotary Regenerative Telegraph Repeater*, A. F. Connery; *Electrical Reproduction from Phonograph Records*, E. W. Kellogg; *Symposium on Television*, led by Dr. Herbert E. Ives.

In commenting on Mr. Angel's paper, Mr. Connery stated that it is much easier to detect an error when using the three-element cable code than when using the five-unit code.

Mr. Angel pointed out that the received impulses with the cable printer are larger and better able to stand disturbances than the impulses when using cable Morse code and that the accuracy is quite as good. Commenting on Mr. Connery's paper he stated that the rotary and non-rotary repeater each has its field. The rotary repeater, he said, is more suitable for leaking off messages. He said also that brush transmission is better than contact transmission. Mr. Connery claimed that in view of recent developments relay transmission is probably quite as satisfactory as brush transmission and is much simpler and easier to maintain.

In discussing Mr. Kellogg's paper, C. R. Hanna claimed that any magnetic arrangement would give practically the same sensitivity and therefore the scheme which is most suitable from a mechanical standpoint could be implied. The two factors which govern sensitivity, he stated, are the net stiffness of the vibrating element and the inductance of the magnetic circuit.

The symposium on television was abstracted in one short lecture by Dr. H. E. Ives, who was introduced by E. B. Craft. In a brief and interesting manner Dr. Ives covered the main points in the group of five papers which were as follows: *Television*, H. E. Ives; *The Production and Utilization of Television Signals*, F. Gray, J. W. Horton and R. C. Mathes; *Synchronization of Television*, H. M. Stoller and E. R. Morton; *Wire Transmission of Television*, D. K. Gannett and E. I. Green; *Radio Transmission of Television*, E. L. Nelson.

Demonstrations of the television equipment were given at various hours on Thursday afternoon and Friday. A complete set-up of equipment for sending, transmitting and receiving was in operation in a lower section of the hotel. Members were allowed to inspect the equipment and also to view the moving image of a human subject transmitted by wire from one room to another.

#### *Cable Joints, Control, Wave Propagation and Electrical Units—Thursday, Session B.*

In Session B on Thursday morning (L. W. W. Morrow presiding) the following four papers were presented: *High-Voltage Multiple-Conductor Joints*, T. F. Peterson; *Use of High-Frequency Currents for Control*, C. A. Boddie; *Electromagnetic Waves Guided by Parallel Wires*, S. A. Levin; *The International Electrical Units*, E. C. Crittenden.

In commenting on Mr. Peterson's paper, D. W. Roper said that three-conductor joints, such as those described, have been very successful. He emphasized the need of very careful selection of material, absolute cleanliness and proficient workmanship. His Company gives very thorough training to men who make such joints, and it has had no failures in 400 joint-years of service on 66-kv. cable.

E. D. Eby urged the use of stepped insulation instead of penciled insulation.

D. M. Simons stated that a satisfactory joint could also be made by carrying the conducting shield entirely across the joint and by applying stepped insulation by hand. These two operations differ from those employed in Mr. Peterson's joint.

F. A. Brownell also stated that such joints as mentioned by Mr. Simons had been found highly satisfactory.

J. F. Fairman mentioned the importance of installation of oil reservoirs on cable joints and cited the good results which had been obtained from such installation.

W. F. Davidson urged the need for cables so constructed and

impregnated that they would have longitudinal as well as radial dielectric strength.

Herman Halperin stated that his experience with petrolatum for 33-kv., three-conductor joints had been unfavorable and that a more fluid oil had been substituted with very satisfactory results.

#### *Corona, Dielectrics and Rectifiers—Friday, Session A.*

In Session A on Friday morning the six papers given below were presented. W. B. Kouwenhoven was Chairman of this session. *An Investigation of Corona Loss*, E. C. Starr and W. L. Lloyd; *Law of Corona and Dielectric Strength*, F. W. Peek; *Puncture Voltage as a Precision Measurement*, V. Bush and P. H. Moon; *The Electrical Resistivity of Insulating Materials*, H. L. Curtis; *Electric Strength of Solid and Liquid Dielectrics*, Wm A. Del Mar, W. F. Davidson and R. H. Marvin; *Mercury-Arc Rectifier Phenomena*, D. C. Prince.

In commenting upon the papers on corona, V. Karapetoff suggested two schemes for simplifying the work of reading cathode ray oscillograms—the first, a mechanical transcriber for changing the abscissas to Cartesian coordinates; and the second, a determination of areas and lines by weighing with a balance.

C. F. Harding brought out the fact that corona losses at very high voltages are less than the losses calculated by the quadratic law for lower voltages. He pointed out that transmission lines designed with the quadratic law in mind are therefore on the safe side in respect to corona losses. Mr. Peek agreed that with the higher voltages, the equation changes, but suggested that the important thing is to work below the corona voltages.

In discussing the paper by Messrs. Bush and Moon, both W. W. Shaver and F. M. Clark agreed with the authors that the breakdown of impregnated insulation cannot be explained on the basis of the pyroelectric theory. W. F. Davidson and Herman Halperin contributed further discussion.

#### *Overhead Railway Contact Systems—Friday, Session B.*

In Session B on Friday morning five papers on overhead contact systems for electric railways were presented. J. V. B. Duer was Chairman of this session. The papers were as follows: *Current Collection from an Overhead Contact System Applied to Railroad Operation*, S. M. Viele; *Catenary Design for Overhead Contact Systems*, H. F. Brown; *Catenary Construction for Chicago Terminal Electrification of Illinois Central Railroad*, J. S. Thorp; *Collection of Current from Overhead Contact Wires*, R. E. Wade and J. J. Linebaugh; *Railway Inclined-Catenary Standardized Design*, O. M. Jorstad.

In commenting on these papers M. W. Manz stated that it was his belief that the ideal contact-wire system is one in which the inertia of the contact wires is the same from one end of the system to the other.

G. I. Wright stated that the Illinois Central is considering the application of roller bearings for contactors. He differed with Mr. Jorstad's prophecy that the inclined catenary will be the future standard overhead system because, he stated, there are many important railroads which prefer the chord construction.

J. C. Damon mentioned the advantages of employing very heavy messenger and non-rusting construction.

K. T. Healy said that the cost of construction should largely govern any design of overhead system. He emphasized the necessity for coordinated design of both pantograph and overhead construction. He stated that on some European pantographs, the effective inertia has been reduced by introducing a secondary bow for the shoe—this bow being free to swing about its own axis and being held in position by small springs. The small bow, weighing only a few pounds, follows the minor irregularities of the trolley height. Experience has shown that a single shoe will collect 180 amperes perfectly at 55 mi. per hour and 250 amperes, at 27 mi. per hour. Pantograph pressures have been kept down to 79 lb. and aluminum shoes are used with negligible wear on the contact wires. Lighter overhead construction is

used and the costs per mile are less than half of the costs for corresponding types of American practise.

N. Litchfield outlined the history of the development of the modern catenary.

In answer to some questions, Mr. Viele stated, among other things, that splices in the contact wire mean a deterioration of about five times that which occurs without the splices. The effect of the variation in height in a span length is relatively small as compared with the effect of splices.

#### SOCIAL EVENTS

The principal events scheduled for the entertainment of those in attendance were the President's reception and dance on Tuesday evening, the Convention banquet on Wednesday evening, the musicale by Professor Karapetoff, Thursday afternoon, and the lake ride on Thursday evening. In addition to these, the ladies enjoyed a number of teas, drives and other events.

The social program opened on Monday evening with an informal dance, which was held in the Crystal Ballroom of the Book-Cadillac Hotel.

The President's reception took place in the Grand Ballroom on Tuesday evening, with a receiving line of President C. C. Chesney, President-elect Bancroft Gherardi and a number of other past and present officers of the Institute, together with accompanied ladies. After the reception, there was dancing with a very pleasing entertainment novelty introduced during intermission.

On Wednesday evening the convention banquet was held. Alex Dow presided as Chairman at the dinner, and after opening the meeting, he introduced C. F. Hirshfeld, who acted as toastmaster. Mr. Hirshfeld introduced the three speakers of the evening. The first speaker was C. F. Kettering, Vice-President of the General Motors Corporation, who spoke on the need for and the value of scientific research. He was followed by C. M. Newcomb who gave a talk on the psychology of laughter. The last speaker was W. B. Stout, President of the Stout Metal Airplane Division of the Ford Motor Company, who spoke on commercial aviation. He told of the great developments which have been made in perfecting safe airplanes for commercial purposes. Throughout the delightful dinner music was furnished by the Book-Cadillac Hotel orchestra and vocal selections were rendered.

On Thursday afternoon Professor Vladimir Karapetoff entertained a large audience with a recital upon the five-stringed cello which he has developed. In addition to playing a number of delightful selections Professor Karapetoff also explained the problems encountered in designing this special instrument.

A very enjoyable ride up the Detroit River and in Lake St. Clair was taken Thursday evening on the Steamer Tashmoo. Among the features of the ride were dancing to music from a ten-piece orchestra, vaudeville entertainment and the prize drawing for an electric refrigerator.

As already mentioned, there were a number of other entertainment events for the ladies, including a reception and teas, bridge parties, putting contests, a matinee party and sightseeing drives.

#### INSPECTION TRIPS

A very large number of those in attendance took the opportunity of making the inspection trips which were arranged. There were three main trips. The first trip on Tuesday afternoon was made in busses to a large number of points of general interest in the city.

Probably the most important trip was that to the Trenton Channel Generating Station of the Detroit Edison Company, which was made on Wednesday afternoon.

On Thursday a trip was made to the Ford Airport where quite a number of the members made 30-mile airplane flights over the manufacturing and suburban districts of Detroit.

There were also many visits by small parties to automobile manufacturing plants, power company plants, telephone plants, radio stations and other points of interest.

#### SPORTS

Both golf and tennis tournaments were held during the convention. There were a large number of entrants for the golf tournament which was held at the Hawthorne Valley Golf Club. The main event in this tournament was the competition for the Ralph D. Mershon Cup and this event was won by J. H. Sweetnam. His name will be added to the list of the names of 12 others who have already won this contest one time. Winning of the cup twice entitles the winner to permanent possession of it. The runner-up in this contest was G. V. Brown. Various other contests were held—the winner of the low gross score on Tuesday being R. O. Bentley and the low net score J. E. Kearns. On Wednesday the winner of the low gross score was J. D. Lyon; the low net score, S. P. Grace; the best selected 9 holes, J. S. Lapp, and the best par three holes, W. J. Foster. On Thursday the winner of the kicker's handicap was P. O. Noble and the best par three holes, F. A. Scheffler. All of the winners received handsome prizes.

In the tennis tournaments there were 16 entrants and both singles and doubles tournaments were played. The winner of the singles tournament was G. A. Sawin and the runner-up was J. Nikonow. This contest was played for the Mershon Tennis Trophy, which must be won twice by one player for permanent possession. The doubles tournament was won by G. A. Sawin and H. B. Vincent and the runners-up were A. Howard and J. Nikonow. Appropriate prizes were presented to the winners and runners-up of both tournaments.

#### CONFERENCES OF SECTION AND DISTRICT DELEGATES

The first day of the Summer Convention, Monday, June 20, was devoted to the Conference of Section and District Delegates held under the auspices of the Sections Committee until 4:00 p. m., and under the auspices of the Committee on Student Branches from 4:00 to 6:00 p. m.

Forty of the fifty-two Sections were represented by delegates. Three Geographical Districts were represented by their Secretaries or alternates, and seven District Committees on Student Activities were represented by officially appointed Counselor Delegates. A considerable number of officers, officers-elect, and other interested members were present also.

Professor Harold B. Smith, Chairman of the Sections Committee, presided over the parts of the conference held under the auspices of his Committee. The following program, which had been prepared in advance by a special committee and mailed to all the delegates, gives the principal subjects discussed.

1. Announcements by Professor Harold B. Smith, Chairman, Sections Committee.
2. Remarks by President Chesney.
3. Remarks by President-elect Gherardi.
4. Resumé of the results of previous Sections Committee Conferences by National Secretary Hutchinson.
5. Public Relations.

Discussion of the report of the Special Committee to Develop Contacts With the Public. Included in the program upon the recommendation of that Committee, approved by the Board of Directors, April 8, 1927. This report includes topics a, b, and c below.

- a. Local membership of Sections.
- b. Visiting speakers for Sections.
- c. Radio broadcasting of engineering talks.
- d. Means of obtaining publicity on Section activities.
- e. General discussion of participation of engineers in public affairs.
6. Proposed annual report from each Section.  
Reports to include aims, activities, programs, etc., and all to be printed in single pamphlet for distribution to the Sections.
7. Any other business of the Sections Committee.

Following the discussion of Public Relations as outlined in 5, the Conference passed the following resolutions expressing its

concurrence in the suggestions of the Special Committee to Develop Contacts With the Public and making certain recommendations to the Board of Directors regarding the procedure to be followed in putting them into effect:

1. **RESOLVED**, that this Conference of Section Delegates believes that many of the sections are so situated with respect to local engineering industry and to other engineering bodies as to provide the opportunity to establish a grade of local membership which will accomplish two purposes.

(1) to enlarge the points of contact of the engineering profession with the semi-engineering and lay public,

(2) to establish a selected group of prospective members of the Institute,

**RESOLVED**, therefore, that this Conference of Section Delegates is in accord with the Report of Committee on Contacts with the Public in its recommendation to the Board of Directors that such Sections of the Institute should be encouraged to enroll local members, not limited to engineers but to include any persons interested in the application of engineering to the advancement of public welfare,

**RESOLVED**, further, that the Sections be urged to impress upon appropriate local members the desirability of qualifying for membership in the American Institute of Electrical Engineers in order that the local membership program shall perform the function of sustaining the growth of the national organization at a rate commensurate with the growth of the electrical industry,

**RESOLVED**, further, that it is desirable that those Sections which have had local members should, for the benefit of other sections contemplating such a policy, incorporate their local membership receipts, total expenditures and accumulated reserve in their annual financial report.

2. **RESOLVED**, that it is the opinion of the Conference that each District Executive Committee should develop a plan whereby each Section in the District shall be assisted in securing one or more prominent speakers for appropriate dates on the annual program.

3. **RESOLVED**, that this Conference recognizes radio broadcasting as an effective means of bringing before the public the aims and accomplishments of the engineering profession and therefore advocates that Sections utilize local or chain broadcasting of all programs that contain matter of interest to the general public;

**RESOLVED**, further, that this Conference advocates also the broadcasting of such portions of regional meetings and Institute conventions and of such special addresses as will contribute to a better public appreciation of the services rendered by the engineering profession.

There was a general agreement that some form of annual report upon the activities of each Section is desirable, and a motion was passed requesting that the Chairmen of the Sections Committee and the Committee on Student Branches, appointed for the year 1927-28, meet soon after August 1 to appoint a joint editing committee to secure the desirable information during the year and make it available for use next spring.

The latter part of the conference was devoted to a discussion of student activities, and was presided over by Dr. C. E. Magnusson, Chairman of the Committee on Student Branches.

Reports upon all Student Conventions and District Conferences on Student Activities were presented for the purpose of bringing to the attention of those present the best ideas and practices from all Districts. The conference was concluded by a brief general discussion of Branch problems.

An abstract of the proceedings of the entire conference will be printed in pamphlet form and mailed to all delegates in attendance, and to Section, Branch, and National officers. Any Institute member who is interested in the proceedings may obtain a copy of the pamphlet without charge upon application to Institute headquarters, New York.

#### APPRECIATION OF CONVENTION COMMITTEE'S WORK

A most able and effective convention committee with Alex Dow as chairman and G. B. McCabe as vice-chairman and consisting of 70 men and 70 ladies, is responsible for the success of this meeting. In view of the thorough organization and good management of the convention the Board of Directors of the Institute at its meeting on June 23 passed a resolution of appreciation of the work of this convention committee.

#### A. I. E. E. Directors Meeting

A meeting of the Board of Directors of the Institute was held on Thursday afternoon, June 23rd, at the Book-Cadillac Hotel, Detroit, Michigan.

Present: President C. C. Chesney; Vice-Presidents H. M. Hobart, B. G. Jamieson, A. G. Pierce, H. H. Schoolfield, Herbert S. Sands; Managers J. M. Bryant, H. P. Charlesworth, F. J. Chesterman, H. C. Don Carlos, M. M. Fowler, H. A. Kidder, I. E. Moulthrop, E. C. Stone; National Secretary F. L. Hutchinson. By invitation: Past Presidents B. J. Arnold and A. W. Berresford; Officers-elect J. L. Beaver and E. B. Meyer; C. H. Sharp, President, U. S. National Committee of the I. E. C.; C. E. Skinner, Chairman, American Engineering Standards Committee; Harold B. Smith, Chairman Sections Committee; and Assistant National Secretary H. H. Henline.

On the recommendation of Mr. Arnold, Chairman of the American Committee on Electrolysis, the Board voted to continue its representation of three upon this joint committee.

On the recommendation of the Board of Examiners, the following actions were taken upon pending applications:

- 70 Students were ordered enrolled
- 310 applicants were elected to the grade of Associate
- 7 applicants were reelected to the grade of Associate
- 1 applicant was reinstated to the grade of Associate
- 22 applicants were elected to the grade of Member
- 1 applicant was reelected to the grade of Member
- 1 applicant was elected to the grade of Fellow
- 54 applicants were transferred to the grade of Member
- 4 applicants were transferred to the grade of Fellow

The Board ratified the approval, by the Finance Committee, for payment of monthly bills amounting to \$26,964.45.

Upon the request of Vice-President Sands of Denver, supported by the recommendation of the Coordination Committee of the Institute, it was voted to hold the 1928 Summer Convention in Denver during the week beginning Monday, June 25, 1928.

The Committee on Coordination of Institute Activities reported that it had considered the various movements for meetings, both national and regional, and submitted the following schedule of proposed meetings with the recommendation that this schedule be adopted, subject to such adjustments regarding exact dates and locations as may become necessary in order to distribute the meetings to the best advantage chronologically and geographically. The committee called attention to the undesirability of concentrating the principal meeting activities of the year within the first six months, and recommended a greater interval of time between meetings.

The Board voted to approve the above recommendations and the schedule of meetings, as printed below:

- Del Monte, California, September 13-16, 1927, Pacific Coast Convention. (previously authorized).
- Chicago, Illinois, November 28-30, 1927, Regional Meeting of Great Lakes District.
- New York City, February 1928, Annual Winter Convention. Northeastern District, Spring 1928, Regional Meeting (exact date and location to be determined later).
- Denver, Colorado, week beginning Monday, June 25, 1928, Annual Summer Convention.
- Northwest District, probably September 1928, Annual Pacific Coast Convention
- Southern District, Fall of 1928, Regional Meeting.

A report of the Committee on Award of Institute Prizes, dated May 11, which had been distributed to the members of the Board in advance, was considered. This report included a recommended revision of the present regulations regarding Institute National and Regional prizes and also embodied a plan for the grading of papers in making awards. It was voted to adopt the report of the Committee which is printed on another page of this issue of the JOURNAL.

A report was submitted by Professor H. B. Smith, Chairman of the Sections Committee, on the actions taken at the Sections Delegates' Conference held on Monday, June 20 (see account published elsewhere in this issue). It was decided to postpone consideration of Professor Smith's report until the next meeting of the Board. In the meantime, a copy of the report will be sent to each member of the Board.

Other matters of importance were discussed, reference to which may be found in this and future issues of the JOURNAL.

The meeting closed with a unanimous vote of appreciation to President Chesney for his work on the Board and for the Institute during the past year.

### Exposition of Chemical Industries

When the Eleventh Exposition of Chemical Industries opens its doors at the Grand Central Palace, September 26th, there will be one of the greatest collections of exhibits ever assembled in any one place in the world.

For the first time in the history of the Exposition, foreign methods and practises will be shown, giving the manufacturers and users of the products the opportunity to compare domestic and foreign products, methods and practises which today have reached a high state of efficiency in all industry; in fact, the chemical engineer has had no small share in this advancement of civilization.

The Exposition management announces that it is receiving communications from many manufacturers of metals and alloys and expects to be able to show between twelve and twenty of the various new non-corrosive iron and steel alloys.

### John Scott Medal Awarded to Grid-Glow Tube Inventor

The John Scott medal, given annually in recognition of "useful inventions for the use and benefit of mankind," has been awarded to D. D. Knowles, 28-year-old inventor of the Grid-Glow Relay. Notice of the award, which carries a cash prize of \$1000 was given by Walter R. Russel, Acting Secretary. Presentation will be made at a later date.

Mr. Knowles perfected his invention in the research laboratories of the Westinghouse Elec. & Mfg. Company. His grid-glow relay has been acclaimed as the most sensitive current-controlling device ever developed. The glow tube, which functions on a billionth of a watt, is set in operation by such tiny impulses as the mere approach of the human hand, a drop of water or the light of a match.

### Revision of Transformer Standards Suggested

A revision of Section 13, A. I. E. E. Standards for Transformers, Induction Regulators and Reactors has been proposed by the A. I. E. E. Technical Committee on Electrical Machinery. The revision suggested is a development of those outlined in the May 1927 JOURNAL. The text of the revision is quoted herewith. Any suggestions or criticisms relative to these revisions should be addressed to H. E. Farrer, Secretary, A. I. E. E. Standards Committee. Copies of the current No. 13

may be obtained at a cost of 40 cents (50% discount to members A. I. E. E.)

### SUGGESTED REVISION OF A. I. E. E. STANDARD NO. 13 TRANSFORMERS, INDUCTION REGULATORS AND REACTORS

#### 13-101 Grounding Transformers

(a) *Definition*—Grounding transformers are used solely for the purpose of clearing a short circuit or accidental ground of a transmission line by means of relays or otherwise.

(b) *Rating*—The rating of a grounding transformer shall be based upon the line voltage or terminal voltage during a ground if less than the line voltage, the frequency, the current in the ground circuit when one line becomes grounded, and the time the transformer must carry the current.

**13-200 Limiting Temperature Rises.** The temperature rises above the temperature of the cooling medium of apparatus or parts thereof when tested in accordance with the rating, shall not exceed the values given in the following table. Temperature shall be determined by the methods indicated in Table I. Where two methods are specified neither of the limiting values, corresponding to a particular method, shall be exceeded.

TABLE I

Item	Kind of rating	Method of temperature determination	Limiting temperature rise in deg. cent.	
			Class A Insulation	Class B Insulation
1	Transformers and other stationary induction apparatus other than 2, 3 & 4	Continuous or Short-time	Resistance 55	Thermometer 75
		Nominal	Resistance 60	Thermometer 65
2	Air blast transformers (see par 13-208 b)	Continuous or Short-time	Resistance 55	Thermometer 60
		Nominal	Resistance 60	Thermometer 65
3	Transformers having a nominal rating	Nominal	Resistance 60	Thermometer 60
4	Reactors	Continuous	Thermometer 55	80
5	Metallic parts in contact with or adjacent to any kind of insulation, shall not attain a temperature in excess of that allowed for the adjacent insulation.			
6	Metallic parts other than those covered by Item 5 may attain such temperatures as shall not be injurious in any respect.			

**13-250 Short-circuit Current of Transformers.**—All transformers while in service shall be capable of withstanding short circuit without injury for the time periods given in the following table, assuming that normal line voltage is maintained:

Per cent Impedance	Time of short circuit in seconds
4	2
5	3
5	4
7 and above	5

In a multi-winding transformer, the minimum impedance will determine the time of short circuit.



Transformers having an impedance less than 4 per cent shall be capable of withstanding under service conditions 25 times normal full load current for two seconds.

For the purpose of standardization the calculated temperature of the copper under short-circuit conditions given above shall not exceed 250 deg. cent. assuming:

- (a) All heat stored in the copper.
- (b) An initial temperature of 90 deg. cent. when the cooling medium is water.
- (c) An initial temperature of 105 deg. cent. when the cooling medium is air.

The increase in temperature during short-circuit conditions may be computed by the following formula\*:

$$\theta = A t \left[ \frac{B}{2 \theta_1} + \frac{618.4 E}{B} \right] + \theta_0$$

where

- $\theta$  = Final temperature deg. cent.
  - $\theta_0$  = Initial temperature deg. cent.
  - $\theta_1$  = Absolute initial temperature =  $(\theta_0 + 234.5)$ .
  - $t$  = Time in seconds.
  - $E$  = Ratio eddy current to  $I^2 R$  loss at 75 deg. cent.
- $$A = \frac{\text{Watts per lb. (at } \theta_0)}{180} + 4.6 \left( \frac{\text{amps.}}{\text{sq. in.}} \right)^2 \theta_1 10^{-11}$$

$$= \frac{75 \theta_1}{\left( \frac{\text{Cir. mils}}{\text{amps.}} \right)^2}$$

$$B = 2 \theta_1 + A t$$

**Exceptions:**

- (a) Auto-Transformers, see Par. 13-253.
- †(b) Transformers which are to be directly connected to other apparatus possessing inherent reactance. In this case the combined reactance of the transformer and the connected apparatus shall be considered as limiting the short circuit of the transformer.

**13-252. Short-Circuit Current of Reactors.**

Current limiting reactors having an impedance of 3 per cent or more shall be capable of withstanding without injury for five seconds the maximum current that would result from any short circuit on the system with normal line voltage maintained at the supply terminals and with only the inherent impedance of the reactors in the circuit.

**Exception:** Reactors having an impedance of less than 3 per cent shall be capable of withstanding without

\*This formula is not rigorously correct but for temperatures up to 350 deg. cent. gives results accurate enough for practical purposes. Accurate results under any or all assumed conditions will be obtained by the following formula:

$$\theta = 309.5 \sqrt{\left[ \left( \frac{\theta_0 \times 234.5}{309.5} \right)^2 + E_c \right] (\text{Log}_{10}^{-1} A t) - E_c - 234.5}$$

where

- $\theta$  = Final temperature in deg. cent.
- $\theta_0$  = Initial temperature in deg. cent.
- $E_c$  = Ratio of eddy current loss to the  $I^2 R$  loss at 75 deg. cent.
- $t$  = Time in seconds.
- $A = 4.0 \times 10^{-11} D^2$

where  $D$  = amperes per sq. in. of conductor.

or

$$A = 1.56 \times 10^{-6} W$$

where  $W$  = Watts per lb. ( $I^2 R$  at 75 deg. cent.)

or

$$A = 65 M^{-2}$$

where  $M$  = Cir. mils per amp.

†For the purpose of this rule, directly connected apparatus shall be considered to mean apparatus located only a few feet apart and connected by busses or cables, so arranged that there will be practically no possibility of a short circuit occurring between them.

injury for five seconds a current equal to  $33^{1/3}$  times the rated current.

For the purpose of standardization the temperature of the copper under the short-circuit conditions given above shall not exceed 250 deg. cent. for Class A insulation or 350 deg. cent. for class B insulation, when calculated by means of the formula in Par. 13-250 assuming:

- (a) that all heat is stored in the copper, and
- (b) an initial temperature of 105 deg. cent. for Class A insulation and 125 deg. cent. for Class B insulation.

**13-254 Grounding Transformers.**—Grounding transformers shall be capable while in service of withstanding a short circuit for a minimum specified time of 60 seconds.

For the purpose of standardization, 160 deg. cent is set as the maximum permissible ultimate temperature at the end of the 60-second period based on a calculation of the temperature, assuming that all of the heat is stored in the copper and that the initial temperature of the copper is 75 deg. cent.

The increase in temperature during the short circuit condition may be computed by the formula given in Par. 13-250.

If conditions should require that the time of short circuit exceed 60 sec., or if the transformer is to be used also for power purposes, the case shall be considered as special.

If additional resistances or reactance is to be provided external to transformer the amount, based on kv-a. (such as the kv-a. of a generator, etc.) should be stated.

**13-306 Measurement of Losses in Transformers.**

(a) \*No-load Losses: No-load losses of transformers shall be measured by impressing rated nameplate voltage† at normal frequency on one winding with the other winding, or windings, open circuited.

(b) \*Load Losses: Load losses of transformers shall be measured by applying a primary voltage, at rated frequency, sufficient to produce rated load current in the windings with the secondary winding short-circuited.

**13-402 Test Voltage to be Induced in Exceptions under 13-400.**

(n) Transformers with Graded Insulation: Transformers, if for use on circuits of 66,000 volts and above and having windings directly and permanently grounded to the core or case, and designed to take advantage of the fact that the neutral or other point of the circuit is to be directly and permanently grounded, shall be tested by induced voltage with connections so made that the ungrounded or line terminals shall receive test voltage to ground not less than 2.73 times the normal voltage developed by the winding, plus 1000 volts. If each phase of a three-phase transformer is tested separately, then an additional induced voltage test shall be made so as to produce between line terminals two times the rated circuit voltage, plus 1000 volts.

Where transformers have graded insulation they shall be so marked.

\*For the purpose of these measurements it is generally immaterial which winding is considered the primary winding.

In some cases where transformers have three or more windings it is necessary to use special methods of measuring load losses in order to determine those losses under specified load conditions.

†It is recognized that under load conditions with rated secondary voltage maintained, the losses are slightly increased, the amount depending upon the load, power factor and whether for stop-up or stop-down service, but since in service conditions the increase in total losses are not over 3 or 4 per cent (and in most cases less) for a power factor as low as 0.6, it has a negligible effect on the kv-a. output.

### A Useful Library on Electric Communication

What is perhaps the most complete private collection of works on the subject of electric communication is owned by Mr. Donald McNicol, a Fellow of the Institute and past-president of the Institute of Radio Engineers.

This collection was begun twenty-five years ago, and in order to make for its completeness in historical record and in all that is modern in communication theory and practice, it has been added to regularly.

The historical matter includes many original documents, reports and the life history of all telegraph, telephone, cable and radio companies; statistics of communication; reports of all International congresses and conventions; and the history and copies of all telegraph codes and cipher.

In this library there are approximately twenty scrap-books containing early references to telephone litigation, invention and legal controversies, and a bound annual volume of every telegraph journal published in the United States from 1853 up to the present time. The collection of radio magazines contains Vol. I, No. 1 of all American and foreign periodicals on the subject, as well as a complete file of A. I. E. E. and I. R. E. literature.

There are about fifty books on electrical biography and transcripts of all government investigations of telegraph, telephone and radio operation and ownership. The fiction of electric communication is covered in many volumes collected over a long period of years. One large scrap-book contains copies of nearly a thousand poems which have appeared on the telegraph, submarine cable, telephone and radio since the inception of these arts. The scrap-books on radio include practically all of the original and important announcements on the subject.

There are other scrap-books containing original signatures of practically all engineers and executives who have been prominent in the development of communication methods and systems.

In addition to this literary collection, Mr. McNicol has in his library at Roselle Park, N. J., another extensive collection of early telegraph, telephone and radio apparatus.

In his long experience with electric communication, Mr. McNicol has found time to write five books on communication subjects. By him also, another book entitled *A History of Radio* is soon to be published.

### Vice-President Dobson Visits Institute Sections

W. P. Dobson, of Toronto, the Institute's Vice-president in District No. 10, on May 18 presented before the Saskatchewan Section at Regina, a paper entitled *The Present State of the Insulator Problem*, and on May 25, the same paper before the Vancouver Section. In each case he discussed Institute activities with relation to the Sections in Canada. He attended the annual meeting of the Vancouver Section on June 7, but, due to lack of time, was unable to accept invitations to visit the San Francisco and Los Angeles Sections. He did, however, visit Seattle, and met the officers of the Section there, with other members.

Mr. Dobson reports great enthusiasm among the members of the Saskatchewan and Vancouver Sections. These include in their membership most of the electrical men in their respective territories.

### Orville Wright Recipient of Washington Award

Another honor has been accorded Orville Wright, pioneer in aviation, in the bestowal upon him of the Washington Award for 1927. The award was administered by the Western Society of

Engineers, the American Society of Civil Engineers being represented on the Commission. Mr. Wright has of late been doing consulting engineering.

## ENGINEERING FOUNDATION

### MR. FLINN RECEIVES HONORARY DEGREE

Incidental to its centenary ceremonies, the University of Louvain conferred upon Alfred D. Flinn, Director of Engineering Foundation, the honorary degree of Doctor of Science. So special a dispensation of the Academic Council is noteworthy as an expression of good will from this ancient university to the engineers of the United States. Doctor Edward Dean Adams received the diploma for Mr. Flinn, whose work for Engineering Foundation necessitated a visit to the Pacific Coast at this time.

## PERSONAL MENTION

E. J. PRINDLE has been elected president of the New York Patent Law Association. He was formerly with Prindle, Wright, Neal & Bean of New York, N. Y.

GIUSEPPE FACCIOLI, works engineer of the Pittsfield works of the General Electric Co., has been appointed associate manager and works engineer there. The appointment was effective July 1.

D. R. CLEMONS, for ten years an instructor in Dodge's Institute, Valparaiso, India, on May 3d joined the Development Branch of the engineering staff of the Western Electric Co., at Chicago.

RAY W. PRESTON has been transferred from the Unit Cost Department of the Southern California Edison Company to the position of Estimating Engineer in its Resident Engineers' Office at Big Creek, Fresno Co., Calif.

CLAUDE C. BROWN has been appointed Gas Administrator for Southern California by the California State Railroad Commission. Mr. Brown is a graduate of the University of California and chairman of the California Gas Research Council.

ELMER A. SPERRY, president of the Sperry Gyroscope Co., Brooklyn, N. Y., has been appointed on the Executive Committee of the A. S. M. E., to fill the unexpired term of George J. Mead, vice-president of Pratt & Whitney Aircraft Co., Hartford, Conn., resigned. Mr. Sperry is a charter member of the Institute.

BURTON L. DELACK, assistant manager of the Schenectady works of the General Electric Company since December, 1926, has been appointed acting manager, effective July 1. Mr. Delack fills the vacancy caused by the promotion of C. E. Eveleth, elected a vice-president, June, 1927.

ARTHUR PHELPS MARR, consulting engineer and attorney, New York, N. Y., is spending July and August in London and Berlin, interesting capital in the foreign rights of a number of American inventions. Mr. Marr became an Associate of the Institute in 1918.

EDWARD A. WAGNER, formerly of the Fort Wayne works of the General Electric Co. but since July, 1926, managing engineer in charge of all distribution transformers, with headquarters in Pittsfield, has been made acting manager of the Pittsfield works, succeeding Mr. C. C. Chesney, who has been chosen vice-president in charge of manufacturing, since the retirement of F. C. Pratt.

PAUL O. REYNEAU has just become affiliated with the Cutter Electrical & Manufacturing Company of Philadelphia, Pa. He will devote the major portion of his time to the development of applications for air circuit breakers, for which work his long service in engineering and operating of electric light and power

company particularly qualifies him. Mr. Reyneau joined the Institute in 1910.

EDWARD B. DOYLE, who has been identified with Westinghouse Elec. & Mfg. Co., New York, N. Y., is now representing the North East Service, Inc., in Indiana, the western half of Kentucky, the southern half of Illinois and eleven counties along the Mississippi River in Missouri, in both the sales and service of automotive equipment and electric typewriter equipment which his new company builds for the Remington Typewriter Company.

AMORY R. HAYNES, for the past 16 years with the Puget Sound Power & Light Co., at Dieringer Wash., has accepted an appointment as Electrical Engineer, Light Division, Dept. of Utilities of the City of Tacoma. Mr. Haynes is the author of several technical articles on hydroelectric and steam station operation. In 1926 he received third prize in the Puget Sound Power & Light Co. Suggestion Contest for his paper on *Economies in System Operation*.

GEORGE W. QUENTIN has resigned from McGraw Hill Publishing Company, Inc., and has accepted a position as sales engineer with the American Transformer Company, of Newark, New Jersey. Mr. Quentin has been an active member of the Institute, especially in the Pittsburgh and New York branches. He has spent many years training in public utility work, and also in industrial plant engineering. Much of his time will be spent in the field, studying the problems of the customers of the American Transformer Company.

JOHN MURPHY, Fellow of the Institute, electrical expert of the Railway Commission and the Department of Railways & Canals of Canada, was, on July 11, elected President of the Canadian National Committee of the International Electrotechnical Commission. Mr. Murphy succeeds the late president, James Kynoch, Chief Engineer of the Canadian General Electric Company, who died on June 1. The next Plenary Meetings of the International Electrotechnical Commission will be held in Italy in September, at Como and Rome, Mr. Murphy attending as Canada's official delegate.

## Past Section Meetings

### SECTION MEETINGS

#### Erie

Annual Dinner. A talk on *Aims and Activities of the A. I. E. E.* was given by H. H. Henline, Assistant National Secretary. The following officers were elected: Chairman, L. H. Curtis; Secretary, C. P. Yoder. June 15. Attendance 47.

#### Los Angeles

Field Day. A trip was made to the Long Beach Steam Plant of the Southern California Edison Company, which was followed by a dinner at The Breakers Hotel. Talks were given by G. A. Fleming, Southern California Edison Co.,

on *The Electrical Features of the Long Beach Steam Plant*; Raymond Wilcox on *The Mechanical Equipment of the Long Beach Steam Plant*; and Charles A. Blunt, Long Beach Chamber of Commerce. June 11. Attendance 47.

#### Milwaukee

*Trans-Atlantic Radio Telephony*, by H. S. Osborne, American Tel. & Tel. Co., May 18. Attendance 200.

*Recent Experiences Abroad*, by W. M. White, Allis-Chalmers Mfg. Co. Annual Meeting. The following officers were elected: Chairman, John D. Ball; Secretary-Treasurer, Wm. J. Ladwig. June 29. Attendance 24.

#### Minnesota

*My Western Trip*, by S. B. Hood, Northern States Power Co. (Presented by M. E. Todd). The following officers were elected: Chairman, J. E. Sumpter; Secretary-Treasurer, Gilbert Cooley. June 9. Attendance 27.

#### Philadelphia

*Engineers and Publicity Men*, by Major J. S. S. Richardson, Director, Pa. Public Service Information Committee. The following officers were elected: Chairman, I. M. Stein; Secretary, R. H. Silbert; Treasurer, E. C. Drew. June 13. Attendance 50.

#### Sharon

*The Human Element in Industry*, by E. S. McClelland, Westinghouse Elec. & Mfg. Co.;

*Our Flag*, by Dr. John Caldwell. Banquet. The following officers were elected: Chairman, L. H. Hill; Secretary-Treasurer, H. B. West. June 14. Attendance 156.

#### Toledo

Dinner Meeting. Short talks were given by Messrs. W. E. Richards, E. B. Featherstone, D. W. Yambert, C. H. Matthews and H. W. Jeannin. The following officers were elected: Chairman, T. J. Nolan; Vice-Chairman, W. T. Lowery; Secretary-Treasurer, Max Neuber. June 14. Attendance 20.

#### Urbana

Business Meeting. The following officers were elected: Chairman, J. O. Kraehenbuehl; Secretary-Treasurer, Prof. J. K. Tuthill. June 7. Attendance 14.

#### Utah

*Engineering Observations on a World Tour*, by A. N. Geyer, Utah Power and Light Co. The following officers were elected: Chairman, D. L. Brundige; Secretary-Treasurer, C. B. Shipp. May 26. Attendance 22.

#### Vancouver

Annual Meeting. Motion picture on Lamp and Small Motor Manufacture was shown. The following officers were elected: Chairman, A. C. R. Yuill; Secretary, J. Teasdale. June 7. Attendance 36.

#### Worcester

Inspection trip to American Steel & Wire Company. The following officers were elected: Chairman, Guy F. Woodward; Vice-Chairman, A. F. Snow; Secretary-Treasurer, F. B. Crosby. June 16. Attendance 50.

## A. I. E. E. Student Activities

### CONFERENCE ON STUDENT ACTIVITIES AT SUMMER CONVENTION

Immediately after the conclusion of the Sections Committee Conference, held at Detroit on June 20, in conjunction with the annual Summer Convention, a Conference on Student Activities was held, with Dr. C. E. Magnusson, Chairman of the Committee on Student Branches, presiding. There were present several members of the Board of Directors, many Section Delegates, seven Counselor Delegates, representing their District Committees on Student Activities, three District

Secretaries or alternates, and a considerable number of other members.

The program of this Conference had been prepared in advance, after requesting all Counselors to submit suggestions of subjects which should be discussed. In order that representatives from all parts of the country might have the advantages of such knowledge, it was deemed highly desirable to have reported at the meeting, all of the best ideas, methods, etc., brought out in the various Districts. With this end in view, the following program was presented:

## I. REPORTS ON DISTRICT CONFERENCES ON STUDENT ACTIVITIES AND STUDENT CONVENTIONS

- District No. 1*—Student Activities at Pittsfield Regional Meeting, May 25-28, 1927. Professor W. H. Timbie, Counselor Delegate.
- District No. 2*—Conference on Student Activities at Bethlehem, Pa., April 23, 1927. Professor H. B. Dates, Counselor Delegate.  
Student Convention at Drexel Institute, March 21, 1927. L. J. Costa, Chairman, Philadelphia Section.
- District No. 3*—New York Student Convention April 8, 1927. H. H. Henline, Assistant National Secretary.
- District No. 5*—Conference on Student Activities at Chicago, November 30, 1926. Professor J. F. H. Douglas, Counselor Delegate.
- District No. 6*—Conference on Student Activities at Boulder, Col., February 26, 1927. Professor W. C. Du Vall, Counselor Delegate.
- District No. 7*—Conference on Student Activities, at Kansas City, March 16, 1927. Professor G. C. Shaad, Counselor Delegate.
- District No. 8*—Student Convention at Stanford University, January 14, 1927, and other student activities in the District. Professor R. W. Sorensen, Counselor Delegate.
- Districts No. 8 and No. 9*—Conference on Student Activities at Salt Lake City, September 6, 1926. Professor G. S. Smith, Counselor, University of Washington Branch.
- District No. 9*—Section and Branch Conference at Portland, Ore., February 18, 1927. Professor J. A. Thaler, Counselor Delegate.

## II. BRANCH PROBLEMS

Discussion opened by H. H. Henline, Assistant National Secretary.

A general discourse on some of the more important phases of Branch activities, including some discussion of the reports presented in Part I, was held just before the close of the meeting. The following is a brief summary of the principal thoughts presented during the entire session:

The principle functions of Student Branches are to provide opportunity for students to carry on activities in a manner very similar to that employed by members; *i. e.*, the preparation, presentation, and discussion of papers, reports, abstracts, etc., on engineering subjects; and to promote friendship between students and older engineers.

Branch activities supply many opportunities for the development of initiative, originality, and leadership, all of which help to advance the growth of qualities which are essential to success in any kind of engineering undertaking. In recent conferences, several men have emphasized the thought that Branch work might be considered an excellent "laboratory" for cultivating important elements of leadership. With this result in mind, it is most desirable that Branch activities be managed practically entirely by the students, with the Counselors standing ready to advise when necessary. Suggestions for the major portion of Branch programs should be supplied by the students, with visiting speakers and motion pictures used only occasionally. To secure the maximum benefits of their opportunities, students must develop ability to speak before the meetings.

Student interest in Branch meetings fluctuates violently during an academic year, and one of the greatest problems before the Branches is that of securing a strong and sustained interest throughout the year. This can probably be accomplished by providing unusually attractive meetings at moments when the vital interest evidences a tendency to wane.

In many parts of the country, cooperation between Sections and Branches is being carried on very successfully. It has appeared in several forms, some of which are the sponsoring of student conventions by Sections, joint meetings with mixed program, student programs at regular Section meetings, joint inspection trips, etc.

Students have been highly complimented upon the quality of their papers presented at student conventions and most of such papers have been of good quality and well presented; the discussion too has been very good.

It seems desirable that District student conventions and conferences be held in connection with regional meetings in order that the students may attend other sessions and incidentally become acquainted with the older engineers.

The thought that some of the student criticism of the *JOURNAL* is based up on assumptions rather than facts was emphasized. It was believed that many students can read a considerable number of the papers in the *JOURNAL* with good results, if they really try, but Faculty members can be of great assistance to them by supplying some guidance in getting them started in such reading.

In closing the conference, Dr. Magnusson remarked that, from the reports of today, it appears quite evident that the Institute Branches are very much alive and doing an excellent work; but that it is also apparent that "we have lots of problems before us, and that there will be plenty to do before the next meeting,—a year from now."

## BRANCH MEETINGS

### Municipal University of Akron

*The Life of Sir Oliver Heaviside*, by Prof. J. T. Walther, and  
*The Electrical Development Around Akron during the Last Ten Years*, by A. L. Richmond, Northern Ohio Traction and Light Co. Annual Banquet. June 16. Attendance 16.

### California Institute of Technology

Business Meeting. Mr. Gottier announced the Pacific Coast Convention at Del Monte to be held in September. The following officers were elected: President, J. G. Thatcher; Vice-President, L. H. Mesenkop; Secretary, J. G. Kuhn; Treasurer, R. J. Love. May 25. Attendance 13.

### Drexel Institute

General discussion of the fundamental concepts and definitions and attempts to explain the various electrical units as simply as possible. The following officers were elected: Chairman, J. E. Young; Secretary, Charles Backman; Treasurer, W. H. McMakin. June 3. Attendance 32.

### University of New Hampshire

*The Nernst Lamp*, by C. Williams, student;  
*Variable Condensers*, by L. P. Whitten, student, and  
*Arched Dam Investigation*, by D. H. Williams, student. April 30. Attendance 36.

Business Meeting. The following officers were elected: Chairman, S. S. Appleton; Secretary, H. B. Rose. May 14. Attendance 33.

*Electricity in the Paper Industry*, by H. F. Bannon, Westinghouse Elec. & Mfg. Co. May 21. Attendance 33.

*Watt-hour Meters*, by C. Williamson, student, and  
*Recent Developments in Radio Communication*, by E. L. St. Clair, student. May 28. Attendance 41.

*High Voltage Insulation*, by Mr. Drew, student, and  
*The New General Electric Transmitting Tube*, by I. Gove, student. Illustrated. June 4. Attendance 38.

### North Carolina State College

Business Meeting. The following officers were elected: Chairman, J. C. Davis; Vice-Chairman, W. P. Stainback; Secretary, T. C. Farmer. May 25. Attendance 18.

## Engineering Societies Library

*The library is a cooperative activity of the American Institute of Electrical Engineers, the American Society of Civil Engineers, the American Institute of Mining and Metallurgical Engineers and the American Society of Mechanical Engineers. It is administered for these Founder Societies by the United Engineering Society, as a public reference library of engineering and the allied sciences. It contains 150,000 volumes and pamphlets and receives currently most of the important periodicals in its field. It is housed in the Engineering Societies Building, 29 West Thirty-ninth St., New York.*

*In order to place the resources of the Library at the disposal of those unable to visit it in person, the Library is prepared to furnish lists of references to engineering subjects, copies or translations of articles, and similar assistance. Charges sufficient to cover the cost of this work are made.*

*The Library maintains a collection of modern technical books which may be rented by members residing in North America. A rental of five cents a day, plus transportation, is charged.*

*The Director of the Library will gladly give information concerning charges for the various kinds of service to those interested. In asking for information, letters should be made as definite as possible, so that the investigator may understand clearly what is desired.*

*The library is open from 9 a. m. to 10 p. m. on all week days except holidays throughout the year except during July and August when the hours are 9 a. m. to 5 p. m.*

### BOOK NOTICES JUNE 1-30, 1927

Unless otherwise specified, books in this list have been presented by the publishers. The Society does not assume responsibility for any statement made; these are taken from the preface or the text of the book.

All books listed may be consulted in the Engineering Societies Library.

#### BRIDGE ARCHITECTURE.

By Wilbur J. Watson, N. Y., William Helburn, Inc., 1927. 288 pp., illus., 14 x 11 in., cloth. \$17.50.

This beautiful book is a pleasure to the engineer, the architect and the lover of beauty in general. It aims to illustrate the art of good bridge design as exemplified by ancient and modern bridges by means of large photographs of representative structures.

The volume contains illustrations of two hundred bridges, grouped chronologically in six periods and covering bridge building from the earliest times to the present day. The collection is especially rich in bridges built since 1830. The text is brief but gives concisely the principal facts about each bridge, such as the date, the designer, the dimensions, etc.

#### BUSINESS ANNALS.

By Williard Long Thorp. N. Y., Nat'l. Bureau of Economic Research, Inc. 1926. 380 pp., 9 x 6 in., cloth. \$4.00.

Tells, in descriptive form, the vicissitudes of economic fortune in seventeen countries for periods ranging from thirty-six to one hundred and thirty-six years. Presents briefly, for each country, the year by year fluctuations in manufacturing, construction, employment, trade, prices, speculation, financial operations and agriculture, as well as important non-economic events that supposedly influence economic activity. The book throws valuable light upon business cycles and is a useful condensed record of happenings in the recent past.

#### CARE AND OPERATION OF MACHINE TOOLS.

By J. W. Barritt. N. Y., John Wiley & Sons, 1927. 292 pp., illus., 9 x 6 in., cloth. \$2.75.

Contents: Lubrication.—Emery wheel.—Drill press.—Shaper.—Vertical boring mill.—Lathe.—Planer.—Horizontal boring mill.—Milling machine.—Index.

The author explains the construction of the various parts of machine tools, explains why and where adjustments are necessary, tells how to make them, gives directions for operating the different mechanisms properly and calls attention to the precautions necessary for accuracy, speed and neatness. The text is simple and explicit, suitable for use by apprentices and trade-school students and for individual study.

#### ELECTRICAL ENGINEERING LABORATORY EXPERIMENTS.

By C. W. Ricker and C. E. Tucker. 2nd edition. N. Y., McGraw-Hill Book Co., 1927. 310 pp., 9 x 6 in., cloth. \$2.25.

This laboratory course, originally used by students at the Massachusetts Institute of Technology, has been revised with a view to adapting it to the requirements of engineering schools in general. The course is designed to require original thought by the student and to encourage him to original research as well as to instruct him regarding the construction and operation of electrical machinery.

#### ELEMENTS OF MINING SCIENCE.

By David E. Thomas. Lond. & N. Y., Oxford University Press, 1927. 80 pp., illus., 10 x 6 in., boards. \$1.50. (Gift of American Branch.)

Originally prepared for a course of lectures to teachers of science in the mining district of England, this book gives a brief account of some of the work accomplished through the contributions of pure science to mining. Among the topics treated are the composition of mine air, methane, the barometer in mines, the spontaneous combustion of coal, moisture in mine air, the control of atmospheric conditions in deep mines, and coal-mine explosions. While no originality is claimed, the volume is a convenient summary of recent work toward improved health conditions and greater safety in mining.

#### FATIGUE OF METALS; with chapters on the Fatigue of Wood and Concrete.

By H. F. Moore and J. B. Kammers. N. Y., McGraw-Hill Book Co., 1927. 326 pp., illus., diags., tables, 9 x 6 in., cloth. \$4.00.

The aim of this book is to present the important results of experimental investigations of the strength of metals under repeated stress, to review current theories of fatigue of metals, and to describe the apparatus and methods used in studying the subject experimentally. The authors have been actively engaged in investigation of the subject and have also drawn on the work of other American and foreign investigators, with the result that their book is a useful review of present knowledge. A good bibliography is included. In addition to the main subject, wood and concrete are discussed and the scanty data available given.

#### FOURTH POWER KINK BOOK. Compiled by Editorial Staff of Power.

N. Y., McGraw-Hill Book Co., 1927. 232 pp., illus., 9 x 6 in., cloth. \$1.50.

The editors of *Power* have selected the contents of this book from the articles contributed to that magazine by men in charge

of the operation and repair of power plant machinery. These articles describe original ways of making unusual repairs, "short-cuts," and labor-saving devices which have been used successfully by practical men.

#### DIE GRAPHISCHE INTEGRATION.

By Josef Gerstenbrandt. Wittenberg, A. Ziemsen Verlag, 1926. 135 pp., 8 x 6 in., cloth. 6-r. m.

A concise handbook upon the use of graphic integration, intended for practising engineers who have some knowledge of the theoretical principles. The book consists chiefly of illustrations of the application of the method to problems that recur frequently in structural design, and that are more conveniently solved by this method than by other common ones. The examples are worked out completely.

#### HEROES OF AVIATION.

By Laurence La Tourette Driggs. New and revised edition. Boston, Little, Brown & Co., 1927. 346 pp., ports., 8 x 5 in., cloth. \$2.00.

A vividly written account of the part played by the aviator in the World War, especially the exploits of the more famous airmen in the various armies on the western front. Tabulations of the victories accredited to the strongest air fighters of each nation are included, and there is a roster of the Americans killed while flying. First published in 1918; now revised.

#### HISTORY OF THE SCIENCES IN GRECO-ROMAN ANTIQUITY.

By Arnold Reymond, N. Y., E. P. Dutton & Co., 1927. 245 pp., 8 x 5 in., cloth. \$2.50.

Professor Reymond of the University of Lausanne has for many years given the advanced students a course of instruction in the history of science. The portion of that course which relates to antiquity is now offered in an English translation. It offers to the student an admirable survey, in which the known facts are clearly brought forth and divested of an excess of detail, and the tendencies of science in that period, its achievements and failures, are set forth clearly.

#### INVENTIONS AND PATENTS, Their Development and Promotion.

By Milton Wright. N. Y., McGraw-Hill Book Co., 1927. 225 pp., 8 x 6 in., cloth. \$2.50.

A plainly written book of practical advice for inventors and would-be inventors. Tells how to obtain a patent and how to market it. Warns the inventor of various dangers in his path.

#### LECTURES ON DIELECTRIC THEORY AND INSULATION.

By J. B. Whitehead. N. Y., McGraw-Hill Book Co., 1927. 154 pp., diags., tables, 9 x 6 in., cloth. \$2.50.

Professor Whitehead's book reviews the salient features of dielectrics for which the classical theory fails to account, reviews the literature describing experimental research upon the behavior of dielectrics and coordinates it with fundamental theory as fully as possible and indicates some directions in which further experimentation may be fruitful. The treatment is very condensed. The text is in the form of nine lectures, prepared for delivery in France as an exchange professor, which summarize the course given by the author to advanced students at the Johns Hopkins University. A bibliography is included.

#### LEGAL ASPECTS OF ZONING.

By Newman F. Baker. Chic., University of Chicago Press, 1927. 182 pp., 8 x 5 in., cloth. \$2.50.

Mr. Baker discusses the attitude of courts and lawmakers toward some of the more important questions that arise in connection with city planning. The extent to which the law takes cognizance of municipal aesthetics, legislation respecting zoning and the problem of the metropolitan area or region are considered, special attention being paid to court decisions upon contested points. Of interest to engineers as well as lawyers.

#### LOGIC OF MODERN PHYSICS.

By P. W. Bridgman. N. Y., Macmillan Company, 1927. 228 pp., 9 x 6 in., cloth. \$2.50.

Many of the new facts discovered in recent years in the domain of relativity and quantum theory have necessitated such complicated modifications in our notions of the fundamental concepts of physics that it has become a matter of the first importance to review these concepts in inclusive fashion. This task Professor Bridgman essays in the present volume. He examines critically the various concepts, in the light of experimental knowledge, with the purpose of leading to a clearer understanding of what the ideals of physics should be and of what the present structure of physics is.

#### MACHINE DESIGN, CONSTRUCTION AND DRAWING.

By Henry J. Spooner. 6th edition. Lond. & N. Y., Longmans, Green & Co., 1927. 775 pp., illus., diags., 9 x 6 in., cloth. \$7.00.

An English textbook which begins with instruction in mechanical drawing, and then proceeds to treat with fullness machine parts—fastenings, bearings, gearing, etc. An unusual amount of practical information is given.

#### MATHEMATICS OF ENGINEERING.

By Ralph E. Rost. Baltimore, Williams & Wilkins Co., 1927. 540 pp., 9 x 6 in., cloth. \$7.50.

The author, who is professor of mathematics in the Post-graduate School of the U. S. Naval Academy, has prepared this book primarily for the student officers who are to specialize in mechanical, civil, electrical, aeronautical, or radio engineering, in aerology, in naval construction, or in ordnance engineering. The result is a convenient introduction to mathematics with special attention to the requirements of the engineer, intended for students of maturity who already are somewhat familiar with conventional courses in mathematics.

#### MATHEMATISCHE HILFSMITTEL FÜR TECHNIKER.

By A. Deckert and E. Rother. Wittenberg, A. Ziemsen Verlag, 1927. 254 pp., 8 x 6 in., cloth. 7,50 r. m.

A collection of formulas and other rules of differential and integral calculus used by engineers and scientists, arranged in convenient form for quick reference.

#### METALLURGY; a general treatise for the use of students of engineering.

By Henry Wysor. 3rd edition. Easton, Pa., Chemical Publishing Co., 1927. 433 pp., illus., 9 x 6 in., cloth. \$6.00.

In preparing this elementary textbook, the author has had in mind not only those students who intend to become producers of metals but also those who will become responsible for their selection and fabrication. His book therefore aims to concentrate attention upon the properties of the various metals and upon the mechanical and thermal operations by which these properties are developed and utilized.

Beginning with descriptions of the raw materials, their preparation, and of metallurgical furnaces, the extraction and refining of the various metals are explained. Chapters are then devoted to general matters, such as alloys, casting, working and heat treatment. The text is concise and clear.

#### MODERN INDUSTRY.

By Ernest L. Bogart and Charles E. Landon. N. Y., Longmans, Green & Co., 1927. 593 pp., illus., maps, 9 x 6 in., cloth. \$3.75.

The authors of this work, believing that an understanding of industry precedes an understanding of business, have filled a gap that they believe exists in our economic textbooks, by this volume, which is intended as a background to the study of economics.

Starting with a description of the characteristics of modern industry, the book discusses successively man as a contributing agent and nature as a conditioning factor. Typical great agri-

cultural and manufacturing industries are then studied, to make clear the principles underlying modern industry and the methods followed in producing wealth. Finally, processes of exchange are considered.

The book is descriptive, not theoretical. It gives a clear, interesting account of industry as a whole, in which the relations of the different parts to each other are brought out. Excellent lists of references are given.

#### NOMOGRAPHIE DES BAUINGENIEURS.

By Max Mayer. Ber. u. Lpz., Walter de Gruyter & Co., 1927. 111 pp., diags., 6 x 4 in., cloth. 1,50 r. m.

Explains the method, points out the theoretical possibilities of nomography in structural engineering and provides a useful collection of nomograms which illustrates the practical application of these charts.

#### OLD TOWPATHS; The Story of the American Canal Era.

By Alvin F. Harlow. N. Y., D. Appleton & Co., 1926. 403 pp., illus., maps, 9 x 6 in., cloth. \$5.00.

This book provides for the general reader an interesting account of the rise of the canal era in America, of its period of prosperity and of the decline and practical extinction of the canal. There are also chapters on canal engineering and operation, on life on the canal, on travel, on canal lotteries and other interesting subjects. In addition to this general account, the author devotes a chapter to the individual history of each important canal project. There are many interesting illustrations from old prints and photographs, and a useful bibliography. The author has brought together an immense amount of widely scattered information.

#### OLD TRADES AND NEW KNOWLEDGE; Six lectures delivered before a "juvenile auditory" at the Royal Institution, 1925.

By Sir William Bragg. Lond., G. Bell & Sons, 1926. 266 pp., illus., plates, 8 x 5 in., cloth. 8s.

The "trades" discussed in these lectures are those of the sailor, the weaver, the dyer, the potter, and the miner. Sir William treats each trade in an interesting fashion, giving special consideration to the ways in which modern scientific knowledge is changing these old crafts. The book will interest many adults as well as the "juvenile" audience for which it was prepared.

#### PRINCIPLES OF EMPLOYMENT PSYCHOLOGY.

By Harold Ernest Burt. Bost. & N. Y., Houghton Mifflin Co., 1926. 568 pp., 9 x 6 in., cloth. \$4.00.

"This book", says its author, "is an outgrowth, in the first instance, of material used for several years in presenting principles of employment psychology to college students, and in the second instance, of practical experience in personnel work and frequent contact with business men interested in psychology in so far as it relates to their problems. Effort is made, on the one hand, to give a fairly comprehensive account of the principles involved for the use of students preparing for practical psychological work in industry, and on the other hand, to avoid a discussion that is too technical for the reader without a psychological background." An extensive bibliography is given.

#### PSYCHOLOGY OF SELECTING MEN.

By Donald A. Laird. 2d edition. N. Y., McGraw-Hill Book Co., 1927. 345 pp., illus., charts, 9 x 6 in., cloth. \$4.00.

This book is the work of a trained psychologist who has attempted to supply a technical account, in a non-technical way, of the fundamental considerations in selecting men.

Dr. Laird first surveys critically the traditional methods of selection, by letter, by interview, by photograph, etc. The latter portion of the book describes the scientific methods of selection and discusses the use and limitations of psychological and intelligence tests.

This edition contains new chapters which point the way for the utilization of definite tests in choosing employees.

#### RADIOTECHNIK, v. 4; Stromquellen für Röhrenempfangsgerate.

By Richard Albrecht. Ber. u. Lpz., Walter de Gruyter & Co., 1927. 108 pp., illus., diags., tables, 6 x 4 in., cloth. 1,50 r. m.

The fourth volume of Dr. Albrecht's concise textbook takes up cells, storage batteries and other sources of power. The theory is explained clearly and practical directions are also given. A critical evaluation of the different sources of power for receivers is given.

#### SLIDE VALVES AND VALVE GEARING.

By Peter Youngson. Glasgow, James Munro & Co., 1927. 233 pp., illus., diags., 10 x 8 in., cloth. 12s 6d.

A clearly written, profusely illustrated textbook on the working and management of steam valve gear, intended especially for marine engineers. The author is the head of the Marine Engineering Department, Central Municipal Technical School, Liverpool.

#### STATICS AND THE DYNAMICS OF A PARTICLE.

By William Duncan MacMillan. N. Y., McGraw-Hill Book Co., 1927. 430 pp., 9 x 6 in., cloth. \$5.00.

A discussion of the general theory, intended particularly for students of astronomy, physics or mathematics, but also of interest to engineers who wish further knowledge than that necessary for ordinary applications. The text begins with the fundamental concepts and postulates and covers the subjects usually taught in colleges. A knowledge of the calculus is necessary.

#### STATISTICAL MECHANICS WITH APPLICATIONS TO PHYSICS AND CHEMISTRY.

By Richard C. Tolman. N. Y., Chemical Catalog Co., 1927. (American Chemical Society. Monograph Series). 334 pp., 9 x 6 in., cloth. \$7.00.

Statistical mechanics offers to the chemist and physicist a powerful method, wide in scope, for attacking theoretical problems. Those engaged in the study of the behavior of atoms and molecules will find this book useful, for it develops the theory of statistical mechanics in logical fashion and shows how the science may be applied to the elucidation of a number of chemical and physical phenomena.

#### TECHNISCHE SCHWINGUNGSLEHRE, bd. 2; Schwingungen im Maschinenanlagen.

By L. Zipperer. Ber. u. Lpz., Walter de Gruyter & Co., 1927. 124 pp., illus., 6 x 4 in., cloth. 1,50 r. m.

After the discussion of vibration in general given in the first volume of the work, the second proceeds to discuss the individual methods for calculating the specific rate of torsional vibration in shafts with various numbers of disk flywheels. The method of calculating transverse vibrations is then given. Attention is then turned to experimental methods and to methods for avoiding vibration.

#### DER TRANSFORMATOR IM BETRIEB.

By Milan Vidmar. Berlin, Julius Springer, 1927. 310 pp., diags., 9 x 6 in. Boards. 19,-r. m.

This book is in a sense an extension of the author's larger work entitled "Die Transformatoren," from which it differs by treating the subject from the point of view of the operator, instead of the designer and maker. It is a textbook upon transformer operation, intended for the operating engineer and discusses the problems which confront him.

The first chapter is devoted to questions of the cost and efficiency of transformers. Chapter two discusses transformers for lighting circuits. Connections are considered in chapter three, which is followed by chapters on overloading, on voltage

regulation, and on cooling. The final chapter treats of minor operating problems.

VORLAUFIGE RICHTLINIEN FÜR DIE AUSFÜHRUNG VON BAUWERKEN AUS BETON IM MOOR, IN MOORWASSERN UND ÄHNLICH ZUSAMMENGESetzten WASSERN.

By Deutsche Ausschuss für Eisenbeton. Berlin, Wilhelm Ernst & Sohn, 1927. 7 pp., 11 x 8 in., paper. 0,30 mk.

A pamphlet giving the specifications of the Deutsche Ausschuss für Eisenbeton covering the construction of concrete structures in swamps and waters containing acids and other substances injurious to concrete.

ZEITSTUDIEN BEI EINZELFERTIGUNG.

By Hans Kummer. Berlin, Julius Springer, 1926. 113 pp., diags., 9 x 6 in., paper. 9,60 r. m.

Most of the literature upon time studies, says this author, is devoted to studies of the time required for producing machine parts manufactured in large numbers or in series. In the present book he discusses the application of time studies to operations that occur infrequently and to the making of single parts of machines. The book describes the methods for making studies, the preparation of standard tables and the practical use of the findings.

## Engineering Societies Employment Service

*Under joint management of the national societies of Civil, Mining, Mechanical and Electrical Engineers cooperating with the Western Society of Engineers. The service is available only to their membership, and is maintained as a cooperative bureau by contributions from the societies and their individual members who are directly benefited.*

Offices:—33 West 39th St., New York, N. Y.,—W. V. Brown, Manager.

58 West Jackson Blv'de., Room 1736, Chicago, Ill., A. K. Krauser, Manager.

57 Post St., San Francisco, Calif., N. D. Cook, Manager.

**MEN AVAILABLE.**—Brief announcements will be published without charge but will not be repeated except upon requests received after an interval of one month. Names and records will remain in the active files of the bureau for a period of three months and are renewable upon request. Notices for this Department should be addressed to **EMPLOYMENT SERVICE, 33 West 39th Street, New York City**, and should be received prior to the 15th day of the month.

**OPPORTUNITIES.**—A Bulletin of engineering positions available is published weekly and is available to members of the Societies concerned at a subscription rate of \$3 per quarter, or \$10 per annum, payable in advance. Positions not filled promptly as a result of publication in the Bulletin may be announced herein, as formerly.

**VOLUNTARY CONTRIBUTIONS.**—Members obtaining positions through the medium of this service are invited to cooperate with the Societies in the financing of the work by nominal contributions made within thirty days after placement, on the basis of \$10 for all positions paying a salary of \$2000 or less per annum; \$10 plus one per cent of all amounts in excess of \$2000 per annum; temporary positions (of one month or less) three per cent of total salary received. The income contributed by the members, together with the finances appropriated by the four societies named above, will it is hoped, be sufficient not only to maintain, but to increase and extend the service.

**REPLIES TO ANNOUNCEMENTS.**—Replies to announcements published herein or in the Bulletin, should be addressed to the key number indicated in each case, with a two cent stamp attached for reforwarding, and forwarded to the Employment Service as above. Replies received by the bureau after the positions to which they refer have been filled will not be forwarded.

### POSITIONS OPEN

**ELECTRICAL ENGINEER**, experienced in the design of electrical control for elevators including multi-speed alternating current and variable voltage controlled equipment. Only high grade thoroughly experienced men need apply. Apply by letter. Location, Ohio. X-2875-C.

**SALES ENGINEER**, young, for New York, N. Y. Electrical engineering graduate with test experience preferred. Apply by letter giving full particulars, experience, age, qualifications and salary desired. X-2893.

**ENGINEER**, capable of recognizing and supervising engineering department for manufacturer of high-grade electrical switching equipment. Must have had five years or more practical experience in design and manufacture of electrical equipment. Apply by letter. Location, East. X-2994.

(For further particulars see p. 21, Adv. Sec. this issue).

### MEN AVAILABLE

**ELECTRICAL ENGINEERING GRADUATE**, 1926, B. S. in E. E., single, 23, with definite ability in research and development, and in general technical writing, desires permanent position with manufacturer of electrical apparatus. Vicinity of New York preferred. C-2967.

**GRADUATE MECHANICAL AND ELECTRICAL ENGINEER**, desires permanent position in United States or Canada, Age 24, married. G. E. test course, eight months operating, eighteen months general workshop, twelve months' drawing office experience. Willing to start on living wage if hard work appreciated. Available four months. C-3224.

**ELECTRICAL DESIGN AND CONSTRUCTION ENGINEER**, 32, married, university graduate Electrical Engineer, with nine years,

practical experience in design, construction and operation of central stations and substations, wishes position with public utility or engineering firm. Expert in automatic substations, control relay and metering. Location immaterial. B-6560.

**RECENT GRADUATE**, M. E., desires enter consulting work, research, editorial work, construction or teaching. Good habits, honest, reliable, highest references, excellent college record. Commercial course in high school; Spanish, accounting, typing. New York City and vicinity only. C-3235.

**ELECTRICAL ENGINEER**, eighteen years' experience development, design and manufacture of high grade electrical apparatus and instruments. Meters, pyrometers and their application to various industries. Executive experience, organization and administration. American born Christian. B-2721.

**PRODUCTION ENGINEER OR MANAGER**, competent engineer and executive trained on production control, scheduling, machine operations, equipment, budgeting, valuations, costs, wage incentives, with technical and college degrees and background of electrical and mechanical engineering experience with eleven years' constructive record of development, desires position in Eastern States. Now engaged on installing production control methods in large organization. Age 32, married. B-9676.

**PROFESSOR**, Electrical Engineering, 42, married, teacher, Electrical Engineering, desires to make a change. Teaching experience of over ten years covers practically all basic course, both laboratory and theory. Contact with the industry has been broad and includes General Electric, Westinghouse and utility experience. Will publish a book in the near future. Desires professorship in a recognized institution. B-7083.

**GRADUATE ELECTRICAL AND MECHANICAL ENGINEER**, desires position with an electric railway or industrial concern. Experience includes six years of railway projects and traction equipment, and five years on power development. C-3260.

**MECHANICAL AND ELECTRICAL ENGINEER**, Cornell graduate, eighteen years' experience, including efficiency engineering for large industrial (paper mill) along steam and power production lines; combustion studies, boiler house rehabilitation, etc. Industrial power sales engineering for utility. Prior to foregoing; supervision electrical installation for large electrical manufacturer while stationed in Eastern city. B-6764.

**ELECTRICAL ENGINEER**, 22, single, technical graduate, two years' experience managing municipal water and light system, including generating plant, pumping plant, office, etc., also some experience in high-tension substation work. Location, East preferred. C-3194.

**GRADUATE ENGINEER**, 21, single, B. S. in E. E., 1927, desires work in electrical manufacturing, design, research, or installation and testing. Thorough and conscientious, good habits. Location preferred, United States. C-3255.

**TECHNICAL ENGINEER**, six years' experience in public utilities, purchasing, sales, testing, installation and appraisal work. Excellent reference. Energetic and pleasing personality. Desires permanent position with a future. Moderate salary to start. C-1973.

**DISTRIBUTION ENGINEER**, 27, single, over five years' experience layout and design of transmission and distribution systems of two large Eastern utilities. Experience in overhead, underground and substation construction. Has had supervision of men in both positions. Initia-



tive and aggressiveness. Location immaterial. B-8707.

**ELECTRICAL ENGINEER**, 24, technical graduate, with one year's experience in the construction lighting distribution systems, and an excellent house wireman. Desires position with large electrical contractor with opportunity for permanent employment. Location anywhere. Available August 30th. C-3305.

**SALES OR SALES AND SERVICE**, 28, single, technical graduate; six years' experience covers testing and service engineering work on

many different types of electrical apparatus, desires position with small or moderate sized firm in sales or sales and service. Location preferred, New Jersey. C-3020.

**ELECTRICAL ENGINEER**, 21, single, junior electrical engineer, B. S. Degree in Electrical Engineering from the University of Southern California, desires a position, preferably with manufacturing concern. Location preferred, South, West or Southwest. C-3310-77-C-1.

**ELECTRICAL ENGINEER**, 28, University graduate. Three years shop work, eighteen

months electrical drafting, two years maintenance and operation, electrical railroad substations, five months traction department electric railroad. At present employed. Available on short notice. Location immaterial. C-3317.

**GRADUATE ELECTRICAL ENGINEER**, seven years' experience in the engineering and construction of aerial and underground distribution, transmission and street lighting systems. Desires position with firm or public utility engaged in transmission or station construction projects. Location immaterial. B-9408.

## MEMBERSHIP — Applications, Elections, Transfers, Etc.

### RECOMMENDED FOR TRANSFER

The Board of Examiners, at its meeting held July 19, 1927, recommended the following members for transfer to the grade of membership indicated. Any objection to these transfers should be filed at once with the National Secretary.

#### To Grade of Fellow

- BARNES, JAMES P., President, Louisville Railway Company, Louisville, Ky.
- MAHAN, JAMES S., Electrical and Fire Prevention Engineer, Western Actuarial Bureau, Chicago, Ill.
- STIGANT, STANLEY A., Manager, Transformer Dept., Johnson & Phillips, Ltd., London, England.

### APPLICATIONS FOR ELECTION

Applications have been received by the Secretary from the following candidates for election to membership in the Institute. Unless otherwise indicated, the applicant has applied for admission as an Associate. If the applicant has applied for direct admission to a higher grade than Associate, the grade follows immediately after the name. Any member objecting to the election of any of these candidates should so inform the Secretary before August 31, 1927.

- Aemmer, F., American Brown Boveri Electric Co., Camden, N. J.
- Anderson, H. O., Rockbestos Products Corp., New Haven, Conn.
- Borch, H. J., B. M. T., Brooklyn, N. Y.
- Borton, J. T., (Member), Kohler Co., Philadelphia, Pa.
- Bradley, W. R., Missouri Power & Light Co., Excelsior Springs, Mo.
- Brown, H., Southwestern Oil Co., Houston, Texas
- Brown, H. E., Pennsylvania Railroad, Newcomerstown, Ohio
- Busby, A. H. W., Consolidated Mining & Smelting Co., Trail, B. C., Can.
- Campfield, L. M., Westinghouse Elec. & Mfg. Co., East Pittsburgh, Pa.
- Divito, A. A., 104 S. 3rd St., Harrison, N. J.
- Doobin, A. M., New York Central Railroad Co., New York, N. Y.
- Dubs, F. H., Toledo Edison Co., Toledo, Ohio
- Epstein, S., A-One Electric Co., Brooklyn, N. Y.
- FitzGerald, A. S., (Member), General Electric Co., Schenectady, N. Y.

- Fortin, R. P., Trade & Commerce Dept., Dominion Gov't., St. John, N. B.
- Garratt, Joseph F. G., E. L. Philips Construction Co., Far Rockaway, N. Y.
- Gilcrease, E. E., Molony Electric Co., St. Louis, Mo.
- Godoy, E. R., Mexican Tel. & Tel. Co., Mexico, D. F., Mex.
- Goodman, I. E., Goodman Engineering Co., Cleveland, Ohio
- Grant, C., Electricity & Gas Insp. Service, Dominion Gov't., St. John, N. B., Can.
- Grant, E. G., Nashwaak Pulp & Paper Co., Fairville, N. B., Can.
- Gray, J. C., Gray Electric Co., Detroit, Mich.
- Guckel, C. H., United Electric Light & Power Co., New York, N. Y.
- Hamilton, J. G., Westinghouse Elec. & Mfg. Co., East Pittsburgh, Pa.
- Hanson, E. T., Stone & Webster, Havre de Grace, Md.
- Hersh, D., Graven & Mayger, Chicago, Ill.
- Jayne, G. E., Mountain States Tel. & Tel. Co., Denver, Colo.
- Johns, G. J., Union Gas & Electric Co., Cincinnati, Ohio
- Johnson, H. R., (Member), Schneider Electrical Works, Omaha, Nebr.
- Jones, G., Hedley Gould Mining Co., Ltd., Hedley, B. C., Can.
- Kern, E. A., United Electric Light & Power Co., New York, N. Y.
- Key, E. F., B. C. Electric Railway Co., Ltd., Lake Buntzen, B. C., Can.
- Klipsch, P. W., General Electric Co., Schenectady, N. Y.
- Knieriem, P. H., Duquesne Light Co., Braddock, Pa.
- Knowles, D. D., Westinghouse Elec. & Mfg. Co., East Pittsburgh, Pa.
- LeVan, J. D., Cutler-Hammer Mfg. Co., Milwaukee, Wis.
- Lynch, E., General Electric Co., W. Lynn Works, Lynn, Mass.
- Montville, H. H., Greer Electrical Construction Co., New York, N. Y.
- Moreland, L. D., Phoenix Utility Co.; Florida Pr. & Lt. Co., Sarasota, Fla.
- Nachmani, A., 1421 Madison Ave., New York, N. Y.

- Norton, R. H., (Member), B. C. Fire Underwriters Ass'n., Vancouver, B. C.
  - Nuezel, E. F., Columbia Engg. & Management Corp., Cincinnati, Ohio
  - Ogden, P. L., Public Service Co. of No. Illinois, Chicago, Ill.  
(Applicant for re-election.)
  - Pagot, A. L., General Electric Co., Schenectady, N. Y.
  - Paton, R. E., Leeds & Northrup Co., Philadelphia, Pa.
  - Peet, H. D., Jr., Kentucky Development Co., Louisville, Ky.
  - Pierre, G. J., Detroit Edison Co., Detroit, Mich.
  - Reck, J. E., Piqua Dist., Dayton Power & Light Co., Piqua, Ohio
  - Santschi, A. E., Western Electric Co., Chicago, Ill.
  - Simonds, K. C., Florida Power & Light Co., Lakeland, Fla.
  - Terry, W. S., American Tel. & Tel. Co., New York, N. Y.
  - Waldhorst, F., Greenridge Court, White Plains, N. Y.
  - Weatherwax, O. K., Pierce Electric Co., Miami, Fla.
  - Werner, F., Molony Electric Co., St. Louis, Mo.
  - White, R. M., Sperry Gyroscope Co., Brooklyn, N. Y.
  - Williams, S. T., (Member), Victor Talking Machine Co., Camden, N. J.
  - Wunderlich, N. E., Neutrowound Radio Mfg. Co., Homewood, Chicago, Ill.
  - Zucker, M., General Electric Co., Schenectady, N. Y.
- Total 58.

#### Foreign

- Atkinson, J. W., (Member), British Engine-Boiler & Electrical Insurance Co., Ltd., Manchester, Eng.
  - deMare, F. G. S., (Member), Andes Copper Mining Co., Antofagasta, Chile, S. A.
  - Mitchell, J. A., Electrical Engineer, Kidderminster, Eng.
  - Pereira, C. F., Ahmedabad Electricity Co., Ltd., Ahmedabad, India
  - Sahgal, S. R., Public Works Dept. Secretariat, Fort Bombay, India
  - West, F. R., Manila Electric Co., Manila, P. I.
- Total 6.

OFFICERS A. I. E. E. 1927-1928

<b>President</b>	
BANCROFT GHERARDI	
<b>Junior Past Presidents</b>	
C. C. CHESNEY	M. I. PUPIN
<b>Vice-Presidents</b>	
H. M. HOBART	O. J. FERGUSON
B. G. JAMIESON	E. R. NORTHMORE
GEORGE L. KNIGHT	J. L. BEAVER
H. H. SCHOOLFIELD	A. B. COOPER
A. E. BETTIS	C. O. BICKELHAUPT
<b>Managers</b>	
JOHN B. WHITEHEAD	I. E. MOULTROP
J. M. BRYANT	H. C. DON CARLOS
E. B. MERRIAM	F. J. CHESTERMAN
M. M. FOWLER	P. C. HANKER
H. A. KIDDER	E. B. MEYER
E. C. STONE	H. P. LIVERSIDGE
<b>National Treasurer</b>	
GEORGE A. HAMILTON	
<b>National Secretary</b>	
F. L. HUTCHINSON	
<b>Honorary Secretary</b>	
RALPH W. POPE	

LOCAL HONORARY SECRETARIES

- T. J. Fleming, Calle B. Mitre 519, Buenos Aires, Argentina, S. A.
- H. W. Plashman, Aus. Westinghouse Elec. Co. Ltd., Cathcart House, 11 Castle-rough St., Sydney, N. S. W., Australia.
- Carroll M. Mauseau, Caixa Postal No. 571, Rio de Janeiro, Brazil, S. A.
- Charles le Maistre, 28 Victoria St., London, S. W. 1, England.
- A. S. Garfield, 45 Bd. Beausejour, Paris 16 E. France.
- P. W. Willis, Tata Power Companies, Bombay House, Bombay, India.
- Guido Semenza, 30 Via Monte Napoleone, Milan, Italy.
- P. H. Puwell, Canterbury College, Christchurch, New Zealand.
- Axel P. Enstrom, 24a Grefsturegatan, Stockholm, Sweden.
- W. Elsdon-Dew, P. O. Box 4563, Johannesburg, Transvaal, Africa.

A. I. E. E. COMMITTEES

The list of committees is omitted from this issue, as new appointments are being made for the administrative year beginning August 1. The new committees will be listed in the September issue.

A. I. E. E. REPRESENTATION

A complete list of A. I. E. E. representatives on various bodies will be published in the September issue.

LIST OF SECTIONS

Name	Chairman	Secretary	Name	Chairman	Secretary
Akron	A. L. Richmond	W. A. Hillebrand, Ohio Insulator Co., Akron, Ohio	Panama	L. W. Parsons	I. P. McIlhenny, Box 413, Balboa Heights, C. Z.
Atlanta	C. E. Bennett	W. F. Oliver, Box 2211, Atlanta, Ga.	Philadelphia	I. M. Stein	R. H. Silbert, 2301 Market St., Philadelphia, Pa.
Baltimore	W. B. Kouwenhoven	R. T. Greer, Madison St. Building, Baltimore, Md.	Pittsburgh	W. C. Goodwin	H. E. Dyche, University of Pittsburgh, Pittsburgh, Pa.
Boston	E. W. Davis	W. H. Colburn, 39 Boylston St., Boston, Mass.	Pittsfield	E. F. Gehrken	C. H. Kline, General Electric Co., Pittsfield, Mass.
Chicago	B. E. Ward	L. J. Vanhalanger, Conway Building, Chicago, Ill.	Portland, Ore	J. E. Yates	L. M. Moyer, General Electric Co., Portland, Ore.
Cincinnati	R. C. Fryer	Leo Dorfman, 3531 Vista Ave., Cincinnati, Ohio	Providence	F. N. Tompkins	F. W. Smith, Blackstone Valley Gas & Electric Co., Pawtucket, R. I.
Cleveland	A. M. Lloyd	E. W. Henderson, 1088 Ivanhoe Road, Cleveland, Ohio	Rochester	E. C. Karker	Wade H. Reichard, Gen. Rwy. Signal Co., Rochester, N. Y.
Columbus	F. C. Nesbitt	W. E. Metzger, Interurban Terminal Bldg., Columbus, Ohio	St. Louis	L. F. Woolston	L. P. Van Houten, 2670 Washington Boulevard, St. Louis, Mo.
Connecticut	A. E. Knowlton	R. G. Warner, Yale University, New Haven, Conn.	San Francisco	D. I. Cone	A. G. Jones, 807 Rialto Bldg., San Francisco, Calif.
Denver	A. L. Jones	R. B. Bonney, Telephone Bldg., P. O. Box 960, Denver, Colo.	Saskatchewan	J. D. Peters	W. P. Brattle, Dept. of Telephones, Telephone Bldg., Regina, Sask., Canada
Detroit-Ann Arbor	Harold Cole	F. H. Riddle, Champion Porcelain Co., Detroit, Mich.	Schenectady	T. A. Worcester	R. F. Franklin, Room 301, Bldg. No. 41, General Elec. Co., Schenectady, N. Y.
Erie	L. H. Curtis	C. P. Yoder, Erie County Elec. Co., Erie, Pa.	Seattle	C. R. Wallis	Ray Rader, Puget Sound Pr. & Lt. Co., Seattle, Wash.
Fort Wayne	P. O. Noble	F. W. Merrill, General Elec. Co., Fort Wayne, Ind.	Sharon	L. H. Hill	H. B. West, Westinghouse Elec. & Mfg. Co., Sharon, Pa.
Indianapolis-Lafayette	J. B. Bailey	C. A. Fay, 4206 Cornelius Ave., Indianapolis, Ind.	Southern Virginia	W. S. Rodman	K. H. Berry, 1338 Rockbridge Ave., Norfolk, Va.
Ithaca	R. F. Chamberlain	H. H. Race, Cornell University, Ithaca, N. Y.	Spokane	Richard McKay	James B. Fiske, Washington Water Power Co., Lincoln & Trent, Spokane, Wash.
Kansas City	S. M. DeCamp	B. J. George, Kansas City Pr. & Lt. Co., Kansas City, Mo.	Springfield, Mass.	C. A. M. Weber	B. V. K. French, American Bosch Magneto Co., Springfield, Mass.
Lehigh Valley	M. R. Woodward	G. W. Brooks, Pennsylvania Pr. & Lt. Co., 8th & Hamilton Sts., Allentown, Pa.	Syracuse	C. E. Dorr	F. E. Verdin, 615 City Bank Bldg., Syracuse, N. Y.
Los Angeles	L. C. Williams	H. L. Caldwell, Bureau of Light & Power, Los Angeles, Cal.	Toledo	T. J. Nolan	Max Neuber, 1257 Fernwood Ave., Toledo, Ohio
Louisville	D. C. Jackson, Jr.	W. C. White, Southern Bell Tel. & Tel. Co., Louisville, Ky.	Toronto	C. E. Sisson	F. F. Ambuhl, Toronto Hydro-Elec. System, 226 Yonge St., Toronto, Ont., Canada
Lynn	W. F. Dawson	V. R. Holmgren, Gen. Elec. Co., Bldg. 64 G, Lynn, Mass.	Urbana	J. O. Kraehenbuehl	J. K. Tuthill, 106 Transportation Bldg., University of Illinois, Urbana, Ill.
Madison	J. T. Rood	H. J. Hunt, D. W. Mead and C. V. Seastone, State Journal Bldg., Madison, Wis.	Utah	Daniel L. Brundige	C. B. Shipp, General Electric Co., Salt Lake City, Utah
Mexico	Carlos Macias	G. Solis-Payan, Ave. Portales 89, General Anaya, Mexico, D. F., Mexico	Vancouver	A. C. R. Yuill	J. Teasdale, British Columbia Elec. Railway Co., Vancouver, B. C., Canada
Milwaukee	John D. Ball	Wm. J. Ladwig, Wisconsin Tel. Co., 418 Broadway, Milwaukee, Wis.	Washington, D. C.	M. G. Lloyd	H. E. Bradley, Potomac Elec. Pr. Co., 14th & C Sts., N. W., Washington, D. C.
Minnesota	J. E. Sumpter	Gilbert Cooley, Rice & Atwater, St. Paul, Minn.	Worcester	Guy F. Woodward	F. B. Crosby, Morgan Construction Co., 15 Belmont St., Worcester, Mass.
Nebraska	N. W. Kingsley	Roy Hagen, General Electric Co., Omaha, Nebraska			
New York	L. W. W. Morrow	J. B. Bassett, General Elec. Co., 120 Broadway, New York, N. Y.			
Niagara Frontier	L. E. Imlay	E. P. Harder, 205 Electric Building, Buffalo, N. Y.			
Oklahoma	Edwin Kurtz	C. C. Stewart, Okla. Gas & Elec. Co., Norman, Okla.			
			Total 52		

LIST OF BRANCHES

Name and Location	Chairman	Secretary	Counselor (Member of Faculty)
Akron, Municipal University of, Akron, Ohio	C. R. Delagrang	P. W. Bierman	J. T. Walther
Alabama Polytechnic Institute, Auburn, Ala.	T. S. Lynch	P. E. Sandlin	W. W. Hill
Alabama, University of, University, Ala.	Sewell St. John	J. M. Cardwell, Jr.	
Arizona, University of, Tucson, Ariz.	Gary Mitchell	Audley Sharpe	J. C. Clark
Arkansas, University of, Fayetteville, Ark.	Carroll Walsh	W. H. Mann, Jr.	W. B. Stelzner
Armour Institute of Technology, 3300 Federal St., Chicago, Ill.	L. J. Anderson	H. T. Dahlgren	D. P. Moreton
Brooklyn Polytechnic Institute, 99 Livingston St., Brooklyn, N. Y.	William Berger	Joseph Heller	Robin Beach
Bucknell University, Lewisburg, Pa.	G. B. Timm	A. C. Urffer	W. K. Rhodes
California Institute of Technology, Pasadena, Calif.	J. G. Thatcher	J. G. Kuhn	R. W. Sorensen
California, University of, Berkeley, Calif.	A. G. Montin	R. T. Montin	T. C. McFarland
Carnegie Institute of Technology, Pittsburgh, Pa.	R. A. Giles	J. R. Britton	B. C. Dennison
Case School of Applied Science, Cleveland, Ohio	G. J. Currie	R. C. Taylor	H. B. Dates
Catholic University of America, Washington, D. C.	Wm. S. Sparks	C. S. Daily, Jr.	T. J. MacKavanaugh
Cincinnati, University of, Cincinnati, O.	C. W. Taylor	W. C. Osterbrock	W. C. Osterbrock
Clarkson College of Technology, Potsdam, N. Y.	H. J. Myrback	W. E. Turnbull	A. R. Powers
Clemson Agricultural College, Clemson College, S. C.	L. R. Miller	J. U. Wilson	S. R. Rhodes
Colorado, University of, Boulder, Colo.	J. A. Setter	R. D. Palmer	W. C. DuVal
Colorado State Agricultural College, Fort Collins, Colo.	Harold Groat	Howard Steinmetz	H. G. Jordan
Cooper Union, New York, N. Y.	E. T. Reynolds	Wilfred Henschel	N. L. Towle
Denver, University of, Denver, Colo.	G. K. Baker	L. L. Booth	R. E. Nyswander
Drexel Institute, Philadelphia, Pa.	J. E. Young	Charles Backman	E. O. Lange
Duke University, Durham, N. C.	O. T. Colclough	F. A. Bevacqua	W. J. Seeley
Florida, University of, Gainesville, Fla.	W. H. Johnson	A. C. Dean	J. M. Weil
Georgia School of Technology, Atlanta, Ga.	W. M. McGraw	F. L. Kaestle	E. S. Hannaford
Idaho, University of, Moscow, Idaho	R. G. Elliott	F. B. Peterson	J. H. Johnson
Iowa State College, Ames, Iowa	A. G. Baumgartner	J. B. Cecil	F. A. Fish
Iowa, State University of, Iowa City, Iowa	Theo. Van Law	E. J. Hartman	A. H. Ford
Kansas State College, Manhattan, Kansas	A. M. Young	John Yost	R. G. Kloeffler
Kansas, University of, Lawrence, Kans.	Claire Williamson	D. M. Black	G. C. Shaad
Kentucky, University of, Lexington, Ky.	R. W. Spicer	C. D. McClanahan	
Lafayette College, Easton, Pa.	Herbert Heinrich	Daniel Paul	Morland King
Lehigh University, Bethlehem, Pa.	H. C. Towle, Jr.	W. D. Goodale, Jr.	J. L. Beaver
Lewis Institute, Chicago, Ill.	L. F. Masonick	G. M. Berg	F. A. Rogers
Louisiana State University, Baton Rouge, La.	R. C. Alley	W. S. Marks	M. B. Voorhies
Maine, University of, Orono, Maine	R. F. Scott	E. W. Jones	Wm. E. Barrows, Jr.
Marquette University, 1200 Sycamore St., Milwaukee, Wis.	J. R. Adriansen	H. J. Lavigne	J. F. H. Douglas
Massachusetts Institute of Technology, Cambridge, Mass.	W. M. Hall	H. F. Krantz	W. H. Timbie
Michigan State College, East Lansing, Mich.	H. E. Hunt	S. W. Luther	L. S. Foltz
Michigan, University of, Ann Arbor, Mich.	L. J. VanTuyl	W. E. Reichle	B. F. Bailey
Milwaukee, Engineering School of, 415 Marshall St., Milwaukee, Wis.	Joseph Havlick	H. F. Brundage	John D. Ball
Minnesota, University of, Minneapolis, Minn.	G. C. Brown	G. C. Hawkins	H. Kuhlmann
Mississippi Agricultural & Mechanical College, A. & M. College, Miss.	H. M. Stantion	B. W. Robins	L. L. Patterson
Missouri School of Mines & Metallurgy, Rolla, Mo.	C. H. Brittingham	E. J. Gregory	I. H. Lovett
Missouri, University of, Columbia, Mo.	C. E. Schooley	W. D. Johnson	M. P. Weinbach
Montana State College, Bozeman, Mont.	W. E. Pakala	J. A. Thaler	J. A. Thaler
Nebraska, University of, Lincoln, Neb.	W. A. Van Wie	Keith Davis	F. W. Norris
Nevada, University of, Reno, Nevada	Kenneth Knopf	Clark Amens	S. G. Palmer
Newark College of Engineering, 367 High St., Newark, New Jersey	E. S. Bush	C. H. Clarendon, Jr.	J. C. Peet
New Hampshire, University of, Durham, N. H.	S. S. Appleton	H. B. Rose	L. W. Hitchcock
New York, College of the City of, 139th St. & Convent Ave., New York, N. Y.	Joseph Leiziger	A. H. Rapport	Harry Baum
New York University, University Heights, New York, N. Y.	H. U. Hefty	Henry Och	J. Loring Arnold
North Carolina State College, Raleigh, N. C.	J. C. Davis	T. C. Farmer	G. C. Cox
North Carolina, University of, Chapel Hill, N. C.	D. M. Holshouser	W. C. Burnett	P. H. Daggett
North Dakota, University of, University Station, Grand Forks, N. D.	Alfred Botten	Nels Anderson	D. R. Jenkins
Northeastern University, 316 Huntington Ave., Boston 17, Mass.	Wm. P. Raffone	John L. Clark	Wm. L. Smith
Notre Dame, University of, Notre Dame, Ind.	W. C. Davis	C. H. Schamel	J. A. Caparo
Ohio Northern University, Ada, O.	John Simmons	Verl Jenkins	I. S. Campbell
Ohio State University, Columbus, O.	A. B. Crawford	L. G. Stewart	F. C. Caldwell
Ohio University, Athens, O.	Clarence Kelch	G. R. Smith	A. A. Atkinson
Oklahoma A. & M. College, Stillwater, Okla.	Benny Fouts	Jerry Robertson	Edwin Kurtz
Oklahoma, University of, Norman, Okla.	Dick Mason	S. Hannon	F. G. Tappan
Oregon Agricultural College, Corvallis, Ore.	J. D. Hertz	Richard Setterstrom	F. O. McMillan
Pennsylvania State College, State College, Pa.	Carl Dannerrth	W. J. Gorman	L. A. Doggett
Pennsylvania, University of, Philadelphia, Pa.	F. H. Riordan, Jr.	Wm. H. Hamilton	C. D. Favcett
Pittsburgh, University of, Pittsburgh, Pa.	M. G. Jarrett	D. P. Mitchell	H. E. Dyche
Princeton University, Princeton, N. J.	John Reine	J. McN. Myers	Malcolm MacLaren
Purdue University, Lafayette, Indiana	H. L. Lindstrom	H. A. Hartley	A. N. Topping
Rensselaer Polytechnic Institute, Troy, N. Y.	W. F. Hess	B. S. Morehouse	F. M. Sebast
Rhode Island State College, Kingston, R. I.	C. F. Easterbrooks	Charles Miller	Wm. Anderson
Rose Polytechnic Institute, Terre Haute, Ind.	D. L. Fenner	W. F. A. Hammerling	C. C. Knipmeyer
Rutgers University, New Brunswick, N. J.	N. A. Kiet	J. E. Conover	F. F. Thompson
Santa Clara, University of, Santa Clara, Calif.	R. P. O'Brien	C. E. Newton	D. W. Griswold
South Dakota State School of Mines, Rapid City, S. D.	D. A. White	Harold Eade	J. O. Kammerman
South Dakota, University of, Vermillion, S. D.	Stanley Boegler	L. E. Crowell	B. B. Brackett
Southern California, University of, Los Angeles, Calif.	Gilbert Dunstan	Osborne Hatch	P. S. Biegler
Stanford University, Stanford University, Calif.	G. G. Chambers	T. L. Lenzen	T. H. Morgan
Stevens Institute of Technology, Hoboken, N. J.	D. B. Westrom	G. E. Witham	F. C. Stockwell
Swarthmore College, Swarthmore, Pa.	T. C. Lightfoot	W. F. Denkhaus	Lewis Fussell
Syracuse University, Syracuse, N. Y.	E. D. Lynde	T. P. Hall	C. W. Henderson
Tennessee, University of, Knoxville, Tenn.	F. N. Green	B. M. Gallaher	C. A. Perkins
Texas A. & M. College of, College Station, Texas	C. A. Altenbern	J. L. Pratt	C. C. Yates
Texas, University of, Austin, Texas	A. L. Mayfield	G. E. Schade	J. A. Correll
Utah, University of, Salt Lake City, Utah	H. E. Larson	Junior Petterson	J. F. Merrill
Virginia Military Institute, Lexington, Va.	W. F. R. Griffith	F. Barkus	S. J. Anderson
Virginia Polytechnic Institute, Blacksburg, Va.	R. M. Hutcheson	M. B. Cogbill	Claudius Lee
Virginia, University of, University, Va.	R. C. Small	H. M. Roth	W. S. Rodman
Washington, State College of, Pullman, Wash.	Harry Wall	E. G. Peters	R. D. Sloan
Washington University, St. Louis, Mo.	R. L. Belshe	J. G. Mazanec, Jr.	H. G. Hake
Washington, University of, Seattle, Wash.	Wm. Bolster	Arthur Peterson	G. L. Hoard
Washington and Lee University, Lexington, Va.	R. E. Kepler	Bernard Yoeppe	R. W. Fockey
West Virginia University, Morgantown, W. Va.	I. L. Smith	P. E. Davis	A. H. Dicman
Wisconsin, University of, Madison, Wis.	John Sargent	Leonard Saari	C. M. Jansky
Worcester Polytechnic Institute, Worcester, Mass.	D. A. Calder	C. H. Kauke	H. A. Maxfield
Wyoming, University of, Laramie, Wyoming	John Hicks	Edward Joslin	G. H. Sechrist
Yale University, New Haven, Conn.	Wm. W. Parker	J. W. Hinkley	C. F. Scott

# DIGEST OF CURRENT INDUSTRIAL NEWS

## NEW CATALOGUES AND OTHER PUBLICATIONS

*Mailed to interested readers by issuing companies*

**Oil Fuse Cutouts.**—Bulletin GEA 732, 8 pp. Describes D & W oil fuse cutouts. General Electric Company, Schenectady, N. Y.

**Circuit Breakers.**—Bulletin 11. Describes all types of Pacific Electric oil circuit-breakers and control mechanisms. The Pacific Electric Manufacturing Company, 5815 Third Street, San Francisco, Cal.

**Generator Voltage Regulators.**—Bulletin GEA 709. 32 pp. Describes G-E automatic generator voltage regulators. General Electric Company, Schenectady, N. Y.

**Lifting Magnets.**—Bulletin 900. Describes the new EC & M lifting magnet, type SA. A number of improvements over existing designs have been incorporated in the new magnet. The Electric Controller & Manufacturing Company, Cleveland, Ohio.

**Ground-Ohmer.**—Bulletin 150, 4 pp. Describes a portable instrument for measuring ground resistance. It has a 35-cycle generator, 1:1 and 1:10 transformer, shielded dynamometer type galvanometer with direct reading slide wire and checking resistance. Herman H. Sticht & Company, 15 Park Row, New York.

**Water Wheel Driven Generators.**—Bulletin GEA 739, 44 pp. A profusely illustrated publication picturing typical hydroelectric installations utilizing G-E water wheel driven generators, and having an aggregate capacity of more than two million kilowatts. The total capacity of such machines now in operation is considerably in excess of six million kilowatts. General Electric Company, Schenectady, N. Y.

**Groundmeters.**—Bulletin 77, 4 pp. Describes a meter designed especially for measuring resistance ground electrodes. The various types of groundmeters are essentially a-c. Wheatstone bridges with a telephone receiver for detecting the bridge balance, and there are, therefore, no moving parts other than the interrupter in the primary circuit. The meters are all portable. Groundulet Company, Newark, N. J.

## NOTES OF THE INDUSTRY

**The Allen-Bradley Company, Milwaukee,** announces that George F. Pain, district manager of the Philadelphia office, has moved into new quarters at 600 South Delaware Avenue, Philadelphia.

**The Union Electric Manufacturing Company, of Milwaukee, Wis.,** has opened a district office for the States of Louisiana and Mississippi, at 801 Tchoupitoulas Street, New Orleans, La., to be in charge of G. P. Robbins and G. P. Robbins, Jr.

**Roller-Smith Company, New York,** has appointed the Petroleum Electric Company, 217 East Archer St., Tulsa, Okla., as its representative for the State of Oklahoma. The Petroleum Electric Company will handle Roller-Smith instruments, circuit breakers and relays in that territory. The personnel of the Petroleum Electric Company includes T. D. Williamson and C. F. Dagwell.

**Corning Glass Works** announces the opening of a sales office at No. 369 Lexington Avenue, New York City, under the direction of Raymond W. Lillie, formerly of R. W. Lillie Corporation, to handle the exclusive sales of Pyrex power insulators for the United States and Canada. W. H. Taubert formerly of the R. W. Lillie Corporation and later with the American Brown Boveri Corp. has again become associated with Raymond W. Lillie in the furtherance of the sales of Pyrex power insulators in the United States and Canada, with headquarters at 369 Lexington Avenue, New York City.

**The Lincoln Electric Company** has moved its Missouri

district office from 1808 Railway Exchange Building, St. Louis, to 1003 Davidson Building, Kansas City, Robert Notvest being in charge. The St. Louis district will be handled by Mr. Notvest, his time being divided between the two cities.

A branch office has also been established at 220 Nicholas Building, Toledo, in charge of A. H. Homrighaus, who was formerly in charge of the Missouri district.

**New Wire Stripper.**—A new tool for quickly stripping insulation from electrical wires from 10 to 20 gauge has been marketed by the Pyramid Products Company, 2311 South State Street, Chicago, Ill. The device operates like an ordinary pliers.

**New Across-the-Line Starter.**—The Cutler-Hammer Manufacturing Company, Milwaukee, has placed on the market what is claimed to be the littlest across-the-line starter for 5 h. p. and smaller a-c. motors. The new device gives push button control of starting and stopping, and provides thermal overload protection and no-voltage protection.

**Consolidation of Power Specialty and Wheeler Condenser Companies.**—The Power Specialty Company and the Wheeler Condenser & Engineering Company have been merged and will be known hereafter as the Foster Wheeler Corporation, New York. The most widely known products of these companies include superheaters, economizers, coal pulverizers, condensers and other steam power equipment. No change in the management will be made.

**New York Edison Company to have World's Largest Electric Generator.**—An electric generator rated at 160,000 kilowatts is to be installed by the New York Edison Company in its generating station at 14th Street and East River. The generator will have a capacity nearly three times as large as any in service, and more than half again as large as any under construction anywhere in the world, according to the General Electric Company, its builders.

The New York Edison Company is also obtaining from the General Electric Company the necessary transformers and two 40,000-kilowatt frequency changer sets of the synchronous-induction type.

**Hydroelectric Development Progresses in Russia.**—Amtorg Trading Corporation of New York announces that additional orders valued at \$250,000 have been placed in the United States for construction equipment for work on the 650,000 h. p. hydro-electric development on the Dnieper River in the Soviet Union. Since the beginning of April equipment valued at upwards of \$500,000 has been purchased here for the Dnieper work.

**Westinghouse Receives Order for Huge Generator Unit.**—The United Light & Power Company of New York has purchased from the Westinghouse Electric & Manufacturing Company a steam turbine generator unit of approximately 225,000 horse power electrical output, for an extension of the Hellgate generating station located at 132nd Street and East River, New York City. The new generating unit, which is of the cross-compound design, will be equipped with two 1800 rev. per min. generators, each having a capacity of 94,200 kv-a.

**General Electric Earnings and Orders.**—General Electric Company sales billed for the first six months of 1927 amounted to \$149,795,026.99 compared with \$147,450,867.96 for the corresponding period last year. Profit available for dividends on common stock for the six months of 1927 was \$22,542,972.76 compared with \$19,000,392.63 for the same six months last year.

Orders received for the three months ending June 30 amounted to \$78,105,247 compared with \$78,972,062 for the second quarter of 1926, a decrease of one per cent. For the six months ending June 30, orders totalled \$155,655,828, representing a decrease of six per cent compared with \$165,405,720 in the corresponding six months of 1926.

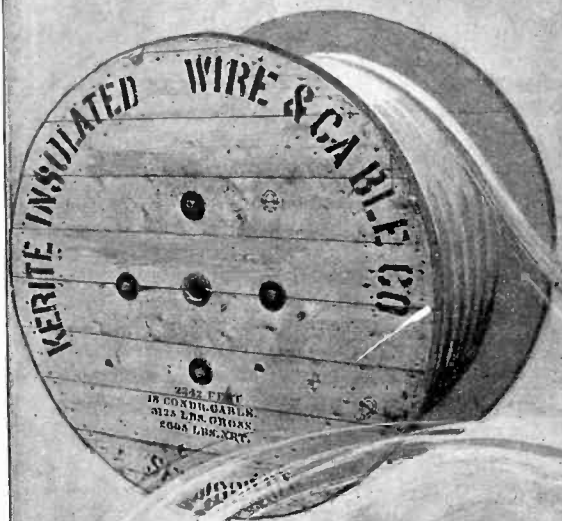

# KERITE

in a half-century of  
*continuous production,*  
 has spun out a record  
 of performance  
 that is  
*unequaled* in the  
 history of insulated  
 wires and cables

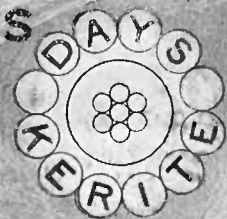

**KERITE INSULATED WIRE & CABLE COMPANY**  
 NEW YORK CHICAGO

Jillbridge 20-535

# Again — PEIRCE *excels* with a **NEW** *Secondary Rack*

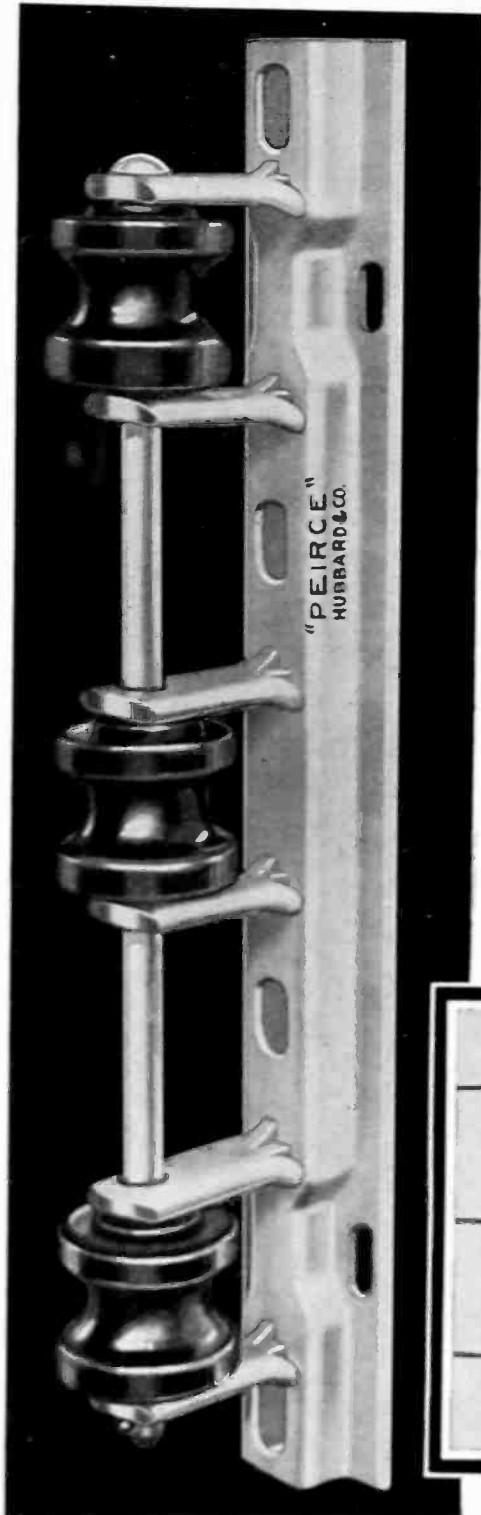

No. 3746

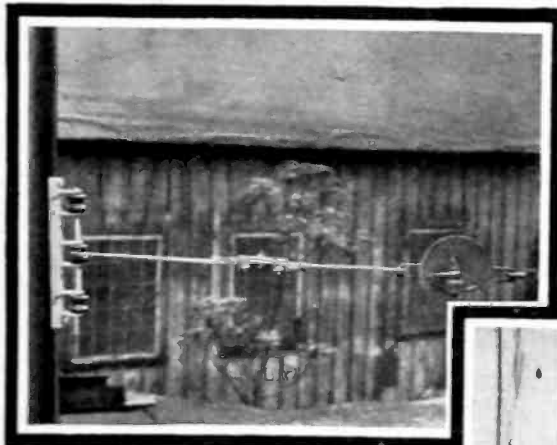

*Strength*

After years of study with the Distribution Engineers, Superintendents and Lineman, Hubbard and Company have produced a light weight Secondary Rack which meets with their approval. This Rack has been developed with strength and is amply strong to take care of all light weight secondary rack construction.

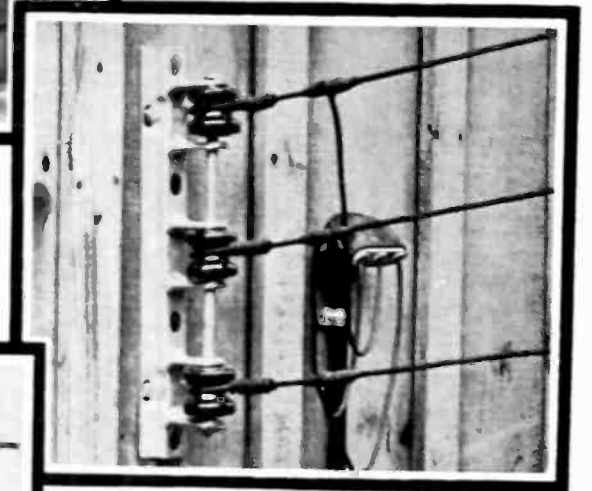

*Utility*

The light type Secondary Racks are used by many construction men for making house service connections. The four mounting slots on the one-piece flanged Racks back provide holes for attaching these Racks to frame buildings by 1/4-inch Lag Screws and to brick buildings by 3/8-inch Expansion Bolts.

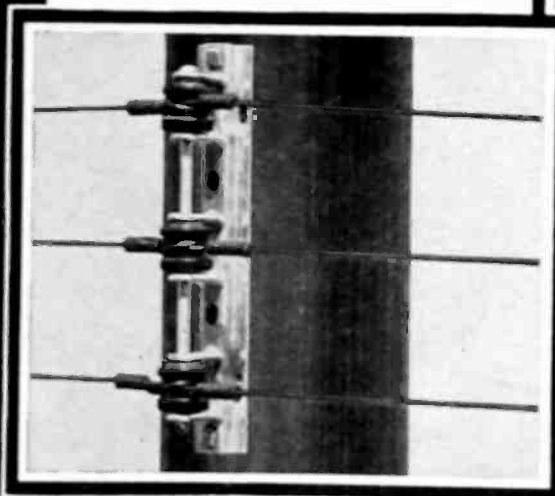

Installation of Peirce No. 3746 Secondary Rack on a pole. Two 3/8-inch Through Bolts are used for making this installation.

*Beauty*

These Racks are carried in stock and sold exclusively through the leading Electrical Jobbers.



# Hubbard and COMPANY

PITTSBURGH & OAKLAND, CAL. & CHICAGO

Please mention the JOURNAL of the A. I. E. E. when writing to advertisers.

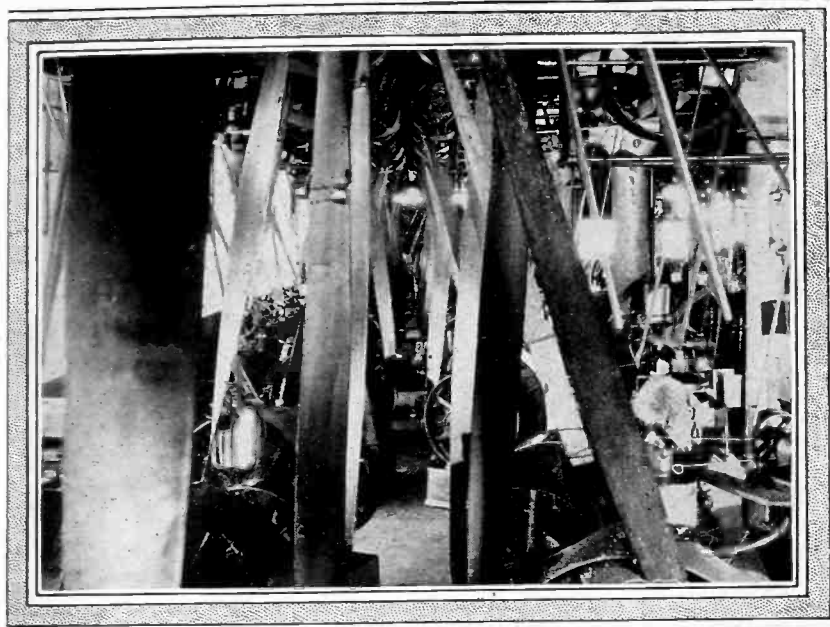

*Before*

*After*



***Cut Expenses  
in Half and  
Add to Profits***

**T**HE growing tendency to displace unsightly, hazardous, power-wasting belts with individual drive electric motors has made the advantages of ball bearings increasingly significant.

Cleaner and more efficient motors are the rule where New Departures are used for they can be mounted with seals that keep lubricant *in* the bearings and *out* of the windings. Lubrication is positive and is also simplified for New Departures need be lubricated but once a year.

Mechanical or electrical injuries due to drop of rotor are eliminated because of the absence of wear in New Departure Ball Bearings and for the same reason, readjustments are never necessary.

Friction is brought to an absolute minimum by the pure rolling motion of New Departures. Productive time is increased since there are no interruptions because of bearing troubles.

The foregoing advantages represent a saving of at least one-half the usual maintenance expense.

Write for publications entitled "Cutting Your Costs" (non-technical), "Booklet K" (technical) and Engineering Data Bulletins on "Ball Bearing Application to Electric Motors." Any or all sent on request. Engineering representative will call for personal consultation if desired.

The New Departure Manufacturing Company  
Chicago      Bristol, Connecticut      Detroit

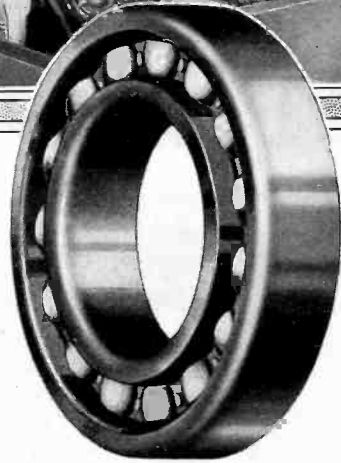

**New Departure  
Quality  
Ball Bearings**

665



# INSULATION

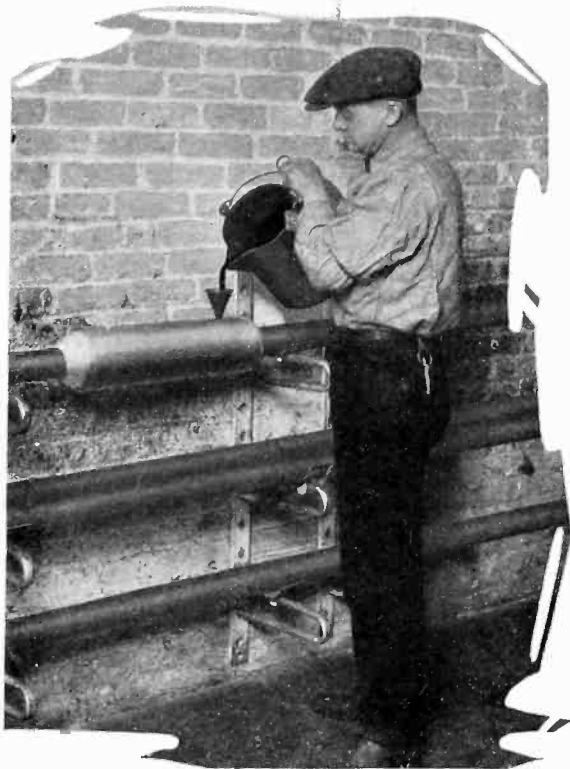

⦿ ⦿ ⦿ ⦿ affects economical operation directly. ⦿ ⦿ ⦿ ⦿

Choose insulating materials which have stood the test of time.

High Voltage calls for High Grade Insulating Compound.

**MINERALLAC ELECTRIC COMPANY**

1045 Washington Blvd., Chicago, Ill.

# MINERALLAC

Please mention the JOURNAL of the A. I. E. E. when writing to advertisers.





*Always associated with the best*

## Every modern facility for Quality Cable Making

Habirshaw Cable has safe permanence because it is made under the most careful control and supervision.

All materials are carefully tested before use and processes are under scientific control at every step.

Manufacture is by modern machinery much of which is of exclusive Habirshaw design.

Every foot of wire or cable is tested before shipment, in extensive laboratories where voltages up to a half million are available.

Woven into each of these steps is Habirshaw's more than thirty-five years of cable-making experience.

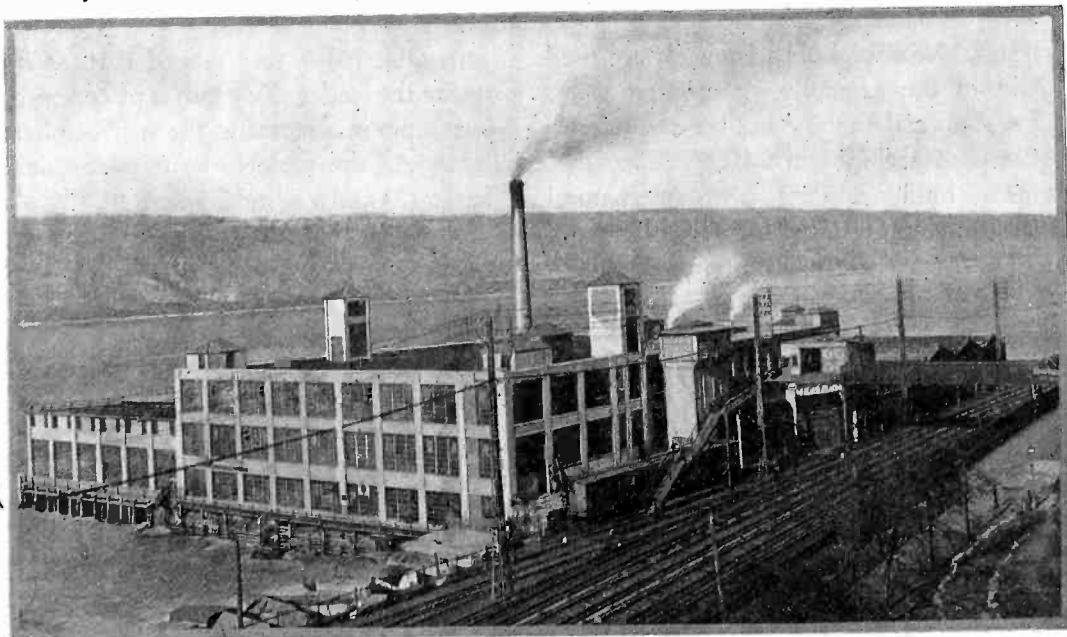

HABIRSHAW CABLE AND WIRE CORPORATION

10 East 43rd Street, New York City

Plants: Yonkers, N. Y.—Bridgeport, Conn.—Nepperhan, N. Y.

# HABIRSHAW

PROVED BY THE TEST OF TIME

Paper Insulated Cable—Varnished Cambric Insulated Cable—Armored Cable—Rubber Insulated Cable

Please mention the JOURNAL of the A. I. E. E. when writing to advertisers.

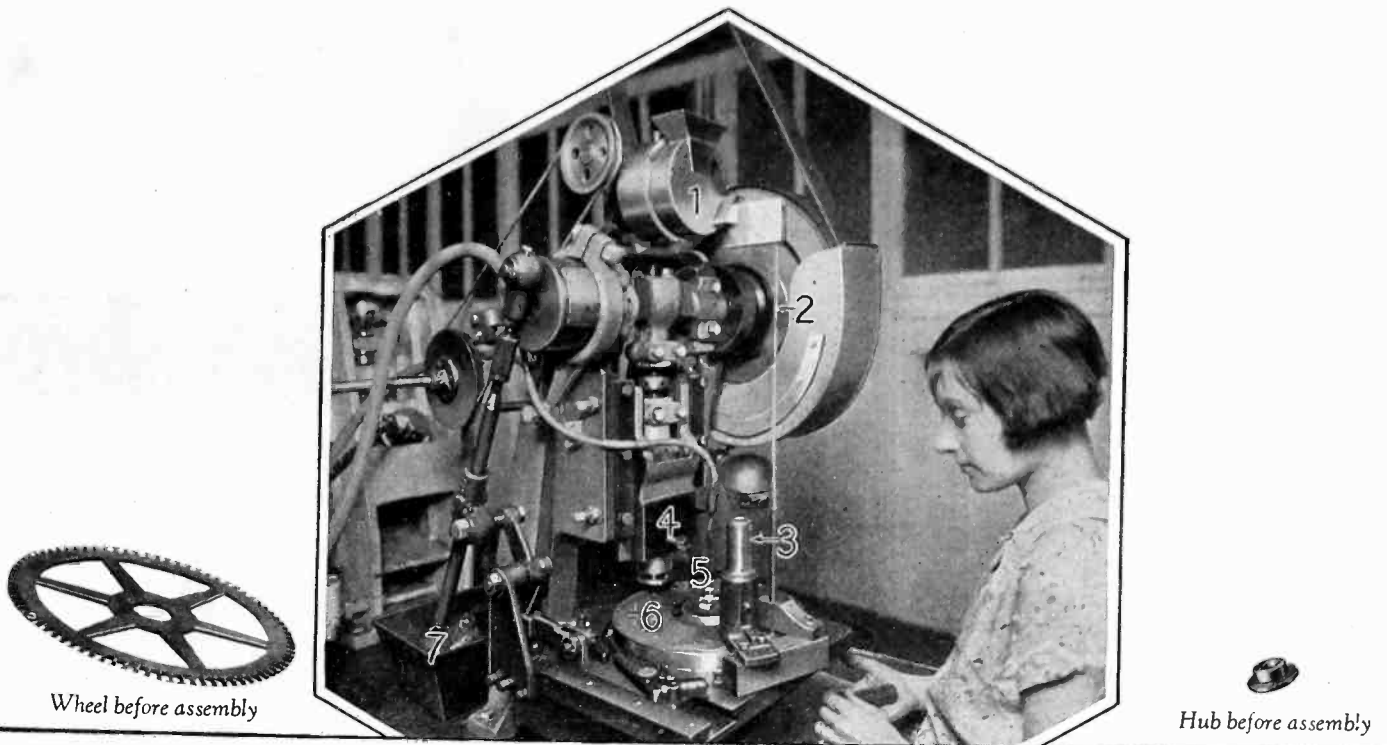

## MAKING THE WHEELS GO ROUND

THOUSANDS of hubbed wheels are used daily in the assembly of Sangamo meter registers. A special machine has been developed in the Sangamo machine and tool department that performs the hubbing operation with mechanical precision and uniformity, at a high rate of speed. The human element is removed; every hub is riveted into the wheel under a blow of the same force.

The operation of the machine is ingenious but simple. The hubs are poured into the hopper (1) at the top of the machine; from there they are automatically strung in correct position on to a rod feeder (2). The wheels are loaded in large stacks in the cylindrical feeder (3). The revolving

turn table (6) is so arranged that, as it passes under the feeder (2), a hub is placed in position over a pin in a recess in the surface of the turn table. As the table turns it passes under the feeder (3) and a wheel is automatically placed in position over the hub. At (4) the hub is riveted solidly into the wheel and at (5) a jet of air blows the assembled hub and wheel into the pan (7). In this way one operator turns out 140 uniformly hubbed wheels per minute.

This is just one detail of the precision manufacture of Sangamo registers. The expression "Built like a Watch" has a real application to Sangamo registers and in fact every part of Sangamo Meters.

SANGAMO ELECTRIC COMPANY

SPRINGFIELD, ILLINOIS

# SANGAMO METERS

FOR EVERY ELECTRICAL NEED

Please mention the JOURNAL of the A. I. E. E. when writing to advertisers.

# American



# Transformer

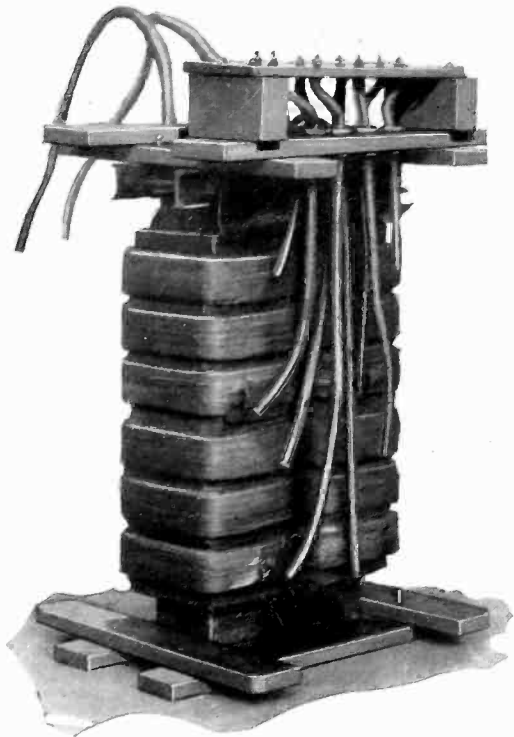

## *Up for air*

### **—after 23 years**

This transformer was purchased in 1903 and set-up in the laboratory of one of America's largest industrials. It has been in service ever since.

Transformer design has changed somewhat in two decades yet a glance at the interior view shows that even that long ago, the American Transformer Company were designing and building a transformer that compares very favorably with many put out in recent years.

We are telling you in detail about this transformer because it is added proof of our stand on transformer manufacture, viz.:

American Transformers are built to do the job for which they are intended. No standard type of transformer can be expected to fulfill the varying requirements of the industry.

Efficient performance — long life and minimum maintenance have become characteristic of American Transformers through years of successful operation for almost every purpose.

Whatever your problem, consult with us. We have had more than 25 years' experience in helping the other fellow to do a better, quicker and more practical job.

So far this year, we have published two new bulletins, 1035-J and 1040-J on High Voltage and on Small Air Cooled Transformers respectively. Copies will be mailed you upon request.

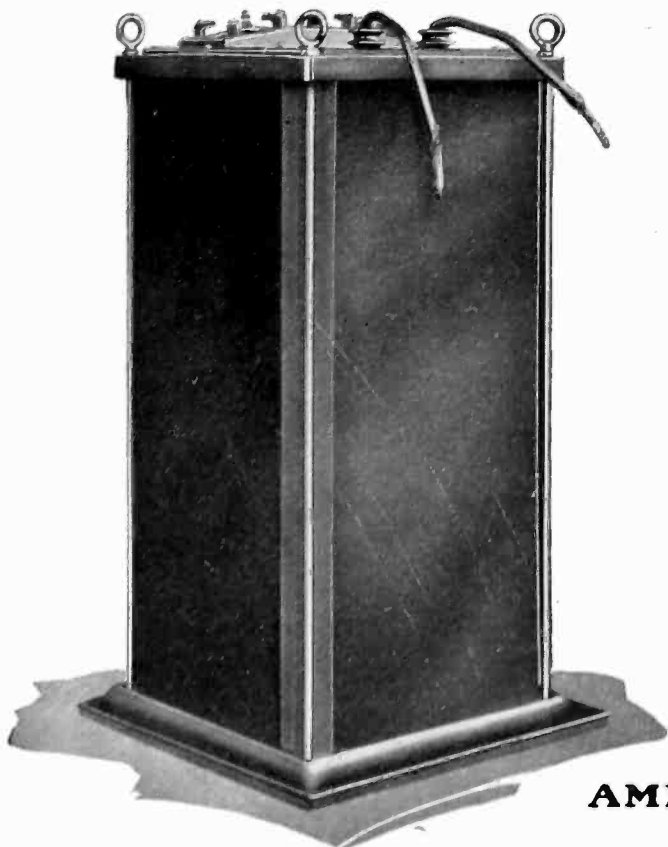

**AMERICAN TRANSFORMER COMPANY**

176 Emmett Street, NEWARK, N. J.

Please mention the JOURNAL of the A. I. E. E. when writing to advertisers.

# G-E Relays



## Induction Type

These current and voltage relays combine the following features:

Accuracy	Low friction
Consistent operation	Large current capacity
High torque	High contact pressure
Low energy	Simplicity
Indicating Target	

Type IA Relays are only part of the contribution which G-E relay specialists have made to the protection of equipment and the control of distribution systems. These specialists are available to assist protection engineers in the solution of relay problems.

### G-E SWITCHBOARD EQUIPMENT

Air Circuit Breakers  
Stationary Switchboards  
Outdoor Station Equipment  
Switchboard Accessories and  
Devices



Relays  
Oil Circuit Breakers  
Truck-type Switchboards  
Automatic Switching Equipment  
Switches

# GENERAL ELECTRIC

GENERAL ELECTRIC COMPANY, SCHENECTADY, N. Y.. SALES OFFICES IN PRINCIPAL CITIES

501-8

Please mention the JOURNAL of the A. I. E. E. when writing to advertisers.

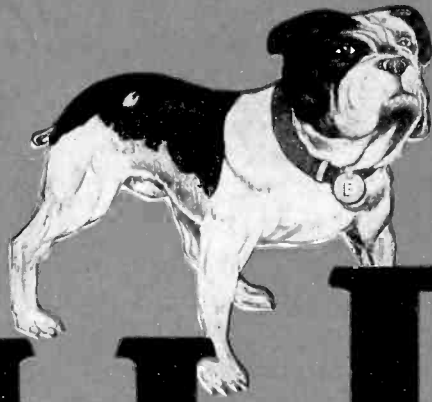

# BULL DOG

## UNIT ~ VERSAL

# PANELBOARDS

OVER 25 YEARS OF RESEARCH AND DEVELOPMENT

Greatest development ever made in electrical control and distribution. Bull Dog Unit-Versal Panelboards are a complete line and include Lighting Panelboards, Metering Panelboards and Power and Light Feeder Distributing Boards. Advanced Safety—Complete Standardization—Interchangeable—Convertible—Low Maintenance Cost—Long Life—Economy.

## SAFtoFUSE FEEDER PANELS

Furnished in types, sizes and arrangements to meet any installation requirement. Standard stock types shown below at left and right.

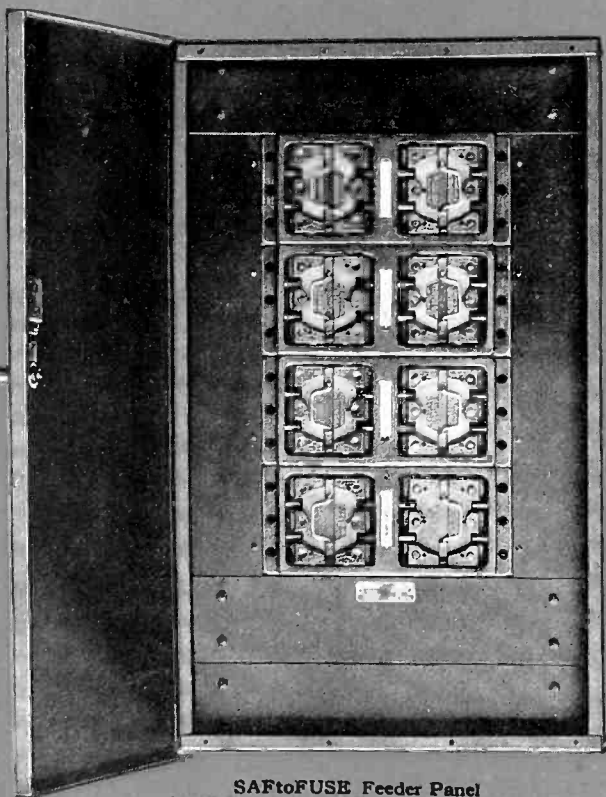

SAFtoFUSE Feeder Panel  
30-60 Amperes, 250 Volts; 3-3 Wire Units.

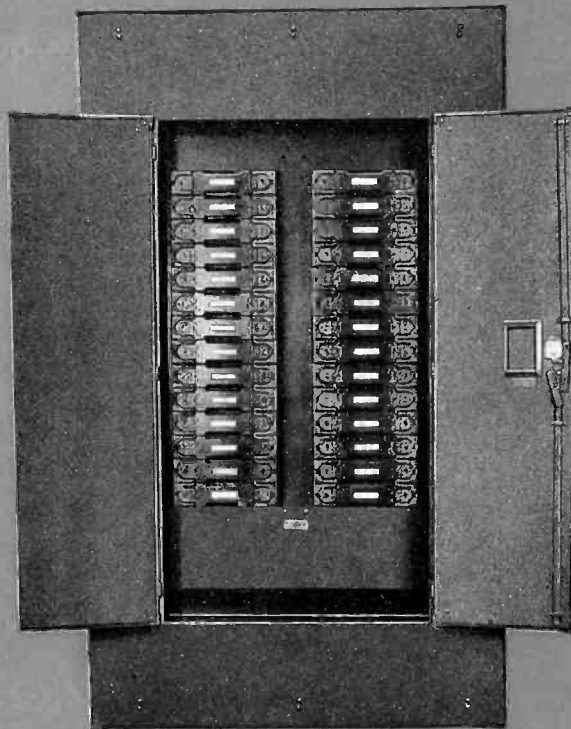

Double Row SAFtoFUSE Panel  
built for Detroit Edison Company.

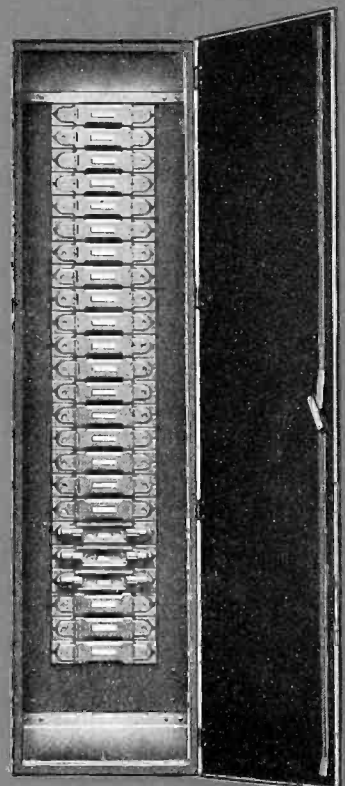

SAFtoFUSE Feeder Panel.  
Single Pole Units.  
30-200 Amperes 250 Volts.  
30-100 Amperes 600 Volts.

**BULLDOG ELECTRIC PRODUCTS CO.**  
(MUTUAL ELECTRIC & MACHINE CO.)  
DETROIT MICH. U.S.A.

# BULL DOG UNIT-VERSAL SAFTOFUSE Units

## Same Width as Other Units

A few of the Bull Dog Unit-Versal SAFTOFUSE units are illustrated. All units are standardized and interchangeable, and are assembled on busbars to meet any feeder circuit requirements. The SAFTOFUSE conforms to Bureau of Standards Safety Rules.

Basic width of all units is 11 inches, standardized with lighting and metering units. Cabinets are 19 inches wide, allowing 4-inch wiring space on each side. Send for complete catalog.

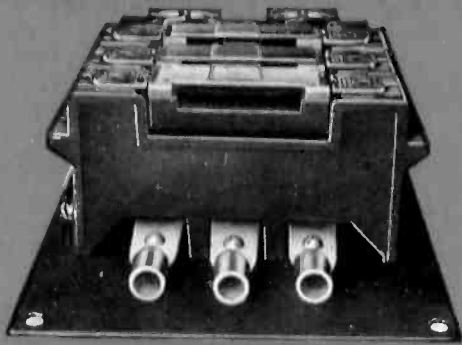

Bull Dog Unit-Versal SAFTOFUSE Units mounted on busbars. In "on" position.

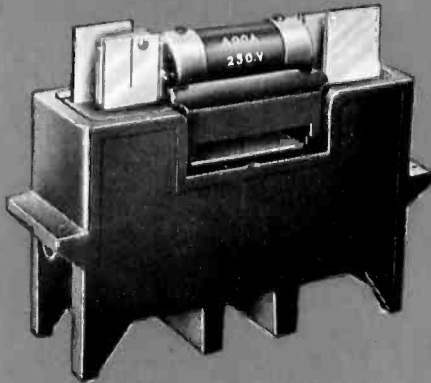

Bull Dog Unit-Versal SAFTOFUSE Unit, 400 Amperes, 250 Volts. In "off" position.

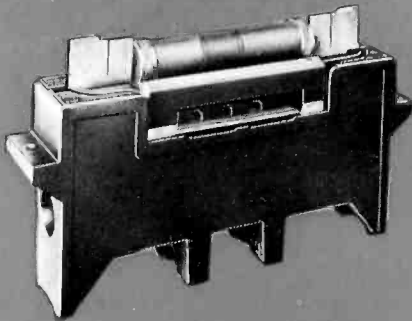

Bull Dog Unit-Versal SAFTOFUSE Unit, 200 Amperes, 600 Volts. In "off" position.

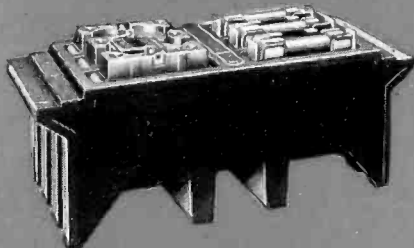

Double Branch, 3-3 Wire SAFTOFUSE Unit, 30 or 60 ampere branches; one unit "on" and one unit "off".

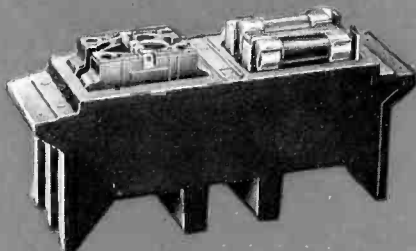

Double Branch, 3-2 Wire SAFTOFUSE Unit, 30 or 60 ampere branches; one unit "on" and one unit "off".

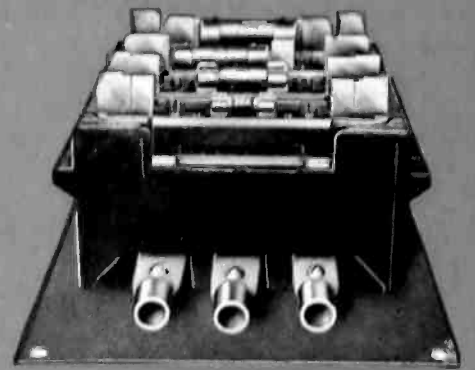

SAFTOFUSE Units, convertible, same unit arranged for 30, 60, 100 or 200 ampere, 250 volt fuses. All units "off."

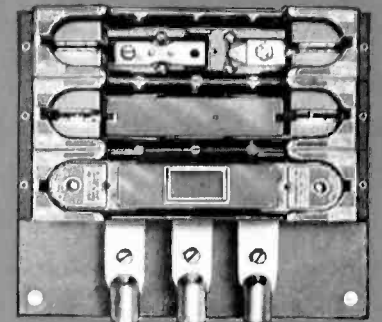

Bottom unit in "on" position, middle unit with head removed showing live parts guarded, top unit with guard removed. Shows connections to busbars and mounting screws.

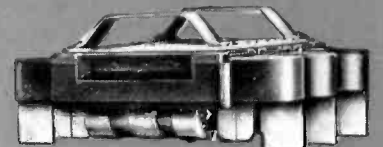

Bull Dog Unit-Versal SAFTOFUSE Unit. Combinations of 3 SAFTOFUSE heads, mounted together.

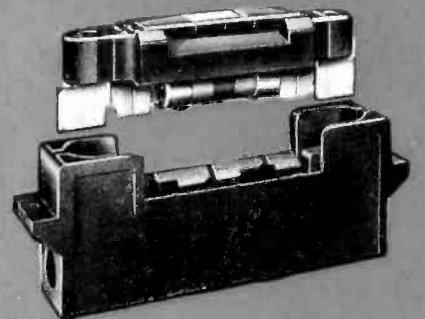

Bull Dog Unit-Versal SAFTOFUSE Unit. Flat type used on lighting panelboards. Shows head of unit drawn out of body.

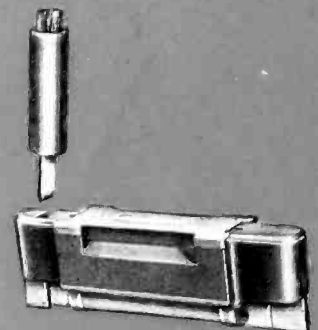

Head of motor testing SAFTOFUSE Unit. Shows motor-testing head and test jack.

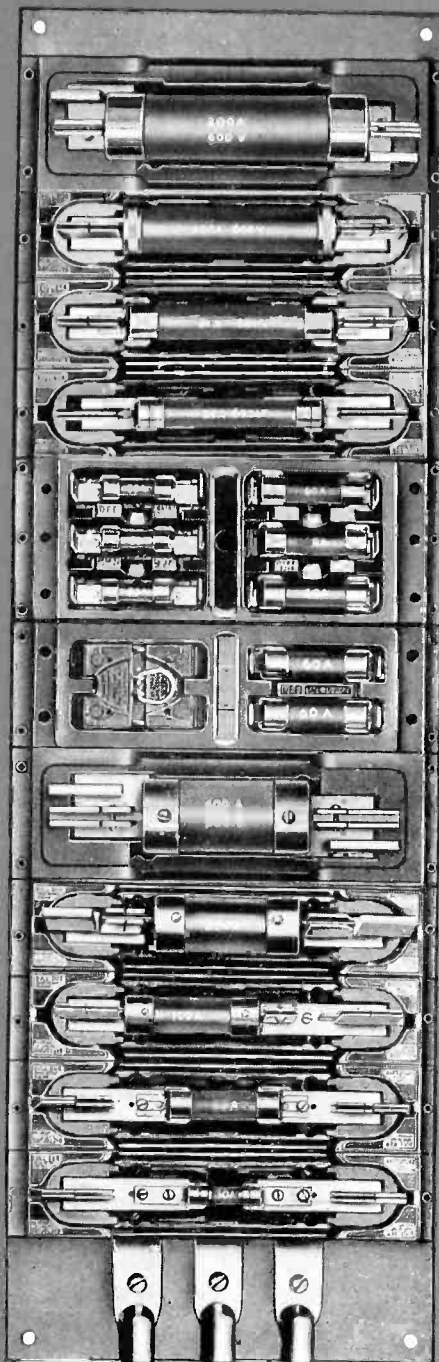

Standardized Unit-Versal SAFTOFUSE Units of various types assembled on same busbar for cabinet. Units may be assembled into any combination desired.

**BULLDOG ELECTRIC PRODUCTS CO.**  
(MUTUAL ELECTRIC & MACHINE CO.)  
DETROIT MICH. U.S.A.

# BULL DOG UNIT-VERSAL Lighting Panelboards and Cabinets

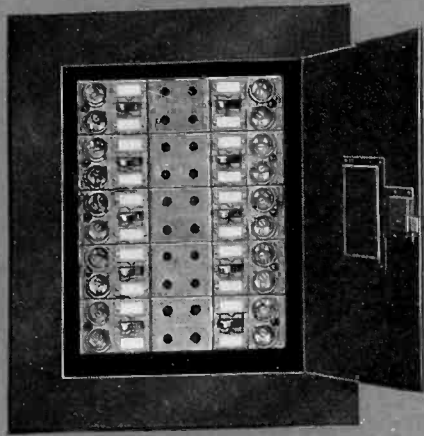

Bull Dog Unit-Versal Lighting Panel Cabinet. 5 Double Branch Units with 10 double pole Toggle Switches and Plug Fuse Connections—10 circuits.

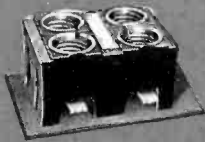

Double Branch, Bull Dog Lighting Panel Unit, with Plug Fuse Branch Connections.



Front view, Double Branch Panel Unit with 2 double pole, heavy duty Bull Dog Toggle Switches and Cartridge Fuse Connections.



Sectional view, Double Branch Panel Unit with 4 single pole, heavy duty Toggle Switches and Cartridge Fuse Connections.

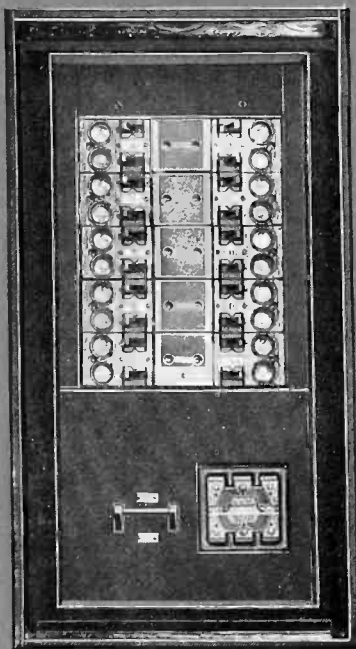

Bull Dog Unit-Versal Lighting Panel. 5 Double Branch Units, Main Toggle Switch and SAFtoFUSE. 20 single pole branch Toggle Switches and Plug Fuse Connections—20 circuits.

## Same Width as Other Units

All types, sizes and arrangements of lighting panelboards and cabinets in safety type. Unit-Versal lighting units combined with SAFtoFUSE and metering units meet any condition of residential, public, commercial and industrial building.

All units standardized and interchangeable. Basic width, 11 inches; wiring gutters, 4 inches. Standardized boxes 19 inches wide with 128 knockouts in each.

Units are cold moulded asbestos base composition. Highest quality in materials, design and workmanship. Complete catalog on request.

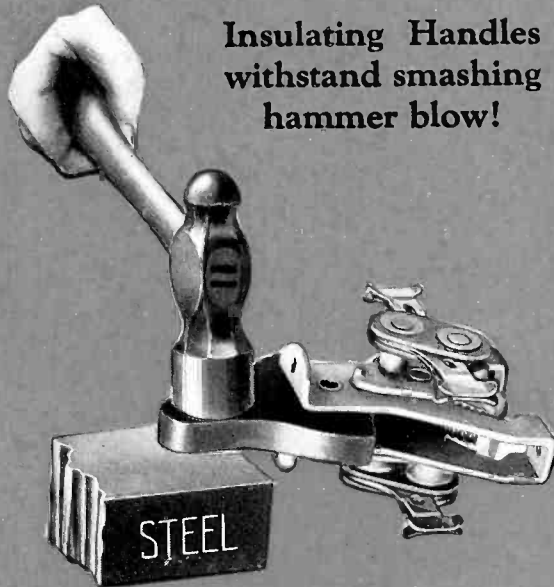

Insulating Handles withstand smashing hammer blow!

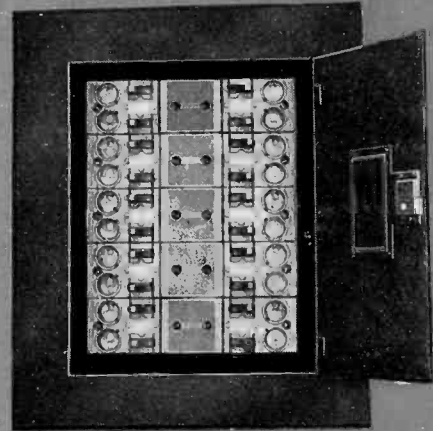

Bull Dog Unit-Versal Lighting Panel Cabinet. 5 double Branch Units with 20 Bull Dog Toggle Switches and Plug Fuse Connections—20 circuits.

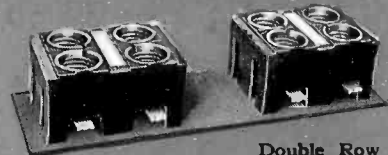

Double Row Double Branch Panel Unit with Plug Fuse Branch Connections.

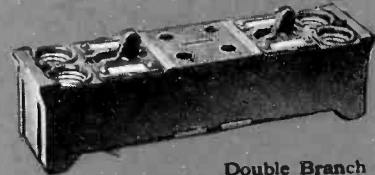

Double Branch Panel Unit with 2 Heavy Duty, Double Pole Toggle Switches and Plug Fuse Connections—2 circuits.

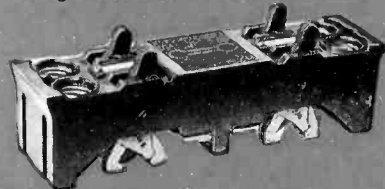

Double Branch Panel Unit with 4 Heavy Duty, single pole Bull Dog Toggle Switches and Plug Fuse Connections—4 circuits.

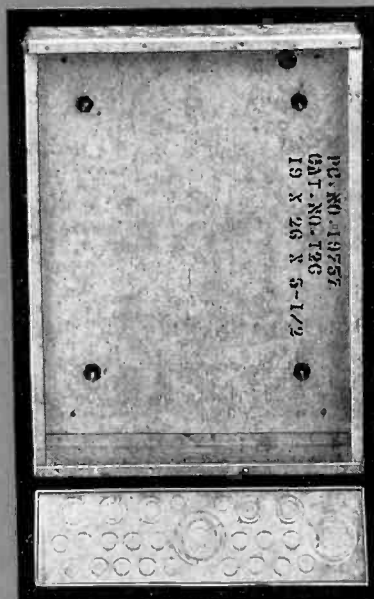

Standardized Panelboard Boxes furnished in various sizes. Width 19 inches, 4-inch wiring gutters. 128 knockouts in each.

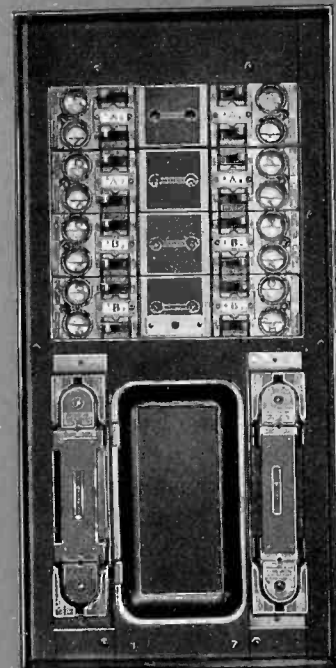

Bull Dog Unit-Versal Lighting Panel. 4 Double Branch Units and 2 Main SAFtoFUSES. 16 Bull Dog Toggle Switches and Plug Fuse Connections—16 circuits.

**BULLDOG ELECTRIC PRODUCTS CO.**  
(MUTUAL ELECTRIC & MACHINE CO.)  
DETROIT MICH. U.S.A.

# BULL DOG UNIT-VERSAL Metering Panels

Same Width as Other Units



Rigid bar type metering panel unit, without safety guards and meter bar connections.

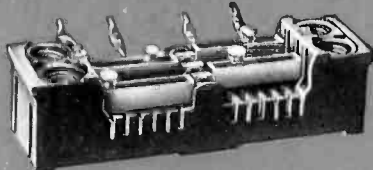

Rigid bar type metering panel unit, with insulating guards and meter bar connections.

Only safety type metering panels on the market. Dead front with all live metal parts guarded and locked, with provisions for sealing. Furnished in rigid type and Flexo type, differing in the connections between circuits and meter bars.

Basic width of units, 11 inches; wiring gutters, 4 inches; standardized widths of cabinets, 19 inches. All units standardized and interchangeable with SAFToFUSE and lighting panel units. Write for complete catalog.

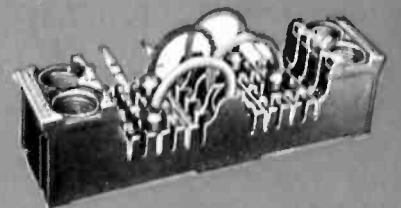

Flexo type metering panel unit, without locking bars.

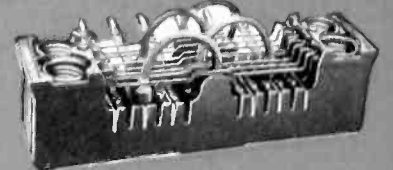

Flexo type metering panel unit, with locking bars.

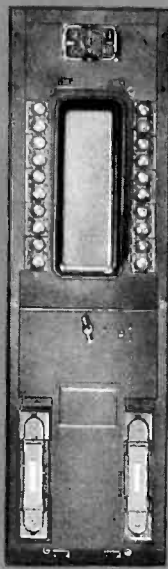

Bull Dog Unit-Versal Rigid Type Metering Panel combined with SAFToFUSES, closed and with hinged cover plates open.

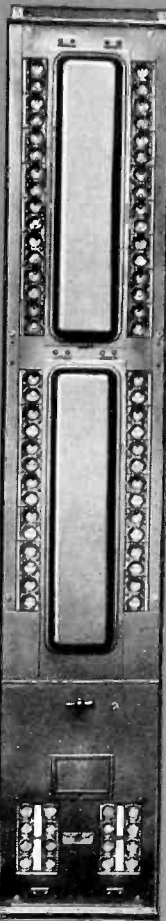
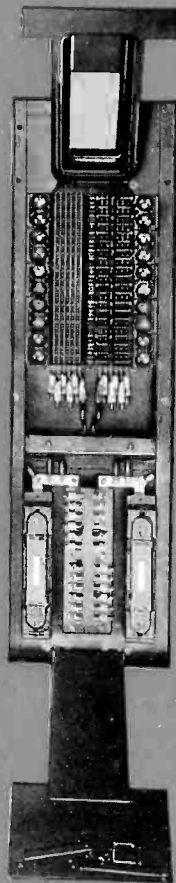

Bull Dog Unit-Versal Rigid Type Metering Panels combined with lighting panel units, closed and one cover plate open.

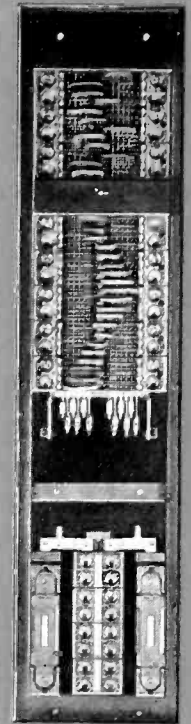

Bull Dog Metering Flexo Type Panels combined with lighting panel and SAFToFUSE Units, cover plates removed.

The Complete Line of Bull Dog Electrical Products  
for Greater Safety, Convenience and Dependability in  
Electrical Control and Distribution.



Safety Switches

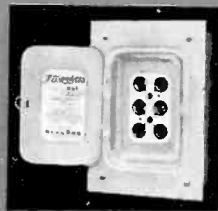

Fusernters

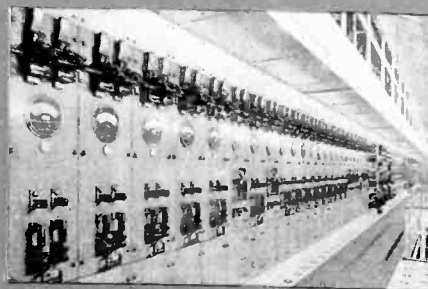

Switch Boards

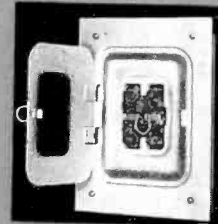

SAFToFUSE

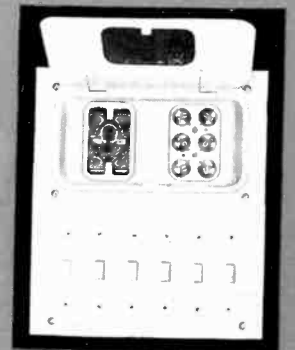

Combinations

**BULLDOG ELECTRIC PRODUCTS CO.**  
(MUTUAL ELECTRIC & MACHINE CO.)  
DETROIT MICH. U.S.A.



# Compression Resistance Starters Are Superior to Compensators

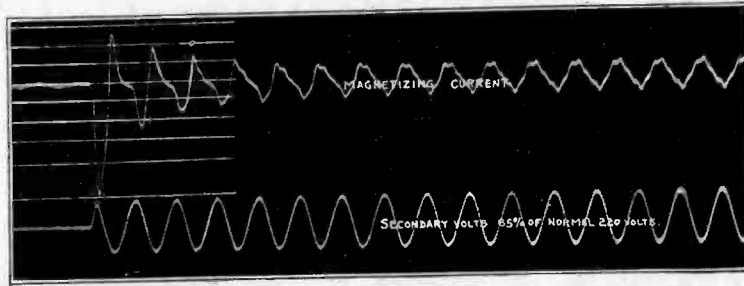

## Hysteresis in the Compensator Core Causes Hysteresis in the Line Voltage

THE transformer, used in a compensator for reducing the starting voltage of an induction motor, frequently causes a heavy current inrush when the compensator is first thrown into the starting position.

Likewise, the first inrush required to magnetize the core of a compensator is usually high, as illustrated by an actual oscillogram shown above. Several cycles are required for the current to become normal, and a bad voltage dip or flicker is produced by this initial current inrush.

Like all transformers, the compensator has an iron core which must be fully magnetized when the compensator is first connected to the main line. Power engineers know that ammeters used in measuring the exciting current of transformers must be protected from the violent inrush that usually occurs when the transformer is first connected to the line. After the initial inrush, the exciting current drops to a very low value

The Allen-Bradley Compression Resistance Starter has no transformer. It draws no excessive initial starting current. In fact the starting current builds up gradually from zero to just enough to start the motor. The graphite disc resistors limit the starting current and thereby preserve the stability of the line voltage.

*This oscillogram illustrates the serious current inrush drawn by a compensator when first thrown on the line, due to the excessive magnetizing current required for the compensator core.*

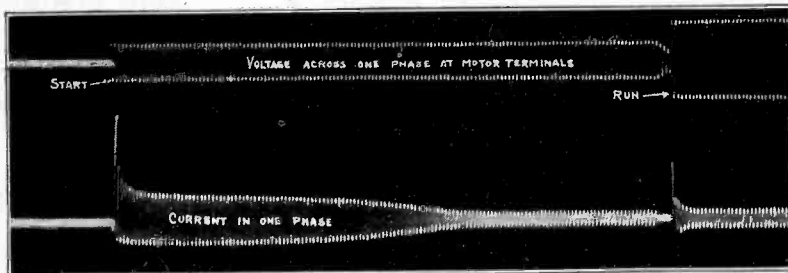

Allen-Bradley Compression Resistance Starters provide smooth, stepless acceleration, and solve the problem of starting squirrel-cage motors without disturbance to line voltage.

Mail the coupon for engineering bulletin containing oscillograph tests on compensators and compression resistance starters.

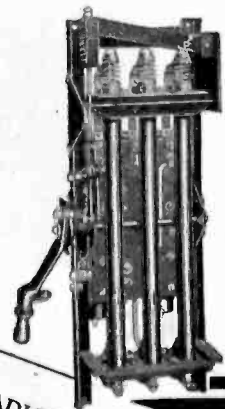
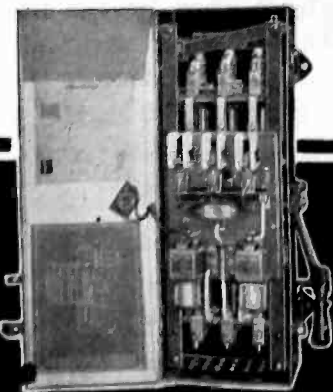

**Allen-Bradley**  
Graphite Compression  
**RESISTANCE STARTERS**  
for Squirrel-Cage Motors

ALLEN-BRADLEY CO.,  
494 Clinton St., Milwaukee, Wis.  
Please send me engineering bulletin with oscillograph test of squirrel-cage motor starters.

Name.....  
Company.....  
Address.....

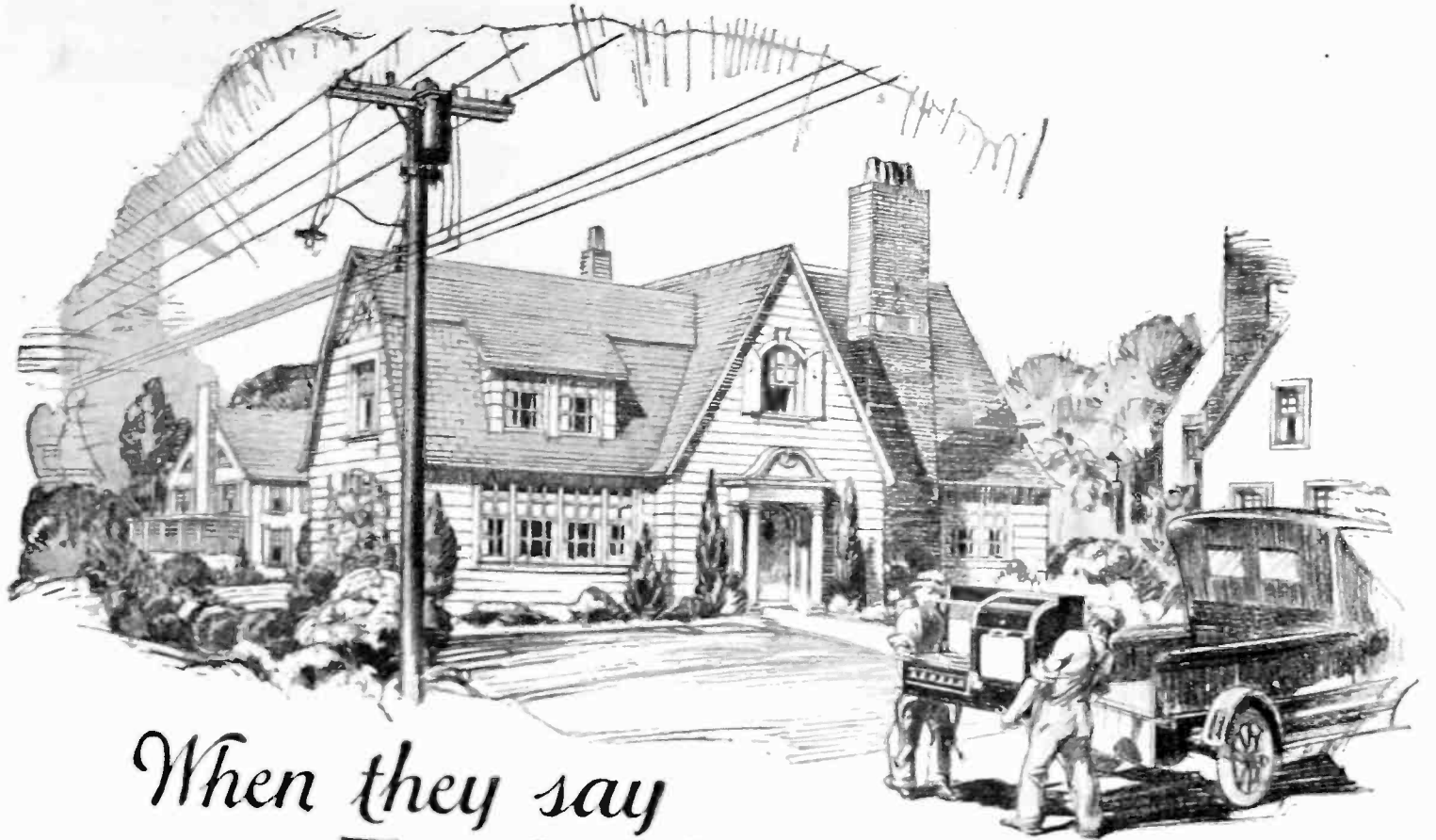

*When they say*  
**Find a better way**  
**to obtain loading data**

It's another case of having outgrown the methods of the past. The constant addition of new light, heat, and power loads to the distribution system necessitates more accurate knowledge of the output required from individual transformers.

General Electric has successfully met this situation with the thermotel, one of its latest developments in G-E Transformer and Accessory Products. There is a distinct demand for better, safer, and more economical loading data—made possible with this unique, useful instrument.

The thermotel is mentioned here merely as an example of General Electric enterprise in producing needed equipment of this class and in finding a practical solution of every distribution problem.



*Showing method of installing pole-type thermotel*



**Transformer Products**  
*— the Standards of Quality*

**GENERAL ELECTRIC**

GENERAL ELECTRIC COMPANY, SCHENECTADY, N. Y., SALES OFFICES IN PRINCIPAL CITIES

Please mention the JOURNAL of the A. I. E. E. when writing to advertisers.



# Why do so few engineers win to the top — while so many are lost in the crowd?

P. F. WALKER, Dean of the Engineering School of the University of Kansas

**A**N IMPRESSIVE FIGURE in the field of technical education is Dean P. F. Walker, head of the Engineering School of the University of Kansas.

With keen personal interest Dean Walker has watched the progress of the engineers whom he has trained. And he has noticed that in a very short time after their graduation they have separated themselves into two distinct groups.

The majority, adding nothing to their technical training, have gradually settled down into the rut of a specialized job.

The others have come to realize that without business training, technical training carries a man just about so far, and no farther.

But how can a technical man secure the distinct and profitable advantage of business training? The best answer to that question which Dean Walker has been able to find is the Alexander Hamilton Institute.

In a recent letter he wrote:

### The danger of specialization

"For the young engineer who has left school and gone into some position where his time is filled with technical matters associated with his job, it is of the utmost importance that the Business Course of the Alexander Hamilton Institute should be brought to his attention.

"From my own past experience I know there is a tendency to let down and to perform only the routine work called for on the job. This is the most

*On this page, Dean Walker answers the most pressing question that challenges the young engineer graduate today.*

dangerous thing that can befall a young engineer graduate. The Modern Business Course becomes a continual challenge and stimulus, impelling him to go on with his work in lines that will supplement the technique of his engineering job. *I recommend it without qualification to all men who graduate from this school.*"

Rather a startling statement, coming from such a man, isn't it?

But put it to the proof yourself. Look about you, and in case after case you will find the specialist in a subordinate position, while at the head of the business is a man who may know less about each department than the department heads, but *whose all-round knowledge of business fits him to direct their activities.*

### What the Institute does

When Mr. T. H. Bailey Whipple was Director of Education for the great Westinghouse Electric and Manufacturing Company, he said:

"I know of no other preparation that equals your Course for fitting a man to grasp his opportunity and succeed in it when it comes.

"If conscientiously pursued, your Course, coupled with one's daily problems and activities, unquestionably does for men what experience and native ability alone can never do."

In a few words, this is what the Institute does:

It takes a man in any department of industry, technical or clerical, and gives him a working knowledge of all the other departments. In a few months of interesting reading, it gives him a conception and understanding of business as a whole which ordinarily he could gain only after years of actual experience. Automatically it lifts him out of the class of men of which there are too many, into the class of which there are too few.

### Send for "Forging Ahead in Business"

Technical men find much that is interesting and valuable in the Institute's descriptive book, "Forging Ahead in Business." It gives all the facts about the Modern Business Course and Service, and tells what it has done for over 30,000 other technical men.

This booklet will be sent you gladly, and without the slightest obligation.

If you have ever asked yourself, "Where will I be ten years from now?"—send for it.

*This coupon will bring you the facts*

ALEXANDER HAMILTON INSTITUTE  
 920 Astor Place New York City

Send me the new, revised edition of "Forging Ahead in Business," which I may keep without charge.

Signature \_\_\_\_\_  
*Please write plainly*

Business Address \_\_\_\_\_

Business Position \_\_\_\_\_

## Alexander Hamilton Institute

IN CANADA, address the Alexander Hamilton Institute, Limited, C. P. R. Bldg., Toronto



IN ENGLAND, 67 Great Russell St., London  
 IN AUSTRALIA, 116 Castlereagh St., Sydney

Please mention the JOURNAL of the A. I. E. E. when writing to advertisers.



# DOSSERT

## Solderless Connectors

are furnished in every required size and type for conductors from No. 14 B & S gauge, to large cables of 3,000,000 cir. mils. They are the adopted standard in

**Central Station Practice**



# DOSSERT

## Solderless Connectors

Tests which have been made from time to time by users of Dossert connectors show that the connectors run at as low temperature as enabled by the wires connected to them.

*Send for Catalog Twenty*

**Dossert & Company**

H. B. LOGAN, President  
242 West 41st Street, New York



Please mention the JOURNAL of the A. I. E. E. when writing to advertisers.

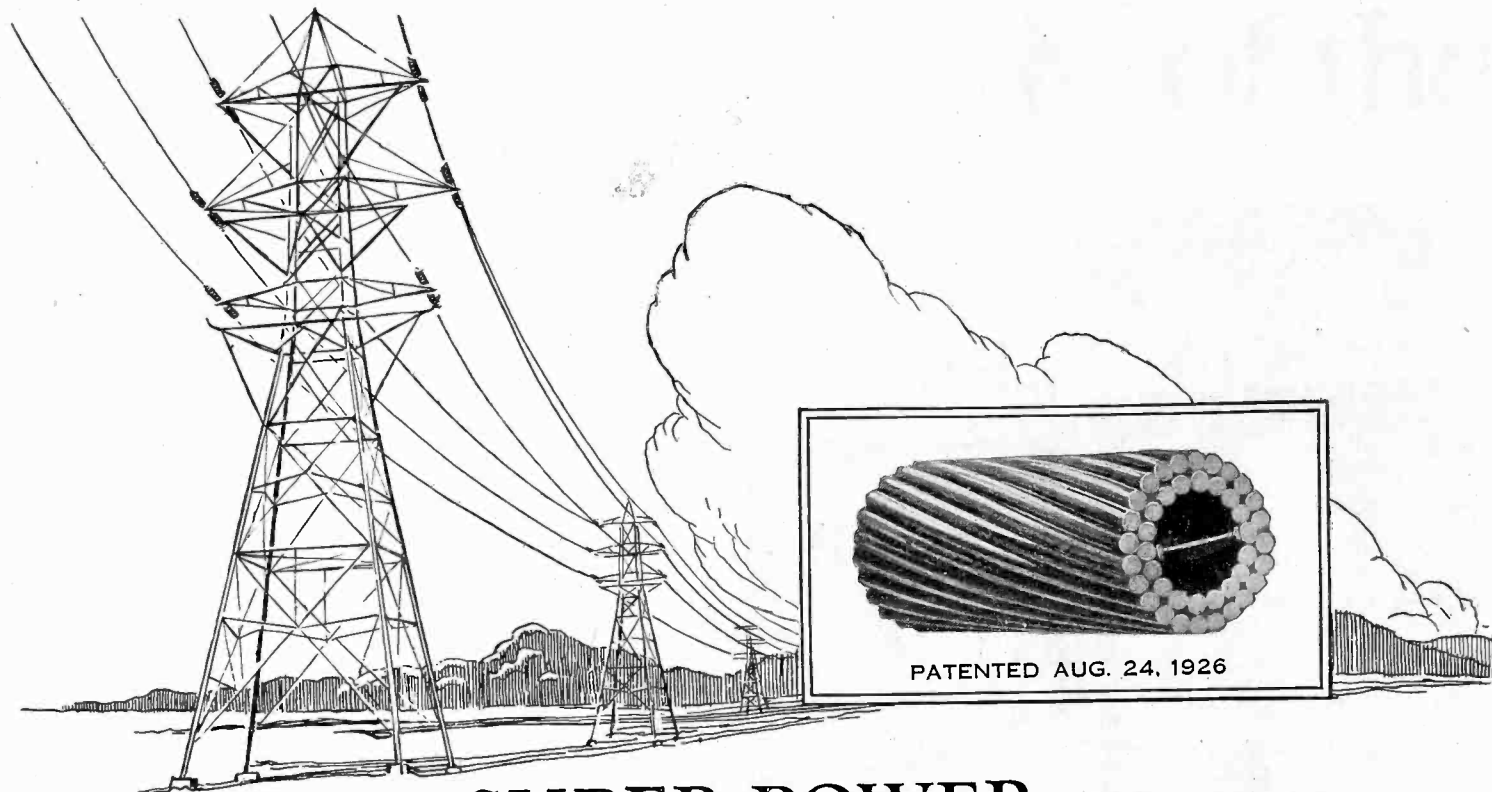

# SUPER-POWER and ANACONDA HOLLOW CONDUCTORS

**L**INKING up the power resources of the country, the building of super-power lines has marked an epoch in electrical development. The chief problem still lies in the economical transmission of high voltages over long distances.

In the Anaconda Hollow Conductor engineers have found the means of overcoming some of the principal difficulties of long distance transmission. Corona and resistance losses are reduced by providing the required diameter in a conductor made entirely of copper—the most logical transmission material.

Light in weight and high in tensile strength, the hollow construction of this conductor permits the variation of outside diameters and cross sections within wide limits in order to insure the most efficient design for

any given requirement of service. There is no inert weight in the Anaconda Hollow Conductor. The core, being of copper, is a conductor as well as a support for the strands. Unlike hemp or galvanized steel, this core is permanent. Since both strands and core are of copper, there can be no shifting of stresses between them due to temperature changes and there is no magnetic material to cause losses which would increase with the current.

The high efficiency and low maintenance cost of Anaconda Hollow Conductors mark them as an important contribution to the development of super-power. They offer engineers an opportunity to further demonstrate the economies to be derived by connecting together contiguous power systems. Write for Research Bulletin C-6.

ANACONDA COPPER MINING CO.—THE AMERICAN BRASS COMPANY  
*Rod, Wire and Cable Products*

General Offices: 25 Broadway, New York Chicago Office: 111 W. Washington St.

# ANACONDA COPPER

**BRASS**  **BRONZE**

Please mention the JOURNAL of the A. I. E. E. when writing to advertisers.

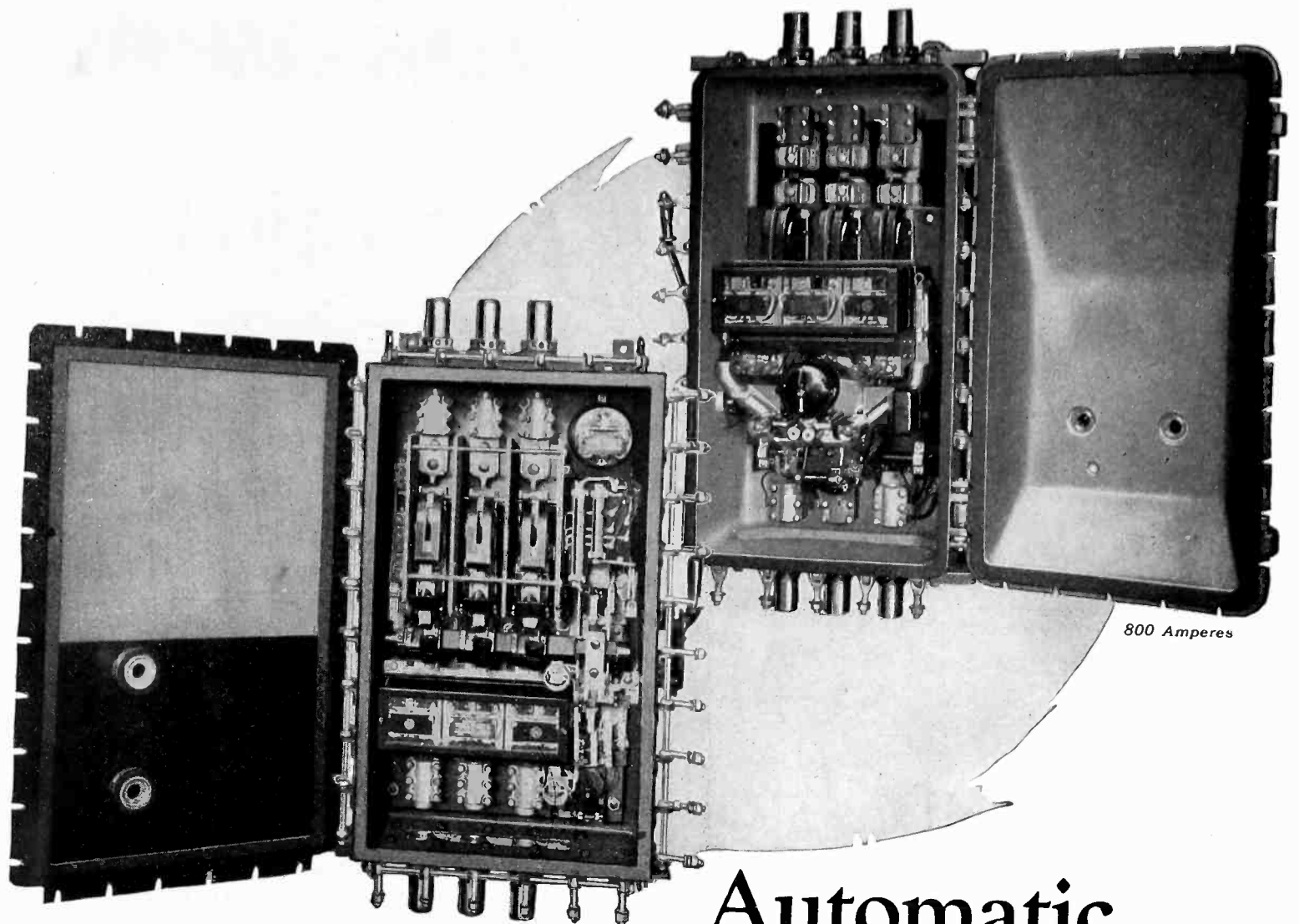

500 Amperes

800 Amperes

## Automatic A-c. Network Protectors

Provide power-directional protection between network systems and feeder transformers.

### Ratings

Motor operated—800, 1200, and 2000 amperes. Solenoid operated—500 amperes

Submersible and non-submersible  
Compact—Efficient—Reliable

The many G-E automatic network protectors now in service are proving these claims.



### Network Protectors

—part of the complete line of General Electric equipment to control and protect power generating and distributing apparatus

# GENERAL ELECTRIC

GENERAL ELECTRIC COMPANY, SCHENECTADY, N. Y., SALES OFFICES IN PRINCIPAL CITIES

Please mention the JOURNAL of the A. I. E. E. when writing to advertisers.

# An action picture of the Pellet Arrester

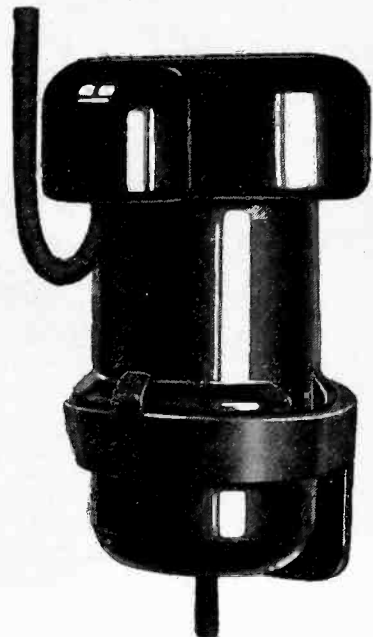
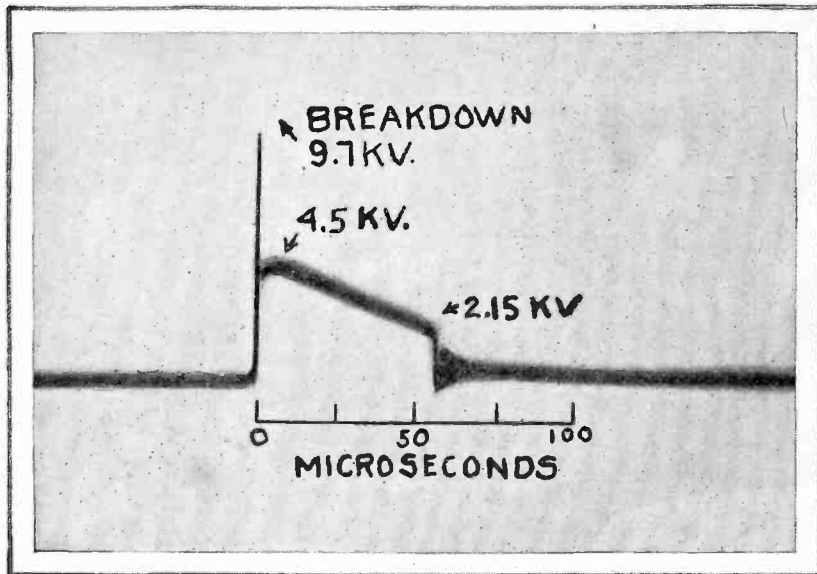

G-E Pellet-Type Oxide Film Arrester, built for voltages from 1,000 to 50,000

## Explained thus:

A lightning voltage of steep wave front is impressed on the arrester. As a result the potential across the arrester rises very rapidly until the arrester gap breaks down, at 9.7 kv., the voltage dropping at once to a low value. All this happens within 1 microsecond. Immediately following the breakdown, lightning current begins to flow through the arrester, the resistance of which causes a slight rise of voltage. The new peak is reached in two microseconds more, but at the low value of 4.5 kv. During the next 75 microseconds the arrester conducts lightning current to ground, while the voltage tapers off. Eighty microseconds—80 millionths of a second—after the action begins, the potential drops to zero and the arrester has completed its job.

It is exact knowledge of this kind, made available by research, that enables G-E engineers to determine definitely what constitutes efficient lightning protection, and to design arresters accordingly.

*For more information regarding the above test see GENERAL ELECTRIC REVIEW for October, 1926, or send for reprint, No. GEA-549*



With the aid of science, G-E engineers have brought the lightning arrester to a stage of development where it is as dependable as the transformer and other equipment it protects. And the name General Electric brings to the lightning arrester, also, the same guarantee of adequate strength, endurance, and long life that characterizes every other G-E product.

440-5

# GENERAL ELECTRIC

GENERAL ELECTRIC COMPANY, SCHENECTADY, N. Y., SALES OFFICES IN PRINCIPAL CITIES

Please mention the JOURNAL of the A. I. E. E. when writing to advertisers.

Pop asks how it happened

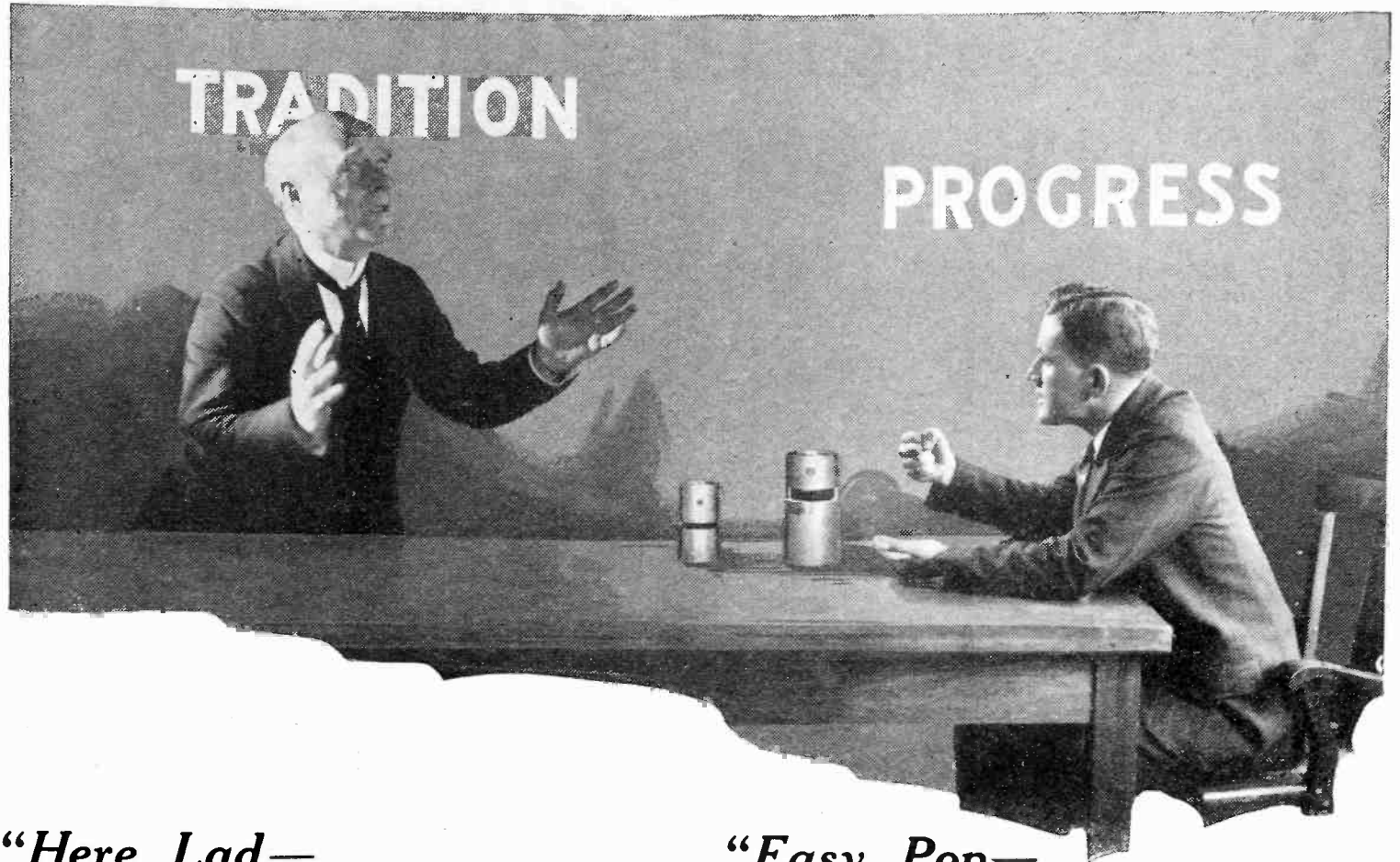

**“Here, Lad—**

if you would spend more time looking after the motors that we’ve got and less time trying to have me get this new-fangled motor the next time I buy—we wouldn’t have to be arguing here about the amount of money it costs us to keep motors going. How does it happen that this motor of yours suddenly becomes a world beater?”

**“Easy, Pop—**

it didn’t happen. The best things *never* happen—they’re achieved.

The “Linc-Weld” people didn’t happen on bearings and shafts that are bigger than those of any other motor.

Being motor specialists they knew years ago that these items cause the most trouble in motor operation—so they deliberately developed these to a point where these troubles were licked.

By accurate logging of our motor shutdowns, 75% were directly the result of bearing failure.

So I’m simply asking you, Pop, to look at these two bearings—

The little fellow is ours—the big brute is the “Linc-Weld,” and tell me which you’d choose if your life and not your prejudices were at stake on the final outcome in service?”

The Lincoln Electric Co., Dept. No. 21-8, Cleveland, Ohio

MA-19

**L** *“Linc-Weld”*  
**INCOLN MOTOR**

Please mention the JOURNAL of the A. I. E. E. when writing to advertisers.



## *Unusual Opportunity*

### For Engineer of Exceptional Ability

ONE of the oldest established manufacturers of high grade electrical switching equipment has an opening for an engineer capable of reorganizing and supervising its engineering department. To measure up to the unusual opportunity presented he must have had at least five years' practical experience in the design and manufacture of electrical equipment, with thorough knowledge of electrical and mechanical engineering principles and of modern shop practice. True executive ability is required.

Salary fully commensurate with his ability and an assured future, real opportunity for personal development and the full cooperation of his fellow executives.

If you believe you measure up to this position, or if you know a man who does, write in strictest confidence, giving complete information. Address Box 129, JOURNAL of the A. I. E. E., 33 West 39th Street, New York.

*P.S. This company's stock is privately owned and does not appear on the "board."*

*with* **LINDBERGH**  
to Paris

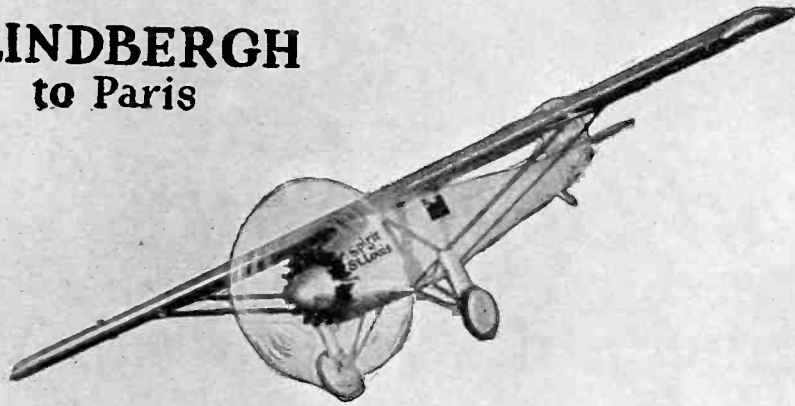

*with* **CHAMBERLIN**  
into Germany

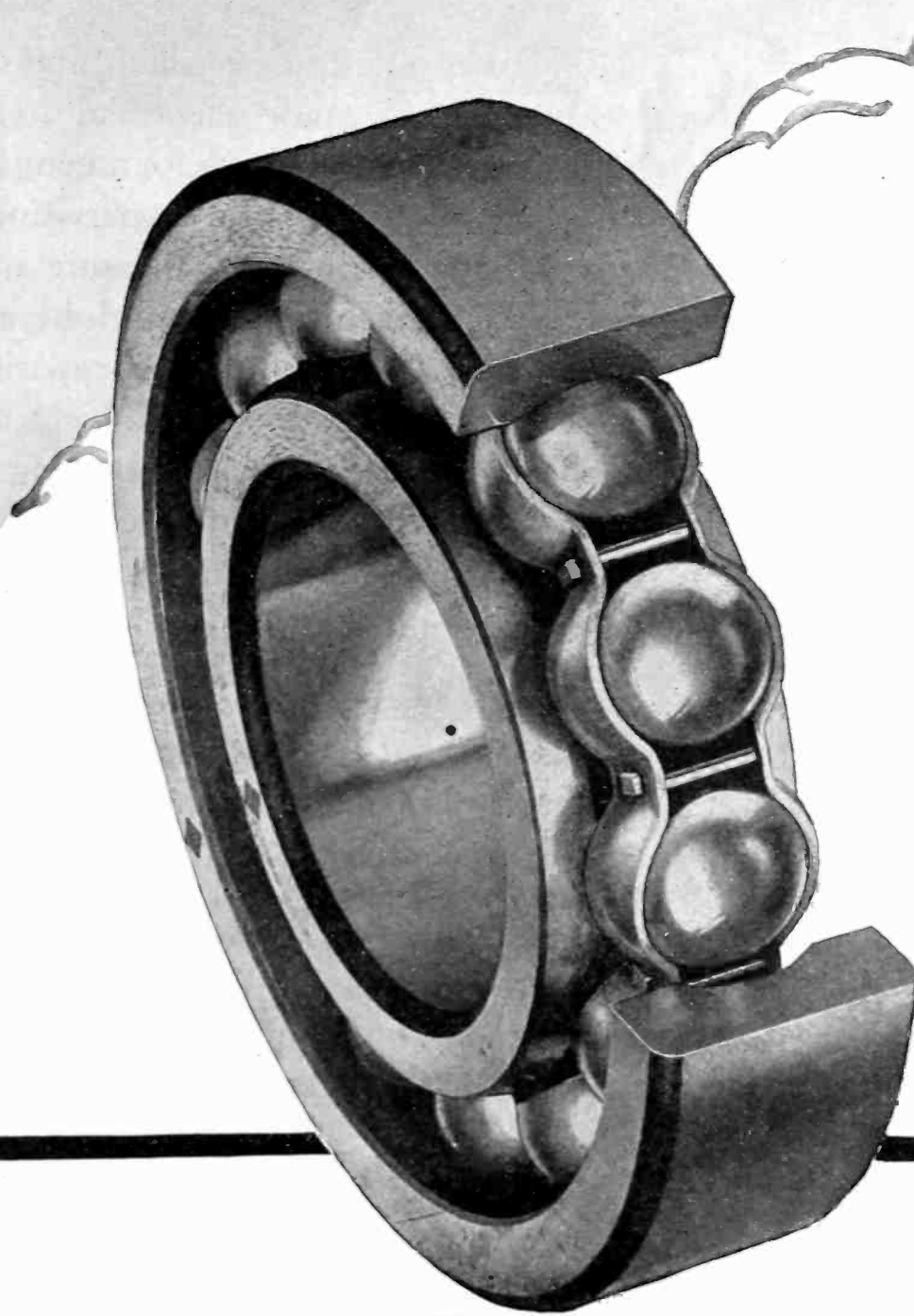
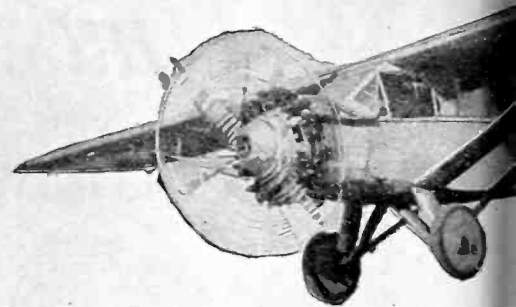

## SRB

### DEPENDABILITY

Back of the heroic efforts of these pioneers stand the engineers who conceived their planes. With everything at stake, it is significant that they selected SRB Ball Bearings for the vital task of supporting the propellers of the Wright Whirlwind Engines that made all these achievements possible.

# STANDARD STEEL AND BEARINGS

Please mention the JOURNAL of the A. I. E. E. when writing to advertisers.



*with* **MAITLAND**  
to Hawaii

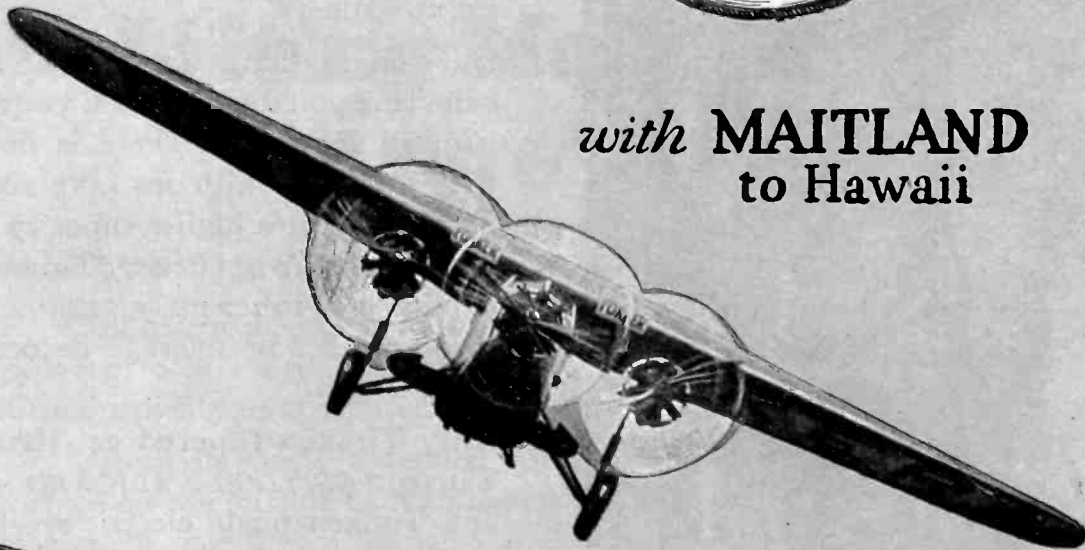

*with* **BYRD** and his crew  
across the Atlantic

**INCORPORATED** · *Plainville, Conn.*

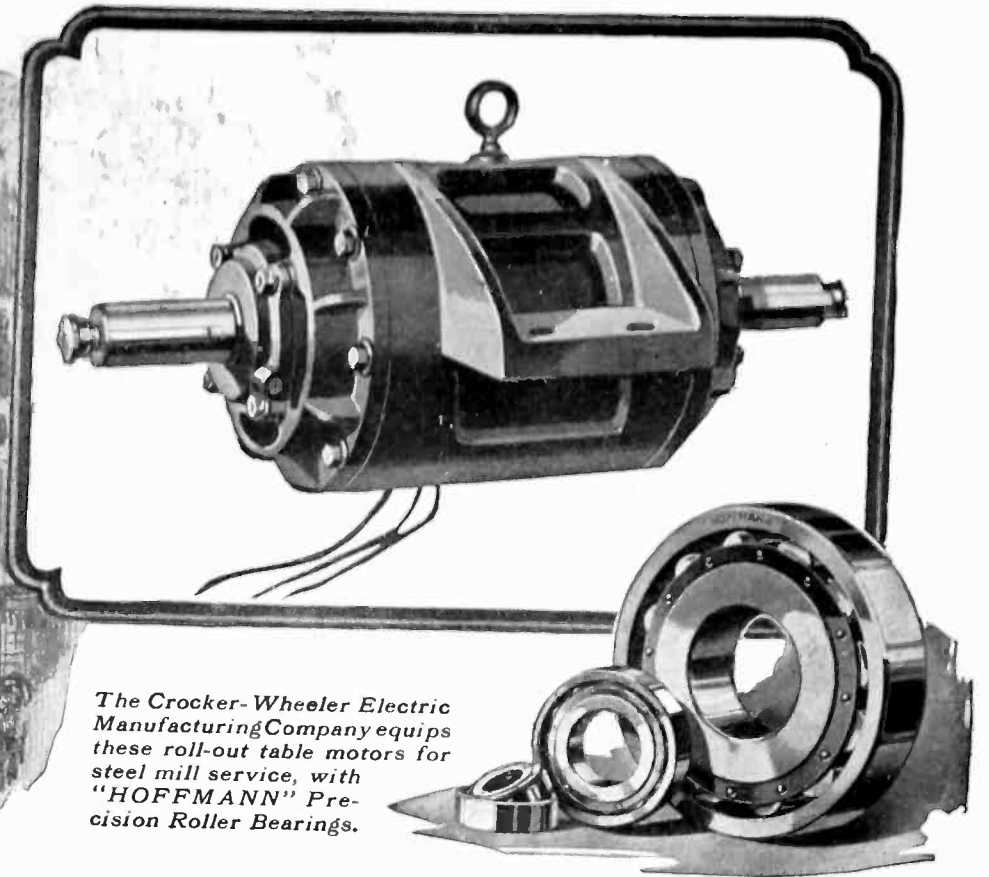
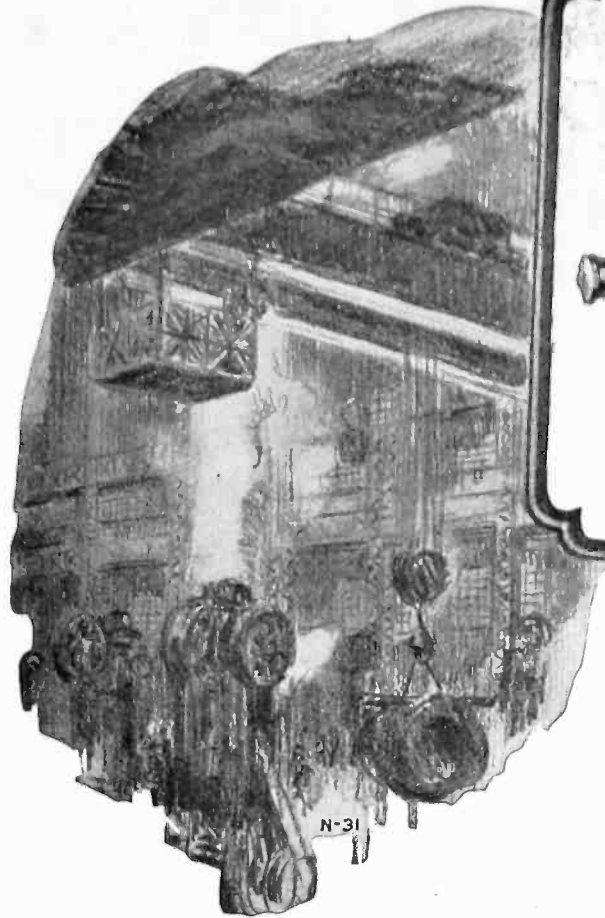

*The Crocker-Wheeler Electric Manufacturing Company equips these roll-out table motors for steel mill service, with "HOFFMANN" Precision Roller Bearings.*

**W**HERE loads are heaviest and service hardest—where dependability must be had regardless of severe conditions—engineers and designers in ever-increasing numbers are turning to "HOFFMANN" Precision Roller Bearings for the stand-up-ability they must have. Their rugged reliability is a distinct advantage where failure would be most costly.

*Why not let our engineers work with you, on your heavy duty bearing problems—without obligation?*

Ask for Catalog 904.

NORMA-HOFFMANN BEARINGS CORPORATION  
STAMFORD, CONN. . . . U.S.A.

In the field of more moderate powers and of less arduous duties,

**"NORMA"**  
PRECISION  
BALL BEARINGS

continue to enjoy the confidence of those who place performance before price because they must have dependable bearing service. Let us send Catalog 905



NB-873

**"HOFFMANN"**  
PRECISION  
ROLLER BEARINGS

Please mention the JOURNAL of the A. I. E. E. when writing to advertisers.



*Instrument board similar to that used by Lindbergh in his epoch-making New York to Paris flight*

## A Complete Wire Service For Precision Instrument Manufacturers

**T**HE Earth-Inductor Com-  
passes, manufactured by the  
Pioneer Instrument Company,  
and used by Lindbergh, Cham-  
berlain, Maitland, and Byrd,  
were wound with Belden Mag-  
net Wire and equipped with  
Belden wire throughout. The  
precision with which Belden  
wire is drawn, the highly per-  
fected processes by which it is  
insulated, and the repeated in-  
spections and tests it must pass  
during manufacture, make it  
ideal for winding the most deli-  
cate instruments.

Belden Magnet Wire is made in  
a variety of sizes and insulations  
to meet the most exacting re-  
quirements. Belden Flexible  
Lead wires, rubber covered  
wire, and other standard Belden  
wires make the service complete.  
Manufacturers of delicate instru-  
ments will find Belden complete  
service a saver of time and money,  
as well as a decided convenience.

Belden engineers can render you  
valuable assistance in the solu-  
tion of difficult winding prob-  
lems. Write them for help.

### BELDEN PRODUCTS

- Beldenamel and Textile  
Magnet Wire  
Coil Windings  
Beldenmold  
(Molded Bakelite Products)  
Automotive Wires and Cables  
Airplane Assemblies  
Radio Wires, Cords  
and Cables  
Rubber Covered Wires  
Armored Cables  
Flexible Armature Wires  
Motor Lead Wires  
Braided and Stranded  
Copper Cables  
Cotton Sleaving*

**Belden Manufacturing Company**  
2316B South Western Avenue Chicago, Illinois

# Specify Belden

# ALLIS-CHALMERS MOTORS

Motors that win textile preference have sure advantages for any motor user. Power economy, endurance to guard against stoppage, smooth starting, compactness, and no oil dripping are all essential in textile practice.

Highest extra wear resistance is apparent throughout Allis-Chalmers motors. Frames and many other parts are electric steel. Virtually unit construction has been developed for cores. Exclusive silver-brazing makes rotors practically indestructible. Insulation is the toughest known.

*Bearings are also most nearly permanent* in A-C Timken-equipped motors. Timken Tapered Roller Bearings overcome *ALL* forms of wear—not only friction, but thrust, shock and speed. Timken load capacity is so much greater that smaller housings are possible, with better placed vents and a 15% saving in length. Closure is perfect. Starting is fast and easy. Lubricant lasts for months.

Allis-Chalmers users in every field are reducing every item of motor cost. No order can be wisely placed today without considering the Allis-Chalmers line.

ALLIS-CHALMERS MFG. CO., MILWAUKEE  
*District Sales Offices in all Principal Cities*

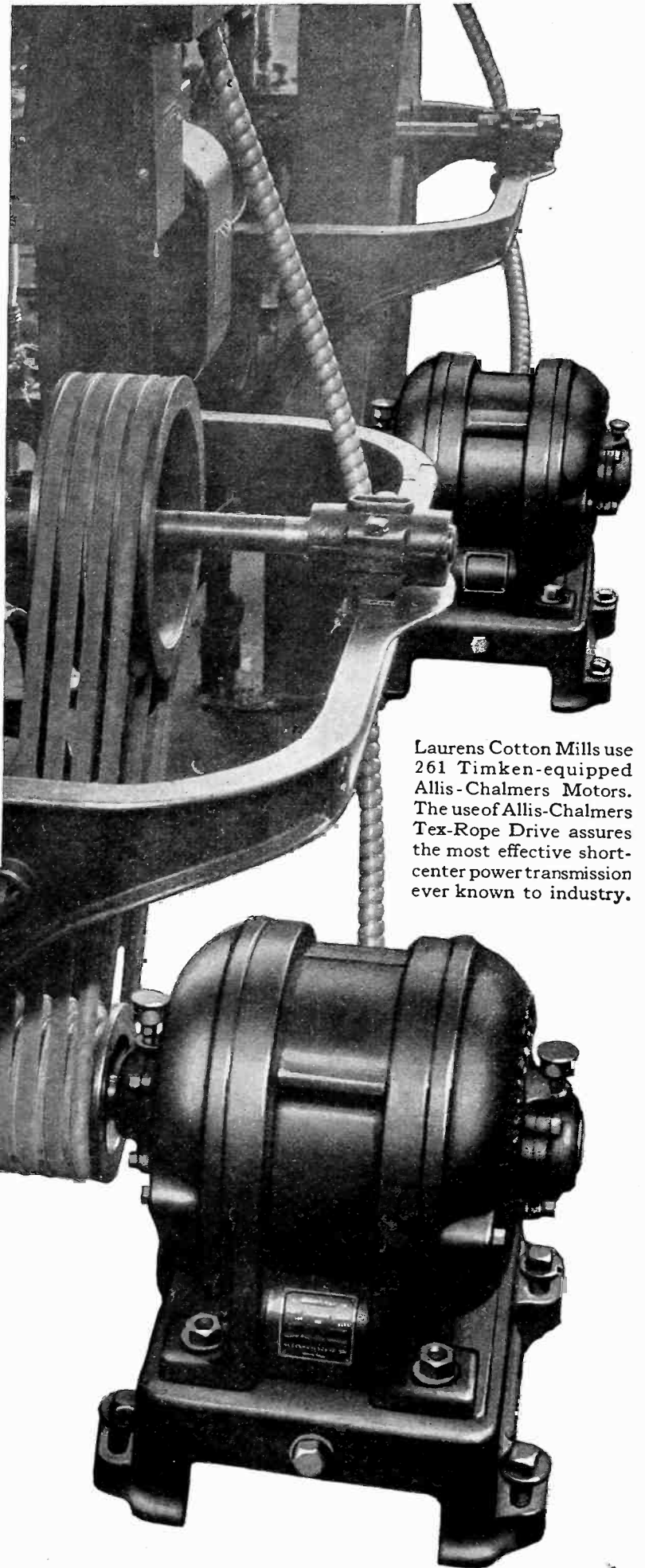

Laurens Cotton Mills use 261 Timken-equipped Allis-Chalmers Motors. The use of Allis-Chalmers Tex-Rope Drive assures the most effective short-center power transmission ever known to industry.

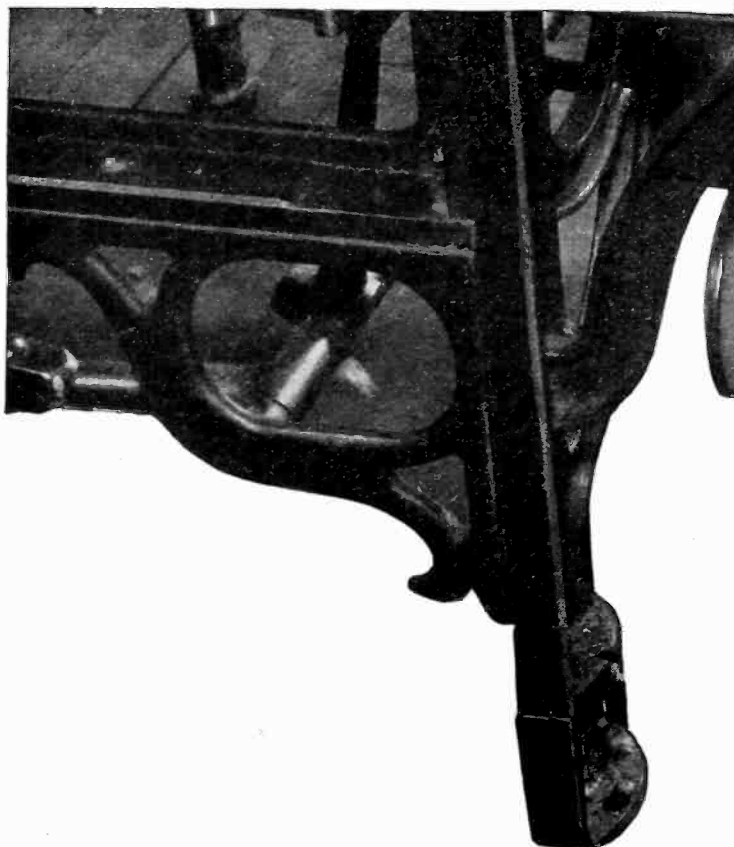

Please mention the JOURNAL of the A. I. E. E. when writing to advertisers.

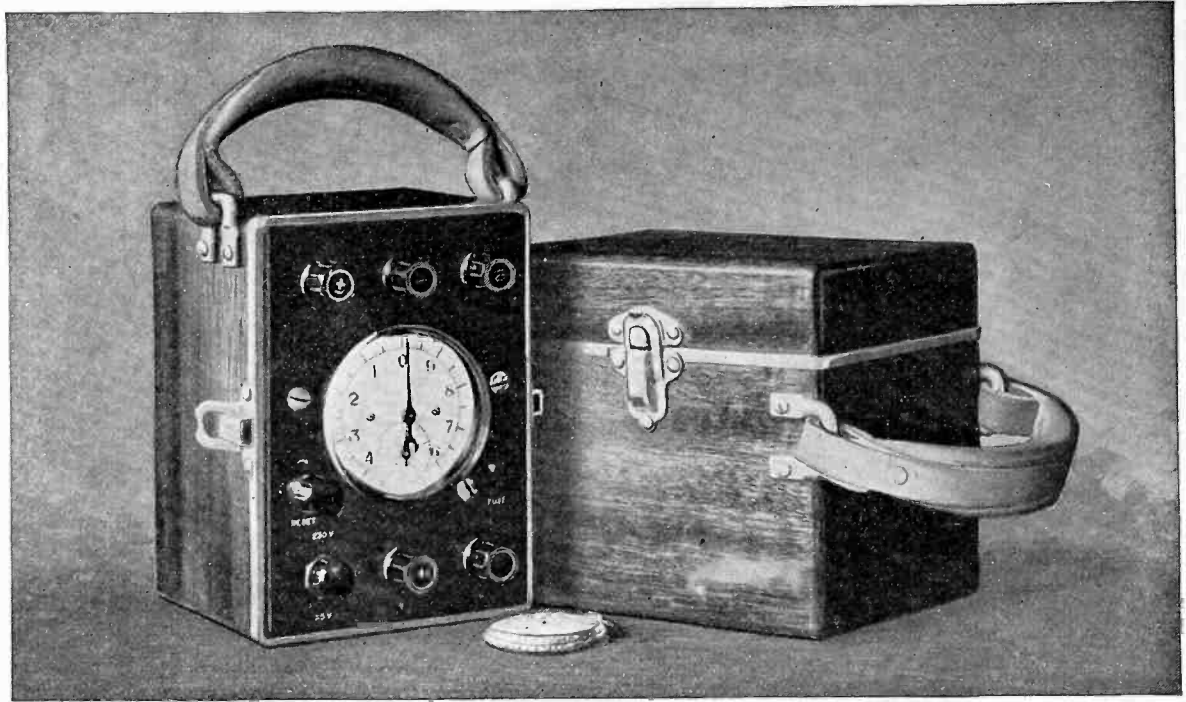

*And Now —*

# PRECISION

## *—Without Bulk*

LIKE the modern jewelled watch, the new Westinghouse OB Portable Standard is a marvel of precision. Its metering element is a refinement of the OB service meter which set a new standard for accuracy in measuring power consumption. It has simplified micrometer adjustments and complete temperature compensation. Like most fine things, it is small and light—the complete meter weighs but 5.6 pounds.

A case worthy of such a fine instrument encloses and protects the metering element. It is

molded in one piece from Micarta, an exclusively Westinghouse product that is strong and light, that will not warp nor crack, that is unaffected by temperature and time. There is not a joint nor seam—moisture and dust cannot enter the case. Its finish is polished mahogany with nickeled trimmings.

The Westinghouse OB Portable Standard Watthour Meter is an instrument that the meter man will be proud to use and one that will arouse a feeling of confidence in the mind of your customer whose meter is being tested.

Westinghouse Electric & Manufacturing Company  
Newark Works Newark, N. J.

Sales Offices in All Principal Cities of  
the United States and Foreign Countries

**Westinghouse**  
Portable Standard  
Watthour Meters

X93641

Please mention the JOURNAL of the A. I. E. E. when writing to advertisers.

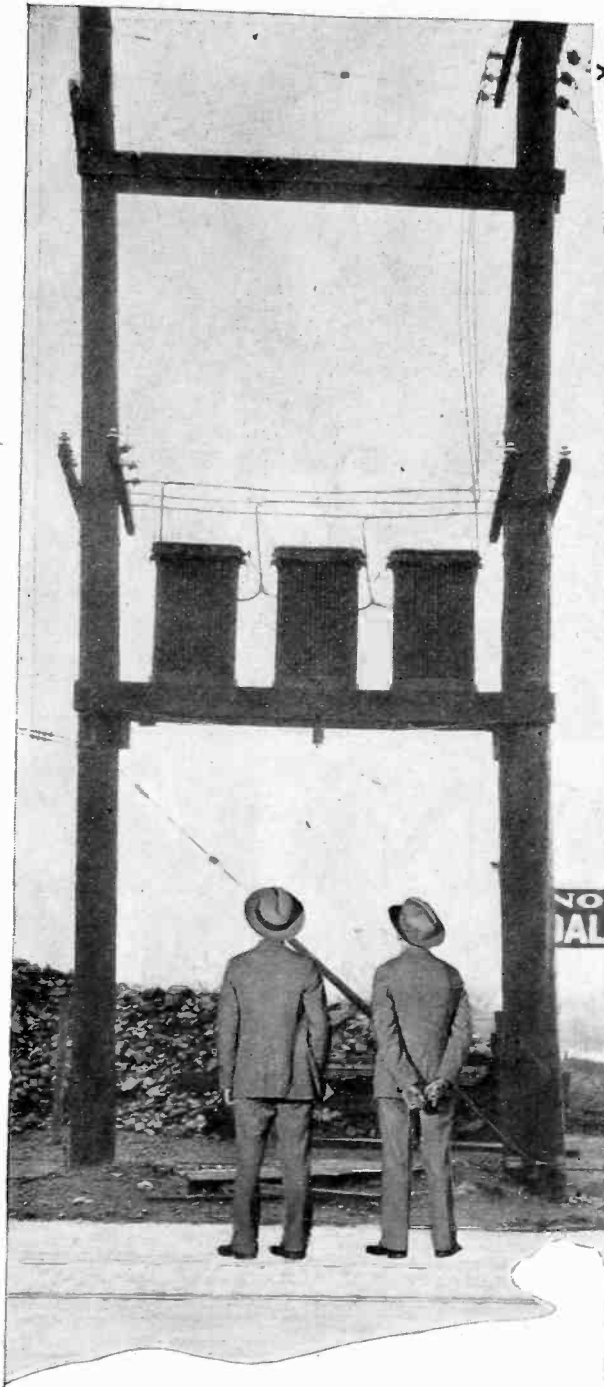

\*“**How shall I test these transformers?”**”

*Answer to A.C.S.\**  
**Re: Transformer Testing**

If you will refer to Kuhlman Kurrents for January and March of this year, you will find articles that answer your question in considerable detail. These two articles are a compact and convenient compilation of methods, instruments required and sequence of tests for the engineer who is occasionally but not regularly engaged in the testing of transformers.

Resistance, iron loss and exciting current, copper loss and impedance, and polarity are discussed in January Kuhlman Kurrents. The March article has to do with temperature, regulation, efficiency and voltage tests.

We have always encouraged transformer users to make their own comparative tests. Such tests will do more to make them realize the quality and economy of Kuhlman Transformers than anything we can say about coil ventilation, special low-loss silicon steel for cores, other high grade materials or painstaking workmanship.

We shall gladly send you these two numbers of Kuhlman Kurrents. It is a pleasure to add to our mailing list the name of anyone who operates transformers and will write us on his business letter-head.

*This is one of a series of important questions frequently asked us regarding transformer design, construction and operation*

# KUHLMAN TRANSFORMERS

**KUHLMAN ELECTRIC CO., Bay City, Michigan**

Akron.....High and Barges Sts.	Dallas.....Unit 2, Santa Fe Bldg.	Minneapolis.....1004 Marquette Ave.	Salt Lake City.....134 West 2d South St.
Atlanta.....411 Glenn Bldg.	Denver.....1843 Wazee St.	New York.....Graybar Bldg.	San Francisco.....Call Bldg.
Boston.....69-71 High St.	Detroit.....3-260 Gen. Motors Bldg.	Oklahoma City.....1013 Braniff Bldg.	Seattle.....314 Seneca St.
Buffalo.....280 Carolina St.	Greensboro, N. C.....333 S. Davie St.	Omaha.....923 W. O. W. Bldg.	Toledo.....424 Spitzer Bldg.
Chicago.....844 Rush St.	Indianapolis.....202 Indiana Ter. Whse.	Philadelphia.....1700 Walnut St.	Washington.....1328 New York Ave.
Cincinnati.....1308 Union Trust Bldg.	Los Angeles.....316 American Bank Bldg.	Pittsburgh.....839 Oliver Bldg.	N. W.
Cleveland.....627 Union Trust Bldg.	Milwaukee.....1031 Clybourn St.	Saint Paul.....1479 Blair St.	York, Pa.....335 W. Market St.

Please mention the JOURNAL of the A. I. E. E. when writing to advertisers.



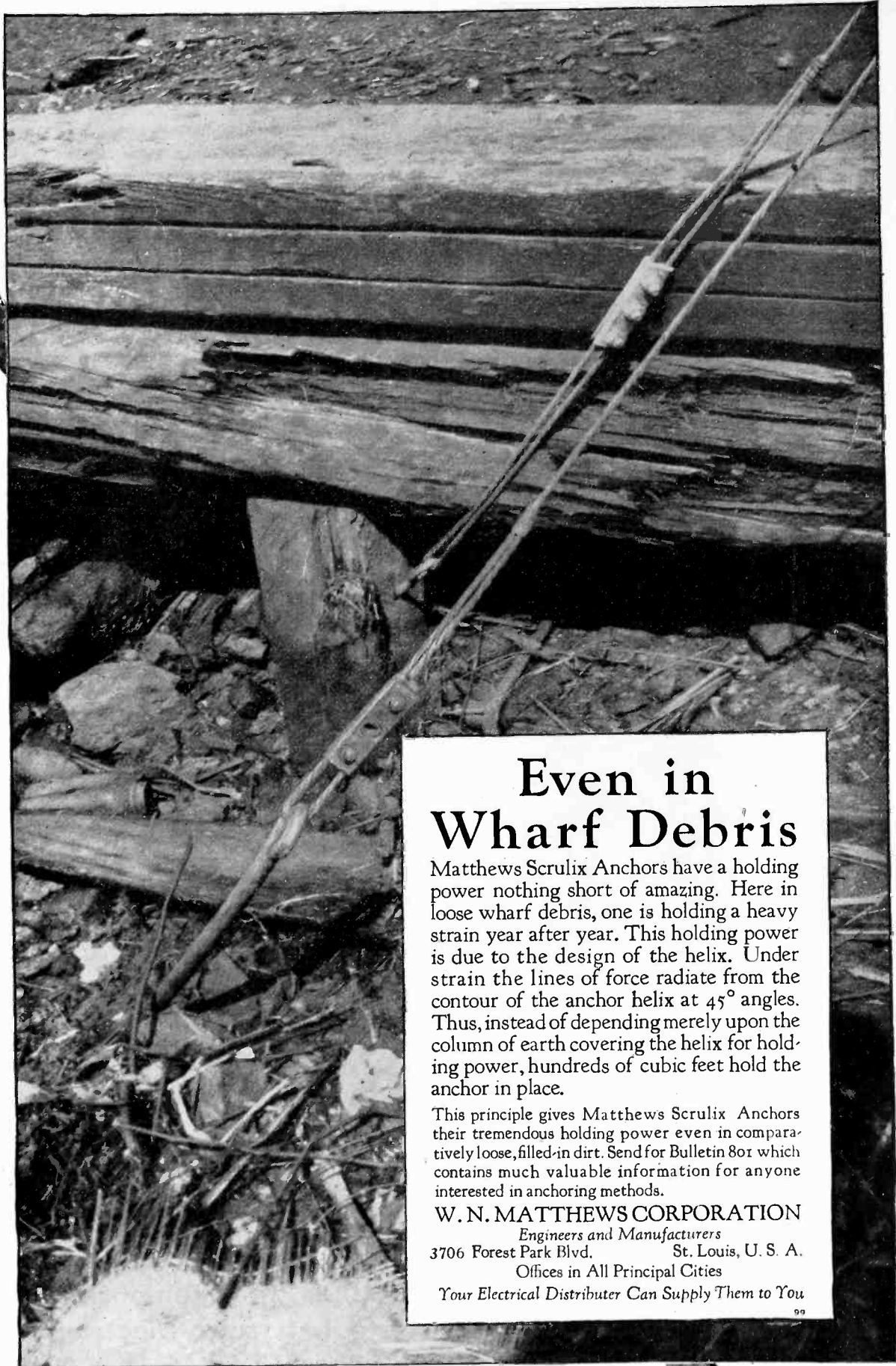

## Even in Wharf Debris

Matthews Scrulix Anchors have a holding power nothing short of amazing. Here in loose wharf debris, one is holding a heavy strain year after year. This holding power is due to the design of the helix. Under strain the lines of force radiate from the contour of the anchor helix at 45° angles. Thus, instead of depending merely upon the column of earth covering the helix for holding power, hundreds of cubic feet hold the anchor in place.

This principle gives Matthews Scrulix Anchors their tremendous holding power even in comparatively loose, filled-in dirt. Send for Bulletin 80r which contains much valuable information for anyone interested in anchoring methods.

**W. N. MATTHEWS CORPORATION**

*Engineers and Manufacturers*

3706 Forest Park Blvd. St. Louis, U. S. A.

Offices in All Principal Cities

*Your Electrical Distributer Can Supply Them to You*

99

# MATTHEWS

## SCRULIX ANCHORS

*Look for "SCRULIX" on the Helix*

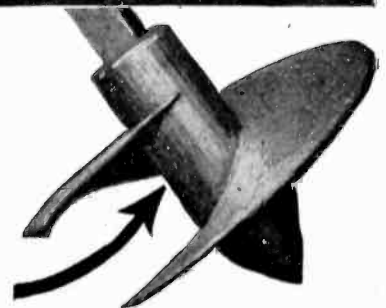

Please mention the JOURNAL of the A. I. E. E. when writing to advertisers.

# FERRANTI TRANSFORMERS

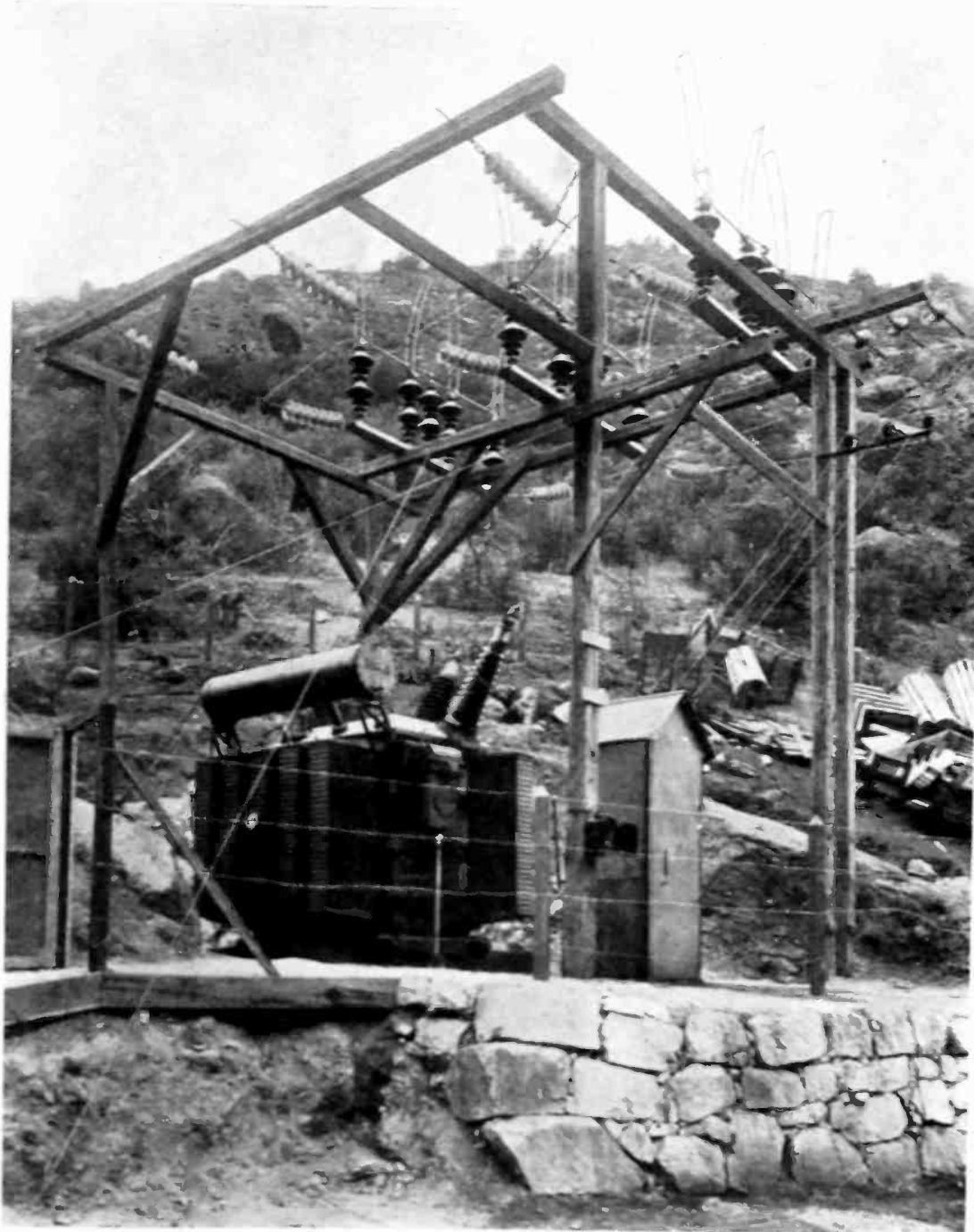

A 1333 KVA. 110,000 Volts temporary Sub-station of the CIA. Hidro-Electrica Volcan, Chile. Three 13,333 KVA. 110,000 Volts FERRANTI Transformers are also being supplied.

FERRANTI, INC.  
130 W. 42ND STREET  
NEW YORK

FERRANTI, LTD.  
HOLLINWOOD  
ENGLAND

FERRANTI, ELECTRIC  
LIMITED  
TORONTO, CANADA

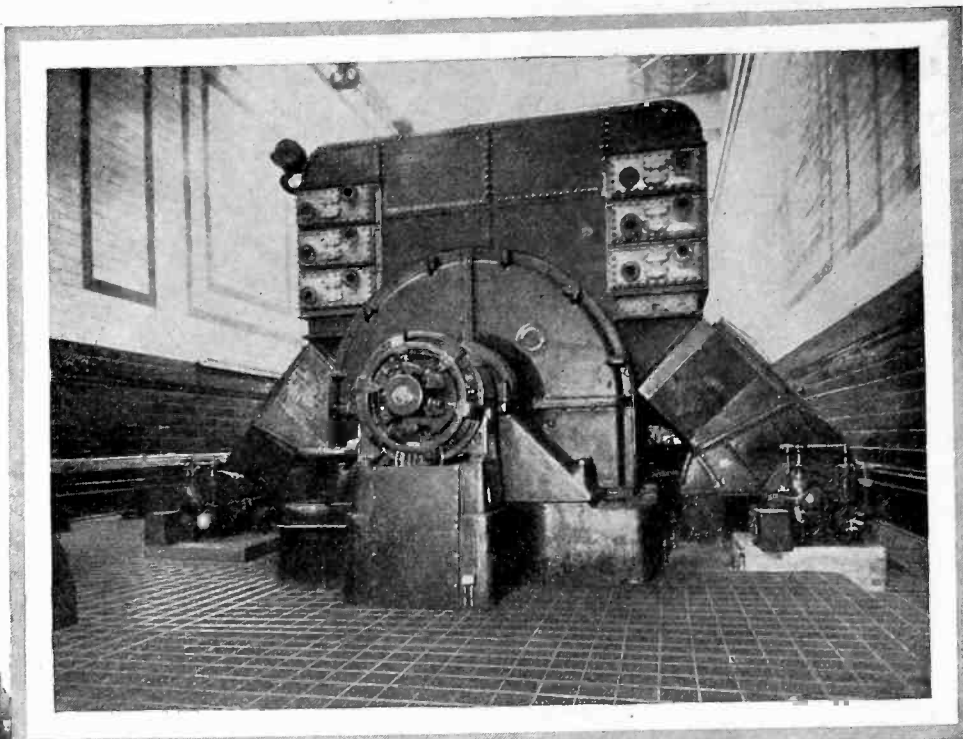
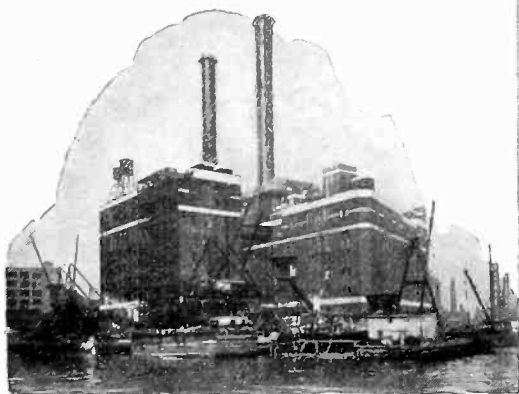

50,000-kw. G-E turbine-generator, East River Station, New York Edison Company. Surface air coolers are mounted on the generators—a suitable location where space is not available below the machine

# Another problem solved with G-E Surface Air Coolers

The location of the East River Station demands the utmost quiet in the operation of the plant. Therefore, G-E surface air coolers have been installed to decrease noise and also to obtain these additional advantages:

Confinement of hot ventilating air.

Minimum fire hazard. The contained air can support but little combustion.

Perfect cleanliness. Only clean air circulates through the machines.

These advantages have been demonstrated by surface air coolers applied to synchronous condensers, frequency-changers, waterwheel generators, turbine-generators, and similar electric machinery. The specialist in the nearest G-E sales office will show you the value of enclosed ventilation.

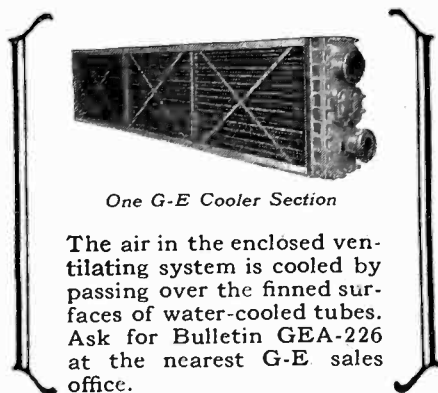

# GENERAL ELECTRIC

GENERAL ELECTRIC COMPANY, SCHENECTADY, N. Y., SALES OFFICES IN PRINCIPAL CITIES

Please mention the JOURNAL of the A. I. E. E. when writing to advertisers.

880-8

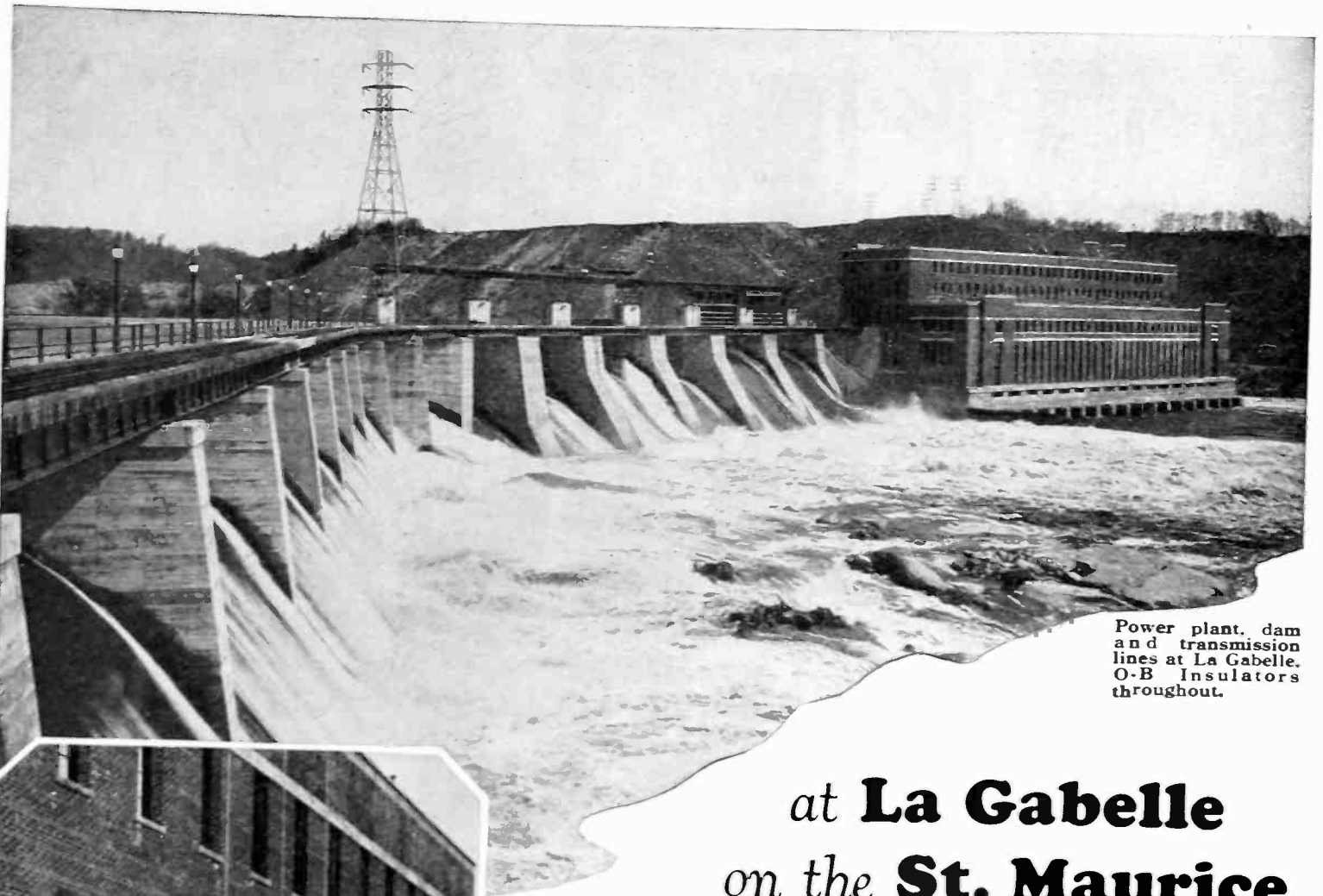

Power plant, dam and transmission lines at La Gabelle. O-B Insulators throughout.

## at **La Gabelle** on the **St. Maurice**

WITH an installed capacity of 120,000 h. p., ultimate capacity 150,000 h. p., the La Gabelle development of the St. Maurice Power Company constitutes one of the three units of power totaling 507,500 h. p., generated within a stretch of only 13 miles on the St. Maurice River in the Province of Quebec, Canada.

The dam floods out the La Gabelle Rapids and Les Gres Falls, for one mile, giving an average operating head of 65 feet.

The power house forms part of the dam and rests on the original bed of the river.

Part of the Shawinigan System, the St. Maurice Power Company takes justifiable pride in its part in contributing to industrial expansion in the Province of Quebec.

Ohio Brass Company, Mansfield, Ohio  
Dominion Insulator & Mfg. Co. Limited  
Niagara Falls, Canada  
414M



Line entrances at La Gabelle station. O-B suspension insulators and entrance bushings throughout.

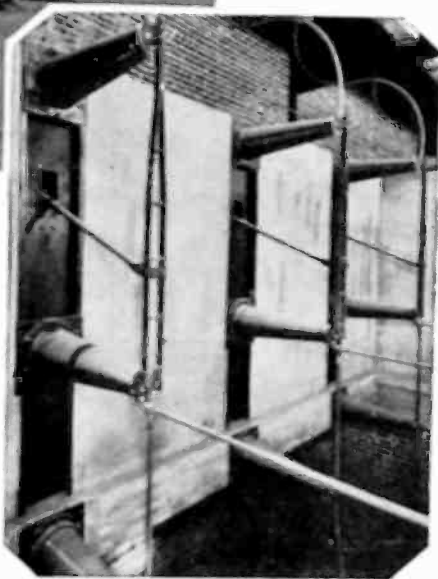

Motor-operated disconnecting switches at La Gabelle. O-B post insulators.

# Ohio Brass Co.

SALES OFFICES: NEW YORK CHICAGO PHILADELPHIA PITTSBURGH CLEVELAND SAN FRANCISCO LOS ANGELES

PORCELAIN INSULATORS  
LINE MATERIALS  
RAIL BONDS  
CAR EQUIPMENT  
MINING MATERIALS  
VALVES

Please mention the JOURNAL of the A. I. E. E. when writing to advertisers.

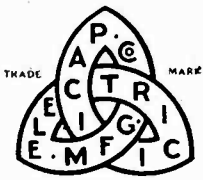

# Pacific Electric Equipment in a California Substation

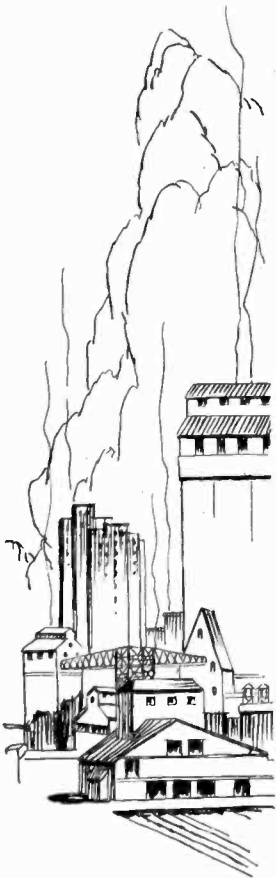
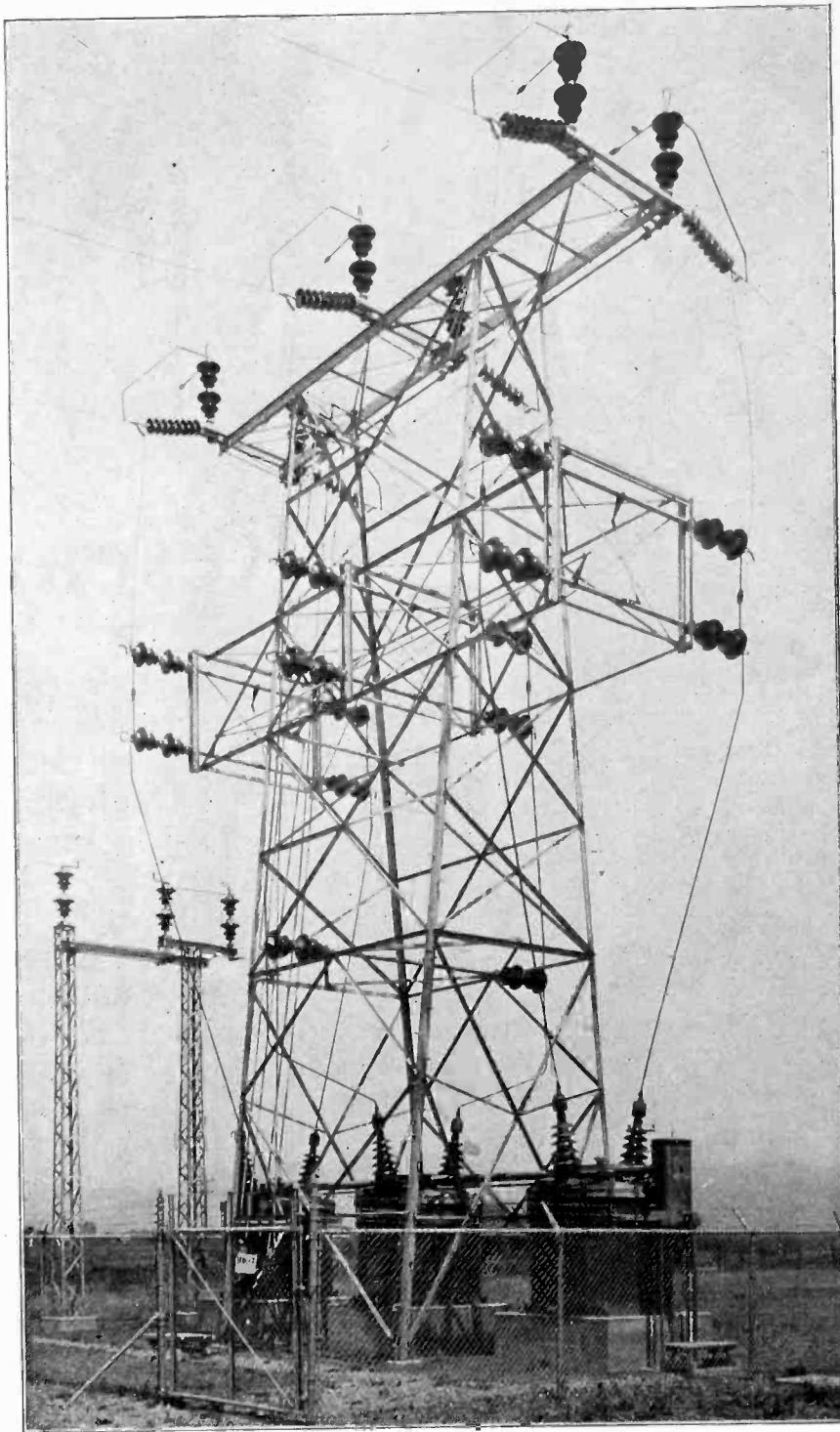
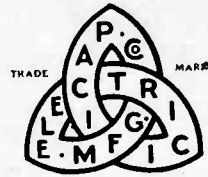

Pacific Type "R," 110 Kv., 400 Amp., Oil Circuit Breaker installation at Tie-in of Pacific Gas & Electric Company with Coast Valleys Gas & Electric Company (Byllesby Engineering and Management Corporation), Salinas, California.

## Pacific Electric Manufacturing Co.

*The Only Manufacturer of Horizontal Rotary Break Oil Circuit Breakers in the U. S. A.*

5815 Third St.  
SAN FRANCISCO, CALIFORNIA

Agencies in Principal Cities

419 Chemical Building  
ST. LOUIS, MISSOURI

Please mention the JOURNAL of the A. I. E. E. when writing to advertisers.

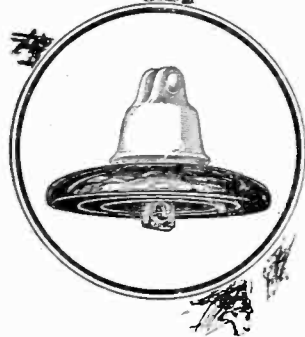

## Research

Research is industry's reply to the demand for progress. Great laboratories, perfectly equipped, have been dedicated to industrial research. Haphazard invention has been replaced by organized scientific study and development.

Thirty-five years of experience and constant development enable the Locke Insulator Corporation to offer you today services adequate to your most exacting needs.

Our progressive, continuous research program is an assurance to you of intelligent service—not only under present conditions—but under the changing conditions of tomorrow.

LOCKE INSULATOR CORPORATION  
BALTIMORE MARYLAND

The engineering and research facilities of the Locke organization are available at any time to transmission engineers.

There is no obligation, either actual or implied. We welcome the opportunity to help you with your individual problems.

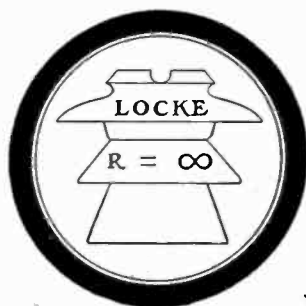

# LOCKE PORCELAIN



LOCKE QUALITY

LOCKE SERVICE

Please mention the JOURNAL of the A. I. E. E. when writing to advertisers.

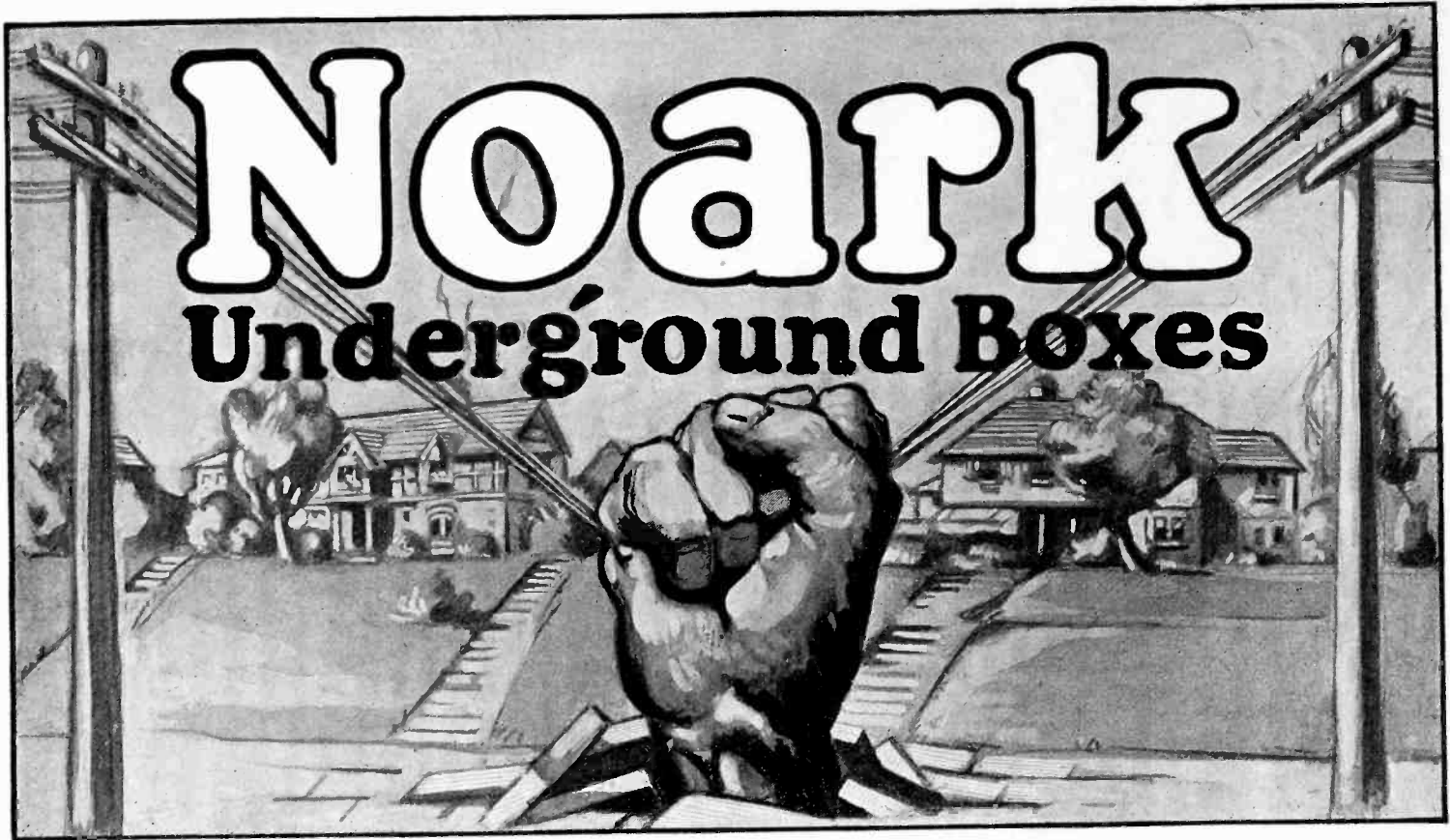

# Noark Underground Boxes



**SECTIONALIZATION** of power transmission has so many advantages over complete interconnection of feeders that your chief problem lies not in deciding whether to use UNDERGROUND BOXES for your layouts, but which type to use and how best to employ them.

**UNDERGROUND FOR PERMANENCE**

Noark Underground Boxes are designed with generous factors of safety against every conceivable form of accident or trouble.

Heavy, cast-iron boxes house the operating mechanism and fuses, affording full protection against cave-ins or other damaging mishaps.

A clean, dry compartment for the fuses and electrical connections is insured by the watertight and moisture proof construction, and the pothead unions.

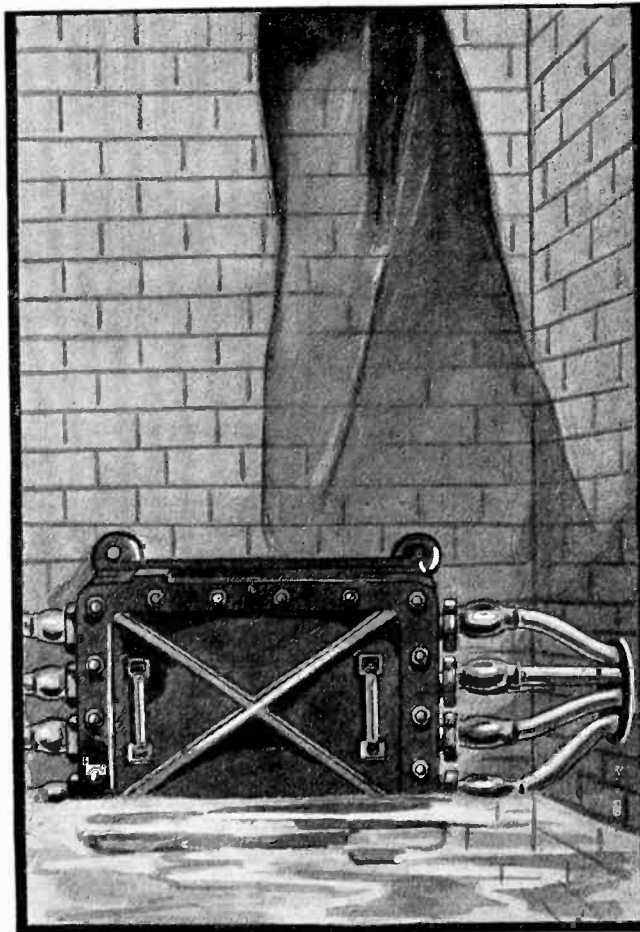

Once installed, NOARK UNDERGROUND BOXES afford the most permanent and dependable installation yet devised—an installation that will stand indefinitely and at a minimum of operating and maintenance expense.

**NOARK ENGINEERING SERVICE**

is always at your command. Whether you want assistance in analyzing your problems, planning your layouts or quotations on a certain definite bill of equipment, you can depend upon us to work with you and to give you the benefit of our years of specialized experience along this particular line.

A comprehensive description of your requirements or a set of layout sketches with electrical data are all we need to go to work on your problem.

**COLT'S PATENT FIRE ARMS MFG. CO.**

*Electrical Division*

**HARTFORD, CONN. U. S. A.**

NEW YORK ~ BOSTON ~ CHICAGO ~ SAN FRANCISCO



33-U-99

Please mention the JOURNAL of the A. I. E. E. when writing to advertisers.

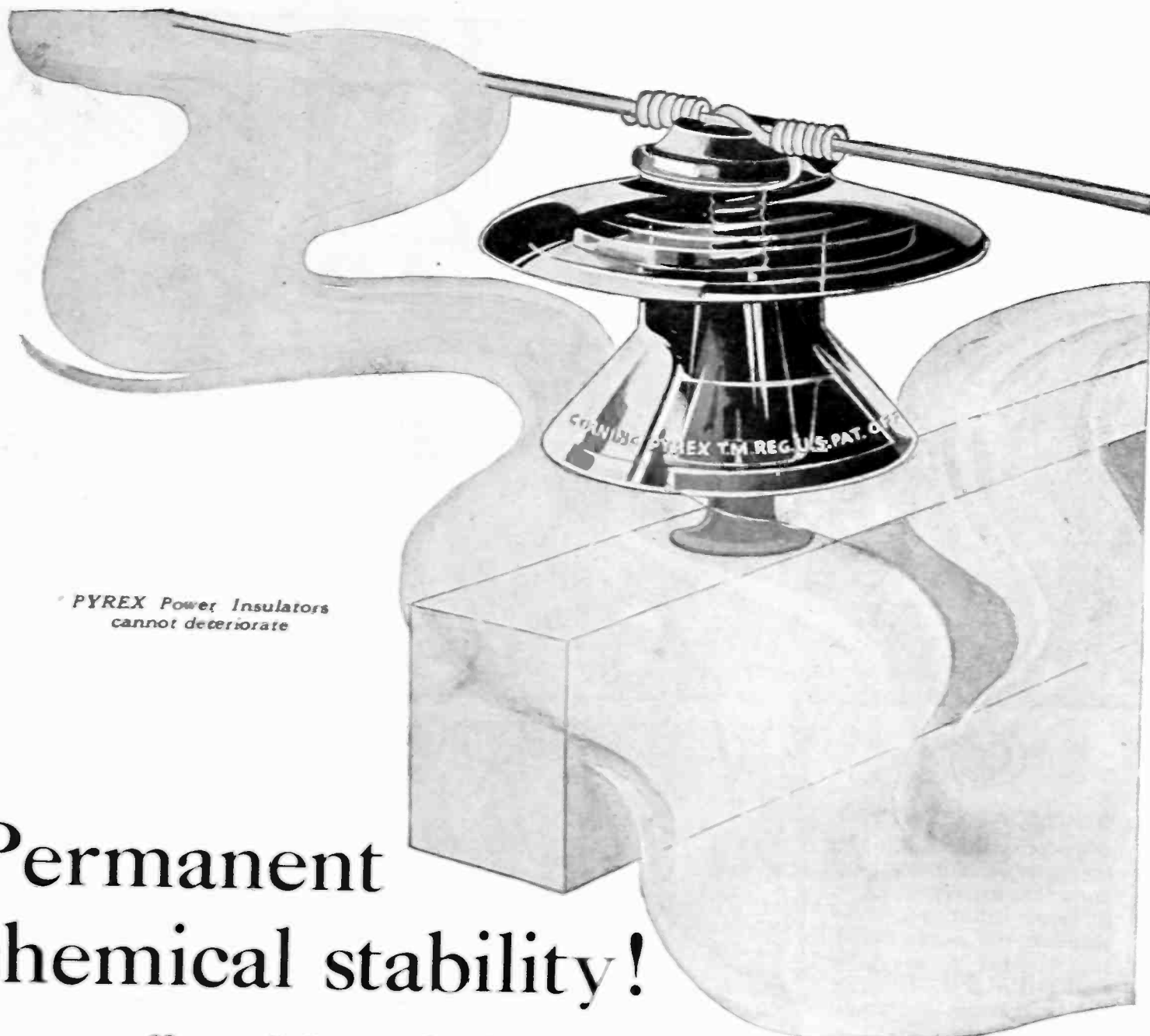

\*PYREX Power Insulators  
cannot deteriorate

# Permanent chemical stability!

*unaffected by salt fogs, industrial fumes*

ONE of the most enduring substances ever made by man is glass. But \*PYREX Power Insulators are super-glasses — sturdy, non-porous, *permanently insulating*. Exposure to hot sun, cold rain, industrial fumes and salt fogs, brings no deterioration. Write for catalog. Dept. R. Corning Glass Works, Corning, N.Y.

*See our exhibit at the Eleventh Exposition of Chemical Industries,  
Grand Central Palace, New York, Sept. 26th to Oct. 1st, 1927*

# PYREX

T. M. REG. U. S. PAT. OFF.

## POWER INSULATORS

\*Trade-mark Reg. U. S. Pat. Off.

Please mention the JOURNAL of the A. I. E. E. when writing to advertisers.

### *Sales Offices*

369 Lexington Ave.,  
New York, N. Y.

97 Milk Street,  
Boston, Mass.

Candler Building,  
Atlanta, Ga.

Polson Building,  
Seattle, Wash.

211 I. W. Hellman Building,  
Los Angeles, Calif.





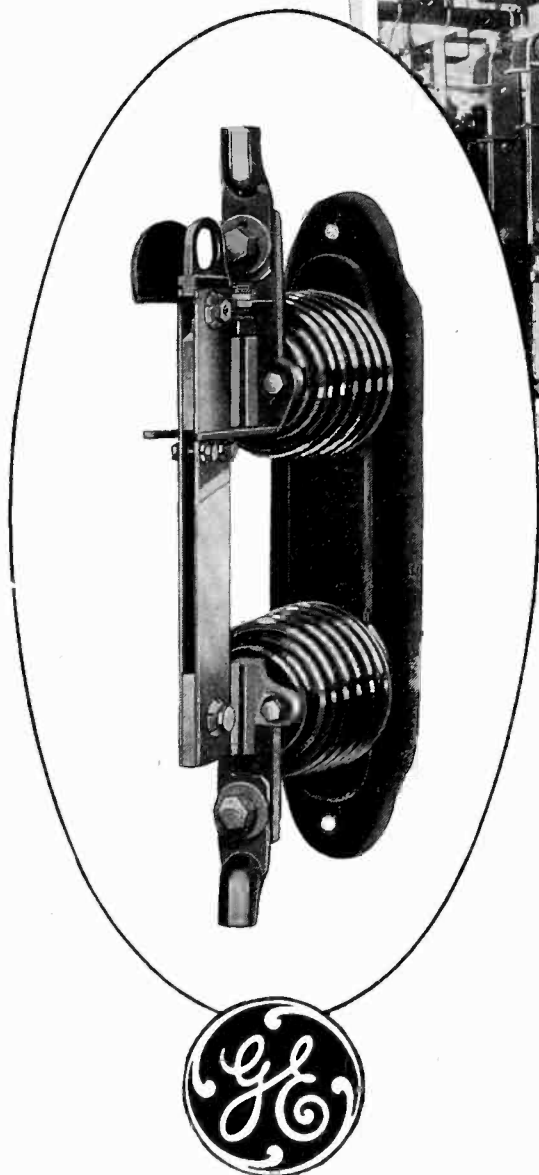
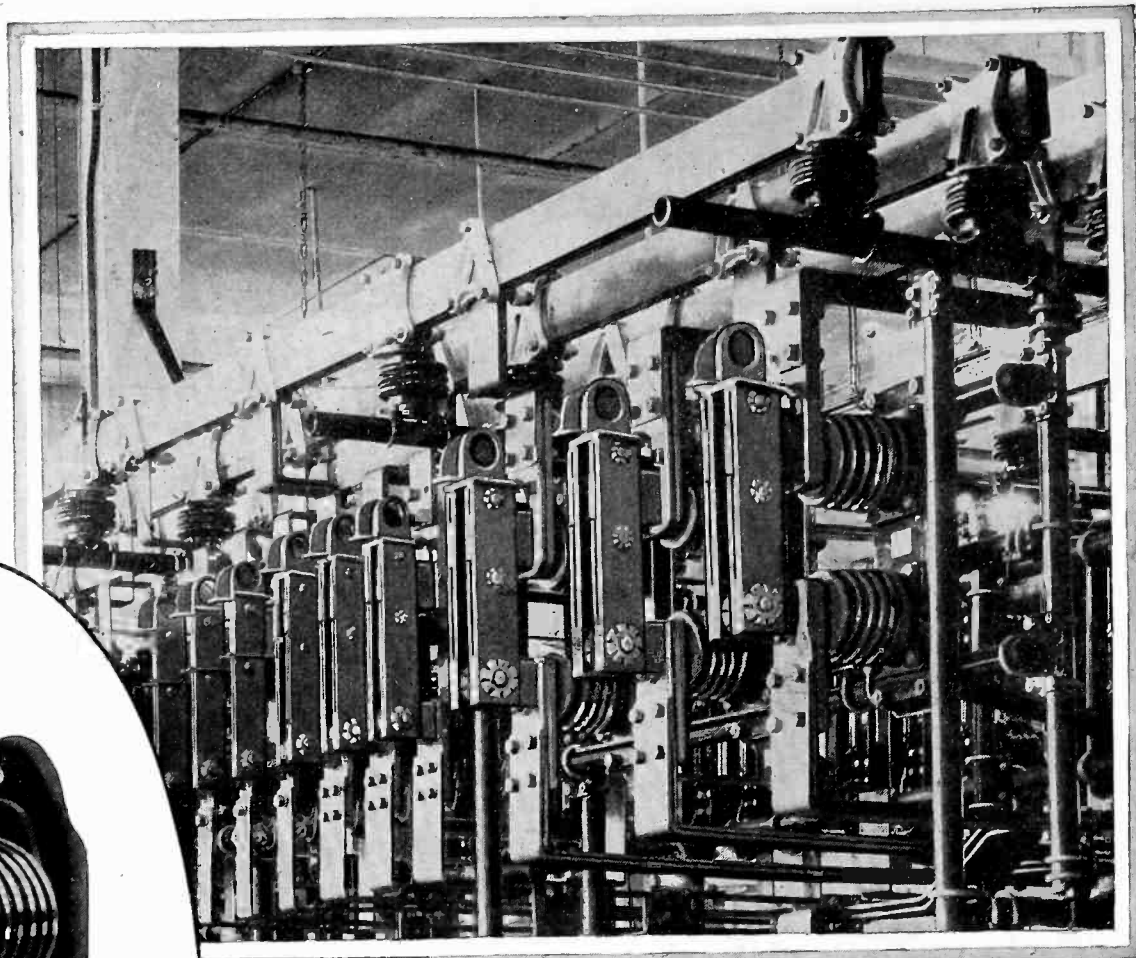

Indoor Disconnecting Switches

—part of the complete line of General Electric Equipment to control and protect power generating and distributing apparatus

## Type LG-17 Indoor Disconnecting Switch

### Features—

Heavy and uniform contact pressure—the switch blades are adjustable.

Positive latching assured when the switch is closed.

A single downward pull unlatches the blades and opens the switch.

Easy to open—lever in the blade overcomes the high static friction of the heavy-pressure contact.

# GENERAL ELECTRIC

500-4

GENERAL ELECTRIC COMPANY, SCHENECTADY, N. Y., SALES OFFICES IN PRINCIPAL CITIES

Please mention the JOURNAL of the A. I. E. E. when writing to advertisers.

# Hazard

## Spiralweave Mine Shaft Signal Cables

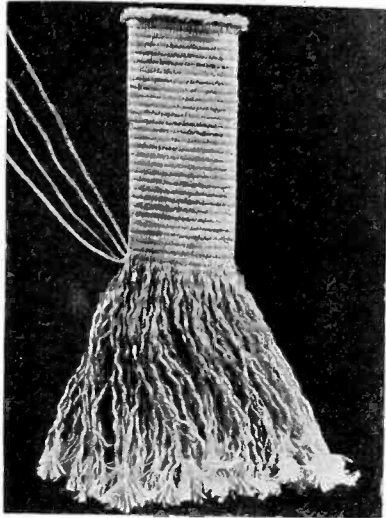
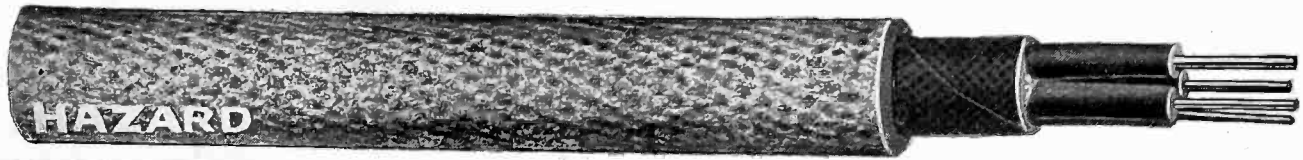

Hazard Spiralweave covering before treating with weatherproof compound.

The durable qualities of Spiralweave and its great strength make Spiralweave Mine Shaft Signal Cables especially desirable. The longitudinal strength of the covering permits of vertical suspension, directly supporting the cable without the use of steel armor wires or other metallic covering.

Spiralweave is a heavy, tightly woven, thoroughly waterproofed protective covering.

Comparatively light in weight, yet strong and durable.

### HAZARD MANUFACTURING COMPANY

Wilkes-Barre, Pa.

New York  
Denver

Pittsburgh  
Birmingham

Chicago  
Philadelphia

*Hazard Cables Reduce Mining Costs*

## STEEL

# TOWERS

*and component parts*

FOR ELECTRIC TRANSMISSION

## AMERICAN BRIDGE COMPANY

71 Broadway, New York City

TOWER DEPARTMENT

Frick Building, Pittsburgh, Pa.

*Offices in Principal Cities*

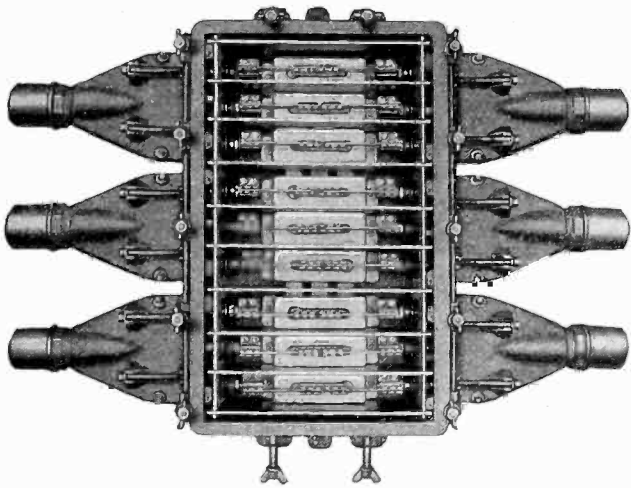

TYPE EM 6-WAY JUNCTION BOX

### Think of STANDARD

when planning your underground electric distribution system. STANDARD Junction Boxes embody in their design the specialized experience of over 45 years in the manufacture and installation of underground cable systems. Their exclusive and patented features insure to your cable system the greatest degree of protection and facilitate its installation and operation.

#### STANDARD Type EM Boxes

represent a new design in which economy and convenience have been given special consideration in addition to the usual protective features. For instance the nipples are easily detachable to permit jointing to cables away from the box. The nipple is then brought to the box and connected.

This is but one of an extensive line of junction boxes designed to meet a large variety of operating conditions. Whatever your operating problem there is a STANDARD Box suited to your requirements. *Write our nearest sales office about your installation problems.*

### Standard Underground Cable Co.

General Offices: Pittsburgh, Pa.

BOSTON  
NEW YORK

PHILADELPHIA  
WASHINGTON

ATLANTA  
CHICAGO

DETROIT  
ST. LOUIS

KANSAS CITY  
SEATTLE

LOS ANGELES  
SEATTLE

*We manufacture Electric Wires and Cables of all kinds and for all purposes, also Cable Accessories.*

# Why let good engineering stop at the POLE TOP

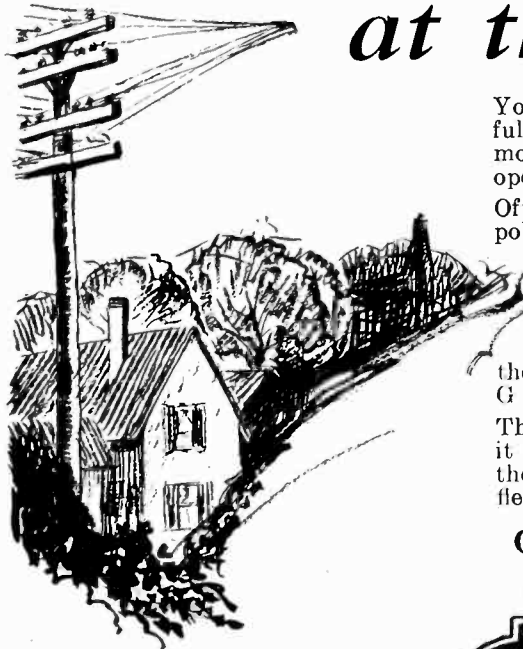

Your substations, the pole lines—all carefully designed with full advantage taken of modern equipment to give you greatest operating efficiency at least cost.

Oftimes good engineering fails to include the space at the pole top. Full advantage is not taken of the space at the pole top. Here is great opportunity not only for economy in arrangement but also for economy and speed in service restoration. All this is possible by simply taking advantage of the convenience and time saving features of G & W Disconnecting Potheads.

They are made in shapes and sizes so that it is possible with proper engineering to get the maximum in simplicity, protection, flexibility, and economy.

**G & W Electric Specialty Co.**

7780 Dante Ave., Chicago, Ill.



**Exactly What You Want!**

G & W design and manufacture practically every device for the end of a cable. See Catalog No. 26.

Potheads	Underground Boxes
Series Outouts	Conduit Bells
Primary Outouts	Ground Pipe Caps
Oil Fuse Outouts	Ground Pipe Points
Vault Unit	Oil Disconnect
G & W AUTOMATIC MASTER CONTROL	

# More than Protection **G & W** for the Cable Ends **POTHEADS AND BOXES**

Please mention the JOURNAL of the A. I. E. E. when writing to advertisers.

"It costs less to prevent Rust than to endure it."

## "COPPERWELD"

Does Not Rust

Its strength, mechanical stability and permanence make it

### The Ideal Overhead Ground Wire

Because the excellent qualities of both steel and copper are combined in Copperweld.

**Copperweld Steel Company**

MAIN OFFICE & MILLS: BRADDOCK P. O., RANKIN, PA.  
30 CHURCH ST., NEW YORK. 129 S. JEFFERSON ST., CHICAGO.  
403 RIALTO BLDG., SAN FRANCISCO.

In Canada: Northern Electric Co., Ltd.

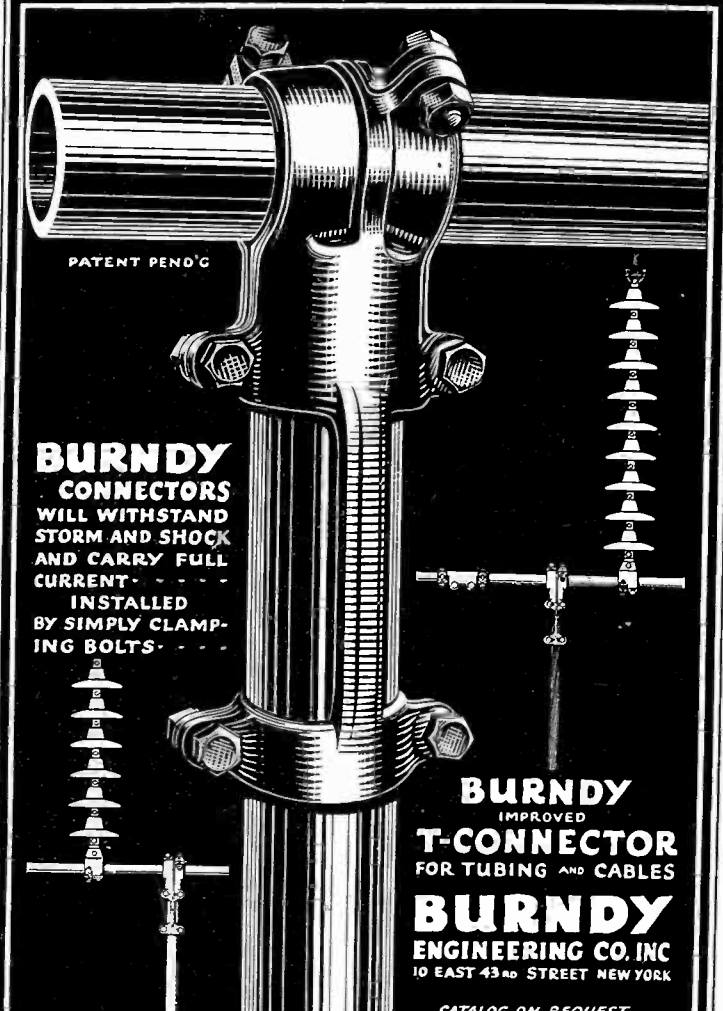

PATENT PEND'G

**BURNDY CONNECTORS**  
WILL WITHSTAND  
STORM AND SHOCK  
AND CARRY FULL  
CURRENT  
INSTALLED  
BY SIMPLY CLAMP-  
ING BOLTS

**BURNDY**  
IMPROVED  
**T-CONNECTOR**  
FOR TUBING AND CABLES  
**BURNDY**  
ENGINEERING CO. INC  
10 EAST 43rd STREET NEW YORK

CATALOG ON REQUEST

# Roebbling

Electrical Wires and Cables. High in Conductivity and Reliability.

John A. Roebbling's Sons Co.  
Trenton, New Jersey



## WIRE PRODUCTS For Varied Applications

We manufacture many types of wires, cords and cables for specific uses. Among them are:

Rubber Covered Wire—Solid Conductor, Stranded Conductor, Flexible Conductor, Extra Flexible Conductor. Lamp Cords, Reinforced Cords, Heater Cord, Brewery Cord, Canvasite Cord, Packinghouse Cord, Deck Cable, Stage Cable, Border Light Cable, Flexible Armored Cable, Elevator Lighting Cable, Elevator Operating Cable, Elevator Annunciator Cable. Switchboard Cables, Telephone Wire, Flameproof Wires and Cables, Railway Signal Wires, High Voltage Wires and Cables. Automobile Ignition Cables, Automobile Lighting Cables, Automobile Starting Cables, Automobile Charging Cables. Moving Picture Machine Cable.

**Boston Insulated Wire & Cable Co.**

Main Office and Factory:  
Dorchester District Boston, Mass.  
Canadian Branch, Office and Factory, Hamilton, Ont.

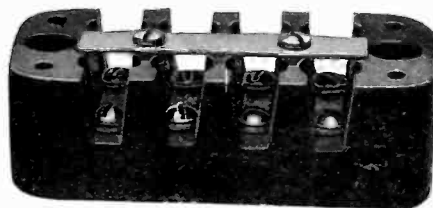

**CONTROLEAD TERMINAL BLOCKS  
WITH INTERCHANGEABLE SWITCH PARTS**

*Sample and Bulletin furnished on request*

**BURKE ELECTRIC CO., ERIE, PA.**

Please mention the JOURNAL of the A. I. E. E. when writing to advertisers.

# FIBREX TREE WIRE

Where trees must not be trimmed



A typical Fibrex installation in New England

Where hazards are greatest - places where trees must not be trimmed and where wires are rubbed and chafed by swaying limbs - splice in a piece of Fibrex Tree Wire.

Central Stations find that Fibrex creates good will by eliminating the short circuits and swinging grounds that interfere with the maintenance of steady voltage.

Short pieces of Fibrex spliced into the line will afford ample protection where overhead lines must run through trees.

Fibrex consists of a rubber insulated copper conductor protected by successive layers of tape, tarred jute, non-metallic Fibrex armor and a wear-resisting weatherproof braid.

An immediate check-up along the line and the early installation of Fibrex at danger points will save the repair gang many annoying and expensive emergency calls.

## SIMPLEX WIRE & CABLE CO

MANUFACTURERS

201 DEVONSHIRE ST., BOSTON

CHICAGO      SAN FRANCISCO      NEW YORK  
CLEVELAND      JACKSONVILLE



Holabird & Roche, Chicago, Architects  
Thompson-Starrett Co., New York, General Contractors  
L. K. Comstock & Co., Chicago, Electrical Contractors

### The NEW PALMER HOUSE. Chicago

Wired with

## American Steel & Wire Company's

### Rubber-Covered Wire

WE take distinct pride in the selection of our product for this building. It not only further proves the many superiorities of the wire, but is an excellent example of the standing of American Steel & Wire Company electrical wire with leading architects and contractors.

When wire specifications are most exacting for buildings of any size, large or small, American Steel & Wire Company wire may be specified and used with perfect confidence in its long satisfactory service. . . . Let us send you an indexed catalog and handbook of Electrical Wires and Cables. Estimates furnished promptly from any of our offices in all the principal cities.

#### SALES OFFICES

CHICAGO	208 So. La Salle Street	NEW YORK	80 Church Street
CLEVELAND	Rockefeller Building	BOSTON	185 Franklin Street
DETROIT	Foot of First Street	PITTSBURGH	Prick Building
CINCINNATI	Union Trust Building	PHILADELPHIA	Widener Building
MINNEAPOLIS--ST. PAUL	Merchants Nat'l Bank Bldg., St. Paul	ATLANTA	101 Marietta Street
ST. LOUIS	508 Olive Street	WORCESTER	94 Grove Street
KANSAS CITY	417 Grand Avenue	BALTIMORE	32 So. Charles St.
OKLAHOMA CITY	First Nat'l Bank Bldg.	BUFFALO	970 Elliott Street
BIRMINGHAM	Brown-Marx Bldg.	WILKES BARRE	Minera Bank Bldg.
MEMPHIS	Union and Planters Bank Bldg.	*SAN FRANCISCO	Rialto Bldg.
DALLAS	Practorian Building	*LOS ANGELES	2087 E. Stinson Ave.
DENVER	First National Bank Bldg.	*PORTLAND	6th and Alder Sts.
SALT LAKE CITY	Walker Bank Bldg.	*SEATTLE	4th Ave. So., & Conn. St.
		*United States Steel Products Company	

# Moloney Transformers

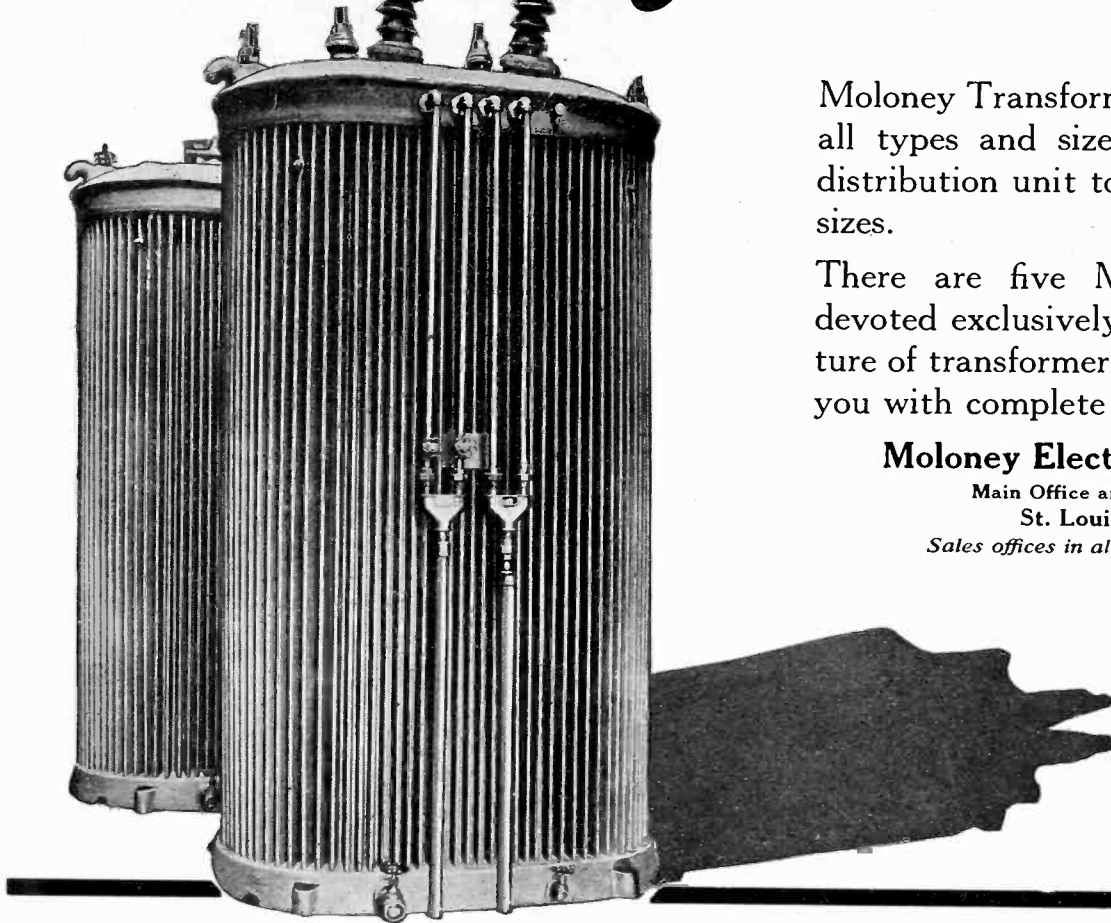

Moloney Transformers can be had in all types and sizes from the small distribution unit to the larger power sizes.

There are five Moloney factories devoted exclusively to the manufacture of transformers. Let us furnish you with complete details.

## Moloney Electric Company

Main Office and Factories  
St. Louis, Mo.

*Sales offices in all principal cities*

## Pittsburgh Transformer Company

Largest Manufacturers of Transformers exclusively  
in the United States

Pittsburgh, Pennsylvania

**Yes! JEFFERSON**  
builds Special Transformers  
to order for Engineers and  
Experimenters

We are equipped to design or make transformers to your specifications. Submit your problem, without obligation.

**Jefferson Electric Mfg. Co.**

546 SO GREEN ST CHICAGO, ILL. U.S.A.

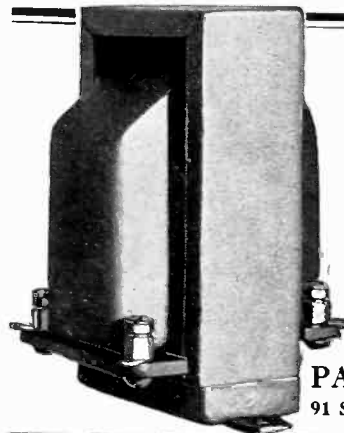

**RUGGEDLY** built high grade audio transformers designed to meet the requirements of flat curve distortionless amplification over the entire musical scale, and to carry high plate potentials used in modern power amplifying circuits.

*Write for curve charts  
and technical data.*

**PACENT ELECTRIC CO., INC.**  
91 SEVENTH AVENUE, NEW YORK CITY

## PACENT Transformers

Please mention the JOURNAL of the A. I. E. E. when writing to advertisers.

# SHARPLES Simplicity

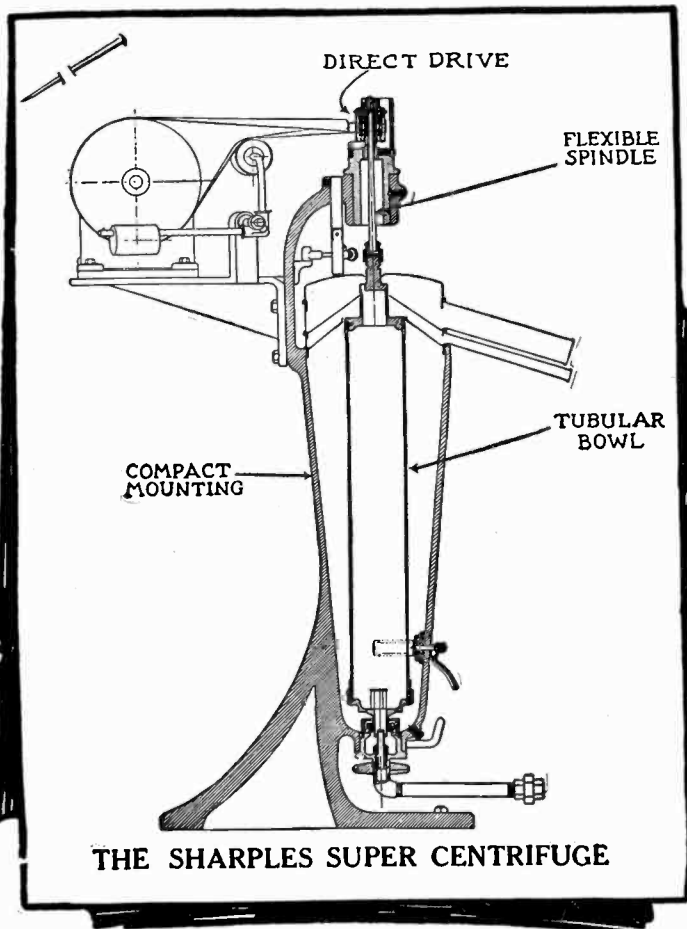

## Mechanical Perfection of the Sharples

- 1** TUBULAR BOWL: Develops several times the centrifugal force of short, "squat" bowls.
- 2** FLEXIBLE SPINDLE: Suspends bowl from ball bearing, permitting free rotation around true center of gravity.
- 3** DIRECT DRIVE: Bowl is driven from the top by motor, belt, steam or compressed air. No driving mechanism below to be contaminated by drips. No gears to wear out or to be misaligned.
- 4** COMPACT MOUNTING: Whole assembly is mounted on strong, rigid frame. Installation requires less than 3-foot square space.
- 5** EASY OPERATION: Can be started, stopped, cleaned and re-assembled in 15 minutes or less.

Sharples mechanical and operating "Simplicity" offers the most complete and economical purification possible for Lubricating and Fuel Oils, and for Transformer and Switch Oils.

Complete bulletins on Sharples low-cost centrifugal clarification will be forwarded without cost or obligation. Sharples Engineers will be glad to point out how the Sharples Super Centrifuge can save you time, labor and repair costs.

THE SHARPLES SPECIALTY COMPANY, 2324 WEST-MORELAND STREET, PHILADELPHIA. Boston, New York, Pittsburgh, Chicago, Detroit, Tulsa, New Orleans, San Francisco, Los Angeles, Seattle, Toronto, London, Paris, Tokio.

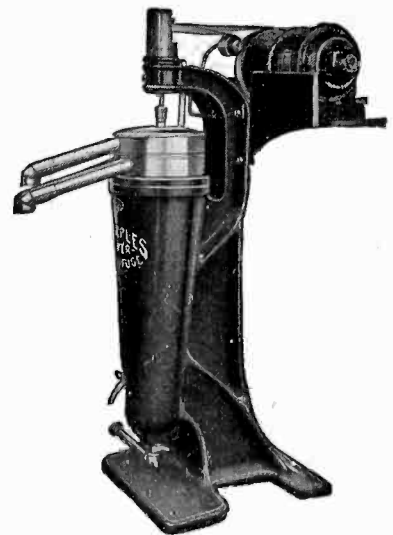

# SHARPLES

A GREAT FORCE

Please mention the JOURNAL of the A. I. E. E. when writing to advertisers.



**Lapp Insulators  
do not fail!**

**LAPP INSULATOR CO., Inc.**  
LE ROY, N. Y.

*Sales Representatives*

BIRMINGHAM, ALA., Industrial Supply Co., 239 Brown-Marx Bldg.  
 BOSTON, Van Rosen Co., Statler Building  
 CHARLOTTE, N. C., J. W. Fraser & Co., Commercial Bank Bldg.  
 CHICAGO, Transelectric Co., Inc., 140 So. Dearborn St.  
 COLUMBUS, O., Engineering Merchandising Syndicate, 600 Joyce Realty Bldg.  
 DALLAS, TEX., J. K. Webb, 1521 Commerce St.  
 DENVER, The O. H. Davidson Equip. Co., 130 W. 14th Ave.  
 INDIANAPOLIS, W. D. Hamer Co., 518 Trac. Terminal Bldg.  
 KANSAS CITY, MO., Power Machinery Co., 301 Dwight Bldg.  
 LOS ANGELES, S. Herbert Lanyon, 210 Transportation Bldg.  
 MINNEAPOLIS, J. E. Sumpter Co., 515 Security Bldg.  
 NEW YORK CITY, Shield Electric Co., 149 Broadway.  
 PHILADELPHIA, Harris & Butler, Real Estate Trust Bldg.  
 PITTSBURGH, Henry N. Muller Co., 2204 First National Bank Bldg.  
 SAN ANTONIO, TEX., L. G. Bassett, 723 Navarro St.  
 SAN FRANCISCO, S. Herbert Lanyon, 609 New Call Bldg.  
 SYDNEY, AUSTRALIA, Chas. M. Terry.  
 WELLINGTON, NEW ZEALAND, A. C. Thomas.

# KEARNEY

MANUFACTURERS OF

Preheated Certified Malleable Iron Screw Type Anchors  
 Outdoor Type Fuse Switches, Disconnecting Switches,  
 Choke Coils, and Combinations, 7500 and 15000 volts  
 Aluminum, Copper, and Galvanized Iron Guy Wire Clips  
 Extension Sleeve Twisters with Interchangeable Dies  
 Solderless Service Connectors  
 Expulsion Porcelain Plug Cutouts  
 Tap Off Clamps

Write for Catalog

**JAMES R. KEARNEY CORPORATION**  
 4220 Clayton Avenue ST. LOUIS, MO

**Thomas Quality**  
 PORCELAIN INSULATORS  
 LINE HARDWARE  
 WIRING PORCELAINS  
 and  
 Porcelain Specialties  
*An American Standard since '73*

**THE R. THOMAS & SONS CO.**  
 New York Boston East Liverpool, Ohio Chicago London

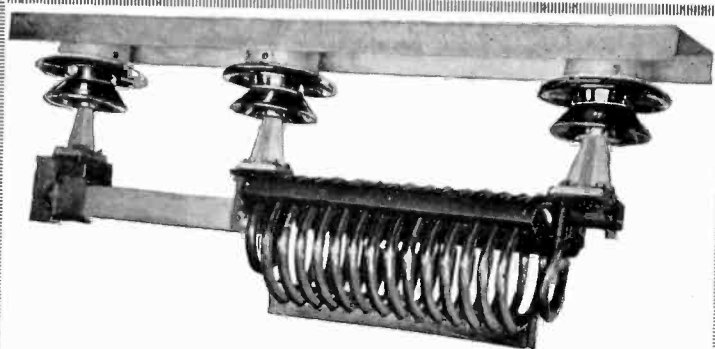

The New  
**THONER & MARTENS**

*underslung outdoor  
 disconnecting switch*

THE standard T & M underslung outdoor disconnecting switch, 800 amp., is now equipped with choke coil.

Working pressure is 22,000 volts, dry flush is over 88,000 volts and wet flush over 55,000 volts.

Other T & M features are the Bolt type lock and new sleet cover.

Write for further details

**THONER & MARTENS**  
 463 Commercial St., Boston, Mass., U. S. A.

MANUFACTURERS OF INSULATORS

For 2,200 to 220,000 Volts  
**HIGH VOLTAGE PORCELAIN**

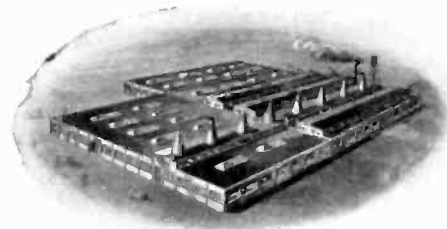

Catalog  
 on request

**CANADIAN PORCELAIN COMPANY**  
 Limited

HAMILTON — ONTARIO — CANADA  
 Cable Address "PORCELAIN," Hamilton, Ontario

**HEMINGRAY**  
**GLASS**  
**INSULATORS**

The transparency of Hemingray Glass Insulators makes line inspection very simple. The lineman can tell at a glance whether the insulator is intact or not. Hemingray insulators are mechanically and dielectrically dependable, non-porous and uniform in structure. They defy moisture and age.

Send for Bulletin No. 1.  
**HEMINGRAY GLASS COMPANY**  
 Muncie, Indiana



## K-P-F POLE-TOP SWITCHES

Reduce Your Installation and Maintenance Costs

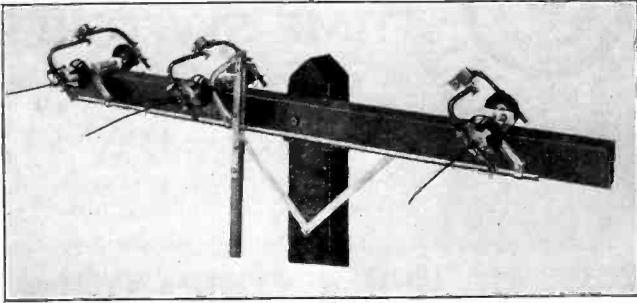

K-P-F type L-115—4500-V. Bolts to the cross-arm. Line wires can be dead-ended directly to it.

### FOR SECTIONALIZING AND DISTRIBUTING SERVICE

Manufactured For Any Voltage

K-P-F SWITCHES have established their reputation for dependability, efficiency and economy through a period of many years of actual service under varying conditions.

Extra deadends not required. Switch bolts to a single cross-arm. Shipped completely assembled—ready to install.

*Bulletin #106 covers this equipment in detail*

**K-P-F ELECTRIC CO.**

855-859 Howard St.

San Francisco, Cal.

## There can be no compromise—

Executives concerned with important applications of electrostatic condensers are content only with capacitors of proven dependability.

There are several hundred distinct Faradon units in regular production on which data is available upon mention of the required application. Faradon engineers are always ready to assist in effecting a solution of any special capacitor problem.

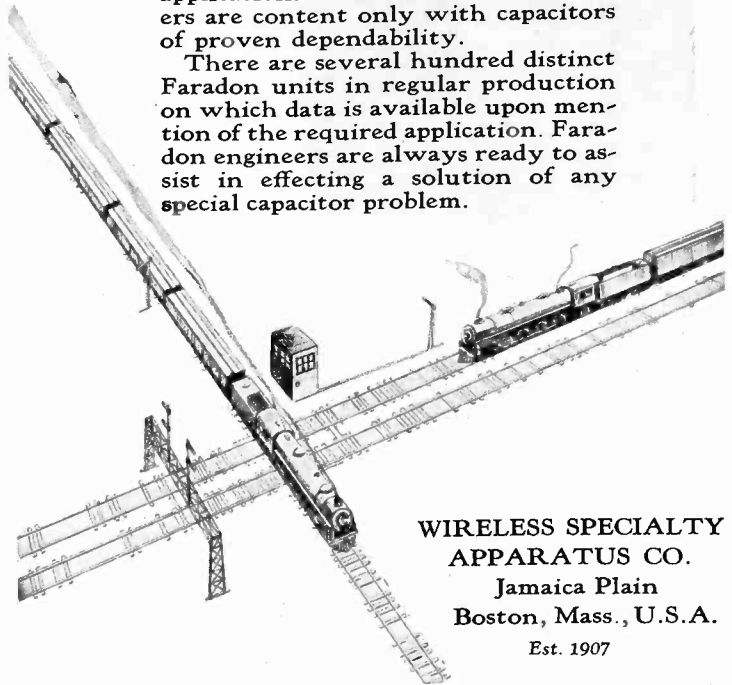

**WIRELESS SPECIALTY APPARATUS CO.**

Jamaica Plain

Boston, Mass., U.S.A.

Est. 1907

# Faradon

1136

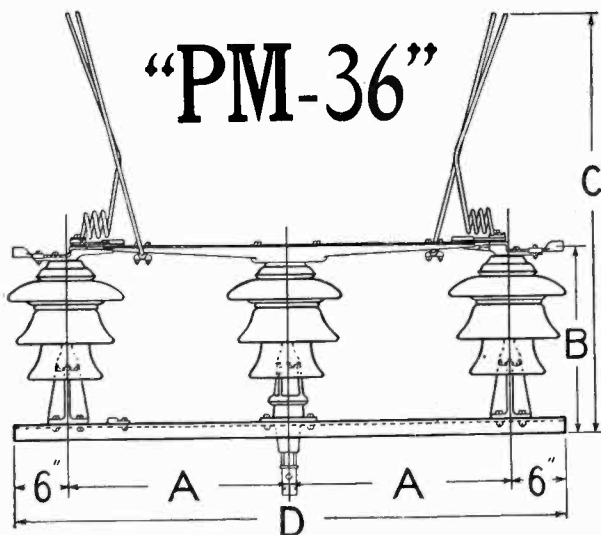

Construction of 50 k. v. and 73 k. v. Switches

## THE STANDARD OF YEARS

Hard service, storms, intense competition have beat about it—but today it remains the real standard.

(Write for our monthly publication)

**Delta-Star Electric Co**

2400 Block, Fulton St.

Chicago, Illinois

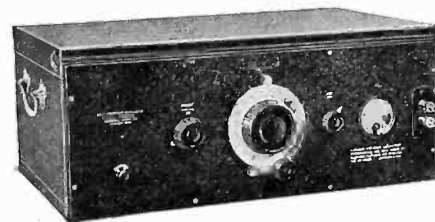

## Beat Frequency Oscillator

Range 15-9,000 cycles

In the testing of audio frequency devices some form of oscillator is required. Speed in measurement requires that the frequency be varied by means of a single control.

In the type 413 oscillator the single control feature is made possible by use of the beat frequency between two high frequency oscillators.

The type 413 oscillator is particularly adaptable to loudspeaker measurements.

Type 413 Oscillator . . . Price \$210.00

**GENERAL RADIO COMPANY**

Thirty State Street

CAMBRIDGE, MASSACHUSETTS

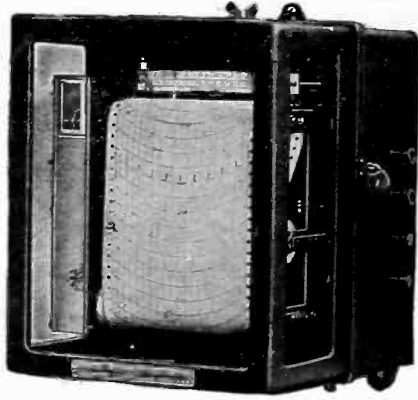

Bristol's Recording  
Wattmeter Strip Chart  
type; for single, two or  
three phase current.

## RECORDS

*in Kilowatt Hours*

made by Bristol's Recording Wattmeters provide a continuous check on feeder lines: showing how heavily they are loaded, together with the time and extent of load changes which occur during the day's run.

The Electrical Engineer who desires SERVICE in an instrument may well consider the enthusiastic approval accorded the "Bristol's" in thousands of installations. A simple, rugged design insures continued accuracy and freedom from trouble.

Write us for further information.

The Bristol Company Waterbury, Connecticut  
FOR 36 YEARS Technical Engineer MAKERS OF  
BRISTOL'S RECORDING INSTRUMENTS

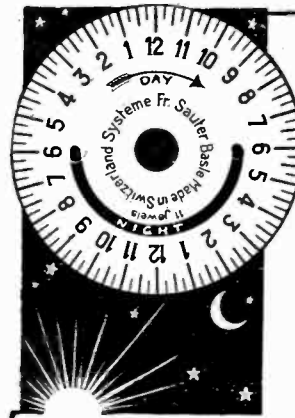

## SAUTER Electric TIME SWITCHES

These "astronomic" time switches are carried in stock for circuits of  
250 Volts: 10, 25, 40, 60, 100, 200,  
300 Amps.  
4600 Volts: 25 and 50 Amps.  
8000 Volts: 25 and 50 Amps.

Ask for new catalog S-1.

R. W. CRAMER & COMPANY, Inc.  
136 Liberty St. New York City

## DUNCAN Watt-hour Meters

Accurate

and

Dependable



Model M2.

Write for bulletins

DUNCAN ELECTRIC MFG. CO.  
Lafayette, Ind.

# RECOMMENDED PRACTISE FOR Electrical Installations on Shipboard

(MARINE RULES)

SECTION No. 45, A. I. E. E. STANDARDS

A new edition of "Recommended Practise for Electrical Installations on Shipboard" (Marine Rules) is now available. This pamphlet of eighty-four pages is published as Section 45 of the A. I. E. E. Standards at a cost of \$1.50 (50% discount to members of the A. I. E. E.)

These rules have been drawn up to serve as a guide for the equipment of merchant ships with electrical apparatus for lighting, signaling, communication, power and propulsion. They indicate what is considered good engineering practise with reference to safety of the personnel and of the ship itself, as well as reliability and durability of the electrical apparatus.

American Institute of Electrical Engineers

33 West Thirty-ninth Street, New York

# Reliance— on Springs

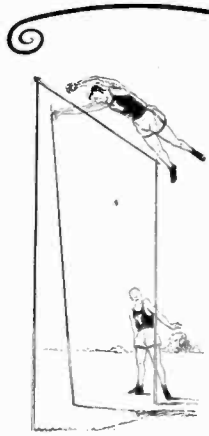
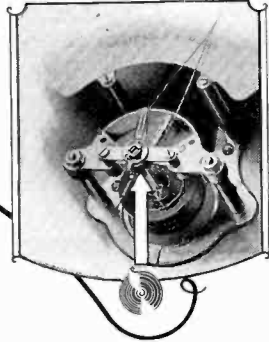

THE EXACT SPOT

UP—over the bar and safely down—to a new record. How important is this factor of the spring in establishing still greater heights in the field of Electrical Measuring Achievement!

Consider that the reading of an instrument is not always the *final value* sought.

When this measurement is used as the COEFFICIENT in arriving at PROFIT and LOSS statements,—machine operation over a year's time, for example,—it will be easier to visualize the importance of the *accuracy factor*. Also why Westons have been the universal choice for so many years.

The refinement of the spring on the Movable Coil of a Weston D. C. Instrument is only one of the many developments during the past forty years which define Weston leadership.

### Weston Model 45 Portable D. C. Instrument

This is one of the most popular and widely-known "electrical inspectors" in industry. No plant should be without it, and few are. Made as Voltmeters, Millivoltmeters, Ammeters and Milli-ammeters in a comprehensive list of ranges to meet various industrial requirements.



## WESTON ELECTRICAL INSTRUMENT CORPORATION

48 Weston Avenue

Newark, N. J.



STANDARD THE WORLD OVER  
**WESTON**  
Pioneers since 1888



Type RA-1

## For fire alarm systems *the standard charger is the Balkite RA*

Here is a charger specially designed for fire alarm service. Introduced less than a year ago, it has already been adopted as standard by several of the leading organizations operating fire alarm systems. These are some of the reasons for this immediate acceptance:

1. It operates on the unfailing Balkite principle of electrolytic rectification.
2. It is shipped complete ready to install.
3. It operates on any 115 volt AC supply of 25 to 100 cycles.
4. It charges from 1 to 6 cell (2 to 12 volt) storage batteries at rates up to  $\frac{3}{4}$  ampere.
5. Its charging rate is readily adjustable.
6. It requires no other attention than the infrequent addition of water.
7. It requires no replacements.

Write for descriptive bulletin.

FANSTEEL PRODUCTS COMPANY, Inc., North Chicago, Ill.

# FANSTEEL Balkite Battery Chargers

FANSTEEL PRODUCTS COMPANY, Inc., North Chicago, Illinois  
Gentlemen: Please send me your bulletin TC-8 which describes the new Balkite Chargers.

Name \_\_\_\_\_

Company \_\_\_\_\_

Address \_\_\_\_\_

Position \_\_\_\_\_

A. I. E. E. - 4-27

# I-N BOARD West Virginia Fibre Board

*For Electrical Insulation*

**Tested and approved by the Underwriters' Laboratories.**

**High tensile and dielectric strength. Used successfully by many of the large electrical manufacturers.**

**A decided factor for economy.**

*Pulp Products Department*

**West Virginia  
Pulp & Paper Company**

200 Fifth Avenue, New York, N. Y.  
505 Dime Bank Bldg. Detroit, Mich. 732 Sherman Street Chicago, Ill.  
503 Market Street, San Francisco, Cal.

Prominent manufacturer is desirous of obtaining new electrical devices for manufacturing and marketing. Compensation for accepted items will be paid on a royalty basis or outright purchase arrangement if desired. Submit full particulars in strictest confidence to Box 126, JOURNAL of A. I. E. E., 33 West 39th St., New York.

## TRUMBULL

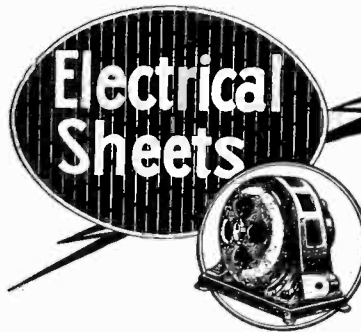

for years have stood the most exacting tests of scores of the largest motor, dynamo, generator, and radio builders in the United States. Our Engineering Department is at your service. Write us concerning your requirements.

**THE TRUMBULL STEEL COMPANY**  
WARREN Mills, Laboratories and General Offices OHIO

## "IRVINGTON" PRODUCTS

Black and Yellow

Varnished Cambric Varnished Paper  
Varnished Silk  
Flexible Varnished Tubing  
Insulating Varnishes and Compounds  
"Cellulak" Tubes and Sheets

**IRVINGTON VARNISH & INSULATOR Co.**  
Irvington, New Jersey.

*Sales Representatives*

Mitchell-Rand Mfg. Co., New York  
E. M. Wolcott, Rochester  
I. W. Levine, Montreal  
A. L. Gillies, Toronto  
Consumer's Rubber Co., Cleveland  
Martin Woodard, Seattle  
Prenler Brothers, Inc., Chicago  
White Supply Co., St. Louis  
Clapp & La Moree, Los Angeles

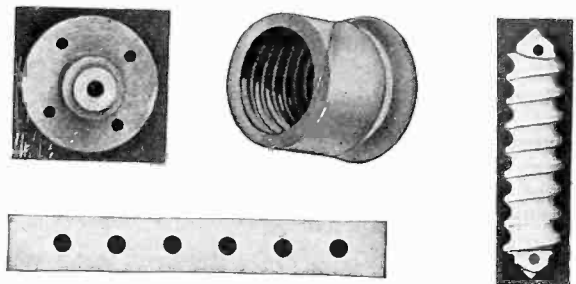

# LAVA INSULATORS

Lava Insulators are unexcelled in instruments requiring a fixed relation of their parts under all conditions.

Permanent in nature, lava is not subject to variations in structure and composition.

**AMERICAN LAVA CORPORATION**  
27-67 Williamson St.,  
Chattanooga Tennessee  
*Manufacturers of Heat Resistant Insulators*

**NATIONAL  
VULCANIZED  
FIBRE**

**SHEETS  
RODS  
TUBES  
SHAPES**

*Graded to  
your requirements*

*Paper base  
Canvas base*

**PHENOLITE**  
Laminated BAKELITE

**SHEETS  
RODS  
TUBES  
SHAPES**

**PEERLESS  
INSULATION**

**NATIONAL VULCANIZED FIBRE CO.**  
WILMINGTON DEL., U. S. A.  
*Offices in principal cities*

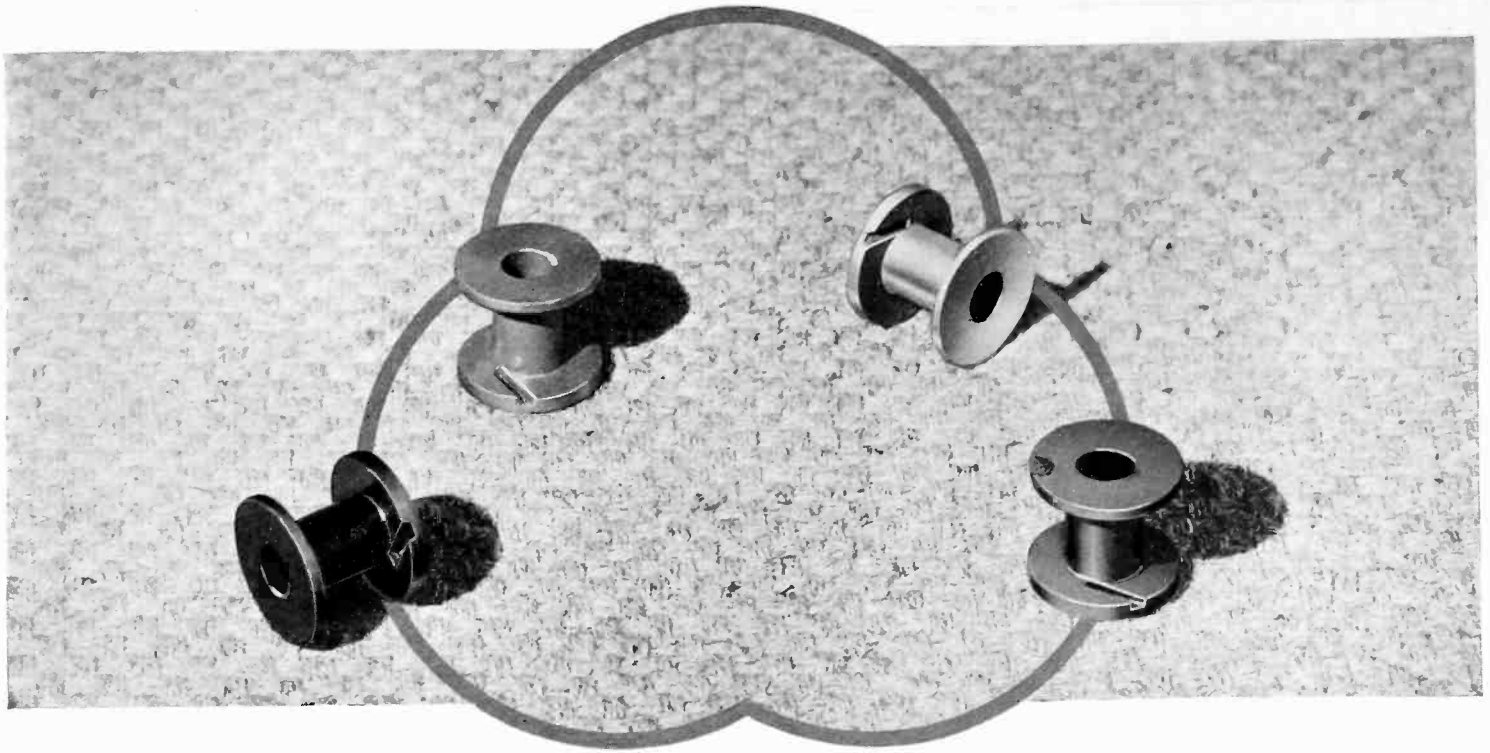

Magnet Spools of colored Bakelite Molded.

## Bakelite Molded Spools in various colors to indicate different ratings

**E**ACH of the magnet spools pictured above is formed of a different color of Bakelite Molded, each color indicating a specific circuit rating, so there is small chance of error in selecting the one required.

The fact that Bakelite Molded is a material of high insulation value, which may be obtained in a variety of colors, has been taken advantage of by a number of elec-

trical manufacturers, as color indexing prevents mistakes.

You, too, may be making some insulation parts that could be advantageously formed of colored Bakelite Molded. Our engineers

and research laboratories would be glad to cooperate with you in determining its possibilities for your particular work. Write for Booklet No. 3, "Bakelite Molded."

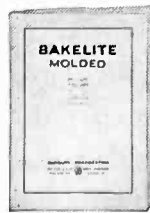

### BAKELITE CORPORATION

247 Park Ave., New York, N. Y., Chicago Office: 635 West 22nd St.

BAKELITE CORPORATION OF CANADA, LTD., 163 Dufferin St., Toronto, Ontario, Can.

# BAKELITE

REGISTERED U. S. PAT. OFF.



THE MATERIAL OF A THOUSAND USES

The registered Trade Mark and Symbol shown above may be used only on products made from materials manufactured by Bakelite Corporation. Under the capital "B" is the numerical sign for infinity, or unlimited quantity. It symbolizes the infinite number of present and future uses of Bakelite Corporation's products.

Please mention the JOURNAL of the A. I. E. E. when writing to advertisers.

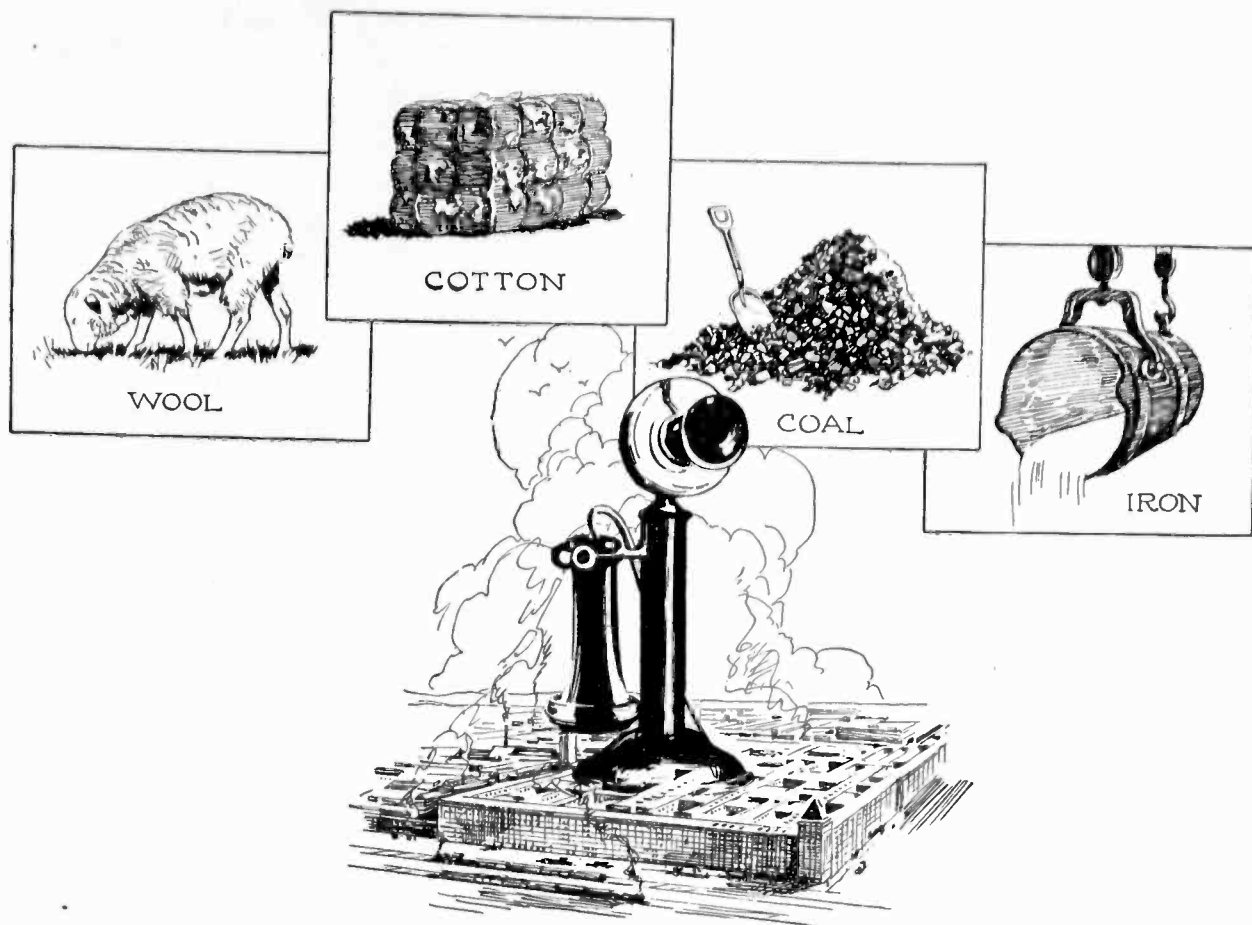

## Industrial "intake"

ONE yardstick for judging the true importance of an industry is its relation to other industries—not as to its output but rather its intake of their products.

Measured thus, the Western Electric telephone factory has an importance beyond its own walls, as a marketplace for many of the country's basic industries.

The manufacture of millions of telephones, with all the switchboards, cable and countless items of apparatus essential to telephone service, calls for vast quantities of iron, cotton, wool, coal, copper and many other materials in the raw or partially fabricated.

Thus Western Electric is a factor not only with the nation of individuals for whom it makes telephones but also with the manufacturers and producers for whom it provides a market—a striking example of the interdependence of industries.



Back  
of your  
telephone

No. 1 of a series

# Western Electric

SINCE 1882 MANUFACTURERS FOR THE BELL SYSTEM

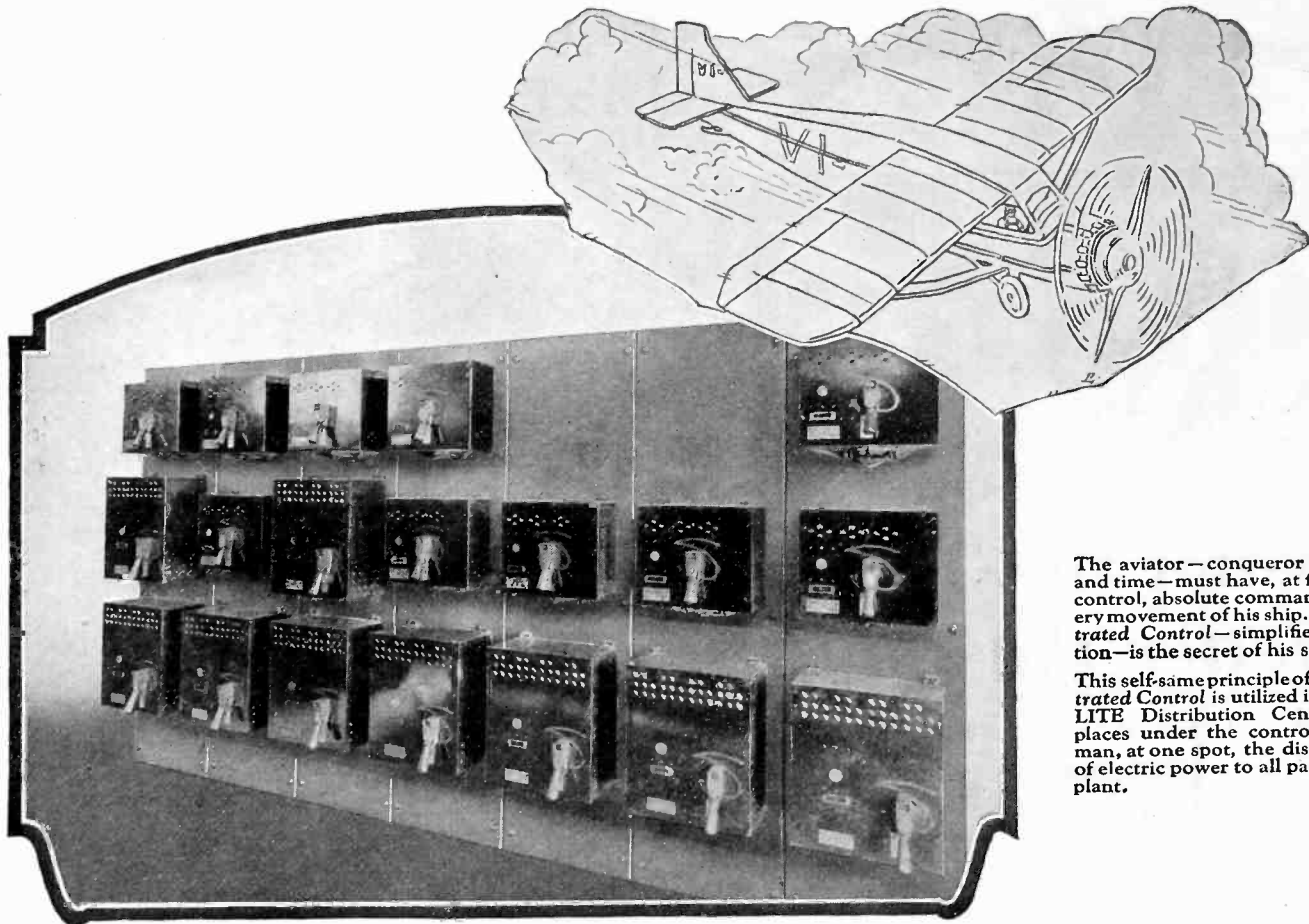

The aviator—conqueror of space and time—must have, at finger-tip control, absolute command of every movement of his ship. *Concentrated Control*—simplified operation—is the secret of his success.

This self-same principle of *Concentrated Control* is utilized in U-RE-LITE Distribution Centers. It places under the control of one man, at one spot, the distribution of electric power to all parts of the plant.

# CONCENTRATED CONTROL

## DISTRIBUTION **U-RE-LITE** CENTERS

U-RE-LITE is made for *Central Station Auxiliaries*, as well as for industrial applications, for voltages up to 600 A. C. or D. C. Through the use of U-RE-LITE dead front switchboards, the entire problem of distribution has taken on a new meaning, where electrical safety and economy are concerned.

On one switchboard—under the supervision and absolute control of one man—is concentrated the distribution of power to each and every machine—to each motor or group of motors—to every part of the building. Wasted steps, lost time, fuse hunting and crippled production are entirely eliminated. And in their place comes faultless, continuous service, day in and day out.

The rupturing capacity of U-RE-LITE for “shorts” is practically unlimited, just as its ability to protect against overloads and single phasing is unquestioned. U-RE-LITE breaks the circuit instantly, protecting your equipment against burn-outs and destruction. It is, without doubt, the finest piece of protective equipment ever devised for plant safety.

The U-RE-LITE Handbook—a 96-page bound volume on electrical protection—is yours for the asking. Write for a copy today—for the protection of your men, motors, machines and minutes. (In writing, please mention your firm’s name.)

THE CUTTER COMPANY—Est. 1888—505 N. 19th St., PHILADELPHIA

# CUTTER

U-RE-LITE & I-T-E CIRCUIT BREAKERS

Please mention the JOURNAL of the A. I. E. E. when writing to advertisers.

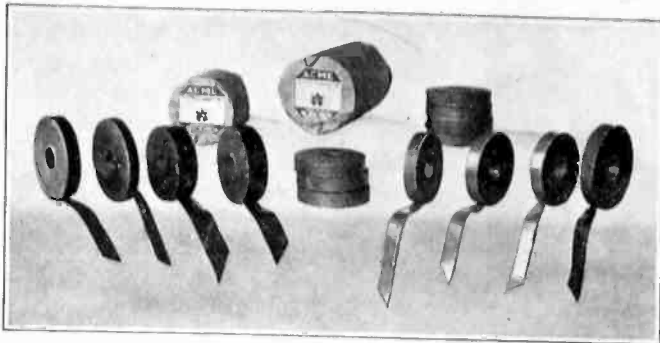

## Better the Tape Better the Job!

The worth of tape, like anything else, is the number of days, months or years of service you get for what you pay.

In the manufacture of Acme Varnished Cambric Tapes, only pure vegetable oil varnish is used. This is made in our own plant and applied under careful heat control to cambrics woven from long-staple cotton yarn.

The result is a tape of high dielectric resistance, combined with great physical strength. . . . the best that can be made for repair work.

In black and yellow, straight and bias cut, seamless and sewed. Thicknesses, .005" to .015"—widths, 1/4" to 36"—72 linear yds. to the roll. Standard finishes; dry, greasy and tacky.

If not at your jobber's write for catalog A and we will see that you are supplied.

## ACME WIRE PRODUCTS

THE ACME WIRE CO.

Main Office and Plant, New Haven, Conn.

Branches at

New York, 52 Vanderbilt Ave. Chicago, 427 West Erie Street  
Cleveland, Guardian Bldg.

## Gurneys Too - - - - DISTRIBUTE THE LOAD



The total load carried by a train of pack mules is distributed over a number of animals. If more animals are added the burden of each is proportionately reduced. In the Gurney maximum type ball bearing, the load is distributed over a greater number of large size balls and in this way each ball carries a correspondingly smaller load. Gurney balls are forged from tough, wear-resisting Molybdenum steel. These are the reasons for the extra carrying capacity and longer life of Gurney bearings.

It costs more to build bearings the Gurney way but because of the capacity and additional service, it actually costs less to use Gurneys.

Reason enough for specifying them in your equipment. Our Engineering Department will gladly help you.

MARLIN - ROCKWELL CORPORATION

Gurney Ball Bearing Division

Jamestown, N. Y.

# GURNEY

## BALL BEARINGS

BETTER STEEL - BIGGER BALLS - MORE OF THEM



*"They Keep*

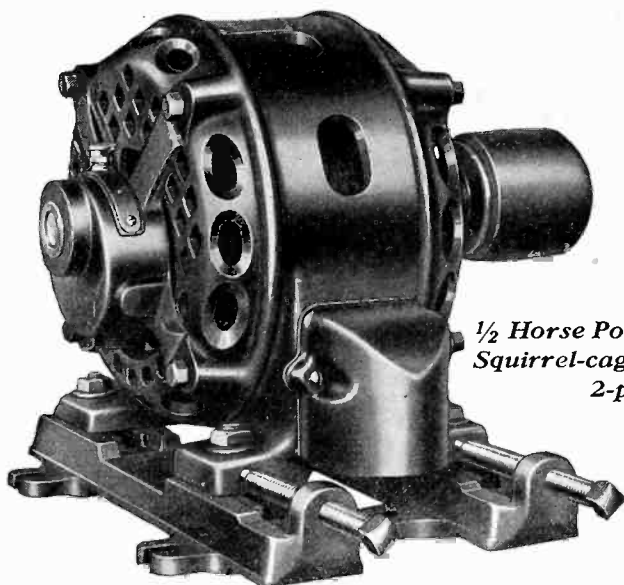

*a-Running"*

*1/2 Horse Power Century Type SC  
Squirrel-cage Induction 3- and  
2-phase Motor*

## Century Wool-yarn System of Lubrication Protects Bearings Against Abrasion

The Century Wool-yarn System of Lubrication, standard on all one horse power and smaller Type SC Squirrel-cage Induction 3- and 2-phase Motors, completely filters all oil before delivery to the bearing surfaces—protecting them against abrasive wear. In addition, brass dust caps and collars placed in the bearing-housing openings make them as dust-tight as is possible to build them.

- 1** Only continuous, unbroken strands of pure wool yarn are used—the highest grade of material available.
- 2** At least one year's continuous 24-hour-per-day operation is assured without reiling.
- 3** Oil is constantly delivered to the bearing surfaces by capillary attraction of the pure wool yarn.
- 4** Oil is conserved indefinitely. Leakage tendencies are eliminated because there is no drain plug at the bottom of the oil well.

Century Type SC Squirrel-cage Induction 3- and 2-phase Motors are built in all standard sizes from  $\frac{1}{4}$  to 75 horse power. Temperature rise not more than 40° Centigrade.

**CENTURY ELECTRIC COMPANY**

1806 Pine St.

St. Louis, Mo.

*For More Than 23 Years at St. Louis*



$\frac{1}{4}$  to 75 H. P.

$\frac{1}{4}$  to 75 H. P.

Please mention the JOURNAL of the A. I. E. E. when writing to advertisers.

Trade "ESCO" Mark

## ELECTRIC SPECIALTY CO.

Engineers and Manufacturers



DESIGN —  
DEVELOP —  
PRODUCE —

Small Motors, Generators, Dynamotors,  
Motor Generators, Rotary Converters, Etc.  
FOR SPECIAL PURPOSES—Send Us Your Problems

222 South Street, STAMFORD, CONN., U.S.A.

# MODELS

for

MANUFACTURING STANDARDS  
SALES DEMONSTRATION AND DISPLAY  
USE IN LITIGATION

Experimental Development under Client Supervision

MANUFACTURERS' & INVENTORS'  
ELECTRIC CO.

(Smith Building)  
228 West Broadway, N. Y. City  
Incorporated 1897

# UNIQUE THIN LEAD COLORED PENCIL

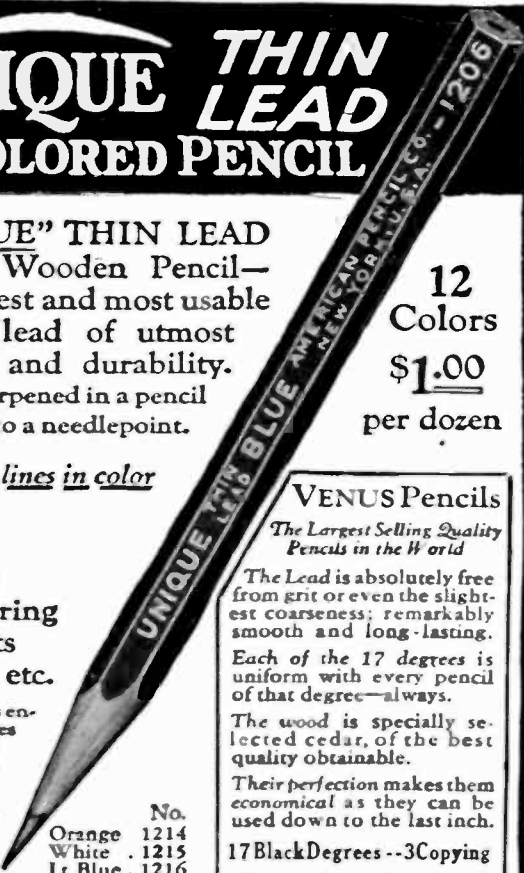

"UNIQUE" THIN LEAD Colored Wooden Pencil—has the best and most usable **thinnest** lead of utmost strength and durability. Can be sharpened in a pencil sharpener to a needlepoint.

Make fine lines in color  
for  
figuring  
checking  
underscoring  
blueprints  
charting, etc.

The 12 colors enable executives to have their own symbol.

**12 Colors**  
**\$1.00**  
per dozen

**VENUS Pencils**  
The Largest Selling Quality Pencils in the World

The Lead is absolutely free from grit or even the slightest coarseness; remarkably smooth and long-lasting.

Each of the 17 degrees is uniform with every pencil of that degree—always.

The wood is specially selected cedar, of the best quality obtainable.

Their perfection makes them economical as they can be used down to the last inch.

17 Black Degrees -- 3 Copying  
Plain ends—per Doz. \$1.00  
Rubber " —per Doz. \$1.20

No.	No.
Blue . 1206	Orange 1214
Red . 1207	White . 1215
Green 1208	Lt. Blue . 1216
Yellow 1209	Pink . . 1217
Purple 1210	Lt. Green 1218
Brown 1212	Maroon 1219

At all dealers, or write direct  
AMERICAN LEAD PENCIL CO., 204 Fifth Ave., New York  
Sample of UNIQUE (any color) and VENUS (any degree) sent on request

# CLASSIFIED ADVERTISEMENTS

**RATES.** Fifty cents per line; minimum charge based on use of five lines; maximum space cannot exceed twenty lines.

Copy should be received by the 15th of the month, for insertion in the following issue.

**TECHNICAL TRANSLATIONS** by engineering graduate of American and European universities, handling highly specialized translations for largest manufacturers of electrical and mechanical equipment in the United States. Extreme accuracy and reliability are offered to manufacturers through this technical service. Adolph Luque, 150 Nassau Street, New York.

**WANTED:** Man with experience in exhausting of vacuum tubes, to take charge of approximately 15 trolley exhaust positions, also experience in maintenance and operation of pumps. Apply by letter giving full details as to age, experience, salary desired and when available. Address Box 128, JOURNAL of A. I. E. E., 33 West 39th Street, New York.

**FOR SALE:** A. I. E. E. TRANSACTIONS. A member wishes to dispose of his complete set of the yearly bound volumes of the A. I. E. E. Selling price \$250.00, including shipping charges. Address the A. I. E. E., 33 West 39th Street, New York.

**WANTED:** Copies of the December (1926) issues of the JOURNAL of the A. I. E. E. Wrappers returning these copies should bear the sender's name and address. Twenty-five cents will be paid for each copy received. Address American Institute of Electrical Engineers, 33 West 39th Street, New York.

**BINDERS** for the JOURNAL of the A. I. E. E. A loose cover binder, especially designed for the JOURNAL, is now available. The new binder is exceptionally pleasing in appearance, durable and handy. One to six copies of the JOURNAL can be inserted. Covers of long-wearing processed material, closely resembling rich brown leather. Remittance of \$2.25 for a set of two, (or \$1.25 for one) should accompany order. A. I. E. E., 33 West 39th Street, New York.

**POPULAR RESEARCH NARRATIVES** are proving useful 'round the world in many offices, schools and laboratories. They are interesting home reading, too. Two little books, just pocket size. In each book 50 short stories of research, invention, discovery—footprints of progress. Introductions by Dr. E. E. Slosson and Prof. M. I. Pupin. Only \$1.50 for the two volumes, postpaid. Engineering Foundation, 29 West 39th Street, New York, N. Y.

## Engineering Societies Library

A reference library for engineers—contains 150,000 volumes—receives over 1,300 technical journals and periodicals on all branches of engineering.

Searches are made upon engineering subjects, translations from foreign publications, photostats made, etc.

Books may be borrowed by members of the A. I. E. E. For information address, The Engineering Societies Library, 33 West 39th St., New York.

At Your Service



**Martindale Megohm Insulation Meter**

Range: 200 Ohms  
to 100 Megohms

Low Cost—Wide Range  
Instantaneous Readings  
Accurate Results

Price: Only \$97.50

*Shipped on approval*  
Weight only 11 lbs.  
Fully Guaranteed

MARTINDALE ELECTRIC CO.

1250 W. 4th St.

Cleveland, O.

**SUNDH CONTACT ELECTRIC COMPANY**

The Elements

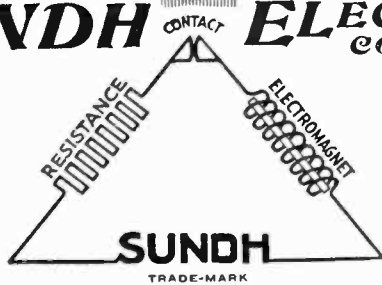

of our Business

Automatic Starters  
Circuit Breakers  
Float Switches  
Hand Starters  
Magnet Switches

Pressure Regulators  
Remote Switches  
Speed Regulators  
Transfer Switches  
Valve Control

**WRITE FOR CATALOG**

Sundh Electric Company, 4 Ave. C, Newark, N. J.  
Branch Offices or Sales Representatives in Principal Cities

**THE PIONEER MANUFACTURER**

OF

**Interpole & Ball Bearing Motors**

1/2 to 1000 H. P. D. C. and A. C.

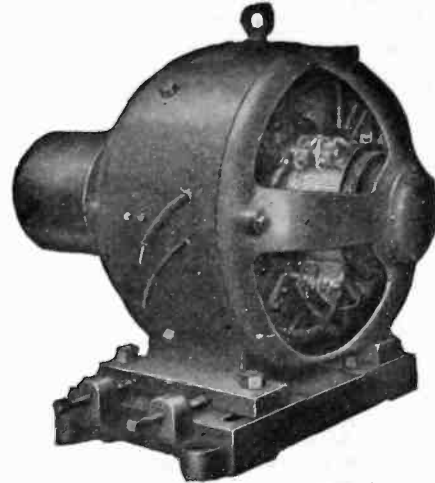

Type "S" Ball Bearing Motor with base and pulley

**ELECTRO DYNAMIC COMPANY**

Established 1880

BAYONNE, N. J.

Sales Offices in Principal Cities

**Star Ball Bearing Motors**

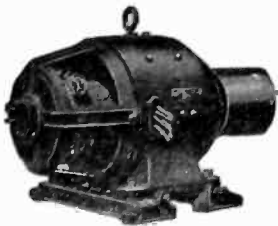

For Hard Usage  
—  
A. C. and D. C.

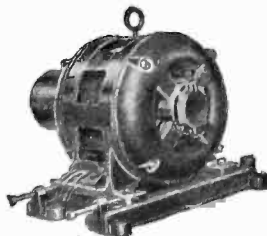

Complete line of standard motors and generators, all sizes up to 75 h. p. and 50 kw. respectively.

*Our Engineering Department at your service for all special applications*

**STAR ELECTRIC MOTOR CO.**  
NEWARK, NEW JERSEY

**Sturtevant Electric Motors**

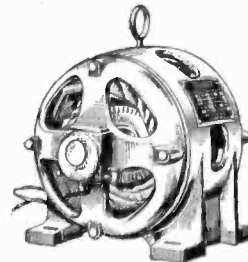

—A. C. and D. C.; single and polyphase—built in sizes from small fractional to 250 horse-power—designed to operate under a constant full load where uninterrupted service is demanded.

**B. F. STURTEVANT COMPANY**

HYDE PARK, BOSTON, MASS.



**Here's a new starter!**

Completely oil-immersed

Dust tight—Gas tight—Weatherproof

*Write for complete details of this new across-the-line starter.*

**ROWAN CONTROL**  
THE ROWAN CONTROLLER CO., BALTIMORE, MD.

# PROFESSIONAL ENGINEERING DIRECTORY

For Consultants in the Fields of Engineering, and Related Arts and Sciences

<p><b>AMBURSEN DAMS</b> Hydroelectric Developments Water Supply and Irrigation Dams DAMS ON DIFFICULT FOUNDATIONS AMBURSEN CONSTRUCTION CO. Incorporated Grand Central Terminal, New York Kansas City, Mo. Atlanta, Ga.</p>	<p><b>DAY &amp; ZIMMERMANN, Inc.</b> Engineers Power Plants, Sub-Stations, Transmission Lines, Industrial Plants Examinations and Reports, Valuations, Management of Public Utilities 1600 WALNUT ST., PHILADELPHIA New York Chicago</p>	<p><b>HOOSIER ENGINEERING CO.</b> Erectors of Transmission Lines and Substations 325 South New Jersey Street INDIANAPOLIS INDIANA</p>
<p><b>W. S. BARSTOW &amp; COMPANY</b> Incorporated Financial and Operating Managers of Public Utilities 50 Pine Street New York</p>	<p><b>DAVID V. FENNESSY</b> Consulting Power Engineer MILLS BUILDING EL PASO, TEXAS</p>	<p>Dugald C. Jackson Edward L. Moreland <b>JACKSON &amp; MORELAND</b> CONSULTING ENGINEERS 31 St. James Ave. Boston, Mass.</p>
<p><b>BATTEY &amp; KIPP</b> Incorporated ENGINEERS Complete Industrial Plants Power Plants &amp; Electrical Installations Engineering Reports, Analyses &amp; Appraisals 231 South LaSalle Street CHICAGO</p>	<p><b>FORD, BACON &amp; DAVIS</b> Incorporated ENGINEERS 115 Broadway, New York Philadelphia Chicago San Francisco</p>	<p><b>E. S. LINCOLN</b> Consulting Electrical Engineer Designs Investigations Reports Electrical Research Laboratory Graybar Building 420 Lexington Avenue NEW YORK</p>
<p><b>BLACK &amp; VEATCH</b> Consulting Engineers Water, Steam and Electric Power Investiga- tions, Design, Supervision of Construction, Valuation and Tests. Mutual Building KANSAS CITY, MO.</p>	<p><b>FRANK F. FOWLE &amp; CO.</b> Electrical and Mechanical Engineers MONADNOCK BUILDING CHICAGO</p>	<p><b>MCCLELLAN &amp; JUNKERSFELD</b> Incorporated Engineering and Construction Power Developments—Industrial Plants Electrifications—Examinations Reports—Valuations NEW YORK 68 Trinity Place Chicago St. Louis</p>
<p><b>BYLLESBY</b> ENGINEERING AND MANAGEMENT CORPORATION 231 S. La Salle Street CHICAGO New York San Francisco</p>	<p><b>FREYN ENGINEERING COMPANY</b> Industrial Electric Power Generation—Application—Purchase Combustion Engineering Electric Furnace Installations CHICAGO PHILADELPHIA 310 South Michigan Ave. 1500 Chestnut St.</p>	<p>John Minton I. G. Maloff <b>JOHN MINTON, PH. D.</b> Consulting Engineer For Developing, Designing &amp; Manufacturing of Radio Receivers, Amplifiers, Transformers, Rectifiers, Sound Recording &amp; Reproducing Apparatus. Radio &amp; Electro-Acoustical Laboratory. 8 Church Street White Plains, N.Y.</p>
<p><b>WALTER G. CLARK</b> Consulting Engineer Electrical, Mining and Industrial Reports Supervision of Organization and Arrange- ments for Financing LOS ANGELES NEW YORK 1211 Insurance Exch. Bldg. 40 Wall St.</p>	<p><b>A. BARNETT GREEN</b> Writing — Editing — Compiling Engineering Matter 1328 BROADWAY NEW YORK</p>	<p><b>N. J. NEALL</b> Consulting Engineer for Electrical and Industrial Properties 12 PEARL STREET BOSTON, MASS.</p>
<p><b>EDWARD E. CLEMENT</b> Fellow A. I. E. E. Attorney and Expert in Patent Causes Soliciting, Consultation, Reports, Opinions McLachlen Bldg. Washington, D. C. 700 10th St., N. W.</p>	<p><b>AUGUSTUS M. HENRY</b> COUNSELOR AT LAW (Patents and Patent Causes) WOOLWORTH BLDG. NEW YORK</p>	<p><b>NEILER, RICH &amp; CO.</b> Electrical and Mechanical Engineers Consulting, Designing and Supervising 431 So. Dearborn St. — — — Chicago</p>
<p><b>HAROLD A. DANNE</b> LIGHT AND POWER 41 PARK ROW NEW YORK</p>	<p>Card space limited to 1"x2" for each advertiser.</p>	<p><b>OPHULS &amp; HILL, Inc.</b> Formerly Ophuls, Hill &amp; McCreery, Inc. CONSULTING ENGINEERS 112-114 WEST 42nd ST., NEW YORK CITY Ice Making and Refrigeration Investigations and Reports</p>

Please mention the JOURNAL of the A. I. E. E. when writing to advertisers.

# PROFESSIONAL ENGINEERING DIRECTORY

For Consultants in the Fields of Engineering and Related Arts and Sciences

**FARLEY OSGOOD**  
 Consultant  
 Design, Construction, Operation  
 Inter-Connection  
 of  
**PUBLIC UTILITIES**  
 National Bank of Commerce Building  
 31 Nassau Street, New York, N. Y.  
 Tel.: Rector 7878 Cable Address: Fargood

**SCOFIELD ENGINEERING CO.**  
 Consulting Engineers  
 Power Stations Gas Works  
 Hydraulic Developments Electric Railways  
 Examinations & Reports Valuations  
 Philadelphia

**STONE & WEBSTER**  
 Incorporated  
 DESIGN AND CONSTRUCTION  
 EXAMINATIONS REPORTS  
 APPRAISALS  
 INDUSTRIAL AND PUBLIC SERVICE  
 PROPERTIES  
 New York Boston Chicago

**I. S. PRENNER**  
 Mem. A. I. E. E.  
 Lawyer — Engineer  
 Patent Practice  
 Liberty Trust Bldg.  
 Broad and Arch Sts. PHILADELPHIA

**J. E. SIRRINE & COMPANY**  
 Engineers  
 Textile Mills; Hydro-Electric Develop-  
 ments; Tobacco Products Plants; Cotton,  
 Tobacco and General Warehousing; Indus-  
 trial Housing; Steam Power Plants; Steam  
 Utilization.  
 General Offices: Greenville, South Carolina  
 Branches  
 Chattanooga, Tenn. Birmingham, Ala.

**PERCY H. THOMAS**  
 Consulting Engineer  
**ELECTRIC POWER**  
 Generation — Transmission  
 Applications  
 120 BROADWAY NEW YORK

**PUBLIC SERVICE  
 PRODUCTION COMPANY**  
 Engineers and Constructors  
 Design and Construct: Power Plants,  
 Transmission Lines, Industrial Plants,  
 Highways, Railroad Shops and Terminals,  
 Gas Plants, Commercial Buildings  
 Make: Examinations, Reports and Valuations  
 80 PARK PLACE NEWARK, N. J.

**JOHN A. STEVENS**  
 CONSULTING POWER ENGINEER  
 16 Shattuck Street  
 LOWELL MASSACHUSETTS

**THE U. G. I. CONTRACTING CO.**  
 Engineers & Constructors  
 Power Developments, Industrial Plants, Gas  
 Plants, Transmission Systems, Appraisals  
 Broad & Arch Sts., PHILA., PA.  
 421 Peoples Gas Bldg., Chicago, Ill. 928 Union Trust  
 Bldg., Pittsburgh, Pa.

**SANDERSON & PORTER  
 ENGINEERS**  
**PUBLIC UTILITIES & INDUSTRIALS**  
 Design Construction Management  
 Examinations Reports Valuations  
 Chicago New York San Francisco

**STEVENS & WOOD  
 INCORPORATED**  
 Engineers and Constructors  
 120 BROADWAY, NEW YORK  
 Youngstown, O.

**THE J. G. WHITE  
 ENGINEERING CORPORATION**  
 Engineers—Constructors  
 Oil Refineries and Pipe Lines,  
 Steam and Water Power Plants,  
 Transmission Systems, Hotels, Apartments,  
 Offices and Industrial Buildings, Railroads  
 43 EXCHANGE PLACE NEW YORK

**SARGENT & LUNDY**  
 Incorporated  
 Mechanical and Electrical  
 Engineers  
 1412 Edison Bldg., 72 West Adams Street  
 CHICAGO ILLINOIS

**STOCKBRIDGE & BORST**  
 Patent Law  
 41 PARK ROW NEW YORK CITY

**J. G. WRAY & CO.**  
 Engineers  
 J. G. Wray, Fellow A.I.E.E. Cyrus G. Hill  
 Utilities and Industrial Properties  
 Appraisals Construction Rate Surveys  
 Plans Organization Estimates  
 Financial Investigations Management  
 576 First National Bank Bldg., Chicago

**YOUR CARD** in 24,000 copies of each issue of this publication  
 —12 times a year, will keep your name and specialized  
 service constantly before the electrical industry.  
 Qualified advertisers in the Engineering Directory are invited  
 to send for rates.

**ELECTRICAL  
 TESTING  
 LABORATORIES**  
 80th Street and East End Ave.  
 NEW YORK

*Inspections — Tests — Research*  
 Tests may be used by the purchaser for the following purposes:  
 (1) To determine the quality of competing samples. This enables the purchase  
 of the best quality for the money.  
 (2) To make sure that shipments comply with specifications. This makes possible  
 the assurance to the customer that shipments match buying samples.  
 (3) To furnish an impartial decision in case of disputes between purchaser and  
 manufacturer.  
 Testing places the whole buying problem on a sound basis.

Please mention the JOURNAL of the A. I. E. E. when writing to advertisers.

# Classified Advertiser's Index for Buyers

Manufacturers and agents for machinery and supplies used in the electrical and allied industries.

Note: For reference to the Advertisements see the Alphabetical List of Advertisers on page 66.

- AIR COMPRESSORS**  
Allis-Chalmers Mfg. Co., Milwaukee  
General Electric Co., Schenectady  
Western Electric Co., All Principal Cities
- AIR WASHERS**  
Sturtevant Co., B. F., Boston
- AMMETER COMPENSATING COILS**  
Minerallac Electric Co., Chicago
- AMMETER, VOLTMETERS**  
(See INSTRUMENTS, ELECTRICAL)
- ANCHORS, GUY**  
Hubbard & Co., Pittsburgh  
Kearney Corp., Jas. R., St. Louis  
Matthews Corp., W. N., St. Louis
- ARMS FOR STREET LIGHTING**  
Hubbard & Co., Pittsburgh
- BATTERY CHARGING APPARATUS**  
Allen-Bradley Co., Milwaukee  
Electric Specialty Co., Stamford, Conn.  
Fansteel Products Co., Inc., North Chicago  
General Electric Co., Schenectady  
Western Electric Co., All Principal Cities  
Westinghouse Elec. & Mfg. Co., E. Pitts-  
burgh
- BEARINGS, BALL**  
Gurney Ball Bearing Division of Marlin-  
Rockwell Corp., Jamestown, N. Y.  
New Departure Mfg. Co., The, Bristol, Conn.  
Norma-Hoffmann Bearings Corp., Stamford,  
Conn.  
Standard Steel & Bearings, Inc., Plainville,  
Conn.
- BEARINGS, ROLLER**  
Timken Roller Bearing Co., The, Canton, O.
- BLOWERS**  
Sturtevant Co., B. F., Boston
- BOXES, FUSE**  
Bull Dog Electric Products Co., Detroit  
General Electric Co., Schenectady  
Kearney Corp., Jas. R., St. Louis  
Metropolitan Device Corp., Brooklyn, N. Y.  
Western Electric Co., All Principal Cities  
Westinghouse Elec. & Mfg. Co., Pitts-  
burgh
- BOXES, JUNCTION**  
G & W Elec. Specialty Co., Chicago  
Metropolitan Device Corp., Brooklyn, N. Y.  
Standard Underground Cable Co., Pittsburgh
- BOXES UNDERGROUND**  
Colt's Patent Fire Arms Mfg. Co., Hartford,  
Conn.
- BRACKETS AND PINS, METAL**  
Hubbard & Co., Pittsburgh
- BRUSHES, COMMUTATOR**  
*Carbon*  
Morganite Brush Co., Inc., L. I. City, N. Y.  
National Carbon Co., Inc., Cleveland  
Westinghouse Elec. & Mfg. Co., E. Pitts-  
burgh  
*Copper Graphite*  
Morganite Brush Co., Inc., L. I. City, N. Y.  
National Carbon Co., Inc., Cleveland  
Westinghouse Elec. & Mfg. Co., E. Pitts-  
burgh
- BUS BAR FITTINGS**  
Burdny Engineering Co., Inc., New York  
Delta-Star Electric Co., Chicago  
General Electric Co., Schenectady  
Westinghouse Elec. & Mfg. Co., E. Pitts-  
burgh
- CABLE ACCESSORIES**  
Delta Star Electric Co., Chicago  
Dossert & Co., New York  
G & W Electric Specialty Co., Chicago  
General Electric Co., Schenectady  
Minerallac Electric Co., Chicago  
Standard Underground Cable Co., Pittsburgh  
Western Electric Co., All Principal Cities
- CABLE RACKS**  
Hubbard & Co., Pittsburgh  
Metropolitan Device Corp., Brooklyn, N. Y.
- CABLES**  
See WIRES AND CABLES
- CABLEWAYS**  
American Steel & Wire Co., Chicago  
Roebing's Sons Co., John A., Trenton, N. J.
- CAMBRIC, VARNISHED**  
Belden Mfg. Co., Chicago  
General Electric Co., Bridgeport, Conn.  
Irvington Varnish & Ins. Co., Irvington, N. J.  
Westinghouse Elec. & Mfg. Co., E. Pitts-  
burgh
- CARRIER CURRENT TELEPHONE EQUIP-  
MENT**  
Western Electric Co., All Principal Cities  
Wireless Specialty Apparatus Co., Boston
- CIRCUIT BREAKERS**  
*Air-Enclosed*  
Allen-Bradley Co., Milwaukee  
Cutter Co., The, Philadelphia  
Roller-Smith Co., New York  
Sundh Electric Co., Newark, N. J.  
Western Electric Co., All Principal Cities  
*Oil*  
Condit Electrical Mfg. Corp., Boston  
General Electric Co., Schenectady  
Pacific Elec. Mfg. Co., San Francisco  
Westinghouse Elec. & Mfg. Co., E. Pitts-  
burgh
- CLAMPS, GUY & CABLE**  
Burdny Engineering Co., Inc., New York  
Hubbard & Co., Pittsburgh  
Kearney Corp., Jas. R., St. Louis  
Matthews Corp., W. N., St. Louis
- CLAMPS, HOT LINE**  
Hubbard & Co., Pittsburgh  
Kearney Corp., Jas. R., St. Louis
- CLIPS, CABLE**  
Hubbard & Co., Pittsburgh  
Kearney Corp., Jas. R., St. Louis
- CLOCKS**  
Cramer & Co. Inc., R. W., New York
- COILS, CHOKE**  
Burke Electric Co., Erie, Pa.  
General Electric Co., Schenectady  
Kearney Corp., Jas. R., St. Louis  
Westinghouse Elec. & Mfg. Co., E. Pitts-  
burgh
- COILS, MAGNET**  
Acme Wire Co., New Haven, Conn.  
Belden Mfg. Co., Chicago  
Dudio Mfg. Corp., Ft. Wayne, Ind.  
General Electric Co., Schenectady  
Westinghouse Elec. & Mfg. Co., E. Pitts-  
burgh
- COMMUTATOR SLOTTERS**  
Martindale Electric Co., The, Cleveland
- COMMUTATOR STONES**  
Martindale Electric Co., The, Cleveland
- CONDENSATION PRODUCTS**  
Bakelite Corporation, New York
- CONDENSERS, COUPLING**  
*For Carrier Current Telephone*  
Wireless Specialty Apparatus Co., Boston
- CONDENSERS, RADIO**  
General Radio Co., Cambridge, Mass.  
Pacnet Electric Co., New York  
Wireless Specialty Apparatus Co., Boston
- CONDENSERS, STEAM**  
Allis-Chalmers Mfg. Co., Milwaukee  
General Electric Co., Schenectady  
Westinghouse Elec. & Mfg. Co., E. Pitts-  
burgh
- CONDUIT, UNDERGROUND FIBRE**  
Western Electric Co., All Principal Cities
- CONNECTORS, SOLDERLESS**  
Dossert & Co., New York  
Kearney Corp., Jas. R., St. Louis  
Western Electric Co., All Principal Cities  
Westinghouse Elec. & Mfg. Co., E. Pitts-  
burgh
- CONNECTORS AND TERMINALS**  
Belden Mfg. Co., Chicago  
Burke Electric Co., Erie, Pa.  
Burdny Engineering Co., Inc., New York  
Dossert & Co., New York  
G & W Electric Specialty Co., Chicago  
Western Electric Co., All Principal Cities  
Westinghouse Elec. & Mfg. Co., E. Pitts-  
burgh
- CONTACTS, TUNGSTEN**  
Fansteel Products Co., Inc., North Chicago  
General Electric Co., Schenectady
- CONTROLLERS**  
Allen-Bradley Co., Milwaukee  
Electric Controller & Mfg. Co., Cleveland  
General Electric Co., Schenectady  
Rowan Controller Co., Baltimore  
Sundh Electric Co., Newark, N. J.  
Western Electric Co., All Principal Cities  
Westinghouse Elec. & Mfg. Co., E. Pitts-  
burgh
- CONVERTERS—SYNCHRONOUS**  
Allis-Chalmers Mfg. Co., Milwaukee  
Electric Specialty Co., Stamford, Conn.  
Westinghouse Elec. & Mfg. Co., E. Pitts-  
burgh
- COPPER CLAD WIRE**  
Belden Mfg. Co., Chicago  
Copperweld Steel Co., Rankin, Pa.  
Standard Underground Cable Co., Pittsburgh  
Western Electric Co., All Principal Cities
- CROSS ARMS, STEEL**  
Hubbard & Co., Pittsburgh
- CUT-OUTS**  
Condit Electrical Mfg. Corp., S. Boston  
General Electric Co., Schenectady  
G & W Electric Specialty Co., Chicago  
Kearney Corp., Jas. R., St. Louis  
Metropolitan Device Corp., Brooklyn, N. Y.  
Western Electric Co., All Principal Cities  
Westinghouse Elec. & Mfg. Co., E. Pitts-  
burgh
- DRAWING INSTRUMENTS**  
Cramer & Co., Inc., R. W., New York
- DYNAMOS**  
(See GENERATORS AND MOTORS)
- DYNAMOTORS**  
Burke Electric Co., Erie, Pa.  
Electric Specialty Co., Stamford, Conn.
- ELECTRIFICATION SUPPLIES, STEAM  
ROAD**  
General Electric Co., Schenectady  
Ohio Brass Co., Mansfield, Ohio  
Westinghouse Elec. & Mfg. Co., E. Pitts-  
burgh
- ENGINEERS, CONSULTING AND CON-  
TRACTING**  
(See PROFESSIONAL ENGINEERING  
DIRECTORY)
- ENGINES**  
*Gas & Gasoline*  
Allis-Chalmers Mfg. Co., Milwaukee  
Sturtevant Company, B. F., Boston  
*Oil*  
Allis-Chalmers Mfg. Co., Milwaukee  
Sturtevant Company, B. F., Boston  
*Steam*  
Allis-Chalmers Mfg. Co., Milwaukee  
Sturtevant Company, B. F., Boston
- FANS, MOTOR**  
Century Electric Co., St. Louis  
General Electric Co., Schenectady  
Star Electric Motor Co., Newark, N. J.  
Sturtevant Company, B. F., Boston  
Western Electric Co., All Principal Cities  
Westinghouse Elec. & Mfg. Co., E. Pitts-  
burgh
- FARM LIGHTING GENERATORS**  
Western Electric Co., All Principal Cities  
Westinghouse Elec. & Mfg. Co., E. Pitts-  
burgh
- FIBRE**  
Belden Mfg. Co., Chicago  
National Vulcanized Fibre Co., Wilmington,  
Del.
- FLOW METERS**  
General Electric Co., Schenectady
- FURNACES, ELECTRIC**  
General Electric Co., Schenectady  
Westinghouse Elec. & Mfg. Co., E. Pitts-  
burgh



Is your  
name on our  
mailing list  
for bulletins  
and catalog?

# Morganite Brushes

Morganite  
Brush Co., Inc.  
3302-3320 Anable Ave.,  
Long Island City,  
N. Y.

Please mention the JOURNAL of the A. I. E. E. when writing to advertisers.

# They Must be correct to the last detail

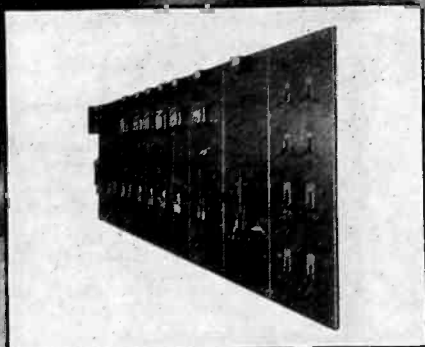
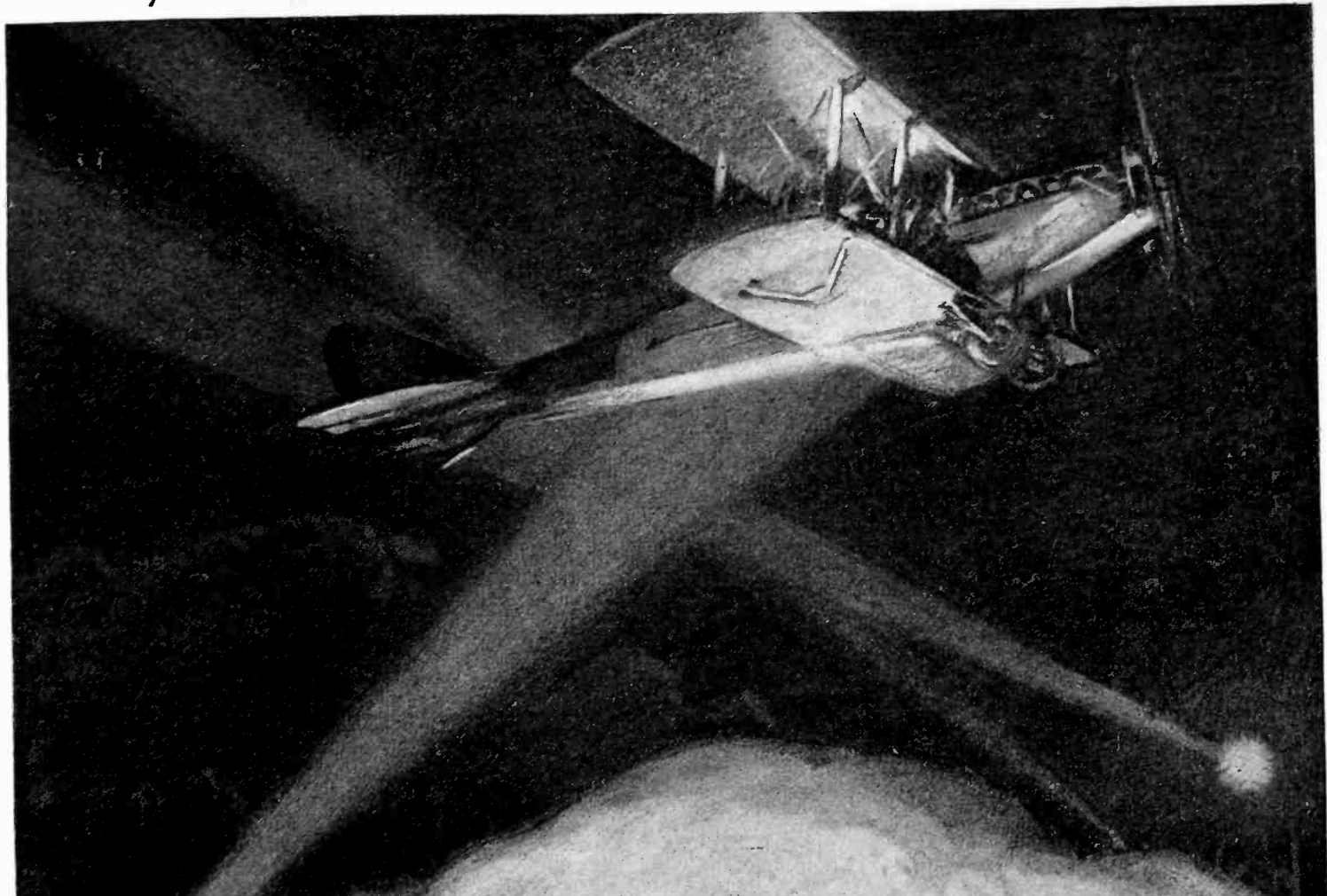

**C**ONDIT Switchboards like trans-oceanic planes are built and tested part by part, step by step, with full appreciation on the part of every engineer, workman and inspector of their heavy responsibility for continuously dependable service.

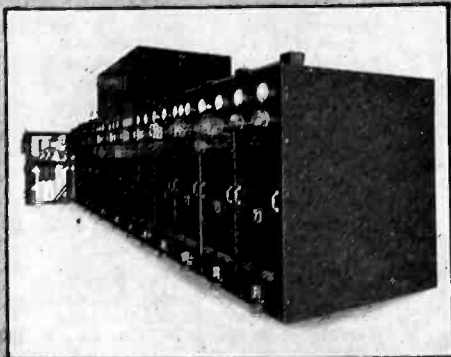
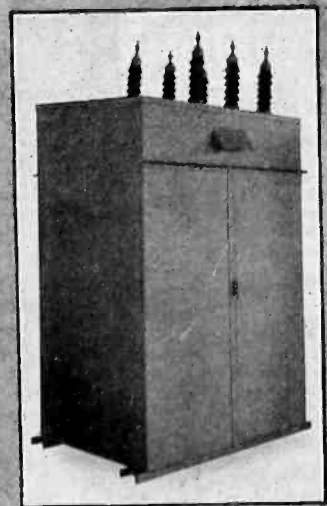

For Safety Enclosed Switchboards, Removable Truck Type, Bench Boards, Automatic, Electrical and Manual Controlled Switchboards, it pays to get in touch with Condit.

CONDIT ELECTRICAL MFG. CORP.  
Manufacturers of Electrical Protective Devices  
Boston, Mass.  
*Northern Electric Company*  
LIMITED  
Sole Distributor for the Dominion of Canada

# CONDIT

## Classified Advertiser's Index for Buyers—Continued

## FUSES

- Enclosed Refillable*  
Colt's Patent Fire Arms Mfg. Co., Hartford, Conn.  
General Electric Co., Schenectady  
Western Electric Co., All Principal Cities  
Westinghouse Elec. & Mfg. Co., E. Pittsburgh
- Enclosed Non-Refillable*  
Colt's Patent Fire Arms Mfg. Co., Hartford, Conn.  
General Electric Co., Schenectady  
Western Electric Co., All Principal Cities
- Open Link*  
General Electric Co., Schenectady  
Metropolitan Device Corp., Brooklyn, N. Y.  
Western Electric Co., All Principal Cities
- High Tension*  
Colt's Patent Fire Arms Mfg. Co., Hartford, Conn.  
Delta-Star Electric Co., Chicago  
Metropolitan Device Corp., Brooklyn, N. Y.  
Western Electric Co., All Principal Cities
- FUSE PULLERS**  
Kearney Corp., Jas. R., St. Louis
- GEARS, FIBRE**  
General Electric Co., Schenectady
- GENERATORS AND MOTORS**  
Allis-Chalmers Mfg. Co., Milwaukee  
Burke Electric Co., Erie, Pa.  
Century Electric Co., St. Louis  
Chandeysson Electric Co., St. Louis  
Electric Specialty Co., Stamford, Conn.  
Electro-Dynamic Co., Bayonne, N. J.  
General Electric Co., Schenectady  
Lincoln Electric Co., The, Cleveland  
Star Electric Motor Co., Newark, N. J.  
Sturtevant Company, B. F., Boston  
Western Electric Co., All Principal Cities  
Westinghouse Elec. & Mfg. Co., E. Pittsburgh
- GENERATING STATION EQUIPMENT**  
Allis-Chalmers Mfg. Co., Milwaukee  
Burke Electric Co., Erie, Pa.  
General Electric Co., Schenectady  
Western Electric Co., All Principal Cities  
Westinghouse Elec. & Mfg. Co., E. Pittsburgh
- GROUND CONNECTIONS**  
Hubbard & Co., Pittsburgh
- GROUND RODS**  
Copperweld Steel Co., Rankin, Pa.  
Hubbard & Co., Pittsburgh  
Western Electric Co., All Principal Cities
- HEADLIGHTS**  
Ohio Brass Co., Mansfield, O.
- HEATERS, INDUSTRIAL**  
General Electric Co., Schenectady  
Western Electric Co., All Principal Cities  
Westinghouse Elec. & Mfg. Co., E. Pittsburgh
- INDICATORS, SPEED**  
Bristol Co., The, Waterbury, Conn.  
Roller-Smith Co., New York
- INDICATORS, REMOTE, WATER LEVEL**  
Bristol Co., The, Waterbury, Conn.  
Cramer & Co., Inc., R. W., New York
- INSTRUMENTS, ELECTRICAL**  
*Graphic*  
Bristol Co., The, Waterbury, Conn.  
Ferranti, Ltd., Hollinwood, England  
Ferranti, Inc., New York  
Ferranti Electric, Ltd., Toronto, Ont.  
General Electric Co., Schenectady  
Westinghouse Elec. & Mfg. Co., E. Pittsburgh
- Indicating*  
Bristol Co., The, Waterbury, Conn.  
Ferranti Ltd., Hollinwood, England  
Ferranti, Inc., New York  
Ferranti Electric, Ltd., Toronto, Ont.  
General Electric Co., Schenectady  
Jewell Elec. Instrument Co., Chicago  
Roller-Smith Co., New York  
Westinghouse Elec. & Mfg. Co., E. Pittsburgh
- Integrating*  
Weston Elec. Inst. Corp., Newark, N. J.
- Radio*  
Duncan Elec. Mfg. Co., Lafayette, Ind.  
Ferranti, Ltd., Hollinwood, England  
Ferranti, Inc., New York  
Ferranti Electric, Ltd., Toronto, Ont.  
General Electric Co., Schenectady  
Roller-Smith Co., New York  
Sangamo Elec. Co., Springfield, Ill.  
Western Electric Co., All Principal Cities  
Westinghouse Elec. & Mfg. Co., E. Pittsburgh
- Repairing and Testing*  
Electrical Testing Laboratories, New York  
Jewell Elec. Instrument Co., Chicago
- Scientific, Laboratory, Testing*  
General Electric Co., Schenectady  
Jewell Elec. Instrument Co., Chicago  
Metropolitan Device Corp., Brooklyn, N. Y.  
Roller-Smith Co., New York  
Western Electric Co., All Principal Cities  
Westinghouse Elec. & Mfg. Co., E. Pittsburgh
- Telegraph*  
Weston Elec. Inst. Corp., Newark, N. J.  
Western Electric Co., All Principal Cities

## INSULATING MATERIALS

- Board*  
General Electric Co., Bridgeport, Conn.  
West Va. Pulp & Paper Co., New York
- Cloth*  
Acme Wire Co., New Haven, Conn.  
General Electric Co., Bridgeport, Conn.  
Irvington Varnish & Ins. Co., Irvington, N. J.  
Minerallac Electric Co., Chicago  
Westinghouse Elec. & Mfg. Co., E. Pittsburgh
- Composition*  
American Lava Corp., Chattanooga  
Bakelite Corporation, New York  
Belden Mfg. Co., Chicago  
General Electric Co., Bridgeport, Conn.  
Westinghouse Elec. & Mfg. Co., E. Pittsburgh
- Compounds*  
General Electric Co., Bridgeport, Conn.  
Minerallac Electric Co., Chicago  
Standard Underground Cable Co., Pittsburgh  
Western Electric Co., All Principal Cities  
Westinghouse Elec. & Mfg. Co., E. Pittsburgh
- Fibre*  
General Electric Co., Bridgeport, Conn.  
National Vulcanized Fibre Co., Wilmington, Del.  
West Va. Pulp & Paper Co., New York
- Lava*  
American Lava Corp., Chattanooga, Tenn.  
Chicago Mica Co., Valparaiso, Ind.
- Mica*  
Chicago Mica Co., Valparaiso, Ind.  
Westinghouse Elec. & Mfg. Co., E. Pittsburgh
- Paper*  
Acme Wire Co., New Haven, Conn.  
General Electric Co., Bridgeport, Conn.  
Irvington Varnish & Ins. Co., Irvington, N. J.  
Westinghouse Elec. & Mfg. Co., E. Pittsburgh
- Silk*  
Acme Wire Co., New Haven, Conn.  
General Electric Co., Bridgeport, Conn.  
Irvington Varnish & Ins. Co., Irvington, N. J.
- Tape*  
Belden Mfg. Co., Chicago  
General Electric Co., Bridgeport, Conn.  
Minerallac Electric Co., Chicago  
Okonite Co., The, Passaic, N. J.  
Western Electric Co., All Principal Cities  
Westinghouse Elec. & Mfg. Co., E. Pittsburgh
- Varnishes*  
Acme Wire Co., New Haven, Conn.  
General Electric Co., Bridgeport, Conn.  
Irvington Varnish & Ins. Co., Irvington, N. J.  
Minerallac Electric Co., Chicago  
Westinghouse Elec. & Mfg. Co., E. Pittsburgh
- INSULATORS, HIGH TENSION**  
*Composition*  
General Electric Co., Schenectady
- Glass*  
Hemingray Glass Co., Muncie, Ind.
- High Voltage Glass*  
Corning Glass Works, "PYREX," Corning, N. Y.
- Porcelain*  
Canadian Porcelain Co., Ltd., Hamilton, Ont.  
General Electric Co., Schenectady  
Hubbard & Co., Pittsburgh  
Lapp Insulator Co., Inc., LeRoy, N. Y.  
Locke Insulator Corp., Baltimore  
Ohio Brass Co., Mansfield, O.  
Thomas & Sons Co., R., East Liverpool, O.  
Western Electric Co., All Principal Cities  
Westinghouse Elec. & Mfg. Co., E. Pittsburgh
- Post Type*  
Delta-Star Electric Co., Chicago
- INSULATORS, TELEPHONE & TELEGRAPH**  
Hemingray Glass Co., Muncie, Ind.  
Western Electric Co., All Principal Cities
- INSULATOR PINS**  
Hubbard & Co., Pittsburgh  
Ohio Brass Co., Mansfield, O.  
Thomas & Sons Co., R., East Liverpool, O.
- LAMP GUARDS**  
Matthews Corp., W. N., St. Louis  
Western Electric Co., All Principal Cities
- LAVA**  
American Lava Corp., Chattanooga
- LIGHTNING ARRESTERS**  
Delta-Star Electric Co., Chicago  
General Electric Co., Schenectady  
Hubbard & Co., Pittsburgh  
Western Electric Co., All Principal Cities  
Westinghouse Elec. & Mfg. Co., E. Pittsburgh
- LOCOMOTIVES, ELECTRIC**  
General Electric Co., Schenectady  
Westinghouse Elec. & Mfg. Co., E. Pittsburgh
- LUBRICANTS**  
Texas Co., The, New York
- MAGNETIC SEPARATORS**  
Electric Controller & Mfg. Co., Cleveland
- METERS, ELECTRICAL**  
(See INSTRUMENTS ELECTRICAL)

## METER SEALS

- Metropolitan Device Corp., Brooklyn, N. Y.
- MICA PRODUCTS**  
Chicago Mica Co., Valparaiso, Ind.  
Westinghouse Elec. & Mfg. Co., E. Pittsburgh
- MICA UNDERCUTTERS**  
Martindale Electric Co., The, Cleveland
- MOLDED INSULATION**  
Bakelite Corporation, New York  
Belden Mfg. Co., Chicago  
Burke Electric Co., Erie, Pa.  
Colt's Patent Fire Arms Mfg. Co., Hartford, Conn.  
Westinghouse Elec. & Mfg. Co., E. Pittsburgh
- MOLYBDENUM**  
Fansteel Products Co., Inc., North Chicago
- MOTORS**  
(See GENERATORS AND MOTORS)
- OHMMETERS**  
Jewell Elec. Instrument Co., Chicago  
Martindale Electric Co., Cleveland  
Roller-Smith Co., New York  
Weston Elec. Instr. Corp., Newark, N.J.
- OIL SEPARATORS & PURIFIERS**  
Sharples Specialty Co., The, Philadelphia  
Westinghouse Elec. & Mfg. Co., E. Pittsburgh
- PANEL BOARDS**  
(See SWITCHBOARDS)
- PATENT ATTORNEYS**  
(See PROFESSIONAL ENGINEERING DIRECTORY)
- PLUGS**  
Delta-Star Electric Co., Chicago  
General Electric Co., Schenectady  
Western Electric Co., All Principal Cities  
Westinghouse Elec. & Mfg. Co., E. Pittsburgh
- POLE LINE HARDWARE**  
Hubbard & Co., Pittsburgh  
Ohio Brass Co., Mansfield, O.
- POLES, STEEL**  
American Bridge Co., Pittsburgh  
Western Electric Co., All Principal Cities
- POLES—TIES, WOOD**  
Western Electric Co., All Principal Cities
- POTHEADS**  
G. & W Electric Specialty Co., Chicago  
Standard Underground Cable Co., Pittsburgh  
Western Electric Co., All Principal Cities
- PROTECTIVE DEVICES**  
Metropolitan Device Corp., Brooklyn, N. Y.  
Western Electric Co., All Principal Cities
- PULLERS, SLACK**  
Matthews Corp., W. N., St. Louis
- PUMPS**  
Allis-Chalmers Mfg. Co., Milwaukee
- PUMPS, SPIRAL**  
Morris Corporation, I. P., Philadelphia
- RADIO LABORATORY APPARATUS**  
General Radio Co., Cambridge, Mass.  
Westinghouse Elec. & Mfg. Co., E. Pittsburgh
- RAILWAY SUPPLIES, ELECTRIC**  
General Electric Co., Schenectady  
Ohio Brass Co., Mansfield, O.  
Western Electric Co., All Principal Cities  
Westinghouse Elec. & Mfg. Co., E. Pittsburgh
- REACTORS**  
General Electric Co., Schenectady  
Metropolitan Device Corp., Brooklyn, N. Y.
- RECTIFIERS**  
Fansteel Products Co., Inc., North Chicago  
General Electric Co., Schenectady  
Western Electric Co., All Principal Cities  
Westinghouse Elec. & Mfg. Co., E. Pittsburgh
- REELS, PAYOUT AND TAKEUP**  
Matthews Corp., W. N., St. Louis
- REGULATORS, VOLTAGE**  
Burke Electric Co., Erie, Pa.  
General Electric Co., Schenectady  
Western Electric Co., All Principal Cities  
Westinghouse Elec. & Mfg. Co., E. Pittsburgh
- RELAYS**  
Cramer & Co., Inc., R. W., New York  
Electric Controller & Mfg. Co., Cleveland  
General Electric Co., Schenectady  
Westinghouse Elec. & Mfg. Co., E. Pittsburgh
- RESISTOR UNITS**  
Allen-Bradley Co., Milwaukee  
General Electric Co., Schenectady
- RHEOSTATS**  
Allen-Bradley Co., Milwaukee  
General Electric Co., Schenectady  
Sundh Electric Co., Newark, N. J.  
Ward Leonard Electric Co., Mt. Vernon, N. Y.  
Western Electric Co., All Principal Cities  
Westinghouse Elec. & Mfg. Co., E. Pittsburgh
- ROPE, WIRE**  
American Steel & Wire Co., Chicago  
Roebing's Sons Co., John A., Trenton, N. J.

Please mention the JOURNAL of the A. I. E. E. when writing to advertisers.



*Chandeysson*

**Generators**  
25 to 25,000 Amperes

Direct Connected to



**Motors**

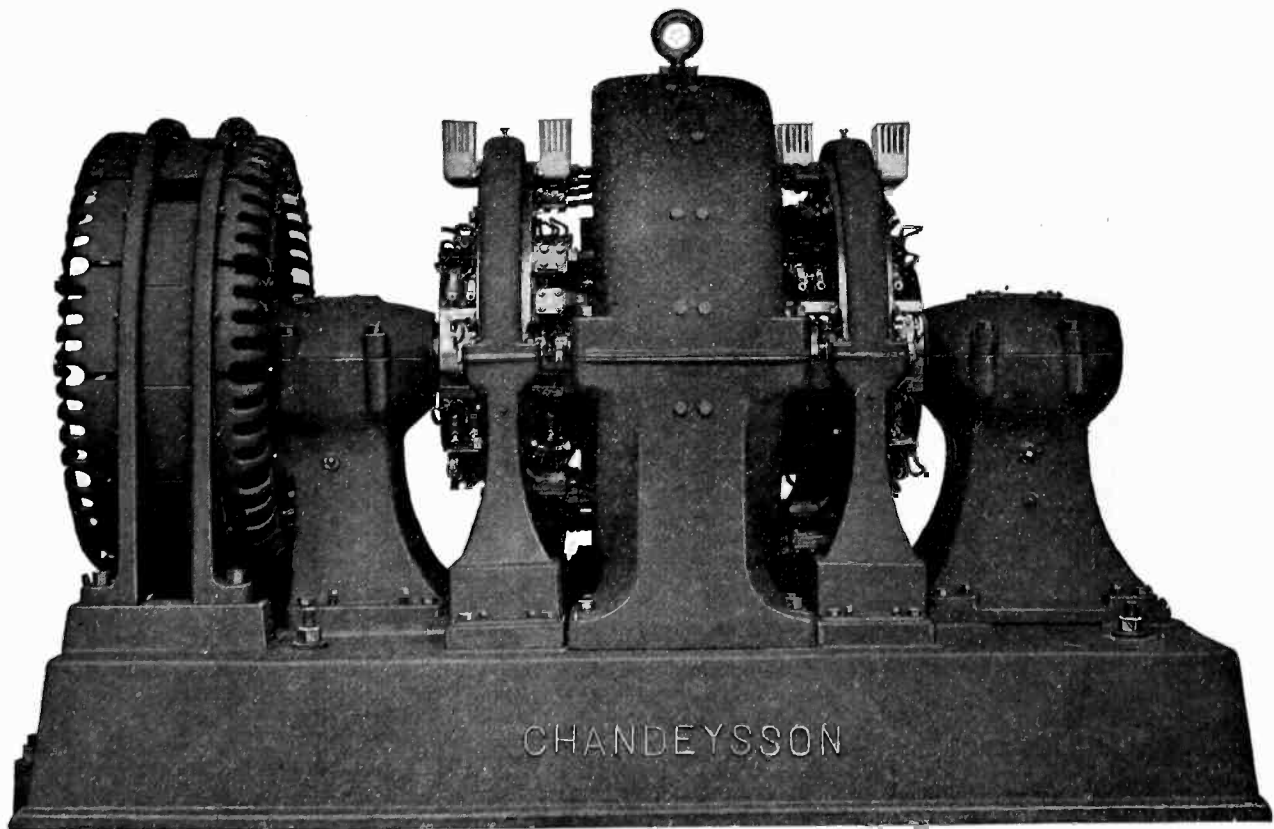

50-h.p. 300-r p.m.  
G-E Synchronous Motor

5000-amp., 6-volt;  
2500-amp., 12-volt Generator

**81.2% Overall Efficiency**

including excitation losses of the motor and of the generator

CHANDEYSSON ELECTRIC CO., St. Louis, U. S. A.

# Classified Advertiser's Index for Buyers—Continued

- SEARCHLIGHTS**  
General Electric Co., Schenectady  
Westinghouse Elec. & Mfg. Co., E. Pittsburgh
- SHEETS, ELECTRICAL**  
Trumbull Steel Co., The, Warren, O.
- SLEEVE TWISTERS**  
Kearney Corp., Jas. R., St. Louis
- SOCKETS AND RECEPTACLES**  
General Electric Co., Schenectady  
Western Electric Co., All Principal Cities  
Westinghouse Elec. & Mfg. Co., E. Pittsburgh
- SOLENOIDS**  
Acme Wire Co., New Haven, Conn.  
Belden Mfg. Co., Chicago  
Dudlo Mfg. Co., Ft. Wayne, Ind.  
Electric Controller & Mfg. Co., Cleveland  
General Electric Co., Schenectady  
Sundh Electric Co., Newark, N. J.  
Ward Leonard Electric Co., Mt. Vernon, N. Y.  
Westinghouse Elec. & Mfg. Co., E. Pittsburgh
- SPRINGS**  
American Steel & Wire Co., Chicago
- STARTERS, MOTOR**  
Allen-Bradley Co., Milwaukee  
Condit Electrical Mfg. Corp., Boston  
Electric Controller & Mfg. Co., Cleveland  
General Electric Co., Schenectady  
Rowan Controller Co., Baltimore, Md.  
Sundh Electric Co., Newark, N. J.  
Westinghouse Elec. & Mfg. Co., E. Pittsburgh
- STEEL, SHEET & STRIPS**  
Trumbull Steel Co., The, Warren, O.
- STOKERS, MECHANICAL**  
Sturtevant Company, B. F., Boston  
Westinghouse Elec. & Mfg. Co., E. Pittsburgh
- SUB-STATIONS**  
General Electric Co., Schenectady  
Westinghouse Elec. & Mfg. Co., E. Pittsburgh
- SWITCHBOARDS**  
Allis-Chalmers Mfg. Co., Milwaukee  
Bull Dog Electric Products Co., Detroit  
Condit Electrical Mfg. Corp., Boston  
General Electric Co., Schenectady  
Metropolitan Device Corp., Brooklyn, N. Y.  
Western Electric Co., All Principal Cities  
Westinghouse Elec. & Mfg. Co., E. Pittsburgh
- SWITCHES**  
*Automatic Time*  
Cramer & Co., Inc., R. W., New York  
General Electric Co., Schenectady  
Minerallac Electric Co., Chicago  
Sundh Electric Co., Newark, N. J.  
Westinghouse Elec. & Mfg. Co., E. Pittsburgh  
*Disconnecting*  
Burke Electric Co., Erie, Pa.  
Condit Electrical Mfg. Corp., Boston  
Delta-Star Electric Co., Chicago  
General Electric Co., Schenectady  
Kearney Corp., Jas. R., St. Louis  
K-P-F Electric Co., San Francisco  
Matthews Corp., W. N., St. Louis  
Pacific Elec. Mfg. Co., San Francisco  
Thoner & Martens, Boston  
*Fuse*  
Bull Dog Electric Products Co., Detroit  
General Electric Co., Schenectady  
Kearney Corp., Jas. R., St. Louis  
Matthews Corp., W. N., St. Louis  
Metropolitan Device Corp., Brooklyn, N. Y.  
Thoner & Martens, Boston  
*Knife*  
Colt's Patent Fire Arms Mfg. Co., Hartford, Conn.  
Condit Electrical Mfg. Corp., Boston  
Cramer & Co., Inc., R. W., New York  
Electric Controller & Mfg. Co., Cleveland  
General Electric Co., Schenectady  
Matthews Corp., W. N., St. Louis  
Western Electric Co., All Principal Cities  
Westinghouse Elec. & Mfg. Co., E. Pittsburgh  
*Magnetic*  
Allen-Bradley Co., Milwaukee  
*Oil*  
Condit Electrical Mfg. Corp., Boston  
General Electric Co., Schenectady  
Pacific Elec. Mfg. Co., San Francisco  
Western Electric Co., All Principal Cities  
Westinghouse Elec. & Mfg. Co., E. Pittsburgh  
*Remote Control*  
Condit Electrical Mfg. Corp., Boston  
Cramer & Co., Inc., R. W., New York  
General Electric Co., Schenectady  
Rowan Controller Co., Baltimore  
Sundh Electric Co., Newark, N. J.  
Western Electric Co., All Principal Cities  
Westinghouse Elec. & Mfg. Co., E. Pittsburgh
- TANTALUM**  
Fansteel Products Co., Inc., North Chicago
- TELEGRAPH APPARATUS**  
Western Electric Co., All Principal Cities
- TELEPHONE CONNECTORS**  
Kearney Corp., Jas. R., St. Louis
- TELEPHONE EQUIPMENT**  
Western Electric Co., All Principal Cities
- TESTING LABORATORIES**  
Electrical Testing Labs., New York
- TOWERS, TRANSMISSION**  
American Bridge Co., Pittsburgh  
Western Electric Co., All Principal Cities
- TRANSFORMERS**  
Allis-Chalmers Mfg. Co., Milwaukee  
American Transformer Co., Newark, N. J.  
Duncan Elec. Mfg. Co., Lafayette, Ind.  
Ferranti, Ltd., Hollinwood, England  
Ferranti, Inc., New York  
Ferranti Electric, Ltd., Toronto, Ont.  
General Electric Co., Schenectady  
Jefferson Elec. Mfg. Co., Chicago  
Kuhlman Electric Co., Bay City, Mich.  
Moloney Electric Co., St. Louis  
Pittsburgh Transformer Co., Pittsburgh  
Western Electric Co., All Principal Cities  
Westinghouse Elec. & Mfg. Co., E. Pittsburgh  
*Factory*  
American Transformer Co., Newark, N. J.  
Kuhlman Electric Co., Bay City, Mich.  
Moloney Electric Co., St. Louis  
Pittsburgh Transformer Co., Pittsburgh  
Western Electric Co., All Principal Cities  
*Furnace*  
Allis-Chalmers Mfg. Co., Milwaukee  
American Transformer Co., Newark, N. J.  
Moloney Electric Co., St. Louis  
Pittsburgh Transformer Co., Pittsburgh  
*Metering*  
American Transformer Co., Newark, N. J.  
Ferranti, Ltd., Hollinwood, England  
Ferranti, Inc., New York  
Ferranti Electric, Ltd., Toronto, Ont.  
Jefferson Elec. Mfg. Co., Chicago  
Pacnet Electric Co., New York  
*Mill Type*  
Pittsburgh Transformer Co., Pittsburgh  
*Radio*  
American Transformer Co., Newark, N. J.  
Ferranti, Ltd., Hollinwood, England  
Ferranti, Inc., New York  
Ferranti Electric, Ltd., Toronto, Ont.  
Jefferson Elec. Mfg. Co., Chicago  
Pacnet Electric Co., New York  
*Street Lighting*  
Kuhlman Electric Co., Bay City, Mich.  
Western Electric Co., All Principal Cities
- TROLLEY LINE MATERIALS**  
General Electric Co., Schenectady  
Hubbard & Co., Pittsburgh  
Ohio Brass Co., Mansfield, O.  
Western Electric Co., All Principal Cities  
Westinghouse Elec. & Mfg. Co., E. Pittsburgh
- TURBINES, HYDRAULIC**  
Allis-Chalmers Mfg. Co., Milwaukee  
Morris Corporation, I. P., Philadelphia
- TURBINES, STEAM**  
Allis-Chalmers Mfg. Co., Milwaukee  
General Electric Co., Schenectady  
Sturtevant Company, B. F., Boston  
Western Electric Co., All Principal Cities  
Westinghouse Elec. & Mfg. Co., E. Pittsburgh
- TURBO-GENERATORS**  
Allis-Chalmers Mfg. Co., Milwaukee  
Westinghouse Elec. & Mfg. Co., E. Pittsburgh
- VALVE CONTROL, ELECTRIC**  
Bristol Company, The, Waterbury, Conn.
- VALVES, JOHNSON HYDRAULIC**  
Morris Corporation, I. P., Philadelphia
- VARNISHES, INSULATING**  
General Electric Co., Bridgeport, Conn.  
Irvington Varnish & Ins. Co., Irvington, N. J.  
Minerallac Electric Co., Chicago  
Westinghouse Elec. & Mfg. Co., E. Pittsburgh
- WELDING MACHINES, ELECTRIC**  
General Electric Co., Schenectady  
Lincoln Electric Co., The, Cleveland  
Ohio Brass Co., Mansfield, O.  
Westinghouse Elec. & Mfg. Co., E. Pittsburgh
- WELDING WIRES & RODS**  
American Steel & Wire Co., Chicago  
Lincoln Electric Co., Cleveland  
Ohio Brass Co., Mansfield, O.
- WIRES AND CABLES**  
*Armored Cable*  
American Steel & Wire Co., Chicago  
Belden Mfg. Co., Chicago  
Boston Ins. Wire & Cable Co., Boston  
General Electric Co., Schenectady  
Habirshaw Cable & Wire Corp., New York  
Hazard Manufacturing Co., Wilkes-Barre, Pa.  
Kerite Ins. Wire & Cable Co., New York  
Okonite Company, The, Passaic, N. J.  
Roebbling's Sons Co., John A., Trenton, N. J.  
Simplex Wire & Cable Co., Boston  
Standard Underground Cable Co., Pittsburgh  
Western Electric Co., All Principal Cities  
*Asbestos Covered*  
American Steel & Wire Co., Chicago  
Belden Mfg. Co., Chicago  
General Electric Co., Schenectady  
*Automotive*  
American Steel & Wire Co., Chicago  
Belden Mfg. Co., Chicago  
Boston Ins. Wire & Cable Co., Boston  
General Electric Co., Schenectady  
Habirshaw Cable & Wire Corp., New York  
Kerite Ins. Wire & Cable Co., New York  
Roebbling's Sons Co., John A., Trenton, N. J.  
Simplex Wire & Cable Co., Boston  
Standard Underground Cable Co., Pittsburgh  
Western Electric Co., All Principal Cities  
*Bare Copper*  
American Steel & Wire Co., Chicago  
Anaconda Copper Mining Co., Chicago  
Belden Mfg. Co., Chicago  
Copperweld Steel Co., Rankin, Pa.  
Hazard Manufacturing Co., Wilkes-Barre, Pa.  
Roebbling's Sons Co., John A., Trenton, N. J.  
Standard Underground Cable Co., Pittsburgh  
Western Electric Co., All Principal Cities  
*Copper Clad*  
American Steel & Wire Co., Chicago  
Copperweld Steel Co., Rankin, Pa.  
Standard Underground Cable Co., Pittsburgh  
Western Electric Co., All Principal Cities  
*Flexible Cord*  
American Steel & Wire Co., Chicago  
Belden Mfg. Co., Chicago  
Boston Ins. Wire & Cable Co., Boston  
General Electric Co., Schenectady  
Hazard Manufacturing Co., Wilkes-Barre, Pa.  
Okonite Company, The, Passaic, N. J.  
Roebbling's Sons Co., John A., Trenton, N. J.  
Simplex Wire & Cable Co., Boston  
Standard Underground Cable Co., Pittsburgh  
Western Electric Co., All Principal Cities  
*Heavy Duty Cord*  
American Steel & Wire Co., Chicago  
Belden Mfg. Co., Chicago  
Hazard Manufacturing Co., Wilkes-Barre, Pa.  
Okonite Company, The, Passaic, N. J.  
Simplex Wire & Cable Co., Boston  
*Fuse*  
American Steel & Wire Co., Chicago  
General Electric Co., Schenectady  
Roebbling's Sons Co., John A., Trenton, N. J.  
Western Electric Co., All Principal Cities  
*Lead Covered (Paper and Varnished cambric insulated)*  
American Steel & Wire Co., Chicago  
Anaconda Copper Mining Co., Chicago  
General Electric Co., Schenectady  
Habirshaw Cable & Wire Corp., New York  
Hazard Manufacturing Co., Wilkes-Barre, Pa.  
Kerite Ins. Wire & Cable Co., New York  
Okonite Company, The, Passaic, N. J.  
Okonite-Callender Cable Co., The, Inc., Passaic, N. J.  
Roebbling's Sons Co., John A., Trenton, N. J.  
Simplex Wire & Cable Co., Boston  
Standard Underground Cable Co., Pittsburgh  
Western Electric Co., All Principal Cities  
*Magnet*  
American Steel & Wire Co., Chicago  
Belden Mfg. Co., Chicago  
Dudlo Mfg. Corp., Fort Wayne, Ind.  
General Electric Co., Schenectady  
Maring Wire Co., Muskegon, Mich.  
Roebbling's Sons Co., John A., Trenton, N. J.  
Standard Underground Cable Co., Pittsburgh  
Western Electric Co., All Principal Cities  
*Rubber Insulated*  
American Steel & Wire Co., Chicago  
Belden Mfg. Co., Chicago  
Boston Ins. Wire & Cable Co., Boston  
General Electric Co., Schenectady  
Habirshaw Cable & Wire Corp., New York  
Hazard Manufacturing Co., Wilkes-Barre, Pa.  
Kerite Ins. Wire & Cable Co., New York  
Okonite Company, The, Passaic, N. J.  
Roebbling's Sons Co., John A., Trenton, N. J.  
Simplex Wire & Cable Co., Boston  
Standard Underground Cable Co., Pittsburgh  
Western Electric Co., All Principal Cities  
*Tree Wire*  
Hazard Manufacturing Co., Wilkes-Barre, Pa.  
Okonite Company, The, Passaic, N. J.  
Simplex Wire & Cable Co., Boston  
*Trolley*  
American Steel & Wire Co., Chicago  
Anaconda Copper Mining Co., Chicago  
Copperweld Steel Co., Rankin, Pa.  
Roebbling's Sons Co., John A., Trenton, N. J.  
Standard Underground Cable Co., Pittsburgh  
Western Electric Co., All Principal Cities  
*Weather proof*  
American Steel & Wire Co., Chicago  
Anaconda Copper Mining Co., Chicago  
Copperweld Steel Co., Rankin, Pa.  
General Electric Co., Schenectady  
Kerite Ins. Wire & Cable Co., New York  
Okonite Company, The, Passaic, N. J.  
Roebbling's Sons Co., John A., Trenton, N. J.  
Simplex Wire & Cable Co., Boston  
Standard Underground Cable Co., Pittsburgh  
Western Electric Co., All Principal Cities

## A. I. E. E. PUBLICATIONS

### JOURNAL. Published monthly.

An engineering periodical containing in full or in abstract engineering and theoretical papers and discussions as presented before meetings of the Institute and its Sections and Branches; descriptions of new developments characterized by notable advances, and items relating to the activities of the Institute and other organizations.

Subscription price \$10.00 per year. Agents, publishers and dealers are allowed 20 per cent discount; a special discount of 50 per cent is allowed on single subscriptions received directly from college or public libraries. Postage to Canada on annual subscription \$0.50 additional, and to foreign countries, \$1.00. (Postage should not be included when computing discounts).

**JOURNAL BINDERS.** A loose-leaf binder, especially designed for the JOURNAL of the A. I. E. E. is now available. The new binder is attractively finished in a long-wearing, processed material, resembling brown leather. From one to six copies of the JOURNAL can be inserted. The name of the publication is embossed in gold on the front cover and backbone. The binders are sold in sets of two at \$2.25; or \$1.25 for one.

### TRANSACTIONS. Published annually.

Contains such of the technical papers and reports published by the Institute in the JOURNAL and elsewhere as are selected and authorized by the Publication Committee; also the discussions on the technical papers. The TRANSACTIONS form a permanent record of the progress of electrical engineering. Subscription price (to Institute members only) \$2.00 per year.

Current volume may be purchased by non-members at \$10.00 per year in either paper or cloth binding. (Prices for half morocco bound copies furnished on request.)

Available volumes of the TRANSACTIONS published prior to 1921 may be obtained at reduced prices. The volumes in stock and prices will be supplied upon request.

Discounts allowed on the current volume are as follows: 20 per cent to publishers and subscription agents 50 per cent to college and public libraries upon direct subscription to Institute headquarters.

**INDEX TO TRANSACTIONS.** Published every ten years. Vol. III of the TRANSACTIONS Index (Jan. 1, 1911 to Jan. 1, 1922) is a practical bibliography (168 pp.) of all A. I. E. E. papers and discussions printed during the period 1911-1922. Price to members and non-members \$2.00, with dealers' discount of 20 per cent.

### SEPARATE PAPERS AND DISCUSSIONS.

Most of the recent papers and discussions contained in the TRANSACTIONS can be furnished separately at the following prices: Single copies of any paper, usually with discussion, \$0.50. Five or more copies of any paper, each \$0.40.

A discount of 20 per cent to publishers and subscription agents; 50 per cent is allowed from the above prices to Institute members and college and public libraries.

### A. I. E. E. STANDARDS.

The work of revision of the A. I. E. E. Standards which has been in progress for several years has now reached a stage where a large number of sections of the Standards have been approved by the Board of Directors and are available in pamphlet form, as follows:

1—General Principles Upon Which Temperature Limits are Based in the Rating of Electrical Machinery, (\$.20); 5—Direct-Current Generators and Motors and Direct-Current Commutator Machines in General, (.40); 7—Alternators, Synchronous Motors and Synchronous Machines in General, (.40); 8—Synchronous Converters, (.40); 9—Induction Motors and Induction Machines in General, (.40); 10—Direct-Current and Alternating-Current Fractional Horse Power Motors, (.30); 11—Railway Motors, (.30); 13—Transformers, Induction Regulators and Reactors, (.40); 14—Instrument Transformers, (.30); 15—Industrial Control Apparatus, (.40); 16—Railway Control and Mine Locomotive Control Apparatus, (.40); 19—Oil Circuit Breakers, (.30); 22—Disconnecting and Horn Gap Switches, (.30); 30—Wires and Cables, (.40); 33—Electrical Measuring Instruments, (.30); 34—Telegraphy and Telephony, (.30); 36—Storage Batteries, (.20); 37—Illumination, (.30); 38—Electric Arc Welding Apparatus, (.40); 39—Electric Resistance Welding Apparatus, (.30); 41—Insulators, (.30); 42—Symbols for Electrical Equipment of Buildings, (.20); 45—Recommended Practice for Electrical Installations on Shipboard, (1.50); 46—Hard Drawn Aluminum Conductors, (.20).

A discount of 50% is allowed to Institute members. Numbers of the Standards Sections should be given when ordering.

**STANDARDS BINDERS.** The various sections of the Standards can be kept in bound form with the practical binder which has been designed for this purpose. Capacity of the binder is from 10 to 30 sections or pamphlets. Finished in brown fabrikoid with imprint on stiff back. Price \$1.75.

### YEAR BOOK OF THE A. I. E. E.

A directory, published annually in March, of the membership of the A. I. E. E. Gives in alphabetical order, the names, occupations and addresses of all members. The membership is also listed in geographical order. The Year Book contains general information regarding the scope and activities of the Institute, including the Constitution and By-Laws, lists of Sections and Branches, the various committees, governing body, etc. Single copies will be supplied to members without charge upon application.

**American Institute of Electrical Engineers**  
33 West Thirty-ninth Street, New York, N. Y.

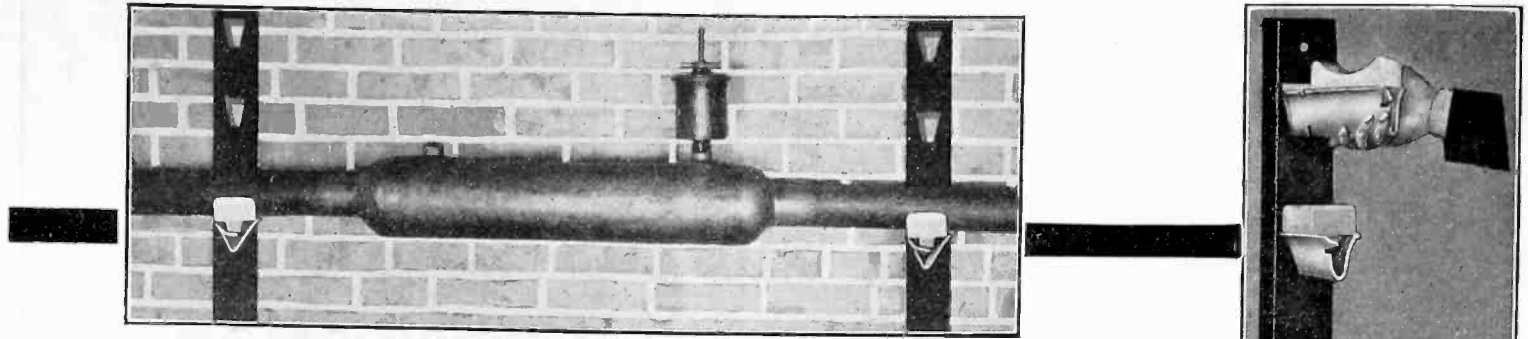

## Good Generation Deserves Good Distribution

### Specify Metropolitan Joints

for 11,000 volts and above. Test figures upon request prove typical joints withstood 160,000 volts over eight hour period.

Metrolatum which is used for filling the Metropolitan High Tension Cable Joint is a high grade mineral oil compound. It has high dielectric strength (we guarantee 25,000 volts per 1/10 inch gap at 120° F.) and low dielectric loss. It insures perfect uniformity of saturation between joint, sleeve and cable ends.

### Specify Metropolitan Racks

This type hanger does not require that cable be placed in a set or fixed position from racking wall of a manhole. To change size of arms is a simple matter—just raise arm out of notches and insert the one required. The porcelain insulator interposes a barrier to the spread of stray currents.

### Specify Metropolitan Subway Sectionalizing Units

the most economical and convenient way of—

Branching main feeders; connecting transformers to a low tension network;  
Connecting sub-feeders, taps and tie-lines, and connecting services.

Safely cutting-out any bad section line or transformer with a minimum shut-down and with the least possible part of the system out of service.

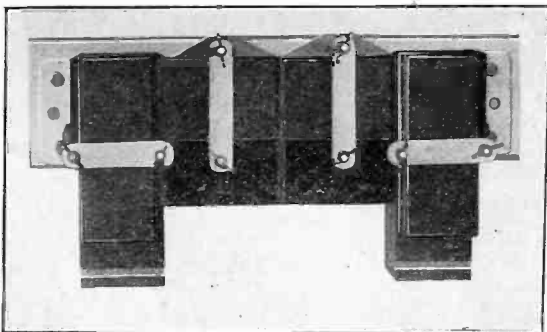

Metropolitan Subway Sectionalizing Units are waterproof, and the grounding of conductors due to flooded manholes is eliminated.

*For full information, use the Coupon.*

**Metropolitan Device  
Corporation**  
1250 Atlantic Ave., Brooklyn, N. Y.

**METROPOLITAN DEVICE CORPORATION**  
1250 Atlantic Avenue, Brooklyn, N. Y.

Gentlemen: Please send me booklets describing Cable Joints, Racks and Sectionalizing Units.

Name ..... Company .....

Address ..... Title .....

# Send for a copy of this **NEW** **BOOK**

## To Operating Executives:

We are all aware of the unprecedented demands that the expansion of the Electric Light and Power industry has placed upon plant and operating facilities.

The necessities thus produced are too numerous and diversified to be dealt with as a whole. The engineering problems they create must be solved separately and each exigency met with its own especial remedy.

It is for this reason that this little book concentrates on the use of Aerial Power Cable. The chief object is to describe the conditions where aerial power cable can be installed with successful results. It may often prove to be the best way out of tight places, and as well as the most economical course, as well as the most desirable from a service standpoint.

Having had long experience in the installation and operation of a large number of Aerial Power Cables, I would like to call attention to the advantages afforded by this form of construction in cases offering appropriate use for it.

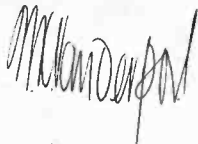

(W. K. VANDERPOEL)  
Vice President and Executive Engineer

Before becoming associated with the Okonite Organization, Mr. Vanderpoel was General Superintendent of Distribution with Public Service Electric & Gas Company (New Jersey). He has always been actively connected with important national technical committees and is a recognized authority on outdoor plant construction.

Page 3

Copyright, 1925  
The Okonite Company  
The Okonite Cable Company, Inc.

**32  
pages!**  
**Fully Illustrated**

THIS little book presents the latest and most complete information available on **AERIAL POWER CABLE**, Where Used, How Installed, Types of Cable, etc., and closes with an interesting chapter, "Notes Regarding Catenary Construction." It is profusely illustrated and just the book for your reference library.

*Be sure to get your copy To-Day! Use Coupon.*

### MAIL COUPON TODAY

THE OKONITE COMPANY, PASSAIC, N. J. Please send me booklet on "AERIAL POWER CABLE."

J. A. I. E.

Name .....

Street Number .....

City and State .....

Official Position .....

with .....



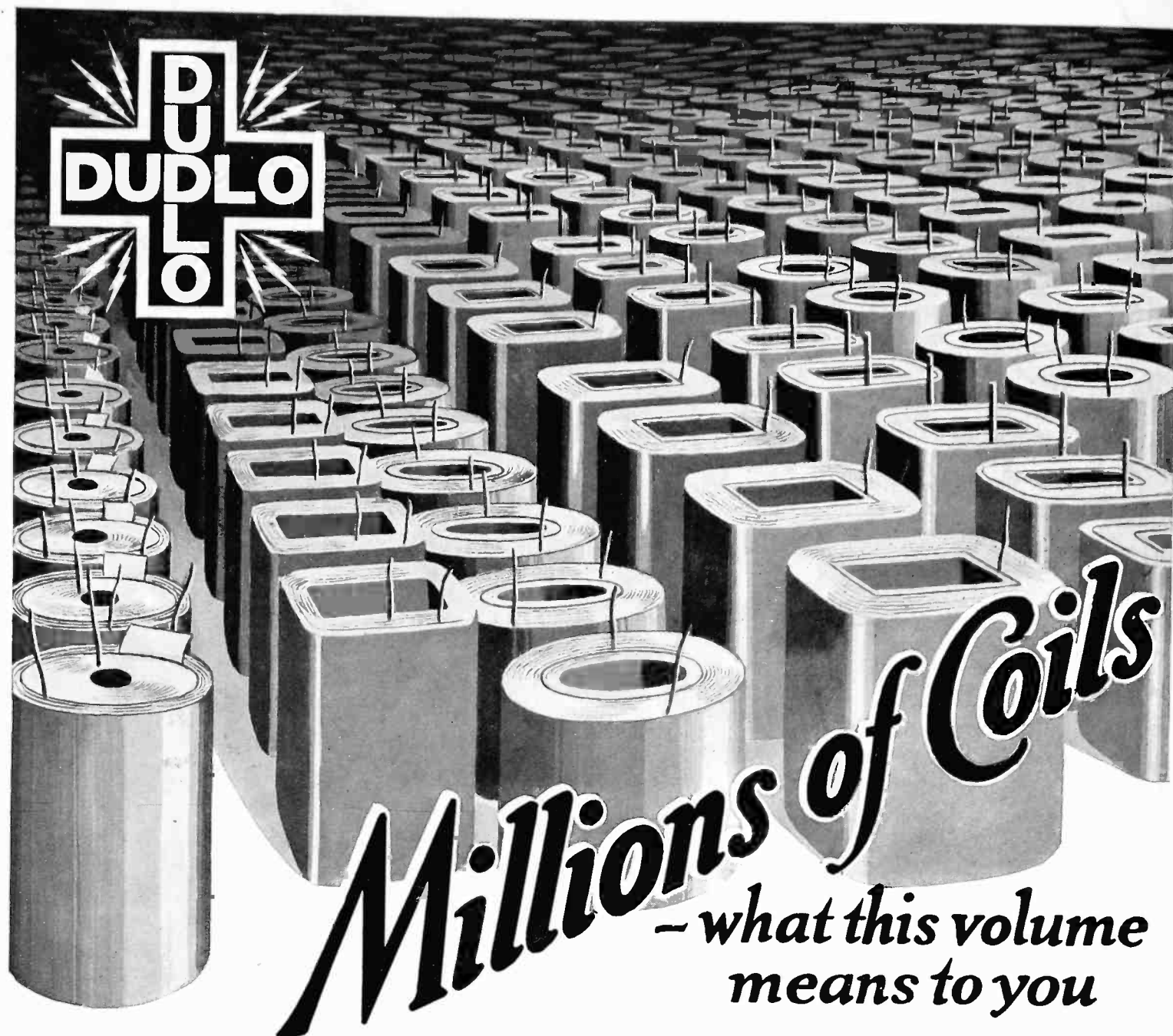

The fact that literally millions of coils are produced by Dudlo every season means not only that Dudlo is the world's headquarters for magnet wire and coils—but it has even greater significance.

This tremendous output automatically requires highly specialized manufacturing methods—impossible in smaller plants. It provides testing and inspection facilities that guarantee a more uniform product. It assures exact adherence to customers' specifications.

Such enormous volume also permits the maintenance of experimental laboratories that can be of great assistance to you in designing and developing more efficient coils for the products you make or sell.

Rush orders, large seasonal demands, or the unusual requirements of any manufacturer are regularly absorbed in the huge Dudlo plants without confusion, delays, or disappointments. The needs of any one branch of the electrical industry are well within the normal capacity of Dudlo.

Those manufacturers who use Dudlo coils in their products are never victims of lowered manufacturing standards or lax inspection even at the peak of the season.

# DUDLO

**DUDLO MANUFACTURING CORPORATION, FORT WAYNE, INDIANA**

56 EARL STREET  
NEWARK, N. J.

160 NORTH LA SALLE STREET  
CHICAGO, ILL.

4153 BINGHAM AVE.  
ST. LOUIS, MO.

274 BRANNAN ST.  
SAN FRANCISCO, CALIFORNIA