

JOURNAL OF THE A. I. E. E.

DECEMBER 1926



PUBLISHED MONTHLY BY THE
AMERICAN INSTITUTE OF ELECTRICAL ENGINEERS
33 WEST 39TH ST.
NEW YORK CITY

American Institute of Electrical Engineers

COMING MEETINGS

WINTER CONVENTION, New York, N. Y., February 7-11

REGIONAL MEETINGS

Southwest District No. 7, Kansas City, Mo., March 17-18

Middle Eastern District No. 2, Bethlehem, Pa., April 14-16

MEETINGS OF OTHER SOCIETIES

The American Society of Mechanical Engineers, New York, N. Y., Dec. 6-9

The American Physical Society, Annual Meeting, Philadelphia, Pa., Dec. 27-29

JOURNAL

OF THE

American Institute of Electrical Engineers

PUBLISHED MONTHLY BY THE AMERICAN INSTITUTE OF ELECTRICAL ENGINEERS
33 West 39th Street, New York

Subscription. \$10.00 per year to United States, Mexico, Cuba, Porto Rico, Hawaii and the Phillipines, \$10.50 to Canada and \$11.00 to all other Countries. Single copies \$1.00.

Entered as matter of the second class at the Post Office, New York, N. Y., May 10, 1905, under the Act of Congress, March 3, 1879. Acceptance for mailing at special rate of postage provided for in Section 1103, Act of October 3, 1917, authorized on August 3, 1918.

Vol. XLV

DECEMBER, 1926

Number 12

TABLE OF CONTENTS

Papers, Discussions, Reports, Etc.

Notes and Announcements	1201	Hydroelectric Projects of Major Importance	1276
Vacuum Switching Experiments at California Institute of Technology, by R. W. Sorensen and H. E. Mendenhall.	1203	Report of Committee on General Power Application	1277
Report of Committee on Power Transmission and Distribution	1207	Light Sketches Huge Faces on Mountain	1284
Vincent 220-Kv. Transmission Line, The, by C. B. Carlson and H. Michener	1215	Report of Committee on Application to Mining Work	1285
Phase Difference in Dielectrics, by J. B. Whitehead	1225	Discussion at Niagara Falls	
Increase of Electric Power in Factory and Homes	1228	Measurement of Transients by the Lichtenberg Figures (McEachron)	1286
Synchronizing Power in Synchronous Machines, by H. V. Putman	1229	Symposium on Dielectrics and Power Factor Measurements (Whitehead, Curtis, Hanson, Lee, Marbury, Doyle & Salter, Simons & Brown, St. Clair, Kowenhoven & Betz)	1288
Will He See and Hear Across U. S. in 1929?	1237	Discussion at Annual Convention	
Wind Makes Power Lines "Heavy on Their Feet"	1237	Law of Magnetization (Gokhale)	1298
Circle Diagram of a Transmission Network, The (Abridged), by F. E. Terman	1238	Synchronous Machines—I (Doherty and Nickle)	1302
Electric Power for Sicily's Sulphur Mines	1245	Report of Committee on Electrical Machinery (Hobart)	1306
Lightning. A Study of Lightning Rods and Cages (Abridged), by F. W. Peek, Jr.	1246	Discussion at Pacific Coast Convention	
Electricity Traps Iron Out of Smoke	1254	Variable-Voltage Equipment for Electric Power Shovels (McNeill)	1306
Construction of the 110-Kv. Transmission Line of the Washington Water Power Company, by L. R. Gamble	1255	Temperature of a Contact and Related Current-Interruption Problems (Sleplan)	1308
Electricity and Coal Mining, by Daniel Harrington	1264	110-Kv. Transmission Line Construction of the Washington Water Power Company (Gamble)	1309
New Type Single Sleeve Valve Engine	1267	Illumination Items	
Controlling Insulation Difficulties in the Vicinity of Great Salt Lake, by B. F. Howard	1268	Practical Color Photometry	1309
Research Relations Between Colleges and Industry, by A. A. Potter	1272	Must the Traveler Read Slowly?	1310
		Automatic and Supervisory Control of Hydroelectric Stations	1310

Institute and Related Activities

A. I. E. E. Regional Meeting	1311	Army Engineers Oppose Ocean-to-Lakes Ship Canal	1316
Transportation to be Discussed Before New York Section	1312	Muscle Shoals Fight in Next Congress	1316
Future Section Meetings	1312	Air-Cooled Engine Airplans Successfully Tested	1316
A. I. E. E. Appointment	1312	Air Rules Discussed	1316
Mechanical Engineers Plan Big Program	1313	Engineering Foundation	
Many Novelties at Power and Mechanical Engineering Exposition	1313	Progress in Testing Experimental Dam	1316
American Association for the Advancement of Science	1313	Personal Mention	1316
Standards Committee Meeting	1313	Addresses Wanted	1317
New Louisville Section Holds First Meeting	1313	Obituary	1317
A. I. E. E. Branch at College of Engineering, Newark Technical School	1314	Engineering Societies Library	
American Engineering Council		Book Notices	1318
Meeting of Administrative Board	1314	Past Section and Branch Meetings	1320
The Sterling Fellowship for Research	1314	Membership, Application, Elections, Transfers, Etc.	1321
Bureau of Standards' 25th Anniversary	1315	Engineering Societies Employment Service	
Business Historical Society Preserving Documents	1315	Positions Open	1329
A. S. T. M. Tentative Standards Now Available	1315	Men Available	1329
New Radio Stations Established	1315	Officers A. I. E. E.	1331
Work for Accident Prevention Praised	1315	Local Honorary Secretaries	1331
Important Engineering Subjects for Next Congress	1315	List of Sections	1331
Supervisory Control Safety System for Hudson Tunnel	1315	List of Branches	1332
		Digest of Current Industrial News	1348

A REQUEST FOR CHANGE OF ADDRESS must be received at Institute headquarters at least ten days before the date of issue with which it is to take effect. Duplicate copies cannot be sent without charge to replace those issues undelivered through failure to send such advance notice. With your new address be sure to mention the old one, indicating also any change in business connections.

Copyright 1926. By A. I. E. E.

Printed in U. S. A.

Permission is given to reprint any article after its date of publication, provided proper credit is given.

Current Electrical Articles Published by Other Societies

Agricultural Engineering, October 1926

Rural Electrification from an Economic and Engineering Standpoint, by
L. S. Wing

Institute of Radio Engineers, Proceedings, October 1926

A Method for Maximization in Circuit Calculation, by W. van B. Roberts

Combines Electromagnetic and Electrostatic Coupling and Some Uses of the
Combination, by E. H. Loftin and S. Y. White

Field Distribution and Radiation Resistance of a Straight Vertical Unloaded
Antenna Radiating at One of Its Harmonics, by S. A. Levin and C. J.
Young

Long Distance Radio Receiving Measurements and Atmospheric Disturbances
at the Bureau of Standards, in 1925, by L. W. Austin

On the Origin of the Superheterodyne Method, by W. Schottky

Reduction of Interference in Broadcast Reception, by A. N. Goldsmith

Some Measurements of Short-Wave Transmission, by R. A. Heising, T. C.
Schelleng and G. C. Southworth

Theory of Detection in a High Vacuum Thermionic Tube, by L. P. Smith

Journal, Franklin Institute, October 1926

Theory and Development of the Interpole Motor, by M. MacLaren

Journal of the A. I. E. E.

Devoted to the advancement of the theory and practise of electrical engineering and the allied arts and sciences

Vol. XLV

DECEMBER, 1926

Number 12

Engineering Education

The engineering graduate has often been criticised of late years for various shortcomings. These criticisms naturally reflect upon the institutions that give education in engineering subjects. As an educator, I would like to say a few words concerning this matter and set forth briefly both some of the reasons for criticism and some of the measures that educational institutions are using to rectify the causes of criticism. In this connection, I might point out that before becoming an educator I spent more than twenty-five years in the actual practise of engineering, and therefore have been able to observe this problem from both sides.

Of the many criticisms that have been leveled at the engineering graduate of the present day, I believe that the two most frequent are:

1st. That he lacks a proper appreciation of the economics of his chosen field.

2nd. That he lacks ability to express himself adequately either in writing or in speech.

Both of these criticisms are undoubtedly often justified. The obvious cure is more and better instruction in economics, English and public speaking. But how can more time be taken from engineering subjects for such additional instruction in these non-engineering subjects? Engineering has become much more complex and far reaching in its demands on the curricula for engineering subjects during the last twenty or thirty years than was even dreamed of in the early days of engineering education. To cite a specific example, the steam turbine is only about twenty-five years old, but its place in the field of deriving power from heat is today supreme. No engineering curriculum would today be adequate that did not undertake to inculcate the principles underlying the steam turbine. However, the steam turbine has not displaced the reciprocating machine and the principles underlying the latter must be inculcated as well as for the turbine. In other words, the rise of the steam turbine has placed an additional burden on the present day engineering curriculum that did not exist twenty-five years ago. And this specific example is only one out of dozens of the same nature that might be cited. The existing knowledge today is vastly greater than that of yesterday and this statement is particularly true of engineering subjects.

To repeat my previous question then, how can the engineering curriculum cover adequately the basic principles of engineering as expanded at the present day and still devote adequate attention to non-engi-

neering subjects? One answer to this question is to increase the time; extend the usual four year course to five or even to six years. This remedy has often been proposed and in a few cases has been applied. Where tried it has not met with any great favor if the number of students may be taken as a criterion. My own personal reaction to this proposal is adverse: I do not believe that the embryo engineer can afford to take more than four years out of his life for his technical education. If we accept the proposition that the engineering course should not cover more than four years (as I believe we must) it follows that our engineering curricula must not only cover the vastly increased technical field during that four years, but also must cover adequately those non-technical subjects, the lack of which has in the past provoked so much adverse criticism.

I wish to point out specifically that engineering educators are acutely alive to the problems that confront them. The Society for Promotion of Engineering Education is now and for some years past has been undertaking a comprehensive study of engineering curricula. This study covers all phases of these curricula, both engineering and non-engineering. To be still more specific, a committee of the S. P. E. E. on "Economic Content of Engineering Education" is now at work on this particular phase of the problem. In its endeavor to find the answer to this problem, the committee proposes to consult not only educators but also, so far as possible, every point of contact between the engineer and the community that he serves. This is only one of the many studies that is now being carried on by the S. P. E. E. These studies will cover every part of the engineering curriculum—technical and non-technical. The engineering educator is quite alive to the problems confronting him.

No engineering school pretends to produce a finished engineer; it simply turns out a man who, if he continues to progress in the direction in which he is pointed when he obtains his degree, will eventually become an engineer. His education is by no means completed when he receives his degree; education is a process that ceases only with death. It is the aim of the engineering school to give an inspiration—an impetus—that will continue and without which no man can hope to become an engineer in the true sense.

In closing I might add that the educator does not resent criticism; he welcomes it. But there are two kinds of criticism—destructive and constructive. The destructive kind simply wishes to destroy that which it aims at without setting up anything in its place.

The constructive variety does set up a substitute. It is obvious that constructive criticism is the only kind that is worthy of any real consideration.

P. M. LINCOLN, *Chairman*
Committee on Education

Some Leaders of the A. I. E. E.

William McClellan, thirty-fourth president of the Institute (1921-1922), was born in the city of Philadelphia, Pa., November 5, 1872. Here he also received his education, first at the Manual Training School and later at the University of Pennsylvania, from which, in 1900, he received his B.S. degree; in 1903 he obtained the degree of Ph.D., and in 1914 his degree in Electrical Engineering.

In 1900 Mr. McClellan entered the service of the Philadelphia Rapid Transit Company, at the same time occupying the office of instructor in Physics at the University of Pennsylvania. He next accepted a position with Westinghouse, Church, Kerr & Company in 1905, remaining with them until the formation of his own company, the Champion-McClellan Company, in 1907, with him as one of its directors. In 1915 this Company was reorganized under the name of Paine, McClellan and Champion, Consulting Engineers, New York City, and in 1922, Mr. McClellan's present Company, McClellan & Junkersfeld, Inc., was formed with Mr. McClellan as president.

From 1911 to 1913 he was consulting engineer for the Public Service Commission, Second District of New York, remaining in that capacity until 1919, when he was chosen dean of the Wharton School, University of Pennsylvania. From this date until 1921 he also served the Cleveland Electrical Illuminating Company as vice-president. In 1925 he was elected president of the Commission on Muscle Shoals.

Mr. McClellan's contributions to science have been noteworthy, both as regards the numerous articles published in technical magazines and papers presented before the representative professional bodies. This is true also of his personal work in the many executive offices which he has occupied. He is at present a member of the American Railway Association, The American Society of Mechanical Engineers, the National Electric Light Association; past-president of the Associated Pennsylvania Clubs, member of Alpha Chi Rho, Phi Beta Sigma, Sigma Xi and Beta Gamma Sigma; director of the Intercollegiate Intelligence Bureau, Washington, D. C.; and a member of the following clubs: the India House, Engineers, Bankers, University of Pa. of New York, Union League and University of Philadelphia, University and Cosmos clubs of Washington; the Huntington Valley Country Club and the Huntington Valley Hunt Club of Pennsylvania.

The Federal Judges' Salaries Bill

This Bill has passed the Senate and is definitely set for a vote in the House of Representatives December 9th. It is a public measure, important to the country at large, and particularly to those interested in patents, since sole jurisdiction over suits enforcing or annulling patents rests with the Federal Judges.

The present salaries of the District Judges (\$7500) and of the Circuit Judges (\$8500) are so inadequate, particularly in the larger cities, that due to a feeling of an injustice done them there is general dissatisfaction among the Judges in those cities. A number of the Judges have resigned and not a few are merely holding on to see whether the Bill of December 9th will be passed.

The Bill only increases the salaries of the District Judges to \$10,000, those of the Circuit Judges to \$12,500, and other Federal Judges accordingly. It *must be passed* if the quality of the Federal Judiciary is to be maintained.

American Engineering Council and practically all of the Engineering Societies are making final effort to enact this Bill now, for if it does not pass on December 9th, it will be many years probably before another attempt will be made. Every member of the Institute is therefore requested to write his member of the House of Representatives, urging him to be present on December 9th when the Graham Bill, H. R. 10,554, will be voted upon, and to give to this Bill his hearty support.

A New Type of Rectifier

Preliminary announcements have been made of a new type of rectifier which is extremely simple in principle and operation and which will be described in detail in a forthcoming paper before the Institute. The discoverer of the principle is Dr. L. O. Grondahl, who described it in a recent number of *Science*. The rectifier consists of a disk of copper having a coating of oxide formed on its surface and another metallic disk forming the opposite electrode. Under suitable conditions current flows more readily from the oxide to the copper than in the reverse direction.

The peculiarity of the new rectifier lies in the fact that the direction of the electron flow is opposite to that indicated by the theory underlying the electron tube. Explanations of contact rectification that appear most prominently in the literature, as, for example, electrolysis and thermoelectricity, are shown by Dr. Grondahl to be untenable for the new electronic solid-junction rectifier. The seat of rectification is apparently restricted to the layer near the junction between the copper and the compound formed on it.

Vacuum Switching Experiments at California Institute of Technology

ROYAL W. SORENSEN*

Fellow, A. I. E. E.

and

HALLAN E. MENDENHALL*

Associate, A. I. E. E.

Synopsis.—Successful experiments in switching or breaking a circuit in a high vacuum have been made at the California Institute of Technology. This paper is a report on three sets of these experiments which extended over a period of three years. The conclusions drawn from the experiments may be summed up in the statement that vacuum breakers of laboratory type have been successful in breaking circuits and offer a possible solution of the circuit-breaker problem.

The results show that switching in vacuum affords the advantages of no pitting of contacts, quick break, the arc always going out on the first half cycle, small voltage rise across the switch, and small distance of travel necessary for the switch blades.

Making the vacuum switch practical calls for a solution of the problem of making commercial apparatus with vacuum-tight joints, and the elimination of the use of liquid air with the vacuum pump.

EXPERIMENTS on breaking an electrical circuit in a high vacuum have been made during the last three years at the California Institute of Technology in connection with the study of switching high-voltage, high-power circuits. These experiments were undertaken as a result of the well-known limitations of oil circuit breakers. A large number of tests was made on high-vacuum breakers of laboratory type. Some very promising results were obtained in interrupting large currents.

When these experiments were suggested, the question immediately presenting itself was: Will the vacuum maintain itself at the time the arc is formed between the separating metallic parts of an opening switch?

This doubt was quite generally substantiated by the commonly recognized theory of the electric arc,¹ viz., that the maintenance of an arc is dependent upon the giving out of thermions from hot spots on the electrodes between which the arc is formed, with the attendant vaporization of the metal. If this were true, a large current could not be interrupted in a vacuum because the formation of even a small amount of gas would reduce the vacuum and cause it to become a conducting vacuum rather than an insulating vacuum.

The fact of the matter, however, is that if the vacuum is sufficiently high and all adsorbed gases have been removed from the metal electrodes, very large currents can be broken without formation of enough vapor to maintain an arc.

Dr. R. A. Millikan has shown² that, with cold electrodes suitably prepared, millions of volts of potential gradient are required to obtain discharges of any kind between metal surfaces. He has also worked out with much care the conditions necessary for denuding metal surfaces of gases and preventing the impairment of the vacuum through the evolution of gases. A. Janitzky³ also has reported experiments showing that currents will not flow across the space between cold electrodes in a vacuum provided the electrodes have been completely outgassed.

*Both of the California Institute of Technology, Pasadena, Calif.

1. For references, see Bibliography.

Presented at the Pacific Coast Convention of the A. I. E. E., Salt Lake City, Utah, Sept. 6-9, 1926.

According to the older theory, it would seem that considerable vapor might be formed in the vacuum on breaking a circuit. P. Charpentier⁴ has given the following equation:

$$W = 0.07 E I t$$

as the equation for the energy to be dissipated in an oil switch at the time of opening. In this equation, E = voltage, I = current, and t = the time in seconds between the initial separation of the switch contacts and the complete extinguishing of the arc. Charpentier's experiments, and also those made by Swiss engineers in 1915 and 1916, indicate that this energy is used in vaporizing oil at the rate of 46.5 cu. cm. per kw-sec. Some of the tests made on oil switches show the vaporization of smaller amounts of oil per kw-sec. and also show power factors of less than 0.07 across the switch at the time of interruption. Applying Charpentier's equation to a single-pole switch opening a 15,000-volt, 100-ampere, 50-cycle circuit, we find that the switch must dissipate 1.05 kw-sec. if it opens on the first half cycle. Assuming as an extreme case, for the vacuum switch, all of this energy available to vaporize copper at the switch blades, we find that it would vaporize approximately one-fifth gram. This amount of copper turned into vapor would reduce an insulating vacuum in a container of considerable size to a vacuum which would be conducting for 15,000 volts applied between electrodes extending into the container.

However, the later theories to which reference has been made indicate that such an amount of vapor will not be formed provided the vacuum is high and the electrodes are free from gas.

Therefore, in making the experiments, the prime requisites were to have the electrodes entirely free of adsorbed gases and to obtain a good vacuum. Dr. Millikan was immediately interested in the proposal of the tests and placed at our disposition the facilities and high-vacuum experience of the Norman Bridge Laboratory; also he cooperated in the development of the switch by making many valuable suggestions and by assigning to the work two graduate students of the physics department, H. E. Mendenhall and Russell Otis.

Three switches were developed and tested. The first

switch is shown in Fig. 1. It consists of a glass envelope with two fixed electrodes as shown, separated by one-half inch. These have crescent-shaped contact surfaces, *a* and *b*, as shown. The contact area of each of the fixed terminals is $\frac{1}{8}$ sq. in. The circuit is closed by a flat circular copper disk resting upon them with no contact pressure other than the weight of the disk, to which is attached a light plunger. The switch is opened in operation by a

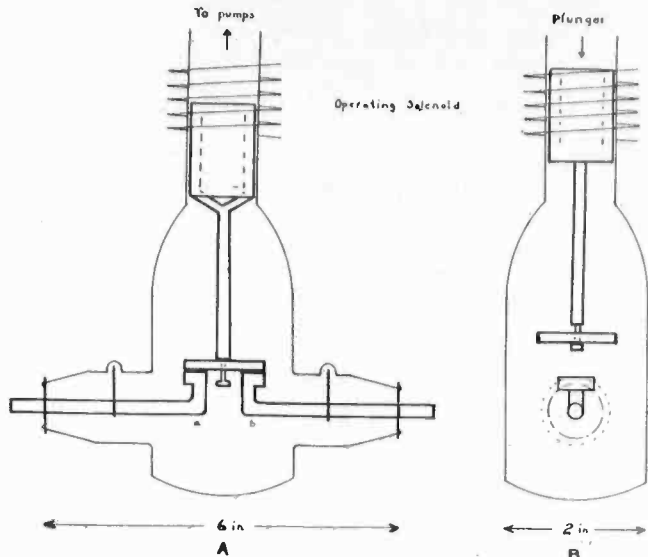

FIG. 1—CROSS-SECTION VIEWS OF SWITCH NO. 1

solenoid which, when energized, raises the plunger. In interrupting the circuit, the bridging circuit contact is raised $\frac{1}{2}$ in. by the solenoid. This type of construction gives two breaks in series when the switch is open.

Vacuum-tight joints between the lead-in conductors

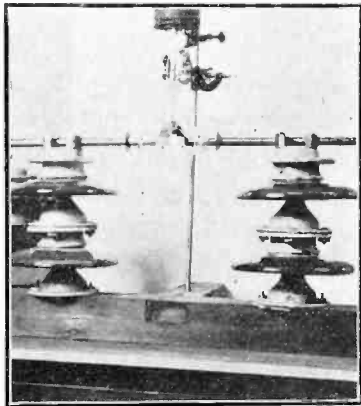

FIG. 2—VACUUM SWITCH NO. 2

and the glass envelope of the switch were easily obtained by means of W. G. Houskeeper's disk seals.⁵ This switch was evacuated down to 10^{-6} centimeters of mercury pressure. An initial test was made by using this switch to interrupt currents up to 125 amperes at 110 volts d-c. The results were encouraging, and the switch was connected to an a-c. supply and the test repeated with very satisfactory results, the interruption of current being accomplished with less arcing than occurred when direct current was used.

The switch was then successively used on a-c.

circuits for 220 volts, 2300 volts, and 15,000 volts. The load in every case was a single-phase load connected and disconnected by means of the switch used as a single-pole switch. There was no apparent difference in the operation of the switch at the different voltages with the exception that the switch was not properly designed to guard against arcing over the outside at 15,000 volts. This trouble was eliminated by immersing the switch in oil. When so immersed the switch was operated many times as a single-pole switch to interrupt 100 amperes at 15,000 volts. Every operation was successful.

The terminals of this switch, however, were very

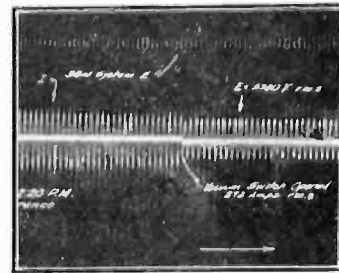

FIG. 3—VACUUM SWITCH INTERRUPTING 272 AMPERES AT 5380 VOLTS

small and therefore a second switch having terminals with more contact surface and leads of greater carrying capacity was built. Fig. 2 shows switch No. 2. This switch was constructed in the same manner as switch No. 1, but is larger and has better contacts, the bridge being made of spring-copper laminations. When the switch is closed, the edges of the laminations are held

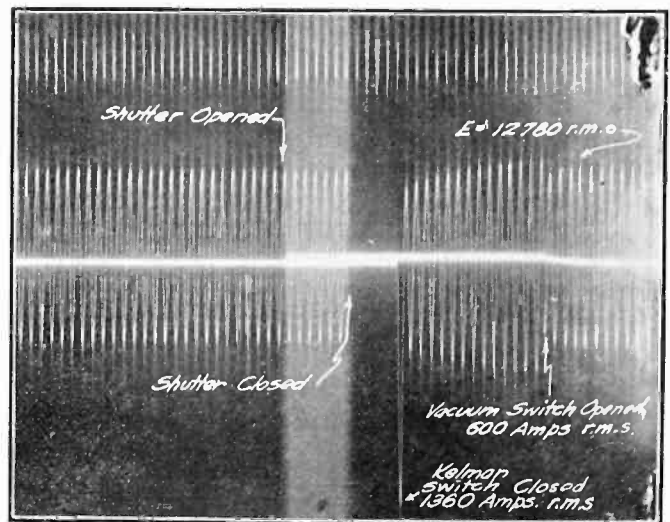

FIG. 4—VACUUM SWITCH INTERRUPTING 600 AMPERES AT 12,780 VOLTS

against the fixed contacts by the weight of the bridge and its lifting solenoid, the total weight being two pounds. The contact area of each fixed terminal is $\frac{3}{4}$ sq. in., the distance between the fixed terminals being one inch. In interrupting circuit the bridge is raised one inch.

This switch was given laboratory tests on a 15,000-volt, single-phase circuit providing currents up to 120

amperes at this voltage. The switch was operated as a single-pole switch to open and close this circuit more than 500 times without showing any burning of the switch contacts. It was then sealed off from the vacuum pump and allowed to stand in the laboratory for three months, during which time it was tested occasionally to determine its condition. At the end of the three months the switch was taken to the Torrence substation of the Southern California Edison Company and used to open short circuits made on a synchronous

switch No. 2 and a standard make of oil switch opening the same circuit on a load of 100 amperes at 15,000 volts. The tests were made under conditions as nearly identical as possible, and within a few minutes of each other. It will be noted from these graphs that the rise in voltage when the circuit is opened with the oil switch is greater than when the circuit is opened with the vacuum switch. The oil switch in a large number of tests failed to open the circuit on the first half cycle, while the vacuum switch always opened the circuit on the first half cycle. An examination of a number of oscillograph records for oil switches and for the vacuum switching showed that when the circuit was opened the rise in voltage above normal circuit voltage was higher for the oil switch than for the vacuum switch. The klydonograph⁶ was used in some of the switching tests to record any high-frequency surges that might occur.

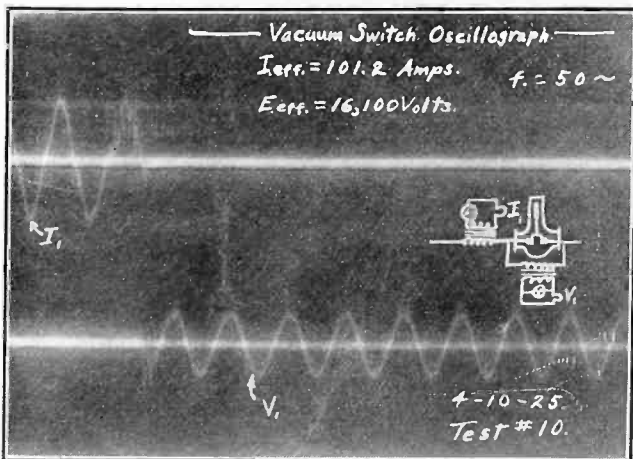

FIG. 5—OSCILLOGRAM SHOWING CURRENT OPENED BY VACUUM SWITCH AND VOLTAGE ACROSS SWITCH AT OPENING

$I_{eff} = 101.2$ amperes $E_{eff} = 16,100$ volts $f = 50$ cycles

condenser just as the condenser was disconnected from the Edison distribution system. The current was supplied to the switch from the condenser through step-up transformers. The switch repeatedly opened the single-phase short circuit thus provided without any failure

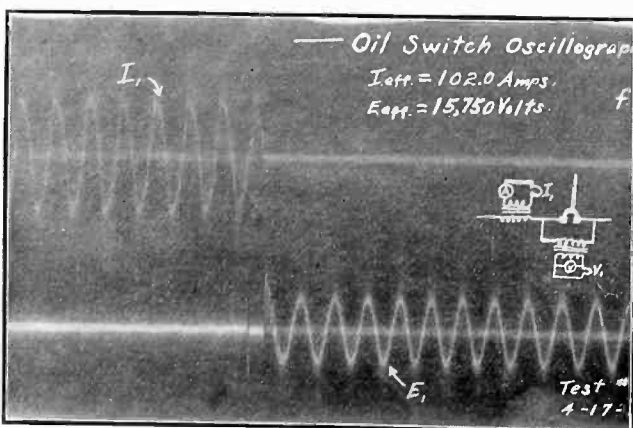

FIG. 6—OSCILLOGRAM SHOWING CURRENT OPENED BY OIL SWITCH AND VOLTAGE ACROSS SWITCH AT OPENING

Note that 12 cycles are between initial contact separation and extinguishing of arc

$I_{eff} = 102$ amperes $E_{eff} = 15,750$ volts $f = 50$ cycles

to interrupt the circuit or any burning of the switch contacts. Figs. 3 and 4 show oscillograms of switch No. 2 opening 272 amperes at 5380 volts and 600 amperes at 12,780 volts, respectively.

Figs. 5 and 6 show oscillographic records of vacuum

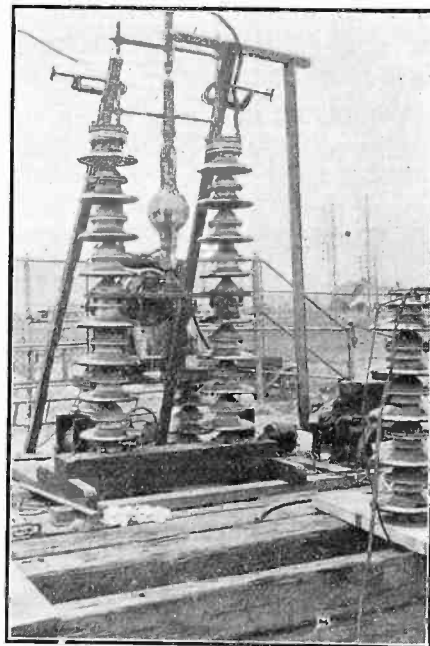

FIG. 7—VACUUM SWITCH NO. 3

In no case did the instrument indicate voltages much above normal.

Following these tests, switch No. 3 shown in Fig. 7 was constructed. The figure shows the switch in the closed position. Switch No. 3 was constructed primarily to overcome the disadvantage, in switches Nos. 1 and 2, of having all moving parts sealed inside the glass envelope of the switch, a condition requiring the operating solenoid to be kept energized when the switch is open, unless a rather intricate locking mechanism also be installed inside the switch to hold it open.

In switch No. 3, the moving contact is of the bayonet type, the bayonet sliding into a cylindrical socket. The bayonet is a $\frac{3}{4}$ -in. copper rod projecting into the socket when closed so as to give a contact length of one in., the total contact surface obtained in this way being 2.3 sq. in. With this construction, there is only a single break, the contacts opening so as to separate them a distance of one in. when the switch is completely open.

The single break appeared to function as well as the double break used in switches 1 and 2. The switch was operated by a standard switch-operating mechanism borrowed from an oil switch. With such an arrangement, the switch can be left open or closed at will. Vacuum-tight joints for the lead-in conductors of this switch were made by cementing to the glass envelope metal caps attached to the leads and forming a part of the leads.

After some preliminary testing in the laboratory, this switch was taken to the Laguna-Bell substation of the Southern California Edison Company and used as a single-pole switch to open single-phase short circuits on a 30,000-kv-a., synchronous condenser. In performing the tests, the synchronous condenser was brought up to speed on the distribution system of the Edison Company, disconnected from the system and immediately short-circuited through the switch. The condenser used was a 6600-volt, three-phase, Westinghouse condenser which, for the purpose of testing the switch, was connected to the switch through step-up transformers by means of which voltages across the switch as high as 41,500 volts were reached. Fig. 8

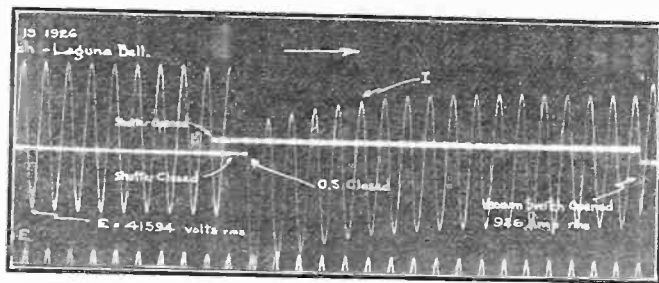

FIG. 8—VACUUM SWITCH OPENING 926 AMPERES AT 41,594 VOLTS

shows an oscillogram for this switch interrupting 926 amperes at 41,500 volts.

A noticeable feature of the vacuum-switch tests is that every oscillographic record shows that the arc produced at the opening of the switch is extinguished at the end of the first half cycle after the separation of the contacts. Only the very best oil-switch operations give this result.

The absence of any pitting of switch contacts and the fact that the vacuum is not reduced appreciably when the switch is in operation is evidence that very little of the energy dissipated when the switch is opened is used in vaporizing metal from the contacts.

When the contacts separate, there is a visible arc, just as when a switch is opened in air or oil. The magnitude of this arc, however, is much less than that of an arc made by like values of voltage and current in air or oil. This is to be expected because there is nothing in a vacuum switch to burn or to support combustion, as is the case when a switch is opened in oil or air.

The action of the arc in vacuum also indicates a

doubt as to the soundness of the theory that an arc to be maintained must be supported by thermions emanating from hot spots on the electrodes between which the arc is formed. J. Slepian⁷ has shown that an arc is probably formed near the surface of metal electrodes by very high temperatures caused by the concentration of electric current in the gas immediately surrounding the electrodes. The experiments at California Institute of Technology show that the vacuum switch, when opened, fails to interrupt an electric circuit if the metal forming the contacts has not been freed of the adsorbed gases; that is, gases adhering to the surface of the metal.

The results of these experiments cannot be taken as conclusive evidence that a new type of electric switch has been developed, because the limits of performance have not been determined and there are many problems relating to details that must be solved to make the switch practical. The switch, however, was never the limiting factor in any of the tests made. There is, therefore, certainly sufficient encouragement to warrant further investigation of the subject for the purpose of determining the fundamentals of switching phenomena, if for no other reason. Also, we have the encouraging fact that many practical devices in use today presented, in the early stages of their development, obstacles which appeared greater than those which these tests indicate.

The authors of this paper are indebted to those already mentioned as having a part in the program, and in addition, to graduate students in the Department of Electrical Engineering, J. J. DeVoe, J. H. Hamilton, and F. C. Lindvall, for assisting in laboratory and field tests; to Julius Pearson and William Clancy for their skill in doing the machine work and glass blowing; and also to the many members of the Southern California Edison Company who made provision for having switches Nos. 2 and 3 tested on the Edison system and helped in making the tests.

Bibliography

1. K. T. Compton, "Theory of the Electric Arc," *Phys. Rev.*, 21, p. 266, (1923).
2. Millikan and Shackleford, *Phys. Rev.*, 15, p. 239, (1920); also Millikan and Eyring, *Phys. Rev.*, 27, p. 51, (1926).
3. Alexander Janitzky, "Über die Bedeutung des Gasgehalts von Metallen für einige elektrische Erscheinungen," *Zeitschrift für Physik*, 31, S277, (1925).
4. P. Charpentier, "Dimensions, Construction and Design of Oil Switches," *Revue General de Lctrique*, May 5, 1923, p. 737.
5. W. G. Houskeeper, "Sealing Base Metals through Glass," *A. I. E. E. JOURNAL*, 42, pp. 954-960, (Sept. 1923).
6. J. H. Cox and J. W. Legg, "The Klydonograph and Its Application to Surge Investigation," *A. I. E. E. JOURNAL*, 44, (Oct. 1925).
7. J. Slepian, "The Transition from Glow to Arc Discharge at Atmospheric Pressure," *Journal of the Franklin Institute*, 201, p. 79, (Jan. 1926).

Transmission and Distribution

Annual Report Committee on Power Transmission and Distribution*

PERCY H. THOMAS, Chairman

To the Board of Directors:

INTRODUCTORY

The present report of the Committee on Power Transmission and Distribution has been prepared through the cooperative efforts of the members of the Committee and does not represent the views of any particular member or group of members. Each of the several topics found below has been considered by those particular committee members who are the best qualified to discuss that subject and the subject matter herein is substantially that prepared by such members.

The purpose of the report is to cover the present state of the art of Power Transmission and Distribution, or the progress during the year, in such a way as to present a clear view of what has been accomplished, this being intended for the consideration not only of transmission and distribution engineers but of other members of the Institute interested in different branches of the electric power field.

Where appropriate, at the end of each section there is added for purposes of discussion a series of topics covering subject matter now being investigated or subject to controversy.

TRANSMISSION LINE STRUCTURES

The trend of the year in transmission structures is a continuation of the study to move large blocks of power over considerable distances. Attention has been given to the design of lighter, cheaper, and simpler structures by careful utilization of materials and by great attention to prevention of corrosion or other forms of rapid depreciation.

A number of new construction methods and ideas have arisen during the year for 220-kv. lines. In eastern Pennsylvania a single-circuit, 220-kv. tower line has just been completed, designed for a general condi-

tion of one-in. radial ice, with exposed sections at higher elevations designed for a loading of one and one-half in. radial ice. To limit the stress that can be thrown upon the tower by unbalanced conductor pull due to unequal loading or a broken conductor, a clamp has been designed to slip at a moderate value. By this means it is possible to secure economies in the weight of tower steel and a decrease in the strain on and consequently the cost of foundations and still assure the safety of the structure.

The same line has brought forward a new structure for heavy angles and dead-ends. To avoid the heavy expense of the tower and footings of the conventional self-supporting structure, use has been made of a guyed mast. This structure is pivoted at the bottom and guyed at the top so that all load upon the tower is vertical and all side pull from the conductors is carried to suitable anchorage through tension members.

In connection with this job a new splice for the steel reinforced aluminum conductor has been developed. This splice combines the advantages of small diameter, ease of make up in the field, and high efficiency. The usual twisted sleeve for the joining of the steel cores has been replaced by a soft iron compression sleeve. A single piece aluminum sleeve is then compressed over the iron sleeve and the aluminum strands.

In California an extension to the Pit River—Vaca Dixon, 220-kv. lines has brought out novel construction for the crossing of the Sacramento and San Joaquin Rivers and the interlying lowlands. The crossing has an overall length of approximately 24,000 ft. and is accomplished by the use of twelve suspension structures and four anchor towers. The special suspension towers (the conductor resting in a saddle supported by suspension insulator strings) vary in height from 200 ft. to 460 ft., while the anchor towers and three suspension towers on the island are standard structures. The two river crossing spans are respectively 4135 and 3175 ft., but the adjacent structures bring the total distance between anchor towers for these sections to 8000 and 8500 ft. Insulation and clearance to towers for the crossing sections have been materially increased above the general transmission design values to reduce hazard of electrical trouble at these points. The entire project is particularly novel because of the difficulties of obtaining suitable footings and because of the extreme height of the crossing towers.

In the Philadelphia region there has been a novel development in double-circuit tower design for operation at 132 kv. Throughout this line the horizontal

*Committee on Power Transmission and Distribution.

P. H. Thomas, Chairman

P. H. Chase, Vice-Chairman

R. N. Conwell, Vice-Chairman

F. M. Farmer, Secretary

C. G. Adsit,

R. W. Atkinson,

A. O. Austin,

F. G. Baum,

John A. Brundige,

V. Bush,

George F. Chellis,

Wallace S. Clark,

Edith Clarke,

W. H. Cole,

M. T. Crawford,

John C. Damon,

W. A. Del Mar,

Herbert H. Dewey,

L. L. Elden,

R. D. Evans,

C. L. Fortescue,

C. D. Gray,

W. A. Hillebrand,

J. P. Jollyman,

A. H. Kehoe,

C. H. Kraft,

A. H. Lawton,

W. E. Meyer,

W. E. Mitchell,

Clifford R. Oliver,

John C. Parker,

F. W. Peek, Jr.

G. G. Post,

D. W. Roper,

C. E. Schwenger,

A. E. Silver,

M. L. Sindeband,

H. C. Sutton,

Philip Torchio,

Theodore Varney,

H. S. Warren,

R. J. C. Wood.

Presented at the Annual Convention of the A. I. E. E. at White Sulphur Springs, June 21-25, 1926.

offset of the middle conductor has been toward the center line of the tower rather than outward, as is customary. In other words, the top and bottom crossarms are longer than the middle one. This was done to provide greater clearance, the minimum for the top conductor being six in. greater than for the other two conductors, and the effect of the batter of the tower in reducing clearance for the bottom conductor being avoided. This line has been designed with special care to maintain clearance to tower equal to the length of the insulator string even under a condition of 30-deg. side swing.

This matter of conductor spacing and clearance to tower members deserves special consideration at this time. Clearance and spacings for the vertical configurations now in common use for double-circuit towers have become somewhat standardized, but for the new types of towers using horizontal configuration a new problem arises. If the double-circuit tower with horizontal arrangement of conductors, such as is now in operation in New England, comes into general use, it would be handicapped should unnecessarily large spacing be adopted at the beginning. We have experience on steel-tower, long-span construction with horizontal configuration at 220 kv., 165 kv., and 150 kv., and at lower voltages with wood pole construction. It seems desirable to give attention to this matter of horizontal spacing for long-span, moderate voltage, double-circuit lines and to determine the relationship of length of span and operating voltage to width of spacing necessary for reliable transmission.

DISTRIBUTION

A-C. Low Voltage Networks. The subject of a-c., low-voltage networks, particularly as applied to underground distribution in heavily loaded areas, has received fully as much attention during the current year as any other distribution problem. A number of installations have already been made and a number are being contemplated. The main features of the problem relate particularly to (a) the method of protection against failure of the transformers and primary feeders supplying the network, in order to insure proper continuity of service, and (b) the most selective isolation of any portion of the system which has developed fault.

During the year there have been developed new types of network protectors consisting of low voltage circuit-breakers with relay and automatic reclosing features, and also submersion-proof, automatic oil-circuit breakers for primary voltages up to 15,000 volts. These two types of equipment are used respectively with two general methods of supply for a-c. networks:

1. Interlaced radial primary feeders with secondary network breakers and reverse power protection.
2. Loop primary feeders sectionalized by circuit-breakers and balanced pilot wire protection.

Secondary Distribution Systems and Voltages. Secondary a-c. systems and voltages have received extended attention. This has arisen primarily from network

situations and the desire to establish combined lighting and power secondaries.

Owing to the square root of three relation which exists between phase, voltage and normal neutral of a three-phase system, it is necessary either to sacrifice an entirely balanced loaded system, or else to deviate from either or both of the lighting or polyphase motor voltage standards, as the ratio between these voltages is two to one. This has resulted in some engineers advocating the modification of the present standard motor voltages, the development of special distribution equipment such as translators, etc.

Often the problems of secondary distribution are greatly influenced by local conditions, principally by the type of system already in existence, when the inherent economies of the different systems do not differ widely. Also the costs of changeover may outweigh the potential savings.

System Grounding Practise. There has been considerable discussion with reference to grounding practise on distribution systems, particularly on the 4000-volt, three-phase, grounded neutral primary systems with a common neutral for both the primary and secondary, and having distributed grounds. This type of system, which it is claimed offers very considerable economies and decreased operating hazards, is receiving increased attention on the part of central station engineers and has been the subject of papers before the Institute during the past year.

High-Voltage Distribution. Using the term "high voltage" with reference to primary distribution voltages above the 4000- to 4800-volt class, the past year has seen more extensive use of the higher voltages and the improvement of methods of construction and protective devices for minimizing costs and operating hazards. There is an increased tendency toward the utilization of voltages of the magnitude of 13,200 volts, which often are the generated voltages, and even higher, for the supply of power for general distribution instead of only for large power consumers. The simplicity and economy of this method in territory having sufficiently great density of load are apparent from the saving in sub-station investment, the avoidance of one transformation, less complication, and decreased primary distribution copper, as compared with the lower voltages. The problems of voltage regulation, insurance to service, and decreased operating hazards have been given such study that very favorable results have been reported.

Street Lighting Distribution. The advantages of supplying the street lighting system from the general distribution system instead of from specialized equipment located in sub-stations have become increasingly apparent. The past year has witnessed a greater application of decentralized supply for street lighting. The choice between multiple lighting with individual or group supply from secondary mains, and series circuits supplied from pole or subway type constant-

current transformers depends very largely upon local conditions such as the availability of lighting mains over the entire territory. The development of reliable outdoor control equipment for both multiple and series systems has made substantial progress.

Power Factor. Power factor conditions on distribution systems have received increased attention. This has led to the development of motors for industrial service which operate at higher power factors. Increased attention has also been given to the possibility of power factor correction by means of synchronous or static condensers. The use of these latter devices in smaller sizes than heretofore considered feasible is now being advocated in many instances. There is a general tendency to raise the power factor on the individual distribution feeder as resulting benefits will be broader than with correction at sub-stations.

Single- Vs. Multiple-Conductor Cable. Particular attention has been directed toward the possibility of using single rather than multiple-conductor cable for distribution purposes. Where local conditions warrant, the single-conductor cable has many advantages, among which may be noted its superiority as regards connection to apparatus, localization of faults, and possibility of replacement of only a single phase of the circuit rather than the entire circuit. These points are particularly true in regard to distributing mains, secondary mains, and services.

For primary feeders the tendency is still to favor the multiple-conductor cable, although in several instances, depending upon local conditions, it is probable that some saving in yearly operating costs could be made by using single-conductor.

Continuity of Service. Continuity of service to customers has been improved by improved methods in fusing of distribution transformers and by the greater utilization of automatic reclosing feeder circuit breakers.

As distinguished from the earlier practise of fusing transformers mainly to protect them against overloads, the practise now tends toward higher fusing, to clear the transformers only in case of short circuits and for the protection of the primary circuit. With proper coordination with the relaying of the feeder breakers in the sub-station, there is increased assurance that failure of a transformer will not trip the entire circuit and, with radial secondary mains, only the customers supplied from the faulty transformer are interrupted.

Continued experience with automatic reclosing equipment on sub-station feeder circuit breakers has shown that the continuity of service to customers is greatly improved owing to the interruptions being usually momentary in the event of trouble on the circuit such as tree contacts, momentary heavy overloads, short circuits, etc.

Group Feeder Voltage Regulation. The past year has shown a tendency to make use of group, rather than individual, regulation for distribution feeders. This results in a simplification of the apparatus necessary

in the sub-station and accordingly affords some economies. Group regulation is made possible for those feeders having approximately the same per cent drop from the sub-station to the load center and which carry approximately the same magnitude and type of load, such as in an a-c. network.

INTERCONNECTION OF POWER UTILITIES

The practise of interconnecting adjacent utilities and of the transfer or exchange of power continues. This practise differs fundamentally from the interchange of power between power plants in a given system in that, in place of the unitary operation and one-man control of the single system, interconnection usually involves independent operation and independent control of the separate utilities. The result of actual operation indicates that unless attention is paid to the synchronizing characteristics of the interconnections and sufficiently close cooperation is secured in operation, each company must be prepared, at least on occasion, to care for its own load, since at times of disturbance it sometimes happens that synchronism between the utilities is lost and the systems separated. This difficulty is especially to be feared in territory subject to disturbance from lightning.

While the benefits of continuity of operation may of course be obtained with interconnected utilities by the same technical methods used in the operation of single large systems, namely, by one-man control and the proper design of governor and other apparatus and connecting lines, such coordination has not so far been undertaken on any large scale.

One of the most notable and extensive interconnections exists in the southeastern states and recent experience in this district is important. There has existed for several years a connection at 110,000 volts between the Alabama Power Company system and the Georgia Railway & Power Company system, the connection being between Gadsden, Alabama and Lindale, Ga. In the late fall of 1924 interconnection was completed at 110,000 volts between the North Auburn Sub-station of the Alabama Power Company and the Columbus Electric and Power Company's sub-station at West Point, Ga. An interconnection at 110,000 volts was also completed in 1925 between Columbus Electric & Power Company's Bartlett's Ferry plant and the Central Georgia Power Company at Macon, Ga. During the dry season of 1925, these interconnections were used to the limit of their capacity in order to transmit power from the steam plants in Alabama to supply the deficiency of the three above mentioned companies in Georgia and also to Augusta, Ga., to which point the Georgia Railway & Power Company extended one of their 110,000-volt circuits.

In 1925 no particularly new problems in operation came up and it was found feasible to interchange blocks of power as large as 40,000 kw. over tie lines which were originally constructed for capacity of 25,000 kw

The principal features to be worked out in connection with the interchange of large blocks of power as far as we have seen in the south are the maintenance of proper frequency and the absolute necessity of the receiving system taking care of not only the wattless current of their own system, but also part of that for the sending system. The necessity of having synchronous condensers or other regulating equipment in order to maintain satisfactory voltage conditions at the receiving load centers if entirely satisfactory service was to be given was clearly demonstrated. Practically none of the interconnected systems in the south have sufficient condenser capacity for conditions such as existed during the drought of 1925. It was frequently necessary to operate large hydro generators as condensers in order to take care of wattless current and voltage regulation. Not being primarily designed for such work, these generators, of course, are not as satisfactory as synchronous condensers.

It was demonstrated that many of the apparently difficult problems of coordination and of technical details as to handling of an individual company's load in a group of interconnected but independently operated systems largely disappeared when it became a question of subordinating these things to the necessity of obtaining power to take care of one's customers. The dry season of 1925 further showed the possibility of steam plants taking care of a serious shortage of hydro power. Power was actually relayed a distance of approximately 500 mi. at 110,000 volts. It was found necessary in some cases to revise relay set-ups of the interconnected companies from their normal set-up in order to take advantage of the maximum interchange. Necessity made many things possible which would not have been done under normal operating conditions. An Operating Committee has been functioning among the power companies of the southeast for some two years, exchanging data on load and generating conditions. This committee worked exceedingly well coordinating to make the maximum use of the power available. Through this committee, load dispatchers gained a better perspective of the interconnected systems, and while each system was operated independently, they were so coordinated that there was no difficulty in making the maximum use of the transmission lines and generating plants.

Speaking generally, it is felt to be proved with reasonable satisfaction that the interconnection of independent systems has been of material benefit in reducing the period of outage due to serious trouble on any one system. Without absolutely unified control of the operation, it is somewhat questionable just how far the interconnection of systems has operated to prevent momentary outages. Unquestionably, it has reduced the duration of outages, however. During the progress of interconnection, from experience in the southeast, the following seem to be the most important items to be considered:

1. A more careful investigation of relay protective equipment of each individual system and their coordination with other systems so that the maximum benefit of interconnection may be made use of.

2. The installation of more synchronous condenser capacity at most centers to take care of wattless current and for voltage regulation.

3. A more thorough understanding on the part of load dispatchers and operating superintendents of each other's system requirements so that shortages may be foreseen as far in advance as possible.

4. A careful study of the value of booster transformers at the point of interconnection between systems, these transformers to be equipped with tap circuits so that the voltage may be changed as required to supply current in either direction without disturbing the balance of either of the two interconnected systems.

The following additional topics for discussion are of general importance:

5. What is the most feasible method of interconnecting large systems, whether under one-man control or not, so that continuity of supply may be assured to all from a base load plant?

6. How should the interchange of power between particular systems and the power factor at various points be controlled where three or more independently operated systems are mutually interconnected by several links?

UNDERGROUND CABLES

The outstanding advance in the field of underground transmission during the past year has been the development of a radically new type of single-conductor cable for operation at 132 kv., three-phase. The New York Edison-United Companies and the Commonwealth Edison Company have placed orders for such cable for lines about 10 and 6 mi. long, respectively, for installation this year. The carrying capacity will be about 90,000 kv-a. per circuit.

The cable will have a 600,000-cir. mil. hollow conductor insulated with 23/32 in. of impregnated-paper insulation. This thickness is less than has been used on single-conductor cables recently installed on 66- and 75- kv., three-phase circuits in this country. The overall diameter will be about 3.1 in. The cable will be impregnated with a thin oil which will be under pressure during operation, in order to minimize the possibility of the formation of voids in the insulation.

The lengths will be connected so that the hollow space will be continuous through the ordinary joints. The line will be divided into sections about one mi. long, each section ending in barrier joints, wherein the copper conductors will be connected, but the central hollow spaces of adjacent sections will be blocked from each other. Elevated reservoirs will be connected by pipe lines which connect through the barrier joints to the hollow space in the conductor and thereby maintain a hydrostatic pressure on the oil. When the cable be-

comes warm during operation, oil will flow from it into the reservoir and vice versa.

An unusual feature of this cable is the large charging current which amounts to about 2400 kv-a. three-phase per mi. of line at a leading power factor of about one per cent.

Several manufacturers are developing other types of 132-kv. cable and making length for short experimental installations.

There has been an increasing interest in three-conductor cable which has a metallic covering over the insulation of each conductor and no belt insulation. A number of commercial installations are at present being made in this country at 27 and 33 kv.; and it is reported that several installations of similar type cable have been made in Europe at various voltages including higher voltages.

The data accumulated by the Electrical Testing Laboratories on their inspection and tests of several million feet of high-tension cable as reported by F. M. Farmer at the Madison meeting, A. I. E. E., May 6th and 7th, show a marked improvement in the quality of the cable made during the last few years. This is shown by the increase in the dielectric strength and reduction of damage to insulation due to bending test. The improvements in quality shown by such test data, combined with operating experience, has led to considerable reductions in the insulation thickness used by some operating companies, and the use of higher voltages for given thicknesses of insulation.

Several American manufacturers are now using wood pulp paper for a portion or all of the insulation in the cable. In some cases the paper is entirely wood pulp, while in other cases the paper is a combination of wood pulp and manila hemp stock. Some manufacturers report that this paper will lead to improved dielectric strength and decreased cost.

It has been learned that one of the principal causes of the failures in high-voltage cable was the use of impregnating compounds that were unstable under the dielectric stresses and temperatures of normal operation. Some of the manufacturers and the Electrical Testing Laboratories have developed tests which will aid in the selection of compounds free from this difficulty.

Some questions now under discussion are as follows:

1. The use of wood-pulp paper insulation instead of paper made from manila hemp rope fiber.
2. The use of three-conductor cable which has a metallic covering over the insulation of each conductor and no belt insulation for voltages above 33 kv.
3. The limiting voltage for three-conductor cables of standard construction.
4. Changes in the test requirements now included in specifications for high tension cables so as to secure more satisfactory operation.
5. Possibilities of increasing the maximum operating

voltage of underground cables by changing the type of construction.

STABILITY AND LOAD LIMIT IN LONG TRANSMISSION LINES

During the past three years, very considerable progress has been made in the subject of transmission stability and load limit, and it seems appropriate at this time to make a resumé of the present status of this problem.

It is now generally recognized that stability constitutes an important problem in the transmission of power over long distances, or for large amounts per circuit. Furthermore, many of the interruptions to service on existing systems have been due to instability at times of transient disturbances, which situation has been recognized as a result of increased knowledge of system operations during and after an abnormal disturbance condition. The extensive investigations which have been made during the last few years have increased our technical knowledge of the stability problem, so that at the present time, given the necessary basic data and machine performance circuit constants, etc., the performance of any system in regard to load limit or static or transient limits can be predicted with a sufficient degree of accuracy for the present purposes. It is believed that the various groups which have been working on the problem would give substantially the same results for identical assumptions as to the layout of the power system, and as to the rate of variation of prime mover governors, kind of voltage regulators, duration of disturbance, etc. The way in which the stability problem affects the design of layout is understood from the technical side, and a number of schemes have been proposed for increasing the stability of systems.

In the actual operation of power systems, the way in which stability studies will manifest themselves is by reducing the number or duration of interruptions to service or by permitting the increased amount of power to be handled without reducing the standard of service. At the present time, the principal problem is not one of determining how the system will act for a definite set of conditions, but to what extent it is desirable to modify the design of systems in order to improve them from this standpoint. In order to do this, it will be necessary to get the cooperation of the operating companies so as to interpret on an economic basis the costs of interruptions to service. When this has been done, it will be a relatively simple matter to determine the additional expense in remedial measures for improving stability which should be employed in any particular case.

The practical value of means to increase the stability or load limit of any system may be evaluated on the basis of the amount of additional power that may be delivered over the system based on the conditions that the transient stability or load limit of the system will

be the same for a given fault condition as it would be for the system without the means with the lower quantity of power delivered. The determination of the actual load at which the systems will be run is a matter for the operating engineers themselves to decide, as this involves the income value of the good will obtained by increased reliability of service which is difficult to define and which will vary with different localities and at different times. In connection with the stability problem, there are certain speculative factors which can be evaluated only by the statistical method. Such factors include the value of fault resistance, the average duration and character of various types of disturbance, etc. In this connection, it should be pointed out that the ordinary records obtained on systems are entirely unsuitable for interpreting the stability conditions, because such instruments are not adapted for recording the high frequency electro-mechanical transients which take place at times of a disturbance. Of particular significance is the move taken by one or two power companies to install specially designed recording apparatus for obtaining adequate records on operating experience from the standpoint of stability. This will logically lead to increased information as to the operation of existing systems, and will ultimately result in the obtaining of sufficient statistical data from which one can predict the operation of future systems.

During the past year, much progress has been made in increasing our technical knowledge of the subject of transmission stability and load limit. Probably the most important investigations are those of tests on an actual system. These tests included both switching operations and short circuit tests, and are described in a paper presented at the Midwinter Convention by Mr. Roy Wilkins. At the Seattle Convention, two papers dealing with the general aspects of the stability problem were presented, one by Messrs. Doherty and Dewey and another by Mr. Fortescue. At the Midwinter Convention, Messrs. Nickle and Lawton presented the results of recent laboratory and shop tests on stability. Miss Clarke presented a method for the determination of static stability limits. Mr. Wilkins presented the paper describing the stability tests on the system of the Pacific Gas & Electric Company. Messrs. Evans and Wagner presented a method for the determination of static stability limits and gave the results of calculations by this method with comparisons of the test results obtained on the P. G. & E. Company system.

Certain power limits have been defined in these papers and it is recognized now that with absolutely fixed excitation for both sending and receiving systems there is a definite power limit under steady load conditions. This power limit depends in this case upon the synchronous impedance of the machines at the sending and receiving ends. If we take the value of excitation which gives the desired terminal voltage

at the power limit we have the static stability or load limit with "fixed excitation" or what is termed hand regulation. It is also recognized that the load limit under transient conditions may be lower. It is not determined by the synchronous reactance solely, but is affected also by what is known as the transient reactance, and the "leakage reactance" of a machine in varying degrees depending upon conditions. It may be stated perhaps more consistently, however, that this action depends upon the actual field being maintained essentially constant for a short period due to internal currents induced in the damper and field windings. In the case of machines operated with automatic voltage regulators there is a theoretical possibility of further extending the limits of stable operation over those obtainable with hand operation. Full agreement on this point has not been reached. One group reports that considerable increase in the limits has been obtained experimentally and the other group reports inability to secure any increase in the limit over that obtained with "fixed excitation."

In view of the fact that the operation of power systems at times of transient disturbances is a relatively complicated phenomenon, it is quite natural that the extensive discussions which have taken place on this subject should have tended to emphasize the relatively minor points on which full agreement has not been secured, and has tended to obscure the major points which have been established. It has, therefore, seemed desirable to present at this time a statement of those underlying principles requisite for good stability conditions. They are as follows:

1. Low series reactance.
2. The supply of reactive kv-a. as close as practicable to the point at which the demand originates.
3. The maintenance of internal voltages in machines by special excitation schemes, or by the use of special machine characteristics.
4. Such a layout of the system as to reduce to a minimum the effect on stability of any abnormal condition. For example, the avoidance of a concentration of power in any particular piece of equipment such that a single fault could render a large part of the system ineffective.
5. The rapid and selective isolation of faults.

In line with the policy which has been laid down for the Annual Convention of presenting committee reports and inviting discussions, the following topics are suggested as worthy of further study and suitable for discussion at the Annual Convention:

1. Further investigations of the stability problem require a more exact knowledge of the characteristics of machines under transient conditions, including among other factors the effect of damper windings.
2. Further work will be required in connection with schemes of excitation designed for the purpose of maintaining internal voltages in machines constant during transient conditions.

3. Special designs of machines such as compensated machines will be subjects for further discussion and study.

4. A number of measures for increasing stability have been investigated, but are of such great importance that actual operation experience will be required before their true value in improving stability can definitely be ascertained. In this category is included the intermediate condenser station, the special governor control, and the compensated machine.

5. A somewhat different line of discussion would be advantageous to bring out the relation between the probability of outages and system loads.

6. Also the determination of the safe operating angle between internal voltages of synchronous machines, or the relation of this angle to the probability of outage.

INSULATORS

During the year there have been no outstanding changes in the design of line insulators either of the pin or suspension types, though the art appears to be developing slowly but surely toward increased reliability in service. This improvement is largely in the mechanical sense and relates principally to suspension insulators. On the electrical side, there is a gradual crystallization of ideas on the means of safeguarding high-voltage, insulator strings from flashover.

Mechanical. Owing to the relatively severe requirements of heavy high-voltage lines, it has been necessary for both manufacturers and prospective users to make extensive tests on the behavior of insulator units, particularly under long sustained mechanical loads. As a result, there are already in use insulator units of so-called high strength type which are capable of supporting for short periods loads of the order of 25,000 lb. Units of this type, when subjected to a continuously applied load, will sustain 16,000 to 17,000 lb. for periods of a year or more without undue failures. Types of still higher duty have also been developed, and it is possible to purchase units having a combined electrical and mechanical strength of approximately 45,000 lb. Results of these studies are also reflected in a marked increase in strength of some of the standard 10-in. units.

Although such tests have been able to furnish much information upon the ultimate strength of insulators under various loading conditions, but little is known of the factor of safety that should be employed. It has been customary to assume a maximum safe working load of 3000 lb. on the ordinary 10-in. suspension unit of 11,000 lb. ultimate strength. A disposition to use somewhat higher loadings has now become evident. Likewise, in the case of the above described high-strength units capable of indefinitely withstanding test loads as high as 16,000 lb., the assumed maximum safe loads in service have been fixed by some companies at 6000 to 8000 lb. The question naturally arises

as to whether it might not be safe to use much higher assumed maximum loadings.

The design of pin-type insulators is tending toward the use of fewer insulator shells for a given voltage and this practise leads to an important saving in cost without lowering the dry flashover value and without appreciable sacrifice in reliability. The latter is made possible because of perfected methods in manufacture leading to a uniformity of product not heretofore attainable.

The subject of porosity has practically ceased to be an important factor in insulators manufactured by any of the older and well established companies.

One manufacturer in this country is engaged upon the problem of commercially producing Pyrex insulators. Apparently much developmental work yet remains to be done, but the material has considerable promise, particularly because of its high immunity against shattering when exposed to heavy arcs.

Foreign development in insulators is different from American practise, in that much effort has been devoted to avoiding the use of cement in assembling. The German manufacturers have been particularly active in this direction and have produced various cementless types, of which the "Kugelkopf" and "Motor" are typical. The latter insulator consists of a heavy cylindrical section of porcelain carrying a porcelain skirt at one end and either a porcelain skirt or a metal shield at the other end. Mechanical loads are supported by means of a metal cap attached at each end of the cylindrical section by means of a lead alloy. In pin-type insulators, foreign practise has adhered largely to the use of hemp in binding the shells together and for attaching pins.

Electrical. For extra high voltage lines, much work has been done during the past year in connection with the grading and shielding of insulator strings. The results indicate that it is entirely feasible to safeguard insulator strings for operating voltages up to 220 kv., but entire agreement has not yet been reached as to the most satisfactory method to apply. Discussion turns upon whether such protection should take the form of arcing horns, rings or shields which also provide a reasonable degree of potential grading, or whether the protection should consist of insulated horns, which arrangement has been designated as "flux control." Generally speaking, these two methods are predicated upon opposing theories as to the origin of certain types of flashover. This is a subject upon which it is expected operating data will be rapidly collected.

General. Pillar insulator designs have been changed but little during the past year, but a pressing demand exists for insulators of this type having greater mechanical strength both in the low-voltage and high-voltage ranges. It is possible to obtain certain types of pillar insulators of considerable strength which are suitable for heavy duty at the low voltages, but these are quite expensive.

During the year some of the highest voltage catenary insulators yet designed have been installed.

Closely related to the subject of insulators is the development during the past two or three years of large coupling condensers for carrier current work on high-tension transmission lines. These condensers, while experimental at first, have later demonstrated a reliability in keeping with insulator bushings and other similar high-voltage equipment.

INDUCTIVE COORDINATION OF POWER AND COMMUNICATION CIRCUITS

During the past year the work of the Joint General Committee of the N. E. L. A. and the Bell Telephone System has been continued and progress has been made by the Joint Subcommittee on Development and Research in its studies of a number of specific problems, among which may be mentioned coordination of transpositions in power and telephone circuits, induction under conditions of jointly used poles including the effects of unbalances in local telephone circuits and power distribution circuits, the origin and regulation of harmonics in power circuits, survey, composition, and effects of noise in telephone circuits, residual voltages and currents of power systems, induction in carrier communication channels, and energy level of telephone circuits. The studies of many of these subjects have been facilitated by the development of improved measuring apparatus and methods, particularly in connection with the wave analysis of power circuit voltages and currents and induced voltages and currents in telephone circuits, and also in connection with the measurement of carrier frequency currents on working power lines.

The organization of the American Committee on Inductive Coordination has been completed and the committee has issued a preliminary report.

Two papers dealing with the subject of inductive relations between power distribution circuits and telephone circuits were presented at the Seattle Convention in September as part of a symposium on power distribution.

RURAL DISTRIBUTION

Interest in the satisfactory and economic supply of energy to the farmer has increased considerably in the past year. Rural supply has undoubtedly been most highly developed on the Pacific Coast, yet the year has seen a greater study given the subject both in the middle west and in the east. Twenty states have set up organized analyses of the situation and experimental projects are now under way.

The small number of customers per mile (averaging perhaps two to three) makes necessary a cheap type of construction which must, however, be sufficiently rugged to demand little maintenance and assure fair service. Three-phase, four-wire main feeders with single-phase and neutral legs to outlying farms seem to be a reasonable answer to the problem, and have come into use in the middle west. On these single

branches galvanized iron wire is used in some sections of the country for obvious economies, the neutral is stapled directly to the pole top, and the phase wire is carried on a bracket with suitable insulator. These extensions are connected to the main feeders through expulsion fuses. While this represents the cheapest type of construction, there are many cases where it is adequate.

Transformers suitable for farm work have been on the market for some time but even this new apparatus has been expensive. Some transformer makers have now come forward with good designs for this service and there are now available transformers that are in line with the general economies needed to make a rural line a paying proposition.

There has been given considerable thought to the development of portable equipment for transient needs and many new ideas have been evolved to render this service. Portable transformer, metering, and motor apparatus is generally available to furnish power to the farmer for wood cutting, threshing, and the like. This equipment is now generally furnished by the power company and a service man usually supervises its use, the general trend being away from the ownership of such apparatus by cooperative groups.

FOREIGN PRACTISE

The Committee has secured this year one paper on foreign practise on power transmission and distribution, this paper being presented at the Niagara Falls Regional Meeting. More variety of design and much less uniformity of construction is noticeable in this country than abroad.

One of the most notable events of the year abroad is perhaps the Wier Report, recommending the adoption of a universal electric power distribution system serving all England and southern Scotland, with some exceptions as regards the city of London. It is proposed in this report that all the power for use by the system shall be generated in some 50 to 60 power houses, this constituting about 10 per cent of the present number of power houses. It is proposed that the National Government own the transmission lines and buy and sell the power at a price based essentially on cost allowing a fixed return on capital,—6½ per cent plus depreciation on money now invested. The distribution systems and the power generating plants, although subject to close government control, would be privately owned. The most important of the generating plants are proposed as mine mouth plants.

It is reported that a bill has passed the second reading in the House of Commons which is intended to carry out some such scheme although departing somewhat from the recommendations of the Wier Report.

Conclusion. In general it may be said that steady progress is being made in many directions in the field of power transmission and distribution and that a continuous expansion in the number and capacity of transmission systems may be expected.

The Vincent 220-Kv. Transmission Line

Engineering and Construction Features

BY C. B. CARLSON¹

Non-member

and

H. MICHENER¹

Associate, A. I. E. E.

Synopsis.—This paper deals with the design and construction of the third 220,000-volt line between Los Angeles and Big Creek, giving the results and brief descriptions of the research engineering investigations which were carried out in connection with the design.

The salient features of the line are:

Terminals—Big Creek No. 3 and Gould Switching Station, near Los Angeles.

Length—223.5 mi.

Route—Direct route with few angles.

Dead-ends—Dead-ends only at station terminals and heavy angles.

Small angles—Small angles up to 11 deg. 40 min., in some cases, turned on suspension insulators.

Conductors—Steel reinforced aluminum. 1,033,500 cir. mils aluminum, 54 strands. 134,000 cir. mils steel, 7 strands. Weight: 1.33 lb. per ft. Diameter: 1.247 in.

Overhead Ground Wire—None.

Towers—Towers of high elastic limit steel. Height of standard towers, 64 ft. to crossarm. Height of anchor tower, 56 ft. to crossarm. Weight of standard tower, 8890 lb. Weight of anchor tower, 13,600 lb.

Tower Footings—Grillage footings in earth. For standard towers, 4 ft. 8 in. sq. at base and 8 ft. deep. Weight, 2040 lb. For anchor towers, 7 ft. 6 in. sq. at base and 9 ft. deep. Weight, 6720 lb.

Tower Extensions—Height 7, 14, or 21 ft. Any of these heights may be placed on any or all corners of the tower and in a few special cases in combination with an additional 14-ft. extension on all corners.

Insulators—10-in. cap and pin having minimum combined electrical and mechanical strength of not less than 18,000 lb.

Suspension insulator assembly: Single string of 13 units where maximum stress in string will not exceed 6000 lb. Double string 13 units in length where maximum load will exceed 6000 lb.

Dead-end assembly: Double string, 15 units in length.

Tie-down assembly: Single string of 14 units.

Shield Rings—Hoops of 3-in. by ³/₁₆-in. strap iron.

Bird Guards—Pans and saw-tooth guards on all towers.

Increases in the generator capacity at Big Creek, which are scheduled to be completed in 1928, will require more transmission capacity to deliver the power to Los Angeles. For this reason, a third 220,000-volt line is being built between those points.

AS indicated in Fig. 1, which shows the general location, the line starts from Gould, crosses the San Gabriel Mountains where it reaches an elevation of 5609 ft., and then crosses the Antelope Valley. Thereafter it passes over the Tehachipi Mountains at an elevation of 5361 ft., beyond which it crosses the southern end of the San Joaquin Valley, and then stays in the foothills along the eastern edge of that valley until it reaches the mountains at Big Creek where it crosses Pine Ridge at an elevation of 4827 ft.

The first fifteen-mile section through the San Gabriel Mountains is the roughest and most inaccessible part of the route. Through this section it was necessary to construct a road to serve the line,—more than two miles of road for every mile of line. But this heavy road expense is less than the right of way expense would have been for a route paralleling the old Big Creek lines. The remainder of the line is very accessible to already existing lines of travel with a few exceptions where short pieces of road are being constructed.

The average number of towers per mi. is 3.94. The normal span in level country for standard towers without extensions is 850 ft. in heavy loading districts and 1000 ft. in light loading districts. As a matter of fact, there are very few, if any, normal spans because of the man-made obstructions in the level country, such as roads, power lines, etc. The span lengths for the whole line range from a minimum of 336 ft. to a maximum of 5191 ft. The two longest spans are the same length.

1. Both of the Southern California Edison Company, Los Angeles, Calif.

Presented at the Pacific Coast Convention of the A. I. E. E., Salt Lake City, Utah, Sept. 6-9, 1926.

It happens that a change from heavy to light loading occurs at one end of one of these spans, so the conductors are dead-ended there. Otherwise these two long spans are supported on double-string suspension insulators.

LOCATION AND SURVEY

The general route of the line was chosen from a study of maps and from a general knowledge of the country. Reconnaissance along this route was carried out by airplane, automobile, horse, or on foot, the choice between the last three means being made according to the terrain. The whole route was flown over at least once and parts of it several times. In two highly developed sections, airplane photographs were taken.

After the reconnaissance work was done, the line was run with transit and chain. It was so located with regard to topography and man-made improvements that a total of four circuits can be placed side by side with 80-ft. center line separation, but a 200-ft. right of way to accommodate two circuits is all that has been obtained. The line actually run on the ground was the center line of the west tower line. In the rough country where there were no control points, a triangulation system was laid out as a check on the line survey.

The profile of this center line was run, using vertical angles and slope distances, and checking on U. S. G. S. and other bench marks of known elevation wherever such were available. Side slopes were taken at the probable tower locations and at all points where the clearance from one of the outside conductors to the ground would be near or less than the allowable minimum.

With this information on the profile the towers were located by means of a celluloid template. Survey crews took these paper locations into the field and staked out

amount. In staking the footing locations, the proper elevations of the footings were determined consistent with the use of the various lengths of leg extensions and downward footing extensions. This information was turned into the office where it was checked in regard to the proper footing elevations and the economic balance between cost of extension and cost of excavation. After checking, it was used for making bills of material for tower and footing extensions.

TELEPHONE LINE

A four-wire telephone lead supported on pressure-treated, southern pine poles is being built. It is located mostly along the roads near the transmission line. It will serve the Construction Department until the transmission line is completed, and after that it will be used for the routine operation of the line and as an additional communicational facility between Los Angeles and Big Creek.

LOADING ASSUMPTIONS

The line from Gould to the south end of the San Joaquin Valley and for 10 mi. south from Big Creek No. 3 is in so-called heavy loading territory where it is assumed that the most severe loading conditions will be one-half in. radial thickness of ice at zero deg. fahr., with a wind pressure of six lb. per sq. ft. on the projected area of the ice-covering. These sections are generally above 3000-ft. elevation except the 18 mi. across the Antelope Valley, which has an elevation of 2500 to 2700 ft. where the line crosses but which is subject to high winds and low temperature. The remainder of the line is in light loading territory where the maximum loading conditions are assumed to be no ice at 25 deg. fahr. with a wind pressure of eight lb. per sq. ft. on the projected area of the wire.

CONDUCTOR

The preliminary mechanical and electrical studies to determine the most economical conductor, tower height, and conductor tension were described by Messrs. Carlson and Shaw at the Pasadena, 1924 Convention.² Since that time the design has been completed. Construction of the necessary roads began in August, 1925, and actual line construction began about January 1st, 1926. It is expected to have the 96 mi. between Gould and Magunden in operation by November, 1926, and the whole line in operating condition by the early months of 1928.

The conductors are steel reinforced aluminum cables having 54 aluminum strands and seven steel strands each 0.1385 in. in diameter. The total diameter is 1.247 in. and the cross-sectional area of the aluminum is 1,033,500 cir. mils. This is equivalent in conductivity to 650,000-cir. mil copper. The weight is 1.33 lb. per ft. The approximate ultimate strengths are 20,000 lb.

2. *Transmission at 220 Kv. on the Southern California Edison System, Sections 3-A and 3-B, Economic Studies of Transmission Line Design*, C. B. Carlson and W. D. Shaw, A. I. E. E. JOURNAL, Vol. 43, Oct. and Nov., 1924, pp. 907 and 1025.

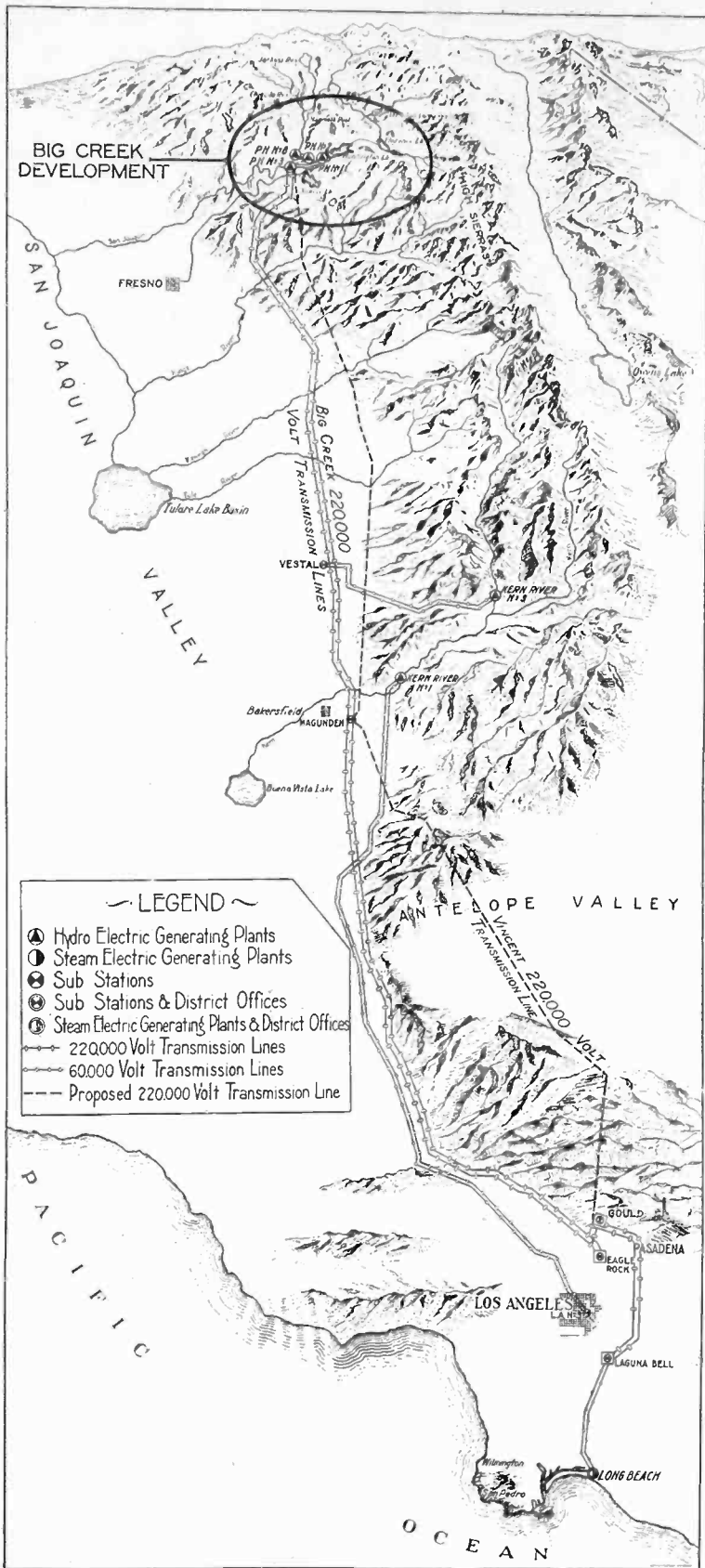

FIG. 1—SYSTEM MAP OF SOUTHERN CALIFORNIA EDISON COMPANY

Showing route of 220-kv. Vincent transmission line

the tower footings, moving the towers along the line if this improved the setting of the towers without decreasing the conductor clearances below the allowable

for the core and 36,000 lb. for the composite cable. This is probably the largest cable ever used as a transmission line conductor.

The line was designed for a maximum conductor tension of 12,000 lb. in both heavy and light loading territory, which gave practically the same unit stress as had existed in the old Big Creek lines for 11 years, but when it came to fitting the wire curve to the profile it was found that strict adherence to the 12,000-lb. maximum would give low clearance from conductor to ground in several spans where the topography made it very difficult to move the towers to get the required clearance. If the 12,000-lb. maximum could not be exceeded, one or more additional towers would be required in these spans and they would be in very costly locations. A slight increase in maximum tension would give ample clearance in these locations at which it was believed that neither maximum wind nor minimum temperature would occur at any time and surely not simultaneously. For these reasons it was decided to allow the maximum tension in these cases to go as high as 13,500 lb. in the heavy loading district and 12,600 lb. in the light loading district, when calculated on the maximum loading assumptions stated above.

CONDUCTOR SPLICES

The conductor splices are being furnished by the manufacturers of the cable and are of the latest type. The main improvement over the old type is in the method of splicing the steel core. Instead of using a

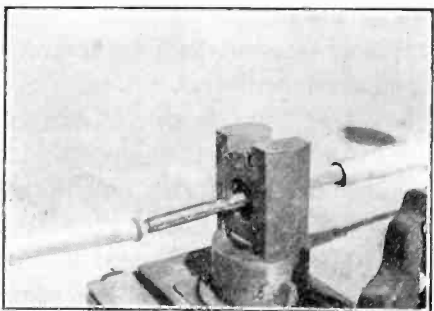

FIG. 2—CONDUCTOR SPLICE BEING MADE

Steel sleeve on core partially compressed. Aluminum sleeve slipped over cable to the right

twisted McIntyre joint, the two ends of core to be joined are each inserted from opposite ends half-way into a single-bore, soft steel sleeve, and then the sleeve is compressed onto the core. On test the core breaks approximately at its calculated ultimate strength and does not slip out of the sleeve. The use of this compression sleeve on the core permits the use of a single-piece, aluminum compression sleeve for connecting the aluminum strands instead of the two-piece, screwed-together compression joint used in the past. These improvements make better and cheaper joints than those previously used.

The steel sleeve and the then exposed parts of the core are given a coating of hot asphaltic compound and

then wrapped with a layer of cambrie tape after the compression has been made and before the aluminum sleeve has been slipped into place. This is to prevent the black-iron sleeve from starting a rusting reaction which may be communicated to the steel core and eventually destroy it. The tape is to prevent the compound from being wiped onto the inside of the aluminum sleeve as it is slipped into place. Accelerated tests have led to the belief that such a coating will protect the core from rusting at least for the life of the galvanized steel and aluminum wires elsewhere in the line. Fig. 2 shows these splices being made.

GROUND WIRE

No overhead ground wire is being installed, but the towers are designed with sufficient strength to carry one ground wire if it should prove desirable to install it later.

TOWERS

The preliminary economical calculations to which reference was made determined the height of structure necessary as well as the maximum tension which would occur in the cable. The design of tower proper, the extensions, transposition frames, footings, etc., involved types of framing and panel lengths which would prove most economical. Previous experience had shown the desirability of vertical legged extensions rather than continuing along the batter of the main tower.

Panel lengths of eight ft. in the main structure made the height of the tower to the crossarm 64 ft., while the panel length was reduced to seven ft. in the extensions to compensate for the increase in stress caused by change in direction. Extension heights of 7, 14, and 21 ft. were those which seemed to supply the needs of the profile. These extension legs were arranged to permit combinations of any of them on a tower to more economically fit the profile. This latter arrangement has proved useful, as much of the country traversed was very rocky and difficult to excavate.

Special cases required the combination of the 14-ft. and 21-ft. extensions making 35 ft. in all, and in the case of the Tule River Crossing two special 120-ft. towers were used. It was also necessary to supply certain other specialties such as transposition frames, attachments for towers to solid rock, footing extensions where uplift cover resistance was not available, and single leg extensions without bracing to main structure. These were developed to best suit field requirements which were reported in the field notes of the survey parties.

Material for the structures was specified which would have a high elastic limit, permitting the use of higher unit stress value. This value was 22,500 lb. per sq. in. or a factor of safety of two on the elastic limit.

For the light loading district, standard towers were designed to withstand (a) the strain caused by two broken wires having maximum tension (reduced by adding the length of the insulator string to the wire

be followed by complete mechanical failure at some subsequent date without increase of load.

4. That there is some indication that at some period during the long time test of 11,000 hours, the average ultimate mechanical strength of all insulators loaded to 9000 and 11,000 lb. decreased some seven or eight

DEAD-ENDS

The development (in so far as it had advanced by the summer of 1924) of a light weight, compression, dead-end fixture to minimize the effect on the conductor itself of conductor vibration has been described and illustrated.³ The main features of this compression

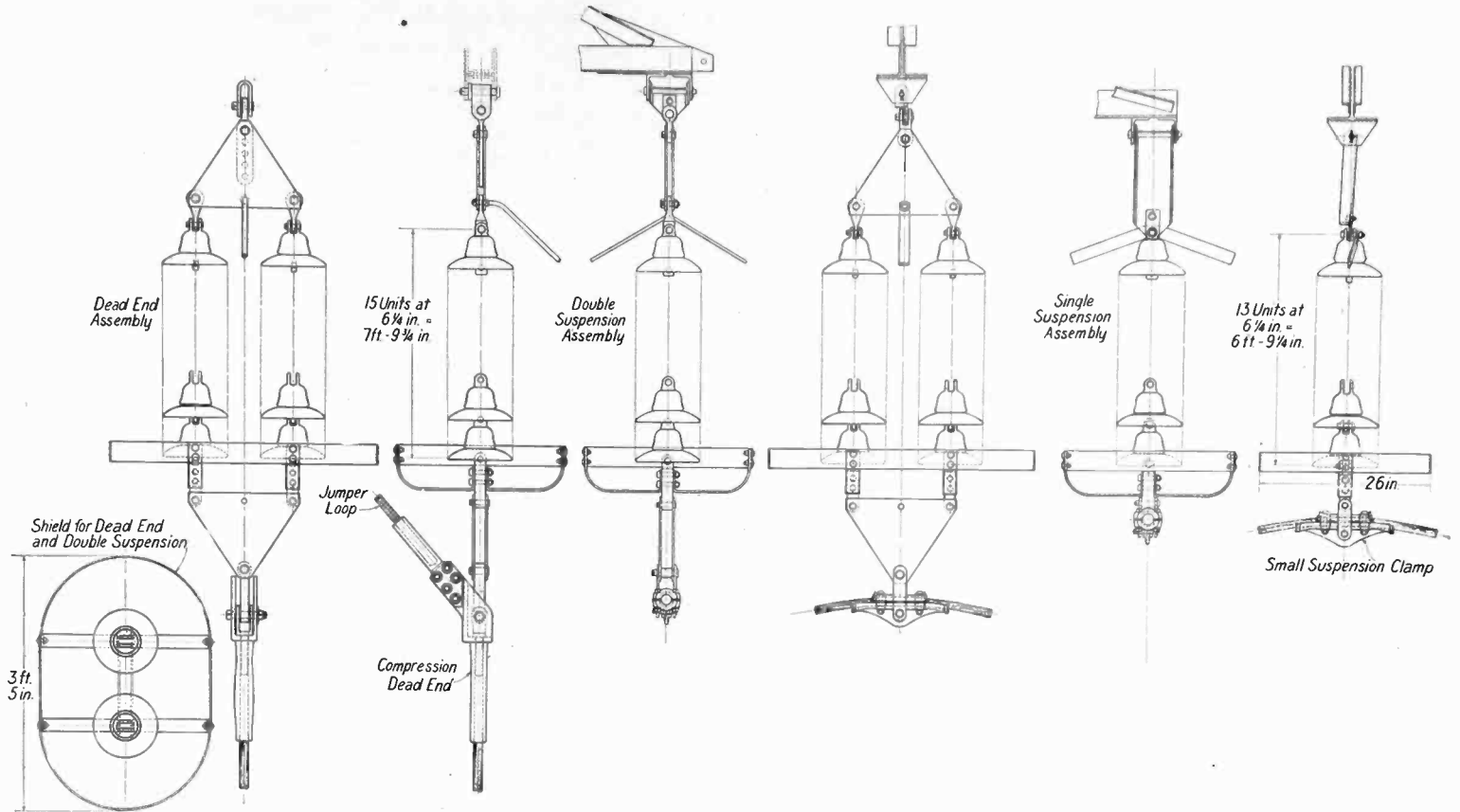

FIG. 3—INSULATOR AND INSULATOR HARDWARE ASSEMBLIES

Showing single-string suspension, double-string suspension, and dead-end with compression clamp on cable

per cent. Great caution must be observed, however, in generalizing from tests made upon an aggregate of only 83 insulators.

INSULATOR HARDWARE

All the insulator hardware is made of forged steel or wrought steel, except the aluminum part of the compression dead-ends and the long suspension clamps which latter are of malleable cast iron. All pins are of chrome-nickle steel.

SHIELD RINGS

The insulator shield rings are practically the same, electrically and also mechanically, so far as over-all dimensions and position on the insulator strings are concerned, as those used on the present 220-kv. lines of this company. However, instead of being of cast aluminum of an inverted U-shaped cross-section, they are each made of a hoop of 3/16-in. by 3-in. steel strap. These are much less expensive than the old shield rings. Laboratory tests do not indicate any particular advantage in favor of the old shape of ring in either voltage grading or flashover characteristics.

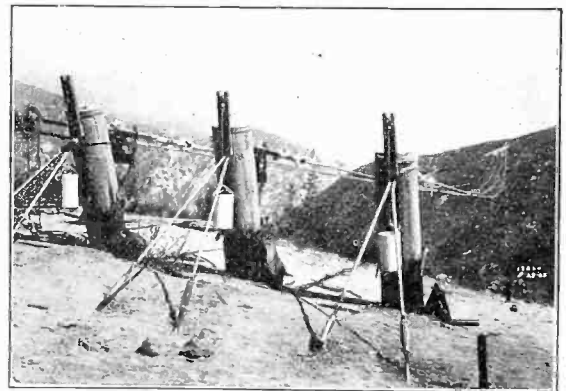

FIG. 4—TEST SPANS FOR DETERMINING AMOUNT OF PERMANENT STRETCH AND MODULUS OF ELASTICITY OF 1,033,500-CIR. MIL STEEL REINFORCED ALUMINUM CABLE

dead-end had been worked out simultaneously by the Aluminum Company of America and the Southern California Edison Company. The main differences in

3. *Transmission at 220 kv. on the Southern California Edison System, Section 4, Vibration of Conductors and Overhead Ground Wires*, by J. M. Gaylord, JOURNAL of A. I. E. E., Nov. 1924, p. 1026.

the two designs were that the former anchored the steel core in the steel clevis-socket by pouring melted zinc around the core in the socket while the latter accomplished the same results by means of conical wedges in a conical socket, and that the former transmitted the load to the insulator assembly from the aluminum compression body through aluminum clevis ears cast onto it while the latter accomplished this result by screwing the aluminum body onto the steel clevis-socket. Both of these schemes undoubtedly would have given satisfactory results in service as they did on test but they were not tried because the Aluminum Company put forward an improvement in the method of attaching the steel core to the steel clevis. Instead of a conical socket, a steel tube about six in. long was forged as a part of the clevis. Into this tube the end of the steel core was placed and then the steel tube was compressed using the same press with smaller dies as was used to press the aluminum. Tests proved that the core would break at approximately its calculated ultimate strength and would not pull out of the tube.

The idea of having the load transmitted from the

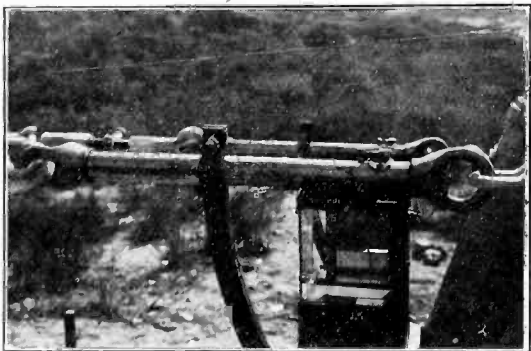

FIG. 5—RECORDING DYNAMOMETER ON TEST SPANS

aluminum compression body to the insulator assembly through an aluminum clevis cast as a part of the compression body was accepted, but a change was made in the position of the lug to which the jumper loop fastens which altered the appearance considerably. This change was due to the desire to have the centerline of the jumper loop, where it is attached to the dead-end, pass through the clevis pin of the dead-end and thus minimize the effect that the jumper loop has on the relative movement between the compression dead-end and the conductor immediately adjacent thereto, due to conductor vibration. A test briefly described below had indicated that the jumper loop very appreciably increases this relative movement and that all reasonable measures should be taken to minimize this effect.

On a span having vibrations forced upon it by a vibration machine, measurements of the relative movement of the compression dead-end and the cable were made by means of a pencil attached to one and a strip of paper in a holder attached to the other. With neither shield ring nor jumper loop attached to the dead-end, the mark drawn as the paper moved past the

pencil was practically a straight line. With the shield ring but not the jumper loop attached, the waves in the pencil mark had an appreciable amplitude. And with both the shield ring and the jumper loop attached, the amplitude of these waves was several times as great as with the shield ring only; hence the conclusions stated above.

Careful consideration was given to the bolted connection between the jumper loop and the compression dead-end. Such bolted connections have been known to give considerable trouble when the bolts and the lugs are of dissimilar metal. In the case of aluminum lugs and steel bolts, the greater expansion of the aluminum with rise of temperature might cause either or both metals to be stressed beyond the elastic limit. In either case the joint would be loosened upon subsequent cooling. This accounts for the large number of bolts in this connection.

TROUBLE AT SUSPENSION CLAMPS

About the time the design of the suspension clamps was being considered, it was discovered that many of the aluminum strands were broken at the ends of many of the suspension clamps on the old Big Creek lines. This breakage was due to the repeated bending caused by conductor vibration. The old suspension clamps were divided on the vertical plane through the conductor axis and they ended with a very short radius of curvature on the part where the cable bore as it left the clamp. The conductor was protected by a sheet aluminum liner which hid the broken strands from outside inspection until a considerable number was broken.

DESIGN OF SUSPENSION CLAMPS

There seemed to be three main features which should be embodied in a new suspension clamp to avoid the troubles experienced with the old clamps:

First, a saddle in which the cable will rest entirely outside of the section gripped in the clamp so that the last point of contact between clamp and cable would never be coincident with the end of the gripped section. This would allow the bending of the cable, due to its rise and fall relative to the clamp, to be distributed over an appreciable length of the cable and not be constrained to one particular point.

Second, the radius of curvature of this saddle over which the cable would bend should be sufficiently large to prevent the repeated bending from breaking the cable strands.

Third, the clamp should be suspended in such a way that it would move with the cable as much as possible and thus keep the bending of the cable at the ends of the clamp to a minimum.

Although, at the time of designing this clamp, it was becoming apparent that the vibration in the conductors could be stopped, it was thought advisable to embody all three of these features in the clamp design.

The points of design which would satisfactorily meet

these requirements were determined in an order the reverse of that in which the requirements are enumerated.

The third was met by pivoting the clamp on a pin passing through it as close to the lower side of the conductor as possible. The clamp is free to move about this pivot through an angle of 23 and 30 deg. both ways, from the normal position for the short and long clamps respectively.

It was determined that the second requirement was reasonably fulfilled by giving the end portions of the clamp a radius of curvature of 16 in. Of course a longer radius would give easier bending conditions on the cable, but cost must be given consideration. Considerable experimental work was done to determine this radius. Single strands of aluminum wire stressed to unit tensions approximately the average of those expected in the line were bent around curves of various radii a sufficient number of times to break them. From these tests it was determined that if bending around a radius of 16 in., the life of the cable can be expected to be in the order of five times as long as if it were bending about a six-in. radius, which is approximately the radius of the old clamps. This was considered a reasonable balance between increase in cable life and increase in cost of suspension clamps.

The first feature specified required a straight section of clamp in which the cable is gripped with two end sections in each of which the cable merely rests for a part of the length. The length of the gripping section was determined to give the holding power desired. Tests show the first slips to occur at 20,000 and 16,000 lb. for the short and long clamps respectively.

It was decided to have the straight section of the bottom half of the clamp extend one inch beyond the grip of the clamp. At these points the two 16-in. radius end sections begin, the straight section being tangent to the two curved sections. To determine the length to which the end sections should be carried so that the most extreme points of contact between cable and clamp would be an inch inside the outer end of the 16-in. radius curve, one in. having been selected as a sufficient margin of safety, it was necessary to calculate from the profile of the line the various angles at which the cable would leave the clamps. It was found that these angles varied from practically nothing to 22.5 deg. and that a clamp to accommodate all these conditions should be 21.75 in. long. Since there were comparatively few of the large angles, two types of clamps were designed, one for angles up to nine deg. and the other for angles up to 22.5 deg. The former was made with a forged steel body 14.75 in. long and the latter was made of malleable cast iron 21.75 in. long. Both were equipped with cast aluminum liners. There are required for the line 2100 of the short clamps and 477 of the long ones.

CONDUCTOR VIBRATION

The experiences with conductor vibration, the

methods of study, the causes, and the means of preventing conductor vibration have been previously described.⁴⁻⁵⁻⁶ Vibration dampers similar to those described by Mr. Stockbridge, but consisting of two cast iron weights attached to a straight and approximately horizontal spring of guy cable, will be used on this line. Judging from the results obtained on the old line, these dampers will entirely eliminate all visible vibration. Fig. 6 shows this type of vibration damper as applied to the old lines.

CONSTRUCTION

Careful plans were made for the construction of the line, particularly with reference to construction equipment, and the results in the field have proved that the expense of this planning was well worth while.

The setting of footings was largely a matter of pick and shovel and powder for the excavation, transit

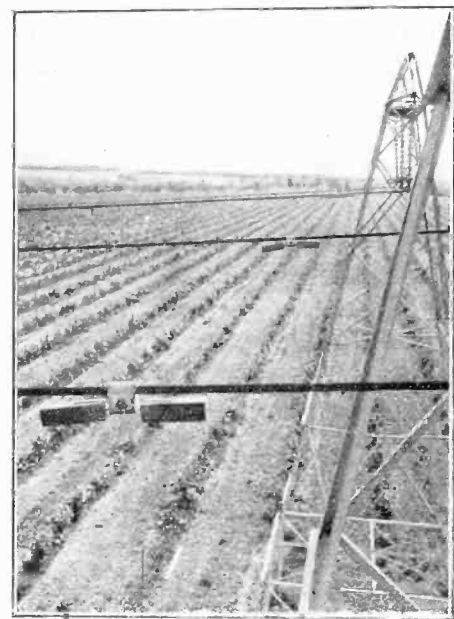

FIG. 6—CONDUCTOR VIBRATION DAMPER.

and level for alinement and elevation, and shovel and tamper for back-filling. It pays to do this job well. Fig. 7 shows footings being set.

TOWER ERECTION

When the Eagle Bell 220,000-volt line was built in 1923, several methods of erecting towers were tried, but the method of assembling piece by piece in the erected position was found to be the most economical if the erecting crews are selected and organized with care.

On the Vincent line this method has been modified somewhat in that wherever it is possible to get a line

4. *Transmission at 220 kv. at the Southern California Edison Company System*, Section 4, *Vibration of Conductors and Overhead Ground Wires*, by J. M. Gaylord, *JOURNAL OF A. I. E. E.*, Vol. 43, November 1924, p. 1026.

5. *Notes on the Vibration of Transmission Line Conductors*, by Theodore Varney. Presented at Niagara Falls meeting, *A. I. E. E.*, May, 1926.

6. *Overcoming Vibration in Transmission Cables*, by G. H. Stockbridge, *Electrical World*, December 26, 1925, p. 1304.

from a truck the panels of the tower sides are assembled on the ground or horizontally on the top of the completed portion of the tower and raised as a unit. Fig. 8. shows the first side-panel being raised into position on top of a 14-ft. extension. The truck is raising the panel.

In this way a crew of 14 men, including the gang



FIG. 7—SETTING TOWER FOOTINGS

Looking southeasterly along line in southern edge of Antelope Valley

foreman and the truck driver, has been able to erect a standard tower in 4 hours and 15 minutes. This tower was put on top of a 14-ft. extension which had been previously erected. When the work is running smoothly, an average of six hours for a standard tower on easily accessible ground should be maintained by a crew of 14 men and a two-ton truck.

CONDUCTOR STRINGING AND STRINGING EQUIPMENT

The most unsatisfactory part of transmission line construction in the past had been the conductor stringing. Many improvements have been made in the equipment for this work on this line.

The most notable improvement and the one which is paying the greatest dividends is in the stringing sheaves. There was nothing on the market at all adequate

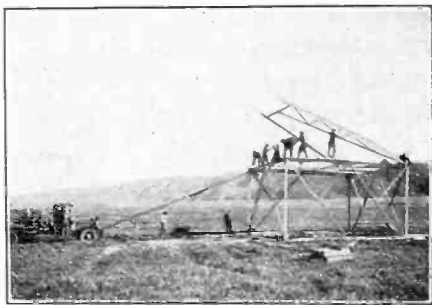

FIG. 8—ERECTING TOWER ON TOP OF 14-FT. EXTENSION

Raising first side-panel

for the job. Plain bearings, small wheels, and flat grooves that let the cable flatten and rub on the sides of the blocks seemed to be the rule without exception. It was decided that the friction in the sheaves should be made as low as possible by the use of roller or ball bearings and that the sheave should be made of aluminum with a deep groove having a good fit to the cable and a bottom diameter of 12 in. These specifications

led to the design shown in Fig. 9. With these sheaves the length of cable that can be pulled to tension at one time is not limited by the sheave friction. Lengths as long as four miles have been pulled and the tensions in the various spans adjusted with entire satisfaction. On level ground it seems that the limit to the length of pull will be set by the number of sheaves available.

The sheave blocks are attached to the bottom of the suspension insulator strings while the conductor is being strung.

For pulling the conductor a 10-ton caterpillar tractor is used. Where the conductors have to be dragged out on the ground, all three are taken at the same time. The pulling of each conductor to final tension is done by the direct pull of the tractor wherever it is possible to find a place for the tractor to travel. The tractor is equipped with a winch, with both drum and spool, with which the pulling is done when the necessary traveling space for a direct pull is not available. The

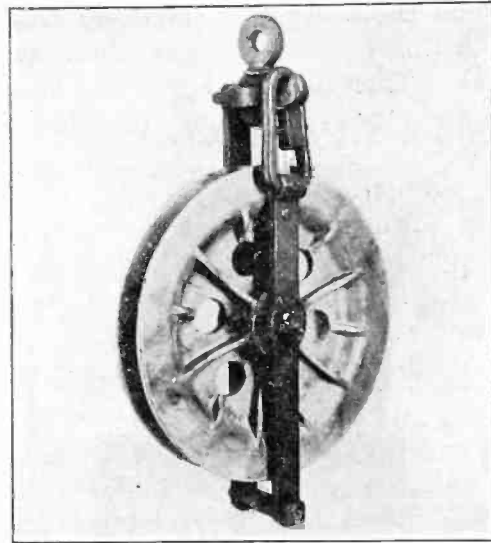

FIG. 9—STRINGING SHEAVE

direct pull of this heavy tractor works very nicely and saves much time over any method of using lighter equipment with a winch or blocks and falls. On level ground with the conductor on the ground except at the sheaves, four mi. of one conductor have been pulled up and the tension adjusted to its proper value at three places in the section in 45 min., no splices having passed around the sheaves in this case. Three conductors of a four-mi. section have been pulled up in this way in three hours.

Telephones are used for communication between the engineers who give the tension orders and the foreman at the tractor end of the section. In some cases twisted pair taps are run to the locations of these men from the telephone line which roughly parallels the transmission line. In other cases, where the telephone line is too far away, a twisted pair is laid along the transmission line from end to end of the pull section. Signaling with flags was tried but was found to be very unsatisfactory for such long pull sections.

As the conductors are pulled to tension, they are anchored to deadmen near the foot of the next tower ahead of the pull section. The come-alongs to hold the two outside wires are placed near the deadmen but the one to hold the center wire is placed very near the sheave in the last tower of the pull section and a steel line is run to the deadman. These come-alongs hold the tension in the line until the cables in the next section to be pulled are spliced on and pulled to tension in the manner described below.

For the outside positions the conductors are not put into the sheaves on the tower where the deadmen are located until the conductors are pulled to sufficient tension to relieve the tension on the come-alongs and the come-alongs are taken off the conductors. This takes place at practically full tension and without appreciably lifting the conductor at the come-alongs from the ground. After the come-alongs are cast off the conductors are placed in the sheaves at that tower.

For the center position the conductor is put through the sheave at the tower near the deadmen and pulled until the steel line between the come-along and the deadmen is slack. Then the steel line is cast loose from the deadmen and the come-along removed from the conductor.

On each wire, after getting loose from the deadman as described, the man at the back end of the pull section tells the foreman at the tractor to pull ahead or back off, as the case may be, until the insulators are vertical on the tower which was at the front end of the last pull, these insulators having been clamped in vertically



FIG. 10—COMPLETED SECTION OF LINE ON STANDARD TOWERS WITH EXTENSIONS

on the conductor when it was anchored to the deadman. Then the engineer three or four spans farther into the section being pulled tells the man at the tractor to pull ahead or back, as required, until the sag in the span he is watching is right. Then another engineer, who is two or three spans back from the tractor, gives whatever orders are necessary to get his span right. If everything has gone well, no more adjusting need be done and the men at the tractor end put on a come-along and attach it to the deadman. After this is done the conductor

can be transferred from the sheaves to the suspension clamps at will.

In rough country, where long and short spans and spans at different elevations are mixed together in the same pull section, some slight modifications of this simple level country procedure are necessary. The longest span, or the span at the lowest elevation, takes more than its share of the proper conductor length for the pull section so it is necessary to let such a span govern the pulling tension until its tension is right and

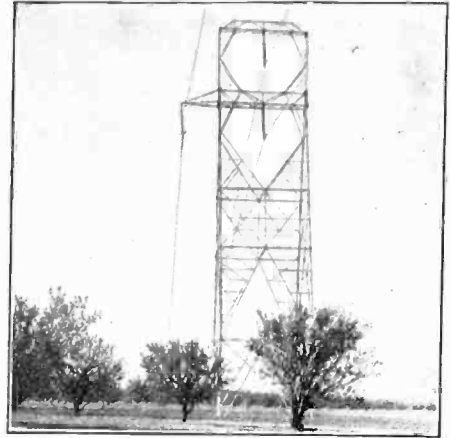

FIG. 11—TRANSPPOSITION TOWER ON EXTENSION

its insulators are clamped to the conductor. Then that span is forgotten and the other spans are given their proper sags, any other spans being treated in this special way if necessary. Of course all the insulators will not hang vertically but there is no way to put up such a line and have all the insulators vertical at all times.

COME-ALONGS

The come-alongs used on previous work had many bolts to be tightened in making one fast to the cable. To shorten the time necessary for this, one was designed with only three set screws to be tightened and it is giving entire satisfaction. The body is of cast steel with aluminum liners held to each half by means of counter sunk screws. The pulling sling is of $\frac{1}{2}$ -in. steel cable and is zined into clevis-sockets which attach to the come-along and the middle of the sling passes around a forged eye to which the pulling line may be attached.

Fig. 10 shows a completed section of line on standard towers with extensions. This is looking north across the Antelope Valley.

Fig. 11 shows a transposition tower with an extension. Two such towers are required at each transposition, one with a right hand and the other with a left hand lower crossarm. These towers are not set off the center line as has been done in some cases. There are seven complete barrels in the line.

BIRD GUARDS

The towers will be equipped with guards to prevent the hawks and other large birds from causing flash-

overs by their semi-liquid droppings bridging the air space between the crossarm and the conductor. Experience has shown such protection to be necessary.^{7, 8} The center conductor position will be protected by a sheet iron pan approximately four ft. wide and ten ft. long on the lower members of the crossarm. This pan will catch the droppings from birds on the central

portion of the tower top, their most favored perch. Birds will be prevented from perching above the outside conductor by saw-tooth guards placed on the crossarm members for a distance of about six ft. from the end of the crossarm. These saw-teeth are three in. long and are made of thin galvanized iron.

CONCLUSION

It is the belief of the authors that the large amount of engineering investigation and careful design work in preparing for this line was decidedly advantageous, not only for this particular line but for the industry in general, parts of which already are profiting by the results of this work.

7. Avoiding Flashovers on 220-Kv. Transmission Lines, by G. H. Stockbridge, *Electrical World*, Vol. 85, No. 12, March 12, 1925, p. 611.

8. *Transmission at 220 Kv. on the Southern California Edison System*, Section 1, *Description of System and Operating Experience*, by H. Michener, *JOURNAL of A. I. E. E.*, October 1924, p. 901.

Phase Difference in Dielectrics

BY J. B. WHITEHEAD¹

Fellow, A. I. E. E.

Synopsis.—A brief description of the origins and causes of phase difference in dielectrics.

HIGH power factor is earnestly sought after in transmission, distribution, and all station loading. Low power factor is just as earnestly sought in the case of insulation, for the higher its value, the greater the internal loss, the higher the temperature, the lower the current capacity, the shorter the life. The term "power factor" in this case describes a property of the material, and as such is of quite different character and significance from its older connotation. It is no doubt largely for this reason that the custom has arisen of describing this property of dielectrics, not as the cosine of the angle of advance of the charging current over the applied voltage, but as the sine of the difference between that angle and 90 electrical deg. This angular difference is known as the "phase difference" or "phase defect" and its usage has the added advantage that up to about 2 deg., the phase difference, itself, in radians, its sine, its tangent, and obviously the power factor in its usual sense, all have the same value within a very small fraction of a per cent. This makes it possible to use these several quantities indiscriminately, thereby greatly simplifying many computations. The use of the tangent of the phase difference is especially convenient, as the ratio of the in-phase to the wattless components of the current.

The importance of phase difference in dielectrics was first appreciated in its influence on the performance of telegraph and telephone cables. Attenuation, distortion, and internal loss are all increased thereby, thus greatly restricting distances of communication.

1. School of Engineering, Johns Hopkins University, Baltimore, Md.

Presented at the Regional Meeting of District No. 1, of the A. I. E. E., Niagara Falls, N. Y., May 26-27, 1926.

In the field of power transmission and utilization, attention was first focussed on dielectric-phase difference by the observations of Siemens in 1864 on the heating of condensers. This is an early date in the history of electrical engineering, and for many years thereafter the losses in dielectrics under alternating stress received the attention of physicists rather than that of engineers. It was in this early period also that residual charge, discovered in the Leyden jar in 1746, was still further stimulating the interest of physicists in dielectric phenomena. This interest showed its first fruits in the brilliant experiments of Hopkinson and in the unassailable theory of Maxwell of the phenomenon of dielectric absorption. It is not generally realized that since Maxwell's time it has been recognized by engineer-physicists, such as Rowland, Hess and a few others, that dielectric absorption necessarily causes alternating-dielectric loss; *i. e.*, dielectric-phase difference. Engineers became immediately concerned in the value of dielectric-phase difference with the first upward step in transmission voltages in the early '90s, and with the use of cables for transmission. The problem of the limitation of dielectric-phase difference thereafter was clear cut and has been with us ever since. Obviously the applications in which it assumes its greatest importance are the high-voltage cable and the commercial power condenser, but its presence and behavior must always be borne in mind in connection with all high-voltage insulation, especially that of composite or flexible character.

Although, as stated above, phase difference is a property of the material of the dielectric, and although this has been recognized for many years, and although an abundant literature is replete with experimental

observations, it is astonishing to find that our knowledge even of the values to be assigned to particular materials is extremely indefinite, and that little has been accomplished towards a systematic understanding and regulation of the factors which control the values of phase difference. This is largely due to the fact that there are at least four and possibly more different classes of phenomena in dielectrics, any one of which will cause an angle of phase difference; and to the further fact that probably all these causes follow different laws under the influence of varying temperature, frequency, and electric intensity. Each of the following well-recognized properties or conditions of insulation, if present, will cause a dielectric-phase difference: (1) normal conductivity, (2) dielectric absorption, (3) anomalous conductivity, (4) absorbed moisture, (5) dielectric hysteresis and (6) gaseous ionization.

Normal Conductivity. Under the original theory of Faraday and Maxwell, still regarded by physicists as fundamental in spite of obvious insufficiency, dielectrics are treated as being perfect of their kind, *i. e.*, as possessing specific inductive capacity only. Maxwell, however, recognized that no such perfect solid dielectric exists, and he treated at considerable length the properties of dielectrics which also possess conductivity. We have then in conductivity one of the fundamental causes of dielectric-phase difference. It is usually assumed that conductivity contributes a negligible proportion of the losses in dielectrics. This is undoubtedly true for most pure and simple materials, especially at ordinary temperatures. It should be noted, however, that the values of conductivity of different dielectrics extend over a wide range and in many cases may contribute a considerable phase difference. The conductivity of most dielectrics increases rapidly with increasing temperature. The rapidly rising phase difference of such a composite material as impregnated paper, for example, under increasing temperature, may be accounted for in very large measure in some instances by the increase in conductivity alone. The important influence of water on conductivity is described below.

Dielectric Absorption. Probably the most important of all causes of dielectric-phase difference is dielectric absorption, *i. e.*, the phenomenon of after-charge and residual charge. It is obvious that if under applied continuous voltage, current continues to flow over a period of time into or through a dielectric, then under alternating voltage there will flow a component of current in phase with the voltage, which, of course, means a definite angle of phase difference. Absorbent dielectrics, in effect, have for a short interval after the application of voltage a greatly increased value of apparent conductivity. On short circuit a charge continues to flow out long after the electrostatic charge has disappeared, and on reversal of the applied voltage the high initial conductivity appears again. Thus, for the rapid reversals of alternating voltage, the dielectric

behaves as though this increased conductivity were continuously present.

Absorption usually occurs whenever a dielectric is composed of two or more different materials. Further, it appears that a very small proportion of a foreign material may cause a large absorption effect. Thus, the absorption often observed in many supposedly pure, simple materials is usually attributed to impurities. This is one of the obscure questions in our imperfect knowledge of dielectric absorption. Although it has been known for years that absorption is one of the most important causes of phase difference, very little attention has been given to the problem of controlling its value, and to the study of the behavior of various dielectric materials singly and in combination. That such study would prove profitable is indicated by the fact that a few composite dielectrics have very low values of phase difference and of absorption. These materials apparently are few in number, and their properties obtained only by cut-and-try and by great care in preparation. However, there is no reason why a further study and control of composite materials should not lead to dielectrics having not only low phase difference, but also other desirable thermal and mechanical properties.

Moisture. Many insulating materials, particularly those of porous and fibrous character, absorb moisture readily from the air. Their conductivity is very often greatly increased thereby. In many cases the moisture is taken up quite rapidly and is completely driven off again only with considerable difficulty. As a consequence, exact statements as to the influence of moisture on conductivity and power factor are not possible. Several definite qualitative relations stand out, however, and the behavior of cable paper in this regard may be taken as generally characteristic. Cable paper when standing in the open will absorb from 10 to 15 per cent of weight of moisture. If continuous voltage is applied to the paper in this state, the current, which in this case is pure conduction current, will increase slowly with time, tending to a steady value. If the voltage is increased the final current will increase roughly as the square root of the voltage. A theory for this behavior has been proposed by Evershed and is based on the assumption that the variation in conductivity is traced to changes in the water films around air bubbles in the capillary fibers of the material. As the paper is heated above ordinary temperatures the conductivity increases and the general behavior outlined above continues up to about 50 deg. or 60 deg. cent. Above this point traces of the normal residual charge and discharge of dielectrics begin to appear, although the conductivity is still very high. If allowed to stand at about 70 deg. for some hours, large quantities of the moisture are driven off, the Evershed effect has disappeared, and the paper begins to show the qualities of a good dielectric and insulator, having, however, pronounced absorption and conductivity. With further

increase in temperature both absorption and conductivity are decreased further, and on standing for long periods at temperatures from 95 deg. to 115 deg. cent. there is little change, and the paper appears to be in more or less steady condition, still showing pronounced absorption but with relatively low value of final conductivity.

Thus, it will be readily seen that the influence of moisture on the phase difference on insulating materials is very complex. The variation with both voltage and time is often to be found in the alternating case. Increase in the amount of absorbed moisture shows itself almost immediately in increased values of phase difference and loss. As a consequence every effort is made in the manufacture of commercial insulation to exclude moisture as completely as possible and to prevent its subsequent absorption. It is safe to say, however, that in few cases is it possible to completely eliminate moisture and that observed values of phase difference and loss are always in some measure increased by residual moisture.

Anomalous Conduction. Nearly all liquid dielectrics show some conductivity. Moreover, this conductivity generally varies with both time and voltage. On the application of continuous voltage the resulting current decreases, approaching a constant value. With increasing voltage the final constant values generally show a departure from Ohm's law. Many attempts have been made to coordinate the results of investigation of this property but without great success. This conductivity is undoubtedly ionic in character and in some cases follows closely the known laws of the ionic conductivity of gases. Values have been obtained for the mobilities of both positive and negative ions for particular materials, but in general the results of such investigations are far from definite in character and this is attributed to the presence of ions or molecular aggregates of different size. Phenomena of this character seem to be particularly susceptible to the presence of impurities in small amounts, to traces of water, etc.

Electrolytic dissociation and resulting conductivity is known to exist in some complex insulating materials. Glass is a remarkable example of this. The metallic constituents of some glasses may be separated out under continuous voltage and deposited on electrodes. Here is an instance of a rigid insulating material through which it is known beyond a doubt that electrolytic ions pass from one electrode to another.

As regards the influence of these two types of conductivity on the phase difference of commercial insulation, it may be said that very little is definitely known. There would appear to be good possibility of the presence of the former type, and it is probably true that the residual conductivities of composite dielectrics made up originally with liquid binders, is in considerable proportion due to the motion of ions of the type usually to be found in liquids.

Hysteresis. Since the days of Siemens, who first noted the heating of impregnated paper under alternating stress, it has been customary to attribute the losses in dielectrics to some form of molecular friction, apparently arising in the same types of cause pertaining to the case of magnetic hysteresis. There are many differences between the two phenomena which indicate that they are of essentially different character, and it is undesirable, therefore, to use the word hysteresis in connection with dielectric behavior. In addition to the differences mentioned it is to be noted that in the case of dielectrics there are many other factors, as enumerated above, that appear to be quite sufficient to account for all of the losses which are observed. It is, of course, possible that in addition to these well-recognized causes for loss there may be some residual type of loss arising in the orientation or deformation of molecules and atoms. In fact, there have been numerous suggestions that the phenomenon of absorption itself arises in frictional deformation or the motion of electrons within the atom itself. With due weight given to these considerations it may still be said that the evidence that the nature of the losses in dielectrics is of the character usually understood by the word hysteresis and is so small as to make it appear very unlikely.

Gaseous Ionization. Many forms of commercial insulation are composite in character and built up in layers. Conspicuous examples are the insulation of all electromagnetic machinery and of many types of high-voltage underground cable. The assembly and application of this type of insulation invariably provides opportunity for the enclosure or entrapping of certain amounts of air, which is never completely removed by such processes as evacuation and subsequent pressure impregnation. This air, when voltage is applied to the insulation, breaks down electrically under the process known as ionization. It is also known that in some cases the constituents of impregnating materials break down under stress, with the generation of gases and the further increase in the size of the voids in the body of the insulation. These gases are also subject to ionization. The products of this gaseous ionization are usually highly active oxygen and ozone. Not only is the ionized gas a good conductor but the products of the ionization attack the surrounding material rendering it conducting, thus further increasing the conductivity.

It will be seen, therefore, that this type of conductivity is not necessarily inherent in the material itself, but is a result of imperfect methods of assembling and applying the material. However, it is probable that even at very low stresses this type of conductivity is present to some extent in all insulations in the class mentioned. Standard specifications for cables, for example, include clauses giving tests for increase in power factor due to this cause, and limiting values for such increase, thereby recognizing its necessary presence. Power-factor curves of this type of insulation only show marked increase above certain values of

stress, and such increase is in all probability rightly attributed to this type of ionization.

It can not be emphasized too strongly, however, that internal ionization is highly destructive to the structure of composite insulation, and that if such insulation is operated above a stress at which ionization is known to occur, the days or months of the life of this insulation are already numbered.

Bearing in mind these various causes giving rise to a phase difference in dielectrics, it is not to be wondered at that there is much conflict of evidence as to the behavior under different conditions of insulation of any particular type. Of the several causes enumerated the laws of only two of them may be said to be well known, namely, conduction and absorption. Inherent conductivity of the type found in metals leads to a value of losses readily calculable. Dielectric absorption has been carefully studied and it is known that in insulation of comparatively simple structure absorption accounts for most of the loss. In the uncertain laws controlling the losses of other character there is plenty of explanation of the erratic behavior often reported. It may be pointed out, however, that these uncertain phenomena are usually of a type which seems to yield to care and control in preparation of materials and methods of assembly. Moisture may be largely driven out, anomalous conductivity reduced to extremely small proportions, and it is possible to reduce gaseous ionization to negligible proportions. With care of this character, therefore, it is legitimate to consider the behavior of dielectrics from the standpoint of conductivity and absorption alone. It has been shown that the extension of Maxwell's theory of absorption to the alternating case will account for the outstanding features of the behavior of composite insulation. For example, the loss is in proportion to the square of the voltage, and to the frequency. Moreover, it is shown that the variation of power factor with the frequency shows a maximum value, which may lie at a low or very high value of frequency, depending upon the constituents of the material. Further, and due to the same causes, variations of temperature within the usual range may cause either sharp increase or sharp decrease of power factor. The fact that variations of this character are in accord with the simple theory of absorption as the principal source of loss is extremely encouraging and a great step in advance.

In closing this brief discussion of the origin of phase difference in dielectrics, it may be pointed out that a moderate value of phase difference or power factor appears to be practically a necessary feature for composite insulation. On the other hand, there is no objection to a phase difference of moderate amount provided that it remains constant. If the phase difference of a given dielectric increases with the electric stress its cause should be carefully investigated and the insulation always operated below the stress at which such increase in phase difference begins. The increase due to temperature is more difficult to control, but there is reason

to suppose that it has a definite value in any particular case, and that it is therefore subject to control. If these considerations are correct, there is good reason to hope that a well considered program of experimental research will result in the placing of the design of insulation on an engineering basis comparable to that pertaining to the other elements of circuits and machinery. The essentials of such a program would be principally the checking of the laws which now appear most probable, and the study of the properties of insulating materials, singly and in combination. The preparation and coordination of a program to meet this need is already under way in the work of the Committee of Insulation of the Division of Engineering and Industrial Research of the National Research Council.

INCREASE OF ELECTRIC POWER IN FACTORIES AND HOMES

In his Annual Report of the Department of Commerce Secretary Hoover states that there has been a large increase in the application of electrical power in manufacturing, and while there has been an increase during this period of between five and six million horse power used in factory production, there has been no increase in boilers and engines installed within these plants, the increase having been made almost entirely by electrical motors operated through purchased power. There has also been a transformation from direct-connected steam equipment within factories to factory electrical generation for distribution throughout the plants until at the present moment apparently 70 per cent of factory power is delivered to the machines electrically.

The application of electrical power to home use has received enormous expansion. The number of homes served has increased in six years from 5,700,000 to over 15,000,000. The number of farms served is expanding rapidly, and in some States, such as California, farm electrification far exceeds that in any other locality in the world. Owing to the economies brought about through central generation and interconnection and through the advances in electrical science the average price of power throughout the country is now somewhat less than before the war, it being one of the few commodities to be delivered on less than a pre-war basis.

This transformation, it may be said at once, has increased the productivity of our workmen beyond those of any other country; it contributes to our maintenance of high real wages and to the reduction of human sweat; it relieves the home makers of many irksome tasks and adds immeasurably to home comforts.

There is still further promise of great progress in the reduction of fuel consumption in the extension of electrification, particularly in the further replacement of factory steam plants, in the electrification of our large railway terminals, and in the expansion of household use of power.

Synchronizing Power in Synchronous Machines Under Steady and Transient Conditions

BY H. V. PUTMAN¹

Associate, A. I. E. E.

Synopsis.—The accuracy of all calculations relating to the hunting of synchronous machines connected mechanically to reciprocating apparatus depends largely upon the correctness with which the value of the synchronizing power P_s may be determined. Thus, the calculation of flywheels necessary for the parallel operation of engine driven generators depends entirely on a correct value of P_s . Likewise, the WR^2 which it is necessary to incorporate in the rotors of synchronous motors when driving compressors or pumps can be calculated correctly only when P_s is accurately known.

So far as the author is aware, no attempt at a complete analysis of the subject has been made heretofore. The object of this paper is to develop a method by which the synchronizing power P_s may be calculated fairly accurately under any condition likely to be met with. The method applies only to synchronous machines of the usual definite pole construction. Blondel's conception of two reactions with some modifications and extensions is followed generally throughout the paper.

* * * * *

SECTION I. INTRODUCTION

SYNCHRONIZING power, P_s , may be defined as the rate at which the input power to a synchronous motor changes with corresponding changes in the angular displacement. The displacement referred to here is not that which actually exists between the rotor and the rotating electrical field in the motor but it is the displacement between the rotor and an imaginary electrical field which corresponds in phase position to the terminal voltage. This will be explained more fully later.

P_s is often called a constant. It would be more correct to say that P_s is constant for a given set of operating conditions because its value changes with the load, the excitation, and with the frequency at which the mechanical load pulsates.

If, for a given synchronous motor operating under constant excitation, a curve is plotted showing the power input as function of the angular displacement, it will appear similar to that shown in Fig. 1.

Now it is obvious that if the mechanical load on the motor changes very slowly, the rate of change of power with displacement is given by the slope of the tangent to the curve at the point corresponding to the given load on the motor. If, however, the mechanical load pulsates up and down rapidly as it does in the case of a compressor, the rate of change of power with the displacement is no longer given by the slope of the tangent to the curve but by the slope of some other line similar to the dotted line in Fig. 1.

The reason for the above phenomenon is not hard to find. A sudden increase in the load on a motor is accompanied by a sudden increase in the armature reaction which tends to buck down, and distort the field flux. It is, however, impossible for the field flux to change immediately, and for the first instant the effect of the armature reaction on the field flux is practically offset by a sudden increase in the field current

produced by an induced voltage due to the changing field flux. The result is that the armature reaction has not had time to function at least completely, and the field current has increased or decreased to make up for it. This is precisely what happens in a synchronous motor driving a compressor. The armature reaction functions only partially and the field is kept continually in a transient state. Oscillograms of the field current taken when a machine is hunting often show marked pulsations amounting to a considerable percentage of the average value.

The problem of calculating P_s is thus not simply that of calculating the slope of the tangent line in Fig. 1, but rather the more complicated problem of calcu-

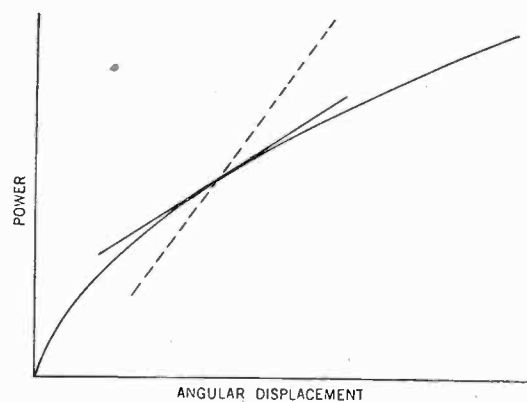

FIG. 1—CURVE SHOWING POWER AS FUNCTION OF DISPLACEMENT UNDER STEADY LOAD

Dotted line represents change of power with displacement under condition of pulsating load.

lating the slope of the dotted line. In the theoretical analysis which follows, the angular displacement of the machine will be calculated first according to Blondel's theory, then the slope of the tangent line in Fig. 1, and finally that of the dotted line.

SECTION II. THEORETICAL TREATMENT

The following symbols will be used throughout the remainder of this paper:

- E_i = Induced voltage
- E_n = Nominal voltage
- E_t = Terminal voltage
- E_0 = Impressed voltage

1. Electrical Engineer, Westinghouse Elec. & Mfg. Co., East Pittsburgh, Pa.

Presented at the Pacific Coast Convention of the A. I. E. E., Salt Lake City, Utah, Sept. 6-9, 1926.

- I = Current
 r = Resistance
 x = Reactance
 x_s = Synchronous reactance operating on the component of current at right angles to E_n
 x_s' = Synchronous reactance operating on the component of current in phase with E_n
 $x_d = x_s - x_s'$
 x_e = Effective synchronous reactance, $x < x_e < x_s$
 z = Impedance
 $z_s = \sqrt{r^2 + x_s^2}$ = Synchronous impedance
 $z_s' = \sqrt{r^2 + x_s'^2}$ = Synchronous impedance
 m = Coef. of armature reaction. (Ratio of demagnetizing ampere-turns to the no-load excitation ampere-turns)
 F_r = Resultant field excitation
 F_f = Applied field excitation
 θ = Power factor angle lagging
 δ = Angle between I and E_n
 ψ = Angular displacement of the rotor
 P = Power input
 $P_s = \frac{dP}{d\psi}$ = Synchronizing power
 K' = Factor of effectiveness of armature reaction
 N = No. of turns on field pole
 L = Effective inductance of the field
 r_f = Effective resistance of the field
 K = Coef. of coupling between armature and field
 E = D-c. voltage impressed on the field
 $p = \text{Operator } \frac{d}{dt}$
 i = Component of current in phase with E_n
 i_1 = Component of current at right angles to E_n
 t = Time in sec.
 $\Phi \sin \omega t$ = Pulsating flux provided by the demagnetizing component of armature reaction
 ω = Frequency of the mechanical pulsation in radians per sec.
 i_f = Current in the field circuit
 ψ_r = Resultant flux in the field pole

The fundamental equation of all electrical machines is:

$$E_i = E_t + I z \quad (1)$$

This equation simply states that the induced voltage is the vector sum of the terminal voltage and the impedance drop.

The induced voltage is proportioned to the flux producing it and lags behind the flux by 90 deg. This is expressed mathematically,²

2. The use of a linear relation here between F_r and E_i does not mean that the effect of saturation in the machine has been neglected. In fact, the proper value of c to be used for a given set of operating conditions must be determined from the saturation curve. c is really the slope of a straight line from the zero point through the operating point on the saturation curve.

$$F_r = j c E_t \quad (2)$$

where c is the proportionality factor.

The resultant excitation F_r is the sum of the armature reaction $I m$ and the applied excitation F_f ; thus

$$F_r = F_f + I m \quad (3)$$

Substituting (3) in (2) and solving for E_t ,

$$E_t = -j \frac{F_f}{c} - j I \frac{m}{c} \quad (4)$$

The term $-j \frac{F_f}{c}$ is defined by most writers as the nominal voltage and denoted by E_n . From (4) it may be seen that it is equal to the induced voltage at no load. Substituting (1) in (4) and replacing $-j \frac{F_f}{c}$ by E_n ,

$$E_t + I z + j I \frac{m}{c} = E_n$$

or

$$E_t + I \left[r + j \left(x + \frac{m}{c} \right) \right] = E_n \quad (6)$$

The term $\left(x + \frac{m}{c} \right)$ is the synchronous reactance, x being the real reactance, and $\frac{m}{c}$ the reactance equivalent of the armature reaction. The complete bracket in equation (6) is, therefore, the synchronous impedance and represented by z_s .

$$E_n = E_t + I z_s \quad (7)$$

It is interesting to note the similarity between equations (1) and (7). The nominal voltage corresponds to the induced voltage, and the impedance has become synchronous impedance. Equation (1) applies to all electrical devices while equation (7) is the fundamental equation of, and applies only to, synchronous machines.

For a synchronous motor, equation (7) is more conveniently written

$$-E_n = E_0 - I z_s \quad (8)$$

E_0 being the impressed voltage.

The vector diagram for a synchronous motor based on equation (8) is shown in Fig. 2. $-E_n$ has been chosen as zero vector, so that vectorially

$$-E_n = E_n + o j$$

It should be noted in connection with Fig. 2 that θ is the power-factor angle lagging, and δ is the angle between I and E_n .

Now it can be shown that the angle between E_n and E_0 is the angular displacement of the machine. It is, however, somewhat different from the angular displacement between the rotor and the rotating electrical field.

It is actually the angular displacement between the rotor and an imaginary rotating electrical field corresponding in phase position to the terminal voltage, while the actual rotating electrical field corresponds in phase position to the induced voltage. There is a distinct advantage in calculating the displacement from the terminal voltage rather than from the induced voltage since the terminal voltage vector always rotates at uniform velocity provided the frequency of the impressed voltage is constant. But in a machine which is hunting, the induced voltage vector or the actual electrical field in the stator does not rotate uniformly because of the reactance, the Ix drop pulsating as the current pulsates. In problems involving hunting, it is necessary to calculate the variations in the speed of the rotor. This is done by calculating the angular displacement of the machine as function of time but it is evident that the angular displacement must be referred to a uniformly rotating vector. The advantage of referring the angular displacement to the terminal voltage rather than to the induced for all problems concerned with hunting and the calculation of P_s on this basis is thus apparent.

The angular displacement is therefore

$$\psi = (\theta + \delta) \quad (9)$$

The value of ψ corresponding to a given power input at

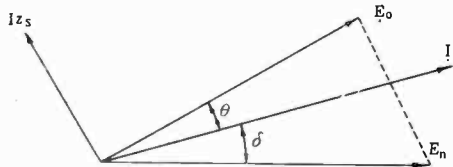

FIG. 2—VECTOR DIAGRAM OF SYNCHRONOUS MOTOR UNDER STEADY LOAD

a given power factor is easily determined from equation (8) as follows:

From Fig. (2),

$$\begin{aligned} I z_s &= I (\cos \delta + j \sin \delta) (r + j x_s) \\ &= I [(r \cos \delta - x_s \sin \delta) + j (x_s' \cos \delta + r \sin \delta)] \end{aligned} \quad (10)$$

It should be noted that an x_s' is used with the component of current in phase with E_n or that component of the current which is maximum when the armature coils are directly under the centers of the field poles. This is according to Blondel's well known theory of two reactions and amounts to the same thing as Dr. Berg's³ method with the exception that Dr. Berg based his equations on the induced voltage as zero vector which introduces a slight error especially at larger loads.

Substituting (10) in (8),

$$\begin{aligned} E_n &= E_0 [\cos (\delta + \theta) + j \sin (\delta + \theta)] \\ &\quad - I [r \cos \delta - x_s \sin \delta + j (x_s' \cos \delta + r \sin \delta)] \end{aligned} \quad (11)$$

Equation (11) may be separated into two equations, one involving only real terms, the other only imaginary.

3. Berg and Upson, "First Course in Electrical Engineering," Chapter XXXV, McGraw Hill & Co., 1916.

Thus, from the imaginary terms is obtained the equation,

$$E_0 (\sin \delta \cos \theta + \cos \delta \sin \theta) = I (x_s' \cos \delta + r \sin \delta)$$

or

$$\sin \delta [E_0 \cos \theta - I r] = \cos \delta [I x_s' - E_0 \sin \theta] \quad (12)$$

or

$$\tan \delta = \frac{I x_s' - E_0 \sin \theta}{E_0 \cos \theta - I r} \quad (13)$$

This equation, which was derived by Blondel⁴, gives the value of the angle δ for any load and power factor and consequently the displacement ψ , since $\psi = \delta + \theta$.

Very often, however, the field excitation and consequently the nominal voltage is fixed, and it is desired to find the displacement as function of the power under this condition.⁵

Equation (12) may be rewritten:

$$x_s' I \cos \delta + r I \sin \delta = E_0 \sin \psi \quad (14)$$

In a similar manner the real terms of equation (11) give:

$$r I \cos \delta - x_s I \sin \delta = E_0 \cos \psi - E_n \quad (15)$$

Equations (14) and (15) may be solved by determinants for $I \cos \delta$ and $I \sin \delta$ as follows:

$$I \cos \delta = \frac{r (E_0 \cos \psi - E_n) + x_s E_0 \sin \psi}{r^2 + x_s x_s'} \quad (16)$$

and

$$I \sin \delta = \frac{r E_0 \sin \psi - x_s' (E_0 \cos \psi - E_n)}{r^2 + x_s x_s'} \quad (17)$$

These are the two components of I along and at right angles to E_n , so that vectorially

$$I = I \cos \delta + j I \sin \delta \quad (18)$$

Also from the vector diagram, Fig. 2,

$$E_0 = E_0 \cos \psi + j E_0 \sin \psi \quad (19)$$

The input power may now be calculated by telescoping (18) and (19). Thus:

$$P = E_0 \cos \psi I \cos \delta + E_0 \sin \psi I \sin \delta \quad (20)$$

Substituting for $I \cos \delta$ and $I \sin \delta$ from equations (16) and (17) gives the input power as function of the displacement as follows:

$$\begin{aligned} P &= E_0 \cos \psi [r (E_0 \cos \psi - E_n) + x_s E_0 \sin \psi] \frac{1}{(r^2 + x_s x_s')} \\ &\quad + E_0 \sin \psi [r E_0 \sin \psi - x_s' (E_0 \cos \psi - E_n)] \frac{1}{(r^2 + x_s x_s')} \end{aligned} \quad (21)$$

4. "Synchronous Motors and Converters," McGraw Hill & Co., 1913. Blondel's equation involves + signs because it is derived for the alternator instead of the motor.

5. Incidentally, this is the problem involved in the calculation of P_s with the exception that the field transient must also be considered.

which reduces to

$$P = \frac{E_0^2}{(r^2 + x_s x_s')} \left\{ r - \frac{E_n}{E_0} (r \cos \psi - x_s' \sin \psi) + \sin \psi \cos \psi (x_s - x_s') \right\} \quad (22)$$

Equation (22) is useful as it gives the input power of a definite pole synchronous motor for a given angular displacement. A close approximation may be made to (22) by disregarding the resistance. This gives the somewhat simpler expression,

$$P = \frac{E_0^2}{x_s x_s'} \left\{ \frac{E_n}{E_0} x_s' \sin \psi + \sin \psi \cos \psi (x_s - x_s') \right\} \quad (23)$$

Differentiating (22) with respect to ψ , the slope of the tangent line shown in Fig. 1 is obtained:

$$P_s = \frac{dP}{d\psi} = \frac{E_0^2}{(r^2 + x_s x_s')} \left[x_d \cos 2\psi + \frac{E_n}{E_0} (x_s' \cos \psi + r \sin \psi) \right] \quad (24)$$

where

$$x_d = x_s - x_s'$$

or disregarding resistance terms

$$P_s = \frac{dP}{d\psi} = E_0^2 \left[\left(\frac{1}{x_s'} - \frac{1}{x_s} \right) \cos 2\psi + \frac{E_n}{E_0} \frac{1}{x_s} \cos \psi \right] \quad (25)$$

As pointed out in the beginning of this paper, this is not the P_s to be used in problems of hunting because it does not take into account the field transient. It does, however, represent the lowest limit of the value which P_s would approach if the forced oscillations were to take place very slowly—so slowly that the armature reaction and consequently the synchronous reactance would have time to function completely and there would be no field transient.

*The Transient P_s of the Synchronous Motor Neglecting Resistance.*⁶

If a machine which has been operating under steady load at displacement ψ is suddenly loaded so that its displacement increases by $\Delta\psi$ almost instantaneously, just what happens?

It is at once apparent from the vector diagram, Fig. 3, that the $I z_s$ vector is increased. This means an increase in the power, current, and armature reaction of the machine. Disregarding the resistance for the present, the $I z_s$ drop may be considered as made up of two components $i_1 x_s$ and $i x_s'$ according to Blondel's theory of two reactions. These components are shown in

6. A complete derivation taking resistance into account is given in the appendix.

Fig. 3. The reactance x_s' which operates on the energy component of current which is i probably acts almost instantaneously. At least it is probable that the cross flux can build up and down as fast as any of the forced oscillations encountered in cases of hunting would require. The main flux, however, requires time to build up or down and so x_s cannot function instantly, or rather that part of x_s which is due to armature reaction cannot function instantly. Hence, the reactance which operates on a sudden increase in the wattless current is some transient or effective reactance which may be denoted by x_e and which lies between x , the real reactance, and x_s , the synchronous reactance, its value depending on the rate of change of the wattless current.

The power given by the motor, corresponding to an increase in the displacement from its average value of ψ to $(\psi + \Delta\psi)$, can be calculated as follows under the

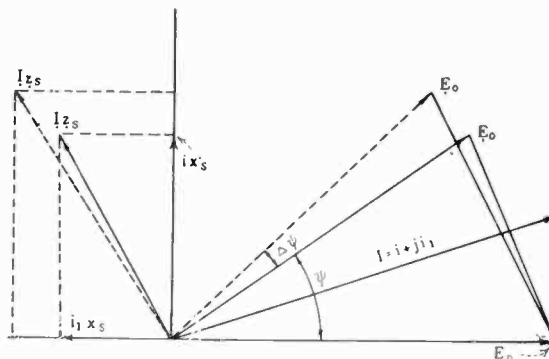

FIG. 3—VECTOR DIAGRAM OF SYNCHRONOUS MOTOR SHOWING EFFECT OF SUDDEN INCREASE IN LOAD

above assumptions. The method is simply to obtain expressions for E_0 and I_0 and telescope the vectors.

From Fig. 3,

$$E_0 = E_0 [\cos (\psi + \Delta\psi) + j \sin (\psi + \Delta\psi)] \quad (26)$$

and before the displacement occurred

$$I z_s = - [E_n - E_0 \cos \psi] + j E_0 \sin \psi \quad (27)$$

Therefore, disregarding the resistance, the initial value of the current, corresponding to the average displacement ψ , is from (27).

$$I = \frac{E_0 \sin \psi}{x_s'} + j \frac{E_n - E_0 \cos \psi}{x_s} \quad (28)$$

The real component of I corresponding to the increased displacement $(\psi + \Delta\psi)$ is

$$i = \frac{E_0 \sin (\psi + \Delta\psi)}{x_s'} \quad (29)$$

The increase in the wattless component is

$$\Delta i_1 = \frac{E_0 [\cos \psi - \cos (\psi + \Delta\psi)]}{x_e} \quad (30)$$

Note that the effective reactance is used here, since, as was shown above, it is the effective reactance which limits an increase in the wattless current. The wattless component of current corresponding to the increased displacement is then

$$i_1 = \frac{E_n - E_0 \cos \psi}{x_s} + \frac{E_0}{x_e} [\cos \psi - \cos (\psi + \Delta \psi)] \quad (31)$$

or

$$i_1 = E_0 \left\{ \left(\frac{1}{x_e} - \frac{1}{x_s} \right) \cos \psi - \frac{1}{x_e} \cos (\psi + \Delta \psi) + \frac{E_n}{E_0 x_s} \right\} \quad (32)$$

The power at displacement $(\psi + \Delta \psi)$ is therefore

$$P = \frac{E_0^2 \cos (\psi + \Delta \psi) \sin (\psi + \Delta \psi)}{x_s'}$$

$$+ E_0^2 \sin (\psi + \Delta \psi) \left\{ \left(\frac{1}{x_e} - \frac{1}{x_s} \right) \cos \psi - \frac{1}{x_e} \cos (\psi + \Delta \psi) + \frac{E_n}{E_0 x_s} \right\} \quad (33)$$

or

$$P = E_0^2 \left\{ \frac{\sin 2 (\psi + \Delta \psi)}{2 x_s'} + \sin (\psi + \Delta \psi) \left[\left(\frac{1}{x_e} - \frac{1}{x_s} \right) \cos \psi + \frac{E_n}{E_0 x_s} - \frac{1}{x_e} \cos (\psi + \Delta \psi) \right] \right\} \quad (34)$$

Differentiating P with respect to $\Delta \psi$, we obtain the rate of change of power with respect to an increase in the displacement which is P_s . Thus

$$P_s = E_0^2 \left\{ \left(\frac{1}{x_s'} - \frac{1}{x_e} \right) \cos 2 (\psi + \Delta \psi) + \cos (\psi + \Delta \psi) \left[\left(\frac{1}{x_e} - \frac{1}{x_s} \right) \cos \psi + \frac{E_n}{E_0 x_s} \right] \right\} \quad (35)$$

which is P_s at any displacement $(\psi + \Delta \psi)$.

At ψ

$$P_s = E_0^2 \left\{ \left(\frac{1}{x_s'} - \frac{1}{x_e} \right) \cos 2 \psi + \left(\frac{1}{x_e} - \frac{1}{x_s} \right) \cos^2 \psi + \frac{E_n}{E_0 x_s} \cos \psi \right\} \quad (36)$$

This is the value of P_s which should be used in all problems of hunting, and is represented by the slope of the dotted line in Fig. 1.

It still remains to calculate the value of x_e to be used in any given case. It has been shown that, in value, x_e lies in between x and $x_s = x + m/c$, where x is the real reactance and m/c is the armature reaction part

of the synchronous reactance. Now when a motor is hunting, the demagnetizing component of armature reaction is a pulsating reaction against the field. If the pulsations take place slowly enough, the armature reaction will cause the field flux to pulsate the same amount. If, however, the pulsations are more rapid, the field flux will not have time to follow the pulsations in the armature reaction.

The problem then is merely to find out how much effect the armature reaction has on the field flux. This is a measure of the effectiveness of the m/c term in the synchronous reactance x_s . For very high speed pulsations $m/c = 0$. For very slow speed pulsations $m/c = m/c$, and in general,

$$x_e = x + K' m/c \quad (37)$$

where K' is the factor of effectiveness of armature reaction in destroying and building up the field flux in the main path.

K' may be determined from the following considerations:

Referring to Fig. 4, let the pulsating flux provided

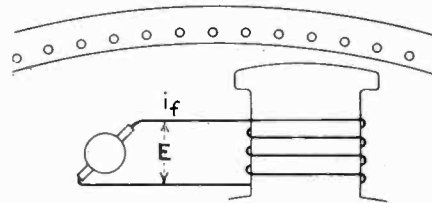

FIG. 4—DIAGRAM ILLUSTRATING PULSATING ARMATURE REACTION

by the demagnetizing component of armature reaction be represented by

$$\Phi \sin \omega t.$$

where

ω = frequency of the pulsations in radians per sec.

Let

N = No. of field turns per pole.

L = Effective inductance of the field.⁷

r_f = Effective resistance of the field.⁷

K = Coef. of coupling between armature and field.

E = D-c. voltage impressed on the field.

The equation of the field circuit is:

$$E = i_f (r_f + pL) + NK \Phi \omega \cos \omega t. \quad (38)$$

or

$$i_f = \frac{E - NK \Phi \omega \cos \omega t}{r_f + pL} \quad (39)$$

the permanent solution of which is:

$$i_f = \frac{E}{r_f} - \frac{NK \Phi \omega}{\sqrt{r_f^2 + L^2 \omega^2}} \cos \left(\omega t - \tan^{-1} \frac{L \omega}{r_f} \right) \quad (40)$$

This is the pulsating field current which exists in a machine when it is hunting. It may be seen from (40)

7. By "effective" resistance and inductance, the writer intends to consider the effect of the amortisseur winding, as will be seen later.

that if ω is small, there is little pulsation in the field current. If, however, ω is larger, there will be larger pulsations.

The resultant flux in the field pole can be obtained from the equation,

$$E - i_f r_f = N \frac{d\phi_r}{dt} \tag{41}$$

or

$$\phi_r = \frac{1}{N} \int E - i_f r_f \tag{42}$$

From equation (40)

$$E - i_f r_f = \frac{N r_f K \Phi \omega}{\sqrt{r_f^2 + L^2 \omega^2}} \cos \left(\omega t - \tan^{-1} \frac{L \omega}{r_f} \right) \tag{43}$$

$$\therefore \phi_r = \frac{r_f K \Phi}{\sqrt{r_f^2 + L^2 \omega^2}} \sin \left(\omega t - \tan^{-1} \frac{L \omega}{r_f} \right) + C \tag{44}$$

The constant of integration in this case is the steady component of the resultant flux ϕ_r . From (44) it follows that the magnitude of the a-c. component of the resultant flux is

$$\Phi_r = \frac{r_f K \Phi}{\sqrt{r_f^2 + L^2 \omega^2}} \tag{45}$$

Now when ω is very small, the armature reaction is 100 per cent effective and

$$\Phi_r = K \Phi$$

$$\therefore K' = \frac{r_f K \Phi}{\sqrt{r_f^2 + L^2 \omega^2}} \div K \Phi = \frac{r_f}{\sqrt{r_f^2 + L^2 \omega^2}} \tag{46}$$

or

$$K' = \frac{1}{\sqrt{1 + \left(\frac{L}{r_f} \right)^2 \omega^2}} \tag{47}$$

In this formula $\left(\frac{L}{r} \right)$ refers to the field alone and is the time constant which determines the field transient occurring when the field circuit is closed on a constant voltage source. If this time constant is determined by an oscillogram of the starting current in the field, the effect of the amortisseur winding is automatically taken into consideration. K' is thus determined and from it x_e may be calculated by equation (39).

SECTION III. EXAMPLES AND CONCLUSIONS

To determine the relative importance of the various factors which affect the value of P_s , consider a typical low-speed synchronous motor, the constants of which are:

$$\left. \begin{array}{ll} x_s = 0.85 & r = 0.06 \\ x_s' = 0.60 & x = 0.30 \\ & m/c = 0.55 \end{array} \right\} \tag{48}$$

$$\frac{L}{r_f} = 0.21 \dots \text{(from oscillogram of field transient)}$$

Assume that the speed of the above motor is 80 rev. per min. and that it is direct connected to a single-cylinder, double-acting compressor. A compressor of this type has two peaks in its torque curve every revolution so that the speed of the impressed pulsations is 160 per min. or $\omega = 16.75$ radians per sec.

From (37)

$$x_e' = x + K' \frac{m}{c} \tag{37}$$

where

$$K' = \frac{1}{\sqrt{1 + \left(\frac{L}{r_f} \right)^2 \omega^2}} \tag{47}$$

Substituting the above values for L/r_f and ω in (47), it is found that $K' = 0.273$ which means that the armature reaction in the main field is only 27.3 per cent effective.

The effective reactance may be calculated from equation (37) thus:

$$x_e = 0.30 + 0.273 \times 0.55 = 0.45 \tag{48}$$

Having determined all the necessary constants, the behavior of the motor may now be calculated. Assume the machine to be operating at full-load unity power factor so that $\theta = 0$. The angular displacement may be calculated from (13).

$$\tan \delta = \frac{0.60 - 0}{1 - 0.06} = 0.638 \tag{49}$$

Since

$$\theta = 0, \quad \psi = \delta = 32.6 \text{ deg.}$$

The nominal voltage at full-load unity power factor may be determined from equation (15). Thus

$$E_n = 0.843 - (0.06 \times 0.843 - 0.85 \times 0.54) = 1.26 \tag{50}$$

Resumé of constants necessary for the calculation of P_s at full-load unity power factor, 80 rev. per min., single-cylinder double-acting compressor:

$$\left. \begin{array}{ll} x_s = 0.85 & r = 0.06 \\ x_s' = 0.60 & x_e = 0.45 \\ \psi = 32.6 \text{ deg.} & E_n = 1.26 \end{array} \right\} \tag{51}$$

Neglecting resistance, the value of P_s may be obtained by substituting (51) in equation (36).

$$\begin{aligned} P_s &= \left(\frac{1}{0.60} - \frac{1}{0.45} \right) 0.42 + \left(\frac{1}{0.45} - \frac{1}{0.85} \right) 0.71 \\ &\quad + \frac{1.26}{0.85} \times 0.843 = 1.76^s \end{aligned} \tag{52}$$

Effect of Frequency of Load Pulsations on P_s .

If the motor had been driving a two-cylinder, double-

8. This value of P_s is given on a percentage basis. To get it in kw. it must be multiplied by the kw. rating of the motor.

acting compressor, the torque curve of which would have four peaks per revolution, ω would be twice as great and

$$K' = 0.141$$

and

$$x_e = 0.378$$

With this value of x_e , P_s would be somewhat greater, thus:

$$P_s = \left(\frac{1}{0.60} - \frac{1}{0.378} \right) 0.42 + \left(\frac{1}{0.378} - \frac{1}{0.85} \right) 0.71 + \frac{1.26}{0.85} \times 0.843 = 1.88 \quad (53)$$

Thus it is evident that the value of P_s for this case is about 7 per cent greater when the motor is used to drive a two-cylinder, double-acting compressor, than it is when driving a single-cylinder, double acting

proaches the breakdown point. At no load the function would theoretically be a straight line.

The dotted lines are constant power-factor curves and show roughly the power factor which will be obtained for various values of excitation and load.

The half-load line is of particular interest. There

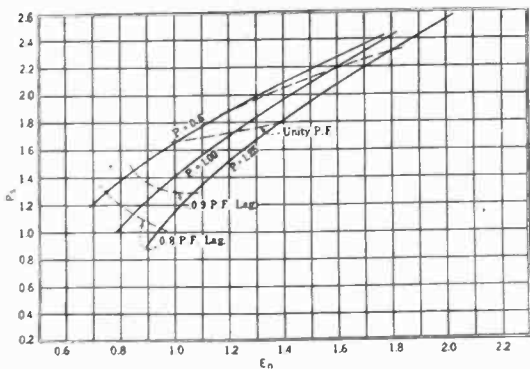

FIG. 5—CURVES SHOWING SYNCHRONIZING POWER, P_s , AS FUNCTION OF THE NOMINAL VOLTAGE, E

machine. In higher speed motors this difference will be still less so that, while P_s is not entirely independent of the nature of the load, it is approximately so, for compressors of the conventional types and speeds.

Effect of Resistance on P_s .

The effect of the resistance on the value of P_s may be determined by calculating P_s from equation (20), given in appendix, which gives

$$P_s = 1.81 \quad (54)$$

This represents an increase of only 2 1/2 per cent in the value of P_s obtained by neglecting resistance. It should also be noted that 6 per cent resistance is unusually high and hence it may be concluded that for practical work the effect of the resistance may be disregarded.

Effect of Excitation on P_s .

Fig. 5 shows a family of three curves which give P_s as function of the excitation E_n , for 1 1/4 load, full load, and half load.⁹ It may be seen at a glance that the relationship is practically linear for a given load, except at the lower end where the curves droop as the motor ap-

9. The values used in plotting the curves in Figs. 5 and 7 were obtained by substituting (51) in equations (13), (15), and (36).

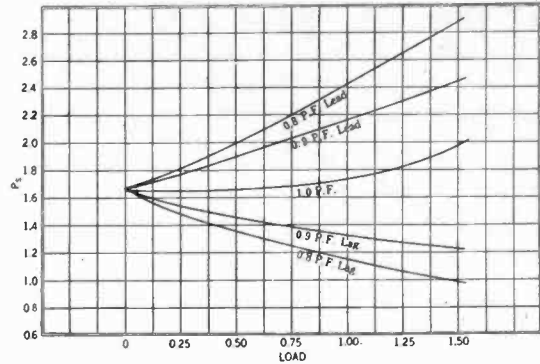

FIG. 6—CURVES SHOWING EFFECT OF CHANGES IN LOAD ON THE VALUE OF THE SYNCHRONIZING POWER, P_s

is very little tendency for the curve to droop even at the lower extremity. This shows that the motor may be operated at half load at a power factor as poor as 0.7 lagging or even less without danger of the motor falling out of step. In fact it would be possible to reduce P_s to a value as low as 1.1 at half load by reducing the excitation sufficiently.

This fact is made use of in connection with the unloading of two-cylinder, double-acting compressors by removing one connecting rod. Ordinarily the flywheel is so designed that the natural frequency corresponds

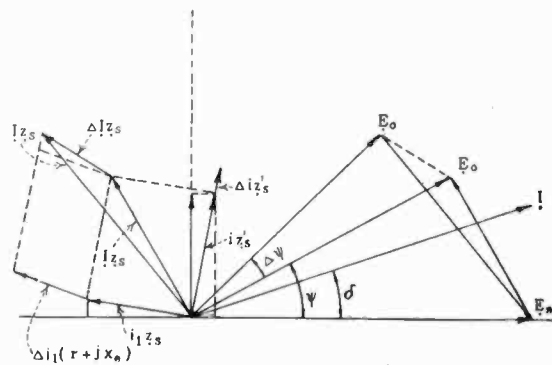

FIG. 7—VECTOR DIAGRAM OF SYNCHRONOUS MOTOR SHOWING EFFECT OF SUDDEN INCREASE IN LOAD. (RESISTANCE TAKEN INTO ACCOUNT)

to about twice the revolutions. This is all right for two-cylinder, double-acting compressors since there is no second harmonic in the torque curve. But if the machine is unloaded there is a large second harmonic and, if severe hunting is to be prevented, the natural frequency must be brought below it. This can be done by reducing P_s and running the motor at a poor lagging power factor. While such operating is not to be recommended as standard practise, it is valuable to know that it may be resorted to in emergency cases.

Effect of Load on P_s .

Fig. 6 shows another family of curves which give P_s

as a function of load for various power factors. At a slightly lagging power factor P_s is almost unaffected by the load, while at 0.8 leading power factor there is a decided increase in P_s with load. At 0.8 lagging power factor there is a decided decrease to half load after which the value remains practically the same.

Range of P_s .

In calculating the value of P_s for a number of engine-type, slow-speed synchronous motors, the writer has found that the value is practically always between 1.6 and 2.2 at full load unity power factor. In general, P_s is low in motors of large size and very slow speed, but higher in motors of smaller size and higher speed. Its value depends largely on the real reactance of the machine and on the ratio of the no-load excitation to the full-load armature reaction. A large reactance and low ratio tend to make a low value of P_s .

Appendix

The Transient P_s of the Synchronous Motor Taking Resistance into Account.

It has been shown in Equations (16) and (17) that under ordinary steady conditions

$$I = i + j i_1$$

where

$$i = \frac{r(E_0 \cos \psi - E_n) + x_s E_0 \sin \psi}{r^2 + x_s x_s'} \quad (1)$$

and

$$i_1 = \frac{r E_0 \sin \psi - x_s' (E_0 \cos \psi - E_n)}{r^2 + x_s x_s'} \quad (2)$$

Now suppose ψ is suddenly increased to $(\psi + \Delta \psi)$. Just as before, there is an increase in the $I z_s$ drop as shown in Fig. 7 which is

$$\Delta I z_s = E_0 \{ - [\cos \psi - \cos (\psi + \Delta \psi)] + j [\sin (\psi + \Delta \psi) - \sin \psi] \} \quad (3)$$

This increase in $I z_s$ is made up of two $i z$ drops. One is due to the real component of I , which is

$$\Delta i (r + j x_s') \quad (4)$$

since it is assumed that the cross armature reaction flux has time to function. The other $i z$ drop is due to the wattless component of current i , and is

$$j \Delta i_1 (r + j x_e) \quad (5)$$

where x_e is the effective reactance.

Hence, from the above statement and equations (4) and (5),

$$\Delta I z_s = \Delta i r - \Delta i_1 x_e + j (\Delta i x_s' + \Delta i_1 r) \quad (6)$$

Equating real and imaginary parts of equations (3) and (6),

$$\Delta i r - \Delta i_1 x_e = E_0 [\cos (\psi + \Delta \psi) - \cos \psi] \quad (7)$$

$$\Delta i x_s' + \Delta i_1 r = E_0 [\sin (\psi + \Delta \psi) - \sin \psi] \quad (8)$$

Therefore

$$\Delta i = \frac{E_0}{r^2 + x_s' x_e} \{ x_e [\sin (\psi + \Delta \psi) - \sin \psi] + r [\cos (\psi + \Delta \psi) - \cos \psi] \} \quad (9)$$

and

$$\Delta i_1 = \frac{E_0}{r^2 + x_s' x_e} \{ x_s' [\cos \psi - \cos (\psi + \Delta \psi)] + r [\sin (\psi + \Delta \psi) - \sin \psi] \} \quad (10)$$

By adding Δi and Δi_1 to the original components of current, the new components are obtained.

$$i = \frac{E_0}{r^2 + x_s x_s'} \left\{ r \left(\cos \psi - \frac{E_n}{E_0} \right) + x_s \sin \psi \right\} + \frac{E_0}{r^2 + x_s' x_e} \{ x_e [\sin (\psi + \Delta \psi) - \sin \psi] - r [\cos \psi - \cos (\psi + \Delta \psi)] \} \quad (11)$$

and

$$i_1 = \frac{E_0}{r^2 + x_s x_s'} \left\{ r \sin \psi - x_s' \left(\cos \psi - \frac{E_n}{E_0} \right) \right\} + \frac{E_0}{r^2 + x_s' x_e} \{ x_s' [\cos \psi - \cos (\psi + \Delta \psi)] + r [\sin (\psi + \Delta \psi) - \sin \psi] \} \quad (12)$$

The new voltage is:

$$E_0 \{ \cos (\psi + \Delta \psi) + j \sin (\psi + \Delta \psi) \} \quad (13)$$

Telescoping the current and voltage, the power is obtained.

$$P = E_0^2 \cos (\psi + \Delta \psi) \left[\frac{r \left(\cos \psi - \frac{E_n}{E_0} \right) + x_s \sin \psi}{r^2 + x_s x_s'} + \frac{x_e \{ \sin (\psi + \Delta \psi) - \sin \psi \} - r \{ \cos \psi - \cos (\psi + \Delta \psi) \}}{r^2 + x_s' x_e} \right] + E_0^2 \sin (\psi + \Delta \psi) \left[\frac{r \sin \psi - x_s' \left(\cos \psi - \frac{E_n}{E_0} \right)}{r^2 + x_s x_s'} + \frac{x_s' \{ \cos \psi - \cos (\psi + \Delta \psi) \} + r \{ \sin (\psi + \Delta \psi) - \sin \psi \}}{r^2 + x_s' x_e} \right] \quad (14)$$

In the above equation let

$$\left. \begin{aligned} r^2 + x_s' x_e &= z_e^2 \\ r^2 + x_s x_s' &= z_0^2 \end{aligned} \right\} \quad (15)$$

Substituting (15) in (14) and reducing,

$$P = E_0^2 \cos (\psi + \Delta \psi) \left[\frac{-r(x_s - x_e)}{z_0^2 z_e^2} \{ -r \sin \psi + x_s' \cos \psi \} + \frac{1}{z_e^2} \{ x_e \sin (\psi + \Delta \psi) + r \cos (\psi + \Delta \psi) \} - \frac{r E_n}{z_0^2 E_0} \right] + E_0^2 \sin (\psi + \Delta \psi) \left[\frac{x_s' (x_s - x_e)}{z_0^2 z_e^2} \{ x_s' \cos \psi - r \sin \psi \} \right]$$

$$+ \frac{1}{z_e^2} \{ r \sin (\psi + \Delta \psi) - x_s' \cos (\psi + \Delta \psi) \} + \frac{x_s' E_n}{z_o^2 E_o} \quad (16)$$

In Equation (16), let

$$C = \frac{(x_s - x_e)}{z_o^2 z_e^2} \{ x_s' \cos \psi - r \sin \psi \} \quad (17)$$

Substituting (17) in (16),

$$P = E_o^2 \cos (\psi + \Delta \psi) \left[-r C + \frac{1}{z_e^2} \{ x_e \sin (\psi + \Delta \psi) + r \cos (\psi + \Delta \psi) \} - \frac{r E_n}{z_o^2 E_o} \right] + E_o^2 \sin (\psi + \Delta \psi) \left[x_s' C + \frac{1}{z_e^2} \{ r \sin (\psi + \Delta \psi) - x_s' \cos (\psi + \Delta \psi) \} + \frac{x_s' E_n}{z_o^2 E_o} \right] \quad (18)$$

Differentiating P with respect to $\Delta \psi$ to get P_s ,

$$P_s = E_o^2 \left\{ \left(C + \frac{E_n}{z_o^2 E_o} \right) [x_s' \cos (\psi + \Delta \psi) + r \sin (\psi + \Delta \psi)] + \frac{x_e - x_s'}{z_e^2} \cos 2 (\psi + \Delta \psi) \right\} \quad (19)$$

At displacement ψ , (19) becomes

$$P_o = E_o^2 \left\{ \left(C + \frac{E_n}{z_o^2 E_o} \right) [x_s' \cos \psi + r \sin \psi] + \frac{x_e - x_s'}{z_e^2} \cos 2 \psi \right\} \quad (20)$$

which is the required value of P_s , taking resistance into account. In this formula, c is given by equation (17), and z_e and z_o by equation (15).

If the resistance terms are disregarded,

$$C = \frac{(x_s - x_e)}{x_s x_s' x_e} \cos \psi \quad (21)$$

Substituting (21) in equation (20) and neglecting r , equation (20) degenerates into

$$P_s = E_o^2 \left\{ \left(\frac{1}{x_e} - \frac{1}{x_s} \right) \cos^2 \psi + \left(\frac{1}{x_s'} - \frac{1}{x_e} \right) \cos 2 \psi + \frac{E_n}{E_o x_s} \cos \psi \right\} \quad (22)$$

which is the expression obtained previously for the case of no resistance, Eq. (36).

Bibliography

1. Berg and Upson, First Course in Electrical Engineering, 1916, Chapt. XXXV and XXXVIII.
2. Steinmetz, A. I. E. E. TRANS., Vol. XXXIX, Part II, p. 1215.
3. Steinmetz, Alternating-Current Phenomena, 1916, Chapt. XXII.
4. Steinmetz, Electrical Apparatus, 1917, Chapt. XVIII.
5. Henningsen, Calculation of Synchronizing Power, *G. E. Review*, 1921, p. 951.
6. Blondel, Synchronous Motors and Converters, 1913, (Translation by C. O. Mailloux) Part 3, Chapt. I. Also see foot-note p. 95.
7. Doherty and Shirley, A. I. E. E. TRANS., Vol. XXXVII, Part 2, p. 1209.
8. Doherty and Nickle, A. I. E. E. JOURN., Paper presented at Annual Convention of the A. I. E. E., White Sulphur Springs, W. Va., June, 1926.
9. V. Karapetoff, Variable Armature Leakage Reactance, *JOURN. of A. I. E. E.*, June, 1926, p. 686.
10. V. Karapetoff, Hunting and Parallel Operation of Synchronous Machines, *The Sibley Journal of Engineering*, March, 1920.

WILL HE SEE AND HEAR ACROSS U. S. IN 1929?

"I expect to see and hear by electricity the presidential inauguration in 1929 even though I may be thousands of miles away from Washington," declares Dr. Gerald Wendt, director of the division of industrial research, Pennsylvania State College. He is foreseeing electrical advances that are sure to be made in the next few years by industrial research. "Single pictures are already being sent across the sea," he points out. "When a more sensitive photoelectric cell is developed, a picture will be transmitted as rapidly as the movie can flash it on the screen. In Washington during the ceremony, the microphone will have a 'microscope' alongside it and I shall be sitting in my own living room seeing and hearing the entire performance as if I were on the spot. Then we shall have radio movies for every home."

WIND MAKES POWER LINES "HEAVY ON THEIR FEET"

Power lines have to be built to support wind as well as wire. Where a new high-tension line crosses the Sacramento River with a span four-fifths of a mile long, the tallest power-line tower in the world rears its top 459 feet in air. The weight of wire suspended in a long arc from this tower to another 410 feet high on the opposite side of the stream is 69,000 pounds but wind pressure against the wires may add as much as 14,400 lb. to the load. The tallest steel structure itself weighs 405,000 lb. but is built to resist a wind pressure of 108,000 lb. It stands on a foundation of piles driven 80 ft. into the ground under a concrete base weighing a million pounds. Sixty-six per cent of this piling and concrete is required for wind load only.

Abridgment of The Circle Diagram of a Transmission Network

BY FREDERICK EMMONS TERMAN¹

Associate, A. I. E. E.

Synopsis.—The first circle diagrams of the character herein described were published almost simultaneously by Thielemans in Europe and Evans and Sels in this country. The diagram of Evans and Sels is not nearly as complete as Thielemans's, but is more easily constructed because of the mathematical methods employed to determine the circle centers and radii. The present paper is an elaboration of the work done by these two investigators. It coordinates the graphical and mathematical methods of construction and extends their application.

The principal contributions of this article are incorporated in Tables I and II and in the paragraphs concerning geometrical checks that may be applied to the circle diagram. Tables I and II include formulas for determining the coefficients of a large number of circular loci which have not been heretofore constructed by mathematical methods. Other formulas given in Tables I and II are to be found elsewhere, but generally in a somewhat more complicated, although equivalent, form. The graphical checks that result from

the geometrical properties of the circle diagram, as first investigated by Thielemans, have not heretofore been applied to diagrams derived by mathematical computations. By establishing the identity of the Thielemans and Evans and Sels diagrams, it has been possible to utilize the numerous geometrical properties of the diagram that Thielemans has worked out, as well as to make use of other graphical properties. With the aid of the information incorporated in the following paragraphs it is possible to construct a circle diagram on which may be drawn circles representing almost any conceivable locus. This construction is carried out with the aid of computations made from the relatively simple formulas incorporated in Tables I and II. Any errors in the mathematical or graphical work that lead to an incorrect diagram can be simply and quickly uncovered by applying the numerous geometrical checks that are given in the paper. The result is a diagram easy to obtain, almost error proof, and of extreme usefulness.

* * * * *

INTRODUCTION

IN the last few years there has been considerable development in methods for the graphical solution of transmission systems. The principal results of this work have been the conception of network constants developed by Evans and Sels,² and the work that has been done on the circle diagram by Thielemans³, Evans and Sels², and others.

At the present time the information available on the circle diagram consists of more or less incomplete and unrelated fragments that have been developed by these different writers. It is the purpose of the present paper first, to coordinate, consolidate and expand the work that has been done on the circle diagram; second, to develop simpler methods of constructing the diagram; and finally, to determine new loci.

Any electrical network to which power is supplied at two terminals and this power transmitted by the network to another pair of terminals can always have its characteristics represented by either of the following pairs of equations in which the subscripts *s* and *r* denote sending-end and receiving-end quantities, respectively:

$$E_s = A E_r + B I_r \quad (1a)$$

$$I_s = C E_r + D I_r \quad (1b)$$

$$E_r = D E_s - B I_s \quad (2a)$$

$$I_r = A I_s - C E_s \quad (2b)$$

These two pairs of equations are equivalent to each

1. Instructor in Electrical Engineering, Stanford University, Calif.

2. Evans and Sels, *Electric Journal*, 1921.

3. "Diagrams of Transmission Lines," by L. Thielemans, *Revue Generale de L'Electricite*, 1920-1921.

Presented at the Pacific Coast Convention of the A. I. E. E., Salt Lake City, Utah, Sept. 6-9, 1926. Complete copies available to members on request.

other but it is often convenient to utilize all four equations. The frequency of transmission and the character of the electrical network being used for transmission are taken into account by the four complex quantity coefficients *A*, *B*, *C*, and *D*. A set of such constants, commonly referred to as the *network constants*, can always be determined from a knowledge of the network elements and the frequency. Only three of the four constants are independent, for it can be shown that in any network the relation $AD = 1 + BC$ must hold true. Also, in the special case of a network which is symmetrical about the center it can be shown that $A = D$.

RECEIVING-END CIRCLE DIAGRAM

Construction of the Diagram. Let us first lay out a coordinate system in which the *X* and *Y* axes represent received power P_r and received reactive power Q_r , respectively, with *leading values of Q_r considered as positive*. With the aid of equations (1) and (2) it is possible to compute values of P_r and Q_r which will give a constant generator voltage E_s . When these results are plotted on the $P_r - Q_r$ coordinate system, the result is found to be a circle no matter what constant value of E_s is being investigated *when the receiver voltage E_r is constant*. The only effect of the value of E_s is to vary the radius, so that the locus of points on the $P_r - Q_r$ coordinates which represent constant values of E_s is a family of concentric circles, as shown in Fig. 1. If the investigation is continued, it is found that the loci of points in Fig. 1 which represent constant generator power factor, constant efficiency of transmission, constant sending-end power, etc., are also circles, *provided only that the receiver voltage is kept constant*. A $P_r - Q_r$ coordinate system upon which such circular

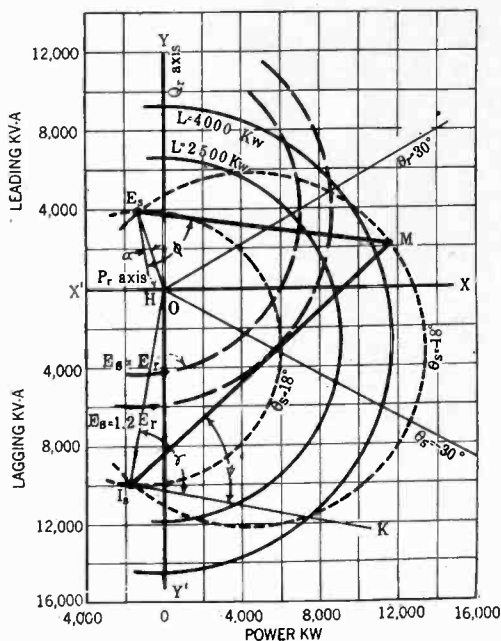

FIG. 1—TYPICAL RECEIVING-END CIRCLE DIAGRAM
Showing loss circles, sending-voltage circles, and sending-end power-factor circles

loci have been placed is called the *receiving-end circle diagram* of the transmission network.

In order that the circle diagram may be of practical use, it is necessary to find some satisfactory way of drawing the various circular loci that may be put on the coordinates in Fig. 1. To draw a circle, one must know the coordinates of the center and the value of the radius measured in terms of the coordinate system. Starting with the equations (1) and (2), it is possible to derive equations that give the relation of P_r , Q_r and E_r to other quantities, such as generator voltage, generator end power, etc. These all come out as equations of circles, and from these equations we can determine the P_r and Q_r coordinates of the circle centers and the length of the circle radii. The results of such a series of computations are given in Table I which presents the formulas required to compute the center and radius of any kind of circle that one may desire to draw on the $P_r - Q_r$ coordinates. The method used in obtaining the equations in Table I is indicated in Appendix A. In Appendix C will be found a numerical example which

TABLE I
CIRCLE COEFFICIENTS OF RECEIVING-END DIAGRAM

Kind of circle	P_r coordinate of center	Q_r coordinate of center	Radius	Remarks*
Sending-end voltage...	$-w = -e_r^2 \frac{a}{b} \cos(\alpha - \beta)$	$-x = -e_r^2 \frac{a}{b} \sin(\alpha - \beta)$	$\frac{e_r e_s}{b}$	Circles are concentric
Power loss in transmission.....	$-w + m \cos^2 \beta$	$-x - \frac{m}{2} \sin 2\beta$	$\sqrt{mL - mw + m^2 \cos^2 \beta}$	Circles are concentric
Sending-end power factor.....	The sending-end power factor circles can be drawn by a simple geometric construction that is much quicker than the analytic method. See text for graphical method.			
Sending-end current...	$-e_r^2 \frac{c}{d} \cos(\gamma - \delta)$ $= -w + \frac{e_r^2}{bd} \cos(\beta + \delta)$	$-e_r^2 \frac{c}{d} \sin(\gamma - \delta)$ $= -x - \frac{e_r^2}{bd} \sin(\beta + \delta)$	$\frac{i_s e_r}{d}$	Circles are concentric
Efficiency of transmission.....	$-w + \frac{m}{2} \left[\cos 2\beta + \frac{1}{\eta} \right]$	$-x - \frac{m}{2} \sin 2\beta$	$\sqrt{\frac{m^2}{4} \left[1 + \frac{1}{\eta^2} + \frac{4}{\eta} \left(\frac{\cos 2\beta}{2} - \frac{w}{m} \right) \right]}$	Circles are not concentric
Sending-end power.....	$-w + m \frac{\cos 2\beta}{2}$	$-x - m \frac{\sin 2\beta}{2}$	$\sqrt{m P_s + \frac{m^2}{4}}$	Center is usually off page
Sending-end reactive volt-amperes.....	$-w - \frac{r}{2} \sin 2\beta$	$-x - \frac{r}{2} \cos 2\beta$	$\sqrt{\frac{r^2}{4} + r Q_s}$	Circles are concentric
Reactive volt-amperes consumed by line....	$-w - r \frac{\sin 2\beta}{2}$	$-x + r \sin^2 \beta$	$\sqrt{r V - r x + r^2 \sin^2 \beta}$	Circles are concentric
Receiver current.....	0	0	$i_r e_r$	Circles are concentric
Receiver admittance.....	0	0	$Y_r e_r^2$	Circles are concentric
Sending-end conductance	$-w - k \cos 2\beta$	$-x + k \sin 2\beta$	k	Circles are not concentric
Sending-end susceptance.....	$-w + l \sin 2\beta$	$-x + l \cos 2\beta$	l	Circles are not concentric

Notation
 $A = a / \alpha$
 $B = b / \beta$
 $C = c / \gamma$
 $D = d / \delta$
 } Network constants
 P = Power in watts per phase
 Q = Reactive volt-amperes per phase
 E = Voltage to neutral
 I = Current in each wire
 G = Conductance to neutral
 B_s = Susceptance at sending end
 Y = Admittance
 $L = P_s - P_r$ = Watts loss in transmission per phase
 $\eta = P_r / P_s$ = Efficiency of transmission
 $V = Q_s - Q_r$ = Reactive volt-amperes consumed in transmission

$$w = \frac{a}{b} e_r^2 \cos(\alpha - \beta); \quad x = \frac{a}{b} e_r^2 \sin(\alpha - \beta)$$

$$m = \frac{e_r^2}{bd \cos(\delta - \beta)} \quad r = \frac{e_r^2}{bd \sin(\delta - \beta)}$$

$$k = \frac{1}{2} \frac{m e_r^2}{G_s b^2 m - e_r^2}$$

$$l = \frac{1}{2} \frac{r e_r^2}{B_s b^2 r - e_r^2}$$

Subscript "s" denotes a sending-end quantity.
 Subscript "r" denotes a receiving-end quantity.
 A positive Q or V denotes leading reactive volt-amperes.
 In designating vector quantities a capital letter denotes the vector while the small letter denotes the length of this vector.

*These remarks apply only to the case when the receiver-end voltage is constant.

shows in a specific way the method of utilizing Table I in constructing the circle diagram.

After Table I has been used to determine the circular loci, and these have been drawn on the $P_r - Q_r$ coordinates, the values of the sending-end voltage, power, power factor, etc., that go with known receiving-end conditions can be determined by inspection from the diagram. It is necessary merely to observe the various circles that pass through the point on the coordinate system that represents the known receiving-end conditions. This indicates the great usefulness of the circle diagram, for the one set of computations required to draw the diagram gives the solution of the transmitting system for all possible conditions.

It is evident from Table I that a great number of families of circular loci may be drawn on one system of coordinates. Not all of these are ordinarily needed in the solution of any particular problem, however, and in any event it is best to draw no more than three or possibly four sets of circles on one coordinate system. When more loci are required it is preferable to divide them between two or more diagrams.

When deciding which loci to draw on a diagram, it is well to keep in mind the information in Table I under the column entitled "Remarks." When representing the characteristics of a transmission system for ordinary purposes it is usually sufficient to draw three families of circles, which can best be sending-end voltage circles; transmission power-loss circles; and either sending-end power factor circles, or sending-end reactive power circles; drawing each family of circles in colored ink of a distinguishing hue. The data given by these sets of circles will enable other items of importance to be easily determined. Thus the sending-end power can readily be found by adding the power loss to the received power; the efficiency of transmission is the ratio of receiver to sending-end power, etc.

It is worth noting that all of the circle centers and radii can be computed from Table I without involving the network constant C . This is possible because only three of the network constants are independent, so that the constant C can be expressed in terms of A , B , and D .

Procedure to be followed in drawing circle diagram. In drawing the receiving-end circle diagram it is necessary to take the following steps:

1. Lay out a set of $P_r - Q_r$ coordinates to any convenient scale which will cover the range of values to be expected.
2. Decide upon the kinds of loci that will be best suited to give the information that is desired.
3. Compute the centers and radii of the desired circles with the aid of Table I, and draw these circles on the coordinate system that has been laid out. In making these computations it is necessary to exercise care in determining the algebraic signs of the terms involving sines and cosines of angles.
4. Apply as many of the geometrical checks and constructions described below as are desired.

A receiving-end circle diagram can be drawn only for a fixed value of receiving voltage E_r . It is necessary to draw a separate receiving-end diagram for each receiver voltage to be considered. The approximate locations of the various circle centers are shown in Figs. 1, 2, and 3, which represent actual results given by a long transmission line with terminal transformers. The notation of these figures is that of Table I, with the addition that the center of the P_s circles is designated by P_s , the center of the E_s circles by E_s , etc.

The units involved in the diagram need introduce no confusion. The results given in Table I are based on equations (1) and (2); thus the units of the circle diagram are the units of these equations. This will ordinarily mean volts to neutral, current in each wire, watts and volt-amperes per phase, transmission loss in watts per phase, etc., as indicated in Table I.

Geometrical properties of the receiving-end circle diagram. A circle diagram drawn following the formu-

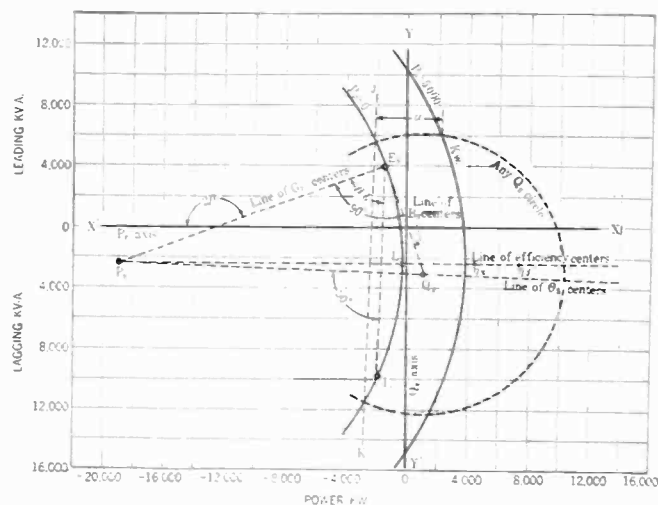

FIG. 2—RECEIVING-END CIRCLE DIAGRAM

Showing approximate location of centers and some of the diagram's geometrical properties

las in Table I must possess certain geometrical properties. While these properties can be used to draw the circular loci, it is more accurate and much quicker to draw the diagram with the aid of Table I, and to use the geometrical properties as checks to verify the correctness of the construction. The only exception to this is in the case of sending-end power factor circles, which are most satisfactorily drawn by the geometrical construction given below. The more important graphical properties of the receiving-end circle diagram follow:

Location of E_s . The angle $X O E_s$ (see Fig. 3) must equal $(180^\circ + \alpha - \beta)$ when measured in the conventional manner from $O X$.

Location of I_s . The angle $X O I_s$ (see Fig. 3) must equal $(180^\circ - \gamma + \delta)$ when measured backward from $O X$.

Locus of constant receiver power factor. Constant receiver power factor is equivalent to a constant Q_r/P_r , and the locus of this condition is a straight line passing through the origin of the $P_r - Q_r$ coordinates.

distance from this intersection to the line tt' is proportional to the value of Q_s at the intersection. If this distance is u' (see Fig. 3) when measured in terms of the coordinate system, the value of the Q_s circle that gives this distance is

$$Q_s = \frac{u'}{\cos(\beta - \delta)}$$

The notation used is that given in Table I. Intersections to the right of tt' are caused by leading or positive values of Q_s , and intersections to the left of tt' represent lagging or negative values of Q_s .

V circles. The center of these circles, the point V in Fig. 3, is where the parallel to YY' that passes through the point Q_s intersects the sending-end reactive

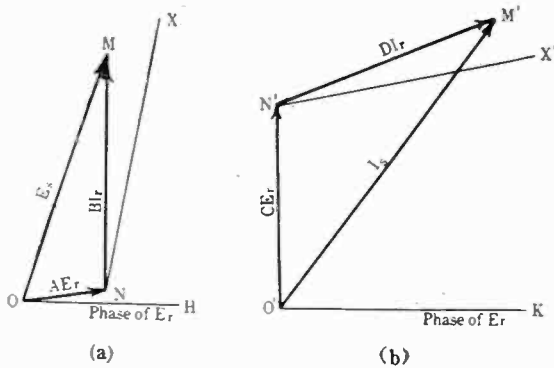

FIG. 4A-B—VECTOR DIAGRAM REPRESENTING EQUATIONS (1A) AND (1B) IN VECTOR FORM

power circle representing $Q_s = 0$. This is shown in Fig. 3. These circles must have radii of such values that the V circles intersect the circle $Q_s = 0$ at a value of Q_r , which is the negative of the value of V at the intersection.

G_s circles. Circles representing different values of sending-end conductance have their centers lying on the line $E_s P_s$. See Figs. 2 and 3.

B_s circles. Circles representing different values of sending-end susceptance have their centers lying on the line $E_s Q_s$, as shown in Figs. 2 and 3.

In addition to these geometrical properties, the receiving-end diagram must satisfy certain other relations. Thus the P_s circles must intersect the loss circles at a value of P_r such that the received power plus the loss equals the sending power. Similarly, the point of intersection of the P_s circles with the efficiency circles must be a value of P_r equal to the sending power multiplied by the efficiency. Certain angular relations must also exist between construction lines. These are shown in Fig. 2, and are as follows:

Angle $P_s E_s Q_s = 90$ deg.

Angle $P_s E_s I_s = \beta - \delta$

Angle between $E_s P_s$ and axis $XX' = 180^\circ - 2\beta$

Geometrical basis of the receiving-end diagram. Since the receiving-end diagram is determined by the mathematical properties of equations (1) and (2), it is possible to plot these equations in vector form and obtain

the receiving-end diagram without the use of Table I. This has been done by Thielemans, and gives an alternative method of construction.

Using the received voltage as the axis of reference, equations (1a) and (1b) give the vector diagrams shown in Figs. 4a and 4b. The parts NM of Fig. 4a and $N'M'$ of Fig. 4b are both determined by the phase and magnitude of the received current. By suitably choosing the voltage scale in Fig. 4a with reference to the sending-end current scale in Fig. 4b, it is possible to make NM and $N'M'$ represent received current to the same scale. It is then possible to superimpose NM on $N'M'$, with the result shown in Fig. 5. This is a compound diagram, for the part ONM is a sending-end voltage diagram in which OH represents the phase of E_r , while $O'NM$ is a sending-end current diagram in which $O'K$ represents the phase of E_r . These two triangles are related by the common link NM which simultaneously represents a component of sending voltage, a component of sending-end current, and the received current vector. The phase of the received current is determined by NX , the position of NM when the receiver current is in phase with the receiver voltage. The scales in the different parts of Fig. 5 are not the same, but are related to one another by the common part NM .

Let us consider Fig. 5 for a constant value of receiver voltage E_r . In this case, points O , O' , and N , in Fig. 5, are fixed, and the position of point M , which is deter-

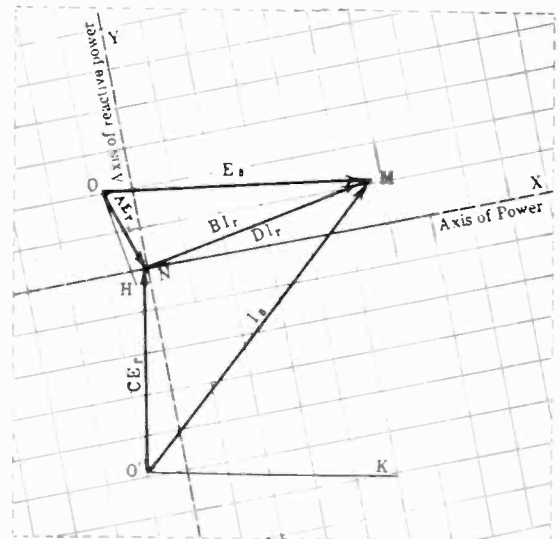

FIG. 5—COMPOUND DIAGRAM RESULTING FROM THE SUPERPOSITION OF FIGS. 4A-B

mined by the received current, is the only variable point on the diagram. Since the receiver voltage is constant, it is possible to make NX and NY the P_r and Q_r axes of a system of power-reactive power coordinates. This is because the received real and reactive power are proportional to the in-phase and quadrature components of received current, respectively, when the receiver voltage is constant, and it is obvious that these current components are the projections of NM on NX and NY .

Now compare Fig. 5 with Fig. 1. It is evident that these two diagrams are the same, as far as they represent the same things. The points $O, O', N,$ and M in Fig. 5 correspond exactly to $E_s, I_s, O,$ and M in Fig. 1, and the power coordinate systems are identical in the two cases. Thielemans has investigated the geometrical properties of Fig. 5, and his results form the basis of many of the geometrical checks given above for use in verifying the accuracy of the diagram construction.

It is helpful to keep in mind the relation between

of M that lie on a circle having 0 as the center. It is the identity of Figs. 1 and 5 that makes it desirable to plot leading quantities as positive, as explained in Appendix B.

SENDING-END CIRCLE DIAGRAM

Construction of the diagram. Instead of using a system of $P_r - Q_r$ coordinates, as in the receiving-end circle diagram, it is possible to use a set of $P_s - Q_s$ coordinates. When results computed from equations

TABLE II
CIRCLE COEFFICIENTS OF SENDING-END DIAGRAM

Kind of circle	P_s coordinate of center	Q_s coordinate of center	Radius	Remarks*
Receiver voltage.....	$y = \frac{d}{b} e_s^2 \cos(\delta - \beta)$	$z = \frac{d}{b} e_s^2 \sin(\delta - \beta)$	$\frac{e_s e_r}{b}$	Circles are concentric
Power loss in transmission.....	$y - n \cos^2 \beta$	$z + \frac{n}{2} (\sin 2\beta)$	$\sqrt{Ln - yn + n^2 \cos^2 \beta}$	Circles are concentric
Receiver power factor..	The receiving-end power factor circles can be drawn by a simple geometric construction that is much quicker than the analytic method. See text for graphical method.			
Receiver current.....	$e_s^2 \frac{c}{a} \cos(\gamma - \alpha)$ $= y - \frac{e_s^2}{ab} \cos(\beta + \alpha)$	$e_s^2 \frac{c}{a} \sin(\gamma - \alpha)$ $= z + \frac{e_s^2}{ab} \sin(\beta + \alpha)$	$\frac{e_s i_r}{a}$	Circles are concentric
Efficiency of transmission.....	$y - \frac{n}{2} (\cos 2\beta + \eta)$	$z + \frac{n}{2} \sin 2\beta$	$\sqrt{\frac{n^2}{4} \left[1 + \eta^2 + 4\eta \left(\frac{\cos 2\beta}{2} - \frac{y}{n} \right) \right]}$	Circles are not concentric
Receiver power.....	$y - \frac{n \cos 2\beta}{2}$	$z + \frac{n \sin 2\beta}{2}$	$\sqrt{\frac{n^2}{4} - n P_r}$	Center is usually off page
Receiver reactive volt-amperes	$+y + \frac{s}{2} \sin 2\beta$	$+z + \frac{s}{2} \cos 2\beta$	$\sqrt{\frac{s^2}{4} - s Q_r}$	Circles are concentric
Reactive volt-amperes consumed by line....	$y + \frac{s}{2} \sin 2\beta$	$z - s \sin^2 \beta$	$\sqrt{sV - sz + s^2 \sin^2 \beta}$	Circles are concentric
Sending-end current...	0	0	$e_s i_s$	Circles are concentric
Sending-end admittance	0	0	$Y_s e_s^2$	Circles are concentric
Receiver-end conductance.....	$y - t \cos 2\beta$	$z + t \sin 2\beta$	t	Circles are not concentric
Receiver-end susceptance.....	$y + u \sin 2\beta$	$z + u \cos 2\beta$	u	Circles are not concentric

Notation
 $A = a / \alpha$
 $B = b / \beta$
 $C = c / \gamma$
 $D = d / \delta$
 } Network constants
 P = Power in watts per phase
 Q = Reactive volt-amperes per phase
 E = Voltage to neutral
 I = Current in each wire
 G = Conductance to neutral
 B_r = Susceptance at receiving end
 Y = Admittance
 $L = P_s - P_r$ = Watts loss in transmission per phase
 $\eta = P_r / P_s$ = Efficiency of transmission
 $V = Q_s - Q_r$ = Reactive volt-amperes consumed in transmission

$$y = \frac{d}{b} e_s^2 \cos(\delta - \beta); \quad z = \frac{d}{b} e_s^2 \sin(\delta - \beta)$$

$$n = \frac{e_s^2}{ab \cos(\alpha - \beta)}; \quad s = \frac{e_s^2}{ab \sin(\alpha - \beta)}$$

$$t = \frac{1}{2} \frac{n e_s^2}{G_r b^2 n + e_s^2}$$

$$u = \frac{1}{2} \frac{s e_s^2}{B_r b^2 s + e_s^2}$$

Subscript "s" denotes a sending-end quantity.
 Subscript "r" denotes a receiving-end quantity.
 A positive Q or V denotes leading reactive volt-amperes.
 In designating vector quantities, a capital letter denotes the vector while the small letter denotes the length of this vector.

*These remarks apply only to the case when the sending-end voltage is constant.

Figs. 1 and 5. The principal difference is that in Fig. 1 the important points of the diagram are located by plotting on the $P_r - Q_r$ coordinate system, while in Fig. 5 these same points are found to be ends of important vectors in the representation of equations (1a) and (1b). With Fig. 5 in mind it is easy to see why some of the loci are circles. Thus the sending-voltage vector in this diagram is represented by OM , and obviously a constant sending voltage must be for positions

(1) and (2) on the basis of a constant generator voltage E_s , are plotted upon this system of coordinates, properties similar to those of the receiving-end diagram are found. Thus the loci of points on the $P_s - Q_s$ coordinate system which represent constant receiver voltage, constant receiver power factor, constant efficiency of transmission, constant receiver power, etc., are all circles, provided the sending voltage is constant. Such a diagram is known as the sending-end circle diagram of the trans-

mission network. It is found that for every property possessed by the receiving-end diagram there is a corresponding property of the sending-end diagram.

The construction of the sending-end diagram is carried out in a manner exactly similar to that used in obtaining the receiving-end diagram. The only differ-

The difference between the sending-end and receiving-end diagrams is in the coordinate system and in the quantities that are represented by the circular loci. The receiving-end diagram must always be drawn for a constant receiver voltage, and similarly, the sending-end diagram can be drawn only for a constant sending-end voltage. If the sending voltage is changed, it is necessary to draw a new diagram.

Procedure to be followed in drawing the sending-end circle diagram. This procedure is exactly the same as that given under the heading of Receiving-End Circle Diagram, with the exception that the circles are determined with the aid of Table II instead of Table I and that the geometrical properties of the sending-end diagram are somewhat different. The approximate locations of the circle centers are shown in Figs. 6, 7, and 8 which have been drawn to represent a long trans-

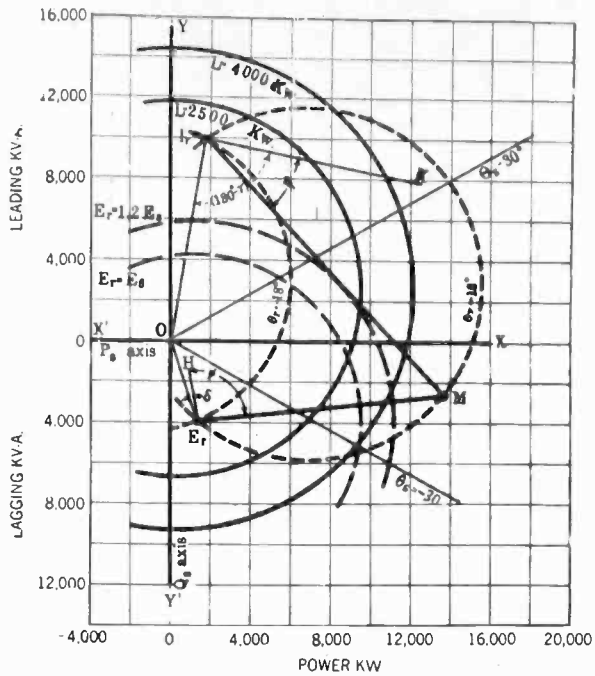

FIG. 6—TYPICAL SENDING-END CIRCLE DIAGRAM

Showing loss circles, receiving-end, power-factor circles, and receiver-voltage circles

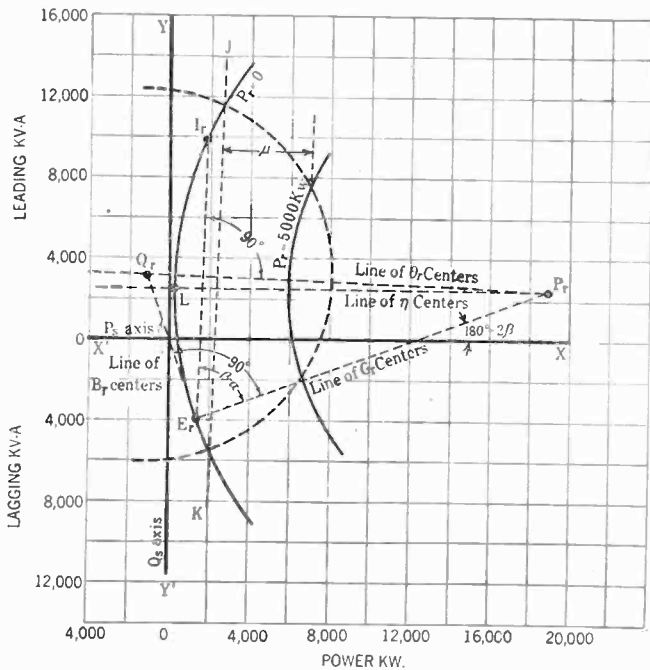

FIG. 7—SENDING-END CIRCLE DIAGRAM

Showing approximate location of centers and some of the diagram's geometrical properties

ence is in the formulas used in determining the centers and radii of the circles. The coordinates of the circle centers and the length of the radii can be derived from equations (1) and (2) in the manner indicated in Appendix A. The results of such derivations are given in Table II, which is used in exactly the same number as is Table I.

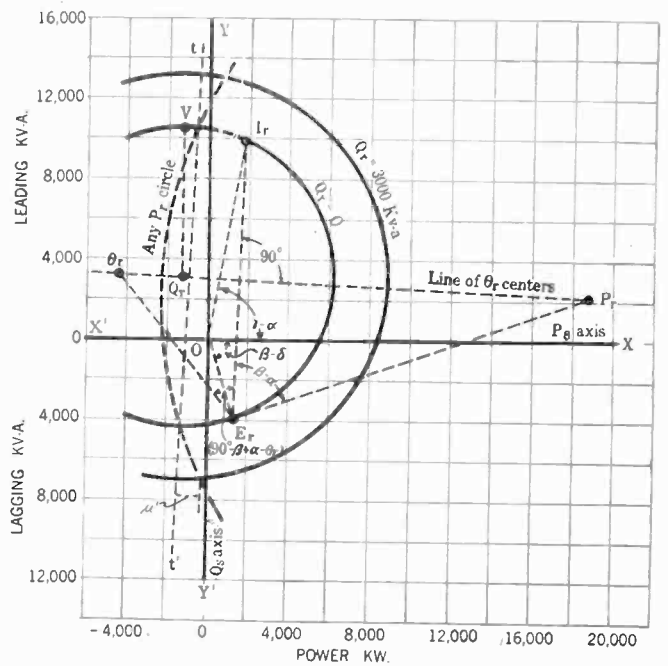

FIG. 8—SENDING-END CIRCLE DIAGRAM

Showing approximate location of centers and some of the diagram's geometrical properties

mission line with terminal transformers. The notation of these figures is that of Table II with the addition that the center of the P_r circles is labeled P_r , the center of the E_r circles is labeled E_r , etc. As with the receiving-end diagram, care must be taken in using Table II to ensure the correct algebraic signs of terms involving sines and cosines.

Geometrical properties of the sending-end circle diagram. The circle diagram drawn with the aid of the formulas in Table II possesses certain geometrical properties. These properties are analogous to those of the receiving-end circle diagram and have the same practical usefulness. These geometrical properties are indicated in Figs. 6, 7, and 8. A complete description of them is given in the unabridged paper.

The receiving-end power factor circles which, as indi-

cated in Table II, are most satisfactorily drawn graphically can be obtained by the following construction.

Receiving power-factor circles. The locus of points on the sending-end diagram which represents constant receiving-end power factor is a circle passing through E_r and I_r and having its center on the perpendicular bisector of the line $E_r I_r$. The location of this center depends upon the power factor being represented and is at the intersection of the perpendicular bisector with a line passing through E_r in such a way that the angle $\theta_r E_r I_r$ is equal to $(90 \text{ deg.} - \theta_r - \beta + \alpha)$ measured in the conventional direction from $E_r I_r$. This construction is shown in Fig. 8.

Geometrical basis of the sending-end diagram. Since the sending-end diagram is determined by the mathematical properties of equations (1) and (2), it is possible to plot these equations in vector form and obtain the sending-end diagram without the use of Table II, just as it was possible to derive the receiving-end diagram by means of a vector construction.

MISCELLANEOUS TOPICS

Relations between sending-end and receiving-end diagrams. When the receiver end of the transmission network is supplying power to the network, the received power P_r is negative and the operating point is somewhere to the left of the axis $Y Y'$ in Fig. 1. It is possible in this way to extend the circle diagram to cover generator action at the receiver, and since generator action at the receiver is equivalent to making the receiver a sending-end of the diagram, it is evident that the negative part of the receiver diagram is closely related to the positive part of the sending-end diagram, and vice versa.

The reduced circle diagram. The receiving-end circle diagram must be drawn for a constant E_r , and the sending-end diagram must be constructed for a constant E_s . When neither terminal voltage is constant, it is necessary to use the circle diagram indirectly by drawing the diagram for a certain voltage and then multiplying results obtained from this diagram by appropriate factors to convert the results to those for the voltage desired.

The basis for determining this multiplying factor is that all power and reactive power quantities are proportional to the voltage squared and all current quantities are proportional to the voltage. In this way it is possible to draw a sending-end or receiving-end diagram for a terminal voltage of one volt and from this diagram determine the network solution for any terminal voltage.

Use of current and admittance coordinate systems. Instead of calibrating the axes of the coordinate system in watts and reactive volt-amperes, these can be calibrated in terms of reactive and in-phase components of the terminal current, or in terms of terminal conductance and susceptance. This is possible since when the terminal voltage is constant a definite terminal power is equivalent to a certain in-phase current and a

certain conductance. When the coordinate system is in terms of current components all centers and radii computed with the aid of Tables I and II must be divided by the constant terminal voltage before plotting on the current coordinates. When the coordinate system is in terms of admittance components, all centers and radii computed from these two tables must be divided by the square of the terminal voltage before plotting.

The geometrical properties of the sending-end and receiving-end diagrams are the same whatever the kind of calibrations that are put on the coordinate axes.

ELECTRIC POWER FOR SICILY'S SULPHUR MINES

Sulphur is one of the few minerals that Italy possesses and exports in large quantities, but since her practical monopoly in this ore ceased in 1905, when America began working the deposits of Louisiana and Texas, the conditions under which this branch of the Italian mining industry has labored have been very difficult and at one time disastrous. Since 1923, when an agreement as to output and sales was signed with America, there has been an improvement, but the export figures for 1925 again showed a decline.

Sulphur mines occupy nearly one-fifth of the area of Sicily and afford employment to some 18,000 persons. They are therefore of great economic importance to the Island, but hitherto they have labored under the disadvantage of antiquated equipment and working organization. While the wages paid to labor have been notoriously low, the cost of production has been high. It has long been felt that the electrification of the mines was the essential to their economic recovery and now at last comes a decisive step in this direction.

On the 11th May, 1926 the corporation for the technical and economic development of the sulphur industry of Sicily signed a contract for the electrification of all the services connected with the Sicilian sulphur mines, the power to be produced by a central thermal electric station at Catania and transmitted to all the sulphur mining districts over a main line at 40,000 volts running between Catania, Caltanissetta and Campo-Franco, with a subsidiary line at 10,000 volts for the Caltanissetta-Sommato district. The agreement requires that the whole installation be completed in three years' time, but it is believed that the work will be finished much sooner.

The cost of the installation is estimated at from 34 to 35 million lire of which the corporation for the technical and economic development of the Sicilian sulphur mines will contribute eight million.

The total length of the lines to be installed is not less than 500 km. Expert opinion pronounces the scheme adopted a sound one, both technically and economically. Modern mining industry cannot prosper unless it can avail itself of an adequate power supply which can be transmitted and subdivided readily, and is available at a low cost. These are the expedencies of electric power.

Abridgment of
Lightning
A Study of Lightning Rods and Cages, With Special Reference
to the Protection of Oil Tanks

By F. W. PEEK, JR.¹

Fellow, A. I. E. E.

Synopsis.—Former papers have discussed the voltage and nature of lightning, lightning voltages on transmission lines, and means of protecting against them, the effect of lightning voltages on insulations, etc. This paper is a further report on this investigation which has been in progress a number of years. Special attention is given here

to additional work on the chance of objects being struck; the area protected from direct strokes, by a rod or number of rods, overhead wires, grids, nets, etc.; the effect of nets and cages in reducing induced voltages, etc. This work is particularly applicable to the protection of oil tanks, buildings, magazines, etc.

OIL TANKS AND RESERVOIRS

OIL is frequently stored in very large quantities. This storage is often so great, in fact, that, economically, metal tanks are said not to be feasible. The tanks or reservoirs, which are usually made of reinforced concrete, are frequently 500 ft. in diameter, but sometimes in oval form as large as 600 by 1200 ft. and 30 ft. deep. Occasionally some of the smaller tanks are of metal. The capacity ranges from seven hundred thousand to three million barrels. A group of tanks makes up a farm.

The tops of the tanks are covered with wood or wood covered with felt or other materials to keep out the sun and to prevent evaporation. Between the roof and the surface of the oil there is an air space which may contain oil vapors. The mixture of air and oil gases may be in the right proportions to be explosive and ignited by a very small spark. Sparks can occur between metal parts on the roof or between wet parts by induction, or by direct strokes, and cause fires or explosions. It is probable that induced voltages can cause fires only when inflammable or explosive gases are present. Direct strokes can set fire to either oil or wood.

Various principles found in the general study of lightning, as well as specific investigations for transmission lines, etc., can be applied to oil tank and reservoir protection.² Work already reported³ will be outlined here for convenience. Additional work done,

1. Consulting Engineer, General Electric Co., Pittsfield, Mass.

2. F. W. Peek, Jr.—*The Effect of Transient Voltages on Dielectrics*, TRANSACTIONS, A. I. E. E., 1915, Vol. 34, page 1857; 1919, Vol. 38, p. 1137; 1923, Vol. 42, p. 940.

Lightning and other Transients on Transmission Lines, A. I. E. E., 1924, Vol. 43, p. 1205.

F. W. Peek, Jr., *High-Voltage Phenomena*, *Journal*, Franklin Institute, January, 1924;

Lightning, *Journal*, Franklin Institute, February, 1925.

3. F. W. Peek, Jr., "High-Voltage Phenomena," *Journal of Franklin Institute*—Jan. 1924. "Lightning," *Journal of the Franklin Institute*, 1925.

Presented at the Pacific Coast Convention of the A. I. E. E., Salt Lake City, Utah, Sept. 6-9, 1926.

specifically on model oil tanks, will be given in greater detail. Although work on models and theoretical work cannot always exactly simulate or anticipate all practical conditions, it should be of great help in solving the problems of protection.

HOW SPARKS OCCUR

Sparks can occur in oil tanks by a *direct stroke*, *electrostatic induction* or by *electromagnetic induction*. A direct stroke can take place when the storm center is over the oil tank and set fire to wooden roofs, ignite oil directly or indirectly, or melt thin, metal plates. Sparks can form between conducting parts by electrostatic induction from storms overhead or at a considerable distance. As already noted, induced sparks can generally cause fires only by the ignition of gases. Electromagnetic induction could cause sparks as a result of heavy currents caused by a direct stroke in the vicinity of the tank.

Direct strokes are by far the most dangerous, but voltages by direct strokes are much less likely to occur than by induction. Induced sparks can occur only between isolated conducting parts or conducting parts in poor contact. These conducting parts could be of metal or water, etc. Trouble by electromagnetic induction is probably the least likely to occur.

INDUCED VOLTAGES

A brief description may be of interest as to how electrostatic induction occurs. Assume the cloud in Fig. 1 to be negatively charged. A well insulated wire along an equipotential surface takes the potential of the space in which it is located and becomes (+) on the side nearest the cloud and (-) on the side farthest from the cloud (Fig. 1A). When the cloud discharges, the two charges on the wire go together and the potential of the wire becomes zero. In this case, it is possible for a spark to occur between the insulated wire and some other wire near it but differently located in space, even though the cloud does not discharge. What is usually known as electrostatic induction, however, occurs as follows: Assume the wire in Fig. 1B to be poorly insulated, or grounded;

the negative charge leaks away. The wire becomes positively charged, while its potential becomes zero. When the cloud discharges, the bound charge on the wire is released, which causes it to take a potential above ground with a sign opposite to that of the cloud. The wire generally reaches its maximum potential at the instant the cloud reaches zero. The potential that the wire assumes is approximately equal to its height above ground times the voltage gradient or volts per foot, measured vertically. The voltage gradient depends upon the position of the cloud with reference to the wire. The maximum voltage that a

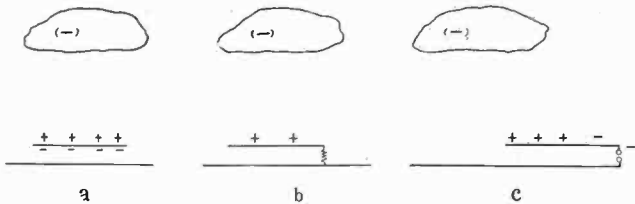

FIG. 1—VOLTAGE INDUCED BY LIGHTNING

wire can assume is equal to 100,000 times its height in feet above ground. This is practically a direct stroke. In general, this voltage is,

$$V = g \alpha h = G h$$

where g is the gradient in volts per foot and h is the height in feet. As shown in Fig. 2, g depends upon the distance of the cloud from the wire. For short wires, α is unity. In the case of long transmission lines, α would be less than unity, its exact value depending upon the rate at which the cloud discharges. This would follow because in slowly discharging clouds the charge would be dispersed over the line for a considerable distance before the cloud became completely discharged. Measured values of g , α , or apparent gradients, G , as high as 50,000 kv/ft., have been obtained on transmission lines. Sparks may occur between wires or other conductors on tanks, due to these induced voltages. Grounded wires near and parallel to the line wire reduce induced voltages; a cage around the wire still further reduces them, while a complete metal cover eliminates them. Ground wires are considered effective on transmission lines if induced voltages are cut in half; this would not be the case of conductors in oil tanks because even 500 volts could cause a tiny spark between metal parts almost in contact. The work on models has shown that tiny sparks can occur between conductors inside of cages even when the mesh is comparatively small. No sparks could be obtained in complete metal tanks. (See Table VII). Sparks can occur in metal tanks, however, between plates making poor contact or from wires or pipes brought in from the outside and not making good contact with the tank.

Electromagnetic induction resulting from heavy currents flowing in the vicinity of the tank may cause sparks. In experiments, it was not possible to obtain

sparks in the complete metal tank or in the tank with open sides. Sparks were obtained only in the extreme case shown.

DIRECT STROKES

While the most severe lightning effects are produced by direct strokes, in order to have a direct stroke at a given spot, it is necessary for the cloud to be over that spot at the instant it is charged to sufficient voltage to cause a discharge. Voltages by direct stroke are thus much less likely to occur than voltages by induction since induced voltages can be produced by any storm within a radius of several miles. Sparks by induced voltages cannot occur unless there are conducting parts almost in contact or making poor contact; as wire, nails or wet spots on a wooden roof, etc.

Although the chances of direct strokes are usually small, the effects are so severe that an exhaustive study of protection against them seemed worth while. The general methods followed were similar to those used in previous work. Models were built to scale and subjected to voltage from the lightning generator as well as all other types of voltages. The same general results were obtained from all types of clouds, points, spheres and planes. The hits were recorded by placing paper targets under the tank or other object under study. A hole in the paper recorded the spot struck. It was found that either the rod was struck or the ground approximately four or more rod lengths away. There was an area immediately around the rod that was not struck. It can be seen that a model building or tank properly located with reference to the rod inside of

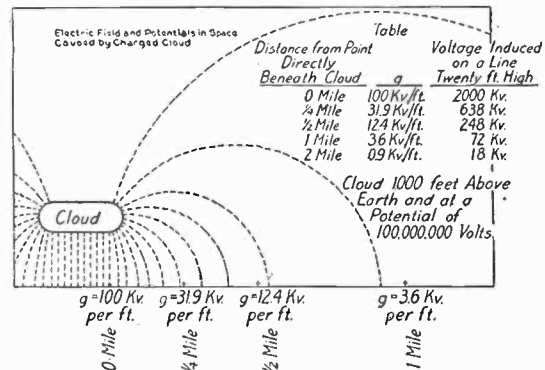

FIG. 2—ELECTRIC FIELD AND POTENTIAL IN SPACE CAUSED BY CHARGED CLOUDS

the protected area would not be struck. It has been found that this same principle applies to a number of rods. For instance, if four rods are arranged at equidistant points around a circle in such a way that their protected areas overlap, a spark never strikes inside of the circle. Thus, a building or tank placed within the circle would be protected from direct hits. It is desirable to place the rods a rod-length away from the tank. Fig. 6 illustrates how this can be applied to an oval tank.

There are other methods of protection which have

been investigated and which will be described below. An umbrella frame of conductors, placed over the tank, can be made to take direct hits. Parallel wires strung over the tank would prevent direct hits to the tank provided the wires were not separated more than four times their height above the tank. Other types of meshes or cages could be used. The disadvantage of such arrangements is that it is generally not practicable to place the conductors high enough above the tank to prevent side flashes to the roof. The lightning flash is also brought directly over the tank with the possibility of dropping hot metal, magnetic induction, etc.

PRACTICAL PROTECTION

From the investigation it seems that a metal tank offers the only complete protection in oil storage against both direct strokes and induced lightning voltages. The thickness of the metal is not important from the standpoint of induction but from the standpoint of direct strokes must be great enough to prevent melting through. The cover and all other metal parts must be in good electrical contact. This applies especially to parts near together. When explosive or inflammable gases can be eliminated the problem is greatly simplified since it is reduced to the protection of the tank against direct hits. It appears that this can be done by placing pointed rods around the tank. A round tank can be protected by three rods. The method is shown in Fig. 23. No part of the protected area must be a greater distance from some rod than approximately four times the height of the rod. To secure a greater factor of safety it may sometime be advisable to use a ratio of less than four as indicated in Fig. 19. It is desirable to locate the rods about a rod's length away from the tank although it is possible that this distance may be as small as half a rod length without trouble. The object of placing the rods in this way is to cause the hits to occur at some distance from the tank and to prevent side flashes. The rods should be grounded to damp earth immediately below. Where the ground resistance is high or uncertain it is probably best to connect the rod to the tank ground as well as to its own ground. Figs. 10 and 11 show tests on protected and unprotected tanks. If guys are used, it is desirable to make them as short as practicable and to attach them to the rod as near the ground as practicable. When there are projections above ground, the height of the rods is increased an amount equal to the height of the highest projection.

When inflammable gases are present it is important to reduce or eliminate induced voltages. This can be done by means of a thin metal or conducting roof grounded and preferably extending over the sides. A less degree of protection can be obtained by nets or wires placed on the roof in the same way. When nets are used, the closer the mesh the greater the protection. Less protection would be given by wires

or nets in practise than indicated by tests on models. This follows because the inductance of long wires would not permit them to go instantly to zero potential.

The high degree of protection given by an all metal tank is probably most nearly approached by a combination of rods to take direct hits and a thin metal or conducting roof and sides to protect against induced voltages. Wires or mesh on or above the roof instead of metal sheets would reduce induced voltages to a less extent. In tests with a uniform field, a considerable variation of the distance of the net above the roof did not materially change its protective value. While there may be theoretical reasons for placing a net a distance above depending upon the size of the mesh, it would appear less expensive and, by tests, as effective to put it directly upon the roof. All metal parts close to the net should be connected to it. If this is difficult or

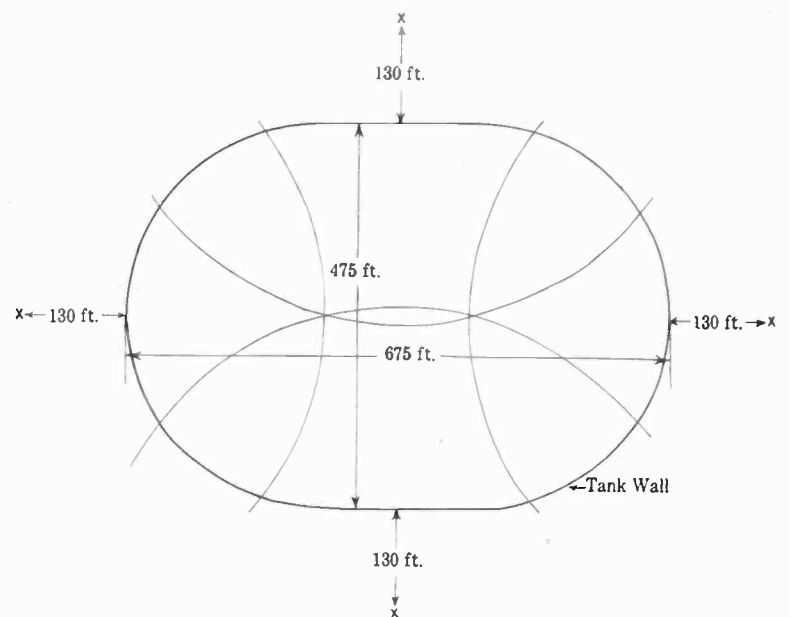

FIG. 6—DIAGRAM SHOWING PROTECTION OF OIL TANK FROM DIRECT-LIGHTNING STROKE

Height of roof peak—35 ft.

Crosses denote four 130-ft. poles, 130 ft. from tank wall

Arcs indicate area within the tank wall, protected by each grounded pole

uncertain, it may generally be desirable to raise the net on slats or otherwise to bring it away from such objects. With quarter-inch mesh, the supporting slats need not be more than several inches high. (See induced voltages in Table VII). In working out the protection for any tank, such details are important.

The above may be summarized as follows:

1—An all metal tank offers the most complete protection against both induction and direct strokes. Such a tank does not seem to be always economically feasible.

2—When explosive or inflammable gases are not present, it is not necessary generally to provide for protection against induced voltages. Rods can then be used to protect against direct hits. Rods do not protect appreciably against induced voltages.

3—When inflammable gases are present protection against induced voltages and direct strokes are necessary. When an all-metal tank is not practicable from

the standpoint of cost, the next best thing would be thoroughly bonded and grounded metal roof and sides to protect against induced strokes combined with rods to take direct hits. The roof could be of thin metal, since direct hits would go to the rods.

4—For the same purpose as the metal roof in (3), but

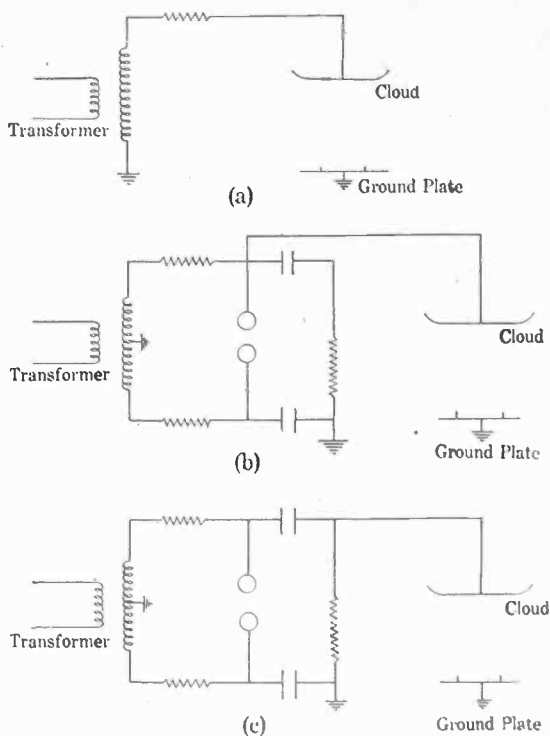

FIG. 7—LIGHTNING GENERATOR CIRCUIT USED IN TESTS

less effective, would be the substitution of a wire net. The smaller the mesh the more effective the net. Details are important in placing the net. Other methods of protection can be worked out from the test data

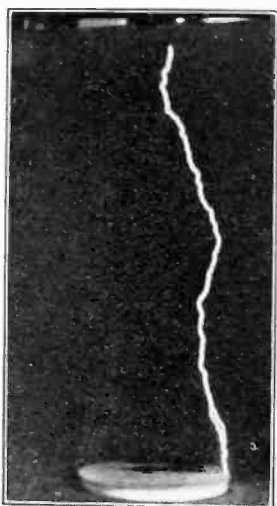

FIG. 10—LIGHTNING STRIKING UNPROTECTED OIL TANK WITH COVER (TANK FILLED WITH OIL)

given below. The above methods were discussed in detail as an example, because they seemed among the most practicable.

An actual test was made on a model of the tank shown in Fig. 6. All of the hits went to the rods with

clouds no higher than ten times the height of the rod. Fig. 12 shows a section of a tank farm protected by rods. In tests on the model, with the storm center at various positions as indicated, the tanks were never hit.

3. EXPERIMENTAL INVESTIGATION

The arrangements used for studying lightning discharges as well as the lightning generator have been described in former papers⁴. The results obtained in these papers also have a bearing upon the present study. The circuits are shown in a, b and c, Fig. 7. Fig. 7A gives a 60-cycle spark. In Fig. 7B a dielectric field is established over the tank or wires under test. When the sphere-gap discharges, this dielectric field collapses, voltage is induced, and the effect of a cloud discharging in the distance is simulated. When still higher voltages are used, a direct stroke is made to take place to the object under test. How well this arrangement simulates a natural lightning discharge is illustrated in

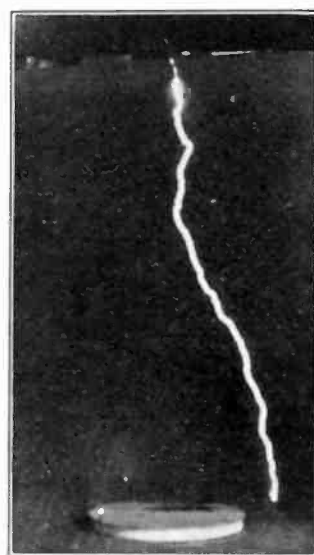

FIG. 11—LIGHTNING STRIKING RODS PROTECTING OIL TANK WITH COVER (TANK FILLED WITH OIL)

Fig. 10 and 11, which show zig-zag discharges, split strokes, side flashes and branches. The branches which show quite plainly in the photographic negative are partly lost in reproduction. Both unidirectional and oscillatory discharges may be obtained with this circuit. The tests were made in such a way that the cloud was about half the time negative and half the time positive. The circuit in Fig. 7C gives an impulsive discharge. The cloud is "dead" until the discharge takes place. It would simulate one cloud discharging to another and then to ground. Tests have been made also up to 350 kv. d-c., with clouds both + and -.

In studying any condition, from fifty to several hundred discharges were usually made. Voltages up to 2,250,000 r. m. s. effective, 60-cycle, 2,000,000 lightning and oscillatory were used.

4. F. W. Peek, Jr., "High Voltage Phenomena", *Journal of Franklin Institute*, Jan. 1924. "Lightning", *Journal of Franklin Institute*, February, 1925.

The cloud shown diagrammatically in Fig. 7 was a horizontal plate 5 ft. x 7½ ft. (152 cm. x 229 cm.) with rounded edges. The height above ground was usually about 43½ in. (110 cm.). Other types of "clouds" such as spheres, and points were used. A short pointed rod was usually suspended from the plane to represent the storm center.

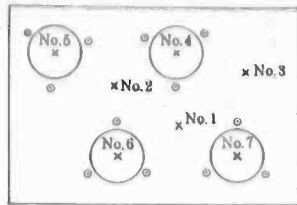

Scale: 1 in. = 850 ft.
 o Denote positions of Grounded Towers
 x Denote positions of Storm Center over Farm

FIG. 12—SHOWING PROTECTION OF OIL TANK FARM FROM DIRECT-LIGHTNING STROKES

Position of storm center	Hits to rods in per cent of total from cloud	Hits to ground in per cent of total from cloud	Location of hits to ground
No. 1	80%	20%	All hit directly beneath storm center, some distance from tanks
No. 2	30%	70%	All hit directly beneath storm center, some distance from tanks
No. 3	90%	10%	All hit directly beneath storm center, some distance from tanks
Nos. 4, 5, 6, 7	100%	0%	All strokes were to rods, with none to tanks or ground

Height of rods = 1.24 in. (equivalent to 105 ft.)
 Height of storm center = 12.4 in. (equivalent to 1050 ft.)
 Ratio of cloud height to rod height = 10 : 1
 Diameter of tank = 532 ft.
 Distance rod to tank = 60 ft.

Division of hits around a tank. These tests were made to determine the division of hits between the ground around the tank, the inside of the tank and the edge of the tank. The tank consisted of a circular or elliptical ring, made of a thin metal strip placed on a metal plane. Fig. 14A is a typical target for a circular tank. A number of strokes went inside of the tank, a number to the edge of the tank and a number to the ground at some distance from the tank. In Fig. 14B the diameter of the tank was reduced while the height was kept the same. In this case, there are no hits inside of the tank. Either the edge of the tank or the ground some distance away was struck. *The tests show that a hit never occurs within a circular tank when the height of the tank is greater than one-tenth the diameter.*

If rods are placed around the tank shown in Fig. 14B, so that a line drawn from the top of a rod to the center of the tank just touches the edge of the tank practically all hits go to the rods.

Area protected from direct hits by wires and nets. Fig. 17 shows a typical target of a wire parallel to and connected to ground. Either the wire is hit or the ground some distance from the wire. *For a single*

wire, the ground is never hit nearer the projection of the wire than about four times its height above ground.

A similar test was made on parallel ground wires. It was found that the ground between the wires was never hit when the separation of the wires was not greater than about four times their height. Both of these rules however, are subject to the cloud height as discussed later.

In general, ground wires are not especially efficient. There are also several factors not shown by these tests. Since, for large tanks, the wires must be quite long compared to their height above the tank, side flashes to the tank are thus likely to occur. Wires arranged like



FIG. 14—TARGET MADE BY LIGHTNING STROKES FROM CHARGED CLOUD

- a. 6¼-in. circular tank, ½-in. high
- b. 5-in. circular tank, ½-in. high

an umbrella frame would be somewhat more efficient, but a direct hit would be likely to side flash or follow the central insulating pole to the tank. Heavy currents flowing in such wires could produce internal voltages by electromagnetic induction, while hot metal could drop on the tank.

Area protected by rods. In previous investigations it was found that lightning either struck a rod or the ground some distance from the rod. There was always

a protected area around the rod equal to about four times the height of the rod. This is illustrated in Fig. 5. The protective ratio should, however, vary with the height of the cloud for a given rod. The following relation would be expected theoretically:

$$R_p = \sqrt{2 R_c - 1}$$

Where

R_p = protective ratio

R_c = cloud height divided by rod height or cloud rod ratio.

Actually, however, a ratio much greater than four would not be expected in practise because irregularities

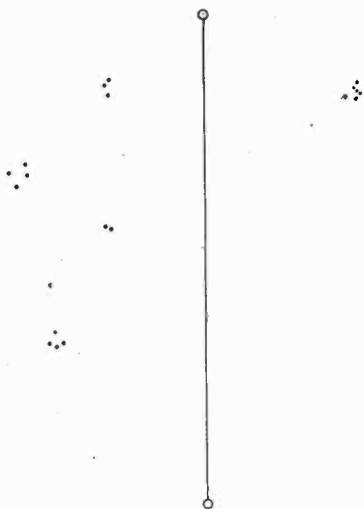

FIG. 17—TARGET MADE BY LIGHTNING STROKES FROM CHARGED CLOUD ONE HORIZONTAL GROUND WIRE, 3/4-IN. ABOVE GROUND

would overcome the slight increased distance effect. This is well illustrated in Fig. 19 where the theoretical and measured curves are plotted together.⁵

It was found that a given area could be protected by placing a number of single rods so that their protective circles or areas over-lapped. For example, with a cloud about fifty times the height of a rod the protective ratio should be about five. Four rods were arranged symmetrically about a circle. It was found that no hits took place within the circle when no rod was at a greater distance from the center than five times its height

Complete data on the area protected by three or more rods with different cloud heights and different types of clouds are given in Tables IV and V.

It may be concluded from these tests that a given area can be protected by arranging a number of rods about it so that no point on the area is at a greater distance from a rod than the protective ratio times the rod height. The protective ratio varies with the cloud-rod ratio or the ratio of the height of the cloud to the height of the rod.

5. When steady direct current is used, the measured curve Fig. 19 is followed with cloud (-). With cloud (+) the protective ratio for a given cloud-rod ratio is less. Theory indicates a cloud is likely to be (-). Steady direct current does not represent the usual lightning condition.

The practical protective ratio will usually vary between three and four.

The results in Table VI show the effect of projections within the protected area. It will be noted that, for the given ellipses, complete protection is obtained for a flat plane with the protective ratio of 3.47. This area is still protected when a roof as high as one-third of the rod height is used. The effect of varying the position of the cloud is also illustrated. In this case a protective ratio of four does not give complete protection for all positions of the cloud. The height of the cloud, however, was taken unusually low.

It is desirable to protect a tank from all directions of approach of a storm. For this reason it is not well to use less than three rods.

It is desirable to place the rods one rod length away from the tank to prevent side flashes.

Chance of non-metallic objects being struck. It is important to know if non-metallic but partly conducting objects such as green trees, wet wood, wet wooden roofs, etc., affect the electrostatic field sufficiently to determine the direction of a stroke as metallic rods do. Tests were made by placing dry wooden poles, wet wooden poles, dry and green branches to simulate trees, etc., under the model cloud. It was found that the green trees or the wooden poles completely wet to ground determined the direction of the stroke in the

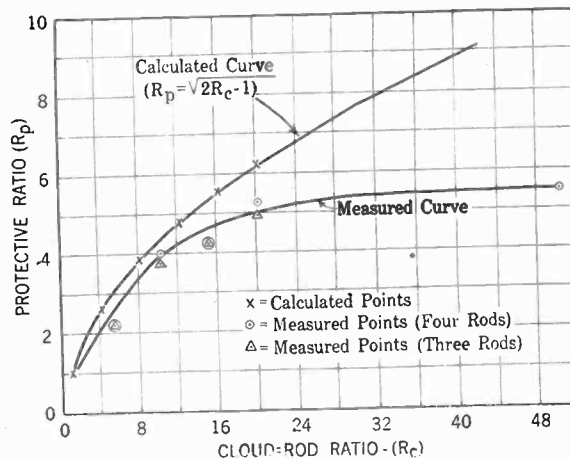

FIG. 19—PROTECTION OF AREAS FROM DIRECT-LIGHTNING STROKES

Curves showing relation between R_p (Ratio of radius to rod height) or protective ratio, and R_c (Ratio of cloud height to rod height)

same way that metal rods did. However, when the trees or wet wooden pieces were struck they were badly shattered and side flashes took place. The dry pieces had practically no effect. Thus a tall dry "building" was not struck but a nearby green tree of less height was. A green tree was generally struck at the top without appreciable effect but with great explosive damage at exit part way down under the branches. An examination of the tree without knowledge of what had really happened would give the impression that the hit took place under the branches.

Since wet wood has the same effect in determining the

direction of a stroke as metal it would appear that a metal cover on a wooden roof would not greatly increase the hazard of the tank being struck.

Electrostatic induction. In previous investigations, it was found impossible to obtain sparks in all-metal

tanks unless there were metal parts extending in from the outside and making poor contact with the tank.

Table VII gives the results of an investigation to determine the reduction of voltage due to over-head grounded nets or cages. It will be seen that a cage of

TABLE III
LIGHTNING PROTECTION BY PARALLEL GROUND WIRES
Cloud height = 30 in. (at storm center)
Wire " = 3 in.

Distance between ground wires	Cloud Height wire height ratio	Ratio of 1/2 distance between wires to wire height	Percentage division of strokes		Distance to nearest ground hit-in.	Ratio of distance to hit to wire height
			to ground (inside wires) per cent	to wires per cent		
24.0"	10:1	4.00:1	50	50	7.88	2.63
18.0"	"	3.00:1	10	90	7.75	2.58
16.5"	"	2.75:1	5	95	8.38	2.79
15.0"	"	2.50:1	5	95	7.00	2.33
13.5"	"	2.25:1	0	100		
Cloud height = 30 in. (at storm center) Wire " = 1.5 in.						
15.0"	20:1	5.00:1	40	60	4.00	2.67
13.5"	"	4.50:1	10	90	5.62	3.74
12.7"	"	4.25:1	10	90	6.00	4.0
12.0"	"	4.00:1	0	100		

TABLE IV

EFFECT OF CLOUD HEIGHT—ROD-HEIGHT RATIO ON AREA PROTECTED BY RODS SYMMETRICALLY ARRANGED AROUND A CIRCLE ON A CONDUCTING PLATE

Test arrangement	Cloud height (At storm center) in.	Rod height in.	Cloud-rod ratio	* Radius-rod ratio	Percentage Division of strokes	
					To ground (inside rods)	To rods
Three rods	30.0	6.0	5:1	2.5:1	10	90
" "	"	"	"	2.0:1	0	100
" "	"	3.0	10:1	4.0:1	5	95
" "	"	"	"	3.5:1	0	100
" "	"	2.0	15:1	5.0:1	50	50
" "	"	"	"	4.5:1	10	90
" "	"	"	"	4.0:1	0	100
" "	"	1.5	20:1	5.5:1	20	80
" "	"	"	"	5.0:1	0	100
Four "	"	6.0	5:1	3.0:1	30	70
" "	"	"	"	2.5:1	15	85
" "	"	"	"	2.0:1	0	100
" "	"	3.0	10:1	5.0:1	80	20
" "	"	"	"	4.5:1	10	90
" "	"	"	"	4.0:1	0	100
" "	"	2.0	15:1	5.0:1	50	50
" "	"	"	"	4.5:1	10	90
" "	"	"	"	4.0:1	0	100
" "	"	1.5	20:1	6.0:1	30	70
" "	"	"	"	5.5:1	10	90
" "	"	"	"	5.0:1	0	100

Special tests using 25 cm. sphere as cloud. (No needle on sphere).

Four rods—sphere over center	30.0	3.0	10:1	4.0:1	25	75
Sphere over center	30.0	3.0	10:1	3.5:1	0	100
Four rods—Sphere off-set 1/3 from center	30.0	3.0	10:1	4.0:1	0	100
Four rods—Sphere off-set 1/4 from center	30.0	3.0	10:1	4.0:1	5	95
Four rods—sphere off-set 1/6 from center	30.0	3.0	10:1	4.0:1	0	100

*Radius of circle divided by rod height.

TABLE V

VARIATION OF PROTECTIVE RATIO OR RADIUS—ROD RATIO, WITH CLOUD-HEIGHT ROD-HEIGHT RATIO

Rods used	Cloud height Rod height Ratio	Ratio of Maximum Radius to Rod Height for complete protection
Four symmetrical rods	50:1	5.00:1
" " "	20:1	5.25:1
" " "	15:1	4.25:1
" " "	10:1	4.00:1
" " "	5:1	2.25:1
Three symmetrical rods	20:1	5.00:1
" " "	15:1	4.25:1
" " "	10:1	3.75:1
" " "	5:1	2.25:1

TABLE VI

AREA PROTECTED BY RODS ARRANGED ON THE AXIS OF AN ELLIPSE

Cloud height = 30 in. (at storm center)
Rod height = 3 in.

Test arrangement	Cloud-rod Ratio	Radius-rod Ratio *	Percentage division of strokes	
			To ground (Inside rods)	To rods
Four rods arranged on metal plate at ends of axes of 7 x 4 ellipse. Storm center over center of ellipse.	10:1	4.60:1	5	95
Same conditions as above		4.05:1	0	100
Same as above except storm center moved 1/3 of distance along major axis	"	"	20	80
Same as previous conditions	"	3.47:1	0	100
Same as previous conditions except metal piece 1/7 height of rods placed along major axis to simulate roof	"	"	0	100
Same as previous test except metal piece made 1/3 of rod height.	"	"	0	100
Same as previous test except metal piece made 7/8 of rod height.	"	"	0	100
Same as previous test except metal piece 1/3 of rod height used. Rod spacing also increased.	"	4.05:1	90 (To roof)	10
	"		25 (To roof)	75

*This "Radius-Rod Ratio" is the ratio of (the minimum radius of those arcs drawn from each rod position for the given arrangement which will just cover the entire area within the rods) to—(the height of the rods used).

1/4-in. mesh reduced the induced voltages between a model tank and ground practically to zero, while cage of 2-in. mesh reduced induced voltage to 8 per cent of the values without a cage.

A net of 2-in. mesh over the tank only reduced the

TABLE VII
REDUCTION OF INDUCED VOLTAGES ON MODEL TANKS
BY MEANS OF OVERHEAD NETS OR CAGES

Size of mesh used—in.	Clearance to tank—in.	Position of mesh	Induced voltage on tank	Actual induced voltage in per cent of voltage induced of unprotected tank
Cage or net 21 inches square				
1/4	1.0	No protection	41.4	100
2	"	Over top and around sides	0(+)	0(-)
2	"	Over top and around sides	3.2	8
2	"	Around sides only	20.7	50
2	"	Over top only	6.1	14.8
2	"	"	5.5	13.3
2	2.0	"	5.1	12.3
2	4.0	"	5.9	14.3
2	8.0	"	7.4	17.9
Net, 36 in. square over top only				
2	1.0		2.4	5.8

Diameter of tank:—17 in. Cloud height:—44.5 in.
Height of tank:—6 in. Cloud voltage:—372 kv.

TABLE VIII
LIGHTNING PROTECTION OF OBLONG TANKS

Special tests with arrangement simulating a 1170-ft. x 583-ft. tank, placed on 50 ft. of sand and protected by 140-ft. rods, 110-ft. from edge of tank
Cloud height = 30 in. (at storm center)
Rod height = 3 in.

Test Arrangement	Cloud rod ratio	Radius rod Ratio *	Percentage Division of strokes		Remarks
			To ground (Inside rods)	To rods	
25.0 in. x 12.5 in. lead foil on 1 in. of sand, protected by four 3 in. rods, 2.36 in. from foil edges. Lead foil ungrounded, storm center over middle of tank	10:1	3.32:1	0	100	
Same as previous test, except lead foil grounded	"	"	0	100	
Same as previous test, except storm center offset 1/3 along major axis	"	"	0	100	
Same as previous test, except rods on top of sand were ungrounded	"	"	0	100	Strokes to rods were afterwards found to have fused sand beneath ungrounded rods
Same as previous test, except lead foil, as well as rods was ungrounded	"	"	0	100	Strokes to rods were afterwards found to have fused sand beneath ungrounded rods
Same as previous test, except rods and foil were placed on top of grounded metal plate set on sand	"	"	0	100	

*This "Radius-Rod Ratio" is the ratio of (the minimum radius of those arcs drawn from each rod position for the given arrangement which will just cover the entire area within the rods) to (the height of the rods used.)

voltages to about 15 per cent. The reduction was practically the same whether the net was very near the top of the tank or a considerable distance above. In the last test a large 2-in. mesh net corresponding more nearly to the size of the cloud was used. Since the edge effect on the tank was removed in this way and the field was practically uniform, some idea of the reduction due to a similar net on a large tank should be given. The voltages were reduced to about 6 per cent of voltages in an unprotected tank. Thus nets do not eliminate induced voltages, but very materially reduce them. It is probable that the hazard is reduced in a greater proportion than the reduction of voltage.

A roof of high-resistance or partly conducting material could take as great a bound charge as a roof of conducting material. Upon release of the charge, however, the high resistance roof could not discharge

TABLE IX
PROTECTION OF ROUND OIL TANK FROM DIRECT LIGHTNING STROKES, BOTH FILLED AND EMPTY, AND WITH VARIOUS TANK COVERINGS AND GROUNDS

Diameter of pan used to simulate tank: 10 in.
Height of pan used to simulate tank : 3/4 in.
Height of cloud needle : 30 in. (storm center)
Number of rods used : 3
Height of rods used : 2 in.
Distance of rods to edge of pan : 2 in.

Note: All tests were made with both 60 cycle and oscillatory lightning generator circuits—(see A and B on Fig. 7. See Figs. 8, 9, 10 and 11.)

Test No. 1—With empty pan Conditions	Results
No rods—no roofing	All strokes were to edge of pan
3 rods—no roofing	All strokes were to rods
3 rods—dry cardboard roof	All strokes were to rods
3 rods—wet cardboard roof	All strokes were to rods
3 rods—wet cardboard roof (pan insulated)	All strokes were to rods
Test No. 2—With pan filled with oil	
No rods—no roofing	All strokes were to edge of pan
3 rods—no roofing	All strokes were to rods
3 rods—dry cardboard roof	All strokes were to rods
3 rods—wet cardboard roof	All strokes were to rods
3 rods—wet cardboard roof (pan insulated)	All strokes were to rods

instantly. High local voltages would result and such a roof would appear to be a hazard.

Tests on Model Tanks and Practical Applications. A number of tests were made on model tanks. A very complete example is illustrated in Figs. 10 and 11, while the results are tabulated in Table IX. In this test a study was made of the effect, with and without oil, in an open and covered tank with both wet and dry roof.

Further tests were made on models to scale of single tanks, groups of tanks and a large farm. A few of the arrangements are illustrated in Table X. Table VIII gives results on the effect of ground resistance.

In applying rods to the protection of tanks one of the factors that must be decided upon is the protective ratio to use. By referring to Fig. 19 it will be noted that this ratio depends upon the height of the rod and the cloud. If it is assumed that the minimum thunder cloud height is 1500 ft., the cloud rod ratio is ten for a 150 ft. tower and the protective ratio, four. Weather

TABLE X
ACTUAL LIGHTNING PROTECTIVE ARRANGEMENTS FOR OIL TANKS

Object being protected	Tank size	Actual ht. of tower ft.	No. of tower minus roof ht. ft.	Distance of tower to nearest tank wall-ft.	Actual radius-rod ratio	Effective-radius-rod ratio
					(Using actual tower ht.)	(Using tower ht. minus roof ht.)
Single oblong oil tank	675 x 475 Fig. 6	130	95	130	2.92	4.0
Oil tank	583 x 1177	140	119	110	3.4	4.0
Three tank farm	One oval two round	150	107	100	2.85	4.0
Four tank farm	Round and oval	150	107	150	2.85	4.0
Section of tank farm (four tanks)	Fig. 12	105	85	60	3.24	3.83
Large tank farm (thirty tanks)	520 ft. and 430 ft.	150	120	150	3.4	4.0

authorities usually give the cloud heights considerably greater than the above value.

A number of layouts were made of single oval and round tanks as well as of tank farms. (See Table X). A height of rod was used that covered the tank with a

rod height attained seems about right for the condition assumed. In the above, it is assumed that the top of the rod is brought to a point.

Perhaps a more direct method would be to use a actual protective ratio of 3 to 3.5, depending upon the rod height, neglecting the effect of the roof when it is less than one-quarter of the rod height.

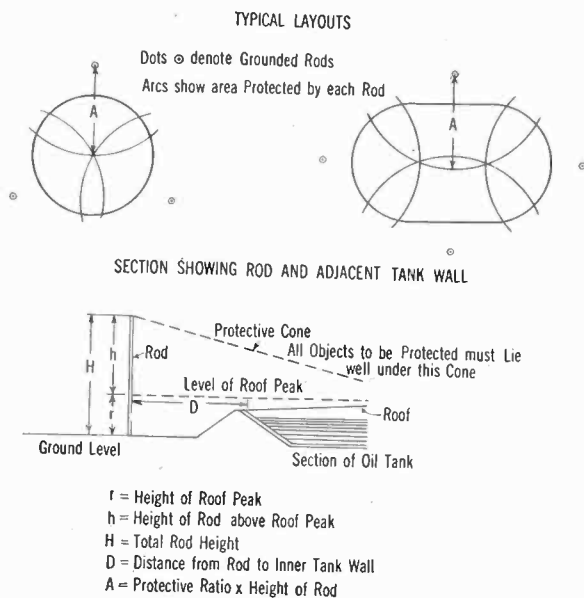

FIG. 23—DIAGRAMMATIC LAYOUT SHOWING PROTECTION AGAINST DIRECT STROKES

protective ratio of four. The height of the tallest part of the roof above ground was then added to the rod height. The method is illustrated in Fig. 6 for a single oval tank. Fig. 23 gives the general method. The rods were always placed at least one-half of the rod length away from the tank. All directions of approach were guarded against by using at least three rods per tank. In the tests of these models a cloud rod ratio of ten was used. The layout gave complete protection on the models in all cases. By referring to Table X it will be seen that the actual protective ratio used in making the layout, neglecting the effect of the roof, was considerably less than four and, in fact, varied from 2.85 to 3.4. As shown in Table V, however, the effect of the roof is not so great as the allowance made for it in the layouts. In any event, the actual

4. MISCELLANEOUS FACTORS

It might not be out of place to mention here several factors outside of the scope of this paper.

Any leakage of inflammable gases should be prevented or means taken to prevent flames starting on the outside from going back into the tank. This would apply to vents or to other possible leakage.

It is quite evident that the hazard is increased as the amount of oil stored at a given place is increased. It would thus seem desirable to reduce storage or separate places of storage when practicable.

ELECTRICITY TRAPS IRON OUT OF SMOKE

About 75,000 tons of iron is wasted into the air annually in the Birmingham, Ala., iron district along with the flue gases escaping from blast furnaces, according to the U. S. Bureau of Mines. This loss could be prevented by passing an electric charge through the furnace stacks, a Bureau report says. This process of reclaiming solid matter out of industrial flue gases is a common one and is used in many cities by electric power companies to reduce the amount of smoke from coal-burning power stations.

In the case of the blast furnaces, the particles of escaping iron would be attracted to a plate and allowed to fall into a hopper. By present practise the iron particles go out into the atmosphere along with the approximate 300,000 tons of other flue dust. This dust is about 25 per cent iron and the 75,000 tons of iron dust equals about 3 per cent of the whole yearly iron output of the Birmingham district.

Construction of the 110-Kv. Transmission Line of the Washington Water Power Company

BY LESTER R. GAMBLE¹

Associate, A. I. E. E.

Synopsis.—This paper describes some of the features of design and construction of the 110-kv. transmission lines of The Washington Water Power Company.

A brief outline is given of the loads served and existing interconnections, with other electric utilities.

The general design of single- and double-pole circuits, covering the alignment, the profile, and the structure types, is taken up in detail. Special reference is made to certain long span construction and to the construction required in heavy frost-loading areas.

The materials used are fully described and several important construction details are discussed. Illustrations are included, showing the form of sag tension curves used for stringing and sagging conductors.

A new type of 110-kv. fuse used in conjunction with an induction type relay is described, the new type of fuse being used on 110-kv. substations of relatively low capacity.

The paper is concluded with a full description of a new method of pole preservation known as the "Cold Treater Dust Method."

GENERAL

THE territory served by The Washington Water Power Company extends 200 miles in an easterly and westerly direction from the Montana State line through northern Idaho into the State of Washington as far west as the Cascade Mountains and 150 miles in a northerly and southerly direction from the Canadian Border almost to the south boundary line of Washington.

The industrial and agricultural development in the area described has been very marked during the past few years. In the northern and western parts of the area, large sections of land have been utilized in the growing of orchards. These orchards are irrigated in most cases by electric pumping. In the west and south is a large wheat growing section. Most of this land is non-irrigated but the large annual production of grain has been effective in developing a number of thriving communities. To the east is the Coeur d'Alene Mining District of northern Idaho, where large quantities of both base and precious metals are produced. To the north and south of the mining districts are some of the large lumber producing areas of the Pacific Northwest.

The power supply to the section above described is about centrally located, so that it requires the transmission of large blocks of power over distances of 100 miles or more.

In the year 1917, the first 110-kv. transmission line was built from the Long Lake generating station, southwesterly to Taunton. This line is 113 miles long and was built to serve the Chicago, Milwaukee and St. Paul Railway when their line through the Cascade Mountains to the Coast was electrified. After the building of this line, the 110-kv. transmission facilities were rapidly extended, until now they carry power into every section of the area served. The single line diagram shown in Fig. 1 is the existing 110-kv. transmission

1. Assistant Electrical Engineer, Washington Water Power Co., Spokane, Wash.

Presented at the Pacific Coast Convention of the A. I. E. E., Salt Lake City, Utah, September 6-9, 1926.

system. This diagram indicates the industries served, their power requirements and the distances of transmission.

INTERCONNECTION WITH OTHER POWER COMPANIES

The interconnection which exists with the Puget Sound Power & Light Company on the west and the Montana Power Company on the east is shown also in Fig. 1. The connection on the west is made with the Snoqualmie plant through the Chicago, Milwaukee and St. Paul Railway 110-kv. bus. This connection is maintained continuously and successful operation is accomplished. The connection on the east is made, at the present time, through 100 miles of 60-kv.

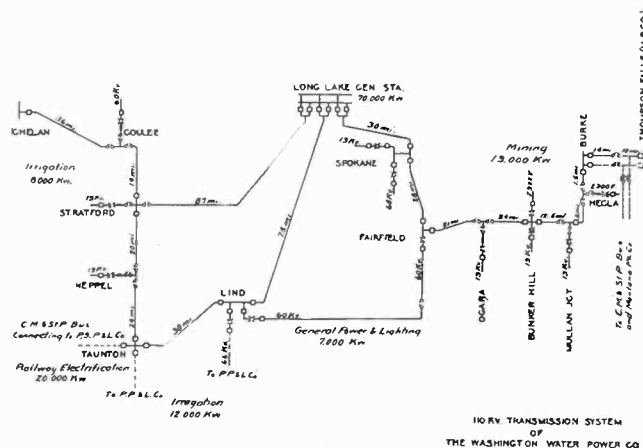

FIG. 1—PLAN OF 110-Kv. TRANSMISSION SYSTEM OF WASHINGTON WATER POWER CO.

transmission line and a 15,000-kv-a. bank of from 110,000- to 60,000-volt transformers. Continuous parallel operation has not been possible with this connection because the transformer bank has not sufficient capacity to take care of the large swings in power transfer.

With the new 110-kv. line now practically completed into the Coeur d'Alene Mining territory, a direct connection with the Montana Power Company will be made, as shown in Fig. 1. A study has been made of this proposed tie and it is found that a maximum of 30,000 kw. can be transmitted. The interconnection

of the three power companies will represent an electrically connected system, 550 miles in length, reaching across the entire states of Washington, Idaho, and half way into the state of Montana.

DESIGN FEATURES

Voltage regulation and power loss. The voltage regulation and power loss for various kinds and sizes of

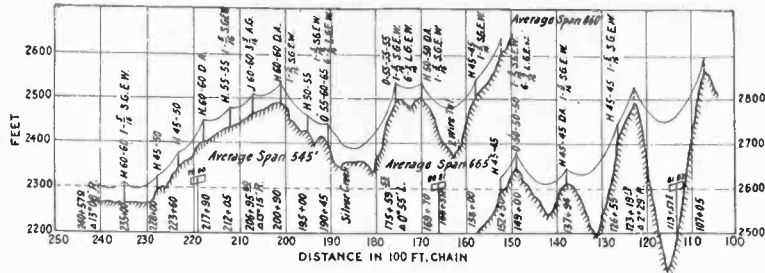

FIG. 2—PROFILE OF 110-KV. TRANSMISSION LINE
Horizontal Configuration; 7-Strand, No. 7 Copper Conductors

conductors are determined by means of the Perrine-Baum chart, and the economical size of conductor calculated with due regard to corona limitations. Where stability is a factor, it is also evaluated. All factors established, the kind and size of conductor

which will give the most desirable and economical line is chosen. On account of corona loss in the usual altitudes encountered, the minimum size of conductor used is one having a diameter equivalent to seven strands of No. 8 copper. For altitudes above 2800 ft., a diameter equivalent to seven strands of No. 7 copper is specified.

Alignment and profile. The data furnished by the survey of a line is sufficient for the drawing up of a plan and profile. (Profile shown in Fig. 2.) The plan is drawn to a scale of 400 ft. to the inch and the profile to a vertical scale of 40 feet to the inch. The sheets are of such size as to cover about two miles of line. The structures are located by means of celluloid sag templates made through the application of the "Melvin-Wynne Sag Tension Charts." The templates represent to scale the approximate catenary which the conductors will take at 100 deg. Fahr. and -30 deg. Fahr. The 100-deg. template represents the wires in extremely hot weather, when they are sagged to a maximum amount, and is used to determine the location and heights of poles to maintain the specified ground clearances. The 30-deg. template represents the conductors in cold weather when they are sagged to a minimum

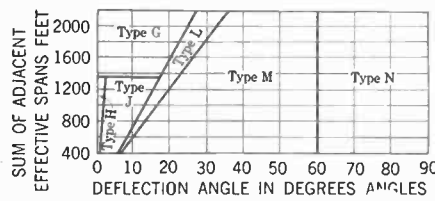

FIG. 3—ANGLE AND GUY CHART FOR 7-STRAND, NO. 7 COPPER CONDUCTORS

Structure type	Normal span	Max. actual span	Max. sum of effective spans	Angles		Side guys		Line guys		Remarks
				from	to	5/16" S.M.	7/16" S.M.	5/16" S.M.	7/16" S.M.	
G	850	1350	2200	0	4°	1 E. W.				Dead end each way
				4°	30°	1			4 E. W.	
H (S. A.)	450	850	1350	0	2°	1				Angle guy Above 650' spans Next to crossing str.
H (D. A.)	850	1350	2200			1 E. W.		2		
J (S. A.)	450	850	1350	0	6°	1				
J (D. A.)	850	1350	2200	6°	12°	2				
				12°	18°	3				
K	850	1350	2200			1 E. W.			4 E. W.	
L	450	1350	2200	6°	12°	2				
				12°	18°	3				
				18°	24°	4				
				24°	31°		3			
M	450	1350	2200	7°	12°	2				
				12°	18°	3				
				18°	24°	4				
				24°	37°		3			
				37°	48°		4			
N	450	1350	2200	48°	60°		5			
O	450	1800				3			3 E. W.	See guy plan dwg. B-1665
						1 E. W.			6 E. W.	To be used only when approved by engr. office

Assumptions:
24" clearance of conductor to structure with 60 mi. wind and no ice.
Guying to withstand tension in all conductors.

Guis.

amount. This curve is used to check up strain on any of the poles as located.

The height and type of structure at each location is determined by the length of span, the effective spans, the loading conditions, the conflict with other lines and other classes of utilities, and the degree of angle through

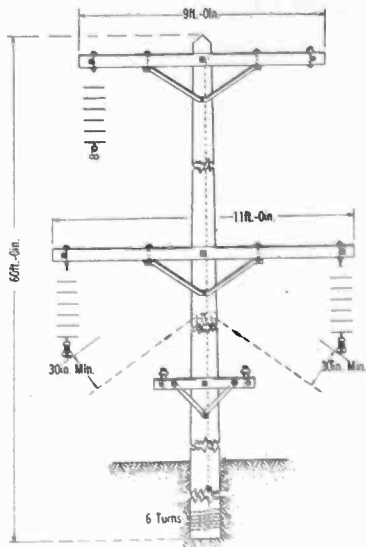

FIG. 4—TYPE "A" SUSPENSION, SINGLE-HOLE STRUCTURE

which the line is turned. Referring to Fig. 2, a notation on the profile H-50-55 indicates an H type structure, having one pole 50 ft. long and another 55 ft. long; DA refers to a double arm; $4\frac{7}{16}$ L. G. E. W. indicates four $\frac{7}{16}$ -in. guy wires each way in the line; and $1\frac{5}{16}$ S. G. E. W. indicates one $\frac{5}{16}$ -in. side guy each way.

The proper guying for all structures is obtained from

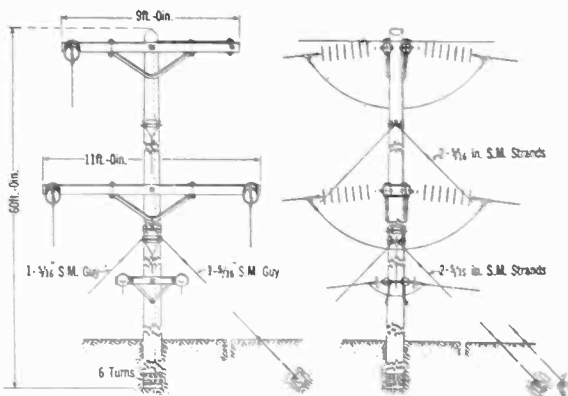

FIG. 5—TYPE "CT" DEAD-END, SINGLE-POLE STRUCTURE

a chart such as shown in Fig. 3. The chart shown is made for seven strands of No. 7 copper. The maximum actual span as referred to in the chart is that one which is limited because of pole strength, conductor spacing and wind pressure. The sum of the effective spans is that span which is limited by crossarm strength. The chart is based on guys being placed at 45 deg. with the structure. Where the angle is decreased, the number of guys is correspondingly increased.

Structure Types. In the development of the 110-

kv. transmission structures, the wood pole has been universally used. Two forms of conductor arrangement are provided. One is known as the L type configuration, which is used on single-pole lines and the

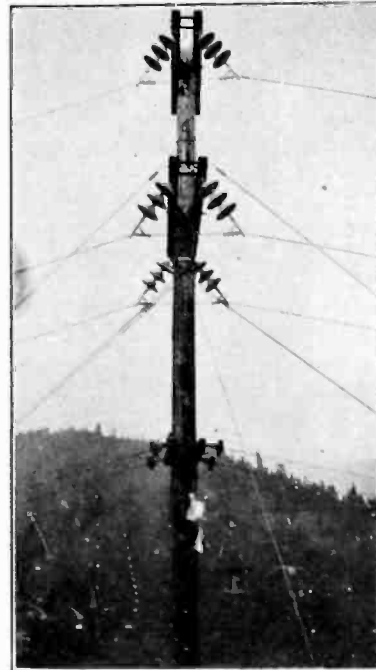

FIG. 6—TYPE "E" SEMI-TENSION, SINGLE-POLE STRUCTURE

other is the horizontal type of configuration used on double-pole lines. The single-pole structures have their application on the less important lines where



FIG. 7—TYPE "A" SUSPENSION, SINGLE-POLE STRUCTURE, SHOWING APPLICATION OF CONDUCTOR WEIGHTS

conductors are relatively small and where short spans can be maintained.

There are seven types of such structures; the type A for normal tangent suspension, the type B for very slight angle points, the type C and CT for semi-

tension and dead-ends, and the types *D*, *E* and *F* for large angle points.

Fig. 4 illustrates the *A* type of structure, Fig. 5, the *CT* type of structure, and Figs. 6 and 7 show the actual structures, Fig. 6, being one of the semi-tension type. The semi-tension type of structure is used quite extensively for the purpose of stiffening the line at intervals of approximately one and one-half to two miles in long tangents; also, at points of heavy strain, such as at the top of a ridge where the effective spans are ex-

cessive for the suspension structures. This structure is also used in many instances at railroad and telephone crossings. The primary reason for using the semi-tension construction in place of the actual dead-end is to avoid placing insulators in strain position where they are not electrically as good. The use of this structure also permits of the conductors being strung through and facilitates the maintenance of the insulators.

up-strain does not occur. In the few cases in which they are used, they have been necessary because of a slight error in the profile which is discovered when the conductor is installed. The double-pole structures are used on all lines of any considerable importance and where the size of copper is No. 00 or larger, also where the profile is rough and long, actual, or effective spans are necessary. Such structures are also used on lines where heavy ice-loading conditions are encountered. There are eight distinct types of these structures. The *H* type is used for tangent suspension structures; the *G* type for dead-end structures; the *J* type for slight angle structures; the *K* type for semi-tension structures; the *L*, *M* and *N* types are three-pole, angle structures; and the *O* type is for especially long spans and is used also

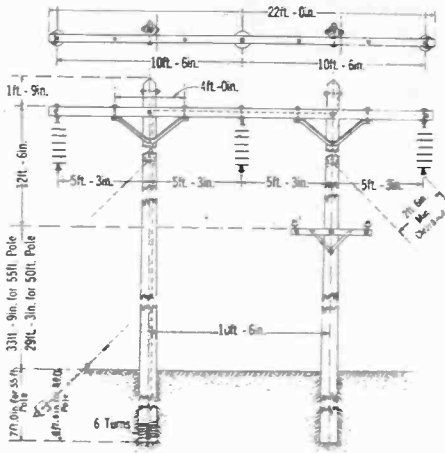

FIG. 8—TYPE "H" SUSPENSION, DOUBLE-POLE STRUCTURE

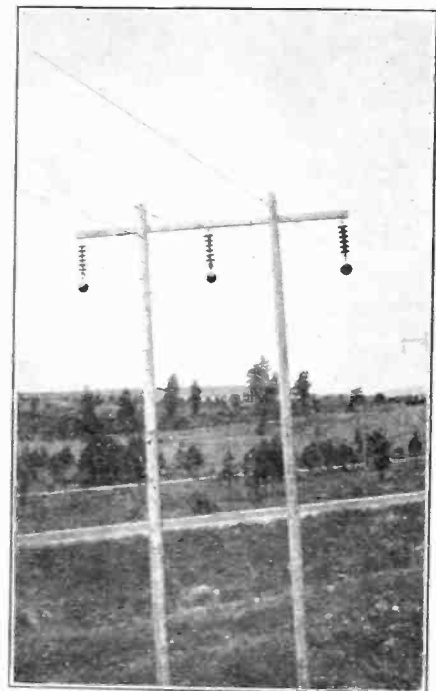

FIG. 10—TYPE "H" SUSPENSION, DOUBLE-POLE STRUCTURE SHOWING APPLICATION OF CONDUCTOR WEIGHTS

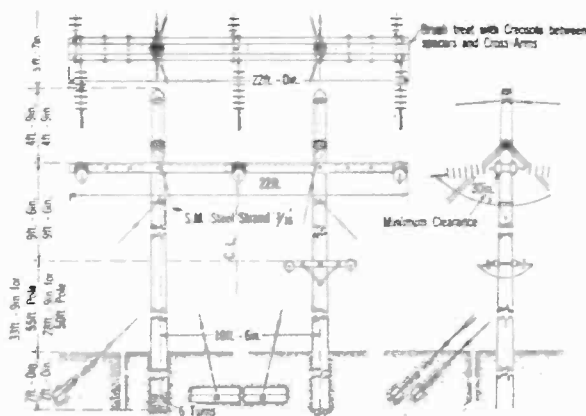

FIG. 9—TYPE "G", DOUBLE-END, DOUBLE-POLE STRUCTURE

cessive for the suspension structures. This structure is also used in many instances at railroad and telephone crossings. The primary reason for using the semi-tension construction in place of the actual dead-end is to avoid placing insulators in strain position where they are not electrically as good. The use of this structure also permits of the conductors being strung through and facilitates the maintenance of the insulators.

Fig. 7 shows a type *A* suspension structure, demon-

strating the use of conductor weights. These weights are used where up-strain occurs in the conductor and where the sum of the negative effective spans is less than 500 ft. Where the sum of the negative effective spans is more than 500 ft., however, a standard, dead-end structure is used. As a general rule, these weights are not used, as the intention is to place structures so that

in places where the effective spans are excessive. There is one additional structure which has no letter of designation and is known as the *transportation structure*. Fig. 8 is an illustration of the type *H* suspension structure. Fig. 9 represents the type *G* dead-end structure. Fig. 10 is from a photograph of an *H* structure; a slight error in profile required the installation of the weights as shown. Figs. 11 and 12 are taken from photographic reproductions of the type *G* or dead-end structure, and Figs. 13 and 14 show the three-pole structures used in long span construction. The structure shown in Fig. 14 is supporting a span 2640 ft. in length. In the construction of this span it was necessary to place the telephone on a separate structure. The telephone circuit insulation was equal to that used in the power conductors so that the telephone conductor could be used as a power wire in case of power-wire failure. The bus arrangement between the two structures facilitates connections in case of emergency.

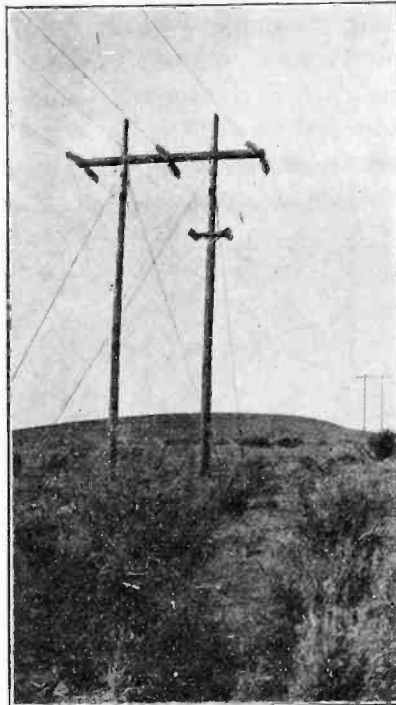
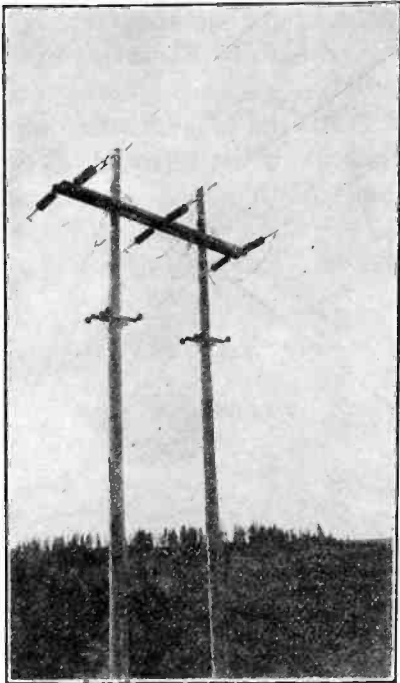

FIGS. 11-12—TYPE "G" DEAD-END, DOUBLE-POLE STRUCTURES



FIG. 13—TYPE "O", THREE-POLE STRUCTURE

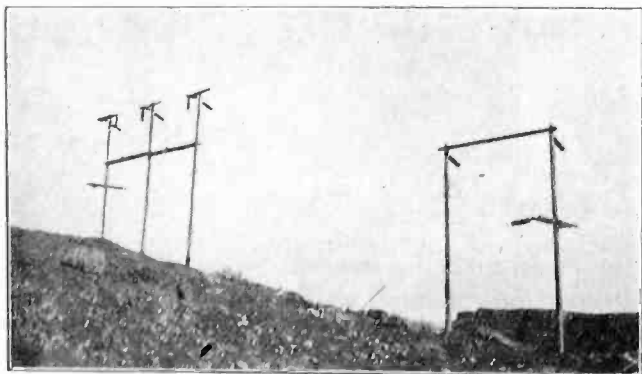

FIG. 14—TYPE "O", THREE-POLE STRUCTURE FOR EXTRA LONG SPANS

Fig. 15 shows the three-pole structure where excessively high poles were required. This span crosses the Columbia River where a 50-ft. clearance over the water was required.

Figs. 16 and 17 show angle structures, types *N* and *M*, respectively.

On a very recently constructed line into the Coeur

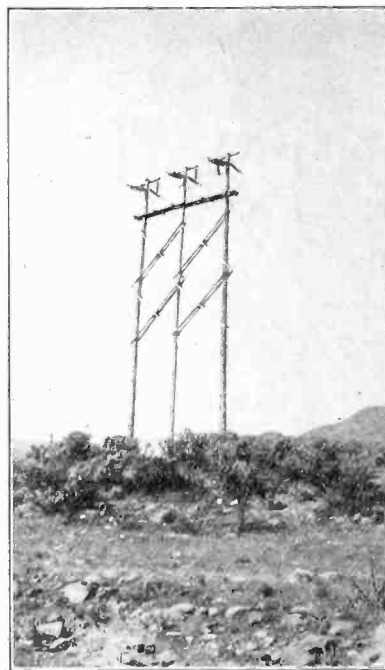

FIG. 15—TYPE "O", THREE-POLE STRUCTURE FOR LONG POLES

d'Alene Mining territory, it was necessary to cross the lower end of Coeur d'Alene Lake for a distance of approximately half a mile. The crossing was made through shallow water and the structures placed on piling. Three structures were required in the construction of this crossing. Fig. 18 illustrates the structure

used. Figs. 19 and 20 depict the structures in the process of erection. A 1/2-in. chain was used in lashing the piling together, rather than the 5/16-in. Siemens Martin steel strand shown on the drawing. It was found the chain was more easily applied and did not

Heavy Loading Districts. In a number of localities, the lines are subjected to an extremely heavy frost loading. Frost measuring 8 in. in diameter and weighing 2.33 lb. to the foot has been recorded. Lines constructed through these frost belts are built with short spans and double-pole structures. The conductor is sagged excessively. Fig. 21 shows a line in a heavy

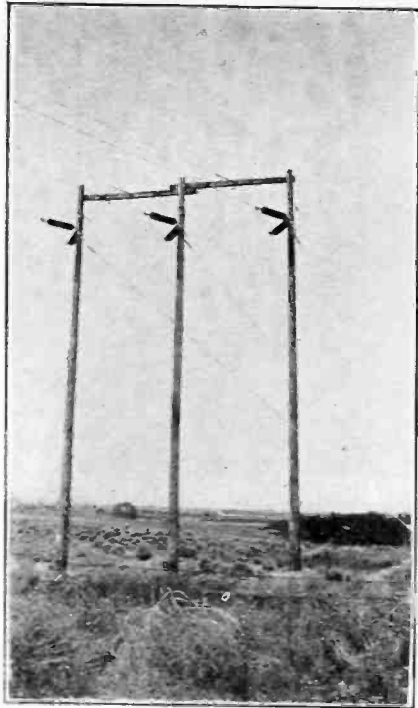

FIG. 16—TYPE "N", THREE-POLE ANGLE STRUCTURE

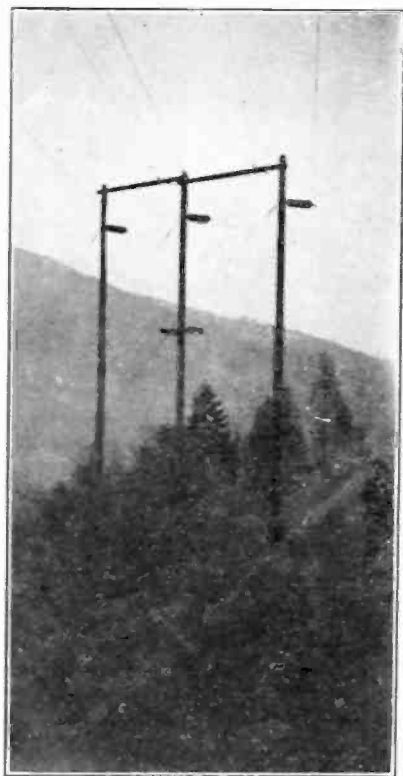

FIG. 17—TYPE "M", THREE-POLE ANGLE STRUCTURE

mutilate the piling when being pulled snug. Two complete wraps were made and the chain fastened to the piling by means of drift pins. The bottom of the lake at the point of crossing was extremely soft, and pilings 65 ft. in length were required.

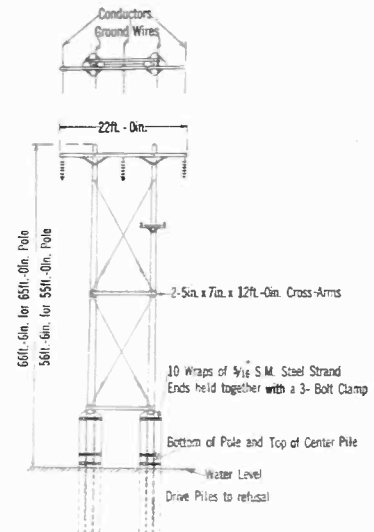

FIG. 18—PILE FOOTINGS FOR STRUCTURES PLACED IN MARSHY OR BOGGY GROUND

loading area. The conductor in this line is of No. 000 copper and sagged 18 ft. at 60 deg. The span length is 350 ft. and the sag given is sufficient to prevent the

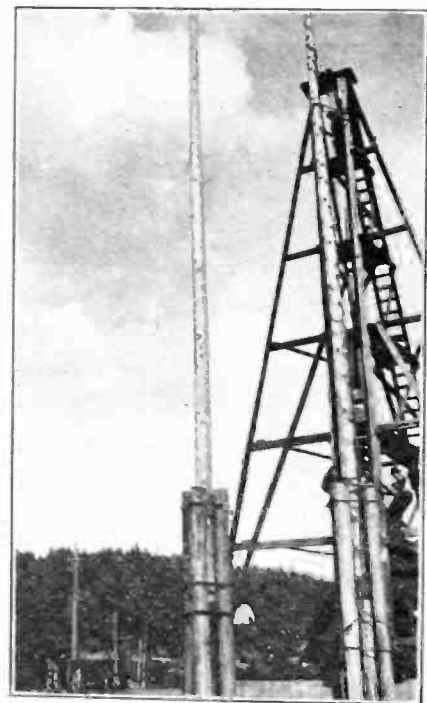

FIG. 19—ERECTION OF STRUCTURE ON PILE FOOTING

conductor from being over-stressed with a loading of 2 1/2 lb. per foot of frost, and a wind load of one pound per foot.

Clearances. The ground clearances provided are as follows: Over ordinary ground, spans 700 ft. or less—27 ft.; over ordinary ground, spans more than 700 ft.—

29 ft. Over cultivated fields—29 ft. Inside the corporate limits of cities—29 ft. Clearances to guys must be not less than 30 in. The clearances over railroads, telephone circuits and other power lines are such as to be within the requirements of State Law.

Telephone Circuits. A telephone circuit is placed on

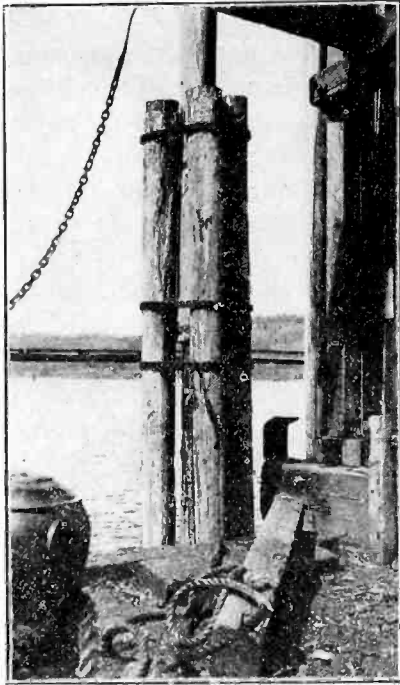

FIG. 20—PILE FOOTING SHOWING CHAIN LASHINGS

practically all lines, the primary use of such a circuit being for patrol purposes. Such circuits however, are used also for the transaction of other business. The insulation is of the 13,000-volt class and the conductors are transposed at practically every half mile. Where balance points occur at convenient locations, sectionalizing switches are provided in the telephone circuit. Also the placing of telephone booths at certain advantageous points is arranged.

Power Line Transpositions. Transpositions are not placed in the power conductors unless necessary because of interference with foreign telephone or telegraph lines.

Static Wires. Overhead ground wires are installed on practically all lines to insure the service against lightning discharges. The ground wire is also used to give a certain degree of mechanical stability to the line.

One ground wire is installed on single-pole lines at the outer end of the upper crossarm. This wire is grounded at every structure. On two-pole construction, two ground wires are installed, one attached to each pole; these wires are grounded, one on each alternate structure. None of the pole-line hardware is bonded or grounded.

MATERIALS AND CONSTRUCTION

Poles. Class B, 8-in. top, Western red cedar poles are used for all lines. The pole butts are penetrated

and butt-treated by the open-tank, B process. Poles treated in this manner have been used almost exclusively until very recently.

The poles on a new line just constructed in the Coeur d'Alene Country were not creosoted but were given a special treatment at the time of setting. This treatment is discussed in the last section of this paper.

In view of inability to dig holes to an exact depth, making it very hard to properly line up the structure, the poles in double-pole structures are not framed until after they are set.

Crossarms. The crossarms used on the single-pole structures are $4\frac{3}{4}$ in. by $5\frac{3}{4}$ in. by 9 ft. and $4\frac{3}{4}$ in. by $5\frac{3}{4}$ in. by 11 ft. The crossarms for the double-pole structures are 5 in. by 7 in. by 22 ft. The telephone cross arms are $3\frac{1}{4}$ in. by $4\frac{1}{4}$ in. by 4 ft. 8 in. All power conductor crossarms are provided with 48-in. angle iron braces; the telephone crossarm, with a 28-in. flat brace. To prevent the arms from splitting a $\frac{1}{2}$ -in. machine bolt is placed five inches from each end of all crossarms.

Insulators. Insulators of various types consisting of the cap-and-pin, the Jeffery DeWitt and the Hewlett are used. For the suspension strings, six cap-and-pin type, six Hewlett type or five Jeffery DeWitt type, are used. For the strain positions, seven cap-and-pin type, seven Hewlett type, or six Jeffery DeWitt type, are used. As a general rule only the Hewlett type insulator is used in strain.

Wires and Cables. The conductors used are stranded medium hard-drawn copper; aluminum, steel reinforced cable or extra high strength copper-clad cable. The overhead ground wires are 5/16-in., Siemens Martin, seven-strand, galvanized cable. The telephone wires

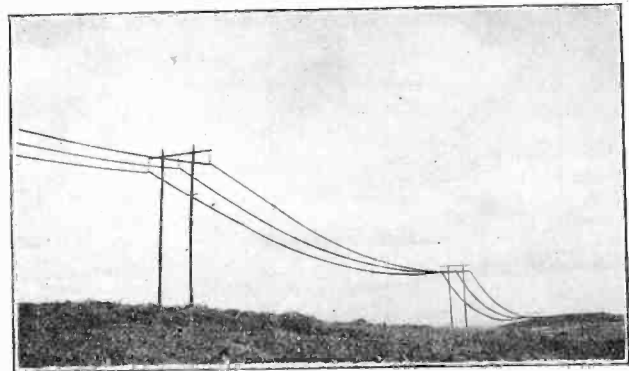

FIG. 21—LINE CONSTRUCTION IN EXTRA HEAVY LOADING DISTRICTS. (NOTE EXCESSIVE AMOUNT OF SAG IN CONDUCTORS)

usually consist of No. 6, high-strength, copper-clad wire. The guy wire consists of 5/16-in., and 7/16-in., Siemens Martin, seven-strand, galvanized cable. The power conductors are spliced with two copper splicing sleeves, having two and one-half complete turns each. The ground wire is spliced with one steel sleeve, having three and one-half turns. The telephone wires are spliced with two sleeves, each sleeve having three turns. At the points of attachment to the pole the guy wires

are provided with 4-in. by 8-in. strain plates and guy hooks; standard three-bolt clamps are used, one clamp for 5/16-in. cable and two clamps for the 7/16-in. cable.

Guys. Pressure treated, creosoted ties 7 in. by 8 in. by 4 ft. are used for anchors. The galvanized guy rods are 3/4 in. by 8 ft., equipped with one 4-in. by 4-in. square washer and two nuts. Only one 3/4-in. rod is

No metal grips are used in pulling the conductors, but a 1 1/2-in. rope snub is provided for this purpose. The conductor is entwined through the strands of this rope snub for a distance of four or five feet. A pull on the end of the snub causes the rope strands to firmly grip the wire and makes it possible to pull it into position without injury. This rope snub is commonly termed the "grapevine grip" and is very quickly applied to the conductor.

Dynamometers are used in all cases, but they are used, primarily, for the purpose of giving the conductor the initial pull, which is designated as twice the stringing tension at 100 deg. Fahr. The conductor is held at this tension for three minutes and then slacked back to the stringing tension. However, due to the various inaccuracies which may occur in the dynamometer

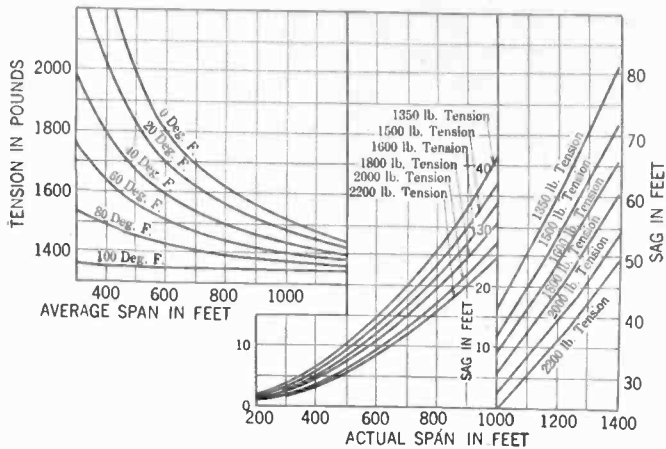

FIG. 22—SAG-TENSION CHART FOR 7-STRAND, NO. 7 COPPER CABLE

Maximum Stress in 7-Strand, No. 7 B & S Cable, 25,000 lb. per sq. in., (2850 lb.) at 15 deg. Fahr. with N. E. S. C. medium loading. Modulus of elasticity, 16,000,000; coefficient of expansion, 0.0000096 (Melvin-Wynne Sag-Tension Chart)

used to an anchor. The maximum number of guys in the rod is two 7/16-in. steel cable. A 1-in. thimble is used to take the two 7/16-in. guy wires. In certain locations, where it is impossible to install side guys, the poles are cross-guyed, as shown in Fig. 18. All

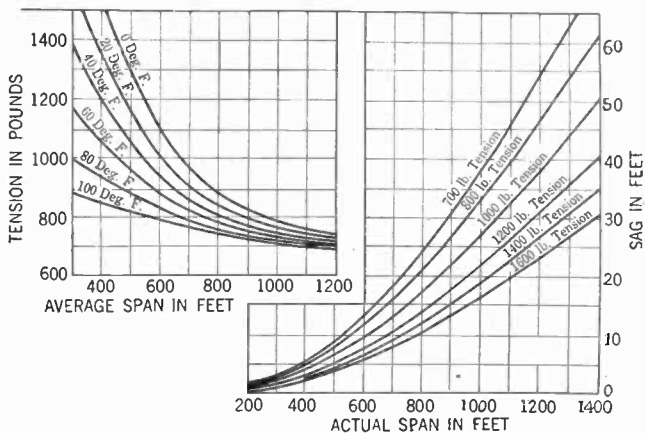

FIG. 23—SAG-TENSION CHART FOR 5/16-IN. SIEMENS MARTIN CABLE

Maximum stress, 40,000 lb. per sq. in., (2430 lb.) at 15 deg. Fahr. with N. E. S. C. medium loading. Modulus of elasticity, 29,000,000; coefficient of expansion, 0.0000064 (Thomas Sag-Tension Chart)

guy wires are protected by means of a wooden guy guard.

Stringing and Sagging. The conductors, which are supported by suspension insulators, are strung through snatch blocks suspended from each insulator support. The snatch blocks have hardwood sheaves and are designed so as to prevent injury to the conductors.

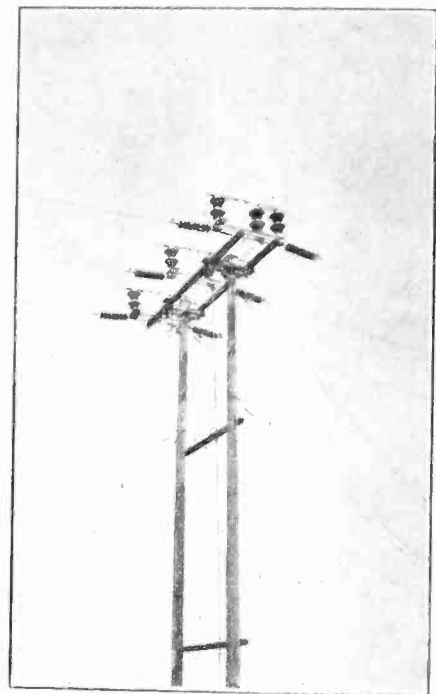

FIG. 24—TWO-POLE STRUCTURE FOR SECTIONALIZING SWITCH

reading the conductor is never sagged by reading the dynamometer. The proper sag is always obtained by measurement in some convenient span in the section pulled. By the use of thermometers and the sag-tension charts shown in Figs. 22 and 23, the construction forces are able to sag the conductors with a considerable degree of accuracy. Fig. 22 is a chart for seven-strand, No. 7 copper and Fig. 23, a chart for 5/16-in., Siemens Martin steel strand.

Having given the average span in the section of line being pulled, the actual span where the sag measurement is to be made and the temperature at the time of pulling the wire, the procedure in the use of the sag-tension charts is as follows:

Determine the tension from the curves on the left-hand side of the chart; refer this tension to the tension curves on the right-hand side of the chart and read the sag for the actual span in which the sag is to be measured.

The ground wires are never sagged parallel to the power wires but in accordance with the curves for the material used. In sagging the ground wires, a special dolly, consisting of an iron frame supporting a $\frac{3}{4}$ -in. pipe roller and fitted to the top of the crossarm, is used. The device permits the wire to run freely when being pulled in and also avoids injury to the crossarm.

The telephone wires are always sagged parallel to the power conductors.

SWITCHES AND SUBSTATIONS

For the purpose of sectionalizing the transmission lines at certain convenient and advantageous points, a

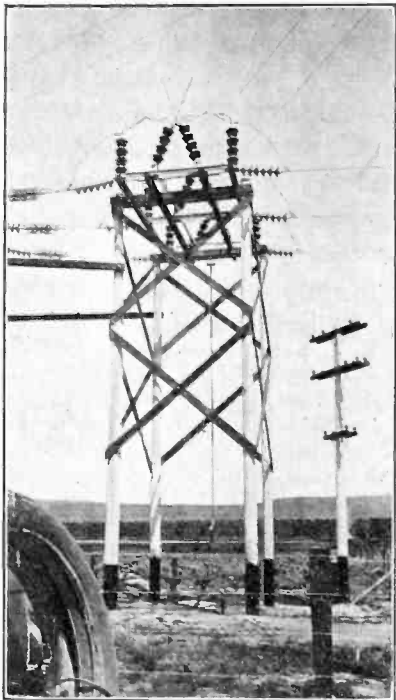

FIG. 25—FOUR-POLE STRUCTURE FOR MOUNTING HEAVY TYPE SECTIONALIZING SWITCH

three-phase air break switch is usually installed. The type of structures used in mounting such switches are shown in Figs. 24 and 25. A typical 110-kv. substation is shown in Fig. 26.

At the smaller substations, oil circuit breakers are not installed on the 110-kv. side of the transformer bank but fuses are used.

For the 1000- and 1500-kv-a. substations, a satisfactory medium priced 110-kv. fuse which will operate effectively with the relay operation of the balance of the network is not available. The desire has been to have a fuse which will give some selectivity. Such a fuse has been developed recently but as yet it has not been placed in actual service. It is expected that this fuse will be placed at one of the substations where a bank of three 400-kv-a., 110,000- to 13,000-volt transformers will be installed. These transformers are single-bushing transformers with neutral of the Y solidly grounded. The fuse will be of the ordinary open type, designed to give protection from both short circuit and overload, and, at the same time, provide a fuse wire of sufficient

size to prevent deterioration due to corona. The fuse is mounted on two stacks of six Jeffery DeWitt post-type insulators. On one post is mounted a small sheet metal cabinet, containing an induction type relay and a suitable clip, into which one end of a micarta tube is secured. A fuse wire of not less than 30-ampere capacity is placed in the tube and secured at the opposite insulator post by a binding screw. At the clip end, a small heating coil, having the same impedance as the relay circuit, is slipped over the lead fuse wire. This heating coil is connected to the tripping circuit of the relay. Under normal operation the main line current passes through the fuse and relay coils to the load. Overload protection is secured by the proper setting of the relay which, when called upon to function, closes its contacts, shunting part of the load current through the heat coil and melting the fuse, thereby opening the 110-kv. circuit. The fuse is equipped with horns so that the arc established is readily extinguished.

COLD TREATER DUST METHOD OF POLE PRESERVATION

The poles which have been used in transmission line construction during the past year have been treated by the "Cold Treater Dust Method." The dust consists of several chemical compounds, obtained in the process of smelting ores. These compounds have varying degrees of solubility, some being highly soluble while others are soluble to a much lesser degree.

The treatment is not applied to the pole before it is set, but always at the time of setting. It may also be applied around poles which have been in the ground for any length of time. The effectiveness of the dust was established after a series of tests covering a period of several years. The tests disclosed the following facts:

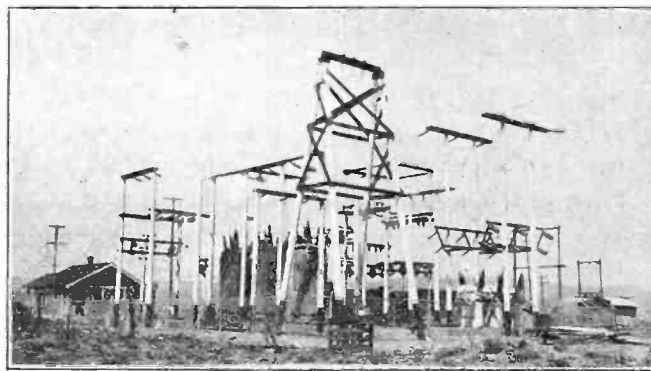

FIG. 26—6000-KV-A. SUBSTATION, 110 KV. TO 60 KV.

1. That the dust absorbs moisture from the surrounding earth and becomes a putty-like mass.
2. That, in all soils except rock, the dust does not readily leach out in the earth.
3. That the highly soluble compounds are soon dissolved and carried up through the outer fibers of the wood by capillary action, and thus immediately head off any decay.
4. That the less soluble compounds act as a storage reservoir, keeping up the supply to the pole in sufficient quantity to prevent decay.

5. That very little or none of the compound is evident in the wood below its point of application.

6. That those portions of wood impregnated with the compound are hard and tough.

7. That the dust must be placed in actual contact with the pole to be effective—any dust out in the earth around the pole is practically useless.

8. That the dust, to be effective, must be placed far enough below the ground surface to get below that point where decay will start.

9. That any rot on the pole at the time of application acts as a cushion or barrier and does not allow the compound to reach the good wood of the pole and thereby stop further rot.

10. That in marshy ground the treater dust is soon dissolved and carried away by the water.

11. That in certain lines built three years ago, in which every alternate pole was treated, there is at this time no evidence of decay and that those poles in the same line which were left untreated show one-fourth to one-half inch of rot.

The following specifications are used in applying the dust:

Seven pounds of treater dust are used at each pole butt. The first application is made by placing one pound of the dust in the bottom of the hole before the pole is set. This is for the purpose of insuring against any heart rot which may develop.

The second application consisting of two pounds of the dust is put around the pole after the hole has been

backfilled to approximately midway between the bottom of the hole and a point two feet below the ground line. A narrow groove about $\frac{3}{4}$ -in. wide and one inch deep is made in the earth around the pole with a special tamping bar and this groove is filled with the dust. This application is made as a security against any decay below the two foot level. It is found that in some territory decay will take place as far down as six feet. The hole is then backfilled to within two feet of the ground surface.

The third and last application is then made at this point (two feet below the ground surface) by tamping a groove around the pole with the same tamping bar as previously used but with groove made two inches deep so as to take four pounds of the dust. The hole is then backfilled and the dirt banked solidly up around the pole.

In marshy ground the dust is not used.

In rock holes the dust is applied in the usual manner but dirt is mixed with the rock used in backfilling so as to fill all crevices between the rocks and thus prevent the sifting away of the dust.

All deadmen for guys are treated with five pounds of the dust placed under and on top of the deadmen.

The cost of the dust ranges from three to five cents a pound. The labor of making the application is relatively small, although the pole setting crew will be forced to lose a little time. Taking everything into consideration the treatment will possibly cost in the neighborhood of \$1.00 per pole.

Electricity and Coal Mining

BY DANIEL HARRINGTON

Non-Member

WHILE the far western states (Arizona, California, Colorado, Idaho, Montana, New Mexico, Oregon, Utah, Washington, and Wyoming) are known much more for metal mining than for coal, their ultimate natural wealth in coal nevertheless far exceeds that of all combined metallic resources. Government estimates place the combined coal tonnage in the above mentioned states as only a trifle less than 50 per cent of the total coal tonnage of the entire United States, yet these states now produce less than five per cent of the annual output of the United States. Utah alone is credited with having within its boundaries nearly 200,000,000,000 tons of coal and to date has mined less than 100,000,000 tons or about $\frac{5}{100}$ of one per cent, annual tonnage mined being around 5,000,000. From the above it will be seen that coal constitutes a vital part of the resources of the West

and while water-generated electricity is a strong competitor of coal, yet much of the coal mined goes to generate electricity and on the other hand electricity enters very actively into the mining of coal. Consequently the subject of electricity and coal mining is of decided interest to the West as well as to all of the rest of the United States, but as it is a very broad subject, this paper will be confined chiefly to influence of electricity at the mines rather than including the broader subject of influence on markets.

The major underground operations in coal mining are cutting of the coal, lighting, blasting, haulage, drainage, and ventilation, and those on the surface are sizing, cleaning, and loading the product. Twenty-five years ago electricity was being utilized only in a comparatively minor way in the coal mines of the United States, while up-to-date installations at the present time are going largely if not almost entirely to electricity for practically every one of the above mentioned operations.

1. Consulting Mining Engineer, Salt Lake City, Utah.

Presented at the Pacific Coast Convention of the A. I. E. E., Salt Lake City, Utah, Sept. 6-9, 1916.

Hand or pick mining is almost a thing of the past; compressed air mining machines are rapidly disappearing and even where used, the compressed air is usually of electrical compression; the old hard-boiled solid shooting methods are confined to "back-woods" properties; and some form of electrically operated cutting equipment (undercutters, over-cutters, shearers) is now relied upon for up-to-date mining or preliminary loosening of coal.

The recent extensive experimentations in mechanizing of coal-handling at or around coal-mine faces, involving various kinds of loaders, conveyors and scrapers, as well as combinations of them with or without cutting machines, practically all depend upon electricity for their motive power. Even where hydraulic principles are applied or where compressed air is used in these underground mechanical coal handling contrivances, the pumps or compressors are almost invariably driven by electric motors.

Most of our up-to-date coal mines use incandescent electric lighting on main haulage roads or at hoist or pump stations or other underground places where there is much concentrated activity; occasionally one finds face regions wired for electric lighting and it seems probable that the new intensive systems of mining now being tried out as above mentioned will greatly increase the wiring of face regions for lighting purposes. At least one-third of the 750,000 coal miners of the United States use storage battery electric lights which are both safer and more efficient than the open flame lights which have caused loss of hundreds of lives and millions of dollars worth of property in the mines of the United States. Utah leads in that she alone of the coal producing states has eliminated the dangerous, inefficient open lights from coal mines and now requires that the coal miner's light shall be from the safe, sane, efficient permissible electric safety lamp.

The old-time steam or compressed air hoists and locomotives have largely given way to electrical equipment, though steam-operated main hoisting plants still give good service where located on the surface close to steam boilers. Steam pumps underground are a rarity except in some very old installations; compressed air pumps are in use to some extent but here again the tendency is strongly towards electrical equipment, except that at some very gaseous mine faces compressed air pumps are used, but ordinarily the air compressor is electrically driven.

Many main fans for coal mines are steam driven and while steam driven fans are generally preferred because of dependability and general safety, still electrically operated fans are coming very much into use, in fact are rapidly displacing steam driven units. There is also a decided tendency toward use of small electrically driven "booster" fans underground, a policy which appears unsafe and unnecessary.

Blasting by electricity is by no means as nearly universal in coal mines as it should be, as it is much

safer and more efficient than the older methods using squibs or fuse. Here again the state of Utah points the way to all other coal producing states in the Union in that nothing but electrical blasting is allowed in her large coal mines. Moreover, Utah has more than half of its coal produced by mines in which all blasting is done by electricity when all persons, including the *shot firers*, are out of the mine; this system is by all odds the safest in the world when it is accompanied by exclusion of all explosives from the mine when the working shift is in the mine and having all explosives brought into the mine by shot firers after the regular working shift.

In addition to these major underground activities most of which are being handled electrically in up-to-date coal mines, there are numerous minor operations in which electricity takes or appears about to take the leading role; among them are signaling systems, telephones, rock dusting machines, heaters, drilling machines, as well as a host of others.

Up-to-date surface tipples or breakers which do the coal sizing, cleaning and loading are almost wholly driven by electricity and it is by no means unusual to have 20 or more electric motors on an up-to-date coal screening plant. Box car loaders, elevators, conveyors, car dumps, car hauls, car retarders, machine shop equipment, in fact nearly every mechanical activity around the modern tipple or coal mining plant, is electrically driven where 25 years ago practically all of this type of work was done by steam or hand power.

The coal mining town or camp which is not electric lighted in offices, residences and streets is decidedly behind the times and electric washing machines, electric irons and other similar household electrical conveniences are more generally found through coal mining camps than in the general run of homes of the middle class in our larger cities.

Coal mining men of the United States who have in recent years visited foreign coal mines, especially those of Europe, state that we are far in advance of any foreign country in the adaptation of electricity to coal mining; in fact, many of the every-day uses to which we put electricity in our coal mines are prohibited by law in some foreign countries. A commission of labor men from Great Britain's coal mines recently made a study of our coal mining conditions chiefly to ascertain why we are able to pay peak wages to our coal miners, yet produce coal at comparatively low cost; among the most important of their conclusions was that our superiority in coal mine working conditions, at least as to high wages, was due chiefly to the fact that our coal mining companies do not hesitate to "scrap" out-of-date equipment and substitute for it up-to-date equipment even though the first cost of doing so may be comparatively high. Boiled down, this means essentially that much of the good position our coal miners occupy as against foreign coal miners is due largely to the fact that our coal mines have been quick to adopt and to

adapt new, more flexible, more efficient electrical machinery and to discard older, less efficient, even if not completely worn out, compressed-air or steam equipment; and curiously enough many of these changes are made with active opposition of the miners who have thus been benefited.

While progress in the electrification of our coal mines has been especially rapid during the past 15 years, there remain a large number of older mines in which electrification is only partial or has scarcely begun. Stress of competition in these days of immense overproduction will soon force modernization (which essentially means electrification), or these out-of-date properties must close. Many of the mines electrified 10 to 15 years ago are now pretty much out of date, and with the extra competition due to concentrated mining, these one-time model mines will also be forced to discard old equipment or methods such as the d-c. installations for the newer more efficient, more flexible alternating current now coming so much into use. Hence it appears that notwithstanding the "slump" in coal mining, there will be heavy purchases in the more or less immediate future of large quantities of electrical equipment for the coal mines of the United States.

Whether or not this extensive electrification of our coal mines continues uninterrupted depends largely upon electrical men themselves; unless electrical men and manufacturers of coal mining machinery which needs electrical equipment, acquire a type of conscience which many of them now lack, there is likely to be a sharp reaction against use of electricity in mines which may result in drastic state regulations against electrification especially at or near working faces. With the increased use of electricity in coal mines, there is absolutely no question that there is also an increased hazard as to explosions as well as to contact electrocutions. In the period from 1910 to 1924, out of 200 explosions in the coal mines of the United States, 15 explosions or 7½ per cent were charged against electricity as the igniting agent; in 1924, the last year included in the above list, of 200 explosions, 10 explosions were listed and of these 5 or 50 per cent were of electrical origin; in 1925, out of 10 known coal mine disasters, 6 or 60 per cent were attributed to electricity as the starter. Hence, while only 7½ per cent of our coal mine explosions during the 15-year period from 1910 to 1924 were of electrical origin, the percentage of explosions of electrical origin jumped to 50 in 1924 and to 60 in 1925.

Electrical men usually resent publication of figures of this description; they say they are overdrawn, are inconclusive because of being fragmentary, are "harrowing," and so on; and the amount of "buck passing" encountered by the coal mine safety engineer in calling attention to dangers of electricity is remarkable in the extreme. A manufacturer of small booster fans, when confronted with dangers of these small fans near coal mine faces, especially when electrically driven,

shrugged his shoulders and said, "I sell fans; I should worry how they are driven." The machinery manufacturer who purchases from other companies the electric motors which operate his equipment only too frequently washes his hands as to the degree of safety with which the purchased electric motor may be used underground; in other words, "he should worry" also. The manufacturer of electric motors, or of almost any electrical equipment, seldom inquires into the safety side of the use of the equipment in the proposed sale and leaves that to the mine management. In general the mine management has a purchasing agent who seldom if ever sees the inside of the mine and who wouldn't be able to interpret conditions if he did see the mine workings, and his prime conception of his official duties is to purchase at minimum cost, with possibly some attention to probable efficiency but with seldom a thought as to safety; in fact, if the safety situation enters into the matter and there is any substantial increase in price for the safety feature, the purchasing agent usually rejects it because of the price increase; and the salesman fearing loss of sale seldom if ever presses the safety element in his higher priced product, this being the case especially if he has also some lower priced, less safe substitute. The man at the mine usually gives his order in general terms, relying upon the salesman to supply the correct kind of material or equipment.

This "vicious circle" is in itself sufficient to explain much of the increased percentage of coal mine disasters due to electricity, but there are also other important contributing factors:—state laws and regulations as to electricity in coal mines are usually much out of date, loosely worded and are now and always were entirely inadequate; in the few instances where state laws are even fairly sensible as to use of electricity in coal mines, they are not enforced, as there are very few (probably not any) state coal mine inspectors who have anything like a sufficient knowledge of electricity to enable them to interpret the safety of underground electrical conditions as a prior requisite to enforcement of adequate electrical regulations; company mine safety inspectors seldom if ever are sufficiently well grounded in electricity to give competent advice as to safe underground practise in electricity and very seldom is a competent electrical man employed to make periodical underground inspections as to *safety* in electrical installations or safe use of electrical equipment; "white collared" electrical engineers frequently map out elaborate underground electrical systems but seldom if ever go underground to aid in correct or safe installations, or to "look things over" during operations to see that the system is operated as designed.

In view of the fact that much electricity is being used and will be used increasingly in coal mines, it appears that the electrical people (engineers, manufacturers, and others) owe it to themselves to take the lead in directing thought towards its *safe* use rather

than trailing along as obliging followers of mine officials whose knowledge of safety with electricity is frequently nil; unless intelligent direction is given towards safety in installation and use of electricity in the coal mines of the United States, there is very likely to be a series of disasters charged to electricity with consequent definite barricade placed against further extensions.

In view of the fact that almost any kind of electric arc may ignite either coal dust or explosive gas and start a disaster in almost any kind of coal mine, it would appear that all electrical appliances or equipment used in coal mines should, in so far as feasible, be arc proof; hence there should not be allowed to go into any coal mine any electric motor, switch, etc., of the non-permissible type. This appears drastic but in the final analysis, it is logical and in time will be the rule; hence electrical manufacturers should now be bending their efforts towards construction of nothing but permissible equipment or appliances for use in coal mines; and electrical salesmen should advocate the use of nothing but permissible equipment for all coal mines whether gaseous or so-called non-gaseous.

Electrical men (engineers, manufacturers, salesmen) should initiate and forward a movement looking to the establishment of sensible safe electrical standards not only of electrical materials, appliances, equipment, etc., but also of sane, safe practises and installations in mines in the use of these electrical materials and appliances. These standards should be specific rather than generalized as is so frequently found in attempted standards, generalizations usually meaning little or nothing and getting nobody anywhere at any time.

In view of the fact that alternating current now is used successfully for nearly every operation in or around coal mines with the one exception that it has not been adapted to haulage locomotives, it would appear that our electrical friends should "get busy" and produce a practicable a-c. locomotive and thereby eliminate the necessity for having both alternative and direct current in nearly all of our coal mines. Possibly the ultimate solution will be the use of storage batteries for all underground purposes including main haulage, thus eliminating practically all underground wiring which would be real progress since underground power wires are dangerous, expensive and decidedly undesirable. There is said to be at least one coal mine in the United States using storage batteries for practically all underground power operations and some interesting and extensive experimental work has been done by the Phelps Dodge Corporation of Dawson, New Mexico in the utilization of storage batteries for main haulage as well as for mining machines, pumps, etc.

There appears to be much lack of authentic information as to what kind of electrical current (alternating or direct) is the safer, voltage for voltage, amperage for amperage; also which is the more likely to ignite methane or coal dust in a mine. One English professor a few years ago published a paper stating that alternating current was the safer both as to contact accidents

and as to ignitions of gas or coal dust, and the writer has seen these statements denied yet has been unable to secure accurate definite information. It would appear that these matters should be cleared by publication of experimental evidence by electrical men.

In conclusion, it seems that our coal mines are almost certain to become much more thoroughly electrified than they now are, and that the electrical men owe it to themselves as well as to their customers in the coal business to take the lead in pointing out the advisability, in fact, the necessity, of practically complete electrification; on the other hand, the electrical men are morally obligated to make certain that the more intensive electrification of our coal mines will be accompanied by greater rather than less safety for the mines and the employees of the mines.

NEW TYPE SINGLE SLEEVE VALVE ENGINE

The first public announcement of what is considered an important advance in automotive engineering was made November 15 at the monthly meeting of the Metropolitan Section of the Society of Automotive Engineers. At this meeting was described a single sleeve valve engine which has been in course of development for nearly two years.

Such parts as the crankshaft, connecting rods, piston, and spark plugs are of the design used in the conventional poppet valve engine, but the cam shaft and valve gear are replaced by a single valve of tubular form in the new design. Ports are cut at the upper end of this sleeve and in the cylinder, the sleeve being moved up and down and partly turned at the same time so that exhaust and intake manifolds are properly connected to the cylinder.

Lubrication for the sleeve valve engine is made possible by the characteristic twisting movement of the sleeve valve which causes the oil to be rolled evenly over the entire sleeve surface.

Operating efficiency, good power output and silence in operation were given as the chief advantages of a single sleeve valve engine. A test was made on a six-cylinder engine of this type, run for 1000 hours at full load. At the end, the gears ran as quietly as at the start and on dismantling the engine the maximum wear on the piston skirt was only one-thousandth of an inch, while the wear on the outside diameter of the sleeve was undiscernible. The power output was gradually built up during the first 100 hours until it reached 44 b. h. p., after which it remained constant until the test was completed. Silence in operation is achieved by avoiding the hammer and anvil blows of the poppet valve, and it is partly due to the fact that the valve actuating mechanism does not extend outside of the engine body. About 50 lb. weight can be saved by substituting a single sleeve valve engine of average bore with an aluminum casing for a poppet valve engine with a conventional cast iron construction.

Controlling Insulation Difficulties in the Vicinity of Great Salt Lake

BY B. F. HOWARD¹

Member, A. I. E. E.

Synopsis.—The difficulties encountered in maintaining a sufficiently high degree of line insulation on long communication circuits in the vicinity of Great Salt Lake, Utah, are dealt with in this paper and a review of the study and solution of the problem of controlling the insulation is made.

Leading up to this is a description of observations on about 40 mi. of line over a part of the Great Salt Lake Desert known as the mud flats west of the Lake. The description

also covers observations on other lines north of the Lake.

The object of these studies was to ascertain the variations in the line insulation caused by different weather and temperature conditions in each of these routes. It was necessary also to determine which route would be better for constructing the central transcontinental communication circuits which were about to be built at that time for extending service to provide telephone connection between points on the Atlantic and Pacific coasts.

IN 1913, when it had been decided to construct a transcontinental telephone line in order to connect Atlantic and Pacific coast points, a warning was given by other wire-using companies of difficulties which would be encountered in the Great Salt Lake Desert, owing to very low insulation of the lines under certain weather conditions. These companies were in the communication business and possessed lines which passed through the section.

At certain times, they had experienced complete failure of telegraph lines in that vicinity, due to this low insulation, particularly when heavy fogs prevailed. It was very important to the success of the transcontinental telephone lines that the insulation should be controlled and prevented from falling below a certain minimum. This was particularly true because at that time the most practical way of giving very long distance service was by means of "loaded" circuits. This required high insulation at all times, for if it fell below a certain limit, the qualities of the line for conveying speech would be even worse than had it not been loaded at all.

For a long time these insulation conditions had existed on lines which had been strung over the mud flats west of Salt Lake. There was evidence that there were stretches of line on the route north of the Lake (one of the two routes under consideration) which showed insulation conditions similar to those on the lines situated upon the mud flats. These stretches on the northern route, however, could be avoided by building the lines around them, whereas, in the case of the southern route, it was impossible to avoid crossing the mud flats and salt beds.

It may be well to give here a description of the mud flats and salt beds which have been known for some time as the Great Salt Lake desert. This desert is comprised of an old lake bed probably many hundreds of feet deep consisting of a deep valley filled with mud. It

1. Electrical Engineer, The Mountain States Telephone and Telegraph Company, Denver, Colo.

Presented at the Pacific Coast Convention of the A. I. E. E., Salt Lake City, Utah, September, 6-9, 1926.

is known with certainty to be over 400 ft., for a chemical company put a drill down at a place where the surface is covered by a large bed of salt and passed through eight ft. of this, 200 ft. of mud, 30 ft. of solid salt, and another 200 ft. of mud. Drilling was stopped at this point, and it is not definitely known what is below.

The salt-bed surface is about eight mi. wide and 20 mi. long, and varies from a few inches to eight ft. in thickness. The mud flats, as they are called, are covered with a salty crust which, in the dry season, is capable of carrying the weight of a horse and has even carried a tractor; but when a hole is broken through this crust, it will rapidly fill with salt water. The mud becomes softer with the depth; where the surface was wet the author has pushed a broom handle down into the mud with ease. The melting snow and rains from the mountains run into these flats, and the surface water, which varies from one in. to several inches in depth, is blown for miles by the wind. Frequently an area that has been covered with water one day will be dry the next for miles, owing to the removal of the water by the wind to a distance of several miles during the night. To say the surface is dry is hardly correct, since except at that time of the year when a salty crust forms it is impossible to walk upon the surface without splashing the mud in all directions.

After storms, salt is sometimes found upon the windows of houses 15 mi. from the Lake in Salt Lake City, where salt-laden moisture has been deposited upon the glass. Telephone leads in the vicinity of Salt Lake City have had their insulation considerably lowered on account of salt and alkali dust being blown upon them.

The track of the Western Pacific Railroad and the lines of two telegraph companies and at the present time the transcontinental telephone lines all pass across this desert. It is understood that the railroad company when building their road laid a floor of planks on the mud and put a gravel bed upon this. In some places, it is necessary to protect this roadway from the action of the drifting water by filling it in with rock.

Investigations made showed that the salt is blown upon the insulators during storms and splashed by the

action of rain. This salt forms a crust on the surface, and when this takes place on the interior of the insulators, the insulation of the lines is materially reduced. During fogs which are very prevalent at certain seasons of the year this salt becomes wet and the insulation resistance falls rapidly to a very low value. At such times it has been observed to fall to values as low as 0.09 megohms per mi.

The effect of freezing is interesting. During the tests which were made for the purpose of investigating this subject, it was observed that at sunrise, after sufficient time has elapsed for the insulator coating to thaw, the insulation would drop materially; and then, as the warmth of the sun evaporated the moisture, the insulation would rise again. In one case when the insulation fell to 0.5 megohms per mi. between wires and ground the wind in one hour dried it so that the insulation returned to 4600 megohms per mi.

The southern route known as the Western Pacific Route appeared to be the better for these transcontinental telephone lines when all things were considered, provided the insulation difficulties could be overcome. It had several points of advantage over the northern route. For example:

1. It would shorten the mileage considerably.
2. Less cable would be introduced.
3. A considerably less amount of interference from foreign circuits would be felt.
4. In addition, by shortening the route, there would be less cost for construction and maintenance.

There were favorable climatic conditions on this route from a point of construction and maintenance, and also it was along a through-line of railway which was kept open at all times of the year. The Lincoln Highway, which was not built at that time, was under consideration and quite likely to be constructed by the side of the railroad tracks which passed over the mud flats. This highway has since been built as expected.

The experience of one of those who had given warning of the difficulties which had been encountered in maintaining satisfactory insulation of lines had extended over thirty to thirty-five years. It was therefore decided to make a series of tests in order to find out the cause and, if possible, the remedy for the falling insulation. It was known that this trouble was usually noticed during January, February, and March of each year and chiefly during the night hours. Consequently in January 1914 an investigation was launched on an experimental basis. The lines chosen for this were those already existing north of the Lake and others to be specially built over the mud flats west of the Lake. The test stations chosen were Kelton in the first case and Arinosa in the second.

The preliminary tests showed how very important it was to have all glass insulators well washed and cleaned before being put in place on the poles. If this were not done, differences of about fifty per cent were

observed between the insulations of one line and another which was of similar character.

The observations made were carried out during January, February, and March of 1914, and a series of observations was made and recorded every three hours throughout the twenty-four hours of each day. These comprised insulation tests between wires and between wires and ground, hygrometric, thermometric and barometric observations; and the dew points were calculated.

The charts, Figs. 1 and 2, show typical values of insulation resistance measured between wires and ground

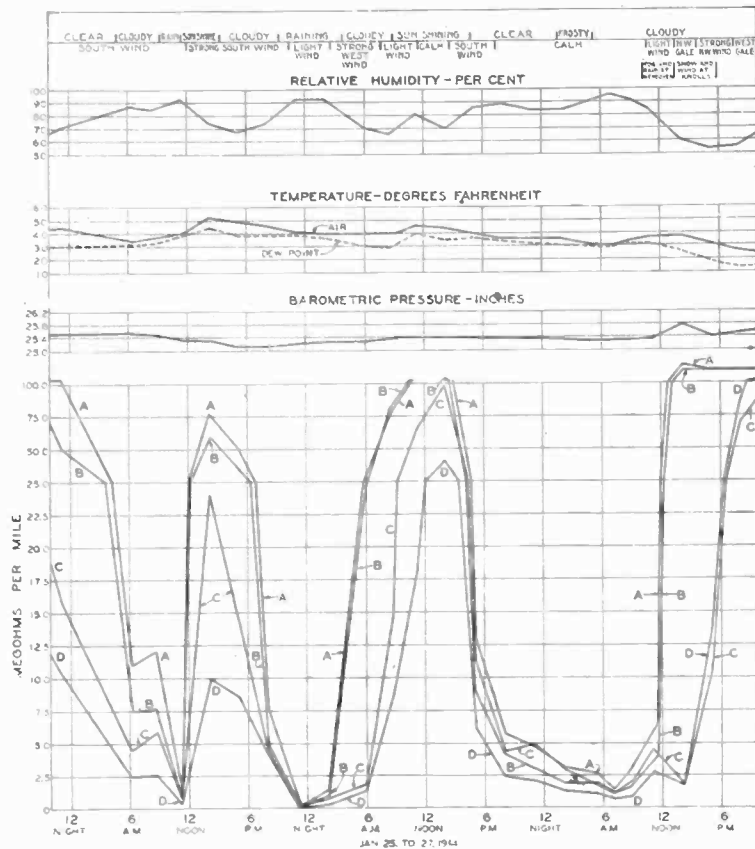

FIG. 1—CHART SHOWING LINE CONDITIONS. AVERAGE INSULATION OF WIRES TO GROUND. KNOLLS—ARINOSA—WENDOVER WIRES THAT HAD BEEN STRUNG UPON INSULATORS FOR SOME TIME AND THEREFORE EXPOSED TO WEATHER

- A—Copper circuits—Arinosa to Wendover
- B—Iron circuits—Arinosa to Wendover
- C—Copper circuits—Arinosa to Knolls
- D—Iron circuits—Arinosa to Knolls

upon various circuits under different conditions of temperature and weather. These show clearly the value of having the insulators clean. It was observed that iron-wire lines have a relatively lower insulation than those of copper under ordinary conditions. It is thought that this is due to metallic salts, such as chloride of zinc and iron, or oxides of the latter, being washed onto the arms and the outer surface of the insulators by rain and the action of dripping. The insides of the insulators probably receive these deposits by the action of rain splashing the salts when it strikes the arms around the insulators. These salts when deposited upon the surfaces of the insulators cause leakage which is very marked in damp and foggy

weather. As the inside surface of an insulator plays a very important part in its proper functioning, this seems to teach that these surfaces should be as clean as possible at the time of installation. Careless handling and lack of this precaution will often cause unequal leakage on the two sides of a circuit.

The result of this study brought out the following:

That the liability of the insulation of the lines to fall to a dangerously low value was about as great on the route north of the lake as on the southern route west

upon the insulators as it is exposed to storms which blow from the lake.

The transcontinental telephone pole line as constructed on the mud flats consists of 20-ft. by 7-in. Western Cedar poles with 176-ft. spans. The guying on this part of the line is done in all four directions every mile with side guying both ways half-way between. The line crosses the Salt Lake Desert between Clive and Wendover. At locations where the loading coils were placed on the poles, cross pieces were fitted to prevent the poles sinking in the mud owing to the extra weight they had to carry.

It may be interesting to note that it has not been found necessary to apply any preservative to the wooden poles which are set in the mud because of impregnation with salt in solution which preserves the wood to a remarkable extent.

The problem of washing the insulators was a somewhat serious one because, if it were necessary to take the insulators down, it would mean interruption to service and damage to the conductors by undoing and retying the tie wires, and this would be a long and expensive process. The author therefore devised a method by which the insulators could be successfully washed from time to time without climbing the poles or untying the wires. This method consists in spraying the insulators with saturated steam or finely divided hot-water spray. Of course the recognized aging action of steam on glass surfaces might make it undesirable to adopt generally such a method for cleaning insulators, but under the unusual conditions prevailing in this case the method described seemed justified.

The steam is applied through a nozzle at the end of a

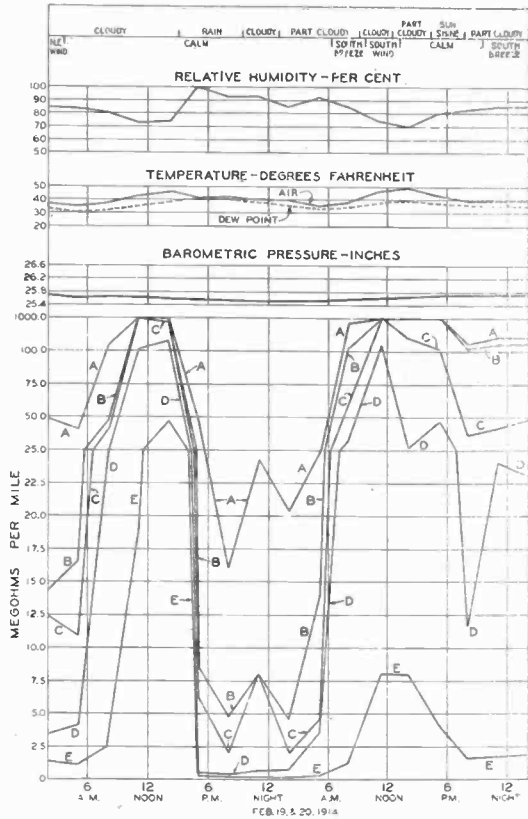

FIG. 2—CHART SHOWING LINE CONDITIONS—ARINOSA TO KNOLLS. AVERAGE INSULATION OF WIRES TO GROUND

- A—Experimental circuit—No. 8, B. W. G. Copper wires strung upon clean insulators
 - B—210-lb. copper wires
 - C—Iron wire, No. 118
 - E—Iron wires, No. 19 & No. 1
 - D—No. 8 B. W. G. Copper wire
- } Strung upon insulators that had been in place for some time

of the lake, and that the solution of the problem of preventing these reductions in insulation was to remove the salt from time to time by washing the insulators. It was therefore decided that this would have to be done in the case of either of the routes under consideration.

It was further decided that, all things being considered, the best engineering solution was to build the transcontinental telephone line which passes through Salt Lake City over a route south of Great Salt Lake. This route, after bending in a northwesterly direction, proceeds westward over the mud flats to the Nevada line and so on towards San Francisco. A portion of this line crosses eight mi. of solid salt and 34 mi. of mud flats, besides a stretch immediately south of the lake which is open to receiving a deposit of salt

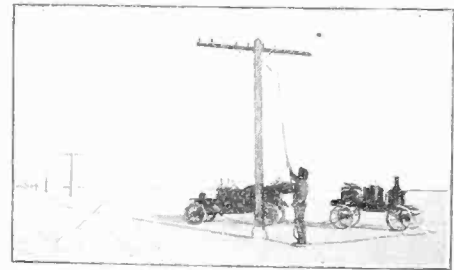

FIG. 3—WASHING INSULATORS WITH STEAM

fishing-rod device which is held under the insulator to be cleaned. The steam is generated in a portable boiler which is heated by an oil fire; see Fig. 3. The temperature is automatically governed so that the steam is kept at about 70- to 90-lb. pressure per sq. in. When an insulator is to be washed, after the nozzle has been placed in position, a valve is opened and the steam forces the water out of the boiler through a pipe leading to the nozzle, and it passes out in the form of a finely divided spray or wet steam. An automatic arrangement of pumps supplies water to the boiler to replace that which is used.

It is advisable to mention that in this location

economy in the use of water is important, as water is a large item in expense; therefore, the time necessary to wash an insulator has been carefully ascertained as 30 sec. All fresh water has to be carried out to the machine from a considerable distance. It is brought by the railroad, distributed at intervals along the line, and then rolled out in barrels across the mud flats.

During the time when an insulator is being washed, no appreciable disturbance has been noticed in the service taking place over the lines. The rapidity with which salt or alkali dust, both of which are of a stubborn nature, is removed by the steam is astonishing.

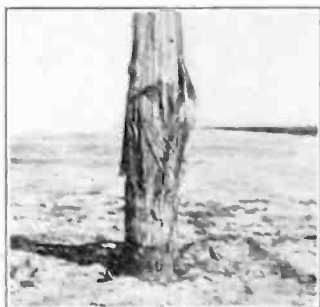

FIG. 4—POLE WITH SAP WOOD SPLIT BY ACTION OF SALT

To give an illustration, a broken glass insulator encrusted with salt to the thickness of half an inch was subjected to the spray and in less than a minute after the steam was applied, the glass was completely cleaned.

The steam washing plant is built with wide metal tires and is pulled sometimes by horses and at other times by a Ford car which is also equipped with wide tires. These are fitted on the usual type of demountable rims so that it is easy to change quickly to rubber tires when necessary. Many miles of the mud have been found so soft that it was necessary to lay planks in order to keep the car and the steam-generating plant from sinking. These planks were taken up after the machines had passed over them and relaid in front.

It has been found necessary to wash the insulators at least once every two years but the frequency, of course, is governed by conditions of salt deposit. When the insulation resistance is found to drop to a predetermined amount, it is time to arrange for a washing of the line. While this is in process, the improvement in the insulation of the wires may be observed as the washing proceeds.

The following example of some insulation measurements made in 1923 between a wire and ground shows the effect of washing the insulators.

INSULATION IN MEGOHMS PER MILE

January	March	June	August	October
11.37	32.3	101.6	68.2	637.0

When the insulation had fallen to so low a level in January, when dry, it was decided to wash the insulators

as soon as conditions on the mud flats would permit, since in wet weather it would go to about 0.5 megohms per mi. Accordingly they were washed after August. The table shows how the insulation rose from 68.2 megohms per mi. to 637.0 after the washing. Both of these months were comparatively dry months.

The cost of washing the insulators on the mud flats ranges between \$500 and \$700, according to prevailing conditions.

The accompanying illustration, Fig. 4, shows the action of the salt upon the poles above the ground line. This, at first sight, appears to be rather alarming but it has been observed that the rending action of the salt, which takes place as it crystallizes, affects the sapwood only. On poles which are formed by splitting trees into quarters, only the sapwood which exists on one of the three sides seems to be affected in this manner.

Once since the line was built a rather peculiar experience was recorded. This was at a time when rain had fallen in quantity and was upon the surface of the salt solution on the flats. This was followed by a heavy frost and ice formed in thick layers. The wind broke this into floes, which were forced against the poles and did considerable damage by abrasion. Fig. 5 shows a pole damaged in this way.

The telephone line was built at a distance of 1000 ft. from the railroad. The reason for this was because the engines burn oil as fuel, and a deposit from the products of combustion would form upon the insulators if the line were close to the railroad.

The difficulties of constructing this line can be realized from the description which has been given. Mud boats were used to convey material. The insulators were carefully washed close to the railroad and before



FIG. 5—POLE CUT BY ACTION OF ICE

they were carried out to be placed in position, each was placed in a paper bag in order to prevent it being splashed with mud while being carried out to the line over the mud flats.

Those in charge of maintenance of lines carrying electric energy, be it either for power or communication purposes, may well consider the advisability of cleaning the insulators from time to time in sections in which

they are exposed to receiving a deposit of such substances as tend to lower the insulating qualities of the lines.

After an experience extending over more than twelve years with these transcontinental lines, it is gratifying to find that that portion which passes over the mud flats of the Great Salt Lake Desert is perhaps

more free from disturbance due to weather conditions than any other part of this lead which connects the Atlantic and Pacific Coasts. If, however, the insulation of this portion were not kept at a high standard at all times by periodically washing off the accumulation of salts from the insulators, this would doubtless be the worst section from an insulation viewpoint.

Research Relations Between Colleges and Industry

BY A. A. POTTER¹

Non-Member

Synopsis.—The engineering colleges of the U. S. A. are expending about one million dollars per year for research of direct value to industry. The organized research departments or engineering experiment stations of many state supported engineering colleges are cooperating with industry in a variety of projects. In several institutions the amounts appropriated by the cooperating agencies are large, but the total funds expended for engineering research in colleges is less than one-thirtieth of the amount

spent by these institutions for undergraduate instruction.

While the results of cooperative research are directly of value to industry, the by-product of such research relations is a supply of scientifically trained research engineers.

Industry has a clear cut obligation to support engineering research at colleges in order to improve the quality of the college training, to advance basic knowledge in engineering and to increase the supply of trained personnel.

ABOUT forty American engineering colleges are now carrying on organized engineering research.

In about nine institutions the funds for this purpose come partly or entirely from state appropriations and these state grants for research have amounted to a total of about \$123,000 during the year 1924-25. During the same year about twenty institutions have set aside a total of approximately \$451,000 in their engineering college budgets for engineering research. During 1924-25 fifteen engineering colleges received through cooperative relations with industry over \$500,000 for research. Thus the total annual expenditure by the engineering colleges for research is about one million dollars, or, roughly speaking, one-thirtieth of the amount spent by these colleges for undergraduate instruction, not including interest on educational plants or depreciation.

The following summary is intended to show the variety of projects which are being carried on in cooperation with industry by engineering colleges which have organized Engineering Experiment Stations or Departments of Engineering Research:

1. The Cornell University Engineering Experiment Station has cooperated with industries for a number of years in research projects of considerable magnitude. No data are available as to details.

2. The Engineering Experiment Station of the University of Illinois has been cooperating with industry in the following projects:

1. Dean of the Schools of Engineering and Director of Engineering Experiment Station, Purdue University, Lafayette, Ind.

Presented at the A. I. E. E. Regional Meeting of District No. 5, Madison, Wis., May 6-7, 1926.

a. The Austin Manufacturing Company contributes \$1200 each year for a period of two years from February 1, 1925, to pay the stipend of two research graduate assistants in highway engineering. One assistant is making a study of the maintenance of earth roads; the other assistant is investigating the maintenance of gravel roads.

b. Investigation of the Fatigue Phenomena of Metals is carried on in cooperation with the Engineering Division of the National Research Council, the Engineering Foundation, the General Electric Company, the Allis-Chalmers Manufacturing Company, the Copper and Brass Association, and the Western Electric Company. This investigation has been in progress since November 1919, the amount appropriated each year approximating \$15,000.

c. An investigation of the Fatigue of Steel Castings has been carried on in cooperation with the American steel foundries since the spring of 1925. The amount contributed by the American steel foundries is \$2000.

d. In cooperation with the National Warm Air Heating and Ventilating Association, an investigation of warm air furnaces and heating systems has been carried on since October 1918. The activities of this investigation were expanded last year by the addition of the Warm Air Heating Residence valued at \$22,800. The annual expenses of the investigation average \$8000.

e. The Illinois Gas Association furnishes \$1200 each year for the maintenance of two research graduate assistants in Gas Engineering. These assistants have been maintained since 1916.

f. An investigation of plumbing is carried on in

cooperation with the Illinois Master Plumbers Association for which an appropriation of \$1800 is made annually. It has been in progress since April 1925.

g. The Department of Railway Engineering cooperates with the Illinois Central Railway in an investigation of railway signaling.

h. The University of Illinois Engineering Experiment Station is also cooperating with a committee which represents six state public utilities in studies of direct value to the utilities of the nation. Appropriation by cooperating agency is \$25,000 per year for two years.

i. It has also cooperated with the American Gas Association in a study of the steaming of horizontal gas retorts; with the Illinois Central Railroad in research on railway signal equipment, and with several railway companies in investigations of rail joints and special railway equipment. It is carrying on in cooperation with the American Railway Engineering Association studies of large steel rollers.

j. In May 1925, the University of Illinois Engineering Experiment Station has reported to the New York State and New Jersey Interstate Bridge and Tunnel Commissions on ventilation tests for use in the construction of the Hudson River Vehicular Tunnel. The amount appropriated for this work was between \$40,000 and \$50,000 and the investigation required about four years for its completion.

k. The University of Illinois Engineering Experiment Station is conducting a cooperative investigation with the United States Bureau of Public Roads to secure data on the factors affecting the design of drainage ditches and the improvement of natural channels to minimize the damage from floods. This investigation was started in 1925 and the U. S. Government furnishes one man on full time.

3. The Engineering Experiment Station of the Iowa State College has carried on investigations dealing with the following subjects:

a. *Culvert Pipe.* In cooperation with a joint committee of the American Concrete Institute, American Association of State Highway Officials, American Railway Engineering Association, American Society for Testing Materials, American Concrete Pipe Association, and American Society of Civil Engineers. For a number of years about \$6000 annually has been spent on this investigation.

b. *Strength of Clay Sewer Pipe incased in different thickness of concrete.* In cooperation with the Clay Products Association which is paying about \$550 for tests of 24-in. pipe.

c. *The Iowa State College Engineering Experiment Station has been investigating the strength and loading of highway culverts, tractive resistance and fuel consumption of motor vehicles on various types of highway surfaces, and highway bridge impact.* The U. S. Bureau of Public Roads has cooperated in these projects since April 1922 with the following expenditures: 1921-22—\$1,571; 1922-

23—\$8,216; 1923-24—\$10,797; 1924-25—\$21,462; 1925-26—\$7000.

4. The Engineering Experiment Station of the Kansas State Agricultural College has cooperated with industry in the following investigations:

a. *Tests of automatic ventilators.* (Value of ventilators donated about \$400).

b. *Tests of oil burners for house heating, in cooperation with manufacturers of burners.* (Value of equipment donated for tests about \$200).

c. *For about four years the Kansas State Agricultural College Engineering Experiment Station has been studying air resistance to movement of motor vehicles.* (Contribution by U. S. Bureau of Public Roads to date about \$15,000).

5. For a number of years the University of Kansas Engineering Experiment Station has cooperated also with industry in research. These include studies of Kansas coal (in cooperation with the coal producers) and several special projects which are supported by the Chambers of Commerce of the cities of Kansas.

6. The Technology Plan which was put into practise by the Massachusetts Institute of Technology in 1919 is a cooperative arrangement whereby industrial concerns seeking aid in scientific and engineering research may pay the Institute stated sums of money as retainer fees for a period of five years, in return for which they have at their disposal, with certain limitations, the research staff and facilities of M. I. T. The services supplied by M. I. T. in connection with this plan include:

a. *Personnel records of M. I. T. alumni available for the purpose of assisting contractors in locating desirable men.*

b. *The libraries of M. I. T. open to the representatives of contractors.*

c. *Arrangements made for representatives of contractors to consult with members of M. I. T. staff.*

d. *Advice given by M. I. T. to contractors for the solving of special problems or the carrying out of tests. (In such cases as call for work in M. I. T. laboratories by members of the staff, the contractor is expected to pay such sums as are mutually agreed between him and the staff. The overhead varies with the nature of the service but the average is about fifty per cent).*

The Division of Industrial Cooperation and Research which administers the Technology Plan, acts as a clearing house whereby the questions of the contractors may be discussed, planned for and attacked in a prompt and efficient manner.

Professor Charles L. Norton, the Director of the M. I. T. Division of Industrial Cooperation and Research, states that it is very difficult to make even a rough estimate of the amount of money which has been spent on industrial research at M. I. T. He believes, however, that this has been in excess of \$175,000 annually.

7. The Department of Engineering Research of the

University of Michigan reports an expenditure of over \$50,000 per year for cooperative engineering research. Among the major projects are included:

a. *Natural illumination.* (Study is in the third year).

b. *Single-phase and fractional horse power motors.* (Two years' work have been devoted to these projects).

c. *Natural ventilation.* (Project is in its third year).

d. *Cutting of metals.* (This study, in cooperation with Michigan Manufacturers, has been carried on for three years).

e. *Admiralty and Muntz metals.* (Investigation has continued for two years and involves the properties of these metals at high temperatures).

f. *Development of a machine for automatically testing bearings for noise.* (This has continued for over two years with results of great value to industry).

g. *Boiler feed water treatment.*

h. *Studies of charcoal iron.*

i. *Refrigerating media.*

8. The Minnesota Engineering Experiment Station reports the following cooperative projects with industries:

a. *Transmission of heat through building materials in cooperation with the Flaxlinum Insulating Company.* (Contribution by cooperating agency \$1750 per year for two years.)

b. *Investigation of rotary pumps for viscous oils in cooperation with the Northern Fire Apparatus Company.* (Appropriation by cooperating agency \$750 per year).

c. *Behavior of asphalt under temperature variation in cooperation with McLaughlin and Sons.* (Contribution \$500).

9. The University of Missouri Engineering Experiment Station is cooperating with industry in the following manner:

a. *The National Lime Association has furnished \$3000 during a period of eighteen months for a study of the effect of lime products on dirt roads.*

b. *The Southeastern Missouri Sunflower Growers Association has furnished material for studies of commercial uses of sunflower oils.*

c. *The Radium Company of Colorado, the U. S. Radium Corporation and the Keystone Metals Reproduction Company have cooperated in an investigation of processes for the extraction of radium from carnotite ores.*

10. The Ohio State University Engineering Experiment Station, beside the cooperative investigations with the ceramic industry (which it has practically created) is at present studying:

a. *The betterment and the gasification properties of Ohio coals in cooperation with the Southern Ohio Coal Association, Ohio Oil Gas Men's Association, American Gas Association and the Southern Ohio Pig Iron and Coal Association.* Contribution by cooperating agencies \$10,000 for two years.

11. The University of Cincinnati, Ohio, has been carrying on the following studies:

a. *Cooperation for about four years with the Tanner's Council of America in research of a fundamental character and of direct value to the leather manufacturers.*

b. *Lithographic research of a basic character, started March 1, 1925, in cooperation with the Lithographic Foundation.*

c. *In cooperation with the Civic Commercial Club and the Union Gas and Electric Company of Cincinnati, studying the sub-surface resources of Cincinnati, Ohio.*

12. The North Carolina Engineering Experiment Station reports tests of the strength of poles for the Carolina Light and Power Company. Public Utility is furnishing poles valued at about \$3500.

13. The Pennsylvania State College Engineering Experiment Station is studying the following problems:

a. *In cooperation with eight Pennsylvania manufacturers, it is attacking problems of cold storage.* (Appropriation \$800).

b. *In cooperation with the Pennsylvania Railroad an investigation is being made of refrigerator cars.*

c. *In cooperation with the U. S. Navy and with several private parties, a study of internal combustion engines is being carried on.* (Contributions in materials and apparatus to date are valued at about \$11,000).

d. *In cooperation with the American Society of Heating and Ventilating Engineers an investigation is being carried on dealing with heat transmission.* (Contribution \$500).

e. *The Pennsylvania State College Engineering Experiment Station is cooperating with the U. S. Bureau of Mines in investigations of explosiveness of flour mill and elevator dusts.*

14. The Engineering Experiment Station of Purdue University is studying:

a. *The causes and prevention of discoloration of Indiana limestone; in cooperation with the Indiana Limestone Quarrymen's Association* (Appropriation by cooperative agency \$4000 per year, plus materials valued at about \$500 per year). Project has continued for two years and appropriation was renewed for the third year, effective April 1, 1926.

b. *In cooperation with the Automotive Industry investigations of automobile carbureters, manifolds, spark plugs, pistons, piston rings and cylinders; also special problems of steering, detonation, supercharging, fuels, etc.* (Contribution by cooperating agencies equipment (mainly), fuel oils, and about \$3500 for special assistance.

c. *Standardization of Tractors in cooperation with tractor manufacturers and U. S. War Department.* Contribution by cooperating agency equipment (mainly), fuel, oil and \$1200 for special assistance.

d. *Study of insulators for high voltages (up to 600,000 volts) in cooperation with manufacturers of insulators.*

e. *Tests of brake shoes, pulleys, insulators, materials of construction and a variety of devices for industry.*

(Income from such commercial tests has varied from \$3000 to \$6000 per year for a number of years).

f. *Celite* as an insulating material in cooperation with the *Celite Products Company*. (Fellowship \$1000 per year for one year).

g. It is cooperating with the mining interests of Indiana in a study of the steaming qualities of Indiana coal and in connection with methods for the improvement of its quality.

h. Investigations in cooperation with the Indiana Sand and Gravel Association.

i. The Purdue University Engineering Experiment Station is cooperating with the American Railway Association in an investigation of power brakes and power-brake appliances. This study was undertaken on March 1, 1925. The amount expended by the cooperating agency from March 1, 1925 to April 1, 1926 has been in excess of \$100,000. This investigation will involve an additional expenditure of about half a million dollars before it is completed.

j. The Purdue Engineering Experiment Station is also cooperating with the railroads in studies of brake shoes, rail joints, and special railway equipment.

k. The American Railway Association has contracted to start a cooperative study of draft gears at Purdue University. The machine to be used in these studies will consist of a drop testing machine using a 27,000-lb weight.

l. It is cooperating with the telephone utilities in investigation of buried load cables and with electric light and power utilities in studies of high-voltage insulators, electric meters and in the emergency braking of electric cars.

m. The Purdue University Engineering Experiment Station in cooperation with the U. S. Bureau of Public Roads is studying the effect of moisture on the strength of concrete and on the warping of concrete road slabs, the effect of small amounts of reinforcing in preserving the surface of concrete against cracks, the fatigue of concrete, and a new test for surface hardness of concrete measured by the impression of a standard steel ball. These studies have continued for about four years, the U. S. Bureau of Public Roads furnishing two men on full time.

15. The University of Tennessee Engineering Experiment Station is cooperating with the following units:

a. The American Limestone Company, in an examination of a special grade of limestone as a basis for concrete. (Contribution by cooperating agency \$600).

b. The Southern Appalachian Coal Operators Association has contributed \$1500 toward a study of the properties of Kentucky and Tennessee coals.

16. The State College of Washington is cooperating with the State Automobile Association in the study of the relation of road surfaces to automobile tire wear.

17. The University of Washington has been cooperating with local industries in studies of centrifugal blowers, heat treatment of cement, intakes for high

velocity flumes, flow of water in concrete and vitrified clay sewer pipe, and coal washing problems.

\$160,000 has been provided to the University of Washington by outside sources during the past three years for investigations on the K-B propeller.

18. West Virginia University is cooperating with the Gasoline Recovery Corporation in a study of absorption materials for the recovery of gasoline.

19. The Engineering Experiment Station of the University of Wisconsin has the following projects in cooperation with industry:

a. The study of pipe bend losses in cooperation with the Vilter Manufacturing Company and Crane Company who have furnished pipe bends for this study.

b. The electrical standards laboratory renders services to the state somewhat analogous to the services rendered to the nation by the U. S. Bureau of Standards. An established schedule of fees is used for such services.

c. Studies in cooperation with Wisconsin industries of the friction of line shafting, welded joints, steel chain, fatigue of rock drills, riveted and bolted joints. (Appropriation by cooperating agencies \$2400 plus special equipment and specimens).

d. At a cost of \$1000 per year the Wisconsin Utilities Association has supported two fellowships in electrical engineering at the University of Wisconsin. Since 1917 the Gas Utilities has supported one fellowship by providing \$500 per year for this purpose. The Wisconsin River Light and Power Company has contributed \$500 for research.

Besides the above investigations under the organized Engineering Research Department the following are of interest:

1. The American Society of Mechanical Engineers is cooperating with Harvard University and the Massachusetts Institute of Technology in steam research and the extension of the steam tables. The total expenditures for this study to date is about \$43,000.

2. The National Research Council is (a) indirectly cooperating in connection with the highway investigations in several institutions, and (b) has assigned to the Engineering Experiment Station of the University of Illinois one of its Fellows to make an investigation of the surface tension of the elements. The stipend for this Fellow is \$2500 per year. It is also cooperating with Illinois in the investigation of fatigue of metals as mentioned in the earlier part of this paper.

3. The National Electric Light Association is cooperating in the studies of Rural Electrification with seventeen colleges. This cooperative project involves an expenditure of about \$250,000 per year, half of which is being contributed by the utilities.

4. The American Society of Civil Engineers is cooperating with the University of Illinois in investigating reinforced concrete arches contributing toward this about \$2000 per year.

5. Practically every engineering college is serving individual manufacturers by special tests and investi-

gations on their products. In some cases the results of such commercial tests are published for the benefit of the public, but in the majority of cases they belong exclusively to the manufacturer paying for the investigation.

6. Cooperation between state engineering colleges and state highway departments is quite general. In many states the state engineering colleges have furnished the testing laboratories for the newly created State highway departments. As the State highway departments grew it became desirable that routine tests of road materials be carried on in laboratories outside of the colleges. A number of colleges, however, are constantly assisting their state highway department by special investigations and by studies of road materials in their respective states. The character of the highway projects undertaken in different states shows the value of special state investigations to meet local conditions. Eighteen engineering colleges report very definite projects in cooperation with State highway departments.

7. Cooperation in research is also quite general between engineering colleges and the U. S. Bureau of Public Roads, the United States Bureau of Mines, State Bureaus of Mines, the U. S. and the State Geological Surveys, and with other technical departments of the Federal Government and of the State Governments.

8. The Guggenheim Fund of \$2,500,000 for Aeronautics has been announced recently. It is hoped that the trustees of this fund will make a considerable portion of this available for research at engineering colleges

The above summary indicates that the engineering colleges are competent to undertake research projects which vary greatly in scope. While the results of such cooperative investigations are directly of value to industry the by-product of such research relations between the engineering colleges and industry is a supply of scientifically trained research men. Engineering colleges which have good facilities for research attract men of superior mentality desiring to pursue graduate study as a preparation for a research career. Industries and utilities can benefit themselves and stimulate graduate instruction in engineering by sending back to the engineering colleges for advanced study and research, certain of their selected employees.

The industries and utilities have a clear cut obligation to provide the engineering colleges with special equipment and funds for the solution of new problems through research in order to be certain that the engineers of the future have intellectual curiosity and ability to extend the frontiers of engineering knowledge. More liberal support for engineering research at colleges will improve the quality of the engineering college graduate, will advance basic knowledge in engineering and will increase a supply of trained personnel for the research laboratories of industry.

HYDROELECTRIC PROJECTS OF MAJOR IMPORTANCE

In its visualization of a policy of water development, the department has indicated seven great projects of major importance: (1) Mississippi system; (2) Columbia River system; (3) Colorado River; (4) Great Lakes system; (5) the Great Valley of California; (6) intra-coastal waterways; (7) other important developments, including the Rio Grande and Hudson Rivers.

Each system must be considered as a whole and organized to the maximum results. We need immediate determination of the broad objective and best development of every river, stream, and lake in our country in order that we do not undertake or permit haphazard development, whether public or private, that will destroy the possibilities of the maximum future returns.

Progress of science and engineering, inventions in construction methods, improvements in water craft, discoveries in transmission of electricity have brought us to the threshold of a new era in utilization of our water resources. We are able to undertake great projects with confidence of successful accomplishment.

During the year, the department has vigorously advocated a policy of water development. Actual inspections have been made on the Great Lakes system, Mississippi River system, Columbia Basin, and in the Great Valley of California. In various addresses, the Secretary of Commerce has directed public attention to the fundamental benefits of the development and indicated its immediate national importance.

The St. Lawrence Commission of the United States, under the chairmanship of Secretary Hoover, has been engaged in consideration of the improvement of the St. Lawrence River from Lake Ontario to Montreal, providing not only canalization for deep-sea navigation to the Lakes but the development of large quantities of electrical power. A joint board of American and Canadian engineers has been actively at work on the engineering aspects and will report later this year. The Department of Commerce has conducted a searching economic study of the effects and benefits of the project for consideration of the commission.

A concurrent study of an alternative route from the Great Lakes across New York State also is in progress. With economic and engineering studies of both routes in hand, sound conclusions can be reached and final recommendations prepared for the consideration of the country.

During the year, at the request of Secretary Hoover, negotiations with Canada were undertaken resulting in the appointment of a joint commission to consider methods for the preservation of the scenic beauty of Niagara Falls. Concentration of water in a V-shaped notch in the Canadian Falls is breaking down the escarpment at a serious rate.—(From the Annual Report of the Secretary of the Dept. of Commerce.)

General Power Application

Annual Report of Committee on General Power Application*

A. M. MacCUTCHEON, Chairman

To the Board of Directors:

Continuing the policy of last year the committee organized its work along the following lines:

1. To secure and present papers covering general power applications not previously on record before the Institute.

2. To study the field of general power application with a view to indicating such parts of the field as are not now adequately served and to point the way toward future developments.

3. To summarize in the Annual Report the progress in General Power Applications during the past year.

4. To present a bibliography which may be referred to by those who desire more complete and detailed information.

The program of the Regional Convention at Cleveland was largely prepared under the direction of this committee. The subject of Sectionalized Electric Drive as applied to paper machines was presented in a series of three papers. Electric refrigeration from the standpoint of the refrigerator manufacturer and the Central Station was discussed in two papers.

The committee has requested the assignment of a session at the 1927 Midwinter Convention and has already arranged for a paper on a-c. elevator motors and a paper on sectionalized group drive applied to the manufacture of steel wool. It is suggested that continued attention in future years be given to this subject of sectionalized group drive where the different motors on the group or train must be synchronized in speed. In the discussion of the committee report it is hoped that other subjects will be suggested, indicating those fields of application in which the members of the Institute will be most interested.

This year the committee can do no more than initiate a consideration of such of the industrial fields as are not now adequately served. Information of this nature must largely come from the user. It is considered that a very real service will be rendered to industry by recording such needs in the proceedings of the Institute. As examples, the manufacturers of refrigerating machines feel that there is a real need for developing a motor for household refrigerators which

shall have adequate starting torque and yet be considerably less expensive. This is not a simple problem but deserves the most careful consideration. There is opportunity for rendering a real service to industry in developing a control system for synchronizing the various motors of a group or train drive, which shall have many of the advantages of, and be less expensive than, the extremely accurate control systems developed for paper mill applications. Several suggestions have been received that the Central Stations increase the possibilities of small polyphase motor applications, where such motors might be less expensive, more reliable, and of better operating characteristics than single-phase motors.

It is requested that all members of the Institute record with the General Power Committee the unsatisfied needs of the electrical industry as such needs come to their attention.

The following have been suggested as suitable subjects for papers. Discussion is invited.

"Power Factor Correction" by the Use of Condensers.

"Texrope" Drive for Short Belt Centers.

Induction Motor Control under Starting Conditions by the Use of Resistance Starters.

Double Squirrel-Cage Rotor Induction Motors.

A-C. Elevator Drive.

Experience with Antifriction Bearings Applied to Electric Motors.

Electric Welding of Long Pipe Lines in the Field.

Isolated Small Power Plants for Standby Purposes to Insure Continuity of Service.

Co-operation between Power and Telephone Companies in Eliminating Problems of Inductive Interference.

A summary of the progress in general power applications can never be complete. This report records only those applications which have come to the attention of the committee. The thanks of the committee is extended to Allis-Chalmers Mfg. Co., American Brown Boveri Elec. Corp., D. H. Braymer Equipment Co., Can. Gen. Elec. Co., Century Elec. Co., Condit Elec. Mfg. Co., Elec. World Pub. Co., Fairbanks, Morse & Co., General Electric Co., Goodyear Tire & Rubber Co., Haughton Elevator & Machine Co., Howell Elec. Motors Co., Lincoln Elec. Co., National Elec. Condenser Co., Ohio Bell Telephone Co., Pittsburgh Elec. Furnace Corp., Reliance Electric & Engineering Co., Ridgway Dynamo & Engine Co., Westinghouse Elec. & Mfg. Co., who have rendered most valuable aid in the preparation of the report.

*Committee on General Power Applications:

A. M. MacCutcheon, Chairman

P. H. Adams,

H. D. James,

H. W. Rogers,

D. H. Braymer,

P. C. Jones,

H. L. Smith,

H. E. Bussey,

J. C. Kositzky,

W. H. Timbie,

R. F. Chamberlain,

A. C. Lanier,

W. K. Vanderpoel,

C. W. Drake,

W. S. Maddocks,

A. E. Waller,

E. W. Henderson,

N. L. Mortensen,

W. C. Yates.

Presented at the Annual Convention of the A. I. E. E., at White Sulphur Springs, W. Va., June 21-25, 1926.

LUMBER AND WOOD WORKING MACHINERY

Electric Dogs. The application of electric motor drive to the dogging devices and set works of reversing saw carriages is not only a distinctive forward step from a safety standpoint, but also it makes possible numerous operating economies not obtainable with any form of manual or mechanical operation. For electric dogging and tapering devices, high torque motors can be furnished for either a-c. or d-c. operation, although the former is most generally used. The motors have been thoroughly tried out in this service and proved themselves admirably adapted to the work. Due to the reversing motion of the carriage and operation in other than the horizontal position, the motor bearings are of the waste-packed sleeve type. Each dogging and tapering device is equipped with three motors of the same size and all are interchangeable, which greatly reduces the stock of wearing parts needed.

The control for electric dogs is constructed to withstand the heavy shocks and jars of logs slammed on the carriage by the nigger. The contactors for controlling all motions on the carriage may be housed in a steel cabinet, to protect them against damage and prevent the entrance of dust, and the push button stations mounted on the most convenient locations.

Electric Set Works. Although electrically-driven set works have been available for several years, the motors used on this equipment were formerly belted to the mechanism and ran continuously. For this scheme, a clutch was necessary to apply the motive power for setting or receding the carriage knees.

Present practise favors the use of a direct-connected motor which requires less space, eliminates the friction clutch, and operates only during the setting or receding operation. An electrically-operated brake is used in connection with the direct-connected squirrel-cage motor, which acts as a recoil mechanism and makes it unnecessary to use a recoil pawl. The action of the brake is entirely automatic. When the motor is not running, the brake is set but as soon as power is applied to the motor the brake releases.

The control for the direct-connected motor may be either push-button or drum-controller operated, and consists of magnetic reversing contactors designed particularly to function reliably in the rapid operation of the log carriage.

Band Mill Drive. A 9-ft. band mill has been built with the lower wheel shaft direct connected to a 300 h. p. motor through a flexible coupling. This is the first large band mill ever built with a direct-connected motor drive.

RUBBER MILLS

The synchronous motor has made greater strides in general application in 1925 than probably during any other one year, and in no industry is this more true than that of the rubber industry.

Equipment is now being built for several automatic

across-the-line starters with dynamic brake for synchronous motors driving rubber mill lines. These starters are unique in that three-pole, double-throw, oil-immersed, 2200-volt contactors will be used to throw the motors across the line when the contactor is in the upper position. The lower or dynamic braking contacts of the contactor are closed by gravity assisted by spring action. This is the first installation in which a double-throw contactor will be used for both dynamic braking and across-the-line starting.

A synchronous motor has been used to drive a rubber-hog, a machine used to cut up old tires, scrap rubber, etc. We believe this is the first time a synchronous motor has been used on this machine.

BAKERIES

For dough mixer drive up to and including 50 h. p., two-speed, squirrel-cage motors have certain desirable characteristics. When starting, the motors are thrown across the line using the slow-speed connection and automatically transferred to the high-speed connection. This reduces the starting current below that of a single-speed motor, and also makes available two running speeds. Magnetic across-the-line starters are used with the proper automatic sequence obtained so that the motors will always start on the low connection.

PETROLEUM INDUSTRY

Two-speed, wound-rotor induction motors of 20-50 h. p. and 25-65 h. p. capacity with suitable controllers have been developed to meet increased requirements of pumping service. Similarly, to meet the demand of shallow light pumping wells particularly in foreign fields, a 10-25 h. p. two-speed motor and complete controller has been developed. There are gaseous oil fields where protected-type electrical equipment must be employed in drilling service, and in some instances protected motors and controllers are desired on pumping wells. This condition, together with the fact that any two pumping motors may be used to form a twin-motor, cable-tool drilling equipment, has resulted in developing enclosing parts for the slip rings of the entire line of pumping motors.

On the protected equipment, the motor slip rings are enclosed in a steel housing on the end of the shaft. The housing is designed to meet the specifications of the Bureau of Mines for explosion-proof apparatus. No parts of the motor subject to sparking are left exposed.

The controllers for the protected pumping motors have been made with all arcing contacts oil immersed. This includes the drum cam contactor-type controller, pole-changing switch, and circuit breaker, which are the only parts presenting a fire hazard due to sparking.

IRRIGATION

Hollow-shaft, squirrel-cage induction motors are at present being extensively used for driving turbine or centrifugal type pumps used in the irrigation fields

along the Pacific Coast. The pumps are of small diameter so that they can be lowered in the well casing and submerged in the water. As the water level lowers the pump is lowered and the shaft is extended to meet the new conditions.

The motor consists essentially of a standard vertical squirrel-cage motor with a hollow shaft, the inside bore being sufficiently large to accommodate, with clearance the extension of the pump shaft. The motor drives this shaft at the upper end by means of a coupling. The pump half of the coupling is threaded to the pump shaft so that the proper adjustment and alignment of the pump impeller at the other end of the shaft can be made conveniently. The upper ball bearing is sufficiently large to handle the thrust weight due to the motor rotor and the pump impeller and shaft, while the lower ball bearing of the motor acts as a guide bearing for the motor rotor. A cover or hood, which is easily removable for adjusting purposes, encloses the coupling and shaft end and also protects the motor from dripping water without interfering with the ventilation.

The principal demand for these motors is in sizes from five h. p. to 50 h. p. of four and six poles with a tendency to go to higher speeds, that is, two poles and larger horse powers. These motors are so designed that they may be started directly on the line.

CHEMICAL AND ELECTRO-CHEMICAL

In this field one large installation consists of a large, geared, turbine-driven, d-c. electrolytic unit, rated at 2800 kw., 136½ volts. This unit, the largest of its kind, is representative of the most efficient type of electrolytic power unit obtainable, where the power plant and electrolytic-cell room are adjacent.

One copper mining company has purchased 11,500 kw. in synchronous motor-generator sets to supply d-c. power for obtaining copper electrolytically from the leached ore.

A new type of drive for centrifugal extractors in chemical and other industries involved the use of a direct-coupled squirrel-cage motor to secure high starting torque with low power consumption and good performance at full speed. This motor has a high resistance section in the rotor winding built in the form of a fan and located at the top of the motor. The heated air developed is thus expelled without passing through the motor proper. Adjustments in acceleration and speed are obtained by use of double busses, one high-voltage and one low-voltage, the accelerating being done on the high-voltage bus, the motor running on the low-voltage bus.

ELECTRIC FURNACES

A 15-ton, electric arc furnace requiring 5000 kv-a. electrical equipment has been applied for melting cold scrap, and another 25-ton electric arc furnace requiring 5000 kv-a. electrical equipment, for refining steel.

A 25-ton furnace for duplexing special steels from open hearths for ingot production is of interest. A large industrial plant has installed two 15-ton furnaces for duplexing blast furnace iron direct. In another plant, open hearth to electric furnace duplexing is being carried on with a 1½-ton electric furnace with most satisfactory results, although this size is somewhat smaller than is usually employed.

Continuous melting and the introduction of permanent molding machines has created a necessity for a continuous supply of hot metal. Batch operation is usually unsuitable for these improved molding methods.

A large percentage of recent electric furnaces put into operation have been installed for high-quality, close-grained, strong, electric-furnace, gray irons.

Of particular interest is a recent double electric furnace installation on the duplexing of malleable iron from cupolas on a continuous process. While this installation is unusual on account of the large tonnage handled, the results already obtained indicate that they will have a marked effect on malleable practice generally.

Since its invention, about a decade ago, the high-frequency induction furnace has been exploited on a basis of operation at approximately 12,000 cycles, this frequency being obtained by means of mercury-arc oscillators. In the last year the use of 500-cycle generators in melting copper, brass, nickel-silver, and similar metals has been quite successful. Sets of 2000 cycles also have been supplied.

Arc furnaces, originally supplied with single-voltage equipments, were superseded by two-voltage ones and during the past year three-voltage furnaces were under construction. These latter use the high voltage for breaking down the scrap, an intermediate voltage for completing the melting, and the customary refining potential of approximately 90 volts.

ELEVATORS

The first full-automatic floor-landing elevator equipment for high-speed passenger service was produced and is now in operation. This equipment automatically brings the car to the floor after the operator has initiated the stop by moving the car switch to the "off" position. This constitutes an important improvement over previous elevator operation in that the car stops at the floor, but does not stop before reaching the floor and then creep to it, nor does it overrun the floor and then creep back.

TUNNEL VENTILATION

While motor application to ventilation problems is not new there is one outstanding instance of such to be found in the furnishing of 90 motors, totaling 6000 h. p., to drive the fans which will ventilate the Holland tunnel, a vehicular passageway under the Hudson River connecting New York and Jersey City. The tunnel has a capacity of 2000 vehicles per hour in each direction, is approximately 8500 feet long and is the largest

tunnel of this type in the world. The motors are standard wound-rotor induction motors and will be installed late in 1926.

CEMENT MILLS, CRUSHERS, ETC.

There is a tendency toward the application of slow-speed, direct-connected motors to grinding mills. Two 900-h. p., 180- rev. per min. clutch-type synchronous motors have been sold to operate 7-ft. by 40-ft. compartment tube mills. These will be among the largest motors for tube-mill drive ever manufactured.

The application of clutch-type synchronous motors has made rapid progress, particularly in the case of grinding and crushing machinery in the cement and copper industries, but installations in flour mills, on pumps, and on other applications have also been made. This motor has been developed for use in applications where the well-known advantages of the synchronous motor are desired and where high starting torque with low starting current is essential. The motor is a combination of a synchronous motor of standard type and a magnetic clutch arrangement to form a compact self-contained unit. The motor rotor can be revolved independently of the load and after synchronous speed is reached the load can be started by exciting the clutch.

Controllers have been developed for this motor ranging from manual control of both motor and clutch to automatic motor starting and automatic clutch engagement. All forms of controllers have both the clutch and motor control built together as a unit.

While the motors above are of the clutch type there have also been applied motors of the same rating (900 h. p. at 180 rev. per min.) of the induction synchronous type for direct connection to compeb mills without the use of a clutch.

High-speed, gyratory crushers driven by vertical direct connected induction motors have been placed on the market by a large manufacturer.

AGRICULTURE

Applications of electricity to agriculture greatly increased during the year. Much attention has been given to this branch both on the continent and in America. Some of these applications include electrical plows, electrical treatment of ensilage, fodder, etc., and general farm and dairy machinery.

ARC WELDING

The past year has seen an interesting development in the field of arc welding. While for some years past there have been occasional applications of arc welding in the building industry, the past year has shown several striking applications which no doubt will lead to its adoption, eliminating riveting in many instances. Tests that have been conducted show conclusively that an arc-welded joint made in the fabrication of structural steel is both stronger and cheaper than a riveted joint of the same class of construction. Besides being cheaper and stronger, the elimination of the nerve-

racking din of the pneumatic hammer alone will make this process welcome to the inhabitants of the larger cities where building operations are most active.

The introduction of a new and improved automatic arc-welding head for production work is another of the notable advances in the field of arc welding. This head is much simpler than anything yet produced and promises to be a decided advance in this class of work.

The construction and application of automatic welding machines for the commercial production of tanks, range boilers, etc., was continued and a variety of mechanisms adapted to particular classes of work were constructed.

INDUSTRIAL HEATING PROGRESS

Industrial electric heating made marked advancement in 1925, both in increased connected load and in new developments. It is estimated that throughout the country more than 200,000 kw. was added to central station lines not including arc welding.

The use of electric heat is increasing rapidly in such processes as japanning, core baking, drying, heat treating and annealing metals, glass annealing, melting steel, brass, and the soft metals. The application of small units to process machines is increasing the rate of production in many lines and the use of small devices such as glue pots, soldering irons, and immersion units is becoming standard practise.

New developments were carried on in cloth singeing, sheet-metal, tinning, heating mine drills, and in baking bread and other food products.

PAPER MILLS

A new rotary-contact regulator for sectional paper-machine drive has been applied to both fourdrinier and cylinder-paper machines and is operating successfully. This regulator is fully described in a paper presented by Mr. S. A. Staeger before the Cleveland Section of the A. I. E. E. during the March 1926 meeting. During the coming year a number of paper machines under control of this rotary-contact regulator will be put into operation. These machines make a variety of papers at maximum speeds varying from 450 to 1400 ft. per min.

A specially-developed d-c. drive for paper cutters has been applied with a resulting appreciable increase in production and uniform quality of product. The motor has a speed range of three or four to one by field control, and the control is designed so as to permit uniform acceleration to a predetermined speed and uniform retardation to the full field speed of the motor. The operation is obtained entirely from the push-button station, and permits the operator to slow down immediately when necessary to remove poor sheets. Also the cutter can be driven at the maximum speed suitable to the product.

An automatic control equipment designed to govern the synchronous motor driving two magazine pulp grinders has been developed. This control, in case of

failure of the power supply to either of the feed motors, continues to function and holds approximately half load on the other stone. It also maintains automatic control on one stone when the other is not in use, and permits of the use of the feed mechanism as a hoist, raising and lowering the magazine when it is necessary to change stones.

In Canada, synchronous motors have been applied with success for direct connection to screens and vacuum pumps of the Nash type. In the past, these have been driven by chain or belt, but, on account of the low-speed, direct-connected induction motors, have not been satisfactory. Higher efficiencies and smaller floor space are the principal advantages.

PRINTING

The standard drive for printing presses is a two-motor arrangement consisting of a large driving motor and a small motor for threading the paper through the rolls at a very low speed. In a certain installation, a special drive was provided which involved the use of one wound-rotor motor for each press instead of the customary two. The necessary speed variation was secured by means of two synchronous motor-generator sets for supplying current to the driving motors, the generators being of low and high frequency. Full automatic control was provided, and by pressing the proper push button any of the driving motors could be made to run at a threading speed of 1/15 to 1/20 of the normal speed.

LAUNDRY MACHINERY

An improved control for reversing washing machines in laundries has been developed. The control consists of a drum driven by the machine which is to be reversed. The machine makes a given number of revolutions in one direction, bringing the drum to the point where the connections are changed and the motor reversed. A special motor is used, and the combined design is such that the motor is brought to rest gently and started again in the opposite direction without shock to the machinery, thus combining the advantages of electric control with the cushioned effect of the belt-driven machine.

STEEL MILLS

A 2500-h. p., 257-rev. per min., synchronous motor has been applied for tube-mill drive. This is apparently the first installation of synchronous motors for this work.

A marked tendency has been evidenced to get back to the use of d-c. motors where variable-speed drive is required.

As regards main-roll drives, the year was one of unprecedented activity in the application of electric motors. One large manufacturer supplied a continuous capacity of 133,000 h. p. in motors for this service.

An unusual equipment was required by the Youngstown Sheet & Tube Company. Instead of driving the

several stands of a Morgan Mill from one common line shaft, the stands are combined in several groups, each group driven by a separate adjustable-speed motor. Both a-c. and d-c. adjustable drives are used. The roughing train will be driven by a 3600-h. p., adjustable-speed Kraemer Drive, and the intermediate train by a 7500-h. p. similar drive, while the last three stands will each be driven by a 2000-h. p., d-c. motor. The equipment is unique in that the machines can be re-grouped in many combinations, providing high efficiencies even on the lighter loads.

The first application of a decidedly large synchronous motor to main-roll drive is being made by the McKinney Steel Company, where a 9000-h. p., unity-power-factor, 107-rev. per min., 6600-volt, 25-cycle unit is used. The motor will drive a 10-stand, Morgan, continuous sheet bar mill. In addition to being the first large synchronous unit so applied, this motor has a higher continuous rating than any other motor so far applied to industrial purposes in this country and possibly abroad. The complete operation of starting and throwing on the line is entirely automatic and under control of a master switch.

A new and interesting application in the steel industry is the use of individual roll drive on run-out tables, etc. The motors themselves are of a small capacity and of the squirrel-cage induction type, but the installations are interesting in that speed variations of as high as three to one are required in some cases while two to one is very common. The speed variation is accomplished by supplying variable frequency to the motors, this being obtained from a motor-generator set, the motor of which is usually of the adjustable-speed, d-c. type. The alternator voltage follows the frequency changes and the roll motors have the characteristic of constant torque.

RAILWAYS

The Ward Leonard system of control was applied for the first time to the operation of a lift and turnover dumper for railroad coal cars. This dumper can handle a 120-ton car and the cradle hoist requires two 450-h. p., d-c. motors supplied with power by two synchronous motor-generator sets. The Barney haul for bringing the car up to the cradle also uses two 450-h. p. motors with similar control. The dumping is entirely automatic.

A number of five-h. p. motors were applied in the operation of car retarders, a service heretofore secured pneumatically. The function of these retarders is to stop railroad cars at the proper place in a classification yard and the retarding action is secured by wedging the car wheels between two sections of rail which are actuated by the five-h. p. motors. Through remote control the car dispatcher has the entire government of the cars.

The application of oil engines in combination with generators and motors for the propulsion of electrically-

driven motor cars has advanced considerably in the past year. New installations have been made by the Canadian National Railway and by the New York Central.

Gas-electric busses, while not new, made large gains in the number of applications.

Mining. A new application of the so called super-synchronous motor is to be found in installations for driving mine ventilating fans. The characteristics of these fans are such that the driving motor must be able to start and bring the fan up to speed under full load.

Tap-Changing Transformers. Considerable publicity has been given to the use of tap-changing transformers arranged for changing ratio under load. This type of transformer has found a special field for electric furnace work and is being manufactured by several companies.

Synchronized Group Drive. Reference is made under Paper Mills to the continued improvement in the highly specialized and accurate systems of control used in paper mill drives.

In the use of the much simpler and less expensive but likewise less accurate "dancer roll" control, experience has shown that it is much easier to keep the various motors in step during the period of acceleration by the use of the Ward Leonard System. As in the paper mill drive, the speed change of the group as a whole is accomplished by changing the line voltage, leaving only the correction in speed of the individual motors to be accomplished by field change.

Several applications of train drive have been made to continuous strip mills where the speed-torque characteristics of the various motors have been so related as to permit the elimination of all corrective rheostatic action. The various motors are held in step by the strip of steel being rolled under tension.

Probably the most novel application of train drive during 1925-26 was in connection with the manufacture of steel wool. Ten motors are kept in synchronism by a novel type of dancer roll which permits the maintenance of an adjustable but uniform tension on the wire which is being cut. This application will be described in detail in a paper to be presented next winter by Crosby Field.

Anti-Friction Bearings. The use of antifriction bearings on motors has increased rapidly. While ball-bearing motors have been supplied for years there is a continued improvement in the method of mounting and provision for disassembly. Standard lines of general purpose motors are now available with roller bearings. While possibly this subject does not come within the scope of this committee, it is referred to as being of unusual interest to the user. The steel mill electrical men have been particularly active in investigating the advantages and disadvantages of this type of bearing.

CONTROL

A time-element magnetic control has been used for d-c. motors. Definite time intervals between the closing of successive accelerating contactors is secured by relays which have a lag in their operation due to the self inductance of a short-circuited coil.

Mine-hoist control in the past has been provided with current-limit acceleration relays. Definite time-accelerating relays have lately been employed with success.

Considerable progress has been made in the development and application of magnetic switches for throwing induction motors directly on the line. Special switches have been designed for dust-tight service in cement mills, etc.

A reversing master switch intended for use with magnetic switch starters and providing undervoltage protection in both forward and reverse directions has been applied for shipper-rod control of machine tools.

Temperature type overload relays have superseded older forms and are now developed for circuits of 2000 amperes.

Manually operated contactors have been applied replacing knife switches on motor circuits. These will safely interrupt ten times their continuous rated current and may be used on either a-c. or d-c. systems.

An electrically-operated pressure governor used in connection with a pressure-regulator control has been applied where water is either not available or not suitable for operating the hydraulic type of regulator.

One manufacturer reports the development of a new type of speed-regulating controller. With this equipment it is possible to maintain a substantially constant low speed on a slip-ring motor independent of load variations. The speed is maintained constant by means of an oil pump geared to the motor. The pressure developed by the pump varies with the speed and this change in pressure causes secondary contactors to open and close, thus regulating the speed. The same device provides automatic acceleration of the motor. It also disconnects the motor from the line at zero speed after it has been reversed to obtain a quick stop.

Inductive time-limit controllers have been applied not only to all types of mill auxiliaries, but also to bucket cranes.

Development was completed on a new type of space heater. In the new design, the resistor is imbedded in an insulating material of the refractory type, which produces a sturdy unit and one which can be overloaded with less danger of burnout.

There has been placed in operation a new type of liquid slip regulator. In this design, the electrodes are stationary and the liquid level is varied by forcing low-pressure air into and out of a displacement chamber. The regulator is remote-operated, a master switch controlling the primary contactors, the air compressor, and solenoid-operated valve which admits air to the

displacement chamber. A second valve provides slip regulation by bleeding air from the displacement chamber. In this way the liquid level is lowered on heavy loads and rises again as the load decreases.

A new line of a-c. controllers has been put on the market utilizing a new type of thermal overload relay. This relay consists of a pair of heaters enclosed in molded insulating material. An overload causes the melting of a special alloy and allows a contact mechanism to open the control circuit. The alloy hardens after the overload is removed and the contact mechanism can then be reset manually. The relay is provided with adjustment for varying the tripping point.

The application of Dean motor-operated valve units has been extended. A smaller unit has been brought out which has found its principal application in oil refineries. An explosion-proof station for this service has also been designed.

Some novel applications of magnetic clutches have been reported. A number of these clutches have been used to drive elevators, feeding gravity conveyors. If material backs up in the gravity conveyor, the circuit to the clutch is opened, thus stopping the elevator and preventing the feeding of additional material into the jammed conveyor.

Marine. Electrical propulsion of naval craft received a decided impetus in the launching of the airplane carriers U. S. S. *Saratoga* and *Lexington*. These are the largest naval craft afloat and each will carry propelling equipment of approximately 180,000 s. h. p.

The application of electrical drive to operate unloading machinery as cited in the case of the "*T. W. Robinson*," a 13,000-ton Great Lakes Steamship, which itself is equipped with turbine electric drive, was a new departure.

In the past, numerous ferry boats have been provided with electric propulsion through fore and aft propellers. In 1925, for the first time, Diesel-electric drive was applied to the operation of a side-wheel ferry boat.

The city of Houston placed the first order for a Diesel electrically-driven and equipped fire boat.

The greatest advance in the marine field is probably the large increase in electrically-driven auxiliaries.

The first successfully operated electric platform hoists were installed on the S. S. *George Washington* and *Robert E. Lee*

FOREIGN DEVELOPMENTS

The economical viewpoint involved in motor application when considered in connection with low speed driven machines has resulted in the development of a specially designed built-in, oil-immersed, high precision reduction gear, located in the end shield of the motor so as to form a unit. This application has been made to three-phase induction motors ranging from $\frac{1}{3}$ to five h. p. and to three-phase and single-phase commutator motors from 5 to 15 h. p. A notable application has been to ring spinning frames in textile mills.

A-c. motors with built-in centrifugal starting device have found an increasingly wide application, being used to cover horse powers from $2\frac{1}{2}$ to 250. The unusually difficult problems encountered in starting and accelerating sugar centrifugals have been successfully met by the use of this type of starting device on vertical motors.

The further development of three-phase and single-phase commutator motors with series characteristics has received a great deal of attention. Likewise extensive research work has been carried on in the development of 25-cycle, high-powered commutator motors with suitable controls for traction service.

MISCELLANEOUS

The a-c. brush shifting motor was applied for the first time to the operation of punch presses, draw presses, and shears. These machines are ordinarily driven by a high-resistance type of squirrel-cage motor but the ability to adjust speed to the work in hand is very desirable.

The sale of "Texrope" drives increased tremendously. This is not particularly an electrical development but is of interest in the application of motor drive where the motor is placed close up to the work.

An interesting application is that of small induction motors operating on frequencies of 300 to 400 cycles and at speeds of 18,000 to 25,000 rev. per min. to grinding and polishing machinery. Even higher speeds are anticipated.

Synchronous motors of the vertical-shaft type have been applied for driving plate-glass grinders.

Refrigerating motors have been further developed by several companies. There is a real need of a satisfactory low-priced motor for this service, comparable if possible to automobile-starting motors.

Application of power apparatus for household purposes goes on apace. A new phonograph motor has recently been developed and is in use by some of the larger companies.

An improved type of mooring tower erected at the Ford Airport, Dearborn, Mich., afforded a new application for electrically-driven elevator and mooring mechanism.

Bibliography

AGRICULTURE

- Elec. Wld.*, Jan. 31, 1925, p. 235. Power on the Farm.
E. T. Z., Mar. 19, 1925, v. 46, pp. 405-7. Electric plows in Germany.
Elektro Jour., Feb. 25, 1925, v. 5, pp. 68-72. Rotary plows.
C. R. E. A. Bul., Mar. 20, 1925, v. 1, pp. 1-11. Elec. applications to agriculture in California.
C. R. E. A. Bul., Mar. 20, 1925, v. 1, pp. 11-12. Electricity in curing of ensilage in silos.
Revue Gén. de l'Elec., Mar. 28, 1925, v. 17, pp. 490-504. French apparatus for production and utilization of electricity for farm processes.
Mfrs. Rec., Apr. 23, 1925, v. 87, pp. 79-82. Experimental work of Alabama Power Co. re Agriculture applications.
N. E. L. A. Bul., Sept. 1925, v. 12, pp. 554-568. What 17 organized States have accomplished in rural electrification.

Ind. Elec., Sept. 25, 1925, v. 34, pp. 422-26. New uses of Elec. Engineering in Agriculture.

Elec. South, Dec. 1925, v. 5, pp. 39-40, 84. Electrifying the Rice Farming Industry.

BAKERIES

Elec. Wld., June 13, 1925, v. 85, p. 1271. Advantage of Elec. in Bakeries.

BEARINGS

Ind. Engr., Mar. 1925, p. 127. Changes in Sleeve, Ball and Roller Bearings.

Ind. Engr., Jan. 1925, p. 12. Do Ball and Roller Bearings Justify Their Cost When Used on General Purpose Motors.

CONTROL

Elec. Wld., Mar. 14, 1925, p. 551. Automatic Control for Auxiliaries.

Elec. Wld., May 9, 1925, p. 978. Complete Automatic Control of Pumps in Water Works Plant.

Elec. Wld., Jan. 2, 1926, p. 65. Summary of Development in Control Equipment.

Elec. Wld., Jan. 23, 1925, p. 301. Motor Control for Valves.

Elec. Wld., Mar. 28, 1925, p. 655. Automatically Controlled Asbestos Still.

Power, May 12, 1925, p. 722. Operation of High Speed Traction Elevator Control.

Power, May 19, 1925, p. 782. Automatic Control for Forced Draft Fans at Wabash River Station.

Power, Sept. 22, 1925, p. 438. Three-Speed Traction-Elevator Direct-Current Controller.

Power, Jan. 26, 1926, p. 134. Tendencies in Electric Motor Control Installations.

DOMESTIC

Elec. Wld., June 6, 1925, v. 85, pp. 1219-1222. Development of Domestic Refrigerator.

Refrig. Eng., June 1925, v. 11, pp. 416-17, 432. Household Refrigeration and Research.

ELEVATORS

Elec. Wld., June 25, 1925, p. 159. High Speed Elevator Developments.

Power, Jan. 13, 1925, p. 54. Operation of Electric Elevator Machines.

MEDICAL SCIENCE

A. I. E. E. JOUR., Aug. 1925, v. 44, pp. 829-832. Vibration Recorder for Pathological Analyses.

MISCELLANEOUS

Elec. Wld., Dec. 19, 1925, p. 1253. Electrical Installation in Brick Yard.

Power, Apr. 28, 1925, p. 648. Application of Static Condensers to Power Factor Correction.

Power, Dec. 1, 1925, p. 836. Electric Motors and Their Applications.

Power, June 2, 1925, p. 864. New Type of Synchronous Motor for Driving Reciprocating Compressors.

Power, June 14, 1925, p. 47. Synchronous Motors used for Voltage and Power Factor Regulation.

Power, Aug. 11, 1925, p. 204. Operation of Synchronous Motors for Power-Factor Correction.

Am. Mach., v. 61, pp. 215 and 261. Elec. Equipment for Machine Tools.

Am. Mach., v. 62, p. 163. Motor Drives in Auto Shops.

Am. Mach., v. 62, p. 492. Motorized Motor Shop on Pacific Coast.

Am. Mach., v. 62, pp. 242, 318, 428, 541, 612, 741, 696, 776, 1001, 1004. Modern Methods of Mounting Motors.

Am. Mach., v. 62, p. 780. Machine Tools with Built-in Electrical Equipment.

Zeit. Tech. Physik., No. 2, 1925, v. 6, pp. 74-76. Derivation of Gold from Mercury by Action of Elec. Discharges.

Factory, July 1925, v. 35, pp. 106, 108, 110. Motor Mechanism for Operating Long Rows of Window Sash in Factory Buildings.

Engng. News, Rec. Aug. 27, 1925, v. 95, pp. 346-48. Electrically Operated Gauges Devised for Filters.

Elec. Rev., Sept. 1925, v. 97, pp. 490-91. Defrosting Frozen Meat with Electricity.

Blast. Fur. & St. Pl., Oct. 1925, v. 13, pp. 414-15. Electrolytic Scale Preventions.

MOTOR DRIVES

Ind. Engr., Apr. 1925, p. 166. Short Center Belt Drives.

Ind. Engr., May 1925, p. 214. Silent Chain Drive.

Ind. Engr., June 1925, p. 265. Belt Capacity Affected by Service Conditions.

Ind. Engr., July 1925, p. 310. Power Survey of a Motor Load.

PAPER MILLS

Ind. Engr., Nov. 1925, p. 510. Paper Mill Drives and Motor Control Layouts.

Elec. Wld., Apr. 4, 1925, p. 705. Dual Frequency Super-Calender Drive.

Elec. Wld., Dec. 5, 1925, p. 1143. Elec. Drive in a Modern Paper Mill.

PETROLEUM

Jour. Elec., May 15, 1925, v. 54, pp. 359-60. Utilization of Elec. in Salt Creek Oil Fields.

Elec. Wld., May 30, 1925, v. 85, pp. 1119-1122. Elec. Power in Oklahoma Oil Fields.

Elec. Wld., Aug. 22, 1925, v. 86, pp. 374-75. Economies of Pumping Oil Electrically.

SHIPS

Met. Vick. Gaz., Aug. 1925, v. 5, pp. 33-44. Application of Elec. on Board Ship.

STEEL MILLS

Ind. Engr., Sept. 1925, p. 407. Problems of Steel Mill Operation Involving Motor Drive.

Ind. Engr., Sept. 1925, p. 423. Maintenance of Large Motors in Steel Mills.

TEXTILE

Elec. Wld., Aug. 22, 1925, p. 365. Power Factor Correction in Hosiery Mill.

LIGHT SKETCHES HUGE FACES ON MOUNTAIN

Sketching out 60-ft. heads of Washington, Lincoln, Jefferson and Roosevelt on the bald rock face of Rushmore Mountain in the Black Hills of South Dakota is one of the huge tasks which Gutson Borglum, noted sculptor of memorials, is carrying out with electric light preliminary to the actual carving. Lantern slides projected at night against the mountain by powerful light were used for this work when Borglum laid out and partly executed the famous memorial of the South on Stone Mountain near Atlanta. The faces are drawn on the slides and thrown on the rock surface in the exact size of the finished work. Painters in slings hung against the sheer rock surface of the mountain drew the outlines indicated by the light so that on the following days the work of stone cutting could proceed.

Electricity in Mine Work

Annual Report of Committee on Applications to Mining Work*

F. L. STONE, Chairman

The Committee on Applications to Mining Work has done very little constructive work during the past year. From the nature of things, the Committee can only watch the development of the use of electric power in mines. This use is becoming more general every year and electric motors are supplanting every other kind of motive power. This is due, of course, to their higher efficiency and flexibility of control, combined with the fact that they are just as reliable, if properly designed for mine use, as any of the other forms of drive. I think that no mine operator who is contemplating the opening of a new mine would consider any other method of drive.

In coal mines there always exists the hazard of explosion from gas, and in the bituminous mines from both gas and coal dust. These explosions have destroyed hundreds of lives and ruined millions of dollars' worth of property. The operators consequently are making strenuous efforts to eliminate the initial cause of such explosions.

A small percentage of these explosions has been traceable to the electric arc. After such an explosion has occurred, all traces of its initial cause are usually obliterated. Consequently many explosions have been attributed, for the want of a better explanation, to electric arcs, without any real justification.

The hazard, however, does exist and it is entirely wrong for electrical engineers to attempt in any way to dodge the issue. It is unquestionably unsafe to operate open motors at the face of any mine that may become gaseous with little or no warning.

This condition, which is fully recognized by mining engineers, is putting a new problem to the electrical engineers. They must design apparatus which, to say the least, will be safer than that in use at the present time. The apparatus must be such that when its free space is filled with explosive gas or coal dust in suspension and this mixture ignites, sufficient heat will not be transmitted to the outside of the motor to cause the ignition of explosive mixtures surrounding the motor. The connections to the apparatus must be such that they cannot be tampered with or opened while power is on the motor, thereby drawing an arc. It is not the purpose of this report to outline in detail the many problems that are now up to the electrical engineer to produce apparatus which will be safe, even in gaseous atmospheres.

The United States Bureau of Mines has rendered very valuable assistance to the manufacturers in describing in detail what constitutes safe apparatus, and will issue to manufacturers what is known as approval plates, which means that this particular piece of apparatus for which the plate is issued has been tested by them and has been found to be safe for use in explosive atmospheres in so far as they can ascertain. Quite a long list of such apparatus has been approved by the Bureau of Mines already and this list is increasing continually. The Chairman of this Committee believes that it will not be many years before state legislation decrees that all electrical apparatus used at the face of any coal mine must be similar to that which is now known as "approved apparatus."

Due to the great number of producing bituminous mines, the bituminous industry finds itself in a very precarious position. As a whole, the potential capacity of the industry to produce is very greatly in excess of the demand. Consequently, the price of the product is extremely low, and it would seem as though only the most efficiently operated mines can exist. This condition has led mining engineers to reconsider and intensively study their mining conditions with a view to reducing costs. The result of this study is that several new methods of mining have been evolved all of which require electric motors in some form or other. We have several successful mechanical loading devices where the coal is loaded mechanically into the cars after being shot. We have other schemes where the coal is drawn to the entry in large scraper buckets and there loaded directly in cars. There are also innumerable conveyor schemes which carry the coal from the face to the mine car, the conveyors being more or less portable and so arranged that they can follow the face as it recedes.

The electrical equipment for these entirely new devices does not present any very serious problem beyond the proper selection of motors to meet the conditions indicated.

In the effort to reduce further the costs at the mines, we find more and more fully automatic substations being installed for supplying direct current and also fully automatic pumping stations. We find the electrical engineers of the coal mines watching their peak demands and installing meters much more freely than in the past.

The electrification of power shovels continues at an ever increasing rate, the general scheme being the use of Ward Leonard controlled generators, using a motor and generator on each of the motions.

The metal mines have been fairly active this year, and electrification of these mines has proceeded along standard and well-defined lines.

*Committee on Applications to Mining Work:

F. L. Stone, Chairman, General Electric Co., Schenectady, N. Y.		
W. C. Adams,	G. M. Kennedy,	Charles H. Matthews,
M. C. Benedict,	R. L. Kingsland,	D. C. McKeehan,
Graham Bright,	A. B. Kiser,	W. F. Schwedes,
H. W. Eales,	Carl Lee,	W. A. Thomas,
L. C. Hsley,	John A. Malady,	C. D. Woodward.

Presented at the Annual Convention of the A. I. E. E.,
While Sulphur Springs, W. Va., June 21-25, 1926.

Discussion at Niagara Falls

MEASUREMENT OF TRANSIENTS BY THE LICHTENBERG FIGURES¹

(McEachron)

NIAGARA FALLS, N. Y., MAY 27, 1926

SALT LAKE CITY, UTAH, SEPTEMBER 7, 1926

(DISCUSSION AT NIAGARA FALLS)

J. H. Cox: I am glad to note that the Lichtenberg figures are receiving attention, from the engineering standpoint, by others. All of this work will hasten a more thorough understanding of the phenomenon.

I may state that the klydonograph, the surge recorder which utilizes this principle, was placed in use not with the contention that we knew all there was to be known about the phenomenon, but rather that we knew enough about it to be sure that valuable and sufficiently reliable information could be obtained by its use and that any information so widely desired as that on transmission-line surges should not be withheld until all of the less important points were determined. Of course, the sooner these points are learned the better.

Although from the standpoint of a surge recorder the data obtained by Mr. McEachron at the extremes of wave front are of no practical value, they are interesting in view of the figures in the practical range.

In general, Mr. McEachron's results agree quite well with our own. I am surprised that he obtained such large positive figures with slowly applied potentials. Our tests show that the more sloping wave fronts produce smaller figures. This effect was noticeable to a slight degree at 60 cycles, true to a greater extent with the negative figures but also evident with the positive figures whether half-cycles or the full wave was taken.

Dr. P. O. Pedersen, who has probably done more work than any other investigator on this subject, states the following: "The figures appear only if the potential difference across the Lichtenberg gap is altered in an impulsive or sudden manner, and not if the potential is raised gradually." This observation was made by Reis and Mikola: "At a certain stage of the charging of the electrode the intensity of the field between it and the plate reaches a value at which ionization by collision commences. The ionization current charges the surface of the insulating plate and thus keeps the intensity of the electric field between the electrode and plate below the high value necessary to form the Lichtenberg figure. With a rapidly varying potential there is, however, a possibility of obtaining sufficiently strong fields because it takes some time to establish the compensating charge on the insulating plate."

In our work at East Pittsburgh we were able to obtain some figures but they were smaller than the impulse figures. We found that there were variations due to conditions of the emulsion and it is possible that Dr. Pedersen's emulsion was so conductive that his failure to obtain figures with slowly applied potentials was due to conduction current rather than ionization currents.

The nature of the formation of the figure is still unknown, but we all agree that it is caused by the state of stress in the gas adjacent to the emulsion.

In the klydonograph, when a potential is impressed on the electrode there is an electrostatic field set up between it and the metal plate. The gradient is of course more intense near the electrode and, proceeding away from the electrode, a point is reached where the gradient is not sufficient to form the figure, and hence the boundary of the figure. If the emulsion surface were conducting there would then be a charge distributed over the surface of the plate and the stress would be entirely in the dielectric. Since there would be no stress in the gas there would be no figure.

It is evident that with emulsions such as we get, which are only slightly conducting, there is no time for this charge to creep out from the electrode under impulsive conditions, but the slower the application the more creepage is possible and hence a smaller figure.

Surface conductivity increases with moisture content and we have found that under humid conditions 60-cycle figures are smaller than under dry conditions. As far as we have been able to determine, there is not time enough for this effect under any application rapid enough to be important in surge conditions on transmission systems.

Mr. McEachron's positive figures agree with ours, and as he states, their appearance is only an approximate measure of the rate of application. I am unable to understand the difference between his negative figures and ours. Our abrupt-front negatives were very clean-cut with straight rays. The five-microsecond negatives were clean-cut, but clover-leaved. It was only in the longer wave fronts that they had the fuzzy appearance.

We have found in practise that the negative figures are much less satisfactory to deal with than the positive, and agree that they vary more with frequency.

Fortunately, the large majority of surges found in practise are positive. I see no reason for this in the case of switching surges, but it is nevertheless true.

In the case of an oscillation the negative is evident and can be measured, although smaller than the positive, except in the case of a sustained oscillation, when we are not interested in it because it would have no higher voltage than the positive.

It seems rather remarkable that the distinct breaks shown in Mr. McEachron's curves for negative figures come at the same point of wave front for all voltages. There seems to be no explanation why there should be such an abrupt break in a phenomenon of this sort. Is it not possible that this was caused by the change in the type of circuit used when going from the long to the short wave fronts?

As to accuracy, I cannot help but feel that a great part of the variation in the figures is due to applied voltage. My reason for believing this is that when a potential was impressed on six terminals in parallel usually no measurable difference could be detected in the figures. We found, as Mr. McEachron did, that an occasional freak figure would appear. This would be perhaps 50 per cent smaller than it should be, never larger. However, such a picture would occur in less than one per cent of the tests and therefore does not throw a great amount of doubt on conditions found from tests over any appreciable length of time.

I would like to ask what degree of accuracy is possible with the cathode ray oscillograph. I noticed in some of Mr. Lee's work that the width of the zero line of an oscillogram was sometimes 20 per cent of the maximum deflection. I would also like to ask whether or not successive oscillograms taken with the same circuit with the same settings were identical in all respects.

It is desirable, of course, to know the accuracy of any instrument we use and therefore any work done to determine this is valuable. However, extreme accuracy in a surge recorder is not necessary. I believe it will be agreed that the operating engineer is interested only in the order of magnitude of the surge voltages on his line. Any instrument which will give this within 25 per cent is sufficiently accurate for practical purposes. I am confident that the accuracy of the klydonograph is well within that margin—within the frequencies present in actual lines. These frequencies range from one microsecond to a few hundred microseconds. I do not believe that we need worry about wave fronts steeper than one microsecond. Our tests have strengthened this belief.

1. A. I. E. E. JOURNAL, October, 1926, p. 934.

(DISCUSSION AT SALT LAKE CITY)

Joseph Sleptan: The klydonograph is the only practical graphic surge recorder available at present, and its growing use is bringing us a wealth of information about abnormal voltages occurring on lines in practise. The proper interpretation of the figures obtained, therefore, is of highest importance, and Mr. McEachron is to be commended for his painstaking study of the relation between the figures and the surges which produce them.

As Mr. McEachron says, in spite of the interest which has been aroused by these figures, no adequate theory of them has yet been developed. However, there are a few facts which have been well established and which may be used in interpreting such data as Mr. McEachron presents.

First, we can be sure that the figures are produced by the high electrostatic stress in the air immediately adjacent to the film. Undoubtedly, the primary cause of the figures is some sort of electric discharge in the air. We know this because if a gas other than air is used or if the air pressure is changed, the figures are changed very radically both in appearance and size.

Second, we know that the figures are formed with extreme rapidity, in less than 10^{-2} seconds. In fact, the figures have been used to measure times as short as 10^{-11} seconds.

Now if the figures are produced by stress in the gas next to the photographic film, and in such very short times, it seems to follow inevitably that the figure size must accurately depend upon the peak stress in the gas, irrespective of the shape of the surge producing this stress up to the fastest surges with which we would be interested in practise. If, however, the figure size does vary under different circumstances with constant peak surge voltage in the line, it must be only because the peak stress in the gas does not bear a constant ratio to the peak voltage in the line. Such a variation in the ratio of stress in gas to line voltage is only to be expected if the electrostatic system in the neighborhood of the electrode on the plate is considered. It is evident that the electrostatic field at the electrode end will be determined not only by the voltage on the electrode but also by the dielectric properties of the glass, and by the surface electrical conductivity of the film. Evidently for extremely low frequencies, the surface conductivity of the film will play a significant part, and will operate to reduce the stress in the gas. Hence for these lower frequencies, from perhaps a thousand cycles downwards, the figures will come out too small. This agrees with Mr. McEachron's findings. For higher frequencies, however, the influence of this surface leakage should be negligible.

If there is any systematic variation in size of figure with frequency for higher frequency then this is to be attributed to the dielectric properties of glass under single impulses.

I do not believe that Mr. McEachron has proved that there is a systematic change in figure size with frequency for the higher frequencies, even for negative figures, for which Mr. McEachron shows the greatest per cent variation.

Examining Mr. McEachron's Fig. 6, and considering only those points to the right of, say, his 10-volt per microsecond line, we see that it is extremely hazardous to draw any kind of straight line through the points. The upward tendency of the lines which Mr. McEachron has drawn is largely due to his including low-frequency points on the lines. However, I believe it is erroneous to assume that the undoubted upward tendency of the points at low frequencies exists also at the high frequencies. If, as is likely, this effect is due to surface leakage, it will disappear at the higher frequencies. I suspect that we have here an erroneous extrapolation of the effect of surface leakage.

All that we may conclude from Mr. McEachron's points at the right of his Fig. 6 is that he obtained considerable variation in the figure size. I have plotted these points of Mr. McEachron on a sort of shot-gun diagram, and find that for a given figure size, the extremes of voltage differ by 33 per cent from their average. This, then, would be maximum error for practically occurring

surges if the arrangement of Mr. McEachron were used in a klydonograph.

It is interesting to compare this result with the results obtained by Westinghouse engineers. Mr. Peters, in his early work with photographic plates, found that the figures produced simultaneously by a single surge, on a single plate, never differed in size among themselves by more than five per cent. When the figures were produced on different plates, differences as much as 15 per cent were found occasionally. When figures were produced by successive discharges from the same condenser circuit, Mr. Peters also found variations which he was led to attribute to variation in the surge voltage.

The character of the discharge in a short-impulse circuit is affected greatly by the state of the initiating spark-gap, and Mr. Peters believed that variations in the surge voltage due to the varying state of the initiating spark-gap caused apparent variations in figure size.

On this account, therefore, I would like to ask Mr. McEachron whether an oscillogram was taken for each point shown in Fig. 6, and if not, whether some of the variability was not due to the discharges not repeating accurately.

I would like to ask Mr. McEachron about the nature of his voltage-dividing system for the Dufour oscillograph, which is indicated as being a resistance potentiometer in Fig. 3, and particularly whether, for the very steep wave fronts, the capacity to space of these resistors might not cause the oscillogram to fail to portray the voltage on the Lichtenberg-figure electrode. Also, I would like to know whether these resistors contributed to the damping out of oscillations at the oscillograph, and if so, whether these oscillations might not still be present at the Lichtenberg-figure electrode.

Herman Halperin: It appears to me that Mr. McEachron deserves great credit for his exhaustive calibration of the Lichtenberg figures. These figures, as recorded on the commercial device known as the klydonograph, have been used in investigating transient voltages on several large systems during the past few years. There has been considerable discussion as to the frequency of surges on transmission systems, and the nearest that we could come to the nature of the surges up to this time was to use the klydonograph figures and estimate whether the surge was "fast" or "slow." Now from the data given in Figs. 5 and 6, it appears that a much more definite idea can be obtained of the steepness of the surges that occur on commercial transmission systems.

The figures obtained in the experience of the Commonwealth Edison Company on its 12-kv., 60-cycle, underground cable system showed that the surges were of the upper range of Type II. Its experience also indicated that most of the surges recorded were positive in nature. The probable reason for this is that when a negative surge occurred, the length of the figure was so small that it was covered by the line made on the klydonograph plate by the positive alternations of the normal 60-cycle supply. As shown by Mr. McEachron's paper, the positive figures are several times as large as the negative figures for a given voltage. This meant that a negative surge would have to be several times normal voltage in order to be found. The experience of the members of the various companies represented on the A. E. I. C. Subcommittee on Transients on Underground Cable Systems showed that the highest three per cent of the transient voltages on underground systems were 3.0 to 4.7 times normal operating voltage. It appears from the paper that the negative surges of even three times normal operating voltage would be covered by the figures caused by normal operating voltage of the positive polarity.

P. B. Garrett: It was my privilege to take a small part in the practical tests which were made on the system of the Southern California Edison Co. with the klydonograph. My primary interest in the Lichtenberg figures, therefore, lies in the practical knowledge which has resulted from their use.

From the studies made by Westinghouse engineers, it was felt that the klydonograph was sufficiently accurate, within the range of surge frequencies encountered in practise, to make it an entirely feasible and practical instrument for system studies. We felt it to be accurate within 25 per cent and it is particularly gratifying to find that Mr. McEachron's very thorough investigation bears this out. I believe that Figs. 6 and 7 in Mr. McEachron's paper indicate very clearly that the figures produced within the practical range of frequencies are well within the 25 per cent error just mentioned. In fact, these figures show in some cases an accuracy within approximately 10 per cent in the negative figures and considerably less in the positive figures. In this connection, it seems a happy circumstance that by far the greater number of the figures encountered in our practical tests were positive in nature. We know of no very good reason why this should be true, but it nevertheless is the case. The negative figures being so much less satisfactory to deal with in every way than the positive figures makes us very grateful for the positive figures we find in such large majority in practise.

K. B. McEachron: In conducting this investigation every care was taken to insure reliable results, many of the figures at the different wave fronts being checked several times.

The films used were not subjected, for this particular study, to any conditioning process either to increase or decrease the moisture content, as this would introduce a condition different from that usually found in practise.

The reference made by Mr. Cox to the lack of clearness of the negative figures compared with those obtained in the tests he made, can probably be best explained by stating that the increased clearness of figures seems to be due to the presence of oscillations on the wave front. The statement in the paper about this point is to be found in the last paragraph before the conclusions.

The experience of myself and those associated with me is that it is extremely unlikely that any impulse circuit producing impulses having fronts of the order of one microsecond will not be free from oscillation unless some proper oscillographic device is used to guide one in improving the circuit.

It seems likely that the reason why the switching surge is usually positive is because in a damped oscillation the negative, although occurring first, is obscured in many cases by the larger positive figures even though the positive lobe may have a much smaller amplitude than the negative.

The abrupt change in the negative figures with slow waves mentioned by Mr. Cox has not been accounted for as yet. With such slow waves, it seems doubtful that any circuit changes could have any effect when the voltage and time relations are known in every case. The circuit can only have an effect when it modifies the wave front.

Concerning the accuracy of the cathode ray oscillograph there is much to be said, but I am satisfied that for the results given in this paper the voltage is within five per cent and the time within one per cent of the correct values. The width of the trace on the photographic film is not troublesome as shown by the oscillograms given in the paper, the traces being as good as with the ordinary oscillograph, and frequently much finer and sharper lines are obtained.

It is true that successive impulses from the same circuit differ frequently, but since oscillograms were taken of every voltage application the changes in voltage and time relations could always be properly evaluated.

Dr. Slepian's discussion of the stress conditions in the air is interesting and agrees with our own analysis. I do not agree, however, that it is proper to consider only data beyond a certain arbitrary point such as the 10-volts per microsecond point in Fig. 6 without having experimental evidence to establish the existence of such a point. It is recognized that when dealing with Lichtenberg figures a curve or line drawn represents averages only, and that the true calibration is not a line but a band whose

width is such that practically all the points fall within its boundary.

Dr. Slepian raises the same question as that asked by Mr. Cox as to the possibility of variation in succeeding impulses. The answer is the same, *i. e.*, an oscillogram was taken for each of the Lichtenberg figures.

It was early recognized in dealing with transients that stray capacities even of extremely small values could not be neglected. To make the dividing system function correctly without being dependent upon wave front it has been necessary to introduce proper compensation. The possibility of oscillations of disturbing magnitude existing between the dividing system and the surge recorder is rather remote because this possibility along with many others was foreseen and oscillograms were taken to determine whether or not such oscillations existed, and if found, the circuit was redesigned until the oscillations became small enough to be negligible.

SYMPOSIUM ON DIELECTRICS AND POWER-FACTOR MEASUREMENTS

(WHITEHEAD¹, CURTIS², HANSON³, LEE⁴, MARBURY, DOYLE AND SALTER⁵, SIMONS AND BROWN⁶, ST. CLAIR⁷, KOUWENHOVEN AND BETZ⁸)

NIAGARA FALLS, N. Y., MAY 26, 1926

P. L. Hoover: I should like to discuss briefly power-factor measurement in connection with bridge methods. There may be some doubt as to the accuracy of any bridge in measuring power factor, for, as Mr. Lee has pointed out, power factor is the ratio of the total power loss to the product of the voltage and the current. Now if a tuned vibration galvanometer is used for detecting the balance point of the bridge, only the losses due to a single frequency and not the total losses are measured. Fortunately in most cases the error that is introduced in this connection is probably very small and negligible. Nevertheless, most a-c. bridges cannot be regarded as precision power-factor bridges, since the power-factor balance is so critically dependent on an accurate capacity balance. For instance, with the Wien or the Schering bridge, if the capacity balance is off by one per cent the power factor may be off by as much as 50 or 100 per cent. Experimentally this means that the capacity balance must be made to a much greater precision than is required for the power factor. Such an experimental condition is to be avoided if possible.

A new type of bridge which is in use at the Harvard Engineering School and which was described recently before the Institute⁹ avoids this difficulty. In this new bridge, a mutual inductance between the galvanometer circuit and one arm of the bridge measures the difference in phase of the two sides of the bridge so that the mutual inductance may be calibrated directly in power factor. Furthermore, with this new bridge the power-factor balance is not so critically dependent on an accurate capacity balance and it may thus be regarded as a precision power-factor bridge.

E. W. Davis: The problem of making dielectric loss measurements on reel lengths of cable as a part of routine testing in the process of the manufacture of a cable requires a method of great simplicity and of an accuracy equal to that of the knowledge of the variables involved. The use of direct-deflection wattmeters from the above point of view offers one of the simplest methods of making such measurements.

1. A. I. E. E. JOURNAL, December 1926, p. 1225.
2. A. I. E. E. JOURNAL, November 1926, p. 1084.
3. A. I. E. E. JOURNAL, August, 1926, p. 719.
4. A. I. E. E. JOURNAL, August, 1926, p. 746.
5. A. I. E. E. JOURNAL, June 1926, p. 556.
6. A. I. E. E. JOURNAL, June 1926, p. 524.
7. A. I. E. E. JOURNAL, August, 1926, p. 729.
8. A. I. E. E. JOURNAL, July 1926, p. 652.
9. *Ionization Studies in Paper-Insulated Cables.* C. L. Dawes and P. L. Hoover. JOURNAL A. I. E. E., April, 1926, p. 337.

Two direct-deflection wattmeters recently developed for this service have been thoroughly tested and found satisfactory.

One of these meters is of the single-pivot type with no damping; the other, of special suspension construction wherein jewel and pivot friction losses have been reduced to a minimum. The constants of these instruments have been obtained to a great degree of accuracy and have been found to remain constant over the range of operation of the meters. Both meters have a very small phase angle between the current and potential circuits, an angle considerably smaller than is ordinarily found in commercial instruments. One of the meters is designed with an inverted scale so that while the maximum reading is 0.2 watt, a minimum of 0.01 watt can be read easily and accurately. Check measurements made between these instruments and an Irwin dynamometer, usually used in such tests, show the existing errors to be negligible. Results of tests on hundreds of reel lengths in our factory check very satisfactorily with tests made by more complicated methods in our laboratory.

The lack of suitable standards for the calibration or checking of various dielectric-loss sets has for some time been appreciated. Attempts are being made to construct or use suitable standards of glass or similar material. The use of such standards does not seem to promise high precision of determination of accuracy, but for the present the accuracy may be sufficient.

By use of the same cable sample and very careful determination and control of temperature, duration of application of voltage and mechanical handling of the sample, etc., we have checked three separate methods (two dynamometer and one bridge method) and found them to give results within five per cent of each other. This of course is not high precision but for the present seems to be sufficient.

The calorimetric method of checking dielectric losses discussed by Mr. St. Clair offers a wide field for investigation, but the chances of error are great and the complication and time required reduce it to a very special laboratory test.

The use of identical samples and various series-multiple connections of them does not work out very well in practice due to the impossibility of obtaining exactly identical samples, which of course means uneven distribution of voltages for the various series connections tried.

The paper by Mr. Hanson on the "Accuracy Required in the Measurement of Dielectric Power Factor" offers too much material for adequate discussion at this time. With the tremendous variation of the thermal and electrical constants of insulating materials and with the still greater variation of the thermal characteristics of the medium in which the cable is installed, it is rather difficult to conceive why such great accuracy in the power-factor measurement is required. Purely as a laboratory measurement, such accuracy might be desirable. As a factory routine test we do not believe that such accuracy is necessary.

A dynamometer-wattmeter method of measuring dielectric losses which is radically different from those discussed in this series of papers, was suggested by Prof. Dawes, of Harvard, some years ago and used for a short time in our laboratory.

In this method, the wattmeter and also the ammeter are in the high-tension leads, enclosed in suitable metallic shields which are placed on insulators. The shield for the wattmeter is made sufficiently large to hold the compensating resistances and capacitances.

The potential circuit is supplied by potential transformers, the case of which is also on insulators and at line potential. All leads are shielded as well as ends of the cable sample.

By this method, all leakage currents are eliminated or at least prevented from affecting the meter readings. No run is necessary to determine set losses. By grounding the high-tension lead and the low tension of the potential transformers supplying the wattmeter through a second potential transformer, the poten-

tial differences between coils in the meter is reduced to a minimum.

I. M. Stein: I should like to suggest that a complete bibliography be made a part of this symposium. Some authors have given references that they have used in their papers, but no one of the papers gives a complete bibliography.

Mr. St. Clair's talk of shielded resistances brought to mind a recent publication of the Bureau of Standards. This is Scientific Paper No. 516, "A Shielded Resistor for Voltage-Transformer Testing." The Bureau of Standards designed and has been using for potential-transformer testing for a number of years, a shielded resistance that should be of interest in some dielectric-loss measurements.

J. D. Stacy: I should like to discuss Mr. Marbury's paper. It seems to me that perhaps the measurement of dielectric loss with the dynamometer wattmeter is largely a matter of application detail in order to make it as feasible to handle by the ordinary test man as the method which Mr. Marbury uses.

We have used the phase-defect, compensation, dynamometer-wattmeter method in the measurement of power factor of capacitors very successfully, making several thousand measurements per year. The initial calibration of the instrument was laboratory work involving the method described by Mr. St. Clair. Our general results in the use of this instrument have been very satisfactory.

Delafield Du Bois: What we need most is a means of judging the merit of any given testing set, so that we may not only determine if an installed equipment is satisfactory for its continued use, but may also determine the most satisfactory new test set to install.

I can do no more than outline what such a measure of merit might be in the hope that some one will perfect it.

In judging the merit of a test set there are three primary considerations: accuracy, convenience and cost.

Obviously, accuracy must meet a certain minimum for commercial testing, but greater accuracy than this is usually desirable.

Under the heading of convenience, many things may be listed, but the most important are speed and the skill required to test.

Cost should include not only the first cost, but the cost of such spare parts as might be necessary to carry in stock in order to put the set back in service following a puncture of insulation during test.

Accuracy, convenience and cost may each be expressed numerically so that the sum of the three numbers will be the figure of merit of the test set considered.

The simplest means of reducing accuracy to a number is by establishing a standard test sample, such as the one Mr. Doyle has constructed. If a test set can measure the power factor of this test sample to within, say, B per cent accuracy, the figure of merit for accuracy will obviously be a function of B such, for instance, as $(C - B)D = A$ where C and D are well chosen constants. The actual values of C and D to be acceptable will, of course, have to be worked out by conference.

To arrive at a figure of merit for convenience let E be the time in man-minutes required to make two tests under widely different conditions. Then the figure of merit for convenience will be a function of E , such as $(F - E)G = H$.

If the skill required by the tester is greater than that of the usual laboratory assistant E should be corrected in proportion to the increased cost of testing.

If the number of tests per day can be estimated, cost can be reduced to a fixed charge per test. This can be expressed in equivalent man-minutes, and the figure of merit for cost I would be a function of these man-minutes similar to that used in determining the figure of merit for convenience.

If the constants C , D , F and G are well chosen, then $A + H + I = M$ will express the merit of the set.

This is only a suggestion but I believe it expresses an actual need.

Brian O'Brien: In classifying dielectric losses is it desirable to distinguish between (1) normal conductivity and (3) anomalous conductivity? The weight of evidence would indicate that no measurable electronic conduction similar to metallic conduction occurs in dielectrics, and that all conduction here is of an electrolytic character, that is, ionic, even when the conduction obeys Ohm's law. If this be true, the distinction between class (1) and class (3) lies only in the magnitude of the disturbing factors which cause departures from Ohm's law. If such a distinction is useful for the practical treatment of the subject, it might be well to emphasize the fact that the two losses are probably identical as regards the fundamental phenomena.

Granting that no measurable hysteresis effect occurs in dielectrics in the sense of a lag in polarization independent of time as found in magnetic materials, and that thus no permanent polarization of the dielectric as a whole will, in general, exist, this does not necessarily exclude the possibility of permanent polarization of the molecules of the dielectric. Kelvin and others have shown that such a polarization may exist without manifesting itself as a polarization of the whole dielectric. Therefore in dismissing dielectric hysteresis this possible molecular polarization and its effects on other forms of loss, such as absorption, must not be overlooked.

N. L. Morgan: Mr. Lee referred to the method of measuring dielectric loss by the use of the wattmeter and the water-tube multiplier. We have been using this method since 1917. The water-tube multiplier which we have been using consists of a straight quarter-inch glass tube about five ft. long and fitted with short brass tubes for making the taps. The ratio of the taps is 1, 2 and 4. Sufficient common salt is dissolved in the water to obtain the most convenient conductivity.

The form of the water-tube resistance used by Mr. Lee, I understand, was of the coiled-hose type used by Ryan and others. I think that the form of the resistance may be the reason why the check tests shown in Figs. 6, 7, 8 and 9 do not agree. In this resistance, I assume that the hose is coiled. There is an appreciable capacity between turns, and the capacity current passes through the potential coils of the dynamometer. The resistance is shielded against capacity to ground, but not against capacity between turns. This would also account for the large discrepancy between the curves of Figs. 8 and 9 obtained by using the full resistance and a portion of it respectively.

In the circuit I am using, the variation of the resistance of the multiplier with temperature is of no consequence. An ammeter is placed in this circuit and this current and the line voltage are observed at the time of reading the deflection of the dynamometer. Then variation of the multiplier current can be placed in the equation of power, which is

$$W = K D E / a$$

where

W = power

K = a constant

D = deflection of dynamometer

E = time voltage

a = current in the potential circuit

We have not found that shielding of the water-tube against capacity to ground is necessary on cable of greater lengths than five ft., if grounded metal is not closer than three ft. to the resistance.

The accuracy has been very good. We have sent cables to various laboratories and they have checked within close limits. As for convenience, a man can take five readings in about ten minutes. The parts, outside of the transformer and dynamometer, cost about 20 cents.

I should suggest that when using this method the potential coil be compensated for eddy currents as described by Rosa in a bulletin of the Bureau of Standards, otherwise the constant K will vary with the line voltage E . I should suggest also that when determining the constant of the dynamometer, alternating

current be used instead of direct. I think that with these precautions and proper shielding of the dynamometer and low-tension leads this method of measuring dielectric loss is sufficiently accurate for commercial testing.

R. Notvest: In connection with Dr. Whitehead's paper it seems to me that in describing the process of deterioration of composite dielectrics, the tendency prevails to investigate symptoms only and to pay little attention to the primary cause. In other words, all has been concentrated upon the heating effect and gaseous ionization which are secondary phenomena only when certain investigations led to the belief that a piezoelectric effect is the primary cause.

Very little work has been done in this field. Madame Curie has been the pioneer; also the 1919 A. I. E. E. TRANSACTIONS contain a very valuable paper on the subject by A. M. Nicholson of the Western Electric Co.

It is a fact that practically all insulation materials, with the exception of glass (an undercooled colloidal liquid) contain more or less crystalline substances. This is true of the many grades of porcelain, marble, lava, soapstone and slate. The multitude of synthetic insulation materials consist mainly of an electric inert mineral filler embedded in a plastic or semiplastic matrix of either a natural or artificial gum of the phenol-resin type. Any crystalline substance subjected to a mechanical stress will produce a potential parallel to an optical axis and when subjected to an electrostatic stress, will develop a certain amount of kinetic energy at right angles to the direction of the stress. Since there is a tremendous quantitative difference in the value of the piezoelectric effect of the various mineral substances utilized for insulation materials, in some instances the effect can be identified only through a superfine and tricky arrangement of the means of observation; yet a piezoelectric effect contributes to the deterioration of the paper insulation of power cables since cellulose always contains a certain amount of SiO_2 , silicic acid.

Under the direction of Dr. Booth of Western Reserve University, I have spent considerable time within the past few years in investigating this problem and hope to be able to present a paper soon covering the subject.

The matter can be expressed as follows. Whenever an insulation material is of, or has in its structure, crystalline substances, it is subject to a piezoelectric effect. Where such crystalline substances are embedded in a plastic or semiplastic matrix and exposed to an electrostatic stress, the individual crystals have a tendency to reorient themselves so that some optical axis (the one having the highest piezo effect) is at right angles to the direction of the potential pressure. When the direction of the electrostatic stress changes rapidly, a gradual microscopical opening of the structure takes place, increasing the amount and volume of voids and through molecular friction and the emission of charged particles from the crystals themselves, ionizing the occluded or infiltrated gases which in time causes the mechanical rupture and breakdown of the specimen.

J. B. Whitehead: We have had in foregoing meetings a number of excellent papers on the quadrant electrometer as a high-tension wattmeter. We have two such papers in this program, but the greater number are devoted to the electro-dynamometer wattmeter. I have worked a great deal with the former, and have found it of great value and accuracy above a certain value of phase difference; but in the very low range, it suffers the serious disadvantage that the fractional value of voltage on the needle introduces a phase error, troublesome to determine and to eliminate. While I have not worked extensively with the electro-dynamometer, it would appear that it is subject to the same type of error, as well as others of electromagnetic character, in the voltage circuit.

I have been working recently with the Schering bridge, and I prefer it to all other methods for the measurement of very low loss and power factor at high voltage. It is very rapid and the

possible errors are easy to detect and to eliminate; they arise principally in neutral capacity between the two sides of the bridge and to ground. Errors of this type are easily found and suitable screening will eliminate them. Particular attention must be given to the use of guard electrodes for both the sample under test and the air condenser, and to a screening system maintained at all times at the same potential as the test electrodes. This may readily be accomplished by resistance in the ground connection of the guards and their screening systems. Too little attention has been given to this source of error. I have found, for example, that 1200 ohms in a certain case was necessary in the guard-to-ground connection to ensure equality of potential with the test electrode. This connection in many cases is made directly to ground. In the case mentioned, a change of 100 ohms in 1200 was sufficient to unbalance the bridge. The principal disadvantage of the method is the requirement of a high-voltage air condenser, the capacity of which, for best accuracy, must increase with the capacity of the specimen to be measured. Thus the Schering bridge in its simple form is not suited to the measurement of the loss in long samples of cable. With a suitable air condenser and for relatively short cable lengths it possesses very great advantages.

Referring to Mr. Lee's historical review of the use of the electro-dynamometer wattmeter, I wish to point out that in 1891, when I entered Rowland's laboratories, I found that in collaboration with Prof. Louis Duncan, he had developed a number of types of electro-dynamometer, and was at that time investigating the value of the instrument for the measurement of dielectric loss. In a subsequent paper in the *American Journal of Science* he described a number of valuable methods for its use. Rowland's instruments were subsequently developed and sold by a well-known firm of manufacturers of electrical instruments.

H. L. Curtis: I should like to ask Prof. Kouwenhoven if the resistance of the battery in the electrometer method is negligible. It seems to me that in the final analysis it would have to be mentioned.

Mr. Hoover, in speaking of the bridge methods, stated that by a mutual-inductance method the sensitivity obtained in measuring the out-of-phase current was greatly increased. I regret that there are not a number of papers at this meeting on bridge methods. The bridge methods have much in common, the only difference being in the manner of making the adjustments. In all bridges it is necessary to vary the magnitude and phase of the current in one arm. What it amounts to is that the potential at the terminals of galvanometer is the same at each instant. There are a number of ways by which this can be accomplished. The Schering bridge has been used lately somewhat. This varies the phase by varying a condenser in parallel with the resistance in one arm. The adjustment, however, can be accomplished just as well and quite as conveniently by using the Rosa method where an inductance is in series with the resistance. The compensation can also be accomplished by putting a resistance in series with the condenser, or by a variable mutual inductance properly placed.

I cannot see that with any of these bridge methods or with the electro-dynamometer method you are going to get away from the fact that you have to compensate for the magnitude of the current as well as its phase. If you try to avoid compensating one of these, you throw the burden on some other measurement. I also don't see that by using a mutual-inductance method you are necessarily going to gain in sensitivity over what you would obtain by any other method.

Mr. St. Clair mentioned the question of using two condensers in series as a check on the accuracy of measurement. I have always found that a very unsatisfactory method. It may work if you are using very large condensers where you can get them close together in value of capacitance and where the capacitance to ground is relatively unimportant; but with small condensers,

the method of checking by using two in series is something which I have always found extremely difficult and feel that the check would be less satisfactory than some of the direct measurements which might be made.

There is one point in connection with Dr. Whitehead's suggestion about the potential of the guard plate of the condenser. It is essential that the potential of the guard plate and the guarded plate shall be the same at every instant. Generally, this condition is very closely approached by using a resistance between the guard plate and the earth, but if for any reason a phase angle is introduced in the measuring arm, an equal angle must be introduced also in the compensating arm.

C. F. Hanson: The particular phase of Mr. Lee's paper which I wish to bring to your attention is in regard to shunts generally supplied for use in connection with the dynamometer wattmeter.

The use of a shunt in measuring the power factor of a sample of cable 10 ft. long is not necessary, but it is necessary in measuring the power factor of a cable 500 ft. long, particularly if the same wattmeter is used for both jobs. The charging current of a 500-ft. cable may be of the order of one ampere corresponding to a voltage of 100 volts per mil, whereas the charging current of a 10-ft. sample of another cable may be only 0.002 ampere corresponding to a voltage of 40 volts per mil. A wattmeter which is sufficiently sensitive to measure power factor when 0.002 ampere is flowing, will not have sufficient current capacity to measure power factor when one ampere is flowing. A shunt is therefore necessary.

A shunt is usually constructed of two resistances and a capacitor of convenient dimensions. The capacitor is connected in series with the current coil of the wattmeter. The first resistance is connected in parallel with the capacitor. The magnitude of this resistance and the capacitor is so chosen that the current coil circuit behaves like a pure resistance at a given frequency. It is then a simple matter of connecting the second resistance, in the form of an Ayrton shunt, across the current-coil circuit containing the shunted capacitor.

The combination of the shunt and wattmeter coil may have a resistance of approximately 200 ohms when the shunt is set on 10, and 20 ohms when the shunt is set on 100. In other words, with a shunt setting of 10, a resistance of 200 ohms is connected in series with the cable and in some cases the error introduced may amount to 0.002 in the power-factor reading. With a shunt setting of 100 the error is only 0.0002 and is of no significance. The shunt settings chosen in this case typify those which might be used in an ionization test (the increase in power factor as the voltage stress is increased from 20 volts per mil to 100 volts per mil). Usually, by acquainting himself with his power-factor apparatus, the operator can avoid the foregoing error to a great extent if he exercises discrimination in the choice of his shunt setting.

One difficulty with most shunts is that the resistance coils in them are not provided with sufficient means for dissipating heat. This deficiency usually results in extraordinarily rapid deterioration.

The paper by Messrs. Doyle and Salter states that, in the case of three-phase measurements, they carefully control the voltage on a particular phase at the time when power factor is being measured on that phase. This voltage control does not eliminate a phase error, referred to in Appendix IV, which arises from inequality of voltage on the three phases. A similar error arises under two other conditions. The first is the condition of less insulation thickness on one conductor than on each of the other two, even though equality of voltage exists on all three phases. The second condition exists when the voltage vectors of the three phases are not equally spaced by 120 deg., even though the magnitude of the vectors may be equal and the insulation of the three conductors may be the same.

In Fig. 1 herewith are shown the vector relations between

charging currents flowing in the cable and the voltage applied to each conductor. The three voltage vectors are equally spaced at 120 deg. and the cable is symmetrical including equality of insulation thickness on the three conductors. The cable is considered to have zero power factor. The vectors E_1 and E_3 are of equal magnitude but E_2 is greater in magnitude. In other words, transformers No. 1 and No. 3 are supplying voltages of equal magnitude but transformer No. 2 is supplying a voltage of greater magnitude.

Fig. 1 is shown for a Y-connection of the supply transformers.

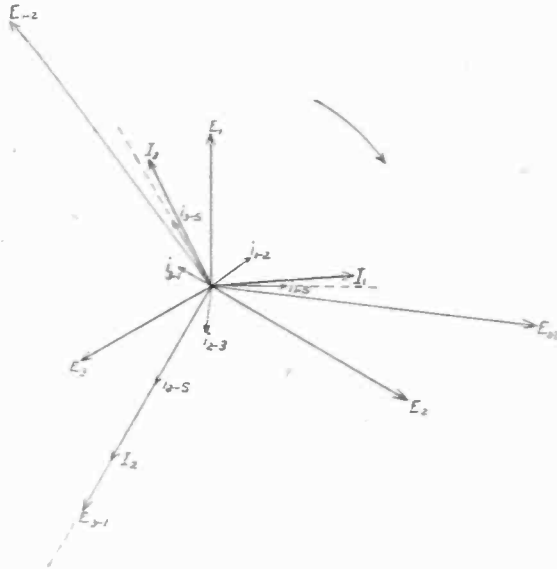

FIG. 1—THE VECTOR RELATIONS OF CURRENT AND VOLTAGES IN A THREE-CONDUCTOR CABLE WHEN IT IS CONNECTED TO A THREE-PHASE, Y-CONNECTED TRANSFORMER BANK

The common point of the transformers is connected to the sheath of a three-conductor cable and to earth. The high-voltage terminals of the transformers are each connected to a conductor of the cable. The various vectors shown are as follows:

- E_1 is the voltage to neutral on conductor No. 1.
- E_2 is the voltage to neutral on conductor No. 2.
- E_3 is the voltage to neutral on conductor No. 3.
- i_{1-2} is the charging current flowing from conductor No. 1 to sheath.
- i_{2-3} is the charging current flowing from conductor No. 2 to sheath.
- i_{3-1} is the charging current flowing from conductor No. 3 to sheath.
- E_{1-2} is the voltage between conductor No. 1 and conductor No. 2.
- E_{2-3} is the voltage between conductor No. 2 and conductor No. 3.
- E_{3-1} is the voltage between conductor No. 3 and conductor No. 1.
- i_{1-2} is the charging current flowing from conductor No. 1 to conductor No. 2.
- i_{2-3} is the charging current flowing from conductor No. 2 to conductor No. 3.
- i_{3-1} is the charging current flowing from conductor No. 3 to conductor No. 1.
- I_1 is the vector sum of i_{1-2} , i_{1-3} and i_{2-1} and is the total current flowing into conductor No. 1.
- I_2 is the vector sum of i_{2-3} , i_{2-1} and i_{3-2} and is the total current flowing into conductor No. 2.
- I_3 is the vector sum of i_{3-1} , i_{3-2} and i_{1-3} and is the total current flowing into conductor No. 3.

As the cable is considered to have zero power factor, the vector I_1 should be in quadrature with the vector E_1 . The quadrature position is shown by the dotted line. Fig. 1 shows that I_1 is

less than 90 deg. ahead of E_1 . This condition exists because the vector E_2 is greater than E_1 and E_3 , and indicates the error that will exist in the power factor as read on conductor 1. As the vector I_2 is in quadrature with the vector E_2 no error will exist in the power factor as read on conductor No. 2. The error of the power factor as read on conductor No. 3 will be of equal magnitude as the error existing in the conductor No. 1 power factor but of opposite sign.

The dielectric loss as read on conductor No. 2 will be abnormally high because the charging current I_2 is erroneously high. On conductor No. 1 dielectric loss will be abnormally high because of the erroneously high power factor. On the other hand, on conductor No. 3 dielectric loss will be abnormally low because of the erroneously low power factor.

In Fig. 1 of the paper by Messrs. Doyle and Salter the shielding problem is considerably simplified if the ground is removed from the lead sheath of the cable, and connected to the low-voltage terminals of the transformers. Any current then leaking over the transformer bushings and bus insulators will not flow through the current coil of the wattmeter but will return directly to the grounded terminals of the transformers.

In their Fig. 2, the ground cannot conveniently be removed from the lead sheath of the cable because it is not convenient to connect the current coil of the wattmeter into the high-tension lead from the transformer to a cable conductor. Therefore, in this case, the transformers must be insulated from ground. The case of each transformer should be connected to its low-voltage terminal. Likewise, all metal shields of the insulators of each bus should be connected to the low-voltage terminal of the transformer respective to the bus. Currents leaking over the transformer bushings and bus insulators will then return to the low-voltage terminals of the transformers without passing through the current coil of the wattmeter. These precautions are indicated in their Fig. 2 but hardly with sufficient clearness.

E. S. Lee: We have been told that there are no standards for these measurements. The question then is, how do we know we are accurate when we obtain a value?

In the General Electric Company, we used the dynamometer wattmeter first and obtained certain values. We had an opportunity to compare these with others observed more or less directly and they looked about right. Then we set up a Schering bridge and a year ago I reported our results. At that time I said that with the usual observers day in and day out we would check in general within about 0.002 on power factor, that is, 0.2 of one per cent. But we might expect at any time a difference of perhaps 0.004.

I always have wanted to see if we could not use some other method. In the paper he presented Mr. St. Clair told you of a calorimetric method which was used by himself and others in standardizing measurements made on capacitors. This was not an easy problem, either. It seems that there are difficulties at 2500 to 3000 volts, just as there are at the higher voltages.

From this work, it was found that the calorimeter method enabled these measurements as carried on in different laboratories to be standardized. Thus it occurred to us to apply similar methods to cables.

Two pieces of three-conductor cable, each 35 ft. long, were placed horizontally in a closed box as represented diagrammatically in Fig. 2 herewith. The box was 21 ft. long enclosing the central portion of these lengths.

Thermocouples were systematically placed along and around the sheaths of the cables over an 8-ft. length, the "hot" junctions being placed on one cable and the "cold" junctions on the other.

With copper-ideal thermocouples and a galvanometer of sensitivity 6.5×10^{-6} amperes per millimeter deflection at one meter scale distance, it was found that by using nine thermocouples in series for each unit, a temperature difference of $1/75$ of 1 deg. cent. between the sheaths was indicated by a deflection of one cm. on

the galvanometer scale. In watts, this means that one cm. deflection indicated a difference of power dissipation of 0.005 watts per ft.

Measurements were made by applying three-phase potential to one cable, and circulating direct current through the conductors of the other cable until there was thermal equilibrium with the same sheath temperature as indicated by zero deflection of the galvanometer. The d-c. watt input was then calculated and considered to be equal to the dielectric a-c. power loss.

At this time we have only completed one test, the results of which are shown in Table I.

There are three tests: Nos. 1, 2 and 3.

The values of three-phase power loss calculated from single-

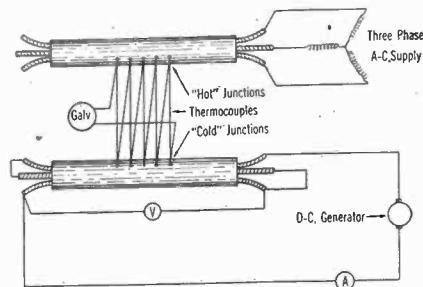

FIG. 2—SCHEMATIC DIAGRAM SHOWING LAYOUT FOR DETERMINATION OF DIELECTRIC POWER LOSS IN CABLES BY COMPARISON OF HEATING

phase measurements in watts per foot are: 0.266, 0.276 and 0.275, or an average of 0.272.

By comparison of heating, the measured power loss in watts per foot for tests Nos. 1, 2 and 3 are: 0.297 which compares with 0.266; 0.289 which compares with 0.276; and 0.280 which compares with 0.275. The average is 0.282.

The differences are a little larger on the individual tests, but the average gives 0.272 three-phase power loss, calculated from single-phase measurements as against 0.282 by comparative heating, a difference of not quite four per cent.

Of course, if the watts check, the power-factor values should check. The value we obtain by taking an average of the results obtained in the three-conductor high measurement and the one-conductor high measurement, gives a value of 0.74 per cent. The power factor from the comparison of heating test was 0.72 per cent.

The voltage was a little bit higher in the comparison of heating tests: 36.0, 35.8 and 36.2 kv.

The results of these measurements are: first, our method of determining the power loss from three-phase supply from single-phase measurements seemed to give correct results; and second, that our standards in the outfit, our air capacitor and our method of compensation and our method of determining the watt constant evidently were quite correct.

The next thing we shall do will be to interchange the cables and then test at other voltages.

The thing that appeals to me is this; that here is a set-up that anybody can put up without very much trouble and be able to satisfy himself very adequately, I believe, of the accuracy of his own results by an independent method. The equipment is not considerable, though the time required is quite long, one or two days being required for each test.

Because of the most satisfying agreement obtained on these first measurements with the dynamometer-wattmeter equipment, it is our hope that other laboratories will provide similar set-ups as a means both of checking their equipments and of learning more concerning this method.

The results are satisfying to us, and I believe that in general the method is simple enough so that it provides a satisfactory

method which can be used by different observers in different laboratories to satisfy themselves of the reliability of their results.

TABLE I
COMPARISON OF RESULTS
DETERMINATION OF DIELECTRIC POWER LOSS IN CABLES
Tests on three-conductor, 350,000-cm. (Sector) Cable, 7/32 in. by 3/32 in.
Treated Paper Insulation 1/8 in., Lead 15 kv.

A. BY COMPENSATED DYNAMOMETER WATTMETER

Test	Three-Phase Power Loss (Calculated from single-phase measurements) Watts per Foot	Power Factor Per Cent		Voltage Kv.
		Three-Cond. High	One-Cond. High	
1	0.266	0.70	0.78	35.3
2	0.276	0.60	0.88	35.3
3	0.275	0.59	0.87	35.3
Average	0.272	0.74 per cent		

B. BY COMPARISON OF HEATING

Test	Measured Power Loss Watts per Foot	Power Factor	Kv.
1	0.297		36.0
2	0.289		35.8
3	0.260		36.2
Average	0.282	0.72 per cent	

E. H. Salter: In connection with the paper presented by Mr. Marbury on the resonance method of determining power factor as a factory or control method, there is one point of importance that has not been mentioned. By inserting a large inductance in series with the condenser under test the measuring instrument is protected in case of a short circuit or of failure of the condenser to stand the voltage.

Mr. Hanson has gone to great length to show what he terms the limits of accuracy in power-factor measurements of high-voltage cable. While a high degree of accuracy is desirable in such measurements, it seems that the stress is being laid on the wrong point when it is considered that two of the usual short samples of cable taken off the same end or reel of cable may show characteristics which differ by as much as 50 to 100 per cent, while the variation over a line, miles in length, may be much wider.

Mr. St. Clair suggested a method for checking dielectric-loss-measuring equipments by securing four identical condensers and after determining the characteristics of each, using series-parallel combinations. In precision measurements of the dielectric loss of condensers shielding and guarding play quite an important part. In making series-parallel combinations proper guarding would be difficult to obtain.

D. M. Simons: Mr. Lee's calorimetric method of comparing losses is of interest and should be of value. I think one warning should be included, and doubtless Mr. Lee had this in mind. Mr. Lee proved equality of losses in two cables by equality of temperature rise. This is true only if the two cables have equal thermal resistance from the sheath outward. The differences in surface thermal resistivity of different samples of leaded cable have been found to be great sometimes, though this effect should be minimized by the small temperature difference involved in Mr. Lee's method. This possible error can be eliminated by the method Mr. Lee has proposed of interchanging the a-c. and d-c. between the two cables, or it could be checked by heating both cables with equal values of continuous current, and proving equal temperature rises.

I should like to confirm Mr. Hanson's conclusion of the necessity for accurate determination of current-carrying capacity, and especially the effect of having a large number of cables in a

duct bank with very high-voltage cables. 66,000-volt cable is now in operation in two places with two circuits per duct bank. I doubt if it would be economical to include another circuit in the same duct bank, though it may be necessary in certain special cases. For 132,000-volt cable, careful consideration must be given in each case as to whether or not it is economical to use more than one circuit in a duct bank; that is, each circuit can carry less power if two circuits are in one duct bank than if they were in two separate duct banks. The gain in carrying capacity obtained by using separate duct banks may be worth the cost of one additional conduit line.

Mr. Hanson's figures show a rather dangerous condition of instability of temperature in some of the higher-voltage cables, particularly with large numbers of cables per duct bank. I do not believe the actual conditions are as bad as shown; I am under the impression that Mr. Hanson figured the temperature rise based on the calculation of dielectric losses assuming a constant power factor throughout the entire body of insulation. In an actual single-conductor cable with thick insulation there is usually a considerable difference of temperature between conductor and lead, which means that the power factor of the entire cable is by no means that of the layers of insulation near the conductor, and therefore the actual watt losses may be considerably lower than those used by Mr. Hanson.

As pointed out elsewhere, I believe the temperature rise of conductor above lead due to dielectric loss should be figured in terms of a constant power factor of the insulation at the maximum conductor temperature. For the temperature rise of the lead sheath above the duct structure and of the duct structure above the original no-load temperature of the earth, the actual watt loss in the cable should be used, including the fact that there is a temperature gradient in the insulation. If this method of calculation is used, the conditions of stability shown by Mr. Hanson will be probably more favorable.

A few years ago⁵ Mr. Brown and I showed that the quadrant electrometer could be used in a null method by bringing back the deflection to zero by the insertion of a resistance in the lead to the electrometer needle. If the initial deflection should be "negative," we had to adopt special means. Dr. Kouwenhoven's method is, I believe, a distinct improvement. He reduces the deflection to zero by the insertion of a continuous potential in the needle circuit (as well as across the quadrants), but he has the advantage of being able to reverse the polarity of the battery in the needle circuit, and can thus use his method to balance deflections which are initially negative. I have not had an opportunity to try out his method, and do not know which of the two is the simpler, but I am sure that all those who have used electrometers will appreciate this new and valuable method of attack suggested and worked out by Dr. Kouwenhoven.

B. W. St. Clair: I am in agreement with the comments of Dr. Curtis about series-parallel methods of checking the voltage accuracy of a test equipment, when the samples are of small capacitance when compared with the capacitance of leads and parts of the outfit to ground. With samples of appreciable size where currents of milliamperes or amperes magnitude circulate, I believe the method is an excellent one for checking relative voltage accuracy. As pointed out in the paper it does not give a clue to absolute accuracy but does give a definite check on the accuracy of the shape of the voltage-power factor curve of a given test equipment.

I have been much interested in the self-contained instrument for checking dielectric loss of reel lengths of cable that was mentioned by Mr. Davis. In the design of one of these we had to depart somewhat from the more usual portable-instrument practise. Ordinarily a wattmeter is built to have full scale deflection at about 60 per cent power factor at rated current and voltage. Under these conditions it is possible to have very good operating characteristics without excessive

losses. It is possible by sacrifice of torque and with increased potential and current-circuit losses to build portable instruments for operation at 30 per cent or even 20 per cent power factor. To reduce this to the 1.5 per cent or 2 per cent necessary for cable tests means at least a ten-fold increase in instrument sensitivity. Reduction in operating torque below this 20-per cent point will result in unsatisfactory performance from bearing friction, and likelihood of trouble from stresses incidental to transportation. Any attempt to retain a reasonable operating torque by the use of greater ampere-turns on the armature results in increased armature weight or increased phase-angle corrections or increased potential losses. For a given weight of armature there is a minimum operating torque below which operation will be unsatisfactory. The net result is that there is no compromise in electrical characteristics possible with the standard bearing construction. Two alternatives are possible; the use of the monopivot construction or the use of a strip suspension that will serve the dual purpose of torque member and supporting member of the armature. I have preferred the latter method because it completely obviates the bearing trouble that is almost necessarily coincident with the rather heavy weights and low torque of a well damped sturdily built armature, even in a single-pivot construction.

The suspension arrangement is not a panacea for all instrument failings and it does impose double duty on the suspension members. Fortunately the development of special bronzes and processes incidental to good spring characteristics has brought forth sufficient knowledge of the limitations of such doubly stressed material as to permit easy design for satisfactory operation with exceedingly good electrical characteristics. The dependability of such devices will be inferior to the more robust double-pivot ones but will be satisfactory for checking losses on a factory or routine basis.

I am a firm believer in calorimetric methods of checking the fundamental accuracy of a dielectric test outfit. It is the only direct method I know that measures the losses in terms of some physical quantity that is easily amenable to accurate measurement. Thermal work of this sort requires a high degree of skill and considerable patience. It is a method that has been carried to a high level of certainty and usefulness by biologists interested in general metabolism work. It is quite customary for them to make tests of heat output where the total heat flow is but a very few watts with an error not over five per cent. I have seen many tests where the claimed error was less than two per cent. It is possible that we could learn much from a survey of their present methods and equipment.

C. A. Adams: This thermal-balance method of measuring dielectric losses seems to me a very interesting one. Mr. St. Clair spoke of the difference between the location of the material in which the heat is generated and the conductor material, and Mr. Simons spoke of another possible error, the difference in thermal conductivity.

I feel sure that neither of these considerations affects the test as outlined by Mr. Lee. When I saw that he had a long conductor with various sections and that the flow of heat must be substantially radial at the central section, it was obvious that the relative thermal conductivities have no influence. The amount of heat dissipated from the surface is dependent wholly upon surface conditions. The heat is practically all dissipated by convection, and at those low temperature differences is dependent wholly upon the nature of the surface and possible obstructions.

The thermocouple leads may possibly offer some such obstructions, but apart from that, as between two lead sheaths, it is quite unlikely that there will be any significant difference.

The question as to whether the heat is generated in the conductor or insulation has nothing to do with the case as long as the heat flow is radial.

One of the authors spoke of the use of reactance in series with the supply transformer for smoothing out the e. m. f. wave.

⁵ TRANSACTIONS OF A. I. E. E., 1924, p. 311.

Ten years ago when I was making tests on some 25,000-volt cable in Boston, about five miles in length, where the charging current was some 1600 kv-a., we used that method for two purposes, to get double the transformer voltage on the cable and also to smooth out the wave.

We heard a great deal in the old days about the danger of resonance, but if you have resonance with the fundamental, you are a long way from resonance with the harmonics. The reactance in series; through the medium of almost infinitesimal harmonic current, will absorb practically all of the harmonic voltages, so that the actual voltage impressed upon the cable was practically sinusoidal, so nearly so in this case that it was impossible to detect the difference on the oscillogram.

The reactance proved useful in another direction, since any incipient failures in the joints which resulted in small transient currents gave distinct knocks in the reactance. You could put your ear to the core of this reactance and hear every little spit in the joints and there were a good many of them when the voltage was 50,000, which was double the normal operating voltage of the cables. That was some time ago when we didn't know as much about making joints as we do now. But in one case we stopped the test before failure and examined the junction boxes, 13 of which were found smoking. They had a semi-liquid filler compound through which these transient discharges had taken place.

Just one word in regard to this whole question of dielectric phenomena. There are few who realize how differently we employ words and what different meanings those words convey to different minds. I refer to some of the remarks concerning anomalous conduction. The fact is that we are dealing mostly with the superficial side of all of these phenomena. We don't know what actually is going on.

For example, take Maxwell's theory or hypothesis concerning the absorption current. That is what you might call an equivalent-circuit scheme and if it fits the facts it is very useful. And it may, as has been shown by Mr. Dunsheath, be transferable; that is to say, our knowledge of the absorption current may enable us to predict approximately what the dielectric loss is going to be; but that does not prove the hypothesis to be correct.

I think Dr. Whitehead is absolutely correct in saying that barring ionization (and in a good cable there should be very little ionization) the major factor of the dielectric loss is that which is represented by the absorption current, but these are all superficial considerations and tell us nothing of the ultimate nature of the phenomena.

There are a number of hypotheses that delve a little bit more deeply and have to do with the ionization of the dielectric material itself and with the tearing off of electrons from the molecules or atoms but we haven't yet come to the point where we can connect up the actual, practical phenomena that we observe with the fundamental laws of atomic structure.

There has been a great deal more written about this than most of us realize, but it has been done by scientists in their quiet way, and most of their articles are buried in the proceedings of the highly scientific societies. If we were to try to understand a little more thoroughly the ultimate nature of the phenomena and follow more closely the work that is being done by our scientific friends, we might perhaps arrive a little more quickly at some fundamental relationships which would enable us to predict from knowledge of the elements that go into a composite insulation what is going to happen under specified conditions.

As yet our work is too empirical, too superficial. Frankly, my real interest in this problem has to do almost wholly with that delving into the ultimate nature of things, trying to understand a little bit more the reason why, rather than merely collecting a lot of superficial information which is in the long run requires much more time.

Delafield DuBois: At one time I was associated with the Russell Sage Institute of Pathology, where we had a calorimeter to determine the heat radiated by the human body. To give an idea of the extreme sensitivity of the apparatus, let me tell of an incident. The doctor in charge of the laboratory happened to be in the calorimeter flat on his back and not moving, but looking out through the window, he saw me enter the laboratory. Not long after that the assistant who was plotting the curve of heat generated vs. time called me over to the test table and showed me a slight kink in the curve that indicated the time when I came in. Apparently the mere sight of me made a slight difference in the heat generated by the doctor.

C. L. Kasson (communicated after adjournment): In regard to measurement of dielectric loss and power factor,—are not the results dependent on wave form, especially in short-length measurements? What agreement can be expected between the results on ten-foot samples and reel lengths?

Has the possibility of end losses in short samples been investigated as a source of error? These end losses must consist of leakage over the end and energy dissipated into the air and then picked up again on the lead sheath. The usual form of guarding does not take into consideration this latter factor which is important.

P. A. Borden (communicated after adjournment): Except, possibly, in those laboratories where the facilities of time and equipment are almost unlimited, the outlook upon the measurement of dielectric losses is at best a rather gloomy one; and we must thank Mr. Lee for having introduced a distinct ray of optimism at the psychological moment. The thermal-balance method, which he describes, while at once scientific and precise, is at the same time capable of application in almost any electrical laboratory, and with equipment which is neither expensive nor highly specialized in its construction or operation.

As an alternative arrangement, and as a possible improvement, I would suggest the replacement of the thermocouples by a resistance bridge, the varying arms of which would consist of a number of turns of enameled magnet wire wound upon the sheath of the cable. There is no doubt that the assembling of this circuit could be more quickly accomplished than the placing of the thermocouples which Mr. Lee has described; and there is the added advantage of the superior sensitivity of the circuit, as well as of increased precision due to the equivalent of an infinite number of points of thermal contact.

If, as has been anticipated by some, there be a source of error due to difference in the conditions of the lead surfaces, it would be possible to surround the cables with oil baths of small dimensions, or to immerse the two sections in a common bath, either of which measures should reduce such an error to negligible proportions.

J. B. Whitehead: The question was asked why, in my list of causes of phase difference in dielectrics, I had included three different types of conductivity, and why all types of conductivity are not the same. There is every evidence that electric conductivity in every instance consists of the motion of some kind of an electric charge, but there are many different kinds of charges,—for example, electrons as in the process of metallic induction, molecular ions and molecular aggregates of various sizes. The presence of any one of these types of ions will result in conductivity and to that extent they well might be included in one class, but the conductivities resulting from these several types of ions follow quite different laws as regards voltage, temperature, frequency, etc. Until these laws are brought together, therefore, and until the nature of dielectric absorption is better known, it appears to me advisable to separate the conductivities arising from different causes.

C. F. Hanson: Mr. E. W. Davis has expressed his doubt of the necessity of the high degree of accuracy which I have pre-

scribed for power factor measurements of 132-kv. cable, in view of the variation existing in thermal constants and the inaccurate knowledge of them. Mr. E. H. Salter has expressed a similar doubt but for a different reason. His reason is that the power factor of a cable is too far from being uniform to warrant the accuracy prescribed. Both of them are correct in their views if the subject is considered from the point of view of present knowledge of thermal constants and the usual uniformity of power factor. This subject, as far as 132-kv. cable is concerned, should not be approached from that point of view. Rather, it should be considered from the point of view of the requirements of the accuracy of our knowledge of all the properties pertaining to the performance of a 132-kv. cable. If a 132-kv. cable is to perform in accordance with experience obtained with lower voltage cables, then I believe the accuracy I have prescribed is hardly too rigid, particularly for a six-cable duct bank. This statement, of course, implies that the power factor of the cable has to be uniform. The thermal properties of the cable and of the duct must also be uniform and known to a high degree of accuracy. If these conditions cannot be met, then it is possible that a 132-kv. cable will have to be replaced by a lower voltage cable.

I have used the term "uniform" loosely. In the case of power factor, it means a permissible variable excess above a certain value considered to be satisfactory. A deviation below this certain value is of no serious consequence because it does not impair the expected current capacity of the cable.

Power-factor uniformity varies with the operating voltage of the cable. In the case of 132-kv. cable the uniformity should be of the order of the accuracy required in the power-factor measurements. The case of lower voltage cables is quite a different story. For example, the permissible power-factor error and uniformity of a 13-kv. cable may be of the order of six per cent, depending upon the knowledge of the thermal constants. I am sure that this accuracy is not alarming and this uniformity is very likely well within the limits stated by Mr. Salter.

Mr. D. M. Simons has called attention to a rather important item in the matter of calculating the actual dielectric loss existing during the operation of a 132-kv. cable. The method which I did use is that prescribed by him in his paper which I have cited. I did not, however, follow the advice which he also gives in his paper, that in some cases a second calculation should be performed to obtain more nearly the actual dielectric loss. I have now done that for one cable.

Before proceeding to explain the method I employed in my second calculation, I shall present a few definitions in an attempt to clarify the subject.

1. The dielectric loss in a cable is usually considered to be that which exists when the entire insulation of the cable is at the same temperature. This is the loss measured in the laboratory according to American practise. I shall designate this loss as the "measured dielectric loss."

2. In actual use the entire insulation is not at the same temperature. The insulation near the conductor is at a higher temperature than the insulation near the sheath. The power factor of the insulation near the conductor, therefore, will be higher than the power factor near the sheath according to the power factor-temperature characteristic of the insulation. The dielectric loss of the cable under this condition, when the conductor is at the maximum permissible operating temperature, will be less than the "measured dielectric loss," and I shall designate this loss as the "actual dielectric loss."

3. The "actual dielectric loss" is distributed throughout the insulation of the cable. It is greater near the conductor than it is near the sheath, for two reasons:

a. The electric stress is greater near the conductor than it is near the sheath, and

b. The power factor is greater near the conductor than it is near the sheath.

In calculating current capacity it is difficult to deal with the "actual dielectric loss" as a distributed loss. It is much more convenient to deal with it as a concentrated loss on the surface of the conductor. This procedure may be followed by considering a fractional part of the "actual dielectric loss" as concentrated on the conductor surface. This fractional part of the "actual dielectric loss" I shall designate as the "conductor-equivalent dielectric loss."

The $R I^2$ loss in the conductor and the "conductor-equivalent dielectric loss" raise the temperature of the conductor above that of the lead sheath. The $R I^2$ loss in the conductor, the "actual dielectric loss" and the sheath eddy-current losses, raise the temperature of the sheath above the base temperature of the earth.

In my calculations I used 50 per cent of the "measured dielectric loss" as the "conductor-equivalent dielectric loss."

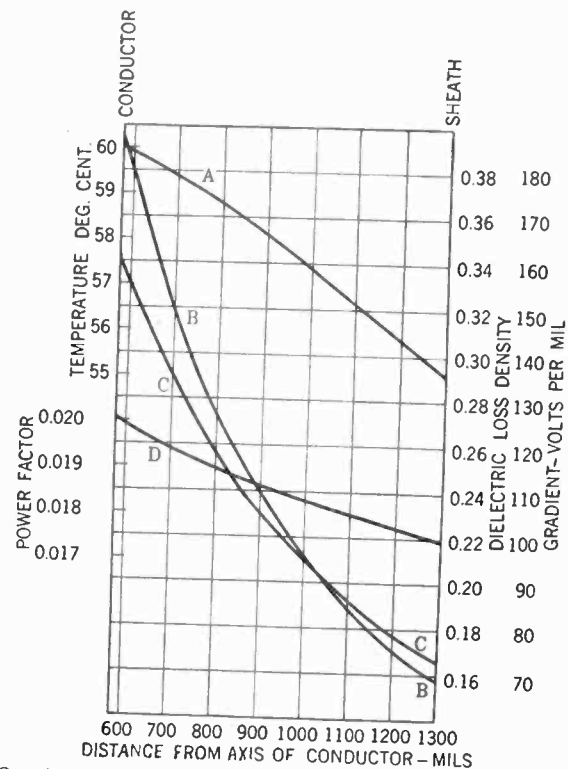

FIG. 3—ACTUAL CONDITION EXISTING IN CABLE No. 15

A—Temperature deg. cent.
 B—Dielectric loss density, watts per ft. per 0.06-in. thickness
 C—Voltage gradient
 D—Power factor

I shall demonstrate by example that this procedure is not always rigorous. For my example, I have chosen Cable No. 15, the power factor-temperature characteristic of which is shown in Fig. 5. This cable was calculated to have a current capacity of 187 amperes under the conditions specified.

I divided the insulation of the cable into a series of 12 concentric cylinders, each having a wall thickness of 0.06 in. (approximately 1/16 in.). I started with the inner cylinder against the conductor. I calculated the temperature and the voltage gradient of this cylinder 0.03 in. from the surface of the conductor. With these values I calculated the dielectric loss per foot for the first cylinder. The second cylinder from the conductor will have this dielectric loss flowing through it in addition to the copper loss. After having calculated the temperature and volt-

age gradient in the second cylinder, I calculated its dielectric loss. I proceeded in this manner until I had reached the lead sheath. The results of this series of calculations are shown in the accompanying Fig. 3.

A summary of the results follows:

The "measured dielectric loss" of the cable at 60 deg. cent. is 3.09 watts per ft.

The "actual dielectric loss" of the cable when the copper temperature is 60 deg. cent. is 2.91 watts per ft.

The "conductor-equivalent dielectric loss" was found to be 1.46 watts per ft., which is 50 per cent of the "actual dielectric loss" and 47.2 per cent of the "measured dielectric loss."

It appears, therefore, that I have gone wrong in my original calculations to the extent that I used 50 per cent of the "measured dielectric loss" instead of 47.2 per cent as the value for the "conductor-equivalent dielectric loss."

I believe that the summarized results show that my original calculations are approximately correct, although they are not absolutely correct. The difference is even not as much as it appears because there is a compensating error. In Fig. 5, I have shown the unstable power factor-temperature characteristic, EF , as a straight line. In reality this is not a straight line but is a curve which droops at the higher temperatures. This drooping probably offsets entirely the little advantage gained in the revised calculations. In conclusion, I believe so far as calculations are concerned, that my Figs. 5 and 6 show very nearly a correct picture. The thermal constants I have used may not fit all cases by any means, but they do most likely fit an average case.

Mr. Lee: As regards the nature of the surface of the cable in the heat comparator method, that certainly is very important and we must take it into account. There is, however, this fact; that there is only a one- or two-deg. rise which enters into the proposition and it is simplified in that regard.

There is one question I should like to ask Mr. Simons. It comes up in connection with the use of the electrostatic wattmeter, and is about the maximum voltage at which he knows it can be used. I have stated in my paper that we have to go up to 100,000 volts in these measurements. As I understand it, the electrostatic wattmeter has not been used much above 35,000 volts. Above that voltage several disturbing factors are introduced.

Also, Prof. Whitehead spoke regarding the size of a resistor that he had which wasn't very large. Again, I had in mind 100,000 volts.

W. B. Kouwenhoven: Dr. Curtis mentioned the effect of the resistance of the battery. The resistance of the battery which is inserted in the needle circuit of the electrometer in the method described by Betz and me has a negligible effect upon the compensation. Simons and Brown produced zero deflections of the electrometer by the insertion of a resistance in the needle circuit. The value of the resistance needed in their method is of the order of 20,000 ohms. The resistance of the battery that Betz and I used in the needle circuit was small and therefore had no effect upon the results obtained.

Messrs. Simons and Brown state on the third page of their paper that one way of eliminating the charging current to the needle is to put the ground at the mid point of the quadrant resistance R_1 . I have tried this method experimentally and found that it does not eliminate the trouble.

One advantage that the electrometer wattmeter possesses over the dynamometer wattmeter is its simplicity and range. If various sized samples are to be tested with a dynamometer wattmeter, either the instrument must be shunted or else several different current windings must be available. In the case of the quadrant electrometer wattmeter, different ranges may be obtained by changing the value of the resistance R_1 , which

shunts the quadrants. With the same electrometer I have measured losses in cables which were only a foot in length, whole reel lengths of cables and current-limiting reactors. In the measurements the values of the resistance R_1 varied from several thousand ohms to one one-hundredth of an ohm. The current ranged from a few milliamperes up to 200 amperes. This indicates clearly the wide range of the electrometer.

I used the zero method described by Betz and me for measuring the loss in the current-limiting reactor mentioned above. The measurements were made in the field and the results were quickly determined. The method worked very satisfactorily.

A number of different methods have been discussed here for measuring the power loss or power factor of cables and dielectrics. They are as follows:

Electrodynamometer wattmeter, bridge methods, quadrant electrometer wattmeter, and calorimeter methods. In using the bridge methods it is necessary to balance both for ratio and phase angle. The accuracy of the results depends to a large extent on the ratio of the bridge. The closer the ratio is to unity the greater the accuracy and ease of obtaining a balance. Consequently the bridges are limited to samples of approximately the same size. This is also true of the dynamometer wattmeter methods unless shunts are introduced with their attendant difficulties. In using calorimeter methods, care must be taken to see that the radiation coefficients of the lead sheaths of the cable under test and of the standard sample are the same. As pointed out, the quadrant electrometer has a wide range of application. Its use, however, also introduces those certain difficulties which have been discussed.

E. H. Salter: Mr. Hanson brought the question of the use of shunts in connection with the electro-dynamometer wattmeter. We find that a dynamometer wattmeter which is sufficiently sensitive for use without a shunt on short samples of cable, can be used in connection with the shunt on cables up to the full reel. As an instance there we have made comparatively recently some tests using the compensated dynamometer or the phase-defect compensation method in which the apparent defect angle of an air condenser is compared with the apparent defect angle of the sample of cable.

In this particular case to which I refer, the air-condenser charging current was about 15 milliamperes, whereas the charging current of the cable sample which was a full reel ran in the neighborhood of one ampere.

In order to obtain sensitivity, the balance on the air condenser was made using the direct connection of the electro-dynamometer in the circuit, whereas the balance on the full-reel sample was made with the shunt set for a multiplying factor of 1000.

We have used the shunted wattmeter over a complete range between those points, between the one multiplier and the 1000 multiplier, and have tried interchecks, shifting from one shunt position to another with the same voltage and the same cable sample and have found the result perfectly satisfactory.

Mr. Hanson also raised the question of the connection in Fig. 2 of our paper. I can state that the connections are made with the low-voltage end of these windings connected to the transformer case and that the transformer cases are insulated one from the other.

Mr. St. Clair raised a question regarding the statement: "With the present methods of determining compensation, it is believed that an accuracy of ± 0.05 per cent in power factor should be obtained." That refers to absolute power factor and not to percentage accuracy.

He raised a similar question with reference to the statement on the fourth page in the second column. There I think the percentage is clearly stated as measurements: "A careful operator should be able to make measurements to within ± 0.05 per cent power factor. The losses as computed from the current and power factor should be well within ± 5 per cent accuracy." There it is changing it over to the accuracy basis.

Discussion at Annual Convention

LAW OF MAGNETIZATION¹

(GOKHALE)

WHITE SULPHUR SPRINGS, W. VA., JUNE 25, 1926

J. R. Craighead: In the study of any characteristic of a material for engineering purposes the first results must be obtained by measurement. From these results an empirical formula is usually developed which should be accepted until fresh data disagree, when the formula should be modified or extended to include all the data.

When knowledge of the characteristic advances sufficiently, a rational formula may be proposed. To be acceptable, the rational formula must not be inconsistent with the existing data and must meet the mental needs of engineers by representing a theory of the variation of the characteristic.

In this case the formula of Frolich with the other developments of it to which Mr. Gokhale has referred, constitutes a long step toward a rational formula. Weber's theory of molecular magnets is at present the fundamental on which magnetic formulas should be based.

Frolich's law is obtainable from Weber's theory by assigning a specific value to the distribution ratio. Mr. Gokhale's tests have shown that this value is not suitable for determining the actual performance in the region near saturation.

Consequently, Mr. Gokhale attempted to find a substitute for that value, and a new formula which would be at least equally in agreement with the Weber theory. He found this in the formula which is quoted in the paper.

Following this step he studied it in comparison with previous formulas and determined it to be a corollary of Lamont's equation, consequently basing it on Weber's theory in the same way that Lamont's equation is based. Thus the formula has a mathematical connection directly back to previous magnetic efforts and represents an effort to connect with the latest data those which were available to those who developed the earlier formulas.

It is not claimed that Mr. Gokhale's law of magnetization near saturation is the final one or that there will never be any more data which will extend it. It is possible that the fundamental Weber theory will be changed, in which case there may be radical changes in the formulas derived from it. But in establishing a step in advance of the formulas that have already been recognized, covering very much more thoroughly a wider range of data, Mr. Gokhale has made a definite advance in the art.

Hans Lippelt: The magnitude of the problem in hand is well illustrated by the fact that the author confines his work to the range of magnetization near saturation, limiting it at the lower end by a magnetizing force of $H = 300$, which is a high value for practical and industrial purposes.

In going over the experimental data given, it should be observed that no attention whatever has been paid to magnetic hysteresis. Small as it may be near saturation, it becomes noticeable and effective as the magnetization curve falls off the saturation value. The majority of the test data start with a high value of H , which is receding as the test proceeds. This state of affairs characterizes each of the respective β curves as part of the descending branch of a hysteresis curve. Both branches of the hysteresis curve should be subjected to test and observations recorded and presented.

The establishment of a new law of magnetization necessarily

calls for conclusive evidence. With one-half of the evidence left out, the other evidence presented can hardly be called conclusive. This is said without depreciating the great merits of this exemplary piece of research work.

In connection herewith it should be observed that not all the βH curves are shown with their ordinates (or axis of ordinates) starting at the zero line. Fig. 1-8 has the first division at 13,000, and that seems to be the residual magnetism of the sample, being corroborated by Figs. 1-3 and 1-2. It is doubtful whether such a high residual magnetism will be accepted as the basis or starting value for a new law of magnetization. Strictly speaking, the maiden curve of magnetization, which goes through the origin of the system of coordinates, is the only pure representative of the true law of magnetization.

The author, in paragraph 15 of his paper, has explained the insensitive character of the reluctivity curve, and has pointed out that its apparent straightness is no reliable criterion for the course of other correlated curves. I believe it befalls the author to prove that the line of incremental permeability, Fig. 3-1, is inherently sensitive to the curvature of correlated curves. In other words, it should be proved that in spite of other correlated curves (say the $\beta \mu$ curve) possessing a certain definite curvature, the curve of incremental permeability is actually a straight line, and not merely the average value of several undulations such as are noticeable in Fig. 3-1.

The justification for such a proof will hardly be denied in view of the fact that the main equations (29) and (30), which represent one main result of the study, are derived from that line.

We also should not lose sight of the fact that the author of the paper violates his own theory (to a certain extent) when he eliminates β from equation (21) and reduces it to the form of (23) and (26).

Fig. 1-6 shows two straight logarithmic lines. They give rise to the question as to whether the material under test undergoes a distinct molecular change. Such a change may be either gradual and finishing, or occurring abruptly at the point of their intersection. Such a phenomenon would not be unusual with iron, which is known to suffer a change of its elasticity and strength, when under thermal stress. (Breaking strength of steel increases up to 300 deg. cent.)

Another possibility would be that the two straight lines are really the asymptotes of a curve which otherwise runs very close to its asymptotes.

It is conspicuous that no corresponding kink can be detected in the correlated $H D$ curve of Fig. 1-6.

That Frolich's law permits a modification which renders it more flexible was shown by myself in a recent paper on the magnetic hysteresis curve.²

I believe it would be advantageous for the readers if, in Mr. Gokhale's paper, the method and wiring of the tests were illustrated by diagram.

J. E. Jackson: It is quite gratifying to find that Mr. Gokhale's saturation curve is a straight line, since it was a consideration of Weber's theory two years ago that led O. E. Charlton and myself³ to predict that the a-c. iron losses would decrease as d-c. excitation was superposed on the core. Weber's theory states that hysteresis loss is due to friction between the molecules or electrons as they reverse their position or polarity under the

2. A. I. E. E. JOURNAL, April, 1926, p. 355. See also Discussion A. I. E. E. JOURNAL, August, 1926, p. 770.

3. Losses in Iron under the Action of Superposed Alternating- and Direct-Current Excitations, by O. E. Charlton and J. E. Jackson, TRANS. A. I. E. E., 1925, p. 824.

1. A. I. E. E. JOURNAL, September, 1926, p. 846.

influence of an alternating magnetomotive force. If this is true, a strong d-c. field should hold the molecules locked in one position so that they cannot reverse, and therefore the hysteresis loss would not appear. Also, the permeability of the specimen should approach that of air. Both of these facts were proved by actual tests; as d-c. excitation was increased the a-c. iron losses decreased.

A. E. Kennelly (communicated after adjournment): The paper is an interesting compendium of the various formulas which have been offered, at different times, to account for the phenomenon of magnetization in the magnetic metals, from the point of view of the physicist, and particularly in regard to the phenomenon of high magnetization, near saturation. It shows that the various formulas of Bosanquet, Emery, Lamont, and the speaker, are much more closely connected with each other than is generally evident or recognized, and also connected with the pioneer work of Frolich, in 1882. It shows, moreover, that none of them is quite satisfactory in the neighborhood of saturation. Near saturation, the paper advocates the formula given in the synopsis, which is a modified form of Lamont's formula.

When we consider the relatively complex and unstable molecular configurations involved in the generally accepted Ewing's theory of magnetization in iron, it would be quite surprising if any single and simple formula satisfied the entire process, from the feeblest to the most powerful magnetization. Near saturation, however, when the last dregs of latent magnetization are being evoked, an exponential relation of the type advocated in the paper seems very reasonable. That is, if we plot the latent induction γ against the magnetizing force \mathcal{H} , on arith-log paper, as in Fig. 1-7, we should look for a straight line, or a pair of straight lines, as saturation approaches. This relation should be carefully examined in future, with various samples of magnetic material. The technique of magnetic measurement for advanced values of magnetizing force, however, should be standardized for that purpose. If this straight-line relation between $\log \gamma$ and \mathcal{H} is brought out, the paper will have supplied a valuable contribution.

In regard to the assumption on the fourth page of the paper about latent flux, namely, that "it is made up of two groups of flux lines in opposite directions making an algebraic total of zero lines," it seems to need some proof. The conception of each iron molecule inherently possessing its own bundle of magnetic flux, so that when they are all completely aligned, the resulting flux density is determined only by the number of molecules per square cm. of cross-section, is interesting but perhaps unsafe. It seems to go beyond the needs of Ewing's theory.

In regard to my paper of 1891, the ascending straight-line law of metallic or intrinsic reluctivity there pointed out, is indeed based upon the previously published researches of Ewing, Rowland and others, as the paper states. The speaker arrived at the relation, however, from his own tests of samples of dynamo steel, for which the notes and records are still retained. It was found that when the reluctivity ρ was plotted, on ordinary squared paper, as ordinates, against magnetizing force \mathcal{H} as abscissas, the graph was always a pair of straight lines, one descending and then the other ascending, with an elbow connecting them, and with the maximum value of the permeability occurring at this elbow. From an engineering point of view, it appears to the speaker that this is still the simplest quantitative relation between the ordinary magnetic phenomena. From a strict physical theory standpoint, however, this pair of straight lines may be only a first approximation to a much more complicated phenomenon. It seemed more convincing, in 1891, to express the geometrical facts in relation to already published researches than in connection with new and unchecked tests.

S. L. Gokhale: I believe that some of the points brought out in the course of the discussion can be best explained by a brief

history of the investigation which forms the subject of the paper under discussion.

In January 1913, I was called upon to add to our equipment a simple and reliable method for determination of saturation value of magnetic material used for engineering purposes. Prior to this date and also for some years afterwards, this determination was made by extrapolation according to Kennelly's law on the basis of data for $H = 50$ to 200. By the beginning of 1915 I had succeeded in developing a new method of measuring saturation value, (A. I. E. E. TRANS., 1920, p. 819) together with a suitable instrument for that purpose, *viz.*, the saturation permeameter. (See Law of Magnetization, Table I-1.) The new method was easily recognized as the simplest method for this work but its reliability was seriously questioned because the saturation value determined by this method did not agree with the computed value by extrapolation according to Kennelly's law. (See Circular of B. of S. No. 17, p. 36.) When the result of a measurement by a new method conflicts with a law unani- mously accepted by the scientific world for nearly forty years, the reliability of the new method should be questioned rather than the law; this was the generally accepted view, and I must confess that I held the same view at first. For about five years I tried unsuccessfully to detect error in the saturation permeameter, until by the beginning of 1920 I began to feel convinced that the permeameter was quite reliable and that the error was probably in the extrapolation method. In April 1920 I expressed this view in the discussion of Dr. Yensen's paper, but I could not convince him at that time. In May 1923 I was able to demonstrate the existence of the second inflection together with the left-handed curvature above that point (Fig. 4-2) by tests on toroid rings; this demonstration indicated the possibility of failure of Kennelly's law for values of β near saturation, although the point was still not proved conclusively. About this time I had also succeeded in obtaining by tests on toroid rings the curve for incremental permeability (Fig. 3-1) which suggested the linear equation of progress (equation 26), together with the corresponding exponential law of magnetization (equation 30). I showed these results to Dr. Steinmetz, who seemed to be well convinced by the evidence, but he suggested that a successful demonstration of the phenomenon of saturation would be much more convincing. In September 1923 I succeeded in demonstrating saturation for a toroid ring of standard sheet steel for a range of $H = 650$ to 1000 (Fig. 4-1.)

In May 1924, I showed my notes to Dr. Kennelly and solicited his criticisms. He made many valuable suggestions, the most important one being that I should secure more data on a larger number of test samples tested by approved methods. This advice has been carefully followed; in the preparation of the paper only tests on toroid rings were included for purpose of demonstration.

For purpose of data for the βH curve, the test procedure was the well-known procedure described in standard books. The curve obtained is what Mr. Lippelt calls the "maiden curve," which in every case probably goes through the origin as may be seen from the tables of data. In plotting the curve the lower part of the curve is generally omitted for the simple reason that this paper is limited to a study of the law of magnetization for values of β near saturation; the reason for the preference has already been explained.

In order to develop a sufficiently strong magnetizing force without excessive heating, a form of winding of the magnetizing coil has been developed. (See Fig. 6-0 accompanying this discussion.) This scheme of winding offers the best facilities for cooling; it was found in one case that a test at $H = 1000$ occupying a period of 15 sec. caused a fall in temperature from 23.4 deg. cent. to 22 deg. cent. instead of a rise, which demonstrates the cooling efficiency of this kind of winding.

Fig. 3-0 herewith gives the scheme of wiring for the test for incremental permeability and Fig. 4-0 herewith, for the βH

relationship; the method of test is described fully in the introductory paragraphs in Tables III and IV.

Mr. Lippelt observes that in my investigation "no attention whatever has been paid to magnetic hysteresis." The point is correctly observed; I have concentrated my attention for the present on the form of the normal induction curve near saturation, just as he has concentrated his attention on the form of the hysteresis curve. The field of magnetic phenomena is too vast to

it to $H = 200$; Dr. Yensen covered the range $H = 200$ to 500. When my turn came, I started where my predecessors had stopped and carried the limit to $H = 1600$ on toroid rings, and to $H = 4000$ on the saturation permeameter. The problem of hysteresis is certainly very important, and I believe we are all glad to know that Mr. Lippelt has been studying it very carefully, but I fail to see what that problem has to do with the study of the phenomenon of saturation and allied phenomena.

Incidentally, I may mention here that the βH curves in the paper under discussion are normal induction curves; they are not the descending side of the hysteresis loops, as has been assumed by Mr. Lippelt. A large part of his criticism is based on this assumption and needs no further discussion.

With reference to the comparative sensitiveness of the several types of curves, it should be remembered that this peculiarity has no reference to curves expressing the relationship of directly measured variables; it refers to derived variables only. For example, in plotting a $H \rho$ curve the values of H are plotted directly from measurement, but the values of ρ are derived by computation from values of β and H .

The question of sensitiveness has no reference to the βH curve; it is relevant in reference to the $H \rho$ curve; this is also true

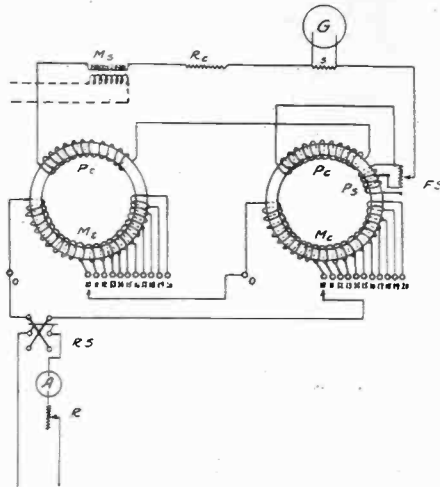

FIG. 3-0—SCHEME FOR TEST FOR INCREMENTAL PERMEABILITY

- Pt Potential coil for test ring (Sheet iron ring No. 1)
- Pc Potential coil for auxiliary ring (Sheet iron ring No. 2)
- Ps Potential coil for auxiliary (Supplementary)
- Fs Fractionizing shunt
- Mt Magnetizing coil for test ring (Sheet iron ring No. 1)
- Mc Magnetizing coil for auxiliary ring (Sheet iron ring No. 2)
- Ms Standard mutual inductor
- G Galvanometer
- R C Calibrating resistance

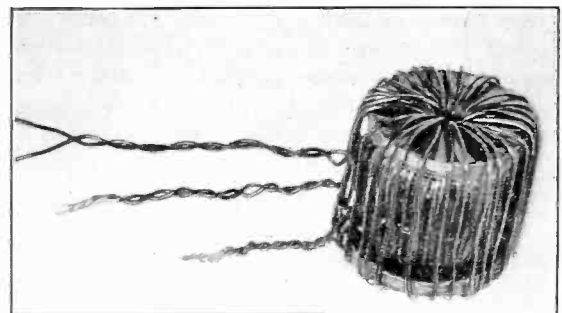

FIG. 6-0—CRATE-WOUND IRON RING SAMPLE

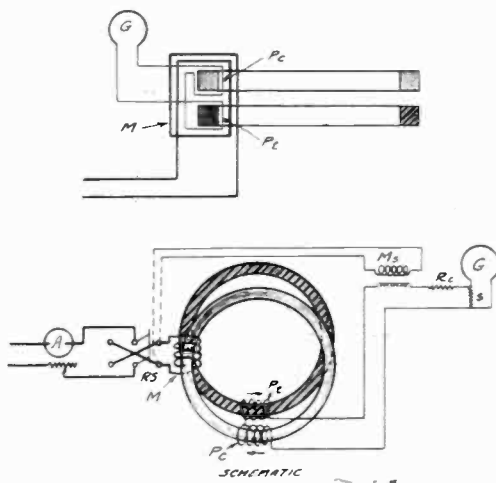

FIG. 4-0—TOROID RING WITH CORRECTION FOR SPACE FACTOR

- Pt Potential coil for test (Sheet iron ring)
- Pc Potential coil for compensation (Bakelite ring)
- M Magnetizing winding
- G Galvanometer
- Ms Standard mutual inductor
- Rc Calibrating resistance
- RS Reversing switch

be covered fully and satisfactorily by any single explorer; it calls for the collective effort of a large number of physicists, who are expected to divide the field into sections, each one choosing for himself the part he is best fitted to study. Lord Raleigh and Dr. Kennelly made a special study of the magnetization curve below the point of maximum permeability. Dr. Kennelly carried the upper limit of test to $H = 90$; Dr. Steinmetz carried

of the $\beta \mu$ curve because the values of μ are not obtained by direct measurement, but are always derived by computation from values of β and H . In the case of the $\beta \mu'$ curve (Fig. 3-1) the data for β or μ' are both obtained directly, which makes irrelevant any question about the sensitiveness of the $\beta \mu'$ curve.

As to the law of magnetization, the function of the straightness of the $\beta \mu'$ curve (Fig. 3-1) is purely suggestive; it is not intended to demonstrate the law. The law in its final form is an equation expressing the relation of β to H (equation 30); its legitimate demonstration should consist of an agreement of the βH curve by observation, with the corresponding curve by computation from the equation in question (see Figs. 1-8, 4-4, 12-4, etc.).

For the same reason the $H, \log \gamma$ curve is not well suited to the purpose of demonstration. There is no method available at present for direct measurement of $\log \gamma$ for any required value of H . The values of $\log \gamma$ are derived by computation from measured values of β . The value of the $H, \log \beta$ curve for purpose of demonstration is dependent on the sensitiveness of the curve, which is quite insensitive for low values of H , and supersensitive for high values of H , as saturation approaches. In view of these facts I have based my demonstration on the agreement of the βH curve with the corresponding reconstruction curve, rather than on the straightness of the $H, \log \gamma$ curve.

One part of Mr. Lippelt's criticism is not clear to me; he says: "The author of the paper violates his own theory (to a certain extent) when he eliminates β from equation (21), and reduces it to the form of (23) and (26)." I should be glad to give full consideration to his criticism on this point, if I only knew what he meant thereby.

As to the two straight lines in Figs. 1-6 and 3-4; the study of that part of the problem has just been started. It is not possible to say anything confidently at present, while further experiments

are in progress. Mr. Lippelt's suggestions are noted for consideration. The absence of a corresponding kink in the $H D$ curve is not significant, as none was to be expected. Such kinks are scarcely noticeable except when they are very pronounced, or unless the curve is very nearly straight. For example, the practically abrupt bend in the $H \rho$ curve has long been noticed, but nobody notices a corresponding kink in the βH curve.

With reference to Mr. Lippelt's modification of Frolich's law, that modification does not affect the form of the curve near saturation. The law even in its modified form, therefore, is not expected to give any better agreement with the observation curve than the law in its original form.

With reference to Dr. Kennelly's comments, it is satisfactory to note his agreement on all the main points, except one which will be discussed later.

With reference to latent flux, he takes exception to the assumption that "it is made up of two groups of lines in opposite directions making an algebraic total of zero lines." Perhaps he is right; the assumption may need more evidence than has yet been presented, but I fail to see how that criticism concerns me. All I have done in paragraph 4 of the paper is to present the Weber-Ewing theory in my own words, so as to be able to reduce the theory to an analytical form as represented by equations 5 and 6. Valid or invalid, it is their theory and my duty was merely to paraphrase it correctly in my own words. It is easy to see that that aspect of the theory to which Dr. Kennelly takes exception is really a part of the original theory as presented by Prof. Ewing. This may be seen from the following extracts from Ewing's *Magnetic Induction*, Chapter XI, Molecular Theory.

"The Weber molecule is a magnet before it begins to act, and the amount of magnetism in it need suffer no change, however widely the magnetism of the bar be altered. Hence Weber's theory explains the process of induction to this extent, that it makes the magnetic change in the bar be brought about by a change in the position of the molecules, and not by any change in the quality of the molecules."

"The fact that a definite saturation value is now known to exist adds much probability to Weber's hypothesis."

In article 179, "Amount of Retentiveness Possible Under Molecular Theory," Prof. Ewing takes m = magnetic moment of a single molecule, and treats it as a constant in the integral equations which are functions of the angle of orientation α . It is obvious, therefore, that the constancy of flux in a magnetic molecule is one of the requirements of the Weber-Ewing theory.

Incidentally, I may add that this is also my personal view, but that this consideration is not responsible for my statements in paragraph 4 of the paper, which is merely a presentation of the Weber-Ewing theory, irrespective of my own views on the subject.

On one point it seems we have not been able to reach an agreement; the best I could do is to state the difference as I see it, in explicit terms; I hope that in the course of time one of us or perhaps both of us will have reason to revise the present views, and thus reach an agreement.

Dr. Kennelly's view is that for a range of magnetizing force up to about $H = 90$,

(1) The $H \rho$ curve has the form of approximately two straight lines with a short elbow connecting them. (This is Kennelly's law.)

(2) This law was well supported by test data prior to the discovery of the law; later test seems to have confirmed it. Some new tests seem to contradict it, but these are yet unchecked and their evidence is yet unconvincing.

(3) From an engineering point of view, the straight-line relation presented by the $H \rho$ curve is the simplest relation, connecting the fundamental quantities H and β .

(4) From the physical theory point of view, the straight line

is the first approximation towards a more complicated law, and the straight-line law is therefore quite correct in that limited sense.

My own view is:

(5) The straightness of the $H \rho$ curve is not approximate straightness as is generally believed, but only an apparent straightness caused by the insensitive character of the $H \rho$ curve.

(6) Assuming that the reliability of Kennelly's law was well proved by the data presented by Dr. Kennelly in the first place, it must be conceded that no new data have been presented by me or by anybody else to refute it.

(7) On the contrary, my own tests have strongly supported the law over a limited range, viz., (a) for the region of first inflection, (b) for the region of second inflection, (c) for the region of saturation.

(8) My objection to Kennelly's law is merely this—that it is not reliable for purpose of computing saturation value. On this point there is no difference of opinion between me and Dr. Kennelly. This objection to Kennelly's law is not an objection to that form of the law, but to Frolich's law in general, of which that law is only one form.

(9) In addition to the above mentioned objection, which holds against all forms of Frolich's law, there is one objection peculiar to the Kennelly form of the law, viz., that the reluctivity curve is insensitive and misleading. The straightness of the curve is only apparent due to the insensitive character of the curve, and is therefore illusive. The insensitiveness of the reluctivity curve has been demonstrated in the paper analytically by equations 31-2, and graphically by Figs. 5-1 and 5-2. I believed that this evidence of insensitivity should have been quite convincing. Fig. 5-2 was expected to convince Dr. Kennelly in particular, as it represents data (Table V-2) on which he had based his law, instead of what he calls "new and unchecked tests."

(10) Kennelly's law is not the simplest form of Frolich's law. Bosanquet's law, $\mu = a \gamma$, is certainly a much simpler form, as may be ascertained by anybody who tries to compute the values of H for any required value of β .

(11) The only reason why Bosanquet's law never became as popular as Kennelly's law is that in that case the failure of the law to represent facts is so obvious as to compel one to reject it. In the case of the failure of the linear law of reluctivity not being so obvious, some of the best scientific minds have been misled by the apparent straightness. For example, in 1891, while expounding the law of reluctivity, Dr. Kennelly had said that the purpose of his paper was to show that while the $\beta \mu$ curve is a "complicated curve"—a curve which "you would not like to define by any particular formula"—the "curve which follows from the conception of inverse of permeability is fortunately a very simple one," being made of two straight lines connected by an elbow. In the paper under discussion, I have shown by mathematical reasoning that if for any range of magnetizing force the $H \rho$ curve consists of two straight lines, the $\beta \mu$ curve for the same range must also consist of two straight lines, and conversely if, as Dr. Kennelly admits, the $\beta \mu$ curve be incapable of representation by a pair of straight lines, neither can the $H \rho$ curve be so represented. The appearance of straight lines in such a case must be recognized as illusory and misleading, and its value as evidence must be ignored.

The above conclusion (No. 11) is the main point of difference between myself and Dr. Kennelly. The conclusion is not based on any particular tests old or new, checked or unchecked; it follows a mathematical reasoning, based on a study of the relation of $\beta \mu$ and $H \rho$ curves irrespective of any test data. If, therefore, this conclusion is unacceptable to Dr. Kennelly, it must be only by reason of some fallacy in that reasoning of which I am unconscious and which he has not yet disclosed. I would be very thankful if he makes himself clearer on this point.

SYNCHRONOUS MACHINES—I¹

(DOHERTY AND NICKLE)

WHITE SULPHUR SPRINGS, W. VA., JUNE 23, 1926

C. A. Adams: In nearly every piece of electrical machinery we have two or more magnetomotive forces. There are two general methods of dealing with these m. m. fs. They may either be combined into a resultant m. m. f. and the corresponding flux computed therefrom, or the several fluxes produced by the several m. m. fs. acting separately may be computed and combined into a resultant. These two methods yield the same result, provided the reluctances of the magnetic circuits in which they act are constant.

In the part of the machine under consideration—namely, the air-gap region—reluctances may be assumed approximately constant, although varying from point to point along the air-gap.

I have never quite liked the method of dealing with the total apparent reactance of the armature of an alternator, either for the salient-pole or the non-salient-pole machine, since it deals with a hypothetical flux in a very complicated magnetic circuit. I much prefer the method in which the field and armature m. m. fs. are combined or compounded. In the case of the non-salient-pole machine, this method may be applied as follows:

Leaving the local variation of gap reluctance, due to the presence of the teeth, to be considered separately in terms of the resultant tooth harmonics, the air-gap permeance may be considered constant from point to point around the periphery. First, compute the peripheral distribution of field m. m. f. and resolve this into its space fundamental and space harmonics. Combine this space fundamental with the space fundamental of the armature m. m. f. in their proper space-phase relation. The resultant sinusoidal space distribution will yield a sinusoidal flux which determines the fundamental of the armature e. m. f.

The space harmonics of the field m. m. f. will yield corresponding harmonic fluxes, which will generate harmonics e. m. fs. in the armature, the magnitude of which will depend otherwise upon the nature of the winding. In most non-salient-pole machines these harmonic e. m. fs. should be small, particularly in three-phase machines with an armature coil pitch of about 86 per cent.

The harmonics of the armature m. m. f. distribution considered separately will yield space harmonic fluxes revolving at speeds inversely as the orders of the harmonics; that is, they will induce in the armature winding e. m. fs. of fundamental frequency. Moreover, as these fluxes are proportional to the armature current, the resulting e. m. fs. will be in quadrature with the armature current and therefore reactive e. m. fs., the sum of which is nothing more nor less than what has been called the belt-leakage e. m. f., as Mr. Doherty has already pointed out. The question as to whether this includes the tooth-tip leakage e. m. f. depends upon the definition of tooth-tip leakage. Personally, I prefer to consider the tooth-tip leakage as involving only that flux which passes between the tops of two adjacent teeth by way of such iron surface as may partially close the circuit on the other side of the air-gap, which in large alternators is usually small and may be included as an extra term in the individual slot leakage.

This method would leave only three items for the reactance voltage of the machine: the slot leakage, including a small amount of tooth-tip leakage above described; the coil-end leakage; and the belt leakage, which is nothing more than the e. m. f. induced in the armature conductors by the space harmonics of the armature m. m. f. This latter in a three-phase machine with balanced load and 5/6 coil pitch is a fraction of 1 per cent.

In the case of the salient-pole machine, there is no method available superior to Blondel's two-reactance method, although

the method outlined above can be applied with certain rather crude approximations to take account of the lack of uniformity in air-gap reluctance in different parts of the periphery.

Mr. Doherty's amplification or extension of the Blondel method is certainly a very interesting and valuable contribution to this important subject.

P. L. Alger: There are three points about this paper on which I think it is worth while to enlarge somewhat. In the first place, the paper is very long and it might appear that it would be possible to combine all these long series into a few terms and get shorter equations which would be simpler to use. The answer to that is that we have a great many problems which require very complete analyses and others which require only incomplete analyses, so that we need a theory which will satisfy either demand.

The old approximate theories are sufficient for ordinary problems, but if we have to abandon them and go to another extensive theory for special problems, it is too inconvenient to tolerate. Therefore, by developing the whole problem in terms of series in which the first few terms are important, later terms less important and the last terms very unimportant, we can solve all problems by the same method no matter how complicated they may be by carrying the calculations only as far as each case demands. Thus we have a complete theory for all purposes and yet the work done in each case is suited to the particular need at hand. So I think this method of carrying the whole analysis out in infinite series is by all means the best, and the one which should be followed in most problems of a similar degree of complication.

The second point I should like to enlarge upon is that of showing the need for such extended solutions in every-day life. Nowadays we try to make a study of the conditions and make a machine to fit those conditions. Thus we have a great many freak machines or machines that are not at all good electrically, but yet are so designed as to serve a particular purpose most economically. For example, in manufacturing we desire to have only a few dies, and to keep in stock only a few sets of punchings, and yet to be able to apply these to all cases. This requires that we have fractional slots per pole on almost all machines. We put up with the inconvenience of having irregularities in the winding to get the greater convenience of manufacturing simplicity.

This leads to the result that our armature windings are sometimes unbalanced by a small amount, and also they are nearly always irregular.

Messrs. Doherty and Nickle assume throughout that each pole is like every other pole; that is, that the number of slots per pole is integral. We actually have a variation of armature reaction around the periphery which makes each pole different from its neighbors, but which balances around the whole machine. These variations lead to additional harmonics and other things not touched upon by this paper.

But the method is such that these features can be added at any convenient time by simply calculating the variation of armature reaction around the periphery and treating that as an additional source of harmonics, additional fluxes and voltages without disturbing the structure of the whole theory.

One case where a practical problem to which this theory lends great aid arises is in making a synchronous machine without external excitation. We ordinarily think of synchronous machines as requiring some supply of d-c. excitation from outside, although by making a salient-pole machine such as Mr. Nickle has shown, a synchronous speed can be obtained with a certain amount of power without external excitation.

Suppose we make a machine with one large harmonic in addition to the fundamental in its m. m. f. distribution, and with a variable permeance as well. By so selecting the harmonics of the m. m. f. and permeance distribution that the flux made by the fundamental m. m. f. acting on a permeance harmonic will have

the same number of poles as the harmonic m. m. f. acting on the average permeance, we can produce a new type of machine.

For this machine will have two separate revolving fields produced by different sources whose relative speeds depend on the speed of the rotor, and will synchronize at a certain rotor speed. That will give a synchronous machine operating with quite a large torque without any external excitation. It can be done, to be sure, only if the machine operates below the synchronous speed for the fundamental itself, which leads to high losses; but it is quite feasible for small motors such as those used for driving control instruments, so that there is quite a field for this kind of machine.

This paper gives a theory which explains and enables us to solve quite completely many of these special problems.

The final point which I should like to bring out is that touched upon by Professor Adams and Mr. Doherty; this is the problem of calculating the reactance due to the slots. Both Professor Adams and Mr. Doherty have given the impression that the reactance due to the slot harmonics, themselves, is very small; but if we build a machine with very few slots per pole, this reactance may become a large part of the whole, and a very important feature of the machine.

In the case of an induction motor, the theory in the articles such men as Arnold and Professor Adams have worked out and published, involves the calculation of the effect of the slot openings, as that of the average overlapping. These formulas are rather hard to apply, and they are indefinite in the case of a large ratio of slots. By taking another point of view, a much simpler and more accurate solution can be obtained. This point of view is to consider that each coil in a slot makes a rectangular m. m. f. wave and a corresponding flux distribution, and to show that the total flux is simply made up of the sum of all the various rectangles made by all the coils. It is evidently possible to calculate the total voltage made by each rectangle of flux, and hence the total voltage produced in the winding by the total air-gap flux. Subtracting from the total the voltage due to the useful or fundamental flux, which is easily calculated, the difference gives the reactance voltage due to all the harmonics of the air-gap flux.

The formula so derived for the total zigzag leakage reactance is very simple. It is this:

$$X_T = \frac{\pi^2}{10} \left(\frac{P^2}{S_1^2} + \frac{P}{S_2^2} \right) X_M$$

where P is the number of poles, S_1 and S_2 the number of primary and secondary slots, respectively, and X_M is the magnetizing reactance corresponding to the fundamental of the air-gap flux.

By zigzag leakage I mean the harmonics of air-gap flux produced by the localization of the m. m. f. in slots, which are the harmonics that have distribution and pitch factors equal to the corresponding factors for the fundamental.

This formula shows the reactance due to the tooth harmonics in the flux, obtained by subtracting the useful from the total e. m. f. produced by the air-gap flux. The analysis assumes, of course, that the slot m. m. fs. are concentrated at points rather than distributed across the slot openings.

In the infinite series of air-gap flux harmonics, those which have unity values of distribution and pitch factors with respect to the fundamental are included in my formula. They are much more important usually than the other harmonics which correspond to the true belt leakage.

The belt leakage is due to the winding arrangement as regards pitch, and number of phases; and is nearly independent of the zigzag reactance with which I have been dealing. It is best to separate the two and keep them distinct.

By taking the same idea of a rectangular m. m. f. applied over the permeance distribution worked out by Mr. Doherty, we hope to obtain a similar formula for the tooth-tip leakage

reactance of synchronous machines. We know this reactance may be large and in some cases we find it is a vital element in the design of a machine. So, by utilizing these ideas of permeance distribution calculated from flux plots, and m. m. f. waves made up of certain totals and certain useful fundamentals, we hope to derive simpler formulas for the reactance than have heretofore been available. If our plans go well, a paper along these lines will be presented to the Institute in the near future.

C. A. Adams: Mr. Alger must have misunderstood what I was saying. I was referring exactly to that same point of view. I spoke of the armature combination of magnetomotive forces and the separation of the total magnetomotive forces and the fundamentals. Those harmonic fluxes are proportional to the currents and generate reactance voltages, but it was a cross-gap flux to which I referred when I spoke of the particular case of less than 1 per cent.

M. I. Pupin: An alternator or an a-c. motor may sometimes look like a queer machine, depending upon the purpose for which you wish to use it.

Now I shall give a brief description of an alternator that I have been working with for a number of years. Consider an alternator with suitably laminated field and armature cores. Send a small direct current through the field coils and rotate the armature, the armature being short-circuited. What do we get? We get alternating electromotive forces in the armature as well as in the field coils, not one of them but an infinite series in each; the components of the series are harmonically related to each other.

I have treated this scheme mathematically and find that, mathematically, the problem can be solved. You get two beautiful series, each of which is convergent. The coefficients of the various harmonics are also infinite convergent series.

Suppose I want to use that machine for the purpose of modifying the feeble field current by a cable signal. As long as you have a constant current in the field the machine will generate an alternating high-frequency current of constant amplitude. Now superpose the cable signal and you will have an alternating current with amplitudes varying in accordance with the variation of your cable signal. The machine generates a high-frequency e. m. f. modulated by the cable signal and it is obvious that it offers a means of amplifying low-frequency cable signals. It works beautifully except for some of the difficulties the gentlemen brought out this morning.

If the air-gaps vary, or if the field core and the armature core vary from point to point, then you get fluctuations, even without the cable signals. Therefore, when rectified, you will not get a straight line but a wavy line, and that is absolutely useless for cable signaling purposes. It may be useful for some other purpose, but not for cabling. Experimentation with a machine of that kind will show how difficult it is to make an alternator which will give a constant electromotive force of definite frequency and amplitude. It is practically impossible as long as you use iron in the field and in the armature. I have tried it and failed.

Then I did this: I used an alternator without any iron in the field or in the armature. There you don't get any variations due to the material of which the magnetic field is made, the variation due to the variation of the air-gap is negligibly small because the whole machine is an air-gap.

You will say that this is a very inefficient machine. It is, but it does the trick, and you don't care how inefficient it is because you can use the amplifier and amplify to any desirable limit.

R. W. Wieseman: I should like to say a few words about the graphical solution of plotting magnetic flux distribution as shown on the fifth and sixth pages of this paper.

It is sometimes thought that the predetermination of flux-density curves is purely a theoretical operation. On the contrary, it is a very practical problem and it is used extensively in

the design of dynamo machinery. A number of flux-distribution coefficients can be obtained by the graphical solution and their values check test results very closely. A good example of this is the predetermination of the characteristic curves of a two-speed, salient-pole, synchronous motor.²

In the near future, I shall present a paper which will show the practical application of the graphical solution of plotting flux-density curves to the design of synchronous machines.

R. D. Evans: I should like to suggest to those interested in the matter of space and time harmonics, comparison of the method presented in this paper with that given by C. L. Fortescue in his paper on *Symmetrical Coordinates*.³

With reference to the variation in leakage reactance caused by the non-cylindrical rotor construction salient-pole machines, I note that the authors pointed out that the variation is quite small. In such investigations that I have carried out for other purposes, my experience would indicate that such variations are small.

In regard to the power-angle diagrams, which are quite important for such studies as stability, the use of a two-reaction method of some sort is, of course, very necessary. Otherwise, as pointed out, large discrepancies in the relation of rotor position to terminal voltage would arise. The use of a two-reaction method seems to be particularly desirable for transient investigations because the paths of the direct-component flux and the cross-component flux are physically different and the resolution into two parts would permit taking them into account separately. In connection with the determination of the relation between rotor position and terminal voltage and excitation, Mr. Wagner and I carried out some investigations measuring the rotor position by another machine on the same shaft. We obtained very close checks of rotor position relative to terminal voltage from test results with the classical method of Blondel.⁴

John F. H. Douglas (communicated after adjournment): This paper is an important step forward in the theory of synchronous machines, since it considers for the first time the effects of the harmonics in the magnetomotive force wave, upon the characteristics of the machines. One striking conclusion of this paper is the fact that the reactance and reaction coefficients can be obtained from the analysis of the wave of air-gap permeance. Another, shown by Figs. 5-11, is that the permeance in the interpolar regions of these machines, is considerable. It is not generally appreciated that the permeance of the air-gap is different for field and armature magnetomotive forces, and that it is different for different orders of the armature harmonics of m. m. f.

The accompanying Fig. 1 shows a method of testing air-gap permeance used by the writer and E. W. Kane of Marquette University. While our tests gave waves of the zero order, yet our values check closely with those given by the authors of this paper. It is noteworthy that Table II in conjunction with equations (1c) and 2c yield a ratio of transverse to direct reaction of approximately 50 per cent. This ratio is substantially higher than that obtained by those authors who neglect the permeance of the interpolar regions.

It is a fact that in predicting reactance, the flux paths assumed lead to values less than the experimental value. Considerable discrepancy exists between rational and experimental values of reactance. It is to be noted that the third and fifth terms in eq. (3c) may in some cases increase values of reactance calculated by some 30 per cent. Thus the refinement in theory is well justified, if more accurate estimates of reactance can be obtained.

Some of the results of this paper are negative. For instance eq. (7) indicates that direct and transverse reactance are sub-

stantially equal. This conclusion, however, is based on the definition of reactance as due to local fluxes, and fluxes in relative motion to the field structure. A more useful definition is that "reactance" and "reaction" are those vectors proportional to the current in the e. m. f. and the m. m. f. diagram respectively. Since only tests can determine this question, the existence of a "variable leakage reactance" must still be regarded as an open question.

The authors say, "The effect of salient poles on the magnitude of required excitation is very small." While this is generally the case, there are exceptions under conditions of abnormal conditions of operation, as for example in the "nose" region of the synchronous-motor characteristic and near the unstable

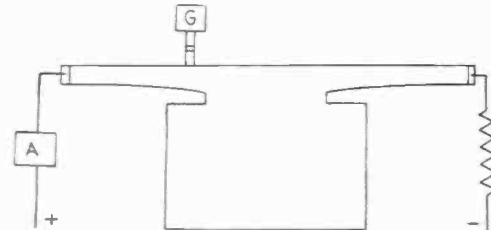

FIG. 1—METHOD OF TESTING AIR-GAP PERMEANCE

point of generator operation. Consider Fig. 2 herewith for a generator carrying heavy charging current of a transmission line and no other load. The drop $I X_q$ is less than the terminal voltage, and this in turn is less than the drop $I X_d$. The Potier diagram gives a positive, the Blondel, a negative excitation. Fig. 2 also shows the complete zero-leading power-factor characteristics predicted by both methods.

Fig. 27 is based on three assumptions; saturation in the arma-

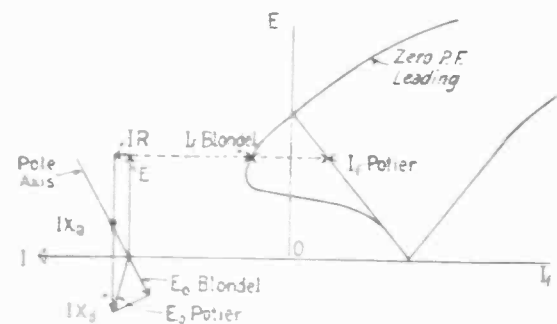

FIG. 2—COMPARISON OF BLONDEL AND POTIER DIAGRAMS NEAR UNSTABLE REGION

ture and cross field negligible, and a transverse reactance identical with direct reactance. In deciding whether a given component of the effect shall appear in the m. m. f. diagram the question is whether experiment shows this factor as more constant as an e. m. f. or an m. m. f. vector. The writer knows of no way to settle this point theoretically. It is conceivable, for example, that all the cross fluxes, not only those represented by X_{aq} but those of X_{1q} might be affected by saturation.

The data given by the writer in a paper on "Synchronous Motor Characteristics"⁵ indicated at least that X_{aq} is greatly affected by saturation.

Quentin Graham (communicated after adjournment): Messrs. Doherty and Nickle have dealt in a comprehensive way with a problem that is treated usually in a much less rigorous manner. The method of harmonic analysis is certainly the only one that is adequate for the treatment of many of the more complex problems of synchronous machines. It seems to me that the chief usefulness of the paper is not in a refinement of reactance and reaction calculations, with which Part I is concerned, but

5. Douglas, Engeset and Jones, A. I. E. E. TRANS., 1925, p. 164.

2. A. I. E. E. TRANS., 1925, p. 436.

3. A. I. E. E. TRANS., 1918, p. 1027.

4. Studies of Transmission Stability, by R. D. Evans and C. F. Wagner, A. I. E. E. JOURNAL, April, 1926, p. 374.

rather in the solution of innumerable special problems in which a similar method of attack is required.

Since the assumption of uniform permeance is a common one in considering synchronous-machine performance it may be well to emphasize some of the differences that a variable permeance produces. It is shown in the paper that fundamental voltages are set up in the armature conductors by the following fluxes:

a. The flux which results from the fundamental of the armature m. m. f. and the zero-order component of the permeance series.

b. The flux resulting from the fundamental of the armature m. m. f. and the second-order component of the permeance series.

c. The flux resulting from the combination of any higher harmonic of the armature m. m. f. and the zero-order of the permeance wave.

d. The flux resulting from the combination of any higher harmonic in the armature m. m. f. and the second-order term in the permeance wave.

e. The fundamental component of the no-load field form.

In a machine having a cylindrical field member with uniform permeance the fluxes *b* and *d* are absent. There is left then the flux *a*, which is the usual armature reaction flux, and *c* which is a wave of short span traveling at slow speed whose effect is more conveniently grouped with the reactance fluxes. With the assumption of uniform permeance, that is, with only the zero-order term present in the permeance expression, we may say that all harmonics in the armature m. m. f. wave including the fundamental set up fluxes which generate fundamental voltage in the armature. Further, no voltages of other frequency are generated or, expressed differently, no time harmonics appear.

The introduction of salient poles and variable permeance is responsible for the flux *b*, which adds to the armature reaction flux, and *d* whose effect is grouped with the reactance. The fluxes under *d* are of various wave lengths but travel at such speeds as to give fundamental voltages. In addition there are the various fluxes having combinations of wave length and speed of rotation such as to produce frequencies which are multiples of the fundamental. It is the variable permeance that is responsible for the presence of time harmonics except of course, those that are due to the shape of the field flux form and which are present even though there is no current flowing in the armature.

These facts are all contained in the original paper but are repeated here in different form and with a slightly different point of view.

There are two points of possible importance which the authors appear to have omitted in their paper. The first is the effect of a damper winding on the magnitude of the various harmonic fluxes. Any m. m. f. wave which has a velocity other than synchronous may set up secondary currents in the rotor which will have the effect of reducing the magnitude of the flux waves set up by that m. m. f. The paper contains a discussion of the induced currents in the field winding and concludes that they may be neglected. It is probable that the same conclusion was reached concerning the induced currents in damper bars although I believe these currents should be considered in cases where particular time harmonics are of importance. Their effect on reactance in the steady state is probably imperceptible.

The other point to which I wish to call attention is the phase sequence of the fundamental voltages generated by the various fluxes. Since the fifth space harmonic, for example, travels against rotation and produces a flux wave with the same direction of travel, the voltage induced in the three-phase armature winding has opposite sequence to the main induced voltage.

This negative sequence voltage which is grouped among the reactances appears at the terminals as an unbalance in the three voltages. In Fig. 15 of the paper e_{5d7} and e_{5q7} are voltages produced by positively rotating flux while e_{5d5} and e_{5q5} are the result of fluxes rotating negatively. The same is true of part of the fundamental voltages arising from the 11th and other space harmonics of the armature m. m. f. It is surely incorrect to add these various voltages in the final reactance equation just as though they were all induced by positively rotating flux waves. I realize that the voltages calculated are for one phase and that equations (58a) and (59a) could give correct values for the voltage of, say, phase 1. But since the time relation of between voltages induced by positively rotating and negatively rotating fluxes is different for phase 2 and phase 3 the same equations would not apply.

I have been particularly interested in the footnote on the thirteenth page which refers to the harmonics of irregular windings since I have in the course of preparation a paper which covers in some detail the calculation and the effects of these harmonics.

R. E. Doherty: Professor Adams has said that it is immaterial, so far as final results are concerned, whether fluxes or m. m. fs. are superposed. When saturation does not exist, such quantities which exist at the same point may be superposed. All armature m. m. fs. are distributed along the armature surface and hence may be superposed. The field m. m. f., however, is located at some distance from the armature surface and, hence, cannot, in general be superposed directly with armature m. m. fs.

I am just raising the point that every now and then we are likely by habit to superpose quantities that properly cannot be superposed. If we assume a fictitious m. m. f. which, if located at the armature surface, would produce the same effect as the actual field winding, then of course we may superpose this fictitious m. m. f. with those due to the armature since they are now at the same point. In cylindrical-rotor machines, this fictitious m. m. f. would be practically the same as the actual m. m. f. and it would be immaterial which we use. In salient-pole machines, however, the fictitious m. m. f. would be greatly different from the actual m. m. fs. In such cases it becomes much simpler to superpose fluxes than to attempt to obtain the correct m. m. f. to use.

As to the question of fractional slots which Mr. Alger has brought up, we especially stated that the treatment of this is beyond the scope of this paper. I hope that some one in the future—perhaps Mr. Alger—will treat this case.

Mr. Graham has stated that the fifth-harmonic flux, rotating backward with respect to the armature, will induce a negative-sequence fundamental voltage in the armature winding. For a fundamental wave, phases 1, 2, and 3 are located at 0 deg., 120 deg. and 240 deg. respectively. For a fifth-harmonic wave these angles become 0 deg., 600 deg. and 1200 deg. which of course are the same as 0 deg., 240 deg., and 120 deg., respectively. This phase rotation for a fifth harmonic is thus opposite to the phase rotation for the fundamental. Hence it is necessary that a fifth-harmonic flux wave travel in a direction opposite to that of the fundamental wave in order to generate fundamental voltages having the same sequence as the fundamental.

Mr. Graham also raises a question regarding the effect of a squirrel-cage winding. The present paper does not cover this case. However, it is important to call attention to the fact, as Mr. Graham has done, that squirrel-cage currents may have an important effect on the value of the harmonic flux waves, and therefore upon the leakage reactance of the machine, even under steady-state conditions. It is the authors' opinion that the effect of such currents is not negligible, and an appropriate approximation would have to be made in case a squirrel-cage winding is present.

REPORT OF COMMITTEE ON ELECTRICAL MACHINERY¹

(HOBART)

WHITE SULPHUR SPRINGS, W. VA., JUNE 22, 1926

H. B. Dwight: The report states that the committee desires that suitable commercial test methods be developed for a more accurate determination of the efficiency of synchronous machines than is given by the present Standardization Rules. Possibly one of these items is the amount of core loss corresponding to full-load conditions.

At present the Standardization Rules specify the core loss for full load and rated voltage to be practically the same as that for no load and rated voltage, the small correction for resistance drop being almost negligible. If a satisfactory, precise test for determining the internal voltage of a synchronous machine were to be devised, full-load core loss could be taken equal to the reading on the core-loss curve corresponding to the internal voltage. This under full-load conditions would mean an increase in core loss of from 20 to 50 per cent, which is of considerable importance.

The internal voltage is equal to the vectorial sum of the terminal voltage and the reactive drop in the winding. What is desired, therefore, is a dependable test for the leakage reactance of a synchronous machine. There is a possibility that for cer-

1. A. I. E. E. JOURNAL, October, 1926, p. 940.

tain types of machines and for certain purposes, the leakage reactance may be taken equal to the measured reactance of the armature with the rotor removed. While this may not be precisely equal to the true leakage reactance, it is nearly equal to it for many usual machines, and it has the advantage that it is a definite, easily measured quantity.

Two students of the Massachusetts Institute of Technology, C. F. Kirsch and M. L. Libman, have arranged a sample machine so that they could make a direct measurement of the leakage reactance and compare it with the reactance when the rotor was removed. To do this, they isolated part of the winding which was large enough to be representative of the total winding. They put a load on the main part of the winding and measured the difference in the terminal voltages of the main part and the isolated part. This difference, corrected for the number of coils in each part, was equal to the reactance drop in the winding, and the voltage on the unloaded part was proportional to the internal voltage of the machine. The difference between the reactance measured in this way and the reactance of the main part of the winding when the rotor was removed, was about 20 per cent.

This "search winding" method is not intended to be a commercial measurement of the reactance of a complete machine, since it requires part of the winding to be set aside as a search winding. It is a means for judging other methods of measuring or calculating the reactance of synchronous machines.

Discussion at Pacific Coast Convention

VARIABLE-VOLTAGE EQUIPMENT FOR ELECTRIC POWER SHOVELS

(McNEILL)

SALT LAKE CITY, UTAH, SEPTEMBER 9, 1926

P. S. Stevens: Mr. McNeill has mentioned the effect of electric power on the mechanical design of the shovel, such as better gearing, lubrication, etc. I would like to further point out that the variable-voltage control with separately excited motors described by Mr. McNeill is so complete and well suited to shovel operation that it has been possible to simplify the mechanical design of electric shovels without any sacrifice. For example, on two models of medium-sized shovels recently developed, the usual band-type air-operated clutch previously required for disconnecting the engine or motor from the hoisting drum has been omitted. This clutch has been omitted for the same reason also on a large 12-yard Diesel-electric dipper dredge recently put in operation. The elimination of this clutch and its operating mechanism, reduces the care and maintenance of the shovel and is made possible by the quick acceleration and quick and smooth stopping afforded by the separately excited motor control with motor lowering. The motor is actually driven down to a certain extent, so that fast lowering speed is obtained and the shovel operator can graduate his lowering speed or check it any time under perfect control.

On the swing and thrust motions the variable-voltage control with separately excited motors is so perfect in stopping and plugging that swing and thrust brakes having large heat capacity and requiring air operation are omitted from the two models of shovels mentioned above, being replaced by the usual solenoid-operated motor brakes for holding and infrequent stopping. Hence the complete compressed-air equipment, including compressor, governor, tank, piping and all magnet valves, is eliminated, reducing operating costs and resulting in a more reliable shovel unit.

R. W. McNeill: Since preparing this paper the writer has been fortunate enough to secure graphic meter records showing the performance of a 4½-yard railway shovel, equipped with

variable-voltage electrical equipment. This shovel is one of a number which are in operation at a mine of a large western copper-mining company, which has recently gone through the process of converting all of its steam shovels to electric drive.

Electrical equipment on these 4½-yard railway-type shovels consists of a main motor-generator set, an exciter motor-generator set, two hoist motors, a swing motor, a thrust motor, and a motor-driven air compressor. With this equipment is included necessary starting and control equipment for all items. The main motor-generator set consists of a 225-h. p., 80-per cent power factor, 1200-rev. per min., 5000-volt, 3-phase, 60-cycle synchronous motor designed for starting at full line voltage; a 125-kw., 1200-rev. per min., 250-volt, differential compound-wound d-c. generator for operation of the hoist motion of the shovel, and two 30-kw., 1200-rev. per min., 250-volt, differential compound-wound d-c. generators for operation of the swing and thrust motions. The generators are designed to give a maximum voltage of 400 at no load, and a maximum current under stall conditions of approximately 1000 amperes in the case of the hoist generator and 250 amperes for the swing and thrust generators. The exciter set is of 7.5-kw. capacity at 125 volts and is driven by a 220-volt, 3-phase, 60-cycle motor. The hoist motors are of series type each rated 95 h. p., 230 volts, 440 rev. per min. These motors are operated in parallel from the 125-kw. hoist generator. The swing and thrust motors are of the separately excited shunt-wound type, each rated 50 h. p., 230 volts, 485 rev. per min. The air compressor is operated by a 7.5-h. p., 220-volt, 3-phase, 60-cycle motor. Transformers are used to step down the power for the compressor motor and the motor driving the exciter motor-generator set from 500 volts, the line potential, to 220 volts for the motors.

Fig. 1, herewith, shows power input to this 4½-yard shovel, measured on the 5000-volt line feeding the shovel. The upper curve is made with high paper speed and shows variations in power requirements of the shovel throughout several cycles of operation. The lower curve is made with low paper speed and shows to some extent the percentage of operating time obtained

with this shovel equipment. Records kept over a considerable length of time show that the shovels are in operation approximately 60 per cent of the time, the other 40 per cent being taken up with delays due to causes outside of the control of the shovel operator, the principal cause of these delays being waiting for empty cars. The power consumption on this property for

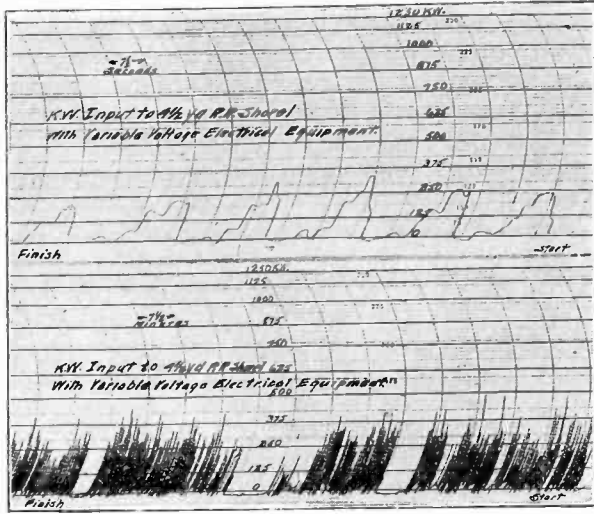

FIG. 1

shovel service averages approximately 0.2 kw-hr. per ton of material excavated. The amount of material excavated in a given time will depend upon a number of factors; however, average daily loading on this property is approximately 5000 tons per shovel per 8-hr. day. This is roughly equivalent to 3300 cu. yd. per day or 700 cu. yd. per hour of actual digging time.

Fig. 2 shows volt and ampere input to the hoist motors of the shovel over several cycles of operation. I would like to call especial attention to the regularity and uniformity of these charts. The largest area on the voltage chart represents digging areas, while the smaller areas, occurring regularly between

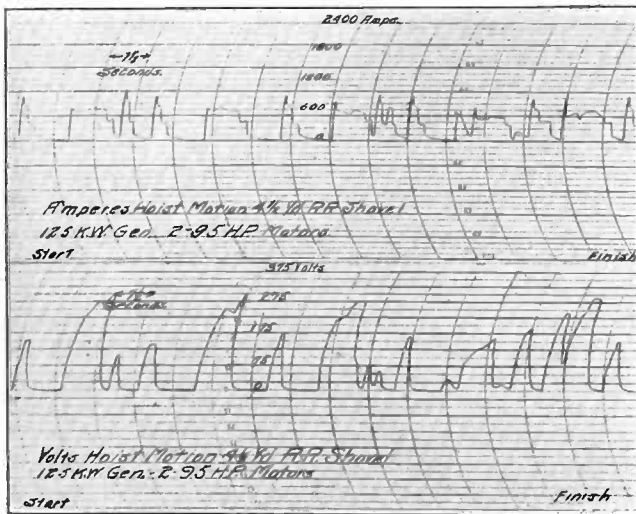

FIG. 2

the digging areas, represent power requirements for hoisting the loaded dipper during the dumping period.

Similar areas can be distinguished readily on the ampere curve. It will be noted that neither the current nor the voltage shown on the chart reverses in direction. This is due to the fact that the shovel dipper is lowered by gravity, during which period the hoist motors remain stationary, lowering of the dipper being accomplished by release of a clutch between the hoist drum and the hoisting motors.

Fig. 3 shows volt and ampere charts taken on the swing motion. The same regularity is apparent on this chart as on those taken on the hoist motion with the difference that the current and voltage both reverse in direction, as the swing motor has to furnish power in both directions of swing. The charts as shown on Fig. 3 were made simultaneously and it will be noted that the current reverses at times when the voltage stays in the same direction. This reversal of the current without the voltage reversing gives regenerative braking, which is used to stop the swing motion at the end of travel.

Fig. 4 shows volt and ampere charts taken on the thrust

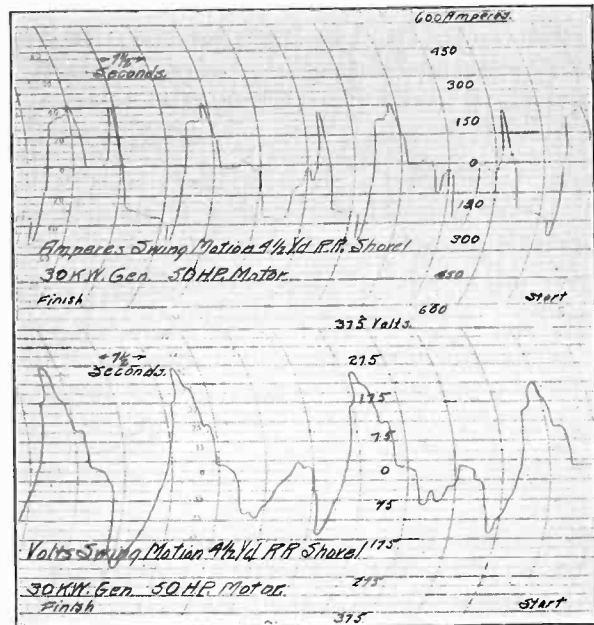

FIG. 3

motion. While there is an appearance of considerable regularity on these charts it is not so pronounced as in the case of the hoist and swing motion as operation of thrust motion does not follow nearly so definite a cycle as is the case on the hoist and swing

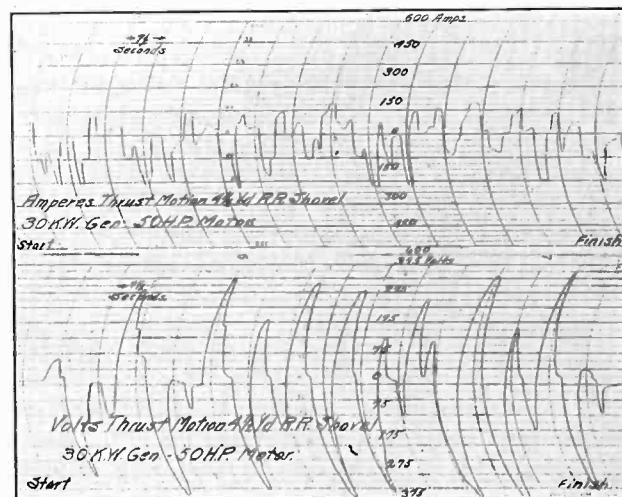

FIG. 4

The operations, however, are more numerous and a snappy thrust motion contributes considerably to the successful operation of the shovel. Plugging or regenerative braking contributes in no small degree to the successful operation of the thrust motion. The curves as shown on Fig. 4 were made simultaneously and the action of the current in reversing at plugging can be seen quite clearly.

Mr. Stevens in his discussion mentions that he has found the action of the variable-voltage control with separately excited

motors to be so perfect in stopping and plugging that swing and thrust brakes having large heat capacity and requiring air operation are not necessary and that they can be replaced by the usual solenoid-operated brake designed for holding and infrequent stopping. Along the same lines I would like to say that the user of the $4\frac{1}{2}$ -yard railway-type shovels, on which the curves presented herewith were taken, has found that on his variable-voltage equipped shovels he obtained improved operation by not using the motor brakes on the swing and thrust motions in ordinary operations. His method of operation is to allow these brakes to remain released during the greater part of his operation. On the swing motion about the only time the brake is used is when the shovel is traveling, at which time the brake is applied to keep the shovel boom from swinging. On the thrust motion the brake is used when it is necessary to thrust the dipper out beyond the end of the shovel boom for dumping, and where digging conditions are very severe. The shovel operator has the option of using the motor brakes if he chooses, as the only modification made in the control equipment to allow operation with brakes "released" was the installation of a small switch to short-circuit the controller contacts used for releasing the brake magnet coil. When this switch is closed, the brake will stay released, and when switch is open the brake will respond to the operation of the controller, that is, it will release when power is applied to the motor and will apply when the controller is brought to the off position. The advantages of operating without swing or thrust brakes are readily apparent as with the motors free to turn even a small amount, sudden impacts are softened and mechanical strains on the shovel parts decreased.

TEMPERATURE OF A CONTACT AND RELATED CURRENT-INTERRUPTION PROBLEMS¹

(SLEPIAN)

SALT LAKE CITY, UTAH, SEPTEMBER 9, 1926

F. E. Terman (communicated after adjournment): The results obtained by Dr. Slepian and his speculations on their significance are most fascinating. After reviewing the approximate temperature rise for different cases, as given in Table I, it is interesting to consider at least qualitatively the effect of some of the factors which have not been taken into account in the formula the paper derives for temperature rise.

The principal modifying influence is the temperature coefficient of resistivity. At the high temperatures which are often obtained at the last point of contact, it is apparent that there must be a large change of resistance of this active spot which carries the final burden of the break. While the derivation of a formula to take this change of resistivity into account is complicated by the fact that the voltage gradient cannot then be correctly expressed by equation (3), it is at least possible to speculate on the nature of this effect without resorting to a lot of mathematics of doubtful value. In the case of conductors which increase their resistivity with an increase of temperature, as is the case with most metals, the temperatures at the final contact point will be considerably less than indicated in Table I. With other materials, such as carbon and many poorly conducting bodies, the temperature rise reduces the resistivity. In these latter cases the temperature of the contact spot will be more than indicated in Table I. The change in resistivity in any case depends upon the temperatures generated, and this is influenced by the voltage to be broken. Accordingly, the results given in Table I are more nearly exactly correct as the temperature rise becomes smaller, and the temperatures will depart more and more from a proportionality with the square of the voltage broken as this voltage increases.

The results in Table I also assume that the steady-state temperature conditions at the contact spot are instantly established. Any failure to establish the steady state completely will give lower temperatures than indicated in Table I, and

although it is evident that the speed by which the steady state comes into existence is very rapid as the contact area gets smaller and smaller, yet at the last instant the speed of break at the contact is also infinitely great. I would enjoy seeing a discussion of this by Dr. Slepian, for I know from personal discussion with him that he has considered this point.

J. Slepian: Mr. Terman's remarks as to the influence of the temperature coefficient of resistivity of the electrode materials are very good and to the point. The increase of resistivity of metals with temperature will certainly greatly reduce the temperature rise at a last contact with a given voltage applied. If the formula of the paper is used, a value should be taken for the electrical resistivity larger than the resistivity of the cold metal.

The reason I believe that steady-state conditions apply at the last contact point is as follows: The mass of the material to be heated varies as the cube of the linear dimensions of the small contact area, whereas the electrical and thermal conductance vary as the first power of the linear dimensions. Hence, regardless of the speed with which the contact area is reduced to zero, the mass to be heated will play a vanishingly small part in the balance between the heat input, proportional to the electrical conductance, and the heat lost, proportional to the thermal conductance.

In the six weeks which elapsed between the presentation of my paper and the preparing of this closing discussion, some experiments have been carried out under my direction which require me now to take the unusual role of adverse critic of my own paper.

As critic, I must point out that in the formula for temperature rise as given, no account is taken of a specific contact resistance. It is assumed that all the resistance is through the material of the two electrodes up to the area of contact, and no account is taken of the voltage necessary to carry the current out of the one electrode and into the other, across the contact surface. Such a voltage is necessary, however, and it is found that this voltage varies nearly proportionally with the current density crossing the contact area, and also approximately inversely as the pressure on the contact area. Thus for clean copper surfaces, at 1-lb. per sq. in. pressure, the contact resistance is of the order of 0.0002 ohms per cm.²

When electrodes separate, this contact resistance varies inversely as the area of contact (and also inversely with pressure) whereas the resistance discussed in the paper—that is, that of the electrode material up to the contact area—varies inversely as the square root of the area. Hence, this contact resistance will certainly predominate when the area is small enough, and will limit the current so that very much lower temperatures will result than are given by the formula of the paper. In fact, it would seem quite possible to separate two metal electrodes in a circuit of a few volts so rapidly that no high temperature results at the last points of contact.

Now, replying as author, I explain the failure to consider contact resistance as due to my belief that such contact resistance was caused by surface oxide layers, and did not exist for clean metals. Also I believed that these surface layers were broken down at very low voltages so that a contact drop of more than a fraction of a volt was not obtainable. Since it appears that I was mistaken in these ideas, I must admit that the basis of much that is in my paper is lost. However, it is certain that it is almost impossible not to draw an arc between contacting metal electrodes in a circuit of a few volts, and that the difficulty of drawing an arc goes up with resistivity of electrode material in the way indicated in my paper. This may indicate, perhaps, that the contact resistance at the last contact point is for some reason negligibly small. It would be very desirable to have this whole paper worked over again, taking contact resistance into account.

Lest it be thought that this change of viewpoint follows upon a paper which was prematurely presented, I wish to state that the paper was written more than three years ago. The information

1. A. I. E. E. JOURNAL, October, 1926, p. 930.

on contact resistance at very high current densities (more than 100,000 amperes per cm.²) was obtained only in the last few weeks.

110-KV. TRANSMISSION LINE CONSTRUCTION OF THE WASHINGTON WATER POWER COMPANY¹

(GAMBLE)

SALT LAKE CITY, UTAH, SEPTEMBER 6, 1926

C. R. Higson: I should like to ask Mr. Gamble regarding the effect of this powder on cattle or on a man's hands, or if it is poisonous in case a man should happen to get it in his mouth.

Harold Michener: In the paper, weights are shown at points where there are uplifts due to the structures being low. The author attributes the necessity of these weights to a slight error in profile. In general, for lines over rough country, there will be unavoidable structure locations which, because of being lower than one or both of the adjacent structures, will require either a weight, a tie-down, or a dead-end, to maintain proper clearance between the conductor and the structure under a heavy wind across the line. Usually there will be no actual uplift of the conductors at these structures. The angle to which any unrestrained suspension insulator will swing is the angle the tangent of which is the horizontal wind pressure on the conductor in one-half the sum of the adjacent spans divided by the vertical load on those insulators. The wind pressure on and the weight of the insulators themselves can usually be neglected without appreciable error. If this angle is greater than the allowable clearance will permit, one of the previously mentioned methods of restraining the conductor swing must be employed.

L. R. Gamble: On all the tests we have made in the use of this powder or treater dust, we have never had any cattle or any animal get poisoned. However, the dust is poisonous and to get any of it on the hands, especially if there is an open sore, may cause a little trouble which will necessitate treatment, but such a condition is not dangerous. Dr. Gardner of the Anaconda Copper Mining Co. at Anaconda, Mont., is the chemist who has worked out various uses of this compound and has put it on the market. On his ranch in Montana where he has a number of sheep and cattle he has used this dust for several years in the treating of fence posts and none of his sheep or cattle has in any way been injured by it. In our specifications for the use of dust on poles we specify very definitely that a man should wear gloves when placing the dust around the poles and should also be very careful not to rub his face or eyes while he is applying it. If the dust enters the nose or mouth it is very irritating, and care should be exercised in its handling.

In the design of our lines we use the celluloid sag templets and spot poles from these templets, giving the required clearance to ground. These curves are made up for 100 deg. Fahr. and -30 deg. Fahr. The -30 deg. Fahr. curve is our cold curve and we apply it to the profile of the line and if we find any evidence of upstrain, we immediately re-spot the poles to get away from that upstrain. There is a certain amount of variance in making these sag templets, so we always allow a margin of 4 ft.; that is, if we are sagging between two structures and use the cold curve, we put the cold curve between the structures on the two consecutive spans and if the template rests above the pole in the center of these two spans it indicates upstrain. If the cold template rests below the top of the pole there is no upstrain. We usually allow about 4 ft. below the top of the pole in order to play safe. We find that sometimes a little error actually exists in the profile, and 4 ft. is not enough. When we find during construction that there is upstrain it is taken care of by conductor weights. We very rarely find any case in which more upstrain than we can take care of by the use of weights exists. In one instance, however, it was necessary to make a dead end out of the structure.

ILLUMINATION ITEMS

By Committee on Production and Application of Light

PRACTICAL COLOR PHOTOMETRY*

By the usual methods of photometry, two lights are compared by balancing the brightness of adjacent surfaces which are illuminated by the two sources. In this way, lights from sources of slightly different color can be compared with a probable error of photometric measurement of about 1 or 2 per cent. When the color difference is considerable, however, as when red, blue or green light is compared with white light in determining the transmission of colored glass or accessories for colored lighting and the luminous output of colored lamps, the measurements become extremely difficult and the observational errors may be quite large.

There are two better methods available for evaluating lights of decidedly different color. The first requires an analysis of the spectrum by which the luminous effect of the amount of energy radiated in the different wavelengths can be calculated. This is the more accurate method, but it is long and tedious.

Lights of different colors can be compared also by the use of a flicker photometer in which surfaces illuminated by the two sources are presented alternately and rapidly to view. This method is quicker but somewhat less accurate than the former.

An investigation has been made recently by the Lighting Research Laboratory at Nela Park to determine the accuracy with which the relative illuminating value of lights of decidedly different color can be measured with the flicker photometer. The test was conducted by determining the transmission factors of eight color filters by both the spectrum analysis and the flicker photometer method.

This set of eight filters was representative of practically all colors encountered in practice, with the exception of light sources having line spectra. The commonest examples of which are mercury arcs, other arcs and gaseous discharge tubes. The color sensitivity characteristics of each observer were determined with the standard Ives test solutions of copper sulphate and potassium bichromate, and a Kingsbury type flicker photometer. The standard test solutions have been designed to transmit such amounts of yellow and blue light that the illumination obtained therewith, when used in connection with a carbon lamp operating at four watts per candle, appear equal to an observer with normal eyesight. If the observer does not judge the yellow and blue light transmitted by these solutions

*Abstract of a paper on "Heterochromatic Photometry" presented at the 1926 Annual Convention of the Illuminating Society, by A. H. Taylor of the Lighting Research Laboratory, Nela Park, Cleveland, Ohio.

as being of the same brightness, a correction must be applied to his measurements.

Each observer made a set of readings on a flicker photometer with each color filter when it was used to filter the light from a tungsten lamp operated at the color temperature 2680 deg. K. The illumination of the photometer screen was approximately 50 meter-candles (4.6 foot-candles) and the speed of flicker was practically the minimum at which the flicker could be made to disappear or at which a photometric observation could be made. In most cases, a filter of intermediate color was kept on the opposite side of the photometer in order to reduce the decided color difference between the two measurements with and without the test filter. In the case of one of the red filters—a very saturated red—the measurements were made in terms of two other lighter red filters in order to avoid the very great color difference involved in direct measurement.

The transmission factor of each color filter was computed from the curve showing the distribution of energy in its spectrum by using the standard visibility curve showing the illuminating power of a given amount of energy radiated in various wavelengths.

Table I shows the transmission factors of the eight color filters as observed by the flicker photometer and as computed from spectrophotometric data.

Color	Transmission Factor	
	As observed by flicker photometer per cent	Computed from spectrophotometric data—per cent
*Light red.....	28.0	30.3
*Purplish-red.....	17.6	18.3
Deep red or ruby....	8.0	9.5
*Light amber.....	65.5	64.5
Dark amber.....	36.7	37.7
Yellow-green.....	25.1	23.2
Light blue-green....	36.9	36.7
Blue.....	5.44	5.04

*Dyed gelatine on glass.

Assuming the results obtained by computation of spectrophotometric data to be correct, the flicker photometer gave, for these particular screens, values that were high for the blue and low for the red light. The average difference between computed and observed transmission values was only 5.8 per cent, however, which is a very small error for color differences as great as these. By a modification of the method of interpreting flicker photometer results the average error would be reduced to 3.1 per cent. Thus under the conditions of this test the flicker photometer furnishes a very practical method of color photometry with many advantages.

MUST THE TRAVELER READ SLOWLY?

Common experience tells us that it is more difficult to read on a train when it is in motion than when it is stationary. Most methods of travel are by no means free from vibration. This means that in such visual processes as reading, it takes the eyes longer to function properly in transmitting thoughts from the printed page to the brain. Inasmuch as reading is perhaps the most common means of passing time for those who must commute daily between their homes and places of business, and for those who use the street cars, busses and railroads considerably, the effect of light on the reading of "jiggling" printed matter is of special in-

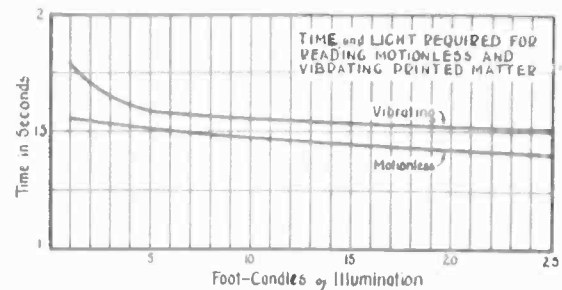

terest. Will exceptionally good lighting materially increase the ease of reading under such conditions?

In a series of tests which was carried out at the Lighting Research Laboratory at Nela Park, this subject was studied briefly. Sixteen observers were asked to read two pages of printed matter which were fastened to a vibrating mechanism, the movements of which closely approximated the motions encountered on moving trains. In these tests the time required to read a given amount of material was recorded for both stationary and vibrating conditions under various levels of illumination. The accompanying curves tell the story of the results. The lower curve is the usual form of speed of vision curve. The upper curve shows the performance of the eyes under different foot-candle values and for vibrating conditions. These curves lead us to the conclusion that for the same relative ease of reading a person needs a higher level of illumination when riding than he would in his home or office.

AUTOMATIC AND SUPERVISORY CONTROL OF HYDROELECTRIC STATIONS

In the publication of the discussion on the paper *Automatic and Supervisory Control of Hydroelectric Stations* by F. V. Smith, in the October issue of the JOURNAL, a part of the discussion presented by C. F. Publow was transposed by mistake to the end of the comments presented by Mr. Smith. This part of the discussion consisting of the last eight paragraphs (pages 1034 and 1035) should have appeared as a subcaption under Mr. Publow's Fig. 2 on page 1033.

JOURNAL OF THE American Institute of Electrical Engineers

PUBLISHED MONTHLY BY THE A. I. E. E.

33 West 39th Street, New York

Under the Direction of the Publication Committee

C. C. CHESNEY, *President*

GEORGE A. HAMILTON,

F. L. HUTCHINSON,

National Treasurer

National Secretary

PUBLICATION COMMITTEE

L. F. MOREHOUSE, *Chairman*

F. L. HUTCHINSON

E. B. MEYER

DONALD McNICOL

I. E. MOULTROP

GEORGE R. METCALFE, *Editor*

Subscription: \$10.00 per year to United States, Mexico, Cuba, Porto Rico, Hawaii and the Phillipines; \$10.50 to Canada and \$11.00 to all other countries. Single copies \$1.00. Volumes begin with the January issue.

Changes of advertising copy should reach this office by the 15th day of the month for the issue of the following month.

The Institute is not responsible for the statements and opinions given in the papers and discussions published herein. These are the views of individuals to whom they are credited and are not binding on the membership as a whole.

A. I. E. E. Regional Meeting

NEW YORK CITY DISTRICT

A program of great interest was presented at a two-day meeting of District No. 3 of the A. I. E. E. at the Engineering Societies Building, 33 West 39th St., New York, November 11-12. The attendance was approximately 700, comparing favorably with some of the national meetings. The technical sessions, which were well attended, included papers under the three general subjects of a-c. distribution networks, illumination, and communication. The technical program was augmented by a very interesting lecture on Thursday evening by Professor Robert W. Wood, of Johns Hopkins University, who spoke on some of the latest accomplishments and discoveries in the field of physical research, and on Friday evening by a demonstration of the Vitaphone, arranged through the courtesy of the New York Electrical Society.

There were five organized inspection trips, on which the attendance was unexpectedly large, in addition to numerous unorganized trips which were made by members individually.

A buffet luncheon was served on the fifth floor of the Engineering Societies Building on both days of the meeting, which not only conserved the time available for luncheon but afforded an additional interval for social intercourse.

THURSDAY MORNING SESSION

The first session was called to order by G. L. Knight, Vice-President of District No. 3, who after a few words of welcome introduced Chairman Philip Torehio of the Transmission and Distribution Committee. Before commencing the technical program, President Chesney was called upon to address the meet-

ing and responded with a brief address describing his visit to the Pacific Coast and numerous Western Sections of the Institute.

The technical program was then resumed and the following papers were presented by the authors: *Recent Progress in Distribution Practice*, J. F. Fairman and R. C. Rifenburg, *Automatic A-C. Network Switching Units*, G. G. Grissinger, *Evolution of the Automatic Network Relay*, J. S. Parsons, *Operating Requirements of the Automatic Network Relay*, W. R. Bullard, *A-C. Network Relay Characteristics*, D. K. Blake.

These papers were discussed as a group by Messrs. John C. Parker, A. H. Kehoe, Harry Richter, H. R. Searing, O. C. Traver, Gordon R. Milne, H. C. Forbes, J. H. Brooks, D. K. Blake, C. A. Corney and W. B. Jackson.

THURSDAY AFTERNOON

This afternoon was set aside for inspection trips, no technical session being held. The organized trips for which transportation both ways was furnished were as follows:

Lighting Institute, Edison Lamp Works, Harrison, N. J. An interesting display of all types of lamps and lighting.

American Telephone and Telegraph Co. Walker St., New York City. Demonstrations of picture transmission by telegraph, and telephone machine switching.

Electrical Testing Laboratories, East End Ave. and 80th St., New York City. All of the departments of the Laboratories were open to visitors.

Vehicular Tunnel, connecting the New York and the New Jersey shores. The tunnel is now rapidly approaching completion.

Hudson Ave. Station of Brooklyn Edison Co. Installed capacity 230,000 kw., including an 80,000-kw. generator, the largest in the world.

THURSDAY EVENING

One of the outstanding features of the meeting was the lecture *On the Frontier of Science*, by Robert W. Wood, Professor of Experimental Physics, Johns Hopkins University. Professor Wood talked briefly on a number of the most interesting experiments and theories of modern science. He told of experiments made on certain metals at the temperature of liquid helium at which temperature the metals have no electrical resistance and an electrical current started in them will continue indefinitely if not subject to outside influence. He talked on the modern quantum theory of light and showed how, to some extent, it could be reconciled with the theory of wave propagation. One of his most absorbing topics was that of supersonic vibrations, or mechanical vibrations in liquids at frequencies far above the audible frequencies. He mentioned particularly the experiments made on physiological effects of these vibrations.

FRIDAY MORNING

This session was a joint one with the N. Y. Section of the Illuminating Engineering Society. The first paper presented was *Remote Control of Multiple Street Lighting Systems*, W. S. Dempsey. This was discussed by Messrs. A. H. Kehoe, Nicholas J. Kelly, H. R. Searing, William H. Suydam and O. F. Haas.

The next paper was entitled *Lighting of Railway Classification Yards*, G. T. Johnson, and was presented by the author. It was discussed by Mr. J. A. Sommers.

The last paper of the session was preceded by a brief talk by Mr. Saul Dushman, setting forth the theoretical considerations underlying the new lamp described in the following paper: *The Induction Lamp, a New Source of Visible and Ultra-Violet Radiation*, T. E. Foulke, which was presented by the author who also demonstrated several different types of the induction lamp. A discussion followed by Messrs. Herman Goodman, C. H. Sharpe, Selby Haar, John B. Taylor and O. H. Ovler.

FRIDAY AFTERNOON

The last technical session of the meeting was on Friday afternoon and was devoted to the field of electrical communica-

tion. The first paper was entitled *Frequency Measurements with the Cathode-Ray Oscillograph*, F. J. Rasmussen, which was presented by the author and discussed by D. E. Shea.

The next paper, *A Shielded Bridge for Inductive-Impedance Measurements*, W. J. Shackelton, was read by the author and was not discussed.

The last paper of the session was *Radio Broadcast Coverage of City Areas*, Lloyd Espenschied, presented by Mr. R. W. King in the absence of the author. It was discussed by Mr. Zambataro, John B. Taylor, W. D. A. Peaslee, G. T. Crocker and K. B. Lyman.

FRIDAY EVENING

The closing feature of the meeting was the demonstration of the Vitaphone and this presentation filled the Auditorium to capacity at 7:30 p. m. and again at 9:30 p. m. Mr. E. B. Craft, of the Bell Telephone Laboratories introduced the demonstration in person rather briefly, after which a talking picture of himself explaining the principles and operation of the Vitaphone told its own story. This was followed by the overture from Tannhaeuser by an orchestra and brief sketches by Al. Jolsen, Mischa Elman, Mary Lewis and other well-known artists. The combined screen and vocal reproductions were rendered with wonderful perfection and were accorded most enthusiastic applause. This demonstration by courtesy of the New York Electrical Society, was a repetition of its program at a meeting on October 27.

The plans for this meeting, which were carried out with notable success, are due to the committee in charge of the New York Regional Meeting, of which the personnel is as follows: G. L. Knight, Vice-President, District No. 3, H. A. Kidder, General Chairman, O. B. Blackwell, W. A. Del Mar, H. V. Bozell, E. B. Meyer, H. E. Farrer, G. H. Stickney.

Transportation to be Discussed Before New York Section

On the evening of Friday, December 3, 1926, the New York Section of the A. I. E. E. will hold a meeting on the subject of "Transportation." Two speakers of the evening will be men of great prominence in the New York field; Mr. Frank Hedley, President of the Interborough Rapid Transit Co. will talk on "The Interborough Rapid Transit System—A General Description of Its Operation," and the second speaker will be the Honorable George S. Silzer, Ex-Governor of New Jersey and Chairman of the Port of New York Authority. Mr. Silzer will have for his subject "The Port of N. Y. Authority—Its Functions and Progress."

Because of the size and formation of New York City, the transportation of passengers and the distribution of freight present difficulties met in no other city of the world. It is important both in the interest of the public and of the profession that engineers should acquaint themselves with these problems, and at this meeting they will have an unusual opportunity to obtain from men who are leaders in their respective fields, a broad, general picture of the progress that has been made by way of a solution of these problems. The meeting will be held in the Auditorium of the Engineering Societies Building, 33 West 39th Street, New York City, at 8.15 p. m. All engineers interested are invited to attend as guests of the New York Section.

Future Section Meetings

Akron

Outdoor Substations, by a specialist from the Delta-Star Company. Moving pictures of substation construction will be shown. December 17.

Power-Factor Problems, by Frank Wallene. This talk will be accompanied by a demonstration in the Electrical Laboratory of the University of Akron. January 14.

Baltimore

The Influence of Residual Air and Moisture on Impregnated Paper Insulation, by J. B. Whitehead, Johns Hopkins University. December 16.

Boston

Talk by Dean Dexter S. Kimball, Cornell University. Tremont Temple. December 9.

Cleveland

The Transmission of Pictures over Telephone Lines, by R. D. Parker, American Telephone and Telegraph Co. December 16.

Mercury-Arc Rectifier for Power Transmission, by D. C. Prince, General Electric Co. January 20.

Columbus

Standards, by C. E. Skinner, Westinghouse Electric & Mfg. Co. December 3.

Railway Electrification. January 7.

Pittsfield

Why Intelligent People Do Not Vote, by W. J. Millard, National Municipal League. December 16.

Relation of Capital to Labor, by C. F. Kettering, General Motors Co. (Tentative) January 18.

St. Louis

Radio-Photography, by Dr. E. F. W. Alexanderson, General Electric Co. December 15.

Banking of Transformers, by M. T. Mitschrich, Moloney Electric Co. January 19.

Seattle

Diablo Development of the Skagit River Project, by J. D. Ross, Supt. of the Light and Power Dept., City of Seattle. December 15.

Vancouver

Electric Boilers, by Douglas Robertson. December 7.

Visit to Dunbar Automatic Substation. Demonstration of Operation by R. L. Hall. January 11.

A. I. E. E. Appointment

Professor Henry H. Henline of Stanford University, California, has been appointed Assistant National Secretary of the American Institute of Electrical Engineers, and will join the headquarters' staff of the Institute in New York about January 1, 1927.

Because of the constantly increasing activities of the Institute, the desirability of adding to the permanent staff has long been appreciated by members of the Board of Directors and by the National Secretary; this appointment was made accordingly by the Board upon the recommendation of President Chesney and National Secretary Hutchinson.

Professor Henline was born in Colfax, Illinois, March 12, 1889, and was graduated from the University of Illinois in the Electrical Engineering course in 1914. After two years' experience in Chicago, he became an instructor at Stanford University in 1917 and was later promoted to his present position of Associate Professor of Electrical Engineering.

Professor Henline has been deeply interested in the Institute for many years and is well equipped by training and experience, including personal participation in Institute activities, for his new work. He was elected to membership in 1919, has presented several papers at Institute conventions, was elected Chairman of the San Francisco Section in 1922, is at present Counselor of the Institute Branch at Stanford University, and at the recent Pacific Coast Convention in Salt Lake City, was elected by his associate Counselors in the Pacific District, Chairman of the Committee on Student Activities for that District.

Mechanical Engineers Plan Big Program

The program of the coming Annual Meeting, Dec. 6-7 inclusive, as planned by The American Society of Mechanical Engineers, will include five speakers of international repute. William L. Abbott, the retiring president, will deliver his president's address the evening of December 7th, and will introduce as the president-elect, Charles M. Schwab. Upon Mr. Elmer A. Sperry, a member of the A. I. E. E., will be bestowed the John Fritz Medal. The Robert Henry Thurston Lecture will be delivered at 4:30 on the afternoon of December 7th by Dr. Cecil H. Lander, English civil and mechanical engineer, Director of Fuels Research, Dept. of Science and Industrial Research, London and, during the World War, Lieutenant R. N. V. R. in charge of the Electrical Section of Explosive Paravanes. The technical sessions have been arranged with great care and there also will be special features of interest to the visiting ladies. No inconsiderable attention will be devoted also to the student activities; in fact, the meeting will close Friday night with the college reunions.

Many Novelties at Power and Mechanical Engineering Exposition

The Fifth National Exposition of Power and Mechanical Engineering, to be held in the Grand Central Palace, New York, December 6-11, will be inclusive of all types of power and mechanical equipment. The exposition will occupy four full floors of the Palace and power generating apparatus and accessories will furnish the main attraction. There also will be numerous exhibits in the displays of refrigeration apparatus, heating and ventilating equipment, materials handling devices and other mechanical power transmission machinery.

No less than 200 projects are under way subject to the cooperation of 350 national technical societies, trade organizations and government departments.

The exposition is under the able leadership of Mr. I. E. Moulthrop, Chairman of the Advisory Committee and member of the Institute. Managers of the Exposition are Fred W. Payne and Charles F. Roth, with offices in the Grand Central Palace.

American Association for the Advancement of Science

A meeting of Section M of the American Association for the Advancement of Science will take place Wednesday, December 29, 1926, in the auditorium of the Franklin Institute, Philadelphia, Pa., with Doctor Charles Russ Richards, Chairman of Section M, presiding.

The meeting will open at 9:30 a. m. with a symposium on the contributions made by pure science to the advancement of engineering and industry. This symposium will include the following subjects: Astronomy, Dr. Frank Schlesinger, Director of the Yale Observatory; Biology, by Dr. Vernon Kellogg, Permanent Secretary, National Research Council; Chemistry, Dr. Charles H. Herty, President of the Synthetic Organic Chemical Manufacturers' Association; Economics, Dr. Joseph H. Willets, Head of the Department of Industry, Wharton School of Finance and Commerce, University of Pennsylvania; Geology, Dr. Heinrich Ries, Professor of General and Economic Geology, Cornell University. The afternoon session, starting at 2:30 p. m., will continue the symposium as follows: Mathematics, Dr. G. A. Bliss, Professor of Mathematics, University of Chicago; Medical Science, Dr. Randle C. Rosenberger, Professor of Preventive Medicine and Bacteriology, Jefferson Medical College; Physics, Dr. R. A. Millikan, Director of the Norman Bridge Laboratory of Physics, California Institute of Technology; and Psychology, Dr. J. McKeen Cattell, President of the Psychological Corporation, Editor of *Science*, the *Scientific Monthly* and *School and Society*. This session will be followed by general discussion.

An informal dinner, under the auspices of the Engineers' Club of Philadelphia, will be served at the Hotel Bellevue-Stratford. The following addresses will be made:

The Stimulation of Research in Pure Science That has Resulted From the Needs of Engineers and of Industry, Dr. W. R. Whitney, Research Laboratory, General Electric Company, Schenectady, N. Y.

Imhoff Tanks, Harrison P. Eddy, Consulting Engineer, Boston, Mass., representing the American Society of Civil Engineers.

The Scientific Aspects of Lighting, Dr. M. Luckeish, Director, Lighting Research Laboratory, National Lamp Works, Cleveland, Ohio.

The Relationship between Science and the Study and Testing of Engineering Materials, W. H. Fulweiler, Chemical Engineer with the United Gas Improvement Company, Philadelphia, Pa.

New Louisville Section Holds First Meeting

The organization meeting of the new Louisville Section of the Institute was held October 27. Section officers were elected and a talk was given by Arthur G. Pierce, Vice-President in the Second District, A. I. E. E., on the subjects, *The Electrical Engineer in Industry* and the *Relation of the A. I. E. E. to Industry*. This first meeting was very enthusiastic.

The officers elected were as follows: Chairman, D. C. Jackson, Jr.; Secretary-Treasurer, W. C. White; Executive Committee, consisting of E. D. Wood, H. W. Wischmeyer, G. M. Miller and Philip P. Ash.

The formation of the Louisville Section brings the total number of Institute Sections up to fifty-two.

Standards Committee Meeting

The Standards Committee met at Institute Headquarters on Friday, November 5; the following were present: J. Franklin Meyer, Chairman, H. E. Farrer, Secretary, and Messrs. H. M. Hobart, H. S. Osborne, A. M. McCutcheon, C. H. Sharp, W. I. Slichter, R. H. Tapscott, J. C. Parker, E. B. Paxton, and C. M. Gilt. The Board has authorized the employment of an assistant in the office of the Secretary of the Committee, and the chairman was directed to make the necessary arrangements as soon as possible. The work of the committee can be made more efficient by having the office of the secretary handle details that are now necessarily done by chairmen of working committees.

In order that there may be the fullest cooperation between the various technical committees and the Standards Committee, the chairman of each technical committee was asked to designate some member of his committee to serve as a "point of contact" with the Standards Committee. The following members of technical committees have been designated as such "points of contact" for their respective committees: Protective Devices, F. L. Hunt; General Power Applications, A. M. McCutcheon; Communication, K. L. Wilkinson; Electrical Machinery, E. C. Stone; Research, Harold Pender; Instruments and Measurements, J. R. Craighead; Applications to Marine Work, J. S. Jones; Electrochemistry and Electrometallurgy, G. W. Vinal; Power Transmission and Distribution, R. H. Tapscott; Transportation, J. V. B. Duer; Applications to Mining Work, W. H. Lesser.

The report of the Marine Rules Committee having been approved by the Board as Section 45 of the Institute Standards, under the title "Recommended Practice for Electrical Installations on Shipboard," the Standards Committee now submits these rules to the Sectional Committee on Standards for Electrical Installations on Shipboard for consideration.

The report of the Subcommittee of the Protective Devices Committee on Automatic Substations was received and ordered printed as a report for comment and criticism. The report of Working Committee No. 29 on Standards for Electrical Measur-

ing Instruments was ordered submitted to letter ballot. The result of the letter ballot of the Committee on the report of the Sectional Committee on Standards for Hard Drawn Aluminum was reported and the Standards Committee submitted this report to the Board of the Institute for approval and adoption.

A. I. E. E. Branch at College of Engineering, Newark Technical School

A new Branch of the A. I. E. E. has been formed at the College of Electrical Engineering of the Newark (N. J.) Technical School. The officers of the Branch are: H. G. Patton, Chairman; Edward Bush, Vice-Chairman; Robert Meyer, Treasurer; C. H. Clarendon, Jr., Secretary; and Prof. J. C. Peet, Councilor.

Two meetings have been held since the authorization of the Branch, October 15. On October 20 two papers were presented: *Mineral Wool*, by W. Condit, student, and *The Great Men of Electricity*, by S. Fishman, student. On November 3, F. E. McKone of the faculty spoke on the subject of aerodynamics and F. R. House of Sperry Gyroscope Company gave an illustrated lecture on *Electrification of Air Ways*.

AMERICAN ENGINEERING COUNCIL

MEETING OF ADMINISTRATIVE BOARD

Meeting at Cornell University November 11-12, 1926, with its president, Dean Dexter S. Kimball, the Administrative Board of American Engineering Council weighed several of the outstanding national engineering problems. Important among its actions were decisions to assist in minimizing the volume of corporate reports, to assist in the Hoover plan for the development of a national policy for water resources, to sponsor a standardization program for street and highway safety signals, to continue its prosecution of the effort to secure a National Department of Public Works and Domain, to make further study of the proposed Standard State Mechanics Lien Act, to regularize patent procedure and urge a more adequate patent office building.

Recognizing the burden and high cost annually saddled upon industry by demand for data for the Federal and State Governments, the Board took its first step in cooperating with the National Association of Manufacturers and other bodies to minimize this waste. Plans were also laid for suitable coordination and simplification of these data and reports, so that the data collected could be used by all governmental agencies and be made available in a larger way to outside organizations. Reports to the Board brought out the fact that though much data had been assembled for special purposes, it was seldom useful in other studies even though they might be related to the original subject for which the data were gathered.

Endorsement of the plan of Secretary Hoover for a national policy in the development of the water resources of the country was enthusiastically given together with a pledge of the active support of the Council in carrying out this plan. The Secretary's plan includes more extensive development of inland waterway transportation, irrigation, reclamation, flood control, power, and a suitable federal organization to handle all of this work. The plans of Secretary Hoover harmonize closely with three pieces of national legislation now being endorsed by American Engineering Council; namely, the bill proposing an inventory of the water resources of the country, the bill which would establish a national hydraulic laboratory, and the National Department of Public Works bill.

As an outgrowth of American Engineering Council's work in the National Conference on Street and Highway Safety, a special committee on Street Signs, Signals and Markings was authorized and directed to secure the necessary funds in cooperation with other interested organizations so that it may prosecute a nationwide study of the whole problem. Determination of the present

practices relating to size, shape, color, illumination and location will be involved. The relative merits of manual or automatic methods, location of signs, etc., will be included. The appointment of a committee of engineers who have been prominent in this field was authorized to carry on the work.

The report of a committee of organization experts who have been making a special study of a suitable internal organization for the proposed Department of Public Works was adopted in so far as it had been completed. The study, which has been in progress for over a year, has covered all of the engineering and public domain functions of the Federal Government and resulted in recommendations that the following offices be included in the proposed department: from the Department of the Interior—Geological Survey, Bureau of Reclamation, The Alaska Railroad, National Park Service, General Land Office; from the Department of Agriculture—The Bureau of Public Roads; from the War Department—Board of Road Commissioners for Alaska, Alaska Telegraph and Cable-System, Northern and Northwestern Lakes Survey, and the non-military river and harbor work of: Office of Chief of Engineers, Board of Engineers for Rivers and Harbors, Mississippi River Commission, California Debris Commission, and Supervisor of the Harbor of New York; from the Treasury Department—the Office of the Supervising Architect; also the following independent offices, commissions, etc.—Federal Power Commission, Office of Public Buildings and Public Parks of the National Capital, Departmental Services for Maintenance and Operation of Buildings, and the Office of the Architect of the Capital. The layout for the new department will be completed and submitted as a part of this report.

The Administrative Board went on record as being definitely opposed to the extension of the time limitation on patents and the enactment of any special patent legislation for the benefit of individuals. Those in charge of the present buildings program for the United States Government were urged to provide better housing facilities for the United States Patent Office out of the \$50,000,000 appropriation available for Federal Government Buildings in the District of Columbia.

The general subject of compensation of professional engineers was widely discussed as the result of a report to the Board. This report stated that because of the major purpose of American Engineering Council to "support movements affecting public welfare when from an economic viewpoint such movements are believed to be worthy of support," it was the opinion of Council's Committee on Compensation of Engineers that Council should not enter into the field of discussion as to the compensation which professional engineers should receive. According to the report, the "solution is wholly an internal problem of the profession calling for no publicity but self-examination and criticism."

A further study of the Standard State Mechanics Lien Act, which was developed under the auspices of the department of Commerce, will be made by a special committee of council, appointed for that purpose.

A cordial welcome was extended to the Board by Dr. Farrand, President of Cornell University, and Dean Kimball, President of American Engineering Council. The next meeting of the Board will be in conjunction with the Annual Meeting of American Engineering Council, to be held in Washington, D. C., January 13-15, 1927, at The Mayflower.

The Sterling Fellowships for Research

For the academic year 1927-28, Yale University again announces the Sterling Fellowships for Research, previously mentioned in the January 1926 issue of the Institute's JOURNAL.

The Fellowships are divided into the two general classes of Research or Senior Fellowships and Junior Fellowships, candidates for the first restricted to those holding a Ph.D degree or an equivalent of the experience in Research which it indicates; the Junior Fellowships taking only those well advanced in work

toward the Ph.D. degree. Applications should be addressed to the Dean of the Graduate School of Yale University, New Haven, Conn., on blanks obtainable upon application. All applications must be submitted by March 1.

Bureau of Standards 25th Anniversary

Twenty-five years of successful scientific research work will be celebrated by the twenty-fifth anniversary of the Bureau of Standards, Department of Commerce, on Saturday, December 4, 1926, when the Bureau will keep "open house" and give a banquet at which its many friends may meet the staff and reminisce with them regarding the achievements of the last quarter century, as well as discuss the present and future work. A group of distinguished guests will attend. The event is of interest to the world of science as well as to the industrial experts who have worked so closely in cooperation with the Bureau, in turn making application of its discoveries and developments in perfecting the measured control of processes.

The Bureau will extend a welcome to its many friends and take pleasure in affording them this opportunity to inspect its experimental research facilities.

Business Historical Society Preserving Documents

Engineers will be interested to know of the foundation of the Business Historical Society, incorporated in 1925, the purpose of which is to encourage and aid the study of evolution of business in all periods in all countries.

The Harvard Business Library has become the depository of the society's collections. Among the material which the society wishes to collect are the data on early railroading, money and banking, commerce, and economics statistics.

It is planned to use every effort to increase the original data so that facilities for research and study may be constantly promoted.

A. S. T. M. Tentative Standards Now Available

The 1926 edition of A. S. T. M. TENTATIVE Standards, issued annually, is now available. This volume comprises 1100 pages and contains 227 Tentative Standards as follows:

33	relating to Steel, Ferro-Alloys and Wrought Iron
20	" " Non-Ferrous Metals
22	" " Cement, Lime, Gypsum and Clay Products
15	" " Preservative Coatings
22	" " Petroleum Products and Lubricants
49	" " Road Materials
2	" " Coal and Coke
6	" " Timber
16	" " Waterproofing
11	" " Insulating Materials
4	" " Shipping Containers
3	" " Rubber Products
10	" " Textile Materials
3	" " Slate
11	" " Miscellaneous

The Standards and Tentative Standards of the American Society for Testing Materials are recognized as authoritative in the field of engineering materials. The term "Tentative Standard" as distinguished from "Standard" is applied to a proposed standard which is printed for one or more years with a view of eliciting criticism of which the committee concerned will take due cognizance before recommending final action toward the adoption of such tentative standards by formal action of the Society.

The volume is available at the price of \$7.50 in paper and \$8.50 in cloth binding and may be obtained by addressing C. L. Warwick, Secretary A. S. T. M., 1315 Spruce St., Philadelphia, Pa.

New Radio Stations Established

Sixty-three new radio broadcasting stations and 62 changes in wavelengths have been reported between July 1 and October 15 to the Department of Commerce by its radio supervisors in the nine radio districts of the United States.

According to officials, practically all of the 62 wavelength changes were made presumably because of the lack of restriction and regulation of radio broadcasting brought about by the Attorney General's decision divesting the Department of Commerce of regulatory control and by the failure of Congress to enact radio legislation at the last session.

Of the 62 changes in wavelengths, most are said to be from the old Class A wavelengths below 280 meters to wavelengths in the former Class B band, ranging from 280 meters to 545 meters.

Work in Accident Prevention Praised

Representatives of several industries interested in accident prevention were told recently by Ethelburt Stuart, Commissioner of Labor Statistics, that while the casualty companies were doing valuable work in accident prevention in the compilation of statistics, there was further opportunity for improvement in the usefulness of these statistics by basing accident rates upon hours of exposure to employes. At present accident statistics are based for the most part upon volume of payrolls, so that a much lower rate is figured when wages and accidents are high than when wages are lower and accidents fewer.

Mr. Stuart further stated that he wanted to point out to all interested in accident prevention that what the State and Federal Governments want in the way of accident statistics is within the power of industrial companies to supply even though present methods of compiling such statistics might not give, in every instance, the direct information desired.

Important Engineering Subjects for Next Congress

Congress will reassemble at noon on Monday, December 6th, faced with a program including passage of all of the big appropriation bills, a plan for disposition of alien property, varying proposals for tax reduction, the disposal of Muscle Shoals, radio legislation, the Federal Judges Salaries Bill, Public Works legislation, Rivers and Harbors bill, the survey of the water resources of the country, regulation of the coal industry, railroad consolidation, etc. In many of these pieces of legislation, American Engineering Council and its constituent organizations are greatly interested. Since the session will be restricted to approximately ten weeks of actual legislative work, intensive effort will be necessary to show any real accomplishment.

Supervisory Control Safety System for Hudson Tunnel

An electrical protective system based on the supervisory control system developed for railway and power stations and modified to meet the particular conditions of the tunnel will insure super-safety to the Holland Vehicular Tunnel between New York and New Jersey. The new vehicular tunnel is to have the most elaborate provisions for safety of any place in the world. Three kinds of traffic signals will direct motorists—green for "go-ahead"; red for "stop" with a special "stop-engine" signal beside. These lights will be spaced 240 ft. apart. Traffic officers every 480 ft. will patrol the tunnel and for each

officer there will be a traffic light control station and telephone. A board located in the administration building in New York and carrying 926 pilot lights will inform a central operator of everything going on within the tunnel enabling him to take full charge of any situation at any time. All changes in the traffic lights made by the traffic officers will be registered in the control room, and, if necessary, the central operator, himself, will be able to stop traffic at any desired point. When this happens, however, the traffic officers in the tunnel cannot reset the signals; but this can be done by the central operator only. The tunnel will be illuminated by lamps every 20 ft. except at the entrances where they will be placed every 10 ft. to help in counteracting daylight. Each lamp is placed in an enameled reflector set into the wall and screened with a special frosted glass panel.

Army Engineers Oppose Ocean-To-Lakes Ship Canal

It was stated orally October 29, that, through the Chief of Engineers of the Army, the Department of War will report to Congress against the proposal of an all-American ship canal across the State of New York to connect the Great Lakes and the Atlantic Ocean through the Hudson River and New York Harbor.

For some months the Board of Engineers has been holding hearings on the matter and following the decision against the proposal, information was sent according to law to approximately 100 witnesses who testified in favor of the proposed all-American canal.

No announcement, it was stated orally at the Department of War, has been made officially from the office of the Chief of Engineers in Washington. The first official announcement will be the report to Congress.

Muscle Shoals Fight in Next Congress

Effort to reach a decision as to the disposal of Muscle Shoals will be one of the outstanding issues of the approaching session of Congress. Since those favoring Government ownership will probably be augmented in the 70th Congress, advocates of sale to private parties are preparing to bring about a final vote before the session ends March 4th, 1927. On the other hand, the Government operation advocates will make a determined fight to prevent a vote until the next Congress. Senator Deneen, Republican of Illinois, Chairman of the committee, will seek passage of the bill and Senator Norris of Nebraska will direct the opposition.

Significant in connection with this legislation is the Boulder Canyon Bill which proposed to provide for a gigantic development of the Colorado River by the Government. Proponents of Government operation feel that if this can be gotten through it would be a precedent for Government Operation of Muscle Shoals.

Air-Cooled Engine Airplane Successfully Tested

The Navy Department announces that a Navy Curtiss airplane equipped with a new Pratt-Whitney 400-h. p. radial air-cooled engine has just completed a test flight from Washington to San Diego and back without mishap or delay.

It was thoroughly inspected and tested at San Diego before returning to Washington by way of Seattle, Salt Lake City and Dayton. The total flying time for the round trip was about 65 hr., covering a total of approximately 7000 mi.

Air Rules Discussed

A recent announcement from the Assistant Secretary of Commerce for Aeronautics, William P. MacCracken, Jr., shows that the seven conferences which were contemplated by the Department have been held and have assured "mutual cooperation by the Department and commercial operators, manufacturers, and insurers."

The work of the air registration and inspections, as discussed during the series of conferences, will be divided into four classes, as follows: Registration and inspection of commercial or industrial aircraft, licensing of pilots and mechanics, rating of air navigation facilities and air traffic rules.

The registration of aircraft will be divided into three classes: Private aircraft engaged in no commercial work; industrial aircraft, and transport aircraft; planes to be subject to inspection from time to time regardless of the annual inspection.

The license of a pilot will be good until revoked for cause, subject to semiannual physical examinations and minimum flying requirements, while the license for aircraft will remain in force for a period of one year. No pilot will be permitted to operate a registered plane without first being licensed by the department. He will be given a physical and professional examination before the license is issued.

ENGINEERING FOUNDATION

PROGRESS IN TESTING EXPERIMENTAL DAM

From time to time progress reports have been issued with regard to the testing of the experimental dam erected at Stevenson Creek, California. A recent interesting report from Engineering Foundation gives results obtained to date. The dam was completed June 4, the progress work involving the testing of concrete to an average strength of 2000 lb. at 28 days, or 10 per cent more than the 1800 lb. desired. Tests with the reservoirs filled to a certain level and then emptied were made more or less continuously from July 12 to September 22, the depth of the water varying by intervals of 10 ft. from 20 ft. to the total 60 ft., and most of them at night when temperature changes were minimum. At present the testing proper has been stopped and the staff is busy interpreting observations.

PERSONAL MENTION

R. F. CARBUTT, Engineer, Henry L. Doherty & Co. has also become an officer of the Metropolitan Section of the American Electric Railway Association November 5, 1926, as its 1st vice president.

HAROLD W. NORTH is now employed as a technical assistant in the Department of Personnel and Statistics, Brooklyn Edison Co., having resigned his position with the Duquesne Light Company of Pittsburgh on Oct. 15th.

L. BURBRIDGE, president of R. A. Lister & Co. Inc., announces that his company's business will combine with Peet & Powers, Inc., under the joint supervision of their respective directors and Mr. Burbridge's own surveillance.

T. R. LANGAN, manager of transportation, Westinghouse Electric & Manufacturing Co. was chosen president of the Metropolitan Section of the American Electric Railway Association at its meeting of November 5, 1926.

R. A. MANWARING formerly with Dwight P. Robinson & Co., has resigned to accept the position of Secretary and Treasurer of the Philadelphia Electrical & Manufacturing Company. Mr. Manwaring will succeed Mr. C. L. Bundy, who has held this position since 1906.

R. M. BAYLE will be service manager in charge of the new Fairmont Service Station of the Westinghouse Electric and

Manufacturing Company with headquarters at Fairmont, W. Va. Mr. Bayle was previously with the home office at East Pittsburgh as supervising field engineer.

HENRY O. DIEFENDAHL, on November 1, 1926, accepted a position with The American Fire Prevention Bureau, Inc., New York City, as supervising engineer. Mr. Diefendahl has previously taught in the New York Electrical School, but he is now giving up his teaching work to enter the practical field.

WILLIAM G. ANGERMANN, who, for the past two years has been Instructor in Electrical Engineering at Cornell University, has been appointed Instructor in Electrical Engineering at the University of Southern California, where he will start work this fall. He will have charge of the Electrical Engineering courses for juniors.

CLARENCE G. HADLEY has given up his position as superintendent of the Municipal Electric Properties of Rochester, Minn., to take charge of the Central Heating and Power Plant which is now being designed by Ellerbe & Co., architects of St. Paul. This plant will supply light, water, heat and power to the various buildings belonging to the Mayo Clinic and Kahler Corporation.

J. C. SOMUS, who for approximately three years has been schedule engineer in the office of the chief engineer, Duquesne Light Company, Pittsburgh, Pa., in charge of production and improvement budget, and also doing valuation engineering for the company, resigned November 1st to engage in similar work for the Pennsylvania Water and Power Co., Baltimore, Md.

Addresses Wanted

A list of members whose mail has been returned by the postal authorities is given below, together with the addresses as they now appear on the Institute records. Any member knowing the present address of any of these members is requested to communicate with the Secretary at 33 West 39th Street, New York.

All members are urged to notify Institute Headquarters promptly of any change in mailing or business address, thus relieving the member of needless annoyance and also assuring the prompt delivery of Institute mail, accuracy of mailing records, and the elimination of unnecessary expense for postage and clerical work.

- 1.—J. M. Andress, 55 Hanson Place, Brooklyn, N. Y.
- 2.—J. A. Arcaute, 85 Pleasant St., Claremont, N. H.
- 3.—E. A. Aspnes, 260 W. 6th St., St. Paul, Minn.
- 5.—Matthew M. Becker, Public Serv. Prod. Co., 54 Park Place, Newark, N. J.
- 6.—R. L. Bertolacci, 2937 S. Normandie Ave., Los Angeles, Calif.
- 7.—Lincoln Bouillon, 731—21st Ave. N., Seattle, Wash.
- 8.—F. D. Burr, 378 S. Corona St., Denver, Colo.
- 9.—Andres R. Conde, 505 S. 5th Ave., Maywood, Ill.
- 10.—J. E. Contesti, 352 W. 58th St., New York, N. Y.
- 11.—Edward A. Crosse, 319 W. 89th St., New York, N. Y.
- 12.—Earl E. Deitrich, 922 N. Payson St., Baltimore, Md.
- 13.—John C. Donahue, 1601 N. 8th St., Tacoma, Wash.
- 14.—I. H. El-Kordi, Royal Consulate of Egypt, 103 Park Ave., New York, N. Y.
- 15.—John C. Fretz, N. Y. & Queens Elec. Lt. & Pr. Co., Bridge Plaza, Long Island City, N. Y.
- 16.—L. M. Gamble, 1829 Decatur St., Brooklyn, N. Y.
- 17.—Wm. F. Gilman, Belgrade Lakes, Me.
- 18.—Newman D. Gray, 41 Sanford St., St. Augustine, Fla.
- 19.—H. A. Hallead, 53 W. Jackson Blvd., Chicago, Ill.
- 20.—Edward C. Hanson, Box 59, Pinelawn, N. Y.
- 21.—A. Hirth, 519 Lincoln Pl., Brooklyn, N. Y.
- 22.—D. Brainerd Jones, 131—25th St., Jackson Heights, N. Y.
- 23.—Daniel Jund, 1194 Sherman Ave., Bronx, New York, N. Y.
- 24.—Eric Kjellgren, 145—13th St., Milwaukee, Wis.
- 25.—Otto U. Lawrence, Avenue A., Bound Brook, N. J.
- 26.—Archie L. Lewis, 1609½—11th St., Sacramento, Calif.
- 27.—Akos Ludasy, P. O. Box 1841, Chicago, Ill.

- 28.—A. W. Manby, 438 John St., Niagara Falls, Ont.
- 29.—A. W. Mann, Haines City, Fla.
- 30.—W. W. Marshall, 106 S. Portland Ave., Brooklyn, N. Y.
- 31.—Eugene Messinger, Otis Elevator Co., 26th St. & 11th Ave., New York, N. Y.
- 32.—Stafford Montgomery, Riverside, Ill.
- 33.—J. N. Mullen, 63 Boutelle Road, Bangor, Me.
- 34.—Syed Mustafa, Box 1194, Indianapolis, Ind.
- 35.—Anders Oxehufwud, 222 Genesee St., Utica, N. Y.
- 36.—F. H. Parker, 8112 Sixth Ave., Brooklyn, N. Y.
- 37.—Harry D. Ramsay, 1424 Felicity St., New Orleans, La.
- 38.—Alwin Schmidt, 251 W. 95th St., New York, N. Y.
- 39.—E. J. Schouw, 775—27th St., Milwaukee, Wis.
- 40.—Paul H. Schulz, 332—35th St., Milwaukee, Wis.
- 41.—Bartolomeo Scola, 227 Ave. U, Brooklyn, N. Y.
- 42.—Wm. E. Seamen, 1253 Leland Ave., New York, N. Y.
- 43.—Clifford S. Sharp, 9 Seymour Ave., Jamestown, N. Y.
- 44.—Bertrand Smith, W. E. & M. Co., 3451 E. Marginal Way, Seattle, Wash.
- 45.—Oliver Smith, 1324 State St., Schenectady, N. Y.
- 46.—Angelos A. Spilios, 572 Ocean Parkway, Brooklyn, N. Y.
- 47.—Edw. G. Stone, Cassel, Shasta Co., Calif.
- 48.—Frederick L. Suttle, 20 Seventh Ave., New York, N. Y.
- 49.—E. A. Swiedom, 231 McClellan St., Schenectady, N. Y.
- 50.—L. H. Thullen, Machinery Club, 50 Church St., New York, N. Y.
- 51.—Herman A. Tischer, 3801 Montgomery Road, Norwood, Cincinnati, Ohio.
- 52.—James A. Weddell, General Delivery, Mansfield, Ohio.
- 53.—Brian Wheeler, Westinghouse Club, Wilkesburg, Pa.
- 54.—Chas. W. Whittall, 340 Edwards Court, Bayonne, N. J.
- 55.—Geo. F. Whitworth, Geo. F., Hotel Carleton, Berkeley, Calif.

Obituary

Alexander E. Keith, Chief Engineer of the Automatic Electric Company, Chicago, and Fellow of the Institute since 1913, died at his home, Hyde Park Boulevard, September 24th, following a brief illness with pneumonia. He had just returned to Chicago from his summer home in Wisconsin, preparatory to spending the winter in Texas.

Mr. Keith was a native of Baltimore, Md., and his early education was acquired in the public schools of that city; his technical training was largely a matter of personal study during the prosecution of his own work, but his rise in the profession was rapid. Starting as a messenger boy of the Baltimore and Ohio Railroad in 1874, Mr. Keith, in two years' time had advanced to telegraph operator, B. & O. Express. In 1877 he engaged with the American Bell Telephone Company, until 1886 being associated with its subsidiary companies in Baltimore, Nashville, Tenn., Philadelphia, New York and Washington in varying and responsible capacities. In 1886 he was sent to Venezuela by his company to care for telephone and electric light work, but he returned in 1889 to become superintendent of the Brush Electric Company, Baltimore, Md., until 1892. Then the Automatic Electric Company was organized to continue the business previously carried on by the Strowger Automatic Telephone Exchange and Mr. Keith was made chief engineer. He remained the engineer in charge of development of the automatic telephone exchange apparatus for over 20 years. The United States patents and 34 unissued applications are to his credit, the two most notable of his productions being the plunger type of line switch and the present arrangement of automatic central office trunks.

Mr. Keith joined the Institute in 1912 and was elected a Fellow the following year.

Hazen Greeley Tyler, Professor of Experimental Engineering

in the College of Engineering and Director of the evening Engineering Division of New York University, died October 27, 1926, following an operation.

Dr. Tyler was born in Brooklyn, N. Y., March 21, 1890. He attended the Brooklyn public schools and the Polytechnic Institute, from which he was graduated in 1911 with the Electrical Engineering degree. Remaining at the Institute as an assistant in Mechanical Engineering until 1916, he received his M. S. degree in 1912 and M. E. in 1913. During this same period he was studying at the New York University and in 1916 he received

its degree of D. Sc. He then went to Rensselaer Polytechnic Institute for a year as instructor in Mechanical Engineering. October 1917, Doctor Tyler was chosen Assistant Professor of Mechanical Engineering at the New York University, in 1921 he was made Associate Professor in Mechanical Engineering and in 1924 he was made Associate Professor of Experimental Engineering.

He was a member also of The American Society of Mechanical Engineers, the Society for the Promotion of Engineering Education and the American Physical Society.

Engineering Societies Library

The library is a cooperative activity of the American Institute of Electrical Engineers, the American Society of Civil Engineers, the American Institute of Mining and Metallurgical Engineers and the American Society of Mechanical Engineers. It is administered for these Founder Societies by the United Engineering Society, as a public reference library of engineering and the allied sciences. It contains 150,000 volumes and pamphlets and receives currently most of the important periodicals in its field. It is housed in the Engineering Societies Building, 29 West Thirty-ninth St., New York.

In order to place the resources of the Library at the disposal of those unable to visit it in person, the Library is prepared to furnish lists of references to engineering subjects, copies or translations of articles, and similar assistance. Charges sufficient to cover the cost of this work are made.

The Library maintains a collection of modern technical books which may be rented by members residing in North America. A rental of five cents a day, plus transportation, is charged.

The Director of the Library will gladly give information concerning charges for the various kinds of service to those interested. In asking for information, letters should be made as definite as possible, so that the investigator may understand clearly what is desired.

The library is open from 9 a. m. to 10 p. m. on all week days except holidays throughout the year except during July and August when the hours are 9 a. m. to 5 p. m.

BOOK NOTICES (OCT, 1-31, 1926)

Unless otherwise specified, books in this list have been presented by the publishers. The Society does not assume responsibility for any statement made; these are taken from the preface or the text of the book.

All books listed may be consulted in the Engineering Societies Library.

CAST IRON FOR DIESEL ENGINES.

By A. Campion. Lond., E. & F. N. Spon, 1926. (Reprint of paper read before The North East Coast Institution of Engineers and Shipbuilders, January 22, 1926). 27 pp., illus., diags., 10 x 6 in., paper. 3s 6d.

The unusual conditions of temperature and stress to which oil engines are subjected have given rise to much trouble with cast-iron parts. The present pamphlet discusses the effect of these conditions upon the strength, growth, hardness and structure, the metallurgical principles which must be applied in determining the type of iron to be used for the various parts of the engine, and the factors concerned in the production of metal which will retain its strength at the temperatures encountered, will not change in shape or size and will resist abrasion.

CHEMICAL ENGINEERING CATALOG, 1926.

N. Y., Chemical Catalog Company, 1926. 1175 pp., illus., 12 x 9 in., fabrikoid. Purchase price, \$10.00. Leasing fee, \$2.00 in U. S.; \$3.50 in Canada and European countries.

This useful catalog again appears in its 11th edition and gives to chemical engineers, works managers and purchasing agents the information on equipment, supplies and materials, which they frequently need, in convenient reference form.

The classified directory section contains listings of more than 2000 manufacturers, and the technical and scientific books section includes practically all available chemical books in the English language. The entire catalog has been carefully revised.

ELECTRICAL MACHINE DESIGN.

By Alexander Gray, revised by P. M. Lincoln. 2d edition, N. Y., McGraw-Hill Book Co., 1926. 523 pp., illus., diags., 9 x 6 in., cloth. \$5.00.

The reviser has retained Professor Gray's presentation of fundamental principles and his methods of analysis without modification. He has taken account of the development that has occurred in electrical machinery in the past fourteen years and has modified the example machines so that they represent current designs and changed the various curves, tables, illustrations and other data to conform with present practise.

ELEMENTS OF HEAT-POWER ENGINEERING, v. 1; Thermodynamics and Prime Movers.

By William N. Barnard, Frank O. Ellenwood and Clarence F. Hirshfeld; 3rd edition. N. Y., John Wiley & Sons, 1926. 493 pp., illus., diags., tables, 9 x 6 in., cloth. \$4.50.

This is a new edition of the portions of Hirshfeld and Barnard's Elements of Heat-Power Engineering which relate primarily to thermodynamics and the elementary principles of prime movers. In preparing it the authors have found it necessary to rewrite practically all of the text, in order to incorporate new methods of treatment and to include new material. The new edition is intended as a text for a full year of instruction, and the authors also believe that it will be of interest to practising engineers as an account of recent notable advances in this field.

ELEMENTS OF RADIO COMMUNICATION.

By Ellery W. Stone. 3rd edition. N. Y., D. Van Nostrand Co., 1926. 433 pp., illus., diags., 8 x 6 in., cloth. \$3.00.

This textbook, written originally for radio students in the U. S. Navy, attempts to present the subject from the physical rather than the mathematical point of view, without sacrificing accuracy. The book is written for laymen, with no previous knowledge of the subject.

The third edition has been thoroughly revised and new material has been added.

DER GENAUGKEITSGRAD VON FLUGELMESSUNGEN BEI WASSERKRAFTANLAGEN.

By A. Staus. Berlin, Julius Springer, 1926. 35 pp., illus., diags., tables, 9 x 6 in., paper. Price not quoted. (Gift of Dr. A. Ott).

The current meter is almost universally used for measuring water powers in continental Europe, while in this country and England other methods are generally preferred. This variance in custom has led Dr. Staus to investigate the accuracy of the current meter, in order to ascertain what justification there may be for our distrust of them.

His monograph first systematically discusses all the possible ways in which errors in measurement may arise, through the selection of the point of measurement, the plotting of the profile, the meter itself, the time measurements, the method of measuring the velocity, and the calculation of results. Various improvements are suggested. At the close the degree of accuracy obtainable with current meters is reviewed. A very thorough bibliography is included.

DIE GETRIEBEKINEMATIK ALS RUSTZEUG DER GETRIEBEDYNAMIK.

By Friedrich Proeger. V. D. I. Verlag. 1926. (Forschungsarbeiten auf dem Gebiete des Ingenieurwesens, heft 285). 74 pp., diags., 10 x 7 in., paper. 6 m. 70 pf.

The study of kinematics has first become of considerable importance in practice during recent years, when it has proved helpful in solving many dynamic problems. A number of graphic processes have been developed here, but they have been adapted only for the specific problems. The present work is intended to show that a solution of dynamic problems in general can be obtained.

In the first part of this book the author treats of the principles of the kinematics of gearing. A systematic classification of gears permits a further schematic treatment of the speeds and accelerations of the individual gear points, and the graphic processes necessary for this are explained in detail.

In the second section this knowledge of the kinematics of gearing is applied successfully to the solution of important general problems in their dynamics, and makes possible, according to the author, reductions in the mass of the gear links without harm.

HANDBOOK FOR PROSPECTORS.

By M. W. von Bernewitz. N. Y., McGraw-Hill Book Co., 1926. 319 pp., illus., 7 x 5 in., fabrikoid. \$3.00.

The first part of this book gives advice on equipment, transportation and mining laws. The second part contains elementary information on geology, ore deposits, prospecting, sampling, testing, developing prospects. The third part consists of brief notes on the occurrence, detection and uses of the various minerals, both metallic and non-metallic.

The book covers concisely the topics upon which the prospector is most likely to wish information. The author has had long experience as a miner and metallurgist.

INDUSTRIAL SAFETY ORGANIZATION FOR EXECUTIVE AND ENGINEER.

By Lewis A. De Blois. N. Y., McGraw-Hill Book Co., 1926. 328 pp., illus., tables, 9 x 6 in., cloth. \$4.00.

This is an attempt to deal intimately and at length with the basic principles of safety organization. It summarizes, in a way, the profuse amount of information scattered through periodicals, codes, rule books, bulletins, etc., and presents a connected account of the subject. The author writes from the background of fourteen years of accident prevention work in the du Pont Company.

LABORATORY MANUAL OF TESTING MATERIALS.

By William K. Hatt and H. H. Scofield. 3rd edition. N. Y., McGraw-Hill Book Co., 1926. 182 pp., tables, 8 x 5 in., cloth. \$2.00.

This manual, which is based on long experience in testing and in teaching, attempts to show the student the technological purpose of various tests, train him in the technique of testing and give him some knowledge of materials. It also endeavors to develop his critical faculties.

The third edition reflects recent changes in standard methods and shifts the emphasis upon the several experiments. Some changes of omission and addition have been made.

MACHINE DESIGN.

By Louis J. Bradford and Paul B. Eaton. N. Y., John Wiley & Sons, 1926. 249 pp., illus., diags., tables, 9 x 6 in., cloth. \$2.75.

An unusually brief textbook, intended for use in courses where time is limited. The objects sought are to ground the student in the fundamental facts and processes; to train him to analyze problems, recognize the principles involved and apply sound methods of solution; and give him a general knowledge of good practice. The book is designed to be covered in about twenty-five lessons and is intended to teach the use of data rather than to be a source of data.

MATHEMATICAL AND PHYSICAL PAPERS, 1903-1913.

By Benjamin Osgood Peirce. Cambridge, Harvard University Press, 1926. 444 pp., illus., port., diags., tables, 9 x 6 in., cloth. \$5.00.

The twenty-one papers here assembled appeared originally in the *Proceedings of the American Academy of Arts and Sciences* or in the *American Journal of Science*. They include practically all those published by Professor Peirce during the last ten years of his life, and this republication will be welcome to many scientists. A bibliography of Professor Peirce's writings is included.

MODERN HARBORS; Conservancy and Operations.

By E. C. Shankland. Glasgow, James Brown & Son, 1926. 244 pp., illus., maps, 9 x 7 in., cloth. 21 s.

Commander Shankland, Chief Harbor Master and River Superintendent of the Port of London, here presents the data on navigation, seamanship and conservancy, as they relate to the functions of modern harbors, which he has derived from his wide experience and from visits to the principal harbors of the world. Beginning when the ship gets in communication with the harbor authorities, he follows her course until she is safely docked, describing proper methods of navigation through the waterway, mooring, anchoring, etc. He discusses in detail such topics as wireless, subaqueous and visual signals, pilotage, anchorages, moorings, salvage in harbors, buoying and lighting. A large section is devoted to conservancy, including the preservation of estuaries, harbor charting and sewage in tidal rivers. There are also chapters on oil in waterways, meteorology in harbors, aviation in harbors and life saving stations.

OCEAN MAGNETIC AND ELECTRIC OBSERVATIONS, 1915-1921.

(Researches of the Dept. of Terrestrial Magnetism, v. 5). Wash., D. C., Carnegie Institution of Washington, 1926. 430 pp., illus., maps, tables, 12 x 9 in., cloth. \$7.25.

This book, the second on ocean magnetic and electric observations, gives the final results of those made aboard the non-magnetic ship "Carnegie" in the Atlantic, Indian, Pacific and Southern oceans during 1915-1921. These are given in two reports on magnetic results, by J. P. Ault, and on atmospheric-electric results, by J. P. Ault and S. J. Mauchly. Appended are special reports on: the Hudson Bay expedition, 1914, by W. J. Peters; the navigation of aircraft by astronomical methods by J. P. Ault; the compass-variometer by Louis A. Bauer, W. J. Peters and J. A. Fleming; the sunspot and annual variations of atmospheric electricity with special reference to the "Carnegie" observations, 1915-1921, by Louis A. Bauer; and Studies in atmospheric electricity based on observations made on the "Carnegie," 1915-1921, by S. J. Mauchly.

SCIENCE AND LIFE; Aberdeen addresses.

By Frederick Soddy. N. Y., E. P. Dutton & Co., [1926.] 229 pp., 9 x 6 in., cloth. \$4.00.

These papers by the eminent investigator of radioactivity were first published in 1919. They consist chiefly of addresses delivered during his years at Aberdeen University, and two themes run through them; the significance and importance of radioactivity, and the need of more and better facilities for teaching science. Dr. Soddy's papers are readable, and interesting to a wider audience than one of specialists.

UNTERSUCHUNGEN UBER DIE GESCHIEBEABLEITUNG BEI DER SPALTUNG VON WASSERLAUFEN.

By Hermann Bulle. Berlin, V. D. I. Verlag, 1926. (Forschungsarbeiten auf dem Gebiete des Ingenieurwesens, heft 283). 34 pp., illus., diags., 10 x 7 in., paper. 5 marks.

This pamphlet reports the results of extensive investigations on models, undertaken at the Karlsruhe Hydraulic Laboratory, on the manner in which detritus is divided and deposited when a water course branches in various ways. The matters investigated include the explanation of the processes of flow; inquiry into the effect of the size of the branch angle upon the distribution of the water and detritus, and of the effect of the division of the detritus upon that of the water; a fundamental determination of the influence of a rounding off of the entrance into the branch channel and of the influence of various cross-sections of the branch channel below the separation.

The investigations showed that, when a water course branches from a straight channel, considerably the greater part of the detritus enters the branch and deposits just below the point of separation, forming a large bar. If the cross-sections of the two resulting channels and the amounts of water entering them are almost equal, the side branch receives from 90 to 95 per cent of the material deposited in both, a result that can not be explained by the law of transportation.

VERSTÄRKUNG, UMBAU UND AUSWECHSELUNG VON EISENBAHNBRÜCKEN.

By K. Schaechterle. V. D. I. Verlag. 1926. 160 pp., illus., diags., tables, 12 x 9 in., cloth. 20 marks.

The increasing weight of locomotives and road vehicles has made it necessary to strengthen many railroad and highway bridges in recent years. Periodicals have frequently described such work, but the present book is apparently the first to collect the methods that have been used and examine them critically.

After some remarks on the historical development of the railroad bridge the author reviews the increase in moving loads,

axle pressures, etc. The calculation of the strength of old and new bridges is discussed as well as the effect of heavy service on existing bridges. Economic considerations concerning strengthening and general lines of procedure in planning such work are laid down.

A second section describes the various methods in use. A third section is devoted to methods for replacing iron bridges which cannot be strengthened with economy, and a fourth with the replacement of truss bridges by arches. The concluding section is devoted to the strengthening of piers and foundations.

Past Section and Branch Meetings

SECTION MEETINGS

Akron

Inspection Trip to the Plant of the Timken Roller Bearing Company in Canton. October 16. Attendance 75.

Boston

Cambridge Street Automatic Edison Station of The Edison Electric Illuminating Company of Boston, by W. H. Colburn, W. W. Edson and D. H. Hatheway. October 18. Attendance 175.

Cincinnati

Selectivity of Tuned Radio Frequency Circuits, by Kenneth Jarvis, Crosley Radio Corp. Joint meeting with Institute of Radio Engineers. September 9. Attendance 44.

Modern Laundry Machinery Methods, by J. E. McCarthy, American Laundry Machinery Co. October 14. Attendance 35.

Cleveland

The Application of Carbon Products to Industry, by P. D. Manbeck, National Carbon Co. Illustrated with motion pictures. October 21. Attendance 50.

Columbus

Interconnections in Ohio, by T. J. Williams, The Ohio Power Co. This was accompanied by a motion picture, entitled "Electrified Ohio," and

Cleveland Terminal and Data on Electrical Railways, by W. T. Schumaker, Chief Engineer of J. O. Mills. October 22. Attendance 38.

Connecticut

The History and Future Possibilities of Air Transportation, by T. O. Freeman, Colonial Air Transport Co. October 12. Attendance 60.

Denver

Engineering Education—Some of Its Problems, by H. S. Evans, University of Colorado. Illustrated with slides. October 22. Attendance 24.

Erie

Electrical Manufacturing in Europe, by James Burke, Burke Electric Co. October 19. Attendance 105.

Fort Wayne

Artificial Refrigeration, by A. R. Stevenson, Jr., General Electric Co. Illustrated with slides. A motion picture, entitled "Over the Bounding Main," was shown. November 4. Attendance 70.

Indianapolis-Lafayette

Transmission-Line Costs, by F. H. Miller, Hoosier Engineering Co. October 29. Attendance 27.

Ithaca

The Adirondack Power and Light System, by J. L. Harvey. October 29. Attendance 60.

Kansas City

Electric Welding, by W. M. B. Brady, General Electric Co. Illustrated with slides. October 25. Attendance 43.

Los Angeles

A New 220-Kv. Transmission Line, by H. Michener and C. B. Carlson, Southern California Edison Co., and

Vacuum Switching Experiments, by R. W. Sorensen and H. E. Mendenhall, California Institute of Technology. A dinner preceded the meeting. October 5. Attendance 105.

Present Tendencies in Motor Development, by David Hall, Westinghouse Elec. & Mfg. Co. Illustrated;

Application of Electric Motors to Oil-Well Drilling, by H. H. Anderson, Shell Oil Co. Illustrated with slides, and

Elevator Motors and Control, by H. E. Fuqua, General Electric Co. A dinner preceded the meeting. November 2. Attendance 102.

Lynn

Electricity in Paper Making, by R. G. Rogers, General Electric Co. Illustrated with motion pictures and slides. A buffet luncheon was served. October 20. Attendance 100.

Minnesota

Move it Electrically, by H. S. Greiner, Northern States Power Company;

Chicago Central Station Institute, by C. H. Burmeister and D. Malmgren, students, and

Nela School of Lighting, by Seth Witts, J. C. Brighifelt, N. Ronning, students, and Professor M. E. Todd. Illustrated. Joint meeting with Student Branch at the University of Minnesota. November 1. Attendance 80.

Nebraska

Magic of Communication, by M. T. Castor, Lincoln Telephone and Telegraph Co. November 2. Attendance 34.

Niagara Frontier

Generator Voltage-Regulator Developments, by J. H. Ashbaugh, Westinghouse Electric and Mfg. Co. September 23. Attendance 35.

Management and Standardization, by John Gaillard, American Engineering Standards Committee. Joint meeting with A. S. M. E., S. I. E., Chamber of Commerce, and E. S. B. October 26. Attendance 225.

Philadelphia

Refrigeration, by A. R. Stevenson, Jr., General Electric Co. October 11. Attendance 165.

Pittsfield

A Talk was given by C. C. Chesney, National President, A. I. E. E., who spoke on his trip to the Pacific Coast and Canada. Illustrated with slides. The Pittsfield Section Best Paper Prize was awarded to H. R. West for his paper entitled "The Cross-Field Theory." The Regional Prize was presented to Messrs. E. J. Wade and K. B. McEachron for their paper entitled "The Time Lag of the Needle Gap." November 2. Attendance 700.

Rectification of Alternating Current, by D. C. Prince, General Electric Co. Illustrated with slides. November 9. Attendance 86.

Rochester

Economic and Industrial Aspects of Recent Electrical Experiments, by Giuseppe Faccioli, General Electric Co. Illustrated with slides. Joint meeting with Rochester Engineering Society and Rochester Chamber of Commerce. October 1. Attendance 150.

St. Louis

Changing the Voltage Ratio of Transformers under Load, by L. H. Hill, Westinghouse Electric & Mfg. Co. October 20. Attendance 50.

Saskatchewan

Large Power Transformers, by C. C. Chesney, National President, A. I. E. E. Illustrated by a motion picture, and

Lightning Protection, by K. B. McEachron, General Electric Co. Illustrated by slides. October 4. Attendance 70.

Steam-Turbine Design and Performance, by H. L. King, W. W. Johnson and W. R. Vogel, General Electric Co. October 29. Attendance 18.

Schenectady

Smoker. October 15. Attendance 200.

Waste in Distribution, by H. G. Crockett, of Scobell, Wellington and Co. Joint meeting with Engineering Societies of Schenectady. October 25. Attendance 100.

Educational Opportunities for College Graduates. Symposium by M. L. Frederick, J. D. Harnden, E. E. Johnson, M. M. Boring, C. H. Linder, W. A. Sredenschek and R. E. Doherty, General Electric Co. November 5. Attendance 150.

Sharon

The Penn-Ohio Power System, by C. S. MacCalla, Andrew Carnegie, F. W. Funk, R. W. Graham and H. M. Wood. Illustrated with motion pictures. October 12. Attendance 208.

The Modern Trend in Large Generating Apparatus, by F. D. Newbury, Westinghouse Electric & Mfg. Co. November 9. Attendance 101.

Spokane

Electricity in the Manufacture of Paper, by C. W. Fick, General Electric Co. Illustrated with motion pictures. October 15. Attendance 30.

Springfield

Copper—From Mine to Consumer, by J. C. Bradley, The American Brass Co. Illustrated by moving picture. October 18. Attendance 134.

Toledo

Bond Issues, by F. B. DeFrees. A talk was also given by Mr. W. E. Richards on the Quebec Convention of the Edison Illuminating Society. The following officers were elected: Chairman, O. F. Rabbe; Vice-Chairman, T. J. Nolan; Secretary-Treasurer, Max Neuber. October 15. Attendance 22.

Toronto

Indicating Electrical Measuring Instruments, by J. B. Dowden, Weston Electrical Instrument Corp. October 8. Attendance 70.

The Testing of Thermionic Vacuum Tubes, by J. H. Miller, Jewell Electrical Instrument Co. Illustrated with slides. October 22. Attendance 118.

Urbana

Development of Transmission of Intelligence Since Early Times, by E. B. Paine, University of Illinois. October 14. Attendance 104.

A Report on the Annual Convention at White Sulphur Springs was given by C. A. Keener. October 19. Attendance 14.

Utah

Mexico, by A. W. Ivins. Dance and Banquet. October 19. Attendance 138.

Vancouver

Electricity in Paper Manufacture, by C. W. Fick, General Electric Co. November 2. Attendance 51.

Washington

The Construction of Dirigibles and Their Electrical Control, by Starr Truscott, Bureau of Aeronautics. A dinner preceded the meeting. November 9. Attendance 185.

BRANCH MEETINGS

Alabama Polytechnic Institute

Two films, entitled "The Wizardry of Wireless" and "Revelations by X-Rays," were shown. October 13. Attendance 47.

John A. Brashear—An Autobiography, by J. J. Wilmore. T. J. Lynch, student, gave an account of his last two Summers' work with an electrical contractor. October 20. Attendance 44.

Cable Splicing, by J. B. Davis, student;

Electric Refrigeration, by A. L. Cameron, student,

Summer Work with the Gulf Electric Company, by G. L. Kenny, student, and

The Virginian Railroad Electrification, by Harry Fulwiler, Jr. October 27. Attendance 37.

Electricity as Applied to the Modern Automobile, by C. L. Brown, and

Finance and Banking, by Prof. A. L. Thomas. November 3. Attendance 38.

The Wilson Dam, by R. E. Brown, and

Your Work after Graduation, by Prof. J. C. McKinnon. November 10. Attendance 32.

University of Arizona

Business Meeting. The following officers were elected: President, J. W. Cruse; Vice-President, Tom Davis; Secretary-Treasurer, Audley Sharpe. September 25.

Features of Electrification of Spanish Northern Railway, by Mr. Adkinson, and

Electrolytic Refining of Copper, by Mr. Antillon. October 2.

A New Type of Cold-Cathode Rectifier, by Mr. Collins;

Advantages of the Electric Type of Locomotive, by Mr. Ellicote; and *Facts about Some of the Early Experimenters*, by Mr. Gehringer. October 9.

A motion picture, entitled "Bakelite—The Material of a Thousand Uses," was shown. October 16.

Diesel-Electric Power Plants, by Mr. Glascock;

Some Hints on Motor Winding, by Mr. Hopkins; and

Electric-Drive Gasoline Busses, by Mr. Humbert. October 23.

University of Arkansas

Importance of Student A. I. E. E. Membership, by Dean W. N. Gladson. October 12. Attendance 21.

High-Tension Engineering, by Prof. W. B. Stelzner;

Steam Power in Relation to Hydroelectric Power, by Lloyd Rebsman, and

Automatic Railway Signals. October 26. Attendance 20.

Armour Institute of Technology

Business Meeting. October 21. Attendance 60.

California Institute of Technology

Business Meeting. October 7. Attendance 24.

Vacuum Switching, by H. E. Mendenhall, California Institute of Technology. October 22. Attendance 32.

University of California

Engineering Opportunities in Large and Small Corporations, by Roy Phelan, and

Hydraulics, by Prof. H. W. King, University of Michigan. October 13. Attendance 60.

An Inspection Trip to the U. S. S. Tennessee was made. October 26. Attendance 360.

Carnegie Institute of Technology

Underground Power Cables, by D. M. Simons, Standard Underground Cable Co. He also spoke on the aims and activities of the A. I. E. E. and of the Relation of the Branch to the National Organization. October 20. Attendance 30.

Case School of Applied Science

Business Meeting. The following officers were elected: Chairman, C. J. Brumbaugh; Vice-Chairman, R. J. Kappanadze; Secretary, E. E. Samson; Treasurer, J. P. Ditchman. October 7. Attendance 20.

The Development and Future of the Electrical Industry in Cleveland, by J. North, Electrical League of Cleveland. November 3. Attendance 41.

University of Cincinnati

Business Meeting. The following officers were elected: President, C. W. Taylor; Vice-President, O. C. Schlemmer; Treasurer, B. J. Roof and Wm. Fife; Secretary, W. C. Osterbrock. October 14. Attendance 22.

Clemson College

Electric Suburban Service on The Illinois Central Railroad, by R. M. Marshall; *White-Way Street Lighting for Small Cities*, by H. L. Baldwin, and *Current Events*, by R. H. Mitchell. November 11. Attendance 25.

University of Colorado

The Importance of Fundamentals Such as Physics in Engineering Work, by Dr. O. C. Lester, University of Colorado, and *Productive Lighting in Industry*, by Lester Simpson. October 20. Attendance 60.

The Development and Use of the Telephone, by Mr. Ketterman, Mountain States Telephone Co. November 10. Attendance 40.

Cooper Union

Two motion pictures, entitled "The Audion" and "Electrical Transmission of Speech," were shown. The following officers were elected: Chairman, H. T. Wilhelm; Secretary, E. T. Reynolds. October 30. Attendance 36.

University of Florida

Superpower Systems in the United States, by Mr. Hearne, Tampa Electric Co. October 18. Attendance 30.

Iowa State College

- Business Meeting. October 26. Attendance 20.
Business Meeting. November 2. Attendance 19.

Carnegie Institute of Technology

- Behind the Pyramids*, by J. T. Green, National Carbon Co. October 9. Attendance 16.

Kansas State College

- Automatic Substations on the Pacific Electric Railways*, by F. A. Decker, student; *Work with the Wabash Railway*, by J. O. Johnson, student, and *Work in the Signal Department of the Santa Fe Railway*, by E. W. Wichman, student. October 18. Attendance 65.

- Experiences with the M. K. T. Railway*, by L. K. Willis, student; *Meter-Testing Experiences*, by R. P. Aikman, student, and *Work in the Signal Department of the Frisco Railway*, by Mr. Bradehaft, student. November 8. Attendance 71.

University of Kansas

- Short talks were given by seven students on their work during the past Summer with electrical companies. October 21. Attendance 54.

- Electrification of the Illinois Central Railroad*, by Mr. Dunkelberg, I. C. R. R. Illustrated. November 4. Attendance 68.

Lehigh University

- Economics of Education*, by O. W. Eshbach, A. T. & T. Co. A talk was also given by L. R. Schreiner, student, on his Summer Experience with The Niagara Falls Power Company. Illustrated. October 21. Attendance 55.

Lewis Institute

- Business Meeting. The following officers were elected: President, J. S. Howe; Secretary and Treasurer, O. D. Westerberg. November 9. Attendance 32.

Louisiana State University

- Business Meeting. The following officers were elected: President, K. J. Ozment; Vice-President, E. G. Kemp and Secretary-Treasurer, E. P. Athens. October 6. Attendance 21.

University of Maine

- Business Meeting. The following officers were elected; President, P. E. Watson; Vice-President, P. D. Lamoreau; Secretary, R. F. Scott; Treasurer, B. T. Poor. October 28. Attendance 14.

- Super Regeneration*, by Dean Paul Cloke, College of Tech., and *Public Utilities*, by Arthur Davis and H. W. Coffin, Bangor Hydroelectric Co. November 4. Attendance 35.

- Business Meeting. November 10. Attendance 14.

Marquette University

- Industrial Power Control*, by R. G. Lockett, Cutler-Hammer Co. Illustrated with slides. October 14. Attendance 36.

Massachusetts Institute of Technology

- The Cambridge Street Station of the Edison Electric Illuminating Company*, by three engineers of the Edison Company. An inspection trip was also made to this station. October 18. Attendance 250.

- Inspection trip to the plant and high-voltage laboratory of the Simplex Wire and Cable Co. November 2. Attendance 60.

Milwaukee School of Engineering

- Business Meeting. The following officers were elected: Chairman, L. H. LaFever; Vice-Chairman, R. J. Snyder; Secretary, W. H. Freisleben; Treasurer, M. W. Setzer. October 26. Attendance 20.

University of Minnesota

- Move It Electrically*, by H. S. Greiner, Northern States Power Co.;

- Chicago Central-Station Institute*, by C. H. Burmeister and R. V. Malmgrem, students; *The Nela School of Lighting*, by S. N. Witts, J. C. Brightfelt, N. A. Ronning, students, and Prof. M. E. Todd. A motion picture, entitled "Bringers of Light," was also shown. November 1. Attendance 110.

University of Missouri

- The Aims and Objects of A. I. E. E.*, by Prof. M. P. Weinbach. The following officers were elected: Chairman, V. L. Tiller; Vice-Chairman, C. E. Schooley; Student Secretary, J. L. Egbert; Treasurer, O. P. Minnick; Local Secretary, W. D. Johnson. November 1. Attendance 40.

Montana State College

- Electricity to Keep Trains Safe*, by R. M. Johnson, and *The New Empire of the Saguenay*, by Robert Harrison. October 7. Attendance 152.

- Simple Traffic Signals in Minneapolis*, by Melvin Barbour, and *Neon Tubes and the Radio Transmitter*, by E. A. Elge. October 21. Attendance 148.

University of Nebraska

- Summer Jobs*, by D. J. Fagan, L. A. Kilgore, A. A. Little and L. L. Smith. October 21. Attendance 52.

University of New Hampshire

- The Generation of Electric Power*, by L. B. Blum, student, and *Distribution and Uses of Electric Power*, by R. F. Burnham, student. October 18. Attendance 39.

- Eddy Currents*, by S. S. Appleton, and *High-Voltage Insulators*, by C. C. Connor. October 25. Attendance 39.

- Automatic Motor Starters*, by Mr. Balch, student and *Street Illumination*, by Mr. Dustin, student. November 1. Attendance 37.

College of the City of New York

- Business Meeting. October 14. Attendance 14.

New York University

- Business Meeting. October 1. Attendance 19.

- The Purpose and Operation of Substations*, by Henry Och. October 8. Attendance 20.

- Effects of the "C" Battery on Amplification in a Radio Set*, by Mr. Senanke. October 22. Attendance 18.

University of North Carolina

- Business and Social Meeting. September 23. Attendance 68.
Transmission-Line Construction, by R. M. Farmer. October 7. Attendance 38.

- Lightning Arresters*, by G. M. Wilson, and *Light*, by Professor J. E. Lear. October 21. Attendance 33.

University of North Dakota

- Insulated High-Tension Cable*, by Ted Giese, and *The Business End of Engineering*, by R. L. Holt. October 4. Attendance 21.

- Electricity and Refrigeration*, by Mr. Augustodt; *Hydroelectric Development in the West*, by H. Ikelman, and *The Motion-Picture Machine*, by R. Sturtevant. October 18. Attendance 18.

Northeastern University

- Business Meeting. October 5. Attendance 47.

- The Safety Problem in Electrical Engineering*, by T. Penard, Boston Edison Co. November 2. Attendance 51.

University of Notre Dame

- Business Meeting. October 25. Attendance 60.

Ohio Northern University

- Illumination*, by Mr. Hartley. October 21. Attendance 35.

Oregon Agricultural College

- Business Meeting. October 12. Attendance 41.

Oklahoma Agricultural and Mechanical College

- A talk was given by Mr. Reicer on his Summer experience in the R. O. T. C. and on his visit to Mexico. November 10. Attendance 29.

Oregon State College

- Smoker. October 21. Attendance 75.

Pennsylvania State College

- Summer Experience Talks were given by M. E. King, R. W. Bauer, E. H. Basehorie, J. C. Fink and G. L. Haller. October 20. Attendance 60.

University of Pennsylvania

- Business Meeting. October 8. Attendance 40.

University of Pittsburgh

- Business Meeting. The following officers were elected: Chairman, M. G. Jarrett; Vice-Chairman, H. I. Metz; Secretary-Treasurer, D. P. Mitchell. October 1. Attendance 26.

- The Engineer of the Future*, by C. F. Scott, Yale University. October 8. Attendance 26.

- Piezo Electricity*, by M. G. Jarrett, student; *Current Transformers*, by D. P. Mitchell, student, and *An Engineer's Love*, by H. I. Metz, student. October 15. Attendance 26.

Purdue University

Development of the Telephone and the Talking Movie, by J. L. Wayne and W. W. Sturdy, American Telephone and Telegraph Co. October 25. Attendance 1100.

Rensselaer Polytechnic Institute

Interconnection and Superpower, by S. Q. Hayes, Westinghouse Electric & Mfg. Co. Illustrated. October 15. Attendance 125.

Rhode Island State College

Business Meeting. October 1. Attendance 19.
Business Meeting. October 6. Attendance 21.
The Power House in Newport, by G. A. Eddy. October 20. Attendance 15.
Enamelled Wire Testing, by H. V. Van Valkenburg, student. October 27. Attendance 17.
The New Turbo-Alternator Installation of the Commonwealth Edison Company, by J. E. Rolston. November 10. Attendance 12.

Rose Polytechnic Institute

Business Meeting. The following officers were elected: Chairman, D. L. Fenner; Secretary, W. F. A. Hammerling. October 7. Attendance 15.

Rutgers University

Talks on experiences in their Summer work were given by Messrs. Erdelsley, White and Cortelyou, students. October 11. Attendance 32.
A motion picture, entitled "The Single Ridge," was shown. November 8. Attendance 25.

University of Southern California

Studies of Lightning Phenomena, by F. W. Peek, Jr., General Electric Co. October 12. Attendance 64.

South Dakota State School of Mines

Business Meeting. A letter from the General Electric Company was read, entitled "The Training of Men." October 21. Attendance 12.

University of South Dakota

The Slide Rule and Its Possibilities, by Professor Cosanday. October 20. Attendance 8.

Stanford University

Business Meeting. October 11. Attendance 16.

Stevens Institute of Technology

Waste Elimination, by J. O. G. Gibbons. A motion picture concerning the generation of electric power in steam and hydroelectric stations was shown. November 3. Attendance 48.

Syracuse University

Business Meeting. The following officers were elected: Chairman, G. F. Kern; Secretary-Treasurer, T. P. Hall. September 30. Attendance 25.

Hydraulic Power in Southern Appalachian Region, by A. F. Bagnato; *Hydraulic Power in Northern Appalachian Region*, by D. L. Bangs, and *Prospective Power in Appalachian Region*, by Professor Henderson. October 6. Attendance 24.

Possibilities of Hydraulic Power in New York State, by L. J. Bengamm, and *Power in St. Lawrence River Basin*, by B. Bladen. October 13. Attendance 25.

Present Power in St. Lawrence River Basin, by C. B. Clark, and *Power in Basin in 1950*, by C. W. Cushing. October 20. Attendance 23.

Texas Agricultural and Mechanical College

Methods of Resuscitation, by R. M. Moore. Texas Power and Light Co. October 26. Attendance 150.

University of Virginia

A motion picture on the process in the manufacture of the Okonite Cable was shown. November 2. Attendance 20.

State College of Washington

Business Meeting. October 14. Attendance 8.

Washington University

Business Meeting. October 14. Attendance 25.
Inspection Trip to the Bell Telephone Company. October 27. Attendance 45.

University of Washington

Rates of Electrical Power in Washington, by Professor G. L. Hoard. November 3. Attendance 20.

West Virginia University

Resuscitation from Electric Shock, by J. W. Schram; *Noiseless Construction of Steel Buildings*, by W. W. Williams; *Articles of Recent Development in Electricity*, by K. D. Stewart; *The Structure of the Atom*, by M. S. Diaz; *Failure of Arch Dams*, by S. J. Donley; *Hollow Pole Spans for Line Transmission*, by E. H. Braid; *Electrically Operated Bridges*, by C. L. Parks, and *Operation of Steam and Electric Bridges*, by R. O. Pletcher. October 18. Attendance 37.

Oil-Electric Power House on Wheels, by C. B. Binns; *D-C Generator for Battery Charging*, by G. B. Pyles; *Power System of Penn. R. R. at Harrison, N. J.*, by W. H. Nuhfer; *Latest Planes Herald New Era of Safety*, by H. H. Hunter; *Cheat Haven Power Plant*, by I. L. Smith; *Protection of High-Tension Lines from Lightning*, by F. M. Farry; *Electro-Chemistry and Electro-Metallurgy*, by L. T. Kight, and *A Tidal Dam of Ice*, by G. E. Phillips. October 25. Attendance 37.

Cranes for Handling Freight on Railroads, by H. S. McGowan; *Automatic Train Control*, by E. R. Long; *Problems Confronting Young Engineers*, by A. Izzo; *Ultra-Violet Rays*, by W. W. Reed; *Vital Electrical Statistics*, by A. L. P. Schmeichel; *Principle of Electric Flow Meters*, by J. W. Schram; *Florida East Coast Railway*, by D. Carle; *Water-Quantity Measuring Instruments*, by P. E. Davis, and *Sail Trimming*, by P. J. Johnston. November 1. Attendance 37.

The Longest Railway Tunnel in America, by W. W. Williams; *Charles Steinmetz*, by W. E. Vellines; *A Pump-Propelled Boat*, by E. W. Conway; *Theory of the Planimeter*, by M. S. Diaz; *Electrical Maintenance in Steel Mills*, by W. T. Meyers; *Construction of Commutating Poles*, by C. L. Parks; *Cathode Rays*, by J. P. Paine; *The Most Costly Fuel is the Cheapest*, by S. C. Walsh, and *Can Welding Replace the Rivet?* by A. M. Kalo. November 8. Attendance 37.

University of Wyoming

Business Meeting. October 14. Attendance 21.

Yale University

Business Meeting. October 25. Attendance 38.

MEMBERSHIP — Applications, Elections, Transfers, Etc.

ASSOCIATES ELECTED NOVEMBER 19, 1926

AKERS, ROBERT EDWARD, Sales Manager & Engineer, Carrick Wedderspoon, Ltd., Christchurch, N. Z.
ANTHONY, PERCY ALEXANDER WILLIAM, Engineer in charge of Elec. Dept., A. E. Harding Frew, T. & C. Bldgs., Brisbane, Queensland, Aust.
BAGCHI, SUDHIR KUMAR, General Electrical Foreman, Tata Iron & Steel Co., 97 Q Road West, Jamshedpur, India.
BAILEY, GILBERT STEPHEN, Asst. Valuation Engineer, Great Western Power Co., 375 Sutter St., San Francisco; res., Oakland, Calif.

BAKER, MARTIN PHILIP, Asst. Meter & Testing Engineer, Electricity Dept., Shanghai Municipal Council, 30 Fearon Road, Shanghai, China.
BANKS, WILLIS HOLMES, Assistant Regulator, New York Edison Co., 680 First Ave., New York; res., Brooklyn, N. Y.
BAXENDALE, FRANK, Commercial Engineer, Export Dept., British-Thomson Co., Ltd., Rugby, Eng.
BELL, WATKIN, Electrical Supt., Pine Hill Coal Co., Minersville, Pa.
BERG, JOHN E., Electrical Engineer, Victor X-Ray Corp., 2012 W. Jackson Blvd., Chicago, Ill.

BERNT, ARVID CHRISTIAN, Draftsman-General Electric Co., 44 Waldo Ave., Bloomfield; res., Montclair, N. J.
BLYTHE, GEORGE E. K., Lecturer, Elec. Engg. Dept., Glamorgan County Council, Swansea, Glamorgan, South Wales.
BRYANT, ERNEST, Electrical Foreman, Te Awamutu Electric Power Board, Te Awamutu, Auckland, N. Z.
BUCKTIN, FRANK COLDBECK, Construction Foreman, Springs-Ellesmere Power Board, Templeton, Christchurch, N. Z.
BURBANK, JEROME DOUGLAS, Draftsman, Niagara, Lockport & Ontario Power Co., 605 Lafayette Bldg., Buffalo, N. Y.

- *CHESNUT, FRANK T., Drafting & Design Dept., Gibbs & Hill, Pennsylvania Station, New York; res., Brooklyn, N. Y.
- CORRIN, JOHN G., Pacific Coast Manager, Pittsburgh Transformer Co., 531 Call Bldg., San Francisco, Calif.
- COWART, JAMES ESTUS, Electrical Designer, Thomas E. Murray & Co., 55 Duane St., New York; res., Brooklyn, N. Y.
- CRANE, SYDNEY FREDERICK, District Engineer, Southland Electric Power Board, Invercargill, N. Z.
- DART, SEELY CLARE, Chief Electrician, Oakland Motor Car Co., Pontiac, Mich.
- DE CAMARGO, FLORIANO FERREIRA, Erecting Engineer, Substations, Companhia Paulista de Estrada de Ferro, Jundiahy, Sao Paula, Brazil, S. Amer.
- DEMPSTER, JOHN H., Meter Engineer, Service Dept., Canadian Westinghouse Co., Ltd., Hamilton, Ont; res., Montreal, Que., Can.
- DOBBS, LESLIE JOSEPH, Chief Inspector, Southland Electric Power Board, Tay St., Invercargill, N. Z.
- DOXEY, FLOYD S., Student Engineer, General Electric Co., Schenectady, N. Y.; res., Salt Lake City, Utah.
- ECKARDT, ERICH MAX, Electrical Engineer, New York Rapid Transit Corp., 58 Clinton St., Brooklyn, N. Y.
- ERNST, JOHN PETER, Repair Foreman, Plant Dept., New York Telephone Co., 140 West St., New York; res., Hollis, N. Y.
- EVANS, HECTOR C. H., Electrical Fitter, Newcastle City Council, Newcastle, N. S. Wales, Aust.
- GLADSTONE, JAMES W. B., European Representative, R. Thomas & Sons Co., East Liverpool, Ohio; for mail, 70 Honor Oak Road, London, S. E., 23, Eng.
- HAMMOND, THEODORE AUSTIN, Laboratory Engineer, General Electric Co., Pittsfield, Mass.
- HASKELL, MOSES EDWARD, Superintending Engineer, Morarjee Goculdas & Co., Sudama House, Ballard Estate, Bombay I, India.
- *HOFFMANN, HARRY JOHN, Draftsman, Stone & Webster, Inc., 147 Milk St., Boston; res., Jamaica Plain, Mass.
- HOLTMAN, JOHN EDWARD, Shop Supt., Westinghouse Elec. & Mfg. Co., 1909 Blake St., Denver, Colo.
- HOOKE, JOHN FREDERICK, Electrical Tester, Municipal Electricity Dept., Christchurch, N. Z.
- JACOBS, ERNEST, Asst. Meter & Testing Engineer, Electricity Dept., Shanghai Municipal Council, 30 Fearon Road, Shanghai, China.
- JONES, ALMA LEE, Supt., Terminal Sub-Station, Utah Power & Light Co., Salt Lake City, Utah.
- KEENAN, HENRY BRYANT, Resident Engineer, Wairarapa Electric Power Board, Carterton, N. Z.
- KOOKEN, JAMES REX, Electric Repair Shop Foreman, Chile Exploration Co., Chuquicamata, Chile, So. Amer.
- KUNDERT, ADOLPH, Plant Electrician, The New York Edison Co., New York, N. Y.
- LIBECAP, ROSCOE EVANS, Electrician, Superior Electric Co., 409 S. Ervay St., Dallas, Texas.
- LINDELL, SIGURD I., Electrical Draftsman, Schweitzer & Conrad, Inc., 4435 Ravenswood Ave., Chicago, Ill.
- LOCKWOOD, EARLE LEWIS, Electrical Engineer, Power Dept., Newport News & Hampton Railway, Gas & Electric Co., Hampton, Va.
- MASTER, JEHANGIR J., Maintenance Engineer, Tata Hydro & Andhra Valley Elec. Power Supply Co., Tulsī Pipe Line Road, De Lisle Road, Lower Parel, Bombay, India.
- MASU, SUSUMU, Asst. Chief Engineer, Toho Electric Power Co., Kaijo Bldg., Tokio, Japan.
- MOUNTAIN, CYRIL ELLIOTT, Distribution Engineer, Burma Electric Tramways & Lighting Co., Ltd., Mandalay, Burma, India.
- NIEDERER, ERNST, Curtis Mfg. Co., Kienlen Ave., St. Louis, Mo.
- NORRIS, WILLIAM J., Signal Man, New York Rapid Transit Co., New York; res., Brooklyn, N. Y.
- ORINSKY, EMILE, Peerless Leather Goods Co., 19 High St., New York; res., Brooklyn, N. Y.
- *OWENS, STANLEY, Electrical Engineer, Bureau of Safety, 1205-79 W. Monroe St., Chicago, Ill.
- *PARKER, JOHN BRUCE, Traffic Engineer, Saskatchewan Government Telephones, Albert St., Regina, Sask., Can.
- PECHA, ANTON F., Inspector, Electrical Testing Laboratories, 540 E. 80th St., New York, N. Y.
- PERGLER, FRANK, Chief Engineer, City of Prague, Praha-VII Elektra, Prague, Czechoslovakia.
- PHILLIPS, ALBERT, Lamp Research Inspector, Electrical Testing Laboratories, 80th St. & East End Ave., New York; res., Brooklyn, N. Y.
- PONTIUS, PETER ANGELA, Electrical Engineer, Engg. Dept., Westinghouse Elec. & Mfg. Co., Homewood; res., Wilkensburg, Pa.
- REMSCHIED, EMIL JULIUS, Laboratory Assistant, General Electric Co., Schenectady, N. Y.
- RIMSTIET, JAMES WILLIAM, Field Man Southern Bell Tel. & Tel. Co., 1111 Republic Bldg., Louisville, Ky.
- ROBINSON, J. PERCY, Pacific District Representative, Kerite Insulated Wire & Cable Co., 215 Market St., San Francisco, Calif.
- SAVE, GEORGE ADAM, Draughtsman, N. Y. Edison Co., 130 E. 15th St., New York, N. Y.
- SCURRAH, WILLIAM, Canadian Marconi Co., 173 William St., Montreal, Que., Can.
- SEYLER, PAUL K., Transmission & Protection Engineer, Mountain States Tel. & Tel. Co., Salt Lake City, Utah.
- SHARMA, SURAJ MAL, Asst. Engineer, Messrs. India Electric House, Church Road, Kashmere Gate, Delhi, India.
- SHARP, SAMUEL MILES, Asst. Engineer, Minnesota Power & Light Co., Duluth, Minn.
- SILVESTER, LEWIS THOMSON, Cable Supt. & Chief Station Electrician, "Italcable" Co., Anzio, Roma, Italy.
- SIMPSON, JAMES CATANACH, Electrical Engineer, Bell Telephone Co. of Canada, Ontario St., Montreal, P. Q., Can.
- SOGA, MASAO, Director & Chief Engineer, Keihin Electric Railway Co., Ltd., Kawasaki City, Kanagawaken, Japan.
- STEINDORF, HERMAN ALFRED, Wireman, Riter Conley Construction Co., St. Louis, Mo.
- SVARUP, ANAND, Lecturer, Thomason College, Roorkee, U. P., India.
- SWANN, SAMUEL ARTHUR, Asst. Shift Engineer, Nottingham Electricity Dept., St. Anne's Well Road Power Station, Nottingham, Eng.
- SZENES, ALEXANDER, Estimator, Elec. Constr. Dept., New York Edison Co., 130 E. 15th St., New York, N. Y.
- TIMOFFEEFF, WOLDEMAR A., Chief Engr., Elec. Dept., Bureau of Electrification, Oramenbaum Rwy.; Asst. Prof. Elec. Rwy. Engg., Electrotechnical Inst. of Leningrad, Leningrad, Russia.
- WEITMANN, OTTO, Engg. Dept., Sloan & Chace, Inc., 6th Ave. & 13th St., Newark, N. J.
- WIACK, JOSEPH W., Sub-Foreman, Field Installation Dept., Western Electric Co., Inc., 268 W. 36th St., New York, N. Y.; res., Jersey City, N. J.
- WILLS, FELIX PERCEVAL, Power Engg. Dept., Westinghouse Elec. & Mfg. Co., East Pittsburgh; res., Wilkensburg, Pa.
- *YARLING, FRANK CLARK, Electrical Distribution Dept., Louisville Gas & Electric Co., Louisville, Ky.
- YORK, FRANK JOSEPH, Electrical Contractor, 159 E. Elizabeth St., Detroit, Mich.
- ZORN, FRED W., Supt., Engg. Dept., American Laundry Machinery Co., 134 W. 37th St., New York, N. Y.
- Total 74.
*Formerly Enrolled Students.

ASSOCIATES RE-ELECTED NOVEMBER 19, 1926

- GRONDAHL, LARS OLAI, Director of Research, Union Switch & Signal Co., Swissvale, Pa.
- NEWILL, EDWARD B., Section Engineer, Control Engg. Dept., Westinghouse Elec. & Mfg. Co., East Pittsburgh; res., Wilkensburg, Pa.
- SAND, J. HARVEY, Sales & Process Engineer, Zeller Lacquer Mfg. Co., 20 E. 49th St., New York; res., Brooklyn, N. Y.
- WHITTAKER, CHARLES CLARENCE, Section Engineer, Rwy. Equipment Engg. Dept., Westinghouse Elec. & Mfg. Co., East Pittsburgh, Pa.

MEMBERS ELECTED NOVEMBER 19, 1926

- ANDREE, JOHN W., Production Engineer, So. California Edison Co., 700 Edison Bldg., Los Angeles, Calif.
- BLOIS, ROBIE KERR, Supt., Smoke Dept., Consolidated Mining & Smelting Co. of Canada, Ltd., Trail, B. C.
- GREEN, DANIEL CRANDALL, Vice President & General Mgr., Utah Power & Light Co., Salt Lake City, Utah.
- HALE, JUBAL ANDERSON, Chief Engineer, Utah Power & Light Co., Salt Lake City, Utah.
- HALL, IRVING E., Asst. Works Manager, Roller-Smith Co., Bethlehem, Pa.
- KEATH, HOWARD BASCOMB, Engineer-in-charge, Transformer Division, Wagner Electric Corp., 6400 Plymouth Ave., St. Louis, Mo.
- MINTON, JOHN PRESTON, Consulting Engineer, New York; res., White Plains, N. Y.

TRANSFERRED TO GRADE OF MEMBER NOVEMBER 19, 1926

- ENSTROM, AXEL F., Director, Royal Swedish Institute of Scientific Industrial Research, Stockholm, Sweden.
- HALL, JACK H., Electrical Engineer, Ewa Plantation Co., Ewa, Oahu, T. H.
- KORNER, A. J., Consulting Engineer, Stockholm, Sweden.
- McDONALD, C. G. H., Acting Chief Electrical Engineer, Victorian Railways, Melbourne, Australia.

RECOMMENDED FOR TRANSFER

The Board of Examiners, at its meeting held November 16, 1926, recommended the following members for transfer to the grade of membership indicated. Any objection to these transfers should be filed at once with the National Secretary.

To Grade of Fellow

- DENTON, ALPHEUS P., President & Chief Engineer, Denton Engineering & Construction Co., Kansas City, Mo.
- MILLER, KEMPSTER B., Consulting Engineer, Pasadena, Calif.

To Grade of Member

- AHUJA, D. C., Asst. Chief Electrical Engineer, Tata Iron & Steel Co., Ltd., Jamshedpur, India.
- ALLCOCK, HARRY, Export Manager, W. T. Glover & Co., Ltd., London, England.

- BARROWS, WILLIAM E., Professor of Electrical Engineering, University of Maine, Orono, Me.
- BASTON, CYRIL E., Engineer, Railway Equipment Engineering Dept., Westinghouse Elec. & Mfg. Co., East Pittsburgh, Pa.
- BRENTLINGER, C. M., General Inspector, Western Union Telegraph Co., New York, N. Y.
- CONNELL, EDWIN L., Chief Engineer, Van Dorn Electric Tool Co., Cleveland, Ohio.
- COPELAND, CLEM A., Assistant Electrical Engineer, Bureau of Power & Light, Los Angeles, Calif.
- COX, HERBERT H., Supt. Distributing Stations, Bureau of Power & Light, Los Angeles, Calif.
- FREEMAN, WILLIAM E., Assistant Dean, College of Engineering, University of Kentucky, Lexington, Ky.
- FURST, WALTER A., Manager, Engineering Dept., Westinghouse Elec. & Mfg. Co., Detroit, Mich.
- GRIMES, WILLIAM F., Meter and Relay Engineer, Westinghouse Elec. & Mfg. Co., Los Angeles, Calif.
- HARVEY, R. J., Consulting Engineer to New Zealand Government, London, England.
- HENNINGER, G. ROSS, Engineering Editor, *Journal of Electricity*, San Francisco, Calif.
- HICKERNELL, L. F., Assistant Investigations Engineer, Commonwealth Power Corp. of Michigan, Jackson, Mich.
- HITCHCOCK, HARRY W., Transmission & Protection Engineer, Southern California Tel. Co., Los Angeles, Calif.
- HOLMES, FREDERICK, Vice-President and Secretary, Duncan Electric Mfg. Co., Lafayette, Ind.
- LUNSFORD, JESSE B., Technical Assistant, Design Division, Bureau of Engineering, Navy Department, Washington, D. C.
- MACKNESS, CYRIL F., Consulting & Inspecting Engineer, London, England.
- MOYER, HERBERT C., Chief Engineer, Standards Laboratory, Pennsylvania Power & Light Co., Hazleton, Pa.
- NELSON, AARON L., Asst. Engineer, Railway Locomotive Engineering Dept., General Electric Co., Schenectady, N. Y.
- PURDY, HENRY T., Consulting & Construction Engineer, San Jose, Costa Rica.
- ROSS, JAMES HARVEY, Chief Electrician, Freeport Sulphur Co., Freeport, Tex.
- SALBERG, JOHN, Representative, Westinghouse Electric & Mfg. Co., Salt Lake City, Utah.
- SIEGMUND, HUMPHREYS O., Member of Technical Staff, Bell Telephone Laboratories, Inc., New York, N. Y.
- SHUMAN, JESSE W., Secretary-Treasurer, Power Engineering Co., Minneapolis, Minn.
- TANABE, STEFAN, Meter Design Engineer, Tokyo Electric Co., Kawasaki, Japan.
- UNDERHILL, GEORGE H., Distribution Engineer, Central Hudson Gas & Electric Co., Poughkeepsie, N. Y.
- WRIGHT, C. H., President & Treasurer, Wright-Cason Electric Co., Knoxville, Tenn.
- Angermann, W. G., University of Southern California, Los Angeles, Calif.
- Anissimoff, C. I., 656 S. Mentor Ave., Pasadena, Calif.
- Archer, F. R., H. L. Doherty & Co., New York, N. Y.
- Archer, F. W., Westinghouse Elec. & Mfg. Co., Philadelphia, Pa.
- Armer, A. A., Magnavox Co., Oakland, Calif.
- Ayer, R. B., General Electric Co., Schenectady, N. Y.
- Babcock, Z. F., New York Edison Co., New York, N. Y.
- Bardewyck, A. H., Public Service Gas & Elec. Co. of N. J., Newark, N. J.
- Barker, E. H., The New York Edison Co., New York, N. Y.
- Bennett, W. R., Bell Telephone Laboratories Inc., New York, N. Y.
- Berger, F. J., Philadelphia Electric Co., Philadelphia, Pa.
- Binkley, E. L., Brooklyn Edison Co., Brooklyn, N. Y.
- Bleckley, S. C., Georgia Railway & Power Co., Atlanta, Ga.
- Bloch, I., New York Edison Co., New York, N. Y.
- Bocek, T., (Member), J. G. White Engineering Corp., New York, N. Y.
- Bogan, L. B., Chesapeake & Potomac Telephone Co., Washington, D. C.
- Bokum, W. H., The Philadelphia Electric Co., Philadelphia, Pa.
- Borgers, R. W., Huron Portland Cement Co., Detroit, Mich.
- Boudreau, J. J., United Electric Light & Power Co., New York, N. Y.
- Boyer, G. C., Kansas City Light & Power Co., Kansas City, Mo.
- Brandt, F. L., Ohio Insulator Co., Barberton, Ohio.
- Brightcliffe, N. J., Leeds & Northrup Co., Philadelphia, Pa.
- Brown, E. H., Allis-Chalmers Mfg. Co., Milwaukee, Wis.
- Brown, J. W., Brown Electric Co., Anderson, Ind.
- Burnham, A. H., Jr., Locke Insulator Corp., Baltimore, Md.
- Butler, T. H., General Electric Co., Schenectady, N. Y.
- Byrd, R. H., Cornell University, Ithaca, N. Y.
- Calvert, J. F., Westinghouse Elec. & Mfg. Co., East Pittsburgh, Pa.
- Casey, E. A., Union Switch & Signal Co., Swissvale, Pa.
- Cather, W. A., Barrett, Haentjens & Co., Hazleton, Pa.
- Cerf, E. A., Jr., Yale University, New Haven, Conn.
- Chromy, B. J., School of Engineering of Milwaukee, Milwaukee, Wis.
- Cisneros, S. C., General Electric Co., Lynn, N. Y.
- Cobb, N. M., Philadelphia Electric Co., Philadelphia, Pa.
- Cohn, M., Westinghouse Elec. & Mfg. Co., Baltimore, Md.
- Cosandey, C. J., University of South Dakota, Vermillion, So. Dakota.
- Courtright, A. V., Columbia Eng. & Management Corp., Cincinnati, Ohio.
- Craig, W. F., Westinghouse Elec. & Mfg. Co., Salt Lake City, Utah.
- Crawford, J. E., Duquesne Light Co., Pittsburgh, Pa.
- Croco, C. P., Westinghouse Elec. & Mfg. Co., East Pittsburgh, Pa.
- Curtis, L. B., Gibbs & Hill, Inc., New York, N. Y.
- Daniels, C. E., Scranton Electric Co., Scranton, Pa.
- D'Angelo, F. J., American Can Co., Brooklyn, N. Y.
- Davies, P. J., 29 Quaker St., Granville, N. Y.
- De Lellis, J., United Electric Light & Power Co., New York, N. Y.
- De Shazo, J. S., Pennsylvania Power & Light Co., Hazleton, Pa.
- Dewey, L. K., Westinghouse Elec. & Mfg. Co., Sharon, Pa.
- Dixon, J. T., American Tel. & Tel. Co., New York, N. Y.
- Dixon, W. R., Florida Public Service Co., Orlando, Fla.
- Domenzain, S. F., (Member), Mexican Light & Power Co., Mexico, D. F., Mex.
- Douglas, W. L., Electrical Inspector, City of Newark, Newark, N. J.
- Dressel, P. H., Union Gas & Electric Co., Cincinnati, Ohio.
- Eimers, H. O., Chesapeake & Potomac Telephone Co., Washington, D. C.
- Ellison, C. E., The Milwaukee Elec. Railway & Light Co., Milwaukee, Wis.
- Elwell, F., British Columbia Electric Railway Co., Vancouver, B. C.
(Applicant for re-election.)
- Embree, J. N., Union Electric Light & Power Co., Webster Groves, Mo.
- Engle, H. B., Chesapeake & Potomac Telephone Co., Washington, D. C.
- Evans, C. W., San Antonio Public Service Co., San Antonio, Texas.
- Farnsworth, G. C., Public Service Co. of California, Denver, Colo.
- Feldheim, F., Eagle Pencil Co., New York, N. Y.
- Fischer, T. W., Gibbs & Hill, Brooklyn, N. Y.
- Fischer, W. A., United Electric Light & Power Co., New York, N. Y.
- Flatland, R. D., Robinson Sales Co., Seattle, Wash.
- Folger, D. L., Columbia Engg. & Management Corp., Cincinnati, Ohio.
- Fouk, R. K., Home Gas & Electric Co., Greeley, Colo.
- Fouse, R. W., General Electric Co., Erie, Pa.
- Freeman, S., Jr., General Electric Co., Boston, Mass.
- Gailing, H. A., Elias Nusbaum & Bros., Philadelphia, Pa.
- Gaines, J. M., Westinghouse Elec. & Mfg. Co., Sharon, Pa.
- Gamble, W. H., So. Dakota State College, Brookings, So. Dak.
- Gaubatz, A. J., Radio Business, East St. Louis, Mo.
- Gerber, H. L., Dept. of Electricity, City Hall, San Francisco, Calif.
- Gerstein, E. N., Okonite-Callender Cable Co., Paterson, N. J.
- Gibbs, C. T., (Member), Holmes & Sanborn, Los Angeles, Calif.
- Glass, J. R., Georgia Railway & Power Co., Atlanta, Ga.
- Glatzel, J. J., Public Service Electric & Gas Co., Paterson, N. J.
- Gluck, E. J., Carolina States Elec. Co., Charlotte, N. C.
- Grant, P. A., Jackson & Moreland, Boston, Mass.
- Griffin, F. J., Brooklyn Edison Co., Brooklyn, N. Y.
- Grimke, F. D., New York Edison Co., New York, N. Y.
- Gross, E. S., New York Telephone Co., New York, N. Y.
- Hammond, S., Jr., Public Service Elec. & Gas Co., Newark, N. J.
- Haskell, F. V., New York Edison Co., New York, N. Y.
- Applications for election Gal. 2 Bartels 11-16 G5
- Hendricks, R. E., Fort Worth Power & Light Co., Fort Worth, Texas.
- Hershey, A. W., University of Illinois, Urbana, Ill.
- Higginbottom, E. K., Kuhlman Electric Co., Atlanta, Ga.
- Hildenbrand, H. L., *The Electric Journal*, Pittsburgh, Pa.
- Hilshman, N. S., Lehigh University, Bethlehem, Pa.
- Hobbs, H. G., Brooklyn Edison Co., Brooklyn, N. Y.
- Hobson, J. R. A., Jr., Public Service Production Co., Newark, N. J.
- Hoddy, G. L., General Electric Co., Schenectady, N. Y.

APPLICATIONS FOR ELECTION

Applications have been received by the Secretary from the following candidates for election to membership in the Institute. Unless otherwise indicated, the applicant has applied for admission as an Associate. If the applicant has applied for direct admission to a higher grade than Associate, the grade follows immediately after the name. Any member objecting to the election of any of these candidates should so inform the Secretary before December 31, 1926.

- Allen, J. C., West Penn System, Butler, Pa.
- Anderson, D. G., Puget Sound Power & Light Co., Chehalis, Wash.
- Anderson, H. H., (Member), Shell Co. of California, Los Angeles, Calif.

- Holmes, C. B., Western Electric Co., New York, N. Y.
- Horine, K., (Member), Commonwealth Edison Co., Chicago, Ill.
- Houghton, H. W., Pennsylvania Power & Light Co., Allentown, Pa.
- Houston, H. H., Jackson & Moreland, Boston, Mass.
- Hovgaard, O. M., Acme Apparatus Co., Cambridge, Mass.
- Hume, G. H., L. & N. R. R. Co., Louisville, Ky.
- Hurowitz, S. W., Electrical Contractor, Bronx, New York, N. Y.
- Inouye, I., Electrical Contractor, New York, N. Y.
- Irish, C. V., Westinghouse Elec. & Mfg. Co., East Pittsburgh, Pa.
- Johnson, B. P., Witherbee Sherman & Co., Mineville, N. Y.
- Johnson, F. E., Jr., New Orleans Public Service, Inc., New Orleans, La.
- Johnson, L. S., New York Central Railroad, New York, N. Y.
- Johnson, M., 416, 4th Ave., N. W., Watertown, So. Dakota
- Johnson, P. B., Westinghouse Elec. & Mfg. Co., Cleveland, Ohio
- Johnson, R., U. S. Patent Office, Washington, D. C.
- Johnson, W. D., University of Missouri, Columbia, Mo.
- Johnston, R. M., (Member), Jeffery-Dewitt Insulator Co., Kenova, West Va.
- Journeaux, D., Electrical Testing Laboratories, New York, N. Y.
- Jubien, E. B., General Electric Co., Thompson Research Lab., Lynn, Mass.
- Karelitz, M. B., Pennsylvania Railroad Co., Altoona, Pa.
- Keel, H. C., Westinghouse Elec. & Mfg. Co., New York, N. Y.
- Kehl, C. J., Electric Storage Battery Co., Wilkes-Barre, Pa.
- Keller, F. R., United Electric Light & Power Co., New York, N. Y.
- Kempf, M. B., The Milwaukee Elec. Railway & Light Co., Milwaukee, Wis.
- Klingenschmidt, H. C., Southern Power Co., Salisbury, N. C.
- Koenig, C. O., H. L. Doherty & Co., New York, N. Y.
- Kollmeyer, C. A., Chesapeake & Potomac Telephone Co., Washington, D. C.
- Korn, F. A., Bell Telephone Laboratories, Inc., New York, N. Y.
- Kottman, H. W., H. W. Crowder, Jr. Co., Wilkes-Barre, Pa.
- Krejci, E., N. Y. & Queens Elec. Lt. & Pr. Co., Flushing, N. Y.
- Krewatch, A. V., General Electric Co., Schenectady, N. Y.
- Ku, Y. H., Mass. Inst. of Technology Cambridge, Mass.
- Kurth, H. R., Edison Elec. Ill. Co. of Boston, S. Boston, Mass.
- La Barr, C. S., Ohio Public Service Co., Lorain, Ohio
- Landmesser, L. P., Pennsylvania Power & Light Co., Ashley, Pa.
- Latham, J. W. L., (Member), Chesapeake & Potomac Tel. Co., Washington, D. C.
- Laurence, R. G., Automatic Switch Co., New York, N. Y.
- Lewis, W. A., Jr., California Inst. of Technology, Pasadena, Calif.
- Liebrecht, E. F., Jr., Chesapeake & Potomac Telephone Co., Washington, D. C.
- Locke, C. C., New York Edison Co., New York, N. Y.
- MacLean, James B., The J. G. White Engineering Corp., New York, N. Y.
- MacNeil, D. J., The New York Edison Co., New York, N. Y.
- Maedel, G. F., New York Edison Co., New York, N. Y.
- Mancini, F. G., Pennsylvania Railroad, Altoona, Pa.
- Manuele, J., Jr., Westinghouse Elec. & Mfg. Co., East Pittsburgh, Pa.
- Mason, C. M., Cincinnati & Suburban Bell Tel. Co., Cincinnati, Ohio
- Mawer, A. L., Ferguson, Pailin, Ltd., Toronto, Ont., Can.
- McFarlane, M. L. D., *New York Daily News*, New York, N. Y.
- Meadows, A. V., Toronto Hydro-Electric System, Toronto, Ont., Can.
- Miller, G. B., Jr., Duquesne Light Co., Pittsburgh, Pa.
- Miller, H. P., Georgia Railway & Power Co., Atlanta, Ga.
- Mitchell, J. E. M., (Member) Jeffery-Dewitt Insulator Co., Atlanta, Ga.
- Moore, W. H., New York Edison Co., New York, N. Y.
- Moorhouse, A. H., Commonwealth Edison Co., Chicago, Ill.
- Morris, H. C. B., New York Edison Co., New York, N. Y.
- Morton, F. D., Philadelphia Electric Co., Philadelphia, Pa.
- Morwood, J. E., General Electric Co., Schenectady, N. Y.
- Mukerjee, H. P., International General Electric Co., Schenectady, N. Y. (For mail, Chicago, Ill.)
- Murtha, T. E., T. E. Murray, Inc., New York, N. Y.
- Musseleck, W. F., New York Edison Co., New York, N. Y.
- Nagamine, K., Mass. Institute of Technology, Cambridge, Mass.
- Nally, T. E., General Electric Co., Pittsfield, Mass.
- Nelson, C. C., Westinghouse Elec. & Mfg. Co., East Pittsburgh, Pa.
- Neubauer, J. P., New York Edison Co., New York, N. Y.
- Newell, D. M., Duquesne Light Co., Pittsburgh, Pa.
- Norell, L. W., Victor X-Ray Corp., San Francisco, Calif.
- Oehm, F. A., Chesapeake & Potomac Telephone Co., Washington, D. C.
- O'Meara, W. J., General Electric Co., Philadelphia, Pa.
- Opp, G. C. A., The Detroit Edison Co., Detroit, Mich.
- Parker, G. A., Jr., Chicago Pneumatic Tool Co., Detroit, Mich.
- Parsons, D. E., Railway & Industrial Engineering Co., Philadelphia, Pa.
- Peeling, C. U., (Member), Pennsylvania Power & Light Co., Bethlehem, Pa.
- Peter, E., General Electric Co., Schenectady, N. Y.
- Patho, J. A., Philadelphia Electric Co., Philadelphia, Pa.
- Pickard, R. W., Ohio Power Co., Canton, Ohio
- Pitman, M. H., Georgia Railway & Power Co., Atlanta, Ga.
- Poole, G. D., Gatun Locks, The Panama Canal, Gatun, C. Z.
- Porter, E. Y., (Member), The Southern Sierras Power Co., Riverside, Calif.
- Poteet, J. W., Jr., General Electric Co., Schenectady, N. Y.
- Quinn, G. E., New York Edison Co., New York, N. Y.
- Ratrie, H., Chesapeake & Potomac Telephone Co., Washington, D. C.
- Rempe, P. J., El Paso Electric Co., El Paso, Texas
- Rey, P., Brooklyn Edison Co., Brooklyn, N. Y.
- Rhea, V. L. R., Scranton Electric Construction Co., Scranton, Pa.
- Roberts, C. E., Westinghouse Elec. & Mfg. Co., Springfield, Mass.
- Roberts, C. G., Duquesne Light Co., Pittsburgh, Pa.
- Roberts, C. V., Erie Lighting Co., Erie, Pa. (Applicant for re-election.)
- Rock, J. J., Great Western Power Co. of California, Oakland, Calif.
- Roper, J. W., New York Telephone Co., New York, N. Y.
- Ryan, T. R., Long Island Lighting Co., Mineola, L. I., N. Y.
- Sah, A. P., 16 Elbridge St., Worcester, Mass.
- Samer, H. A., Trumbull Electric Co., Ludlow, Ky.
- Samuel, A. L., Mass. Institute of Technology, Cambridge, Mass.
- Schmidt, C. G., New York Telephone Co., Albany, N. Y.
- Schoening, W. F., Washington University, St. Louis, Mo.
- Schoetker, R. W., Union Electric Light & Power Co., St. Louis, Mo.
- Seaman, E. F., N. Y. & Queens Elec. Lt. & Pr. Co., Flushing, L. I., N. Y.
- Serett, H., A. B. See Elevator Co., Jersey City, N. J.
- Sharp, L. W., General Electric Co., New York, N. Y.
- Sharpe, J. M., Shawinigan Falls Water & Power Co., Shawinigan Falls, P. Q., Can.
- Sinclair, J. F., Jeffery Dewitt Insulator Co., Kenova, West Va.
- Sinclair, W. L., Postal Telegraph-Cable Co., Louisville, Ky.
- Sixtus, E. F., Pacific Electric Mfg. Co., San Francisco, Calif.
- Skeats, W. F., nGeeral Electric Co., Schenectady, N. Y.
- Sklar, S. B., (Member), Chem. Mech. & Elec. Inventor, Washington, D. C.
- Smith, T. A., Radio Corp. of America, New York, N. Y.
- Smythe, R. L., Line Material Co., S. Milwaukee, Wis.
- Southworth, M. D., Mutual Tel. Co., Erie, Pa.
- Speer, J. L. D., Jr., Chesapeake & Potomac Telephone Co., Washington, D. C.
- Starks, F. C., Mutual Tel. Co., Erie, Pa.
- Stevenson, P. J., Erie Lighting Co., Erie, Pa.
- Stewart, H. E., Duquesne Light Co., Pittsburgh, Pa.
- Stewart, W. F., Canadian General Electric Co., Peterboro, Ont., Can.
- Stoddard, H. B., New York Edison Co., New York, N. Y.
- Stoll, P. A., Commonwealth Power Corp., Jackson, Mich.
- Swaim, J. V., Purdue University, W. Lafayette, Ind.
- Taylor, H. S., (Member), Consulting Engineer, Dayton, Ohio
- Teele, R. P., Jr., University of Michigan, Ann Arbor, Mich.
- Tenzel, W. V., Memphis Power & Light Co., Memphis, Tenn.
- Thimme, E. J., Public Service Electric & Gas Co., Paterson, N. J.
- Tholstrup, H. L., University of Minnesota, Minneapolis, Minn.
- Tompkins, W. A., Penn Public System, Erie, Pa.
- Troutman, F. L., General Electric Co., Philadelphia, Pa.
- Venturine, J. B., Cobbs & Mitchell Lbr. Co., Valseltz, Ore.
- Wagoner, A. G., Foreman for Elec. Contractor, Brooklyn, N. Y.
- Waldorf, S. K., Johns Hopkins University, Homewood, Baltimore, Md.
- Walters, E., Cleveland Electric Illuminating Co., Cleveland, Ohio
- Weaver, B. S., General Electric Co., Lynn, Mass.
- Weaver, P. A., Electric Storage Battery Co., Wilkes-Barre, Pa.
- Weber, L., Dept. of Trade & Commerce, Regina, Sask., Can.
- Weilenmann, B. E. A., Metropolitan Mfg. Co., Long Island City, N. Y.
- White, F. D., Mountain States Power Co., Albany, Ore.
- Wilson, E. F., Houston Light & Power Co., Houston, Texas
- Winckler, G., General Electric Co., Lynn, Mass.
- Wright, C. E., International General Electric Co., Schenectady, N. Y.

Wright, M. V., Mutual Tel. Co., Erie, Pa.
 Wu, P. M., Western Electric Co., Toledo, Ohio
 Yankey, H. D., Michigan Bell Telephone Co.,
 Detroit, Mich.
 Zamzow, G. L., Chicago Surface Lines, Chicago,
 Ill.
 Zinn, G. W., Brooklyn Edison Co., Brooklyn,
 N. Y.
 Zubair, M., General Electric Co., Schenectady,
 N. Y.
 Total 236

Foreign

Grey, J. B., Waitomo Electric Power Board,
 Te Kuiti, N. Z.
 King, H. J., (Member), King & Strut, E. Dul-
 wich, London, S. E. 22, Eng.
 Milne, J. A., Westport Coal Co., Granity, West-
 port, N. Z.
 Rhodes, A. E., (Member), Electrical Engineer,
 Auckland, N. Z.
 Sarda, P. M., The Surat Electricity Co., Ltd.,
 Surat, India
 Slater, J. M. L., The Electrical Apparatus Co.,
 Ltd., London, S. W. 8, Eng.
 Weeden, E. H., General Electric Co., Schenectady
 N. Y.; Mackenzie College, Sao Paulo,
 Brazil, S. A.
 Withers, L. F., Lake Coleridge Power Schme,
 Addington, N. Z.
 Total 8

STUDENTS ENROLLED

Abulafia, A., University of Pittsburgh
 Alford, Edward L., Univ. of Missouri
 Allen, Edwin J., Texas A. & M. College
 Allen, Winthrop, Princeton Univ.
 Allera, Joe, Univ. of Colo.
 Altenbern, Carl A., Texas A. & M. College
 Anderson, Lewis G., Ohio State Univ.
 Andrews, Howard L., Brown University
 Archibald, Carl G., Oregon Agr. College
 Armfield, John S., Stanford Univ.
 Asmus, Lester, Marquette University
 Austin, George W., University of Ky.
 Avery, Lloyd D., Northeastern Univ.
 Babcock, Colton W., University of Colorado
 Bagnato, Anthony F., Syracuse University
 Bair, Frank B., University of No. Dak.
 Baker, Robert V., University of Mo.
 Baldwin, William G., Lafayette College
 Bale, Townley W., Oregon Agr. College
 Ballantine, Robert Wm., Princeton Univ.
 Bangs, D. Leslie, Syracuse University
 Bann, Gerald W., Marquette Univ.
 Barber, Clarence D., Kansas State Agr. College
 Barre, Benjamin A., Calif. Inst. of Tech.
 Barris, Henry A., Cornell University
 Beatty, Edwin H., University of Delaware
 Bechlberger, Paul F., Ohio State Univ.
 Beck, Bjorn O., Purdue University
 Becker, Lester J., So. Dak. State School of Mines
 Begard, Karl, Case School of Applied Science
 Benjamin, Louis J., Syracuse University
 Bennett, Gordon W., Ohio State Univ.
 Bent, Joseph G., Jr., Lehigh Univ.
 Berg, Frederick T., University of Maine
 Bering, Donald A., Stanford Univ.
 Betkouski, Marcellian R., Univ. of Santa Clara
 Biebel, Lawrence B., University of Pittsburgh
 Bingham, Harvey C., Case School of Applied
 Science
 Birge, Knowlton R., Calif. Inst. of Tech.
 Black, Donald M., Univ. of Kansas
 Blackburn, H. F., Kansas State Agr. College
 Bladen, Bernard, Syracuse Univ.
 Blascak, Stanley J., Ohio State Univ.
 Block, Henry J., Purdue University
 Blount, Frank, Oregon State Agr. College
 Blugerman, Leonide N., University of Washington
 Boardman, Albert D., Stanford Univ.
 Bond, Marion E., Ohio State Univ.
 Borgman, Theodore, University of Louisville
 Bramble, John H., Lehigh Univ.
 Brandt, Mulford M., Drexel Institute
 Brooks, Hamilton, University of Pittsburgh
 Brown, Byron B., Ohio State Univ.

Brown, John W., Northeastern University
 Brown, Walter M., Drexel Institute
 Brumbaugh, Kenneth D., Case School of Applied
 Science
 Bryan, Arthur L., Ohio State Univ.
 Bub, George L., Case School of Applied Science
 Bullock, Edmund T., University of Ky.
 Bullock, Menifee C., University of Mo.
 Bunting, William L., University of Illinois
 Burke, Francis L., Mass. Inst. of Tech.
 Burke, Wm. E., Oregon Agr. College
 Burris, Frank J., So. Dak. State School of Mines
 Butt, Charles N., University of Washington
 Cain, Walter W., Ohio State Univ.
 Canfield, Wright, Kansas State Agr. College
 Carter, Conway D., Oregon Agr. College
 Caveney, Eldred J., Univ. of Santa Clara
 Cerveney, James P., State College of Wash.
 Chambers, Dudley E., Stanford Univ.
 Chatten, Frank L., Rutgers College
 Chidester, John T., Carnegie Inst. of Technology
 Child, Joseph E., Iowa State College
 Clark, Clifford B., Syracuse Univ.
 Clark, Richard G., University of Maine
 Clark, Will T., Texas A. & M. College
 Clewell, Orlo E., Iowa State College
 Coad, Jack F., Iowa State College
 Colburn, Howard O., Oregon Agr. College
 Cole, Burton R., Stanford Univ.
 Connell, Glenn W., University of Pittsburgh
 Conover, Joseph E., Rutgers University
 Cooper, Victor E., Purdue University
 Courtright, David S., Cornell Univ.
 Cowen, Edward G., Mass. Inst. of Tech.
 Cowhig, Walter W., Northeastern University
 Coyner, John E., Purdue University
 Cozzens, Bradley, Stanford Univ.
 Crawford, Arthur B., Ohio State Univ.
 Creveling, Robert, Calif. Inst. of Tech.
 Crossno, V. O., University of Tennessee
 Crout, Prescott D., Mass. Inst. of Technology
 Crow, George L., University of Missouri
 Cummings, Clifford C., So. Dak. State School of
 Mines
 Cundiff, Robert M., University of Ky.
 Cunningham, David, Univ. of Missouri
 Cunningham, Walter, Oregon Agr. College
 Curtiss, Arthur N., University of Pittsburgh
 Cushing, Charles W., Syracuse Univ.
 Dagon, John W., Lafayette College
 Dalby, Harry W., Oregon Agr. College
 Dalton, Wm. Robert, Rutgers College
 da Roza, F. Gonzalez, Purdue Univ.
 Darrah, Merle D., Iowa State College
 D'Ascensio, Frank, Cornell University
 Daugherty, C. S., University of Ky.
 David, Amos R., University of Ky.
 Davis, Norman D., Case School of Applied
 Science
 Davis, Samuel W., Okla. A. & M. College
 Decker, Floyd A., Kansas State Agr. College
 DeLean, Louis H., Washington State College
 Dempsey, Edward F., Ohio State Univ.
 Demsko, William J., Pennsylvania State College
 Dettmer, Herman W., Rutgers University
 Dice, Robert F., Kansas State Agr. College
 Dietel, E. A., Texas A. & M. College
 Disher, Isaac C., Univ. of Ky.
 Dixon, James E., Univ. of Missouri
 Doehne, Robert, Lehigh Univ.
 Dohr, Joseph N., Marquette University
 Donohue, John W., Marquette University
 Doty, Irwin T., Ohio State Univ.
 Douglass, Dale D., Purdue Univ.
 Dow, Orville E., University of Colo.
 Driscoll, Leslie B., University of No. Dak.
 Driskill, William C., So. Dak. State School of
 Mines
 Duncan, Thomas C., Cornell Univ.
 Dunlap, Norton T., Kansas State Agr. College
 Earnheart, Richard L., Oregon Agr. College
 Eckhouse, Robert H., Lehigh Univ.
 Edelstein, H. E., Cornell Univ.
 Edmonds, Edward C., University of Tennessee
 Edwards, Julian M., Univ. of Arkansas
 Egbert, Jerry L., Univ. of Missouri
 Eisenmann, Samuel B., Rutgers College

Ellis, William T., Case School of Applied Science
 Elsea, Harold D., Univ. of Missouri
 Epley, Frederic I., University of Ky.
 Erb, Harry A., Cornell Univ.
 Ernst, M. Leslie, Syracuse Univ.
 Everts, William J., Northeastern University
 Evitts, William E., University of Iowa
 Ewertz, Gordon E., Lehigh Univ.
 Ewing, Maxwell S., Syracuse Univ.
 Fairhurst, John A., Rose Polytechnic Institute
 Falkenberg, Roy T., Texas A. & M. College
 Fathauer, Walter F., Mass. Inst. of Tech.
 Fayram, Burtis L., Iowa State College
 Fenn, G. Titus, Univ. of Ky.
 Field, Kenneth S., University of Maine
 Fields, Eugene, University of Louisville
 Fisher, William P., Univ. of Santa Clara
 Fishman, Sam, Case School of Applied Science
 Fleck, Hayden A., Kansas State Agr. College
 Flynn, Francis, Armour Inst. of Tech.
 Foley, Robert A., Marquette Univ.
 Foote, Cecil D., Kansas State Agr. College
 Forster, John B., Calif. Inst. of Tech.
 Fortenbach, John H., Rutgers College
 Fouts, Ben S., Okla. A. & M. College
 Francis, Arthur D., University of Wash.
 Frank, Charles W., Mass. Inst. of Tech.
 Franklin, Maurice B., Kansas State Agr. College
 Frazier, Walter B., Purdue Univ.
 Freundt, Gerhard L., Armour Inst. of Tech.
 Frey, J. C., Lehigh Univ.
 Friend, Robert E., Marquette University
 Frink, James C., Syracuse Univ.
 Fuller, Robert L., Univ. of Utah
 Furniss, George A., University of Calif.
 Gamage, F. T., Purdue Univ.
 Garey, Hollis W., University of Maine
 Garnhart, Gordon E., Syracuse Univ.
 Garretson, William A., Iowa State College
 Gates, Lester C., Kansas State Agr. College
 Gear, Robert B., Cornell University
 Ghaus, Shah G., Purdue Univ.
 Gillham, James B., Univ. of Calif.
 Goldstein, Maurice, Armour Inst. of Technology
 Goodale, Walter D., Jr., Lehigh Univ.
 Gove, Harold E., Univ. of Missouri
 Grasser, Marvin H., Ohio State Univ.
 Greenwood, Walter S., Northeastern University
 Gross, Malvern J., Oregon Agr. College
 Grove, John V. T., Syracuse Univ.
 Gum, William A., Univ. of Missouri
 Gussow, Phillip M., Univ. of Missouri
 Habicht, Carl E., Iowa State College
 Hahn, Raymond E., Marquette University
 Hall, Charles R., Ohio State Univ.
 Hall, Henry D., Northeastern University
 Hall, Theodore P., Syracuse Univ.
 Hall, William M., Mass. Inst. of Tech.
 Hamilton, Alvin W., Kansas State Agr. College
 Hansen, Theodore, Iowa State College
 Hansen, Verner H., Iowa State College
 Hardin, William B., Cornell Univ.
 Harrington, Paul, Purdue Univ.
 Harrison, Charles I., Univ. of Calif.
 Hart, Wesley T., Kansas State Agr. College
 Hartley, Harry A., Purdue Univ.
 Harvey, R. L., University of Tennessee
 Hase, Raymond C., Univ. of Missouri
 Hatch, William H., University of Illinois
 Hayden, George E., Rhode Island State College
 Hayes, Thomas H., Kansas State Agr. College
 Haynes, Raymond W., University of Illinois
 Hensarling, Phil H., Jr., Texas A. & M. College
 Hertz, John D., Ore. Agr. College
 Hescocock, Lee F., University of Maine
 Heye, Gus D., Texas A. & M. College
 Hicks, George E., University of Ky.
 Hilarov, Victor A., Syracuse Univ.
 Hilkey, Harold R., Kansas University
 Hill, Edward T., Bucknell Univ.
 Hill, Ezra C., Purdue Univ.
 Hill, Ole A., Jr., Iowa State College
 Hinnrichs, Herbert, Marquette University
 Hippler, F. R., Case School of Applied Science
 Hobson, Henry M., Rutgers University
 Hoeke, William W., Jr., Lehigh Univ.
 Hoffman, Howard A., Lafayette College

- Hoffman, Kermit B., Lehigh Univ.
 Holmes, William R., Univ. of Missouri
 Holt, Roy L., University of No. Dak.
 Hoppe, Paul R., University of Oregon
 Horn, Leonard, Armour Inst. of Tech.
 Hornby, Fred B., Texas A. & M. College
 Hossle, Walter W., Mass. Inst. of Tech.
 Howard, Arthur W., Univ. of Colorado
 Howell, Louis O., Stanford Univ.
 Hudson, Otis B., Syracuse Univ.
 Hunt, John H., Jr., Lafayette College
 Hutton, Donald G., University of Colorado
 Ikohara, Shikao, Mass. Inst. of Tech.
 Israel, John O., Lafayette College
 Itin, David, Armour Inst. of Tech.
 Jack, Carl R., Purdue Univ.
 Jacobs, Paul M., Marquette University
 Jarrott, Marcus G., University of Pittsburgh
 Jennings, Louis A., Northeastern Univ.
 Jepsen, Ernest, Oregon Agr. College
 Jesse, Louis R., University of Ky.
 Johnson, Claude L., Jr., Louisiana State Univ.
 Johnson, Ernest O., Rose Polytechnic Inst.
 Johnson, Erval W., University of Idaho
 Johnson, George S., University of Colorado
 Johnson, Theodore R., Ohio State Univ.
 Johnson, William H., University of Florida
 Jones, C. Sidney, Armour Inst. of Technology
 Jones, Lloyd, University of No. Dak.
 Jordan, Charles O., Kansas University
 Karnik, Vashwant G., University of Illinois
 Kelham, Merl G., Purdue Univ.
 Kelley, Warren T., University of Washington
 Kellogg, Frank L., Oregon Agr. College
 Kendall, George A., Iowa State College
 Kennedy, Wesley M., University of Washington
 Kenny, Greg L., Jr., Alabama Polytechnic Inst.
 Kern, George F., Syracuse Univ.
 Kotel, Carl G., University of Illinois
 Klob, Nelson A., Rutgers University
 Kirn, Fairfax D., University of Colo.
 Klinert, George, Jr., Armour Inst. of Tech.
 Klinestiver, Gordon H., The Pennsylvania State College
 Knight, Arthur R., Ohio State Univ.
 Konkle, Phil, Iowa State College
 Koopman, Richard W., Univ. of Missouri
 Korsznick, John, Lehigh Univ.
 Kossiakoff, Ivan T., University of Washington
 Kramer, Norman J., Lehigh Univ.
 Krantz, Herman F., Mass. Inst. of Tech.
 Kratochvil, Frank M., Armour Inst. of Tech.
 Kratosky, Fred F., Iowa State College
 Krause, August L., University of Washington
 Krawcek, A. E., Syracuse Univ.
 Kriekhause, Glenn, Kansas University
 Kroeger, William J., Carnegie Inst. of Tech.
 Kronmiller, Charles W., Purdue Univ.
 Kuan, Tung, Mass. Inst. of Tech.
 Kuehn, Frederick W., Cornell Univ.
 Kuehne, Herbert A., Iowa State College
 Kuhn, Jackson G., Calif. Inst. of Tech.
 Kurtinaitis, John V., University of Illinois
 Lake, Maurice E., Northeastern University
 Landenslager, Richard L., Lehigh Univ.
 Landon, Lester L., Jr., Univ. of New Hampshire
 Lantz, Lawrence L., University of Illinois
 Larson, H. Eugene, University of Utah
 Larson, Hilmer E., Calif. Inst. of Tech.
 Lavorgna, Michael L., University of Maine
 Leaverton, Lowell D., Kansas University
 Leavitt, Charles F., Brooklyn Polytechnic Inst.
 Leeka, Warren C., Ohio State Univ.
 Lewis, Donald A., Ohio State Univ.
 Libeck, Melvin C., Washington State College
 Lober, Charles N., Univ. of Missouri
 Lockshin, Samuel, Ohio State Univ.
 Lockwood, Mason G., Rice Institute
 Loggan, Harry J., Oregon Agr. College
 Lome, Julius B., University of Ill.
 Love, Russell J., Calif. Inst. of Tech.
 Low, Harold R., Washington State College
 Lowe, Victor A., Case School of Applied Science
 Lueth, Irving B., Armour Inst. of Tech.
 Lukens, Alan F., Princeton Univ.
 Luthropp, Arthur, Marquette Univ.
 MacGregor, Robert W., Jr., Princeton Univ.
 Mackey, Harry S., Cornell Univ.
 MacNutt, Raymond D., Syracuse Univ.
 Madson, August M., Iowa State College
 Markey, Milton L., Cornell Univ.
 Markwald, James, University of Colo.
 Marples, Robert, Stevens Inst. of Tech.
 Marshall, Thomas C., University of Ky.
 Martin, Devereaux, Mass. Inst. of Tech.
 Martin, Everett E., State College of Washington
 Martin, Ken, Oregon Agr. College
 Massa, Frank, Mass. Inst. of Tech.
 Mathews, John T., University of British Columbia
 Matthews, Douglas W., Case School of Applied Science
 May, Montgomery, University of Tennessee
 McClanahan, Charles D., University of Ky.
 McCord, William P., University of Tennessee
 McElroy, Richard H., University of Washington
 McGinty, Edward J., Marquette University
 McGowan, Harry S., West Virginia Univ.
 McKay, Robert, Ohio State Univ.
 McKle, Robert B., Carnegie Inst. of Tech.
 McKown, Henry M., Northeastern Univ.
 McMakin, William H., Drexel Inst.
 McNally, Francis P., Syracuse Univ.
 Mentzer, Paul K., Case School of Applied Science
 Mercer, Aaron L., Oregon Agr. College
 Merchant, Leland A., The University of Maine
 Mesenkop, Louis H., Calif. Inst. of Tech.
 Metz, Henry I., University of Pittsburgh
 Metzger, Daniel C., Mass. Inst. of Tech.
 Meurer, Erwin E., University of Pittsburgh
 Meuth, Rome M., University of Ky.
 Meyers, George J., Marquette University
 Mikelberg, Samuel, Mass. Inst. of Technology
 Miles, Harold L., Cornell Univ.
 Miles, Irving B., Lehigh Univ.
 Miller, George H., University of Colorado
 Miller, Ira W., Ohio State Univ.
 Millsbaugh, Frederick W., Drexel Institute
 Minnick, Oley P., Univ. of Missouri
 Mino, T. Joseph, State College of Wash.
 Minocha, Kanshi R., Mass. Inst. of Tech.
 Mitchell, D. P., University of Pittsburgh
 Mitchell, Standish R., So. Dak. State School of Mines
 Moccia, Carmen, Mass. Inst. of Tech.
 Moon, Monroe E., University of Maine
 Moore, Hudson, Jr., University of Colorado
 Morehodoff, John A., University of Washington
 Morgan, Nathaniel R., Stanford Univ.
 Morris, Rayson, University of Idaho
 Morton, George R., University of Ill.
 Mosier, George, Univ. of Colorado
 Mount, Mark L., Purdue Univ.
 Muench, Roland, Univ. of Missouri
 Muldoon, James, Rensselaer Poly. Inst.
 Murphy, Laran A., Kansas State Agr. College
 Murray, Donald A., Stanford Univ.
 Myers, J. M., Princeton Univ.
 Nader, Joseph, Purdue Univ.
 Neath, Walter A., Armour Inst. of Technology
 Nelson, Harry O., Oregon Agr. College
 Nelson, Loyd B., University of Colorado
 Nelson, Paul E., University of Colorado
 Neumann, Philip C., Marquette University
 Newton, C. Elmer, Univ. of Santa Clara
 Newton, Stanley H., Northeastern Univ.
 Noel, Edward B., University of Illinois
 Nolte, Theodore C., Univ. of Missouri
 Novak, John M., Oregon Agr. College
 Noyes, Warren F., Northeastern Univ.
 O'Brien, Robert P., Univ. of Santa Clara
 Oelkers, Albert L., Stevens Inst. of Tech.
 Ogan, John K., Purdue Univ.
 Olehy, James H., University of Colorado
 Olmstead, Noel C., Mass. Inst. of Tech.
 Olson, Kermit, University of Washington
 Orr, Norman, University of Pittsburgh
 Osborne, George, Oregon Agr. College
 Osenbaugh, Chester L., Purdue Univ.
 Osterholm, R. W., Case School of Applied Science
 Papiieski, Lucien E., University of Pittsburgh
 Park, Howard, University of Washington
 Parker, Lewis C., University of Colo.
 Paul, Daniel, Lafayette College
 Payne, Herbert M., Ohio State University
 Penn, L. B., University of Ky.
 Perrens, Robert O., Carnegie Inst. of Tech.
 Perry, Paul G., Rice Institute
 Peters, Ervin G., State College of Washington
 Peters, R. E., Texas A. & M. College
 Peterson, R. Lee, Mass. Inst. of Tech.
 Peterson, Arthur O., Jr., Univ. of Washington
 Peterson, Fritz B., University of Idaho
 Pierson, Theodore G., Lehigh Univ.
 Pletschmann, Gustav M., Rutgers University
 Pollak, Hyman A., University of Colorado
 Pollard, Ernest I., University of Nebraska
 Pollock, Sam D., Univ. of Missouri
 Poor, Bernard T., University of Maine
 Porter, James C., University of No. Dak.
 Povey, Edmund H., Northeastern University
 Prather, Virgil L., Purdue Univ.
 Pratt, Charles R., Columbia Univ.
 Preble, Herbert P., University of Maine
 Priest, William F., Washington State College
 Prokop, Edmund W., Marquette University
 Quinn, John L., Univ. of Santa Clara
 Raymer, William F., Jr., University of Ky.
 Reber, Elwood E., Kansas State Agr. College
 Rector, Lawrence, Kansas State Agr. College
 Reifsynder, Guy C., Lafayette College
 Reigler, Hartman, Univ. of Arkansas
 Reitsch, Charles W., Montana State College
 Reynolds, Barton C., Univ. of Kansas
 Rlat, Mehar C., Purdue Univ.
 Riechel, Darrel A., Oregon Agr. College
 Riggs, Harold C., Princeton Univ.
 Robb, Harry C., Jr., Syracuse Univ.
 Robbins, Clyde E., University of Illinois
 Robertson, J. D., Oklahoma A. & M. College
 Rochells, Jerome J., University of Ill.
 Roehholz, Curtis A., Iowa State College
 Rockwell, Ronald J., Iowa State College
 Rosenberg, Marks, Brooklyn Polytechnic Inst.
 Roush, Guy F., Bucknell Univ.
 Rowland, James, Rutgers Univ.
 Rubin, Milton M., Rose Polytechnic Institute
 Rmus, Earl, Iowa State College
 Sanders, Robert B., Iowa State College
 Sasser, Ralph E., Purdue Univ.
 Sato, Robert K., Rose Polytechnic Inst.
 Sax, Eli J., Mass. Inst. of Tech.
 Saxe, William R., Cornell Univ.
 Schell, Paul, University of So. Dak.
 Scherner, Hermann, Oregon Agr. College
 Schmelling, Christian E., Syracuse Univ.
 Schmidt, Oliver D., Kansas State Agr. College
 Schnur, Raymond C., University of Louisville
 Scholz, Walter E., Iowa State College
 Scholz, William, Armour Inst. of Tech.
 Schonvizer, Michael, Case School of Applied Science
 Schooley, Charles E., Univ. of Missouri
 Schott, Lionel, Univ. of Missouri
 Scott, Robert F., University of Maine
 Scoville, Ray R., University of Washington
 Seiter, Norman W., Syracuse Univ.
 Sennett, Harold E., University of Maine
 Setterstrom, R. C., Oregon Agr. College
 Shawhan, Sam F., University of Ky.
 Sherman, Kenneth S., Case School of Applied Science
 Sherman, Robert E., University of Ky.
 Sherwood, William E., University of Ky.
 Simokat, Robert F., Case School of Applied Science
 Slocum, Adelbert I., Northeastern University
 Slocum, Richard M., Purdue Univ.
 Slone, Horace, Syracuse Univ.
 Smith, Charles F., Kansas State Agr. College
 Smith, Edgar H., Lafayette College
 Smith, Emerson C., Ohio Northern University
 Smith, Finley W., Pennsylvania State College
 Smith, Rollo A., Okla. A. & M. College
 Smith, W. Paul, Alabama Poly. Institute
 Smoot, Charles B., University of Ky.
 Snelling, Will D., Texas A. & M. College
 Snook, Starr K., So. Dak. State School of Mines
 Snow, Hewitt A., Alabama Poly. Institute
 Sparks, William J., Jr., University of Ky.
 Spittle, Samuel E., Oregon Agr. College

Sprague, Clarence A., Washington State College
 Stage, Joseph H., Marquette University
 Staggs, Russell W., Rose Polytechnic Institute
 Stanat, Arthur E., Cornell University
 Stanley, Wilbur G., Mass. Inst. of Tech.
 Starr, Frank, Jr., University of Colorado
 St. Clair, Elgar L., University of New Hampshire
 Steinert, Paul W., Armour Inst. of Technology
 Stigers, Orren K., Univ. of Utah
 Stocker, Arthur C., Ohio State Univ.
 Stonefelt, Elmer G., So. Dak. State School of Mines
 Stotler, Charles L., Pennsylvania State College
 St. Pierre, Stowell, Northeastern University
 Strobel, Horace R., Marquette University
 Strodthoff, Geo. P., Marquette University
 Swenson, Carl R., University of Washington
 Swingle, William M., Mass. Inst. of Tech.
 Syner, Truman L., University of Idaho
 Tanner, Arnold F., Case School of Applied Science
 Tanner, Carl C., Kansas State Agr. College
 Tarr, James E., University of Maine
 Taylor, Paul G., University of Colorado
 Taylor, Paul H., Stevens Inst. of Tech.
 Taylor, Roland C., Case School of Applied Science
 Tenenbaum, Murray I., Columbia Univ.
 Ter Maat, Edward, Armour Inst. of Tech.
 Thaeler, Charles S., Lehigh Univ.
 Thakur, Manohar L., Mass. Inst. of Tech.
 Thatchner, John W., Calif. Inst. of Tech.
 Thomson, Wilfrid R., University of Toronto
 Thrall, Leon D., Ohio State Univ.
 Tiller, Vernon L., Univ. of Missouri
 Tobey, Raymond E., University of Maine
 Tomkinson, Albert E., Northeastern University
 Tomlinson, George W., Univ. of Kansas

Towle, Howard C., Jr., Lehigh Univ.
 Tracy, Maurice B., Armour Inst. of Tech.
 Tracy, Stephen J., Stevens Inst. of Tech.
 Treweek, James, Lafayette College
 Trice, Thomas W., Carnegie Inst. of Tech.
 Troy, Constantine T., Cornell Univ.
 Tsai, H. L., University of Illinois
 Tsui, J. H. H., University of Pittsburgh
 Tucker, Stanley W., Lewis Institute
 Turner, Earl N., Oregon Agr. College
 Turrell, Robert M., Univ. of Cincinnati
 Tweeddale, Elwood L., Mass. Inst. of Tech.
 Ulmer, Alfred R., Bucknell Univ.
 Uyeda, Tokujiro, Mass. Inst. of Tech.
 Valentine, Francis B., Ohio State Univ.
 Van Blarcom, Philip S., Cornell Univ.
 Vandaveer, Glenn O., Armour Inst. of Tech.
 Van Nort, J. L., Lehigh Univ.
 Vaughan, Daniel C., Lehigh Univ.
 Vellines, Wesley E., West Virginia University
 Vickerman, Charles E., Drexel Institute
 Von Gehr, George, Armour Inst. of Technology
 Voorhies, Andre F., Jr., Lehigh Univ.
 Wade, Charles C., Lafayette College
 Wagner, Homer H., University of Illinois
 Walkama, Toivo E., Stevens Inst. of Tech.
 Walker, Elmer S., Northeastern University
 Walker, Fletcher L., Jr., Stanford Univ.
 Walter, John H., Purdue Univ.
 Walters, John B., Alabama Polytechnic Institute
 Warren, George I., Univ. of Colorado
 Waterman, Roy E., Univ. of Santa Clara
 Waters, Merrill C., Syracuse Univ.
 Watson, Paul E., University of Maine
 Watts, Raymond S., University of Illinois
 Webb, Cloyce, Ohio State Univ.

Weggenmann, Edward E., University of Delaware
 Wehr, Elmer F., Ohio State Univ.
 Welch, Henry, University of Maine
 Welch, Merrill E., Lehigh Univ.
 White, Donald A., So. Dak. State School of Mines
 White, Henry H., Case School of Applied Science
 White, Hugh E., Kansas State Agr. College
 Whitehead, Loren E., Kansas University
 Whitford, Royden K., Jr., Kansas State Agr. College
 Whitwam, Lloyd F., Univ. of Santa Clara
 Wieber, Charles G., Marquette Univ.
 Wiegand, Frank H., Calif. Inst. of Tech.
 Wiewall, Miguel, Jr., Rensselaer Polytechnic Inst.
 Wilcox, J. L., Case School of Applied Science
 Wilder, Robert D., Cornell Univ.
 Williams, Dudley O., University of Ky.
 Wilson, Alfred J., Kansas State Agr. College
 Wilson, Frederick R., Calif. Inst. of Tech.
 Wilson, Nicholas R., Univ. of Calif.
 Wimmer, Lyle G., University of Washington
 Winters, Howard J., Kansas State Agr. College
 Witt, Frederic L., Cornell Univ.
 Wohlers, Karl E., Stevens Inst. of Tech.
 Wood, Raymond E., University of Maine
 Woodard, Clinton A., University of Maine
 Woodard, William E., Texas A. & M. College
 Wootton, John C., Stevens Inst. of Technology
 Wyatt, Charles H., Okla. A. & M. College
 Wycoff, Rodney A., University of Utah
 Young, Lottie E., Kansas University
 Yu, Wei H., Mass. Inst. of Tech.
 Zalesny, E. V., University of Colo.
 Zamudio, Pedro J., Rensselaer Polytechnic Inst.
 Zarwell, Cedric E., Marquette University
 Zenner, Walter J., Armour Inst. of Technology
 Zerweck, Richard, Lehigh Univ.
 Total 585.

Engineering Societies Employment Service

Under joint management of the national societies of Civil, Mining, Mechanical and Electrical Engineers cooperating with the Western Society of Engineers. The service is available only to their membership, and is maintained as a cooperative bureau by contributions from the societies and their individual members who are directly benefited.

Offices:—33 West 39th St., New York, N. Y.,—W. V. Brown, Manager.

53 West Jackson Bl'v'de., Room 1736, Chicago, Ill., A. K. Krauser, Manager.

57 Post St., San Francisco, Calif., N. D. Cook, Manager.

MEN AVAILABLE.—Brief announcements will be published without charge but will not be repeated except upon requests received after an interval of one month. Names and records will remain in the active files of the bureau for a period of three months and are renewable upon request. Notices for this Department should be addressed to **EMPLOYMENT SERVICE, 33 West 39th Street, New York City**, and should be received prior to the 15th day of the month.

OPPORTUNITIES.—A Bulletin of engineering positions available is published weekly and is available to members of the Societies concerned at a subscription rate of \$3 per quarter, or \$10 per annum, payable in advance. Positions not filled promptly as a result of publication in the Bulletin may be announced herein, as formerly.

VOLUNTARY CONTRIBUTIONS.—Members obtaining positions through the medium of this service are invited to cooperate with the Societies in the financing of the work by nominal contributions made within thirty days after placement, on the basis of \$10 for all positions paying a salary of \$2000 or less per annum; \$10 plus one per cent of all amounts in excess of \$2000 per annum; temporary positions (of one month or less) three per cent of total salary received. The income contributed by the members, together with the finances appropriated by the four societies named above, will it is hoped, be sufficient not only to maintain, but to increase and extend the service.

REPLIES TO ANNOUNCEMENTS.—Replies to announcements published herein or in the Bulletin, should be addressed to the key number indicated in each case, with a two cent stamp attached for reforwarding, and forwarded to the Employment Service as above. Replies received by the bureau after the positions to which they refer have been filled will not be forwarded.

POSITIONS OPEN

GRADUATE ENGINEER, with approximately five years' general experience in engineering work, preferably distribution experience in eastern public utility. Experience handling men desirable. Salary \$3000 a year to start. Opportunity. Apply by letter stating age, education, and complete experience in detail, and enclose photograph. Location, New York City. X-1089.

CERAMIC ENGINEER, with one to two years' experience, for chemical company. Apply by letter. Location, New York. X-1117.

AN ESTABLISHED AND SUCCESSFUL CONSULTING ENGINEERING BUSINESS

in New York City desires to add to its staff with an early chance of partnership, a graduate engineer having broad engineering experience, including sales, to take charge of a new extension of their business. No investment necessary, but prefer if applicant could carry himself financially for six months, although latter condition not absolutely necessary. Give detailed account of experience, when available, etc. X-1312.

MEN AVAILABLE

COLLEGE GRADUATE, '25 in E. E., desires position where he can acquire experience either in appraisal or construction work. Available two weeks. Location, New York. C-512.

1925 GRADUATE ELECTRICAL ENGINEER, desires position with public utility. One year's experience in overhead distribution. Available on reasonable notice. C-294.

ELECTRICAL ENGINEER, Lehigh graduate, 36, thoroughly experienced in coal mining, steel mill and allied industrial operations, invites correspondence with view toward connection with responsible firm. Now employed satisfactorily, but future limited by conditions beyond personal control. Available within month. B-4905.

ELECTRICAL ENGINEER, technical graduate, G. E. test and six years' experience with large public utilities including engineering, operation and commercial work; specialized in

cost and rate work. Desires position in valuation and rate work with public utility company or with firm of consulting engineers. B-9732.

ELECTRICAL DESIGNER, thoroughly experienced in substation and power-plant layout; six years European, two and one-half years' American experience with public utility and consulting company. 32 years old, and of Swedish origin. Would consider position as translator from German and the Scandinavian languages. Available immediately. C-2088.

UTILITY ENGINEER, 38, married, technical graduate. Fourteen years' experience testing, manufacture, installation, design and operation. Last six years spent in operation and management of a small utility. Desires position of responsibility with a utility or holding company in or near New York. A-2018.

ENGINEER, with public utility experience, including industrial power sales work; experience with a large industrial covering steam and power production, maintenance, rehabilitation, etc., also test floor and erecting experience with large electrical manufacturer. Cornell graduate, M. E. E. E. Only prospect of reasonably permanent employment considered. B-6764.

ELECTRICAL ENGINEER, 40, married, designer and manufacturer of small interchange-

able electric equipment and parts, automatic machinery, power plants, transmission lines, catenaries and high tension systems, layout, costs and details. Accustomed to purchasing all material needed. Corporation executive work organizing and handling men in field and office and drafting room. Available now. Location preferred, New York, or within commuting area. B-3863.

GRADUATE IN ELECTRICAL ENGINEERING, desires a position in which there are possibilities of a future. Experienced in radio broadcasting and experimental amateur work, eight years. Has had experience in civil engineering and drafting. Location, Philadelphia or vicinity. Available in about two weeks. C-2129.

ASSISTANT ENGINEER, 29, single, technical graduate, with four years' power plant experience, including installation, material, estimating and valuation experience, desires a connection with consulting engineer or firm offering position of similar status on staff. Salary open. Available immediately. Location, East. C-1183.

RECENT GRADUATE IN E. E., with a year of varied experience in utility work, desires a position with construction or holding company. C-2147.

ENGINEER, 33, married, no encumbrance,

desires change. Experience; five years apprentice mechanical engineer, designing and complete installation telephony and telegraphy (high speed cable and wireless), offices and plant, factory and plant management, automotive machinery. Able to handle men. Used to Tropics. Location, any part of World. C-2151.

PROFESSOR OF ELECTRICAL ENGINEERING, desires change, holds degrees from two large American universities. Has twice risen to be head of E. E. departments in State College. Fine administrator and teacher. Age 41, married, Protestant, member of A. I. E. E. and S. P. E. E. Correspondence invited. C-2155.

DISTRIBUTION ENGINEER, technical graduate, 33, married, several years' electrical and mechanical test experience in power stations. Five years' distribution experience with large public utility in East. Desires position in distribution engineering, or sales engineering in distribution field. Location, East. Available one month. Salary \$280.00. B-1410.

DESIGN ENGINEER, age 31, technical man with nine years' experience on electrical design of modern power plants and indoor and outdoor substations. Thoroughly familiar with up to date practises and equipment and capable of supervising and checking work. Location, New York City. C-292.

OFFICERS OF A. I. E. E. 1926-1927

President
C. C. CHESNEY

Junior Past Presidents
M. I. PUPIN
FARLEY OSGOOD

Vice-Presidents
P. M. DOWNING
HERBERT S. SANDS
W. E. MITCHELL
ARTHUR G. PIERCE
W. P. DOBSON

Managers
WILLIAM M. MCCONAHEY
W. K. VANDERPOEL
H. P. CHARLESWORTH
JOHN B. WHITEHEAD
J. M. BRYANT
E. B. MERRIAM

National Treasurer
GEORGE A. HAMILTON

National Secretary
F. L. HUTCHINSON

Honorary Secretary
RALPH W. POPE

LOCAL HONORARY SECRETARIES

T. J. Fleming, Calle B. Mitre 519, Buenos Aires, Argentina, S. A.
H. W. Flashman, Aus. Westinghouse Elec. Co. Ltd., Cathcart House,
11 Castelreagh St., Sydney, N. S. W., Australia.
Carroll M. Mauseau, Caixa Postal No. 571, Rio de Janeiro, Brazil, S. A.
Charles le Maistre, 28 Victoria St., London, S. W. 1, England.
A. S. Garfield, 45 Bd. Beausejour, Paris 16 E, France.
F. W. Willis, Tata Power Companies, Bombay House, Bombay, India.
Guido Semenza, 39 Via Monte Napoleone, Milan, Italy.
P. H. Powell, Canterbury College, Christchurch, New Zealand.
Axel F. Enstrom, 24a Greftevegatan, Stockholm, Sweden.
W. Elsdon-Dew, P. O. Box 4563, Johannesburg, Transvaal, Africa.

A. I. E. E. COMMITTEES

(A list of the personnel of Institute committees may be found in the September issue of the JOURNAL and will be published again in the January 1927 issue.)

GENERAL STANDING COMMITTEES AND CHAIRMEN

EXECUTIVE, C. C. Chesney
FINANCE, H. A. Kidder
MEETINGS AND PAPERS, E. B. Meyer
PUBLICATION, L. F. Morehouse
COORDINATION OF INSTITUTE ACTIVITIES, Farley Osgood
BOARD OF EXAMINERS, Erich Hausmann
SECTIONS, Harold B. Smith
STUDENT BRANCHES, C. E. Magnusson
MEMBERSHIP, L. S. O'Roark
HEADQUARTERS, G. L. Knight
LAW, W. I. Slichter
PUBLIC POLICY, Gano Dunn
STANDARDS, J. Franklin Meyer
EDISON MEDAL, Gano Dunn
CODE OF PRINCIPLES OF PROFESSIONAL CONDUCT, John W. Lieb
COLUMBIA UNIVERSITY SCHOLARSHIP, W. I. Slichter
AWARD OF INSTITUTE PRIZES, E. B. Meyer
SAFETY CODES, J. P. JACKSON

SPECIAL COMMITTEES

LICENSING OF ENGINEERS, Francis Blossom
TECHNICAL ACTIVITIES, A. G. Pierce

TECHNICAL COMMITTEES AND CHAIRMEN

COMMUNICATION, H. P. Charlesworth
EDUCATION, P. M. Lincoln
ELECTRICAL MACHINERY, H. M. Hobart
ELECTROCHEMISTRY AND ELECTROMETALLURGY, George W. Vinal
ELECTROPHYSICS, V. Karapetoff
INSTRUMENTS AND MEASUREMENTS, A. E. Knowlton
APPLICATIONS TO IRON AND STEEL PRODUCTION, A. G. Pierce
PRODUCTION AND APPLICATION OF LIGHT, Preston S. Millar
APPLICATIONS TO MARINE WORK, G. A. Pierce
APPLICATIONS TO MINING WORK, W. H. Lesser
GENERAL POWER APPLICATIONS, A. M. MacCutcheon
POWER GENERATION, H. W. Eales
POWER TRANSMISSION AND DISTRIBUTION, Philip Torchio
PROTECTIVE DEVICES, F. L. Hunt
RESEARCH, John B. Whitehead
TRANSPORTATION, J. V. B. Duer

A. I. E. E. REPRESENTATION

(The Institute is represented on the following bodies; the names of the representatives may be found in the September issue of the JOURNAL and will be published again in the January 1927 issue.)

AMERICAN ASSOCIATION FOR THE ADVANCEMENT OF SCIENCE, COUNCIL
AMERICAN BUREAU OF WELDING
AMERICAN COMMITTEE OF ELECTROLYSIS
AMERICAN ENGINEERING COUNCIL
AMERICAN ENGINEERING STANDARDS COMMITTEE
AMERICAN MARINE STANDARDS COMMITTEE
AMERICAN YEAR BOOK, ADVISORY BOARD
APPARATUS MAKERS AND USERS COMMITTEE
BOARD OF TRUSTEES, UNITED ENGINEERING SOCIETY
CHARLES A. COFFIN FELLOWSHIP AND RESEARCH FUND COMMITTEE
COMMITTEE ON ELIMINATION OF FATIGUE, SOCIETY OF INDUSTRIAL ENGINEERS
ENGINEERING FOUNDATION BOARD
JOHN FRITZ MEDAL BOARD OF AWARD
JOINT COMMITTEE ON COMPENSATION, CHARLES F. SCOTT
JOINT COMMITTEE ON WELDED RAIL JOINTS
JOINT CONFERENCE COMMITTEE OF FOUR FOUNDER SOCIETIES
LIBRARY BOARD, UNITED ENGINEERING SOCIETY
NATIONAL FIRE PROTECTION ASSOCIATION, ELECTRICAL COMMITTEE
NATIONAL FIRE WASTE COUNCIL
NATIONAL MUSEUM OF ENGINEERING AND INDUSTRY, BOARD OF TRUSTEES
NATIONAL RESEARCH COUNCIL, ENGINEERING DIVISION
NATIONAL SAFETY COUNCIL, ELECTRICAL COMMITTEE OF ENGINEERING SECTION
THE NEWCOMEN SOCIETY
RADIO ADVISORY COMMITTEE, BUREAU OF STANDARDS
SOCIETY FOR THE PROMOTION OF ENGINEERING EDUCATION, BOARD OF INVESTIGATION AND COORDINATION
U. S. NATIONAL COMMITTEE OF THE INTERNATIONAL ELECTROTECHNICAL COMMISSION
U. S. NATIONAL COMMITTEE OF THE INTERNATIONAL ILLUMINATION COMMISSION
WASHINGTON AWARD, COMMISSION OF

LIST OF SECTIONS

Name	Chairman	Secretary	Name	Chairman	Secretary
Akron	A. R. Holden	H. L. Steinbach, Electrical Engineering Dept., Goodyear Tire & Rubber Co., Akron, Ohio	Fort Wayne	D. W. Merchant	C. F. Beyer, General Electric Co., Fort Wayne, Ind.
Atlanta	C. E. Bennett	W. F. Oliver, Box 2211, Atlanta, Ga.	Indianapolis-Lafayette	J. B. Bailey	C. A. Fay, 4206 Cornelius Ave., Indianapolis, Ind.
Baltimore	W. B. Kouwenhoven	R. T. Greer, Madison St. Building, Baltimore, Md.	Ithaca	R. F. Chamberlain	G. F. Bason, Electrical Engineering Dept., Cornell University, Ithaca, N. Y.
Boston	Hartley Rowe	W. H. Colburn, 39 Boylston St., Boston, Mass.	Kansas City	R. L. Baldwin	S. M. De Camp, 510 Dwight Bldg., Kansas City, Mo.
Chicago	K. A. Auty	William Wurth, 1634 Peoples Gas Bldg., Michigan Ave. at Adams St., Chicago, Ill.	Lehigh Valley	W. E. Lloyd, Jr.	G. W. Brooks, Pennsylvania Power & Light Co., 8th & Hamilton Sts., Allentown, Pa.
Cincinnati	W. P. Beattie	L. J. Gregory, Union Gas & Electric Co., Cincinnati, Ohio	Los Angeles	R. E. Cunningham	L. C. Williams, H. W. Hellman Bldg., Los Angeles, Calif.
Cleveland	H. L. Grant	W. E. McFarland, 720 Illuminating Bldg., Cleveland, Ohio	Louisville	D. C. Jackson, Jr.	W. C. White, Southern Bell Tel. & Tel. Co., Louisville, Ky.
Columbus	A. W. Janowitz	E. A. Williams, 231 N. Fifth St., Columbus, Ohio	Lynn	D. F. Smalley	Chas. Skoglund, River Works, General Electric Co., W. Lynn, Mass.
Connecticut	E. Knowlton	R. G. Warner, Yale University, 10 Hillhouse Ave., New Haven, Conn.	Madison	J. Kallevang	H. J. Hunt, D. W. Mead & C. V. Seastone, State Journal Bldg., Madison, Wis.
Denver	W. H. Edmunds	R. B. Bonney, Telephone Bldg., P. O. Box 960, Denver, Colo.	Mexico	Carlos Macias	G. Solis Payan, Ave. Portales 89, General Anaya, Mexico D. F., Mexico.
Detroit-Ann Arbor	Harold Cole	F. H. Riddle, Champion Porcelain Co., Detroit, Mich.	Milwaukee	H. L. Van Valkenberg	R. G. Lockett, Cutler-Hammer Mfg. Co., Milwaukee, Wis.
Erie	P. A. Tennant	L. H. Curtis, General Electric Co., Erie, Pa.	Minnesota	S. B. Hood	M. E. Todd, University of Minnesota, Minneapolis, Minn.
			Nebraska	J. W. Minard	N. W. Kingsley, 1303 Telephone Bldg., Omaha, Nebr.

LIST OF SECTIONS—Continued.

Name	Chairman	Secretary	Name	Chairman	Secretary
New York	E. B. Meyer	O. B. Blackwell, American Tel. & Tel. Co., 195 Broadway, New York, N. Y.	Sharon	H. L. Cole	L. H. Hill, Westinghouse Elec. & Mfg. Co., Sharon, Pa.
Niagara Frontier	H. B. Alverson	A. W. Underhill, Jr., 606 Lafayette Bldg., Buffalo, N. Y.	Southern Virginia	W. S. Rodman	J. R. Berry, 1338 Rockbridge Ave., Norfolk, Va.
Oklahoma	E. R. Page	C. C. Stewart, Oklahoma Gas & Electric Co., Norman, Okla.	Spokane	Richard McKay	James B. Pliska, Washington Water Power Co., Lincoln & Trent, Spokane, Wash.
Panama	L. W. Parsons	I. P. McIlhenny, Box 413, Balboa Heights, C. Z.	Springfield, Mass.	L. P. Curtis	J. Frank Murray, United Electric Light Co., 251 Wilbraham Ave., Springfield, Mass.
Philadelphia	Louis J. Costa	R. H. Silbert, 2301 Market St., Philadelphia, Pa.	Syracuse	C. E. Dorr	P. E. Verdin, 615 City Bank Bldg., Syracuse, N. Y.
Pittsburgh	D. M. Simons	W. C. Goodwin, Westinghouse Elec. & Mfg. Co., East Pittsburgh, Pa.	Toledo	O. P. Rabbe	Max Neuber, 1257 Fernwood Ave., Toledo, Ohio
Pittsfield	E. F. Gehrrens	C. H. Kline, General Electric Co., Pittsfield, Mass.	Toronto	M. B. Hastings	P. P. Ambuhl, Toronto Hydro-Electric System, 226 Yonge St., Toronto, Ontario
Portland, Ore.	J. C. Henkle	J. E. Yates, Gasco Bldg., Portland, Ore.	Urbana	J. T. Tykociner	L. B. Archer, 301 Electrical Engineering Lab., University of Illinois, Urbana, Ill.
Providence	Edwin E. Nelson	F. W. Smith, Blackstone Valley Gas & Electric Co., Pawtucket, R. I.	Utah	B. C. J. Wheatlake	D. L. Brundige, Utah Power & Light Co., Box 1790, Salt Lake City, Utah
Rochester	Earl C. Karker	Wade H. Reichard, General Ry. Signal Co., Rochester, N. Y.	Vancouver	R. L. Hall	C. W. Colvin, Electric Railway Co., 425 Carrall St., Vancouver, B. C.
St. Louis	W. H. Millan	L. N. Van Hook, 3809 Park Ave., St. Louis, Mo.	Washington, D. C.	C. A. Robinson	D. S. Wegg, Dept. of Commerce, Room 817, Pennsylvania Ave., at 19th St., N. W., Wash- ton, D. C.
San Francisco	D. I. Cone	A. G. Jones, 807 Rialto Bldg., San Francisco, Calif.	Worcester	C. F. Hood	F. B. Crosby, Morgan Construc- tion Co., 15 Belmont St., Worcester, Mass.
Saskatchewan	S. R. Parker	W. P. Brattle, Dept. of Telephones, Telephone Bldg., Regina, Sask.	Total 52		
Schenectady	R. E. Doherty	R. F. Franklin, Room 301, Bldg. No. 41, General Electric Co., Schenectady, N. Y.			
Seattle	C. E. Mong	C. R. Wallis, 609 Colman Bldg., P. O. Box 1858, Seattle, Wash.			

LIST OF BRANCHES

Name and Location	Chairman	Secretary	Counselor (Member of Faculty)
Akron, Municipal University of, Akron, Ohio	Lee J. Shaffer	S. K. Worthen	J. T. Walther
Alabama Polytechnic Institute, Auburn, Ala.	J. D. Stewart	I. L. Knox	W. W. Hill
Alabama, University of, University, Ala.	Sewell St. John		
Arizona, University of, Tucson, Ariz.	J. W. Cruse	Audley Sharpe	J. C. Clark
Arkansas, University of, Fayetteville, Ark.	Carroll Walsh	W. H. Mann	W. B. Stelzner
Armour Institute of Technology, Chicago, Ill.	M. T. Goetz	C. W. Schramm	D. P. Moreton
Brooklyn Polytechnic Institute, Brooklyn, N. Y.	William Berger	Joseph Heller	Robin Beach
Bucknell University, Lewisburg, Pa.	A. Fogelsanger	J. D. Johnson	W. K. Rhodes
California Institute of Technology, Pasadena, Calif.	Thomas L. Gottier	Alan E. Capon	R. W. Sorensen
California, University of, Berkeley, Calif.	C. F. Dalziel	R. S. Briggs	T. C. McFarland
Carnegie Institute of Technology, Pittsburgh, Pa.	J. R. Power	R. O. Perrine	B. C. Dennison
Case School of Applied Science, Cleveland, O.	C. J. Brumbaugh	E. E. Samson	H. B. Dates
Catholic University of America, Washington, D. C.	W. S. Sparks	C. S. Daily, Jr.	T. J. MacKavanaugh
Cincinnati, University of, Cincinnati, O.	C. W. Taylor	W. C. Osterbrock	W. C. Osterbrock
Clarkson College of Technology, Potsdam, N. Y.	W. R. MacGregor	L. G. Carney	A. R. Powers
Clemson Agricultural College, Clemson College, S. C.	L. R. Miller	J. U. Wilson	S. R. Rhodes
Colorado State Agricultural College, Ft. Collins, Colo.	C. O. Nelson	D. W. Asay	
Colorado, University of, Boulder, Colo.	A. D. Thomas	J. A. Setter	W. C. DuVal
Cooper Union, New York, N. Y.	H. T. Wilhelm	E. T. Reynolds	Norman L. Towle
Denver, University of, Denver, Colo.	Harold Henson	Allea Ohlson	R. E. Nyswander
Drexel Institute, Philadelphia, Pa.	H. D. Baker	R. S. Eninger, Jr.	E. O. Lange
Florida, University of, Gainesville, Fla.	W. Stanwix-Hay	R. D. Ross	J. M. Weil
Georgia School of Technology, Atlanta, Ga.	W. M. McGraw	F. L. Kaestle	E. S. Hannaford
Idaho, University of, Moscow, Idaho	J. W. Gartin	S. Blore	J. H. Johnson
Iowa State College, Ames, Iowa	A. G. Baumgartner	J. B. Cecil	F. A. Fish
Iowa, University of, Iowa City, Iowa	L. Dimond	A. C. Boeke	A. H. Ford
Kansas State College, Manhattan, Kans.	A. M. Young	John Yost	C. E. Reid
Kansas, University of, Lawrence, Kans.	W. L. Immer	H. R. Hilkey	G. C. Shaad
Kentucky, University of, Lexington, Ky.	J. A. Weingartner	C. E. Albert	
Lafayette College, Easton, Pa.	Herbert Heinrich	Daniel Paul	Morland King
Lehigh University, S. Bethlehem, Pa.	F. G. Kear	J. H. Shuhart	J. L. Beaver
Lewis Institute, Chicago, Ill.	James S. Howe	O. D. Westerberg	F. A. Rogers
Louisiana State University, Baton Rouge, La.	K. J. Ozment	E. P. Athens	M. B. Voorhies
Maine, University of, Orono, Me.	P. E. Watson	R. F. Scott	W. E. Barrows, Jr.
Marquette University, Milwaukee, Wis.	R. M. Franey	E. T. Baldwin	J. F. H. Douglas
Massachusetts Institute of Technology, Cambrdgie, Mass.	Constantine Bary	E. A. Michelman	W. H. Timbie
Michigan State College, East Lansing	W. H. Bartels	J. C. Phelps	L. S. Foltz
Michigan, University of, Ann Arbor, Mich.	M. H. Nelson	H. R. Stevenson	B. F. Bailey
Milwaukee, Engineering School of, Milwaukee, Wis.	L. H. La Fever	W. H. Freisleben	B. A. Bovee
Minnesota, University of, Minneapolis, Minn.	C. H. Burmeister	J. H. DuBois	H. Kuhlmann
Missouri, University of, Columbia, Mo.	V. L. Tiller	J. L. Egbert	M. P. Weinbach
Missouri School of Mines and Metallurgy, Rolla, Mo.	W. J. Maulder	R. P. Baumgartner	I. H. Lovett
Montana State College, Bozeman, Mont.	W. E. Pakala	J. A. Thaler	J. A. Thaler
Nebraska, University of, Lincoln, Neb.	M. E. La Bounty	R. D. Reed	F. W. Norris
Nevada, University of, Reno, Nev.	George Fairbrother	Cornelius Fort	S. G. Palmer
Newark Technical School, College of Engineering of, Newark, N. J.	H. G. Patton	C. H. Clarendon, Jr.	J. C. Peet
New Hampshire, University of, Durham, N. H.	T. C. Tappan	F. W. Hussey	L. W. Hitchcock
New York, College of the City of, New York, N. Y.	Harold Wolf	J. Leipziger	Harry Baum
New York University, New York, N. Y.	H. U. Hefty	Henry Och	J. Loring Arnold
North Carolina State College, Raleigh, N. C.	J. W. Fagan	W. E. Mathews	G. C. Cox
North Carolina, University of, Chapel Hill	H. L. Coe	C. M. Lear	P. H. Daggctt
North Dakota, University of, University	Authur Eielson	W. W. Kloster	D. R. Jenkins

LIST OF BRANCHES—Continued

Name and Location	Chairman	Secretary	Counselor (Member of Faculty)
Northeastern University, Boston, Mass.	W. P. Raffone	John L. Clark	W. L. Smith
Notre Dame, University of, Notre Dame, Ind.	W. C. Davis	C. H. Schamel	J. A. Caparo
Ohio Northern University, Ada, Ohio	M. Heft	P. W. Wadsworth	
Ohio State University, Columbus, O.	Lee P. Doyle	J. S. Hoddy	F. C. Caldwell
Ohio University, Athens, Ohio	N. R. Smith	J. E. Quick	A. A. Atkinson
Oklahoma A. & M. College, Stillwater, Okla.	H. M. Horton	Lee Rogers	Edwin Kurtz
Oklahoma, University of, Norman, Okla.	G. B. Brady	J. C. Glaze	F. G. Tappan
Oregon Agricultural College, Corvallis, Ore.	F. D. Crowther	E. F. Reddy	F. O. McMillan
Pennsylvania State College, State College, Pa.	F. F. Wilkins	C. C. Huggler	L. A. Doggett
Pennsylvania, University of, Philadelphia	F. H. Riordan, Jr.	W. H. Hamilton	C. D. Fawcett
Pittsburgh, University of, Pittsburgh, Pa.	M. G. Jarrett	D. P. Mitchell	H. E. Dyche
Princeton University, Princeton, N. J.			
Purdue University, Lafayette, Ind.	A. Howard	T. B. Holliday	A. N. Topping
Rensselaer Polytechnic Institute, Troy, N. Y.	F. M. Sebast	W. C. Michels	F. M. Sebast
Rhode Island State College, Kingston, R. I.	G. A. Eddy	C. Easterbrooks	Wm. Anderson
Rose Polytechnic Institute, Terre Haute, Ind.	J. H. Utt	E. Letsinger	C. C. Knipmeyer
Rutgers University, New Brunswick, N. J.	E. C. Siddons	W. H. Bohlke	F. F. Thompson
Santa Clara, University of, Santa Clara, Calif.	F. Whitwam	W. P. Fisher	D. W. Griswold
South Dakota State School of Mines, Rapid City, S. D.	C. Allen	Harold Eade	J. O. Kammerman
South Dakota, University of, Vermillion, S. D.	Maurice Nelles	Stanley Boegler	B. B. Brackett
Southern California, University of, Los Angeles, Calif.	Karl Raife	E. E. Smith	C. E. Guse
Stanford University, Stanford University, Calif.	A. V. Pering	J. G. Sharp	H. H. Henline
Stevens Institute of Technology, Hoboken, N. J.	D. B. Weststrom	G. E. Witham	Frank C. Stockwell
Swarthmore College, Swarthmore, Pa.	J. S. Donal, Jr.	R. W. Lafore	Lewis Fussell
Syracuse University, Syracuse, N. Y.	G. F. Kern	T. P. Hall	C. W. Henderson
Tennessee, University of, Knoxville, Tenn.	K. N. Green	B. M. Gallaher	Charles A. Perkins
Texas A. & M. College, College Station, Texas	C. A. Altenbern	J. L. Pratt	F. C. Bolton
Texas, University of, Austin, Tex.	F. W. Langner	H. W. Zuch	J. A. Correll
Utah, University of, Salt Lake City, Utah	F. C. Bates	C. E. Hoffman	J. F. Merrill
Virginia Military Institute, Lexington, Va.	R. P. Williamson	M. L. Waring	S. W. Anderson
Virginia Polytechnic Institute, Blacksburg, Va.	R. M. Hutcheson	M. B. Cogbill	Claudius Lee
Virginia, University of, University, Va.	R. C. Small	H. M. Roth	W. S. Rodman
Washington, State College of, Pullman, Wash.	S. H. White	H. R. Meahl	H. V. Carpenter
Washington University, St. Louis, Mo.	E. B. Kempster, Jr.	R. L. Belshe	H. G. Hake
Washington, University of, Seattle, Wash.	C. M. Murray, Jr.	Roy H. Crosby	George S. Smith
Washington and Lee University, Lexington, Va.	C. M. Wood	R. E. Kepler	R. W. Dickey
West Virginia University, Morgantown, W. Va.	I. L. Smith	P. E. Davis	A. H. Forman
Wisconsin, University of, Madison, Wis.	Benj. Teare	N. B. Thayer	C. M. Jansky
Worcester Polytechnic Institute, Worcester, Mass.	D. A. Calder	C. H. Kauke	H. A. Maxfield
Wyoming, University of, Laramie, Wyo.	John Hicks	J. O. Yates	G. H. Sechrist
Yale University, New Haven, Conn.	W. W. Parker	J. W. Hinkley	Charles F. Scott
Total 93			

JOURNAL OF THE American Institute of Electrical Engineers

INDEX TO VOLUME XLV

January 1 to December 31, 1926

INDEX OF PAPERS, DISCUSSIONS, REPORTS, ETC.

Can the Thermal Capacity of Electric Machines be Made a Simple and Practical Element of Rating? (A. E. Kennelly).....	438
— University Aid Industry? (B. F. Bailey).....	742
Discussion.....	1171
Carrier-Current Communication on Submarine Cables, (H. W. Hitchcock).....	923
Carrying Capacity of 60-Cycle Busses for Heavy Currents, (Titus G. Le Clair).....	9
Discussion.....	569
Cipher Printing Telegraph Systems. (G. S. Vernam).....	109
Discussion.....	572
Circle Diagram of a Transmission Network, The. (F. E. Terman).....	1238
Circuit Breaker in Railway Feeder Networks, The High-Speed. (J. W. McNairy).....	619
Discussion.....	1176
Circulation of Harmonics in Transformer Circuits. (T. C. Lennox).....	755
Discussion.....	1014
Coal Mining, Electricity and. (Daniel Harrington).....	1264
Communication on Submarine Cables, Carrier-Current. (H. W. Hitchcock).....	923
Comparison of Natural and Artificial Lighting, The. (D. M. Simons and W. S. Brown).....	230
Compensation for Errors of the Quadrant Electrometer. (D. M. Simons and W. S. Brown).....	524
Discussion.....	1288
Conductor in Corona at 60 Cycles, The Space Charge that Surrounds a. (J. S. Carroll and H. J. Ryan).....	1136
— Tensions, Unbalanced. (E. S. Healy and A. J. Wright).....	1144
Conductors, Notes on the Vibration of Transmission-Line. (Theodore Varney).....	953
Discussion.....	1022
Construction of the 110-Kv. Transmission Line of the Washington Water Power Company. (Lester R. Gamble).....	1255
Discussion.....	1309
Contact, Temperature of a. (J. Slepian).....	930
Discussion.....	1308
Control of Hydroelectric Generating Stations, Automatic and Supervisory. (Frank V. Smith).....	967
Discussion.....	1029
—, Rectifier Voltage. (D. C. Prince).....	630
Discussion.....	1022
Controlling Insulation Difficulties in the Vicinity of Great Salt Lake. (B. F. Howard).....	1268
Correspondence.....	
Charles Scribner Obituary. (John A. McManus).....	939
Discussion on Alternating-Current Analysis. (H. H. Race).....	669
Highway Lighting. (Talarero Milton).....	354
Discussion.....	429
Leakage Reactance. (W. V. Lyons).....	151
Predetermination of Self-Cooled, Oil Immersed Transformer Temperatures Before Conditions Are Constant. (Thomas Rosskopf).....	669
Transmission Line Sag Calculations. (H. B. Dwight).....	773
Discussion.....	773
Cosmic Harness of Moving Electricity, The. Presidents Address. (M. I. Pupin).....	758
Discussion.....	999
Calculation of Magnetic Attraction, The. (Th. Lehmann).....	1009
Discussion.....	627
High-Voltage. (W. A. Del Mar).....	923
—, The Effect of Internal Vacua Upon the Operation of W. Hitchcock).....	1288
Carrier-Current Communication on Submarine. (H. W. Hitchcock).....	719
Discussion.....	1006
Cables, Accuracy Required in the Measurement of Dielectric Power Factor of Impregnated Paper-Insulated Cables, (C. F. Hanson).....	454
Discussion.....	569
Tests of Paper-Insulated High-Tension. (F. M. Cable).....	9
Discussion.....	824
Busses for Heavy Currents, Carrying Capacity of 60-Cycle. (Titus G. Le Clair).....	904
Discussion.....	707
Breakdown of Dielectrics, The Mechanism of. (P. L. Hoover).....	904
Behavior of Radio Receiving Systems to Signals and to Interference. (Leo James Peters).....	1175
Discussion.....	661
Auto-Transformer, General Theory of. (Walter L. Upson).....	271
Automobile Headlighting.....	1029
Discussion.....	967
Generating Stations. (Frank V. Smith).....	574
Automatic and Supervisory Control of Hydroelectric Generating Stations, Automatic and Supervisory. (Frank V. Smith).....	1019
Arresters, Theory of the Autovalve. (J. Slepian).....	665
Discussion.....	763
Armature Leakage Reactance in Saliient-Pole Synchronous Machines, Variable. (Vladimir Karapetoff).....	124
Discussion.....	813
Altitude, The Ratings of Electrical Machines as Affected by. (Carl J. Reihelmer).....	1155
—, Stability Characteristics of. (O. E. Shirley).....	422
Discussion.....	1035
Alternators, Experimental Determination of Losses in. (E. Roth).....	832
Discussion.....	160
— Currents, Rectification of. (O. K. Marti).....	1078
Discussion.....	466
— Circuits, Some Graphical Solutions of. (F. W. Lee).....	43
— Machines, The Cross-Field Theory of. (H. R. West).....	1288
Discussion.....	888
Absorption in Solid Dielectrics, Theory of. (Vladimir Karapetoff).....	286
Discussion.....	286

JOURNAL OF THE American Institute of Electrical Engineers

INDEX TO VOLUME XLV

January 1 to December 31, 1926

INDEX OF PAPERS, DISCUSSIONS, REPORTS, ETC.

Can the Thermal Capacity of Electric Machines be Made a Simple and Practical Element of Rating? (A. E. Kennedy).....	438
— University Aid Industry? (B. F. Bailey).....	742
Discussion.....	1171
Carrier-Current Communication on Submarine Cables. (H. W. Hitchcock).....	923
Carrying Capacity of 60-Cycle Busses for Heavy Currents. (Titus G. Le Clair).....	9
Discussion.....	569
Cipher Printing Telegraph Systems. (G. S. Vernam).....	109
Discussion.....	572
Circle Diagram of a Transmission Network. The. (F. E. Terman).....	1238
Circuit Breaker in Railway Feeder Networks. The High-Speed. (J. W. McNairy).....	619
Discussion.....	1176
Circulation of Harmonics in Transformer Circuits. (T. C. Lennox).....	755
Discussion.....	1014
Coal Mining, Electricity and. (Daniel Harrington).....	1264
Communication on Submarine Cables, Carrier-Current. (H. W. Hitchcock).....	923
Comparison of Natural and Artificial Lighting. The. (D. M. Simons and W. S. Brown).....	230
Compensation for Errors of the Quadrant Electrometer. (D. M. Simons and W. S. Brown).....	524
Discussion.....	1288
Conductor in Corona at 60 Cycles, The Space Charge that Surrounds a. (J. S. Carroll and H. J. Ryan).....	1136
— Tensions, Unbalanced. (E. S. Healy and A. J. Wright).....	1144
Conductors, Notes on the Vibration of Transmission-Line. (Theodore Varney).....	953
Discussion.....	1022
Construction of the 110-Kv. Transmission Line of the Washington Water Power Company. (Lester R. Gamble).....	1255
Discussion.....	1309
Contact, Temperature of a. (J. Slepian).....	930
Discussion.....	1308
Control of Hydroelectric Generating Stations, Automatic and Supervisory. (Frank V. Smith).....	967
Discussion.....	1029
— Rectifier Voltage. (D. C. Prince).....	630
Discussion.....	1022
Controlling Insulation Difficulties in the Vicinity of Great Salt Lake. (B. F. Howard).....	1268
CONRESPONDENCE	
Charles Scribner Obituary. (John A. McManus).....	939
Discussion on Alternating-Current Analysis. (H. H. Race).....	669
Highway Lighting. (Talarero Milton).....	354
Discussion.....	429
Leakage Reactance. (W. V. Lyons).....	151
Predetermination of Self-Cooled, Oil Immersed Transformer Temperatures Before Conditions Are Constant. (Thomas Rosskopf).....	669
Transmission Line Sag Calculations. (H. B. Dwight).....	773
Discussion.....	773
Cosmic Harness of Moving Electricity, The. Presidents Address. (M. I. Pupin).....	758
Discussion.....	999
Calculation of Magnetic Attraction, The. (Th. Lehmann).....	1009
Discussion.....	627
High-Voltage. (W. A. Del Mar).....	923
— The Effect of Internal Vacua Upon the Operation of W. Hitchcock).....	1288
Carrier-Current Communication on Submarine. (H. W. Hitchcock).....	719
Discussion.....	1006
Cables, Accuracy Required in the Measurement of Dielectric Power Factor of Impregnated Paper-Insulated Cables. (C. F. Hanson).....	454
Discussion.....	569
Tests of Paper-Insulated High-Tension. (R. M. Farmer).....	9
Busse for Heavy Currents, Carrying Capacity of 60-Cycle. (Titus G. Le Clair).....	824
Discussion.....	904
Breakdown of Dielectrics, The Mechanism of. (P. L. Hoover).....	707
Discussion.....	1175
Behavior of Radio Receiving Systems to Signals and to Interference. (Leo James Peters).....	961
Discussion.....	1029
Automobile Headlighting. General Theory of. (Walter L. Upson).....	271
Discussion.....	967
Automatic and Supervisory Control of Hydroelectric Generating Stations. (Frank V. Smith).....	574
Discussion.....	1019
Arrester, Theory of the Autovalve. (J. Slepian).....	665
Discussion.....	124
Machines, Variable. (Vladimir Karapetoff).....	763
Armature Leakage Reactance in Salient-Pole Synchronous Machines. (Carl J. Reehelmer).....	124
Discussion.....	813
Altitude, The Ratings of Electrical Machines as Affected by. (O. E. Shirley).....	1155
Discussion.....	422
— Stability Characteristics of. (O. E. Shirley).....	1035
Discussion.....	832
— Currents, Rectification of. (O. K. Marti).....	673
Discussion.....	160
— Machines, The Cross-Field Theory of. (H. R. Lee).....	1078
Discussion.....	466
— Circuits, Some Graphical Solutions of. (F. W. Lee).....	43
Discussion.....	1288
Alternating Current Analysis. (R. D. Mershon).....	719
Discussion.....	888
Power Factor of Impregnated Paper-Insulated Cables. (C. F. Hanson).....	236
Discussion.....	888
Accuracy Required in the Measurement of Dielectric Power Factor of Impregnated Paper-Insulated Cables. (C. F. Hanson).....	719
Discussion.....	43
Alternating Current Analysis. (R. D. Mershon).....	466
Discussion.....	1078
— Machines, The Cross-Field Theory of. (H. R. Lee).....	1078
Discussion.....	160
— Currents, Rectification of. (O. K. Marti).....	673
Discussion.....	832
— Stability Characteristics of. (O. E. Shirley).....	1155
Discussion.....	813
Altitude, The Ratings of Electrical Machines as Affected by. (Carl J. Reehelmer).....	124
Discussion.....	763
Armature Leakage Reactance in Salient-Pole Synchronous Machines, Variable. (Vladimir Karapetoff).....	665
Discussion.....	1019
Arrester, Theory of the Autovalve. (J. Slepian).....	3
Discussion.....	574
Automatic and Supervisory Control of Hydroelectric Generating Stations. (Frank V. Smith).....	967
Discussion.....	1029
Automobile Headlighting. General Theory of. (Walter L. Upson).....	271
Discussion.....	961
Busse for Heavy Currents, Carrying Capacity of 60-Cycle. (Titus G. Le Clair).....	824
Discussion.....	569
Tests of Paper-Insulated High-Tension. (R. M. Farmer).....	454
Discussion.....	1006
Cables, Accuracy Required in the Measurement of Dielectric Power Factor of Impregnated Paper-Insulated Cables. (C. F. Hanson).....	719
Discussion.....	1288
Carrier-Current Communication on Submarine. (H. W. Hitchcock).....	923
Carrying Capacity of 60-Cycle Busses for Heavy Currents. (Titus G. Le Clair).....	9
Discussion.....	569
Cipher Printing Telegraph Systems. (G. S. Vernam).....	109
Discussion.....	572
Circle Diagram of a Transmission Network. The. (F. E. Terman).....	1238
Circuit Breaker in Railway Feeder Networks. The High-Speed. (J. W. McNairy).....	619
Discussion.....	1176
Circulation of Harmonics in Transformer Circuits. (T. C. Lennox).....	755
Discussion.....	1014
Coal Mining, Electricity and. (Daniel Harrington).....	1264
Communication on Submarine Cables, Carrier-Current. (H. W. Hitchcock).....	923
Comparison of Natural and Artificial Lighting. The. (D. M. Simons and W. S. Brown).....	230
Compensation for Errors of the Quadrant Electrometer. (D. M. Simons and W. S. Brown).....	524
Discussion.....	1288
Conductor in Corona at 60 Cycles, The Space Charge that Surrounds a. (J. S. Carroll and H. J. Ryan).....	1136
— Tensions, Unbalanced. (E. S. Healy and A. J. Wright).....	1144
Conductors, Notes on the Vibration of Transmission-Line. (Theodore Varney).....	953
Discussion.....	1022
Construction of the 110-Kv. Transmission Line of the Washington Water Power Company. (Lester R. Gamble).....	1255
Discussion.....	1309
Contact, Temperature of a. (J. Slepian).....	930
Discussion.....	1308
Control of Hydroelectric Generating Stations, Automatic and Supervisory. (Frank V. Smith).....	967
Discussion.....	1029
— Rectifier Voltage. (D. C. Prince).....	630
Discussion.....	1022
Controlling Insulation Difficulties in the Vicinity of Great Salt Lake. (B. F. Howard).....	1268
CONRESPONDENCE	
Charles Scribner Obituary. (John A. McManus).....	939
Discussion on Alternating-Current Analysis. (H. H. Race).....	669
Highway Lighting. (Talarero Milton).....	354
Discussion.....	429
Leakage Reactance. (W. V. Lyons).....	151
Predetermination of Self-Cooled, Oil Immersed Transformer Temperatures Before Conditions Are Constant. (Thomas Rosskopf).....	669
Transmission Line Sag Calculations. (H. B. Dwight).....	773
Discussion.....	773
Cosmic Harness of Moving Electricity, The. Presidents Address. (M. I. Pupin).....	758

JOURNAL OF THE American Institute of Electrical Engineers

INDEX TO VOLUME XLV

January 1 to December 31, 1926

INDEX OF PAPERS, DISCUSSIONS, REPORTS, ETC.

438	Can the Thermal Capacity of Electric Machines be Made a Simple and Practical Element of Rating? (A. E. Kennelly).....	May	438
442	— University Aid Industry? (B. F. Bailey).....	August	442
466	Carrier-Current Communication on Submarine Cables. Discussion (C. F. Hanson).....	August	466
488	Power Factor of Impregnated Paper-Insulated Cables. Discussion (R. D. Mershon).....	January	488
499	Altering Current Analysis. Discussion (R. D. Mershon).....	January	499
509	— Circuits, Some Graphical Solutions of. Discussion (F. W. Lee).....	November	509
524	— Machines, The Cross-Field Theory of. Discussion (H. R. West).....	November	524
534	— Currents, Rectification of. Discussion (O. K. Marti).....	September	534
544	— Generators, Experimental Determination of Losses in. Discussion (E. Roth).....	May	544
554	— Stability Characteristics of. Discussion (O. E. Shirley).....	September	554
564	— Voltage, The Ratings of Electrical Machines as Affected by. Discussion (Carl J. Reehelmer).....	February	564
574	Armature Leakage Reactance in Salient-Pole Synchronous Machines. Variable. Discussion (Vladimir Karapetoff).....	July	574
584	Arresters, Theory of the Autovalve. Discussion (J. Slepian).....	January	584
594	Automatic and Supervisory Control of Hydroelectric Generating Stations. Discussion (Frank V. Smith).....	October	594
604	Auto-Transformer, General Theory of. Discussion (Walter L. Upson).....	July	604
614	Behavior of Radio Receiving Systems to Signals and to Interference. Discussion (Leo James Peters).....	August	614
624	Breakdown of Dielectrics, The Mechanism of. Discussion (P. L. Hoover).....	September	624
634	Busses for Heavy Currents, Carrying Capacity of 60-Cycle. Discussion (Titus G. Le Clair).....	June	634
644	Cable, Tests of Paper-Insulated High-Tension. Discussion (F. M. Farmer).....	May	644
654	Cables, Accuracy Required in the Measurement of Dielectric Power Factor of Impregnated Paper-Insulated Cables. Discussion (C. F. Hanson).....	August	654
664	Carrier-Current Communication on Submarine Cables. Discussion (H. W. Hitchcock).....	October	664
674	— The Effect of Internal Vacua Upon the Operation of High-Voltage. Discussion (W. A. Del Mar).....	July	674
684	Calculation of Magnetic Attraction, The. Discussion (Th. Lehmann).....	October	684
694	Discussion.....	October	694
704	— Cosmic Harness of Moving Electricity, The. Discussion (G. S. Smith).....	August	704
714	Address. (M. I. Pupin).....	August	714
724	438	May	438
734	742	August	742
742	1171	November	1171
752	923	October	923
762	923	October	923
772	572	June	572
782	109	February	109
792	109	February	109
802	569	June	569
812	9	January	9
822	923	October	923
832	923	October	923
842	619	July	619
852	1176	November	1176
862	755	August	755
872	1014	October	1014
882	1264	December	1264
892	923	October	923
902	230	March	230
912	524	June	524
922	1288	December	1288
932	1136	November	1136
942	1144	November	1144
952	953	October	953
962	1022	October	1022
972	1029	October	1029
982	630	July	630
992	1268	December	1268
1002	939	October	939
1012	669	July	669
1022	354	April	354
1032	429	May	429
1042	151	February	151
1052	669	July	669
1062	699	July	699
1072	773	August	773
1082	773	August	773
1092	758	August	758

JOURNAL

OF THE

American Institute of Electrical Engineers

INDEX TO VOLUME XLV

January 1 to December 31, 1926

INDEX OF PAPERS, DISCUSSIONS, REPORTS, ETC.

A

Absorption in Solid Dielectrics, Theory of. (Vladimir Karapetoff).....	March, 236
Discussion.....	September, 888
Accuracy Required in the Measurement of Dielectric Power Factor of Impregnated Paper-Insulated Cables. (C. F. Hanson).....	August, 719
Discussion.....	December, 1288
Alternating Current Analysis. (R. D. Mershon).....	January, 43
Discussion.....	May, 466
— — Circuits, Some Graphical Solutions of. (F. W. Lee).....	November, 1078
— — Machines, The Cross-Field Theory of. (H. R. West).....	February, 160
Discussion.....	July, 673
— Currents, Rectification of. (O. K. Marti).....	September, 832
Discussion.....	October, 1035
Alternators, Experimental Determination of Losses in. (E. Roth).....	May, 422
Discussion.....	November, 1155
—, Stability Characteristics of. (O. E. Shirley).....	September, 813
Altitude, The Ratings of Electrical Machines as Affected by. (Carl J. Fechheimer).....	February, 124
Discussion.....	August, 763
Armature Leakage Reactance in Salient-Pole Synchronous Machines, Variable. (Vladimir Karapetoff).....	July, 665
Discussion.....	October, 1019
Arrester, Theory of the Autovalve. (J. Slepian).....	January, 3
Discussion.....	June, 574
Automatic and Supervisory Control of Hydroelectric Generating Stations. (Frank V. Smith).....	October, 967
Discussion.....	October, 1029
Automobile Headlighting.....	March, 271
Auto-Transformer, General Theory of. (Walter L. Upson).....	July, 661
Discussion.....	November, 1175

B

Behavior of Radio Receiving Systems to Signals and to Interference. (Leo James Peters).....	August, 707
Discussion.....	September, 904
Breakdown of Dielectrics, The Mechanism of. (P. L. Hoover).....	September, 824
Busses for Heavy Currents, Carrying Capacity of 60-Cycle. (Titus G. Le Clair).....	January, 9
Discussion.....	June, 569

C

Cable, Tests of Paper-Insulated High-Tension. (F. M. Farmer).....	May, 454
Discussion.....	October, 1006
Cables, Accuracy Required in the Measurement of Dielectric Power Factor of Impregnated Paper-Insulated. (C. F. Hanson).....	August, 719
Discussion.....	December, 1288
—, Carrier-Current Communication on Submarine. (H. W. Hitchcock).....	October, 923
—, The Effect of Internal Vacua Upon the Operation of High-Voltage. (W. A. Del Mar).....	July, 627
Discussion.....	October, 1009
Calculation of Magnetic Attraction, The. (Th. Lehmann).....	February, 167
Discussion.....	October, 999

Can the Thermal Capacity of Electric Machines be Made a Simple and Practical Element of Rating? (A. E. Kennelly).....	May, 438
— — University Aid Industry? (B. F. Bailey).....	August, 742
Discussion.....	November, 1171
Carrier-Current Communication on Submarine Cables. (H. W. Hitchcock).....	October, 923
Carrying Capacity of 60-Cycle Busses for Heavy Currents. (Titus G. Le Clair).....	January, 9
Discussion.....	June, 569
Cipher Printing Telegraph Systems. (G. S. Vernam).....	February, 109
Discussion.....	June, 572
Circle Diagram of a Transmission Network, The. (F. E. Terman).....	December, 1238
Circuit Breaker in Railway Feeder Networks, The High-Speed. (J. W. McNairy).....	July, 619
Discussion.....	November, 1176
Circulation of Harmonics in Transformer Circuits. (T. C. Lennox).....	August, 755
Discussion.....	October, 1014
Coal Mining, Electricity and. (Daniel Harrington).....	December, 1264
Communication on Submarine Cables, Carrier-Current. (H. W. Hitchcock).....	October, 923
Comparison of Natural and Artificial Lighting, The. (March).....	230
Compensation for Errors of the Quadrant Electrometer. (D. M. Simons and W. S. Brown).....	June, 524
Discussion.....	December, 1288
Conductor in Corona at 60 Cycles, The Space Charge that Surrounds a. (J. S. Carroll and H. J. Ryan).....	November, 1136
— Tensions, Unbalanced. (E. S. Healy and A. J. Wright).....	November, 1144
Conductors, Notes on the Vibration of Transmission-Line. (Theodore Varney).....	October, 953
Discussion.....	October, 1022
Construction of the 110-Kv. Transmission Line of the Washington Water Power Company. (Lester R. Gamble).....	December, 1255
Discussion.....	December, 1309
Contact, Temperature of a. (J. Slepian).....	October, 930
Discussion.....	December, 1308
Control of Hydroelectric Generating Stations, Automatic and Supervisory. (Frank V. Smith).....	October, 967
Discussion.....	October, 1029
—, Rectifier Voltage. (D. C. Prince).....	July, 630
Discussion.....	October, 1022
Controlling Insulation Difficulties in the Vicinity of Great Salt Lake. (B. F. Howard).....	December, 1268
CORRESPONDENCE	
Charles Scribner Obituary. (John A. McManus).....	October, 939
Discussion on Alternating-Current Analysis. (H. H. Race).....	July, 669
Highway Lighting. (Taliaferro Milton).....	April, 354
— — (G. H. Stiekney).....	May, 429
Leakage Reactance. (W. V. Lyons).....	February, 151
Predetermination of Self Cooled, Oil Immersed Transformer Temperatures Before Conditions Are Constant. (Thomas Rosskopf).....	July, 669
Transmission Line Sag Calculations. (H. B. Dwight).....	August, 773
— — — (G. S. Smith).....	August, 773
Cosmic Harness of Moving Electricity, The. President's Address. (M. I. Pupin).....	August, 758

JOURNAL

OF THE

American Institute of Electrical Engineers

INDEX TO VOLUME XLV

January 1 to December 31, 1926

INDEX OF PAPERS, DISCUSSIONS, REPORTS, ETC.

A

Absorption in Solid Dielectrics, Theory of. (Vladimir Karapetoff).....	March, 236
Discussion.....	September, 888
Accuracy Required in the Measurement of Dielectric Power Factor of Impregnated Paper-Insulated Cables. (C. F. Hanson).....	August, 719
Discussion.....	December, 1288
Alternating Current Analysis. (R. D. Mershon).....	January, 43
Discussion.....	May, 466
— — Circuits, Some Graphical Solutions of. (F. W. Lee).....	November, 1078
— — Machines, The Cross-Field Theory of. (H. R. West).....	February, 160
Discussion.....	July, 673
Rectification of. (O. K. Marti).....	September, 832
Discussion.....	October, 1035
Experimental Determination of Losses in.....	May, 422
Discussion.....	November, 1155
Characteristics of. (O. E. Shirley).....	September, 813
Ratings of Electrical Machines as Affected by J. Fechheimer).....	February, 124
Discussion.....	August, 763
Leakage Reactance in Salient-Pole Synchronous Motors, Variable. (Vladimir Karapetoff).....	July, 665
Discussion.....	October, 1019
Theory of the Autovalve. (J. Slepian).....	January, 3
Discussion.....	June, 574
Automatic and Supervisory Control of Hydroelectric Generating Stations. (Frank V. Smith).....	October, 967
Discussion.....	October, 1029
Headlighting.....	March, 271
Transformer, General Theory of. (Walter L. Riegler).....	July, 661
Discussion.....	November, 1175

B

Comparison of Radio Receiving Systems to Signals and to Interference. (Leo James Peters).....	August, 707
Discussion.....	September, 904
Breakdown of Dielectrics, The Mechanism of. (P. L. Hoyer).....	September, 824
Busses for Heavy Currents, Carrying Capacity of 60-Cycle. (Titus G. Le Clair).....	January, 9
Discussion.....	June, 569

C

Cable Tests of Paper-Insulated High-Tension. (F. M. Paner).....	May, 454
Discussion.....	October, 1006
Cable Accuracy Required in the Measurement of Dielectric Power Factor of Impregnated Paper-Insulated Cables. (C. F. Hanson).....	August, 719
Discussion.....	December, 1288
—, Carrier-Current Communication on Submarine. (H. W. Hitchcock).....	October, 923
—, The Effect of Internal Vacua Upon the Operation of High-Voltage. (W. A. Del Mar).....	July, 627
Discussion.....	October, 1009
Calculation of Magnetic Attraction, The. (Th. Lehmann).....	February, 167
Discussion.....	October, 999

Can the Thermal Capacity of Electric Machines be Made a Simple and Practical Element of Rating? (A. E. Kennelly).....	May, 438
— — University Aid Industry? (B. F. Bailey).....	August, 742
Discussion.....	November, 1171
Carrier-Current Communication on Submarine Cables. (H. W. Hitchcock).....	October, 923
Carrying Capacity of 60-Cycle Busses for Heavy Currents. (Titus G. Le Clair).....	January, 9
Discussion.....	June, 569
Cipher Printing Telegraph Systems. (G. S. Vernam).....	February, 109
Discussion.....	June, 572
Circle Diagram of a Transmission Network, The. (F. E. Terman).....	December, 1238
Circuit Breaker in Railway Feeder Networks, The High-Speed. (J. W. McNairy).....	July, 619
Discussion.....	November, 1176
Circulation of Harmonics in Transformer Circuits. (T. C. Lennox).....	August, 755
Discussion.....	October, 1014
Coal Mining, Electricity and. (Daniel Harrington).....	December, 1264
Communication on Submarine Cables, Carrier-Current. (H. W. Hitchcock).....	October, 923
Comparison of Natural and Artificial Lighting, The. (J. Slepian).....	March, 230
Compensation for Errors of the Quadrant Electrometer. (D. M. Simons and W. S. Brown).....	June, 524
Discussion.....	December, 1288
Conductor in Corona at 60 Cycles, The Space Charge that Surrounds a. (J. S. Carroll and H. J. Ryan).....	November, 1136
—, Tensions, Unbalanced. (E. S. Healy and A. J. Wright).....	November, 1144
Conductors, Notes on the Vibration of Transmission-Line. (Theodore Varney).....	October, 953
Discussion.....	October, 1022
Construction of the 110-Kv. Transmission Line of the Washington Water Power Company. (Lester R. Gamble).....	December, 1255
Discussion.....	December, 1309
Contact, Temperature of a. (J. Slepian).....	October, 930
Discussion.....	December, 1308
Control of Hydroelectric Generating Stations, Automatic and Supervisory. (Frank V. Smith).....	October, 967
Discussion.....	October, 1029
—, Rectifier Voltage. (D. C. Prince).....	July, 630
Discussion.....	October, 1022
Controlling Insulation Difficulties in the Vicinity of Great Salt Lake. (B. F. Howard).....	December, 1268
CORRESPONDENCE	
Charles Scribner Obituary. (John A. McManus).....	October, 939
Discussion on Alternating-Current Analysis. (H. H. Race).....	July, 669
Highway Lighting. (Taliaferro Milton).....	April, 354
— — (G. H. Stiekney).....	May, 429
Leakage Reactance. (W. V. Lyons).....	February, 151
Predetermination of Self Cooled, Oil Immersed Transformer Temperatures Before Conditions Are Constant. (Thomas Roskopf).....	July, 669
Transmission Line Sag Calculations. (H. B. Dwight).....	August, 773
— — — (G. S. Smith).....	August, 773
Cosmic Harness of Moving Electricity, The. President's Address. (M. I. Pupin).....	August, 758

Cross-Field Theory of the Alternating-Current Machines, The. (H. R. West).....	February,	160	Relation Between Engineering Education and Engineering Research. (Sorenson).....	January,	64
Discussion.....	July,	673	Some Features and Improvements on the High-Voltage Wattmeter. (Carroll).....	January,	61
Current-Limiting Reactors. (F. H. Kierstead).....	February,	137	Spans Having Supports at Unequal Elevation. (Smith).....	February,	186
Discussion.....	May,	468	Study of Ions and Electrons for Electrical Machinery, The. (Ryan).....	January,	59
— Transformers with Nickel-Iron Cores. (Thomas Spooner).....	June,	540	Two Hundred Twenty-Kv. Transmission Transients and Flashovers. (Wood).....	January,	52
Discussion.....	October,	1015	DISCUSSION AT NEW YORK SECTION MEETING—1925.		
D					
Development and Application of Loading for Telephone Circuits. (Thomas Shaw and William Fondiller).....	March,	253	Hydrogen as a Cooling Medium for Electrical Machinery. (Knowlton, Rice and Freiburghouse).....	March,	281
Discussion.....	July,	674	Three-Phase, 60,000-Kv-a. Turbo Alternators for Gennevilliers. (E. Roth).....	March,	284
— of the Sectional Paper-Machine Drive, The. (H. W. Rogers).....	April,	323	DISCUSSION AT MIDWINTER CONVENTION—1926.		
Discussion.....	September,	894	Calculation of Magnetic Attraction, The. (Lehmann).....	October,	999
Diamond Mining at Night.....	April,	336	Carrying Capacity of 60-Cycle Busses for Heavy Currents. (Le Clair).....	June,	569
Dielectric Absorption and Theories of Dielectric Behavior. (J. B. Whitehead).....	June,	515	Cipher Printing Telegraph Systems. (Vernam).....	June,	572
Discussion.....	September,	888	Concluding Study of Ventilation of Turbo Alternators Multiple Path Radial System. (Fechheimer and Penney).....	June,	572
— Behavior, Dielectric Absorption and Theories of. (J. B. Whitehead).....	June,	515	Cross-Field Theory of Alternating-Current Machines, The. (West).....	July,	673
Discussion.....	September,	888	Current-Limiting Reactors with Fire-Proof Insulation on the Conductor. (Kierstead).....	May,	468
— Constant, Power Factor and Resistivity of Rubber and Gutta-Percha.....	February,	190	Development and Application of Loading for Telephone Circuits. (Shaw and Fondiller).....	July,	674
— Loss Measurement Problem, Some Aspects of the. (B. W. St. Clair).....	August,	729	Dielectric Absorption and Theories of Dielectric Behavior. (Whitehead).....	September,	888
Discussion.....	December,	1288	Experimental Determination of Losses in Alternators. (Roth).....	November,	1155
— Phenomena.....	February,	115	Heaviside's Proof of His Expansion Theorem. (Vallarta).....	May,	471
— Power Factor of Impregnated Paper-Insulated Cables, Accuracy Required in the Measurement of. (C. F. Hanson).....	August,	719	High-Frequency Voltage Test for Insulation of Rotating Electrical Apparatus. (Rylander).....	August,	768
Discussion.....	December,	1288	Ionization Studies in Paper-Insulated Cables—I. (Dawes and Hoover).....	June,	577
— — Loss and Power Factor, Three Methods of Measuring. (E. D. Doyle and E. H. Salter).....	June,	556	Magnetic Hysteresis Curve, The. (Lippelt).....	August,	770
Discussion.....	December,	1288	Mechanical Forces Between Electric Circuits. (Doherty and Park).....	July,	679
Dielectrics at High Voltage and Low Frequency, Standards for Measuring the Power Factor of. (Harvey L. Curtis).....	November,	1084	Methods of High Quality Recording and Reproducing of Music and Speech. (Maxfield and Harrison).....	July,	676
Discussion.....	December,	1288	Motor Band Losses. (Spooners).....	August,	766
—, The Mechanism of Breakdown of. (P. L. Hoover).....	September,	824	New Wave-Shape Factor and Meter, A. (Doggett, Heim and White).....	June,	572
—, Phase Difference in. (J. B. Whitehead).....	December,	1225	No-Load Copper Eddy-Current Losses. (Spooners).....	May,	470
Discussion.....	December,	1288	Operating Performance of a Petersen Earth Coil—II. (Oliver and Eberhardt).....	May,	473
Direct-Current Locomotives, Regenerative Braking for. (A. Bredenberg, Jr.).....	July,	613	Parameters of Heating Curves of Electrical Machinery. (Karapetoff).....	July,	681
— — Machines, Multiplex Windings for. (Carl C. Nelson).....	November,	1094	Properties of the Single Conductor. (Hering).....	August,	766
Discussion.....	November,	1178	Rating of Heating Elements for Electric Furnaces. (Keene and Luke).....	May,	473
DISCUSSION AT PACIFIC COAST CONVENTION—1925.			Ratings of Electrical Machines as Affected by Altitude. (Fechheimer).....	August,	763
Analytical Discussion of Some Factors Entering Into the Problem of Transmission Stability. (Fortescue).....	January,	68	Refraction of Short Radio Waves in the Upper Atmosphere. (Baker and Rice).....	June,	571
Application of Electric Propulsion to Double-Ended Ferry-Boats. (Kennedy and Smith).....	February,	174	Starting Characteristics and Control of Polyphase Squirrel-Cage Induction Motors. (Norman).....	October,	1003
Distribution Line Practise of the San Joaquin Light and Power Corporation. (Moore and Minor).....	February,	188	Supervisory Systems for Electric Power Apparatus. (Lichtenberg).....	July,	671
— Practises in Southern California. (Cunningham).....	January,	63	Temperature Rise and Losses in Structural-Steel Members Exposed to the Fields from A-C Conductors. (Schurig and Kuehni).....	May,	469
— to Supply Increasing Load Densities. (Crawford).....	February,	184	Theory of Absorption in Solid Dielectrics. (Karapetoff).....	September,	888
Engineering Research—An Essential Factor in Engineering Education. (Magnusson).....	January,	64	— — the Autovalve Arrester. (Slepian).....	June,	574
Fundamental Considerations of Power Limits of Transmission Systems. (Doherty and Dewey).....	January,	68	Transmission Stability, Papers on. (Nickle and Lawton, Clarke, Wilkins, Evans and Wagner).....	September,	874
High-Voltage Distributing System, A. (Glen H. Smith).....	February,	174	— Systems with Over-Compounded Voltages. (Dwight).....	May,	467
Improvement in Distribution Methods. (Hood).....	January,	56	Use of Vibration Instruments on Electrical Machinery, The. (Ormondroyd).....	May,	472
Induction from Street Lighting Circuits—Effects on Telephone Circuits. (McCurdy).....	January,	62	DISCUSSION AT CLEVELAND MEETING—1926.		
Line of Maximum Economy, The. (Kirsten and Loew).....	January,	55	Paper-Machine Drive, Papers on. (Staege, Rogers, and Norris).....	September,	894
New Departure in Engineering Education, A. (Pender).....	January,	64			
On the Nature of Corona Loss. (Hesselmeyer and Kostko).....	February,	175			
Opportunities and Problems in the Electric Distribution System. (Blake).....	February,	180			
Power Distribution and Telephone Circuits—Inductive and Physical Relations. (Trueblood and Cone).....	February,	177			

DISCUSSION AT MADISON MEETING—1926.

Behavior of Radio Receiving Systems to Signals and to Interference. (Peters) *September*, 904

Cooperation Between the Colleges and the Industries in Research. (Wickenden, Potter, Bailey, Bennett) *November*, 1171

Effect of Internal Vacua, The. (Del Mar) *October*, 1009

Quality Rating of High-Tension Cable with Impregnated-Paper Insulation, The. (Roper and Halperin) *November*, 1157

Rural Electrification, Papers on. (Neff and Post) *November*, 1166

Some Interconnected-System Operating Problems. (Boyce) *September*, 904

Tests of Paper-Insulated High-Tension Cable. (Farmer) *October*, 1006

DISCUSSION AT NIAGARA FALLS MEETING—1926.

Automatic and Supervisory Control of Hydroelectric Stations. (Smith) *October*, 1029

Circulation of Harmonics in Transformer Circuits. (Lennox) *October*, 1014

Commercial Dielectric-Loss Measurements. (Marbury) *December*, 1288

Compensation for Errors of the Quadrant Electrometer. (Simons and Brown) *December*, 1288

Current Transformers with Nickel-Iron Cores. (Spooner) *October*, 1015

Dielectric-Loss-Measurement Problem, The. (St. Clair) *December*, 1288

Flux Voltmeter for Magnetic Tests, A. (Camilli) *October*, 1014

Lightning and Other Experiences with 132-Kv. Steel Tower Transmission Lines. (Sindeband and Sporn) *October*, 1024

Measurement of Transients by the Lichtenberg Figures (McEachron) *December*, 1286

Notes on the Vibration of Transmission-Line Conductors. (Varney) *October*, 1022

Phase Difference in Dielectrics. (Whitehead) *December*, 1288

Rectifier Voltage Control. (Prince) *October*, 1022

Retardation Method of Loss Determination as Applied to the Large Niagara Falls Generators. (Johnson) *October*, 1016

Sag Calculations for Transmission Lines. (Dwight) *October*, 1020

Significance of Errors in Dielectric-Loss Measurements, The. (Hanson) *December*, 1288

Standards for Measuring Power Factor of Dielectrics. (Curtis) *December*, 1288

Steel-Enclosed Power Rectifiers. (Marti) *October*, 1035

Three Methods of Measuring Dielectric Power Loss and Power Factor. (Doyle and Salter) *December*, 1288

Use of the Dynamometer Wattmeter for Measuring Dielectric Power Loss. (Lee) *December*, 1288

Variable Armature Leakage Reactance in Salient-Pole Synchronous Machines. (Karapetoff) *October*, 1019

Zero Method of Measuring Power with a Quadrant Electrometer. (Kouwenhoven and Betz) *December*, 1288

DISCUSSION AT ANNUAL CONVENTION—1926.

Electric Machinery, Committee on. (Hobart) *December*, 1297

General Theory of the Auto-Transformer. (Upson) *November*, 1175

High-Speed Circuit Breaker in Railway Feeder Networks, The. (McNairy) *November*, 1176

Law of Magnetization. (Gokhale) *December*, 1298

Mercury Arc Rectifiers. (Prince) *November*, 1176

Multiplex Windings for D-C. Machines. (Nelson) *November*, 1178

Production and Application of Light. (Millar) *November*, 1176

Remotely Controlled Substations. (Backwood) *November*, 1174

Standards Committee, Report of. (Osborne) *November*, 1181

Synchronous Machines. (Doherty and Nickle) *December*, 1302

Vibration Recorder. (Mershon) *November*, 1181

DISCUSSION AT PACIFIC COAST CONVENTION—1926.

Construction of the 110-Kv. Transmission Line of the Washington Water Power Company. (Gamble) *December*, 1309

Measurement of Transients by the Lichtenberg Figures. (McEachron) *December*, 1286

Temperature of a Contact and Related Current-Interruption Problems. (Slepian) *December*, 1308

Variable-Voltage Equipment for Electric Power Shovels. (McNeill) *December*, 1306

Distance Range of Radio Telephone Broadcasting Stations, The. *February*, 159

Distribution Practise in Europe, Some Notes on Electricity Transmission and. (G. F. Chellis) *October*, 958

Drive for Paper Machines, Sectional Electric. (R. N. Norris) *May*, 432

Discussion. *September*, 894

Ductile Arc Welds. *August*, 745

Dynamometer Wattmeter, The Use of the. (E. S. Lee) *August*, 746

Discussion. *December*, 1288

E

Eddy-Current Losses, No-Load Copper. (Thomas Spooner) *March*, 264

Discussion. *May*, 470

Education—Its History and Prospects, Engineering. (Henry H. Henline) *September*, 801

Effect of Good Light, The. *August*, 754

— Internal Vacua Upon the Operation of High-Voltage Cables. (W. A. Del Mar) *July*, 627

Discussion. *October*, 1009

Electric Cars for Steam Railroads. *November*, 1114

— Circuits, Mechanical Force Between. (R. E. Doherty and R. H. Park) *March*, 231

Discussion. *July*, 679

— "Eye" Sorts Cigars. *May*, 421

— Furnaces, Rating of Heating Elements for. (A. D. Keene and G. E. Luke) *March*, 222

Discussion. *May*, 473

—"Light Bed" Cure. *September*, 819

— Power Apparatus, Supervisory Systems for. (Chester Lichtenberg) *February*, 116

Discussion. *July*, 671

— for Sicily's Sulphur Mines. *December*, 1245

— Shovel Digs back to Devonian Age. *September*, 819

— Welds for Building Construction. *November*, 1097

Electrical Household Appliances in the Netherlands. *October*, 973

— Practise in the Lead-Silver Mines of Utah. (Leonard Wilson) *September*, 795

Electricity and Coal Mining. (Daniel Harrington) *December*, 1264

— to Keep Trains Safe. *October*, 933

— Traps Iron Out of Smoke. *December*, 1254

— Used to Rush Flowers. *September*, 863

Electrification of Paper-Making Machines. (S. A. Staage) *March*, 272

Discussion. *September*, 894

—, Rural. (G. C. Neff) *August*, 733

Discussion. *November*, 1166

Engineering Education—Its History and Prospects. (Henry H. Henline) *September*, 801

England Has All-Electric Village. *November*, 1182

Equipment for Electric Power Shovels, Variable-Voltage. (R. W. McNeill) *November*, 1151

Discussion. *December*, 1306

Errors of the Quadrant Electrometer, Compensation for. (D. M. Simons and W. S. Brown) *June*, 524

Discussion. *December*, 1288

Establishment of Radio Standards of Frequency by the use of a Harmonic Amplifier. *November*, 1086

Expansion Theorem, Heaviside's Proof of His. (M. S. Vallarta) *April*, 383

Discussion. *May*, 471

Experimental Determination of Losses in Alternators. (E. Roth) *May*, 422

Discussion. *November*, 1155

Eyesight Conservation. *July*, 683

F

Federal Power Commission Will Not Interfere with States Rights. *June*, 545

Fire Protection of Water-Wheel Type Generators. (J. Allen Johnson and E. J. Burnham) *November*, 1121

Flattest Flat, The. *June*, 530

Flux in a Circular Circuit. *February*, 123

— Voltmeter for Magnetic Tests, A. (G. Camilli) *October*, 989

Discussion. *October*, 1014

Force between Moving Charges, The. *May*, 429

G

General Theory of the Auto-Transformer. (Walter L. Upson).....	July,	661
Discussion.....	November,	1175
Generating Stations, Automatic and Supervisory Control of Hydroelectric. (Frank V. Smith).....	October,	967
Discussion.....	October,	1029
Generators, Fire Protection of Water-Wheel Type. (J. Allen Johnson and E. J. Burnham).....	November,	1121
German-Luxemburg Power Scheme.....	June,	539
Graphical Solutions of A-C. Circuits, Some. (F. W. Lee).....	November,	1078

H

Harmonics in Transformer Circuits, Circulation of. (T. C. Lennox).....	August,	1014
Discussion.....	October,	1014
Heat Transfer in Electric Machines with Forced Air Flow, Surface. (G. E. Luke).....	November,	1070
Heating Curves of Electrical Machinery, Parameters of. (Vladimir Karapetoff).....	January,	40
Discussion.....	July,	681
— Elements for Electric Furnaces, Rating of. (A. D. Keene and G. E. Luke).....	March,	222
Discussion.....	May,	473
Heaviside's Proof of His Expansion Theorem. (M. S. Vallarta).....	April,	383
Discussion.....	May,	471
High-Frequency Voltage Test for Insulation, A. (J. L. Rylander).....	March,	217
Discussion.....	August,	768
— Speed Circuit Breaker in Railway Feeder Networks, The. (J. W. McNairy).....	July,	619
Discussion.....	November,	1176
— Tension Cable, The Quality Rating of. (D. W. Roper and Herman Halperin).....	June,	505
Discussion.....	November,	1157
— Cable, Tests of Paper-Insulated. (F. M. Farmer).....	May,	454
Discussion.....	October,	1006
Hydroelectric Development in France Retarded.....	October,	957
— Generating Stations, Automatic and Supervisory Control of. (Frank V. Smith).....	October,	967
Discussion.....	October,	1029
— Projects of Major Importance.....	December,	1276

I

ILLUMINATION ITEMS		
Chapters on Light.....	January,	78
Cost and Standard of Lighting.....	March,	291
Daylight Electric Sign, A.....	August,	774
Depreciation of the Reflecting Properties of White Paints.....	February,	188
Europe Organizes Its Lighting Activities.....	October,	1039
In Its Infancy.....	May,	474
Inside-Frosted Lamps.....	October,	1038
Interesting Aspect of the Inside Frost Lamp.....	January,	77
Light-Color Player, The.....	June,	582
Lighting Installations Should be Designed for Sub-normal Eyes.....	April,	388
Lights Totalling Twenty-Five Million Candle Power Burn Nightly on Broadway Signs.....	September,	905
Must the Traveler Read Slowly?.....	December,	1310
Natural Lighting.....	May,	474
New Corrugated Bulb Aids in the Prevention of Automobile Headlight Glare.....	March,	290
— Lighting Organization in France, A.....	April,	388
Practical Color Photometry.....	December,	1309
Small Corona Lamps.....	July,	683
Solution of a Residence Street Lighting Problem, The.....	March,	201
Trend of Electric Lighting.....	October,	1039
Important Features of a Successful Plan for Rural Electrification. (G. G. Post).....	May,	415
Discussion.....	November,	1166
Increase of Electric Power in Factory and Homes.....	December,	1228
Insulation Difficulties in the Vicinity of Great Salt Lake, Controlling. (B. F. Howard).....	December,	1268
— A High-Frequency Voltage Test for. (J. L. Rylander).....	March,	217
Discussion.....	August,	768
— in Used Machines.....	April,	387

Interconnected-System Operating Problems, Some. (Frank G. Boyce).....	May,	462
Discussion.....	September,	904
Internal Vacua Upon the Operation of High-Voltage Cables, The Effect of. (W. A. Del Mar).....	July,	627
Discussion.....	October,	1009
Investigation of Transmission-System Power Limits, An. (C. A. Nickle and F. L. Lawton).....	September,	864
Discussion.....	September,	874
Ionization Studies in Paper-Insulated Cables—I. (C. L. Dawes and P. L. Hoover).....	April,	337
Discussion.....	June,	577

J

Jordan River to Produce Electricity to Revive Palestine.....	July,	640
--	-------	-----

K

Kilocycle-Meter Conversion Table.....	January,	24
---------------------------------------	----------	----

L

Lake Merrit Has Special Lighting.....	March,	230
Law of Magnetization. (S. L. Gokhale).....	September,	846
Discussion.....	December,	1298
Lead-Silver Mines of Utah, Electrical Practise in the. (Leonard Wilson).....	September,	795
Lichtenberg Figures, Measurement of Transients by the. (K. B. McEachron).....	October,	934
Discussion.....	December,	1286
Light Sketches Huge Faces on Mountain.....	December,	1284
Lighted Streets.....	June,	568
Lightning and Other Experiences on 132-Kv. Steel Tower Transmission Lines. (M. L. Sindband and P. Sporn).....	July,	641
Discussion.....	October,	1024
— A Study of Lightning Rods and Cages, with Special Reference to the Protection of Oil Tanks. (F. W. Peek, Jr.).....	December,	1246
Loading for Telephone Circuits, Development and Application of. (Thomas Shaw and William Fondiller).....	March,	253
Discussion.....	July,	674
Longitudinal Force in Conductors, The.....	May,	453
Loss Determination, Retardation Method of. (J. Allen Johnson).....	June,	546
Discussion.....	October,	1016
Losses in Alternators, Experimental Determination of. (E. Roth).....	May,	422
Discussion.....	November,	1155
— Motor Band. (T. Spooner).....	January,	14
Discussion.....	August,	766
— No-Load Copper Eddy-Current. (Thomas Spooner).....	March,	264
Discussion.....	May,	470
— in Solid Structural Steel, Temperature Rise and. (O. R. Schurig and H. P. Kuehni).....	May,	446
Discussion.....	May,	469
Luminous Fountain of Paris, The.....	January,	45

M

Machines, Synchronous. (R. E. Doherty and C. A. Nickle).....	October,	974
Discussion.....	December,	1302
Magnetic Attraction, The Calculation of. (Th. Lehmann).....	February,	167
Discussion.....	October,	999
— Hysteresis Curve, The. (Hans Lippelt).....	April,	355
Discussion.....	August,	770
— Tests, A Flux Voltmeter for. (G. Camilli).....	October,	989
Discussion.....	October,	1014
Magnetization, Law of. (S. L. Gokhale).....	September,	846
Discussion.....	December,	1298
Measurement Problem, Some Aspects of the Dielectric Loss. (B. W. St. Clair).....	August,	729
Discussion.....	December,	1288
— of Transients by the Lichtenberg Figures. (K. B. McEachron).....	October,	934
Discussion.....	December,	1286
Measuring Dielectric Power Loss and Power Factor, Three Methods of. (E. D. Doyle and E. H. Salter).....	June,	556
Discussion.....	December,	1288

— Power with the Quadrant Electrometer, Zero Method of. (W. B. Kouwenhoven and Paul L. Betz)	July, 652
Discussion	December, 1288
Mechanical Force Between Electric Circuits. (R. E. Doherty and R. H. Park)	March, 231
Discussion	July, 679
Mechanism of Breakdown of Dielectrics, The. (P. L. Hoover)	September, 824
Mercury Arc Rectifiers. (D. C. Prince)	November, 1087
Discussion	November, 1176
Messages from Missouri	September, 800
Method for Determining the Sign of the Smaller Wattmeter Reading in Balanced Three-Phase Power Measurements. (H. K. Humphrey)	May, 430
Methods of Hardening High-Speed Roughing Tools	March, 263
— High Quality Recording and Reproducing of Music and Speech. (J. P. Maxfield and H. C. Harrison)	March, 243
Discussion	July, 676
Mines of Utah, Electrical Practise in the Lead-Silver. (Leonard Wilson)	September, 795
Motor Band Losses. (T. Spooner)	January, 14
Discussion	August, 766
— Vehicle Lighting Tests	October, 1038
Moving Electricity, The Cosmic Harness of. President's Address. (M. I. Pupin)	August, 758
Multiplex Windings for D-C. Machines. (Carl C. Nelson)	November, 1094
Discussion	November, 1178
Muscle Shoals	June, 545

N

Needle Gap, Study of Time Lag of the. (K. B. McEachron and E. J. Wade)	January, 46
Discussion	November, 1925, 1245
New Cathode Ray Tube, A	November, 1143
— Copper Beds Discovered in Canada	November, 1097
— Discovery May Broaden Electric Truck Field	May, 453
— Edition of the A. I. E. E. Standards, A. (F. D. Newbury)	January, 18
— Wave-Shape Factor and Meter, A. (L. A. Doggett, J. W. Heim and M. W. White)	February, 131
Discussion	June, 572
— Electric Code for Mexico	July, 651
— Machine Mines Coal by Electricity	July, 629
— Power Program in Great Britain	April, 354
— Traffic Signals for Chicago	May, 461
— Type Porcelain Protection Tube, A	June, 530
— Single Sleeve Valve Engine	December, 1267
No-Load Copper Eddy-Current Losses. (Thomas Spooner)	March, 264
Discussion	May, 470
NOTES AND ANNOUNCEMENTS.	
Activities and Development of the Meetings and Papers Committee	October, 921
Address of Welcome to the I. E. C.	May, 413
A. I. E. E. Convention Affords Proof of Engineering Competency	August, 705
Artificial Light for Plant Growth	August, 706
Auxiliary Radio Language	March, 216
Companies Encouraging Convention Attendance	March, 216
Distribution Networks	May, 414
Electrification and Farm Prosperity	June, 504
Engineering Education	December, 1201
Federal Judges' Salaries Bill	December, 1202
Ideals of the American University, The	April, 321
Intellectual Renaissance in America	March, 215
Investigation of Engineering Education, The	July, 611
Invisible Service of Science, The	February, 107
Lighting and Continuity of Service	January, 1
Radiation from Carbon Arcs	August, 706
Requirements for Admission and Transfer	June, 503
Research in Pure Science	August, 705
Some Leaders of the A. I. E. E.	
Lewis Buckley Stillwell	January, 2
Dugald C. Jackson	February, 108
Gano Dunn	March, 216
Ralph Davenport Mershon	April, 322
Paul Martyn Lincoln	May, 413
John J. Carty	June, 503
H. B. Buck	July, 612

E. Wilbur Rice, Jr.	August, 705
Comfort A. Adams	September, 794
Calvert Townley	October, 922
Arthur William Berresford	November, 1060
William McClellan	December, 1202
Street Lighting	May, 414
Student Activities in the A. I. E. E.	November, 1059
Work of the A. I. E. E. Sections Committee	September, 793
Notes on the Vibration of Transmission-Line Conductors. (Theodore Varney)	October, 953
Discussion	October, 1022

O

Oil Engines Reclaim the Desert	August, 761
One Genuine Method of Solving the Automobile Headlight Problem	January, 24
Operating Performance of a Petersen Earth Coil—II. (J. M. Oliver and W. W. Eberhardt)	March, 227
Discussion	May, 473
— Problems, Some Interconnected-System. (Frank G. Boyce)	May, 462
Discussion	September, 904
Over-Compounded Voltages, Transmission Systems with. (H. B. Dwight)	January, 25
Discussion	May, 467

P

Paper-Insulated Cables, Ionization Studies in. (C. L. Dawes and P. L. Hoover)	April, 337
Discussion	June, 577
— High-Tension Cable, Tests of. (F. M. Farmer)	May, 454
Discussion	October, 1006
— Machine Drive, Development of the Sectional. (H. W. Rogers)	April, 323
Discussion	September, 894
— Making Machines, Electrification of. (S. A. Staeger)	March, 272
Discussion	September, 894
Parameters of Heating Curves of Electrical Machinery. (Vladimir Karapetoff)	January, 40
Discussion	July, 681
Petersen Earth Coil, Operating Performance of a—II. (J. M. Oliver and W. W. Eberhardt)	March, 227
Discussion	May, 473
Phase Difference in Dielectrics. (J. B. Whitehead)	December, 1225
Discussion	December, 1288
Photoelectric Cell Spots Forest Fires	March, 235
Polarization of Radio Waves. (E. F. W. Alexanderson)	July, 636
Polyphase Squirrel-Cage Induction Motors, Starting Characteristics and Control of. (H. M. Norman)	February, 153
Discussion	October, 1003
Possible Discontinuance of Radio Standard Frequency Transmissions	July, 670
Power Factor of Dielectrics at High Voltage and Low Frequency, Standards for Measuring the. (Harvey L. Curtis)	November, 1084; Discussion, December, 1288
— Three Methods of Measuring Dielectric Power Loss and. (E. D. Doyle and E. H. Salter)	June, 556
Discussion	December, 1288
— Limits, An Investigation of Transmission-System. (C. A. Nickle and F. L. Lawton)	September, 864
Discussion	September, 874
Practical Aspects of System Stability. (Roy Wilkins)	February, 142
Discussion	September, 874
Practising Engineers, Seminars for. (Edward Bennett)	October, 996
Discussion	November, 1171
Prevention of Deterioration of Vulcanized Rubber	February, 141
Properties of the Single Conductor. (Carl Hering)	January, 31
Discussion	August, 766
Protection of Water-Wheel Type Generators, Fire. (J. Allen Johnson and E. J. Burnham)	November, 1121
Purer Iron Produced Electrically	April, 373

Q

Quadrant Electrometer, Compensation for Errors of the (D. M. Simons and W. S. Brown).....	June, 524
Discussion.....	December, 1288
—, Zero Method of Measuring Power with the (W. B. Kouwenhoven and Paul L. Betz).....	July, 652
Discussion.....	December, 1288
Quality Rating of High-Tension Cable, The (D. W. Roper and Herman Halperin).....	June, 505
Discussion.....	November, 1157

R

Radio Receiving Systems to Signals and to Interference, Behavior of. (Leo James Peters).....	August, 707
Discussion.....	September, 904
— Sets on Farms.....	February, 152
— Waves, Polarization of. (E. F. W. Alexander).....	July, 636
—, Refraction of Short. (W. G. Baker and C. W. Rice).....	June, 535
Discussion.....	June, 571
Railway Electrification in Java Planned.....	February, 130
— Feeder Networks, The High-Speed Circuit Breaker in. (J. W. McNairy).....	July, 619
Discussion.....	November, 1176
Rating of Heating Elements for Electric Furnaces. (A. D. Keene and G. E. Luke).....	March, 222
Discussion.....	May, 473
— High-Tension Cable, The Quality. (D. W. Roper and Herman Halperin).....	June, 505
Discussion.....	November, 1157
Ratings of Electrical Machines as Affected by Altitude, The. (Carl J. Fechheimer).....	February, 124
Discussion.....	August, 763
Reactors, Current Limiting. (F. H. Kierstead).....	February, 137
Discussion.....	May, 468
Real Contribution to Knowledge of Stability, A.....	March, 226
Recorder, Vibration. (A. V. Mershon).....	September, 820
Discussion.....	November, 1181
Recording and Reproducing of Music and Speech, Methods of High Quality. (J. P. Maxfield and H. C. Harrison).....	March, 243
Discussion.....	July, 676
Rectification of Alternating Currents, The. (O. K. Marti).....	September, 832
Discussion.....	October, 1035
Rectifier Voltage Control. (D. C. Prince).....	July, 630
Discussion.....	October, 1022
Rectifiers, Mercury Arc. (D. C. Prince).....	November, 1087
Discussion.....	November, 1176
Refraction of Short Radio Waves. (W. G. Baker and C. W. Rice).....	June, 535
Discussion.....	June, 571
Regenerative Braking for Direct-Current Locomotives. (A. Bredenberg, Jr.).....	July, 613
Relations Between Colleges and Industry, Research. (A. A. Potter).....	December, 1272
Discussion.....	November, 1171
— Engineering Colleges and Industry, Research. (W. E. Wickenden).....	October, 987
Discussion.....	November, 1171
Relativity in Oblique Coordinates.....	October, 933
Remote-Controlled Substations. (Blackwood, W. C.).....	June, 531
Discussion.....	November, 1174
REPORTS, A. I. E. E. TECH. COMM. ANNUAL—1925-1926.	
Applications to Iron and Steel Production, Committee on.....	September, 797
— Marine Work, Committee on.....	August, 762
— Mining Work, Committee on.....	December, 1285
Communication, Committee on.....	August, 737
Electrical Machinery, Committee on.....	October, 940
Discussion.....	December, 1306
Electrochemistry and Electrometallurgy, Committee on.....	August, 725
General Power Application, Committee on.....	December, 1277
Instruments and Measurements, Committee on.....	September, 808
Power Generation, Committee on.....	November, 1130
— Transmission and Distribution, Committee on.....	December, 1207
Production and Application of Light, Committee on.....	November, 1115
Protective Devices, Committee on.....	November, 1098
Research, Committee on.....	August, 716

Research Relations Between Colleges and Industry. (A. A. Potter).....	December, 1272
Discussion.....	November, 1171
— Engineering Colleges and Industry. (W. E. Wickenden).....	October, 987
Discussion.....	November, 1171
Retardation Method of Loss Determination, The. (J. Allen Johnson).....	June, 546
Discussion.....	October, 1016
Rural Electrification. (G. C. Neff).....	August, 733
Discussion.....	November, 1166
—, Important Features of a Successful Plan for. (G. G. Post).....	May, 415
Discussion.....	November, 1166

S

Sag Calculations for Transmission Lines. (H. B. Dwight).....	June, 564
Discussion.....	October, 1020
Sectional Electric Drive for Paper Machines. (R. N. Norris).....	May, 432
Discussion.....	September, 894
— Paper-Machine Drive, Development of the. (H. W. Rogers).....	April, 323
Discussion.....	September, 894
Seminars for Practising Engineers. (Edward Bennett).....	October, 996
Discussion.....	November, 1171
Sign of the Smaller Wattmeter Reading in Balanced Three-Phase Power Measurements, Method for Determining the. (H. K. Humphrey).....	May, 430
Single Conductor, Properties of the. (Carl Hering).....	January, 31
Discussion.....	August, 766
Solid Dielectrics, Theory of Absorption in. (Vladimir Karapetoff).....	March, 236
Discussion.....	September, 888
Some Aspects of the Dielectric Loss Measurement Problem. (B. W. St. Clair).....	August, 729
Discussion.....	December, 1288
— Graphical Solutions of A-C. Circuits. (F. W. Lee).....	November, 1078
— Interconnected-System Operating Problems. (Frank G. Boyce).....	May, 462
Discussion.....	September, 904
— Notes on Electricity Transmission and Distribution Practise in Europe. (G. F. Chellis).....	October, 958
Space Charge That Surrounds a Conductor in Corona at 60 Cycles, The. (J. S. Carroll and H. J. Ryan).....	November, 1136
Stability Characteristics of Alternators. (O. E. Shirley).....	September, 813
Standards for Measuring the Power Factor of Dielectrics at High Voltage and Low Frequency. (Harvey L. Curtis).....	November 1084; Discussion, December, 1288
—, A New Edition of the A. I. E. E. (F. D. Newbury).....	January, 18
Starting Characteristics and Control of Polyphase Squirrel-Cage Induction Motors. (H. M. Norman).....	February, 153
Discussion.....	October, 1003
Steady-State Stability in Transmission Systems. (Edith Clarke).....	April, 365
Discussion.....	September, 874
Steam Power vs. Water Power.....	October, 952
Street Lighting began in 1414.....	May, 466
Studies of Transmission Stability. (R. D. Evans and C. F. Wagner).....	April, 374
Discussion.....	September, 874
Study of Time Lag of the Needle Gap. (K. B. McEachron and E. J. Wade).....	January, 46
Discussion.....	November, 1245
Substations, Remote-Controlled. (Blackwood, W. C.).....	June, 531
Discussion.....	November, 1174
Supervisory Systems for Electric Power Apparatus. (Chester Lichtenberg).....	February, 116
Discussion.....	July, 671
Surface Heat Transfer in Electric Machines with Forced Air Flow. (G. E. Luke).....	November, 1070
Switching Experiments at the California Institute of Technology, Vacuum. (R. W. Sorensen and H. E. Mendenhall).....	December, 1203

Synchronizing Power in Synchronous Machines Under Steady and Transient Conditions. (H. V. Putman)	December, 1229
Synchronous Machines. (R. E. Doherty and C. A. Nickle)	October, 974
Discussion	December, 1302
— Under Steady and Transient Conditions, Synchronizing Power in. (H. V. Putman)	December, 1229
— , Variable Armature Leakage Reactance in Salient-Pole. (Vladimir Karapetoff)	July, 665
Discussion	October, 1019
System Stability, Practical Aspects of. (Roy Wilkins)	February, 142
Discussion	September, 874

T

TECHNICAL COMMITTEE ANNUAL REPORTS—1925-1926.	
Applications to Iron and Steel Production, Committee on	September, 797
— Marine Work, Committee on	August, 762
— Mining Work, Committee on	December, 1285
Communication, Committee on	August, 737
Electrical Machinery, Committee on	October, 940
Discussion	December, 1306
Electrochemistry and Electrometallurgy, Committee on	August, 725
General Power Application, Committee on	December, 1277
Instruments and Measurements, Committee on	September, 808
Power Generation, Committee on	November, 1130
— Transmission and Distribution, Committee on	December, 1207
Production and Application of Light, Committee on	November, 1115
Protective Devices, Committee on	November, 1098
Research, Committee on	August, 716
Telephony, Transmission Features of Transcontinental. (H. H. Nance and O. B. Jacobs)	November, 1061
Temperature Affects Radio Signal Strength	September, 863
— of a Contact. (J. Slepian)	October, 930
Discussion	December, 1308
— Rise and Losses in Solid Structural Steel. (O. R. Schurig and H. P. Kuehni)	May, 446
Discussion	May, 469
Tensions, Unbalanced Conductor. (E. S. Healy and A. J. Wright)	November, 1144
Terms of Applications for Broadcasting License in India Changed	February, 136
Tests of Paper-Insulated High-Tension Cable. (F. M. Farmer)	May, 454
Discussion	October, 1006
Theory of Absorption in Solid Dielectrics. (Vladimir Karapetoff)	March, 236
Discussion	September, 888
— the Autovalve Arrester. (J. Slepian)	January, 3
Discussion	June, 574
Thermal Capacity of Electric Machines be Made a Simple and Practical Element of Rating, Can the? (A. E. Kennelly)	May, 438
Three Methods of Measuring Dielectric Power Loss and Power Factor. (E. D. Doyle and E. H. Salter)	June, 556
Discussion	December, 1288
Tide-Power Dreams Are Coming True	September, 812
Time Lag of the Needle Gap, Study of. (K. B. McEachron and E. J. Wade)	January, 46
Discussion	November, 1245
Transformer Circuits, Circulation of Harmonics in. (T. C. Lennox)	August, 755
Discussion	October, 1014
Transients by the Lichtenberg Figures, Measurement of. (K. B. McEachron)	October, 934
Discussion	December, 1286
Transmission and Distribution Practise in Europe, Some Notes on Electricity. (G. F. Chellis)	October, 958
— Features of Transcontinental Telephony. (H. H. Nance and O. B. Jacobs)	November, 1061
— -Line Conductors, Notes on the Vibration of. (Theodore Varney)	October, 953
Discussion	October, 1022
— , The Vincent 220-Kv. (C. B. Carlson and H. Michener)	December, 1215
— of the Washington Water Power Company, Construction of the 110-Kv. (Lester R. Gamble)	December, 1255
Discussion	December, 1309

— Lines, Lightning and Other Experiences on 132-Kv. Steel Tower. (M. L. Sindeband and P. Sporn)	July, 641
Discussion	October, 1024
— , Sag Calculations for. (H. B. Dwight)	June, 564
Discussion	October, 1020
— Network, The Circle Diagram of a. (F. E. Terman)	December, 1238
— Stability, Studies of. (R. D. Evans and C. F. Wagner)	April, 374
Discussion	September, 874
— -System Power Limits, An Investigation of. (C. A. Nickle and F. L. Lawton)	September, 864
Discussion	September, 874
— Systems with Over-Compounded Voltages. (H. B. Dwight)	January, 25
Discussion	May, 467
— , Steady-State Stability in. (Edith Clarke)	April, 365
Discussion	September, 874
Tremendous Wastes Due to Bad Light	July, 640
Turbo Alternators, Ventilation of. Concluding Study. (C. J. Fehheimer and G. W. Penney)	April, 347
Discussion	June, 572

U

Ultraviolet Radiations	March, 221
Unbalanced Conductor Tensions. (E. S. Healy and A. J. Wright)	November, 1144
Unicontrol High-Frequency Radio Direction Finder, A	August, 728
University Aid Industry? Can the. (B. F. Bailey)	August, 742
Discussion	November, 1171
Use of the Dynamometer Wattmeter, The. (E. S. Lee)	August, 746
Discussion	December, 1288
— Vibration Instruments on Electrical Machinery, The. (J. Ormondroyd)	April, 330
Discussion	May, 472
U. S. Has Five Radio Stations to Every One in Europe	February, 136

V

Vacuum Switching Experiments at California Institute of Technology. (R. W. Sorensen and H. E. Mendenhall)	December, 1203
Variable Armature Leakage Reactance in Salient-Pole Synchronous Machines. (Vladimir Karapetoff)	July, 665
Discussion	October, 1019
— Voltage Equipment for Electric Power Shovels. (R. W. McNeill)	November, 1151
Discussion	December, 1306
Various Applications of the Photoelectric Cell with Amplifier to Photometry	April, 329
Ventilation of Turbo Alternators—Concluding Study. (C. J. Fehheimer and G. W. Penney)	April, 347
Discussion	June, 572
Vibration Instruments on Electrical Machinery, The Use of. (J. Ormondroyd)	April, 330
Discussion	May, 472
— Recorder. (A. V. Mershon)	September, 820
Discussion	November, 1181
— of Transmission-Line Conductors, Notes on the. (Theodore Varney)	October, 953
Discussion	October, 1022
Vincent 220-Kv. Transmission Line, The. (C. B. Carlson and H. Michener)	December, 1215
Voltage Control, Rectifier. (D. C. Prince)	July, 630
Discussion	October, 1022
— for Home Use	February, 136
Welding Large Metal Structures	October, 998
Voltmeter for Magnetic Tests, A Flux. (G. Camilli)	October, 989
Discussion	October, 1014

W

Wattmeter Reading in Balanced Three-Phase Power Measurements, A Method for Determining the Sign of the Smaller. (H. K. Humphrey)	May, 430
Wave-Shape Factor and Meter, A New. (L. A. Doggett, J. W. Heim and M. W. White)	February, 131
Welding Large Metal Structures	October, 998
Why Good Headlighting is Difficult	November, 1135
Will He See and Hear Across U. S. in 1929	December, 1237

Wind Makes Power Lines "Heavy on Their Feet"
 Discussion December, 1237
 Windings for D-C. Machines, Multiplex. (Carl C. Nelson) June, 572
 Discussion November, 1094
 Discussion November, 1178

Z
 Zero Method of Measuring Power with the Quadrant Electrometer. (W. B. Kouwenhoven and Paul L. Betz) July, 652
 Discussion December, 1288

INDEX OF INSTITUTE AND RELATED ACTIVITIES

A

Addresses Wanted January, 88; February, 198; March, 303; April, 394; May, 489; June, 593; July, 688; August, 783; September, 912; October, 1052; November, 1188; December, 1317
 Adoption of Metric System Discussed April, 393
 Air-Cooled Airplane Engine Successfully Tested December, 1316
 Air Rules Discussed December, 1316
 Alvord, J. W., to Receive Washington Award May, 485
 American Association for the Advancement of Science December, 1313
 — Chemical Society in Convention September 6th September, 907
 — Electric Railway Association, Special Exhibit of the May, 484
 — Electrochemical Society Meeting October, 1045
AMERICAN ENGINEERING COUNCIL
 Administrative Board Meets at Cornell November, 1187; December, 1314
 Annual Meeting February, 193
 Appeal to Aid Bill for Providing Adequate Salaries for Federal Judges, An January, 86
 Meeting of Administrative Board October, 1047
 National Survey Toward Industrial Safety October, 1047
 Participation in Street and Highway Safety Conference November, 1187
 Proposal for New Patent Office Building November, 1187
 Proposed Legislation for Division of Safety August, 782
 Recommendations for Ordnance Reserve Commissions August, 782
 Reports on Council Work May, 482
 Seeks Solution of Broadcasting Problem August, 782
AMERICAN ENGINEERING STANDARDS COMMITTEE
 — — — Year Book for 1926 September, 909
 Can American and British Screw Threads be Unified? February, 197
 New Limit-Gage for Mass Production February, 196
 Unification of Wire and Sheet Metal Gages Proposed February, 196
 Welcome Suggestions on Symbols and Abbreviations June, 590
AMERICAN INSTITUTE OF ELECTRICAL ENGINEERS
 Appointment December, 1312
 Board of Directors, Report for Year Ending April 30, 1926 June, 588
 Branch, Electrical Exhibition Held at Yale March, 300
 — Established at Newark Technical School December, 1314
 — Holds Electrical Show, Penn State January, 88
 Branches, List of January, 105; April, 410; May, 500; June, 609; July, 702; August, 790; September, 919; October, 1056; November, 1198
 Committees of the January, 102; February, 213; March, 319; April, 411; May, 501; June, 606; July, 701; September, 916
 Convention Annual May, 476; June, 584; July, 684; August, 776
 — Midwinter January, 80; February, 191; March, 293
 — Pacific Coast July, 684; August, 775; September, 906; October, 1040
 — Student-Cambridge February, 193
 — — — M. I. T. May, 475; June, 586
 — — — New York Section April, 392; May, 484
 — — — Swarthmore April, 392
 Directors' Meetings January, 84; March, 298; May, 476; June, 588; August, 779; September, 908; November, 1185
 Election of Officers October, 1046

Meeting, Annual Business May, 481
 — — — and New York Section Meeting June, 589
 — Regional at Cleveland February, 192; March, 295; April, 389
 — — — Madison February, 193; March, 296; April, 390; May, 475; June, 586
 — — — New York in November September, 907; October, 1044; November, 1183
 — — — Niagara Falls February, 193; March, 296; April, 390; May, 475; June, 586; July, 684
 Meetings, Future Section January, 83; February, 193; March, 296; April, 392; May, 482; November, 1185; December, 1312
 — Planned for the Coming Year, Five Regional January, 82
 Nominations January, 79
 Officers of the, 1925-1926 January, 102; February, 213; March, 319; April, 411; May, 501; June, 606; July, 701; August, 790; September, 916; October, 1055; November, 1197; December, 1331
 Representatives of the January, 104; June, 607; September, 918
 Sections, List of January, 105; April, 409; May, 499; June, 608; July, 701; August, 790; September, 918; October, 1056; November, 1197
 Tellers Report—Election of Officers June, 589
 Year Book April, 394
 American Roadbuilders' Association in Convention January 11-14 January, 85
 — Society of Civil Engineers, Philadelphia Convention October, 1045
 — — for Testing Materials, Annual Meeting of June, 589
 — — — — Tentative Standards Now Available December, 1315
 — Welding Society Meeting October, 1045
 Annual Convention of Civil Engineers in October September, 907
 — — — the Illuminating Engineering Society June, 589
 — Meeting of American Society of Civil Engineers January, 83
 — — — — for Testing Materials June, 589
 Armour Institute and Northwestern University to Unite August, 780
 Army Engineers Oppose Ocean-to-Lakes Ship Canal December, 1316
 Automotive Engineers to Discuss Aircraft Progress July, 686

B

Berg, E. J., Gives Steinmetz Lecture Before Schenectady Section June, 591
 Bituminous Coal Conference, Carnegie Institute October, 1046
 Book Reviews April, 395; June, 594
 Bulletin of the Mexico Section, Monthly February, 197
 Bureau of Standards Twenty-fifth Anniversary December, 1315
 — — — Visiting Committee Meets June, 591
 Business Historical Society Preserving Documents December, 1315

C

Carnegie Institute Special Summer Session May, 481; June, 590
 Chandler Gold Medal Award May, 485
 Chesney, Cummings C. January, 79; June, 587
 Civil Aviation Plans September, 909

Columbia University Offers Scholarship in Electrical Engineering.....	March,	300
Convention, A. I. E. E., Annual.....	August,	776
— — Midwinter.....	March,	293
— — Pacific Coast.....	October,	1040

D

Deposits of Manganese Found.....	September,	909
Developed Water Power in the United States.....	September,	910
Diesel Electric Locomotive to Electrification, Relation of.....	February,	195
— Machinery Developments Sought, Further.....	September,	909
Digest of Current Industrial News.....	January, 106; February, 214; March, 320; April, 412; May, 502; June, 610; July, 704; August, 792; September, 920; October, 1058; November, 1200; December,	1348
Directors' Meetings, A. I. E. E.....	January, 84; March, 298; May, 476; June, 588; August, 779; September, 908; November,	1185

E

Edison Medal Awarded Professor Harris J. Ryan.....	January, 84; October,	1042
Effect of Bus Transportation on Railroads.....	August,	782
El Arte delos Metales.....	September,	909
Election of Officers of A. I. E. E.....	October,	1046
Electrical Heating Conference at Purdue.....	March,	299
— Ordinance, A Uniform.....	August,	781
ENGINEERING FOUNDATION		
Arch Dam Investigation.....	May,	484
Detroit Honors Engineering Foundation.....	November,	1186
Edward Dean Adams Gives Generously to Research.....	June,	590
Election of Officers.....	March,	302
Platform for Engineering Foundation, A.....	February,	195
Professor Marx Succeeds Professor Derleth, Jr.....	January,	86
Progress in Testing Experimental Dam.....	December,	1316
— Societies Employment Service.....	January, 94; February, 203; March, 309; April, 401; May, 493; June, 599; July, 693; August, 787; September, 912; October, 1051; November, 1192; December,	1329
ENGINEERING SOCIETIES LIBRARY		
Book Notices.....	January, 89; February, 199; March, 304; April, 396; May, 487; June, 594; July, 689; August, 784; September, 910; October, 1048; November, 1189; December,	1318
Exchange Professor to Lecture in France, Doctor Whitehead Chosen.....	April,	393
Extracts from Annual Report of the Engineering Societies Library.....	April,	395

F

Fellowship for Research at Yale, Sterling.....	January,	88
—, Robinson, at Ohio State University.....	June,	591
Fellowships in Lehigh University, Research.....	March,	300
—, Sterling, for Research.....	December,	1314
— at University of Wisconsin, Research Graduate.....	May,	484
Fuel and Power Meeting Held in Boston.....	January,	88

G

General Electric Review Plans Five-Year Index.....	February,	197
George Westinghouse Memorial Committee Appointed.....	October,	1047
Graduate Instruction in the Moore School.....	July,	687

H

History of Engineering.....	November,	1187
Howard N. Potts Medal Award.....	August,	782

I

Illuminating Engineering Society, Annual Convention of.....	June,	589
— Engineers, Twentieth Anniversary.....	August,	778
Important Engineering Subjects for Next Congress.....	December,	1315
Increase in Salaries of Federal Judges.....	May,	482
Industrial Cooperation with the War Department.....	January,	87
International Electrotechnical Commission, Coming Plenary Meeting of.....	March,	297

— — — First Plenary Meeting in the United States of the.....	May,	477
— — — Meeting Addressed by Prominent European Engineers.....	April,	391
— Mid-Continent Engineering Convention.....	August,	782

J

John Ericsson Medal Award.....	July,	686
— — — Established.....	April,	393
— — — Stamp Memorial to.....	June,	591
— Fritz Medal for 1926 Awarded to Edward Dean Adams.....	February, 195; March, 299; May,	482
— — — Award for 1927.....	November,	1184

K

Kolbe, Dr. Parke Rexford, New President of Polytechnic Institute.....	January,	85
---	----------	----

L

Levy Medal to F. W. Peek, Jr.....	June,	592
Library Service.....	March,	301
Louisville Section, Establishing of.....	June,	586
— — Holds First Meeting.....	December,	1313

M

Mechanical Engineers Plan Big Program.....	December,	1313
Medal for Radio Amateurs.....	April,	393
Meeting, A. I. E. E., New York, May 21.....	May,	481
— of the American Society of Civil Engineers, Spring.....	April,	392
— — International Association of Industrial Accident Boards and Commissions.....	October,	1047
— — — Electrotechnical Commission, Coming Plenary.....	March,	297
Membership (Applications, Elections, Transfers, Etc.).....	January, 95; February, 204; March, 310; April, 403; May, 495; June, 601; July, 695; August, 788; September, 913; October, 1053; November, 1193; December,	1323
Midwest Power Conference Held in Chicago.....	March,	301
Millikan, R. A., Address on High-Frequency Cosmic Rays.....	April,	391
Montefiore Triennial Prize.....	June,	590
Musee Shoals Bids.....	May,	484
— — Fight in Next Congress.....	December,	1316
— —, A New Offer Announced for.....	November,	1187
Museum of Peaceful Arts.....	May,	482

N

National Academy of Sciences Appeals for Research Funds.....	February,	197
— Capital Park and Planning Commission.....	June,	591
— Carbon Company's Moving Picture Entitled "Behind the Pyramids".....	November,	1188
— Electrical Manufacturers Association.....	October,	1046
— Exposition of Power and Mechanical Engineering.....	July, 686; October,	1045
— Museum of Engineering and Industry.....	March,	301
— Research Council: Doctor Charles M. Upham Receives New Appointment.....	July,	686
New Electrical Safety Code Now Ready, First Part of.....	May,	484
— Metallurgical Laboratories.....	February,	197
— York Electrical Society Develops a Neglected Field.....	July,	686
— — — — to Discuss Long Distance Broadcasting.....	January,	83
— — — Society's First Meeting to be on "The Vitaphone".....	October,	1045
— — Section Meetings.....	October, 1044; November, 1185; December,	1312
— — —, Nomination of Officers for Year 1926-27.....	March, 300; April,	394
Nominations, A. I. E. E.....	January,	79

O

Obituary.....	January, 88; February, 198; March, 303; April, 394; May, 485; June, 592; July, 687; August, 783; September, 911; October, 1048; November, 1188; December,	1317
Ocean Magnetic and Electric Observation, Carnegie Institution.....	March,	301

P

Past Section and Branch Meetings... *January*, 90;
February, 200; *March*, 306; *April*, 398; *May*, 490; *June*,
 595; *July*, 690; *August*, 786; *October*, 1051; *November*, 1191;
December, 1320

Peek, F. W., Jr., Receives Levy Medal... *June*, 592
 Personal Mention... *January*, 88; *February*, 197; *March*,
 303; *April*, 394; *May*, 485; *June*, 593; *July*, 687; *August*,
 782; *September*, 911; *October*, 1047; *November*, 1187;
December, 1316

Philadelphia's Sesqui-Centennial... *May*, 484
 Power and Mechanical Engineering Exposition... *December*, 1313
 — Show Reflects Tremendous Advances... *August*, 781
 Prizes, A. I. E. E... *March*, 298; *July*, 685
 — for Papers Awarded in Northeastern District... *August*, 780

R

Radio Engineers, First Convention of... *January*, 84
 — Law, A Request for Decision on... *August*, 780
 — Measures, Action Expected on... *September*, 909
 — Stations Established, New... *December*, 1315
 Regional Meeting at Cleveland... *April*, 389
 — Held at Madison... *June*, 586
 — at Niagara Falls... *July*, 684
 Relation of Diesel Electric Locomotive to Electrifica-
 tion... *February*, 195
 Report of Board of Directors for the Year Ending
 April 30, 1926... *June*, 588
 — Committee of Tellers on Election of Officers... *June*, 589
 — the Engineering Societies Library, Extracts
 from Annual... *April*, 395
 Research Assistantships, University of Illinois Offers
March, 300
 — Fellowships in Lehigh University... *March*, 300
 — Funds, National Academy of Sciences Appeals for
February, 197
 — Graduate Fellowships at University of Wisconsin
May, 484
 — Sterling Fellowships for... *December*, 1314
 — at Yale, Sterling Fellowship for... *March*, 88

S

Salt Lake City Convention... *October*, 1040
 Saskatchewan Section Holds Meeting in a Camp
August, 780
 Saunders, W. L., Address Accepting the 24th Engineers
 Colors... *January*, 87
 Schenectady Section, E. J. Berg Gives Steinmetz Lecture
June, 591
 Scholarship in Electrical Engineering, Columbia Uni-
 versity Offers... *March*, 300
 Scholarships, Westinghouse Annual War Memorial... *May*, 485
 — Awards Educational... *August*, 781

Schwab, Chas, M., President Elect of the American
 Society of Mechanical Engineers... *November*, 1186
 Scientific Congress, Brussels, Belgium... *March*, 299
 Sharon, Pa. Has New Section... *February*, 197
 Stamp Memorial to John Ericsson... *June*, 591
 Standardization of Motor Vehicles for Use by the Govern-
 ment... *October*, 1047
 — — Voltages Will be a Winter Convention Topic
October, 1046
 Standards of the A. I. E. E... *January*, 85
 — Committee Meeting... *December*, 1313
 — for Electrical Measuring Instruments, Revised Re-
 port on... *July*, 686
 — Now Available, New Reports on A. I. E. E.
September, 908
 — Pamphlets, Corrections in... *January*, 85
 Steinmetz Lecture Before Schenectady Section, E. J. Berg
June, 591
 Sterling Fellowship for Research at Yale... *January*, 88
 — Fellowships for Research... *December*, 1314
 Study of Uses of Wood in Electrical Goods... *September*, 909
 Supervisory Control Safety System for Hudson Tunnel
December, 1315
 Swiss Standards Available, Two New... *September*, 909

T

Tests of Welded Rail Joints... *November*, 1186
 Twentieth Anniversary of Illuminating Engineers
August, 778
 Two-Million-Volt, High-Tension Laboratory at Stanford
 University... *November*, 1186

U

United Engineering Society, Extracts from President's
 Report for Year 1925... *March*, 302
 — — Meeting of the Board of Trustees... *March*, 302
 University of Illinois Offers Research Assistantships
March, 300
 — — Pennsylvania Creates New Course... *August*, 781
 — — Placement Bureau... *November*, 1186
 Use of Safety Codes... *November*, 1186

W

Washington Award, J. W. Alvord to Receive... *May*, 485
 Westinghouse Awards Educational Scholarships... *August*, 781
 White Sulphur Springs Convention... *August*, 776
 Whitehead, J. B. Chosen Exchange Professor to Lecture
 in France... *April*, 393
 Work in Accident Prevention Praised... *December*, 1315
 World Language for Electricity, A... *April*, 393
 — Power Conference... *May*, 482
 — — Program and Appointments... *August*, 779

Y

Year Book, A. I. E. E.,... *April*, 394

INDEX OF AUTHORS

A

Adams, C. A., Discussion, *June*, 581; *September*, 891; *December*, 1294, 1302, 1303
 Alexanderson, E. F. W., Paper, *July*, 636
 Alger, P. L., Discussion, *May*, 470; *July*, 673; *August*, 764, 766; *October*, 1003; *December*, 1302
 Atkinson, R. W., Discussion, *June*, 578; *September*, 889; *November*, 1158
 Austin, A. O., Discussion, *October*, 1026

B

Bailey, B. F., Paper, *August*, 742; Discussion, *October*, 1003
 Baker, W. G. and Rice, C. W., Paper, *June*, 535
 Baker, W. G., Discussion, *June*, 571
 Barfoed, Svend, Discussion, *September*, 882
 Barns, B. L., Discussion, *November*, 1155
 Bates, C. W., Discussion, *June*, 573
 Bates, H. S., Discussion, *February*, 176
 Bates, J. S., Discussion, *January*, 66
 Baum, F. G., Discussion, *January*, 55, 60, 74
 Bearce, E. F., Discussion, *September*, 896
 Beaty, W. E., Discussion, *November*, 1176
 Behrend, B. A., Discussion, *August*, 767
 Bennett, Edward, Paper, *October*, 996; Discussion, *September*, 904; *November*, 1174
 Bern, E. G., Discussion, *June*, 570
 Betz, Paul L. and Kouwenhoven, W. B., Paper, *July*, 652
 Blackwood, W. C., Paper, *June*, 531; Discussion, *November*, 1175
 Blake, D. K., Discussion, *January*, 57; *February*, 183
 Bonnett, L. B., Discussion, *March*, 282
 Borden, P. A., Discussion, *October*, 1018; *November*, 1156; *December*, 1295
 Bowler, F. C., Discussion, *September*, 895
 Boyajian, Aram, Discussion, *October*, 1015
 Boyce, Frank G., Paper, *May*, 462; Discussion, *September*, 904
 Brainard, F. K., Discussion, *June*, 573
 Bredenber, A., Jr., Paper, *July*, 613
 Brown, G. O., Discussion, *November*, 1174
 Brown, W. S. and Simons, D. M., Paper, *June*, 524
 Brownell, F. A., Discussion, *October*, 1008, 1010; *November*, 1162
 Burd, H. G., Discussion, *November*, 1160
 Burnham, E. J. and Johnson, J. Allen, Paper, *November*, 1121
 Burnham, J. L., Discussion, *November*, 1178
 Bush, V., Discussion, *May*, 466

C

Camilli, G. Paper, *October*, 989
 Carey, C. E., Discussion, *January*, 55; *February*, 180
 Carlson, C. B. and Michener, H., Paper, *December*, 1215
 Carpenter, H. V., Discussion, *January*, 62, 65
 Carroll, J. S. and Ryan, H. J., Paper, *November*, 1136; Discussion, *February*, 175
 Carroll, J. S., Discussion, *January*, 62
 Chellis, G. F., Paper, *October*, 958
 Clark, J. C., Discussion, *January*, 64
 Clark, W. S., Discussion, *October*, 1006, 1009; *November*, 1157
 Clarke, Edith, Paper, *April*, 365; Discussion, *September*, 886
 Coldwell, J. S., Discussion, *November*, 1172
 Cone, D. I., Discussion, *January*, 54, 57; *February*, 179
 Cook, J. A., Discussion, *November*, 1177
 Cooney, W. H., Discussion, *October*, 1014
 Copley, S. W., Discussion, *January*, 71
 Corbett, L. J., Discussion, *January*, 65; *February*, 178, 187
 Cowles, R. R., Discussion, *January*, 62
 Cox, J. H., Discussion, *January*, 53; *October*, 1028; *December*, 1286
 Craighead, J. R., Discussion, *November*, 1175; *December*, 1298
 Crawford, M. T., Discussion, *January*, 57, 63; *February*, 174, 178, 182, 185, 187
 Creagmile, W. B., Discussion, *May*, 472
 Crossley, J. H., Discussion, *September*, 897
 Cunningham, R. E., Discussion, *January*, 56, 63; *February*, 184, 188
 Curtis, Harvey L., Paper, *November*, 1084; Discussion, *September*, 893; *December*, 1291

D

Darling, A. G., Discussion, *October*, 1033
 Davidson, W. F., Discussion, *June*, 580; *October*, 1010; *November*, 1181
 Davis, E. W., Discussion, *June*, 577; *December*, 1288
 Dawes, C. L. and Hoover, P. L., Paper, *April*, 337

Dawes, C. L., Discussion, *June*, 581
 Dawson, W. F., Discussion; *March*, 284; *July*, 681; *August*, 764; *November*, 1155
 Del Mar, W. A., Paper, *July*, 627; Discussion, *June*, 578; *September*, 888; *October*, 1007, 1012; *November*, 1161
 Dewey, H. H., Discussion, *January*, 76; *September*, 875
 Dickenson, W. K., Discussion, *October*, 1015
 Dobson, W. P., Discussion, *September*, 881
 Dodd, Carl, Discussion, *September*, 904
 Doggett, L. A., Heim, J. W. and White, M. W., Paper, *February*, 131
 Doggett, L. A., Discussion, *June*, 574; *October*, 1018
 Doherty, R. E. and Nickle, C. A., Paper, *October*, 974
 Doherty, R. E. and Park, R. H., Paper, *March*, 231
 Doherty, R. E., Discussion, *January*, 73, 75; *July*, 680; *August*, 763; *September*, 879; *December*, 1305
 Don Carlos, H. C., Discussion, *July*, 671
 Douglas, J. F. H., Discussion, *October*, 1019; *December*, 1304
 Doyle, E. D. and Salter, E. H., Paper, *June*, 556
 Du Bois, D., Discussion, *December*, 1289, 1295
 Duffee, F. W., Discussion, *November*, 1168
 Duncan, J. A., Discussion, *October*, 1011
 Dunsheath, Percy, Discussion, *October*, 1006, 1009; *November*, 1159
 Dwight, H. B., Paper, *January*, 25; *June*, 564; Discussion, *June*, 569; *September*, 881; *October*, 1021; *November*, 1178; *December*, 1306

E

Eberhardt, W. W. and Oliver, J. M., Paper, *March*, 227
 Eberhardt, W. W., Discussion, *May*, 473
 Evans, P. W., Discussion, *June*, 572
 Evans, R. D. and Wagner, C. F., Paper, *April*, 374; Discussion, *September*, 887
 Evans, R. D., Discussion, *January*, 70; *September*, 874; *December*, 1304

F

Fabinger, F., Discussion, *July*, 683
 Farmer, F. M., Paper, *May*, 454; Discussion, *October*, 1008; *November*, 1160
 Faron, F. A., Discussion, *October*, 1023, 1036
 Farrell, C. A., Discussion, *September*, 897
 Fechheimer, C. J. and Penney, G. W., Paper, *April*, 347; Discussion, *June*, 572
 Fechheimer, Carl J., Paper, *February*, 124; Discussion, *March*, 282, 287; *July*, 682; *August*, 765; *November*, 1157
 Ferris, L. P., Discussion, *May*, 473
 Floyd, G. D. and Wood, E. M., Discussion, *October*, 1017
 Fondiller, William and Shaw, Thomas, Paper, *March*, 253; Discussion, *July*, 676
 Forbes, H. C., Discussion, *May*, 469
 Ford, A. H., Discussion, *November*, 1171
 Fortescue, C. L., Discussion, *January*, 53, 60, 71, 77; *September*, 880
 Foster, W. J., Discussion, *May*, 470; *October*, 1017; *November*, 1156
 Freiburghouse, E. H., Discussion, *March*, 283, 288; *November*, 1157
 Frost, L. E., Discussion, *September*, 904

G

Gamble, Lester R., Paper, *December*, 1255; Discussion, *February*, 184; *December*, 1309
 Garrett, P. B., Discussion, *December*, 1287
 Gerrie, W. H., Discussion, *October*, 1029
 Gherardi, Bancroft, Discussion, *July*, 674
 Gilt, C. M., Discussion, *November*, 1174
 Gokhale, S. L., Paper, *September*, 846; Discussion, *August*, 770; *September*, 891; *December*, 1299
 Goodwin, W. N., Discussion, *November*, 1176
 Graham, Quentin, Discussion, *December*, 1304
 Griscom, S. B., Discussion, *January*, 70

H

Halperin, Herman, and Roper, D. W., Paper, *June*, 505
 Halperin, Herman, Discussion, *October*, 1009, 1029; *November*, 1164; *December*, 1287
 Hanna, C. R., Discussion, *July*, 676
 Hansen, K. L., Discussion, *July*, 673; *October*, 1003
 Hanson, C. F., Paper, *August*, 719; Discussion, *October*, 1011; *December*, 1291, 1295
 Harding, C. F., Discussion, *November*, 1173
 Harrington, Daniel, Paper, *December*, 1264

- Harrison, H. C. and Maxfield, J. P., Paper March, 243
 Harvey, H. F., Jr., Discussion February, 174
 Harvey, Tom, Discussion September, 897
 Hayden, C. B., Discussion November, 1166
 Hayden, J. L. R., Discussion November, 1163
 Hayes, S. Q., Discussion October, 1036
 Healy, E. S. and Wright, A. J., Paper November, 1144
 Healy, E. S., Discussion October, 1025
 Heim, J. W., Doggett, L. A. and White, M. W., Paper February, 131
 Heinze, C. A., Discussion, January, 57, 62; February, 175, 184
 Henderson, S. L., Discussion June, 572
 Henline, Henry H., Paper, September, 801; Discussion, January, 66
 Hering, Carl, Paper January, 31
 Hertz, S. S., Discussion October, 1025
 Hesselmeyer, C. T. and Kostko, J. K., Discussion, February, 176
 Higson, C. R., Discussion December, 1309
 Hillebrand, W. A., Discussion November, 1177
 Hitchcock, H. W., Paper October, 923
 Hobart, H. M., Discussion August, 765; November, 1181
 Holcomb, Eugene, Discussion November, 1166
 Hood, S. B., Discussion, January, 58, 62, 63; February, 178
 Hoover, P. L. and Dawes, C. L., Paper April, 337
 Hoover, P. L., Paper, September, 824; Discussion, June, 582; December, 1288
 Howard, B. F., Paper December, 1268
 Humphrey, H. K., Paper May, 430
 Huntington, E. K., Discussion November, 1175
- I**
- Imlay, L. E., Discussion October, 1025
- J**
- Jackson, J. E., Discussion December, 1298
 Jackson, R. P., Discussion August, 767
 Jacobs, O. B. and Nance, H. H., Paper November, 1061
 Jennings, P. D., Discussion February, 177
 Jewett, F. B., Discussion July, 675
 Johnson, F. B., Discussion November, 1174
 Johnson, J. Allen and Burnham, E. J., Paper November, 1121
 Johnson, J. Allen, Paper, June, 546; Discussion, October, 1018
- K**
- Karapetoff, Vladimir, Paper, January, 40; March, 236; July, 665; Discussion, July, 683; October, 1017, 1020, 1029
 Kasson, C. L., Discussion December, 1295
 Katzman, J., Discussion September, 893
 Keene, A. D. and Luke, G. E., Paper March, 222
 Kehoe, A. H., Discussion February, 182
 Kellogg, E. W., Discussion July, 678
 Kennedy, A., Jr., Discussion February, 174
 Kennelly, A. E., Paper, May, 438; Discussion, May, 468, 469; June, 569, 571, 577; July, 678, 682; September, 888; December, 1299
 Kierstead, F. H., Paper, February, 137; Discussion, May, 469
 Kinnard, I. F., Discussion October, 1015
 Kintzing, R. T., Discussion September, 895
 Kirke, W. B., Discussion March, 282
 Kirsten, F. K., Discussion February, 174
 Knowlton, A. E., Discussion October, 1022
 Kostko, J. K. and Hesselmeyer, C. T., Discussion, February, 176
 Kouwenhoven, W. B. and Betz, Paul L., Paper July, 652
 Kouwenhoven, W. B., Discussion June, 571, 579; December, 1297
 Kuehni, H. P. and Schurig, O. R., Paper May, 446
- L**
- Laffoon, C. M., Discussion March, 284
 Lawton, F. L. and Nickle, C. A., Paper September, 864
 Lawton, F. L., Discussion, January, 69; September, 883
 Le Clair, Titus G., Paper, January, 9; Discussion, June, 570
 Lee, Carl, Discussion September, 904
 Lee, E. S., Paper, August, 746; Discussion, June, 579; August, 768; September, 889; November, 1160; December, 1292, 1297
 Lee, F. W., Paper November, 1078
 Legg, J. W., Discussion September, 881; November, 1181
 Le Ghait, E. R., Discussion September, 894
 Lehmann, E. W., Discussion November, 1167
- Lehmann, Th., Paper, February, 167; Discussion, October, 1001
 Lengox, T. C., Paper, August, 755; Discussion, October, 1015
 Lewis, W. W., Discussion May, 469, 473
 Lichtenberg, Chester, Paper, February, 116; Discussion, July, 673; November, 1174, 1176
 Lincoln, J. C., Discussion August, 766
 Lincoln, P. M., Discussion October, 1019
 Linebaugh, J. J., Discussion November, 1176
 Lippelt, Hans, Paper, April, 355; Discussion, August, 771; December, 1298
 Lloyd, M. G., Discussion October, 1020, 1021
 Loew, E. A., Discussion January, 56
 Luke, G. E. and Keene, A. D., Paper March, 222
 Luke, G. E., Paper, November, 1070; Discussion, March, 281; May, 473; July, 681; August, 765, 766, 769
- M**
- Mackerras, A. P., Discussion September, 884
 Magnusson, C. E., Discussion, January, 60, 68; February, 187
 Mailloux, C. O., Discussion October, 990, 1001
 Marbury, R. E., Discussion September, 889
 Markle, L. E., Discussion September, 898
 Marti, O. K., Paper, September, 832; Discussion, October, 1037
 Mauger, S. W., Discussion June, 569
 Maxfield, J. P. and Harrison, H. C., Paper March, 243
 Maxfield, J. P., Discussion July, 678
 Mayer, F. H., Discussion February, 179, 185
 McBerty, F. R., Discussion July, 672
 McCurdy, R. G., Discussion January, 63
 McEachron, K. B. and Wade, E. J., Paper January, 46
 McEachron, K. B., Paper, October, 934; Discussion, June, 574; December, 1288
 McMillan, F. O., Discussion January, 63; February, 178
 McNairy, J. W., Paper July, 196
 McNeill, R. W., Paper, November, 1151; Discussion, December, 1306
 Mendenhall, H. E. and Sorensen, R. W., Paper December, 1203
 Mershon, A. V., Paper, September, 820; Discussion, November, 1182
 Mershon, A. V., Discussion November, 1182
 Mershon, R. D., Paper January, 43
 Michener, H. and Carlson, C. B., Paper December, 1215
 Michener, H., Discussion December, 1309
 Millar, P. S., Discussion November, 1176
 Mills, John, Discussion November, 1172
 Moore, L. J., Discussion February, 188
 Montgomery, T. D., Discussion September, 894
 Montsinger, V. M., Discussion May, 468; August, 768
 Morehouse, L. F., Discussion June, 572
 Morgan, N. L., Discussion December, 1290
 Morrow, L. W. W., Discussion September, 895
 Mortensen, S. H., Discussion November, 1172
- N**
- Naef, Otto, Discussion October, 1023, 1035
 Naeter, Albrecht, Discussion October, 1037
 Nance, H. H. and Jacobs, O. B., Paper November, 1061
 Neall, N. J., Discussion October, 1025
 Neff, G. C., Paper August, 733
 Nelson, C. C., Paper, November, 1094; Discussion, November, 1180
 Newbury, F. D., Paper January, 18
 Nicholson, L. C., Discussion October, 1025
 Nickle, C. A. and Doherty, R. E., Paper October, 974
 Nickle, C. A. and Lawton, F. L., Paper September, 864
 Nickle, C. A., Discussion September, 886
 Nims, A. A., Discussion November, 1178
 Norman, H. M., Paper, February, 153; Discussion, October, 1004
 Norris, R. N., Paper, May, 432; Discussion, September, 901
 Notvest, R., Discussion December, 1290
 Nuttall, G. R. F., Discussion January, 54
- O**
- O'Brien, B., Discussion December, 1290
 Odermatt, A., Discussion November, 1176
 Oesterreicher, S. I., Discussion May, 468
 Oliver, J. M. and Eberhardt, W. W., Paper March, 227
 Ormondroyd, J., Paper, April, 330; Discussion, May, 473
 Osborne, C. P., Discussion November, 1177
- P**
- Paine, E. B., Discussion November, 1171
 Paine, N. D., Discussion September, 895, 898
 Pannell, E. V., Discussion October, 1021

- Park, R. H. and Doherty, R. E., Paper *March*, 231
 Park, R. H., Discussion *July*, 679; *October*, 1000
 Pauly, K. A., Discussion *November*, 1171
 Paxton, E. B., Discussion *August*, 764
 Peek, F. W., Jr., Paper, *December*, 1246; Discussion, *January*, 53; *October*, 1024
 Penney, G. W. and Fechheimer, C. J., Paper, *April*, 347; Discussion, *June*, 572
 Pete's, Leo James, Paper *August*, 707
 Peterson, T. F., Discussion *October*, 1010
 Phelps, H. S., Discussion *February*, 177
 Pohl, Robert, Discussion *March*, 283, 288
 Post, G. G., Paper, *May*, 415; Discussion, *November*, 1171
 Potter, A. A., Paper *December*, 1272
 Powel, C. A., Discussion *September*, 878
 Prince, D. C., Paper, *July*, 630; *November*, 1087; Discussion, *October*, 1014, 1023, 1035; *November*, 1177
 Publow, C. F., Discussion *October*, 1030
 Punga, Franklin, Discussion *March*, 288
 Pupin, M. I., Paper, *August*, 758; Discussion, *June*, 571; *July*, 675; *December*, 1303
 Putman, H. V., Paper *December*, 1229
- Q**
- Quimby, S. L., Discussion *August*, 766
- R**
- Race, H. H., Discussion *May*, 466
 Rhodes, J. F., Discussion *September*, 895
 Rice, C. W. and Baker, W. G., Paper *June*, 535
 Richter, H., Discussion *January*, 54; *February*, 180
 Robinson, L. N., Discussion *January*, 54, 64
 Robinson, L. T., Discussion *July*, 678
 Roge's, H. W., Paper *April*, 223; Discussion, *September*, 899, 900
 Roper, D. W. and Halpe in, Herman, Paper *June*, 505
 Roper, D. W., Discussion, *September*, 889, 904; *October*, 1010; *November*, 1164
 Rosch, S. J., Discussion *November*, 1162
 Rosen, J., Discussion *March*, 283, 289
 Roth, E., Paper, *May*, 422; Discussion *March*, 289
 Ryan, H. J. and Carroll, J. S., Paper, *November*, 1136; Discussion, *February*, 175
 Ryan, H. J., Discussion *January*, 60
 Rylander, J. L., Paper, *March*, 217; Discussion, *August*, 769
- S**
- Salter, E. H. and Doyle, E. D., Paper *June*, 556
 Salter, E. H., Discussion *December*, 1293, 1297
 Sanborn, H. L., Discussion *September*, 895
 Sanford, R. L., Discussion *October*, 1014
 Schurig, O. R. and Kuehni, H. P., Paper *May*, 416
 Schurig, O. R., Discussion *May*, 469
 Sels, H. K., Discussion *September*, 877
 Shand, E. B., Discussion *October*, 1019, 1023, 1036
 Shanklin, G. B., Discussion *June*, 580
 Shaw, Thomas and Fondiller, William, Paper, *March*, 253; Discussion, *July*, 676
 Shirley, O. E., Paper *September*, 813
 Simons, D. M. and Brown, W. S., Paper *June*, 524
 Simons, D. M., Discussion, *October*, 1006; *November*, 1159; *December*, 1293
 Sindeband, M. L. and Sporn, P., Paper *July*, 641
 Sindeband, M. L., Discussion *October*, 1029
 Slepian, J., Paper, *January*, 3; *October*, 930; Discussion, *June*, 575; *July*, 679; *September*, 890; *October*, 999; *December*, 1287, 1308
 Smith, Frank V., Paper, *October*, 967; Discussion, *October*, 1034
 Smith, G. H., Discussion *January*, 57; *February*, 175
 Smith, G. S., Discussion *January*, 66; *February*, 188
 Smith, H. W., Discussion *September*, 875
- Smith, J. J., Discussion *May*, 471; *June*, 572
 Sorensen, R. W. and Mendenhall, H. E., Paper *December*, 1203
 Sorensen, R. W., Discussion, *January*, 54, 59, 61, 67; *February*, 175, 187
 Spencer, H. H., Discussion *September*, 876
 Spierling, A. O., Discussion *September*, 897
 Spooner, T., Paper, *January*, 14; *March*, 264; *June*, 540; Discussion, *May*, 470; *August*, 766; *October*, 1016
 Sporn, P. and Sindeband, M. L., Paper *July*, 641
 Spratt, W. W., Discussion *September*, 897
 Stacy, J. D., Discussion *December*, 1289
 Staeger, S. A., Paper, *March*, 272; Discussion, *September*, 898, 899
 Stauffacher, E. R., Discussion *January*, 56
 St. Clair, B. W., Paper, *August*, 729; Discussion, *December*, 1294
 Stein, I. M., Discussion *December*, 1289
 Stevens, P. S., Discussion *December*, 1306
 Stewart, C. E., Discussion *July*, 671
 Stewart, E. A., Discussion *November*, 1170
- T**
- Terman, F. E., Paper, *December*, 1238; Discussion, *December*, 1308
 Thomas, Percy H., Discussion *January*, 52, 68, 72
 Torechio, Philip, Discussion *March*, 284
 Trueblood, H. M., Discussion *February*, 179
 Turneure, F. E., Discussion *November*, 1173
- U**
- Upson, Walter L., Paper, *July*, 661; Discussion, *November*, 1175
- V**
- Vallarta, M. S., Paper, *April*, 383; Discussion *May*, 472
 Varney, Theodore, Paper, *October*, 953; Discussion, *October*, 1022
 Vernam, G. S., Paper *February*, 109
 Vincent, H. B., Discussion *October*, 1025
- W**
- Wade, E. J. and McEachron, K. B., Paper *January*, 46
 Wagner, C. F. and Evans, R. D., Paper, *April* 374; Discussion, *September*, 887
 Wagner, C. F., Discussion *June*, 569; *September*, 884
 Weller, C. T., Discussion *August*, 768
 Wensley, R. J., Discussion *July*, 671; *November*, 1175
 West, H. R., Paper, *February* 160; Discussion *July*, 674
 Wheeler, R. H., Discussion *October*, 1022, 1035
 White, M. W., Doggett, L. A. and Heim, J. W., Paper; *February*, 131
 White, R. S., Discussion *September*, 896
 Whitehead, J. B., Paper, *June*, 515; *December*, 1225; Discussion, *June*, 581; *September*, 892; *December*, 1290, 1295
 Whiteman, M. J., Discussion *February*, 174
 Wickenden, W. E., Paper *October*, 987
 Wieseman, R. W., Discussion *December*, 1303
 Wilkins, Roy, Paper, *February*, 142; Discussion, *January*, 54, 74; *September*, 888
 Wilkinson, K. L., Discussion *February*, 178
 Williamson, A. A., Discussion *February*, 177
 Williamson, R. B., Discussion *October*, 1016
 Willman, E. C., Discussion *October*, 1006
 Wilson, Leonard, Paper *September*, 795
 Wiseman, R. J., Discussion, *October*, 1007, 1009; *November*, 1159
 Withington, Sidney, Discussion *September*, 884
 Wood, E. M. and Floyd, G. D., Discussion *October*, 1017
 Wood, R. J. C., Discussion, *January*, 55, 73; *February*, 186
 Woodruff, L. F., Discussion *May*, 467
 Wright, A. J. and Healy, E. S., Paper *November*, 1144
 Wright, E. B., Discussion *September*, 896

DIGEST OF CURRENT INDUSTRIAL NEWS

NEW CATALOGUES AND OTHER PUBLICATIONS

Mailed to interested readers by issuing companies

Transformers.—Bulletin 20133-A, 4 pp. Describes Westinghouse SK steel clad distribution transformers. Westinghouse Electric & Mfg. Company, East Pittsburgh, Pa.

Generator Voltage Regulators.—Bulletin 702, 12 pp. Describes quick acting automatic generator voltage regulators. American Brown Boveri Electric Corporation, 165 Broadway, New York.

Graphic Meters. Bulletin 1026, 4 pp. on New Uses for Graphic Meters. Describes the recording of automatic stations performance. The Esterline-Angus Company, Indianapolis, Ind.

Theater Switchboards.—Bulletin 1702-A, 20 pp. Describes various types of switchboards for theater lighting control. Westinghouse Electric & Mfg. Company, East Pittsburgh, Pa.

Battery Charging Control Equipment.—Bulletin GEA 484, 4 pp. Describes a new line of unit control sections for battery charging service. General Electric Company, Schenectady, N. Y.

Electricity in Lumber Industry.—Bulletin GEA-106, 32 pp., entitled "Electric Drive in the Lumber Industry," describes and illustrates the application of electricity to the lumber industry. The General Electric Company, Schenectady, N. Y.

Meggers.—Catalog 1145, 48 pp. Describes Megger insulation testing instruments. The application of the complete line of these devices for the rapid and convenient testing of electrical insulation and measurement of resistance is illustrated by photographs. James G. Biddle, 1211 Arch Street, Philadelphia, Pa.

Supervisory Control.—Bulletin C-1694-B, 12 pp. Describes supervisory control systems, treating on the synchronous visual type of equipment, code visual type and the audible type. Westinghouse Electric & Mfg. Company, East Pittsburgh, Pa.

Edison Hour Radio Programs.—The New York Edison Company, 130 E. 15th St., New York, has issued an attractive pamphlet of thirty-two pages outlining the radio programs to be broadcast from WRNY during Edison hour each Tuesday for the coming winter months. The title of this publication is "Twenty-one Adventurous Nights."

Radio and Electrical Laboratory Apparatus.—Bulletins enclosed in loose leaf binder. Among the apparatus described are decade and variable air condensers, standards of resistance and decade resistance boxes, audibility meters, standards of inductance, decade and capacity bridges, vacuum tube bridges, precision condensers, precision wavemeters, amplification test sets, station frequency meters, miscellaneous transformers and power amplifiers and plate supply. General Radio Company, 30 State Street, Cambridge (39) Mass.

NOTES OF THE INDUSTRY

G-E Reduces Prices of Motors and Transformers.—A reduction in prices on its general purpose motors, amounting to five per cent on most lines and ten per cent on commonly used sizes of squirrel cage induction motors, has been announced by the General Electric Company, effective December 1, 1926. The motors affected by the new price levels include both a-c. and d-c., constant and variable speed general purpose motors, from one to 200 horse power. Prices of standard squirrel cage induction motors have now been brought by the company to a level within about 10 per cent of that in 1914.

Effective November 8, a reduction averaging five per cent was made in the prices of distribution and small power transformers, 500 kv-a. and less, 73,000 volts and below. This is the fifth reduction that has been made by the General Electric Company on this class of material since 1920.

The Simplex Wire and Cable Company, Boston, announces the removal of its St. Augustine office to the Barnett National

Bank Building, Jacksonville, Fla. Miss F. H. Pettee continues as Florida manager.

Air Filters.—Midwest Air Filters, Inc., Bradford, Pa., have placed on the market a "Self Clean" air filter which consists of an endless chain of standard Midwest filter units arranged so that they pass through a tank at the bottom of the device for constantly maintaining a fresh Viscosine surface. The operation is continuous or intermittent, as desired. These "self clean" air filters are supplied in standard units with capacities from 10,000 to 25,000 C. F. M.

The Ohio Brass Company, Mansfield, Ohio, has established new quarters for its San Francisco and Los Angeles branch offices. The address of the San Francisco office is Rooms 531-533 Matson Building, 215 Market Street. The Los Angeles office is located in Room 508 Subway Terminal Building, 417 So. Hill Street. In both of these cities the company will continue to carry ample stock of its various products for the convenience of the Western trade.

Allis-Chalmers Manufacturing Company, Milwaukee, Wis., has opened a branch office in Jackson, Michigan, with L. F. Berry as resident representative. This office is located at 512 Reynolds Building, Jackson, and is a branch office of the company's office in Detroit, which is under the direction of F. S. Schuyler.

The company also announces the appointment of Ernest Smith as sales engineer in the Oruro, Bolivia office. This is a branch of the district office at Santiago, Chile.

The James R. Kearney Corporation, St. Louis, manufacturers of overhead and underground utility equipment, announces that the following have recently joined the sales organization: Herb Keller and Arthur Miller, of Power Machinery Company, Kansas City, Missouri, as special representatives in the Kansas City territory. W. M. Watters, formerly a representative of W. N. Matthews Corporation, in the Kansas City Territory, as special representative in the St. Louis territory. J. J. Costello, as representative in the New England States territory with headquarters in Boston.

A New Improved Mica Insulation.—Phthalic anhydride, a few years ago a chemical curiosity produced from naphthaline or moth balls and quoted at \$5 a pound, and today an important heavy organic chemical used in the manufacture of dyestuffs and selling at 25 cents a pound, has been combined with glycerine, a by-product of the soap industry, to produce a synthetic resin which has succeeded shellac as a binding material in the manufacture of pasted mica insulation or micanite. The resin, developed in the research laboratory of the General Electric Company, is known as Glyptal. It has been standardized by the company for all rigid mica insulation used in its apparatus, including segments, cones and backs for commutators, tubes, washers, plates, blocks, molded shapes, etc.

Highest Voltage Transmission System in Canada.—A 187,000-volt transmission line 140 miles long, operating at a much higher voltage than any other system in Canada, is being constructed by the Shawinigan Engineering Company as a duplicate transmission line between the Isle Maligne generating station of the Duke Price Power Company and the City of Quebec. The oil circuit breakers will be the largest, both electrically and physically, in Canada. The height over the bushings is approximately 20 feet, and the floor space nine by thirty-one feet. The high tension neutrals will be solidly grounded throughout the system. The oil tanks are cylindrical in form, 84 inches in diameter, and are of steel plate with welded joints. Explosion chambers of the C. G. E. design are used. The F-5 bushings will withstand a high potential test of 450,000 volts dry for one minute, equal to four times the line-to-neutral voltage, and provide an ample factor of safety for a system with solidly grounded neutrals.

From the Early Period
of the Telegraph to the present
remarkable development in the field of Electricity

KERITE

has been continuously demonstrating the
fact that it is the most reliable and
permanent insulation known

KERITE INSULATED
WIRE & CABLE **COMPANY**

NEWYORK



CHICAGO

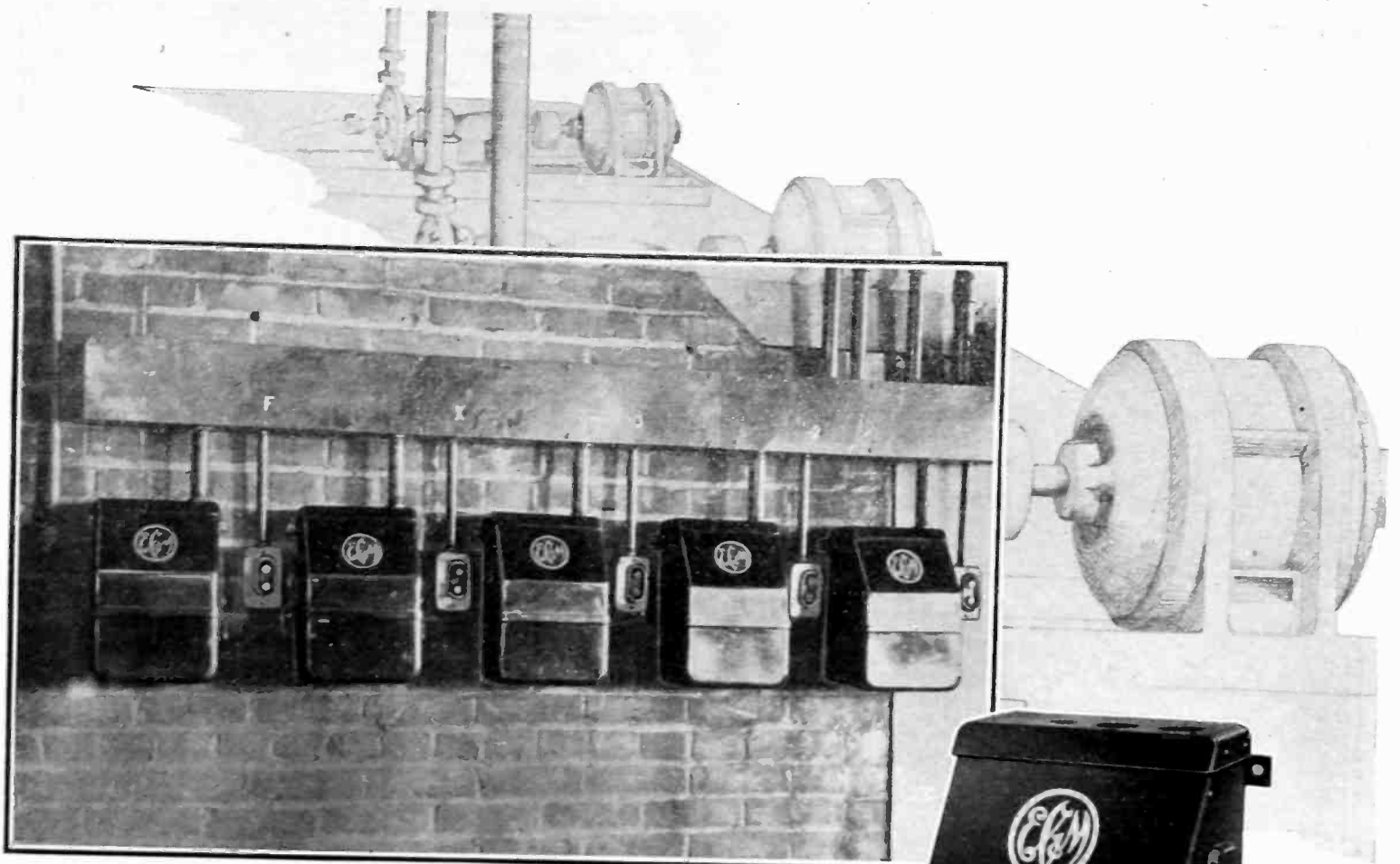

Starting & Protecting A.C. Motors



Place your AC motors under push-button control by installing EC&M Type ZO Switches.

Type ZO Switches are built for across-the-line starting of squirrel cage motors up to 10 H.P. When these switches are in service, your operators have only to press a push button to start or stop their machines.

Type ZO Switches have their contacts immersed in oil so they can be safely used in corrosive atmospheres and where inflammable dusts and gases are present.

In case of overloads, lost phase or other abnormal conditions, your motors are completely protected without any blowing of fuses and costly delays. This protection is provided by an expansion wire trip which is 100% accurate and dependable.

It is not necessary to mount the ZO Switch so that it is accessible to the machine operator. After the overload trip has opened the motor power circuit, the operator has only to wait a few seconds and then press his starting button to again put his machine in operation. He has complete control from his push button.

Write for Bulletin 1048.



THE ELECTRIC CONTROLLER & MFG. CO.

BIRMINGHAM - BROWN-MARX BLDG.

CHICAGO - CONWAY BLDG.

CINCINNATI - INTERNATIONAL BANK BLDG.

DETROIT - DIME BANK BLDG.

NEW YORK - 50 CHURCH ST.

CLEVELAND, OHIO

LOS ANGELES - THOMAS MACHINERY CO.

AMERICAN BANK BLDG.

PHILADELPHIA - WITHERSPOON BLDG.

PITTSBURGH - OLIVER BLDG.

SAN FRANCISCO - CALL BUILDING

SEATTLE - 570 COLMAN BLDG.

TORONTO - TRADERS BANK BLDG.



Please mention the JOURNAL of the A. I. E. E. when writing to advertisers.

Let's Get Down to Fundamentals



Push a book along the table.
Note the drag due to the friction of sliding one surface over the other.



Place the book on pencils.
It moves easier because *rolling* contact is substituted for sliding friction. But note the tendency of the rollers to change direction—and then to resist movement in the original direction.

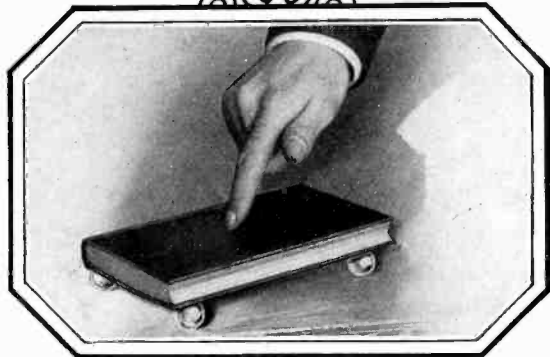

Place the book on balls. The slightest touch starts the book across the table. And note particularly that the balls show no tendency to change the direction in which you are moving the book. Nothing rolls so easily, so true, so free of friction as a ball. *So it is with the New Departure Ball Bearing.*

New Departure Quality Ball Bearings

CONT. 427

Input and Output Brought Nearer Together

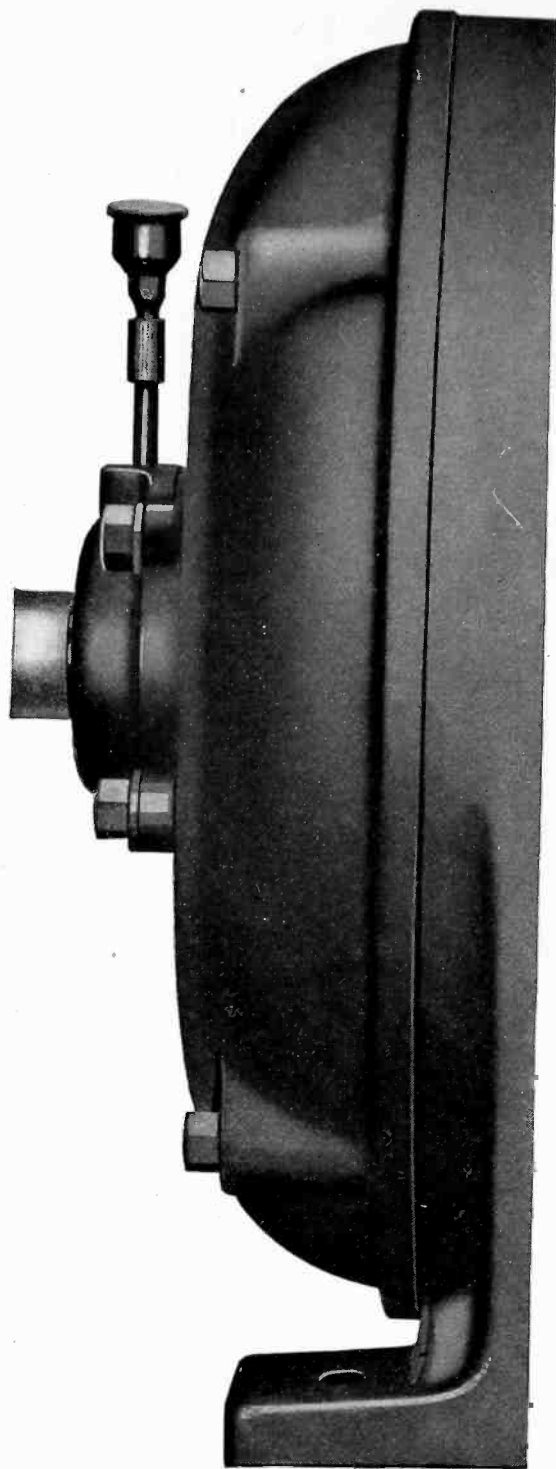

The margin between power input and power output has been steadily narrowed by Allis-Chalmers advancements. And the economy curve is kept flat year after year by Allis-Chalmers electrical and mechanical advantages.

The frames of electric steel are shock-proof, rigid and clean. The special core construction produces an actual unit effect. Allis-Chalmers silver brazing has eliminated the rotor bar assembly as a critical factor. Allis-Chalmers Volume Ventilation is a positive cooling method under any conditions. The smooth, baked-on extra insulation is almost impenetrable.

The permanent wear resistance of the stationary parts is matched by the bearings themselves in Timken-equipped Allis-Chalmers motors! The higher load capacity of Timken Bearings, and their great freedom from friction means refined design, power-saving, and a continuously uniform gap, with no more than two or three greasings a year!

Anti-friction types and all other Allis-Chalmers motors are backed by authentic operating data, available at the Allis-Chalmers office nearest you—or by mail.

ALLIS-CHALMERS MFG. CO.
Milwaukee
*District Sales Offices
in all Principal Cities*

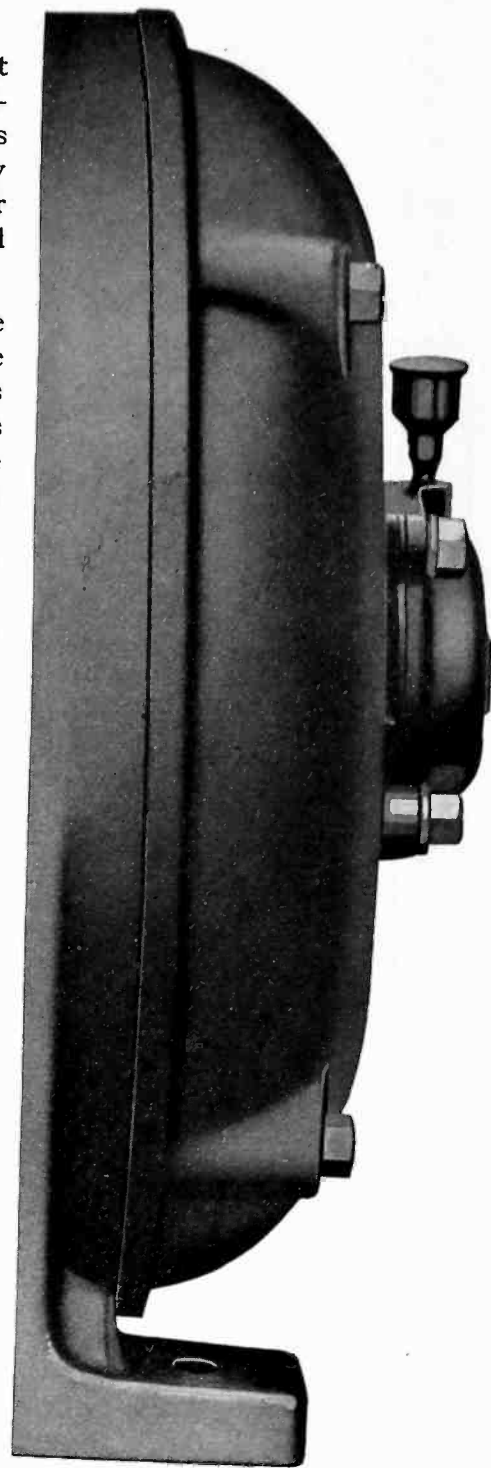

ALLIS-CHALMERS MOTORS

Please mention the JOURNAL of the A. I. E. E. when writing to advertisers.

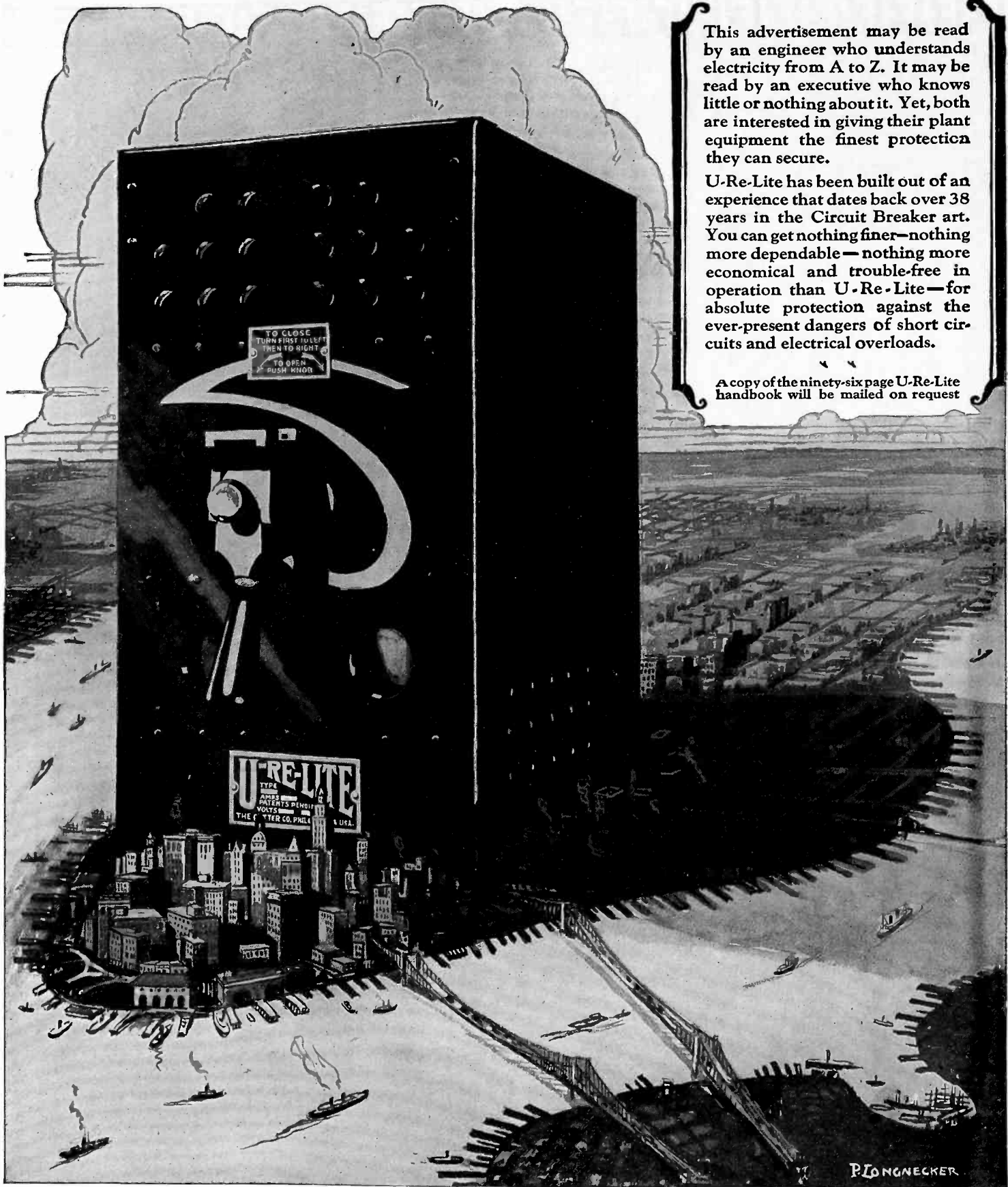

This advertisement may be read by an engineer who understands electricity from A to Z. It may be read by an executive who knows little or nothing about it. Yet, both are interested in giving their plant equipment the finest protection they can secure.

U-Re-Lite has been built out of an experience that dates back over 38 years in the Circuit Breaker art. You can get nothing finer—nothing more dependable—nothing more economical and trouble-free in operation than U-Re-Lite—for absolute protection against the ever-present dangers of short circuits and electrical overloads.

A copy of the ninety-six page U-Re-Lite handbook will be mailed on request

CUTTER

U-RE-LITE & & & I-T-E CIRCUIT BREAKERS

THE CUTTER COMPANY — Established in 1888 — PHILADELPHIA, PENNSYLVANIA

Please mention the JOURNAL of the A. I. E. E. when writing to advertisers.

FERRANTI

TRANSFORMERS

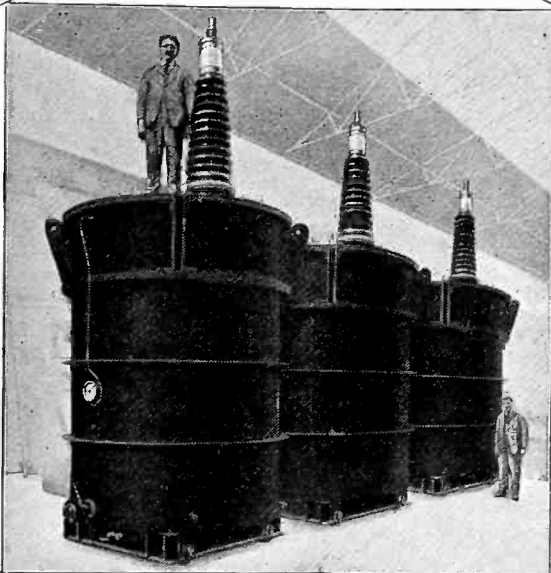
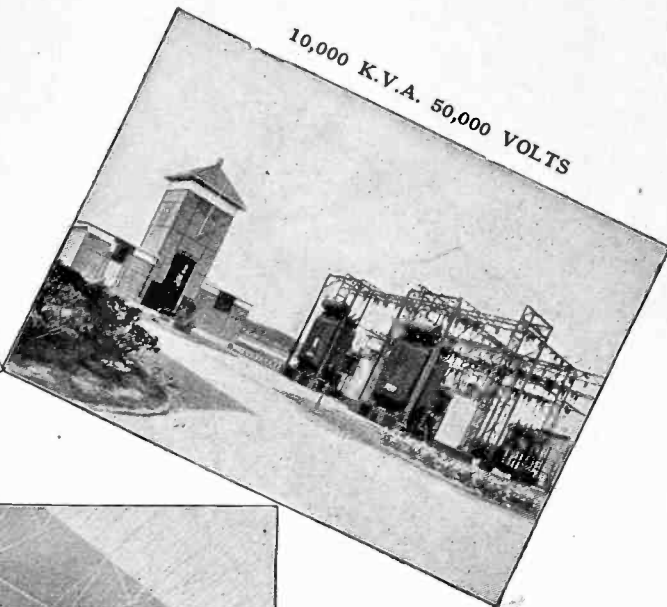
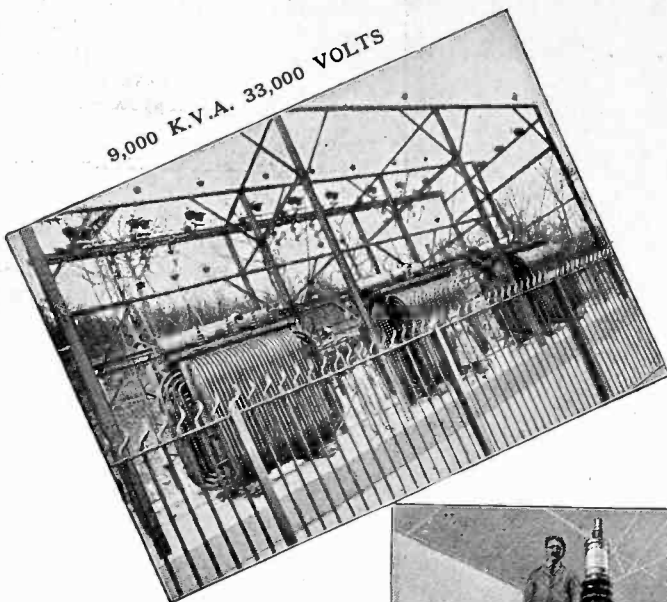

FOR BIG

POWER

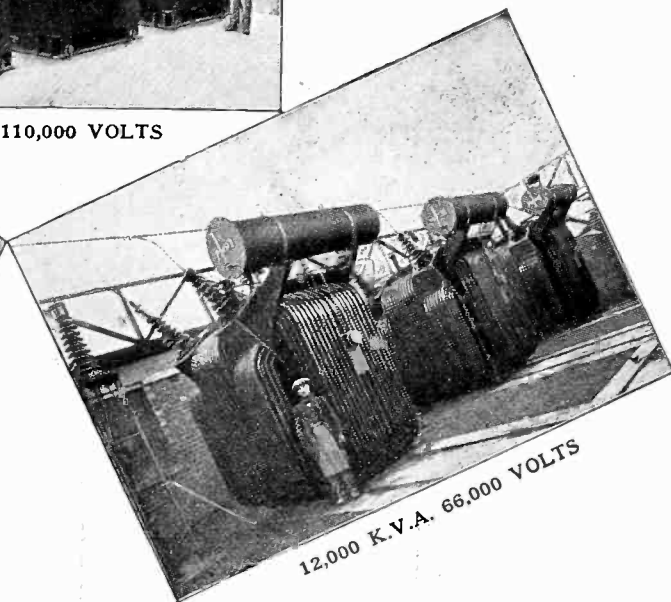
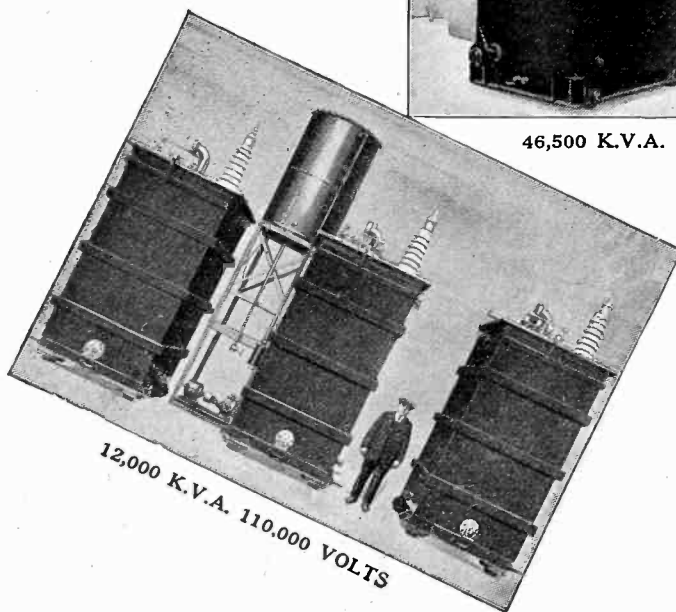

Ferranti, Ltd.,
HOLLINWOOD, ENGLAND

Ferranti Electric, Ltd.,
26 Noble Street,
Toronto, Canada

Ferranti, Inc.,
130 West 42nd Street,
New York, U. S. A.

Pop Decides Not to Fire the Sweeper

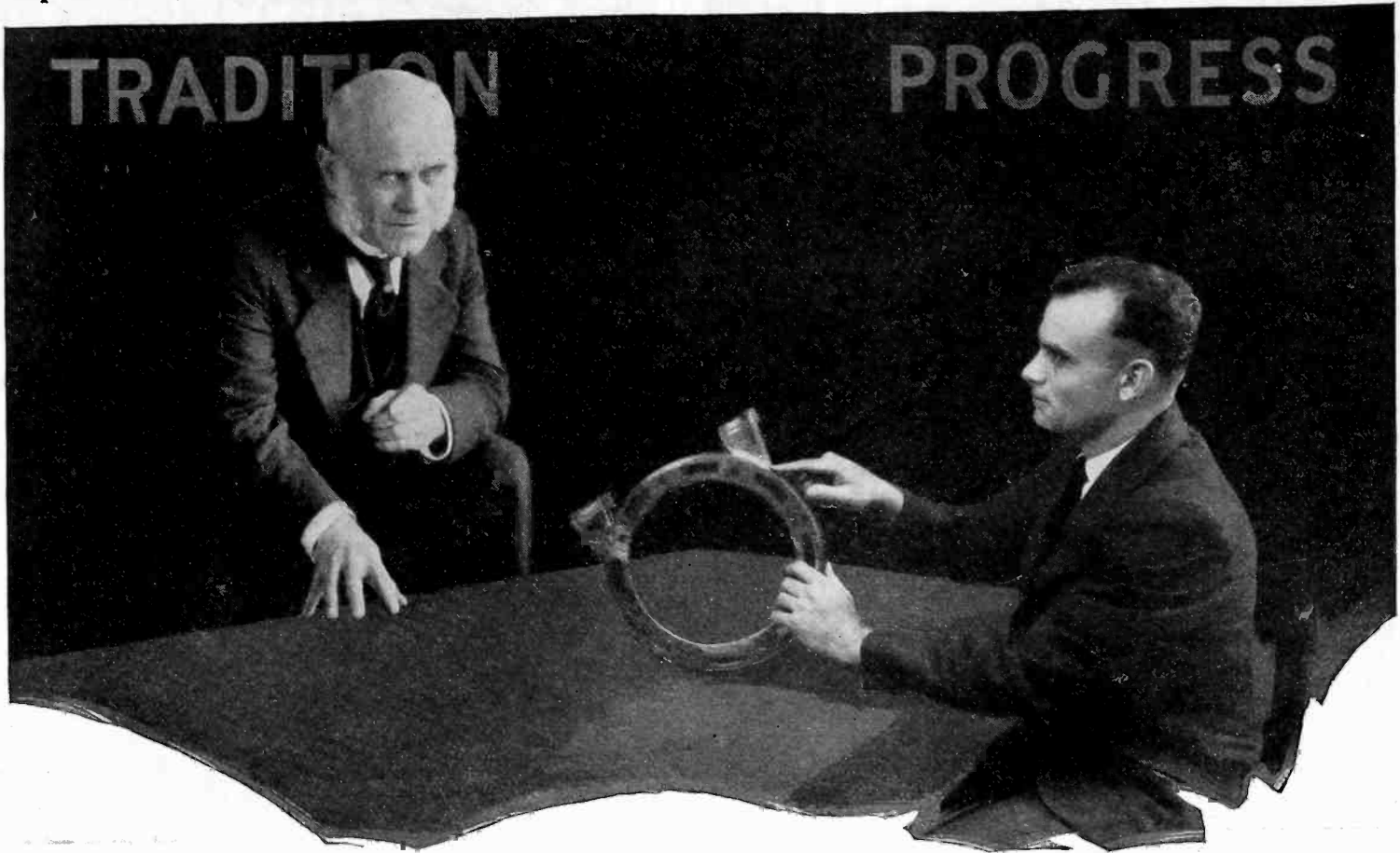

“Here, Lad—

fire that sweeper in the lower plant—he’s too careless! Last night he ran his rubbish truck against a motor and broke a foot off it—so we lose that machine’s production until they get a new motor on the job.”

“No, Pop—

you can’t buy common sense in a sweeper, but you’d at least *expect* it in a motor maker.

There’s always something sideswiping motors—and yet your gang of stiff-back motor assemblers stick to cast-iron feet. If they themselves didn’t have clay feet they would weld drop-forged feet to a steel frame—just as in the Linc-Weld Motor.

Then your sweeper could do calisthenics with a sixteen-pound sledge and he couldn’t “drop” a motor.

See Page 7 of the Motor Book. Better get yourself a copy from—
Department No. 21-12.

The Lincoln Electric Company, Cleveland, Ohio

MA-2

**“Linc-
Weld”**

LINCOLN MOTOR

Please mention the JOURNAL of the A. I. E. E. when writing to advertisers.

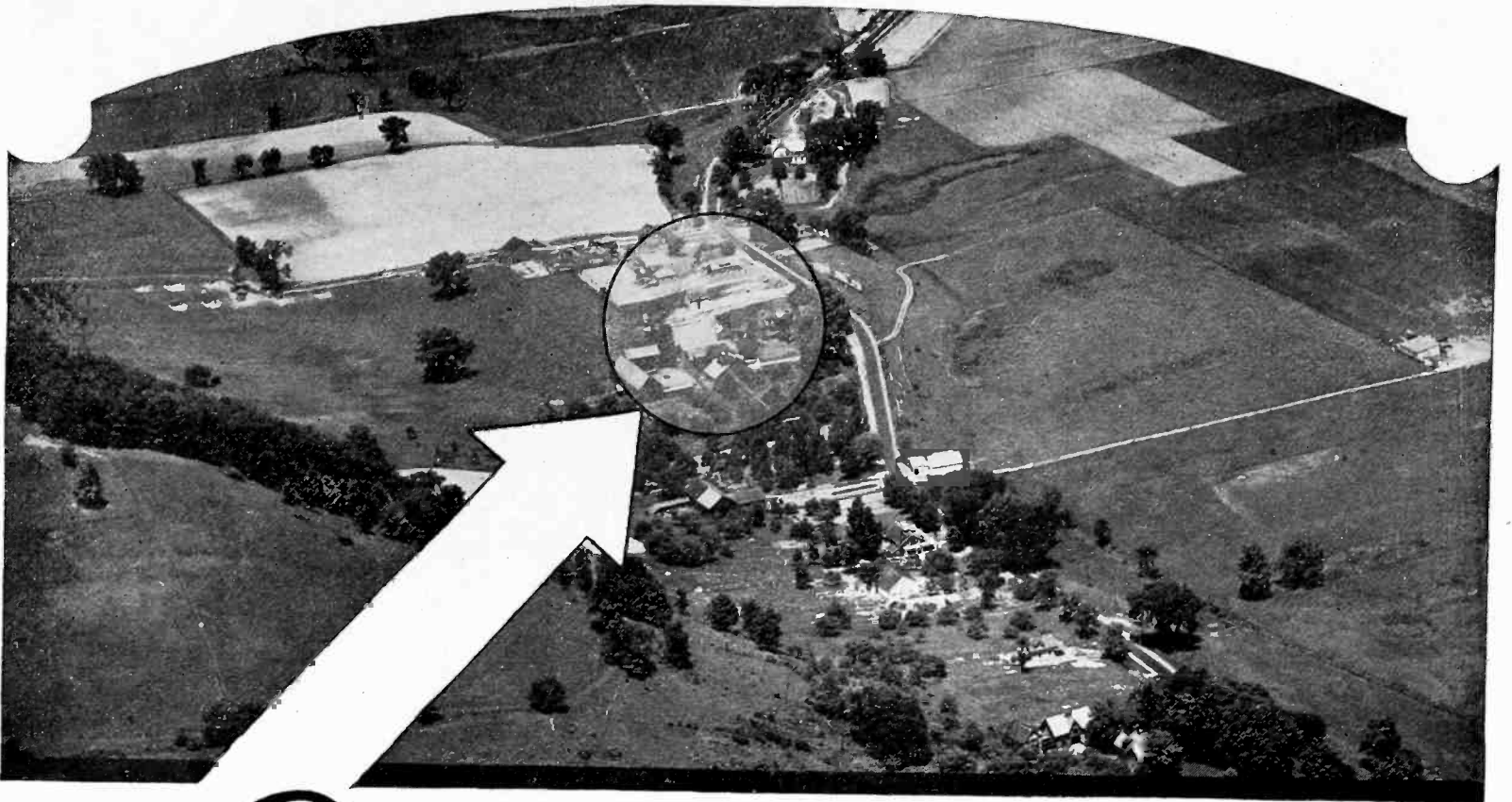

Out where trouble may begin

Troubles out on the line are none the less frequent in rural sections.

Lightning there, in season, is a potential source of trouble.

A wet tree can start as much trouble as a jammed motor.

But this trouble need not get beyond the nearest station. If you have G-E Explosion-Chamber Breakers, it will not.



The rating of G-E Oil Circuit Breakers is always based on data obtained from actual tests. In this the special G-E testing facilities at Schenectady are an important factor. That G-E Breakers are rated well below the power they are able to handle is constantly being demonstrated by their successful operation under exacting conditions.

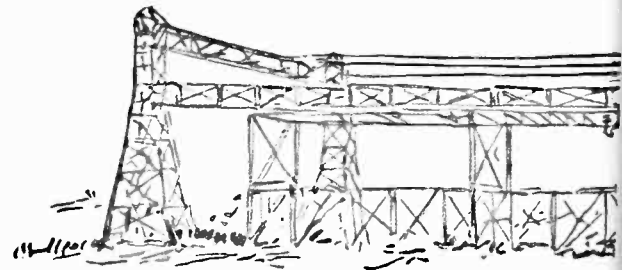

GENERAL

Please mention the JOURNAL of the A. I. E. E. when writing to advertisers.

Gas formation tests at 48,000 volts single-phase. All tests made in same breaker operated by same mechanism and with same generator and transformers operating under identical conditions.

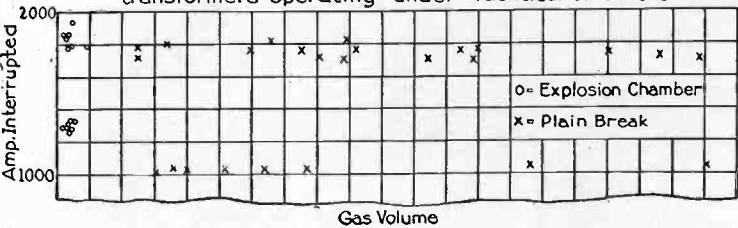

Above are plotted the data obtained in several tests made at the G-E testing station to show the comparatively small gas volume in the operation of explosion-chamber G-E Oil Circuit Breakers. Besides reducing the quantity of gas generated, the explosion chamber reduces the arc length, the duration of the arc, the pressure in the main oil tank, and the burning of the contacts. To these functions of the explosion chamber the remarkable reliability of these G-E Oil Circuit Breakers can be attributed.

One type of Explosion-Chamber Oil Circuit Breaker

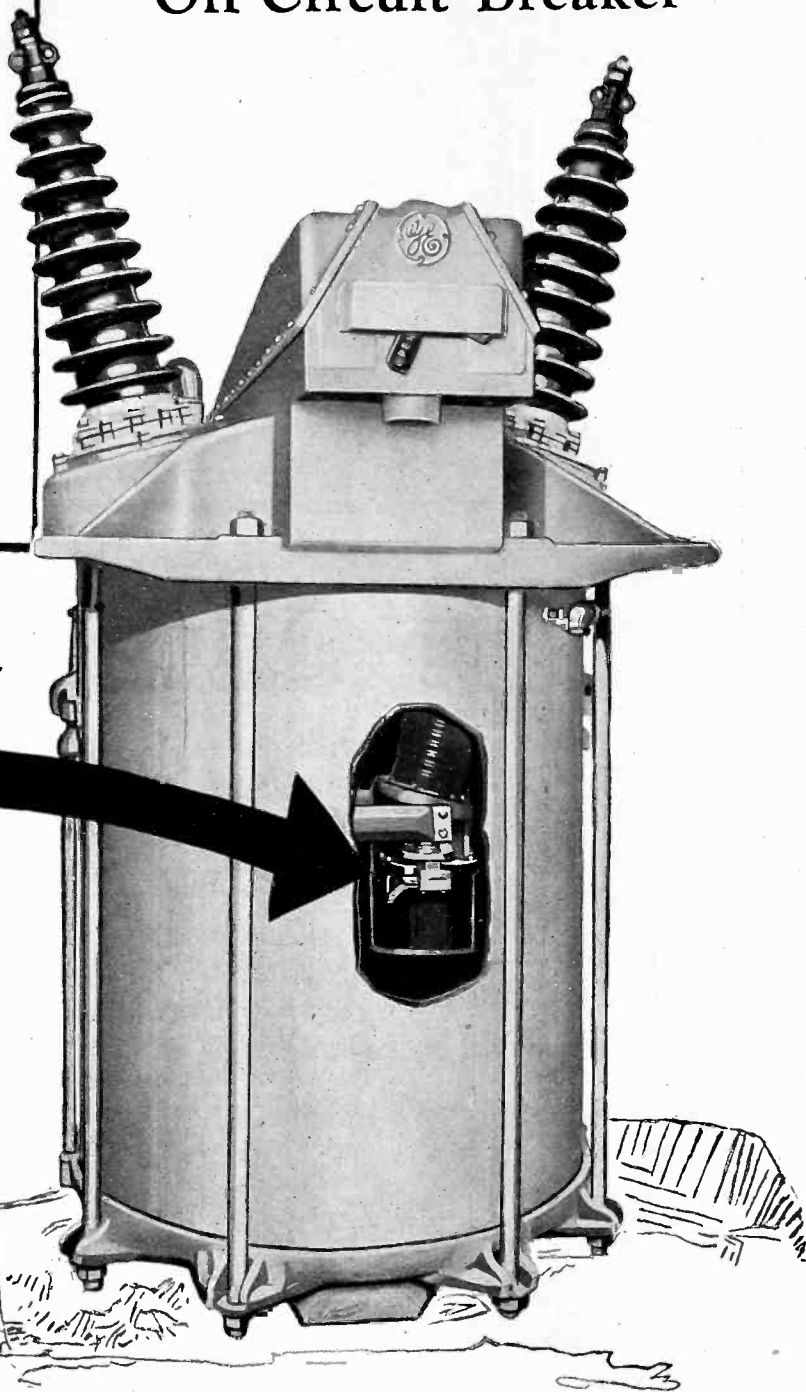

—and where that trouble is ended

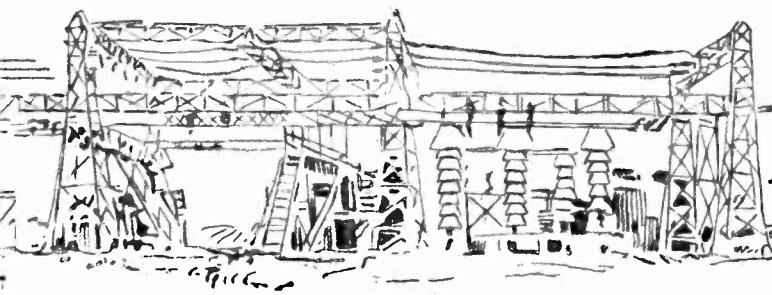

ELECTRIC

23-10

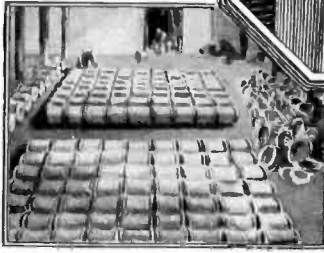
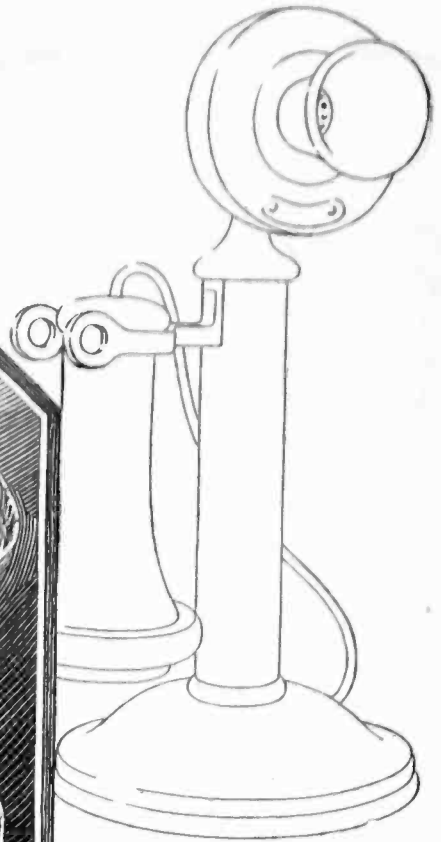

Millions of miles of wire are required every year by the Bell System.

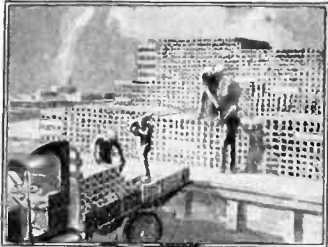

Trainloads of conduit are required daily to put wires safely underground.

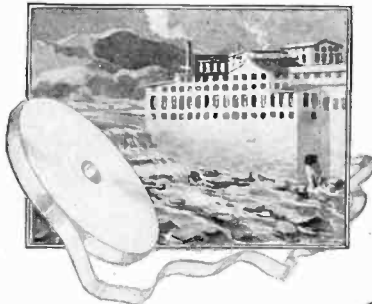

The output of many paper mills is used in insulating cable and printing telephone directories.

Any housewife can understand *-the world's biggest industrial buying job*

BUYING telephone poles by the million, or wire by the millions of miles, gets down to the same simple terms as laying in a winter's supply of apples.

Western Electric buys or makes substantially everything in supplies or equipment used by the Bell Telephone System. The collective buying of these materials, largely standardized, brings about substantial economies for buyer and seller alike.

In Western Electric those

charged with the responsibility of buying, by practicing scientific methods, by anticipating requirements, by knowing when and how to buy are lessening the effect of the increase in cost of most of the telephone plant materials.

Thus are the economies of mass purchasing like those of mass production, representing millions of dollars annually, passed through the Bell System to the American public.



Western Electric

SINCE 1882 MANUFACTURERS FOR THE BELL SYSTEM

Please mention the JOURNAL of the A. I. E. E. when writing to advertisers.

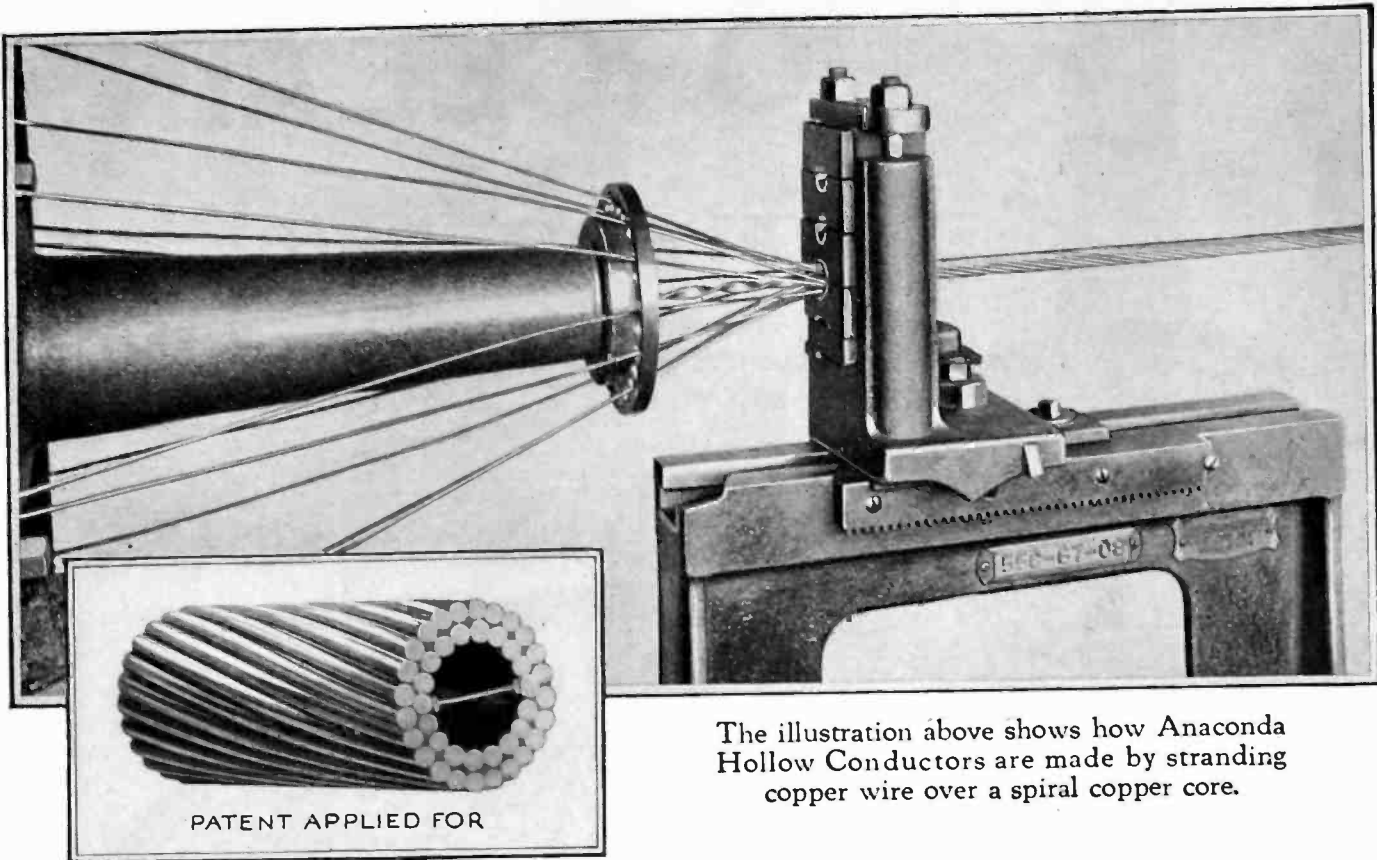

The illustration above shows how Anaconda Hollow Conductors are made by stranding copper wire over a spiral copper core.

*Made entirely of Copper,
and adapted to every transmission need*

ANACONDA HOLLOW CONDUCTORS

IT IS possible to reduce corona and resistance losses in transmission lines by using Anaconda Hollow Conductors which are made entirely of copper—the most logical transmission material.

Anaconda Hollow Conductors can be designed with the diameters best adapted to cut down corona loss effectively, one, two, or three layers of strands being used as required. The twisted copper core, I-beam in shape, adds strength to the hollow construc-

tion without the addition of dead weight, or the sacrifice of conductivity or durability.

Where additional strength is required, the conductor may be reinforced with bronze strands, since bronze has the same temperature coefficient of expansion as copper.

Electrical engineers are invited to investigate the adaptability of Anaconda Hollow Conductors to their power transmission problems. Write for Research Bulletin C-6.

ANACONDA COPPER MINING CO.
THE AMERICAN BRASS COMPANY

Rod, Wire and Cable Products

General Offices: 25 Broadway, New York
Chicago Office: 111 W. Washington St.

ANACONDA COPPER

BRASS BRONZE

Please mention the JOURNAL of the A. I. E. E. when writing to advertisers.

PORCELAIN

You can install
— *and forget*

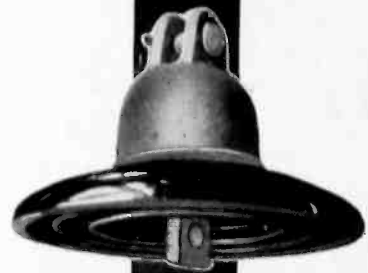

No. 601
Average Ultimate
11,500 Pounds

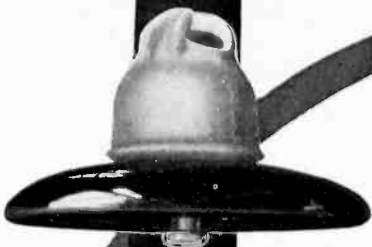

No. 641
Average Ultimate
11,500 Pounds



No. 631
Average Ultimate
20,000 Pounds



No. 633
Average Ultimate
30,000 Pounds

SUSPENSION INSULATORS

THE growth of super-power transmission lines brought higher and higher voltages, constantly lengthening spans, and ever larger conductors. The ceramic industry was put to a test to produce insulators that would support the loads demanded of them.

The problem presented could not be solved by tradition, precedent, or custom. A new trail was necessary, the task of a research engineer.

Westinghouse standard suspension (No. 601) now has a rated ultimate strength of 11,500 pounds. The higher strength insulators, No. 631 and No. 633, have rated ultimate strengths of 20,000 and 30,000 respectively. Such strengths were undreamed of a few years ago.

By reason of Westinghouse leadership in the engineering development of porcelain insulators, you can have confidence in the Westinghouse insulators on your lines. You can safely forget them.

Westinghouse Electric & Manufacturing Company
Westinghouse High-Voltage Insulator Works
Derry, Pa. Emeryville, Cal.
Sales Offices in All Principal Cities of
the United States and Foreign Countries



Westinghouse

X87268

Please mention the JOURNAL of the A. I. E. E. when writing to advertisers.

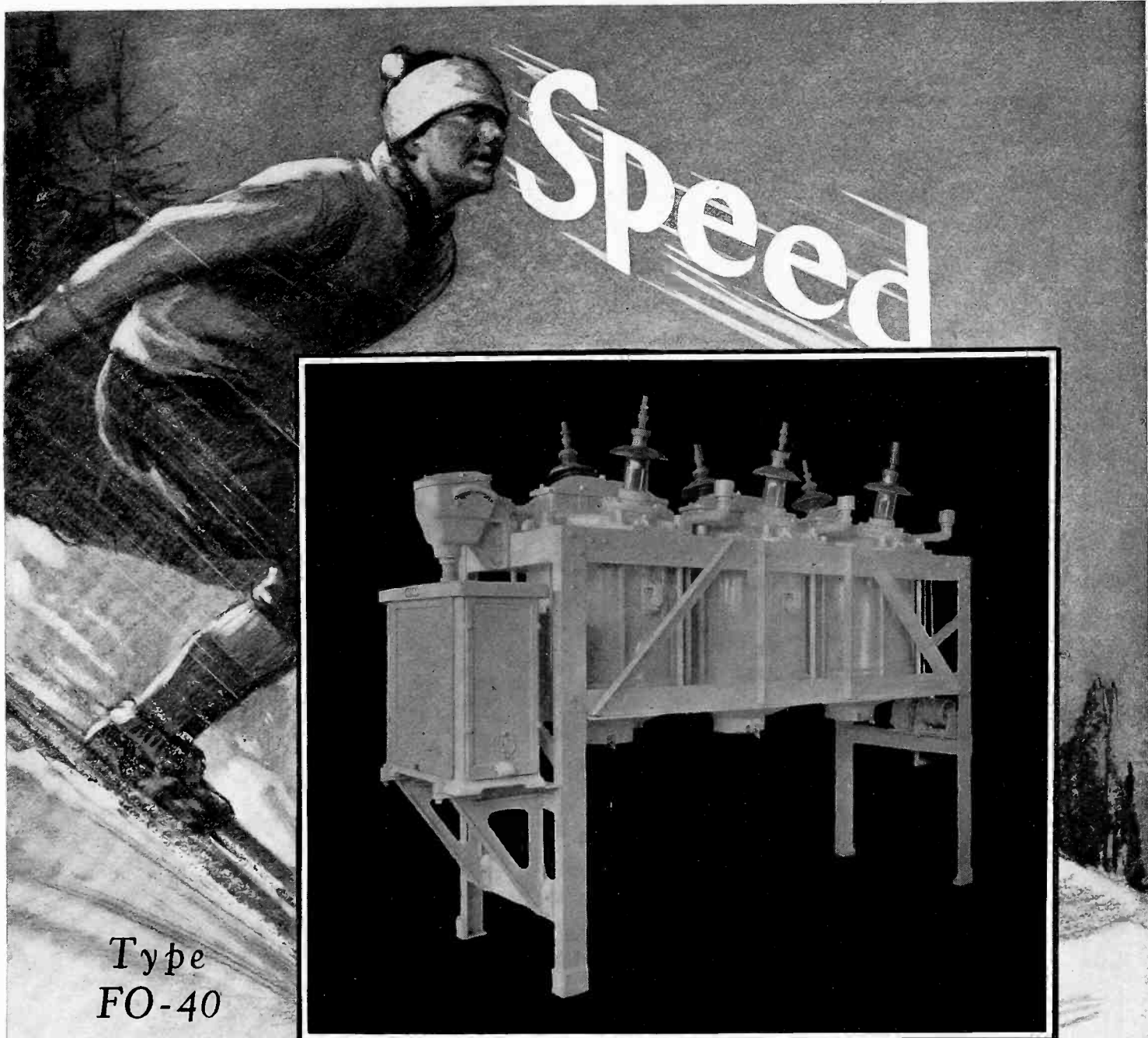

Type
FO-40

LIKE the ski-jumper, the Condit Type FO-40 attains enormous acceleration at the "take-off". Multiple breaks in series accentuate its high speed of circuit interruption—one reason why the Type FO-40 is the outstanding breaker for higher voltage service.

CONDIT ELECTRICAL MFG. CORP.
Manufacturers of Electrical Protective Devices
Boston, Mass.

Northern Electric Company
LIMITED

Sole distributor for the Dominion of Canada

Specifications: 800 Amperes or less; 73,000 Volts; 50,000 Volts; 37,000 Volts. Interrupting Capacity 1,000,000 Kv-a or less. Breaker illustrated is 37,000 Volt B size.

CONDIT

New-

Type TA-1 Horn Gap Switch
15,000 to 73,000 volts
for outdoor service

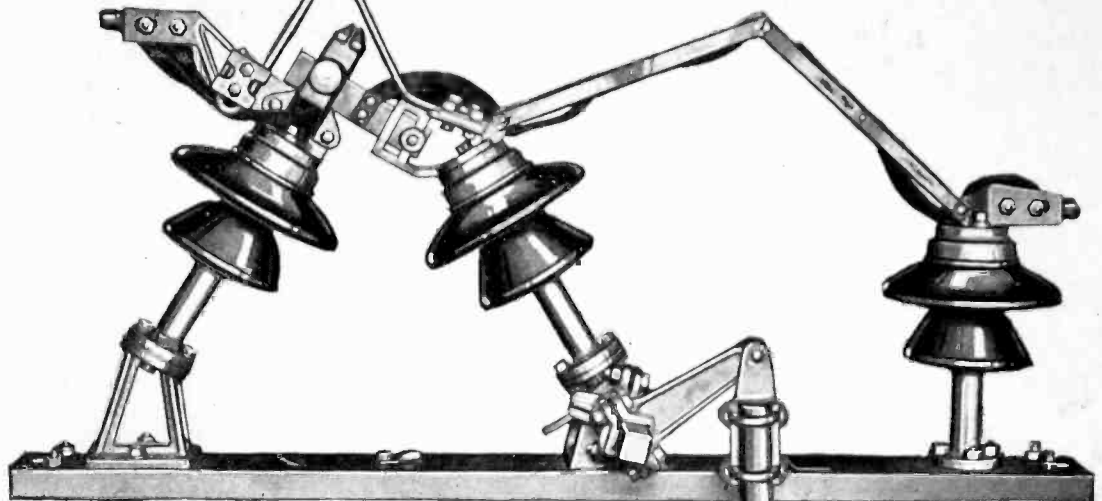

Single-pole element of a Type TA-1 Triple-pole, Group-operated Horn Gap Switch with direct-manual operating mechanism.

Features

- Sturdy construction.
- Self-aligning contacts and blades.
- Chopping action of blade removes sleet.
- Malleable iron castings.
- Hot-dipped galvanized malleable iron and steel parts.
- Brass-bushed main bearings.
- Shock-absorbing buffer springs.
- Removable wooden handle.



General Electric supplies all equipment for outdoor stations, from transformers and oil circuit breakers to connectors and fittings, either individually or as a complete station "co-ordinated by G-E".

GENERAL ELECTRIC

GENERAL ELECTRIC COMPANY, SCHENECTADY, N. Y., SALES OFFICES IN PRINCIPAL CITIES

Please mention the JOURNAL of the A. I. E. E. when writing to advertisers.

*"Steam Cured"
crack-proof*



THE SYMBOL OF SERVICE

Where two or more porcelain parts are cemented together, as in the higher voltage pin type insulators, some means must be provided to safeguard the top and second section from expansion and contraction dangers due to the unequal rate of thermal change of these parts and their reaction on each

other. The Locke "Steam Cured" process has become recognized as the only positive remedy for cracked tops in multi-part pin type construction. Insist upon having only insulators which are "Steam Cured"—your best insurance for low maintenance and service satisfaction.

Process Patented.

LOCKE INSULATOR CORPORATION

Baltimore, Md.

Factories at Victor, N.Y. and Baltimore, Md.



LOCKE
PORCELAIN

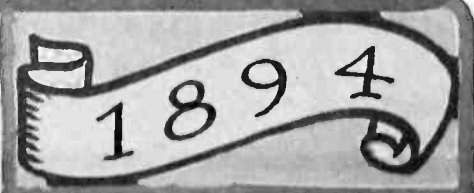

Another DOSSERT

SERVICE . . . on the lines of
the Atlantic City
R.R. ... Reading System
at Camden, N. J.

And here are a lot more services on which Dosserts will save your time and money

Connecting cables, stranded or solid wires, rods and tubing.

Connecting two conductors of same size or different sizes.

Connecting wires to cables, cables to rods or tubing.

Connecting conductors at right angles.

Making three-way splices at right angles or other angles or with wires parallel.

Connecting branch circuit to main circuit.

Connecting one or two conductors to lug direct or at an angle.

Connecting wires to studs.

Connecting one or two cables to anchor.

To equalize load on two feeders.

Connecting to service boxes and cutouts.

Connecting grounds.

Connectors for all iron pipe sizes of tubing.

Special connectors for special services.

Dossert Cable Taps used to connect the horn gap disconnecting switch leads to the power lines.

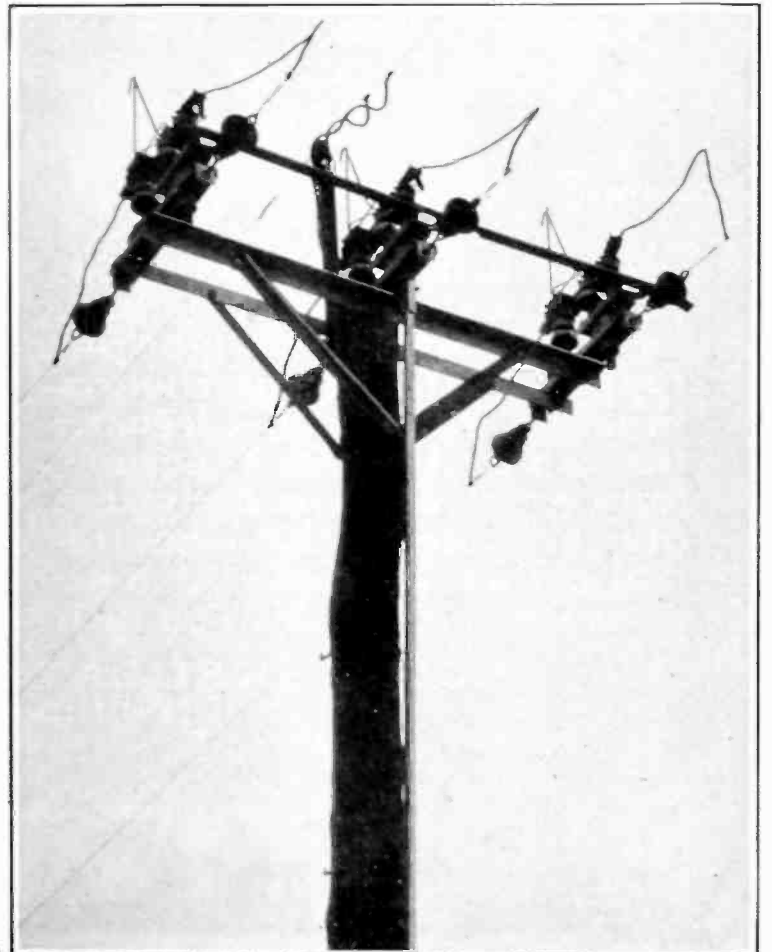

Write for the Dossert 20th Year Book which shows the line and the data.

DOSSERT & COMPANY

H. B. Logan, Pres.

242 West 41st St.

New York, N. Y.

Can a fault on one line of your distribution system cause interruptions on other lines?

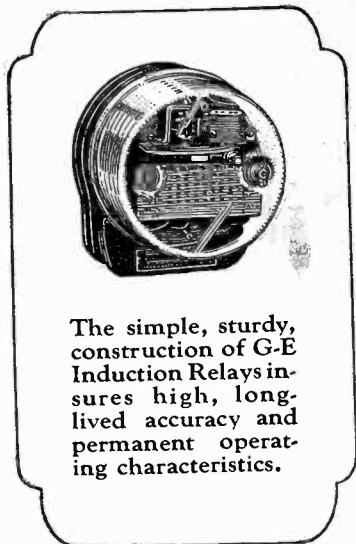

The simple, sturdy, construction of G-E Induction Relays insures high, long-lived accuracy and permanent operating characteristics.

AS DISTRIBUTION systems are always in danger of an occasional fault, they should be protected in such a way that the fault will be isolated before it can cause unnecessary interruptions on the rest of the system.

Relays, their operation depending *only* upon system conditions, operate promptly to take care of trouble by disconnecting the faulty line and keeping the rest of the system in operation even though it may carry for a short time a considerable overload due to the fault.

To establish and maintain a co-ordinated relay installation that will disconnect a line only when it should be disconnected requires a thorough knowledge of the distribution system and of relays—knowledge that many power companies have centralized to their best advantage in a department under the Protection Engineer.

When new problems in the isolation of faults confront the Protection Engineer, valuable assistance in selecting the best method of relay protection can be obtained from G-E Relay Specialists, men who have the benefit of experience with relay installations on distribution systems all over the country.



Relays are an increasingly important factor in the generation, distribution, and utilization of electric power and the protection of electrical apparatus. Hence the Protection Engineer, who thoroughly knows relays and their applications, can be of service to every operating department.

GENERAL ELECTRIC

GENERAL ELECTRIC COMPANY. SCHENECTADY, N. Y., SALES OFFICES IN PRINCIPAL CITIES

501-3

Please mention the JOURNAL of the A. I. E. E. when writing to advertisers.

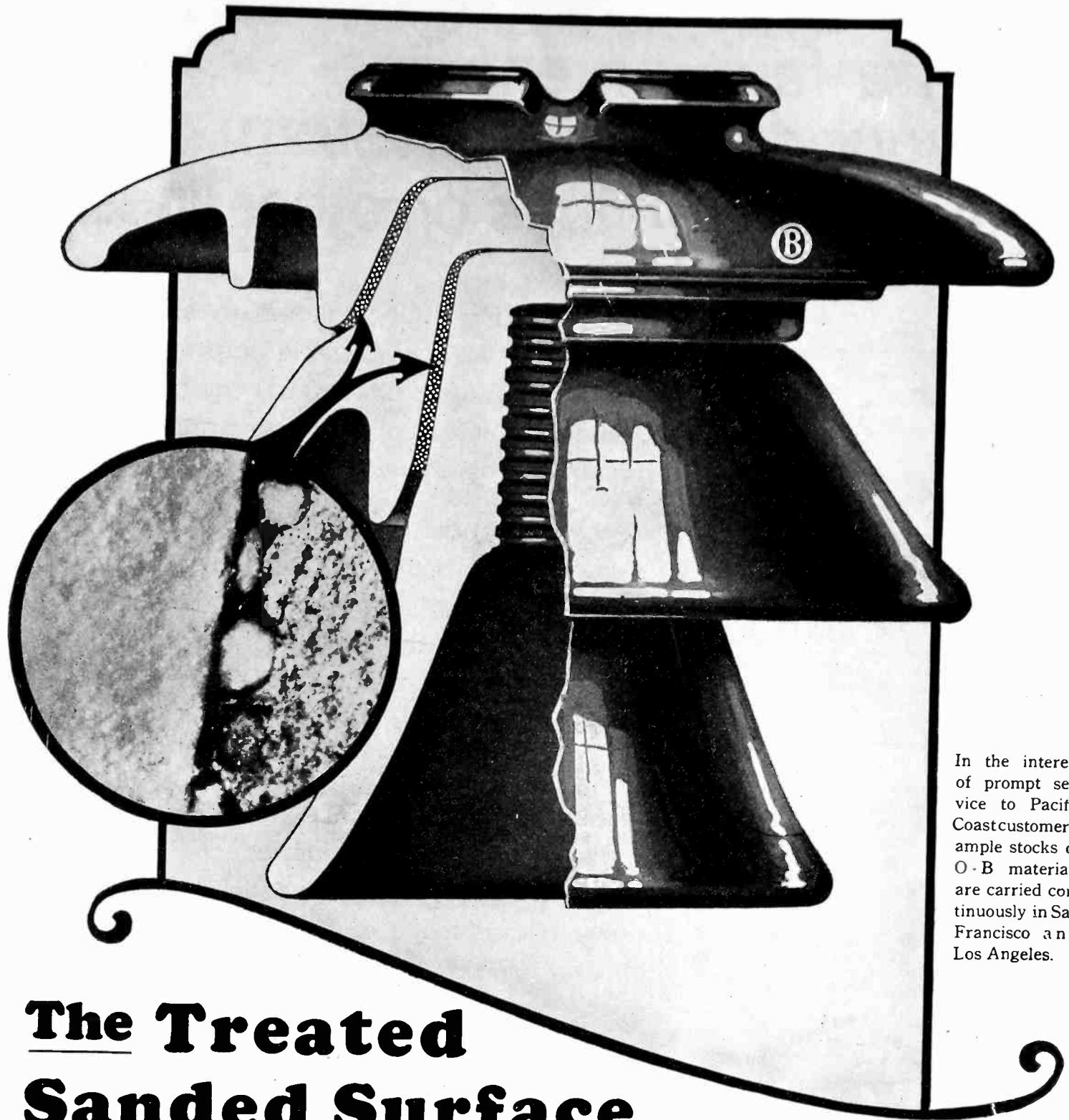

In the interest of prompt service to Pacific Coast customers, ample stocks of O-B materials are carried continuously in San Francisco and Los Angeles.

The Treated Sanded Surface

THE Treated Sanded Surface affords the resiliency—the give and take needed to provide for the internal thermal stresses that would otherwise develop in the insulator to crack the porcelain.

During ten years use, its merit has been proved on over 20 million O-B insulators. Not a single instance of failure or short life from causes it was designed to meet has been reported from the field.

San Francisco
Matson Building

Ohio Brass Company, Mansfield, Ohio
Dominion Insulator & Mfg. Co., Limited
Niagara Falls, Canada
209H

Los Angeles
Subway Terminal Bldg.

HISTORY TELLS WHICH LINE EXCELS

Ohio Brass Co.



PORCELAIN
INSULATORS
LINE MATERIALS
RAIL BONDS
CAR EQUIPMENT
MINING
MATERIALS
VALVES

Please mention the JOURNAL of the A. I. E. E. when writing to advertisers.

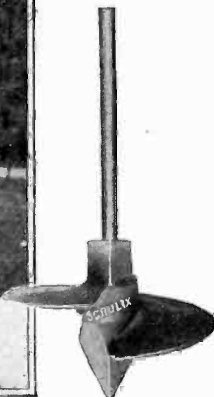
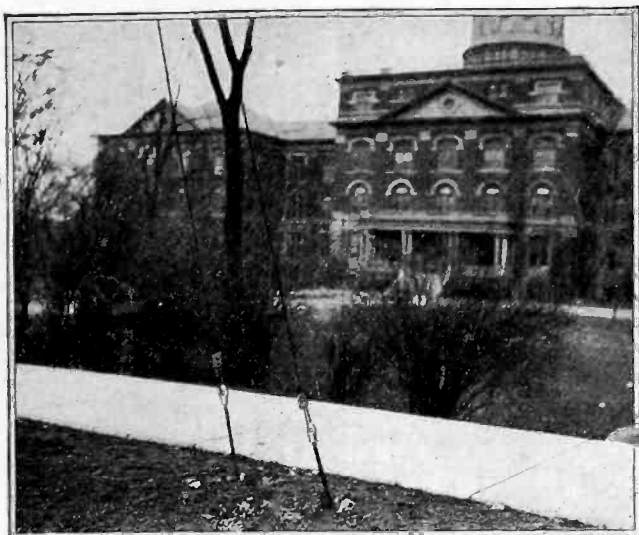

Time Proves

The difference between apparent and real holding power of Matthews Scrulix Anchors

More than one user has written us that his first impression of the probable effectiveness of Matthews Scrulix Anchors was that these comparatively small, easily handled anchors would undoubtedly fall short of the claims made for them. Their ease and low cost of installation, their neatness, and other advantages were definitely and decidedly favorable. But how could such anchors with only six to twelve inch helix possibly perform miracles of holding power in places where formerly it had been necessary to use costly and temporarily satisfactory devices? The secret lies in the design of the helix.

Tons of Resistance

The helix of the Scrulix Anchors is so designed that instead of depending merely upon the column of earth close to the shaft for holding power, it brings into play the tremendous weight of hundreds of cubic feet of earth around it. Under strain the lines of force radiate from the helix at a forty-five degree angle. For all ordinary purposes the use of comparatively small sizes is adequate.

In 5 to 15 Minutes

In less time than it takes to get a hole

well started, two men can turn a Matthews Scrulix Anchor deep down under tons of earth without loosening the ground above. They come completely assembled, all in one piece, ready to install by simply screwing them into place. No moving parts to become lost or be buried unadjusted. One of the simplest and quickest operations in erection work.

No Creepage

Under water, in hard pan, loam, shale—wherever unusual anchorage problems occur—Scrulix Anchors demonstrate their advantages. No take-up in guys due to creepage is required. They hold fast permanently. Made in seven different sizes, Matthews Scrulix Anchors present an easy solution for any anchorage problem.

Learn More About Them Now

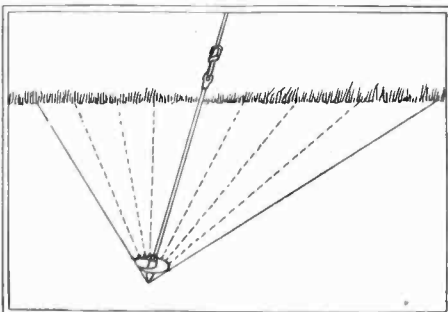

Write for Bulletin 800 covering in detail the interesting variety of applications of this anchorage principle. It will reveal to you complete mastery of anchorage problems as met by many companies during the last twenty years.

W. N. MATTHEWS CORPORATION
3706 Forest Park Blvd., St. Louis, U.S.A.

Ask about these / / / / Matthews Fuswitches / / / / Matthews Disconnecting Switches
Matthews Scrulix Anchors / / / / Matthews Adjustable Reel / / / / Matthews Guy Clamps
Matthews Slack Puller / / / / Matthews Cable Clamps / / / / Matthews Lamp Guards
Matthews Telefault / / / / Matthews Teleheight / / / / Distributors in all Principal Cities.

60



Please mention the JOURNAL of the A. I. E. E. when writing to advertisers.

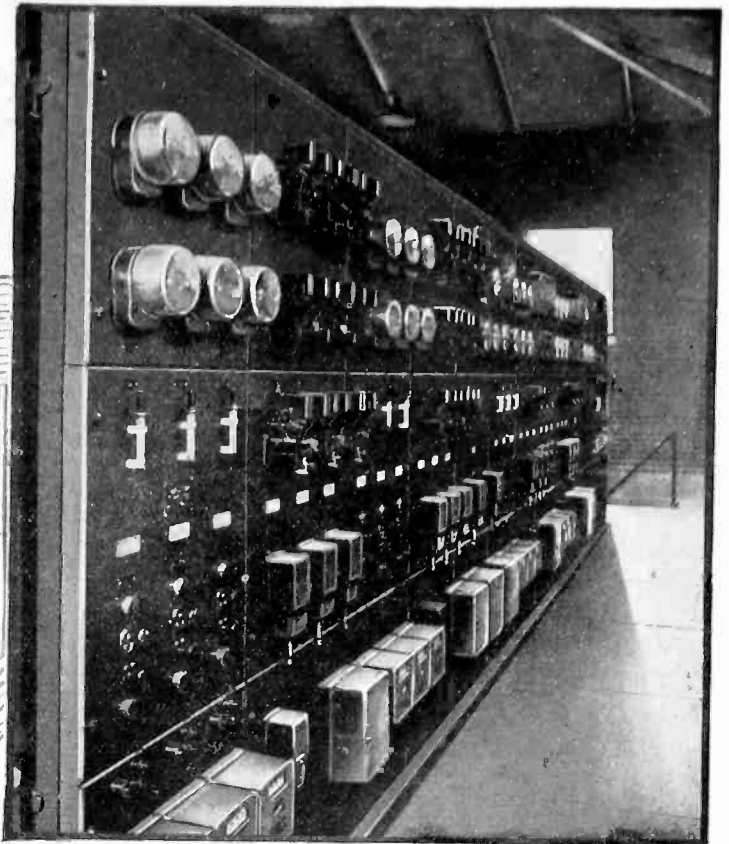

Harrison Substation. Public Service Company of Colorado

Working without pay!

Many industries, of which telephone communication is an outstanding example, are profiting by the economical operation of automatic switching equipment.

During the first year that the Oregon Electric Railway operated seven G-E Automatic Substations, operating and maintenance cost was reduced \$33,232.84. The Public Service Company of Colorado has found that automatic substations effect a net annual saving of approximately \$4500.00 per substation.

But the monetary saving, most pronounced in substations that operate day and night, is only one of the many advantages, for, with G-E Automatic Switching Equipment, service is most satisfactory; interruptions are very few and, when they do occur, they are short-lived; and equipment is completely and constantly protected.

Regardless of the amount of automatic equipment that you can use, whether for one panel or for a dozen stations, capitalize the many advantages offered by G-E Automatics—for they operate promptly, at least cost, with accuracy, safety, and reliability.



Where complete automatic equipment is not desirable, a partial automatic may prove very advantageous from both operating and economic standpoints. Your G-E Sales Office will tell you about the many benefits derived from both types.

GENERAL ELECTRIC

GENERAL ELECTRIC COMPANY, SCHENECTADY, N. Y., SALES OFFICES IN ALL PRINCIPAL CITIES

Please mention the JOURNAL of the A. I. E. E. when writing to advertisers.

50 Sangamo Meters fell 25 feet— None Damaged

THESE Type H meters were on an elevator that fell 25 feet in one free drop. Not only were they not damaged, but they tested within the normal accuracy and required no adjustment before going into regular service.

This extraordinary performance speaks not only for the sturdiness of Sangamo construction, but also for the protective-ness of Sangamo standard packages.

SANGAMO ELECTRIC COMPANY

Springfield, Illinois

New York Boston Chicago Los Angeles San Francisco Birmingham

SANGAMO METERS

FOR EVERY ELECTRICAL NEED

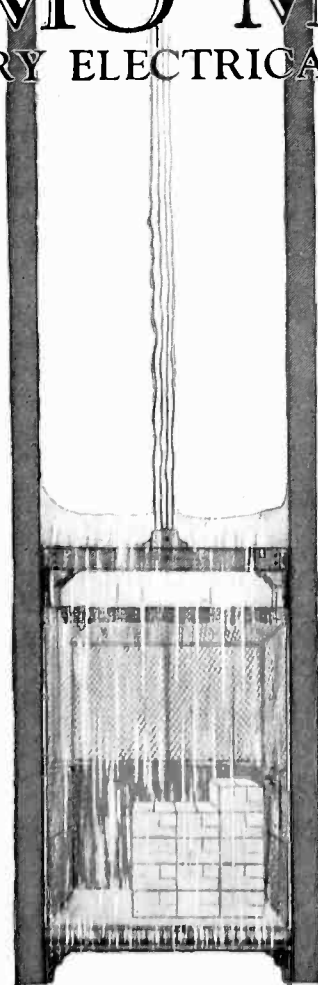

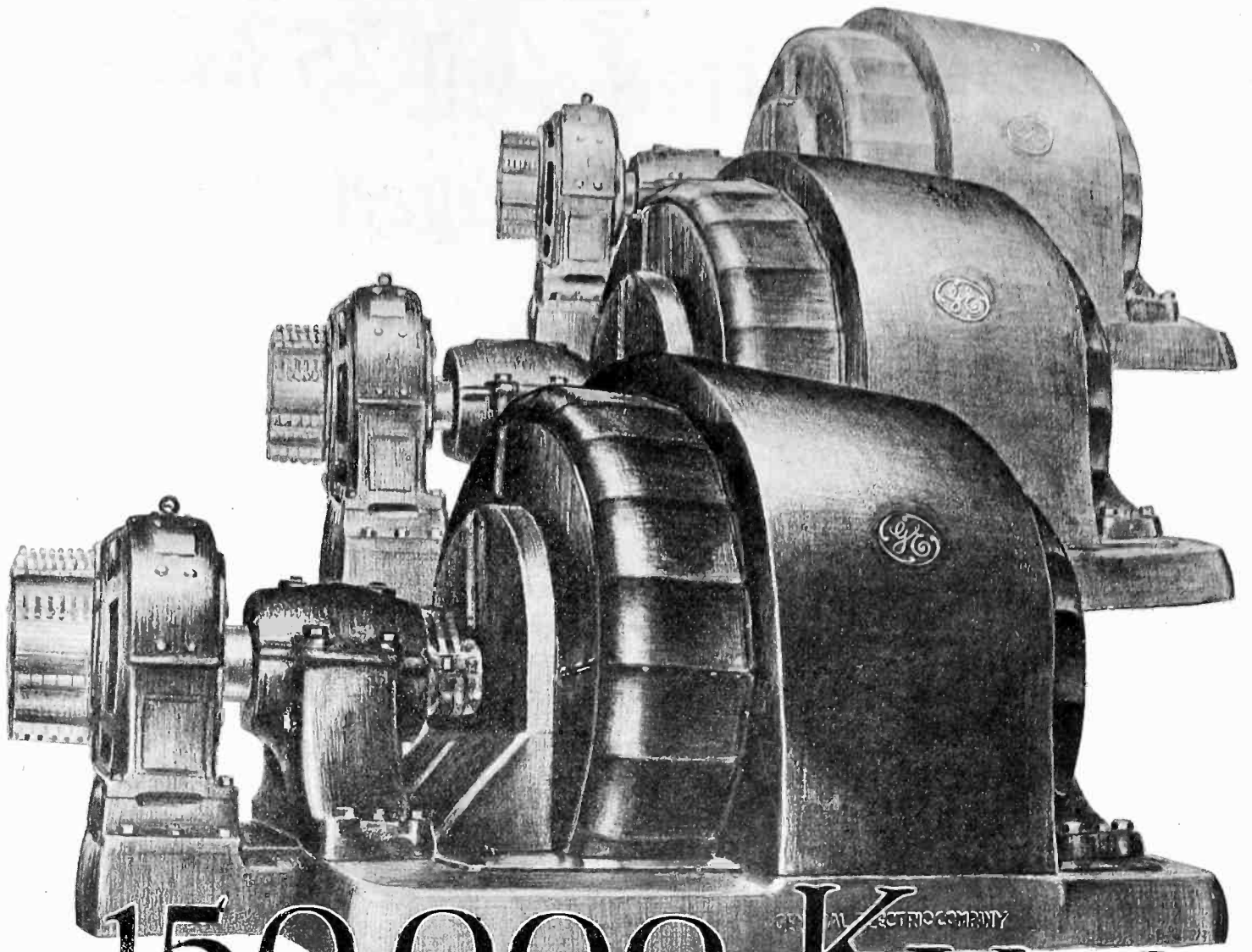

150,000 Kv-a. of Synchronous Condensers



With a standard line of Synchronous Condensers ranging from 500 to 50,000 kv-a., 60 cycles, for voltage control and power-factor improvement, General Electric can meet any demand for machines of this class. Where conditions make automatic operation desirable, installations can be equipped with G-E Automatic Control so as to require no attention other than occasional inspection.

Three 50,000-kv-a. G-E Synchronous Condensers now under construction for the Southern California Edison Company are of much greater capacity than any previously built.

These machines will be used for regulating the voltage of the 220,000-volt transmission lines of that company, which carry power from the Big Creek hydro-electric development into Los Angeles. Two are for installation in the new Lighthipe Substation and the third will be placed in the Eagle Rock Substation.

Other G-E Synchronous Condensers on the lines of the Southern California Edison Company include two 30,000-kv-a. machines, which are installed in the Laguna Bell and Eagle Rock Substations.

GENERAL ELECTRIC

GENERAL ELECTRIC COMPANY, SCHENECTADY, N. Y., SALES OFFICES IN PRINCIPAL CITIES

108-4

Please mention the JOURNAL of the A. I. E. E. when writing to advertisers.

I. P. Morris Hydraulic Turbines

The Wm. Cramp & Sons Ship & Engine Building Co.

Richmond and Norris Streets, Philadelphia

New York Office: 100 Broadway

Birmingham Office: American Trust Building

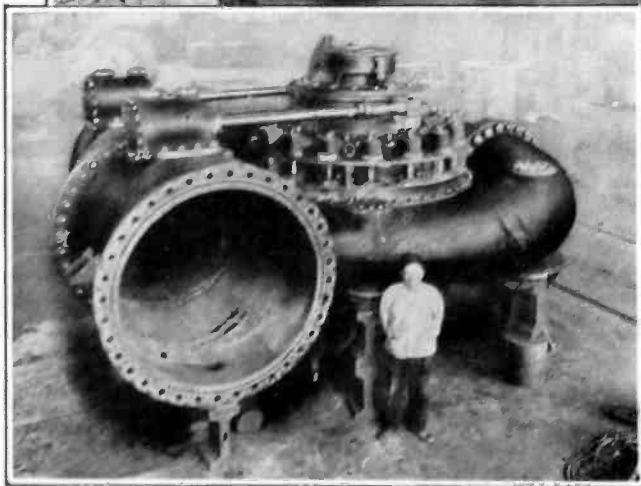
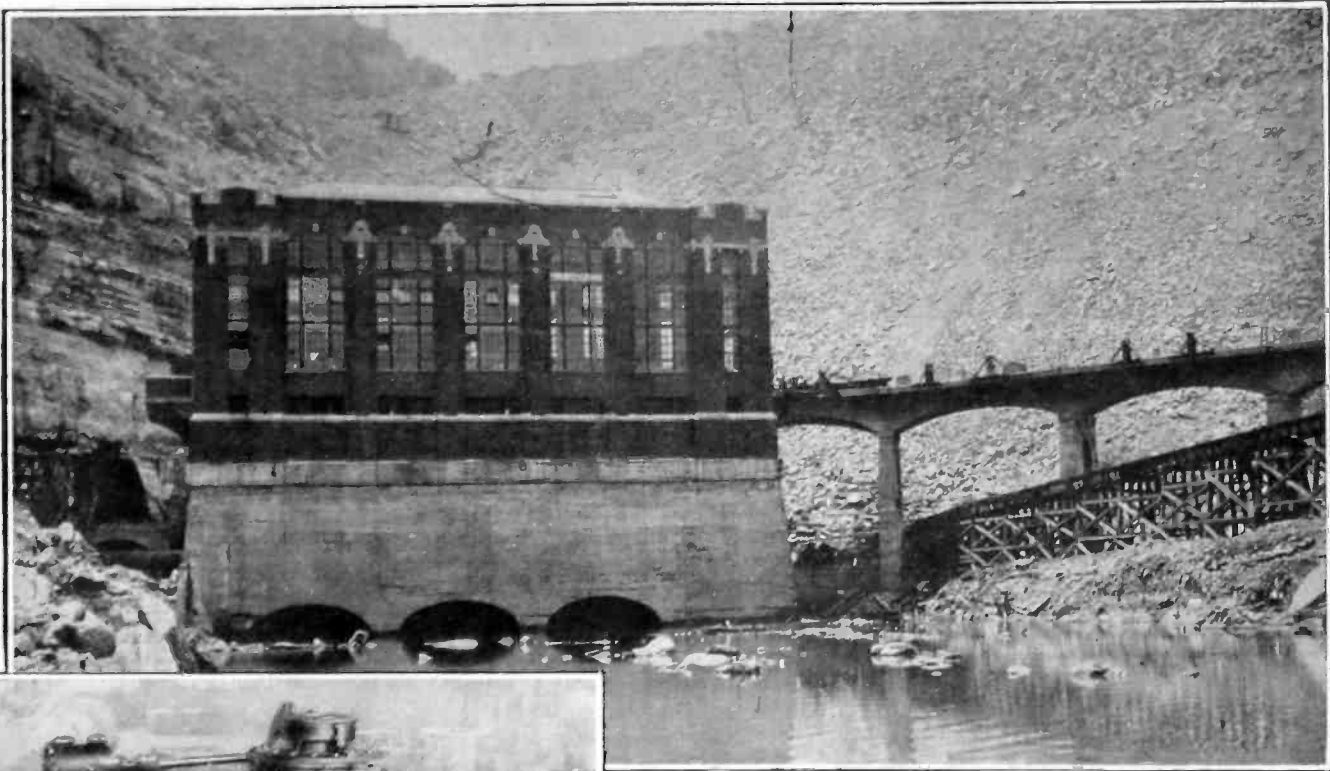

Shop Assembly of Turbine

DIX RIVER PLANT of the Kentucky Hydro-Electric Company

Installed capacity of 33,000 h. p. developed by

Three I. P. Morris Turbines

Head 235 Feet

Speed 300 R.P.M.

These units are noteworthy in that they are designed for operation under a wide range in heads varying from 165 to 235 feet.

With each unit a 102" x 66" type "B" Johnson Hydraulic Valve is installed to control the quantity of water utilized by each turbine.

This project which includes the World's Highest Rockfill Dam, was designed and constructed by L. F. Harza, Hydro-Electric & Hydraulic Engineer, Chicago.

Designers and builders of the Johnson Hydraulic Valve and the Moody Spiral Pump

ASSOCIATED COMPANIES

THE PELTON WATER WHEEL CO., San Francisco and New York
DOMINION ENGINEERING WORKS, LTD., Montreal, Canadian Licensees

Please mention the JOURNAL of the A. I. E. E. when writing to advertisers.

check up
Oil in
transformers ✓
circuit
breakers ✓
oil switches ✓

with the
**American Transformer TS-6
Portable Oil testing outfit**

"Oil is often found in bad condition in above named equipment by the electrical inspectors of The Hartford Steam Boiler Inspection and Insurance Company, whose business it is to insure electrical machinery."

Guard against this on your property by using the American Transformer TS-6 testing set.



Bulletin 1025 fully describes this unit and many other types of testing apparatus. Copy sent on request.

This transformer, complete with potentiometer regulator, primary main line switch, voltmeter, circuit breaker, pilot lamp and oil testing cup, is mounted in a heavy oak case with angle iron protecting pieces on the corners. It can be loaded on a truck or flivver and readily transported to wherever the insulating oil is to be tested.

AMERICAN TRANSFORMER COMPANY, 176 Emmet St., NEWARK, N. J.

Moloney Transformers

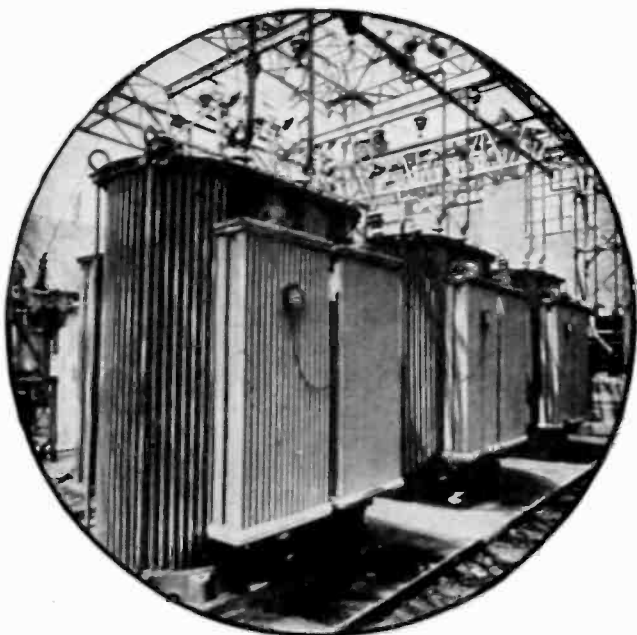

*Every Installation Fully
Demonstrates Moloney Quality*

High quality performance has been identified with the name Moloney over a period of thirty years. During this time we have applied our complete efforts, time and experience to giving industry better transformers.

Complete information furnished upon request

**Moloney Electric Company
St. Louis, Mo.**

Are You overlooking this Opportunity?

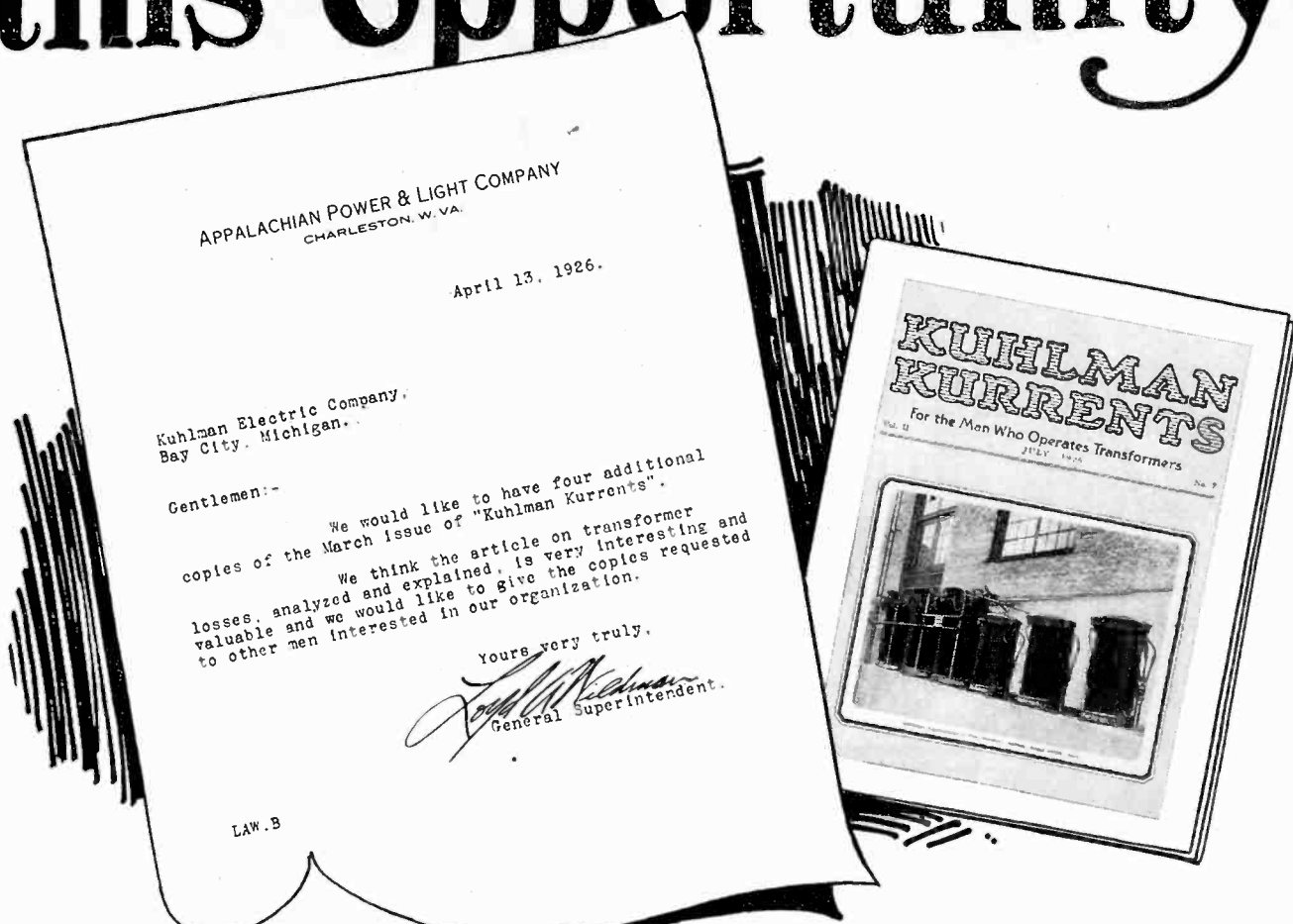

More than 6200 utilities and industrial concerns and individuals in their organizations are now taking advantage of the opportunity offered them by **KUHLMAN KURRENTS**—the opportunity to secure a better knowledge of transformers.

KUHLMAN KURRENTS report new developments in transformer design, construction, and application. They contain comprehensive discussions of the principles of transformer connections; they give interesting information regarding transformer

operation. The letter reproduced here is typical of many requests for back numbers and duplicate copies—evidence of the value of **KUHLMAN KURRENTS**.

If a better knowledge of transformers will be helpful to you or others in your organization, take advantage of this opportunity by writing on your Company letterhead to our nearest office. There is no obligation.

KUHLMAN ELECTRIC CO., Bay City, Michigan

Atlanta.....411 Glenn Bldg.	Dallas.....Unit 2, Santa Fe Bldg.	Minneapolis...1004 Marquette Ave.	Salt Lake City..134 West 2d South St.
Boston.....69-71 High St.	Denver.....1843 Wazee St.	New York.....300 Madison Ave.	San Francisco.....Call Bldg.
Buffalo.....280 Carolina St.	Detroit.....3-260 Gen. Motors Bldg.	Omaha.....727 W. O. W. Bldg.	Seattle.....314 Seneca St.
Chicago.....844 Rush St.	Indianapolis.202 Indiana Term'l Whse.	Philadelphia...1700 Walnut St.	Toledo.....424 Spitzer Bldg.
Cincinnati...1308 Union Trust Bldg.	Los Angeles.316 American Bank Bldg.	Pittsburgh.....839 Oliver Bldg.	Tulsa.....318 So. Boulder St.
Cleveland.....500 East 102d St.	Milwaukee.....1031 Clybourn St.	Saint Paul, Minn.....1479 Blair St.	York, Pa.....335 W. Market St.

KUHLMAN TRANSFORMERS

POWER-DISTRIBUTION - STREET LIGHTING

Please mention the JOURNAL of the A. I. E. E. when writing to advertisers.

STEEL TOWERS

and component parts

FOR ELECTRIC TRANSMISSION

AMERICAN BRIDGE COMPANY

71 Broadway, New York City

TOWER DEPARTMENT

Frick Building, Pittsburgh, Pa.

Offices in Principal Cities

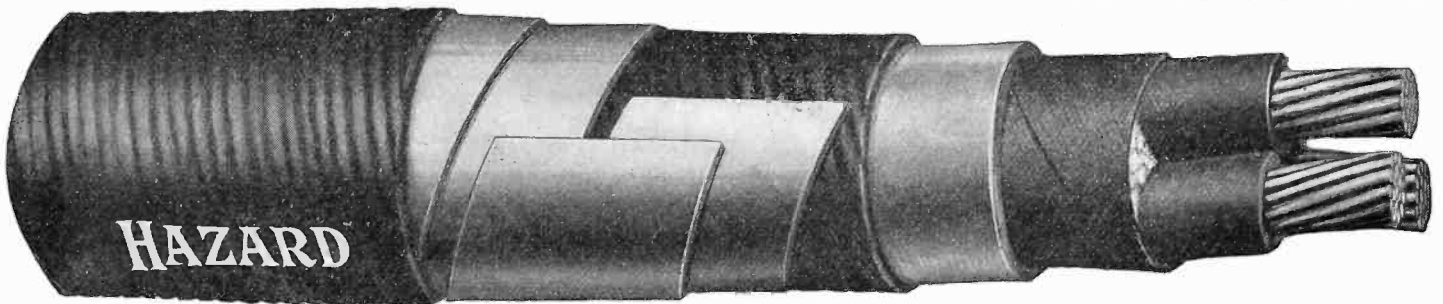

Three-phase Hazard Parkway Power Cable Conductors 0000 B & S 2300 volt service

FOR POWER TRANSMISSION

Consider the advantage of having your power cables safely underground—away from storm hazards and winter ice and snow—without the expense of installing conduits.

Hazard Parkway Cable with lead sheath, double layer of flat steel armor and asphalted jute covering, offers this advantage. By using this trouble-proof cable you can eliminate not only the expense and unsightliness of poles, cross-arms, insulators, etc., but the cost of laying and maintaining conduits.

Installation is simple. Dig a narrow trench, 18 in. to 24 in. deep, lay in the cable and cover up. The lead sheath, double steel tape armor and asphalted jute give permanent protection. No separate conduits are necessary.

This type of cable is especially advantageous for localized power distribution up to 25,000 volts.

ORNAMENTAL STREET LIGHTING

Parkway Cable is now used more than any other type of cable for street lighting, because of its low cost, easy installation and permanent high efficiency.

PUBLIC PARKS and COUNTRY ESTATES can be best lighted through the use of Parkway Cable, as it may be laid practically without disturbance to lawns, walks or roadways.

Let us send full particulars.

Hazard Manufacturing Company, Wilkes-Barre, Pa.

New York Philadelphia Pittsburgh Chicago Denver Birmingham
Maydwell & Hartzell, Agents, 158 11th St., San Francisco

HAZARD Parkway Cable

Please mention the JOURNAL of the A. I. E. E. when writing to advertisers.

SELENIUM

In The
Tirex 60% Rubber Armor
increases the
Resistance to Abrasion
50%



TIREX Cables have always been protected by a sheath of the most wear-resisting rubber compound known to the art, but now with their new Selenium Rubber jacket they have the toughest and most wear-resisting protective armor ever made. Wear tests prove this.

The process of vulcanizing rubber with Selenium was developed in our laboratories and is covered by U. S. patents Nos. 1,249,272 and 1,364,055. This advance in the art of rubber compounding increases the toughness or wear-resisting qualities of a rubber compound fifty per cent.

The use of Selenium in rubber compounds to increase their wearing qualities is as important a development as were rubber sheathed cables, first put on the market by us a few years ago.

Write for further information.

SIMPLEX WIRE & CABLE CO

MANUFACTURERS
201 DEVONSHIRE ST., BOSTON
CHICAGO SAN FRANCISCO NEW YORK
CLEVELAND JACKSONVILLE

BURNDY

OUTDOOR LUGS



Another Burndy Contribution

Strain Arm absorbs all cable pull releasing soldered joint for contact duty only—gap between hard drawn copper U-bolt and cable socket distributes forces of flexure and prevents crystallization of the cable—generous over-all dimensions prevents cable from falling out should solder melt on overload.

BURNDY
ENGINEERING CO. INC
10 EAST 43RD STREET · NEW YORK

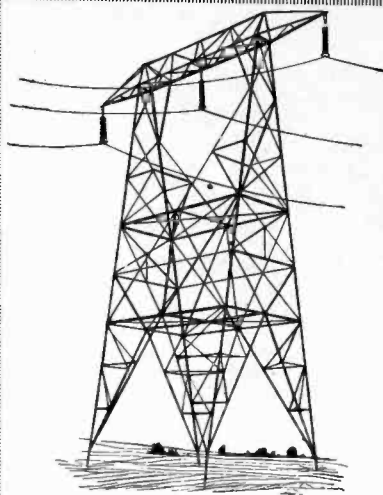

Transmission Line Structures

Built of High Elastic Limit Steel
Refined — Rolled — Fabricated —
Galvanized in Our Own Plants

PACIFIC COAST STEEL COMPANY

MANUFACTURERS OF
OPEN HEARTH STEEL
STRUCTURAL SHAPES MERCHANT AND REINFORCING BARS
TRANSMISSION TOWERS AND STRUCTURES

Gen'l Office: Rialto Bldg., San Francisco Plants: San Francisco, Portland, Seattle

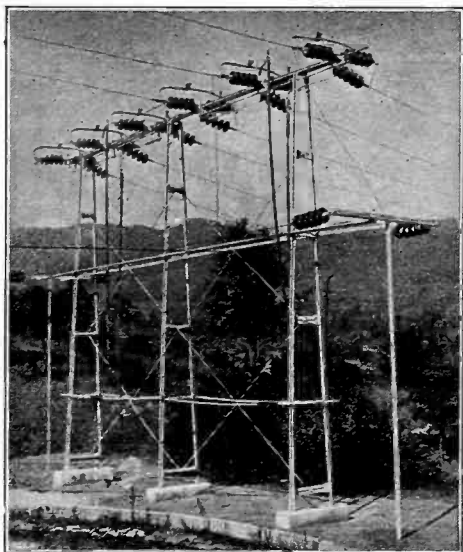

**Simpler—
Stronger—
Better—**

Installation K-P-F
60 KV. Switches,
San Joaquin Lt. &
Pwr. Corp., Calif.

K-P-F POLE TOP SWITCHES consist of fewer parts, are more rugged and require less labor and material for installation than any other.

Each pole becomes a self-contained unit. Switches are shipped ready to bolt on to cross-arm in place of line insulator.

One crossarm supports it. Contacts are far removed from insulators and a unique device prevents sticking or freezing.

Send for bulletin K105 containing full details.

K-P-F ELECTRIC CO.

855-859 Howard St.

San Francisco

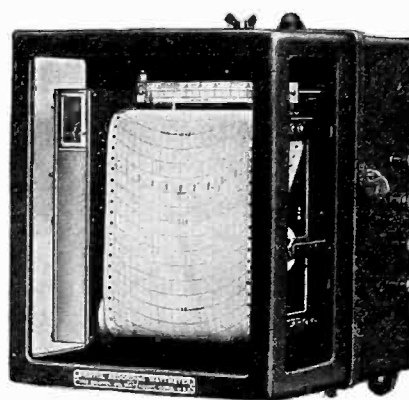

**Check Up
The Loads
At
Every Point**

Good regulation and high efficiency can only be maintained when the character of the load and the maximum demand by every feeder circuit are definitely known. To meet changing conditions this information should be continuously available to both the operators and the executives of the plant.

BRISTOL'S Recording Wattmeters

in both the switchboard and the portable models afford an absolutely dependable means of obtaining a complete survey of your distribution system. Available for A. C. or D. C. and for single and polyphase current.

The Bristol Company Waterbury, Connecticut

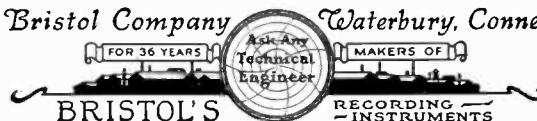

DUNCAN Watt-hour Meters

**Accurate
and
Dependable**

Write for bulletins



Model M2.

DUNCAN ELECTRIC MFG. CO.
Lafayette, Ind.

THE ELEMENTS OF OUR BUSINESS

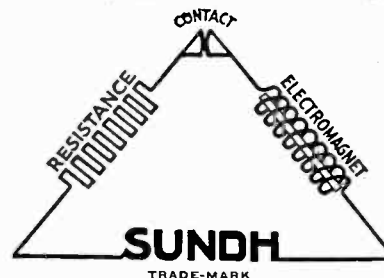

- | | |
|--------------------|---------------------|
| Automatic Starters | Pressure Regulators |
| Circuit Breakers | Remote Switches |
| Float Switches | Speed Regulators |
| Hand Starters | Transfer Switches |
| Magnet Switches | Valve Control |

WRITE FOR CATALOG

Sundh Electric Company, Newark, N. J.
Branch Offices or Sales Representatives in Principal Cities

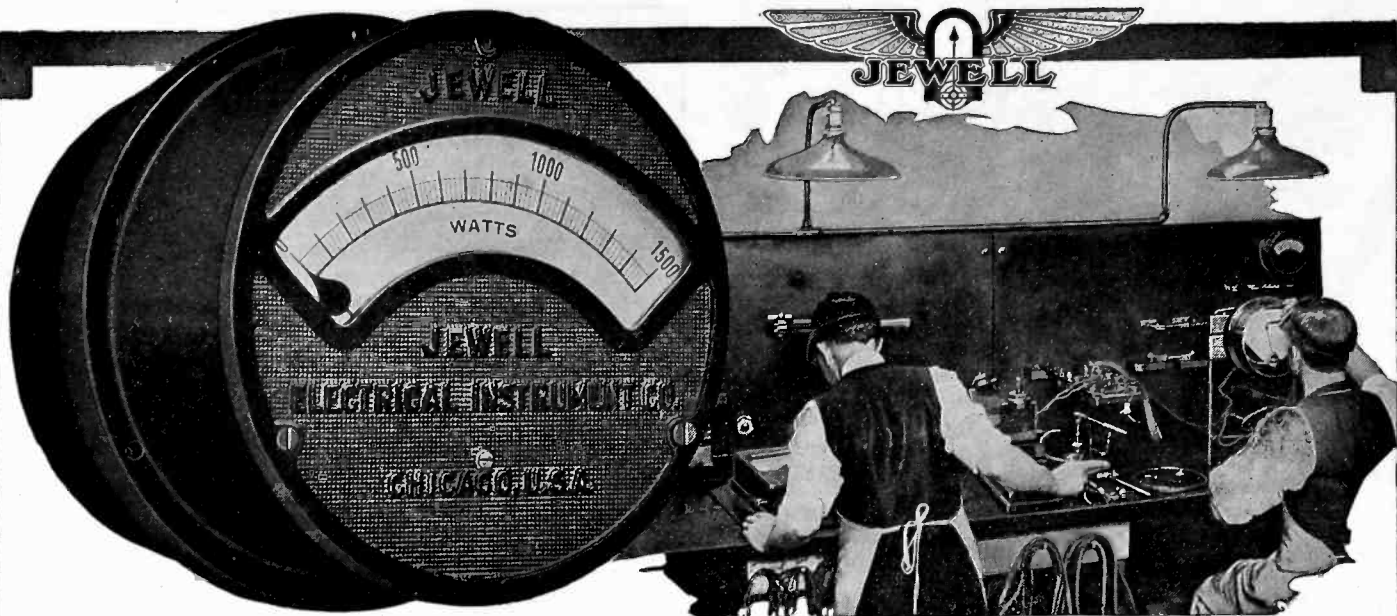

The Jewell Polyphase Wattmeter is of the dynamometer type and employs two full size movements on a single shaft. The separate movements are accurately calibrated and the movements are balanced as a whole so the indications are accurate under all conditions.

Accuracy of indication by calibration

The calibration of switchboard instruments as well as portable instruments is best done by comparing with an accurate standard, stepping the points and drawing the scale on fine bristol board.

The accuracy of Jewell instruments is as much due to the care taken in stepping and calibrating as to the proper use of materials and design. With every detail we go to extremes to make accuracy possible always. For example, the two experts shown in illustration are both giving attention to the same operation.

JEWELL ELECTRICAL INSTRUMENT CO. 1650 Walnut Street, CHICAGO, ILL.

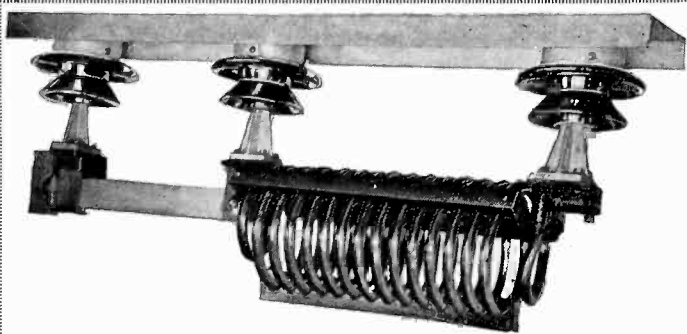

The New
THONER & MARTENS

*underslung outdoor
disconnecting switch*

THE standard T & M underslung outdoor disconnecting switch, 800 amp., is now equipped with choke coil.

Working pressure is 22,000 volts, dry flush is over 88,000 volts and wet flush over 55,000 volts.

Other T & M features are the Bolt type lock and new sleet cover.

Write for further details

THONER & MARTENS
463 Commercial St., Boston, Mass., U. S. A.

OUTDOOR TYPE EQUIPMENT

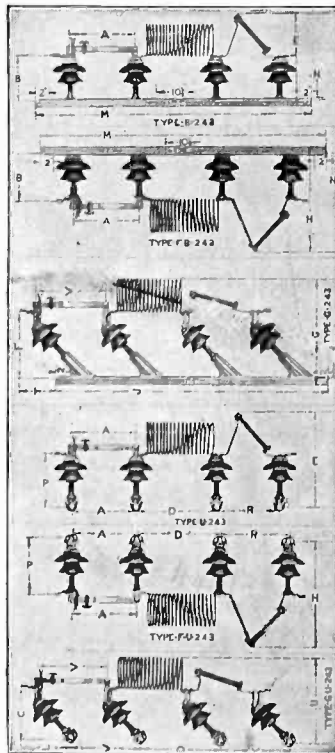

Every Insulator is a Unit Type and is Interchangeable

You Should have Our Bulletins on File

Would You Like a Picture of Our 750 K. V. Laboratory?

Why Not Get On Our Mailing List?

Delta-Star Electric Co

2400 Block, Fulton St. Chicago, Illinois

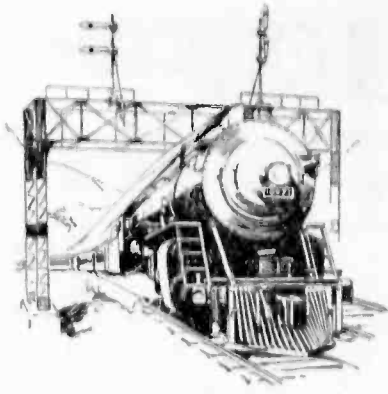

Balkite Trickle Charging in Railway Signal Service

In automatic railway signaling, where the entire railroad service is dependent on the reliability of signal power, Balkite Trickle Charging is now used in the signal systems of over 85 leading North American as well as European and Oriental Railroads.

The same advantages of reliability, simplicity and economy make Balkite Trickle Charging useful in other industries—to furnish emergency lighting systems for hospitals, to furnish emergency power in case of temporary failure of electric current, to operate burglar and fire alarm systems.

A complete booklet describing the system and its operation is available on request. Write for it.

FANSTEEL PRODUCTS COMPANY, Inc.
North Chicago, Illinois

FANSTEEL Balkite Battery Chargers

FANSTEEL PRODUCTS COMPANY, Inc., North Chicago, Illinois
Gentlemen: Please send me a copy of Balkite Trickle Charging

Name _____

Company _____

Address _____

Position _____

When You Buy Condensers

When you buy condensers—what do you demand?

Accuracy! Low Power Factor!
Permanent Capacity!

Dubilier condensers meet these requirements. They are used in practically all transmitting stations and U. S. Government installations.

Dubilier coupling condensers for power line telephony are supreme.

Dubilier consulting engineers are always at your service—they can help you too.

4377 Bronx Blvd., New York, N. Y.

Dubilier

CONDENSER AND RADIO CORPORATION

Faradon

ELECTROSTATIC CONDENSERS FOR ALL PURPOSES



There are over 200 standard "FARADON" condensers on which immediate deliveries can be made. Complete new catalogue will be sent on request. Those interested in Carrier Current Coupling Condensers should ask for copy of Bulletin 101.

The engineering staff of the Wireless Specialty Apparatus Company will co-operate fully with those having special equipment under consideration. Estimating data, quotations or any other information furnished promptly on request.

Wireless Specialty Apparatus Co.,
Jamaica Plain, Boston, Mass.

Established 1907

Charge it!

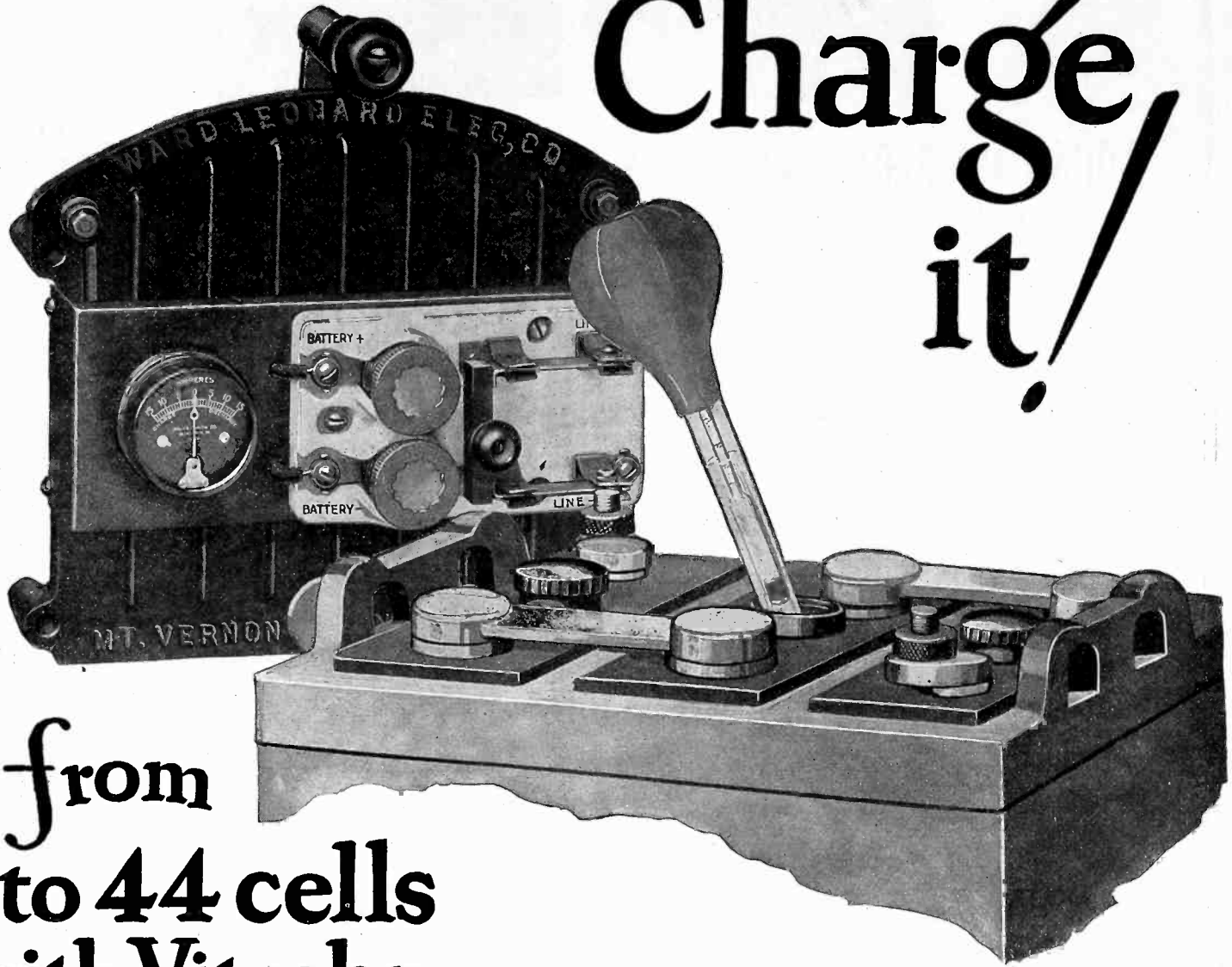

from 1 to 44 cells with Vitrohm Type 73000 Charging Rheostat

HERE is a battery charging rheostat that eliminates all fussing with controls and work with pencil and pad every time you add a battery to the charging line.

There's no worry about the charging rate—no worry about the number or type of cells in the connection—this new Vitrohm Type 73,000 Charging Rheostat takes from 1 cell to 44 and charges at the exact rate you wish.

Money is being made in the battery charging business, but you can't fuss away half your time in getting run down batteries into the line and then spend the balance of the time worrying about the rate at which the batteries are being charged.

This rheostat makes battery charging on 100-120 volt direct current lines simple as A B C. Put any number of cells, from 1 to 44 in series with the Universal Charging Rheostat, place the control handle to the extreme left, and turn on the current. The charging rate can then be regulated to any current you wish. Putting a low battery in the line, or taking a charged cell out, means only a change in the position of the current control handle. All guesswork and worry is gone.

The Charging Rate Range

With Cat. No. 73403—15 Amperes Max. 1.5 Amperes Min.

With Cat. No. 73402—10 Amperes Max. 1 Amperes Min.

Many other sizes, with or without switches—fuses, circuit breakers, etc.

SEE BULLETIN NO. 69—SENT ON REQUEST

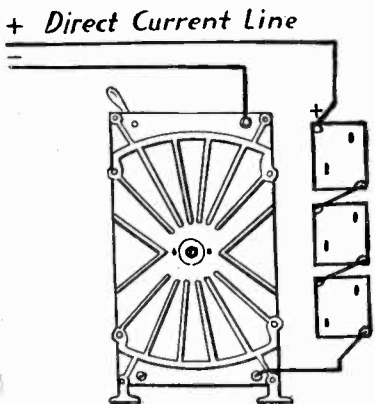

Ward Leonard Electric Company

37-41 South Street



Mount Vernon, N. Y.

6635-2

Please mention the JOURNAL of the A. I. E. E. when writing to advertisers.

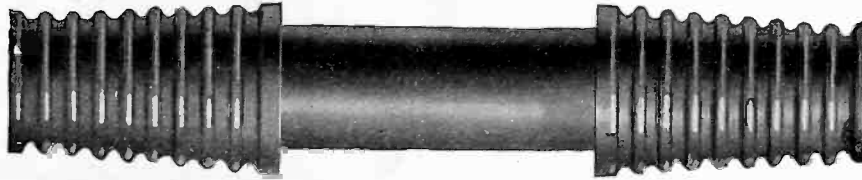

ROUND AND RECTANGULAR WALL AND FLOOR ENTRANCE BUSHINGS

A "Burkelect" Moulded Composition for high voltage use. Made in all sizes.
Write for Descriptive Bulletins.

BURKE ELECTRIC COMPANY
HIGH TENSION EQUIPMENT DIVISION
ERIE, PA.



**Lapp Insulators
do not fail!**

LAPP INSULATOR CO., Inc.
LEROY, N. Y.

Sales Representatives

BIRMINGHAM, ALA., Industrial Supply Co., 21 Brown-Marx Bldg.
BOSTON, Van Rosen Co., 141 Milk St.
CHARLOTTE, N. C., J. W. Fraser & Co., Commercial Bank Bldg.
CHICAGO, Transelectric Co., Inc., 360 No. Michigan Ave.
COLUMBUS, O., Engineering Merchandising Syndicate, 600 Joyce Realty Bldg.
DALLAS, TEX., J. K. Webb, 1521 Commerce St.
DENVER, The O. H. Davidson Equip. Co., 1633 Tremont St.
INDIANAPOLIS, W. D. Hamer Co., 518 Trac. Terminal Bldg.
KANSAS CITY, MO., Power Machinery Co., 301 Dwight Bldg.
LOS ANGELES, S. Herbert Lanyon, 210 Transportation Bldg.
MINNEAPOLIS, J. E. Sumpter Co., 919 Security Bldg.
NEW YORK CITY, Shield Electric Co., 149 Broadway.
PHILADELPHIA, Harris & Butler, Real Estate Trust Bldg.
PITTSBURGH, Henry N. Muller Co., 2204 First National Bank Bldg.
SAN ANTONIO, TEX., L. G. Bassett, 723 Navarro St.
SAN FRANCISCO, S. Herbert Lanyon, 509 New Call Bldg.
SYDNEY, AUSTRALIA, Chas. M. Terry.
WELLINGTON, NEW ZEALAND, Jas. J. Niven & Co.

MANUFACTURERS OF INSULATORS
For 2,200 to 220,000 Volts
HIGH VOLTAGE PORCELAIN

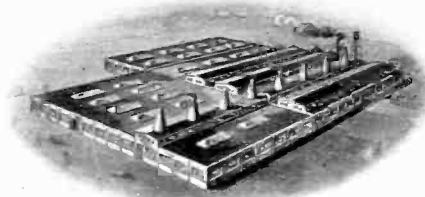

*Catalog
on request*

CANADIAN PORCELAIN COMPANY
Limited
HAMILTON — ONTARIO — CANADA
Cable Address "PORCELAIN," Hamilton, Ontario

Specify
**Thomas
Quality
Insulators**
for
*Permanently
Dependable*
SERVICE

THE R. THOMAS & SONS CO.
East Liverpool, Ohio
New York Boston Chicago London

HEMINGRAY

GLASS INSULATORS

The transparency of Hemingray Glass Insulators makes line inspection very simple. The lineman can tell at a glance whether the insulator is intact or not. Hemingray insulators are mechanically and dielectrically dependable, non-porous and uniform in structure. They defy moisture and age.

Send for Bulletin No. 1.

HEMINGRAY GLASS COMPANY
Muncie, Indiana

Popular Research NARRATIVES

are proving useful 'round the world in many offices, schools and laboratories. They are interesting home reading, too. Two little books, just pocket size. In each book 50 short stories of research, invention, discovery—footprints of progress. Send a set to your layman friend. The Narratives are in language he can read. Introductions by Dr. E. E. Slosson and Dr. M. I. Pupin. Only \$1.50 for the two volumes, postpaid.

ENGINEERING FOUNDATION
29 West 39th Street New York

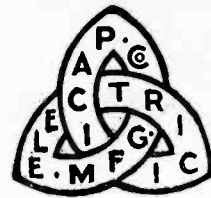
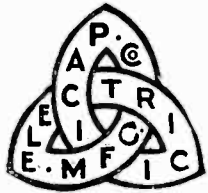

THE PACIFIC ELECTRIC MANUFACTURING COMPANY

*“The Oldest Exclusive Manufacturers of
High Voltage Switches and Circuit Breakers”*

Have opened an office at 419 Chemical Building, St. Louis, Missouri, purchased three acres of land on the Terminal Railroad Association Belt Line at St. Louis Avenue, and will proceed at once with the construction of a factory building to meet the growing demand for the service, design and economy which have made Pacific Switchgear pre-eminent throughout the Pacific Coast.

PACIFIC ELECTRIC MANUFACTURING COMPANY

Manufacturers of Oil Circuit Breakers and High Voltage Switchgear

5815 Third Street, SAN FRANCISCO

30 Church St., New York
1001 McCormick Bldg., Chicago
Symes Bldg., Denver, Colo.
135 High St., Boston, Mass.
Hoge Bldg., Seattle, Wash.

Pioneer Bldg., St. Paul, Minn.
H. W. Hellman Bldg., Los Angeles
Interurban Bldg., Dallas, Tex.
930 Wyandotte St., Kansas City, Mo.
American Trust & Savings Bldg.,
Birmingham, Ala.

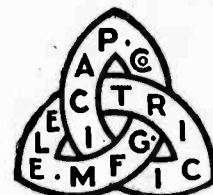
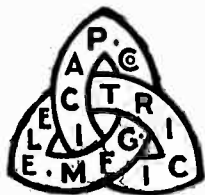

Please mention the JOURNAL of the A. I. E. E. when writing to advertisers.



When Superintendents Meet "Speaking of Lightning Arresters"

IT was during one of those confidential chats that the talk turned to lightning arresters. "Yes", the central station superintendent was saying, "I am strong for the LV Autovalve Arrester because of its maintained leadership in new and constructive ideas about distribution circuit protection."

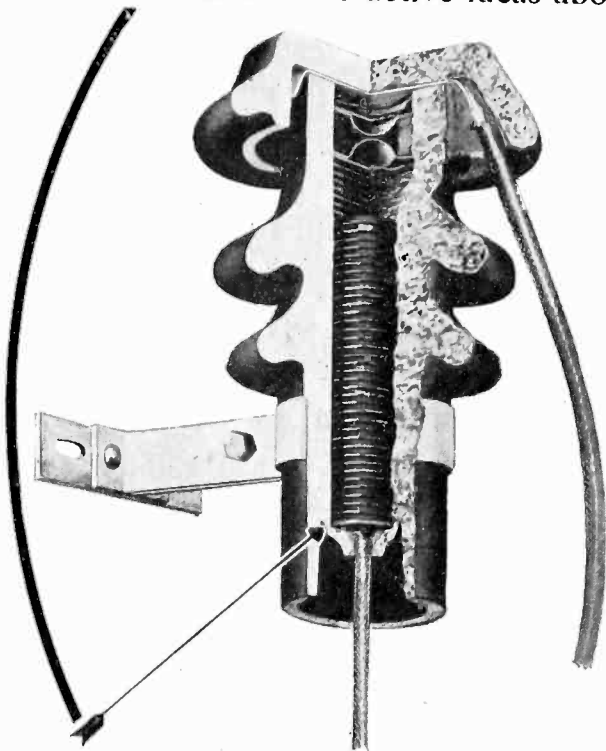

The decreased portion of porcelain which fractures when the 'drop out' functions because of a sustained over-voltage, or a direct stroke.

"It was the first to give us the valve principle of operation for distribution circuit protection.

"The separate mounting bracket was a desirable innovation.

"We can now install arresters with one principle of operation on all our distribution circuits, up to 50 kw.

"Prior to the LV, the high cost of high-quality, higher-voltage arresters prohibited the adequate protection of all our distribution systems.

"The small size and light weight of the higher-voltage LV arresters minimize our installation costs.

"The 'drop out' feature of the latest LV is a definite tell-tale of the arrester condition that an inspector can see readily from the ground.

"Should a sustained over-voltage, or direct stroke, cause the failure of one of these arresters, the 'drop out' functions and our line does not become permanently grounded."

Talks of this character are common wherever central station superintendents meet.

Leaflet 20013 and Circular 1737 describe this trail-blazer in the art of distribution circuit protection.

Westinghouse Electric & Manufacturing Company
East Pittsburgh Pennsylvania

Sales Offices in All Principal Cities of
the United States and Foreign Countries

Westinghouse

X90186

Please mention the JOURNAL of the A. I. E. E. when writing to advertisers.

SHARPLES Simplicity

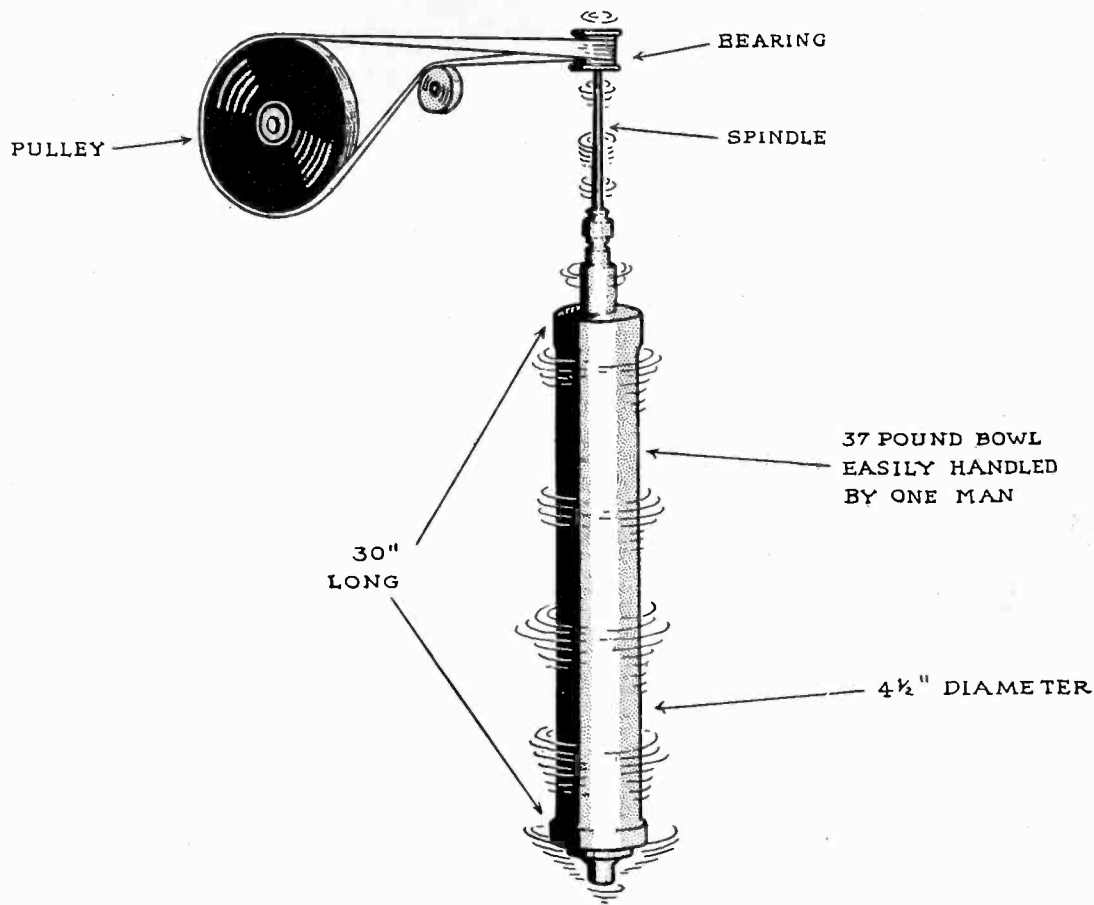

Only 3 rotating units —
(Motor, idler, rotor assembly)

Only 3 parts to clean —
(Bowl shell, bowl bottom, 3-wing)

**Highest centrifugal force
commercially available**

Without any obligations on your part, our engineers will forward valuable facts on purification and dehydration of Transformer Oil, reconditioning of Switch Oil, and purification of lubricating oils with the Sharples Super Centrifuge. Learn how "Sharples Simplicity" means great savings to you in time, labor and money.

THE SHARPLES SPECIALTY COMPANY, 2324 WESTMORELAND STREET, PHILADELPHIA

SHARPLES

A GREAT FORCE

Please mention the JOURNAL of the A. I. E. E. when writing to advertisers.

Trade "ESCO" Mark

ELECTRIC SPECIALTY CO.

Engineers and Manufacturers

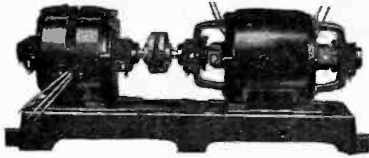

DESIGN —
DEVELOP —
PRODUCE —

Small Motors, Generators, Dynamotors,
Motor Generators, Rotary Converters, Etc.
FOR SPECIAL PURPOSES—Send Us Your Problems
222 South Street, STAMFORD, CONN., U.S.A.

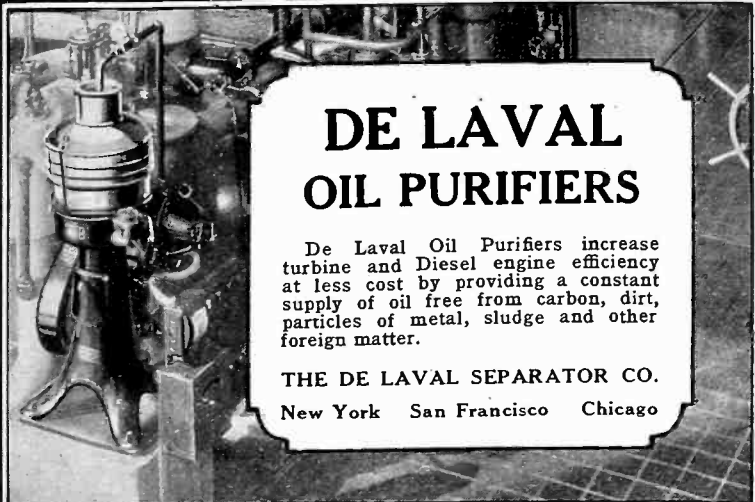

DE LAVAL OIL PURIFIERS

De Laval Oil Purifiers increase turbine and Diesel engine efficiency at less cost by providing a constant supply of oil free from carbon, dirt, particles of metal, sludge and other foreign matter.

THE DE LAVAL SEPARATOR CO.
New York San Francisco Chicago



1200 ampere, two pole independent arm with "interlocked trip."

A New Bulletin

Every man who is interested in the latest developments in the circuit breaker line should send for new Bulletin AE-530 just off the press.

The information in this Bulletin is complete and convenient. It is in get-at-able shape. Just what the busy man needs.

Your copy is waiting for you. Send for it.

"Over thirty years' experience is back of ROLLER-SMITH"

ROLLER-SMITH COMPANY

Electrical Measuring and Protective Apparatus

Main Office: 12 Park Place, NEW YORK  Works: Bethlehem, Penna.

Offices in Principal Cities in United States and Canada.
Representatives in Australia, Cuba and Japan.

That Year in and Year out Service

ROWAN

Impedance Starter

for

Squirrel Cage Induction Motors

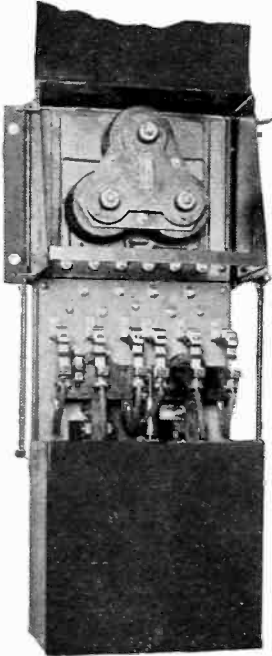

ROWAN CONTROL

THE ROWAN CONTROLLER CO., BALTIMORE, MD.

Pittsburgh Transformer Company

Largest Manufacturers of Transformers exclusively in the United States

Pittsburgh, Pennsylvania

Please mention the JOURNAL of the A. I. E. E. when writing to advertisers.

Chandeysson

Generators
25 to 25,000 Amperes

Direct Connected to



Motors

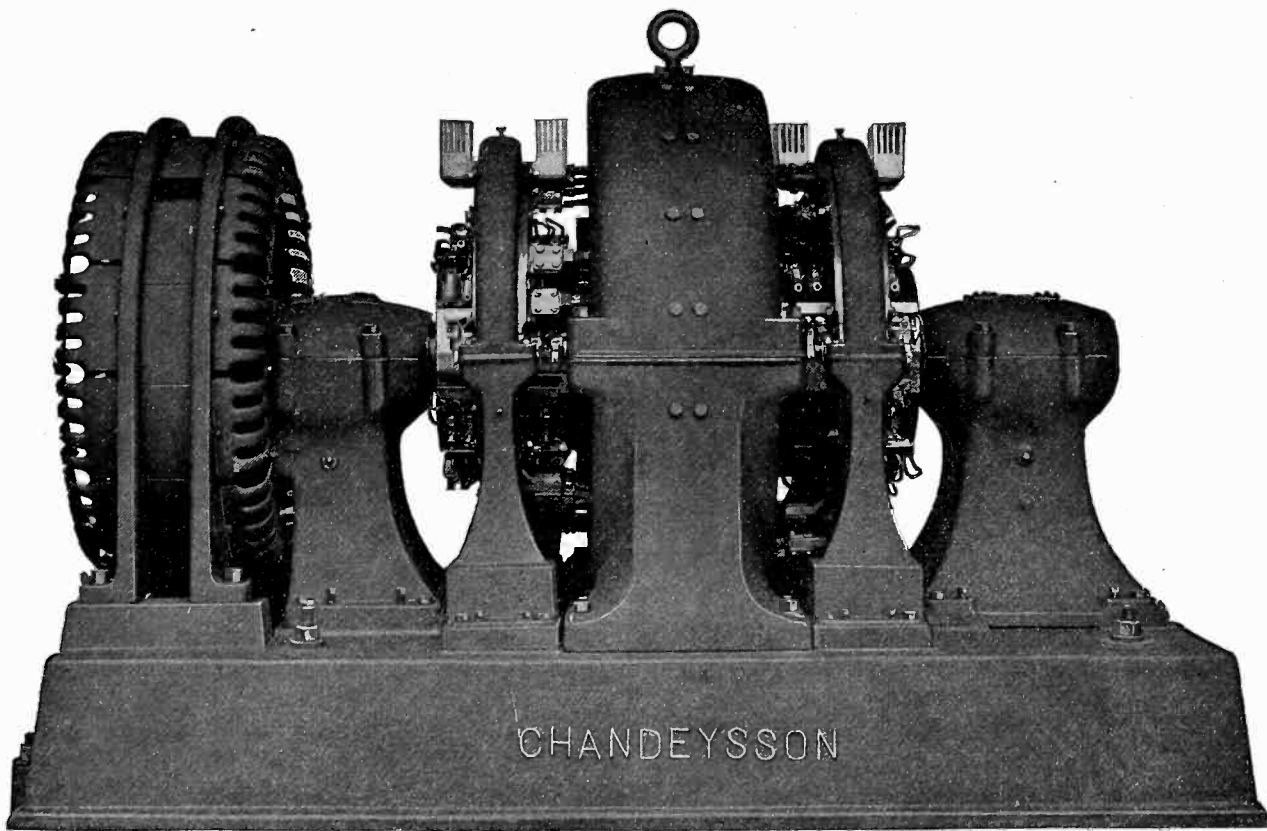

50-h.p., 300-r.p.m.
G-E Synchronous Motor

5000-amp., 6-volt;
2500-amp., 12-volt Generator

CHANDEYSSON ELECTRIC CO., ST. LOUIS, U. S. A.

Please mention the JOURNAL of the A. I. E. E. when writing to advertisers.

"They Keep a-Running"

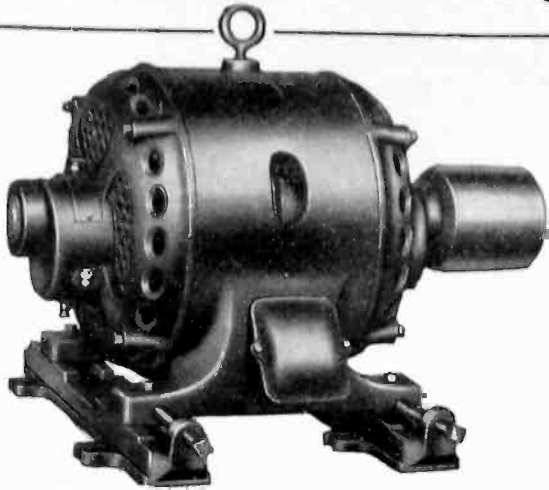

5 Horse Power Century Squirrel-cage
Induction Polyphase Motor

Temperature Rise Not More Than 40° Centigrade

Under normal operating conditions and continuous full load, the temperature rise of Century Squirrel-cage Induction Polyphase Motors will not exceed 40° Centigrade. This is due, in part, to—

- 1 A liberal allowance of steel, copper and other materials in the design of the motor.
- 2 The pyramidal style of field winding, which permits an unrestricted flow of air through the coil structure.
- 3 Armatures which are fitted at each end with sheet steel fans and, in the larger size motors, with grid ventilators so spaced as to circulate a constant volume of air through and around those parts of the motor subject to temperature rises.
- 4 The frames of $\frac{1}{2}$ horse power and larger motors are of "open-duct" construction and provided with inside ribs which direct the circulated air to the field windings and the field core laminations.

Century Squirrel-cage Induction Polyphase Motors are built in all standard sizes from $\frac{1}{4}$ to 50 horse power.

Bulletin No. 38 fully describes and illustrates all constructional features of Century Squirrel-cage Induction Motors. Sent on request.

CENTURY ELECTRIC COMPANY
1806 Pine St. St. Louis, Mo.

For More Than 23 Years at St. Louis

$\frac{1}{4}$ to 50 H. P.

Century
MOTORS

$\frac{1}{4}$ to 50 H. P.

THE PIONEER MANUFACTURER OF Interpole & Ball Bearing Motors

$\frac{1}{2}$ to 1000 H. P. D. C. and A. C.

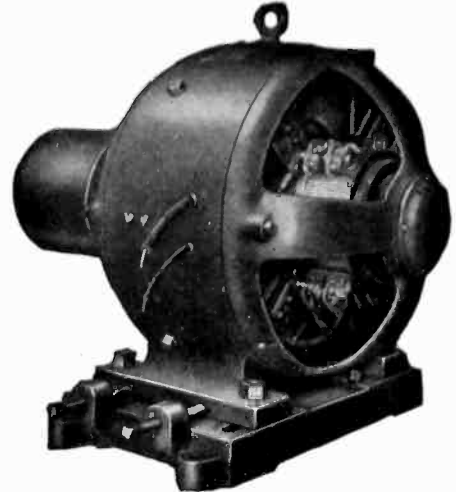

Type "S" Ball Bearing Motor
with base and pulley

ELECTRO DYNAMIC COMPANY

Established 1880

BAYONNE, N. J.

Sales Offices in Principal Cities

Star Ball Bearing Motors



For
Hard
Usage
—
A. C.
and
D. C.

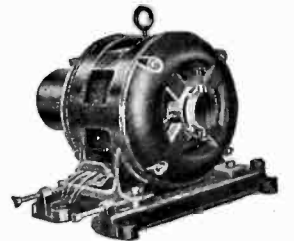

Complete line of standard motors and generators, all sizes up to 75 h. p. and 50 kw. respectively.
Our Engineering Department at your service for all special applications

STAR ELECTRIC MOTOR CO.
NEWARK, NEW JERSEY

Sturtevant Electric Motors

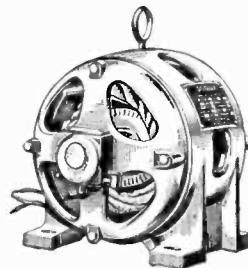

—A. C. and D. C.; single and polyphase—built in sizes from small fractional to 250 horse-power—designed to operate under a constant full load where uninterrupted service is demanded.

B. F. STURTEVANT COMPANY
HYDE PARK, BOSTON, MASS.

Compression Resistance Starters Are Superior to Compensators

The upper wavy line is the oscillographic record of motor voltage during starting and running positions of a compensator. Notice the abrupt change from the starting to running voltage, and also the momentary drop of voltage during switch-over.

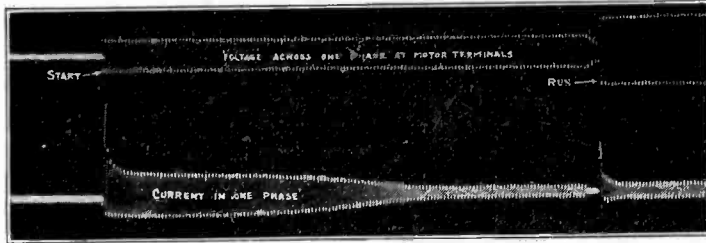

The lower wavy line is the oscillographic record of starting and running current of a squirrel-cage motor started with a compensator. Notice the two current inrushes which are characteristic of motor starting with a compensator.

The Compensator May Look Innocent But It Gives the Line Some Awful Wallops

NO one ordinarily suspects the starting compensator of doing harm to the line voltage, the motor, or the connected machinery.

However, the oscillograph, with its unerring photographic film, records the evidence that explains why power lines are seriously affected when squirrel-cage motors are started with compensators. It is found that the compensator is actually responsible for two severe current inrushes, both of which disturb the voltage stability of a power circuit.

The auto-transformer of the compensator draws a heavy inrush of magnetizing current when it is first connected to the line. This, added to the motor starting current, produces the first wallop or current inrush shown

in the above oscillogram. Then, when the motor is disconnected from the auto-transformer of the compensator and switched to full line voltage, the line receives another wallop. The second inrush occurs because the motor cannot be switched from the auto-transformer to the line without opening the motor circuit.

The Allen-Bradley hand-operated Type H-1852 Compression Resistance Starter, entirely eliminates these wallops to the line voltage, as shown by the lower oscillogram. The motor is started gradually and steplessly from standstill, and brought to line voltage without a jerk or sudden current inrush. No other squirrel-cage motor starter offers such advantages to power companies or motor users.

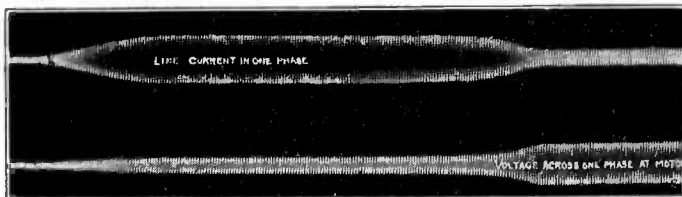

Use the handy coupon below, for full information, catalog and technical report on the advantages of Allen-Bradley Compression Resistance Starters for Squirrel-Cage Motors.

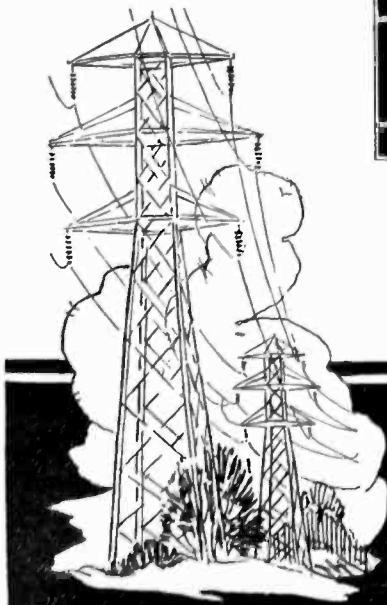
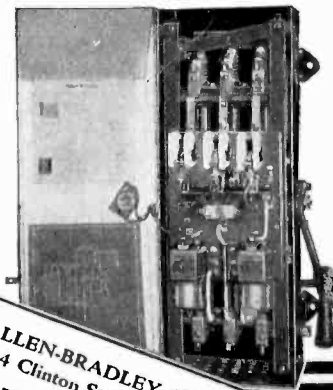

Allen-Bradley
Graphite Compression
RESISTANCE STARTERS
for Squirrel-Cage Motors

ALLEN-BRADLEY CO.,
494 Clinton St., Milwaukee, Wis.
Please send me engineering bulletin with oscillograph test of squirrel-cage motor starters.

Name.....
Company.....
Address.....

Please mention the JOURNAL of the A. I. E. E. when writing to advertisers.

Built for PERMANENCE



Ruggedness—long life—ability to "stand the gaff"—permanence . . . these are some of the Master Standards of Quality built in every MASTER GUARANTEED MOTOR. Included in these motors are many other characteristics which cause an ever-increasing number of leading appliance manufacturers and jobbers to use them.

The Master Electric Co.
Linden & Master Aves. Dayton, Ohio

STOCKS CARRIED IN PRINCIPAL CITIES

MASTER GUARANTEED MOTORS

$\frac{1}{8}$ TO $7\frac{1}{2}$ H.P.  Less than 40°

CLASSIFIED ADVERTISEMENTS

RATES. Forty cents per line; minimum charge based on use of five lines; maximum space cannot exceed twenty lines.

Copy should be received by the 15th of the month, for insertion in the following issue.

WANTED: RADIO TUBE PATENTS. The largest exclusive manufacturer of radio tubes in the United States is ready to assist inventors and persons who have useful ideas or patents pertaining to radio tubes. These ideas can take in processes and construction of 110 volt and other type tubes. This manufacturer has a well equipped laboratory and the most up-to-date factory where all ideas can be brought to a successful conclusion, if at all practical from a manufacturing and merchandising standpoint. Satisfactory remuneration will be the reward for ideas accepted. Address Class-117, JOURNAL of the A. I. E. E., 33 West 39th St., New York.

POPULAR RESEARCH NARRATIVES are proving useful 'round the world in many offices, schools and laboratories. They are interesting home reading, too. Two little books, just pocket size. In each book 50 short stories of research, invention, discovery—footprints of progress. Send a set to your layman friend. The Narratives are in language he can read. Introductions by Dr. E. E. Slosson and Prof. M. I. Pupin. Only \$1.50 for the two volumes, postpaid. Engineering Foundation, 29 West 39th Street, New York, N. Y.

Makes fine lines for

**Figuring
Checking
Underscoring
Blueprints,
etc.**

	No.
Blue . .	1206
Red . .	1207
Green .	1208
Yellow .	1209
Purple .	1210
Brown .	1212
Black . .	1213
Orange .	1214
White .	1215
Light Blue	1216
Pink . .	1217
Light Green	1218

Price
\$1.00
per doz.



U

NIQUE THIN LEAD Colored Pencils

SOMETHING wanted for years! A colored pencil with the same diameter lead as in writing pencils; can be sharpened in a pencil sharpener.

An absolute necessity for making fine lines in color on charts and plans—something never achieved before. The 12 colors also enable each executive to have his own color symbol.

Adopted by
executives • accountants
draftsmen • photographers
artists • teachers
useful to everyone

At all dealers, or write us direct
American Lead Pencil Co.
204 Fifth Ave., New York
Makers of the famous Venus Pencils

A. I. E. E. STANDARDS

THE following approved STANDARDS are available in pamphlet form, at the prices indicated, with a discount of 50% to A. I. E. E. members:

General Principles Upon Which Temperature Limits are Based in the Rating of Electrical Machinery, (.20); Direct-Current Generators and Motors and Direct-Current Commutator Machines in General, (.40); Alternators, Synchronous Motors and Synchronous Machines in General, (.40); Synchronous Converters, (.40); Induction Motors and Induction Machines in General, (.40); Direct-Current and Alternating-Current Fractional Horse Power Motors, (.30); Railway Motors, (.30); Transformers, Induction Regulators and Reactors, (.40); Instrument Transformers, (.30); Industrial Control Apparatus, (.40); Railway Control and Mine Locomotive Control Apparatus, (.40); Oil Circuit Breakers, (.30); Disconnecting and Horn Gap Switches, (.30); Wires and Cables, (.40); Telegraphy and Telephony, (.30); Storage Batteries, (.20); Illumination, (.30); Electric Arc Welding Apparatus, (.40); Electric Resistance Welding Apparatus, (.30); Insulators, (.30); Symbols for Electrical Equipment of Buildings, (.20).

**AMERICAN INSTITUTE of
ELECTRICAL ENGINEERS**
33 West 39th Street New York

Will It Profit You

to pay for Precision in the Bearings of the machines you build to sell?

Yes!

Any slight difference in cost is repaid many hundred fold by their longer life and improved service. Your greater profit lies in the increasing demand for your better product.

"Norma" Precision Ball Bearings, in both open and closed types, for the smaller powers and the highest speeds.

"Hoffmann" Precision Roller Bearings for the heaviest loads, hardest service, and all speeds.

Our engineers will welcome an opportunity to work with yours. Write for catalogs 904, 905 and 915.

NORMA-HOFFMANN BEARINGS CORPORATION

Stamford - Connecticut

PRECISION BALL, ROLLER AND THRUST BEARINGS

NORMA-HOFFMANN



Please mention the JOURNAL of the A. I. E. E. when writing to advertisers.

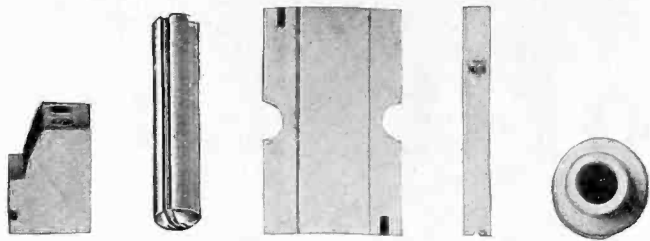

INSULATORS

made of

LAVA

Manufacturers of electric appliances employ lava insulators because they maintain a fixed relation of all their parts under varying conditions.

AMERICAN LAVA CORPORATION
27-67 Williamson Street
Chattanooga Tennessee

A Great Engineering Library

THE Engineering Societies Library, 33 West 39th St., New York, is a reference library for engineers, directed by the national engineering societies. It contains 150,000 volumes and receives 1500 periodicals relating to civil, mining, mechanical and electrical engineering, metallurgy and industrial chemistry.

A staff of experienced investigators is available to make searches upon engineering subjects, prepare lists of references and translate engineering publications from foreign languages.

The Library can also supply photoprint copies of any articles appearing in engineering journals, old or recent. Prices for any services will be quoted on application.

The plan of lending books should particularly commend itself to those who can seldom visit the Library. A good collection of modern American works on engineering, including most of those recently published, is now available and these books may be borrowed by members of the A. I. E. E. and other Founder Societies, located in any part of North America.

At Your Service

TRUMBULL

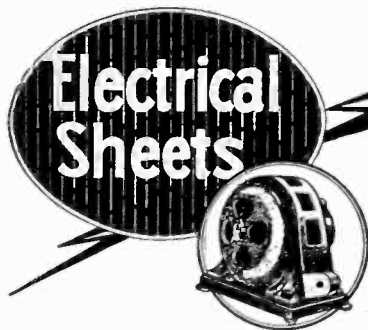

for years have stood the most exacting tests of scores of the largest motor, dynamo, generator, and radio builders in the United States.

Our Engineering Department is at your service. Write us concerning your requirements.

THE TRUMBULL STEEL COMPANY
WARREN Mills, Laboratories and General Offices OHIO

MODELS

for

MANUFACTURING STANDARDS
SALES DEMONSTRATION AND DISPLAY
USE IN LITIGATION

Experimental Development under Client Supervision

MANUFACTURERS' & INVENTORS'
ELECTRIC CO.

(Smith Building)

228 West Broadway, N. Y. City

Incorporated 1897



Is your name on our mailing list for bulletins and catalog?

Morganite Brushes

Morganite
Brush Co., Inc.

519 W. 38th St.
New York

ELECTRICAL TESTING LABORATORIES

80th Street and East End Ave.
NEW YORK

Inspections — Tests — Research

Tests may be used by the purchaser for the following purposes:

- (1) To determine the quality of competing samples. This enables the purchase of the best quality for the money.
- (2) To make sure that shipments comply with specifications. This makes possible the assurance to the customer that shipments match buying samples.
- (3) To furnish an impartial decision in case of disputes between purchaser and manufacturer.

Testing places the whole buying problem on a sound basis.

Please mention the JOURNAL of the A. I. E. E. when writing to advertisers.

What is Mo-lyb-den-um Steel?

How Does It Increase The Life of SRB Ball Bearings? How Does It Give Greater Strength—Greater Load Carrying Capacity—Greater Endurance Than Was Ever Before Possible In Ball Bearings?



The Blow that crushes an ordinary Steel Ball Does Not Break the same ball forged from Mo-lyb-den-um

Makes it 20% stro

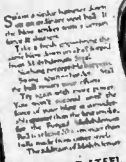

STANDARD STEEL AND BEARINGS INCORPORATED

Mo-lyb-den-um Steel had to stand this!

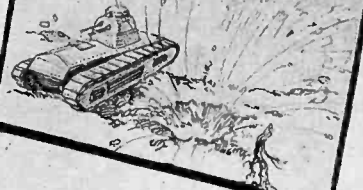

Mo-lyb-den-um
means
More-Life-in-'em
—Why?—

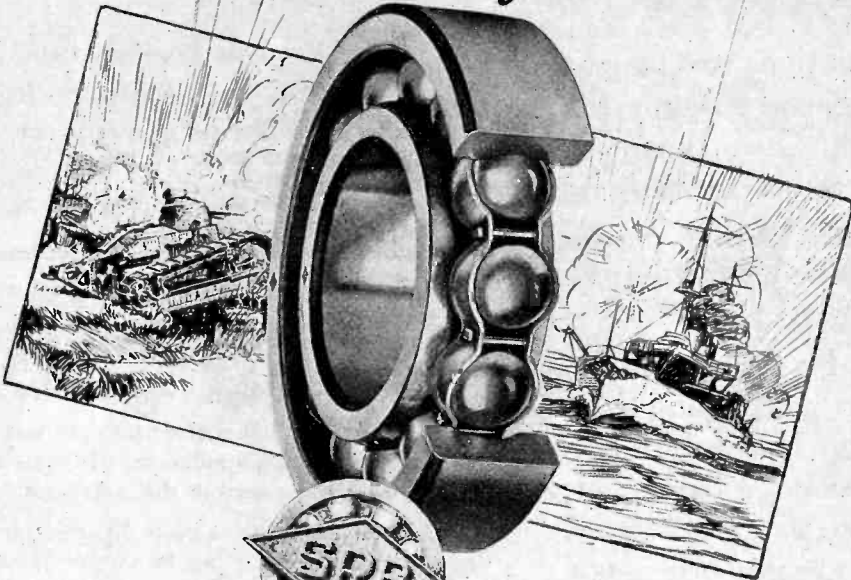

STANDARD STEEL AND BEARINGS INCORPORATED
PLAINVILLE CONNECTICUT

Of course Mo-lyb-den-um increases the life-in-'em but keep this additional fact in mind—the Mo-lyb-den-um balls in an SRB Bearing are hot **FORGED**



More-Life-in-'em

Mo-lyb-den-um
means
More-Life-in-'em

at least 25% more in actual performance

STANDARD STEEL AND BEARINGS INCORPORATED
PLAINVILLE CONNECTICUT

See us at our Booth Number 336,
Mezzanine Floor, Power Show,
Grand Central Palace, New
York City, Dec. 6-11, and
we'll tell you why.

STANDARD STEEL AND BEARINGS INCORPORATED
Plainville Connecticut

USE SRB BALL BEARINGS—*First!*
—they'll last

Please mention the JOURNAL of the A. I. E. E. when writing to advertisers.



Thickness	Code No.	Weight per Sq. Yds., Lbs.	See Page ?	
.005"	2000	32	900-1100	Cambric
.006"	2001	36	900-1100	Cambric
.006"	2022	36	900-1100	Cambric
.007"	2002	40	900-1100	Cambric
.007"	2003	40	900-1100	Cambric
.008"	2004	45	900-1100	Cambric
.009"	2005	50	900-1100	Cambric
.010"	2006	54	900-1100	Cambric
.012"	2007	66	900-1100	Cambric
.012"	2020	67	900-1100	Cambric
.015"	2008	82	900-1100	Cambric
.015"	2012	85	900-1100	Cambric
.016"	2009	87	900-1100	Cambric
.022"	2010	110	400-500	Diaper
.025"	2013	118	400-500	Diaper
.030"	2011	145	400-500	Diaper

SPECIFY CODE NUMBER

What These Code Numbers Mean To You In ACTUAL YARDAGE

As varnished insulations are bought by the pound, the gauge governs the yardage. Over in thickness, under in length. Sometimes short measure is not important, but more often it runs into a loss that counts. At any rate, you are not getting what you expect.

Acme Varnished Products are accurate in weave and gauge, and your guide is our Code Number. This Code is always the same. Take Code No. 2000, for instance, as shown above. This number will always bring you Acme black varnished cambric .005" thick, running 32 pounds per 100 sq. yds., and having a dielectric strength of 900-1100 volts per Mil. A similar Code governs every Acme Varnished Product, and we take pride in adhering strictly to it.

May we send you our catalog of Acme Varnished insulations? We are sure you will be interested in our system of "Yardage insurance." Ask for Catalog No. 3A.

ACME WIRE PRODUCTS

The Acme Wire Co., New Haven, Conn.

Branches at

New York, 53 Vanderbilt Ave.	Chicago, 427 West Erie St.
Boston, 80 Federal St.	Cleveland, Guardian Bldg.

West Virginia Fibre Board

I-N BOARD

For Electrical Insulation

I-N Board has been tested and approved by the Underwriters' Laboratories for electrical insulation.

This board has a very high tensile and dielectric strength and is being used successfully by many electrical manufacturers who are finding it a decided factor for economy.

Pulp Products Department
West Virginia Pulp & Paper Company
 200 Fifth Avenue, New York, N. Y.
 505 Dime Bank Bldg. Detroit, Mich. 732 Sherman Street Chicago, Ill.
 503 Market Street, San Francisco, Cal.

Y-26 High-Heat Mica Plate

For High Temperature Insulation

Possesses all the advantages of natural mica for insulating heating appliances. Is more economical, particularly when used in the larger units.

Supplied in sheets up to 30' x 42", in thicknesses of ten mils or over. Can be cut or punched to any form.

Send for samples and prices.



NEW ENGLAND MICA CO.
 Waltham 54, Mass.
 New York Office — 230 Broadway

ALL FORMS OF MICA FOR ELECTRICAL PURPOSES

"IRVINGTON" PRODUCTS

Black and Yellow

Varnished Cambric Varnished Paper
 Varnished Silk
 Flexible Varnished Tubing
 Insulating Varnishes and Compounds
 "Cellulak" Tubes and Sheets

IRVINGTON VARNISH & INSULATOR CO.
 Irvington, New Jersey.

Sales Representatives in all principal cities

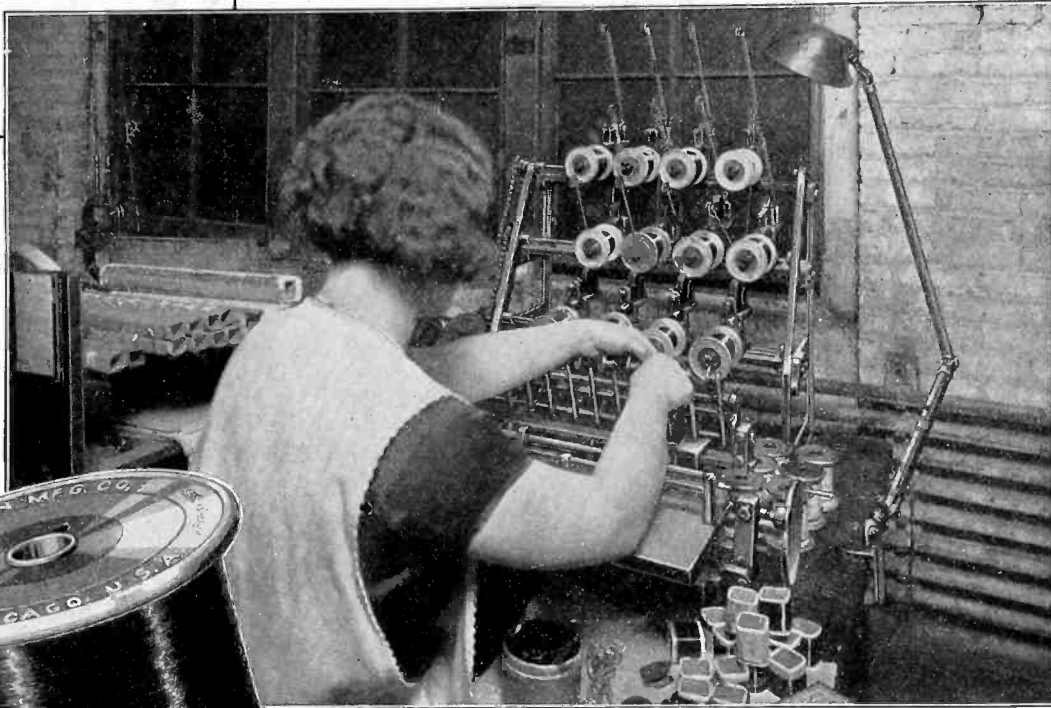

Winding High Tension Coils Demonstrates Beldenamel Superiority

High speed winding of small coils requires a uniform wire with tough and flexible insulation.

RELIABLE insulation for fine wire coils with thousands of turns is no longer a problem. Thanks to the painstaking efforts of Belden Engineers, Beldenamel meets every requirement of this difficult service perfectly. It is flexible and smooth, working from winding machines without trouble. Pliable and tough—it does not crack or break under sharp turns. Its uniformity of size assures a uniform number of turns in a given space. Its smallness of bulk permits many turns in small space—far more turns than are possible with other forms of insulation.

BUT, most important of all, is the utter dependability of Beldenamel insulation. Automatically controlled conditions guard the perfection of Beldenamel through every step in its manufacture. Extensive laboratory and service tests have perfected the formula under which it is made. The liquid enamel is made in the Belden factory under the closest supervision. Dipping and baking treatments are performed with utmost care. The result is a product so uniformly perfect that it is ideal for the exacting service of winding small coils. Investigate the unusual possibilities of Beldenamel magnet wire.

Leading coil manufacturers are using Beldenamel wire extensively for high tension coils. Try Beldenamel on your next winding job.

*Specify
Belden*

USE THE COUPON

Belden Manufacturing Company
2316B So. Western Ave., Chicago

Please send us your booklet on Beldenamel Wire including winding data.

Name.....

Address

.....

Please mention the JOURNAL of the A. I. E. E. when writing to advertisers.

**INSULATING
PAPERS**

AND FOR POWER
TELEPHONE
CABLES

Trade Mark—"ROTHMILL"

Made under Highly Specialized Technical and Practical Control resulting in the Production of Paper Combining *Greatest Mechanical Strength with Highest Insulating Properties*

by

TULLIS, RUSSELL & CO., LTD.,

PAPER MAKERS

HEAD OFFICE AND MILLS
MARKINCH, SCOTLAND
CABLES—"TULLIS, MARKINCH"

ESTABLISHED 1809

SALES OFFICE
1, TUDOR STREET

LONDON, E. C. 4, ENG.

CABLES: AUCHMUTY, LONDON

MANCHESTER OFFICE
376 CORN EXCHANGE BUILDING
CORPORATION STREET
MANCHESTER

Long-Lived Windings

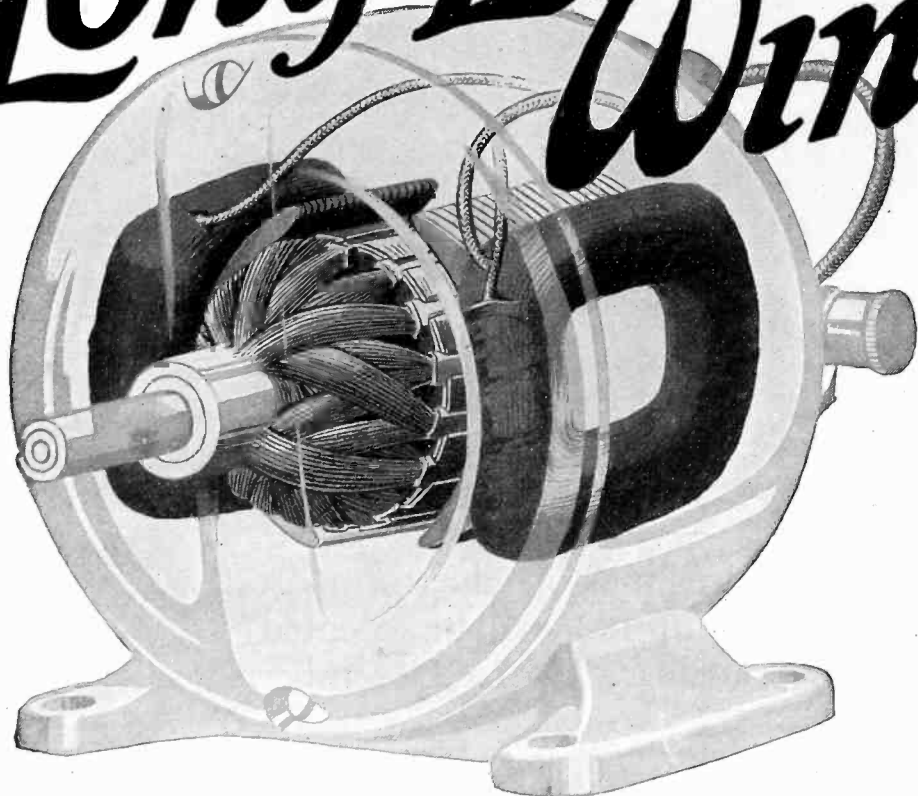

make
Long-Lived
Motors

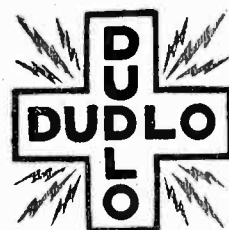

The life of any motor is measured by the durability of its windings. The life of DUDLO Windings is insured through the durability of the wire, particularly the insulation, upon which winding efficiency depends. Manufacturers of fractional horse power motors for all kinds of domestic and industrial equipment will insure the longest possible life for their motors through the use of Dudlo Magnet Wire and Field Coils.

The Dudlo experimental and engineering departments are at the service of any manufacturer, fully and freely, without obligation of any kind.

DUDLO

DUDLO MANUFACTURING CORPORATION, FORT WAYNE, INDIANA

412 Chamber of Commerce Bldg.
NEWARK, N. J.

160 North La Salle Street
CHICAGO, ILL.

4153 Bingham Ave.
ST. LOUIS MO.

274 Brannan St.
SAN FRANCISCO, CALIFORNIA

Please mention the JOURNAL of the A. I. E. E. when writing to advertisers.

Announcement

The advertising rates of the JOURNAL of the A. I. E. E. have been increased, effective January 1, 1927.

Orders covering insertions of advertising in this publication during 1927 will be accepted on the existing rate basis up to December 31, 1926.

The advance in space costs is due to the greatly enlarged circulation of the JOURNAL.

The circulation has increased 75% since the present rates were established, averaging over 23,000 copies per issue during 1926—the largest of any technical periodical in the electrical field.



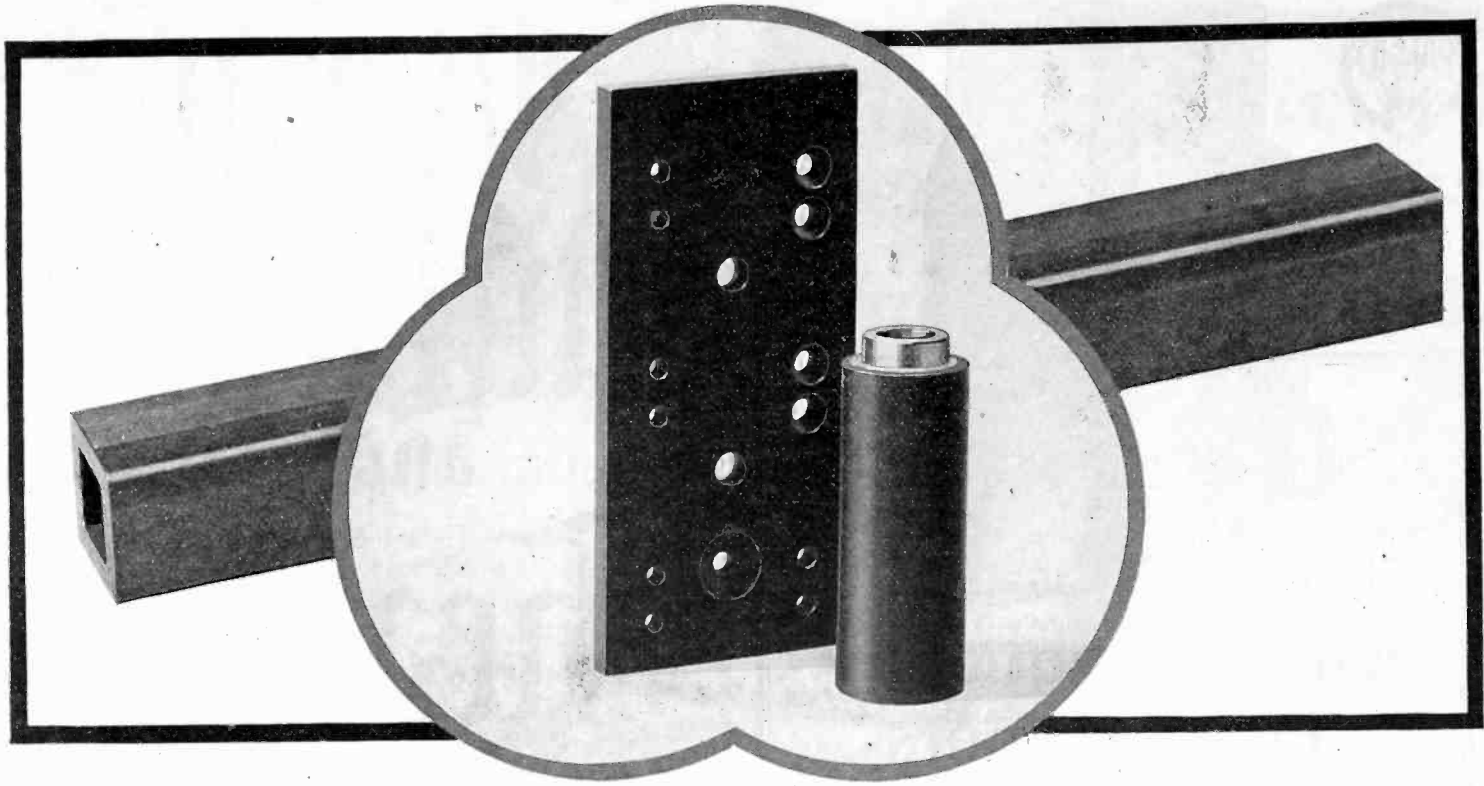

Important parts of Allen-Bradley apparatus are Bakelite Insulated

Over the heavy, square steel shaft of the Allen-Bradley A. C. Contactor is drawn an insulation sleeve of square Bakelite laminated tubing, to which each contactor is rigidly clamped.

The core of the Overload Relay made by this same manufacturer, is of Bakelite molded, with a steel end plug solidly embedded during the molding operation.

All Allen-Bradley push-button stations, used on voltages above 440,

are assembled on a Bakelite laminated contact base.

With this manufacturer, as with many others, the success of Bakelite insulation for one part, led to its adoption for several additional devices.

Bakelite engineers and laboratories are constantly cooperating with electrical manufacturers in adapting Bakelite to the betterment of their own products. This consulting service involves no obligation on your part.

Write for Booklet 3

BAKELITE CORPORATION

247 Park Ave., New York, N. Y.

Chicago Office: 636 West 22nd St.

BAKELITE CORPORATION OF CANADA, LTD., 163 Dufferin Street, Toronto - - Ontario, Canada

BAKELITE

REGISTERED

U. S. PAT. OFF.



THE MATERIAL OF A THOUSAND USES

The registered Trade Mark and Symbol shown above may be used only on products made from materials manufactured by Bakelite Corporation. Under the capital "B" is the numerical sign for infinity, or unlimited quantity. It symbolizes the infinite number of present and future uses of Bakelite Corporation's products.

Please mention the JOURNAL of the A. I. E. E. when writing to advertisers.

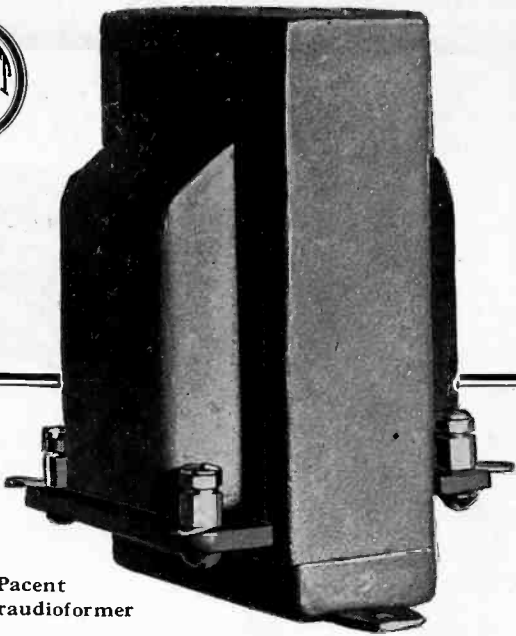

The Pacent
Superaudioformer

Audio Frequency Transformers

EXTREMELY successful transformers developed by the Pacent Engineers, who are primarily specialists in Audio Frequency parts. Handsomely finished in dull bronze, made in two types.

Superaudioformers

INPUT TYPE No. 27A, Ratio 3 to 1, Primary Inductance 124 henrys, designed for use between any vacuum tubes, and also with power amplification requirements in mind.

Shielded \$7.50 Unshielded \$6.00

OUTPUT TYPE No. 27B, Ratio 1 to 1, Inductance 15 henrys.

Shielded \$7.50 Unshielded \$6.00

Pacents Audio Choke

A type of Super audioformer developed for use in filter circuits of power amplifiers and battery eliminators. Unusually sturdy for long usage.

CHOKE TYPE No. 29, Inductance 50 henrys (with no superimposed D. C.); Inductance 32 henrys (with 60 m. a. superimposed D. C.).

Shielded \$6.50 Unshielded \$5.00

Full information on request.

PACENT ELECTRIC CO., INC.
91 SEVENTH AVENUE NEW YORK CITY

Canadian Licensed Manufacturer:

White Radio Limited, Hamilton, Ont.

Manufacturing Licensees for Great Britain and Ireland:

Igranic Electric Co., Ltd., London and Bedford, England

Pacents
RADIO ESSENTIALS

Merry Christmas and a Healthy New Year



•BUY•
•CHRISTMAS•
•SEALS•

THE NATIONAL, STATE AND LOCAL TUBERCULOSIS
ASSOCIATIONS OF THE UNITED STATES



Piezo Electric Oscillator

The Type 275 oscillator is a vacuum tube oscillator the frequency of which is held constant by the Piezo electric action of a quartz plate.

This type of oscillator provides an instrument of great reliability for transmitter adjustment, or as a primary standard for wavemeter calibration. Licensed under Pierce and Cady patents.

Bulletin 723E on request.

PRICE	Type 275 oscillator	\$85.00
	Type 276B plate 25%	30.00
	Type 276C plate 5%	40.00
	Type 276D plate 0.1%	60.00

GENERAL RADIO COMPANY

30 State Street Cambridge, Massachusetts

High Sensitivity Frequency Meters

WESTON RECTANGULAR INSTRUMENTS



ENGINEERS know the Weston Rectangulares as the most modern type of switchboard instruments. Weston does not stop at a thoroughly modernized line but goes further whenever the need arises. The new high sensitivity frequency meters just added to the rectangular group constitute a refinement well worthy of the engineer's consideration. ¶The scales for these new instruments, examples of which are here shown, make possible a much closer frequency control because the scales are much more open and a cycle difference in the center or critical part of the scale covers a considerable longer arc, (up to 13/16" in length). ¶The scales also present a better appearance because they are now substantially the same length for the entire rectangular group. It should be remembered that the rectangular frequency meters possess the characteristic advantages of this group of being unusually readable, standardized as to mounting, economical in use of panel space, unusually handsome in appearance, but now with higher sensitivity they are even more desirable. ¶The new scaled frequency meter is but one of the Weston rectangular group which consists of A. C. Ammeters and Wattmeters, Reactive Component Meters, Power Factor Meters, Triplex Meters and D. C. Voltmeters and Ammeters. ¶Compare the three scales illustrated here — see the obvious advantages. For complete information address—

WESTON ELECTRICAL INSTRUMENT CORPORATION

48 Weston Avenue, Newark, N. J.

Popular Research Narratives

are proving excellent means for introducing *Engineering Foundation* and engineering research to new friends and keeping the name before them.

If you have read these two little books, we suggest that you have copies sent to friends whom you would like to interest. Teachers and young persons in secondary schools and colleges, also, are finding them useful. The price is only \$1.50 for the set, sent post-paid to any address.

These short stories of research, invention and discovery were contributed by eminent scientists, engineers and inventors. They are worth reading and are entertaining.

Requests and remittances may be sent to Engineering Foundation, at 29 West 39th Street, New York.

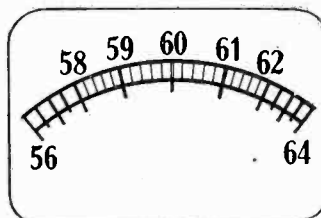

New expanded type of frequency scale

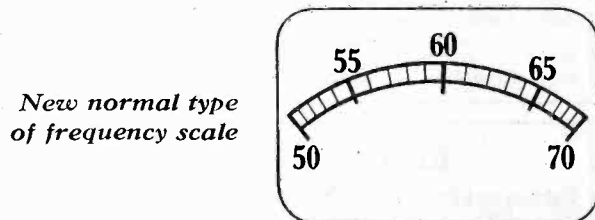

New normal type of frequency scale

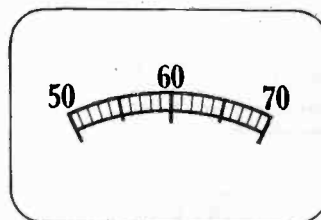

Old type of frequency scale

STANDARD THE WORLD OVER
WESTON
 Pioneers since 1888

Please mention the JOURNAL of the A. I. E. E. when writing to advertisers.

PROFESSIONAL ENGINEERING DIRECTORY

For Consultants in the Fields of Engineering, and Related Arts and Sciences

Established 1857
ALEXANDER & DOWELL
 Attorneys at Law
 PATENT, TRADEMARK AND
 COPYRIGHT CASES
 902 F Street, N. W. Washington, D. C.

WALTER G. CLARK
 Consulting Engineer
 Electrical, Mining and Industrial
 Reports
 Supervision of Organization and Arrange-
 ments for Financing
 LOS ANGELES NEW YORK
 1211 Insurance Exch. Bldg. 40 Wall St.

FRANK F. FOWLE & CO.
 Electrical and Mechanical
 Engineers
 MONADNOCK BUILDING CHICAGO

AMBURSEN DAMS
 Hydroelectric Developments
 Water Supply and Irrigation Dams
 DAMS ON DIFFICULT FOUNDATIONS
 AMBURSEN CONSTRUCTION CO.
 Incorporated
 Grand Central Terminal, New York
 Kansas City, Mo. Atlanta, Ga.

EDWARD E. CLEMENT
 Fellow A. I. E. E.
 Attorney and Expert
 in Patent Causes
 Soliciting, Consultation, Reports,
 Opinions
 McLachlen Bldg. Washington, D. C.
 700 10th St., N. W.

FREYN ENGINEERING COMPANY
 Industrial Electric Power
 Generation—Application—Purchase
 Combustion Engineering
 Electric Furnace Installations
 CHICAGO PHILADELPHIA
 310 South Michigan Ave. 1500 Chestnut St.

THE AMERICAN APPRAISAL CO.
 Valuations and Reports
 of
 Public utility, industrial
 and all other properties
 Rate Cases _____ Condemnation Suits
 Reorganizations _____ Liquidations
 NEW YORK MILWAUKEE
 1896 And Principal Cities 1926

C. E. CLEWELL
 Consulting Engineer
 Municipal Street Lighting Systems
 Factory and Office Lighting
 3400 Walnut Street Philadelphia, Pa.

M. H. GERRY, JR.
 Consulting Engineer
 Electrical Transmission of Power
 Hydroelectric Developments
 Steam and Diesel Plants
 Industrial Applications
 1107 Hobart Building San Francisco

W. S. BARSTOW & COMPANY
 Incorporated
 Financial and Operating
 Managers of
 Public Utilities
 50 Pine Street New York

HAROLD A. DANNE
 LIGHT AND POWER
 41 PARK ROW NEW YORK

A. BARNETT GREEN
 ENGINEERING PUBLICITY
 1328 BROADWAY NEW YORK
 EDITING — COMPILING — WRITING

BATTEY & KIPP
 Incorporated
 ENGINEERS
 Complete Industrial Plants
 Power Plants & Electrical Installations
 Engineering Reports, Analyses & Appraisals
 231 South LaSalle Street CHICAGO

DAY & ZIMMERMANN, Inc.
 Engineers
 Power Plants, Sub-Stations,
 Transmission Lines, Industrial Plants
 Examinations and Reports, Valuations,
 Management of Public Utilities
 1600 WALNUT ST., PHILADELPHIA
 New York Chicago

L. F. HARZA
 HYDRO-ELECTRIC ENGINEER
 Monadnock Bldg. Chicago

BLACK & VEATCH
 Consulting Engineers
 Water, Steam and Electric Power Investiga-
 tions, Design, Supervision of Construction,
 Valuation and Tests.
 Mutual Building KANSAS CITY, MO.

DAVID V. FENNESSY
 Consulting Power Engineer
 MILLS BUILDING EL PASO, TEXAS

AUGUSTUS M. HENRY
 COUNSELOR AT LAW
 (Patents and Patent Causes)
 WOOLWORTH BLDG. NEW YORK

BYLLESBY
 ENGINEERING AND MANAGEMENT
 CORPORATION
 231 S. La Salle Street
 CHICAGO
 New York San Francisco

FORD, BACON & DAVIS
 Incorporated
 ENGINEERS
 115 Broadway, New York
 Philadelphia Chicago San Francisco

HOOSIER ENGINEERING CO.
 Erectors of
 Transmission Lines and Substations
 325 South New Jersey Street
 INDIANAPOLIS INDIANA

MAKE your name and specialized service
 well known to the electrical industry
 through a card in the ENGINEERING DIRECTORY

PROFESSIONAL ENGINEERING DIRECTORY

For Consultants in the Fields of Engineering and Related Arts and Sciences

Dugald C. Jackson
Edward L. Moreland
JACKSON & MORELAND
CONSULTING ENGINEERS
31 St. James Ave. Boston, Mass.

**PUBLIC SERVICE
PRODUCTION COMPANY**
Engineers and Constructors
Design and Construct: Power Plants,
Transmission Lines, Industrial Plants,
Highways, Railroad Shops and Terminals,
Gas Plants, Commercial Buildings
Make: Examinations, Reports and Valuations
80 PARK PLACE NEWARK, N. J.

William M. Stockbridge Victor D. Borst
STOCKBRIDGE & BORST
Patent Lawyers
41 PARK ROW NEW YORK CITY

E. S. LINCOLN
Consulting Electrical Engineer
Designs Investigations Reports
Electrical Research Laboratory
534 Congress St. PORTLAND, MAINE

**SANDERSON & PORTER
ENGINEERS**
PUBLIC UTILITIES & INDUSTRIALS
Design Construction Management
Examinations Reports Valuations
Chicago New York San Francisco

STONE & WEBSTER
Incorporated
Examinations Reports Appraisals
on
Industrial and Public Service
Properties
NEW YORK BOSTON CHICAGO

MCCLELLAN & JUNKERSFELD
Incorporated
Engineering and Construction
Power Developments—Industrial Plants
Electrifications—Examinations
Reports—Valuations
NEW YORK
68 Trinity Place
Chicago St. Louis

SARGENT & LUNDY
Incorporated
Mechanical and Electrical
Engineers
1412 Edison Bldg., 72 West Adams Street
CHICAGO ILLINOIS

PERCY H. THOMAS
Consulting Engineer
ELECTRIC POWER
Generation - Transmission
Applications
120 BROADWAY NEW YORK

W. E. MOORE & CO.
Engineers
Plans and Specifications for
Hydroelectric and Steam Power Plants
Industrial Plants and Electric Furnaces
Union Bank Building Pittsburgh, Pa.

SCOFIELD ENGINEERING CO.
Consulting Engineers
Power Stations Gas Works
Hydraulic Developments Electric Railways
Examinations & Reports Valuations
Philadelphia

THE U. G. I. CONTRACTING CO.
Engineers & Constructors
Power Developments, Industrial Plants, Gas
Plants, Transmission Systems, Appraisals
Broad & Arch Sts., PHILA., PA.
421 Peoples Gas Bldg., Chicago, Ill. 928 Union Trust
Bldg., Pittsburgh, Pa.

N. J. NEALL
Consulting Engineer
for
Electrical and Industrial Properties
12 PEARL STREET BOSTON, MASS.

Card space limited
to 1"x2" for each
advertiser.

VIELE, BLACKWELL & BUCK
Engineers
Designs and Construction
Hydroelectric and Steam Power Plants
Transmission Systems Industrial Plants
Reports Appraisals
49 WALL STREET NEW YORK

NEILER, RICH & CO.
Electrical and Mechanical
Engineers
Consulting, Designing and
Supervising
431 So. Dearborn St. - - - Chicago

J. E. SIRRINE & COMPANY
Engineers
Textile Mills; Hydro-Electric Develop-
ments; Tobacco Products Plants; Cotton,
Tobacco and General Warehousing; Indus-
trial Housing; Steam Power Plants; Steam
Utilization.
Greenville Chattanooga
South Carolina Tennessee

**THE J. G. WHITE
ENGINEERING CORPORATION**
Engineers—Constructors
Oil Refineries and Pipe Lines,
Steam and Water Power Plants,
Transmission Systems, Hotels, Apartments,
Offices and Industrial Buildings, Railroads
43 EXCHANGE PLACE NEW YORK

OPHULS & HILL, Inc.
Formerly Ophuls, Hill & McCreery, Inc.
CONSULTING ENGINEERS
112-114 WEST 42nd ST., NEW YORK CITY
Ice Making and Refrigeration
Investigations and Reports

JOHN A. STEVENS
CONSULTING POWER ENGINEER
16 Shattuck Street
LOWELL MASSACHUSETTS

J. G. WRAY & CO.
Engineers
J. G. Wray, Fellow A.I.E.E. Cyrus G. Hill
Utilities and Industrial Properties
Appraisals Construction Rate Surveys
Plans Organization Estimates
Financial Investigations Management
1217 First National Bank Bldg., Chicago

FARLEY OSGOOD
Consultant
Design, Construction, Operation
Inter-Connection
of
PUBLIC UTILITIES
National Bank of Commerce Building
31 Nassau Street, New York, N. Y.
Tel.: Rector 7878 Cable Address: Fargood

**STEVENS & WOOD
INCORPORATED**
Engineers and Constructors
120 BROADWAY, NEW YORK
Youngstown, O.

*To be printed in the following
issue, copy for cards must be
received by the 20th of the month.*

Classified Advertiser's Index for Buyers

Manufacturers and agents for machinery and supplies used in the electrical and allied industries.

Note: For reference to the Advertisements see the Alphabetical List of Advertisers on page 62.

- AIR COMPRESSORS**
Allis-Chalmers Mfg. Co., Milwaukee
General Electric Co., Schenectady
Western Electric Co., All Principal Cities
- AIR COMPRESSOR FILTERS**
Midwest Air Filters, Inc., Bradford, Pa.
- AIR FILTERS, COOLING**
Midwest Air Filters, Inc., Bradford, Pa.
- AIR WASHERS**
Sturtevant Company, B. F., Boston
- ALARMS, TEMPERATURE, PRESSURE**
Cory & Son, Inc., Chas., New York
- AMMETER COMPENSATING COILS**
Minerallac Electric Co., Chicago
- AMMETER, VOLTMETERS**
(See INSTRUMENTS, ELECTRICAL)
- ANCHORS, GUY**
Matthews Corp., W. N., St. Louis
- ANNUNCIATORS, AUDIO-VISIBLE**
Cory & Son, Inc., Chas., New York
- BATTERY CHARGING APPARATUS**
Allen-Bradley Co., Milwaukee
Electric Specialty Co., Stamford, Conn.
Fansteel Products Co., Inc., North Chicago
General Electric Co., Schenectady
Ward Leonard Electric Co., Mt. Vernon, N. Y.
Western Electric Co., All Principal Cities
Westinghouse Elec. & Mfg. Co., E. Pitts-
burgh
- BEARINGS, BALL**
New Departure Mfg. Co., The, Bristol, Conn.
Norma-Hoffmann Bearings Corp., Stamford,
Conn.
Standard Steel & Bearings, Inc., Plainville,
Conn.
- BEARINGS, ROLLER**
Timken Roller Bearing Co., The, Canton, O.
- BOXES, FUSE**
General Electric Co., Schenectady
Metropolitan Device Corp., Brooklyn, N. Y.
Western Electric Co., All Principal Cities
Westinghouse Elec. & Mfg. Co., Pitts-
burgh
- BOXES, JUNCTION**
G & W Elec. Specialty Co., Chicago
Metropolitan Device Corp., Brooklyn, N. Y.
Standard Underground Cable Co., Pittsburgh
- BRUSHES, COMMUTATOR**
Carbon
Morganite Brush Co., Inc., New York
National Carbon Co., Inc., Cleveland
Westinghouse Elec. & Mfg. Co., E. Pitts-
burgh
Copper Graphite
Morganite Brush Co., Inc., New York
National Carbon Co., Inc., Cleveland
Westinghouse Elec. & Mfg. Co., E. Pitts-
burgh
- BUS BAR FITTINGS**
Burndy Engineering Co., Inc., New York
Delta-Star Electric Co., Chicago
General Electric Co., Schenectady
Westinghouse Elec. & Mfg. Co., E. Pitts-
burgh
- CABLE ACCESSORIES**
Delta-Star Electric Co., Chicago
Dossert & Co., New York
G & W Electric Specialty Co., Chicago
General Electric Co., Schenectady
Minerallac Electric Co., Chicago
Standard Underground Cable Co., Pittsburgh
Western Electric Co., All Principal Cities
- CABLES**
See WIRES AND CABLES
- CABLEWAYS**
American Steel & Wire Co., Chicago
Roebling's Sons Co., John A., Trenton, N. J.
- CAMBRIC, VARNISHED**
Belden Mfg. Co., Chicago
Irvington Varnish & Ins. Co., Irvington, N. J.
- CARRIER CURRENT TELEPHONE EQUIP-
MENT**
Dubilier Condenser & Radio Corp., N. Y.
Western Electric Co., All Principal Cities
Wireless Specialty Apparatus Co., Boston
- CIRCUIT BREAKERS**
Air-Enclosed
Allen-Bradley Co., Milwaukee
Cutter Co., The, Philadelphia
Roller-Smith Co., New York
Sundh Electric Co., Newark, N. J.
Ward Leonard Electric Co., Mt. Vernon, N. Y.
Western Electric Co., All Principal Cities
Oil
Condit Electrical Mfg. Corp., Boston
General Electric Co., Schenectady
Pacific Elec. Mfg. Co., San Francisco
Westinghouse Elec. & Mfg. Co., E. Pitts-
burgh
- CLAMPS, GUY & CABLE**
Burndy Engineering Co., Inc., New York
Matthews Corp., W. N., St. Louis
- COILS, CHOKE**
Burke Electric Co., Erie, Pa.
General Electric Co., Schenectady
Westinghouse Elec. & Mfg. Co., E. Pitts-
burgh
- COILS, MAGNET**
Acme Wire Co., New Haven, Conn.
Belden Mfg. Co., Chicago
Dudlo Mfg. Corp., Ft. Wayne, Ind.
General Electric Co., Schenectady
Westinghouse Elec. & Mfg. Co., E. Pitts-
burgh
- CONDENSATION PRODUCTS**
Bakelite Corporation, New York
- CONDENSERS, COUPLING**
For Carrier Current Telephone
Dubilier Condenser & Radio Corp., New York
Wireless Specialty Apparatus Co., Boston
- CONDENSERS, RADIO**
Dubilier Condenser & Radio Corp., New York
General Radio Co., Cambridge, Mass.
Pacnet Electric Co., New York
Wireless Specialty Apparatus Co., Boston
- CONDENSERS, STEAM**
Allis-Chalmers Mfg. Co., Milwaukee
General Electric Co., Schenectady
Westinghouse Elec. & Mfg. Co., E. Pitts-
burgh
- CONDUIT, UNDERGROUND FIBRE**
Western Electric Co., All Principal Cities
- CONNECTORS, SOLDERLESS**
Dossert & Co., New York
Western Electric Co., All Principal Cities
Westinghouse Elec. & Mfg. Co., E. Pitts-
burgh
- CONNECTORS AND TERMINALS**
Belden Mfg. Co., Chicago
Burke Electric Co., Erie, Pa.
Burndy Engineering Co., Inc., New York
Dossert & Co., New York
G & W Electric Specialty Co., Chicago
Western Electric Co., All Principal Cities
Westinghouse Elec. & Mfg. Co., E. Pitts-
burgh
- CONTACTS, TUNGSTEN**
Fansteel Products Co., Inc., North Chicago
General Electric Co., Schenectady
- CONTROL SYSTEMS**
Ward Leonard Electric Co., Mt. Vernon N. Y.
- CONTROLLERS**
Allen-Bradley Co., Milwaukee
Electric Controller & Mfg. Co., Cleveland
General Electric Co., Schenectady
Rowan Controller Co., Baltimore
Sundh Electric Co., Newark, N. J.
Ward Leonard Electric Co., Mt. Vernon, N. Y.
Western Electric Co., All Principal Cities
Westinghouse Elec. & Mfg. Co., E. Pitts-
burgh
- CONVERTERS—SYNCHRONOUS**
Allis-Chalmers Mfg. Co., Milwaukee
Electric Specialty Co., Stamford, Conn.
Westinghouse Elec. & Mfg. Co., E. Pitts-
burgh
- COPPER CLAD WIRE**
Belden Mfg. Co., Chicago
Copperweld Steel Co., Rankin, Pa.
Standard Underground Cable Co., Pittsburgh
Western Electric Co., All Principal Cities
- CUT-OUTS**
Condit Electrical Mfg. Corp., S. Boston
General Electric Co., Schenectady
G & W Electric Specialty Co., Chicago
Metropolitan Device Corp., Brooklyn, N. Y.
Western Electric Co., All Principal Cities
Westinghouse Elec. & Mfg. Co., E. Pitts-
burgh
- DIMMERS, THEATRE**
Ward Leonard Electric Co., Mt. Vernon, N. Y.
- DYNAMOS**
(See GENERATORS AND MOTORS)
- DYNAMOTORS**
Burke Electric Co., Erie, Pa.
Electric Specialty Co., Stamford, Conn.
- ELECTRIFICATION SUPPLIES, STEAM
ROAD**
General Electric Co., Schenectady
Ohio Brass Co., Mansfield, Ohio
Westinghouse Elec. & Mfg. Co., E. Pitts-
burgh
- ENGINEERS, CONSULTING AND CON-
TRACTING**
(See PROFESSIONAL ENGINEERING
DIRECTORY)
- ENGINES**
Gas & Gasoline
Allis-Chalmers Mfg. Co., Milwaukee
Sturtevant Company, B. F., Boston
Oil
Allis-Chalmers Mfg. Co., Milwaukee
Sturtevant Company, B. F., Boston
Steam
Allis-Chalmers Mfg. Co., Milwaukee
Sturtevant Company, B. F., Boston
- FANS, MOTOR**
Century Electric Co., St. Louis
General Electric Co., Schenectady
Star Electric Motor Co., Newark, N. J.
Sturtevant Company, B. F., Boston
Western Electric Co., All Principal Cities
Westinghouse Elec. & Mfg. Co., E. Pitts-
burgh
- FARM LIGHTING GENERATORS**
Western Electric Co., All Principal Cities
Westinghouse Elec. & Mfg. Co., E. Pitts-
burgh
- FIBRE**
Belden Mfg. Co., Chicago
- FIRE PROTECTION APPARATUS**
Kidde & Co., Inc., Walter, New York
- FLOW METERS**
Cory & Son, Inc., Chas., New York
General Electric Co., Schenectady
- FURNACES, ELECTRIC**
General Electric Co., Schenectady
Westinghouse Elec. & Mfg. Co., E. Pitts-
burgh
- FUSES**
Enclosed Refillable
General Electric Co., Schenectady
Western Electric Co., All Principal Cities
Westinghouse Elec. & Mfg. Co., E. Pitts-
burgh
Enclosed Non-Refillable
General Electric Co., Schenectady
Western Electric Co., All Principal Cities
Open Link
General Electric Co., Schenectady
Metropolitan Device Corp., Brooklyn, N. Y.
Western Electric Co., All Principal Cities
High Tension
Delta-Star Electric Co., Chicago
Metropolitan Device Corp., Brooklyn, N. Y.
Western Electric Co., All Principal Cities
- GEARS, FIBRE**
General Electric Co., Schenectady
- GENERATORS AND MOTORS**
Allis-Chalmers Mfg. Co., Milwaukee
Burke Electric Co., Erie, Pa.
Century Electric Co., St. Louis
Chandeysson Electric Co., St. Louis
Electric Specialty Co., Stamford, Conn.
Electro-Dynamic Co., Bayonne, N. J.
General Electric Co., Schenectady
Lincoln Electric Co., The, Cleveland
Master Electric Co., The, Dayton, O.
Star Electric Motor Co., Newark, N. J.
Sturtevant Company, B. F., Boston
Western Electric Co., All Principal Cities
Westinghouse Elec. & Mfg. Co., E. Pitts-
burgh
- GENERATING STATION EQUIPMENT**
Allis-Chalmers Mfg. Co., Milwaukee
Burke Electric Co., Erie, Pa.
General Electric Co., Schenectady
Western Electric Co., All Principal Cities
Westinghouse Elec. & Mfg. Co., E. Pitts-
burgh
- GROUND RODS**
Copperweld Steel Co., Rankin, Pa.
Western Electric Co., All Principal Cities
- HEADLIGHTS**
Ohio Brass Co., Mansfield, O.
- HEATERS, INDUSTRIAL**
General Electric Co., Schenectady
Western Electric Co., All Principal Cities
Westinghouse Elec. & Mfg. Co., E. Pitts-
burgh
- INDICATORS, LOAD**
Cory & Son, Inc., Chas., New York
- INDICATORS, SPEED**
Bristol Co., The, Waterbury, Conn.
Roller-Smith Co., New York
- INDICATORS WATER LEVEL**
Bristol Co., The, Waterbury, Conn.
Cory & Son, Inc., Chas., New York
- INSTRUMENTS, ELECTRICAL**
Graphic
Bristol Co., The, Waterbury, Conn.
Ferranti, Ltd., London, Eng.
Ferranti Meter & Transformer Mfg. Co.,
Ltd., Toronto, Ont.
General Electric Co., Schenectady
Westinghouse Elec. & Mfg. Co., E. Pitts-
burgh
Indicating
Bristol Co., The, Waterbury, Conn.
Ferranti, Ltd., London, Eng.
Ferranti Meter & Transformer Mfg. Co.,
Ltd., Toronto, Ont.
General Electric Co., Schenectady
Jewell Elec. Instrument Co., Chicago
Roller-Smith Co., New York
Westinghouse Elec. & Mfg. Co., E. Pitts-
burgh
Integrating
Duncan Elec. Mfg. Co., Lafayette, Ind.
Ferranti, Ltd., London, Eng.
Ferranti Meter & Transformer Mfg. Co.,
Ltd., Toronto, Ont.
General Electric Co., Schenectady
Roller-Smith Co., New York
Sangamo Elec. Co., Springfield, Ill.
Western Electric Co., All Principal Cities
Westinghouse Elec. & Mfg. Co., E. Pitts-
burgh
Radio
General Radio Co., Cambridge, Mass.
Jewell Elec. Instrument Co., Chicago
Repairing and Testing
Electrical Testing Laboratories, New York
Jewell Elec. Instrument Co., Chicago

Please mention the JOURNAL of the A. I. E. E. when writing to advertisers.

Thrust!

TIMKEN-EQUIPPED ALLIS-CHALMERS VERTICAL MOTOR

Thrust capacity is the first requisite of vertical motor bearings. Absolute dependability is the first requisite of deep well pump drive. Qualifications like these regularly lead to the choice of Timken-equipped motors, available today through Allis-Chalmers and other leading manufacturers.

By providing higher capacity for loads from all directions Timken Bearings provide more than the expected anti-friction economies. To all possible savings of lubricant and power Timkens add the value of extreme overload capacity. In any position on any form of drive Timken Bearings resist all forms of wear equally well. Only Timken Taper and Timken *POSITIVE ROLL ALIGNMENT* make it possible.

THE TIMKEN ROLLER BEARING CO., CANTON, OHIO

Technical information regarding bearing sizes and mountings is obtainable from the Timken Roller Bearing Service & Sales Company's Branches located in the following cities: Atlanta, Boston, Buffalo, Chicago, Cincinnati, Cleveland, Dallas, Denver, Detroit, Kansas City, Los Angeles, Memphis, Milwaukee, Minneapolis, Newark, New York, Omaha, Philadelphia, Pittsburgh, Richmond, St. Louis, San Francisco, Seattle, Toronto, Winnipeg

TIMKEN
Tapered
ROLLER BEARINGS

Classified Advertiser's Index for Buyers—Continued

INSTRUMENTS ELECTRICAL—Continued

Scientific, Laboratory, Testing
 General Electric Co., Schenectady
 Jewell Elec. Instrument Co., Chicago
 Metropolitan Device Corp., Brooklyn, N. Y.
 Roller-Smith Co., New York
 Western Electric Co., All Principal Cities
 Westinghouse Elec. & Mfg. Co., E. Pittsburgh
 Weston Elec. Inst. Corp., Newark, N. J.

Telegraph
 Western Electric Co., All Principal Cities

INSULATING MATERIALS

Board
 West Va. Pulp & Paper Co., New York

Cloth
 Acme Wire Co., New Haven, Conn.
 Irvington Varnish & Ins. Co., Irvington, N. J.
 Minerallac Electric Co., Chicago
 Westinghouse Elec. & Mfg. Co., E. Pittsburgh

Composition
 American Lava Corp., Chattanooga
 Bakelite Corporation, New York
 Belden Mfg. Co., Chicago
 Westinghouse Elec. & Mfg. Co., E. Pittsburgh

Compounds
 Minerallac Electric Co., Chicago
 Standard Underground Cable Co., Pittsburgh
 Western Electric Co., All Principal Cities

Fibre
 West Va. Pulp & Paper Co., New York

Lava
 American Lava Corp., Chattanooga, Tenn.

Mica
 New England Mica Co., Waltham, Mass.

Paper
 Acme Wire Co., New Haven, Conn.
 Irvington Varnish & Ins. Co., Irvington, N. J.
 Tullis, Russell & Co., Ltd., London, Eng.

Silk
 Acme Wire Co., New Haven, Conn.
 Irvington Varnish & Ins. Co., Irvington, N. J.

Tape
 Belden Mfg. Co., Chicago
 Minerallac Electric Co., Chicago
 Okonite Co., The, Passaic, N. J.
 Western Electric Co., All Principal Cities
 Westinghouse Elec. & Mfg. Co., E. Pittsburgh

Varnishes
 Acme Wire Co., New Haven, Conn.
 General Electric Co., Schenectady
 Irvington Varnish & Ins. Co., Irvington, N. J.
 Minerallac Electric Co., Chicago

INSULATORS, HIGH TENSION

Composition
 General Electric Co., Schenectady

Glass
 Hemingray Glass Co., Muncie, Ind.

Porcelain
 Canadian Porcelain Co., Ltd., Hamilton, Ont.
 General Electric Co., Schenectady
 Lapp Insulator Co., Inc., ReRoy, N. Y.
 Locke Insulator Corp., Baltimore
 Ohio Brass Co., Mansfield, O.
 Thomas & Sons Co., R., East Liverpool, O.
 Western Electric Co., All Principal Cities
 Westinghouse Elec. & Mfg. Co., E. Pittsburgh

Post Type
 Delta-Star Electric Co., Chicago

INSULATORS, TELEPHONE & TELEGRAPH
 Hemingray Glass Co., Muncie, Ind.
 Western Electric Co., All Principal Cities

LAMP GUARDS
 Matthews Corp., W. N., St. Louis
 Western Electric Co., All Principal Cities

LAVA
 American Lava Corp., Chattanooga

LIGHTING FIXTURES
 Cory & Son, Inc., Chas., New York

LIGHTNING ARRESTERS
 Delta-Star Electric Co., Chicago
 General Electric Co., Schenectady
 Western Electric Co., All Principal Cities
 Westinghouse Elec. & Mfg. Co., E. Pittsburgh

LOCOMOTIVES, ELECTRIC
 General Electric Co., Schenectady
 Westinghouse Elec. & Mfg. Co., E. Pittsburgh

MAGNETIC SEPARATORS
 Electric Controller & Mfg. Co., Cleveland

METERS, ELECTRICAL
 (SEE INSTRUMENTS, ELECTRICAL)

MICA
 New England Mica Co., Waltham, Mass.

MOLDED INSULATION
 Bakelite Corporation, New York
 Belden Mfg. Co., Chicago
 Burke Electric Co., Erie, Pa.
 Westinghouse Elec. & Mfg. Co., E. Pittsburgh

MOLYBDENUM
 Fansteel Products Co., Inc., North Chicago

MOTORS
 (See GENERATORS AND MOTORS)

OHMMETERS
 Cory & Son, Inc., Chas., New York

Jewell Elec. Instrument Co., Chicago
 Roller-Smith Co., New York
 Weston Elec. Instr. Corp., Newark, N. J.

OIL SEPARATORS & PURIFIERS
 DeLaval Separator Co., The, New York
 Sharples Specialty Co., The, Philadelphia

Westinghouse Elec. & Mfg. Co., E. Pittsburgh

PANEL BOARDS
 (See SWITCHBOARDS)

PATENT ATTORNEYS (See PROFESSIONAL ENGINEERING DIRECTORY)

PLUGS

Delta-Star Electric Co., Chicago
 General Electric Co., Schenectady
 Western Electric Co., All Principal Cities
 Westinghouse Elec. & Mfg. Co., E. Pittsburgh

POLES, STEEL

American Bridge Co., Pittsburgh

Pacific Coast Steel Co., San Francisco

Western Electric Co., All Principal Cities

POLES—TIES, WOOD

Western Electric Co., All Principal Cities

POTHEADS

G & W Electric Specialty Co., Chicago

Standard Underground Cable Co., Pittsburgh

Western Electric Co., All Principal Cities

PROTECTIVE DEVICES

Metropolitan Device Corp., Brooklyn, N. Y.

Western Electric Co., All Principal Cities

PULLERS, SLACK

Matthews Corp., W. N., St. Louis

PUMPS

Allis-Chalmers Mfg. Co., Milwaukee

PUMPS, SPIRAL

Cramp & Sons Ship & Engine Bldg. Co.,
 The Wm., Philadelphia

RADIO LABORATORY APPARATUS

General Radio Co., Cambridge, Mass.

Westinghouse Elec. & Mfg. Co., E. Pittsburgh

RAILWAY SUPPLIES, ELECTRIC

General Electric Co., Schenectady

Ohio Brass Co., Mansfield, O.

Western Electric Co., All Principal Cities

Westinghouse Elec. & Mfg. Co., E. Pittsburgh

REACTORS

General Electric Co., Schenectady

Metropolitan Device Corp., Brooklyn, N. Y.

RECTIFIERS

Fansteel Products Co., Inc., North Chicago

General Electric Co., Schenectady

Western Electric Co., All Principal Cities

Westinghouse Elec. & Mfg. Co., E. Pittsburgh

REELS, PAYOUT AND TAKEUP

Matthews Corp., W. N., St. Louis

REGULATORS, VOLTAGE

Burke Electric Co., Erie, Pa.

General Electric Co., Schenectady

Western Electric Co., All Principal Cities

Westinghouse Elec. & Mfg. Co., E. Pittsburgh

RELAYS

Cory & Son, Inc., Chas., New York

Electric Controller & Mfg. Co., Cleveland

General Electric Co., Schenectady

Westinghouse Elec. & Mfg. Co., E. Pittsburgh

RESISTOR UNITS

Allen-Bradley Co., Milwaukee

General Electric Co., Schenectady

Ward Leonard Electric Co., Mt. Vernon, N. Y.

RHEOSTATS

Allen-Bradley Co., Milwaukee

General Electric Co., Schenectady

Sundh Electric Co., Newark, N. J.

Ward Leonard Electric Co., Mt. Vernon, N. Y.

Western Electric Co., All Principal Cities

Westinghouse Elec. & Mfg. Co., E. Pittsburgh

ROPE, WIRE

American Steel & Wire Co., Chicago

Roebing's Sons Co., John A., Trenton, N. J.

SEARCHLIGHTS

General Electric Co., Schenectady

Westinghouse Elec. & Mfg. Co., E. Pittsburgh

SHEETS, ELECTRICAL

Trumbull Steel Co., The, Warren, O.

SOCKETS AND RECEPTACLES

General Electric Co., Schenectady

Western Electric Co., All Principal Cities

Westinghouse Elec. & Mfg. Co., E. Pittsburgh

SOLENOIDS

Acme Wire Co., New Haven, Conn.

Belden Mfg. Co., Chicago

Dudlo Mfg. Co., Ft. Wayne, Ind.

Electric Controller & Mfg. Co., Cleveland

General Electric Co., Schenectady

Sundh Electric Co., Newark, N. J.

Ward Leonard Electric Co., Mt. Vernon, N. Y.

Westinghouse Elec. & Mfg. Co., E. Pittsburgh

SPRINGS

American Steel & Wire Co., Chicago

STARTERS, MOTOR

Allen-Bradley Co., Milwaukee

Condit Electrical Mfg. Corp., Boston

Electric Controller & Mfg. Co., Cleveland

General Electric Co., Schenectady

Rowan Controller Co., Baltimore, Md.

Sundh Electric Co., Newark, N. J.

Ward Leonard Electric Co., Mt. Vernon, N. Y.

Westinghouse Elec. & Mfg. Co., E. Pittsburgh

STEEL, SHEET & STRIPS

Trumbull Steel Co., The, Warren, O.

STOKERS, MECHANICAL

Sturtevant Company, B. F., Boston

Westinghouse Elec. & Mfg. Co., E. Pittsburgh

SUB-STATIONS

General Electric Co., Schenectady

Westinghouse Elec. & Mfg. Co., E. Pittsburgh

WITCHBOARDS

Allis-Chalmers Mfg. Co., Milwaukee

Condit Electrical Mfg. Corp., Boston

General Electric Co., Schenectady

Metropolitan Device Corp., Brooklyn, N. Y.

Western Electric Co., All Principal Cities

Westinghouse Elec. & Mfg. Co., E. Pittsburgh

SWITCHES Automatic Time

Ferranti, Ltd., London, Eng.

Ferranti Meter & Transformer Mfg. Co.,
 Ltd., Toronto, Ont.

General Electric Co., Schenectady

Minerallac Electric Co., Chicago

Sundh Electric Co., Newark, N. J.

Westinghouse Elec. & Mfg. Co., E. Pittsburgh

Disconnecting

Burke Electric Co., Erie, Pa.

Condit Electrical Mfg. Corp., Boston

Delta-Star Electric Co., Chicago

General Electric Co., Schenectady

K-P-F Electric Co., San Francisco

Matthews Corp., W. N., St. Louis

Pacific Elec. Mfg. Co., San Francisco

Thoner & Martens, Boston

Fuse

General Electric Co., Schenectady

Matthews Corp., W. N., St. Louis

Metropolitan Device Corp., Brooklyn, N. Y.

Thoner & Martens, Boston

Knife

Condit Electrical Mfg. Corp., Boston

Electric Controller & Mfg. Co., Cleveland

General Electric Co., Schenectady

Matthews Corp., W. N., St. Louis

Western Electric Co., All Principal Cities

Westinghouse Elec. & Mfg. Co., E. Pittsburgh

Magnetic

Allen-Bradley Co., Milwaukee

Ward Leonard Electric Co., Mt. Vernon, N. Y.

Oil

Condit Electrical Mfg. Corp., Boston

General Electric Co., Schenectady

Pacific Elec. Mfg. Co., San Francisco

Western Electric Co., All Principal Cities

Westinghouse Elec. & Mfg. Co., E. Pittsburgh

Remote Control

Condit Electrical Mfg. Corp., Boston

General Electric Co., Schenectady

Rowan Controller Co., Baltimore

Sundh Electric Co., Newark, N. J.

Western Electric Co., All Principal Cities

Westinghouse Elec. & Mfg. Co., E. Pittsburgh

TANTALUM

Fansteel Products Co., Inc., North Chicago

TELEGRAPH APPARATUS

Western Electric Co., All Principal Cities

TELEPHONE EQUIPMENT

Cory & Son, Inc., Chas., New York

Western Electric Co., All Principal Cities

TESTING LABORATORIES

Electrical Testing Labs., New York

TOWERS, TRANSMISSION

American Bridge Co., Pittsburgh

Pacific Coast Steel Co., San Francisco

Western Electric Co., All Principal Cities

TRANSFORMERS

Allis-Chalmers Mfg. Co., Milwaukee

American Transformer Co., Newark, N. J.

Duncan Elec. Mfg. Co., Lafayette, Ind.

Ferranti, Ltd., London, Eng.

Ferranti Meter & Transformer Mfg. Co.,
 Ltd., Toronto, Ont.

General Electric Co., Schenectady

Kuhlman Electric Co., Bay City, Mich.

Moloney Electric Co., St. Louis

Pittsburgh Transformer Co., Pittsburgh

Western Electric Co., All Principal Cities

Furnace

Allis-Chalmers Mfg. Co., Milwaukee

American Transformer Co., Newark, N. J.

Moloney Electric Co., St. Louis

Pittsburgh Transformer Co., Pittsburgh

Metering

American Transformer Co., Newark, N. J.

Ferranti, Ltd., London, Eng.

Ferranti Meter & Transformer Mfg. Co.,
 Ltd., Toronto, Ont.

Pittsburgh Transformer Co., Pittsburgh

Mill Type

Pittsburgh Transformer Co., Pittsburgh

Radio

American Transformer Co., Newark, N. J.

Street Lighting

Kuhlman Electric Co., Bay City, Mich.

Western Electric Co., All Principal Cities

TROLLEY LINE MATERIALS

General Electric Co., Schenectady

Ohio Brass Co., Mansfield, O.

Western Electric Co., All Principal Cities

Westinghouse Elec. & Mfg. Co., E. Pittsburgh



Going down a mile today to insure good service tomorrow

A mine wanted cable—a mile of it—to suspend in a vertical shaft where it would be constantly exposed to a downpour of water.

Ordinary cable might do the job—and it might not!

Before even making an estimate, the G-E Wire & Cable Specialist, clad in heavy oilskins and hip boots, spent more than three hours examining the shaft from top to bottom with the result that he was able to specify cable which he knew would meet successfully all conditions of the installation.

An exceptional case? No. An exceptional installation possibly, but just one example of the service which assures you that the cable you purchase from General Electric is the cable best suited for the work.



All G-E Wire and Cable, from the highest voltage to the lowest, is of one quality—the quality that is inherent in all material bearing the G-E monogram.

GENERAL ELECTRIC⁸¹⁰⁻²

GENERAL ELECTRIC COMPANY, SCHENECTADY, N. Y., SALES OFFICES IN PRINCIPAL CITIES

Please mention the JOURNAL of the A. I. E. E. when writing to advertisers.

Science Abstracts

ALL electrical engineers actively engaged in the practice of their profession should subscribe to "Science Abstracts."

Published monthly by the Institution of Electrical Engineers, London, in association with the Physical Society of London, and with the cooperation of the American Institute of Electrical Engineers, the American Physical Society and the American Electrochemical Society, they constitute an invaluable reference library.

Through "Science Abstracts" engineers are enabled to keep in touch with engineering progress throughout the world, as one hundred and sixty publications, in various languages, are regularly searched and abstracted. "Science Abstracts" are published in two sections, as follows:

"A"—PHYSICS—deals with electricity, magnetism, light, heat, sound, astronomy, chemical physics.

"B"—ELECTRICAL ENGINEERING—deals with electrical plant, power transmission, traction, lighting, telegraphy, telephony, wireless telegraphy, prime movers, engineering materials, electrochemistry.

Through special arrangement, members of the A. I. E. E. may subscribe to "Science Abstracts" at the reduced rate of \$5.00 for each section, and \$10 for both. Rates to non-members are \$7.50 for each section and \$12.50 for both.

Subscriptions should start with the January issue. The first volume was issued in 1898. Back numbers are available, and further information regarding these can be obtained upon application to Institute headquarters.

American Institute of Electrical Engineers
33 West 39th Street, New York



Classified Advertiser's Index for Buyers—Continued

TURBINES, HYDRAULIC

Allis-Chalmers Mfg. Co., Milwaukee
Cramp & Sons Ship & Engine Bldg. Co.,
The Wm., Philadelphia

TURBINES, STEAM

Allis-Chalmers Mfg. Co., Milwaukee
General Electric Co., Schenectady
Sturtevant Company, B. F., Boston.
Western Electric Co., All Principal Cities
Westinghouse Elec. & Mfg. Co., E. Pitts-
burgh

TURBINE SIGNAL SYSTEMS

Cory & Son, Inc., Chas., New York

TURBO-GENERATORS

Allis-Chalmers Mfg. Co., Milwaukee
Westinghouse Elec. & Mfg. Co., E. Pitts-
burgh

VALVE CONTROL, ELECTRIC

Bristol Company, The, Waterbury, Conn.
Cory & Son, Inc., Chas., New York

VALVES, JOHNSON HYDRAULIC

Cramp & Sons Ship & Engine Bldg. Co.,
The Wm., Philadelphia

VARNISHES, INSULATING

General Electric Co., Schenectady
Irvington Varnish & Ins. Co., Irvington, N. J.
Minerallac Electric Co., Chicago
Westinghouse Elec. & Mfg. Co., E. Pitts-
burgh

WELDING EQUIPMENT, ELECTRICAL

General Electric Co., Schenectady
Lincoln Electric Co., The, Cleveland
Ohio Brass Co., Mansfield, O.
Westinghouse Elec. & Mfg. Co., E. Pitts-
burgh

WIRES AND CABLES

Armored Cable
American Steel & Wire Co., Chicago
Atlantic Ins. Wire & Cable Co., Rome, N. Y.
Belden Mfg. Co., Chicago
Boston Ins. Wire & Cable Co., Boston
General Electric Co., Schenectady
Hazard Manufacturing Co., Wilkes-Barre, Pa.
Kerite Ins. Wire & Cable Co., New York
Okonite Company, The, Passaic, N. J.
Roebling's Sons Co., John A., Trenton, N. J.
Simplex Wire & Cable Co., Boston
Standard Underground Cable Co., Pittsburgh
Western Electric Co., All Principal Cities

Asbestos Covered
American Steel & Wire Co., Chicago
Atlantic Ins. Wire & Cable Co., Rome, N. Y.
Belden Mfg. Co., Chicago
General Electric Co., Schenectady

Automotive
American Steel & Wire Co., Chicago
Atlantic Ins. Wire & Cable Co., Rome, N. Y.
Belden Mfg. Co., Chicago
Boston Ins. Wire & Cable Co., Boston
General Electric Co., Schenectady
Kerite Ins. Wire & Cable Co., New York
Roebling's Sons Co., John A., Trenton, N. J.
Simplex Wire & Cable Co., Boston
Standard Underground Cable Co., Pittsburgh
Western Electric Co., All Principal Cities

Bare Copper
American Ins. Wire & Cable Co., Chicago
American Steel & Wire Co., Chicago
Anaconda Copper Mining Co., Chicago
Atlantic Ins. Wire & Cable Co., Rome, N. Y.
Belden Mfg. Co., Chicago
Copperweld Steel Co., Rankin, Pa.
Hazard Manufacturing Co., Wilkes-Barre, Pa.
Roebling's Sons Co., John A., Trenton, N. J.
Standard Underground Cable Co., Pittsburgh
Western Electric Co., All Principal Cities

Copper Clad
American Steel & Wire Co., Chicago
Copperweld Steel Co., Rankin, Pa.
Standard Underground Cable Co., Pittsburgh
Western Electric Co., All Principal Cities

Flexible Cord
American Steel & Wire Co., Chicago
Atlantic Ins. Wire & Cable Co., Rome, N. Y.
Belden Mfg. Co., Chicago
Boston Ins. Wire & Cable Co., Boston
General Electric Co., Schenectady
Hazard Manufacturing Co., Wilkes-Barre, Pa.
Okonite Company, The, Passaic, N. J.
Roebling's Sons Co., John A., Trenton, N. J.
Simplex Wire & Cable Co., Boston
Standard Underground Cable Co., Pittsburgh
Western Electric Co., All Principal Cities

Fuse
American Steel & Wire Co., Chicago
General Electric Co., Schenectady
Roebling's Sons Co., John A., Trenton, N. J.
Western Electric Co., All Principal Cities

Lead Covered (Paper and Varnished cambric insulated)

American Steel & Wire Co., Chicago
Anaconda Copper Mining Co., Chicago
Atlantic Ins. Wire & Cable Co., Rome, N. Y.
General Electric Co., Schenectady
Hazard Manufacturing Co., Wilkes-Barre, Pa.
Kerite Ins. Wire & Cable Co., New York
Okonite Company, The, Passaic, N. J.

Okonite-Callender Cable Co., The, Inc.,
Passaic, N. J.

Roebling's Sons Co., John A., Trenton, N. J.
Simplex Wire & Cable Co., Boston
Standard Underground Cable Co., Pittsburgh
Western Electric Co., All Principal Cities

Magnet
American Steel & Wire Co., Chicago
Atlantic Ins. Wire & Cable Co., Rome, N. Y.
Belden Mfg. Co., Chicago
Dudlo Mfg. Corp., Fort Wayne, Ind.
General Electric Co., Schenectady
Roebling's Sons Co., John A., Trenton, N. J.
Standard Underground Cable Co., Pittsburgh
Western Electric Co., All Principal Cities

Rubber Insulated
American Steel & Wire Co., Chicago
Atlantic Ins. Wire & Cable Co., Rome, N. Y.
Belden Mfg. Co., Chicago
Boston Ins. Wire & Cable Co., Boston
General Electric Co., Schenectady
Hazard Manufacturing Co., Wilkes-Barre, Pa.
Kerite Ins. Wire & Cable Co., New York
Okonite Company, The, Passaic, N. J.
Roebling's Sons Co., John A., Trenton, N. J.
Simplex Wire & Cable Co., Boston
Standard Underground Cable Co., Pittsburgh
Western Electric Co., All Principal Cities

Tree Wire
Hazard Manufacturing Co., Wilkes-Barre, Pa.
Okonite Company, The, Passaic, N. J.
Simplex Wire & Cable Co., Boston

Trolley
American Steel & Wire Co., Chicago
Anaconda Copper Mining Co., Chicago
Atlantic Ins. Wire & Cable Co., Rome, N. Y.
Copperweld Steel Co., Rankin, Pa.
Roebling's Sons Co., John A., Trenton, N. J.
Standard Underground Cable Co., Pittsburgh
Western Electric Co., All Principal Cities

Weather proof
American Ins. Wire & Cable Co., Chicago
American Steel & Wire Co., Chicago
Anaconda Copper Mining Co., Chicago
Atlantic Ins. Wire & Cable Co., Rome, N. Y.
Copperweld Steel Co., Rankin, Pa.
General Electric Co., Schenectady
Kerite Ins. Wire & Cable Co., New York
Okonite Company, The, Passaic, N. J.
Roebling's Sons Co., John A., Trenton, N. J.
Simplex Wire & Cable Co., Boston
Standard Underground Cable Co., Pittsburgh
Western Electric Co., All Principal Cities

Please mention the JOURNAL of the A. I. E. E. when writing to advertisers.

Holabird & Roche, Chicago - Architects
 George A. Fuller Co., Chicago—New York
 General Contractors
 L. K. Comstock & Co., Chicago
 Electrical Contractors



THE NEW PALMER HOUSE, Chicago Wired with
American Steel & Wire
 Company's
RUBBER-COVERED WIRE

We take distinct pride in the selection of our product for this building. It not only further proves the many superiorities of the wire, but is an excellent example of the standing of American Steel & Wire Company electrical wire with leading architects and contractors.

buildings of any size, large or small, American Steel & Wire Company wire may be specified and used with perfect confidence in its long satisfactory service. . . . Let us send you an indexed catalog and handbook of Electrical Wires and Cables. Estimates furnished promptly from any of our offices in all of the principal cities.

When wire specifications are most exacting for

SALES OFFICES

- | | | | | |
|--|---|---------------------------------------|---|--|
| CHICAGO 208 So. La Salle Street | ST. LOUIS 506 Olive Street | NEW YORK 30 Church Street | WORCESTER 94 Grove Street | DALLAS Praetorian Bldg. |
| CLEVELAND Rockefeller Bldg. | KANSAS CITY 417 Grand Avenue | BOSTON 185 Franklin Street | BALTIMORE 32 So. Charles Street | DENVER First National Bank Bldg. |
| DETROIT Foot of First Street | OKLAHOMA CITY First National Bank Bldg. | PITTSBURGH Frick Bldg. | BUFFALO 670 Ellicott Street | |
| CINCINNATI Union Trust Bldg. | BIRMINGHAM Brown-Marx Bldg. | PHILADELPHIA Widener Bldg. | WILKESBARRE Miners Bank Bldg. | SALT LAKE CITY Walker Bk. Bldg. |
| MINNEAPOLIS—ST. PAUL Merchants Nat'l Bk. Bldg., St. Paul | MEMPHIS Union and Planters Bank Bldg. | ATLANTA 101 Marietta Street | | |

UNITED STATES STEEL PRODUCTS COMPANY, San Francisco, Los Angeles, Portland, Seattle

Please mention the JOURNAL of the A. I. E. E. when writing to advertisers.

MIDWEST FILTERED AIR for the Power Plant

PERFORMANCE REPORT
Midwest Air Filters
for Turbo Alternators

Total Cost of Filters—\$1169.
Total Annual Saving
in Power and Labor—\$35,611.

**These Midwest Air Filters Pay
for Themselves Every Ten Days!**

Ask Dept. E for the certified performance report on these filters on the turbo generators of a large Ohio steel mill. It contains much valuable information for the central station executive.



MIDWEST AIR FILTERS
BRADFORD PENNSYLVANIA Offices in Principal Cities

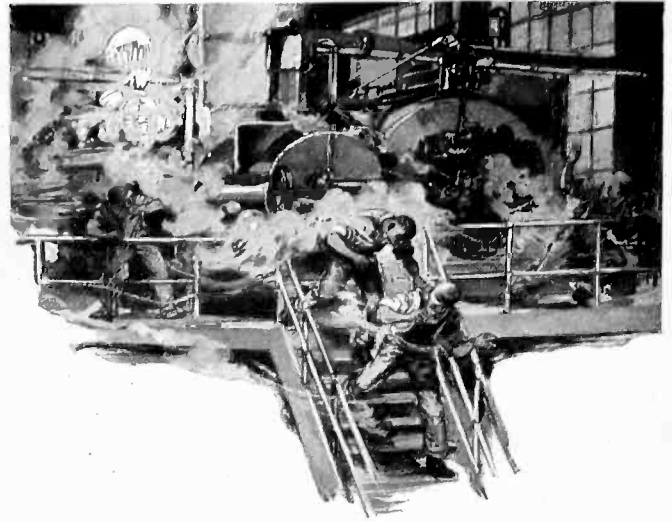

Remote electrical operation of valves

takes the teeth out of hazards
and makes daily routine operation
merely a matter of pressing buttons!

Cory-Recony Standardized Units

are made in five sizes for valves
2" and upwards for every service.

Write for descriptive bulletin

CHAS. CORY & SON, INC.

183-7 VARICK ST., NEW YORK

BOSTON BALTIMORE DETROIT SEATTLE
PHILADELPHIA NEW ORLEANS CHICAGO SAN FRANCISCO

ALPHABETICAL LIST OF ADVERTISERS

	PAGE		PAGE		PAGE
Acme Wire Company, The	46	Electro Dynamic Company	40	Ohio Brass Company, The	18
Alexander & Dowell	54	Engineering Directory	54, 55	Okonite Company, The	3rd Cover
Allen-Bradley Company	41	Fansteel Products Company, The	32	Okonite-Callender Cable Co., Inc.	3rd Cover
Allis-Chalmers Manufacturing Co.	4	Fennessy, David V.	54	Ophuls & Hill, Inc.	55
Ambursen Construction Company, Inc.	54	Ferranti, Limited	6	Osgood, Farley	55
American Appraisal Company, The	54	Ford, Bacon & Davis, Inc.	54	Pacent Electric Company, Inc.	52
American Bridge Company	26	Fowle & Company, Frank F.	54	Pacific Coast Steel Company	30
American Insulated Wire & Cable Co.	28	Frey Engineering Company	54	Pacific Electric Mfg. Company	35
American Lava Corporation	44	G & W Electric Specialty Company	29	Pittsburgh Transformer Company	38
American Lead Pencil Company	42	General Electric Company	8, 9, 14, 17, 20, 22, 59	Public Service Production Company	55
American Steel & Wire Company	61	General Radio Company	53	Research Narratives	34, 53
American Transformer Company	24	Gerry, M. H., Jr.	54	Roebbling's Sons Company, John A.	28
Anaconda Copper Mining Company	11	Green, A. Barnett	54	Roller-Smith Company	38
Atlantic Insulated Wire & Cable Co.	28	Harza, L. F.	54	Rowan Controller Company, The	38
Bakelite Corporation	51	Hazard Manufacturing Company	26	Sanderson & Porter	55
Barstow & Company, Inc., W. S.	54	Hemingray Glass Company	34	Sangamo Electric Company	21
Bathey & Kipp, Inc.	54	Henry, Augustus M.	54	Sargent & Lundy, Inc.	55
Belden Manufacturing Company	47	Hoosier Engineering Company	54	Science Abstracts	60
Black & Veatch	54	Irvington Varnish & Insulator Company	46	Scofield Engineering Company	55
Boston Insulated Wire & Cable Co.	28	Jackson & Moreland	55	Sharples Specialty Company	37
Bristol Company, The	30	Jewell Electrical Instrument Company	31	Simplex Wire & Cable Company	27
Burke Electric Company	34	Journal of A. I. E. E. Increased Rates	50	Sirrine & Co., J. E.	55
Burdy Engineering Co., Inc.	27	Kerite Insulated Wire & Cable Co., Inc.	1	Standard Steel & Bearings, Inc.	45
Byllesby Engineering & Management Corp.	54	Kidde & Co., Inc., Walter	Back Cover	Standard Underground Cable Company	29
Canadian Porcelain Company, Ltd.	34	K-P-F Electric Company	30	Star Electric Motor Company	40
Century Electric Company	40	Kuhlman Electric Company	25	Stevens, John A.	55
Chandeysson Electric Company	39	Lapp Insulator Company, Inc.	34	Stevens & Wood, Inc.	55
Christmas Seals	52	Library, Engineering Societies	44	Stockbridge & Borst	55
Clark, Walter G.	54	Lincoln, E. S.	55	Stone & Webster, Inc.	55, 63
Classified Advertisements	42	Lincoln Electric Company, The	7	Sturtevant, B. F., Company	40
Clement, Edward E.	54	Locke Insulator Corporation	15	Sundh Electric Company	30
Clewell, C. E.	54	Manufacturers' & Inventors' Elec. Co.	44	Thomas, Percy H.	55
Condit Electrical Manufacturing Corp.	13	Master Electric Company, The	42	Thomas & Sons Company, The R.	34
Copperweld Steel Company	28	Matthews Corporation, W. N.	19	Thoner & Martens	31
Cory & Son, Inc., Chas.	62	McClellan & Junkersfeld, Inc.	55	Timken Roller Bearing Company	57
Cramp & Sons, S. & E. Bldg Co., The Wm.	23	Metropolitan Device Corporation	64	Trumbull Steel Company, The	44
Cutter Company, The	5	Midwest Air Filters, Inc.	62	Tullis, Russell & Co., Ltd.	48
Danne, Harold A.	54	Minerallac Electric Company	28	U. G. I. Contracting Company, The	55
Day & Zimmermann, Inc.	54	Moloney Electric Company	24	Viele, Blackwell & Buck	55
De Laval Separator Company	38	Moore & Company, W. E.	55	Ward Leonard Electric Company	33
Delta-Star Electric Company	31	Morganite Brush Company, Inc., The	44	West Va. Pulp & Paper Company	46
Dessert & Company	16	Neall, N. J.	55	Western Electric Company	10
Dubilier Condenser & Radio Corp.	32	Neiler, Rich & Company	55	Westinghouse Elec. & Mfg. Co.	12, 36
Dudlo Manufacturing Corporation	49	New Departure Manufacturing Co., The	3	Weston Electrical Instrument Corp.	53
Duncan Electric Manufacturing Co.	30	New England Mica Company	46	White Engineering Corp., The J. G.	55
Electric Controller & Mfg. Co., The	2	Norma-Hoffmann Bearings Corporation	43	Wireless Specialty Apparatus Company	32
Electric Specialty Company	38			Wray & Company, J. G.	55
Electrical Testing Laboratories	44				

(For classified list of Advertisers see pages 56, 58 and 60.)

Please mention the JOURNAL of the A. I. E. E. when writing to advertisers.

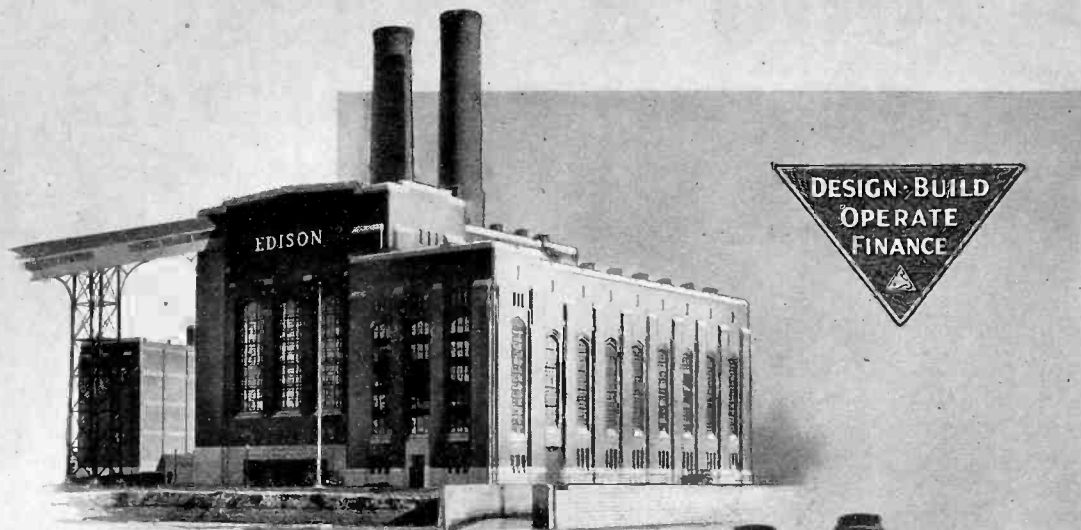

EDGAR STATION
The Edison Electric
Illuminating Company
of Boston.

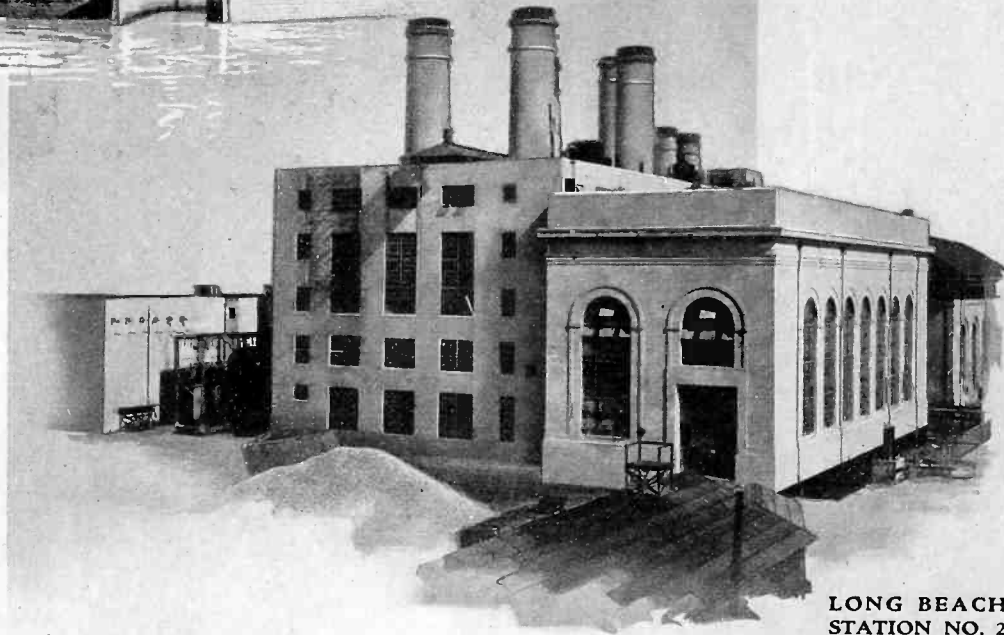

**LONG BEACH
STATION NO. 2**
Southern California
Edison Company.

STONE & WEBSTER built both in 1925.
Now doubling the power for both clients.

STONE & WEBSTER
INCORPORATED

BOSTON, 147 Milk Street
NEW YORK, 120 Broadway
CHICAGO, First National Bank Bldg.

PHILADELPHIA, Real Estate Trust Bldg.
SAN FRANCISCO, Holbrook Bldg.
PITTSBURGH, Union Trust Bldg.

2000 KVA

3040 AMP. 10% 11400 VOLT 25 CYCLE

BUS TIE REACTOR

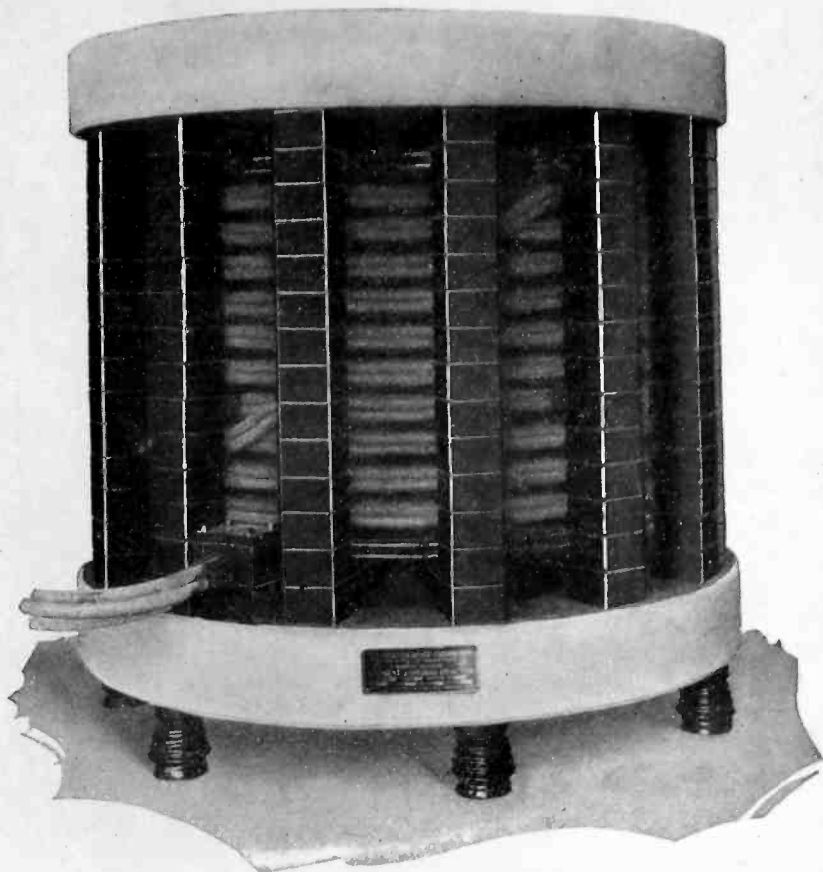

Metropolitan Current Limiting Reactors of this rating are being installed in the new East River Station of the New York Edison Co., and will provide maximum short circuit protection between 60,000 KVA Bus Sections.

When in the market buying "short circuit protection" send us your inquiries—it puts you under no obligation.

Metropolitan Device Corporation
 1250 Atlantic Avenue
 BROOKLYN, NEW YORK

METROPOLITAN DEVICE CORPORATION
 1250 Atlantic Avenue, Brooklyn, N. Y.

Gentlemen: Please send me 32-page booklet describing Metropolitan Current Limiting Reactors.

Name..... Company.....
 Address..... Title.....

Please mention the JOURNAL of the A. I. E. E. when writing to advertisers.