

# RADIO GUIDE 1927.



**Amalgamated Wireless**  
*(Australasia) Ltd*

47 York St., Sydney.  
Charles St., Adelaide

167/9 Queen St. Melbourne  
Queen St., Brisbane



**Price One Shilling**

# AMALGAMATED WIRELESS (AUSTRALASIA) LIMITED.

CAPITAL : £1,000,000

## BOARD OF DIRECTORS:

Sir GEORGE MASON ALLARD, K.B. (Chairman).  
Sir WM. VICARS, K.B., C.B.E.  
Rt. Hon. W. M. HUGHES, P.C., K.C.  
C. P. BARTHOLOMEW, Esq  
ERNEST T. FISK, Esq.  
W. T. APPLETON, Esq.  
Senator J. D. MILLEN.

## EXECUTIVE OFFICERS:

E. T. FISK, Fellow I.R.E., A.M.I.E. (Aus.), Managing Director.  
L. A. HOOKE, Deputy General Manager.  
J. F. WILSON, A.C.I.S., Secretary and Assistant Manager.  
J. L. MULHOLLAND, Assistant Manager.  
P. R. HILL, A.C.A., Accountant.  
A. S. McDONALD, M.Inst.R.E., Chief Engineer.

## SALES DEPARTMENT:

Sydney Sales Manager: W. J. J. WING.  
Melbourne Sales Manager: A. P. HOSKING.  
Assistant: P. MANLEY.  
New Zealand Manager: G. ROBERTSON.  
X-Ray Department Manager: L. E. BURT.  
Adelaide Representative: H. LEMON.  
Brisbane Representative: J. A. McINTYRE.

## PRODUCTION DEPARTMENT:

Production Manager: S. M. GRIME, A.M.I.E. (Aus.).  
Works Manager: E. A. HORNER, A.M.I.E. (Aus.).

## PUBLICITY DEPARTMENT:

F. W. LARKINS, A.I.L.A., A.C.I.S., Dip.Econ.

## PATENT DEPARTMENT:

C. E. TAPP.

## TELEGRAPH DEPARTMENT:

### Transocean and Coastal Services:

Traffic Manager: G. APPERLEY.  
Traffic Officer: G. J. WESTON.  
Superintendent: W. G. CLARK.

## MARINE SERVICE:

Marine Superintendent: W. H. C. PHILLIPS.  
Staff Welfare Superintendent: S. TOOMBS.

## MARCONI SCHOOL OF WIRELESS:

Chief Instructor: H. BUIK.

## TRANSOCEAN WIRELESS NEWS:

W. J. MARTIN.



# RADIO GUIDE

---

Amalgamated Wireless (Australasia) Ltd.

"Wireless House," York Street, Sydney

"Wireless House, 167 Queen Street, Melbourne  
King and King Chambers, Queen St Brisbane

Bower's Building, Charles St., Adelaide

Australasia Chambers, Wellington, N.Z.





**E.T. FISK**

M. Inst. R.E., A.M.I.E. (Aust.)

Managing Director

Amalgamated  
Wireless (Asia) Ltd.

*E.T. Fisk*

# Index to Radio Guide.

## WIRELESS ACTIVITIES.

	Page
Trans-Ocean Communication . . . . .	9
Direct Wireless Services between Australia and England . . . . .	10-11
Coastal Radio Services . . . . .	14
Island Radio Services . . . . .	16
Marine Wireless Services . . . . .	17
Outstanding Broadcasting Transmissions in 1926 . . . . .	18
Wireless on Barren Jack Hydro-Electric Scheme . . . . .	22-23
Wireless on New Guinea Goldfields . . . . .	25
Lighthouse Communication . . . . .	26
Record Long-Distance Short-Wave Communication . . . . .	28-29
Wireless on The Great White Train . . . . .	30
Ocean Newspapers . . . . .	32
Wireless in Outback Australia . . . . .	33
Wireless in Hospitals . . . . .	34
Police Wireless . . . . .	36

## RECEIVERS.

Crystal Set . . . . .	42
Radiola IV.C . . . . .	43
Six and Eight Valve Receivers . . . . .	44
Radiola Standard Six . . . . .	45
Radiola Senior Six . . . . .	46
Radiola Super Six . . . . .	47
Radiola Super Eight . . . . .	48
Radiola Portable Super . . . . .	49

## ACCESSORIES.

C.A.V. Accumulators . . . . .	51
Clyde Accumulators . . . . .	51
Sturdee Hydrometer, Battery Clips . . . . .	51
Battery Chargers . . . . .	52
Battery Cables . . . . .	52
Ever-Ready Batteries . . . . .	52
Columbia Batteries . . . . .	53
Darimont Primary Batteries . . . . .	55



## A.W.A. RADIO GUIDE

	Page
Keeping the Set Fit . . . . .	113
The Loud Speaker . . . . .	114
Fault-Finding in Radio Receivers . . . . .	115-116
Valve Precautions . . . . .	117
The Use of the Marine Direction Finder . . . . .	118-119
Broadcasting Time Schedule . . . . .	120
Commonwealth Wireless Licenses . . . . .	121
Number of Australian Broadcasting Licenses . . . . .	122
Home Construction Receiver Circuit Diagrams . . . . .	123
Single Valve Regenerative Receiver . . . . .	124
Two Valve Receiver . . . . .	124
Three Valve Receiver . . . . .	125
Two Valve Low Frequency Amplifier . . . . .	125
Two Stage Amplifier . . . . .	126
Three Valve Receiver . . . . .	126
Selective Four Valve Receiver . . . . .	127
Five Valve Receiver . . . . .	127
Four Valve Browning Drake Circuit . . . . .	128
Five Valve Neutralised Circuit . . . . .	128
Wave Trap Circuit . . . . .	129
Two Valve Crystal Reflex Circuit . . . . .	129
Map showing Distances between Australian Broadcasting Stations . . . . .	130
Technical Terms used in Radio . . . . .	131-133
World's Standard Time Chart . . . . .	134
Series and Parallel Battery Diagrams . . . . .	135
Some Useful Formulae . . . . .	136
Wireless Symbols . . . . .	137
International Morse Code . . . . .	138
Condenser and Inductance Formulae . . . . .	139-140
Radiotelegraphic Abbreviations . . . . .	141
Frequency & Wave Length Tables . . . . .	142
Useful Data . . . . .	143

### CALL SIGNS AND LICENSES.

Empire Beam Wireless . . . . .	144
Coast Stations . . . . .	146
Australian Short Wave Stations . . . . .	147
H.M. Australian Ships . . . . .	147

## A.W.A. RADIO GUIDE

Australian & New Zealand Ship Stations .. .. .	149-150
Short Wave Stations .. .. .	151-153
Australian Broadcasting Stations .. .. .	154
American Broadcasting Stations .. .. .	155
Australian Transmitting Licenses .. .. .	156-161
Q.S.T. Card of 2M.E. .. .. .	162
New Zealand Broadcasting Stations .. .. .	163
New Zealand Amateur Transmitting Stations .. .. .	164-165
Radiola Dealers' Service .. .. .	166
Radio Dealers (from whom goods shown in this Guide can be obtained)	167-174
Wireless Publications .. .. .	175

### ILLUSTRATIONS.

Australian Beam Stations .. .. .	12, 13, 102, 103, 108, 109, 145
Coastal Radio Set .. .. .	15
Control Room and Broadcasting Studio, Farmers' Broadcasting Service, 2F.C.	19
1, Mount Kosciusko; 2, Jenolan Caves; 3, Balmain Collieries .. .. .	20
1, Randwick Racecourse; 2, Trawler; 3, Aeroplane .. .. .	21
Burren Jack Hydro-Electric Scheme .. .. .	24
Lighthouse Wireless Apparatus .. .. .	27
Short Wave Transmitter & Receiver on "Jervis Bay" .. .. .	29
Wireless Exhibit of A.W.A. on the Great White Train .. .. .	31
Radiola Hospital Equipment installed at Ryde Home .. .. .	35
Wireless on Police Patrol Cars .. .. .	37
Broadcasting Equipment at Farmers' Broadcasting Station, 2F.C. .. .. .	39
Section Machine Shop—A.W.A. Radio-Electric Works .. .. .	41
Scenes from 4Q.G., Brisbane .. .. .	50
Main Mast at Radio Centre, Sydney .. .. .	54
400ft. Mast at Pennant Hills, Sydney .. .. .	60
5K.W. Broadcast Transmitting Equipment .. .. .	70
Broadcasting Studios at 3L.O., Melbourne .. .. .	75
A.W.A. Valve Manufacturing Plant .. .. .	86
The Aerial System of 4Q.G. .. .. .	96
Australian Air Line Distances .. .. .	130
T.S.S. "Jervis Bay" Short Wave Set .. .. .	148
Wireless House, Sydney .. .. .	169
Wireless House, Melbourne .. .. .	171



## Trans-Ocean Communication.

---

The greatest service of wireless will be its utility in Empire trans-ocean communication, and this phase of development, viz., the establishment of a direct wireless telegraph service between Australia and England and between Australia and Canada has been an objective for which Mr. E. T. Fisk, Managing Director of Amalgamated Wireless (A/sia), Limited, has striven for the past ten years. Visualising this application of wireless as an International and Imperial necessity, and as an absolutely essential factor in the development of the economic resources of the Commonwealth, he has backed it with an unlimited faith and against almost overwhelming opposition striven tenaciously for its accomplishment.

Mr. Fisk's belief in the efficiency of a direct commercial wireless service between England and Australia, as against a relay system, is based upon careful scientific experiments and observations extending over a consecutive period of nearly ten years, in the course of which he has made exhaustive tests of the conditions at all hours and in all seasons, in conjunction with every high-power station in the world. From this work a mass of unique and extremely valuable scientific information has been secured.

Remarkable reception results have been obtained by Mr. Fisk and the staff of Amalgamated Wireless in long distance working experiments.

On September 22nd, 1918, the first direct wireless telegraph messages from England to Australia were transmitted by arrangement with Senator G. Marconi from the Marconi Transmitting Station at Carnarvon, Wales, and were received instantaneously, by Mr. E. T. Fisk at his experimental wireless station at Wahroonga, N.S.W., with apparatus designed and manufactured in Sydney.

The first successful transmission on low power short wave signals from England to Australia took place in January, 1924, from the Marconi Station at Poldhu, Cornwall, to Vaucluse, Sydney. Wireless telephonic communication was established in May, 1924, between the same stations, and the first transmission of wireless telegraphic signals from Australia to England took place on 10th November, 1924.

## Direct Wireless Service Between Australia and England.

Work is now proceeding speedily and satisfactorily in connection with the construction of the Australian Beam Wireless Stations.

A great number of men are now employed on the sites in the erection of the administrative buildings and bungalows for the staff; others are engaged in building roads and constructing water services, while the engineers are busily engaged in installing the specially designed wireless plant.

After careful investigation and experiment, the Beam Station sites were selected in the south-eastern portion of Australia.

At Ballan, 50 miles from Melbourne, a large beam transmitting station has been built, and a small village has been erected, consisting of bungalows, single men's quarters and club house for the staff of men who will take charge of the apparatus producing the wireless beams.

At Rockbank, 15 miles from Melbourne, a receiving station is nearing completion, at which the energy of the wireless beams from England and Canada will be collected and concentrated, and from there conveyed over a land wire into the city of Melbourne. At Rockbank another small village is being built to accommodate the staff which will keep this receiving equipment in operation.

The two sites are 25 miles apart, sufficiently distant for technical purposes, i.e., to permit duplex working, but easily accessible for management.

Each transmitting and receiving station will have three masts 650 feet apart and 250 feet high. They have been constructed of lattice steel and each weighs 50 tons. In all 12 masts will be used for the four stations, the total weight being 600 tons.

The actual time of transmission between England and Australia of a wireless signal under the Beam System is approximately one-eighteenth of a second. The operating capacity of the entire system will range from 80 words a minute to at least 400 words a minute, because it will be possible to handle four messages simultaneously by two stations receiving and two transmitting.

With improvements that are now being tested, there are good prospects that this speed in any single direction will go up to 200 words a minute.

As in other countries, the transmission and reception will actually be operated from Central city offices by distant control—the work at the transmitting and receiving station will be automatic only.

One station will be capable of sending a concentrated beam of wireless energy direct to London over the north-western great circle or the south-eastern great circle at will; if this beam were sent in both directions simultaneously, it would form a sort of wireless ribbon completely encircling the earth. The other station will send a concentrated beam of wireless energy direct from Australia across the Pacific Ocean, over the whole of Canada, into a station near Montreal.

## A.W.A. RADIO GUIDE

High-speed automatic telegraph equipment will be installed at the Company's Melbourne office, and there the operators will work over the Beam System direct to London and Montreal, and also to the feeder stations in the other capital cities of Australia.

"Feeder" Stations will be established in each of the other capital cities communicating direct with the main trunk station, and as the relay will be automatic, there should be little delay compared with the handling of messages originating in Melbourne itself. As the system develops, there will probably be additional feeder stations linking up other parts of Australia more efficiently and speedily.

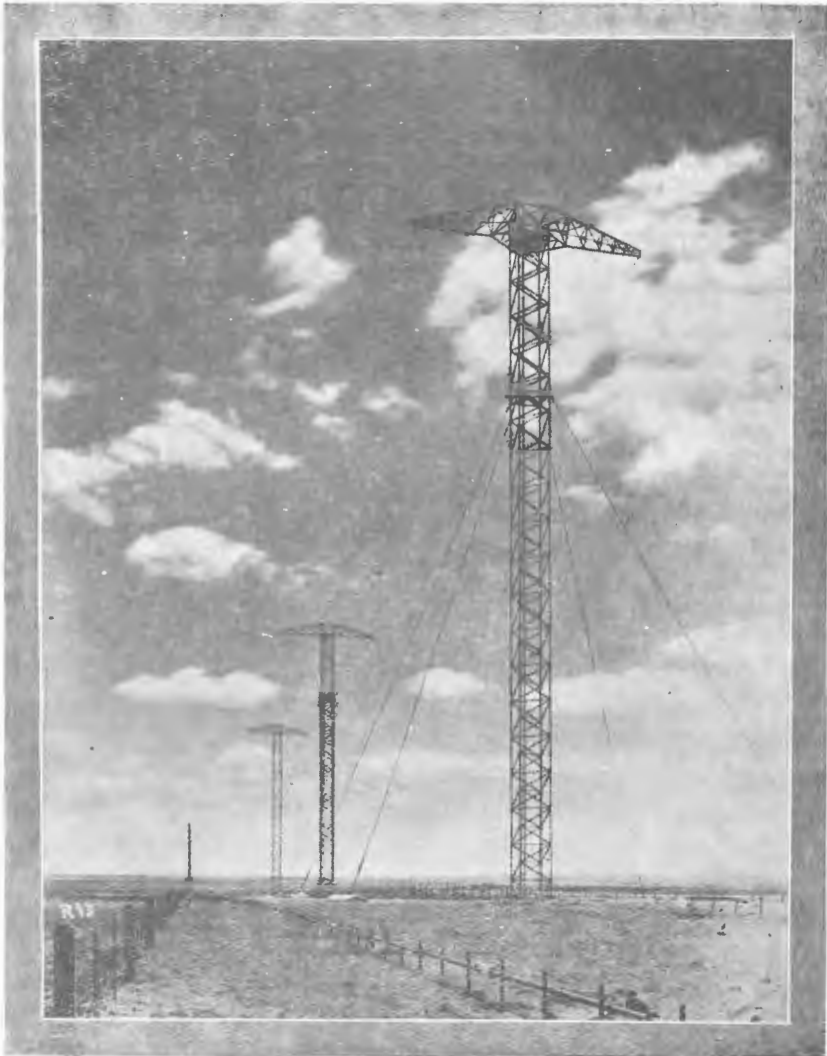

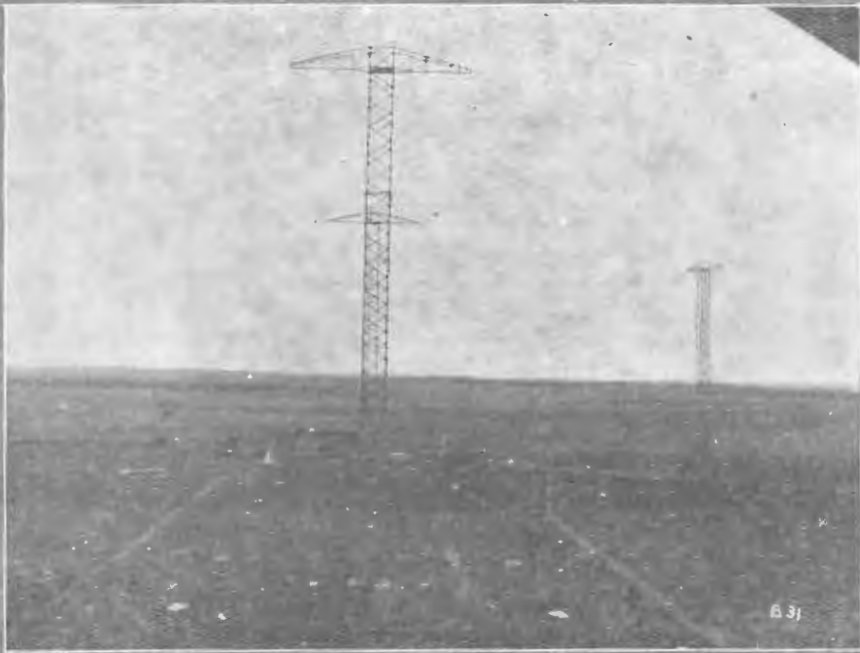
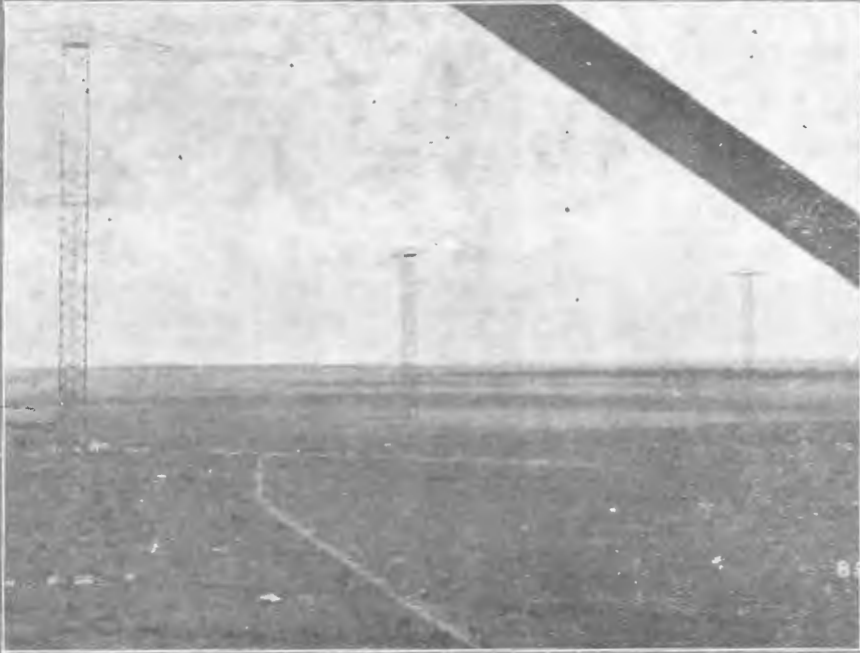

#### AUSTRALIAN BEAM STATIONS.

1. View showing masts supporting the Beam aerials at Ballan. The masts on the extreme left are those supporting the Canadian aerial, while the one in the centre and the one at the right-hand side, and another not shown in this picture, support the English aerial.

2. Same as No. 1, except that it shows the Transmitting Building immediately behind the two masts in the centre of picture.



**AUSTRALIAN BEAM STATIONS.**

1. Transmitter panels at Ballan, for communicating with England.
2. A front view of the Transmitter panels at Ballan.

## Coastal Radio Services.

One of the most important of the many activities of Amalgamated Wireless (Australasia) Limited is the operation of an extensive system of Coastal Radio Telegraph Stations which link up every part of the Australian seaboard with ships at sea, and form the only telegraphic route to many important Pacific possessions.

The service comprises 29 stations, all of which are operated and owned by Amalgamated Wireless. In addition to a station in each of the capital cities of Australia, there are four stations on the coast of Western Australia (Broome, Wyndham, Esperance and Geraldton), three on the Queensland coast (Cooktown, Rockhampton, Townsville), and one at Darwin, Northern Territory. Papua has two stations, one at Port Moresby, and the other at Samarai, while there is a station at Thursday Island, off the extreme northern coast of Australia; King Island and Flinders Island, in the Bass Straits, and Willis Islets, off the Queensland coast. There are nine stations in the mandated territory of New Guinea—Rabaul, Aitape, Madang, Morobe, Kieta, Kaewieng, Manus, Bulolo, and Salamoia.

The primary function of the Australian Stations is to maintain communication between the Mainland and all ships trading to and from all ports in Australia. The Stations are so situated and organised that at any time of the day or night a message from any vessel within 500 miles of the coast receives immediate attention.

The main function of the Island Stations is to provide rapid and reliable means of communication between the various Central Administrations and their outlying posts, and in addition to supply a commercial radiotelegraph inter-island and inter-Australian service. These stations also provide a Marine service with ships.

Besides the transmission and reception of radiograms, certain stations also send out to ships at sea a Press news service, navigation reports and warnings, weather forecasts and time signals.

Radiograms lodged at the Company's offices, or at any Telegraphic Office throughout the Commonwealth, for transmission to ships at sea are routed via one of the above Coastal Radio Stations.

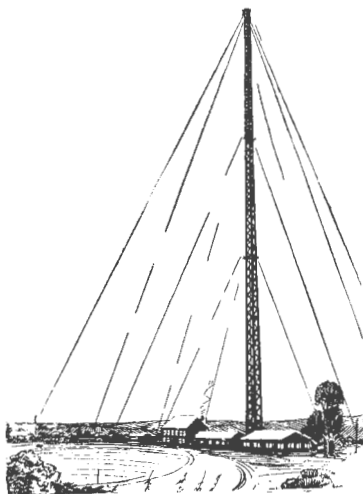

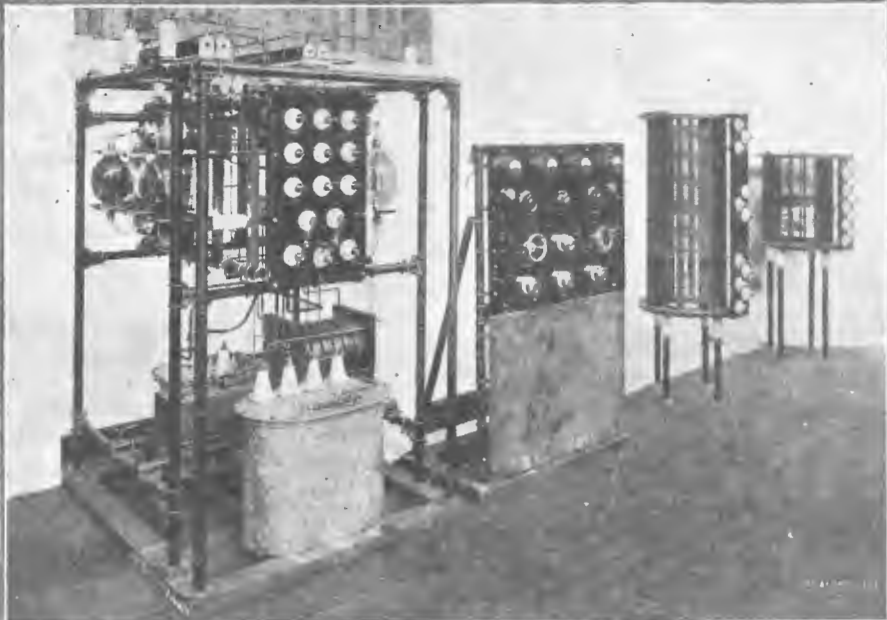

Coastal Radio Set capable C.W., I.C.W., and (with Attachment) Telephony, installed at Thursday Island. This set was designed for Coastal Radio Stations not having outside Electric Power available.

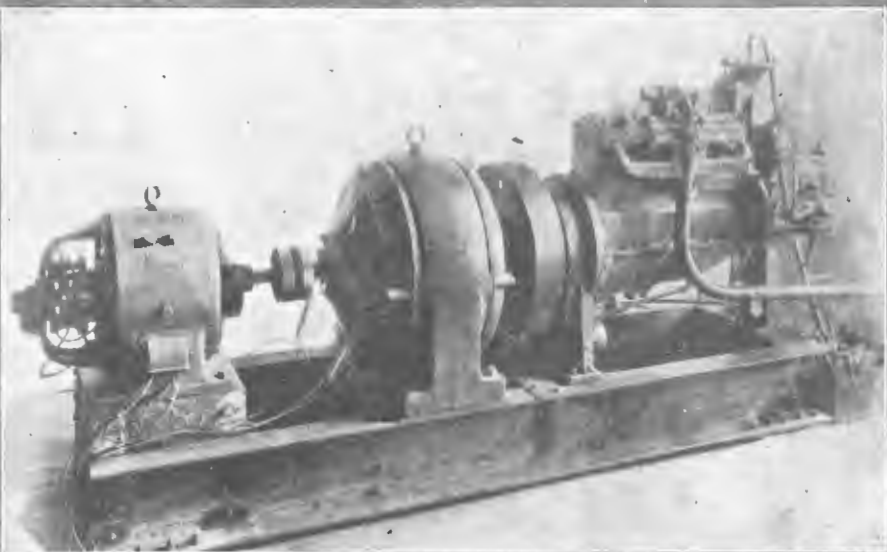

Power Unit showing 10 K.W. Alternator Exciter, at Thursday Island Coastal Radio Station.

## Island Radio Service.

---

Very few people realise how many wireless stations have been installed on the many groups of islands to the north and north-east of Australia, but when one comes to consider it, there is little need for surprise, because, prior to the advent of wireless communication, the only means of communication between islands and between an island and the outside world was by steamer or a sailing vessel.

One of the principal groups of island wireless stations is that operated by the Amalgamated Wireless Company in the Mandated Territory of New Guinea. The main station in New Guinea is at Rabaul, which was originally captured from the Germans by the Australian Naval and Military Expeditionary Forces in 1914, and is now the central radio station for all the western Pacific Islands. At this station the company has substituted modern valve transmitters (both telegraphy and telephony) and receivers for the original telefunken spark apparatus, with the result that constant and efficient communication is now maintained with Australia and with the outlying islands right through the abnormal atmospheric season which occurs throughout New Guinea during the summer months.

At Rabaul there are two steel masts, the main mast being 320ft. high, and power is derived from crude oil engines, which, to cope with the traffic, are required to run continuously for about 10 hours daily, except Sundays and holidays.

In addition to handling a heavy inter-island service, the Rabaul Station receives and distributes all the traffic between Australia and the north and west Pacific Islands, including those of the British Solomons and Japanese Mandate, the latter having its centre at Truk in the Caroline Islands. The main channel connecting the islands with Australia and with other parts of the world is provided between Rabaul, on the island of New Britain, and the radio station at Townsville, in Queensland. All traffic originating in the various island groups finds its way to Rabaul, and from there is transmitted to Townsville. After reaching Townsville, the messages are handed over to the telegraph office for delivery in Australia or for transmission to other parts of the world.

There are 40 commercial stations and 5 private radio stations in the islands distributed as follows:—

Mandated Territory of New Guinea	8
British Solomon Islands	3
Australian and New Zealand Islands	6
Gilbert and Ellice Islands	2
Papua	2
Caroline Islands	5
Cook Islands	4
Fiji Islands	4
Marshall Islands	2
New Caledonia	1
New Hebrides	1
Portuguese Timor	1
Samoan Islands	4
Tonga	2

Besides the transmission and reception of Government and public radiograms between the island and other parts of the world and with ships at sea, the commercial island radio stations send out, for the benefit of ships, navigation reports and warnings, weather forecasts and time signals.



## Australian Marine Wireless.

Travellers at sea to-day are no longer isolated, for, by the aid of Radio, they are able to communicate with their friends in any part of the world, while correspondingly those ashore can keep in touch with those at sea.

To-day ether waves from giant wireless stations encompass the globe, and radio messages are flashed over great distances with the speed of light, annihilating time, and facilitating trade, commerce and social intercourse.

Every ship at sea is a floating telegraph office, handling traffic to and from all parts of the world. A touch of the Morse key and the ether—invisible, intangible, immaterial—is set vibrating, and its tremors awaken similar response in instruments thousands of miles away.

The Marine Wireless Service, conducted by Amalgamated Wireless, comprises the equipment of modern wireless apparatus manufactured in its own works, the services of operators, the benefits of its research organisation, the employment of inspectors, who supervise the efficiency of the installation on the ships and the work of the operators, with reciprocal services in other parts of the world.

Nearly 200 ships wireless stations of the Australasian Mercantile Marine are controlled by Amalgamated Wireless (A/sia) Ltd.

A very successful application of wireless is its use in connection with the trawling industry. Wireless telephone stations are installed on many of the trawlers operating on the New South Wales coast, and, as a result, wireless telephone communication can be effected between the Trawling Company's office at Sydney and the various trawlers, and also between each trawler.

The Company publishes a daily newspaper, the "Wireless News," aboard several Trans-Pacific and Interstate steamers. Each night the news is transmitted across the Pacific to ships at sea from the wireless stations at Pennant Hills, Suva, Fiji, and Estevan, Vancouver Island.

By means of special apparatus, the Company has successfully effected long distance communication by means of low power and short waves. With such apparatus installed at the Coastal Radio Station, Pennant Hills, and on one of the Trans-Pacific liners, communication was effected regularly throughout the voyage of the ship up to the time of its reaching Vancouver. As the distance between Sydney and Vancouver is 7,000 miles, this feat constitutes wonderful short wave Marine Wireless communication.

Amazing results were recently achieved with the short wave low-power set installed on the Commonwealth liner T.S.S. "Jervis Bay." The vessel was in touch with the Amalgamated Wireless short wave station at Pennant Hills, Sydney, during the whole of the voyage to and from London.

The sending and receiving apparatus at both ends was designed and manufactured by Amalgamated Wireless (A/sia) Ltd. at their Sydney works, and is part of a new set of apparatus designed for long distance wireless work between the coastal radio stations in the Commonwealth and ships at sea.

## Outstanding Broadcasting Transmissions in 1926

The year 1926 saw a wonderful advancement in the realm of outdoor and long distance broadcasting transmissions in Australia. In these features both Station 2 F.C. (Farmer and Company Limited) and Amalgamated Wireless (Australasia) Limited shared the honors.

In the previous year a co-operation of these two forces had demonstrated that relay descriptions from sea, during the visit of the American Fleet, and the harbour, during the Imperial Press Delegates visit, could be successfully carried out. But it was left for 1926 to establish a record in world transmissions under extraordinary mechanical conditions.

The pace was set rolling when several of the caves at Jenolan were installed with many miles of wiring and a party travelled through under the direction of the guides, giving a graphic description of all they saw. This was carried by land line to 2 F.C. station at Sydney to be broadcast. Then followed the use of the longest land line in New South Wales, when a description was given of the roof of Australia, and a musical programme rendered from Mount Kosciusko.

Later in the year came the transmission from the Sydney Collieries Limited mine at Balmain. On this occasion the Sydney Male Voice Choir and the 17th Area Battalion Band went down a shaft 4000 feet deep and passed along a drive right under Sydney Harbour, broadcasting a fine musical programme en route.

The week following the first successful broadcast from an aeroplane was carried out by 2 F.C. and Amalgamated Wireless. A "D.H.50" machine of the Civil Aviation Department was fitted out with a full transmitting equipment and a programme descriptive of the sights seen, interspersed with music, was broadcast.

November of 1926 saw two further interesting transmissions, one by land line, the other by re-broadcast. A land line nearly 600 miles in length was brought into use between the Flemington Racecourse, in Victoria, and 2 F.C. studio, when the Melbourne Cup, Australia's greatest horse race, was described in the running.

Re-broadcasting was also carried out from a trawler at sea, music and descriptive detail being transmitted.

These activities have done much to popularise broadcasting in Australia, but they go still further and demonstrate ways and means for the extension of the utility side of wireless. Whatever great strides may be made in the near future of radio are in the lap of the gods, but one thing is very definite, and that is the fact that 1926 was not barren of achievement.



Control Room and Broadcasting Studio,  
Farmer's Broadcasting Service—2F.C. Sydney.



Interesting Broadcasting achievements by  
2F.C., in conjunction with Ama'gamated  
Wireless (Asia) Ltd.

1. Mount Kosciusko.
2. Jenolan Caves,
3. Balmain Collieries.





Interesting Broadcasting  
Achievements by 2 F.C. in  
conjunction with  
Amalgamated Wireless (A/sia)  
Ltd.

- 1 Randwick Racecourse
- 2 Trawler.
- 3 Aeroplane

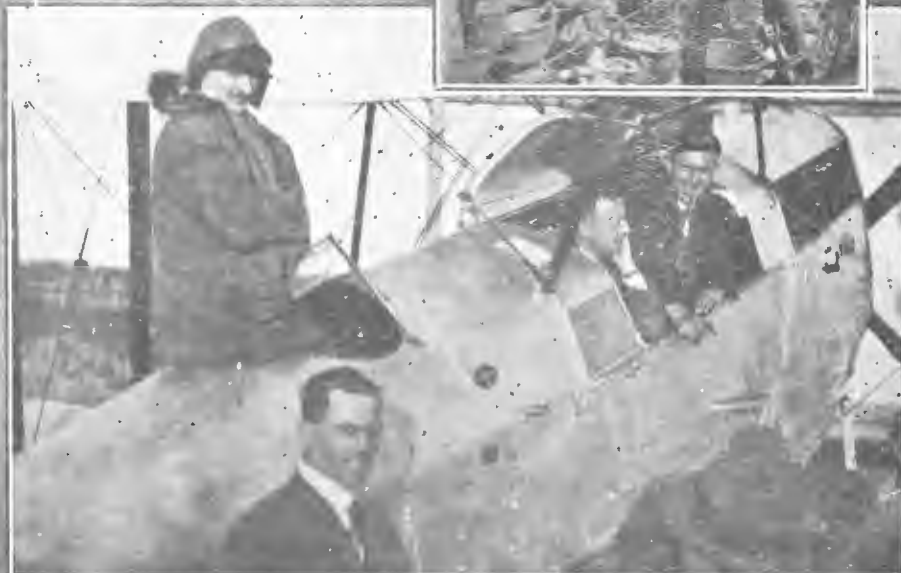

## Wireless on Barren Jack Hydro-Electric Scheme.

A new and unique application of wireless is the installation of three  $\frac{1}{2}$ -k.w. transmitters, being installed by Amalgamated Wireless (A/sia) Ltd., under contract with the Public Works Department of N.S.W., in connection with the Barren Jack Hydro-electric scheme.

The transmitters are located at Gundagai, Mistake Creek, and Saw Mill Camp. The Gundagai station operates under the call sign of 2GI, and the transmitters at Mistake Creek, 2MM, and at Saw Mill Camp, 2CA. The latter two are only temporarily located, and will shortly be transferred to Murrumburra and Cootamundra respectively. An additional transmitter (2BD) of 2 k.w. will shortly be installed at Barren Jack.

Working in conjunction with the three  $\frac{1}{2}$  k.w. transmitters are five portable sets. These will be capable of transmitting and receiving, and will be installed on motor lorries. The object of these installations is to effect a speedy repair to any breakdown to the transmission line; thus, supposing a line were to break—say, between Barren Jack and Gundagai—the station at Gundagai would get into communication with the repair lorry nearest the location of the break. After receiving the required information, this lorry would then proceed to the spot and carry out repairs.

It is of interest to note that the first official message to be passed between any station on the Barren Jack scheme was sent between Gundagai (2GI) and Mistake Creek (2MM). Mr. Hawkins (Electrical Engineer in charge of the Gundagai section of the line) being at one end, and Mr. Humphery (Installing Engineer for Amalgamated Wireless (A/sia) Ltd.), being at the Mistake Creek end. The message instructed the foreman at Mistake Creek to send every available man to fight a bush fire, which was rapidly approaching the creek. This message was the cause of saving a lot of valuable property.

Through the courtesy of Mr. H. G. Carter, the Chief Electrical Engineer of the Public Works Department of N.S.W., we are able to present the following interesting information regarding Barren Jack.

This huge construction scheme consists primarily in the utilisation of the power available from the water discharged through the Barren Jack Reservoir for irrigation purposes. A large power station is being constructed close to the reservoir, containing the essential machinery for the generation of electricity by the aid of this water power, to various towns in Southern New South Wales, principal among which are: Gundagai, Wagga Wagga, Junee, Cootamundra, Murrumburrah, Young and Jugiong.

The power station will consist of a reinforced concrete structure, situated some 1,500 feet down the river from the dam, and will be driven by two vertical water turbines direct coupled to the generators. The water will be fed to these turbines through a 7-foot diameter steel pipe supported on concrete footings.

## A.W.A. RADIO GUIDE

This station will enable an output of 5,000 k.w. to be maintained throughout the system, one generating set being kept available for emergency purposes. Current will be generated at 6,600 volts and stepped up by transformers situated adjacent to the power station to 66,000 volts, at which pressure power will be supplied into the transmission line system.

The Barren Jack Dam is primarily designed to supply water to the irrigation area at Yanco, and its main function, therefore, is to store water during the winter months and to release this water during the summer months in accordance with the irrigation area's requirements.

It must also be borne in mind that the irrigation area for which the Barren Jack Dam is designed is only approximately one-third developed, and consequently, the dam stores more water than is likely to be required for several years to come, until indeed the irrigation area attains approximately its full development.

### TRANSMISSION SYSTEM.

---

This system consists of two transmission lines from Barren Jack, one running west to Wagga, via Gundagai, and the other running north to Jugiong, Harden, and Young. These two lines are connected from Wagga to Harden, via Junee and Cootamundra.

The lines will be constructed for the most part of wooden poles, but steel towers will be used on that section of the line in the vicinity of the Barren Jack Power House. The lines will be constructed so that the minimum clearance of any conductor to ground will be 23 feet. The transmission pressure will be 66,000 volts, as previously stated. This pressure will be broken down at sub-stations suitably located to 6,600 volts for supply in bulk to municipalities, pumping stations, etc.

## A.W.A. RADIO GUIDE



Temporary Wireless Transmission  
Station—500 Watts—on Trans-  
mission Line Camp.

Gundagai Transmitting Station—  
500 Watts.

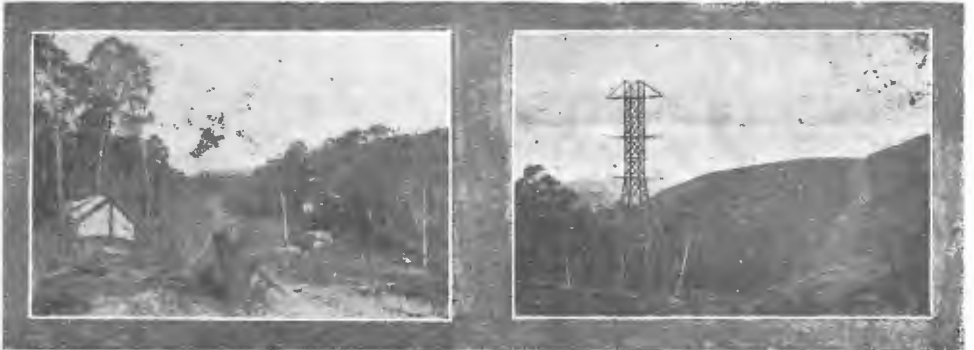

Temporary Transmitting Station.

High Tension Transmission Tower.

### BARREN JACK HYDRO-ELECTRIC SCHEME



## New Guinea Goldfields.

### MODERN SYSTEM OF WIRELESS COMMUNICATION.

A modern low power transmitting and receiving station was recently ordered from Amalgamated Wireless for erection on the New Guinea gold fields. The equipment was shipped to Salamoa in New Guinea, and after transport across the mountains, was erected at Bulolo and at once effective communication facilities became available to the prospectors.

To ensure the equipment against the climatic conditions of New Guinea, each part was packed in special tin-lined boxes and, as the only means of transport was by native carriers, the units were made as small as possible. Mr. Bishton, the Wireless Operator who had charge of the transport arrangements, writes interestingly of the trip from Salamoa Beach to Bulolo:—

I have just been packing my gear, food, and the new wireless set, which arrived here by the "Montoro" last Thursday week.

Benzine and kerosene I will have to leave behind, taking only a case of each, because it would mean another 24 native carriers if I were to take the lot. At present I need 74 carriers. That will mean about another 30 to carry the food for them. That will be 104 carriers. As each boy will carry only 50 lbs. of rice, it means that the carriers to carry food for my carriers will take 1500 lbs., which will last the whole lot, at  $1\frac{1}{2}$  lb. a boy a day, approximately two weeks.

Now, it will take me at least two weeks to arrive on the gold field, so you see there will have to be carriers sent up with rice to feed the carriers on the way back.

A man here is considering mule transport, but everyone laughs at the idea. A man must have both hands free to pull himself up in most places, and you have to wade for hours through rivers and creeks, so the possibility of mule transport being a success is very remote.

People down south have very little idea of what the conditions are like up here, as far as the gold mining business goes. There is plenty of gold but it requires a lot of boys to keep up the food supplies. Twelve thousand ounces were shipped by the "Montoro." That is worth more than £30,000, and, considering that this came from about six men, it will give you some idea of what they are getting.

Things are booming at Salamoa, which is the hopping-off place. Three of the big companies are starting stores. There are about 20 miners waiting to go inland, but they are unable to procure carriers, which is the whole trouble, and many of the new arrivals are down-hearted. Lots who come from Australia will have a rude awakening, as was the case with a few who arrived by the last boat. Everyone has to be inoculated against typhoid before the Government will grant a permit to go to the fields.

At the present time Bulolo Station is operating with great success, and another wireless set is now on its way for installation at Salamoa by Amalgamated Wireless (A/sia) Ltd.

## Lighthouse Communication.

### WIRELESS TELEPHONE SERVICES.

In conjunction with Amalgamated Wireless (A/sia) Ltd., the Commonwealth Lighthouse Service has embarked on some important wireless work which has had the effect of breaking down the isolation in which the keepers of remote manned lighthouses are placed, and keeps them permanently in communication with the remainder of the service. Wherever practicable, the lighthouse service has provided some form of telephonic or telegraphic communication to all its manned posts. In a great many cases this has necessitated not only the erection of land lines, but also the laying of short submarine cables. However, in many cases the expense of laying cables, and the fact that the length of cable over which telephonic conversation may be conducted is limited, has prevented the provision of services to lighthouses, and the keepers of these posts have hitherto been entirely cut off from the remainder of the world. The use of wireless telephony as an effective and relatively cheap means of providing communication services for outlying lighthouses has recently been receiving attention.

Wireless Telegraph-Telephone equipment has been installed at Clifty Island, at Deal Island, and at Wilson's Promontory. As a result the lighthouses at Clifty Island and at Deal Island are in direct Telephony communication with Wilson's Promontory, which in its turn is in direct touch by means of the ordinary land line telephone, with the Head Office of the Commonwealth Lighthouse Service at Melbourne. The distances to Clifty Island and to Deal Island from Wilson's Promontory are 17 and 49 miles respectively.

The apparatus was supplied by Amalgamated Wireless (A/sia) Ltd., and is of Australian design and manufacture. It is in many respects similar to the Wireless Telephone Equipment which for some time past has been successfully utilised on trawlers operating between Sydney and the North Coast and the South Coast of N.S.W. The Transmitter has a power unit of 250 watts—the current necessary to operate it being produced by a petrol-driven generating plant.

This was the first application of telephony to lighthouses in Australia, although at the present time it is extensively utilised in Great Britain. The Victorian lighthouse stations have proved entirely satisfactory in operation, and many reports have been received throughout Australia and Tasmania advising reception at excellent strength.

## A.W.A. RADIO GUIDE



The Wireless Telephone Sets installed at Clifty Island (illustrated) and at Deal Island Lighthouse enable direct Telephone communication to be made with Wilson's Promontory, which in its turn is in direct touch by means of the land line with Melbourne.



Photograph of lighthouse wireless apparatus provided by Amalgamated Wireless (A/sia) Ltd., having a transmission power of 250 watts. The current necessary to operate it is produced by a petrol driven generating set.

## Wireless Achievement.

### RECORDING LONG DISTANCE SHORT WAVE COMMUNICATION.

One of the most notable achievements in wireless for many years was the recent record distance achieved by the short wave transmitter manufactured by Amalgamated Wireless (Australasia) Limited, and installed on the Australian Commonwealth Liner "Jervis Bay" in September last.

During the whole of the voyage from Sydney to London and return the "Jervis Bay" was in daily communication with Pennant Hills (Sydney) Wireless Station.

The power used was only  $\frac{1}{2}$  kilowatt, as compared with the 1000 kilowatts by the big Rugby station, and the wave length used was 34 metres.

The most remarkable feature was that as the vessel got further away from Sydney the signals increased in strength and were more constant; while the messages from the ship were received with equal clearness at the Sydney station, every night of the voyage the "Jervis Bay" being in communication with Australia.

The sending and receiving apparatus both on the ship and at the Pennant Hills station was designed and manufactured by Amalgamated Wireless (Australasia) Limited at their works in Sydney, and is part of a new set of apparatus designed for long distance work between ships and Australian Coast Stations, and suggests the day is not far distant when shipowners in Australia will be able to keep in touch with their ships throughout the voyage to England or other parts of the world.

This achievement is the longest recorded distance worked by a merchant ship, and reflects great credit on the Engineering Staff of Amalgamated Wireless (Australasia) Limited and the Company's Operators on the "Jervis Bay."

It is of particular interest to note that while the S.S. "Jervis Bay" was lying in Tilbury Dock, London, direct communication was effected with the Pennant Hills Wireless Station at Sydney.

On November 12th, 1926, a message was sent to the Prime Minister of the Commonwealth by Sir George Mason Allard, and a reply was received from Mr. Bruce. The messages were as follows:—

"To Right Hon. S. M. Bruce, Prime Minister,  
Australia House, London.

By direct wireless from the Company's station in Sydney to the Commonwealth steamship 'Jervis Bay' lying in Tilbury Dock London I send you greetings and an expression of the heartiest good wishes for the safe return of yourself and Mrs. Bruce with all the members of your mission and for a pleasant journey. This message will be sent from Sydney and received at Tilbury by means of apparatus designed and constructed in the Company's workshops in Australia and operated at both ends by Australians. We have succeeded in exchanging messages by wireless direct between our radio centre Pennant Hills Sydney and the 'Jervis Bay' nearly every day throughout the voyage from Sydney to London and we are now in direct touch with the ship as she lies in Tilbury Dock. The power used at Sydney does not exceed three kilowatts and the power used for this communication in the 'Jervis Bay' is approximately one half of one kilowatt. Our operator in the 'Jervis Bay' would be pleased to send a message from you to Australia direct.

G. MASON ALLARD,

Chairman of Directors,

Amalgamated Wireless (Australasia) Limited."

## A.W.A. RADIO GUIDE

“From London to Sir George Mason Allard, Sydney.

I desire to heartily congratulate Amalgamated Wireless (Australasia) Company on wonderful achievement attained by direct communication from Central Station Sydney to ‘Jervis Bay’ at Tilbury Dock. This feat accomplished as it was on very low power is worthy of the highest commendation and will be received with great accord by those interested in wireless telegraphy throughout the world. It is particularly gratifying to Australians on this side to know that the apparatus used was designed and constructed by your Company in Australia and operated from both ends by Australians. I wish you all success in your further experiments. My wife and I together with members of the Australian delegation thank you for your greetings and good wishes for a safe and pleasant journey home.

S. M. BRUCE.”

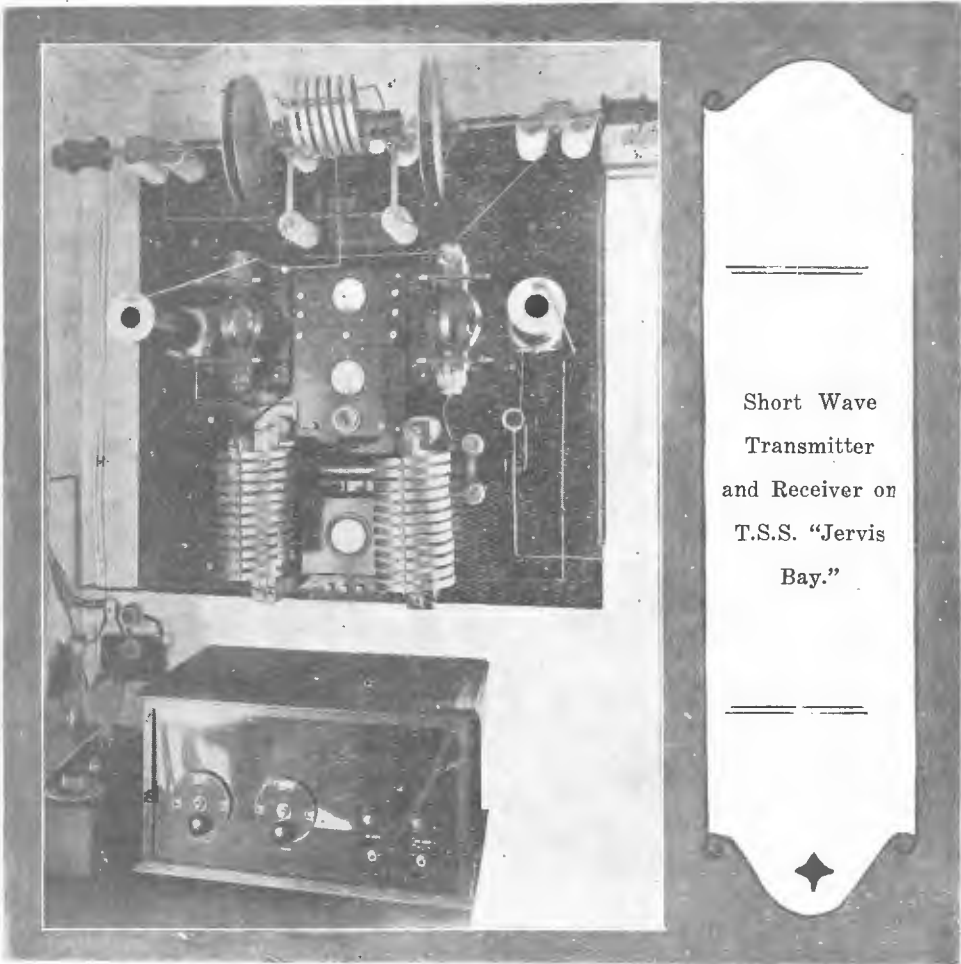

## The Great White Train.

### A UNIQUE TOURING EXHIBITION.

At the instance of the Australian Made Preference League there was despatched from Sydney towards the end of 1925 an exhibition train, on which every carriage was devoted to a display of Australian made products. Some idea of the magnitude of the train may be gathered from the fact that it was over 1000 feet in length, and weighed 565 tons. During its 12 months' itinerary over 100 towns were visited, 45,000 miles of railroad were covered, while over half a million adults and children inspected the exhibits. One of the carriages was wholly devoted to wireless exhibits of Amalgamated Wireless (A/sia) Ltd. A broadcasting transmitter, made by Amalgamated Wireless (A/sia) Ltd., was installed in the carriage, and by means of a specially designed mast the train wireless station (2XT) was nightly on the air.

So successful were the train transmissions that not only were satisfactory reports received from all parts of the Commonwealth, but favourable comment was received from New Zealand and Misima (Papua). Particular reference was made to the clarity and volume, which was sufficient to be received on a loud speaker.

The transmitting power of the station was 500 watts, while it operated on a wave length of 255 metres, with the call signal 2XT.

The aerial consisted of a single wire 60 feet long suspended between steel masts 40 feet above the roof of the carriage, while earth connection was made to the steel rails.

At each town a civic reception was tendered the train and the speeches delivered at the reception, together with lectures on Australian Manufacturing Industries and a programme of vocal and instrumental items, were broadcasted.

The photographs on the opposite page show the exhibit of Amalgamated Wireless (A/sia), Ltd. The Company's Radiola Super is in the foreground, while at the far end of the carriage can be seen the wireless transmitter. Surmounting the receivers are the world-renowned Amplion Loud Speakers. Inset is the mast, which is so arranged that it can be lowered while travelling and easily erected when a town is reached.

The thousands of visitors to the train were agreeably surprised at the magnitude of the travelling exhibition and the enormous growth of manufacturing in Australia, as shown by the displays.

It is of interest to note that in every phase of Australian wireless activity, equipment designed and manufactured in Australia by Australians was being successfully utilised. Wireless equipment for ships, for coast stations, for inland radio, and for broadcasting is being designed and manufactured at the Amalgamated Wireless Company's Radio-Electric Works, and the results achieved by the apparatus are in every way equal to, if not superior, to equipment manufactured overseas.

At the present time the Company employs over 800 people, one-third of whom are engaged in manufacturing operations. It can, therefore, be said without doubt that the Company is making a valued contribution to Australian manufacturing industries.

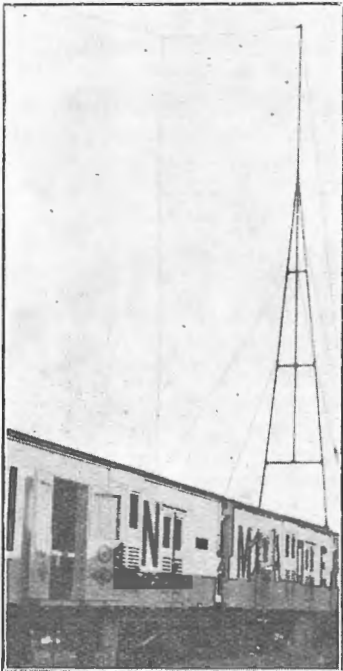

Wireless Mast on "Great White Train"



Wireless Exhibit of Amalgamated Wireless (A/sia) Ltd. on "Great White Train."

## A.W.A. RADIO GUIDE

### OCEAN NEWSPAPERS.

---

No longer are ocean travellers out of touch with world news, for through the instrumentality of wireless, there is now published on board most of the vessels equipped with wireless installations, operated by Amalgamated Wireless (A/sia), Ltd., a Wireless Newspaper known as the "Wireless News."

It is noteworthy that this paper, published by Amalgamated Wireless (A/sia), Ltd., was the pioneer journal in ocean newspapers, being the first marine paper published on British steamers in the Pacific Ocean. The date of the initial publication was May, 1923. Publication was later extended to Intercolonial steamers trading between Australia and New Zealand, and also to vessels trading between Australian ports.

The news is specially prepared on shore, transmitted nightly from the different coastal radio stations to ships at sea, and after being edited by the wireless staff on board, is printed and distributed in newspaper form before breakfast.

A unique feature of this newspaper is that it has the greatest geographical publishing radius of any newspaper in the world. It appears daily on the Pacific, Indian, and Atlantic Oceans, at widely divergent points. Let us trace its sphere, starting from San Francisco. The Union Steamship Company's Royal Mail steamers publish "The Wireless News" throughout their voyages between the United States and Australia, en route to Papeete, Raratonga, Wellington, and Sydney. The intercolonial steamers publish it in the Tasman Sea, and it circulates on the coastal vessels from Cairns to Fremantle, touching at Townsville, Mackay, Brisbane, Sydney, Melbourne, Hobart, Adelaide, and Fremantle.

The Australian Commonwealth Line of Steamers are the only line of steamers trading between Australia and the United Kingdom publishing a daily newspaper on board. The "Jervis Bay," which recently created a world's long-distance wireless record, enjoys the distinction of being the first ship of the Line to publish the "Wireless News."

The overseas steamers are all equipped with special receivers for the reception of press over long distances. The Amalgamated Wireless Coastal Radio Station at Pennant Hills transmits press simultaneously on two waves—one for the steamers in close proximity, and one for the steamers in other parts of the world. Thus it will be seen that the steamers, however distant from Australia they may be, are always able to publish Australian news items.

Special services have been organised for the coastal vessels from Sydney, Melbourne, and Perth. For instance, a passenger leaving Sydney at noon on the "Katoomba," interested in the sporting events which have taken place in the capital cities in the afternoon, instead of having to wait until the vessel's arrival at Melbourne on Monday, is able to read these results on Sunday morning with his cup of tea, while still in his bunk.

More especially on long voyages has "The Wireless News" banished that feeling of isolation, that must have been experienced on ships at sea before the days of wireless telegraphy. Space, which has been shrinking for nearly a century under the influence of steam and electricity, has been annihilated. This modern method of communication, received at first with doubt, because of its undreamed of possibilities, now accepted as a matter of course and an essential feature of modern life, has brought into effect the latest boon for ocean travellers—an ocean newspaper.



The New  
**-AWA-  
VALVE**



**For Greater Range!**



## Wireless in "Outback" Australia.

There is an appreciable section of the Australian population in such parts of the Commonwealth as Northern and Central Australia and large areas in Northern Queensland and Western Australia and the far west of New South Wales, who are living under comparatively isolated conditions, having no telegraph or telephone lines, while postal facilities are meagre.

The wireless telephone and the wireless telegraph are already proving a wonderful boon to settlers in these remote centres.

Special research is being applied to the production of equipment designed specially for Australian inland conditions. Several stations of this kind are already in operation, a typical case being Brunette Downs, Northern Territory. For the Commonwealth Post Office, Amalgamated Wireless have constructed wireless stations at Wave Hill, Northern Territory (400 miles from Darwin, and 1,900 miles from Sydney), and at Camooweal, on the borders of Queensland and Northern Territory—550 miles from Darwin, and 1,400 miles from Sydney. The station at Wave Hill will collect messages from private radio stations outback and communicates with Camooweal, a terminal point of the ordinary telegraph system. Camooweal station exchanges traffic with local private stations, and transfers messages from other parts of Australia to the land telegraph system, relaying similar messages locally when received from the land system.

When it is stated that some of the big cattle stations in the Northern Territory are one or two weeks' journey from a telegraphic centre by horse or camel, and that as a result it is often a month before a reply can be received even to a telegram, it will be realised how beneficial wireless is proving in the Territory.

The call letters of the Wave Hill Station are VJD, and of the Camooweal Station VJJ. The daily news bulletin despatched from Perth, Melbourne and Darwin Coastal Radio Stations to ships at sea are also transmitted from Wave Hill for the benefit of settlers with wireless sets.

The inland stations will thus act as distributing centres for all points within a radius of 200 miles, and be capable in turn of communicating with the main chain of wireless stations round the coast of Australia.

By this means all isolated points will be brought into communication with one another, and with their nearest town, through those with the capital cities, and through the capital cities with every part of Australia, with ships at sea, and with the whole world. The advantages to commerce and production are obvious. Australia depends so much on the production of wool, wheat, meat, butter and fruits, that the fullest information regarding state of crops and weather, and stock reports, etc., is essential. This will be greatly facilitated by a network of wireless posts in all parts of the continent. The bearing on social life generally and on the provision of medical and nursing assistance and advice, is more important in Australia than in most countries.

## Wireless in Hospitals.

One of the finest fields for the application of wireless has been its installation in hospitals. During the past year, thousands of patients in hospitals have forgotten their worries and have had, to some extent, their sufferings alleviated by listening-in during the day and evening to the broadcasting programmes conveyed to their bedsides.

In almost every hospital, especially in hospitals for incurables, there have been cases where people who have not attended a theatre for very many years have had their isolation broken down by means of wireless, and have listened-in to the latest musical items from the leading theatres. Others again who have not been able to attend church for years have listened-in to the church service.

The generosity of the public, and in some cases the specific bequest of private individuals, have resulted in the most modern method of hospital wireless equipment being installed in many of the leading hospitals and sanatoriums throughout the Commonwealth.

The equipment in most hospitals consists of a specially designed multi-valve wireless receiver with extension lines running from the receiver to every bedside. The bedside equipment comprises a small jack box with a pair of head 'phones attached. The patient has simply to pick up the head 'phones, and without any adjusting or tuning-in hears the broadcasted programme.

In some cases a double system of extension lines is employed, in which case the jack box at the bedside has two plugs, each for a different broadcasting service. The patient then plugs in to whichever service he desires. Extensions are also made to the nurses' quarters, where generally loud speakers are installed so that dancing may be indulged in if they so desire.

The Installation Department of Amalgamated Wireless (A/sia) Ltd. has been extremely busy during the year carrying out hospital wireless equipment work, and among the various institutions equipped mention may be made of the following:—

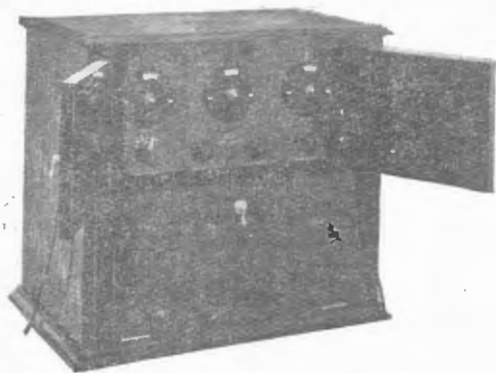

Radiola Hospital Receiver.

Ryde Home for Incurables.  
Western Suburbs Hospital.  
South Sydney Hospital, Rosebery.  
Lazarette, Little Bay.  
Liverpool State Hospital.  
Petersham Home of Peace.  
Wentworth Falls Sanatorium,  
Waterfall Sanatorium.  
Janefield Sanitorium, Janefield, Vic.



• • •  
Radiola  
Hospital  
Equipment  
installed at  
Ryde Home  
for Incurables  
by  
Amalgamated  
Wireless  
(A/sia), Ltd.

### Police Wireless.

During the past year special attention has been paid by the N.S.W. Police Department to the important matter of the detection of crime through the instrumentality of wireless.

Two police patrol cars are permanently equipped with specially designed wireless receiving apparatus. At the Amalgamated Wireless Station at Willoughby a modern transmitter has been specially set apart for police service. An officer there is in constant communication with police headquarters and with the patrol cars. As a result, the patrol cars are informed of any serious happening that has taken place around the city and suburbs and of its location.

Not only have remarkable and expeditious arrests been made in the case of house-breakers, but a large percentage of stolen motor-cars has been recovered through the information transmitted to the patrol cars by the Willoughby Transmitting Station.

The patrols are also informed of all big fires or serious accidents that occur.

Almost all messages are transmitted in Morse. The patrol wireless receivers are modern multi-valve type.

The first Police Patrol installation in Australia was carried out by Amalgamated Wireless Company in October, 1922, when a Receiving Set was erected on a Patrol Car of the Victorian Police Department. A telephone transmitter was installed at the Company's Radio Station, Melbourne, and the excellent reception results obtained on the car and the success of the installation as an aid to the police in the prevention of crime and in capturing criminals was such that 12 months later the Department purchased two fast cars and had both of these fitted with wireless.

The Victorian Police Department have recently installed transmitting sets on the Patrol Cars in addition to receiving sets in order that the members of the Patrol Cars can telegraph Headquarters from the car instead of having to leave the car and use the ordinary telephone for speaking to Headquarters, as was the previous practice.

In order to meet with the specific requirements of the Service, it was necessary to have a transmitter that would be compact and yet be very powerful. A number of designs were considered and finally one was evolved which fulfilled all requirements. It is interesting to note that the transmitter installed at the Victorian Police Headquarters is exceedingly powerful. The power rating is given as 2 k.w., but actually it is in excess of this. It is capable of being used for CW, ICW, and if necessary it can be adapted for speech.

Records show that the average time taken to arrive at the scene of a crime after the receipt of a message is 4.4 minutes. It is hoped, however, with improved apparatus and methods, to halve this period in the near future. The highest motor speed attained for a continuous run was 74 miles per hour in an early morning chase after a suspected car, which was overtaken.

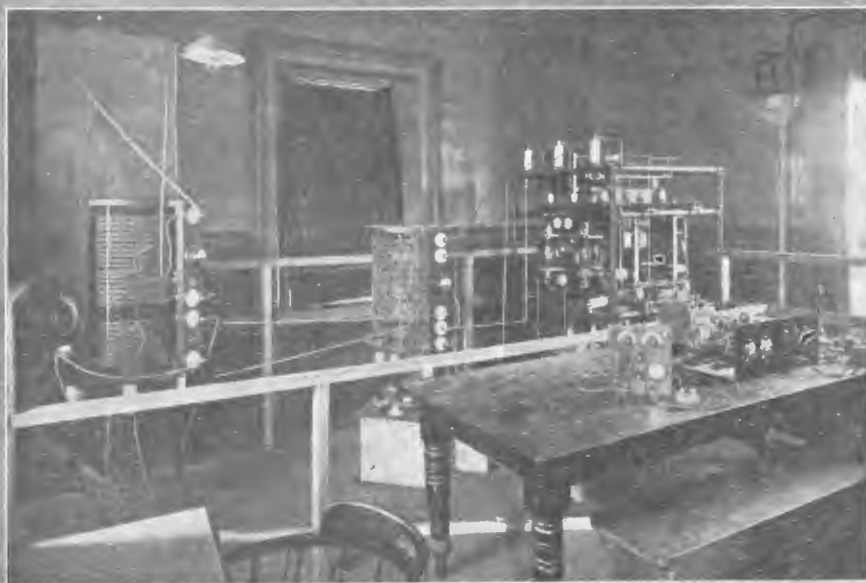
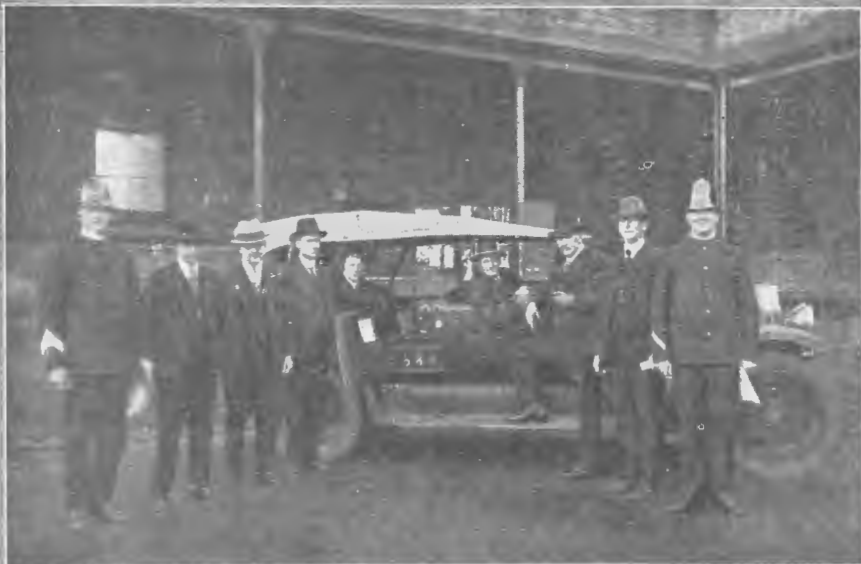

**Wireless is a Necessary Auxiliary to a modern Police Force.**

1. Wireless equipped Patrol Car.
2. Transmitting and Receiving Equipment at Victorian Police Headquarters.

## Broadcasting Transmitter Equipment.

### THE INSTRUMENTS COMPRISED IN THE TOP PHOTO OPPOSITE ARE:—

Reading from left to right:—

- (a) **Independent Drive Unit** on the extreme left—a specific feature of this transmitting set. The purpose of the Drive is to produce an absolutely constant wave length—an essential feature in successful broadcasting. At the top of the panel will be seen the Radio Frequency Inductances, and at the bottom the Power Condenser, which in combination with the Tuning Units at the top form the oscillatory circuit. The normal power of this unit is 3 k.w., but it is so designed that the power input can be considerably increased. The meters at the top of the panel indicate the conditions in various parts of the circuit.
- (b) **Main Oscillator Unit**, together with the Control Switchboard. The Marconi Valves used in this panel fulfil the purpose of converting the 12,000 volt high tension Direct Current delivered from the Rectifier Panel to the necessary high frequency current to be radiated later from the aerial. Although the power input under normal conditions is 5 k.w., the oscillator is capable of handling far greater power.

(c) **Closed Circuit Tuning Inductance** is very similar in construction to the Aerial Tuning Inductance.

(d) **Aerial Tuning Inductance, Power Condenser.** This unit was specially constructed to withstand the very high potentials impressed upon it as a result of the power used. The meter at the bottom of the Unit indicates the current flowing in the Aerial.

The Power Condenser at the top of which is mounted the closed Circuit Variometer. The power condenser is of robust design and employs air dielectric. The purpose of the Variometer is to finely tune the closed Circuit.

(e) **Rectifier Panel.** On the extreme right of photograph. The Power Transformers seen at the base of the panel are constructed so as to transform the Municipal electricity supply to a voltage of 25,000. The high tension windings are divided in the centre, each half secondary feeding one rectifying valve. There are six Rectifying Valves, and consequently six half secondaries, or three complete transformers.

The units immediately above these Transformers are the smoothing condensers necessary for the smoothing out of the pulsating current after it has been rectified. On the same level is the smoothing choke, which also assists in the smoothing out of the pulsating current. The valves are, as will be seen, accommodated at the upper part of the panel. Immediately above the Valves will be seen tubes extending down to within an inch or so of the top of the valves. These tubes convey air to the valves for the purpose of cooling. This is necessary owing to the very high powers being handled in the valves.

The Rectifier unit is capable of supplying continuously 24 k.w. The energy from this unit is used for feeding the high tension to the Independent Drive, Main Oscillator and Modulator Panels.

### THE INSTRUMENTS COMPRISED IN THE BOTTOM PHOTO OPPOSITE ARE:—

Reading from left to right:—

- (a) **The Closed Circuit Tuning Inductance.**
- (b) **Aerial Tuning Inductance.**
- (c) **Rectifier Panel.**
- (d) **Modulator Panel.** This panel is robust in design, and is constructed to accommodate sufficient modulating valves to cope with the powers supplied to the Oscillator.



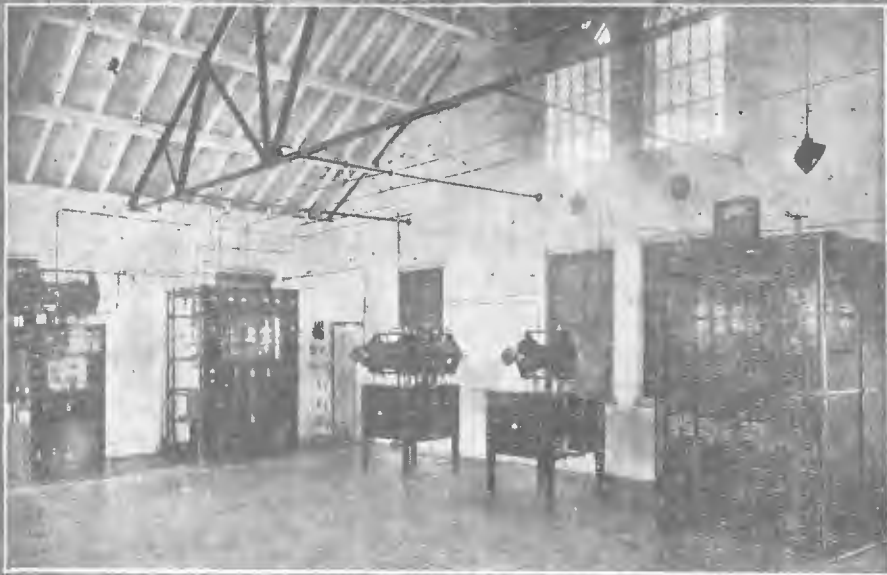

5 K.W. Broadcasting Transmitter Equipment designed and manufactured by:  
Amalgamated Wireless (A/sia) Ltd. and installed at Farmer and Coy's  
Broadcasting Station, 2F.C., Pennant Hills, Sydney.

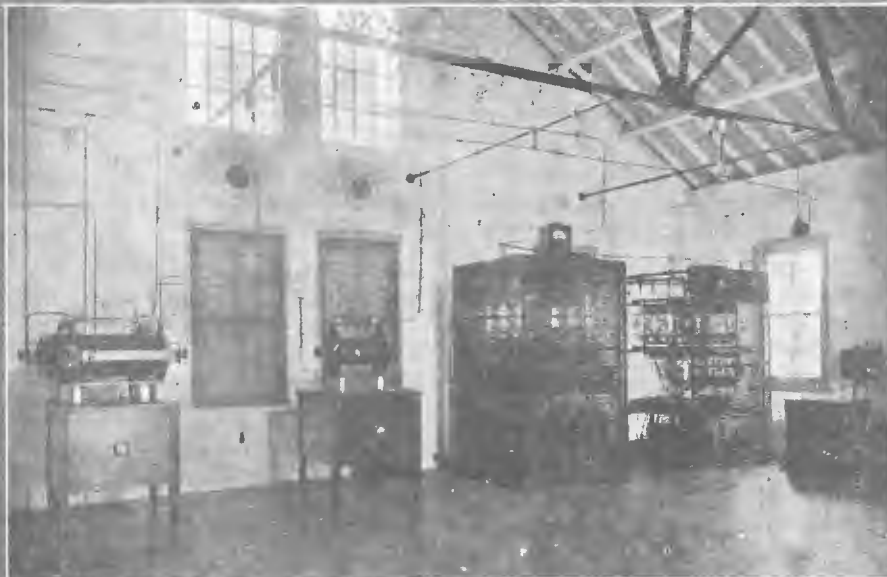

Another View of Transmitting Equipment,  
Farmer's Broadcasting Service, 2F.C., Sydney.

## Broadcasting

Few sciences have made such a wide appeal, have attained such amazing popularity, and have developed to such a degree in so short a space of time as has Broadcasting.

The first actual broadcasting concert was demonstrated by the Marconi Company in June, 1920, and among the artists was Dame Nellie Melba, whose voice was heard a considerable distance across the Atlantic and in many parts of Europe.

The second important broadcasting demonstration was given at the Imperial Press Conference, Ottawa, 1920.

In the same month, August, 1920, Mr. E. T. Fisk, Managing Director, Amalgamated Wireless (Australasia) Ltd., gave a public demonstration of wireless broadcasting in Sydney to an audience of more than one hundred at a meeting of the Royal Society of New South Wales.

In October of the same year he arranged a complete public broadcast concert in the Queen's Hall, Federal Parliament House, Melbourne, to an audience of some hundreds of people. This was the third largest public demonstration of broadcasting that had taken place in any part of the world. In January, 1921, a weekly broadcast programme was transmitted from Melbourne by A.W.A., and was heard by experimenters and others at distances up to 1000 miles.

In the design and construction of broadcasting transmitters, and the erection and organisation of broadcasting stations in Australia, Amalgamated Wireless has played a significant part. During the last few years the Company has installed powerful broadcasting transmitters at 2FC, Sydney, 3LO Melbourne, 5CL Adelaide, 6WF Perth, and 4QG Brisbane. The quality of transmission and range of these stations is equal to, if not better than, the largest overseas broadcasting stations.

It should be a source of pride to Australians to know that the whole of the design and manufacture of this complicated and highly technical equipment was carried out at the Radio Electric Works of Amalgamated Wireless (A/sia) Ltd., Sydney, by Australians, several of whom were specially sent by the Company to Europe and America to investigate the very latest developments in this phase of radio engineering.

During the past year great activity and many technical advances have taken place in broadcasting. Additional stations have been opened in several States, and the programmes of all stations have been still further improved.

Two particularly important happenings were the completion of the Queensland Government Broadcasting Station at Brisbane, which was brought up to full power during the year, and the station accommodation, studios, and offices in the city were completed and opened by the Premier in April.

Farmer's broadcasting station at Sydney, 2FC, was transferred from its temporary site at Willoughby into specially built accommodation at the Sydney Radio Centre, Pennant Hills. This new and up-to-date station was officially opened by the Right Hon. W. M. Hughes, P.C., K.C., at the end of March.

Station 2BL, owned by Broadcasters (Sydney) Ltd., was also moved to a new site at Coogee, new equipment was installed, and the power of the station was brought up to 5 kilowatts.

Two well-known Class B stations are now operating in Sydney, namely, 2KY, conducted by the Sydney Labour Council at the Trades Hall; and 2GB, operated from Adyar Hall, Bligh Street, by the Theosophical Broadcasting Company.



**SECTION OF MACHINE SHOP, RADIO-ELECTRIC WORKS OF A.W.A.**

Located at Knox Street, Sydney, the works are replete with the latest types of automatic turret lathes, screw-cutting machines, power presses, milling and multiple drilling machines, besides a multiplicity of special-purpose machines, including coil-winding and die-casting machines. Electroplating work is also carried out.

The works are now in full operation, and every type of wireless apparatus is manufactured: broadcasting transmitting sets, radio receivers for listening-in, wireless apparatus for use on ship stations, wireless equipment for coast stations, and radio telephone sets for use by settlers in the outlying parts of Australia. Radio receivers are made in several types, from the small crystal set, to the highly finished Radiola Super cabinet type, operating without aerial or earth. Direction finders, lifeboat equipment, and almost every modern wireless device is or can be manufactured in the Company's works.

The Company has pioneered the manufacture in Australia of Electronic Valves. In order that the Company's valve plant should be of the latest type the Company sent abroad a number of its expert staff to study valve manufacture in England and America; as a result of this, of agreements made, and of new plant installed, the Company will not only be able to produce sufficient valves to meet the Australian demand, but in quality its valve products will bear favourable comparison with any.

## A.W.A. RADIO GUIDE

### THE RADIOLA CRYSTAL SET.

This highly efficient Crystal Set is contained in a handsome maple cabinet, and only needs connection to aerial and earth systems to be ready for use.

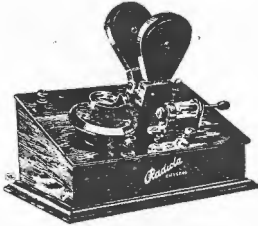

The crystal and spiral contact wire are enclosed in a glass tube, which protects them from dust and dampness and ensures permanent adjustment.

The use of variable inductance coupling ensures selectivity and freedom from atmospheric disturbance.

The tuning coils are interchangeable, so that by using coils of suitable values any required wave-length may be obtained.

The operation of the controls is simplicity itself.

Price, complete with headphones, £3/12/6.

### THE RADIOPHONE.

The Radiophone is a two-valve receiver designed for the reception of radio broadcasting.

The set is very simple to operate.

The necessary controls and adjustments have been reduced to a minimum.

It can be operated by merely turning a dial, and once it is switched on, you can remain seated in an easy chair for the rest of the evening, and listen to a varied entertainment without further effort.

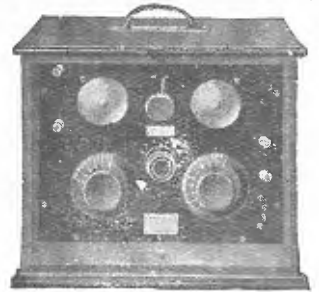

The Radiophone is self-contained, and only needs connection to an aerial and earth system, and the attachment of a pair of headphones and batteries, to be ready for immediate use.

Throughout the whole apparatus, every detail of design and construction has been studied with that thoroughness which characterises all the Company's products, in order to give perfect rendering of all music and speech.

Price, complete with Amplion loud speaker, £14/12/-.

# THE RADIOLA IV.C

A Broadcast Receiver featuring a four-valve regenerative circuit having only two controls.

Wave-length range 200-550 metres.

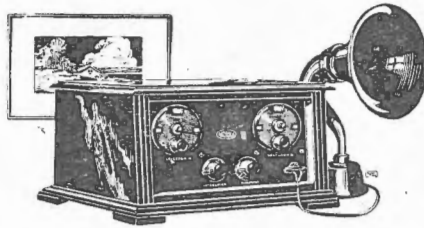

A four-valve receiver of melodious reproduction, long range, and extremely simple of operation, at a price which represents unparalleled value.

The circuit comprises one stage of radio frequency amplification, detector, and two stages of audio-frequency amplification.

The tuning has been simplified considerably by means of improved vernier controls which are fitted to the instrument.

Exceptional amplification is provided by using A.W.A. audio-frequency transformers.

The valves used are the world-famous Radiotrons 201A and A.W.A. 101A, which are interchangeable with the Radiotron UX199 and A.W.A. 99X valves.

Housed in an attractive cabinet of specially selected walnut with full piano finish.

The set can be operated by means of dry batteries, and is thus specially adaptable for

use in the country, where an accumulator charging plant is not always accessible.

One filament control is provided, thus simplifying the operation of the set.

A jack and plug connection is used for the telephones or loud speaker.

The Radiola IV.C, though selling at a popular price, maintains the high prestige of the Radiola line of broadcast receivers. It incorporates the same sound radio engineering principles and faithful workmanship.

A.W.A. supremacy in production of broadcast receivers has been achieved by its concentration on turning out flawless musical instruments reproducing broadcast music and entertainment with amazing clarity.

Price, complete with Amplion Loud Speaker, from £28/5/-.

## **Radiola 6 Valve and 8 Valve Superheterodyne Receivers.**

The introduction of the Radiola Super proved an outstanding development in the manufacture of Broadcast Receivers for Australian conditions.

Never before had a Receiver been available featuring such remarkable selectivity, long range, ease of control, and realistic reproduction.

The superheterodyne principle is recognised by the foremost Wireless Engineers throughout the world as being the highest development in the art of receiver design. This principle makes possible the assembly in a small metal container of all the vital parts of the set.

After assembly the container is filled with insulating compound, which permanently protects the components from damage, interference or variation. Such a Receiver forms an ideal broadcast Receiving Instrument, which can be guaranteed to give consistent performance and every possible satisfaction.

Receiving conditions in Australia are different from those in any other part of the world. In this country the great majority of "Listeners-in," especially those residing in the country, require a Receiver which will give long range interstate reception with the utmost simplicity of control and freedom from breakdown.

In these essentials the Radiola Super stands supreme.

The purchaser of a Radiola Super is always a satisfied listener-in. Whether living in the City or Country he has no difficulty in receiving programmes from the other States. He does not find reception spoilt by interfering stations, as frequently occurs with many receivers now on the market. He obtains complete satisfaction from the day the set is installed and knows that through our extensive system of local Service Stations any difficulties arising will be promptly remedied.

The phenomenal success of the Radiola Super indicates the widespread demand in Australia for a Receiver of this type. Mass production and modern manufacturing facilities have now made it possible to make available a complete range at prices from £45 to £120. This remarkable price range brings a Radiola Super Receiver within the reach of every purse.

## Radiola Standard 6.

A Six Valve Superheterodyne Receiver housed in a handsome laminated Maple Cabinet.

Fitted with two fine-adjustment station selectors.

Cabinet has accommodation for high-tension batteries.

Jacks provided for using either five or six valves as required.

Designed for use with new A.W.A. 99 X or Radiotron UX 199 Valves, thus reducing battery consumption. Has special fitting enabling "filament checking" voltmeter to be used.

A high-grade receiver guaranteed to give interstate reception on average aerial, either in town or country districts.

PRICE .. £45. Complete with all accessories and Amplion Loud Speaker.



Radiola Standard 6.

## Radiola<sup>®</sup> Senior 16.

A Six Valve Superheterodyne Receiver, fitted with loop aerial and housed in handsome laminated maple cabinet with artistically veneered sloping front. The oval shaped panel accommodates all controls. Two latest design station selectors show dial readings in illuminated panel "windows."

Dry Batteries are housed in the cabinet.

Jacks provided for using either 5 or 6 valves as required.

Designed for use with new A.W.A. 99 X Valve or Radiotron UX 199 Valves, thus reducing battery consumption.

Has special fitting enabling "filament checking" Voltmeter to be used. A high-grade Receiver guaranteed to give interstate reception on "loop." Can be used with aerial for long distance day-light reception.

PRICE .. £65. Complete with all accessories and Amplion Loud Speaker.

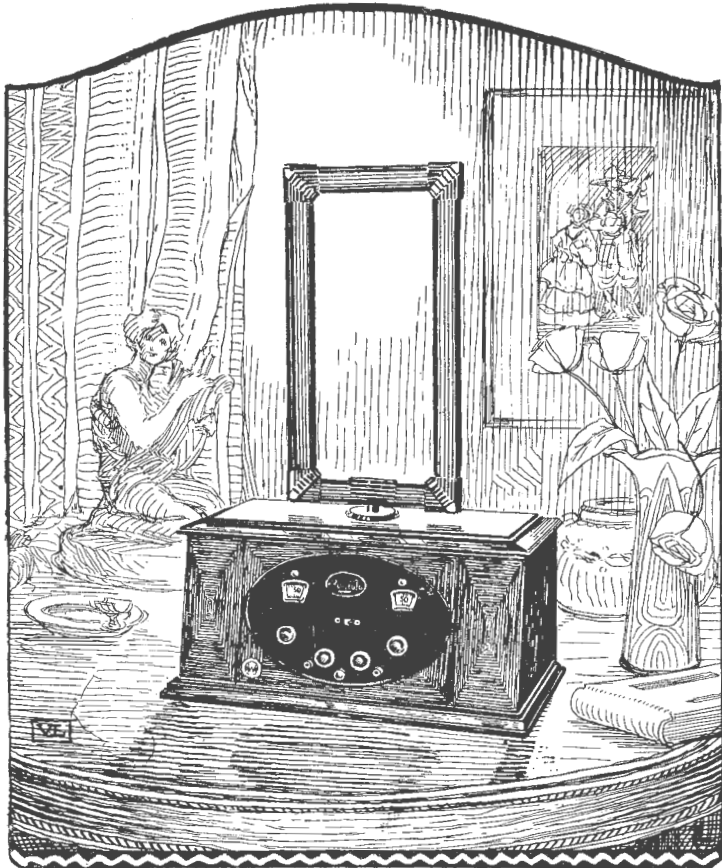

Radiola Senior 16.



## Radiola Super 6.

A Six Valve Superheterodyne Receiver—the Radiola Super is operated with a loop aerial and needs no earth connection; while the controls have been reduced to a minimum, consistent with effective tuning, simplicity of operation and high efficiency.

The impression of exceptional craftsmanship conveyed by the simple lines, the admirable proportions and the artistic finish of the Tasmanian Fiddleback Blackwood Cabinet is quickly confirmed on hearing the exquisite tone quality.

The charm of faithful radio reproduction, combined with the ease of being able to tune in distant stations at will—positive selectivity—plus admirable proportions and elegant design, make the Radiola Super a scientific radio receiver of exceptional merit and a piece of furniture that will harmoniously grace the most artistically furnished home.

The Cabinet houses all batteries. Jacks provided for using either 5 or 6 valves as required.

Its curved front accommodates two exceptionally efficient drum control station selectors.

Designed for use with new A.W.A. 99 X Valves or Radiotron UX 199 Valves, thus reducing Battery consumption.

Has special fitting enabling battery checking Voltmeter to be used.

Fitted with revolving loop aerial with which good interstate reception can be obtained.

PRICE: Table Type, complete with all accessories and Amplion Loud Speaker, £90  
Floor Cabinet Model with Built-in Amplion Loud Speaker, £120.

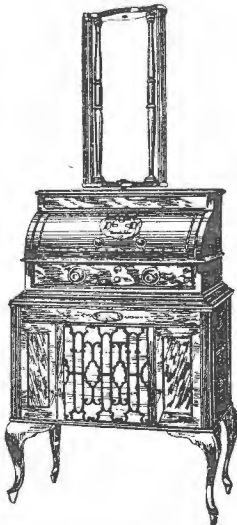

Radiola Super 6.  
Floor Cabinet Type.

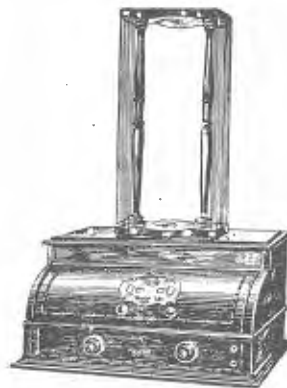

Radiola Super 6.  
Table Type.

## Radiola Super 8

An Eight Valve Superheterodyne Receiver of the most modern and efficient design, fitted in a magnificent floor cabinet, which accommodates all accessories and loop aerial.

Tuning of the different stations is by one control only.

The enclosed loud speaker is the latest Amplion Cone type.

Every facility and improvement devised by modern research has been incorporated in this Radiola, which is the year's outstanding achievement in Broadcast Receiver design.

The special control enables any desired broadcasting station to be tuned-in by simply turning a single knob. The only other control adjusts the music and speech to just the desired volume.

Extreme selectivity ensures a complete freedom from interference by unwanted broadcasting stations.

The A.W.A. Radiola Super 8 is designed for long range interstate reception and the most perfect reproduction possible. Housed in a fine example of modern cabinet-making, the Radiola Super 8 is an example of utmost efficiency, going hand-in-hand with artistic appearance.

PRICE .. £115, entirely complete.

## Radiola Receivers

Have behind them the research facilities, engineering skill and experience of A.W.A.—the Company that designed and manufactured Broadcasting Stations 2FC, 3LO, 4QG, 5CL, and 6WF; that operates practically the whole of the ships' wireless stations of the Australasian Mercantile Marine, and owns and controls the Coastal Radio Stations throughout Australia and New Guinea.

There is every evidence that the quality built in A.W.A. Radiolas has won the enthusiastic approval of the radio public. The owner of a Radiola is always proud to demonstrate his set—to show how clearly and truly it reproduces each broadcasting programme from near or far, without interference.

## The Portable Radiola Super.

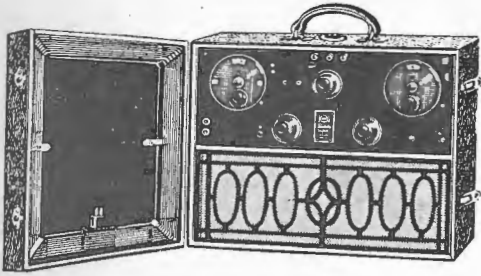

Broadcasting concerts and dance music for the picnic—the motor-boat outing—motor car tour—or the week-end house party.

It works everywhere — mountain, sea, or city.

Just take it where you wish, set it down, adjust the loop aerial, turn a dial or two, and entertain the party with

dance music from the best city orchestras, or listen to the latest news items and sports results.

Tunes in Sydney, Melbourne, Brisbane, Adelaide and other stations without the use of an aerial.

The Six-Valve A.W.A. Portable Radiola Super is an entirely self-contained instrument, incorporating the operating mechanism, battery equipment, loop aerial and Amplion Loud Speaker.

Reception of Broadcasting Concerts from the other States at Loud Speaker Strength on loop guaranteed.

Interference from unwanted stations entirely eliminated.

Enclosed in handsome leather-covered case, with handle for carrying. Adaptable for outdoor or indoor use.

It combines the fine essentials of good reception, fidelity of reproduction, volume, selectivity, distance and ease of operation.

Always ready, reliable and efficient, the Portable Radiola Super provides the last word in summer entertainment.

Price, complete with Enclosed Amplion Loud Speaker, £75.



1. Victoria Bridge and part South Brisbane from Tower 4QG.



2. A corner of the Main Reception Hall—4QG.

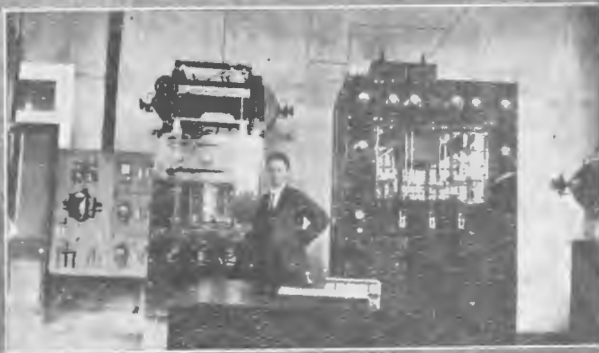

3. Mr. J. W. Robinson, Director, and Mr. F. W. Stevens, Chief Engineer, on the roof of 4-QG.

4. Main Switch-board "Drive" and Oscillator at 4QG.

## A.W.A. RADIO GUIDE

### C.A.V. ACCUMULATORS.



Supplied in 2, 4, or 6 volt types, of either 22, 33, or 44 ampere hour (continuous) capacity. Manufactured by the C.A.V. Company, of England (using only the highest grade of chemically pure materials) with the experience of years, and the services of a highly trained Technical staff.

### SPECIAL INSTRUCTIONS FOR FIRST CHARGE—C.A.V. ACCUMULATORS.

**ACID.**—This should be pure brimstone sulphuric, doubly distilled for preference—specific gravity, 1.215 when cold. The concentrated acid should be diluted with distilled water only, care being taken that the acid is added to the water and not vice versa—allow to cool before filling cell.

**CHARGING.**—The rate should be about half that given on the label and should be kept up CONTINUOUSLY if possible for about 36 hours, or until each cell registers 2.6 volts. The negative plates should then be gassing freely, and the acid will have a milky appearance.

**NOTE.**—These instructions apply to first charge only, after this follow instructions on fixed label carefully. Use hydrometers for testing strength of acid.



### CLYDE "SR" TYPE RADIO BATTERIES.

Made in 4 volt and 6 volt units in four sizes.

The strong and serviceable one-piece container eliminates all troubles with leaking cells and corroding wood or iron carrying crates.

Designed with a thick plate, "SR" type batteries will deliver uniform current over a maximum period of time and will not discharge when idle.

"SR" Batteries 5in. wide, 7 $\frac{1}{2}$ in. high overall.



### STURDY SPECIAL HYDROMETER.

This is a device for testing the specific gravity and condition of both A and B accumulator batteries. For further details, see notice on "Care of Accumulators."

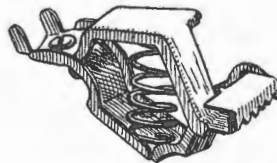

### LEAD COVERED BATTERY CLIP.

A solidly constructed metal clip with heavy lead coating, specially designed for use with accumulator storage batteries. The sulphuric acid used in accumulators is very destructive to most metals, but the heavy lead coating on this type of clip renders it practically immune.

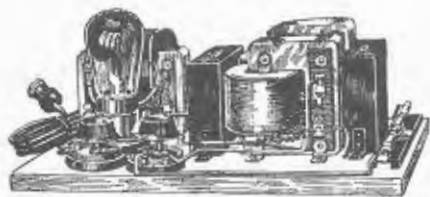

**"APCO" SUPER "B" ELIMINATOR  
SOLVES YOUR B BATTERY  
TROUBLES.**

Gives Constant Current Supply  
Better Reception  
Permanent Satisfaction from your Receiver  
Reduced Operating Costs.

There is a model for use with both A.C. and D.C. current supply. These have been specially made for Australian line voltages.

Variable, Voltage Control—allowing maximum output of 135v. D.C. at 40 M/A.

Three Voltage Taps—22½, 45, 90/135.

Special Rectifying Valve (for A.C. model).

No chemicals, liquids or mechanical attachments.

**"A & B" BATTERY CABLE.**

A 5-cord covered battery cable used for the purpose of connecting the "A, B and C" batteries to a Radio Receiver. The cords are all colored to permit of easy identification, and eliminate all possibility of wrong connections. Lugs are fitted on either end to permit of easy connection.

These Battery Cables are also supplied with 7 cords, where the use of a power valve is required, to permit of the additional High Tension and Bias.

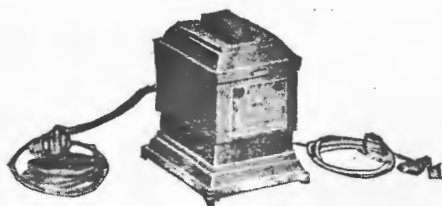

**TUNGAR 2-AMP A & B  
BATTERY CHARGER**

**ALTERNATING CURRENT BATTERY  
CHARGER.**

Tungar Rectifiers are made in various sizes to charge at different rates, and can be supplied to charge either A batteries only, or both A and B batteries. They are noiseless in operation, using the bulb principle of rectification, and are connected to the 240v. Alternating Current electric light mains. Simple to operate, nothing to get out of order. Made in A and B 2 amp type, and A and B 5 amp. type.

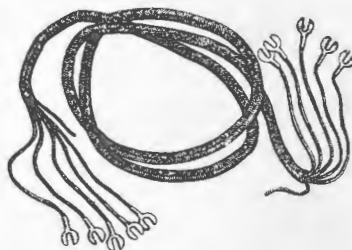

**HIGH TENSION BATTERIES.**

**"EVER-READY" H.T. BATTERY, 42 V.**

This illustrates the Ever-ready Radio High-tension "B" Battery—fitted with a Wanda Plug, and 2 screw Terminals.

Manufactured in Australia specially to suit Australian conditions.

Positive tappings are arranged to suit all required voltages.  
W.P.—Small capacity.  
XP—Large capacity.



The illustration on the left depicts the WP60 type. This is identical with WP40, except that it has a higher voltage.



**COLUMBIA RADIO "A" DRY CELL BATTERIES.**

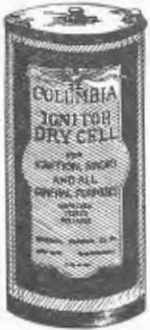

A. Battery  
(No. 6111).

The Columbia Radio "A" Dry Cell Battery, No. 6111, 1½ volts, is made especially to meet the heavy current demands imposed upon dry cells by dry cell vacuum tubes, will prove far more satisfactory for this purpose than any other dry cell, and will give much longer service.

Three or more Columbia "A" Dry Cell Batteries can be connected in series to meet the requirements of the higher voltage tubes, such as the UV-199, UV-201a or other tubes requiring more than 1½ volts on the filament, but not exceeding .25 amps. of current.

When connected in parallel, the voltage of the cells remains the same as the voltage of a single cell, but the total current required by the radio set is equally divided among the cells so connected, so that the drain on each cell is not excessive, thereby greatly prolonging the life of all the cells.

**COLUMBIA "B" BATTERY, No. 4767.**

Especially made for use on all sets using 45 volts or 90 volts with a "C" Battery. Its large cells make this battery powerful and long lasting for this service. Contains 30 cells and is provided with seven Fahnestock Spring Clip Connectors, giving a range of voltage from 16½ volts to 22½ and a 45 volt tap. The Battery can therefore be used for both the detector and amplifier.



B. Battery (No. 4767).



**COLUMBIA "B" BATTERY, No. 4770.**

45 volts for multi-tube sets.

Especially made to supply the heavy "B" Battery drain of multi-tube receiving sets. Its economy is immediately apparent when used on sets having four tubes with 90 volts or more on the plate (no "C" Battery," all sets of five tubes or more, and all power amplifiers).

A.W.A. RADIO GUIDE

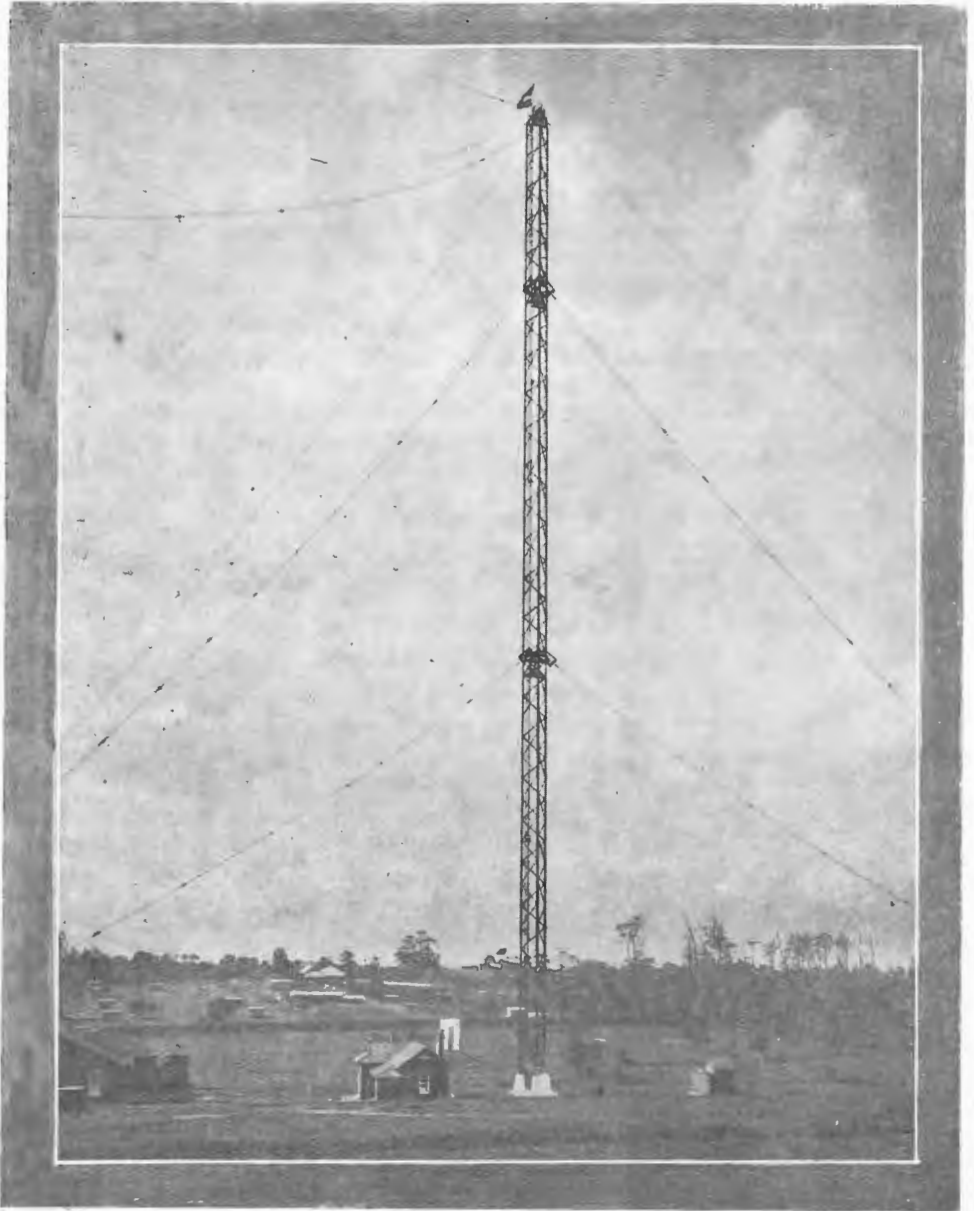

The Main Mast at Radio Centre,  
Amalgamated Wireless (A/sia), Ltd. Wireless Station, Pennant Hills, Sydney.



## A.W.A. RADIO GUIDE

### DARIMONT PRIMARY BATTERIES.

The ideal Battery for use where no charging facilities are available.

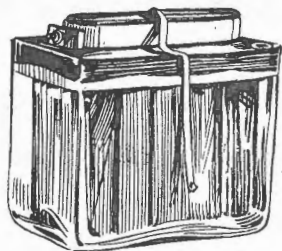

Exhaustive and prolonged research has led to the development of a primary cell having the following characteristics:—

- (1) It gives a constant current at a satisfactorily high E.M.F.
- (2) The current may be used with equal advantage intermittently or continuously.
- (3) The cell is easily re-charged when exhausted.

The difficulties due to effusion have been overcome in the DARIMONT CELL, here described.

In this cell two liquids are used, separated by a porous pot, but the liquids are such as to form a semipermeable membrane in the pores of the porous pot, and therefore, diffusion is negligible.

The excitant, which is called HEMIPOROGENE, is a viscous emulsion with sodium chloride as the main electrolyte; the depolariser, called RADIOGENE, is a solution consisting largely of ferric chloride. Both liquids are inodorous. The zinc chloride which is formed when the cell is in action remains in solution, and the ferric chloride becomes reduced. The terminal voltage remains very constant because depolarisation is rapid and complete, and because the internal resistance does not vary to any considerable extent.

The cell consists of a container made of glass, in the centre of which is the porous pot. The space between the top of the container and top of the porous pot is filled in with a special sealing compound, which holds the carbon plates and porous pot in position. The porous pot contains the Hemiporogene and zinc plate; it is closed by a loose cover having a hole in the centre, through which the lead terminal strip from the zinc is passing.

#### SUMMARY OF CHARACTERISTICS.

- (1) The E.M.F. is about 1.6 volts.
- (2) The internal resistance varies but little.
- (3) The terminal voltage is well maintained on continuous discharge.
- (4) There is no trouble from diffusion of the liquids.
- (5) There is no smell nor crystallization of salts.
- (6) The chemicals used are neither objectionable nor dangerous.
- (7) There is no loss of zinc on open circuit.
- (8) Easily and inexpensively re-charged.
- (9) Minimum attention and maintenance.
- (10) The cell may be used continuously or intermittently.
- (11) Not damaged by short circuit. (No buckling or sulphating.)

#### RECHARGING CELLS.

The cell is re-charged by simply renewing the Hemiporogene and Radiogene (which are supplied in quantities suitable for the purpose), together with zinc. These three constituents are so proportioned that they all require renewing at the same time.

Add Hemiporogene (3 pints) to porous pot and Radiogene (6 pints) to glass container.

## A.W.A. RADIO GUIDE

### For Efficient Results Use AWA DUOLATERAL COILS.

Wound on automatic-precision machinery, AWA Duolateral Coils combine high conductivity with effective insulation between turns.

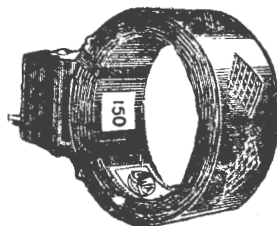

AWA Duolateral Coils are mounted on de-luxe bakelite coil plugs with black celluloid diamond strip, and then the shoulders are specially bound with black waxed thread, which holds the coil rigidly in position.

AWA Coils are non-hygroscopic, offer very low radio-frequency resistance, and self-capacity is at a minimum. They may be used as tuning, loading, coupling, or wavemeter inductances, ensuring the highest degree of efficiency for your set.

Made in sizes to suit your requirements, each AWA Duolateral Coil is attractively boxed, and the wavelength table printed on the carton. Also supplied unmounted in red cartons.

No. of Turns.	M.H. Inductance.	Wave lengths with .001 Condenser.	No. of Turns.	M.H. Inductance.	Wave lengths with .001 Condenser.
20	20	50-260	300	5,000	1,050-4,200
25	30	100-375	400	9,000	1,600-6,000
35	80	150-525	500	15,000	2,000-7,500
50	150	190-675	600	21,500	3,000-9,000
75	330	240-925	750	35,500	4,000-11,000
100	550	340-1,340	1,000	62,250	4,500-16,000
150	1,300	500-1,960	1,250	100,000	6,310-18,240
200	2,400	650-2,675	1,500	160,000	7,635-22,210
250	3,600	725-3,575	1,600	—	—

IT IS NOT AN AWA MOUNTED COIL UNLESS IT IS PACKED IN A BLUE CARTON.

### A.W.A. Duo-Lateral Coils for Australian Broadcast Stations.

NOTE WHEN TUNING IN 6 WF THE A.T. CONDENSER WILL BE IN PARALLEL	COIL "A" OR AERIAL	COIL "S" OR SECONDARY	COIL "P" OR TUNED ANODE	COIL "R" OR REACTION
2UE 2UW 2KY 5DN	{ 25 35	35 50	35 50	50
2BL 3LO 4QG 5CL	{ 35 50	50 75	50 75	50
2FC 3AR 7ZL	50	75	75	50
6 WF	150	200	200	100

## A.W.A. RADIO GUIDE

### "ELECTRAD" CERTIFIED CONDENSORS.

The six pressure points: Ingenious riveting and binding method fastens parts securely at six different points and exerts even pressure upon the largest possible surface. Cannot loosen and change value of condenser.

Materials: Thin sheet of copper is used in place of tin foil. A slip of the soldering iron cannot possibly melt or otherwise damage the copper and thereby ruin this condenser.

Scientific design insures perfect electrical contact always. The soldering lug and the binding strap are in one piece. Neither can work loose from the other.



"Electrad" Certified Condenser,  
"G.S" type.

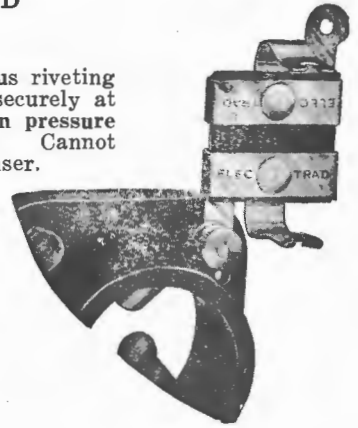

The "G-S" type condenser is especially convenient for attaching directly to the socket terminal.

"Electrad" Condensers, G.S. type, are designed so that minimum wiring is needed. The clips may be fitted directly over the terminal of the valve socket, and the Gridleak mounted on the second set of clips, so that a complete unit is made.

The best Mica Di-electric, together with Copper-Foil Plates, combine to form a Condenser that is to be relied upon for service under all conditions.



"Electrad" Certified Condenser, Standard type. Soldering lug and binding strap in one piece.

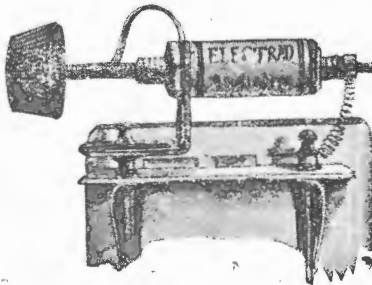

### ELECTRAD AUDIOHM.

Converts noisy distorted volume into clear true tones by a simple twist of adjusting knob. Mount across secondary of your audio transformer as illustrated.



### "ELECTRAD" LIGHTNING ARRESTER.

Consists of an air gap between two copper conductors, arranged in an improved manner, so that it is impossible for the spacing of the gap to vary. It is then hermetically sealed and the gap is, therefore, absolutely water-tight. The housing protecting the air gap is moulded in glazed porcelain with a highly ornamental finish. These arresters comply with Fire Underwriters' Regulations.

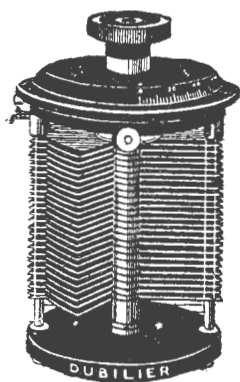

### THE DUBILIER VARIABLE CONDENSERS.

Connection to the movable plates is made through a flexible phosphor-bronze strip, and safety stops are fitted.



### THE DUBILIER GRID LEAKS.

Dubilier "Dumetohm" resistances are a new type of resistance for use in Radio apparatus. They are of a metallic nature and are guaranteed to maintain an absolutely constant resistance value under all normal working conditions.

Dubilier "Dumetohm" Grid Leaks, 0.25, 0.5, 1, 1.5 and 2 megohms.



### THE DUBILIER MICA CONDENSER (Type No. 600).

To keep the efficiency high the electrical losses in every part of a wireless set must be reduced to the absolute minimum. Losses in the condensers are extremely detrimental to the proper functioning of the apparatus.

The Type 600 Dubilier Condenser illustrated is constructed with Mica and is enclosed in a moulded insulating case which carries the terminal connections, so that the highest insulation is secured.

This condenser will withstand the application of a testing voltage of 1,000 volts.



### THE "DUCON"

The "Ducon" is a simple piece of apparatus, enabling those having electric light to secure wireless broadcasting without an aerial. Plug the "Ducon" into an ordinary lampholder or wall socket, connect the terminals at the lower end of the "Ducon" to your receiving set, adjust your instrument in the usual manner, and broadcasting is received perfectly.

The "Ducon" is a neat, compact, well-finished article that can be used with any type of wireless receiving set. It is perfectly safe to use, each one being tested to 2,500 volts. It consumes no current and does not affect the electric light in any way.

### THE DUBILIER MICA CONDENSER, Type 610.

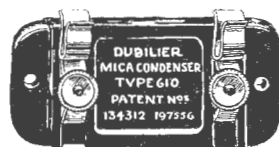

This Condenser is suitable for use everywhere in receiving circuits. The condenser unit is the same in essentials as that of the well-known Dubilier Type 600. As a whole, however, this new condenser represents a distinct improvement. The moulding is of a different design, and the terminals are of the screw type, though the connections can easily be soldered if required. The application of a soldering iron does not in any way affect the moulding or impair the efficiency of the condenser.

The type 610 is supplied with or without Grid Leak Clips, as required. These are detachable—an added convenience when, during experimental work, it may be necessary to remove the clips.

Supplied in all capacities.

## A.W.A. RADIO GUIDE

### BENJAMIN STANDARD VALVE SOCKET.

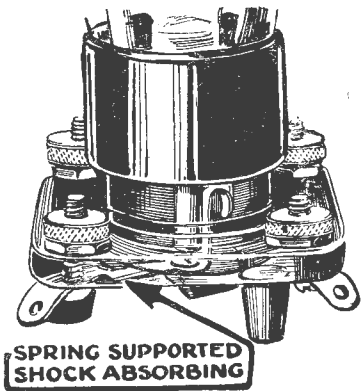

TYPE No. 9040.

Side wiping contacts insure perfect electrical connection to the tube prongs.

Suspension spring and contact member are made in one piece, thereby eliminating the high resistance joints.

All metal parts are heavily nickelled.

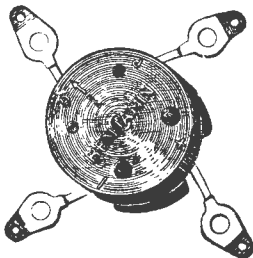

TYPE No. 9049.

No. 9049 is without lower mounting base and is intended for direct panel mounting. They include a drilling template and four machine screws with nuts for attaching.

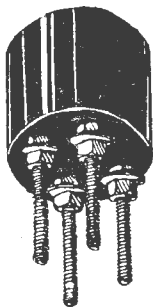
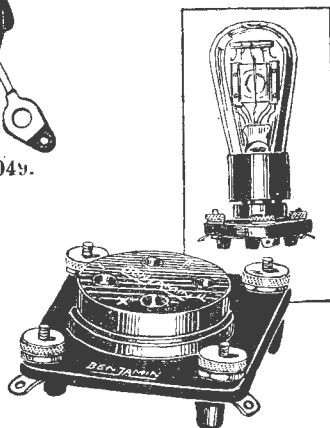

Polished Ebonite "R" Type Valve Sockets, suitable for panel mounting, complete with nuts and washers. The material and finish are of the highest grade and workmanship, and for any English 4-pin valve this socket is ideal.

### A.W.A. CRYSTAL DETECTORS.

A high-grade Crystal Detector in highly polished nickel finish. It has a special glass envelope to keep the crystal free from dust and other injurious matter. Arranged to enable easy fitting to any receiver.

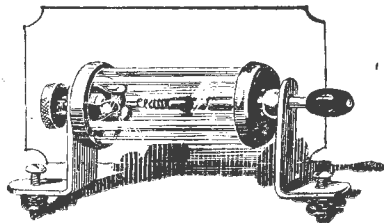



400ft. Mast at Pennant Hills, Sydney

Base View of Mast showing the Glass Insulators upon which the whole structure rests

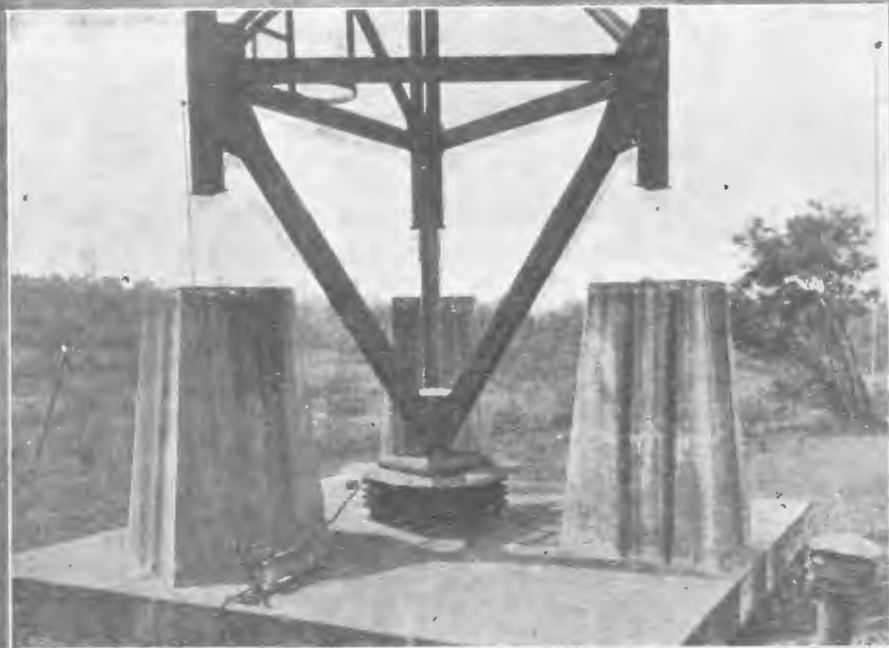

### VERNIER DIAL.

All radio apparatus requires a sensitive indicating device for the careful calibration of a particular setting of the instruments. Such an indicator must be carefully designed in order to include in its operation all the good points that are required.

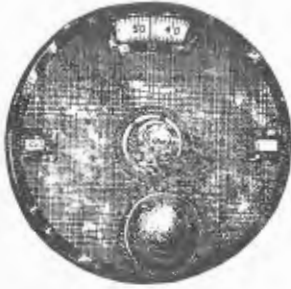

### URALIUM—NATURE'S WONDER CRYSTAL.

#### ONE LARGE SENSITIVE SPOT.

The disadvantage of a Crystal Receiver—its tendency to become insensitive through loss of adjustment to the detector, is removed when Uralium is used. Uralium will give results wherever the whisker touches it.

### SPAGHETTI.

Insulated Sleeving for the purpose of covering and insulating busbar wire and commonly known as "Spaghetti." It has a high resistance value and is easily threaded on to the busbar wire for wiring the set. Supplied in four different colors for identification purposes.

Where the use of "Spaghetti" is not required, a make of insulated wire known as "CELAT-SITE" can be used. The insulation of this wire has a high resistance value, and in addition is water and acid proof.

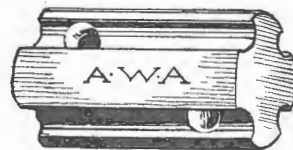

### EBONITE LEAD-IN.

At the point where the aerial enters the house it is necessary to have a permanent arrangement for allowing the "received signals" to pass through, and which will be quite sound mechanically and electrically. The above illustration depicts a lead-in insulator which is specially designed for this particular purpose. It is equally suitable for wood or brick houses. The down lead is guyed securely within close reach of the external terminal, and the slack wire connected to "lead in." The internal wiring then commences from the inside terminal connected.

### PORCELAIN STRAIN INSULATOR.

In making the aerial fast to its supports, whether horizontal or vertical, it must be carefully insulated. The above illustration depicts what is known as the Barrel Insulator. Provision is made for the aerial wire in one groove and the support wire through the other.

The A.W.A. Porcelain strain insulator is made of the purest porcelain and will resist climatic conditions indefinitely. Its insulation value, tensile strength, and ruggedness makes it essential in every aerial system where minimum loss is desired.



Constructed with the Fantail Cupped Lugs for easy soldering. Silver contacts, Bakelite Insulators, polished nickel plating, positive snap.

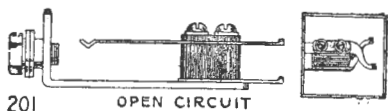

201 OPEN CIRCUIT  
Open Circuit Jack.—Generally used with a detector unit alone or in circuit of last stage of amplification.

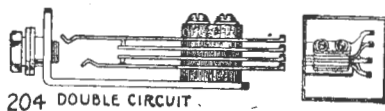

204 DOUBLE CIRCUIT  
Double Circuit Jack.—Generally used between detector and first stage of amplification, or between successive stages before the last.

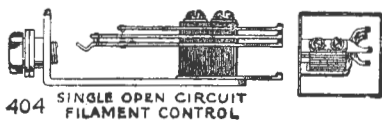

404 SINGLE OPEN CIRCUIT FILAMENT CONTROL  
Single Fil. Control Jack is used in last stage of amplification. Automatically lights or extinguishes filaments of tubes as plug is inserted or withdrawn.

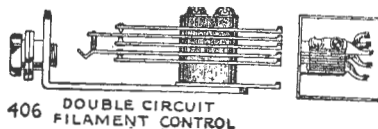

406 DOUBLE CIRCUIT FILAMENT CONTROL  
Same features as Single Fil. Control Jack, but is primarily used in intermediate stages.



The Improved Push-Pull Jack Switch for switching on and off the filament battery current.



# A.W.A. RADIO GUIDE

## METERS.

Radio engineers all agree that it is absolutely impossible to get the best out of a radio set unless the filament voltages are correct and the "B" batteries at their proper operating point. The life of a tube burned 10% above its rated voltage will be cut in half. If burned below its rated voltage the reception will be under normal. A recent survey made by a large set manufacturer showed that 60% of all radio trouble is traceable to defective or run-down batteries.

These are established engineering facts which a radio set owner cannot afford to ignore. The control of filament voltages and checking of "B" batteries will eliminate most of your radio troubles. Nothing is more disappointing in radio than to have trouble or poor reception while listening to a Premier's broadcast message, a grand opera aria, the football returns, or while entertaining guests with a dance programme.

Hand in hand, and in step with the great strides of this industry, the Jewell Co. saw the need for precision instruments to control the plate, filament and antenna currents produced in the operation of continuous wave transmitters.

Always first in the field, JEWELL developed a complete line of instruments for direct, alternating and high frequency currents, uniform in design, accurate in operation—all one size—"THE JEWELL TRIO." High grade D'Arsonval direct current meters, rugged alternating current meters and the superior thermo couple type of radio frequency ammeters make up the Jewell transmitting trio.

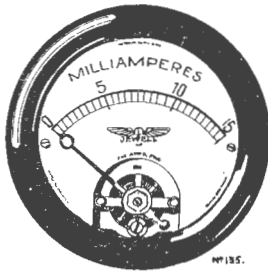

Pattern No. 135.

For panel mounting. Case diameter, 2 inches, with special cup for mounting. 0-15 milliamps, 0-25 milliamps, 0-50 milliamps.

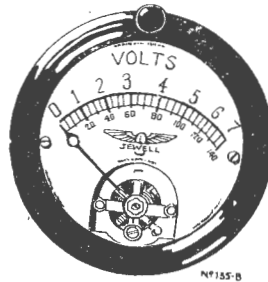

Pattern No. 135-B.

Double reading voltmeter, 2 inch case diameter, with narrow flange. Push button switch for high voltage reading. 0-7.5-150 volts.

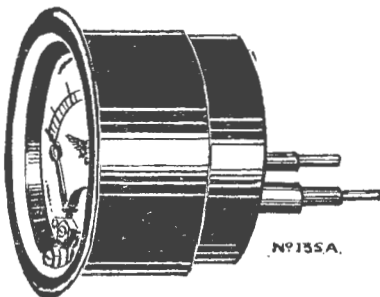

Pattern No. 135-A (Side View).

Two-inch high resistance voltmeter with pin jacks for plugging into Radiola Super. Has zero adjustor. 0.5 volts.

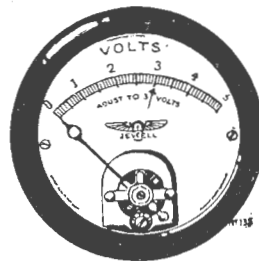

Pattern No. 135-A  
(Front View).

## A.W.A. RADIO GUIDE

### JEWELL METERS.

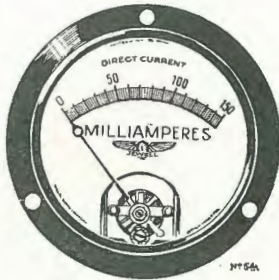

Pattern No. 54.

For transmitting sets. Case 3 inches diameter.

- 0-150 m/amp.
- 0-250 "
- 0-500 "
- 0-1000 "

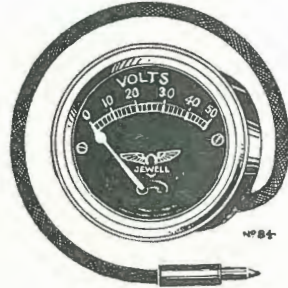

Pattern No. 84.

The most substantial and accurate low-priced voltmeter made for checking "B" batteries. 0-50 volts.

With cord and prod complete.

**Antenna Ammeters.**  
This is one of the "Jewell Trio" for amateurs. 3 inch case. Thermo-couple type. .5, 1.5, 3, and 5 amps.

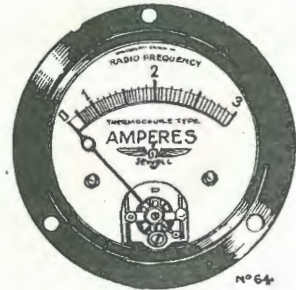

Pattern No. 64.

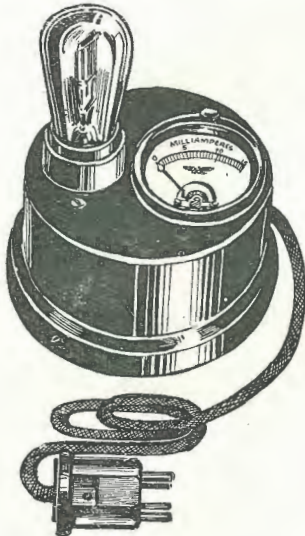

Pattern No. 107.

**Jewell Junior Tube Checker.** The checking of tubes in the home is made easy for set owners. The milliammeter indicates condition of tube. Complete with cord, plug, and adaptor.

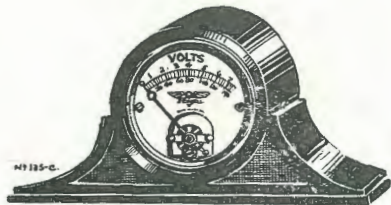

Pattern No. 135-C.

A beautiful portable double-reading voltmeter for Radiola Super. Furnished with two leads with 'phone tips.

0-7.5 and 150 volts.

For testing A & B Batteries.

# AMPLION

*The  
Natural Tone  
Loud Speaker*



Amalgamated  Wireless  
(Australasia) Ltd.



## Amplion Loud Speakers.

The choice of a loud-speaker needs considerable care, for if you have a good aerial and a good set, but a poor loud-speaker, the enjoyment radio can give is considerably lessened.

By purchasing an AMPLION you obtain a loud-speaker giving faithful and pure reproduction over the full tone range.

The remarkable clarity and delightfully natural tone of the world-famous Amplion Loud Speaker, when associated with a suitable receiving set, renders wireless reproduction comparable with the original performance.

With the Amplion, the unseen speaker, vocalist, or orchestra, as the case may be, is brought right into the home and the advantages of Radio Broadcast may be enjoyed to the full.

In artistry of design and fine finish, the Amplion excels just as its efficiency is unapproached, so that the Amplion may well be regarded as the one and only Wireless Loud Speaker for the Home of Beauty and Refinement.

Made by the originators and principal manufacturers of Loud Speaking Telephones, Alfred Graham and Company, London, the Amplion represents the highest development in Loud Speaker Construction.

All Amplion Loud Speakers are supplied in one Standard Resistance, viz:—2000 ohms.

AMPLIONS are adjustable—that is to say, the position of the diaphragm may be varied until it is suited to the volume passed by the set. Once having been adjusted, make future adjustments to the receiver only. If signals are not as loud as they were the night before, the set may not be tuned quite as well; look here for trouble and not to the speaker. If signals are too loud, detune the set by slightly altering the adjustment of the variable condensers until the results are satisfactory.

When connecting up a loud speaker to the receiver make quite sure that the terminal marked “+” goes to the positive H.T. battery, and the “—” terminal goes to the plate of the valve. If this is not done the magnets will become weakened, and a loss of efficiency will result.

# Dragon Type Amplions



**"JUNIOR DRAGON"**

Model A.R. 111 with Metal  
Flare.  
Overall Height 15in.  
Diameter of Flare 10in.



**"SENIOR DRAGON"**

Model A.R. 65  
Overall Height  
Diameter of Flare 12in.  
Chocolate Crystalline Finish,  
Copper Oxidised Base.



**"DRAGON-FLY"**

Model A.R. 102.  
Overall Height 8in.  
Diameter of Flare 5½in.

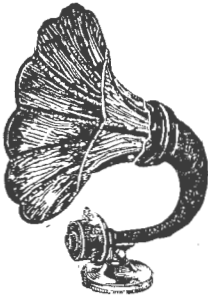

**"STANDARD DRAGON"**

Model A.R. 19  
Overall Height 20in.  
Diameter of Flare 14½in.

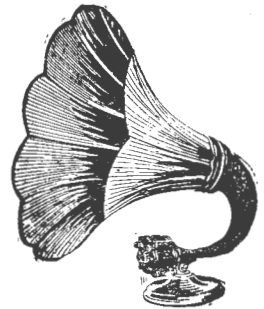

**"CONCERT DRAGON"**

Model A.R.23  
Overall Height 24in.  
Diameter of Flare 21in.

# Swan Neck Amplions



**"DE LUXE SWAN-NECK"**  
with metal trumpet, Model  
A.R.88. Overall Height 24in.  
Diameter of Flare 14in.



**"SENIOR SWAN-NECK"**  
Model A.R. 58. Overall Height  
20in. Diameter of Flare 12in.



**"JUNIOR SWAN-NECK"**  
Model A.R. 38. Overall Height  
20in. Diameter of Flare 10in.



**"DE LUXE SWAN-NECK"**  
Model A.R.88.0, with Oak  
Trumpet.  
A.R.88.M, with Mahogany  
Trumpet.  
Overall Height 24in.  
Diameter of Flare 14in.

## AMPLION GRAMOPHONE ATTACHMENTS.

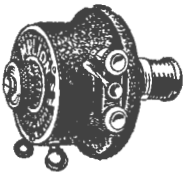

**'CONCERT GRAMOPHONE'**  
Model A.R.35  
(500-2000 ohms).

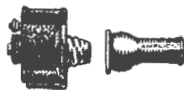

**A.U.4 UNIT**  
Fitted with Rubber, as  
Gramophone Attachment.

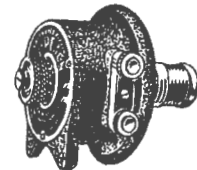

**"STANDARD  
GRAMOPHONE"**  
Model A.R.67

# Radiolux Amplions

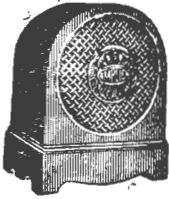

**"RADIOLUX-AMPLION"**  
Junior Model.  
Width 10in. Height 13½in.  
Depth 6in.  
Type RS3.  
Queensland Maple.  
Rosewood Finish.

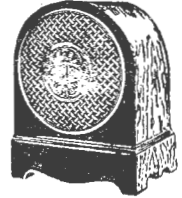

**"RADIOLUX-AMPLION"**  
Junior Model,  
Width 10in. Height 13½in.  
Depth 6in.  
Type R.S.2. O English Oak.

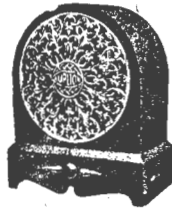

**"RADIOLUX-AMPLION"**  
Junior Model with metal case.  
Width 10in. Height 13½in.  
Depth 6in.  
Model R.S. 2.



**"RADIOLUX-AMPLION"**  
Senior Model with metal case.  
Height 19in. Width 14in.  
Depth 7in.  
Type R.S.1

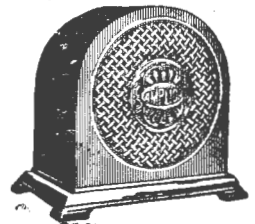

**"RADIOLUX-AMPLION"**  
Senior Model.  
Width 14in. Height 16in.  
Depth 7in.  
Type R.S.1.M English  
Mahogany.  
Type R.S.6 Tasmanian  
Blackwood.

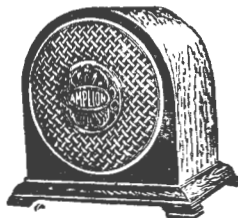

**"RADIOLUX-AMPLION"**  
Senior Model, width 14in.  
Height 16in. Depth 7in.  
Type R.S.1. O English Oak.  
Type R.S.5 Queensland Maple



## A.W.A. RADIO GUIDE

### METHOD OF CONNECTING LOUD SPEAKER TO RECEIVER.

It is very important that due regard should be given to the polarity marked on the Loud Speaker when connecting it to the receiving set. As loud speakers contain a permanent magnet, if the current from the "B" battery does not flow through the speaker in the correct direction it will weaken the magnet and in time destroy it altogether. Fig. 1 shows the correct way to connect up the loud speaker.

Fig. 2 shows an alternative method. In this case the direct current from the "B" battery flows through the choke coil L and is isolated from the loud speaker by the condenser C. This method is preferable to the first when high "B" battery voltages are used, as in the case of power amplification. The polarity of the speaker is immaterial, as no current from the "B" battery flows through it. The condenser C should have a capacity of about 2 microfarads, and the choke coil L requires the same impedance as that of the secondary winding of the average audio-frequency transformer; in fact, a transformer secondary is frequently used for this purpose, the primary being left open.

The use of a "Siftron" is highly recommended. This prevents demagnetisation and improves results.

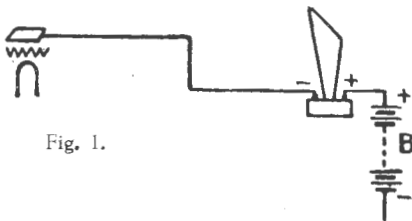

Fig. 1.

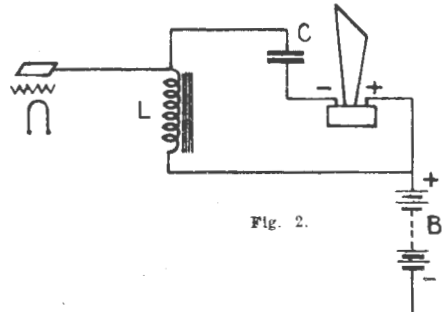

Fig. 2.

### "SIFTRON" CIRCUIT DIAGRAM.

#### For Radio Loud-speakers.

When a SIFTRON is connected in the output circuit of a Broadcast Receiver, only modulated current flows through the windings of the Loud Speaker, thus enabling closer adjustment, which, once made, remains undisturbed.

The magnet of the element cannot become demagnetized and the windings are safeguarded from breakdown.

Using a SIFTRON it is not necessary to connect the Amplion Loud Speaker "a special way round," and "over-loading" is out of the question.

If two or more Loud Speakers are used on the same Set the SIFTRON makes a decided improvement in clarity and quality of signals.

### LOUD SPEAKER CORDS.

Flexible braided cords fitted with standard tips for connecting Amplion Speakers to Broadcast Receivers, etc., etc. They are also suitable for many other purposes. Supplied in two standard lengths, namely, 5ft. and 20ft.



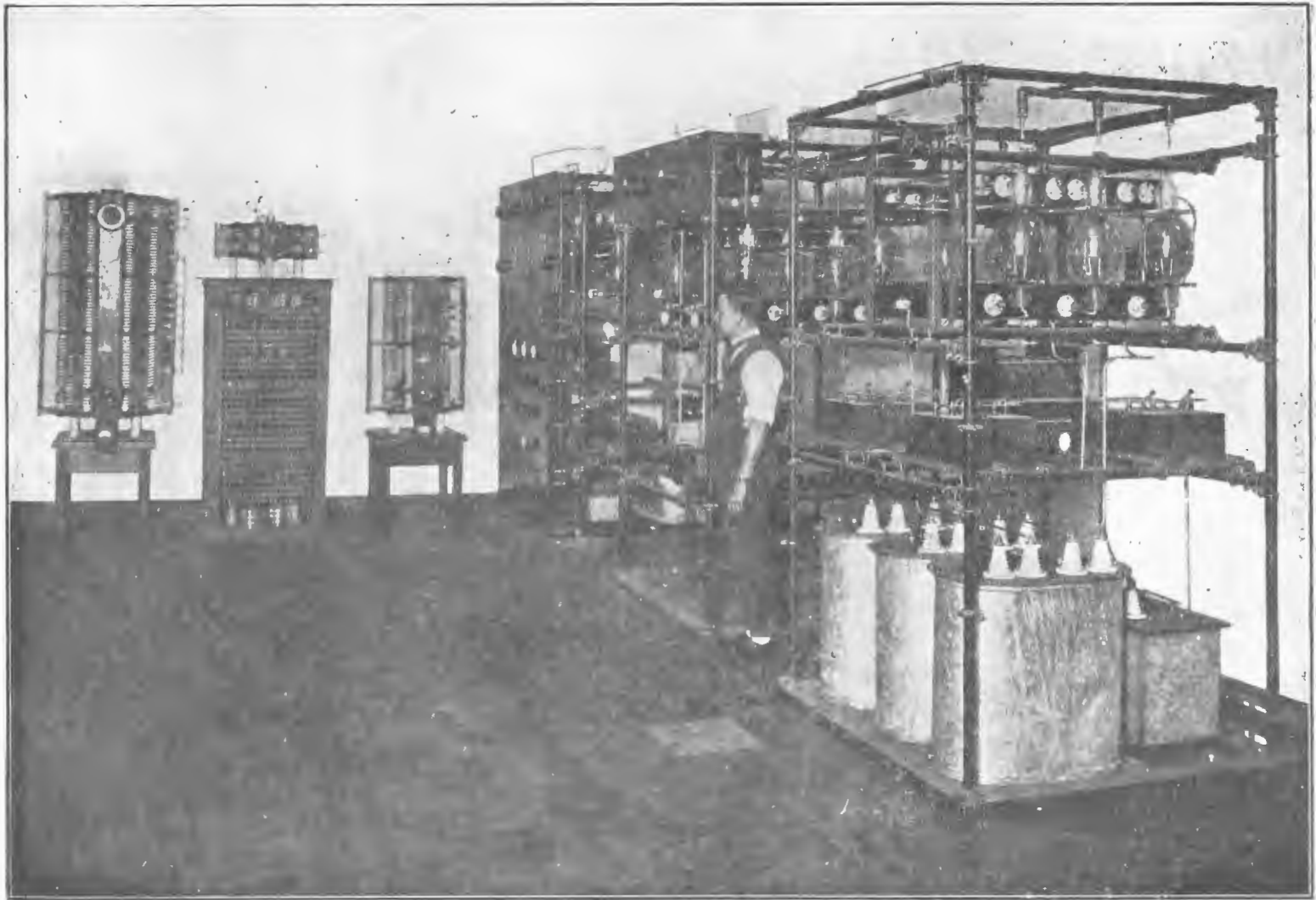

5 K.W. Broadcasting Transmitter, designed and manufactured at the Radio-Electric works of Amalgamated Wireless (A/sia) Ltd. Similar Transmitters were installed at Broadcasting Stations 2F.C. Sydney, 3L.O. Melbourne, 4Q.G. Brisbane, 5C.L. Adelaide, 6W.F. Perth.

**ELECTONE AUTOMATIC PROGRAMME  
SELECTOR.**

Automatically switches on your set for the items you wish to hear and switches off when desired by you.

Simply plug the face of the clock at the hours required, and the automatic control does the rest.

Safeguard your batteries, do not miss the item you desire—time signal—weather report—whatever it may be, the Electone Selector saves you rising to switch your receiver on or off.

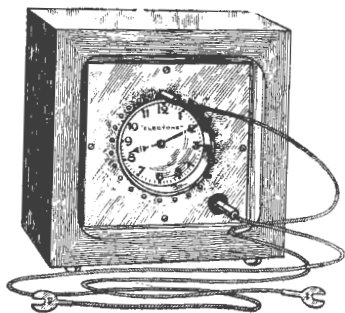

**X-L NEUTRALISING CONDENSER.**

Model N, for use in Neutrodyne, Browning Drake or any circuit where efficient stable neutralisation is essential. Micrometer adjustment allows point of balance to be reached with ease, and as it is approved and used by the originators of the Browning Drake circuit, can be employed in all confidence by you. Capacity 1.8 to 20 Micro-Microfarads.

Model G.—A variable grid condenser allowing 100% efficiency in the detector circuit, ensuring range and purity and perfect control of any circuit. Fitted with gridleak clips. Capacity, .0001 to .0005 Microfarads.

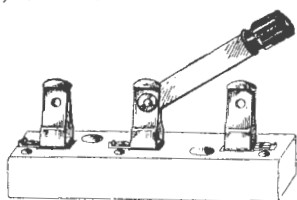

**COUPLING PLUGS DE LUXE.**

are made of the best grade of bakelite, together with highest quality nickel-plated fittings that allow perfect conductivity, at the same time permitting freedom of movement without loss of efficiency.

**PANEL PLUGS DE LUXE.**

consisting of finest quality bakelite, made in Australia, complete with nickel-plated pins and sockets, together with screws of ample length to fit through any thickness of panel, and make perfect contact. Suitable for short wave work as well as broadcasting.

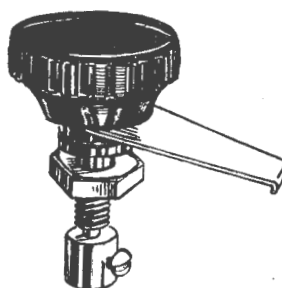

**ROTARY SWITCH ARM.**

In conjunction with contact studs can be used for a variety of purposes in any type of Receiver, such as varying inductance, switching on and off A and B batteries, series parallel connections, etc.

**DOUBLE THROW SWITCH.**

A sturdily constructed copper switch manufactured with single or double poles. Having a porcelain base, they can be used to carry high voltage current.

The single pole switch is admirably adapted and frequently used for connecting in the aerial circuit for the purpose of earthing same where necessary.

The double pole switch can be used for a variety of purposes where a highly insulated switch is required.

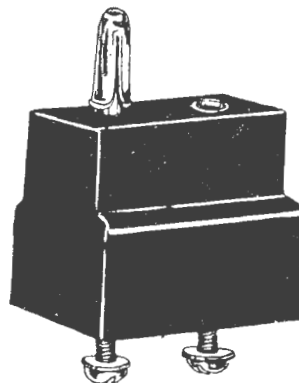

**FRAMINGHAM SWITCH.**

**DOUBLE POLE SWITCH** consisting of two nickelled arms with polished knob having a side lever movement. Can be used for many purposes and is specially designed for varying the condenser and inductance connections in the aerial circuit, thus arranging a series or parallel connection as required.

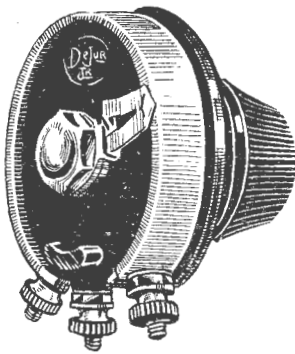
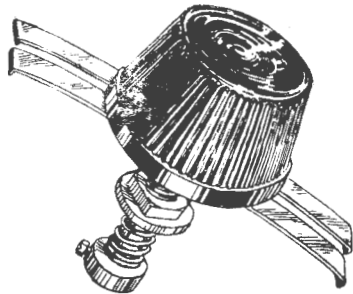

**DE JUR POTENTIOMETERS.**

Of highest-grade workmanship. It is precisely the same mechanically as the De Jur Rheostat, being identical in every respect with the exception of the wiring, and the additional terminal. Absolutely reliable.

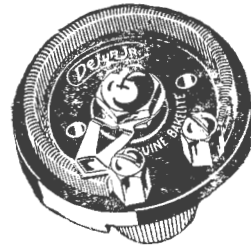

**DE JUR RHEOSTAT.**

Has genuine bakelite base and knob, and only the best of metals employed in the construction of same. It has a special arrangement whereby the tension spring for making contact at the back cannot possibly come adrift, a trouble frequently met with in other rheostats, and which is the cause of great inconvenience. Designed for single hole mounting, but has two holes drilled for those preferring to affix to the panel in the usual way.

Supplied in 6, 10 and 30 ohm. resistances.

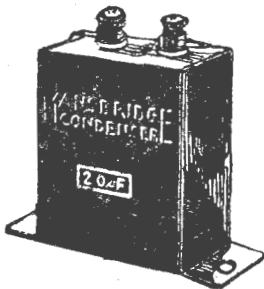

**DUBILIER MANSBRIDGE  
CONDENSERS.**

A special Condenser of the Mansbridge Pattern, designed for "by-pass" work ranging up to 4MF. capacity and tested to 300 v. D.C. Attractively designed and very compact. Fitted with terminals and tinned lugs for making connections. The base has two projecting pierced lugs for affixing to sub-panel or base-board. Carries the usual Dubilier guarantee.

### BRADLEYLEAK.

#### The Perfect Grid Leak.

Grid leaks are among the most sensitive devices in a radio receiver. Each tube requires a slightly different grid leak resistance. An adjustable grid leak provides the only means of getting maximum efficiency from every valve.

The Bradleyleak has a range from  $\frac{1}{2}$  megohm to 10 megohms. A small grid condenser (0.00025 Mfd.) is also offered for mounting across the Bradleyleak terminals. The size, finish and mounting is identical to that of the Bradleystat.

Provision is made for baseboard mounting. The turning of the knob provides a smooth, stepless and noiseless adjustment of grid leak resistance.



Shown with Bradley Micadon Condenser fitted.

### BRADLEYOHM.

#### The Perfect Variable Resistor.

The demand for a reliable, adjustable resistor resulted in the development of the Bradleyohm. This rheostat is similar in appearance to the Bradleystat, but the discs are of radically different composition. The Bradleyohm is made in various ranges.

No. 10—10,000 to 100,000 ohms.

No. 25—25,000 to 250,000 ohms.

No. 50—50,000 to 500,000 ohms.

The Bradleyohm is unaffected by moisture or atmospheric changes, and is especially suited for shunting audio-frequency transformers, for resistance coupled amplifiers, and for many other applications requiring high resistors.

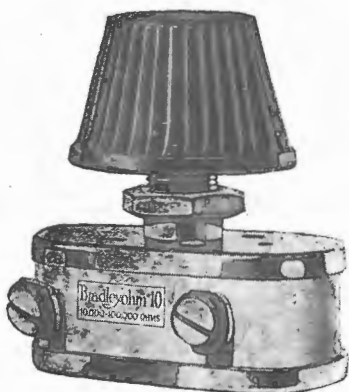

### BRADLEYSTAT.

#### Perfect Filament Control.

This remarkable graphite disc rheostat has an unbroken stepless range of control from approximately  $\frac{1}{2}$  ohm to 100 ohms, thereby affording sufficient control for ALL tubes without change of connections.

All metal parts are nickel-plated, and a one-hole mounting makes installation easy. The knob is of bakelite, and is quickly detachable. The Bradleystat is one of the smallest rheostats on the market. An internal switch opens the battery circuit when desired.



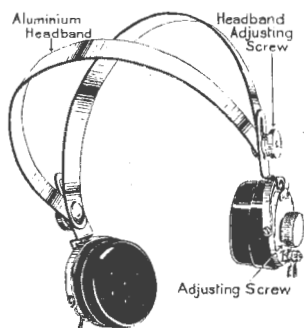

**BROWN'S "TYPE A" HEADPHONES.**

**"The Most Sensitive Headphone in the World."**

Years before broadcasting began the BROWN A-type Headphone had achieved world-wide fame among Wireless Telegraphists.

The BROWN A-type Headphone is being used by wireless and amateurs broadcast listeners to-day, not only because it is more sensitive—and therefore better able to pick up long-distance telephony—but because its speech is more natural and distortionless.

In principle it is unique. Instead of an iron diaphragm an aluminium one (of the thinness of paper) is actuated by a moving reed. The limits of its vibration and its most sensitive position can be corrected by means of an adjusting screw. Headphones without this feature have to allow an appreciable clearance, otherwise the diaphragm would hammer on the magnet when receiving strong signals.

Its construction—as befits the most sensitive headphone in the world—is according to the highest standards.

Supplied in 2000, 4000, 6000, and 8000 ohms.

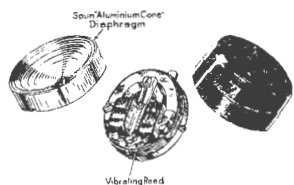

**A.W.A. TELEPHONES.**

Of the highest-grade workmanship, being manufactured by the well-known Ericsson Telephone Company of England. Very light in weight, the earpieces being composed of aluminium. A special feature about this telephone is that by unscrewing the earcap the whole of the magnet section can be detached without releasing any screws. Ideal for broadcast reception.



**TELEPHONE PLUGS.**

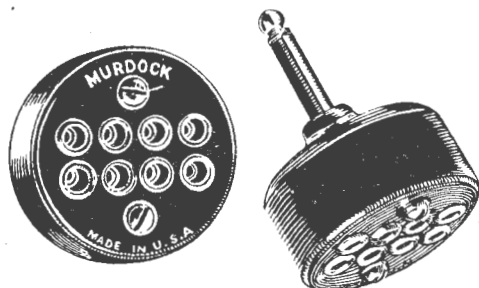

Murdock Multiplug, fits any Standard Jack, to take up to 4 prs. 'Phones either in series or parallel.

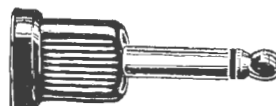

De Jur Quick Change Automatic Plugs are designed to give maximum service with minimum effort. The terminal tags of the Loud Speaker Cord or 'Phone Cord, are merely pushed into the plug, and a firm electrical contact is established. Should it be desired to withdraw the cord, the action is smooth and easily accomplished.



Broadcasting Studios at Melbourne Broadcasting Station 3LO.

# A.W.A. RADIO GUIDE

## VARIOMETERS.

### THE WHY AND WHEREFORE OF TUNING.

What do you want in a broadcast tuner? A self-contained simple instrument, not affected by outside influences, with a minimum of internal connections, robust and sturdy, and one which will give a smooth operation throughout its range,—are not these the features which will meet your requirements?

What can you get as a tuner? There are the three kinds of instrument available. (1) Variable Condenser in combination with Fixed Inductance; (2) Tapped Inductance or Slider; (3) Variometer. The first of these is so affected by the presence of the hand which operates it that the tuning is upset when the hand is withdrawn. The second does not give smooth gradual operation, neither does its construction appeal to many. We claim that the Variometer complies absolutely and exactly with all the above requirements.

This consists in principle of two spherical shaped windings, called the rotor and stator respectively, one fitting inside the other, the former being rotatable on a shaft. There are two connections only. Every position of the inner winding gives a different inductance and the full range of the instrument is effected by one half turn.

Typical applications follow.

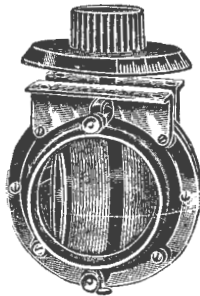

#### H.R. TYPE VARIOMETER.

Suitable for universal application. Stator and rotor of hard mouldings of very high insulating quality. Rotor externally wound with double cotton-covered copper and finished with hard insulating varnish. Stator with internal winding cemented in position with insulating compound. For wave lengths 150-600 metres with windings in parallel, or 150-600 metres when used for tuning a secondary circuit.

Here are two examples of circuits employing Variometers.

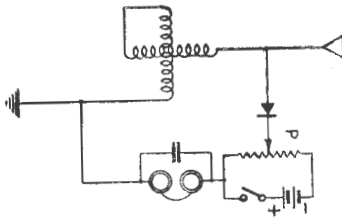

(Fig. 3)  
Simple circuit with crystal detector and potentiometer for correct voltage adjustment.

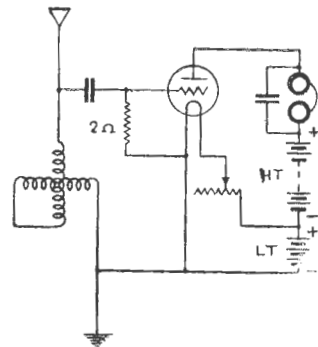

(Fig. 4)  
An excellent arrangement of a single valve set, using a Variometer for aerial tuning.



## VARIO-COUPLERS.

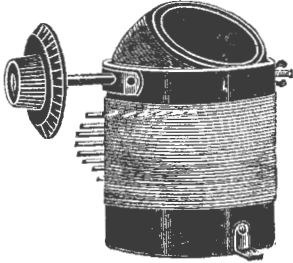

The Vario-Coupler is a development of the Variometer and will be found to give great selectivity. The Stator is cylindrical, and the windings are so arranged that with only two multi-way switches inductance may be varied turn by turn, while loose coupling may be achieved by revolving the rotor. Like the variometers it is made of the finest possible materials. The maximum ratio of coupling is 2-3. Approximate dimensions: 4½ in. external diameter; 5½ in. high.

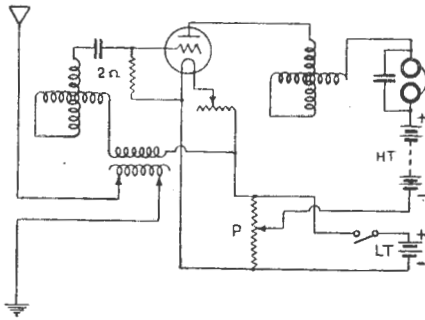

This illustration is an example of a "Jamming-proof" one valve circuit, showing the use of a Vario-Coupler for selection and two Variometers for main and local circuit tuning.

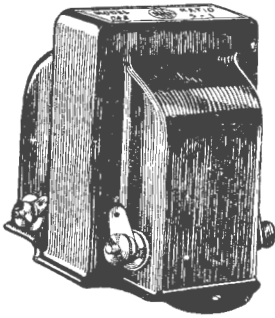

## A.W.A. SUPER AUDIO TRANSFORMER

The A.W.A. Superaudio Transformer has been introduced to meet the demand for an Audio Transformer featuring the high efficiency demanded in present day broadcast Receivers.

Every modern feature is incorporated in the new A.W.A. Superaudio Transformer :

1. Constant amplification over the whole musical scale.
2. Special winding making the distributed capacity negligible.
3. Good amplification at lower frequencies ensured by:—
  - (a) High inductance primary.
  - (b) Ample cross section core.
  - (c) Small air gap.
4. Utmost protection against burn-outs by:—
  - (a) Impregnated windings.
  - (b) Case filled with non-hygroscopic insulating compound.
5. Each Transformer tested in actual Receiver Circuit.
6. All insulation tested at 1000 volts.

The A.W.A. Superaudio Transformer is housed in a pressed steel case which, whilst being of pleasing appearance, effectively localises the Magnetic Field. The Base Area is very small, and the terminals mounted low down; this greatly simplifies wiring and reduces assembly difficulties to a minimum.

Supplied in two Ratios: 5 to 1 and  $3\frac{1}{2}$  to 1.

### A.W.A. AUDIO FREQUENCY TRANSFORMER.

**Ideal for Low Loss Work.**

A.W.A. have spared no effort to produce a thoroughly efficient Audio Transformer. Each Transformer is subject to 1,000 volts insulation test between windings and casing, and between the windings themselves. Low self-capacity and the special arrangement of primary and secondary coils give uniform amplification over the whole band of useful frequencies. Made in two standard ratios—5-1 and  $3\frac{1}{2}$ -1.

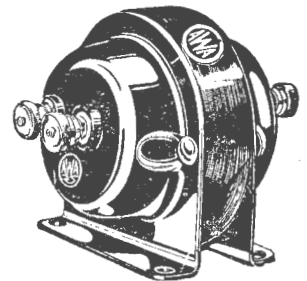

A.W.A. Audio Transformer.

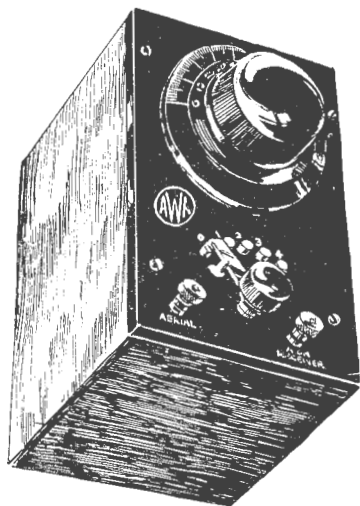

# A.W.A. WAVE-TRAP

## For Eliminating Interference.

This instrument is designed for the purpose of reducing interference in a receiving set from powerful local broadcasting stations.

It is sometimes difficult to receive interstate stations on even a comparatively selective receiver when the wave-length of the local station is close. The wavetrap, however, allows the interfering station to be eliminated.

The wavetrap can be used in two ways, viz.: as a rejector or as an acceptor. In the first case only one station can be eliminated. This is in most cases, all that is necessary. In the second case all stations are eliminated, with the exception of the one desired. This arrangement would be used where interference was caused by a group of stations.

This particular type of wavetrap was decided upon after all the known types had been tested, as the one which gave the best results, it being at the same time easy of operation and simple to connect to a receiver.

The usual method of using the trap, i.e., as a rejector, is shown in Fig. 1.

The aerial is connected to the aerial terminal on the wavetrap. The receiver terminal on the wavetrap is connected to the aerial terminal on the receiver, using a piece of bell wire or similar copper wire about 20 gauge, making sure that the insulation is removed from the ends of the wire which go under the terminals. The earth terminal of the receiver is connected to earth as usual.

To tune in a station, set the switch on the wavetrap to 0, and use the controls on the receiver in the ordinary way until the desired station is tuned in. If interference is noticed from another station, set the switch on wavetrap to stud 2 and rotate the wavetrap dial slowly until the interfering

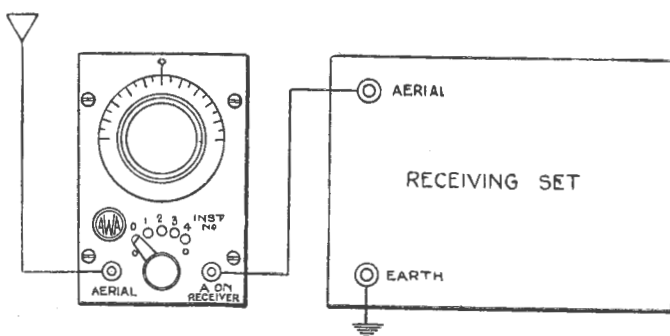

## A.W.A. RADIO GUIDE

station is eliminated. If **complete elimination** is not possible with the switch in this position, move it to stud 4 and again rotate the dial of the wavetraps. Always use the switch on the lowest stud possible for best reception.

It is advisable to readjust the receiver controls after making the final adjustment to the wavetraps.

To use the wavetraps as an acceptor connect as shown in Fig. 2.

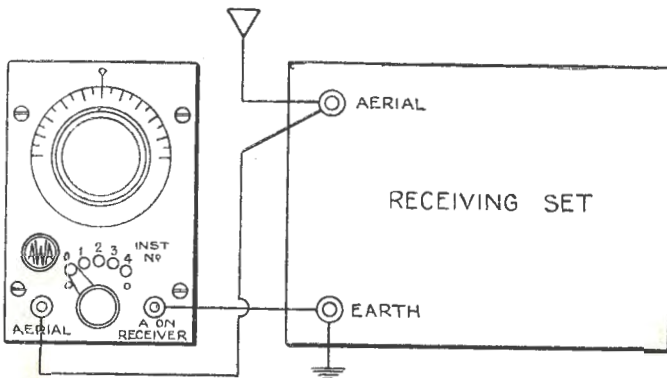

The aerial and earth are connected to the receiver in the usual way. The aerial terminal of the wavetraps goes to the aerial terminal of the receiver, the receiver terminal of the wavetraps to the earth terminal of the receiver. Set the wavetraps switch on 4 and the dial on 100.

Tune in the station desired in the usual way on the receiver, and if interference is noticed rotate the dial of the wavetraps until only the desired station is heard. If this cannot be accomplished with the switch on 4 move it to 3 and so on until

the desired results are obtained. Always use the highest setting of the switch possible in this case.

This arrangement is somewhat critical of adjustment and is not recommended unless the user has become fairly proficient in manipulating the tuning controls of the receiver.

The arrangement of the wavetraps as a rejector is recommended wherever possible. The strength of the desired signal is reduced when using the acceptor circuit, and this arrangement is only recommended in cases of severe interference and when the desired signals are fairly strong.

FOR BETTER  
RECEPTION

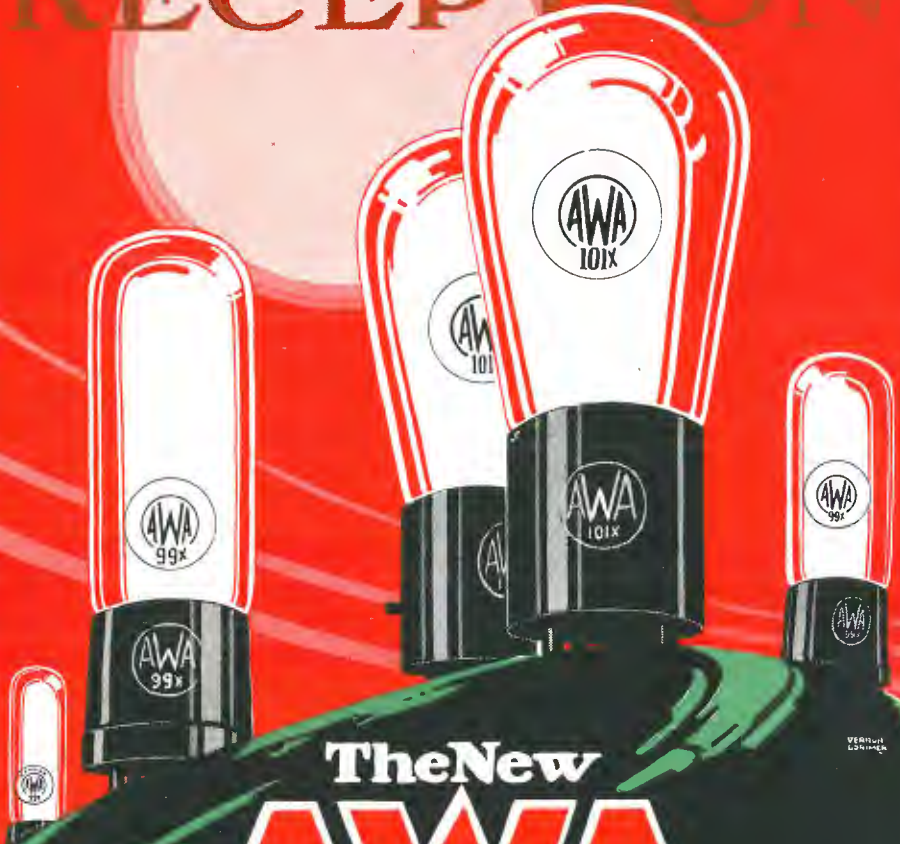

The New

**AWA  
VALVE**

VERBODEN  
te kopiëren



## Valves.

Valves are primarily instruments of precision—the most sensitive ever manufactured and sold on a large scale. They are a kind of artificial eye, for they “see” waves to which our living retinas are unresponsive—the waves which carry broadcasting and speech.

The amount of energy received by a radio set may be only a few millionths of a millionth of that transmitted, but good valves respond to it and amplify it millions, even billions, of times. Despite its sensitivity this extraordinary artificial sense organ is so sturdy that it withstands ordinary usage and it is made in large quantities, so that its price is low. One of the functions of a good valve is to control the flight of billions of electrons—invisible particles of electricity, so small that they bear the same size-relation to atoms that footballs bear to a large dirigible balloon. A stream of electrons speeding from filament to plate is instantly and automatically influenced by the waves from the broadcasting station which affect the grid. What we hear is a duplicate of what is broadcast.

These electrons are shot forth by the heated filament. A few years ago only expensive storage batteries could be used to heat the filament. Now many of these valves are operated by inexpensive dry-cells; their filaments glowing only a dull red.

This improvement is the result of ceaseless research. More electrons are now emitted with less heat—therefore less current. Lower filament temperature also enhances the quality of reception.

An air or gas molecule is immense compared with an electron; it would stop an electron in its flight to the plate. Research showed how obstructing air molecules could be swept out of the bulb.

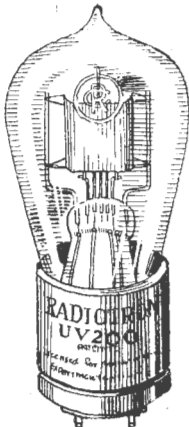

**RADIOTRON UV200.**

The valve is “soft”—that is, special gases are introduced during the manufacturing process giving that characteristic which provides “detection” with great sensitivity.

UV-200 operates from a 6-volt storage battery, and may be used in any circuit.

Socket U.V.



**RADIOTRON UX201a.**

The sturdy UX-201A is the standard, all-round, flexible storage battery valve of radio—good in any detector amplifier circuit. It is recognised as the standard storage battery valve. Its thoriated filament has an electron emission which is not simply high, but extraordinarily high; and this at low current consumption with resulting long life.

Socket UX.

## A.W.A. RADIO GUIDE



### RADIOTRON UX200a.

A wonderful detector of great sensitivity. It is an alkali vapour valve, and employs a new type of filament.

One point of great value about this valve is that both the filament and plate are non-critical. This means that one control, such as the Brachstat, can be used to operate the detector as well as the other valves in any Receiver. The manufacturers specify a shock absorber socket for this valve, and the Benjamin UX Socket is ideally suited for the purpose. This is the finest shock absorber socket on the market, and the 200 A., when used in conjunction with it, can be relied upon to give absolute satisfaction.

Socket UX.



### RADIOTRON UX112.

Just as Radiotron UX-120 takes the place of UV-199 in the last stage of dry-cell valve audio-frequency circuits, so UX-112 takes the place of UV or UX-210A in the last audio stage of storage battery sets. Radiotron UX-112 will deliver far more energy than the average loud-speaker requires. This must be regarded as a distinct advantage. It means not only fine quality, but long life.

UX-112 has an oxide-coated filament which operates at such a low temperature that only a dull red glow is visible. Lower current consumption, considering the power output, follows as a matter of course. Socket UX.



### RADIOTRONS UV199 and UX199.

UV-199 (or UX-199) is the smallest Radiotron made, and is adaptable to either portable or home dry battery operated sets. It is equally serviceable as a detector or as a high-efficiency radio or audio frequency amplifier. Economy of operation is particularly pronounced when used in circuits having more than five valves.

The dry cells of the "A" battery are subjected to very slight drain. The two Radiotrons are electrically identical, differing only in their bases.

Socket UV-199, UX.



### RADIOTRON UX120.

The new dry cell Radiotron UX-120 is to be used exclusively in the last stage of audio-amplification. Owners of the Radiola Super should ask for the UX-120 to be used in the last socket of those sets.

The Radiotron UX-120 was designed to give greater Loudspeaker clarity and volume without distortion.

Socket UX.



## A.W.A. RADIO GUIDE

### RADIOTRON UX210.

#### CHARACTERISTICS—

A Battery Volts.	Filament Terminal Volts.	Filament Current Amps.	Plate Voltage Amplifier.
8 ..	7.5 ..	1.25 ..	425 (max.)
8 ..	7.5 ..	1.25 ..	350
8 ..	7.5 ..	1.25 ..	250
6 ..	6.0 ..	1.1 ..	157.5
6 ..	6.0 ..	1.1 ..	135
6 ..	6.0 ..	1.1 ..	112.5
6 ..	6.0 ..	1.1 ..	90

The Radiotron UX-210 is a super-power amplifying valve primarily designed for use with an 8-volt storage battery or a specially designed rectified AC current supply set. It may, however, be used with reduced output with a 6-volt storage battery. Its plate voltage may be supplied from "B" batteries which are capable of furnishing sufficient current, although it is primarily for use with rectified alternating current. This Radiotron is capable of handling far greater volume without distortion than any receiving valve now in use, and its output is ample to supply any Amplion loud-speaker to its limit of volume. Where extra volume and quality of reproduction are demanded, UX-210 is the power amplifier par excellence.

The super power-valve, several times as powerful as UX-120, is probably the most powerful in existence.



### RADIOTRON UX171.

A new power Radiotron, UX-171, designed to operate loud speakers of low impedance at considerable volume with a minimum of distortion. It is intended for use in the last audio stage only.

Radiotron UX-171 may be operated from a storage battery or, by appropriate power devices, from alternating current lighting mains. The general specifications of the valve appear elsewhere.

Socket UX.

# RADIOTRON CHARACTERISTICS

Model	Use	Base	Grid Condenser Mf	Grid Leak See Note 3 	Detector Grid Return Lead	A Battery Volts Supply	Filament Terminal Volts	A Battery Current Amperes	B Battery Volts Detector	B Battery Volts Amplifier	Negative C Battery Volts	Plate Current Milliampere Normal operating See Notes 1 & 2	Output Resistance Ohms See Note 1	Mutual Conductance Micro Mhos See Note 1	Voltage Amplification Factor See Note 1
Radiotron UV 199	Detector Amplifier	UV 199 Base	.00025	2-9	- F	4.5	3.0	.06	45	90	4.5	2.5	15000	415	6.25
Radiotron UX 199	Detector Amplifier	R.C.A. Small Std UX Base	.00025	2-9	- F	4.5	3.0	.06	45	90	4.5	2.5	15000	415	6.25
Radiotron UV 200	Detector only	Standard UV 201A	.00025	1/2-2	- F	6	5.0	1.0	15-25	—	—	—	—	—	—
Radiotron UX 201A	Detector Amplifier	R.C.A. large Std UX Base	.00025	2-9	- F	6	5.0	.25	45	90 135	4.5 9.0	3 4	12000 11000	675 725	8 8
Radiotron UX 112	Detector Amplifier	R.C.A. large Std UX Base	.00025	3-5	- F	6	5.0	.5	22-45	135 90	9 6	5.8 2.4	5500 8800	1435 890	7.9 7.9
Radiotron UX 120	Audio Amplifier last stage only	R.C.A. Small Std UX Base	—	—	—	4.5	3.0	.125	—	135	22.5	6.5	6600	500	3.3
Radiotron UX 200A	Detector only	R.C.A. large Std UX Base	—	—	—	6	5.0	.25	45	—	—	—	—	—	—
Radiotron UX 210	Amplifier Oscillator	R.C.A. large Std UX Base	—	—	—	8 6	7.5 6	1.25 1.1	—	425 135	35 9	22 4.5	5000 8000	1550 940	7.75 7.5
Radiotron UX 171	Audio Amplifier last stage only	R.C.A. large Std UX Base	—	—	—	6	5.0	.5	—	90 180	16.5 40.5	10 20	3000 2500	1000 830	3 3

Note 1 At normal operating Grid Voltage (Not at Zero Grid)

Note 2 The plate current values given are less than those obtained with zero grid, but are the currents actually obtained when the tube is operated at indicated values of plate voltage & grid bias voltage.

Note 3. The symbol  = megohms

# RADIOTRON AND RECTRON CHARACTERISTICS

GENERAL						DETECTORS AND AMPLIFIERS						AMPLIFICATION							
MODEL	USE	BASE	MAXIMUM OVERALL DIAMETER	MAXIMUM OVERALL HEIGHT	A BATTERY VOLTAGE (SUPPLY)	FILAMENT TERMINAL VOLTAGE	FILAMENT CURRENT (AMPERES)	DETECTOR GRID RETURN LEAD TO	GRID LEAK (KOHMS)	GRID CONDENSER (MFD)	DETECTOR BATTERY VOLTAGE	DETECTOR PLATE CURRENT (MILLIAMPERES)	AMPLIFIER B BATTERY VOLTAGE	AMPLIFIER C BATTERY VOLTAGE	AMPLIFIER # PLATE CURRENT (MILLIAMPERES)	OUTPUT RESISTANCE (OHMS)	MUTUAL INDUCTANCE (MICROHMS)	VOLTAGE AMPLIFICATION FACTOR	MAXIMUM UNDISTORTED OUTPUT (WATTS)
RADIOTRON UX 201 A	Detector Amplifier	R.C.A. Large Standard UX Base	1 1/16"	4 1/16"	6 Storage	5.0	.25	+ F	2-9	.00025	45	1.5	135 90	9 4 1/2	2.5 2	11000 12000	725 675	8 8	55 15
RADIOTRON UV 199	Detector Amplifier	UV 199 Base	1 1/16"	3 1/2"	Dry Cell 4 1/2 Storage	3.0	.06	+ F	2-9	.00025	45	1	90	4 1/2	2.5	16500	380	6.25	7
RADIOTRON UX 199	Detector Amplifier	R.C.A. Small Standard UX Base	1 3/16"	4 8/16"	Dry Cell 4 1/2 Storage	3.0	.06	+ F	2-9	.00025	45	1	90	4 1/2	2.5	16500	380	6.25	7
DETECTORS																			
RADIOTRON UX 200	Detector only	R.C.A. Large Standard UX Base	1 13/16"	4 1/16"	6 Storage	5.0	1.0	- F	1/2 - 2	.00025	16 1/2 - 22 1/2	1	—	—	—	—	—	—	—
RADIOTRON UX 200 A	Detector only	R.C.A. Large Standard UX Base	1 13/16"	4 1/16"	6 Storage	5.0	.25	- F	2-3	.00025	45	1.5	—	—	—	—	—	—	—
POWER AMPLIFIERS																			
RADIOTRON UX 120	Power Amplifier Last Audio Stage only	R.C.A. Small Standard UX Base	1 3/16"	4 1/16"	Dry cell 4 1/2 Storage 4	—	—	—	—	—	—	—	135	22 1/2	6.5	6,600	500	3.3	110
RADIOTRON UX 112	Power Amplifier	R.C.A. Large Standard UX Base	1 13/16"	4 1/16"	6 Storage	—	—	—	—	—	—	—	157 1/2 135 90	10 1/2 9 6	8 2.5	4800 5500 8800	1670 1435 890	8.0 7.9 7.9	195 120 40
RADIOTRON UX 171	Power Amplifier Last Audio Stage only	R.C.A. Large Standard UX Base	1 13/16"	4 1/16"	6 Storage	—	—	—	—	—	—	—	180 * 135 * 90	40 1/2 27 16 1/2	20 16 10	2000 2200 2500	1500 1360 1200	3.0 3.0 3.0	700 330 130
RADIOTRON UX 210	Power Amplifier Oscillator	R.C.A. Large Standard UX Base	2 3/16"	5 5/8"	6 Storage	7.5 7.5 2.5 2.5 6.0 6.0 6.0	1.25 1.25 1.25 1.1 1.1	—	—	—	—	—	425 380 280 157 1/2 135 90	25 16 10 10 1/2 9 4 1/2	22 18 12 4.5 3	5000 5100 5610 7400 8000 9700	1550 1500 1310 1020 940 775	7.7 7.6 7.5 7.5 7.5 7.5	1540 925 360 90 65 16
RECTIFIERS																			
MODEL	USE	BASE	MAXIMUM OVERALL DIAMETER	MAXIMUM OVERALL HEIGHT	PURPOSE														
RECTRON UX 213	Full wave Rectifier	R.C.A. Large Standard UX Base	2 3/16"	5 5/8"	For use in rectifying systems particularly designed for this Rectron.	Filament Terminal Voltage ..... 5.0 Volts Filament Current ..... 2.0 Amperes Max. A.C. input voltage per plate ..... 220 Volts (RMS) Δ Max. Rectified current* (both plates) ..... 65 Milliamperes													
RECTRON UX 216 B	Half wave Rectifier	R.C.A. Large Standard UX Base	2 3/16"	5 5/8"	For use in rectifying systems particularly designed for this Rectron.	Filament Terminal Voltage ..... 7.5 Volts Filament Current ..... 1.25 Amperes Max. A.C. input voltage ..... 550 Volts (RMS) Δ Max. Rectified current ..... 65 Milliamperes													
SPECIAL PURPOSE RADIOTRONS																			
RADIOTRON UX 874	Voltage Regulator Tube	R.C.A. Large Standard UX Base	2 3/16"	5 5/8"	Constant Voltage Device	Specially designed for use in the following devices operated from alternating current lighting mains R.C.A. Duo-Rectron (B Battery Eliminator) R.C.A. Loudspeaker Model 104 Voltage Drop ..... 90 Volts DC Positive (+) to Rod Starting Voltage ..... 125 Volts DC Negative (-) to Cylinder Max. Current ..... 50 Millamps. DC													
RADIOTRON UV 876	Ballast Tube	Standard Mogul Type Screw Base	2 1/16"	8"	Constant Current Device	Specially designed for use in the following devices operated from 105-125 volts 50-75 cycles Radiola 30 RCA Loudspeaker Model 104 Brunswick Models PR. 16C. 26C. 36C. 46C. PR. 28C. 38C. 48C. P. 3 Victor Models W15.1, W9*2, W12.2 Current Rating ..... 1.7 Amperes Voltage Drop ..... 40-60 Volts													
RADIOTRON UV 886	Ballast Tube	Standard Mogul Type Screw Base	2 1/16"	8"	Constant Current Device	Specially designed for use in the following devices operated from 105-125 Volts 40-45 Cycles Radiola 30 RCA Loudspeaker Model 104 Brunswick Models PR. 16C. 26C. 36C. 46C. Victor Models W15.1, W9.2, W12.2 Current Rating ..... 2.05 Amperes Voltage Drop ..... 40-60 Volts													
RADIOTRON UV 877	Protective Tube	Double Contact Bayonet Automobile type	1 1/16"	2 1/2"	Current Limiting Device	Used in B Battery circuits to prevent excessive current resulting from short-circuit which might damage tube or wiring Voltage drop across Filament ..... 2.5 Filament ..... 5 At 20 Millamps. DC 45 ..... 90 At 90 Millamps. DC													

\* Loudspeaker coupling recommended at this plate potential due to large plate current  
 \* At indicated B and C Battery voltages

Δ R.M.S. Indicates "Root Mean Square" as indicated on an AC Voltmeter  
 Δ Δ Connection to shell of base for third terminal which is the lead to mid-point of filament



An Australian Industry Necessitating the Highest Technique.  
Manufacturing Valves at the A.W.A. Valve Works, Sydney.

## A.W.A. RADIO GUIDE

### A.W.A. 33 AND 99X.

These are general purpose valves suitable for dry battery and storage battery operation. Equally serviceable as detectors, or as radio frequency or audio frequency amplifiers. They are identically the same, differing only in the bases.

Their very low filament consumption—most .18 watts—and small plate current, causes a very light drain on the A and B battery. These characteristics make its use most economical, especially where dry batteries of low capacity only are available.

The construction has been so arranged to give low internal capacity, making the ideal for neutrodynes and other receivers employing several stages of radio frequency amplification.

Fil. volts . . . . .	3
Fil. Amps . . . . .	.06
Anode volt . . . . .	20-80
Base A.W.A. 33 Standard English "R" type	
Base A.W.A. 99X Standard American UX	
	(Small)

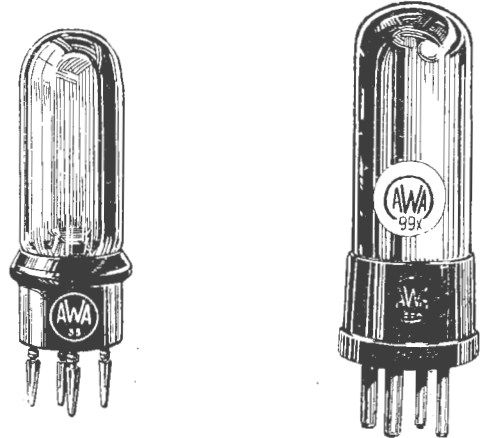

### A.W.A. 101X AND A.W.A. 55.

These are good all round "storage battery operated" valves, equally good as detectors or amplifiers. They are identically the same, differing only in the bases.

The thoriated filament gives an extraordinarily high electronic emission, coupled with long life. Although only taking .25 amps. it is robust and will withstand a surprisingly great amount of rough usage. It has an undistorted output, reaching 55 milliwatts, making its use ideal for last stage audio amplification, capable of giving distortionless loud speaker reproduction of sufficient volume for ordinary large rooms.

Fil. Volts . . . . .	5
Fil. Amps . . . . .	.25
Anode volts . . . . .	40-120
Base "A.W.A.101X" Standard American	
	"UX" (large)
Base A.W.A. 55 Standard English "R" type	

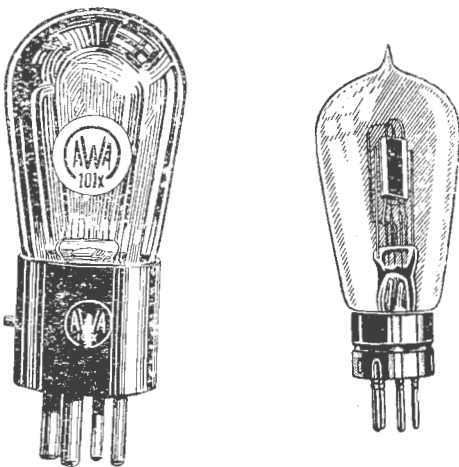

# A.W.A. AND MARCONI VALVE CHARACTERISTICS

## A.W.A. VALVES

TYPE	BASE	FILAMENT		ANODE VOLTAGE		VOLTAGE AMPLIFICATION FACTOR "M"	ANODE IMPEDANCE R IN OHMS	MUTUAL CONDUCTANCE	
		VOLTS	AMPS	DETECTOR & H.F. AMP.	L. F. AMPLIFIER			$\frac{M}{R} \times 10^6$	PLATE VOLTS
AWA 33	Std. Eng. 4 pin	3.0	.06	20-40	40-80	6	15000	400 taken at 90 and 4.5	
AWA 99	Amer. UV199	3.0	.06	20-40	40-80	6	15000	400	" 90 " 4.5
AWA 99X	Amer. UX199	3.0	.06	20-40	40-80	6	15000	400	" 90 " 4.5
AWA 55	Std. Eng. 4 pin	5.0	.25	20-60	60-120	8	10000	800	" 120 " 6.0
AWA 101 X	Amer. UX201A	5.0	.25	20-60	60-120	8	10000	800	" 120 " 6.0

## MARCONI VALVES

R.5.V	Std. Eng. 4 pin	5.0	.7	30-60	60-120	9	30000 25000	300 200	" 60 " 120	" 0 " -4
D.E.3	Std. Eng. 4 pin	2.8	.06	20-40	40-80	6	18500 15500	325 385	" 40 " 80	" 0 " -3
D.E.5	Std. Eng. 4 pin	5.0-6.0	.25	20-60	60-120	7	8500 8000	825 875	" 60 " 110	" 0 " -5
D.E.V		3.0	.20	20-60	—	6	24000	250	" 30	" 0
D.E.Q		3.0	.20	20-60	—	20	100000	200	" 30	" +1.0
V.24		5.0	.75	20-60	—	6	20000	300	" 30	" 0
LS 2	Std. Eng. 4 pin	5.5-6.0	1.5	—	150-600	6	8000	750	" 350	" -20
LS 5	Std. Eng. 4 pin	4.5	.80	—	60-400	5	6000 4500	835 1110	" 150 " 400	" 4.5 " -20
T 15	Std. Eng. 4 pin	5.5-6.0	1.0	—	—	25	50000	500	" 600	" 0
T 30	Std. Eng. 4 pin	6.5-7.0	1.8	—	—	45	70000	645	" 1000	" 0
T 50		7.0	2.5	—	—	30	35000	855	" 1500	" -20

A.W.A. RADIO GUIDE  
**Marconi Valves.**



R.5V.

**MARCONI R.5.V.**

General Purpose Receiving Valve.

With relative adjustment of grid and anode volts, will function as high or low-frequency amplifier, detector or low-power oscillator. Anode volts about 45 with grid return to positive or negative filament lead, according to whether functioning as detector or amplifier. For best results as low frequency amplifier about 100 volts on anode and approx. 4-volts negative grid bias. As detector or high-frequency amplifier 45 volts is ample.

Filament volts, 5; filament current, 0.7; anode volts, 30/120; impedance, 30,000 ohms; amplification factor, 9.

**MARCONI TYPE L.S.5.**

Low Frequency Power Amplifier.

Approximate dimensions:—

Overall length, including pins .. 135 M/m  
 Maximum diameter of bulb . . . . 55 M/m  
 Designed as power amplifier; extremely useful also as low-power transmitter with moderate anode voltage. Probably the best valve yet designed for power amplification work. Has an emission of about 50 milliamps, with low impedance of about 6000 ohms. With 120 volts on the anode and 8 volts negative grid bias (normal working conditions) the anode current obtained is about 6 milliamps. As transmitter it can be allowed to dissipate 10 watts at an anode voltage not exceeding 400 volts. Filament volts, 4.5; filament current, 0.8 amps.; anode volts, 60-400; impedance, 6000 ohms; amplification factor, 5.

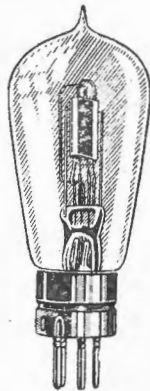

L.S.5

**MARCONI D.E.3.**

Dull Emitter General Purpose Receiving Valve.

Approximate dimensions:—

Overall length, including pins .. 115 M/m  
 Maximum diameter of bulb .. 25 M/m  
 General purpose dull emitter valve. Current consumption is so low—0.06 amps.—that dry cells—three in series—can be used satisfactorily.

Ordinary filament resistances (rheostats) are unsuitable for use with this valve. When running off a 4-volt supply the variable resistance should have a maximum value of 35 ohms, or with 6 volts, 60 ohms, 30 fixed and 30 variable. The filament must never be run bright, and, in any case, the voltage must not exceed 3. Used on the low-frequency amplification side, 80 volts may be used on the plate with approx. 5-6 volts negative grid bias. Use a maximum of 40 volts on plate if employed as detector or high-frequency valve.

Filament volts, 2.8; filament current, 0.06 amps.; anode volts, 20-80; impedance, 18,500 ohms.; amplification factor, 6.

**MARCONI D.E.5.**

Dull Emitter Low Frequency Power Amplifying Valve.

A low-frequency amplifier for distortionless loud-speaker work, with low filament consumption. Particularly recommended as last valve of an amplifier using R.5v or other valves running from a 6-volt accumulator in other stages.

Negative grid bias approx. 5-volts with 120-volts on the anode. Can be used as general-purpose valve with good results. As detector or high-frequency amplifier 30 volts on the anode is ample. Filament volts, 5 to 6; filament current .25 amps; anode volts 20/120; impedance, 8000 ohms; amplification factor, 7.

## A.W.A. RADIO GUIDE

### RHEOSTAT VALUES.

The value of Filament Rheostat depends on the type of valve used and the number of valves controlled by that particular Rheostat. When using one valve per control, A.W.A. 33, 99, 109X, 101A, 55, UX or UV 199, and 201A, Marconi DE5 and DE5B require a 30 ohm Rheostat. The Marconi R, R5V and UV 200 work off a 6 ohm Rheostat.

These same values can also be taken when using three valves per Rheostat in the case of A.W.A. 33, 99, 109X, and UV199. A 6 ohm Rheostat should be employed when working three A.W.A. 101A, 55, UV or UX 201A, and DE5 per control.

A.W.A. 33, 99, 109X, or UX 199 valves will work off  $3\frac{1}{2}$  v. dry cells, but if a number of valves are used it is more economical to use a 4-volt 25 A.H. accumulator. A.W.A. 101A, 55, Marconi DE5, and DE5B, and UX or UV 201A valves work off a 6-volt accumulator, the A.H. capacity depending on the number of valves employed.

### VALVE CHARACTERISTIC CURVES.

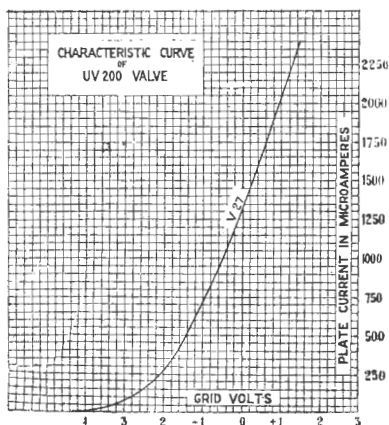
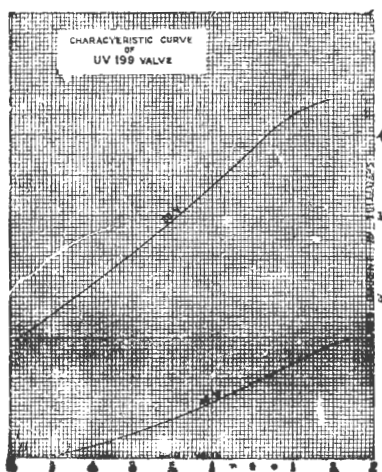
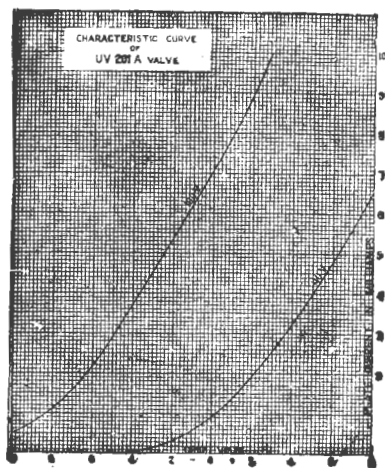

### UV 199, UV 200 and UV201 A.

The same characteristics also apply to Radiotrons UX199, UX200 and UX201 A.



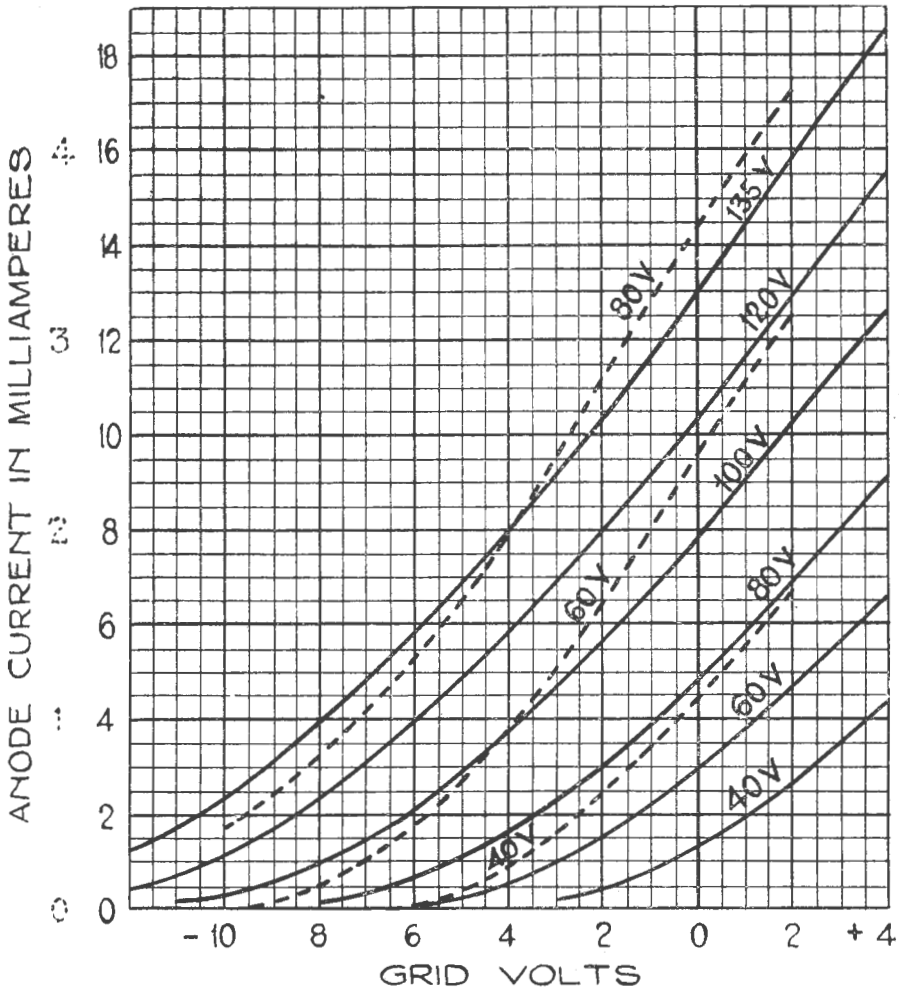

Full line curves = the characteristics for AWA 55 & 101X Valves  
 Dotted line curves = the characteristics for AWA 33, 99, 99X Valves

**CHARACTERISTIC CURVES OF A.W.A. VALVES.**

A.W.A. RADIO GUIDE

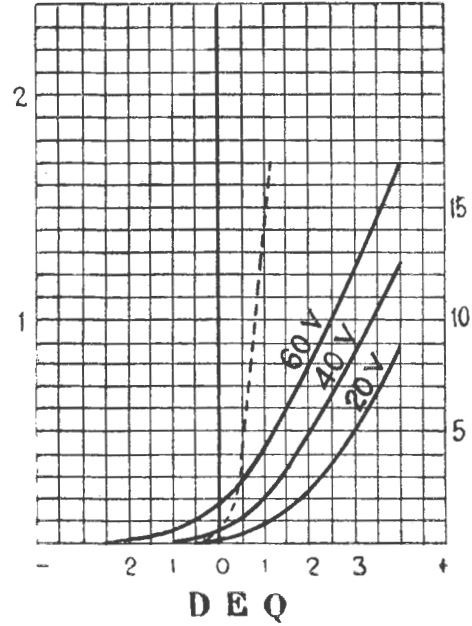
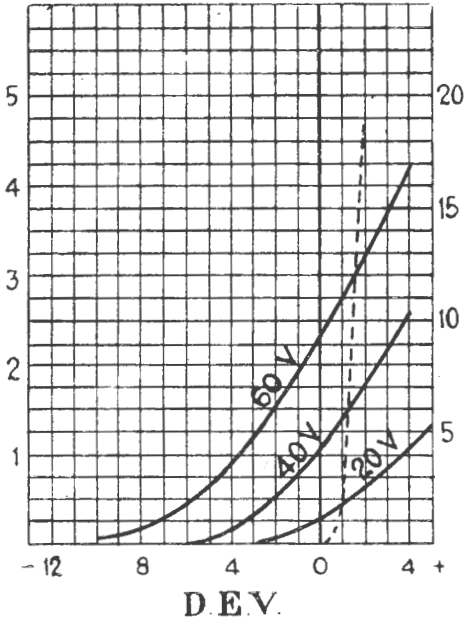
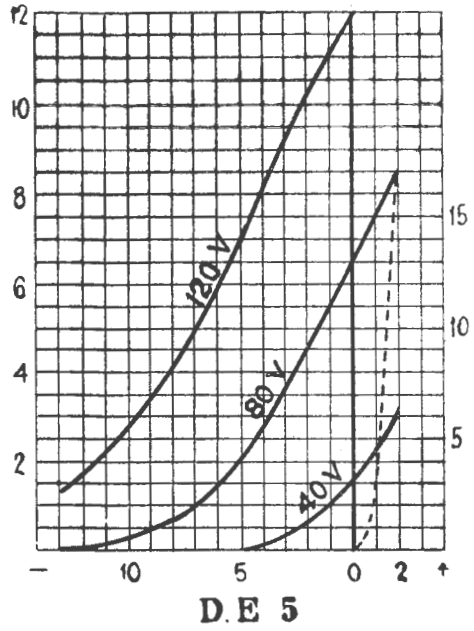
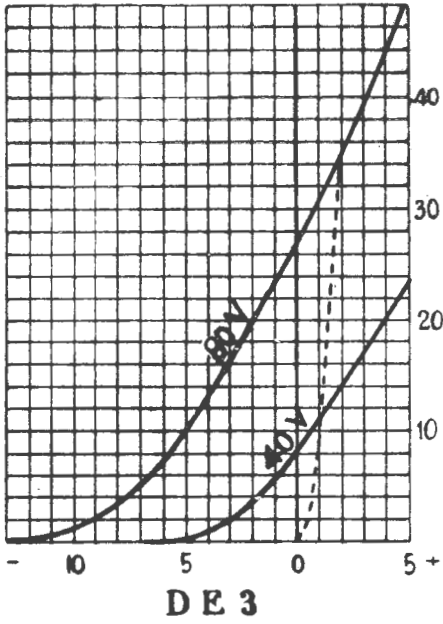

CHARACTERISTIC CURVES.  
MARCONI VALVES.

# A.W.A. RADIO GUIDÉ

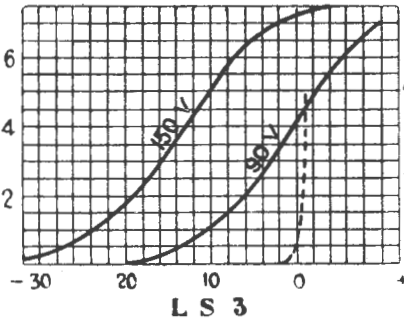
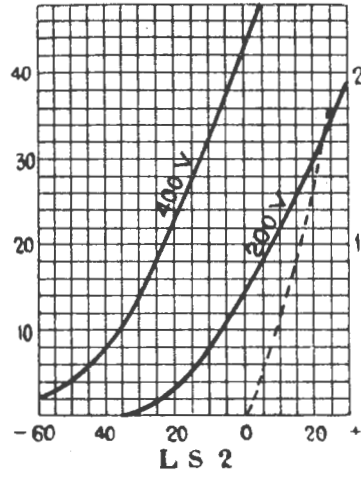
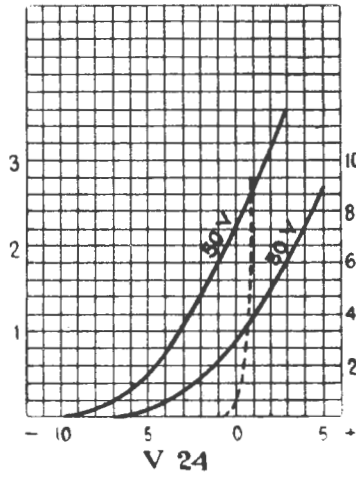
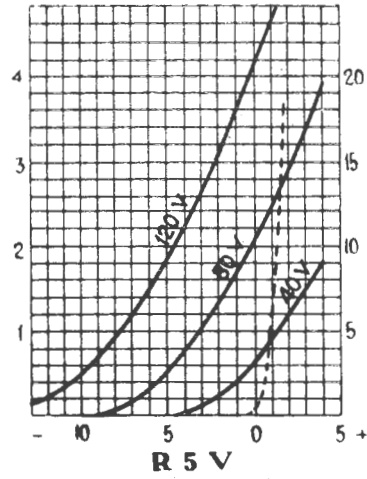
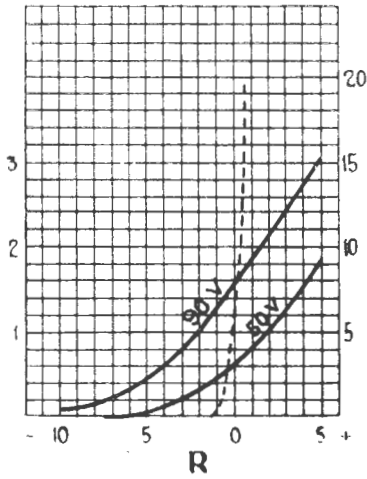

CHARACTERISTIC CURVES.  
MARCONI VALVES.

# A.W.A. RADIO GUIDE

## TRANSMITTING VALVES.

### MARCONI. 15 Watts. T.15.

A small power Transmitting Valve, tested dissipating 15 watts at the anode, suitable for voltages up to 600.

Approximate Data:

Filament Volts . . . . .	5.5/6.0	Impedance (ohms) . .	50,000
Filament Amps. . . . .	1.0	Voltage Magnification	25
Anode Volts . . . . .	600		

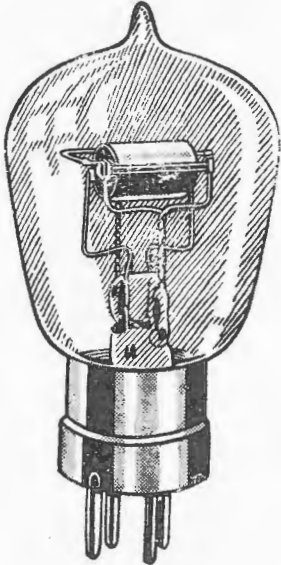

Type T.15.

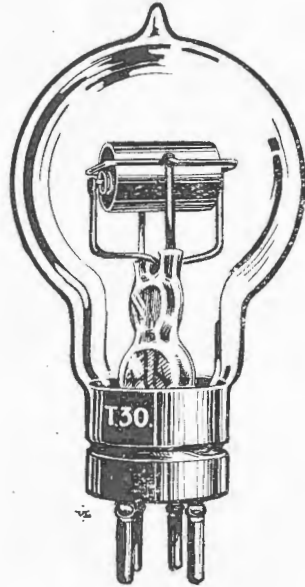

Type T.30.

### MARCONI. 30 Watts.

Type T.30.

(Approximate overall dimensions: 135 x 60 mm.)

A small power Transmitting Valve, tested dissipating 30 watts at the anode, suitable for voltages up to 1,000.

Approximate Data:

Filament Volts . . . . .	6.5/7.0
Filament Amps. . . . .	1.8
Anode Volts . . . . .	1,000
Impedance (ohms) . . . . .	70,000
Voltage Magnification	45

### MARCONI. 50 Watts.

Type T.50.

(Approx. overall dimensions: 145 x 76 mm.).

A small power, double-ended Transmitting Valve, tested dissipating 50 watts at the anode, suitable for voltages up to 1,500.

Approximate Data:

Filament Volts . . . . .	7.0	Impedance (ohms) . . .	35,000
Filament Amps. . . . .	2.5	Voltage Magnification	30
Anode Volts . . . . .	1,500		



Type T.50.

## Transmitting Valves.

### “RADIOTRON.”

Type “UV.202”

A low power Transmitting Valve, dissipating 5 watts at the Anode. Intended for voltages up to 350.

Filament Battery Voltage, 10.  
Filament Terminal Volts, 7.5.  
Filament Amps., 2.35.  
Anode Volts, 350.  
Socket Type—“U.R. 542.”

(Not Illustrated.)

### “RADIOTRON.”

Type “UV.203”

A Transmitting Valve, dissipating 50 watts at the Anode. Suitable for voltages up to 1,000.

Filament Battery Voltage, 12.  
Filament Terminal Volts, 10.  
Filament Amps., 6.5.  
Anode Volts, 1,000.  
Socket Type—“U.T. 541.”

(Not Illustrated.)

### “KENOTRON.”

Type “UV.216”

A Rectifying Valve for use with 5 watt transmitting valve.

Filament Battery Voltage, 10.  
Filament Terminal Volts, 7.5.  
Filament Amps., 2.35.  
A.C. Input Voltage, 550.  
D.C. Output Voltage, 350.  
Socket Type—“U.R. 542.”

(Not Illustrated.)

### “KENOTRON.”

Type “UV.217”

Manufactured for use with 50 watt transmitting valves.

Filament Battery Voltage, 12.  
Filament Terminal Volts, 10.  
Filament Amps., 6.5.  
A.C. Input Voltage, 1,250.  
D.C. Output Voltage, 1,000.  
Socket Type—“U.T. 541.”

(Not Illustrated.)

A.W.A. RADIO GUIDE



The Aerial System of Queensland Broadcasting Service 4QG.

## Crystal Receivers.

The Crystal Receiver employs the simplest of all wireless circuits, it is easy to build and simple to operate, and its upkeep costs are practically nil. It will give good headphone strength up to twenty or thirty miles away from a high powered broadcasting station provided that a good aerial is used. Its chief disadvantages as compared with the Valve Receiver, may be summed up as follows:—It will not successfully operate a loud speaker, and it is rather difficult to tune out undesired stations. Furthermore, most types of crystals require frequent adjustment, which, in addition to the aforementioned interference, rather tends to mar the enjoyment of the programme. Interference, however, may be greatly reduced by carefully following these instructions—Pay particular attention to the aerial and earth, as recommended previously in these pages. Bear in mind that both signal strength and interference increase in proportion to the height of the aerial. Decreasing the height will reduce interference to a greater extent than signal strength. Therefore city dwellers should keep their aerials as small as possible, consistent with comfortable reception.

Before building a receiver, select a circuit employing both aerial and secondary coils tuned by variable condensers. These two coils should be kept as far apart as possible when interference is experienced. This will make the tuning sharper, but interference from undesired stations will be reduced.

The crystal proper plays a very important part in the reception of wireless signals. Briefly, it converts the feeble alternating currents into unidirectional impulses, permitting these to have an audible effect in the headphones.

Crystals may be divided into two distinct classes. The first type, commonly known as "perikon" combinations, require a second crystal to be in contact with them. The second class are those crystals requiring a metal contact. Crystals such as tellurium and zincite; zincite and copper pyrites; zincite and bornite come under the first class. The perikon combinations are not popular amongst broadcast listeners, so we will pass on to the second type without further mention of them. In the second class there are galena, iron pyrites, carborundum, molybdenite and silicon. Both silicon and carborundum require a steel contact; galena will work equally well with gold, silver, brass or copper contacts. Carborundum is the most reliable crystal, but it requires a 3-volt battery and a potentiometer for successful operation. Galena, whether synthetic or natural, is one of the most popular crystals. It is extremely sensitive, but it requires a very light contact with the cat's whisker, and therefore is liable to be easily thrown out of adjustment. However, the synthetic types of galena do not suffer from this defect to the same extent as do the natural types. Crystals should on no account be handled with the fingers. If they become insensitive they may be cleaned by immersing them in alcohol for about ten minutes, and then allowing them to dry.

Headphones used in conjunction with crystal sets should be of the high resistance type (3,000 or 4,000 ohms), and when two or more pairs are used they should be joined in parallel. In order to join two or more pairs in parallel, take one phone tip from each pair of phones and securely fix them to one of the phone terminals of the receiver. The remaining tips are connected to the other phone terminal. Finally, when using several pairs of headphones, make quite sure that they are all of the same resistance, otherwise the lower resistance telephones will have more than their share of the current.

## Choice of a Receiver.

The object of these notes is to give the prospective purchaser an idea of the capabilities of the more common types of wireless receiver on the market to-day.

**The Superheterodyne Receiver.**—This type incorporates the very latest ideas in receiver construction. It will receive interstate stations on the loud speaker without aerial or earth, even in close proximity to a local station. These advantages are not possessed to the same extent by any other type of receiver.

**The Neutralised Receiver.**—This receiver, like the superheterodyne, will bring in all interstate stations at loud speaker strength, but in the majority of cases an outside aerial is required for interstate reception. Being very selective, it will receive interstate stations when locals are working, but not to the same degree as the superheterodyne.

**Tuned Radio Frequency Receivers having Four or Five Valves.**—These receivers are excellent for interstate reception on the loud speaker, provided that they are not installed too near a broadcast station. Receivers of this type are especially suitable in country districts where there is no local station in the near vicinity.

**Two and Three Valve Receivers employing no High Frequency Amplifying Valves.**—This class of instrument will give excellent loud speaker results from local stations, it does not possess the required degree of sensitivity to tune in distant stations as the four or five valve set, but is quite suitable for country districts where there is no local station in the near vicinity.

**Crystal Receivers.**—Whilst the crystal cannot compete with the valve, either in the matter of range or selectivity, it is an ideal receiver for anyone desirous of receiving local stations only at head phone strength. Its chief recommendation lies in the fact that no batteries or valves are required. Thus the initial cost is the only cost.



## Aerials.

One of the first considerations that arises in connection with the erection of an aerial for broadcast reception is as to whether a long or short aerial is the more suitable.

Both types possess certain advantages and disadvantages, and the final selection depends to a large extent upon the type of receiver used.

A long aerial, while increasing the range of the receiver, reduces its degree of selectivity. (A receiver is said to be selective and non-selective according to whether it can or cannot tune out undesired stations when listening to a certain transmission.)

A short aerial, on the other hand, will not have the picking up qualities of a long one, on account of its short length, but with this type it is a simple matter to tune out undesired stations.

Therefore, if you use a crystal receiver, a long high aerial is necessary, one that is capable of picking up the maximum amount of energy; but if you possess a valve set a short aerial will be more suitable. Country listeners require a longer aerial than do city dwellers, because they are generally situated at a fair distance from a broadcasting station.

Before erecting an aerial, bear the following points in mind:—

An inverted "L" aerial (an aerial having the down lead to the receiver located at the extreme end of the horizontal portion) is more suitable than a "T" aerial (one having the down lead in the exact centre).

The efficiency of an aerial increases with its height.

The height of an aerial is not the distance from the horizontal wire to the ground, but the distance from the horizontal wire to the nearest grounded object directly underneath it, whether a roof or a tree.

A single wire aerial is just as efficient as the double wire variety.

A good average length for the wire is 100 feet, this distance being measured from the far end of the aerial to the receiver terminal.

It is not a good plan to join up several pieces of wire to make up the correct length, it being far better to use an unbroken wire. When this cannot be avoided, the joints should be carefully soldered.

3-20 gauge bare copper wire is excellent for receiving aerials. This wire can be obtained in lengths of 100 feet from most wireless dealers.

We would like to point out to readers that these notes are of a purely non-technical nature. We fully appreciate the fact that the average set owner is out to get the best results with the minimum amount of trouble and expense. However, there are certain points which he must thoroughly grasp if he wishes to get the very best results in return for the money he has laid out on his set.

A good aerial is a very important factor in the successful operation of a receiver, and while the majority of aerials are above reproach, it has been noticed that a large number could be considerably improved upon.

A poor aerial usually possesses one or more of the following defects:—

## A.W.A. RADIO GUIDE

The horizontal position of the aerial is only a few feet above the roof of the house. This seems to be rather a common practice, which in many cases could be remedied by taking the end of the aerial to a pole or tree as far distant from the house as possible up to a distance of 60 or 70 feet, and securing the down lead end to the highest portion of the roof or to a chimney.

The down lead runs too close to the walls of a building. This may be rectified by reducing length of the horizontal portion of the aerial to the extent of four or five feet at the down lead end. To do this, it will be necessary to increase the length of the halyard connecting the down lead end of the aerial to the roof by a similar amount. This will keep the down lead of the aerial clear of side of the building. An alternative method is to use a piece of wood 4 or 5 feet long, one end of which is secured at right angles to the top of the wall. An insulator is secured to the other end, through which the aerial down lead is passed.

Portion of the aerial wire is in close proximity to, or brushes against, the branches of a tree. A great many people attach the far end of their aerials to a tree. This is an excellent plan, provided that the end of the aerial wire is kept at least six feet away from the branches. This is done by securing an insulator to the end of the aerial wire and tying a suitable length of sash or other cord to the insulator. Of course, no part of the cord should actually touch the aerial wire, otherwise the insulator becomes useless. The other end of the cord should be either tied to the highest available branch of the tree, or, if the cord is of sufficient length, it may be passed over this branch and made fast to the trunk within hand reach. When a wooden pole is used for supporting the aerial, the end of the wire may be as near as two feet to the pole, but this distance should be doubled when a steel mast is used.

The aerial must be suitably insulated at the point where it enters the house—special lead-in insulators being sold for this purpose by nearly all radio dealers.

The wire between the lead-in insulator and the receiver must be kept as short as possible, and on no account must any portion of this wire touch the walls unless it is well insulated. Bare wire, kept well away from any surrounding objects, is far more satisfactory, though perhaps not quite as neat, as insulated wire fixed to the walls.

These notes would be incomplete without mention of the Fire Underwriters' rules, which stipulate that a lightning arrester, operating at a maximum potential of 500 volts, shall be provided when an outside aerial is used. This arrester must be located as near as possible to the points where the aerial and earth wires enter the building. It may be placed either inside or outside the building, but, in the latter case, the instrument should be protected from the weather. To instal a lightning arrester, a wire is soldered to that portion of the aerial down-lead nearest the arrester, the other end being securely joined to one of the arrester terminals. The remaining terminal is fixed to the earth wire in a similar manner. The former lead must, of course, be kept clear of all obstacles, as this wire forms part of the aerial. Lightning arrestors may be obtained from most radio dealers—detailed instructions being supplied with each instrument.

## Installing a Receiver in Your Home.

---

Let us assume that you have erected your aerial, following the directions as far as possible laid down in these notes. A small table should now be procured and placed as near as possible to where the aerial lead-in enters the room. The receiver is placed on this table and the valves fitted into the sockets.

The filament lighting battery or accumulator should then be connected to the receiver, taking care that the “+” and “—” terminals of the accumulator go to their respective “A+” and “A—” terminals on the receiver. The positive terminal of the “A” battery is either marked “+” or else it is painted red. The battery switch and the filament rheostat are now turned on for a moment to make quite certain that the valves light up.

Next connect up the bias or “C” battery (if used), and finally the high tension, also referred to as the “B” battery. In both cases great care must be taken to ensure that these batteries are connected up the right way round, that is, the “+” battery terminal to the “+” receiver terminal, etc.

Having completed this, join up the aerial and earth leads to the receiver, plug in the phones or loud speaker, switch on the filament battery and turn the filament rheostat until the valves are burning at the required brilliancy. One of the local stations should now be tuned in with the variable condensers, and the filament control given a final adjustment.

Having made yourself familiar with your receiver, turn your attention to the loud speaker. The actual position of this instrument in the room often has a great bearing on the quality of the reception. Apart from keeping the speaker away from the set, its position in the room must be found by experiment. Sometimes better results are obtained with the loud speaker high up, whilst in other cases a low position is found preferable.



#### AUSTRALIAN BEAM STATIONS.

1. A distant view of the control switchboard.
2. A general view of the Power Room at Ballan, showing the Prime Movers at the far end, with the two rows of motor generators in the foreground. The Switchboard can be seen in the centre background. The Rectifier unit can be seen on the extreme right hand side.

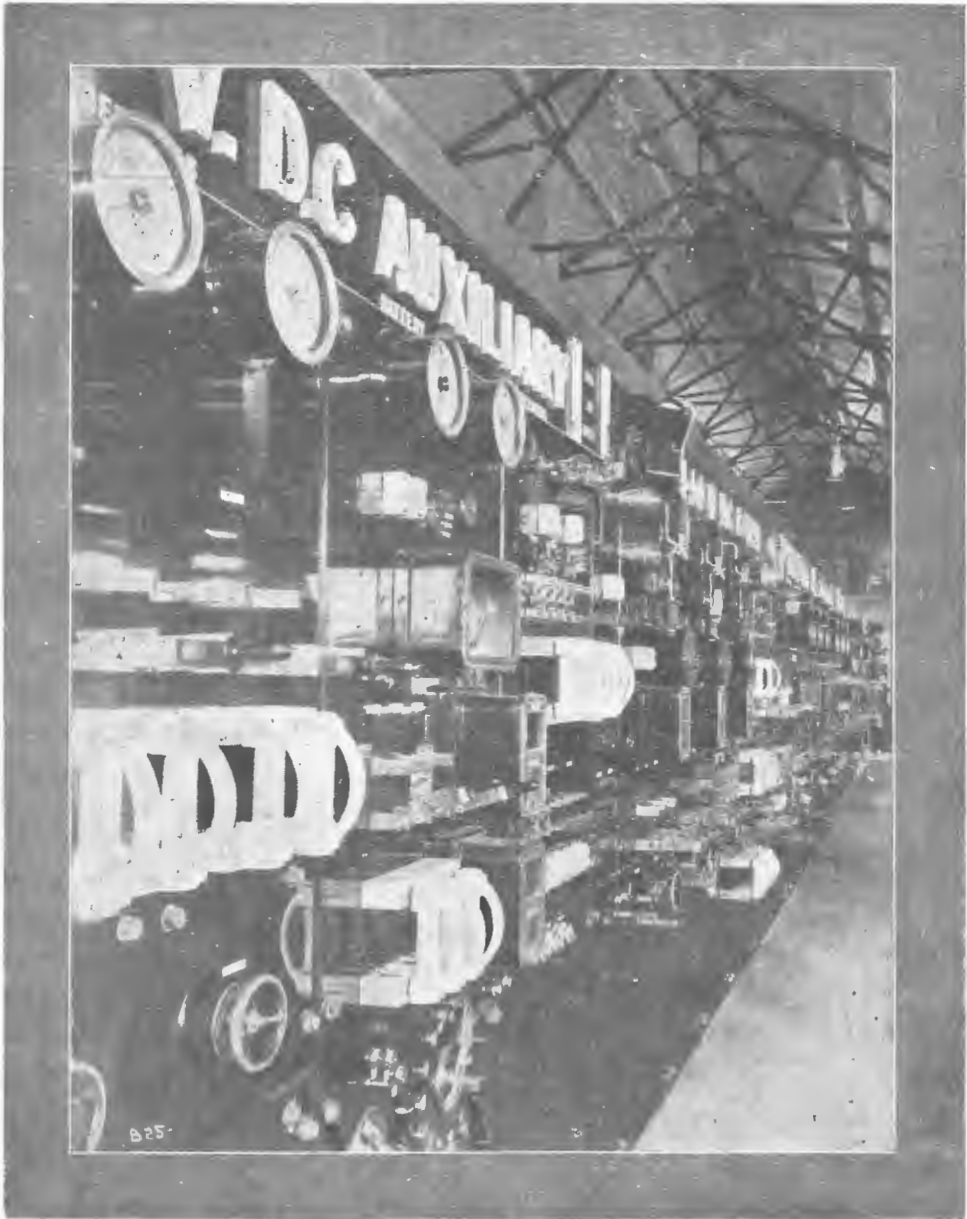

**AUSTRALIAN BEAM STATIONS. .**

View of the Switchboard at Ballan, from which can be gathered the massive nature of the structure.

## Good and Bad Aerials.

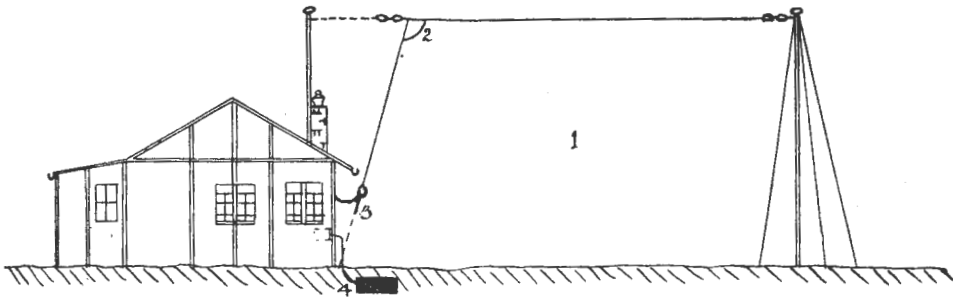

POINTS TO NOTE IN FIG. 1.

1. Clear space underneath the aerial.
2. Down lead does not bend back under the horizontal portion.
3. Bottom of down lead guyed to keep it well away from roof of building.
4. Short length of cable going to earth plate.

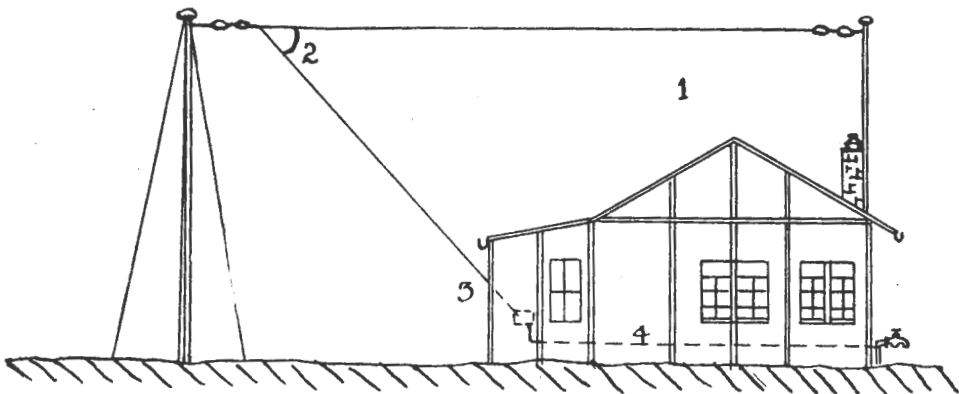

POINTS TO NOTE IN FIG. 2.

1. House underneath the aerial.
2. Down lead bends back under the horizontal portion.
3. Down lead not guyed at base.
4. Long length of cable going to earth.

# Fire Underwriters' Radio Installation Rules

FOR RECEIVING STATIONS ONLY.

## AERIALS.

(a) Antennas outside of buildings shall not cross over or under electric light or power wires, nor shall they be so located that a failure of either antenna or of the above-mentioned electric light or power wires can result in a contact between the antenna and such electric light or power wires.

Antennas shall be constructed and installed in a strong and durable manner, and shall be so located as to prevent accidental contact with light and power wires by sagging or swinging.

Splices and joints in the antenna span, unless made with approved clamps or splicing devices, shall be soldered.

Antennas installed inside of buildings are not covered by the above rules.

NOTE.—Outdoor antennas should be of rugged construction, held securely in place and kept well away from electric light and power wires. It is advisable for the amateur not to make any connections to poles carrying light or power wires. Those unfamiliar with electric wiring will do well to have antennas and other apparatus installed by competent electricians.

The size of the antenna will depend on the span; for the ordinary receiving antenna about 100ft. long, No. 3/20 gauge soft drawn copper wire may be used, or other wire of equivalent strength. Where the span is long, or where the antenna crosses other wires, it should be larger.

## LEAD-IN WIRES.

(b) Lead-in wires shall be of copper, approved copper-clad steel, or other approved metal, which will not corrode excessively, and in no case shall they be smaller than No. 3/20 S.W.G. except that approved copper-clad steel not less than No. 18 (0.044) S.W.G. may be used.

Lead-in wires on the outside of buildings shall not come nearer than twelve (12) inches to electric light and power wires unless separated therefrom by a continuous and firmly fixed non-conductor that will maintain permanent separation. The non-conductor shall be in addition to any insulation on the wire.

Lead-in wires shall enter building through a non-combustible, non-absorptive insulating bushing.

NOTE.—Although desirable from a signaling viewpoint to prevent partial grounding in wet weather, these rules do not require the insulating of lead-in wires, except where they pass through the building wall, where a bushing is specified. This is to protect against possible contact with wires, pipes, or other grounded metal, which may be concealed in walls.

## PROTECTIVE DEVICE.

(c) Each lead-in wire shall be provided with an approved protective device properly connected and located (inside or outside the building), as near as practicable to the point where the wire enters the building. The protector shall not be placed in the immediate vicinity of easily ignitable material, or where exposed to inflammable gases or dust or flyings of combustible materials.

The protective device shall be an approved lightning arrester which will operate at a potential of five hundred (500) volts or less.

The use of an antenna grounding switch is desirable, but does not obviate the necessity for the approved protective device required in this section. The antenna mounting switch, if installed, shall, in its closed position, form a shunt around the protective device.

NOTE.—The protecting device should be an approved lightning arrester; the use of cheap, home-made devices should be discouraged. Fuses are not required, but if installed should be between the lead-in and the lightning arrester.

## PROTECTIVE GROUND WIRE.

(d) The ground wire may be bare or insulated, and shall be of copper or approved copper-clad steel. If of copper the ground wire shall not be smaller than No. 3/20 S.W.G., and if of approved copper-clad steel is shall not be smaller than No. 18 S.W.G. The ground wire shall be run in as straight a line as possible to a good permanent ground. Preference shall be given to water piping. Gas piping shall not be used for grounding protective devices. Other permissible grounds are artificial grounds, such as driven pipes, plates, cones, etc.

The ground wire shall be protected against mechanical injury. An approved

## A.W.A. RADIO GUIDE

ground clamp shall be used wherever the ground wire is connected to pipes or piping.

NOTE.—The proper connection of the antenna to the ground minimises the lightning hazard. A satisfactory ground and properly run ground wire are of primary importance.

### WIRES INSIDE BUILDINGS.

(e) Wires inside buildings shall be securely fastened in a workmanlike manner, and shall not come nearer than two (2) inches to any electric light or power wire unless separated therefrom by some continuous and firmly fixed non-conductor making a permanent separation. This non-conductor shall be in addition to any regular insulation on the wire. Porcelain tubing or approved flexible tubing may be used for encasing wires to comply with this rule.

### RECEIVING EQUIPMENT GROUND WIRE.

(f) The ground conductor may be bare or insulated, and shall be of copper, approved copper-clad steel, or other approved metal which will not corrode excessively under existing conditions, and in no case shall the ground wire be less than No. 3/20 S.W.G., except that approved copper-clad steel not less than No. 18 (0.044) S.W.G., may be used.

The ground wire may be run inside or outside of building. When receiving equipment ground wire is run in full compliance with rules for Protective Ground Wire, in Section (d), it may be used as the ground conductor for the protective device.

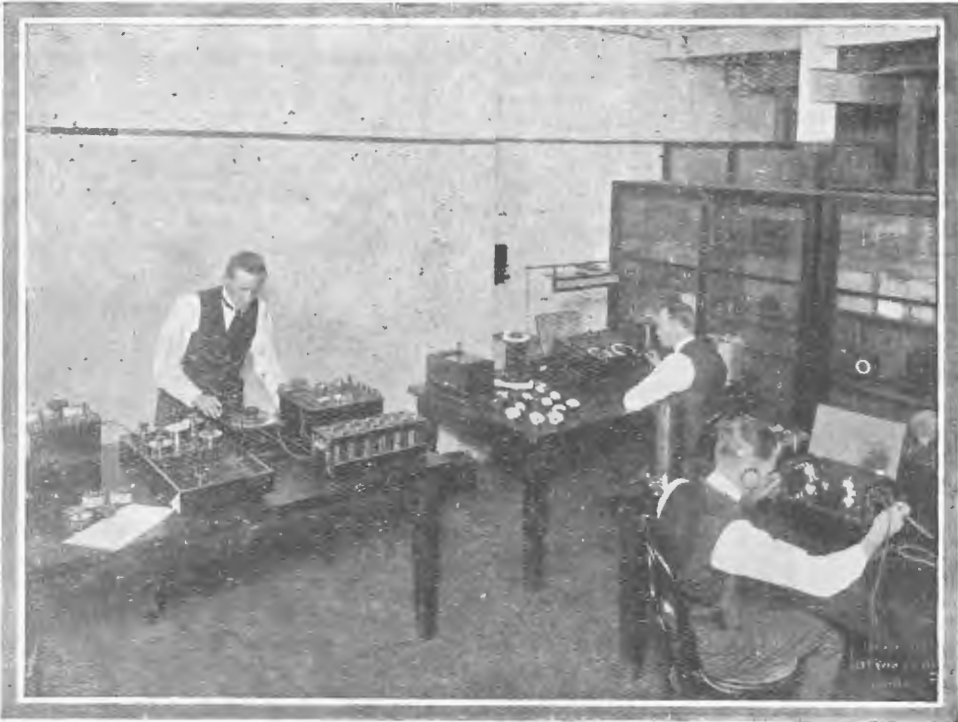

SECTION A.W.A. RESEARCH AND EXPERIMENTAL LABORATORY.

The Company maintains a Technical and Research Staff in touch with the latest wireless developments throughout the world, and is thereby in a position to experiment and devise improved methods and to test and adapt to Australian conditions the very latest inventions. A feature of the Technical Department is a well-equipped laboratory.

Some of the most noteworthy and historical events in Australian Wireless have been carried out by Mr. Fisk with the assistance of the Research Staff.



## The Earth System.

A considerable number of broadcast enthusiasts go to a lot of trouble in erecting their aerials, with a view to obtaining the best possible results, but they totally neglect their earth circuits. This is probably because the earth connections, unlike the aerial, are buried and out of sight, and therefore more or less forgotten. The earth circuit is every bit as important as the aerial, and this point cannot be emphasised too strongly.

The efficiency of the earth circuit depends upon three things:—

First, upon the nature of the soil in which the earth plate is buried, and its moistness. Second, upon the size of the plate or waterpipe which is buried in the soil, and the way in which the earth wire is connected to this plate; and, lastly, upon the length and total area of the wire or wires connecting the receiver to the earth plate of water-pipe.

The percentage of moisture plays a most important part in the satisfactory reception of signals, especially when a crystal set is used.

Moist soil is far more suitable than dry sandy soil, and for this reason the earth plate, whenever possible, should be buried in a spot where the soil is permanently moist. There is always a certain degree of moisture around the roots of trees and bushes, and, of course, in the vicinity of a garden hose, and advantage should be taken of this. In very dry weather a few buckets of water thrown over the spot where the earth plate is buried will usually improve the reception of signals.

When an earth plate is used instead of a water pipe, it should consist of a sheet of galvanised iron about 4 feet x 2 feet. The strands forming the earth wire should be untwisted for a distance of two feet, and each strand carefully soldered to the sheet at well-spaced points on one 4ft. edge. This completed, the plate is buried edgewise, the edge to which the wires are soldered being uppermost, just deep enough to cover this edge.

When a water pipe earth is used, it is most important to solder the earth-wire to the pipe as near to the point where it enters the ground as possible. If this is not done, reception may be seriously affected by the joints in the piping. As an alternative method to soldering the earth wire to a water pipe (which is not always an easy job), a special clip fitted with a terminal to take the wire may be purchased and clamped to the water pipe. This method is quite satisfactory, provided that the pipe and inside of the clamp are periodically cleaned with emery cloth and wiped with a dry cloth.

The comparative results obtained with the plate and water pipe earth may be summed up as follows:—A water pipe earth is superior to a galvanised iron plate in dry, sandy soil, but the plate earth is preferable where the soil is fairly moist, such as in a garden, etc. If in doubt which earth to adopt, make comparative tests with the water pipe, and earth plate, and compare the results. The earth plate nearly always wins where a water pipe is situated at a distance from the receiver.

The wire connecting the receiver to the earth plate must be kept as short as possible. 7/20 gauge aerial wire, which consists of seven strands of No. 20 gauge copper wire, is the best type to use, but for all practical purposes 3/20 gauge will serve as well. It is not necessary to insulate the earth wire unless it is of undue length, and it may be fixed in position round the walls with staples. Needless to say, the receiver must be so placed in the room that the earth wire is as short as possible.

Gas pipes should on no account be used for earthing the receiver on account of the risk of fire and explosion. This method, apart from being most unsatisfactory, is prohibited by the Fire Underwriters' Rules.

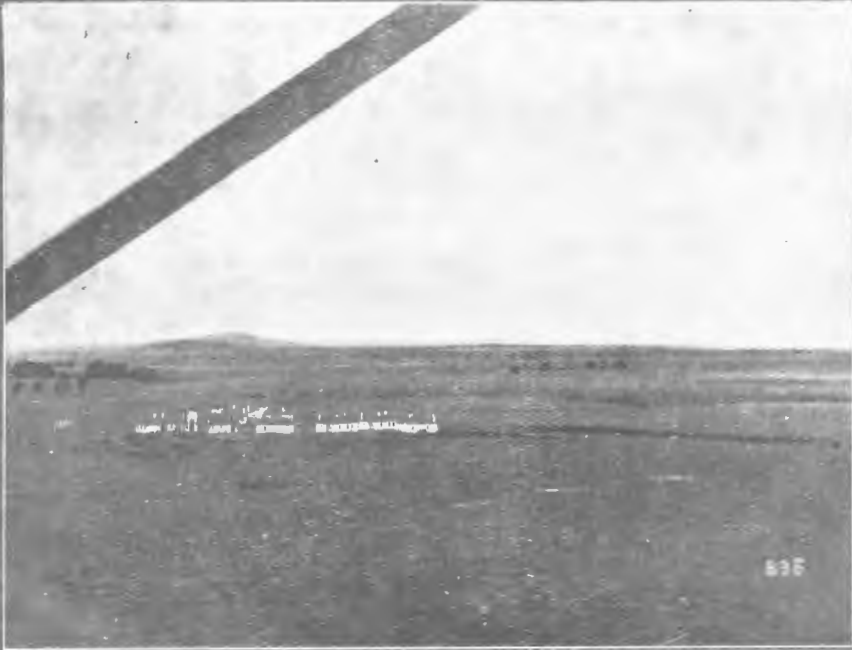

#### AUSTRALIAN BEAM STATIONS.

1. An aerial view of the Staff Quarters and Residences, Ballan.
2. The Transmitting and Power Houses, Ballan, showing the base of one of the masts in the foreground.

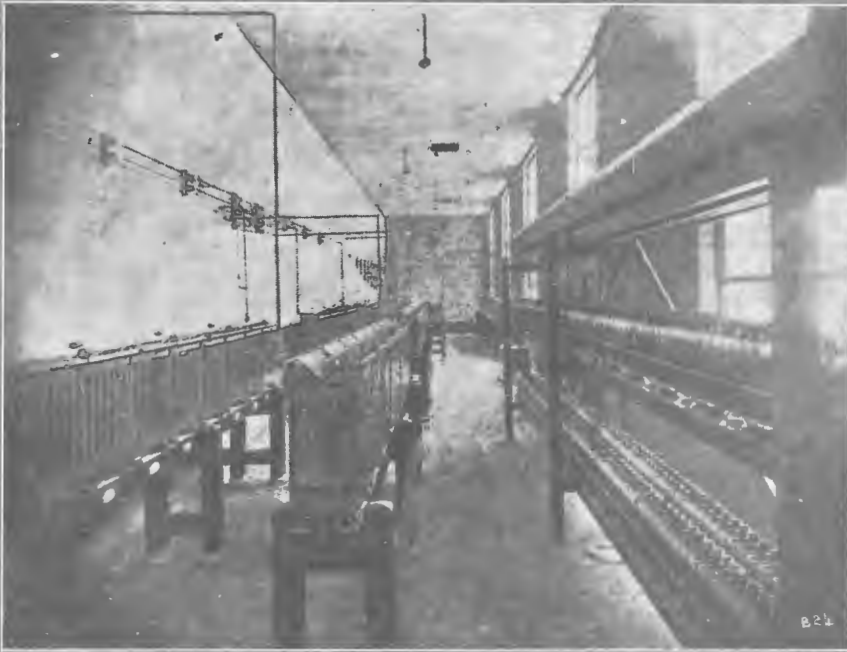

**AUSTRALIAN BEAM STATIONS.  
BALLAN, VICTORIA.**

1. View of the south-eastern corner of the Power House, Ballan, showing the rectifying unit.
2. View, showing the Accumulator Room, Ballan.

## Low Tension Accumulator.

Low tension or filament accumulators, as they are sometimes called, are used for lighting the valve filaments. They vary from 2 to 6 volts, and have an ampere hour capacity of from 20 to 80 ampere hours, according to the type and number of valves used.

The capacity of an accumulator is measured in ampere hours; an accumulator is said to have a capacity of 40 ampere hours when it can deliver one ampere for 40 hours or .5 amps for 80 hours. Thus, supposing we have a receiver using 4 UX 201 A valves; the total current consumed will be .25 amps x 4, or one ampere. Theoretically, a 40 ampere hour battery would supply this receiver with the necessary current for 40 hours, but practically the utmost limit would be 35 hours.

It is a good plan to recharge the battery after it is about three-quarters discharged, in this case 30 amphours.

These rules apply equally well to charging. In the case of our 40 amphour battery, supposing it is charged at 4 amps rate as indicated by the battery charger ammeter. Four amps for 10 hours will give 4 x 10 or 40 amphours, and theoretically at the end of this period it will be charged. However, it will probably require an additional period to completely charge it, as no accumulator will give back all the energy that is put into it. When charging accumulators, always adhere to the charging rate stipulated by the makers. This rate is usually written on the side of the battery, and it is approximately one-tenth of the capacity of the cell. Thus, a 30 amphour battery should be charged at three amps rate, and towards the end of the charging period (when gassing commences), this rate may be reduced to half the normal rate. The condition of the battery may be determined by the gravity of its electrolyte, this gravity being measured by means of a hydrometer. When charged, a cell will show a gravity of from 1220 to 1250, according to the density of the acid used. It should never be allowed to fall below 1175, as indicated by the hydrometer, without recharging.

A few points to remember in connection with accumulators—

- (1) Do not leave the battery in a discharged state for any length of time.
- (2) Do not charge at a higher rate than that stipulated by the makers.
- (3) Do not overcharge the battery.
- (4) Do not add acid unless certain that some of the electrolyte has been spilt.
- (5) Do not allow an accumulator to discharge below its safe limits, as shown by the hydrometer.
- (6) Keep the plates covered with electrolyte by topping the battery with distilled water, until the level is half an inch above the top of the plates.
- (7) Keep the accumulator lugs clean with emery cloth; a slight trace of vaseline on all terminals and connecting strips will prevent corrosion.

A word of warning to those who intend mixing their own electrolyte. Always add the acid to the water, never add water to acid.

## The High Tension Battery.

The majority of broadcast listeners use dry cell H.T. batteries in preference to the accumulator type.

Dry H.T. batteries require practically no attention. However, when possible they should be kept in a cool, dry place, as under these conditions they have a longer life. Small type H.T. batteries, whilst being very satisfactory for one and two valve sets, are not economical for 3, 4 and 5 valve receivers, it being far cheaper to use the heavy duty type for all receivers employing three valves and over. Admittedly they are double the cost of the smaller batteries, but they last more than twice as long.

The H.T. battery need not be discarded until signals are too weak to receive in comfort, or until unpleasant noises develop in the loud speaker. Do not confound these noises with static. The best test is to disconnect the aerial, and if the noises still persist the trouble may be put down to either used up batteries or a bad or faulty connection inside the receiver.

Dust should not be allowed to accumulate on the tops of the batteries, as it may cause a certain amount of current leakage in time.

With regard to the voltages applied to the various stages in a receiver, full instructions invariably accompany the valves. These few notes may not be amiss.

**Radio Frequency Stage.** From 45 to 60 volts H.T. should be applied according to the type of valve used.

**Detector Stage.** Here a lower potential is required of from  $22\frac{1}{2}$  to 45 volts.

**Low Frequency Stage.** Sixty to ninety volts will be found correct for the first stage, and 90 to 120 for the last stage. In both cases a suitable negative bias must be used.

For resistance coupled amplifiers a higher voltage is necessary to compensate for the potential drop across the resistance. This should vary between 120 and 180 volts according to the ohmic value of the resistance.

When connecting two H.T. batteries up in series, in order to increase the total voltage, join the negative terminal of one battery to the negative terminal of the receiver, and the positive terminal of the same battery to the negative terminal of the second battery. The positive terminal of this battery is now joined to the positive receiver terminal.

## The Bias Battery.

The bias battery consists of a small  $4\frac{1}{2}$  volt dry cell which is connected in the grid filament circuit of the amplifier valve or valves.

The object of this battery is twofold.

Firstly, it causes the valve to operate on the straight portion of its characteristic curve, thereby eliminating distortion due to grid current, etc.

Secondly, it effects considerable saving in the high tension battery in that less current is used. This will in no way lessen the sound in the loud speaker, as it is not the actual amount of current which produces the sound, but the variation of that current.

The amount of bias varies proportionately to the amount of high tension used. Roughly speaking, the bias voltage should be somewhere in the region of one-twentieth of the H.T. voltage. Thus an amplifier using 90 volts on the H.T. will require about  $9/2$  or  $4\frac{1}{2}$  volts negative bias. This is only a rough guide, and the reader is strictly advised to follow the detailed instructions issued with the particular valve he has purchased.

The diagram shows the correct method of connecting up a bias battery to a receiver. It will be observed that the positive terminal of the bias battery is connected to the negative filament terminal, the negative bias terminal being joined to the filament terminal of the transformer. These same rules apply in the event of two amplifier valves being used, the only extra connection being from the O.S. or filament terminal of the second transformer to the negative terminal of the bias battery.

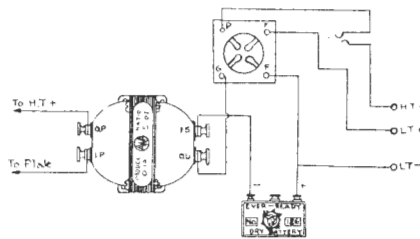

## Keeping the Set Fit.

Broadcast Receivers, as a rule, require very little attention other than keeping the batteries in good condition. In the majority of cases trouble may be due to run down batteries. However, the following points should be observed if good reception is to be maintained.

**AERIAL.**—The aerial requires overhauling annually. It should be lowered to the ground so that the insulators may be thoroughly cleaned, and all joints inspected. Soldered joints require particular attention. If any of the strands forming the aerial wire have broken it is advisable to procure new wire, which is cheap, rather than to solder the connection.

**THE EARTH.**—If the earth lead is fastened to a water tap either with a clip or by winding the wire round it should be removed and both the tap, and either the clip or the end of the wire, rubbed bright with emery cloth.

**THE RECEIVER.**—It is also an excellent plan to go over all nuts and terminal screws, and keep them clean and tight fitting. Very often dust gets between the variable condenser plates, and this should be removed, preferably with a bicycle pump or some other form of blower. On no account must a cloth be used, as it is liable to bend the movable plates.

**H.T. BATTERIES.**—Keep these batteries in a dry place and away from heat whenever possible. Dust must not be allowed to accumulate on the top of the battery, and finally, tighten the terminals occasionally.

**L.T. ACCUMULATORS.**—These, of course, require periodical recharging, which can be done in your own home if you have a battery charger, otherwise at a battery service station. The amount of current taken from the accumulator depends upon the type and number of valves used, and the length of time for which the set is working. It is most unwise to completely discharge an accumulator before recharging it. The terminals should be occasionally cleaned with emery cloth and smeared with vaseline to prevent corrosion.

**TELEPHONE AND LOUD SPEAKERS.**—Most speakers have their terminals marked “+” and “—”. This means that the “+” terminal should be connected to the H.T. Battery and the “—” terminal to the Valve. Failure to comply with these instructions will eventually damage the speaker. Telephones should always be handled with care as they are delicate instruments, and hard knocks or falls will often completely demagnetise them.

## The Loud Speaker.

The loud speaker plays a very important part in the successful reception of broadcast programmes, because, no matter how efficient and costly the receiver may be, if the speaker fails to fulfil its function satisfactorily the results at the best will be poor.

Let us look into the causes which are liable to produce unsatisfactory results in loud-speaker reception. They are two. Under the first heading we may write the following list:—

1. Working the receiver too near the oscillation point.
2. Poorly-designed transformers in the receiver.
3. Inter-action between transformers.
4. Unsuitable valves.
5. No grid bias battery.
6. Incorrect value of H.T. battery.

Any of these defects will result in squealing or distortion in the loud speaker.

Faults associated with the loud speaker proper come under the second heading, and they are usually due to inferior makes of instruments. Here, again, it is urged that only the very best brand of speaker (such as the Amplion) should be used, as it is a waste of money to go to the expense of a really good set if an inferior speaker is attached to it. Inferior loud speakers usually proclaim themselves by their inability to handle loud volume without distortion or by a tinny rendering of the speech or music.

Very often a small fixed condenser varying between .0005 and .002 M.F.D. capacity placed either across the output receiver terminals or across the terminals of the speaker will considerably improve reception. The exact value of this condenser must be found by actual experiment.

Don't forget to connect the speaker to the receiver the right way round. One of the speaker terminals is marked with a "+", and this should be connected to the positive terminal (+) of the H.T. battery. The other terminal is marked "-", this going to the plate terminal of the valve socket. Failure to comply with these instructions will eventually demagnetise the loud speaker.

Finally, it should be borne in mind that improved reception invariably results when the loud speaker is kept away from the receiver by a distance of a few yards. This is because the sound vibrations emanating from the speaker cause the electrodes inside the valve to vibrate in unison. As a result of this, inter-action between the speaker and the valves takes place, resulting in strange noises.



## Fault Finding In Radio Receivers

Tracing the cause of a fault in a receiver is rather a difficult job unless approached in a systematic manner, and many sets are out of action for varying periods due to their owners not being able to locate the fault.

In order to trace the cause of a breakdown a 1½-volt dry cell, a pair of telephones, and a few feet of twin flex are all that is necessary, and they should be connected up as shown in the sketch.

With this simple testing apparatus, most faults occurring in a receiver can be located.

For purpose of classification we will divide the circuits into four sections: the filament, the grid, the plate, and the aerial circuits.

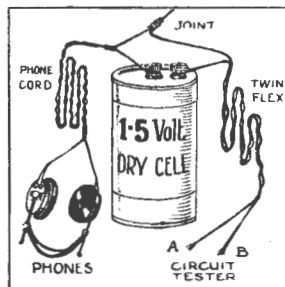

**The Filament Circuit.**—A break in this circuit is invariably proclaimed by the valve refusing to light up. The valve should be carefully removed and tested by placing the two ends A and B of the flex across the two filament prongs of the valve, when a loud click will be heard in the head 'phones if the filament is intact. If no click is heard when the ends A and B are applied to the filament prongs, the valve is defective. The springs in the valve holder should be bent upward, as possibly a bad contact existed between the valve prongs and socket springs. Next examine all the wiring between the valves and low tension battery. If all valves refuse to light the trouble occurs at the accumulator end of the filament circuit (unless the H.T. got across the filaments). If, however, only one valve is defective the fault will be located either in the valve, in its socket, or in the filament leads proceeding to that particular socket.

If the valve filaments light up correctly, the next thing to do is ascertain whether the trouble is located in the radio or audio stages. This is best accomplished by plugging the 'phones first in the detector jack, then in the first audio and finally in the last audio. By this means the approximate location of the fault may be ascertained, as if signals are received with the telephones plugged in the first audio jack and none are heard in last jack, it is in this stage that the trouble obviously lies.

**Grid Circuit.**—Assuming this to be the case, we will turn our attention to the grid circuit of the last valve. This includes the valve, transformer secondary, and bias battery. First substitute the valve by another one; then test the secondary winding with the circuit tester by placing the leads A, B across the two transformer secondary terminals, when a click will be heard in the head 'phones. The primary winding should be tested in a similar manner, as it is even more probable that the trouble is located in this winding. Before passing on to the plate circuit carefully examine all leads, making quite sure that all joints and connections are securely soldered and screwed down. Bend up the springs inside the socket of the valve, as it is here that the open circuit is possibly located.

## A.W.A. RADIO GUIDE

**The Plate Circuit.**—This circuit includes the H.T. Battery, the Jack and Plug, the Telephones, and the Valve. Having previously replaced the valve, we may assume this to be in good working order. However, a bad contact may exist between the jack springs and the telephone plug, in which case the springs should be bent inwards. The H.T. Battery will probably be in good condition, as it supplies the other valves. Should the trouble be in the first or second valves (R.F. and detector) it will be necessary to carefully examine the coils and condensers. In order to test a condenser, one of its connecting wires should be temporarily disconnected and the circuit tester brought into action as previously explained: by placing the flex leads A, B on the two condenser terminals or lugs. However, in this case no click will be heard if the instrument is in good order. Whilst performing this test it is advisable to rotate the condenser plates, and if a crackling noise is heard in the 'phones the two sets of plates are touching at that particular position of the dial. They must be very carefully separated. When testing the grid condenser, the grid leak should be removed. The coil holder may be tested for good contacts with the circuit tester by applying the two leads, say across the secondary tuning condenser terminals. As the ends of this coil are directly connected to these terminals a loud click should be heard.

**Aerial Circuit.**—The aerial must be carefully examined, starting at its free end and following it down to the lead-in insulator. With the circuit-tester ascertain whether a good connection exists between the outside and inside connections of this insulator. Now follow the lead-in to the receiver, trace out the connections to the aerial coil and finally examine the earth circuit down to the point where it enters the ground.

**Conclusion.**—Many of the faults which are the cause of placing receivers out of action are due to some trifling fault such as an unsoldered connection, faulty valve, run down battery, or loose connection either in the aerial, earth, or battery circuits and any of the above can be rectified in a very short space of time, provided that a little patience and thought are exercised.

## A.W.A. RADIO GUIDE

# Valve Precautions

- DON'T handle valves roughly, or elements may be injured.
- DON'T burn valve filaments above rated amperage and voltage.
- DON'T insert valves in sockets unless absolutely certain rheostats are at the proper setting for normal operation.
- DON'T make drastic error of connecting plate battery to the filament terminals—watch all battery connections.
- DON'T burn out a valve through carelessness and expect your dealer to exchange it for another.
- DON'T use excessive plate voltage on power valves.
- DON'T energize the filaments of all the tubes in a cascade circuit at once unless the circuit has been used before.
- DON'T take one tube out of a cascade circuit in which the filaments are in parallel—it causes a rise in current in the remaining filaments and may burn them out. Cut off the current first.
- DON'T make any alterations in your wires while valves are in their sockets. It is quite a common thing for 40 or 60 volts to become twisted up in the filament circuit as a result of this practice. High voltage for the filament spells disaster for your tubes.
- DON'T expect a continued increase in signal strength as your filament temperature increases beyond normal. You will only reduce the life of your tube. Valves function best at one particular point—when you increase the filament current beyond this point you do the signal no good and the tube great harm.
- DON'T forget the necessary filament current may frequently be greatly reduced by proper manipulation of the tuner circuits, especially the tickler or regenerative circuit, if used.
- DON'T expect to have a loud speaker operated from a detector valve—you'll be disappointed. At least one stage of audio-frequency amplification is generally necessary.
- DON'T forget that valves cost from 8 to 10 times as much as ordinary incandescent lamps—they deserve a little respect.
- DON'T expect to get the best results if you use an amplifier valve for a detector, or vice versa.
- DON'T be anxious to produce sound with very great volume—it isn't necessary.
- DON'T expect your loud speaker to work properly if you have a pair of 'phones connected to your detector circuit.

### REGENERATION CONTROL.

In valve receiving circuits employing regeneration, some means is generally provided for controlling this action. If the circuit is adjusted to a point where its action is too great, telephone signals will be distorted by oscillations set up in the detector tube itself. When this happens, it is merely necessary to alter the position of the regeneration control.

Regeneration, when properly employed, has the effect of amplifying incoming signals many times and the best results may be obtained by bringing the regenerator control up to a point just before oscillation starts, or by bringing it to an oscillating point and then reducing it slightly. The point of oscillation may be recognised by a peculiar continuous mushy sound in the telephone receivers and a dull thud may be heard when oscillation starts or stops. Too great a degree of regeneration also has the effect of producing whistling noises.

The regenerative feature in receiving sets when properly employed is of great value, but improperly employed it is not conducive to the best operation. Great care should therefore be taken in employing regeneration; otherwise radio telephone speech and music may become distorted.

## A.W.A. RADIO GUIDE

### The Use of the Marine Wireless Direction Finder. AS AN AID TO THE NAVIGATION OF SHIPS.

The object of the Wireless Direction Finder is to enable ships to ascertain the bearing of other wireless stations which are out of sight. Clearly, there are two methods of effecting this. One is to establish direction-finding stations on land so that they can take bearings of ships and signal such bearings on request; the other is to fit the direction finder in the ship and take bearings of any required wireless station.

The first method is of necessity very restricted in its application, and the captain of a ship is asked to rely upon an aid to navigation over which he has no control, and of whose accuracy he has no means of assuring himself.

The second method is of very much wider application, as the bearings of any coast station, or of other vessels, can be taken at pleasure, if within range. This method will shortly be of still wider application when the system of "Wireless Beacon Stations" is further developed. Further, the captain of the ship has the apparatus and operators under his control, and by regular practice he can assure himself of the reliability of the installation.

The Marine Wireless Direction Finder confers on the navigator the power of obtaining a bearing of any coast wireless telegraph station, or of any other ship, which may be making use of its wireless transmitter. This bearing can be relied upon to be within 1 degree of accuracy, provided the distance does not exceed 70 miles.

The Direction Finder is dependent on the exact position of its special aerial loops, which are erected on board ship, and the bearings which the wireless instrument is capable of taking are what are known as relative bearings; that is to say, they refer to the direction of the ship's keel line, and have no connection with north and south.

Bearings which are to be used for navigation are almost always required to be either true bearings or magnetic bearings; i.e., they must be referred to the direction of the North Pole or to that of magnetic north. In ships which make use of gyro compasses, a repeater card can be mounted beside the direction finder, and then arrangements can be made so that a true bearing can be obtained by direct observation. Where gyro compasses are not in use it is necessary to observe the exact direction of the ship's head by compass at the moment when the wireless bearing is taken. By means of this information the wireless bearing, which, as previously stated, is a relative bearing, may be converted into a true bearing for use by the navigating officers.

As explained above, the action of the Wireless Direction Finder is dependent upon the exact position of its special aerial loops, and once the size and position of these loops has been accurately adjusted it is imperative that they should be kept rigid and constant. It is no exaggeration to say that the direction-finding aerials are as liable to errors due to unskilled or accidental interference as the ordinary marine magnetic compass.

The value of the Marine Direction Finder as an aid to navigation has been well proved, and that value is now growing rapidly, especially since the chief maritime countries have commenced erecting special wireless beacon stations. These stations are small transmitting stations situated at selected points, which operate their transmitting gear during fog, for the special purpose that ships fitted with direction finders may be able to take bearings of them. These "beacon" stations are mostly of low power. Reliable bearings can be taken of them at distances up to 30 to 50 miles.

It is worth noting that a direction finder may be of considerable use even though it is known to be below the proper standard of accuracy. A bearing which can be trusted to be within 5 deg. may often be of great value.

## A.W.A. RADIO GUIDE

It is obvious that a marine wireless direction finder is of the greatest use for watching the movements of crossing traffic in thick weather. For this purpose its range of reception must be considerably reduced, and provision is made for this in the design of the instrument.

On several occasions direction finders have contributed materially to the safety of life at sea by guiding vessels to the assistance of others which have been driven out of their reckoning by stress of weather, and which have therefore been unable to state their position correctly.

There are certain conditions which will make bearings obtained by a perfectly adjusted direction finder unsatisfactory. (1) Within about half an hour of sunrise or sunset varying and uncertain errors up to as much as 5 deg. are often encountered. These errors are due to natural causes, and it is impossible to detect their presence or to know in which direction to allow for them. Fortunately they only exist for brief periods, and an expert operator is aware that the bearings lack their usual sharpness and definition. (2) If the line of bearing touches or approaches the coast line or cuts it at a fine angle, errors are introduced which cannot be foretold or allowed for. Such bearings should be avoided when possible, and in any case they must be regarded as only approximate, and should only be used with due caution.

### **The Use of a Direction Finder at Long Distances.**

It was pointed out above that bearings could be taken of ships or ordinary coast stations at distances up to about 70 miles with a high degree of accuracy. The wireless apparatus is capable of taking bearings with equal accuracy at much greater distances, especially if the transmitting station is powerful, but additional precautions have to be taken when employing such bearings.

At long distances a discrepancy is found, due to the fact that the earth is spherical and the chart is flat. This discrepancy, which can be corrected by applying what is known as the "half convergency," is negligible at distances under 70 miles. There are three methods of ascertaining this correction, viz., tables, diagrams and charts, and all three are supplied with the direction finder instrument, with full particulars as to their use.

N.S.W., Vic., Q'land Tas.		7	8	9	10	11	NOON	1-	2	3	4	5	6	7	8	9	10	11	MN
South Australia		6:30	7:30	8:30	9:30	10:30	11:30	12:30	1:30	2:30	3:30	4:30	5:30	6:30	7:30	8:30	9:30	10:30	11:30
Western Australia		5	6	7	8	9	10	11	NOON	1	2	3	4	5	6	7	8	9	10
New Zealand		8:30	9:30	10:30	11:30	12:30	1:30	2:30	3:30	4:30	5:30	6:30	7:30	8:30	9:30	10:30	11:30		
		am					pm												
SYDNEY	2 FC 442 M		■	■	■	■	■	■	■	■	■	■	■	■	■	■	■	■	■
	2 BL 353 M		■	■	■	■	■	■	■	■	■	■	■	■	■	■	■	■	■
	2 GB 316 M	<i>Tuesdays, Thursdays, and Saturdays excepted</i>																	
	2 KY 280 M	<i>Sundays excepted</i>																	
MELB	3 AR 484 M					■	■	■	■	■	■	■	■	■	■	■	■	■	■
	3 LO 371 M					■	■	■	■	■	■	■	■	■	■	■	■	■	■
	3 UZ 319 M	<i>Monday and Wednesday only</i>																	
BRISBANE	4 QG 385 M	■						■	■	■	■	■	■	■	■	■	■	■	■
HOBART	7 ZL 525 M					■	■	■	■	■	■	■	■	■	■	■	■	■	■
ADELAIDE	5 CL 395 M					■	■	■	■	■	■	■	■	■	■	■	■	■	■
	5 DN 313 M					■	■	■	■	■	■	■	■	■	■	■	■	■	■
	6 WF 1250 M									■	■	■	■	■	■	■	■	■	■
AUCKLAND	1 YA 420 M	<i>Mondays excepted</i>																	
WELLINGTON	2 YK 295 M	<i>Mondays &amp; Wednesdays excepted</i>																	
CHRISTCHURCH	3 YA 400 M	<i>Thursdays excepted</i>																	
DUNEDIN	4 YA 380 M	<i>Mondays and Wednesdays excepted.</i>																	

BROADCASTING TIME SCHEDULE.

## Commonwealth Wireless Licenses.

**Broadcast Listeners' Licences** are obtainable at all Money Order Offices in the Metropolitan area, and at all Official Post Offices in the country, upon application by person, post, or proxy. No application form is necessary.

An **Ordinary Broadcast Listener's Licence** is granted for a residence or place where the licensee operates the receiver for his own purposes and not for financial gain, either **direct** or **indirect**. It is only intended for the entertainment of the licensee's home circle.

The fees for an Ordinary Licence are as follow:—

Zone 1 . . . . .	27/6	per annum
Zone 2 . . . . .	22/6	" "
Zone 3 . . . . .	17/6	" "

but the fee may be paid in two equal half-yearly instalments, and in this case the fees are 30/-, 25/-, and 20/- per annum, respectively.

It should be understood that when a licence is taken out under the instalment system, it is compulsory to pay the second half-yearly instalment **whether a set is installed or not**.

An Ordinary Licence is not issued for a period other than twelve months. A licence is issued for the use of receiving equipment at the address indicated thereon, and permission should be obtained from the State Radio Inspector should the licensee desire to temporarily instal the receiver at another address, or on a motor-car, yacht, etc.

The State Radio Inspector should be informed of any change of address.

A **Special Broadcast Listener's Licence** is issued for use in hotels, restaurants, places of amusement or other places where the reception of the broadcast programmes is intended for a number of people. The fees are:—Zone 1, £10 per annum; Zone 2, £9 p.a.; Zone 3, £7/10/- p.a.

A **Temporary Broadcast Listener's Licence** shall be granted for the temporary use of a Special Licence, as at Show Grounds, Exhibitions, etc. The fee is:—Zone 1, £1 per week; Zone 2, 17/6; Zone 3, 15/-.

A **Dealer's Listening Licence** is issued to a person or firm operating receiving equipment for the purpose of demonstration or test of receivers, with the object of promoting the sale of receiving equipment. The licence fee is:—£5 per annum for Zone 1, £3 for Zone 2, and £2 for Zone 3.

**ZONES.**—For the purpose of the granting of Broadcast Listeners' Licences, and the payment of fees therefor, each State shall be divided into three zones, as follows:—

- (a) In Queensland, New South Wales, Victoria, and South Australia:—
  - Zone 1 shall include the territory between the coastline approximately 250 miles north of Brisbane, and 250 miles west of Adelaide, and a line running about 250 miles from the coast, with such local variations as it is expedient to introduce;
  - Zone 2 shall include the contiguous territory reaching about 150 miles further beyond Zone 1, and
  - Zone 3 shall comprise the remaining territory in those States: and
- (b) In Western Australia and Tasmania—
  - Zone 1 shall comprise the territory of the State embraced by a circle of approximately 250 miles radius drawn from the centre of the town or city in which the station is erected;
  - Zone 2 shall lie between the 250-mile circle and another concentric circle of approximately 400 miles radius; and
  - Zone 3 shall include the rest of the State outside the 400-mile boundary.

A.W.A. RADIO GUIDE

**Total Number of Broadcasting Licenses Issued**

**IN COMMONWEALTH OF AUSTRALIA.**

1st January, 1926, to 31st December, 1926.

	N.S.W.	VIC.	QLD.	S.A.	W.A.	TAS.	TOTAL.
January . . . . .	3262	6549	341	1587	370	54 . . . .	12,163
February . . . . .	3922	9498	319	1169	411	46 . . . .	15,365
March . . . . .	2953	7162	454	756	382	51 . . . .	11,758
April . . . . .	1863	6900	714	557	326	55 . . . .	10,415
May . . . . .	1989	6178	736	610	359	62 . . . .	9,934
June . . . . .	2645	8644	1796	1046	326	124 . . . .	14,581
July . . . . .	3167	6488	4468	1244	245	71 . . . .	15,683
August . . . . .	4730	9869	2321	3625	249	108 . . . .	20,902
September . . . . .	7754	7988	1621	1521	436	208 . . . .	19,528
October . . . . .	6137	8044	1379	1043	327	103 . . . .	17,033
November . . . . .	4742	9808	1415	1755	328	104 . . . .	18,152
December . . . . .	5365	7611	2710	1161	331	86 . . . .	17,264
Total . . . . .	48,529	94,739	18,274	16,074	4,090	1,072 . . . .	182,778



# A.W.A. RADIO GUIDE

## HOME CONSTRUCTION DIAGRAMS.

The following diagrams will help the reader to build a receiver to his own design incorporating ideas from the circuits. For example, should he require a detector followed by a stage of transformer and two stages of resistance coupling, he will be able to obtain the necessary details from Figs. 1 and 5. Should he wish to make use of the Automatic Filament Control, details are shown in Fig. 8, it being a simple matter to place the filament circuit of Fig 8 to suit Fig 6.

### KEY TO PARTS SET OUT IN FOLLOWING CIRCUITS.

- |   |  |
|---|--|
| 1. 1 Coil Mounting                                    | 20. Single Circuit, Filament Control (B.M.S.).                 |
| 2. 2 Coil Mountings                                   | 21. Double Circuit Filament Control (B.M.S.).                  |
| 3. 3 Coil Mountings                                   | 22. 2 or 3 megohm Leak (Dubilier or Electrad)                  |
| 4. .00035 Variable Condenser (A.W.A.).                | 23. Terminals  |
| 5. .0005 Variable Condenser (A.W.A.).                 | 24. Crystal Detector (A.W.A.).                                 |
| 6. .0001 Fixed Condenser (Dubilier or Electrad)       | 25. 35 or 50 Turn Coil Mounted (A.W.A.)                        |
| 7. 00025 Fixed Condenser (Dubilier or Electrad)       | 26. 6 Point Switch (Dubilier)                                  |
| 8. 001 Fixed Condenser (Dubilier or Electrad)         | 27. Filament Switch (B.M.S.)                                   |
| 9. 002 Fixed Condenser (Dubilier or Electrad)         | 28. UX-201A or AWA-101X Valve and Socket (Benjamin)            |
| 10. 1 MFD. Fixed Condenser (Dubilier Mansbridge)      | 29. UX-200A Valve and Socket (Benjamin)                        |
| 11. 6 ohm Rheostat (De Jur)                           | 30. UX-112 Valve and Socket (Benjamin)                         |
| 12. 10 ohm Rheostat (De Jur)                          | 31. $4\frac{1}{2}$ volt. Bias Battery (Ever-Ready or Columbia) |
| 13. 30 ohm Rheostat (De Jur)                          | 32. A.W.A. 99X Valves  |
| 14. 400 ohm. Potentiometer (De Jur)                   | 33. UX 120 Valves.   |
| 15. 5-1 A.W.A. Audio Frequency Transformer            | 34. Neutralising Condenser.                                    |
| 16. 3 $\frac{1}{2}$ -1 " " " "                        | 36. 50,000 to 75,000 ohm Resistances (Dubilier)                |
| 17. Push Pull A.W.A. Audio Frequency Transformers (2) | 37. 100,000 ohm Grid Leaks (Dubilier)                          |
| 18. Double Circuit Jack (B.M.S.).                     | 38. 0.1 MFD Fixed Condensers (Dubilier).                       |
| 19. Single Circuit Jack (B.M.S.).                     | 39. D.E5B Valve and Socket.                                    |

Figure 1.—Single Valve Re-generative Receiver.

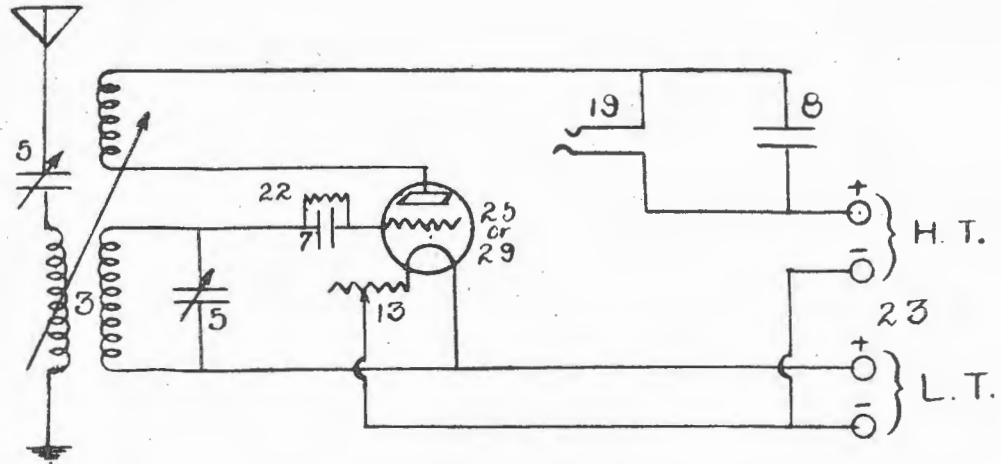

124

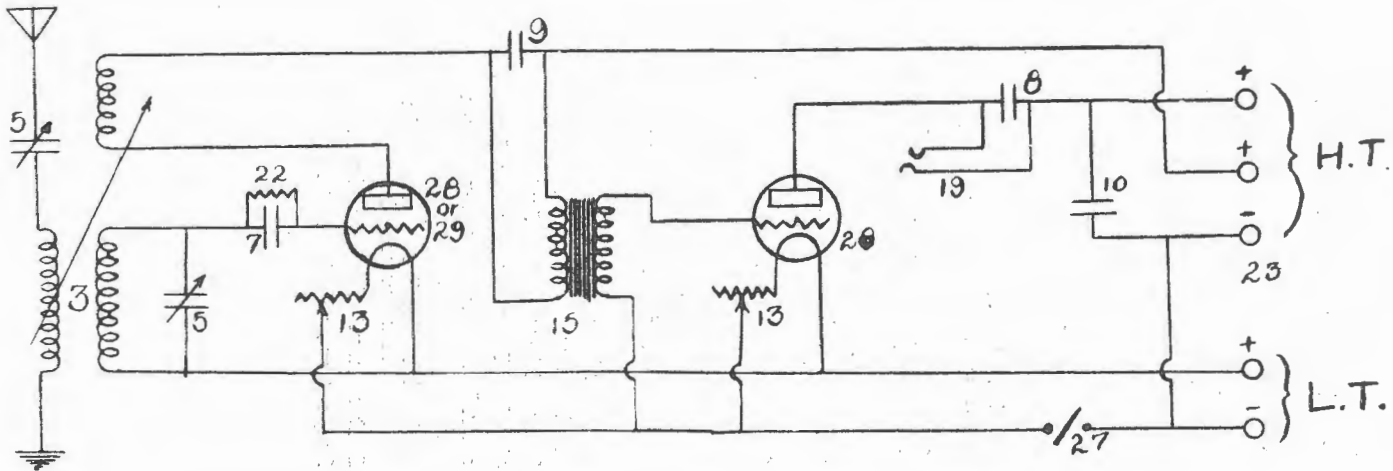

Figure 2.—Two-Valve Receiver—Detector and One Stage Audio Amplification.

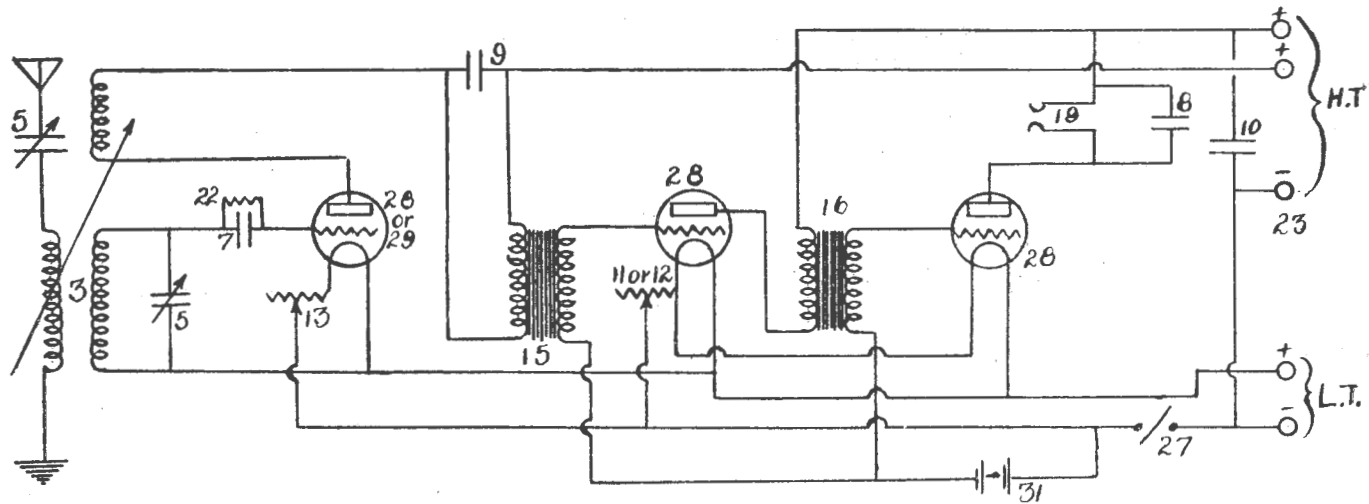

Figure 3.—Three Valve Receiver-Detector and Two Stages Audio Amplification.

125

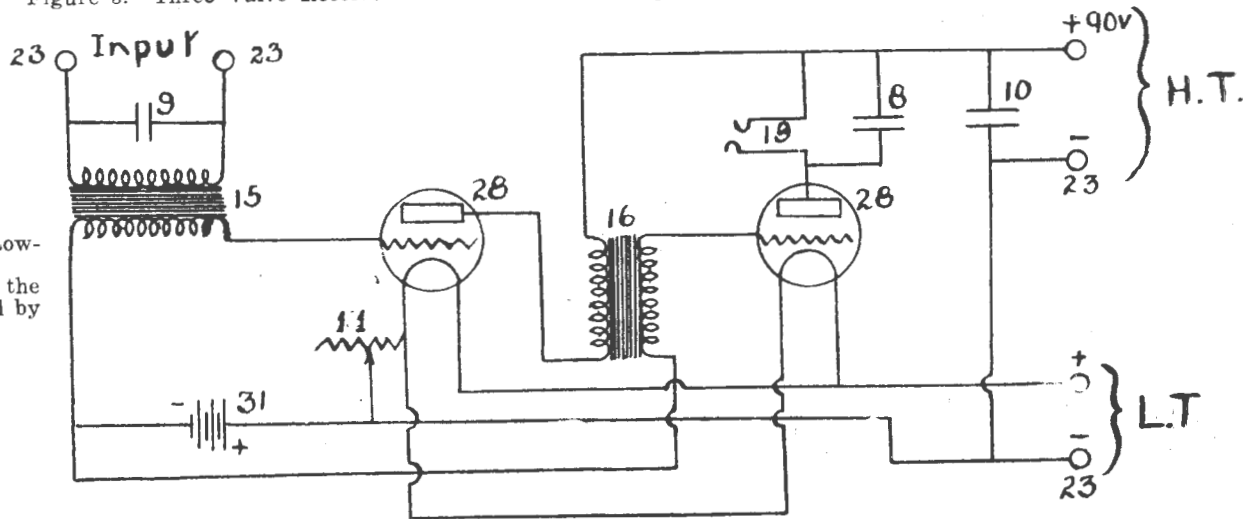

Figure 4.—Two Valve Low-Frequency Amplifier.  
This instrument allows the headphones to be replaced by a Loud Speaker.

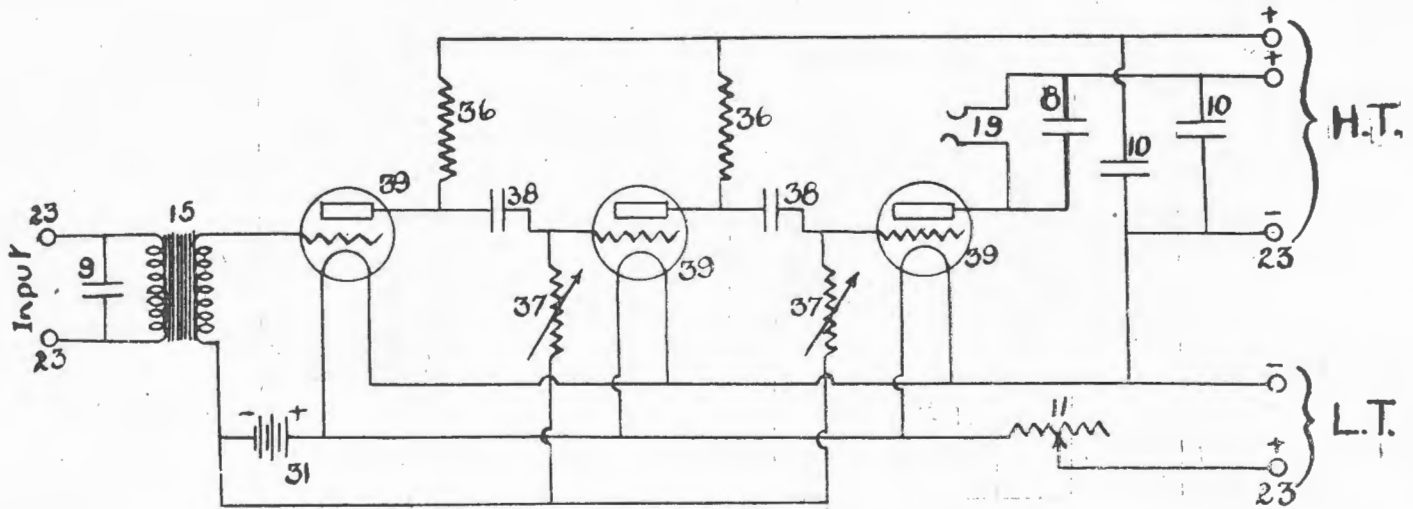

Figure 5.—A Three-Stage Amplifier, employing one Transformer and two Resistances Capacity Coupling Stages.

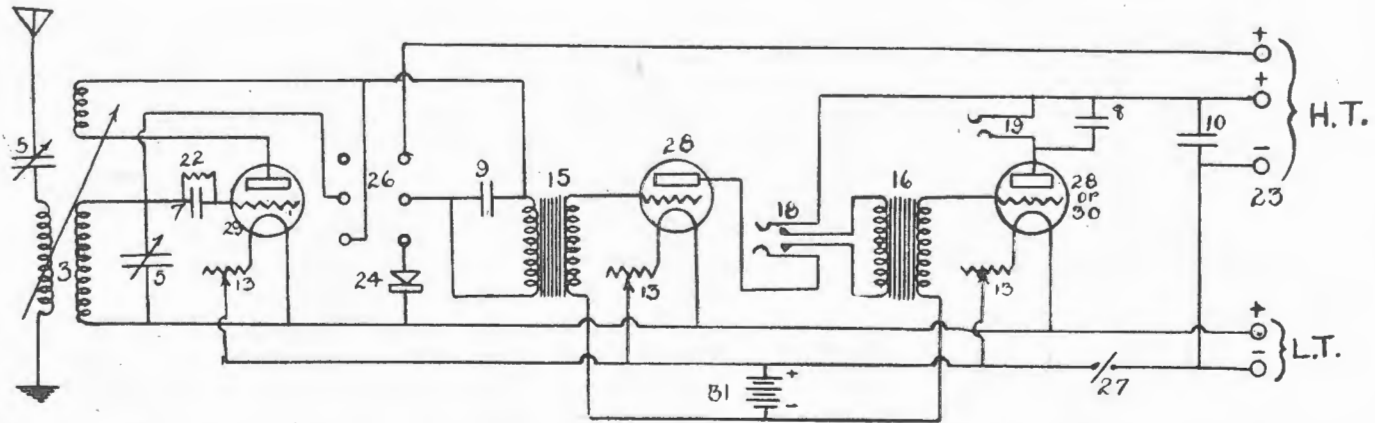

Figure 6.—A Three-Valve Receiver with Switching Device, enabling first valve to be replaced by Crystal.

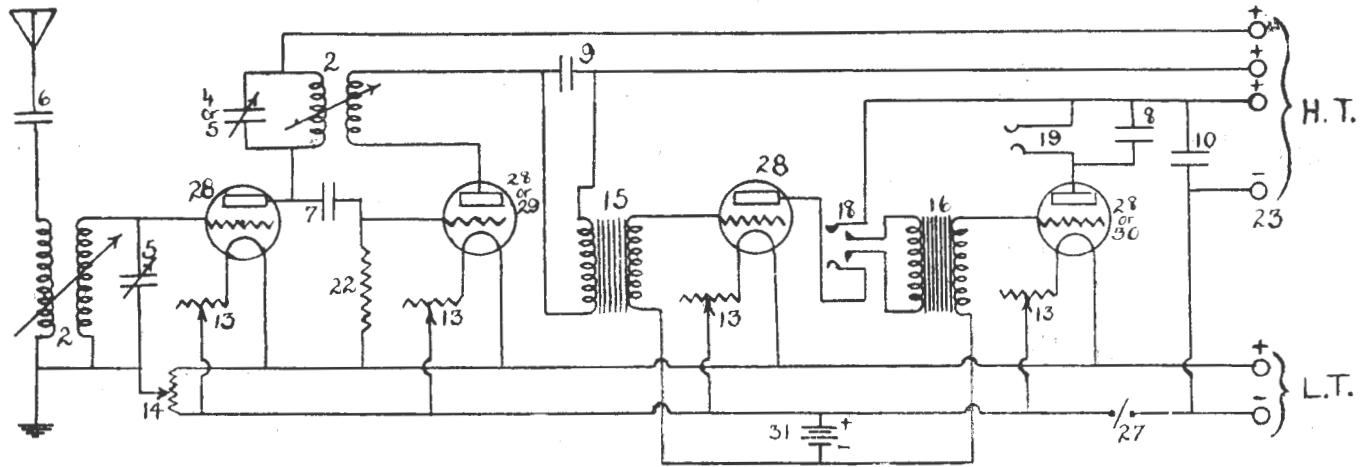

Figure 7.—A Selective Four-Valve Circuit ( Radio, Detector, and two stages Audio Amplification).

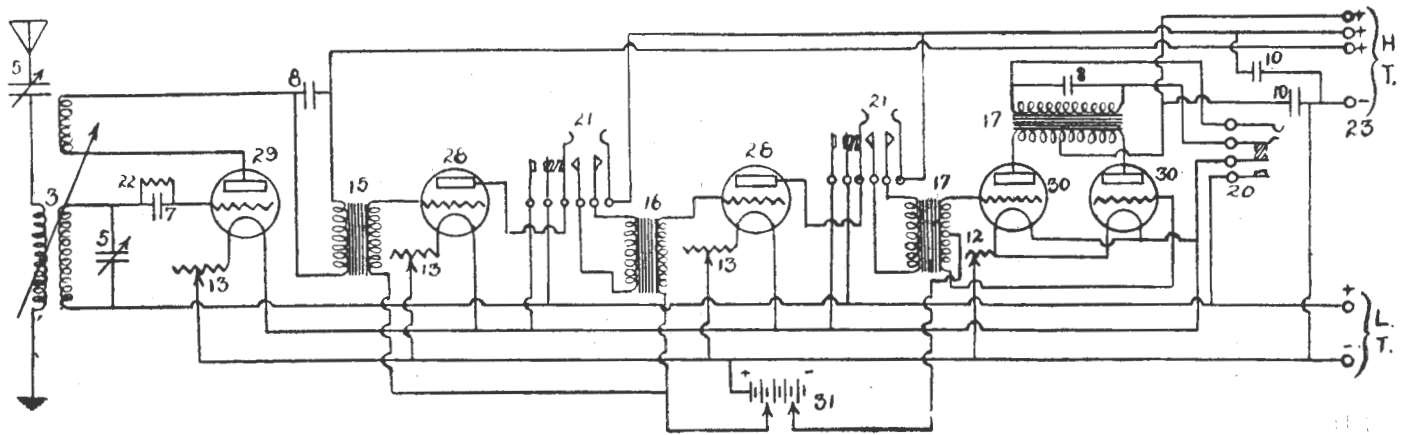

Figure 8.—A Five-Valve Receiver, for use where exceptional power is required. Filaments light up when the plug is inserted into one of the jacks.

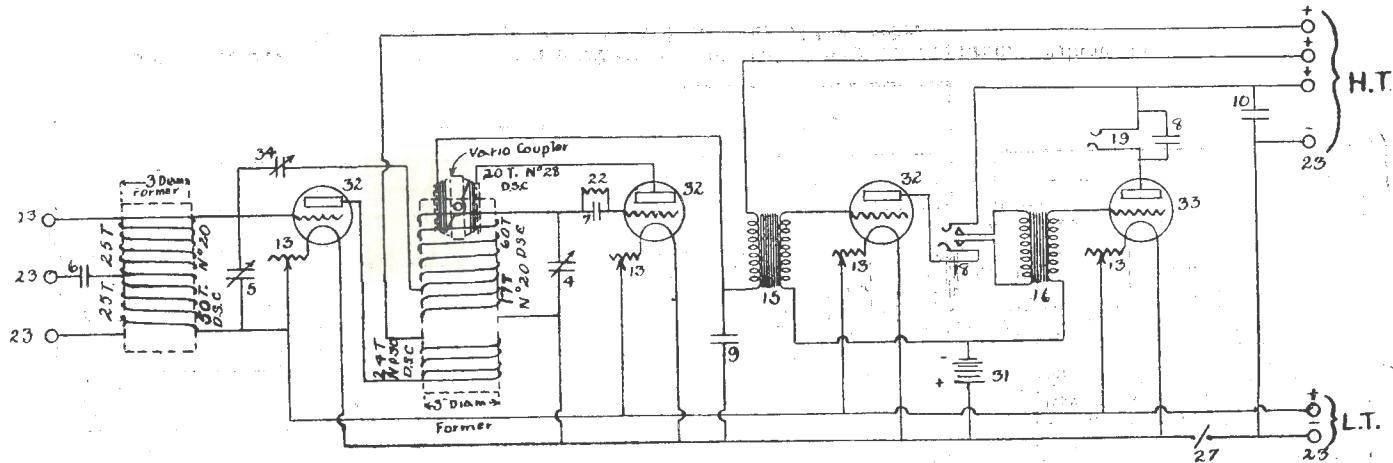

Figure 9.—Four-Valve Browning Drake Circuit. (Radio Detector and two stages of Audio Amplification.)

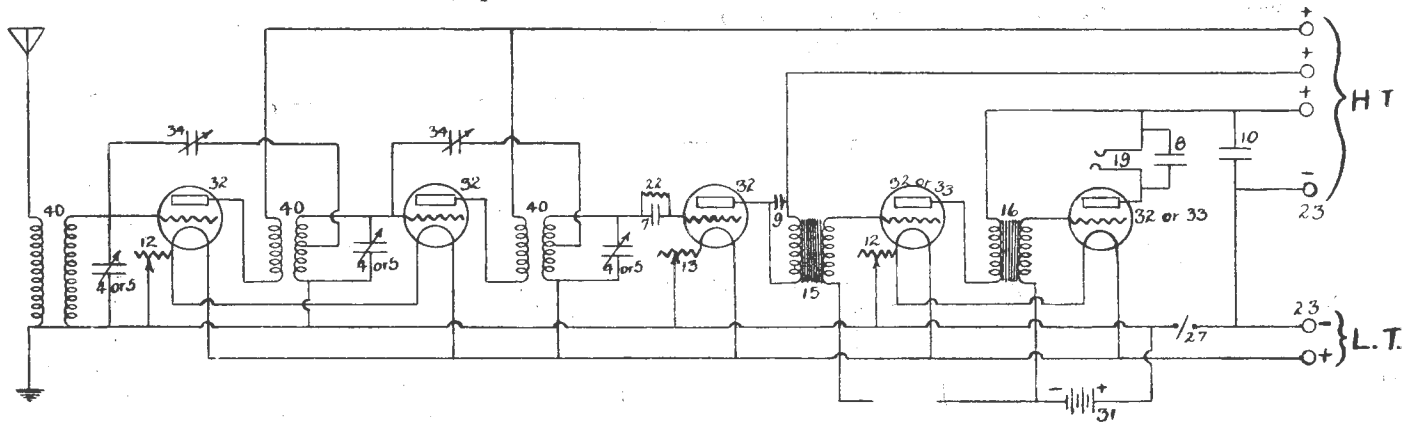

Figure 10.—A Five-Valve Neutralised Circuit, employing two neutralised stages of H.F. Amplification, Detector, and two stages of L.F. Amplification.







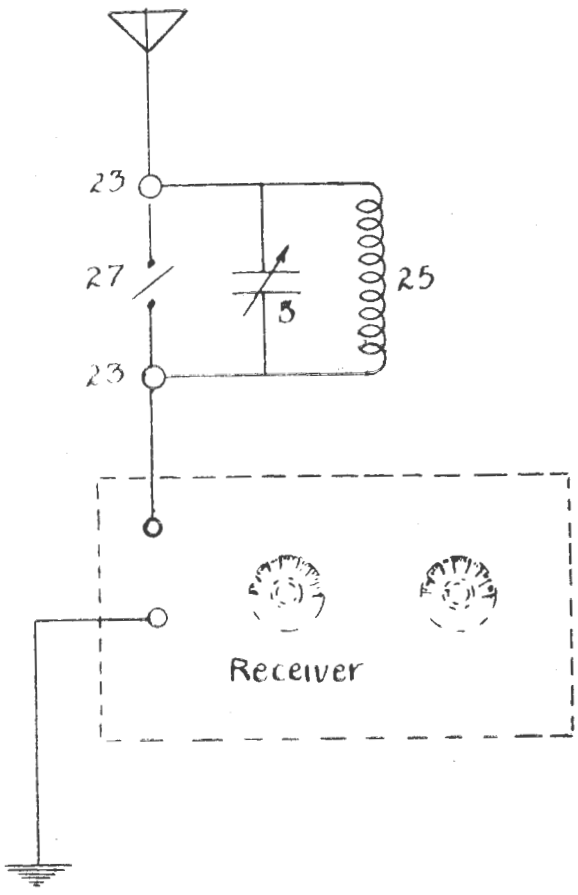

Figure 11.—A Wave Trap Circuit, showing the method of connecting the Trap up to the receiver. When not required the Trap is short-circuited by the switch.

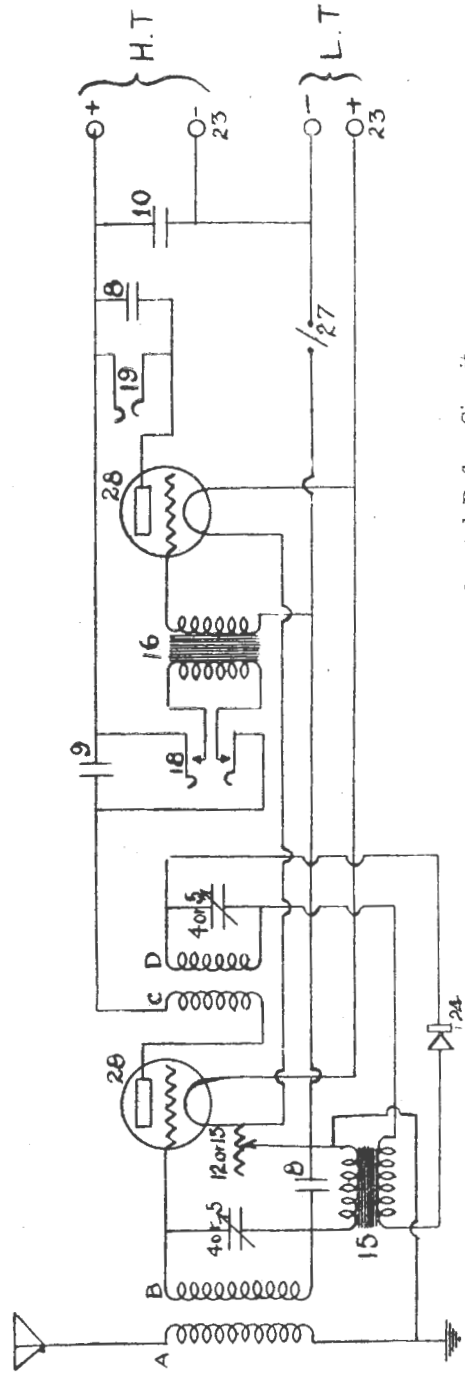
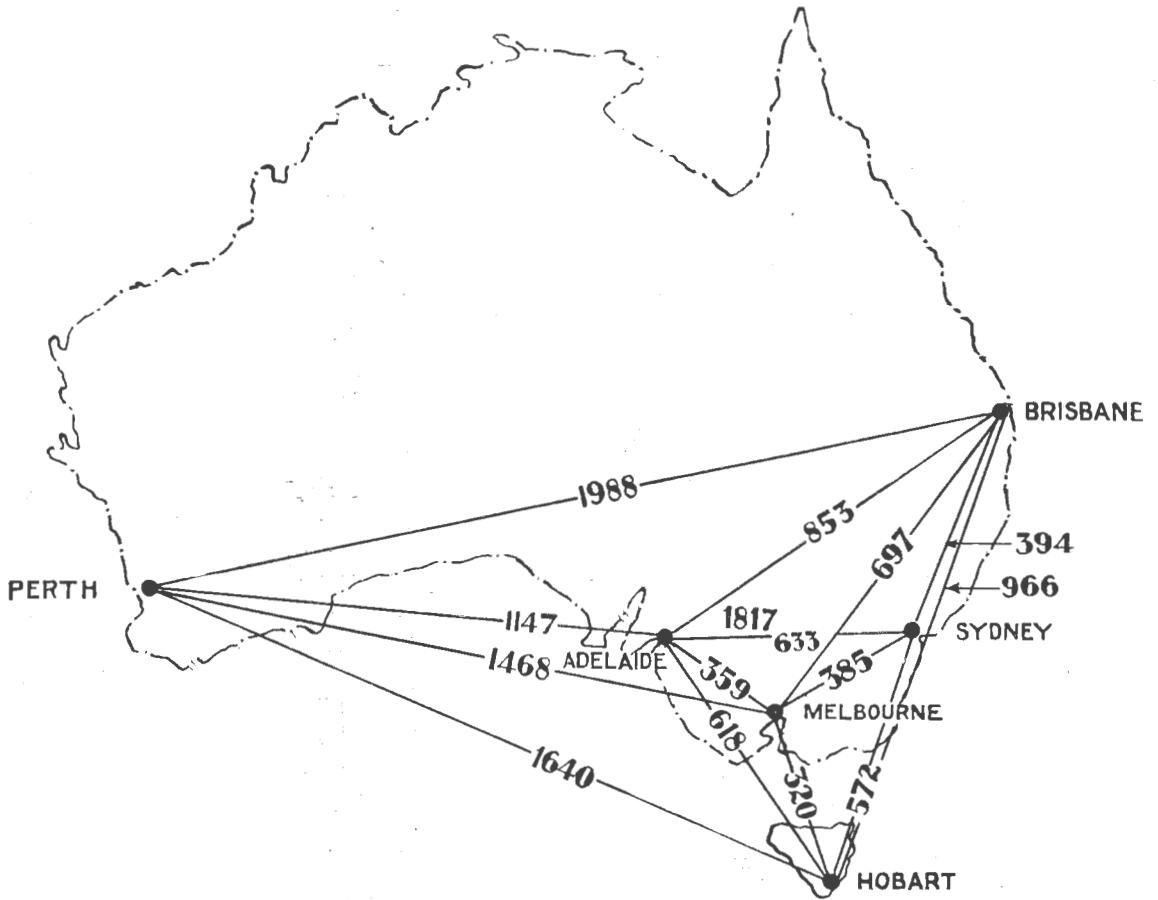

Fig. 12.—A Two-Valve Crystal Reflex Circuit.

A.W.A. RADIO GUIDE



AIR LINE DISTANCES  
IN MILES  
BETWEEN AUSTRALIAN BROADCASTING STATIONS

## Technical Terms Used in Radio.

- Aerial.**—One or more wires insulated from, and suspended at a certain height above the ground, and used to radiate or receive that energy in the form of ether waves produced by a transmitter.
- Alternating Current (Abbreviated A.C.)**.—An electrical current flowing through a wire which has the direction of its flow periodically changed. Thus when we speak of a 60 cycle alternating current, we mean one that completely reverses its direction of flow sixty times per second. Alternating current plays a prominent part in practically every part of the radio circuit.
- Ammeter.**—An instrument used for measuring the flow of current in amperes through a given circuit. An ammeter is invariably connected in series.
- Ampere.**—The standard electrical unit of current flow.
- Amplifier.**—This term is used in referring to either an amplifying valve or an amplifier receiving unit.
- Amplitude.**—In radio work, this refers to the highest point reached by a wave or oscillation, i.e., the crest of each wave. A wave may, therefore, have a high or low amplitude according to the initial energy which created it.
- Antenna.**—See aerial.
- Atmospherics.**—Also known as static, strays, X's. "The noises of space." Natural electrical discharges occurring in the ether, and in reality miniature lightning storms. Since these discharges travel through the same medium as radio waves, they are readily picked up by receivers and prove very troublesome at times. It is difficult to tune out these disturbances, for they have no definite wave length.
- Audio Frequencies.**—Frequencies corresponding to vibrations which are normally audible to the human ear. All frequencies below 10,000 cycles per second are termed audio frequencies. See radio frequencies.
- Broadcasting.**—As applied to radio work, the transmitting, either by radio telegraphy or telephony from a given central point for the benefit of a great number of receiving stations located within the broadcasting station's range.
- Capacity (Abbreviated C.)**—Capacity is the property of a device to store energy in electro-static form. Capacity, as well as inductance, governs the frequency and wave length of a circuit. The unit is the farad, but on account of its size, the micro-farad (Mfd.) is used. A micro-farad is one-millionth part of a farad.
- Cascade Amplification.**—This refers to high amplification of received radio signals, where several valves are employed in cascade fashion. Thus, we may speak of a three-stage (cascade) amplifier.
- Choke Coil.**—A coil wound so as to have great self-induction. This choking action introduced in a radio circuit is called impedance.
- Circuit.**—In radio and electrical work the path in which an electric current flows from the source and returns to it, is called a circuit. A circuit may be either open or closed.
- Close Coupling.**—A tuning coil or coils, or transformer, are said to be close coupled when the primary and the secondary are very close together, thereby causing large values of mutual inductance.
- Condenser.**—Two or more sheets of metal separated by an insulator called the dielectric. A condenser is used in radio work for storing electrical energy and for bringing circuits into resonance or tuning them.
- Counterpoise.**—One or more wires stretched immediately above the earth, but insulated from it, usually directly beneath the regular aerial and employed in transmission and reception instead of, or in connection with, an "earth."
- Continuous Wave (Abbreviated C.W.)**—A form of electro magnetic wave used extensively in radio work, having a constant amplitude and no damping, as distinguished from the older form of discontinuous, highly damped wave. C.W. makes possible long-distance radio telegraphy and telephony.
- Crystal Detector.**—Certain metallic crystals when introduced in a radio received circuit have the property of rectifying the incoming signal oscillations so that the resultant intermittent direct current will operate a sensitive telephone receiver.
- Detector.**—Any apparatus which transforms the oscillations received by the aerial into a form of current which will operate a telephone or other recording device.
- Direct Current (Abbreviated D.C.)**—An electric current flowing continuously in one direction. In a circuit direct current always flows from the positive source to the negative return. Therefore, direct current always has a readily determinable polarity, while alternating current (A.C.), which is periodically reversing its polarity while flowing through a circuit, has no apparent polarity.
- Electron.**—Negative electricity. An atom combined with an electron is a negative ion; an atom minus an electron is a positive ion.
- E.M.F.**—Electromotive force, the unit of which is the volt.
- Ether.**—A medium of great elasticity, supposed to pervade all space as well as the interior of solid bodies. It is the medium through which light, heat and radio waves are transmitted.

## A.W.A. RADIO GUIDE

- Frequency.**—In alternating currents, the number of complete cycles or reversals of current through a circuit per second. Thus, we speak of a 60-cycle current as one which has sixty complete reversals per second. See Alternating Current and Audio and Radio Frequencies.
- Neutralising Condenser.**—A condenser of small capacity used in radio frequency circuits to neutralise the internal capacity existing between the plate and grid elements of the valve.
- Neutral-formers.**—Specially wound radio frequency transformers with a tapped secondary for external connection to the neutralising condenser.
- Wave-meter.**—An instrument for measuring the wavelength of a transmitting station.
- Grid Leak.**—A very high, non-inductive, resistance connected across the grid condenser or between the grid and the filament of a valve to permit excessive electrical charges to leak off to an external source, thus furnishing stable control under all operating conditions, and governing the action of the grid.
- Ground, or Earth.**—In radio work the ground is the low potential end of the circuit, and functions in connection with the aerial of most sending and receiving systems. See Counterpoise.
- Harmonics.**—In radio, harmonics refer to the incidental waves mostly noticeable in undamped wave operation. These harmonics differ in length and frequency from the true and original operative wave of such transmitters. At times, listeners will hear the harmonics of high power long wave stations while their tuners are set for much shorter waves.
- Henry.**—The unit of inductance.
- Hertzian Waves.**—Electro-magnetic waves, named after their discoverer, Prof. Heinrich Hertz.
- Hot Wire Ammeter.**—An instrument used in radio transmission work which measures current in amperes by means of a wire expanding in proportion to the heat generated by the passing current.
- Impedance.**—The combination of resistance and retarding action offered by a coil of wire to a varying current on account of the back e.m.f. produced by the varying lines of force. (See also Reactance.)
- Inductance (Abbreviated I).**—Inductance, like capacity, plays a very prominent part in radio circuits. It is the property of a coil of wire which tends to prevent any change in the value of current flowing through it. It governs the frequency and therefore the wave length of a circuit. The unit of inductance is the henry. In radio work the millihenry and the microhenry are the more practical terms used.
- Induction.**—The transference of energy from one circuit to another by means of electro-magnetic phenomena.
- Insulator.**—A non-conductive material, and one through which an electric current will not pass.
- Ion.**—A gaseous atom having a surplus or deficiency of electrons.
- Kilowatt (Abbreviated K.W.).**—One thousand watts. A unit of power.
- Loop Aerial.**—A small frame aerial used for indoor reception, thus eliminating both outdoor aeriels and earth connections. It gives very marked directional effects.
- Loud-speaker.**—Any receiving device designed to reproduce signals or speech loud enough to be heard without individual use of the conventional telephone receivers.
- Megohm.**—One million ohms.
- Microfarad (Abbreviated Mfd.).**—One-millionth part of a farad, and the practical unit of capacity.
- Microphone.**—A sound magnifier, or an instrument used in both wire and radio telephony to vary the current in circuit by means of speech.
- Milliampere (Abbreviated M.A.).**—The thousandth part of one ampere.
- Ohm.**—The unit of electrical resistance.
- Ohm's Law.**—The fundamental law of electricity. It is that the current in amperes flowing through a circuit is equal to the pressure in volts divided by the resistance in ohms.
- Oscillations.**—Alternating currents of very high frequencies are called electrical oscillations. If the amplitude of a series of oscillations is constant, they are called continuous or undamped waves, but if the amplitude is not constant, as in the spark method, they are called damped waves.
- Potential.**—Referring to electrical pressure. See E.M.F. and Volt.
- Radiation.**—The transmission of energy through space in the form of electro-magnetic waves.
- Radio Frequencies.**—Frequencies corresponding to vibrations not normally audible to the human ear. All frequencies above 10,000 cycles per second are termed radio frequencies. See Audio Frequencies.
- Reactance.**—Opposition offered to the flow of a varying current by a condenser (capacity reactance), or an inductance (inductive reactance).
- Rectifier.**—An apparatus which converts alternating current (A.C.) into pulses of direct current (D.C.). Tungar, and Kenotron apparatus are employed for rectifying purposes. Certain metallic crystals also have rectifying action when used as detectors in radio reception.
- Regenerative Circuit.**—A radio circuit comprising a valve so connected that after detection, the signal introduced in the plate circuit is led back to or caused to react upon the grid circuit, thereby increasing the original energy of the signal received by the grid and greatly amplifying the response to weak signals. In reception, the

## A.W.A. RADIO GUIDE

- leading back of plate energy to the grid for further strengthening is usually accomplished by means of a coil placed close to the secondary of the receiving tuner. This small coil is called the reaction coil.
- Resistance.**—Opposition to the flow of an electric current through a conducting medium. All metals have more or less electrical resistance. Copper is used universally for both electrical and radio work on account of minimum resistance, comparative low cost and ready availability. The unit of resistance is the ohm.
- Resonance.**—A very important function of radio circuits. The theory of electrical resonance is similar to that of acoustics, readily demonstrated by the tuning forks, when one tuning fork will not respond to another unless it is of the same key or pitch.
- Rheostat.**—A variable resistance employed to control or regulate current flow.
- Selectivity.**—In radio work, the power of being able to select any particular wave length to the exclusion of others.
- Sharp Tuning.**—Where a very slight change of a tuner or tuning system will produce a marked effect in the strength of signals.
- Static.**—See Atmospherics.
- Transformer.**—A device used in electrical and radio work for the transference of energy. Thus we have Power Transformers, Amplifying Transformers, Telephone Transformers, Oscillation Transformers.
- Tuning.**—The act of altering capacity or inductive values in a radio circuit so as to bring the circuit into resonance. In radio receiving, the greatest signal strength is obtained when the product of the inductance and capacity value of the receiver matches that of the transmitter.
- Undamped.**—A train of high frequency oscillations of constant amplitude such as continuous waves or C.W.
- Valve.**—In radio work, applies to a glass tube exhausted of air and containing essentially a filament, a plate positively charged, to which electrons are attracted, and a grid, inserted between the filament and the plate, for controlling the amount of electronic flow. This action of the valve plays three leading functions in radio work, i.e., detection, amplification and generation of high frequency electro-magnetic waves.
- Velocity of Waves.**—Wireless waves travel through space at the speed of 186,000 miles per second, or 300,000 kilometres per second.
- Volt (Abbreviated V).**—The unit of electric pressure.
- Voltmeter.**—An instrument for measuring the voltage across an electric circuit.
- Watt (Abbreviated W).**—The unit of electric power. To find power in watts multiply voltage by amperage. 746 Watts equal one horsepower. 1000 watts equal one kilowatt (K.W.).
- Wave Length.**—Radio waves in their passage through the ether, travel in undulating wave form, similar to water waves. When the wind is blowing hard and steady the distance between each wave crest is comparatively long, while if the wind is blowing more mildly and in short spurts, the distance between wave crests is shorter and we have short waves. In radio substitute the wind for the transmitter and you have a similar action.

# A.W.A. RADIO GUIDE

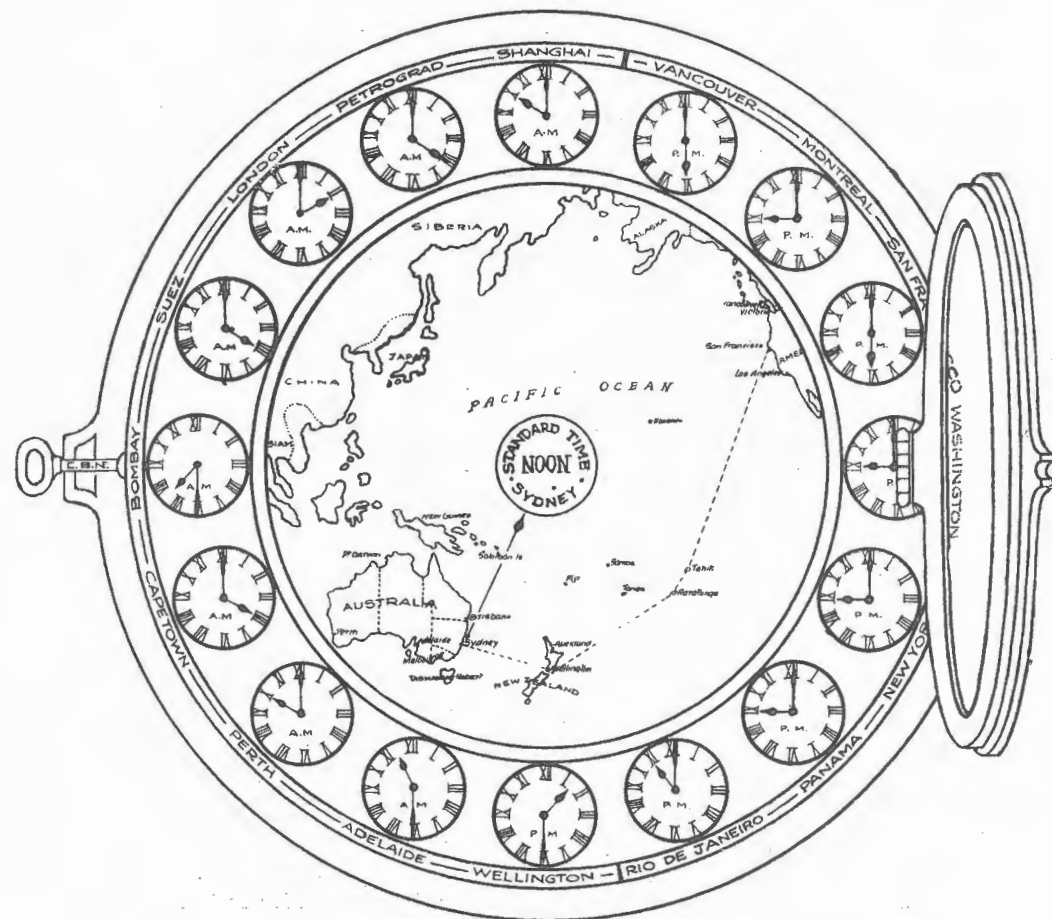

**WORLD'S STANDARD TIME CHART.**

NOTE.—North and South America one day behind.

# Series and Parallel Battery Diagrams.

## How to Connect a Number of Dry Cells Together.

Where one dry cell will not furnish sufficient current a number may be connected together to secure the desired amperage and voltage. This may be done in two ways:

- 1—Series connected.
- 2—Parallel connected.

**Series Connected: Fig. 1.**

In connecting dry cells in series, the positive terminal of one cell is connected with the negative terminal of the adjacent cell. This method furnishes a current of voltage equal to the voltage of one cell multiplied by the number of cells. For instance, as each dry cell furnishes approximately 1.5 volts, four cells connected in series would furnish  $4 \times 1.5$  or 6 volts. The amperage remains that of one cell.

**Parallel Connected: Fig. 2.**

In connecting dry cells in parallel, two or more rows of cells are connected together. Each of these rows is connected in series, as in 1. The positive terminals of the cells at one end of the rows are all connected together, and the negative terminals of the cells at the other end of the rows are connected together. This method of connecting is satisfactory where high voltage is needed with a corresponding light drain upon the individual cells. This method furnishes a current of voltage equal to the voltage produced by the number of cells in any row.

If, for instance, there are two rows of 3 cells, which are connected in series, the voltage of the 6 cells in series multiple will be that of  $3 \times 1.5$ , or about 4.5 volts and the amperage double that of one cell.

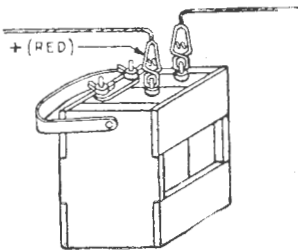
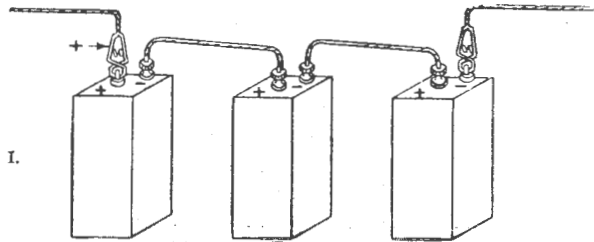

Fig. I.



"A" Battery using one 4-volt Accumulator Battery.

"A" Battery using three 1.5-volt Dry Cells.

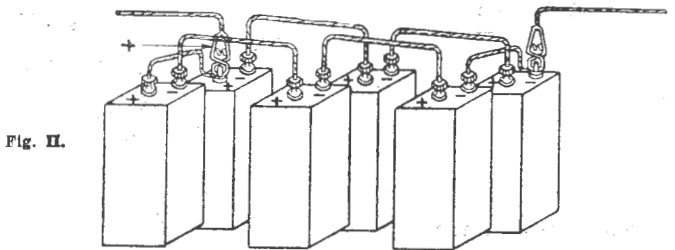
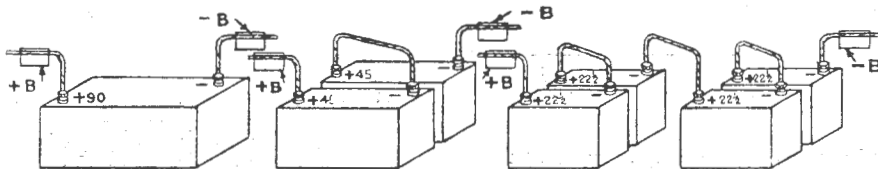

Fig. II.

"A" Battery using six 1.5-volt Dry Cells.



"B" BATTERY.

Using one 90-v. unit. Using two 45-v. units. Using four 22½-v. units.

# A.W.A. RADIO GUIDE

## SOME USEFUL FORMULAE.

### Capacity.

#### CONVERSION TABLES.

The Farad	= 1,000,000 Mfds. 9 x 10 <sup>11</sup> Cms.
The Microfarad	= 0.000001 Farad. = 900,000 Cms. = 900 Jars.
The Jar	= 1000 Cms.

Formula for finding the capacity of a Condenser:—

$$C = \frac{AKN}{4\pi \times d \times 9 \times 10^5} \text{ (Mfds.)}, C = \frac{AKN}{4\pi \times d} \text{ (Cms.)}$$

where A = Area of one plate in square Cms.

- K = Dielectric constant
- N = Number of dielectrics
- D = Distance between plates in Cms.

If inches are used instead of Cms, these formulae will become:—

$$C = \frac{AKN}{d \times 45 \times 10^5} \text{ (Mfds.) and}$$

$$C = \frac{AKN}{5d} \text{ (Cms.)}$$

where A = Area of one plate in sq. ins.

- K = Dielectric constant
- N = Number of dielectrics
- D = Distance between plates in ins.

Dielectric Constants (K)	
Air . . . . .	1
Ebonite . . . . .	2.1 — 2.76
Glass . . . . .	5 — 10
Shellac . . . . .	2.75 — 3.73
Mica . . . . .	4 — 8
India Rubber . . . . .	2 — 3
Porcelain . . . . .	4.4 — 6.8
Paraffin . . . . .	1.7 — 2.3
Bakelite . . . . .	5 — 7
Paraffined Paper . . . . .	3.65

### Capacities in Series and Parallel.

Capacity in Parallel—

$$C = C_1 + C_2 + C_3 \dots \dots \dots + C_x$$

Capacity in Series—

$$C = \frac{1}{\frac{1}{C_1} + \frac{1}{C_2} + \frac{1}{C_3} + \frac{1}{C_x}}$$

Where C = Total capacity of bank  
C<sub>1</sub> C<sub>2</sub> C<sub>3</sub> . . C<sub>x</sub> = Individual capacity of each condenser.

### Wavelength and Frequency.

Relationship existing between the wavelength and frequency—

$$\lambda = \frac{V}{F} \text{ or } \frac{3 \times 10^8}{F}$$

- where V = Velocity of light
- F = Frequency
- λ = Wavelength in metres

Calculation of wavelength from the inductance and capacity—

$$\lambda = 1885 \sqrt{LC}$$

where λ = Wavelength in metres  
L = Inductance in MHS.  
C = Capacity in Mfds.

$$\lambda = 59.6 \sqrt{LC}$$

- where L = Inductance in Cms.
- C = Capacity in Mfds.

### Radiation Resistance.

$$R = 1590 \times \frac{h^2}{\lambda^2}$$

- where R = Radiation resistance in ohms.
- N = Effective height in metres
- λ = Wavelength in metres

Note.—For a fair length of horizontal span the height of an aerial may be considered as the distance from the horizontal span to the earth. For a vertical aerial the effective height is 0.63 of the actual height.

### Reaction in Ohms. of a Condenser.

$$R = \frac{1}{2 \pi N C}$$

- where R = Reaction in ohms.
- N = Frequency of charging source.
- C = Capacity of condenser in farads.

### Reaction in Ohms. of an Inductance.

$$R = 2 \pi N L$$

- where R = Reaction in ohms.
- N = Frequency.
- L = Inductance in henries.





















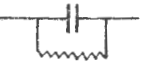



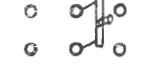



### Formula for finding the Correct Value of a Filament Rheostat.

$$R = \frac{E - e}{i N}$$

- where R = The resistance in ohms.
- E = Accumulator voltage.
- e = Operating voltage of the valve.
- i = Operating current of the valve.
- N = Number of valves operated from the rheostat.



# WIRELESS SYMBOLS

	<p><i>Aerial</i></p>		<p><i>Fixed Inductance or R.F. Choke</i></p>
	<p><i>Earth</i></p>		<p><i>Variable Inductance</i></p>
	<p><i>Frame or Loop Aerial</i></p>		<p><i>Coupled Inductances</i></p>
	<p><i>Fixed Condenser</i></p>		<p><i>Speech or Filter Choke</i></p>
	<p><i>Variable Condenser</i></p>		<p><i>Audio Frequency Transformer</i></p>
	<p><i>Grid Condenser &amp; Leak</i></p>		<p><i>Variometer</i></p>
	<p><i>Tapping (Inductance) Switch</i></p>		<p><i>Fixed Resistance</i></p>
	<p><i>D.P., D.T. Switch</i></p>		<p><i>Variable Resistances or Filament Rheostats</i></p>
	<p><i>D.P., S.T. Switch</i></p>		<p><i>Voltmeter</i></p>
	<p><i>Two-way Switch</i></p>		<p><i>Ammeter</i></p>
<p style="text-align: center;">+ -</p>	<p><i>Positive } Signs Negative }</i></p>		<p><i>Two-electrode Valve</i></p>
	<p><i>Batteries or Accumulators</i></p>		<p><i>Three-electrode Valves</i></p>
	<p><i>Crossed Wires</i></p>		<p><i>Telephones</i></p>
	<p><i>Joined Wires</i></p>		<p><i>Loud Speaker</i></p>
	<p><i>Crystal Detector</i></p>		<p><i>Microphone</i></p>



**THE CONDENSER.**

**Series and Parallel Connections.**

There are two methods of connecting up condensers in an oscillatory circuit. They may be joined up in parallel, as shown in fig. 1, or in series, as in fig. 2.

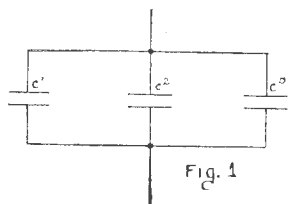

Fig. 1

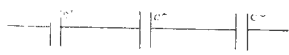

Fig. 2

**Parallel Connections (fig. 1).**

When two or more condensers are connected up as in fig. 1, they are said to be in parallel, and the total capacity of the bank is equal to the sum of the individual capacities.

$$C_T = C_1 + C_2 + C_3$$

When  $C_T$  is the total capacity and  $C_1, C_2$  and  $C_3$  are the capacities of the three condensers.

If  $C_1 = .001$  mfd.,  $C_2 = .00035$  mfd., and  $C_3 = .0005$  mfd., we have  $C_T = .001 + .00035 + .0005 = .00185$  mfd. total.

**Series Connections (fig. 2).**

When two or more condensers are connected up as shown in fig. 2, they are said to be in series, and the total capacity is always smaller than the capacity of the smallest condenser.

$$\frac{1}{C_T} = \frac{1}{C_1} + \frac{1}{C_2} + \frac{1}{C_3} \text{ or } C_T = \frac{1}{\frac{1}{C_1} + \frac{1}{C_2} + \frac{1}{C_3}}$$

In the case of our first example we have:—

$$C_T = \frac{1}{\frac{1}{.001} + \frac{1}{.00035} + \frac{1}{.0005}} = .00017 \text{ mfd.}$$

If two condensers are joined in series, their total capacity will be:—

$$C_T = \frac{C_1 \times C_2}{C_1 + C_2}$$

Let us suppose that  $C_1 = .001$  mfd. and  $C_2 = .0005$  mfd.,

$$\begin{aligned} \text{Then } C_T &= \frac{.001 \times .0005}{.001 + .0005} = \frac{.0000005}{.0015} \\ &= .000333. \end{aligned}$$

Two condensers are often placed in series when they have to withstand a higher voltage than the safe voltage stipulated by the makers. As an example, supposing we require a condenser of .0005 mfd. capacity which will withstand a pressure of 2500 volts, and we already possess two condensers of .001 mfd. capacity, each capable of withstanding 1500 volts in safety. As these two condensers are of equal capacity, they will, if placed in series, withstand  $1500 \times 2 = 3000$  volts, and their joint capacity will be equal to  $\frac{.001}{2} = .0005$  mfd.

Thus, two .001 condensers capable of withstanding 1500 volts each, when placed in series, will have a joint capacity of .0005 mfd., and will be able to withstand a pressure of 3000 volts in safety.

**INDUCTANCE CALCULATION OF SINGLE LAYER COILS.**

These tables and formulæ are of great interest to those amateurs who wind their own coils in receivers such as the neutrodyne, or Browning-Drake, or any other circuit employing single layer inductance coils in the Radio-frequency circuit. The inductance in cms. of a single layer coil "L" may be calculated from the following formula:—

$$L = \frac{(2\pi \times R \times N)^2}{B} \times K$$

Where L = Inductance in cms.

$$2\pi = 6.28$$

R = Radius of coil in cms., as measured from the centre of the former to the centre of the wire (see fig. 1)

N = Number of turns on the former  
B = Length of the winding in cms., and

K = a factor depending on the ratio  $\frac{2R}{B}$ .

The values for this factor are given in the accompanying table.

Let us take the following example:—

We have a coil having a mean radius R of 5 cms. wound with 50 turns of wire, the length of the winding being 7 cms. (There are 2.54 cms. to an inch.)

The inductance will be equal to

$$L = \frac{(6.28 \times 5 \times 50)^2}{7} \times K$$

Now, in order to find the value of K we must divide 2R by B or  $\frac{10}{7} = 1.4$ .

## A.W.A. RADIO GUIDE

Referring to our table we find that the value of K corresponding to 1.4 = 0.6115, so the formula becomes

$$\frac{(6.28 \times 5 \times 50)^2}{7} \times .6115 = 215,326 \text{ cms.}$$

In order to convert cms. to mhs. it is necessary to divide by a thousand or

$$\frac{215,326}{1,000} = 215.3 \text{ mhs.}$$

The reader will probably want to know whether this value (215.3 mhs.), if used with, say, a .001 mfd. variable condenser, will reach up to 550 metres, the upper limit of the broadcast wave-band.

By applying the formula—

$$\lambda = 1885\sqrt{LC}$$

Where  $\lambda$  = wave length in metres,  
 L = inductance in microhenries,  
 C = capacity in microfarads.

We have

$$\lambda = 1885\sqrt{215.3 \times .001} \text{ or } 1885\sqrt{.2153} = \text{approximately } 870 \text{ metres.}$$

If, however, the value of the condenser is reduced to .0005 mfd., this value is reduced to

$$\lambda = 1885\sqrt{215.3 \times .0005} \text{ or } 1885\sqrt{.1076}, \text{ approximately } 610 \text{ metres.}$$

In the event of the answer being below 550 m., it will be necessary to either increase the capacity of the variable condenser or the number of turns of the coil.

### VALUES OF "K" FOR THE RADIO 2R

2R	K	2R	B
0.00	1.0000	1.80	0.5511
0.05	0.9791	1.90	0.5379
0.10	0.9588	2.00	0.5255
0.15	0.9391	2.20	0.5025
0.20	0.9201	2.40	0.4816
0.25	0.9016	2.60	0.4626
0.30	0.8838	2.80	0.4452
0.35	0.8665	3.00	0.4292
0.40	0.8499	3.20	0.4145
0.45	0.8337	3.40	0.4008
0.50	0.8181	3.60	0.3882
0.55	0.8031	3.80	0.3764
0.60	0.7885	4.00	0.3654
0.65	0.7745	4.20	0.3551
0.70	0.7609	4.40	0.3455
0.75	0.7478	4.60	0.3364
0.80	0.7351	4.80	0.3279
0.85	0.7228	5.00	0.3198
0.90	0.7110	5.50	0.3015
0.95	0.6995	6.00	0.2854
1.00	0.6884	6.50	0.2711
1.10	0.6673	7.00	0.2584
1.20	0.6475	7.50	0.2469
1.30	0.6290	8.00	0.2366
1.40	0.6115	8.50	0.2272
1.50	0.5950	9.00	0.2185
1.60	0.5795	9.50	0.2106
1.70	0.5649	10.00	0.2033

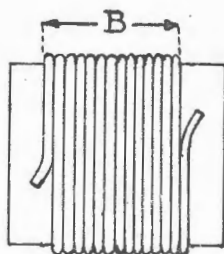
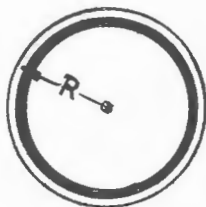

Inductance Calculation from the Formula

$$L = \frac{(2\pi \times R \times N)^2}{B} \times K$$

# A.W.A. RADIO GUIDE

## INTERNATIONAL RADIOTELEGRAPHIC CONVENTION. LIST OF ABBREVIATIONS USED IN RADIO COMMUNICATION.

Abbreviation.	QUESTION.	ANSWER OR NOTICE.
PRB	Do you wish to communicate by means of the International Signal Code?	I wish to communicate by means of the International Signal Code.
QRA	What ship or coast station is that? .....	This is.....
QRB	What is your distance?.....	My distance is.....
QRC	What is your true bearing?.....	My true bearing is.....degrees.
QRD	Where are you bound for?.....	I am bound for.....
QRF	Where are you bound from?.....	I am bound from.....
QRG	What line do you belong to?.....	I belong to the.....Line.
QRH	What is your wave length in metres?.....	My wave length is.....metres.
QRJ	How many words have you to send?.....	I have.....words to send.
QRK	How do you receive me?.....	I am receiving well.
QRL	Are you receiving badly? Shall I send 20? .....	I am receiving badly. Please send 20 for adjustment.
QRM	Are you being interfered with?.....	I am being interfered with.
QRN	Are the atmospherics strong?.....	Atmospherics are very strong.
QRO	Shall I increase power?.....	Increase power.
QRP	Shall I decrease power?.....	Decrease power.
QRQ	Shall I send faster?.....	Send faster.
QRS	Shall I send slower?.....	Send slower.
QRT	Shall I stop sending?.....	Stop sending.
QRU	Have you anything for me?.....	I have nothing for you.
QRV	Are you ready?.....	I am ready. All right now.
QRW	Are you busy?.....	I am busy (or: I am busy with.....). Please do not interfere.
QRX	Shall I stand by?.....	Stand by. I will call you when required.
QRY	When will be my turn?.....	Your turn will be No.....
QRZ	Are my signals weak?.....	Your signals are weak.
QSA	Are my signals strong?.....	Your signals are strong.
QSB	{ Is my tone bad?.....	The tone is bad.
	{ Is my spark bad?.....	The spark is bad.
QSC	Is my spacing bad?.....	Your spacing is bad.
QSD	What is your time?.....	My time is.....
QSF	Is transmission to be in alternate order or in series?	Transmission will be in alternate order.
QSG	.....	Transmission will be in series of 5 messages.
QSH	.....	Transmission will be in series of 10 messages.
QSJ	What rate shall I collect for.....?	Collect.....
QSK	Is the last radiogram cancelled?.....	The last radiogram is cancelled.
QSL	Did you get my receipt?.....	Please acknowledge.
QSM	What is your true course?.....	My true course is.....degrees.
QSN	Are you in communication with land?.....	I am not in communication with land.
QSO	Are you in communication with any ship or station (or: with.....)?	I am in communication with..... (through.....).
QSP	Shall I inform.....that you are calling him?	Inform.....that I am calling him.
QSQ	Is.....calling me?.....	You are being called by.....
QSR	Will you forward the radiogram?.....	I will forward the radiogram.
QST	Have you received the general call?.....	General call to all stations.
QSU	Please call me when you have finished (or: at.....o'clock)?	Will call when I have finished.
*QSV	Is public correspondence being handled? .....	Public correspondence is being handled. Please do not interfere.
QSW	Shall I increase my spark frequency?.....	Increase your spark frequency.
QSX	Shall I decrease my spark frequency?.....	Decrease your spark frequency.
QSY	Shall I send on a wave length of..... metres?	Let us change to the wave length of..... metres.
QSZ	.....	Send each word twice. I have difficulty in receiving you.
QTA	.....	Repeat the last radiogram.
QTE	What is my true bearing?.....	Your true bearing is....degrees from...
QTF	What is my position?.....	Your position is....latitude...longitude.

\* Public correspondence is any radio work, official or private, handled on commercial wave lengths. When an abbreviation is followed by a mark of interrogation, it refers to the question indicated for that abbreviation.

## A.W.A. RADIO GUIDE

### FREQUENCY AND WAVE LENGTH TABLES.

W.L.—Wave lengths in Metres. F.—Number of Oscillations per Second. O. or  $\sqrt{\text{L.C.}}$  is called Oscillation Constant. C.—Capacity in Microfarads. L.—Inductance in Centimetres. 1,000 Centimetres = 1 Microhenry.

W.L.	F.	O. or $\sqrt{\text{L.C.}}$	L.C.
50	6,000,000	.839	.7039
100	3,000,000	1.68	2.82
150	2,000,000	2.52	6.35
200	1,500,000	3.36	11.29
250	1,200,000	4.19	17.55
300	1,000,000	5.05	25.30
350	857,100	5.87	34.46
400	750,000	6.71	45.03
450	666,700	7.55	57.00
500	600,000	8.39	70.39
550	545,400	9.23	85.19
600	500,000	10.07	101.41
700	428,600	11.74	137.83
800	375,000	13.42	180.10
900	333,300	15.10	228.01
1,000	300,000	16.78	281.57
1,100	272,730	18.45	340.40
1,200	250,000	20.13	405.20
1,300	230,760	21.81	475.70
1,400	214,380	23.49	551.80
1,500	200,000	25.17	633.50
1,600	187,500	26.84	720.40
1,700	176,460	28.52	813.40
1,800	166,670	30.20	912.00
1,900	157,890	31.88	1,016.40
2,000	150,000	33.55	1,125.60
2,100	142,850	35.23	1,241.20
2,200	136,360	36.91	1,362.40
2,300	130,430	38.59	1,489.30
2,400	125,000	40.27	1,621.80
2,500	120,000	41.95	1,759.70
2,600	115,380	43.62	1,902.60
2,700	111,110	45.30	2,052.00
2,800	107,140	46.89	2,207.00
2,900	103,450	48.66	2,366.30
3,000	100,000	50.33	2,533.20
4,000	75,000	67.11	4,504.00
5,000	60,000	83.89	7,038.00
6,000	50,000	100.7	10,130.00
7,000	41,800	117.3	13,630.00
8,000	37,500	134.1	18,000.00
9,000	33,300	151.0	22,820.00
10,000	30,000	167.9	28,150.00
11,000	27,300	184.8	34,150.00
12,000	25,000	201.5	40,600.00
13,000	23,100	218.3	47,600.00
14,000	21,400	235.0	55,200.00
15,000	20,000	252.0	63,500.00
16,000	18,750	269.0	72,300.00

# A.W.A. RADIO GUIDE

## USEFUL DATA.

### Enamelled Wire Table.

No. of Wire B. & S. Gauge	Turns per Linear Inch	Turns per Square Inch	Ohms per Cubic Inch of Winding	No. of Wire B. & S. Gauge	Turns per Linear Inch	Turns per Square Inch	Ohms per Cubic Inch of Winding
20	30	885	.748	32	116	21,000	7,547.00
22	37	1,400	1.88	34	145	13,430	2,968.00
24	46	2,160	4.61	36	178	31,820	1,098.00
26	58	3,460	11.80	38	232	54,080	456.00
28	73	5,400	29.20	40	294	86,500	183.00
30	91	8,260	70.90				

### Table of Sparking Distances.

In Air for Various Voltages Between Needle Points.

Volts	Distance		Volts	Distance	
	Inches	Centimeters		Inches	Centimeters
5,000	.225	.57	60,000	4.65	11.8
10,000	.470	1.19	70,000	5.85	14.9
15,000	.725	1.84	80,000	7.10	18.0
20,000	1.000	2.54	90,000	8.35	21.2
25,000	1.300	3.30	100,000	9.60	24.4
30,000	1.625	4.10	110,000	10.75	27.3
35,000	2.000	5.10	120,000	11.85	30.1
40,000	2.450	6.20	130,000	12.95	32.9
45,000	2.95	7.50	140,000	13.95	35.4
50,000	3.55	9.00	150,000	15.00	38.1

### Feet per Pound of Insulated Magnet Wire.

No. of B. & S. Gauge	Single Cotton 4-Mils	Double Cotton 8-Mils	Single Silk 1½-Mils	Double Silk 4-Mils	Enamel
20	311	298	319	312	320
21	389	370	403	389	404
22	488	461	503	493	509
23	612	584	636	631	642
24	762	745	800	779	810
25	957	903	1,005	966	1,019
26	1,192	1,118	1,265	1,202	1,286
27	1,488	1,422	1,590	1,543	1,620
28	1,852	1,759	1,972	1,917	2,042
29	2,375	2,207	2,570	2,485	2,570
30	2,860	2,534	3,145	2,909	3,240
31	3,800	2,768	3,943	3,683	4,082
32	4,375	3,737	4,950	4,654	5,132
33	5,390	4,697	6,180	5,689	6,445
34	6,500	6,168	7,740	7,111	8,093
35	8,050	6,737	9,600	8,534	10,197
36	9,820	7,877	12,000	10,039	12,813
37	11,860	9,309	15,000	10,666	16,110
38	14,300	10,636	18,660	14,222	20,274
39	17,130	11,907	23,150	16,516	25,519
40	21,590	14,222	28,700	21,333	32,107

## EMPIRE BEAM WIRELESS.

### ENGLAND

Grimsby (Australian and Indian Transmitters).

Bodmin (Canadian and South African Transmitters)

Skegness (Receiving Stations for Australia and India).

Bridgewater (Receiving Stations for Canada and South Africa).

### AUSTRALIA

Ballan, Victoria (Transmitting Stations for England & Canada)

Rockbank, Victoria (Receiving Stations for England & Canada)

### CANADA

Drummondville (Transmitting Station).

Yamachiche (Receiving Station).

### SOUTH AFRICA

Klipheuvall, Cape Town (Transmitting Station).

Milnerton, (Receiving Station)

### INDIA

Kirkee, Bombay (Transmitting Station)

Dhond (Receiving Station).

---

## ENGLAND AND NORTH AND SOUTH AMERICAN BEAM STATIONS

Dorchester, England (Transmitting Stations for New York and South America).

Somerton, England (Receiving Stations for New York and South America).

---

## MARCONI SHORT WAVE STATIONS BEING ERECTED FOR THE PORTUGUESE GOVERNMENT

Lisbon,

Cape Verde Islands.

Loanda,

Azores.

Mozambique.



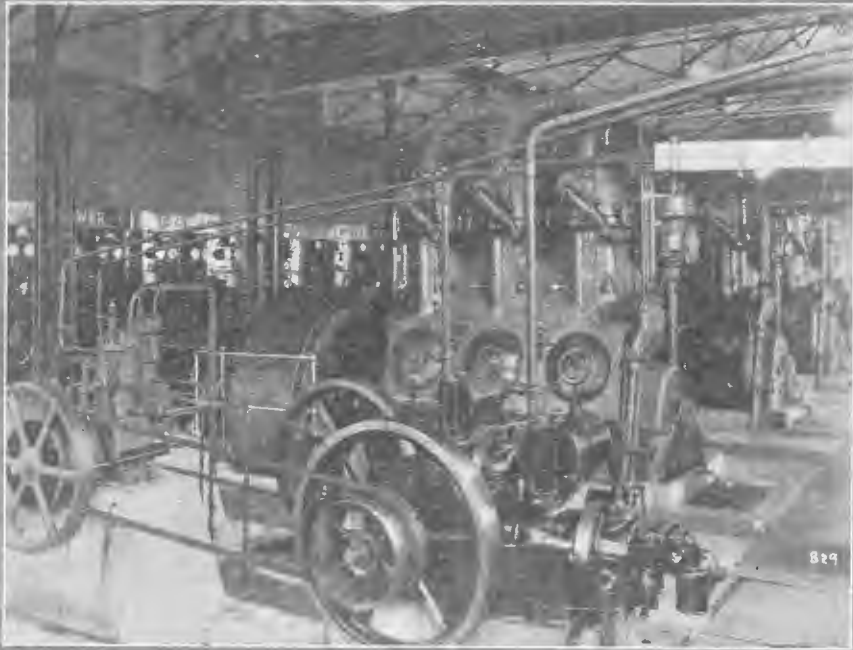
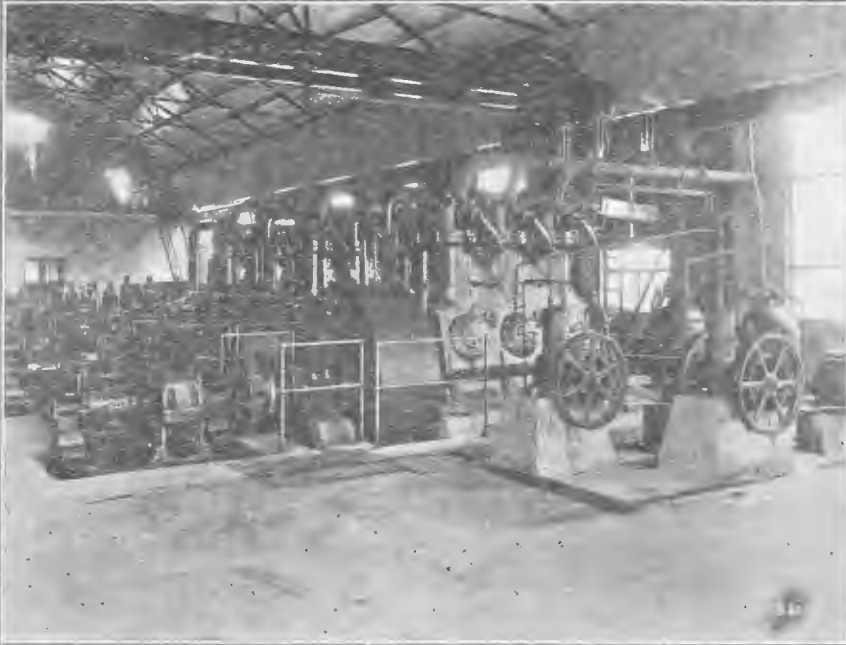

**AUSTRALIAN BEAM STATIONS.**

1. Plan of the Power Room, Ballan, showing the three Prime Movers, consisting of 150 b.h.p. internal combustion engines, direct coupled to 90 k.w. 440 volt generator.
2. View of one of the Prime Movers.

# A.W.A. RADIO GUIDE

## List of Coast Stations.

OWNED AND CONTROLLED BY AMALGAMATED WIRELESS (A/SIA.), LTD.

### AUSTRALIA.

Adelaide Radio . . . . .	VIA
Brisbane Radio . . . . .	VIB
Broome Radio . . . . .	VIO
Cooktown Radio . . . . .	VIC
Darwin Radio . . . . .	VID
Esperance Radio . . . . .	VIE
Flinders Island Radio . . . . .	VIL
Geraldton Radio . . . . .	VIN
Hobart Radio . . . . .	VIH
King Island Radio . . . . .	VZE
Melbourne Radio . . . . .	VIM
Perth Radio . . . . .	VIP
Rockhampton Radio . . . . .	VIR
Sydney Radio . . . . .	VIS
Thursday Island Radio . . . . .	VII
Townsville Radio . . . . .	VIT
Willis Islets Radio . . . . .	CGI
Wyndham Radio . . . . .	VIW

### MANDATED TERRITORY OF NEW GUINEA.

Aitape Radio . . . . .	VZX
Bulolo Radio . . . . .	GF
Kavieng Radio . . . . .	VZR
Kieta Radio . . . . .	VIU
Madang Radio . . . . .	VIV
Manus Radio . . . . .	VZO
Morobe Radio . . . . .	VZK
Rabaul Radio . . . . .	VJZ
Salamoa . . . . .	—

### PAPUA.

Pt. Moresby Radio . . . . .	VIG
Samarai Radio . . . . .	VIJ

### CONTROLLED BY OTHER ADMINISTRATIONS.

#### AUSTRALIAN NAVAL BOARD.

District Naval Office, Hobart . . . . .	VZDM
Naval Staff Office, Adelaide . . . . .	VZDG
"    "    "    Brisbane . . . . .	VZDF
"    "    "    Perth . . . . .	VZDJ
"    "    "    Port Melbourne..	VZDB
"    "    "    Sydney . . . . .	VZDC

#### CAROLINE ISLANDS.

Angaur . . . . .	JRY
Palao . . . . .	JRW
Ponape . . . . .	JRU
Truk . . . . .	JRT
Yap . . . . .	JRZ

#### COOK ISLANDS.

Aitutaki . . . . .	VLF
Mangaia . . . . .	VLG
Niue . . . . .	VLK
Rarotonga . . . . .	VMR

#### FIJI ISLANDS.

Labasa . . . . .	VPE
Savu Savu . . . . .	VQL
Suva . . . . .	VPD
Taveuni . . . . .	VPF

#### GILBERT & ELLICE ISLANDS.

Ocean Island . . . . .	VQK
Tarawa Island . . . . .	VSZ

#### MARSHALL ISLANDS.

Jalouit . . . . .	JRX
Nauru Radio . . . . .	VKT

#### NEW CALEDONIA.

Noumea Semaphore . . . . .	HZG
----------------------------	-----

#### NEW HEBRIDES.

Port Vila . . . . .	HWV
---------------------	-----

#### NEW ZEALAND.

Auckland Radio . . . . .	VLD
Awanui Radio . . . . .	VLA
Awarua Radio . . . . .	VLB
Chatham Islands . . . . .	VLC
Hector Astronomical Observatory, Wellington . . . . .	VLY
Kawau Island . . . . .	VLO
Wellington Radio . . . . .	VLW

#### PORTUGUESE TIMOR.

Dili . . . . .	CRE
----------------	-----

#### SAMOA ISLANDS.

Apia Radio . . . . .	VMG
Ofu Samoa . . . . .	NGX
Tau Samoa . . . . .	NCM
Tutiula . . . . .	NPU

#### SOLOMON ISLANDS.

Tulagi . . . . .	VQJ
Roviana . . . . .	
Vanikoro . . . . .	

#### TASMANIA, AUST.

Maria Island . . . . .	7NP
------------------------	-----

#### TONGA.

Nukualofa Radio . . . . .	VSB
Vavau . . . . .	GON

## A.W.A. RADIO GUIDE

### Australian Short Wave Stations.

Sydney Radio . . . . . VIS 22, 26, 32, 42 and 51.5 metres.	Rabaul Radio . . . . . VJZ 22, 26, 32 and 42 metres.
Melbourne Radio . . . . . VIM 22, 26 and 42 metres.	S.S. Jervis Bay . . . . . VZDK 34 metres.
Perth Radio . . . . . VIP 22, 26, 32, 42 and 51.5 metres.	S.S. Makura . . . . . GDZV 47 metres.
Townsville Radio . . . . . VIT 26 and 42 metres.	

### H.M. Australian Ships.

#### CRUISERS.

Sydney . . . . .	GACL
Adelaide . . . . .	GABC
Melbourne . . . . .	GABR
Brisbane . . . . .	GABH

#### FLOTILLA LEADER.

Swordsman . . . . .	GACK
---------------------	------

#### DESTROYERS.

Success . . . . .	GACH
Tasmania . . . . .	GACM
Swan . . . . .	GACJ
Yarra . . . . .	GACS
Tattoo . . . . .	GACN
Stalwart . . . . .	GABW
Anzac . . . . .	GABD
Torrens . . . . .	GACP
Warrego . . . . .	GACR
Parramatta . . . . .	GABS
Huon . . . . .	GABN

#### DESTROYER DEPOT.

Platypus . . . . .	GABT
--------------------	------

#### SLOOP.

Marguerite . . . . .	GABQ
Mallow . . . . .	GABP

#### SURVEYING SHIPS.

Moresby . . . . .	GMOJ
Geranium . . . . .	GABM

#### COLLIER.

Biloela . . . . .	GGR
-------------------	-----

#### OILER.

Kurumba . . . . .	CGQ
-------------------	-----

### SPECIAL STATIONS.

LICENSED BY COMMONWEALTH GOVT. FOR PRIVATE USE.

Wave Hill, Northern Territory . . . . . VJD	Popo, Papua (Anglo-Persian Oil Co.) . . . . . VJO
Camooweal, Northern Territory . . . . . VJJ	Brunette Downs (A. Cotton) . . . . . VZGO

A.W.A. RADIO GUIDE

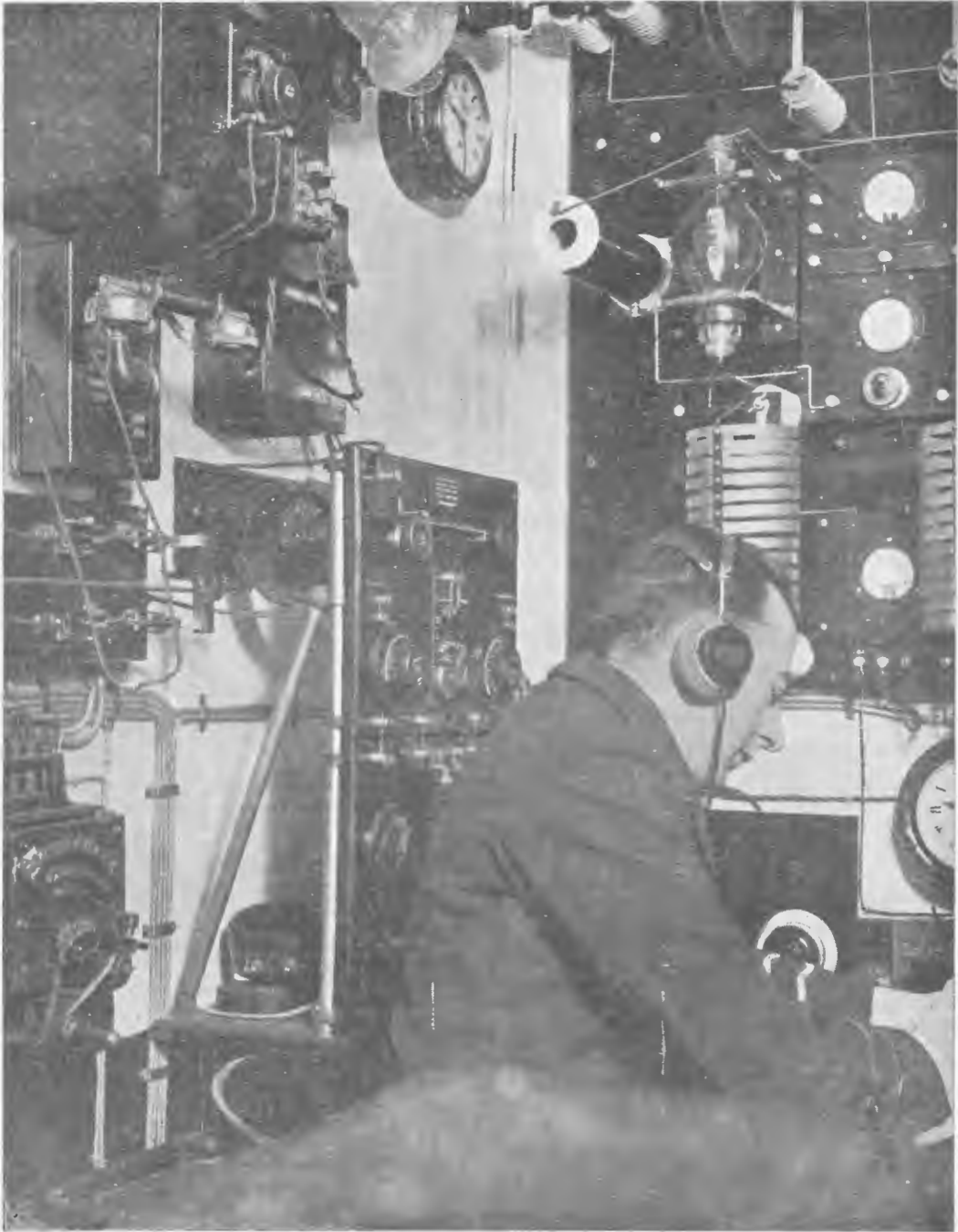

Interior of Wireless Cabin, T.S.S. Jervis Bay,  
showing P.I. Receiver on table and Short Wave Transmitter over operator's head.

A.W.A. RADIO GUIDE

# List of Australian and New Zealand Ship Stations.

Ship.	Call Sign.	Ship.	Call Sign.
Aeon	VKF	Iron Knob	VZDT
Age	VZBK	Iron Master	VZBY
Aldinga	VKD	Iron Monarch	VXI
Allara	VZDP	Iron Prince	VHC
Aorangi	GDVB	Iron Warrior	CGO
Apanui	VMCB	Jervis Bay	VZDK
Arafura	GBFV	Junee	VZF
Arahura	VMA	Kahika	VMBW
Arkaba	VXN	Kaiapoi	VLH
Aroona	VKE	Kaikorai	VLP
Ashridge	VXF	Kaimai	VMCW
Baldina	VHZ	Kaimanawa	GBVT
Bambra	GFTW	Kairanga	VMV
Barunga	VKA	Kaitangata	VLI
Barwon	VXM	Kaitoa	VLQ
Biloela	CGR	Kaitoke	VLT
Bombala	VHF	Kaituna	VLV
Boorara	GBP Y	Kaiwarra	VMES
Bulla	GBJC	Kamo	VHM
Burwah	VKZ	Kangaroo	VJX
Calulu	VZV	Kanna	VHD
Canberra	VHO	Kanowna	VMBJ
Cape Leeuwin	VZDX	Kaponga	VMU
Cape York	CGB	Karetu	VHE
Carina	VZM	Karoola	VMB
Centaur	GMQP	Karori	VMBF
Century	VKK	Kartigi	VMN
Changte	GVFK	Katea	VHN
Chronos	VKJ	Katoomba	VMC
Clansman	VMCJ	Kauri	VLJ
Colac	VXU	Kawatiri	CGW
Coolana	VZBP	Kekerangu	VMBG
Corio	VXT	Kiwitea	VMBN
Corrina	VMBY	Komata	VZBC
Cycle	VZBX	Komura	CGK
Dilga	VXE	Koolinda	VZBT
Dilkerā	VZD	Koolonga	VZBD
Dimboola	VHL	Koonda	VXJ
Dromana	VXP	Kooringa	VXH
Dumosa	VXV	Kooyong	VMD
Dundula	VXW	Koromiko	CGS
Echunga	VJU	Kowarra	VLZ
Ellaroo	VZDN	Kurow	CGQ
Era	VZBM	Kurumba	CGP
Esperance Bay	VZDL	Kybra	VHX
Ferndale	CGA	Kyogle	VHS
Fiona	VHQ	Lady Loch	VZJ
Fordsdale	GCY	Lammeroo	VZBS
Franklin	VHT	Largs Bay	VJH
Gascoyne	GBTL	Loongana	VZDQ
Gorgon	GJBR	Lowana	CGX
Goulburn	VKX	Macedon	VXX
Hauraki	GJFR	Mackarra	VXY
Hebburn	CGD	Macumba	VLE
Hexham	VZBJ	Maheno	VZB
Hinemoa	VMBK	Makambo	VMBZ
Hobson's Bay	VZBW	Mako	GDZV
Iron Baron	VHI	Makura	GLXT
Iron Chief	VZBU	Malabar	VKI
Iron Crown	CGU	Mallina	

## A.W.A. RADIO GUIDE

### List of Australian and New Zealand Ship Stations (continued).

Ship.	Call Sign.	Ship.	Call Sign.
Manaia .....	VLG	Rona .....	VXQ
Manuka .....	VLN	Saros .....	VKH
Maori .....	GDZX	St. Albans .....	MGG
Marama .....	VLR	St. George .....	CGC
Maranoa .....	VHH	St. Olaves .....	VZL
Mararoa .....	VMZ	Suva .....	VJI
Mareeba .....	VZBG	Tahiti .....	MYN
Marella .....	GBKJ	Taiping .....	GVFQ
Marion Sleigh .....	VXB	Tamahine .....	VMBC
Marrowah .....	VZZ	Tanda .....	GKZC
Marsina .....	VKY	Tarcoola .....	VZN
Matangi .....	VMI	Tees .....	VMBO
Mataram .....	VHU	Terawhiti .....	VMH
Maunganui .....	VMM	Time .....	VIK
Melusia .....	CGT	Tofua .....	GFYM
Mernoo .....	CGM	Tutanekai .....	VLX
Merriwa .....	VKB	Ulimaroa .....	VHY
Mildura .....	VXG	Ulooloo .....	VZDR
Milluna .....	VKC	Urilla .....	VZU
Milora .....	VHG	Wahine .....	GFYN
Minderoo .....	GFZP	Waihemo .....	GDBQ
Moeraki .....	VLM	Waihora .....	GFYP
Momba .....	CGH	Waikawa .....	GCNY
Montoro .....	GDJC	Waikouaiti .....	VMS
Moorabool .....	VXR	Wainui .....	VMW
Moreton Bay .....	VZBR	Waitapu .....	GDKM
Morinda .....	VJF	Waipahi .....	VMBD
Mundalla .....	CGL	Waipori .....	VMO
Mungana .....	CGF	Wairuna .....	ENL
Murada .....	VHJ	Waitoahi .....	VMCG
Mangola .....	GVMJ	Waitomo .....	VMJ
Nairana .....	VHP	Waitemata .....	GBNM
Nauru Chief .....	GJLW	Wanaka .....	VMP
Ngaio .....	VLS	Warspray .....	VZBQ
Ngakuta .....	GBDJ	Wear .....	VKG
Ngapuhi .....	VMQ	Werribee .....	VJL
Ngatiawa .....	VMCD	Westralia .....	VJB
Niagara .....	GBE	Whangape .....	VML
Nikau .....	VMBR	William McArthur .....	VZDY
Omana .....	VZBN	Wingatui .....	VLL
Oonah .....	VXA	Wonganella .....	VNW
Period .....	VXC	Woolgar .....	VKM
Poolta .....	VME	Wyola .....	CGV
Rarawa .....	VMT	Yankalilla .....	GHV
Rimu .....	VMCF	Yarra .....	VXS
Riverina .....	VJA	Zealandia .....	VJC

## SHORT WAVE STATIONS

Wave Length. Metres.	Call Signal.	Station.	Wave Length. Metres.	Call Signal.	Station.
13.1	GEC	Oakland, California.	32	VIS	Amalg. Wireless (A/sia), Ltd., Sydney Radio.
13.4	NKS	Bellevue, Anacostia, D.C., U.S.A.	32	VJZ	Amalg. Wireless (A/sia), Ltd., Rabaul Radio.
13.5	POF	Nauen, Germany.	32.79	WCY	Schenectady (N.Y.), Telephony
14.0	FFW	Ste. Assise, France.	32.0	G2YT	Poldhu, England.
14.93	U2XS	Rocky Point, U.S.A.	32.0	FL	Eiffel Tower, Paris.
15.0	U2XAW	Schenectady, N.Y.	32.0	LY	Bordeaux-Lafayette, France
15.5	WDL		32.0	OCNG	Nogent le Rotrou.
16.0	NKF	Bellevue, Anacostia, D.C., U.S.A.	32.0	ANE	Malabar, Java.
17.0	NKF	Nav. Lab., Bellevue, Anacostia, D.C., U.S.A.	32.5	PCLL	Kootwijck, Holland.
18.0	POF	Nauen	32.79	U2XAF	Schenectady, N.Y.
20	JIPP	Tokio (Japan) Telephony.	33.0	VMG	Samoa.
20.0	OCTN	Mourillon, Toulon	33.0	FTJ	"I. Cartier," French ship.
20.0	NAL	Navy Yard, Washington.	33.5	IDO	Italian.
20.0	POX	Nauen, Germany.	34	VZDK	Amalg. Wireless (A/sia), Ltd., S.S. "Jervis Bay."
20.0	U2XAD	Schenectady, N.Y., U.S.A.	34.0	NAJ	Great Lakes, Ill., U.S.A.
20.0	NEPQ	U.S. Ship "Relief."	34.5	OCTN	Mourillon, Toulon.
20.8	NKF	Bellevue, Anacostia, D.C., U.S.A.	34.0	WNP	Holstenborg, Greenland. U.S.A.
21.0	PCTT	Kootwijck, Holland.	35	JIPP	Tokio (Japan) Telephony.
21.0	U2XAD	Schenectady, N.Y., U.S.A.	35.0	U2XI	Schenectady, N.Y.
22	VIM	Amalg. Wireless (A/sia), Ltd., Melbourne Radio.	35.0	WGY	G.E.C., Schenectady, N.Y.
22	VIS	Amalg. Wireless (A/sia), Ltd., Sydney Radio.	35.03	WQO	Rocky Point, U.S.A.
22	VJZ	Amalg. Wireless (A/sia), Ltd., Rabaul Radio.	36.0	LPZ	Buenos Ayres, Argentine.
22.0	WIK	New Brunswick, U.S.A.	36.0	PCUU	Kootwijck, Holland.
23.0	FFW	St. Assise.	37.0	NPU	Tutuila, Samoa.
24.5	ANF		38.0	U2XI	Telephony, Schenectady, N.Y., U.S.A.
25	PCMM	The Hague (Holland) Telegraphy.	38.5	ANDIR	Bandoeng, Java.
25.0	G2YT	Poldhu, England	39.0	OCMV	Mont Valerien, Paris.
25.0	TCMM	P.-u.T.-Ministry, Holland.	39.6	K4YAE	Rottenburg.
25.0	POY	Nauen, Germany.	40.0	NAJ	Great Lakes, Ill., U.S.A.
25.0	FFW	St. Assise (Experimental)	40.0	NAS	Pensacola, Florida, U.S.A.
25.3	AGA	Nauen, Germany.	40.0	NOSN	Coco-Solo, Panama.
25.3	AGB	Nauen, Germany.	40.0	NPG	San Francisco, Calif.
25.6	NKF	Bellevue, Anacostia, D.C., U.S.A.	40.0	UIXAO	Belfast, Maine, U.S.A.
26	VIM	Amalg. Wireless (A/sia), Ltd., Melbourne Radio.	40.0	U2XAC	Schenectady, N.Y.
26	VIS	Amalg. Wireless (A/sia), Ltd., Sydney Radio.	40.2	AGC	Nauen, Germany.
26	VIT	Amalg. Wireless (A/sia), Ltd., Townsville Radio.	40.5	FFW	St. Assise, France.
26	VJZ	Amalg. Wireless (A/sia), Ltd., Rabaul Radio.	41.3	NKF	Bellevue, Anacostia, D.C., U.S.A.
26.0	POX	Nauen, Germany.	41.88	U2XAF	Schenectady, N.Y., U.S.A.
27.0	PCPP	Kootwijck, Holland.	42	VIM	Amalg. Wireless (A/sia), Ltd., Melbourne Radio.
27.5	PCMM	Kootwijck, Holland.	42	VIS	Amalg. Wireless (A/sia), Ltd., Sydney Radio.
28.0	POW	Nauen, Germany.	42	VIT	Amalg. Wireless (A/sia), Ltd., Townsville Radio.
29.0	OCNG	Nogent le Rotrou.	42	VJZ	Amalg. Wireless (A/sia), Ltd., Rabaul Radio.
30.0	F8GA	Clichy, Paris.	42.0	PCUU	The Hague, Holland.
30.0	U2XI	Schenectady, N.Y.,	42.0	U5XH	New Orleans, U.S.A.
30.6	NAL	Navy Yard, Washington, D.C., U.S.A.	43.0	GCS	Yarmouth, England.
31.0	FTJ	"I. Cartier," French ship.	43.0	NPG	San Francisco, Calif.
31.5	HVA	Hanoi, Indo China.	43.02	WIZ	New Brunswick, U.S.A.
31.5	OCDJ	Issy les Moulins, France.	44.0	WQO	Rocky Point, U.S.A.
			44.0	KZA	Los Angeles, Calif., U.S.A.
			44.0	KZB	Los Angeles, Calif., U.S.A.
			45.0	NPG	San Francisco, Calif., U.S.A.

# A.W.A. RADIO GUIDE

## SHORT WAVE STATIONS (Continued)

Wave Length. Metres.	Call Signal.	Station.	Wave Length. Metres.	Call Signal.	Station.
45.0	OCTN	Mourillon, Toulon, France.	78.0	OCDB	Djibouti, Indo-China.
45.0	YZ	Fort d'Issy, France.	79.0	JIAA	Iwatsuki, Japan.
45.0	ZZ	Fort d'Issy, France.	80.0	NEL	Lakehurst, N.J., U.S.A.
46.0	OCMV	Mont Valerien, Paris.	80.0	U2XAC	Schenectady, N.Y., U.S.A.
46.0	PCLL	Kootwijk, Holland.	80.0	U2XK	Schenectady, N.Y., U.S.A.
47	GDZV	Amalg. Wireless (A/sia), Ltd., S.S. "Makura."	81.0	NPG	San Francisco, Calif.
			81.5	NKF	Bellevue, Anacostia, D.C., U.S.A.
47.0	POZ	Nauen, Germany.		RDW	Moscow, Russia.
48.0	OCNG	Nogent le Rotrou.	83.0	NKF	Bellevue, Anacostia, D.C.,
48.0	OCTU	Tunis le Cashah.	84.0	SFR	Clichy, Paris.
49.0	WHD	Sharon, Penns., U.S.A.	85.0	N.Q.C.	San Diego, Calif, U.S.A.
49.0	NPM	Honolulu, Hawaii.	86.0	U6XO	Kahuku, Hawaii.
50.0	AIN	Casablanca.	90.0	UIXAO	Belfast, Maine, U.S.A.
50.0	NKF	Bellevue, Anacostia, D.C., U.S.A.	90.0	KIO	Kahuku, Hawaii.
50.0	WBZ	Springfield, Mass., U.S.A.	92.0	G2YT	Poldhu, England.
50.0	U2XAD	Schenectady, N.Y., U.S.A.	94.0	G2YT	Poldhu, England.
50.0	SAJ	Karisborg, Sweden.	95.0	KEL	Bolinas, Calif., U.S.A.
51.5	VIS	Amalg. Wireless (A/sia), Ltd., Sydney Radio.	96.0	U8XS	East Pittsburg, Pa., U.S.A.
			99.0	KET	Bolinas, Calif., U.S.A.
51.5	WQN	Rocky Point, U.S.A.	99.0	U6XI	Bolinas, Calif., U.S.A.
53.0	NPU	Tutuila, Samoa.	100.0	NAM	Norfolk, U.S.A.
53.0	ZWT	Bremerhaven.	100.0	POX	Nauen, Germany.
54.0	NBA	Balboa, Panama Canal.	100.0	RDW	Telefony, Moscow, Russia.
54.4	N.K.F.	Bellevue, Anacostia, D.C., U.S.A.	100.0	U2XI	Schenectady, N.Y., U.S.A.
			103.0	WGH	Tuckerton, U.S.A.
54	—	Konigswusterhausen (Ger- many), Telephony.	105.0	WHU	U.S. Ship "Big Bill."
			107.0	U2XI	Schenectady, N.Y., U.S.A.
54.5	WQN	Rocky Point, U.S.A.	109.0	U2XX	Schenectady, N.Y., U.S.A.
56.0	KFKX	Hastings, Nehr., U.S.A.	110.0	KFHV	U.S. ship "Facile."
56.0	ANF	Malabar, Java.	110.0	KFVT	U.S. ship "Eloise."
56.0	UIXAO	Belfast, Maine, U.S.A.	110.0	KFWJ	U.S. ship "Gallavant."
57.0	OCTN	Mourillon, Toulon, France.	112.0	UIXAO	Belfast, Maine, U.S.A.
57.0	WQN	Rocky Point, U.S.A.	115.0	KEWK	U.S. ship "Nirvana."
58.0	OCBV	Beirut.	115.0	FL	Eiffel Tower, Paris.
58.79	KDKA	East Pittsburg, U.S.A.	115.3	KFVB	U.S. ship "Bridget."
59.0	RDC	Wyoming, U.S.A. (Ill.).	119.0	NDF	U.S. ship "West Virginia."
60.0	G2YT	Poldhu, England.	119.0	NEDJ	U.S. ship "California."
60.0	UIXAO	Belfast, Maine, U.S.A.	120.0	UIXAO	Belfast, Maine, U.S.A.
62.7	KOKA	East Pittsburg (U.S.A.), Telephony.	133.0	WDYC	Detroit, Mich.
			137.0	WJF	Rochester, N.Y.
63.0	KDKA	Telephony, Pittsburg, Pa., U.S.A.	137.0	WHC	Allentown, Pa.
			137.0	WBI	Frackville, Pa.
67.0	U8XS	Pittsburg, U.S.A.	137.0	WPH	Hazleton, Pa.
68.0	NPO	Cavite, Philippine Islands.	137.0	WJH	Williamsport, Pa.
68.4	WRB	Miami, Florida, U.S.A.	137.0	WLF	Wilsonville, Pa.
68.4	WRP	Miami, Florida, U.S.A.	137.0	WDS	Pottsville, Pa.
70.0	POX	Nauen, Germany.	140.0	KDC	Casper, Wyoming.
70.0	NERM	U.S. Airship "Los Angles."	140.0	KFWR	S. Benito, Tex.
70.5	NQG	San Diego, Calif.	140.0	KFWS	Brownsville, Tex.
71.3	NKF	Bellevue, Anacostia, D.C., U.S.A.	140.0	WGF	Flint, Mich.
			140.0	WAV	Dearbon, Mich.
71.7	NPL	San Diego, Calif.	140.0	WDY	Iron Mountain, Mich.
72.0	OCNG	Nogent le Rotrou.	142.0	WJBF	Charleroi, Pa.
72.0	OCDB	Djibouti, French Indo-China	143.0	KGA	Oakland, Calif.
74.0	WIR	New Brunswick, U.S.A.	143.0	KTA	San Francisco, Calif.
75.0	SFR	Clichy, Paris.	143.0	WEQ	Baltimore, Maryland.
75.0	FL	Eiffel Tower, Paris.	143.0	WAV	Dearbon, Mich.
75.0	LY	Bordeaux-Lafayette, France		WWEE	Marquette Light Station, Mich.
75.0	WGN	Rocky Point, Long Island, N.Y., U.S.A.	143.0	WWED	Stannard Rock Light Stn.
			143.0	WJH	Washington WJH, D.C.
76.0	NAJ	Great Lakes, Ill., U.S.A.	143.0	WJX	Washington WJX, D.C.
76.0	POX	Nauen, Germany.	145.0	WWEB	Duluth Range Rear Light Station, Minn.
77.5	NFV	Quantico, U.S.A.			



# A.W.A. RADIO GUIDE

## SHORT WAVE STATIONS (Continued).

Wave Length. Metres.	Call Signal.	Station.	Wave Length. Metres.	Call Signal.	Station.
145.0	WJF	Rochester, N.Y.	146.0	WEY	Boston, WEY, Mass.
145.0	WWEC	Superior Entry Light Stn., Wis.	146.0	KZI	Hollywood, Calif.
146.0	KFV	Los Angeles, Calif.	146.0	KJU	Culver City, Calif.
146.0	KFZ	Los Angeles, Calif.	146.0	KVP	Dallas, KVP, Texas.
146.0	KGV	Los Angeles, Calif.	150.0	6XO	Kahuku, Hawaii.
146.0	KYI	Culver City, Calif.	200.0	NITZ	U.S. s.s. "Sturgeon Bay."
146.0	KYJ	Culver City, Calif.		KPN	Isabela di Basila, Philippine Islands.
146.0	KYX	Los Angeles, Calif.	202.3	WBAK	Harrisburg, Pa.
146.0	KYY	Los Angeles, Calif.	202.6	WDX	Wyoming, Pa.
146.0	KYZ	Culver City, Calif.	202.6	WBR	Butler, Pa.

A.W.A. RADIO GUIDE

**AUSTRALIAN BROADCASTING STATIONS.**

**VICTORIA.**

Call Sign.	Address.	Class.	Wave Length.	Watts.
3AR	Associated Radio Co. of Aust., Ltd., Melbourne ..	A	484	1600
3LO	Broadcasting Co. of Aust., Pty., Ltd., Melbourne ..	A	371	5000
3UZ	O. J. Nilsen & Co., Bourke St., Melbourne .. ..	B	319	100
3DB	Druleigh Business & Technical College, Melbourne	B	255	500

**NEW SOUTH WALES.**

2BE	Burgin Electric Co., Ltd., 340 Kent St., Sydney ..	B	316	100
2BL	Broadcasters (Sydney), Ltd., Sydney .. . . . . .	A	353	5000
2FC	Farmer & Co., Ltd., Sydney .. . . . . .	A	442	5000
2GB	Theosophical Broadcasting Station, Ltd., Adyar House, 29 Bligh St., Sydney .. . . . . .	B	316	3000
2HD	H. A. Douglas, cr. Darby & King Sts., Newcastle	B	288	100
2KY	Trades and Labour Council, Sydney .. . . . . .	B	280	1500
2MK	Mockler Bros., Hawick St., Bathurst .. . . . . .	B	275	250
2UE	Electrical Utilities Supply Co., 619 George St., Sydney .. . . . . .	B	293	250
2UW	Otto Sandel, 140 Balfour Rd., Bellevue Hill .. ..	B	267	500
2UX	Otto Sandel, 9 Gurwood St., Wagga .. . . . . .	B	300	500

**QUEENSLAND.**

4GR	Gold Radio Electric Service, Margaret St., Toowoomba .. . . . . .	B	294	100
4QG	Queensland Radio Service, Brisbane .. . . . . .	A	385	5000

**SOUTH AUSTRALIA.**

5CL	Central Broadcasters, Ltd., Adelaide .. . . . . .	A	395	5000
5DN	5DN Pty., Ltd., 2-4 Montpelier St., Parkside .. ..	B	313	500
5KA	Sport Radio Broadcasting Station, 51 Kintore Ave., Prospect .. . . . . .	B	250	1000

**WESTERN AUSTRALIA.**

6WF	Westralian Farmers, Ltd., Perth .. . . . . .	A	1250	5000
-----	--	---	------	------

**TASMANIA.**

7ZL	Tasmanian Broadcasters, Pty., Ltd., Hobart .. ..	A	535	3000
-----	--	---	-----	------

A.W.A. RADIO GUIDE

# American Broadcasting Stations.

List of American Broadcasting Stations, with power units of 1000 watts or over:—

Call Sign.	Location.	(Metres) Wave-length.	(Watts) Power.
KDKA	.. East Pittsburg, Pa. .. .. .	309.1	.. Var.
KFAB	.. Lincoln, Neb. .. .. .	340.7	.. 1000
KFI	.. Los Angeles, Calif. .. .. .	468.5	.. 4000
KFKX	.. Hastings, Nebr. .. .. .	288.3	.. 5000
KFNF	.. Shenandoah, Iowa .. .. .	263	.. 1000
KFOA	.. Seattle, Wash. .. .. .	454.3	.. 1000
KFQB	.. Fort Worth, Texas .. .. .	508.2 & 263	.. 1000
KGO	.. Oakland, Calif. .. .. .	361.2	.. 4000
KGW	.. Portland, Ore. .. .. .	491.5	.. 1000
KJR	.. Seattle, Wash. .. .. .	384.4	.. 1000
KLDS	.. Independence, Mo. .. .. .	440.9	.. 1000
KMMJ	.. Clay Center, Neb. .. .. .	228.9	.. 1000
KMOX	.. Kirkwood (St. Lo.), Mo. .. .. .	280.2	.. 1500
KNX	.. Los Angeles, Calif. .. .. .	336.9	.. 1000
KOA	.. Denver, Colo. .. .. .	322.4	.. 5000
KOB	.. State College, N.M. .. .. .	348.6	.. 1000
KPO	.. San Francisco, Calif. .. .. .	328.3	.. 1000
KPSN	.. Pasadena, Calif. .. .. .	315.6	.. 1000
KSL	.. Salt Lake City, Utah .. .. .	299.8	.. 1000
KTAB	.. Oakland, Calif. .. .. .	240	.. 1000
KTCL	.. Seattle, Wash. .. .. .	305.9	.. 1000
KTW	.. Seattle, Wash. .. .. .	454.3	.. 1000
KYW	.. Chicago, Ill. .. .. .	535.4	.. 3500
NAA	.. Arlington, Va. .. .. .	434.5	.. 1000
WAPI	.. Auburn, Ala. .. .. .	248	.. 1000
WBAL	.. Baltimore, Md. .. .. .	246	.. 5000
WBAP	.. Fort Worth, Texas .. .. .	475.9	.. 1500
WBBM	.. Chicago, Ill. .. .. .	226	.. 1500
WBZ	.. Springfield, Mass. .. .. .	331.1	.. 2000
WCBD	.. Zion, Ill. .. .. .	344.6	.. 5000
WCCD	.. Minneapolis, Minn. .. .. .	416.4	.. 5000
WCX	.. Pontiac, Mich. .. .. .	516.9	.. 5000
WEAF	.. New York, N.Y. .. .. .	491.5	.. 5000
WEBH	.. Chicago, Ill. .. .. .	370.2	.. 2000
WENR	.. Chicago, Ill. .. .. .	266	.. 1000
WEW	.. St. Louis, Mo. .. .. .	248	.. 1000
WGHP	.. Detroit, Mich. .. .. .	270	.. 1500
WGN	.. Chicago, Ill. .. .. .	302.8	.. 1000
WGY	.. Schenectady, N.Y. .. .. .	379.5	.. 5000
WHAZ	.. Troy, N.Y. .. .. .	379.5	.. 1000
WHK	.. Cleveland, Ohio .. .. .	272.6	.. 1000
WHO	.. Des Moines, Iowa .. .. .	526	.. 5000
WHT	.. Deerfield, Ill. .. .. .	238	.. 3500
WIBO	.. Chicago, Ill. .. .. .	226	.. 1000
WIOD	.. Miami Beach, Fla. .. .. .	247.8	.. 1000
WJAX	.. Jacksonville, Fla. .. .. .	336.9	.. 1000
WJAZ	.. Mount Prospect, Ill. .. .. .	322.4	.. 1500
WJR	.. Pontiac, Mich. .. .. .	516.9	.. 5000
WJY	.. New York, N.Y. .. .. .	405.2	.. 1000
WKRC	.. Cincinnati, Ohio .. .. .	325.9 & 422.3	.. 1000
WLIB	.. Elgin, Ill. .. .. .	302.8	.. 4000
WLS	.. Crete, Ill. .. .. .	344.6	.. 5000

# Australian Transmitting Licenses.

## VICTORIA.

- 3AC—City of Prahran Radio Club, 282 Chapel St., Prahran.  
 3AD—Davey, J. A., 28 Cole St., Elsternwick.  
 3AF—Bent, A. F. W., 12 Coronation St., Geelong West.  
 3AH—Faul, A. H., 3 St. Leonard's Av., St. Kilda.  
 3AJ—Salamy, E., Timor St., Warrnambool.  
 3AK—Cansick, N. V. C., 81 Southey St., St. Kilda.  
 3AL—Kerr, H. D., 1214 Shirt St., Ballarat.  
 3AM—Forecast, A., 22 St. George's Rd., Malvern.  
 3AP—Morris, R. D., 61 Bealiba Rd., Caulfield.  
 3AR—Associated Radio Co., Elizabeth St., Melbourne (A).  
 3AT—Thomson, A. W., "Arbroath," Ridley St., Sunshine.  
 3AU—Milligan, S. H., "Allowah," Nicholas St., Chilwell.  
 3AY—Jenvey, W. W., "Devonshire," 12 Lord St., Caulfield.  
 3BC—Brighton Radio Club, Higinbotham Hall, Brighton, Library Buildings, Bay St.  
 3BD—Cox, E. H., 5 Gisborne St., Elsternwick.  
 3BG—Osborne, Laing, Terang.  
 3BH—Whitelaw, C. R., Gillies St., Benalla.  
 3BK—Baker, S. C., 234 Clarendon St., South Melbourne.  
 3BL—Fitchet, J. C., 13 Holmwood Av., Brighton.  
 3BM—Love, H. K., "Lindum," Ferncroft Av., East Malvern.  
 3BP—Hood, J. H., 6 Alexander St., East St. Kilda.  
 3BQ—Howden, W. F. M., 10 Hill St., Box Hill.  
 3BY—Holst, H., 27 Bambra Rd., Caulfield.  
 3CB—Sievers, W. F., 30 Lesney St., East Richmond.  
 3CC—University, Melbourne.  
 3CF—Falconer, C. I., 13 Norris St., Canterbury.  
 3CH—Harris, A. C., Sherwood St., Birchip (D).  
 3CI—Cliffy Island Lighthouse (L).  
 3CK—Cook, E., Glenhope, Tresco.  
 3CR—Coburg Radio Club, 80 Sydney Rd., Brunswick.  
 3CS—Sabelberg, C. J., 100 Station St., Port Melbourne.  
 3DA—Dawson, R. S., 25 Kensington Rd., Sth. Yarra.  
 3DC—Embling, S. A., 296 William Rd., Toorak  
 3DB—Dreuleigh Business College, Flinders St., Melbourne.  
 3DJ—Stocks, D. A. J., 35 Highfield Rd., Canterbury.  
 3DP—Culliver, N., 91 Manningtree Rd., Hawthorn.  
 3DR—Dexter, J. H., 23 Beaconsfield Pde., Northcote.  
 3EC—Y.M.C.A., Bendigo, Cr. High and Short Sts., Bendigo.  
 3EF—Maddick, H. W., 89a Spray St., Elwood.  
 3EL—Boyd, N. J., Pearce St., Caulfield, Vic.  
 3EM—Doudney, H. W., 7 Dickens St., Balaclava.  
 3EP—Givens, J., 19 Logan St., Canterbury.  
 3ER—Read, E. H. W., 147 Lygon St., Brunswick.  
 3ES—Yorston, E. S., "Hoversta," Hawthorn Rd., Caulfield.  
 3EV—Evan-Evans, T., 25 Kalyrna Gr., East St. Kilda.  
 3FA—Kerang Motors, Scoresby St., Kerang (D).  
 3FW—Cooke, D. W., 23 Henry St., Footscray.  
 3GF—Frogley, G. J., 5 Richmond Ter., Richmond.  
 3GG—Gamon, G. A., 201 Page St., Middle Park  
 3GH—Hale, W. M., "Ben Nevis," Harvey St., Anglesea.  
 3GI—Cresswell, F. G., 5 Loch St., Camberwell.  
 3GL—Barthold, G. L., 72 Union St., Malvern.  
 3GM—McCulloch, G. R., 511 Havelock St., Ballarat.  
 3GN—Selman, H. G., 35 Queen St., Geelong West.  
 3GS—Semmens, G. S. C., State School, Queens-town, Victoria.  
 3HA—Blackman, H. H., 44 Osborne Av., East Malvern.  
 3HB—Sunshine Radio Club, Hampshire Rd., Sunshine.  
 3HH—Mughan, F. H., 15 Staniland Av., Malvern.  
 3HL—Hutchings, A. T., "Byron Avon," Calawadda.  
 3HR—Reid, A. H., 3 Kingston St., E. Malvern.  
 3JD—Dane, J. E., "Wahroonga," Toorak Rd., Hawthorn.  
 3JG—Jones and Glew, 122 Toorak Rd., Camberwell (D).  
 3JK—Herd, J. K., Main St., Bacchus Marsh.  
 3JM—Bryson, R. W., 149 Eglinton St., Kew.  
 3JO—Ruck, C. L., 3 Glentilt Rd., E. Malvern.  
 3JP—Mitchell, H. E. H., "Glenard," Kean St., Caulfield.  
 3JR—Dunstan, W. J., 7 Cameron St., Ballarat East.  
 3JS—Schultze, J., 24 York St., Glenferrie.  
 3JZ—Whalley, R. P., 4 Bridge St., Sandringham.  
 3KB—Kissick, A. L. H., 7 McFarland St., Brunswick.  
 3KG—Radio Engineering Co., 101 Foam St., Elwood.  
 3KJ—Sawyer, W. E. C., "Sunleigh Park," Hurstbridge.  
 3KM—Kerr and Muir Ltd., 241 Bay Street, N. Brighton (D).  
 3KN—R.A. Air Force, Victoria Barracks, Melbourne.  
 3MC—Newman, S. M., 151 Mt. Albert Rd., Canterbury.  
 3KR—Rankin, K. R., Boundary St., Kerang.  
 3KT—Seccombe, L. M., 144 Tooronga Rd., E. Malvern.  
 3KX—McCalman, M. C., "Ivanhoe," Dryden

## Australian Transmitting Licenses—(continued).

- St., Canterbury.
- 3LD—Deal Island (L).
- 3LG—Glew, L. G., 73 Elphin St., Newport.
- 3LM—Malvern District (W.I.A.), 16 Sutherland Rd., Armadale.
- 3LO—Broadcasting Co. of Australia, 360 Collins St., Melbourne (A).
- 3LP—Paul, L. A., 137 St. George's Rd., Nth. Fitzroy.
- 3LR—Elsternwick Radio Club, A.N.A. Hall, Regent St., Elsternwick.
- 3LS—Busch, R. T., "Stratford," 20 Wordsworth St., Moonee Ponds.
- 3LW—Hiam, C., 222 Carlisle St., St. Kilda.
- 3MH—Stuart, M. H., 571 Mt. Alexander Rd., Moonee Ponds.
- 3MI—Alsop, J. R., "Norvana," 28 Molesworth St., Kew.
- 3MM—Pringie, B., 42 David St., Brunswick.
- 3MP—Hosken, S. V., Queen St., Surrey Hills.
- 3MS—Moore, L. J., "Avalon," Railway Grove, Seymour.
- 3MY—Money, L. D., 8 Maling Rd., Canterbury, Victoria.
- 3NN—Brown, H. R., Yanac.
- 3OG—Menon, G. J., 6 Argyle St., St. Kilda.
- 3OT—Cameron, R. M., "Manuka," Coonil Cr., Malvern.
- 3PB—Palin, H., 44 Irving Av., Armadale, Melbourne.
- 3PD—Police Department (Headquarters' Station), Russell St. (S).
- 3PJ—Smyth, V. L., 130 McIvor St., Bendigo.
- 3PL—Learmouth, L. P., McIntyre St., Hamilton.
- 3PX—Taylor, S., 24 Dalgety St., St. Kilda.
- 3QH—Feldman, J. F., Forest St., Sth. Geelong.
- 3RA—Parker, R. A., C/o. Royal Bank, Bendigo.
- 3RI—Vic. Rlys. Inst. Wireless Club, V.R. Institute, Flinders St., Melbourne.
- 3RK—Evans, T. E., 21 Brunswick Rd., East Brunswick.
- 3RL—Lighton, R., "Nothgil," 232 Alma Rd., East St. Kilda.
- 3RN—Northcote Radio Club, 82 Gooch St., Thornbury.
- 3RP—Payne, R. L., 39 Retreat Rd., Geelong.
- 3RS—Shortell, R. C., 421 Inkerman St., St. Kilda.
- 3RW—Wookey, R. B., 158 Kilgour St., Geelong.
- 3SA—Simpson, L. R., Montana, Queen St., Ararat.
- 3SJ—Mitchell, S. J., 5 Brandon St., Brighton.
- 3SL—Southwell, L. W., c/o Mrs. Neal, High St., Seymour.
- 3SR—Sullivan, J., Yallourn.
- 3SW—Gadsen, S. W., 5 Miller Grove, Kew.
- 3TC—Court, T. P., 4 Sorrett Av., Malvern.
- 3TM—Buck, A. H., 7 Carrington St., Glenferrie.
- 3TR—Tregear, W. S., 22 Cole St., Upper Hawthorn.
- 3TU—Leckie, R. C., "Clifstone," 40 Bamfield St., Sandringham.
- 3UD—United Distributors Ltd., 592 Bourke St., Melbourne.
- 3UI—Dalton, R. M., 105 Murray St., Caulfield.
- 3UX—Steane, G. W., "Pymble," Earle St., Mont Albert.
- 3UZ—Nilsen, O. J., Bourke St., Melbourne (B).
- 3VP—Baker, C. W., "Ewell," 101 Williamson St., Bendigo.
- 3VR—Abbott, R. N., "Fleur-de-Lis," St., Elmo Av., Alphington.
- 3WI—W.I.A., Victorian Division, Ashburton.
- 3WM—McAuley, W. J. M., "Mia Mia," Union St., Brunswick.
- 3WP—Wilson's Promontory Lighthouse (L).
- 3WR—Wangaratta Sports' Depot (D).
- 3WS—Sweeney, W. M., 10 Foam St., Elwood.
- 3XC—Xavier College, Kew.
- 3XF—Chaffer, M., 41 Norwood Cr., Moonee Ponds.
- 3XO—Adams, F. J., "Hambra," Moule Av., Middle Brighton.
- 3XU—Canterbury Radio Club, 18 Northcote Av., Canterbury.
- 3XW—Cullinan, C. A., Bayview, Digger's Rest.
- 3YD—Donne, C. W., "Ovalau," 3 Hughenden Rd., East St. Kilda.
- 3YX—Hardie, B., Missouri Av., Garden Vale.
- 3YY—Bush, A. M., 54 Brougham St., Bendigo.
- 3YZ—McKeown, A., 54 Yarra St., Alphington.
- 3ZK—Bradley, F. R., "Worthling," Beach Cr., Sandringham.
- 3ZN—Israel, M., "Atossa," Station St., Burwood, Vic.
- 3ZR—Snaish, L., 1 Byron St., Footscray.

### NEW SOUTH WALES.

- 2AB—Badger, A. V., 20 Neutral St., North Sydney.
- 2AD—Dixon, A. L., 59 Second St., Canterbury, N.S.W.
- 2AG—Ashfield Service Station, Ashfield, New South Wales (D).
- 2AR—Hudson, W. H., 1 Terrace Rd., Dulwich Hill.
- 2AS—Smith, A. J., 27 Station St., Harris Pk., Parramatta.
- 2AV—Thurston, A. W., Argyle Rd., Penhurst, N.S.W.
- 2AY—Cureton, J. P., 203 Burwood Rd., Burwood.
- 2BA—Bar-ee-Mul (Trawler).
- 2BB—Crocker, E. B., 38 Roseby St., Marrickville.
- 2BC—Hurlin, N. J., "Strathcona," Northcote Av., Killara.
- 2BD—Barrenjack Dam (Public Works Dept.), (L).
- 2BE—Burgin Electric Co., Kent St., Sydney (B).
- 2BF—Forsythe, L. E., "Hoylake," Sailor Bay Rd., Northbridge.
- 2BJ—Binns, C., 27 English St., Kogarah.
- 2BK—Leverrier, F. N., "Lorette," Wentworth Rd., Vacluse.

## Australian Transmitting Licenses—(continued).

- 2BL—Broadcasters (Sydney) Ltd., Sydney (A)  
 2BM—Martin, Bernard, Mona St., Bankstown, N.S.W.  
 2BN—Kimpton, F. W., Moon St., Ballina.  
 2BR—Brolga (Trawler).  
 2BS—Sunter, H. B., 3 Flat, Ambassadors Court, Bondi Rd., Bondi Beach.  
 2BV—Waverley Amateur Radio Club, 89 Macpherson St., Waverley.  
 2BW—Barker, W. H., "Euripides," Wallace St., Concord.  
 2BY—Arnold, E. C., Binnia St., Coolah.  
 2CA—Cootamundra Public Works Department (L).  
 2CC—University of Sydney, N.S.W.  
 2CG—Gorman, C. A., 43 George St., Rockdale, N.S.W.  
 2CL—Caletti, G., "Boston," Beauchamp St., Punchbowl.  
 2CM—Maclurcan, C. D., "Namanula," Agnes Street, Strathfield.  
 2CR—Todd, L. V. G., Denison St., West Tamworth.  
 2CS—Swain, L. T., 49 Everton St., Hamilton, N.S.W.  
 2CU—Campbell, D. D., Ulmarra, N.S.W.  
 2CK—Stowe, H. A., "Rawene," Royal St., Chatswood.  
 2CZ—Exton, G. W., 173 Molesworth St., Lismore.  
 2DE—Renshaw, W. P., "Waimea," Lord St., Roseville.  
 2DG—Campbell, D. G., Sunny Ridge, Kyogle.  
 2DI—Dibbiu (T).  
 2DJ—Cooke, F. B., Namoi Rd., Northbridge.  
 2DN—Blanchard, G. E. H., 47 Foord Avenue, Hurlstone Park.  
 2DS—Davis, R. R., "Yuruga," Fisher Av., Vacluse.  
 2DU—Durendee (T).  
 2DY—Lindsay, D. G., "Navatu," Burgoyne St., Gordon.  
 2EC—Crouch, E. C., 26 Spencer St., Mosman.  
 2EH—Miller, H., "Broadway," Ness Av., Dulwich Hill.  
 2EM—Moore, E. J. T., 180 Kurraba Rd., Neutral Bay.  
 2FC—Farmers Ltd., Sydney (A).  
 2FG—Gibbons, F., 64 Thrupp St., Neutral Bay.  
 2FK—Welch, F., 1 Augusta Rd., Manly, New South Wales.  
 2FP—Baker, E. J., 62 Estell St., Maryville.  
 2FR—Bassett, F. R., "Ramora," Carrington St., Bexley.  
 2FT—Filmer, L. R., "Bundee," Toronto.  
 2GA—Wallace, Miss F. V., cr. Richard and George Sts., Greenwich.  
 2GB—Theosophical Broadcasting Station Ltd., Adyar House, 29 Bligh St., Sydney (B).  
 2GC—Cawood, G. C., c/o Mr. L. J. Lynch, Kurrajong Cr., Dorrigo, N.S.W.  
 2GD—Concord Radio Club, 12 Wallace Street, Concord.  
 2GI—Gundagai, Public Works Department (L)  
 2GK—Koets, C. G., c/o L. T. Watson, Breadalbane.  
 2GM—Cutts, G. M., 25 Malvern Rd., Croydon.  
 2GO—Goorangai (T).  
 2GP—Mackay, C. S., Urunga, N.S.W.  
 2GQ—Barlow, E., Church St., Glen Innes.  
 2GU—Gunundaal (T).  
 2GW—Woolnough, W. G., Florence St., Killara, N.S.W.  
 2HC—Carter, H. R., The Armidale School, Armidale, N.S.W.  
 2HD—Thompson, F., Newcastle (B).  
 2HF—Thompson, F., 40 Short St., Balmain, N.S.W.  
 2HH—Davis, H. H., Torrington Rd. Strathfield N.S.W.  
 2HM—Marshall, H. A., 94 Francis St., Bondi.  
 2HR—Rose, H. E., Tanganbil, Warren, N.S.W.  
 2HS—Hooker, Fanker E., 38 Phillip St., Bondi.  
 2HT—Thomas, H. K. R., Strathearn, Murdoch St., Neutral Bay.  
 2IJ—Gray, A. H., 5 Flat, "The Maples," Killara, N.S.W.  
 2IN—Payne, J., 53 Allison Rd., Randwick.  
 2JA—Mead, A. J., 13 Hampden St., Ashfield.  
 2JK—Brown, J. H., Shadwell, Chelmsford Av., Botany.  
 2JL—Young, J. L., Bulli Plain, Corowa, New South Wales.  
 2JM—Marsden, R. C., "Tamavua," Victoria Rd., Edgecliff.  
 2JP—Pike, J. H. A., Rawson St., Epping.  
 2JR—Reed, J. G., 7 Sloane St., Summer Hill.  
 2JS—Stanley, J. M., 97 Byng St., Orange.  
 2JT—Luckman, C. F. A., "Aldersey," Wongee Rd., Lakemba.  
 2JW—Williams, E. J., 51 Ocean Av., Double Bay.  
 2JY—Young, J. W., "Yothahnee," Eastern Rd., Turramurra, N.S.W.  
 2KC—Fry, R. H., "Baretta," Brighton St., Croydon, N.S.W.  
 2KO—Koraaga (T).  
 2KW—Grant, Archibald, Taylor's Arm Roadside, Macksville.  
 2KY—Trades and Labor Council, Trades Hall, Sydney (B).  
 2LB—Bean, L. P. R., & Co., 229 Castlereagh St., Sydney (D).  
 2LH—Leichhardt & District Radio Club, 176 Johnston St., Annandale.  
 2LL—Lane, L. S., "Narbeth," The Avenue, Randwick.  
 2LM—Wilson, L. M., 6 Kalimona Flat, Reginald St., Cremorne.  
 2LQ—Schultzm, L. N., "Waraba," Burns Bay Rd., Lane Cove.  
 2LP—Bean, L. P. R., 86 Muston St., Mosman.  
 2LR—Dovey, R. L., 36 Alfred St., Milson's Pt.,  
 2LW—Wellman, L. J., 18 Meeks Rd., Marrickville.  
 2LY—Shaw, R. H., 129 Grafton St., Woollahra, N.S.W.

**Australian Transmitting Licenses—(continued).**

- 2MH—Morton, C. E., "Saida," Underwood Rd., Homebush.
- 2MK—Mockler Bros., Howick St., Bathurst (B).
- 2ML—Mosman Radio Research Laboratories (E. C. Crouch), 100 Muston St., Mosman.
- 2MM—Murrumburrah, Public Works Department (L).
- 2MR—Stewart, J. E., Gorrick St., Mayfield.
- 2MS—Spitskowsky, Mat., 3 Veda St., Hamilton, N.S.W.
- 2MU—Nangle, J., "St. Elmo," 11 Tupper St., Marrickville.
- 2MW—Warne, M. L. C., "Essbank," Windsor Ave. Croydon North.
- 2NI—Hammond, H. B., "Chesterfield," Chesterfield Rd., Epping.
- 2NO—Knock, D. B., 102 Cremorne Rd., Cremorne, N.S.W.
- 2NS—Evans, T., Charles St., Blayney.
- 2OB—Mashman, L. W., "Gresley," 8 Donnan St., Bexley.
- 2PA—Public Works Department (P).
- 2PB—Public Works Department (P).
- 2PH—Hoare, P., Mann St., Gosford, N.S.W.
- 2PL—Public Works Department (P).
- 2PQ—Public Works Department (P).
- 2PR—Public Works Department (P).
- 2PS—Stephen, P. G., Mona St., Granville (D).
- 2QA—Goonambe (T).
- 2QB—Gunner (T).
- 2QT—Mutton, A. H., 31 Stafford St., Stanmore.
- 2RB—Beljon, R. E., 92 Lawrence St., Lithgow.
- 2RC—R. Chilton, c/o J. E. Sleemer, Gloucester, N.S.W.
- 2RD—Hardy, W. R., 225 Bridge Rd., Cleve, N.S.W.
- 2RE—Rees, R. M. E., 83 Northumberland Ave., Stanmore.
- 2RG—Reading, E. C., Charlotte St., Bangalow.
- 2RJ—Fagan, R. J., "Sunnyridge," Mandurana.
- 2RL—Litchfield, A. R., "Springwell," Cooma.
- 2RM—McFarlane, R. A., Wakaden St., Grif-fith.
- 2RP—Primmer, R., Gordon St., Gordon (D).
- 2RT—Turner, R. J., 250 Sloane St., Goulburn.
- 2RV—Thomas, R. V., 18 Plowman St., North Bondi.
- 2RW—Cusiter, R. W., "Bellaire," Kissing Pt. Rd., Turrumura.
- 2RX—St. John, H. C., 82 Gibbes St., Rockdale, N.S.W.
- 2SA—Salmon, W. E., "Poldhu," Cr. Park Rd. and Olympia St., Naremburn, N. Sydney.
- 2SB—Sibly, A., 20 Curabella St., Kirribilli, New South Wales.
- 2SH—Short, A., Young St., Lambton.
- 2SJ—Johnson, S., Mortimer St., Mudgee.
- 2SM—Caldecott, H. W. S., 52a Quinton Rd., Manly.
- 2SO—Wireless Society of Newcastle, Y.M.C.A. Bldgs., King St., Newcastle.
- 2SP—Evans, R., "Garth Craig," 6 Flood St., Clovelly.
- 2SS—Wright, A. E., Coledale, N.S.W.
- 2ST—Tatham, S. E., 160 Castlereagh St., Sydney.
- 2SW—Southwell, C. L., "Khan Unis," Kame-ruka Rd., Northbridge.
- 2SX—Slade, C. W., "Rockleigh," Lang St., Croydon, N.S.W.
- 2TB—Squelch, T. H., Byron St., Bungalow (D)
- 2TK—Abbott, T. K., "Murrulla," Wingen, N.S.W.
- 2TM—Turner, H. E. A., "Carmen," 13 Erith St., Mosman.
- 2TY—Troy, T. R., "Glenroy," Great Northern Rd., West Maitland.
- 2UE—Electrical Utilities, Story St., South Randwick (B).
- 2UI—Illawarra Radio Club, 75 Montgomerie St., Kogarah, Rockdale.
- 2UK—Sigal, H. L., 91 Jersey Rd., Woollahra, Sydney.
- 2UW—Sandel, O., 140 Balfour Rd., Bellevue Hill (B).
- 2UX—Sandel, O., 9 Curwood St., Wagga (B).
- 2VS—Stanley, V. E., 9 McLean Av., Chats-wood.
- 2WB—Bullivant, W. N., Charles St., Albury.
- 2WE—Standard Telephones & Cables Ltd., 200 Castlereagh St., Sydney.
- 2WG—Graham, W. D., 44 Cameron St., Rock-dale.
- 2WH—Stitt, W. H. R., "Wandary," Forbes, N.S.W.
- 2WI—W.I.A. (N.S.W. Division), 5 Elizabeth St., Sydney.
- 2WK—Kennedy, W. D., 16 Mabel St., Wil-loughby.
- 2WL—Carter, W. L., 53 Cardigan St., Stan-more.
- 2WR—Wahroonga Radio Club, East Anglia, Young St., Wahroonga.
- 2WS—Breden, W. S., Kitchener Pde., New-castle.
- 2WT—Watt, C. R., "Warrenfels," Tenterfield.
- 2WW—Wireless Weekly, "Krotona," William Edward St., Longerville.
- 2WZ—Zech, W. J., 145 Booth St., Annandale, N.S.W.
- 2XA—James, H. K., 12 Rosemount Av., Sum-mer Hill.
- 2XI—Craig, W. A., "Uabba," Irrara St., Croy-don, N.S.W.
- 2YB—Croydon Radio Club, Lang St., Croydon.
- 2YH—Hannan, W. H., "Glen Osmond," 23 Pr. Alfred St., Mosman.
- 2YI—Nolan, P. Spencer, "Monesk," 152 Belle-vue Rd., Double Bay.
- 2YJ—Sainsbury, R. H., "Kermanshah," 6 Wal-laray St., Concord West.
- 2ZC—Lavington, F. M. E., 9 Gordon Rd., Mos-man.
- 2ZJ—Simpson, A. W., "Manoah," Lea Av., Five Dock, Sydney.
- 2ZL—Otty, W., "Hurst Villa," Killingworth, via Newcastle.
- 2ZO—Willmot, T. R., Coramba Rd., South Grafton.

## A.W.A. RADIO GUIDE

### Australian Transmitting Licenses—(continued).

- 2ZU—Gilmour, N. S., 101 Wycombe Rd., Neutral Bay.  
 2ZX—Bristow, J. M., "The Towers," Kurraba Rd., Neutral Bay.  
 2ZY—Woollett, N., 33 Wolseley Rd., Mosman.

#### QUEENSLAND.

- 4AB—Bardin, W. F., McIlwraith St., South Townsville.  
 4AC—Walker, A. C., Oxford St., Sandgate.  
 4AK—Milner, J., "Beswick," Picot Estate, Kelvin Grove, Brisbane.  
 4AN—Gibson, W. L., Kirkland Av., Greenslopes.  
 4AW—Walz, A. E., Eton St., Nundah.  
 4AZ—Sharpe, F. V., Ashton Hall, Old Sandgate Rd., Woolowin.  
 4BD—Grimes, B. D., Tarragindi Rd., Annerley.  
 4BM—Milne, A. B., Mackay (D).  
 4BN—Cooling, E. R., Donation Lane, Toowoomba.  
 4BW—Cooper, A., Lloyd St., Mareeba, Qld.  
 4CF—Fortescue, C., "Matlock," Arthur St., Toowoomba.  
 4CG—Gold, C. H., Drake St., Hill End, Brisbane.  
 4CK—Norris, E. L., "Parkview," Hume St., Toowoomba.  
 4CM—McDowall, Dr. V., Preston House, Brisbane.  
 4CP—Pinney, C. R., Konedobu, Port Moresby, Papua.  
 4CR—Rich, C. F., London Bay Missionary Station, Fife Bay, Papua.  
 4CS—Geraghty, J. A., Town Hall, Gympie, Qld.  
 4CU—Walker, C., Devonport St., Clifton, Qld.  
 4CW—Buck, A. T., Geebung, North Coast Line.  
 4DA—Eggleton, E., Grenier St., Toowoomba.  
 4DC—Cribb, D. F., Foxton St., Indooroopilly.  
 4DO—Hobler, H. L., 8 Lennox St., Rockhampton.  
 4EG—Gold, E. E., Lindsay St., Toowoomba.  
 4EI—State Engineer, General P.O., Brisbane.  
 4ES—Sagar, E. N., Moonthalie, Douglas St., Greenslopes.  
 4GO—Oxlade, G., cr. Badger Av. and Irving St., Newmarket, Brisbane.  
 4GR—Gold Radio Electric Service, Lindsay St., Toowoomba (B).  
 4HB—Baker, H. E., Gowrie Station, Charleville.  
 4HL—Miller, H. L., cr. Ryan & Hoogley Sts., Hill End, Brisbane.  
 4HM—Milburn, H. L., 10th Street, Home Hill, Queensland.  
 4HW—Walsh, H. D., "Vailima," Toorak Hill, Hamilton, Qld.  
 4KR—Richardson, J. K., "Ascot Downs," Barcaldine.  
 4KY—Coffey, H. F., 6 Oxford St., Hamilton, Queensland.  
 4LG—Le Grand, S. W., 7th Avenue, Windsor, Brisbane.

- 4LJ—Feenaghty, L. J., Dickson St., Woolowin.  
 4MB—Radio Manufacturers Ltd., Queen St., Brisbane.  
 4MM—O'Brien, M. M., Fewings St., Toowong, Queensland.  
 4MC—McPherson, M. J., Merinda, via Bowen.  
 4NW—Starkie, T. W., "Pendarves," Sandgate Rd., Nundah.  
 4PG—Golden, P. J., "Bronte," Pine St., Wynnum South.  
 4PJ—Jessop, P. F., Kamma, near Edmonton.  
 4QG—Queensland Govt., Brisbane (A).  
 4RB—Browne, R. J., "Clifden," Church St., Toowong.  
 4RG—Stephenson, H. J., and Stephenson, C. W., Thorrold St., Woolowin.  
 4RK—Knight, R. K., "Forest Lodge," Jellicoe St., Toowoomba.  
 4RP—Robertson & Provan Ltd., Toowoomba (D).  
 4SM—Ikin, W. G., River Rd., New Farm, Brisbane.  
 4TC—Loombul Radio Club, Eton St. and Sandgate Rd., Nundah.  
 4WB—Bright, W. H., Hume St., Nth. Toowoomba, Qld.  
 4WE—Vining, W. E., Brickland Rd., Nundah.  
 4WF—Finney, W., "Milbong," Arthur Ter., Red Hill, Brisbane.  
 4WH—Hagarty, W. E., Kingfisher St., Longreach.  
 4WI—W.I.A. (Queensland Div.), Queen St., Brisbane.  
 4WN—Woolowin Radio Club, c/o F. J. Thomas, Willmington St., Woolowin.  
 4YN—Harkin, D. J., 101 Flight, R.A.A.F., Bowen, Qld.

#### SOUTH AUSTRALIA.

- 5AC—Cook, V. R. P., 37 John's Rd., Prospect, South Australia.  
 5AE—Hennor, J. M., Alpha Rd., Prospect, South Australia.  
 5AG—Bland, W. J., Buller Ter., Alberton.  
 5AH—Williamson, F. L., 25 Dequetville Ter., Kent Town.  
 5AI—Lloyd, H. H., 16 Trinity St., College Town.  
 5AQ—Sacred Heart College, Glenelg.  
 5AX—Traeger, A. H., Brigalow Ave., Kensington Gardens.  
 5BD—Earle, F. E., 6 Hakewell Rd., St. Peters.  
 5BF—Miller, F. G., Eleanor Ter., Murray Bdg.  
 5BG—Kaufer, H. A., 6 Rothbury Av., Tusmore  
 5BN—Austin, H. L., 8 Parade, Norwood.  
 5BP—Caldwell, R. B., 53 Hughes St., Unley, South Australia.  
 5BR—Blackwood Radio Club, Waite St., Blackwood.  
 5BW—Phillips, J. G., 31 Patridge St., Glenelg.  
 5BX—Saunders, A. L., 17 Esplanade, Glenelg.  
 5CL—Central Broadcasters Ltd., Grosvenor Hotel, North Ter., Adelaide (A).  
 5DA—Buckerfield, S. R., 4 Regent St., Parkside.



## A.W.A. RADIO GUIDE

### Australian Transmitting Licenses—(continued).

- 5DN—5DN Propty. Ltd., Parkside (B).  
 5DP—Brock, H. E., 16 Pennington Ter., North Adelaide.  
 5EB—Bagst, E. D. A., Clovelly, Woodville.  
 5FT—Fitzmaurice, J. S., St. Andrew's St., Nth. Walkerville.  
 5HG—Cooper, H. M., 51 Hastings St., Glenelg.  
 5HS—Trudgen, M. W., 41 Florence St., Fullarton, East Adelaide.  
 5HY—Cotton, A. A., Harvey St., Kilkenny.  
 5JA—Brewer, P. J., 21 Douglas St., Parkside.  
 5KA—Sport Radio Broadcasting Co., 51 Kintore Av., Prospect.  
 5KW—Wadham, K., 2 Elizabeth St., Parkside.  
 5LA—Atkins, L. M., Brougham St., Magill.  
 5LF—Sawford, L. F., Mead St., Peterhead.  
 5LP—Perry, A. L., Strathalbyn (D).  
 5MA—Anderson, M. B., Torrens Rd., Cheltenham, S.A.  
 5NG—Athelstone, G. N., Central Australia.  
 5PR—Port Radio Club, Port Rd., Alberton, S.A.  
 5RB—Bedford, R., Kyanoutta Cottage Hospital, Kyanoutta.  
 5RG—Gurner, R. C., 21 Victoria Ter., New Parkside.  
 5RM—Barker, R. M., 49 Newbon St., Prospect.  
 5SA—Turner, E. R., 10 Godfrey Ter., Leabrook  
 5SF—Ackland, S. F., 74 John's Rd., Prospect.  
 5SR—South Suburban Radio Club, Castle St., Parkside.  
 5WA—Adamson, W. K., 25 Olive St., Parkside.  
 5WH—Barber, W. H., 50 Somerset Avenue, Cumberland.  
 5WI—Wireless Institute of Australia (South Australia Division), 6 Bakewell Rd., St. Peters.  
 5WP—Pitchford, W. S., "Southview," 318 Wakefield St., Adelaide.  
 5WS—West Suburban Radio Club, 44 King St., Mile End.
- WESTERN AUSTRALIA.**
- 6AB—Cecil, C., 53 Macdonald St., Kalgoorlie.  
 6AG—Coxon, W. E., 5th Avenue, Inglewood.  
 6AK—University of W.A., Perth.  
 6AM—Kennedy, P., 210 Walcott St., Mt. Lawley, W.A.  
 6BB—Park, J. C. W., 29 Suburban Rd., Mill Point, South Perth, W.A.  
 6BH—Burrows, F. H., 26 George St., Kalgoorlie.  
 6BN—Stevens, A. E., 7 Ruth St., Perth, W.A.  
 6BO—Grey, A. E., Archdeacon St., Nedlands.  
 6BW—McLaughlan, C. D., 14 Clydesdale St., Victoria Park.  
 6CJ—Darley, E. J., Darley St., Perth.  
 6DA—Saw, F. W., 76 Leonard St., Victoria Park, W.A.  
 6DH—Hardisty, D. C., 2 Duncan St., Victoria Park.  
 6DZ—Burrows, E. W., Station House, Geraldton.  
 6GB—Sutherland, G. B., 36 Fairfield St., Mt. Hawthorn, Perth, W.A.  
 6GL—Lorden, G. A., 30 Thomas St., W. Perth.  
 6GM—Moss, G. A., Willis St., Cottesloe Beach, W.A.  
 6HB—Johnston, H. B., 119 Bourke St., Leederville, W.A.  
 6HE—Cox, H. E., Marine Ter. West, Geraldton  
 6JJ—Jewell, T. J., Leitchfield St., Victoria Park, W.A.  
 6JL—White, J. L., "Brooklands," via Brass Valley.  
 6KM—Saar, A., Post Office Bldgs., Eucla, W.A.  
 6KX—Simmons, H. T., 75 Nicholson Rd., Subiaco, W.A.  
 6LS—Symonds, L., Gldye St., Cottesloe Beach, W.A.  
 6LT—Throssell, L. T., May St., Northam, W.A.  
 6MU—Urquhart, M. S., Hawkestone St., Cottesloe, W.A.  
 6PL—Lindsay, P. E. C., 16 Clive St., West Perth, W.A.  
 6RW—Coxon, R. W., Chidlow St., Northam, W.A.  
 6SA—Austin, S. C., 39 Sussex St., Victoria Park, W.A.  
 6SR—Subiaco Radio Society, Fire Station, Rokely Rd., Subiaco, W.A.  
 6UP—Victoria Park Radio Club, 70 Mackie St., Vic. Park.  
 6VK—Vincent, J., 124 Varden St., Kalgoorlie.  
 6WF—Westralian Farmers Ltd., Perth (A).  
 6WI—Wireless Institute Australia, c/o W. E. Coxon, 5th Avenue, Inglewood, W.A.  
 6WP—Phipps, D. R., 97 Rupert St., Subiaco, W.A.
- TASMANIA.**
- 7AB—Smith, A. C., 21 High St., Launceston.  
 7AH—Medhurst, F. W., "Cranleigh," Beach Rd., Lower Sandy Bay.  
 7AR—Johnson, C. F., "Hevendon," Ryder St., W. Hobart.  
 7AS—Gill, A. S., 17 Frankland St., Launceston.  
 7BK—Preston, T. A. C., King St., Queenstown.  
 7BQ—Crooks, L. J., 64 Frederick St., Launceston.  
 7BT—Sheldrick, E. C., 15 Richards Av., Launceston.  
 7CS—Scott, A. C., 14 Law St., Launceston.  
 7CW—Walch, C., Cambridge Rd., Bellerive.  
 7DX—Watkins, W. T., 146 Warwick St. Hobart  
 7GD—Douglas, G. A., Lochleven, Gormans-town.  
 7GH—Hall, G. L., Waddamanna.  
 7HL—Lovett, Hubert F., 14 Summerhill Rd., West Hobart.  
 7LA—Hope, L. A., 210 George St., Launceston  
 7LJ—Jensen, L. R., 15 Bayley St., Glebe, Tasmania.  
 7MK—Cooper, E. E., Edgely House, Youngtown, Tas.  
 7NP—National Portland Cement Co., Maria Island (L).  
 7NW—Gillham, N. W., 38 Grosvenor St., Sandy Bay.  
 7OM—O'May, R. D., "Elonera," Esplanade, Bellerive, Tas.  
 7PF—Fysh, P. O., 46 Mary St., Launceston.  
 7RB—Buring, R., 19 Anglesea St., Sth. Hobart.  
 7RS—Hope, R. S., 210 George St., Launceston.  
 7WI—Wireless Institute of Australia (Tas. Div.), 181 Charles St., Launceston.  
 7ZL—Associated Radio Co., Hobart (A).



**AUSTRALIA.**  
*The Island Continent of the Pacific.*

Area - - 2,974,581 sq. miles  
Population - - - 6,000,000

Population - - - 7,000,000  
Besides owning and operating the Coastal Radio Stations in Australia and New Guinea, Amalgamated Wireless also controls and carries on wireless services on nearly 300 ships of the Australasian Mercantile Marine. The largest broadcasting stations in Australia were manufactured and erected by the Company; while it maintains laboratories for research and developmental work in every phase of Wireless.

*Amalgamated Wireless  
(A/sia.) Ltd.*  
Sydney, N.S.W., Australia.



A2ME

Q.S.T. Card of Amalgamated Wireless (A/sia), Ltd.  
Experimental Station 2ME, Sydney.

## New Zealand Broadcasting Stations.

- 1YA, AUCKLAND.—Radio Broadcasting Co. of New Zealand Ltd. Power, 500 watts; wavelength, 420 metres.
- 1ZB, AUCKLAND.—La Gloria Gramophone Co. Power, 50 watts; wavelength, 275 metres.
- 1ZY, WHANGAREL.—N. C. Shepherd. Power, 15 watts; wavelength, 250 metres.
- 1ZQ, AUCKLAND.—L. R. Keith, Power, 50 watts; wavelength, 330 metres.
- 2YF, PALMERSTON NORTH.—Radio Club. Power, 5 watts; wavelength, 200 metres.
- 2YK, WELLINGTON.—Power, 120 watts; wavelength, 292 metres.
- 2YM, GISBORNE.—Radio Company. Power, 500 watts; wavelength, 260 metres.
- 3YA, CHRISTCHURCH.—Radio Broadcasting Co. of New Zealand Ltd. Power, 500 watts; wavelength, 400 metres.
- 4YA, DUNEDIN.—Radio Broadcasting Co. of New Zealand Ltd. Power, one kilowatt; wavelength, 380 metres.—
- 4ZB, DUNEDIN.—Otago Radio Association. Power, 50 watts; wavelength, 300 metres.
- 4ZP, INVERCARGILL.—Southland Amateur Radio Club. Wavelength, 275 metres.

# List of New Zealand Amateur Radio Transmitting Stations.

- 1AA Edwards, C. N., 50 Point Chevalier Rd., Auckland.
- 1AC Spackman, L. S., 10 Ardmore Road, Ponsonby, Auckland.
- 1AE Roberts, R. V., 59 Hepburn St., Ponsonby, Auckland.
- 1AF Smithson, G. W., 39 Surrey St., Ponsonby, Auckland.
- 1AG Roberts, F., 24 Kimberley Road, Epsom, Auckland.
- 1AH Hartle and Gray, 7 Alton Rd., Auckland.
- 1AJ Shepherd, N. C., Whangarei, Auckland.
- 1AK Claxton, H., Parawai Road, Thames, Auckland.
- 1AN Arthur, H. B. M., 266 Jevois Rd., Herne Bay, Auckland.
- 1AO White, R. G., 125 Grafton Road, Auckland.
- 1AP Winch, N., Brady St., Te Awamutu, Auckland.
- 1AR Hobbs, F. B., 131 Grafton Rd., Auckland.
- 1AS Grainger, R. E., 88 Clarence Street, Auckland.
- 1AT Swain, G. S., Te Awamutu, Auckland.
- 1AU Aubin, R. E. L., Parnell, Auckland.
- 1AV Reardon, F. C., 154a Hobson Street, Auckland.
- 1AX Orbell, R. J., Wilson Street, Te Aroha, Auckland.
- 1AY Woskett, H. C. A., 10 Ethel St., Eden Terrace, Auckland.
- 1AZ Sherson, J. R., Te Aroha Street, Claudelands, Auckland.
- 1FA West, G. R., White Island, Auckland.
- 1FB Gulde, G. T., Bridge Street, Opotiki, Auckland.
- 1FC Burrell, R. F. D., 2 Hauraki Road, Takapuna, Auckland.
- 1FD Booth, F. R., 28 Rosstrevor Street, Hamilton, Auckland.
- 1FE Wood, A. F., Waihau, Auckland.
- 1FG Lonsdale, J., "Heathdale," Marohemo.
- 1FL Liggins, Dr., J.B., Queen Street, Thames, Auckland.
- 1FM Warn, J. E. B., Woodford Road, Mount Eden, Auckland.
- 1FN Stace, G. O. M., Stanley Road, Te Aroha, Auckland.
- 1FO Cooper, E. R., 8 London Street, Ponsonby, Auckland.
- 1FQ Clarkson, T. R., Madeira Lane, Auckland.
- 1FR Gillies, R. H., 8 Young Street, Hamilton, Auckland.
- 2AA Brown, A. S., 14 Christian St., Dannevirke, Wellington.
- 2AB Wilkinson, D., High Street, Motueka, Wellington.
- 2AC O'Meara, I. H., 209 Harris Street, Gisborne, Wellington.
- 2AD Stevens, P. R., 4 Rutene Street, Kaiti, Gisborne, Wellington.
- 2AE Patty, R. J., 159 Lowe Street, Gisborne, Wellington.
- 2AF Sinclair, W. J., Score Street, Gisborne, Wellington.
- 2AG Strong, S. W. S., Harris St., Gisborne, Wellington.
- 2AI White, R. H., 2 Breakwater Rd., Napier, Wellington.
- 2AK Rowson, L., 438 Devon Street, New Plymouth, Wellington.
- 2AM Buist, W. F., Dr., Hawera, Wellington.
- 2AN Weston, M. L., 47 Barraud Street, Dannevirke, Wellington.
- 2AO Brunette, G. A. J., Opunake, Wellington.
- 2AQ Coutts, W. M., Kuku Street, Taihape, Wellington.
- 2AS Boyle, H. R., 1 Breakwater Rd., Napier, Wellington.
- 2AV Chatfield, R. G., 42 Raroa Road, Kelburn, Wellington.
- 2AW Clarke, C. R., 133 Thorndon Quay, Wellington.
- 2AX Kyle, J. V., Aokautere, Palmerston North, Wellington.
- 2AZ McDonald, H. L., 89 Hamilton Road, Hataitai, Wellington.
- 2BB Ward, C., 63 Norway Street, Kelburn, Wellington.
- 2BD Cunningham, N. R., View Road, Karori, Wellington.
- 2BF Wilkins & Field Hardware Co., Ltd., Hardy Street, Nelson, Wellington.
- 2BG Tinney, J. G., 74 Kainui Road, Hataitai, Wellington.
- 2BJ Evans, A., 269 Taranaki Street, Wellington.
- 2BK Hanson, L. A., 77 Linton Street, Palmerston North, Wellington.
- 2BL Wellington College Radio Club, Wellington College, Wellington.
- 2BN Hislop, S. J. K., 8 Fitzroy Road, Napier, Wellington.
- 2BP Macklin, W. N., 75 Waipapa Road, Hataitai, Wellington.
- 2BQ Edmundson, E. D., 8 May Avenue, Napier, Wellington.
- 2BR Lambert, K. A., "Belmont," Tayforth, Wanganui, Wellington.
- 2BS Hunter, W. R., Barker's Hill, Gisborne, Wellington.
- 2BT Tanner, R. A., Karere Road, Longburn, Wellington.
- 2BV Lane, F. J., 31 Manawatu Street, Palmerston North, Wellington.

## A.W.A. RADIO GUIDE

### List of New Zealand Amateur Radio Transmitting Stations (continued).

- |   |  |
|---|--|
| <p>2BX Black, R. G., Stafford Street, Wellington.</p> <p>2GA Johnson, J., Fortunatus Street, Brooklyn, Wellington.</p> <p>2GC Howarth, A., 12 High Street, Dannevirke, Wellington.</p> <p>2YM Gisborne Radio Co., 4 Rutene Road, Gisborne, Wellington.</p> <p>2XA Shrimpton, E. A., 38 Rongotai Terrace, Wellington.</p> <p>3AA Worthington, L. G., 92 Office Road, Christchurch, Canterbury.</p> <p>3AC Radio Society of Christchurch, St. Asaph St., Christchurch, Canterbury.</p> <p>3AD Fooks, A. C. L., Cr. Park and Peter Streets, Ashburton, Canterbury.</p> <p>3AE Donald, J. G., c/o. Mr. J. Purser, Lees-ton, Canterbury.</p> <p>3AF Ball, L. F., 90 Nursery Road, Linwood, Canterbury.</p> <p>3AI Rangiora High School, Rangiora, Canterbury.</p> <p>3AJ Blake, R. G. F., Rangiora, Canterbury.</p> <p>3AK Grubb, A. H. McL., 205 Wai-iti Road, Timaru, Canterbury.</p> <p>3AL Dawson, W. M., Ashburton, Canterbury.</p> <p>3AM Halcrow, L. A., 441 Madras Street, Christchurch, Canterbury.</p> <p>3AP Cooper, A. M., Wills St. East, Ashburton, Canterbury.</p> <p>3AR Buchanan, D. W., Ashburton, Canterbury.</p> <p>3AS Brown, S. E., 2b Salisbury St., Christchurch, Canterbury.</p> <p>3AT Marquet, L. J., 30 Chichester St., Woolston, Christchurch.</p> <p>3CB Taylor, C. R. H., 45 Weston Road, St. Albans, Christchurch, Canterbury.</p> <p>3CC Grubb, A. H. M. (Portable), 205 Wai-iti Road, Timaru or elsewhere, Canterbury.</p> <p>3CF Simpson, A. E. H., 99 Abberley Road, St. Albans, Canterbury.</p> <p>3CG Brown, H. P. V., 49 Gracefield Street, St. Albans, Canterbury.</p> | <p>3CH Maxted, R., Rolleston House, Rolleston Avenue, Christchurch, Canterbury.</p> <p>3CK Baxendale, J., Blackall, Canterbury.</p> <p>4AA Bell, F. D., Waihemo, Otago.</p> <p>4AB Otago Radio Association (R. Bruce), Princess Street, Dunedin, Otago.</p> <p>4AC Robinson, R. E., 3 Chetham Avenue, Dunedin, Otago.</p> <p>4AD Jordan, A. E., 17 Biggar Street, Invercargill, Otago.</p> <p>4AH MacDonald, I. S., 45 Royal Terrace, Dunedin, Otago.</p> <p>4AI Samson, G. G., 401 North Road, North East Valley, Dunedin.</p> <p>4AK Shiel, W. L., 103 Macandrew Rd., Dunedin, Otago.</p> <p>4AM Crockett, W. McG., Tiverton Street, Palmerston, Otago.</p> <p>4AO Shrimpton, H. N., Coney Hill, Dunedin, Otago.</p> <p>4AP Invercargill Amateur Radio Club, Cr. Esk and Dee Streets, Invercargill, Otago.</p> <p>4AQ Arundel, N., 26 Moray Place, Dunedin, Otago.</p> <p>4AR Wilkinson, W. G., 21 Melrose Street, Roslyn, Otago.</p> <p>4AS Mason, P. H., 211 Highgate, Maori Hill, Dunedin, Otago.</p> <p>4AV Milnes, J. H., 39 Lees Street, Dunedin, Otago.</p> <p>4AX Earland, F. P., 33 Waverley Street, Dunedin, Otago.</p> <p>4AZ Sidey, T. K. S., Caversham, Dunedin, Otago.</p> |
|---|--|

### EXPERIMENTAL RADIO STATIONS.

- |  |  |
|--|--|
| <p>1XI Auckland University College, Prince's Street, Auckland.</p> <p>2XB Florance, Prof. D. C. H., Victoria University College, Wellington.</p> <p>3XB Bingham, J. M., 387 Gloucester Street, Christchurch, Canterbury.</p> |  |
|--|--|

*To Country Clients—*  
We can Arrange to Supply  
Radiola's through the Nearest  
Authorised Radiola Dealer  
who will give Expert Advice  
and Service

**LOOK  
for this  
SIGN**

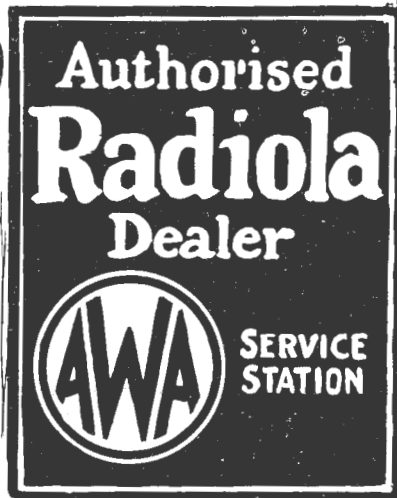

*The  
A.W.A.  
Symbol of Service  
is a Guarantee to  
you of  
PERMANENT  
SATISFACTION.*

## Radio Dealers

**RADIO DEALERS FROM WHOM GOODS SHOWN IN THIS GUIDE  
CAN BE OBTAINED.**

### VICTORIA.

- Adams, R. W., 17 Locke St., Essendon.  
 Aeolian Co., 252 Collins St., City.  
 Alder, W., Embankment Av., Chelsea.  
 Amor, A. E., High St., Mansfield.  
 Australian General Electric Co., Queens St., Melbourne.  
 Baker & Woods, Hargreaves St., Bendigo.  
 Balfours Motors, Gherinhap St., Geelong.  
 Balfour Motors, Mercer St., Geelong.  
 Barclay, K., 82 Russell St., Bendigo.  
 Barker, J. S., Market Square, Castlemaine.  
 Barnes, E. L., 175 Ryrie St., Geelong.  
 Bailey, E. L., Sunbury.  
 Barnes, F., Cust St., Rainbow.  
 Barker & Park, Red Cliffs.  
 Bates, J. E., Tynong.  
 Belt, L., Melville St., Numurkah.  
 Bending, E. V., Dimboola.  
 Bennett, C. H., 80 Sydney Rd., Brunswick.  
 Bent, A. T., 135 Pakington St., Geelong.  
 Bibby, R., Buckley St., Essendon.  
 Billinge, G., Pt. Nepean Rd., Chelsea.  
 Bitcon, G., Numurkah.  
 Bonnett, H., 145 Hoddle St., East Richmond.  
 Bowyer, F., 20 Moonga Rd., Murrumbena.  
 Breach, C. A., 12 Fountain St., E. Malvern.  
 Brian & Maughan, 15 Staniland Av., Malvern.  
 Brighton Beach Garage, 30 Esplanade, Brighton Beach.  
 British Aust. Radio Co., 185 Swanson St., City.  
 British Gen. Electric Co., 590 Bourke St., City.  
 Brodribb Bros., 372 St. Kilda Rd., City.  
 Brooks, Robinson & Co., Elizabeth St., City.  
 Brown, M. C., Traralgon.  
 Brown Motors, 147 Malop St., Geelong.  
 Buckley, C. J., 50 Head St., Sth. Melbourne.  
 Buckley & Nunn Ltd., Bourke St., City.  
 Bull Bros., Bairnsdale.  
 Bulmer, J., Fryers St., Shepparton.  
 Burmeister Bros., 294 Lt. Collins St., City.  
 Cahill, J., 11 Queen St., Geelong West.  
 Cane & Houston, 460 Sydney Rd., Coburg.  
 Carroll, J. E., Burke Rd., Camberwell.  
 Carroll, J. E., 320 Elizabeth St., City.  
 Chandler, D. & W., 276-290 Brunswick St., Fitzroy.  
 Chittock Bros., 69 Nepean Rd., Elsternwick.  
 Clemens, E., Mollison St., Kyneton.  
 Clements, J., Ford St., Beechworth.  
 Cobbledick, T. G., Princess St., Traralgon.  
 Coen, Louis, Wireless Co., 63 Swanson St., Melbourne.  
 Coghlan, J., Cora Lynn.  
 Cohen, J. H., 276 Chapel St., Prahran.  
 Cook, A. N., & Co., 47 Latrobe St., Melbourne.  
 Cookson W. H., 101 McConnell St., Kensington.  
 Dalgety & Co., Bourke St., Melbourne.  
 Dancy, J. W., 202 High St., Kew.  
 Dane, Taylor & Co., 501 Latrobe St., Melb.  
 Danks, J., & Co., 391 Bourke St., Melbourne.  
 Dann, R., & Co., Barker St., Castlemaine.  
 Darlington B., Koo-wee-rup.  
 Davies, C. H., Graham St., Wonthaggi.  
 Dawson, R. B., Station St., Rainbow.  
 Cunningham, A. L., 99 Nicholson St., Footscray.  
 Dingwell, E. G., Oliver's Bldgs., Railway Station, Glenferrie.  
 Doran, W. T., Mollison St., Kyneton.  
 Draper & Co., 267 Lt. Collins St., Melbourne.  
 Drysdale, J., Tinamba.  
 Duncan, A. A., Gisborne.  
 Dutton, H. J., 202 High St., Kew.  
 Eclipse Radio Pty. Ltd., 349 Flinders Lane, Melbourne.  
 Edney, C., Leongatha.  
 Edison Elec. Co., 368 Lt. Collins St., Melbourne.  
 Edwards, G., 75 Nicholson St., Footscray.  
 Egge, R., Longtree Av., Mildura.  
 Electrical Maintenance Service, Bourke St., Melbourne.  
 Emery, J., Napier St., Essendon.  
 Esplanade Taxis & Motors Pty. Ltd., Ormond Esplanade, Elwood.  
 Eutrope, W. H., & Son, 23 Elizabeth St., Melb.  
 Farm & Pastoral Supplies, 560 Bourke St., Melbourne.  
 Fisher, A. J., Patchewoolock.  
 Fleming, H. B., Main St., Croydon.  
 Foster & Fish Pty. Ltd., 288 Lonsdale St., Melbourne.  
 Foster, C. R., 588 Bourke St., Melbourne.  
 Fraser, S. J., 131 Fitzroy St., St. Kilda.  
 Fraser, W. J., 404 High St., St. Kilda.  
 Fry, A. T., Cullinane St., Black Rock.  
 Fynmore, Elsie, 88 Mont Albert Rd., Mont Albert.  
 Gadsden, J., Pty. Ltd., 572 Lonsdale St., Melb.  
 Gilpin, A. V., 200 Dana St., Ballarat.  
 Gippsland Northern Co-op. Co., 492-4 Flinders Lane, Melbourne.  
 Gisborne, W. H., Kooloonong.  
 Gloster E. M., Piper St., Kyneton.  
 Gowland, E. A., Paraparap, via Moriac.  
 Grierson, W. E., 154 Racecourse Rd., Newmarket.  
 Gude, S., Morwell.  
 Guest, S., 8 Ilawarra St., Williamstown.  
 Gulline Bros., Bacchus Marsh.  
 Halpin, J., 119 Liardet St., Port Melbourne.  
 Hartley's Pty. Ltd., 148 Swanston St., Melb.  
 Harvey, A., Ltd., 528 Collins St., Melbourne.  
 Head, W. C., Bunyip.  
 Healing, A. G., & Co., 354 Post Office Place, Melbourne.  
 Hellier, L. J., Murphy St., Wangaratta.  
 Hemley, A., & Sons, Callawadda.  
 Hickmer, J., & Sons, 135 Brighton St., Richmond.  
 Hickox & Rose, 22 Hawthorn Rd., Caulfield.  
 Hill, Mrs. E., Cowes.  
 Hobby, R. H., Tongala.

## A.W.A. RADIO GUIDE

- Holt, H. L., 121 Bridport St., Albert Park.  
 Homecrafts, 211 Swanston St., Melbourne.  
 Hoskin, C. H., & Sons, Firebrace St., Hershham.  
 Howden, H. T., Southern Cross.  
 Johnson & McMillan, 666 High St., Northcote.  
 Jones, W. L., Mair St., Kyneton.  
 Kerr & Muir Wireless Pty. Ltd., 241 Bay St., North Brighton.  
 Kiernan & Co., 291 Elizabeth St., Melbourne; 132a Bridge Rd., Richmond; 224 Smith St., Collingwood.  
 King, H. E., 33 Munro St., Ascot Vale.  
 Kinsella, T. W., Magdala, Lubeck.  
 Lane, R. R., Queen St. Warragul.  
 Langford, Pickles & Co., Puckle St., Moonee Ponds.  
 Lawrence & Brier, 245 Glenhuntley Rd., Elsternwick.  
 Lawrence & Hanson Elec. Co., 172 William St., Melbourne.  
 Leahy, A. J., Kennedy St., Hamilton.  
 Leber Bros., 402 Bridge Rd., Richmond.  
 Lee & Chisholm Bros. Motors, Campbell St., Leviathan Pty. Ltd., Swanston St., Melbourne.  
 Lewis, Jas. R., 99 Dundas St., Albert Park.  
 Loxton, S. L., 129 Smith St., Fitzroy.  
 Machin & Co., Elizabeth St., Melbourne.  
 Mackereth, G. R., High St., Avoca.  
 McPherson & Lawrie, 75 Church St., Middle Brighton.  
 Mair, Alex., & Co., McEwan House, Lt. Collins St., Melbourne.  
 Marrett, J. F., Maryborough.  
 McAuliffe, M., 264 Glenhuntley Rd., Elsternwick.  
 McCann, C. E., Maryborough.  
 McKeown, D. S., 10 Burke Cres., East Geelong.  
 McMillan, W. A., Cohuna.  
 McMullin, R., & Co., Firebrace St., Horsham.  
 McPherson, H. H., Numurkah.  
 Mercer, W. W., 238 Glenferrie Rd., Glenferrie.  
 Metropolitan Vickers Elec. Co. Ltd., 84 William St., Melbourne.  
 Mica Insulating Supplies, 562 Bourke St., Miller & Co., Euroa.  
 Mitchell, C. D., Springfield Rd., Blackburn.  
 Maloney, E., 111 Market St., Sth. Melbourne.  
 Morecraft, L. M., High St., Wedderburn.  
 Morris, G., Boundary Rd., Mordialloc.  
 Morris, P. A., & Co., 298 Lt. Collins St., Melb.  
 Moss, M. J., Main St., Mooroopna.  
 Mounsey, E. A., 6 Archer Ter., Ascot Vale.  
 Mounter, 9 Hillside St., Yallourn.  
 Muir, J., Pty., Ltd., 35 Armstrong St., Ballarat.  
 Murton, L. M., 140 Puckle St., Moonee Ponds.  
 Myers Pty. Ltd., Bourke St., Melbourne.  
 Nalder, G. F., McKenzie's Hill, Castlemaine.  
 Newberry, A., Indi Ave., Red Cliffs.  
 Newbiggin, J. L., 161 Queen St., Melbourne.  
 New Systems Telephones, 25 Queen's Bridge St., Melbourne.  
 Nicolson, N. C., Railway Station, Carnegie.  
 Nilson, O. J., & Co., 45 Bourke St., Melbourne.  
 Norris, C. W., & Co., 447 Lt. Bourke St., City.  
 Noyes Bros., 495 Bourke St., Melbourne.  
 O'Hanlon, P. J., 29-31 Guildford Lane, Melb.  
 Opray Bros., 79 Hawthorn Rd., Caulfield.  
 Osboldstone & Co., Finks Bldgs., Melbourne.  
 Pacific Radio Pty. Ltd., 219 Swanston St., City.  
 Parker, E. J., 366 Sydney Rd., Coburg.  
 Potts, 246 St. George's Rd., Northcote (204).  
 Proctor, J. H., Corach East.  
 Quambatook Stores Pty. Ltd., Quambatook.  
 Radesco Pty. Ltd., 211 Glenferrie Rd., Malvern.  
 Radio Equipment & Service Co., 221 Glenferrie Rd., Malvern.  
 Reddan, D. W., 183 Smith St., Collingwood.  
 Redgan, T. C., Charlton (Jnr.).  
 Revell, G. W., Victoria St., Abbotsford.  
 Roberts, W. J., 23 Auburn Av., Northcote.  
 Richardson, C. N., Houston St., Stawell.  
 Robertson & Mullen, 107 Elizabeth St., Melb.  
 Robson, C. E. H., 16 High St., Windsor.  
 Robotham Pty. Ltd., 183 Bourke St., Melbourne.  
 Robson, C. E. H., 16 Hawsleigh Av., Balaclava.  
 Royle, G. O., 22 Station St., Sandringham.  
 Rumble, F., Moora Rd., Rushworth.  
 Sagers, T., & Son, Tallarook St., Seymour.  
 Salamy & Son, Timor St., Warrnambool.  
 Swan & Audley, Branxholme, Vic.  
 Shrimpton, A. T., 272b Swan St., Richmond.  
 Shuters, J. J., Warburton.  
 Sluiter, J. J., Warburton.  
 Silverman, M., 484 Napier St., Nth. Fitzroy.  
 Siemen Bros., 30 Queen St., City.  
 Slater, F. E., 444 Lt. Collins St., Melbourne.  
 Stalzs', Nunn St., Benalla.  
 Small, H. G., & Co., 360 Post Office Pl., Melb.  
 Smith, H. A., Harris St., Rutherglen.  
 Spring, W. J., 67 Croydon Rd., Surrey Hills.  
 Taylor Bros., 322 Windermerie St., Ballarat.  
 Tolson, W., & Co., 26 St. Francis St., Melb.  
 Tremon Wireless Co., 265 Lonsdale St., Melb.  
 Tuckey, C. H., Raymond St., Sale.  
 Tunafone Wireless, Lit. Collins St., Melbourne.  
 Tye & Co., 108 Bourke St., Melbourne.  
 United Distributors Ltd., 664 Bourke St., Melb.  
 Veall, A. J., 302 Chapel St., Prahran.  
 Venner, A. E., Corryong.  
 Victoria Producers' Co-op. Pty. Ltd., 589-605 Wakefield, J. F., 317 Bay St., Port Melbourne.  
 Warburton, Franki Ltd., 380 Bourke St., Melb.  
 Watson, W., & Sons, 117 Collins St., Melbourne.  
 Watson, W. G., & Co., 200 Queen St., Melb.  
 Waugh, A. J., Johnson St., Maffra.  
 Webb-watts, McLean & Glaisher, 449 Bourke Rd., Camberwell.  
 Webster, J., Williamson St., Bendigo.  
 Weiss, H., High St., Cobram.  
 Wells, L., Mangan St., Tongala.  
 Werring, C. C., 64 Downshire Rd., Elsternwick.  
 White, C. A., 6 Young St., Preston.  
 Whitelaw, A., 43 Park St., St. Kilda.  
 Willis Bros., Piper St., Kyneton.  
 Wilson, R. J., Violet Town.  
 Wilson, V. G., Newstead.  
 Wilson Phonograph & Radio Apparatus, Collins St., Melbourne.  
 Wood, E. W., 229 High St., Northcote.  
 Rogers, R. W., Woodlark St., Lismore.  
 Woods, F., Main St., Devenish.  
 Whitelaw, A., 43 Park St., St. Kilda.



A.W.A. RADIO GUIDE

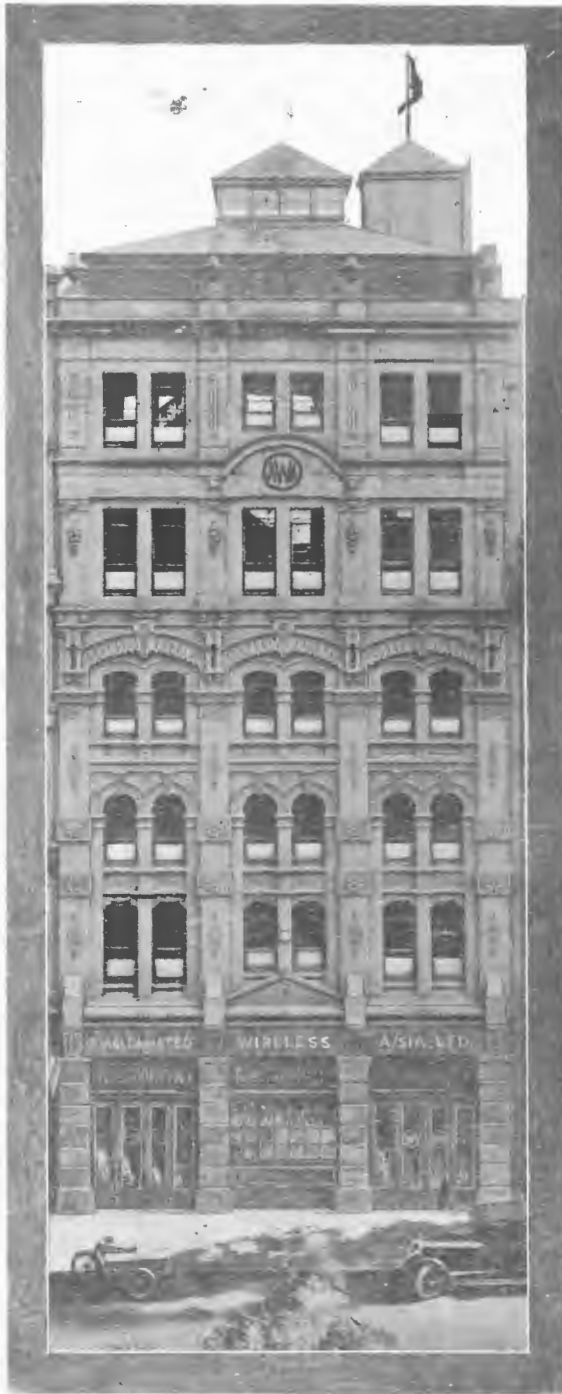

New premises at 47 York Street, Sydney,  
to be shortly occupied by  
Amalgamated Wireless (A/sia) Ltd.

## A.W.A. RADIO GUIDE

### NEW SOUTH WALES.

- Adeock, G. J., "Jusfrute," Gosford.  
 Adnay, W., 74 Ramsay Rd., Haberfield.  
 Aelian Co. (Aust.) Ltd., 416 George St.,  
 Aladdin Industries, 49 Shepherd St., Sydney.  
 Amplion (Aust.) Ltd., 54 Market St., Sydney.  
 Austin & Bratley, Renkin St., Forbes.  
 Anderson Bros., George St., Grenfell.  
 Arnold, Ed. & Co., Ltd., Oxford & Crown Sts.,  
 Ashley, W., Main St., Lithgow.  
 Australian Wireless Co., 140 Castlereagh St.,  
 Sydney.  
 Aust. Gen. Elec. Co., Dean St., Albury.  
 Bailey, A. G., Wyong.  
 Bailey, Clem. A., "Bearbong," Gilgandra.  
 Baker, Herbert W., Gt. North Rd., Gladsville.  
 Baker, J. H., Woy Woy (Wagstaff Pt.).  
 Bale, V., 32 Cathcart St., Lismore.  
 Barron, Peter O., 295 Argent St., Broken Hill.  
 Bartlett, F., Garah.  
 Bartly, A., Wallsend St., Cootamundra.  
 Bega Radio Supplies, Carp St., Bega.  
 Bell, O. S., George St., West Maitland.  
 Bembrick, J. R., Neil St., Harden.  
 Benjamin & Co., A. J., Victoria Av., Chatswood.  
 Bennett & Barkell Ltd., Meagher St., Chippen-  
 dale.  
 Bennie, Matthew, Terrigal.  
 Bergin, W., Gerringong.  
 Bicknell, A. E., 248c Oxford St., Woollahra.  
 Bracey's Ltd., Lithgow.  
 Blake's Busy Book Bazaar, Dean St., Albury.  
 Blackshaw, A. W., Ballina.  
 Burgess & Gibson, Guyra.  
 Bursill, F. C., Katoomba.  
 Bowden, A. L., Sanger St., Corowa.  
 Bogan & Loss, 18 Plaistow St., West Maitland.  
 Breden, W. S., Patey's Chhrs., Newcomer St.,  
 Newcastle.  
 Brooks, F. J., West Wyalong.  
 Brown, J. W., Woy Woy.  
 Brown, Harold F., 364 Auburn St., Goulburn.  
 Bruchhauser, B. S., Sheridan St., Gundagai.  
 British Gen. Elec. Co., 54 Clarence St., Sydney.  
 Brain Bros., Coonabarabran.  
 Bryant, J., Popran, via Gosford.  
 Campbell, J. R. & Sons, Ulmarra.  
 Campbell, D. G., Kyogle.  
 Campbell & Co., Bridge St., Muswellbrook.  
 Cessnock Co-op. Society, Vincent St., Cessnock.  
 Chapman & Sons, Wyong.  
 City Motor Garage & Eng. Co., Grafton.  
 Clarke, W. J., Burrowa St., Young.  
 Clifton, D. V., Motor Garage, Barraba.  
 Costin, H. & Son, Narooma.  
 Cox Bros., Coff's Harbour.  
 Cox, R. S., Prince St., Grafton.  
 Colville Moore Wireless Supplies, 10 Rowe  
 St., City.  
 Crosby, W. J., Armidale.  
 Cradick Bros., Casino.  
 Condon, M. J., Condobolin.  
 Clarke, W. H., Wilga St., Corrimal.  
 Curran, Leo, 109 William St., Bathurst.  
 Cullen, E. R., 96 Bathurst St., City.  
 Clarence Radio Supplies, Lismore.  
 Collard, A. J., West Maitland.  
 Cupitt, E. E. M., Kelly St., Scone.  
 Colefax, A. V., Fitzroy St., Moruya.  
 Cooper, L. T. H., Monaro St., Queanbeyan.  
 Connolly, R. J., 360 Belgrave St., Manly.  
 Colton, Geo., 148 Bridge Rd., Glebe.  
 Cash, L. D., 209 George St., Canterbury.  
 Cross, H. (Sanic Herbal Co.), 156 King St.,  
 Newtown.  
 Crowfoot, J. J., 65 Moncer St., Woollahra.  
 Campbell, D. T., The Crescent, Fairfield.  
 Deal, L. J., Sutton St., Cootamundra.  
 Drury, F. A., Grenfell.  
 Doyle, R., 5 Jane St., Balmain.  
 Dalgety & Co., Bent St., City.  
 De Koningh, 254a Victoria St., Darlinghurst.  
 Desprez, R. V., 118 Railway Pde., Kogarah.  
 Donoghue & Sons, Gibraltar St., Bungendore.  
 Doble, F., Kendall St., Cowra.  
 Doyle, E. E., 18 Station St., West Kogarah.  
 Dunn, W. D., George St., Mayfield East.  
 Everingham, Ivo R., Rusden St., Armidale.  
 Electrical & Wireless Co. of Newcastle, 503  
 Hunter St., Newcastle.  
 Elliott, A. A., Kurrajong Av., Leeton.  
 Epps, Chas., George St., Deniliquin.  
 Emery, O. E., Burrowa.  
 Evans, F. C., Pindimar, via Newcastle.  
 Everett, R., 67a Enmore Rd., Newtown.  
 Exton, G. W., 173 Molesworth St., Lismore.  
 Far Western Motor & Engineering Works,  
 Panjee St., Nyngan.  
 Farmer & Co., Pitt St., City.  
 Failes, L. J., "Moocybah," Bugaldi.  
 Finch, E. R., 7 Effingham St., Mosman.  
 Field, Geo., 608 Harris St., Newcastle.  
 Finlay & Holland, Keen St., Lismore.  
 Foley, H. G., Ross St., Inverell.  
 Flynn, Joseph, Bottle Creek, Murrumbidgee.  
 The Gloria Light Co. of A/sia, Market and  
 Clarence Sts., Sydney.  
 Gissing, H. E., Fitzmaurice St., Wagga.  
 Gladwin & Co., Singleton.  
 Gormly, N., 1 Pier Chambers, Manly.  
 Gow, J. D., Main Av., Yenda.  
 Green & Stanley, Piesley St., Orange.  
 Greenwell & Thomas, Pharmacy, Katoomba  
 St. Katoomba.  
 Gibson, W. A., 270 Beardy St., Armidale.  
 Glossop, H. R., Thirroul.  
 Glover, S. J., Woodstock.  
 Glover, W. C., Richard St., Bourke.  
 General Electric Co., Molesworth St., Lismore.  
 Grace Bros., Broadway, Sydney.  
 Galloway, W., Studios, Kurri Kurri.  
 Grenfell Motors Sales Service (G. Proctor),  
 Main St., Grenfell.  
 Grinstead, Ed. J., Lachlan St., Forbes.  
 Grose, W. J., Holden St., Redfern.  
 Gunning Motors, Gunning.  
 Hand, W. H., High St., Penrith.  
 Hamilton & Baker, 327 Pitt St., City.  
 Haines, W., 6 Julia St., Ashfield.  
 Haynes, J. A., Lismore.  
 Hawken, H. L., Bellambi.  
 Harvey, W. & Sons, Kempsey.



"Wireless House,"  
167-9 Queen Street, Melbourne.

## A.W.A. RADIO GUIDE

- Harding's Wireless, 1a Hunter St., City.  
 Hasenkam, H. C., Mudgee St., Capertee.  
 Haberecht, A. L., Henty.  
 Hain and McKillop, Cooma.  
 Hewett, Fredk., 15 Powell St., Coogee.  
 Hocken, F. G., Carrington St., West Wallsend.  
 Heriott, A. S., The Mall, Leura.  
 Howard, Geo., Broughton and Lane Cove Rds., Artarmon.  
 Home Recreations Ltd., 388 George St., Sydney.  
 Hitchman & Co. Ltd., 9 Castlereagh St., Syd.  
 Hunter Bros., Fitzmaurice St., Wagga.  
 Humphries, Cyril M., Lackey Rd., Moss Vale.  
 Head, H. R., 352 Oxford St., Paddington.  
 Hood & Heogenham, Auckland St., Bega.  
 Homes, D. E., Dubbo.  
 Howell, R. H., 19 Barlow St., City.  
 Hastings Radio Co., High St., Wauchope.  
 Haamey, A. C., Crown St., Wollongong.  
 Heath, G. W., Dowling St., Dungong.  
 Hodge, B., Argyle St., Camden.  
 Heiser, A., Cowper St., Waverley.  
 Huxly, G. H. Molong.  
 Hugill, H. W., McQuarie St., Dubbo.  
 Illingworth, A., Gibbs St., Auburn.  
 Iverach, W. A., Coolamon.  
 Ivers, H., John's River.  
 Irving, G. W., Smith St., Kempsey.  
 Jarratt, H., Gloucester.  
 James, H. K., Rosemount Ave., Summer Hill  
 Jeffrey and Moore, Tamworth.  
 Jenkins, C. A., Ramsgate Av., Bondi.  
 Jones, David, Ltd., York St., City.  
 Jones & Gittoes, Byron Bay.  
 Kibble, John T., Henry St., Deniliquin.  
 Kennedy, W. J., Grey St., Glen Innes.  
 Keynes, R. M., Isabella St., Wingham.  
 Kember, A., Gilgandra.  
 Keynes, R. M. & D. C., Taree.  
 Kitchen, R. E. A., 343 Argent St., Broken Hill.  
 Kinloch Bros., Pine Ave., Leeton.  
 Kirk, R. J., Vincent St., Cessnock.  
 Kuhner, E., Coonamble.  
 Lambert, T., Ltd., Rusden St., Armidale.  
 Le Cornu, O. C., 13 Wyalong St., Willoughby.  
 Lewis, Edgar, Kendall St., Cowra.  
 Levenson, J., 244 Pitt St., City.  
 Littlefield, G., 195 Alt St., Haberfield.  
 Lismore Electric Co., Lismore.  
 Long & Co., Cootamundra.  
 Lindon, C. A., Lachlan St., Cowra.  
 Lee, Joseph, Wellonough St., Ungarie.  
 Loder & Co., A. S., Uki.  
 Loneragan, J. W. C., Gulgong.  
 Lovett Bros., Walcha.  
 Liberty Electric, Five Ways, Rockdale.  
 Mackay & Lewis, Urunga.  
 May, A. M., Lane Cove Rd., Turramurra.  
 Mascord, W. T. J., Collins St., Corrimal.  
 May, F., Nowra.  
 Martin, R. A., Kendall St., Cowra.  
 Marshall, H. A., 94 Francis St., Bondi.  
 Mellor Bros., 232 Burwood Road, Burwood.  
 Murdoch's, in Park St., Ltd., Park St., City.  
 Murray, Joseph, 18a Whistler St., Manly.  
 Munro, F., Miller St., Gilgandra.  
 Milne, Robt., Byron St., Inverell.  
 Mead, L. L., "Uralba," Ballina.  
 Moses, A. G., junr., Wee Waa St., Walgett.  
 Morrison, A., Macksville.  
 Mockler Bros., Howick St., Bathurst.  
 Morrice, G. O., "Murrenambie," Dalgety.  
 Mick Simmons Ltd., 720 George St., Sydney.  
 Meagher, John & Co. Ltd., Forbes.  
 Mellor, G., 81 Auburn Rd., Auburn.  
 Miller & Co., Cressy St., Deniliquin.  
 Mitchell, A. J., 12 Sloane St., Summer Hill.  
 Mynssen, W. J. E., Farm 1558, Leeton.  
 Maurice, Stuart, 215 Anzac Pde., Kensington.  
 McMahon, N., Ariah Park.  
 McMahon, A., Palm Ave., Leeton.  
 McNamara, G. E., Maitland St., Narrabri.  
 McNamara, B., 489 Pitt St., Sydney.  
 McKee, J., Keen St., Lismore.  
 Marks Electrical & Radio, 66 King St., Sydney.  
 McDonald, A., 21 Ocean St., North Bondi.  
 McDonald, Joseph R. H., Wharf St., Murwillumbah.  
 McPherson, A. T., Burrowa St., Young.  
 Neal, A., Parramatta Rd., Auburn.  
 Northern Electric Co., 265 New South Head Rd., Edgecliffe.  
 Noble & Co., E., 256 Anzac Pde., Kensington.  
 Nock & Kirby, 186 George St., Sydney.  
 Northern Rivers Radio, Lismore.  
 Nomchong, P. C., Wallace St., Braidwood.  
 Newport & Baker, "Beverley," Mt. Russell.  
 Onus, J. G., Howick St., Bathurst.  
 Oliver Bros., Gunnedah.  
 Ormerod, H. E., Garfield St., Wentworthville.  
 Osborne & Iverach, Coolamon.  
 Parr, D., Newsagency, Collaroy Beach.  
 Perry, Roy S., 1 Burradoo St., Bowral.  
 Peacocke, V. R., Bingara.  
 Perfrement, C. W., Goonoo Goonoo Rd., Tamworth.  
 Pinnock, H., 114 Wollongong Rd., Arncliffe.  
 Piddington & Simmons Beardy St., Armidale.  
 Pathfinder Radio Co., 53 Shepherd St., Sydney.  
 Pullen, H. & F., "East Anglia," Young St., Wahroonga.  
 Port Kembla Garage Eng. Co., Port Kembla.  
 Powell, J. N., 247 Marrickville Rd., Marrick-Pell, E. M. B., Carp St., Bega.  
 Pinkerton, H. W., Goulburn St., Crookwell.  
 Pile, C., Bulahdelah.  
 Pye, E. J. D., Gt. North Rd., Gladesville.  
 Radio Wireless Mfg. Co., 317 George St., City.  
 Ramsay, Sharp & Co., 217 George St., City.  
 Radio & Electrical Supply Co., 40 Pitt St., City.  
 Rapken, Jack, 16 George St. West.  
 Reliance Radio Co. (C. H. Weyman), 2nd Floor, Wembley House, Railway Square, Sydney.  
 Russell, Noel, & Co., South Grafton.  
 Russell's, Ltd., Goulburn.  
 Sandel, O., 140 Balfour Rd., Bellevue Hill.  
 Saunders, C. A., Warren.  
 Schofield, E. C., 468 Old South Head Road, Bondi Junction.  
 Scott, N., Hoskin St., Temora.  
 Seagrave, L. H., Bulli.

## A.W.A. RADIO GUIDE

### QUEENSLAND.

- Shaw, P., Moree.  
 Sheridan, M. A., 177 Marrickville Rd., Marrickville.  
 Simmons, Mick, Ltd., George St., Haymarket.  
 Simpson, A. J., "Oban," Inverell.  
 Slingsby & Coles, 482 Pitt Street, Sydney.  
 Smithhurst, E. J., 69 Thompson St., Wagga.  
 Smart, W. G., 394 High St., West Maitland.  
 Smith, Percy T., Yass St., Gunning.  
 Smith, R. A. J., Hazelbrook.  
 Smith, W. E., Ltd., 310 George St., Sydney.  
 Smithers, L. J., Manilla.  
 Spooner, G., 3 Station St., Rockdale.  
 Squelch, T. A., Bangalow.  
 Storm, E. J. Taree.  
 Strangman, R. C., 322 Lane Cove Rd., Crow's Nest.  
 Sternbeck, E. A., Main St., Cessnock.  
 Stubble & Harvey, Eurimbla Ave., Randwick.  
 Symonds, R. C., 29a Ballast Pt. Rd., Balmain.  
 Summer, S., Darling Point.  
 Swain & Co., Pitt St., Sydney.  
 Tatham, R. E., 99 Edgecliff Rd., Woollahra.  
 Thomson, D., Rydale Rd., Ryde.  
 Thompson, E., 50 Forest Rd., Bexley.  
 Treeve, J. H. P., Dunedoo.  
 Tripp, Chas., Queen St., Campbelltown.  
 Tighe & Tighe, Market St., Mudgee.  
 Thompson, E., Windeyer, N.S. Wales.  
 Tingle, J. G., The Pharmacy, Maroubra Junc.  
 Turnbull, R. W., 2 Ethel St., Burwood.  
 Taylor, C. R., Railway Av., Queanbeyan.  
 Universal Distributors Co., Eastlake, Canberra.  
 United Motor Owners, Quirindi.  
 Val, G. Radio Co., Military Rd., Cremorne.  
 Vance & Williams, 70 Carlton Pde., Carlton.  
 Venables & Co., Forbes.  
 Vallentine, J. W., 355 Penshurst St., Willoughby.  
 Vale, Harold, & Co. Ltd., 12 Loftus St., Sydney.  
 Walcott & Jeffries, Delegate.  
 Wallace, H., Carp St., Bega.  
 Walcot, T. M., Delegate.  
 Waters, Robt., Cronulla St., Cronulla.  
 Wallace, Miss F. V., 6 Royal Arcade, City.  
 Wels, H. G. W., 44 Beaumont St., Hamilton.  
 Wedgewood, W. D., "Ulomo," Baan Baa.  
 White, W. G., Welham St., Beecroft.  
 White & Hosier, Chloride St., Broken Hill.  
 Williams, E. K., Thirroul.  
 Williams, H., 7 Brand St., Artarmon.  
 Wiltshire, G. E., Pinchin's Lane, Lismore.  
 Willis, J. H., E. Kangaloon.  
 Wiltshire, G., Goolmanger.  
 Wilson Bros., Main St., Lithgow.  
 Williams, H. & Sons, Crown St., Wollongong.  
 Williamson's Motor Garage, Yass.  
 Wiles, W. Harry, 23 Pitt St., Sydney.  
 Wilson, N., 5 Joseph St., Ashfield.  
 Wireless Co. (The), (G. L. Thompson), Moree  
 Wood, W. A., "Rosedale," Parkes.  
 Woolley, W., Marks Pt., Belmont, Newcastle.  
 Wood, H. S. C., Royal Hotel, Mungindi.  
 Wolridge, E. C. R., 30 O'Connell St., Sydney.  
 Wulf, C. A., 107 Summer St., Orange.  
 Wyalong Motors, West Wyalong.  
 Wyatt, R., Ramsay Rd., and Fairlight St., Five Dock.
- A.B.C. Motor Agency, Gympie.  
 Auto Electric Co., Cairns.  
 Blackall Motor Co., Blackall, Queensland.  
 Brisbane Equipment Co., 453 Ann St., Brisbane.  
 Beirne, T. C. & Coy., Brunswick St., Valley.  
 Bowry, Alfred, Mosman St., Charters Towers.  
 Bode & Co., Winton.  
 Canada Cycle & Motor Agency, East Street, Rockhampton.  
 Cullinanes Ltd., Mary Street, Gympie.  
 Chandler, J. B. & Coy., 45 Adelaide Street, Brisbane.  
 Callon, I. A., Nerang Street, Southport.  
 Central Q'ld. Engineering & Motor Coy., Zaron & Pestorius, Hawthorne Street, Blackall.  
 Cheetham, Thomas, Currie Street, Nambour.  
 Clapham, S., Gladstone.  
 Engels, F. A., Edward Street, Brisbane.  
 Electric Energy Supply Coy., Warwick.  
 Ewings, W. E., Dalby.  
 Evans & William, Pomona, N.C.R.  
 Floude & Lawrence, 40 William St., Rockhampton.  
 Finney, Isles & Co. Ltd., Queen & Adelaide Streets, Brisbane.  
 Foster, J. R., 191 Elizabeth St., Brisbane.  
 Fraser, F., Ingran, Queensland.  
 E. Gold, Toowoomba.  
 Greenlees, J. T., Martindale Street, Corinda.  
 Haigh, W. & Co., Nicholas Street, Ipswich.  
 Harris, F. W., East St., Rockhampton.  
 Hobler, H. L., 8 Lennox St., Rockhampton.  
 Jones, P. M., Goonoon St., Gladstone.  
 Lunn, J. (Chemist), Loudon Street, Sandgate.  
 Lord, H. M., McDowall Street, Roma.  
 McWhirters Ltd., Brunswick & Wickham Sts., The Valley.  
 Marsh & Webster, Mackay.  
 Morren, H. K., Florence St., Wynnum.  
 McCulloch, Alec., Brisbane.  
 Nicholls Pharmacy, Flinders St., Townsville.  
 North Queensland Motors, Sturt St., Townsville.  
 Outridge, P. H., McKenzie St., Wondai.  
 Overells Ltd., Brunswick St., The Valley.  
 Philp & Rolfe, 80 Queen St., Brisbane.  
 Queensland Pastoral Supplies Ltd., Bowen St., off Ann St., Brisbane.  
 Queensland Electrical Co., Warwick.  
 Randell, C. O., Innisfail.  
 Rahman, A. H., Naval Hall Buildings, Maryborough.  
 Ramsay, W. G. L., Oakey.  
 Robertson & Provan, Ruthven St., Toowoomba.  
 Radio Service Depot., C/o. D. R. Mullins, Mt. Morgan.  
 Rapson's Music Co., 354 George St., Brisbane.  
 Riverina Motors, Narandera.  
 Ridgway, C. A., 708 George St., Sydney.  
 Rice, J. C., Moombie, Holbrook.  
 Robertson, S., Molesworth St., Hillston.  
 Symons & Head, East & William Sts., Rockhampton.  
 Shaw & Sons Ltd., The Granite Buildings, 241 Queen St., Brisbane.  
 Slayter & Kavanagh, Springsure.

## A.W.A. RADIO GUIDE

Simmons, Mick, Ltd., Queen St., Brisbane.  
Strand Motor Co., Corner Gregory St. & The Strand, Townsville.  
Smith, F. E., Hawthorne St., Roma.  
Somerville & Sheedy, Municipal Buildings, Townsville.  
Shambler, H., Cooroy.  
Sampson, A. S., Charlotte St., Cooktown.  
Thomas Radio Coy., Adelaide St., Brisbane.  
Tait, Robin, Sturt St., Charleville.  
Watson, R., Ellena St., Maryborough.  
Warwick Friendly Society Assn., Palmerin St., Warwick. (H. C. Rowland, Sec.)  
Waters, L., Innisfail.  
Walker, Charles, Devonport St., Clifton.  
Wilson, G., Dutury & Eildon Rds., Windsor.  
Williams, F., Bradshaw Estate, Woolloowin.  
Watson, R. G., Goondiwindi.  
Wireless Supplies Ltd., Queen St., Brisbane.  
Wireless House, Edward St., Brisbane.  
Wilson Bros., Stanthorpe.

### SOUTH AUSTRALIA.

Adelaide Radio Co., 146 Rundle St., Adelaide.  
Aeolian Co., 58 Rundle St., Adelaide.  
Andrews Radio Store, 8 Bowman's Arcade,  
Atkins Ltd., Chas., 88 Currie St., Adelaide.  
A.G.E. Co. Ltd., 25 Grenfell St., Adelaide.  
Bailey, G., Commercial St., Mount Gambier.  
Bullock, J., 65 Rundle St., Adelaide.  
Coen, Louis, 75 Rundle St., Adelaide.  
Dobbie, A. W., & Co., 99 Rundle St., Adelaide.  
Duncan & Fraser Ltd., St. Vincent St., Port Adelaide.  
Edison Swan Electric Co., Grenfell Street, Adelaide.  
Eddys Ltd., Rundle St., Adelaide.  
5CL Radio & Electrical Co., Rundle Street, Adelaide.  
Francis, E. J., Ellen St., Port Pirie.  
Green, D., & Sons, 119 Parade, Norwood.  
Haig & Co. Ltd., Watson Tce., Mount Gambier.  
Harringtons Ltd., 10 Rundle St., Adelaide.

Harris Scarfe Ltd., Grenfell St., Adelaide.  
Holborn, A. H., Victor Harbour.  
Marshall, J. & Co., Rundle St., Adelaide.  
Metro Electrical Radio, Gawler Place, Adelaide.  
Newton, McLaren Ltd., Leigh St., Adelaide.  
Nicoll, G. S., Peake St., Karoonda, S.A.  
Rook & Co., W. H., 93 Rundle St., Adelaide.  
Rosewarne, J. H., Graves St., Kadina.  
Speed, T., Cape Spencer.  
Taylor, E. A., 57 Jetty Rd., Glenelg.  
Unbehaun & Johnstone, 9 Rundle St., Adelaide.  
United Distributors Ltd., 27 Chesser Street, Adelaide.

### WEST AUSTRALIA.

Atkins, W. A., Ltd., 894 Hay St., Perth.  
Craig & Coy., 37 King St., Perth.  
Forrester, M. G., Yuna, W.A.  
Harris, Scarfe & Sandovers, Hay St., Perth.  
Westralian Farmers, Wellington St., Perth.  
Wright & Fendick, 167 James St., Perth.

### TASMANIA.

Hodgkinson, E. F., Ulverstone.  
Lovett, L., 64 Murray St., Hobart.  
Medhurst & Sons, Quadrant, Launceston.  
Slater, J. F., Sheffield.  
Taylor, C. P., Ulverstone.  
White, D. M., Steele St., Devenport West.  
Gatenby, Max, Surprise Bay, King Island.  
King, John & Sons, King's Corner, Launceston.  
Bonner, A. L., 98 Charles St., Launceston.  
Styant-Browne, F. & Co., 112 Brisbane St., Launceston.  
Hopkins, J.; Franklin.  
United Distributors Ltd., 66 Charles St., Launceston.  
Hill, W. P., Stewart St., Devonport.  
Howe & Simmons, 70 Charles St., Launceston.  
Matthews, F. J., Latrobe.  
Parsons & Gilmour Pty. Ltd., Ulverstone.

## Wireless Publications.

OBTAINABLE FROM BOOKSTALLS OR FROM AMALGAMATED WIRELESS  
(A/SIA) LTD.

Title.	Author.		
Mast and Aerial Construction ..	Addyman	Arithmetic of Electric Measurements	Hobbs
Arts & Science Series, No. 3.— Lessons in Wireless Telegraphy	—	Standard Tables of Equation ..	Hoyle
Arts & Science Series, No. 4.— Operation of Wireless Tele- graphy .. . . . .	—	Home Constructor's Wireless Guide	James
Arts & Science Series, No. 6.—Ex- perimental Wireless Construc- tion .. . . . .	—	Morse Code Chart (Celluloid) ..	—
Arts & Science Series, No. 7.— Home-made Elec. Apparatus	—	Calculations and Measurements of Inductance and Capacity .. . .	Nottage
Arts & Science Series, No. 8.— Home-made Elec. Apparatus	—	Auto-time Morse System .. . . .	Perry
Arts & Science Series, No. 9.— Home-made Elec. Apparatus	—	Magnetism and Electricity for Home Study .. . . . .	Penrose
Wireless Telephony .. . . . .	Bangay	Useful Notes on Elec. and Mag- netism, Book 1, Direct Current	Penrose
Oscillation Valve .. . . . .	Bangay	Useful Notes on Elec. and Mag- netism, Book 2, Alternating Current .. . . . .	Penrose
Vacuum Tubes .. . . . .	Bucher	Useful Notes on Elec. and Mag- netism, Book 3, H.F. Current and Wave Production .. . . . .	Penrose
Practical Wireless Telegraphy ..	Bucher	Useful Notes on Elec. and Mag- netism, Book 4, 1½ K.W. Ship Set .. . . . .	Penrose
How to Conduct a Radio Club .	Bucher	Useful Notes on Elec. and Mag- netism, Book 5, The Oscillation Valve .. . . . .	Penrose
Prepared Radio Measurements ..	Batcher	Morse Made Easy .. . . . .	Rye
How to Pass U.S. Govt. Exam.	Bucher	Alternating Current .. . . . .	Shore
Selected Studies in Elementary Physics .. . . . .	Blake	Text Book of Wireless Telegraphy, Part 1 .. . . . .	Stanley
Wireless Telephone: What it is ..	Coursey	Text Book of Wireless Telegraphy, Part 2 .. . . . .	Stanley
How to Build Am. Valve Stations	Coursey	Test Questions, Series 1 .. . . .	—
Telephony Without Wires .. . . .	Coursey	Test Questions, Series 2 .. . . .	—
Construction of Amateur Valve Stations .. . . . .	Douglas	Test Questions, Series 3 .. . . .	—
Wireless Telegraphy and Telephony	Dowsett	Thermionic Tubes .. . . . .	Taggart
Continuous Wave Wireless Tele- graphy .. . . . .	Eccles	Model Answers to Test Questions, Series 1 .. . . . .	—
Weather Book .. . . . .	Elgie	Model Answers to Test Questions, Series 2 .. . . . .	—
Ezi-Wiring, No. 1: A 3-valve Post Receiver Series .. . . . .	—	Model Answers to Test Questions, Series 3 .. . . . .	—
Uncle Jack Frost's Wireless Yarns	Frost	Dictionary of Technical Terms, 3rd Ed. .. . . . .	Ward
Electrons, Electric Waves & W/T	Fleming	Dictionary of Technical Terms, 1st Ed. .. . . . .	Ward
Fifty Years of Electricity .. . .	Fleming	Wireless Atlas of the World .. . .	—
Thermionic Valve, 2nd Ed. .. . .	Fleming	Short Course in Elementary Maths.	Willis
Amateur's Book of Wireless Circuits	Haynes	Practical Amateur Wireless Stations	White
Practical Wireless Sets for All ..	Harris	Practical Aviation .. . . . .	White
Crystal Receivers for Broadcast Reception .. . . . .	Harris		
A.B.C. of Wireless, and How to Work Your Broadcast Receiver	Harris		
Your Broadcast Receiver .. . . .	Harris		
A.B.C. of Wireless .. . . . .	Harris		

## An Ideal and it's Inspiration

---

To apply the science of wireless to the improvement of communication facilities between Australia and Great Britain; to link up Australia with the Dominions and foreign countries; to break down the isolation that retards the development of Australia's vast inland areas; and by means of radio broadcasting to minister to the entertainment of both city and country dweller, is the practical objective of Amalgamated Wireless (Australasia) Limited.

Concurrently to expand the wireless traffic facilities now enjoyed by travellers at sea, and extend the publication of ocean newspapers to every passenger ship, is a feature of the Company's marine programme.

Though Radio is a public utility, whose services are available to all, its wonders never cease to exercise a fascination that far transcends the common-place. To the most experienced Radio engineer, as to the amateur, its manifestations connote a new age in scientific achievement; wonderful as have been its attainments during the past quarter of a century, they are but the forerunner of a future that exceeds the imaginings of the most optimistic visionary.

The genius that actuated Marconi in his discoveries is to us to-day an inspiration to develop throughout Australia the fruits of his humanitarian invention for the benefit of all.





