

AUSTRALIA'S DYNAMIC ELECTRONICS MONTHLY

Win a Toshiba CD player
CD PLAYERS BUYERS GUIDE

Electronics Today

INTERNATIONAL



\$2.95*

NZ \$3.95 incl G.S.T.

DECEMBER 1986

BIRTH OF A 16-BIT COMPUTER

- TESTING SPEAKER CABLE – is it a genuine upgrade?
- ATN-7's RACECAM
- CULTIVATING BIOCHIPS



POWER SUPPLY • LOTTO SELECTOR • NOISE REDUCTION



CRUSADER IS YOUR SUPPLY SOURCE

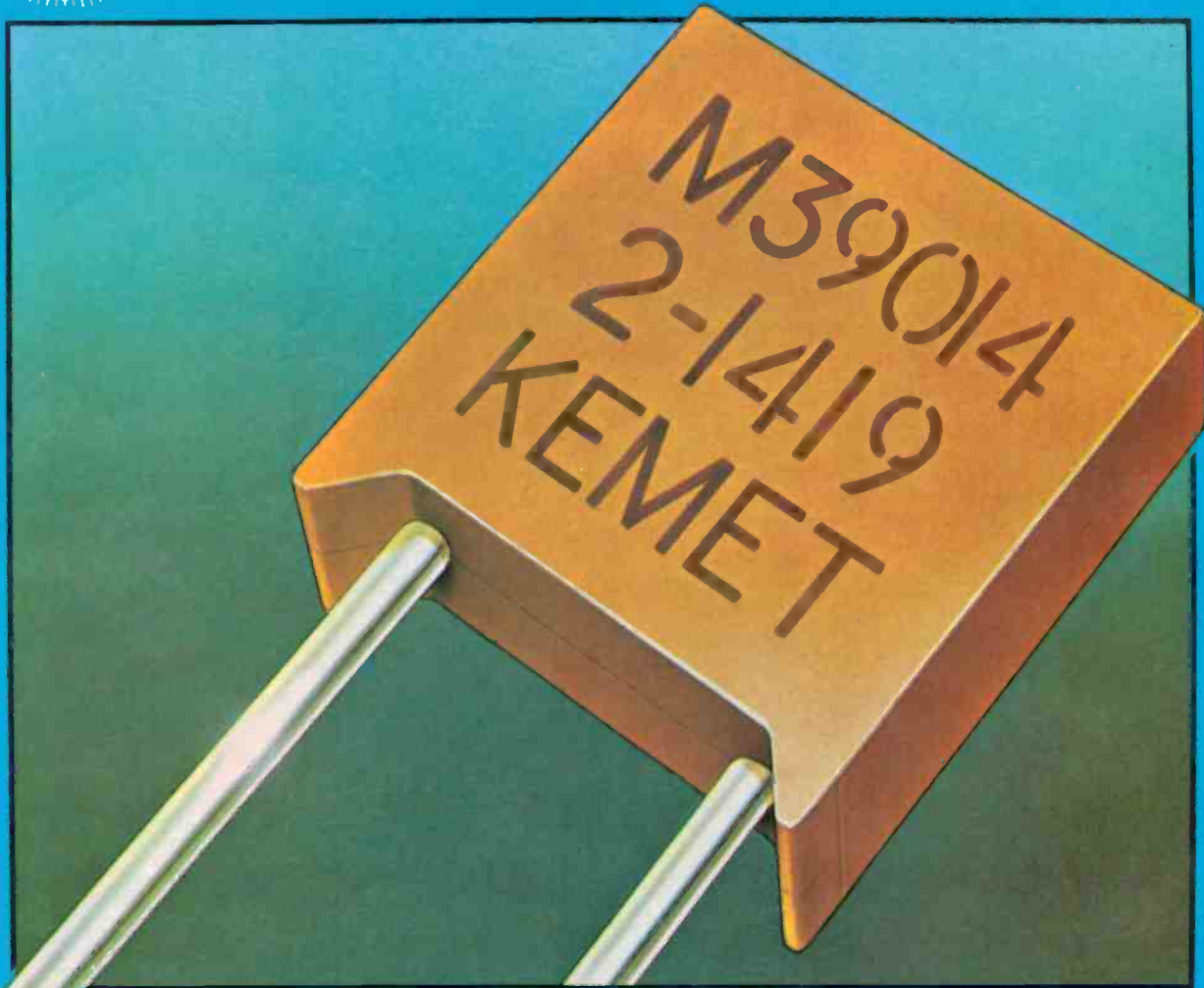

WS6536E SOLUTION

KEMET® Is The Source

**Higher Production. Improved Solderability.
Easier Inspection. Same Compact CKR06 Size!**

Meeting tough specs like WS6536E (weapons) and DoD 2000 is as easy as saying KEMET®

Our revolutionary new-design CKR06 molded ceramic capacitor solves some knotty soldering and inspection problems that may have been making military circuits a headache for you.

It features an imaginative molded-in standoff that improves solder flow around the pre-tinned radial leads. And lets you easily inspect the critical solder fillet between circuit board and component case. So you get higher production yields with assured reliability.

The new KEMET CKR06 meets all applicable requirements of MIL-C-39014/02 for military components, yet maintains the same overall dimensions as standard units (.300" x .300" x .100"). The result: better solderability performance and greater productivity, without increasing board space.

Improve your component on-board placement costs, starting now. Ask for specs, pricing and engineering samples of our new CKR06 capacitor. KEMET helps you get down to business.



Arcotronics

Film Chip Capacitors

Metallized Polyester

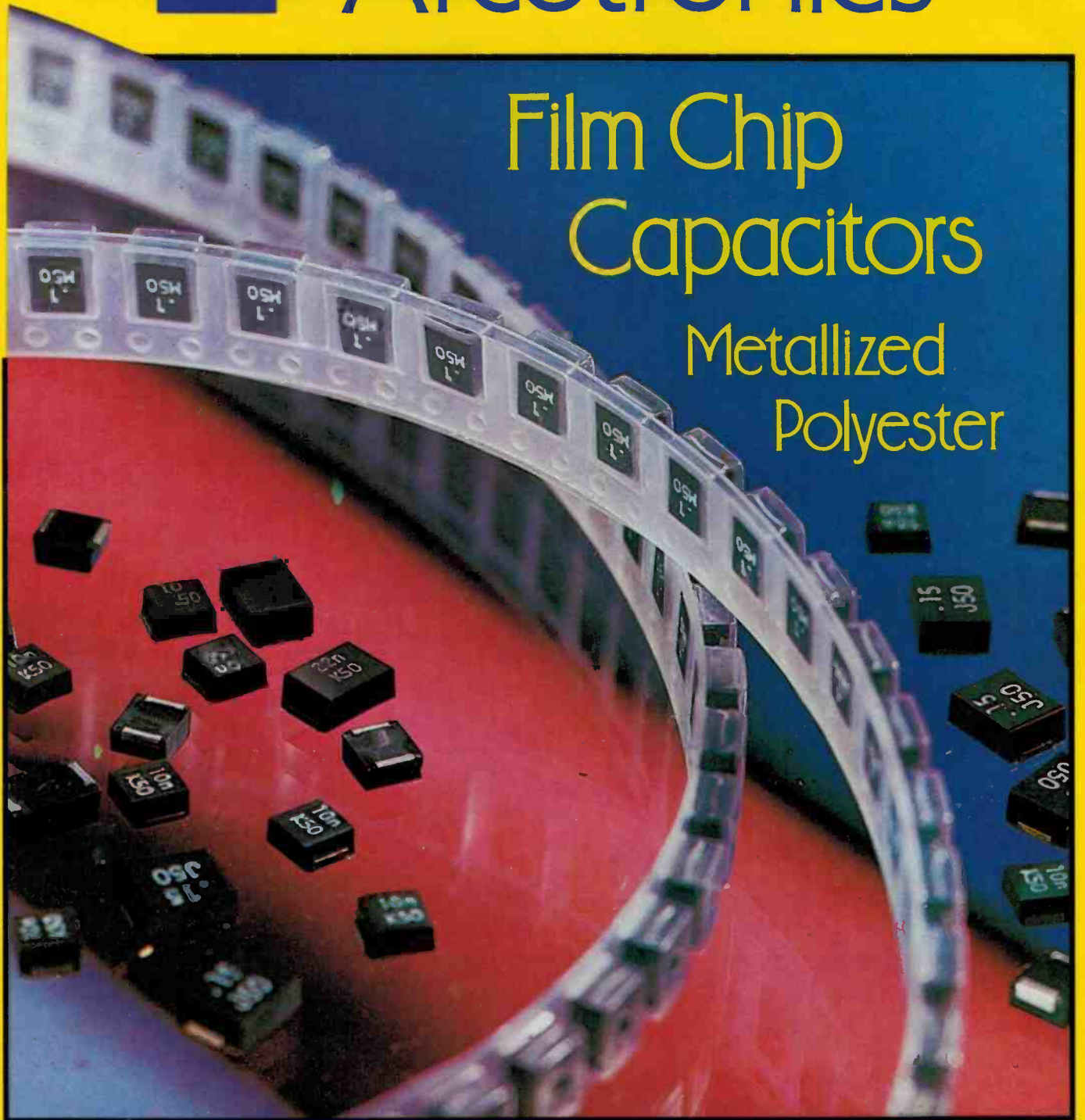

**CRUSADER ELECTRONIC
COMPONENTS PTY. LTD.**

81 PRINCES HWY, ST. PETERS NSW 2044
Phone 519 5030 516 3855 (3 Lines) 519 6685

Telex 123993. Telefax 517 1189.

SYDNEY: GEORGE BROWN & CO PTY. LTD. Phone 519 5855; GEOFF WOOD ELECTRONICS PTY. LTD. Phone 810 6845; **WOLLONGONG:** MACELEC PTY. LTD. Phone 29 1455; **CANBERRA:** GEORGE BROWN & CO. PTY. LTD. Phone 80 4355; **NEWCASTLE:** D.G.E. SYSTEMS PTY. LTD. Phone 69 1625; **MELBOURNE:** R.P.G. AGENCIES PTY. LTD. Phone 439 5834; JESEC COMPONENTS Phone 598 2333; **ROSNIK DISTRIBUTORS PTY. LTD.** Phone 874 3424. **GEORGE BROWN & CO. PTY. LTD.** Phone 419 3355; **BRISBANE:** L.E. BOUGHEN & CO. Phone 369 1277; **COLOURVIEW WHOLESALE PTY. LTD.** Phone 275 3188; **ADELAIDE:** PROTRONICS PTY. LTD. Phone 212 3111; **D.C. ELECTRONICS PTY. LTD.** Phone 223 6946. **PERTH:** SIMON HOLMAN & CO. PTY. LTD. Phone 381 4155; **PROTRONICS PTY. LTD.** Phone 362 1044.

AutoCAD[®] is PCB

The Auto-Board System

The Auto-Board System provides the designer with a powerful design tool with the capability of having a prototype on your desk by the end of the day.

Schematic Capture: Creates a schematic diagram to extract interconnection information (netlist) and symbols to Australian Standards.

PCB Layout: Provides the ability to position electronic packages on virtually any size or shape board.

Auto-routing: Automatically connects traces to components with a 70-90% success rate.

Used in conjunction with AutoCAD[®], the AutoBoard System provides an extensive symbol and component library and complete editing facilities.

For Details contact Entercom Computer Co. (03) 429 9888

SATCAM

SATCAM is a powerful design-assist tool for the professional electronics engineer. SATCAM incorporates many features not found in generic PCB-CAD packages, such as photo-plotting, a comprehensive symbol/component library and CNC drill generation. Among its other features are:

- Fast Professional Schematic Designs
- Cost effective PCB designing
- Automatic netlists and costing
- Photo tooling and NC control drivers
- Total Bureau support
- Supported on 30 different microcomputers
- Library of 30,000 components.

For details contact International Systems Database. Sydney (02) 498 6522 Melbourne (03) 870 3830

The Auto-Board System and SATCAM are complete electronics/PCB CAD packages which fully integrate with AutoCAD[®], the leading Computer-Aided Design solution. Whether you are a small or large company, AutoCAD[®] and SATCAM or Auto-Board System can increase your productivity and enhance your creativity.



The NCR PC8 Advanced Technology (AT) PC is an ideal CAD workstation with its 8 MHz 80286 processor and native 640 by 400 colour graphics capability.

Houston Instruments have defined the industry standard in low cost, high quality plotting with its best selling, A1 size, 16 ips DMP-52 plotter.



AUTOCAD[®]
NUMBER ONE IN AUSTRALIA
AND WORLDWIDE

For further information or demonstration contact your nearest "Authorized AutoCAD[®] Dealer" by contacting us at ...
136 BRIDE RD. RICHMOND
VICTORIA 3121 AUSTRALIA.
PHONE: (03) 429 9888 TELEX: 30625 ME1400

ENTERCOM

Electronics Today

INTERNATIONAL

FEATURES

VLSI device testing The modern circuit has called for new ways of testing	28
Biochemical computer chips Better prospects in their cultivation	30
Instrumenting with PCs Watch out test and measurement — here comes the PC!	32
Inside your computer The communications standard	64
Electronic India Where amateur radio flourishes	68
Signalling African history Verification of changes in the dark continent	72
South Australia The technical state	89
Buyers guide to CD players What's available and what to look for	95
Racecam at the Indianapolis 500 Exporting some ATN-7 technology	104

REVIEWS

Testing speaker cable Does expensive speaker cable really work?	22
Beat generation Casio RZ-1 sampling drum machine	82
Successful Impact Impact's Laser 400 printer	86

PROJECTS

ETI-283: Electronic lotto selector	39
ETI-1533: 300 W switcher Part 2	46
ETI-1616: 16-bit computer	54
ETI-1407: Noise reduction system	58

OFFERS

Toshiba/Goldring/ETI CD player competition	100
Subscriptions offer	106

DEPARTMENTS

News Digest	6	Advertisers Index	9
Feed Forward	34	Dregs	110
New Products	74		

COVER: Photography Peter Beattie, design Brian Jones.

EDITOR

Jon Fairall B.A.

ASSISTANT EDITOR

Mary Rennie B.A.

EDITORIAL STAFF

S. K. Hui B.Sc. (Hons), M.Eng.Sc. MIEEE, MIREE
Terry Kee B.Sc. (Hons), M. Phil.

DRAUGHTING

Bruce Mennie

DESIGNER

Brian Jones

ART STAFF

Ray Eirh

PRODUCTION

Mark Moes

ADVERTISING MANAGER

Peter Hayes B.Sc.

ADVERTISING PRODUCTION

Brett Baker

ACOUSTICAL CONSULTANTS

Louis Challis and Associates

RF CONSULTANTS

Associated Calibration Laboratories

PUBLISHER

Michael Hannan

MANAGING EDITOR

Leo Simpson B.Bus.

HEAD OFFICE

180 Bourke Road, (PO Box 227, Waterloo, NSW 2017)

Alexandria, NSW 2015.

Phone: (02) 693-6666.

Telex: AA74488, FEDPUB.

Federal Facsimile: (02) 693-2842.

ADVERTISING

New South Wales

Mark Lewis (02) 693-6666

Victoria and Tasmania

Virginia Salmon (03) 662-1222

Queensland

Peter Hayes (02) 693-6666

South Australia and Northern Territory

Dane Hansen (08) 212-1212

Western Australia

Estelle de San Miguel

New Zealand

John Easton, 79-6648 (Auckland)

OFFICES

New South Wales: The Federal Publishing Company, 180 Bourke Road, Alexandria, NSW 2015. Phone (02) 693-6666. Telex: AA74488 FEDPUB.

Victoria and Tasmania: The Federal Publishing Company, 23rd Floor, 150 Lonsdale Street, Melbourne, Vic. 3000. Phone: (03) 662-1222. Telex: AA34340, FEDPUB.

South Australia and Northern Territory: John Fairfax & Sons, 101-105 Waymouth Street, Adelaide, 5000. Phone (08) 212-1212. Telex: AA82930.

Queensland: The Federal Publishing Company, 26 Chermiside Street, Newstead, Qld. 406. Phone: (07) 854-1119. Telex: AA145520.

Western Australia: Estelle de San Miguel, John Fairfax & Sons, 454 Murray Street, Perth, WA 6000. Phone: (09) 481-3171. Telex: AA92635.

New Zealand: 3rd Floor, Communications House, 12 Heather Street, Parnell, Auckland. PO Box 8770, Symonds St, 37-291. Telex NZ63122. Phone 79-6648 (Auckland).



ELECTRONICS TODAY INTERNATIONAL is published and distributed monthly by the Electronics Division of the Federal Publishing Company Pty Limited, 180 Bourke Road, Alexandria, NSW 2015 under licence from Double Bay Newspapers Pty Limited, General Newspapers Pty Limited and Suburban Publications Pty Limited. Printed by Hannanprint, Sydney. Distributed by Magazine Promotions. *Maximum and recommended Australian retail price only. Registered by Australia Post, Publication No NBP0407. ISSN No 0013-5216. COPYRIGHT © 1985, Double Bay Newspapers Pty Limited, General Newspapers Pty Limited and Suburban Publications Pty Limited (trading as "Eastern Suburbs Newspapers").

Solar winners

A group from the Joint Microelectronics Research Centre (JMRC) at the University of New South Wales, headed by Dr Martin Green, has announced the development of a solar cell with 19.1% efficiency. This significantly improves on the 11% to 13% efficiency typical of commercial cells. The news is spectacular because the process that produced them is claimed to be commercially viable.

The JMRC group first hit the news in October last year when the team announced the world's most efficient solar cell under unconcentrated light. This glory had to be shared a little later when a team from Stanford University developed a cell with an efficiency of 27.5%, but under highly concentrated light.

The essence of the earlier JMRC development was to etch 10 µm grooves into the surface of the silicon. This increases the efficiency of the cell by reducing the reflection of incidence light.

At Stanford, a system of fresnel lenses was used to focus the sun's rays on the active surface. However, this system requires a sun-seeking active lens and can only use

the direct component of the sun's radiation (typically about three quarters of the total).

Both systems are too expensive for normal commercial use. The Stanford model has its price effectively set by the sophisticated lensing and seeking system. The high degree of purity required to achieve the JMRC result is obtainable only at a price too. However, there is great interest in those cells for use in concentrated systems.

The JMRC team has spent this year looking at ways of making their ideas work in less expensive materials — the types that are used in normal production. They have been working with standard substrates taken from BP So-

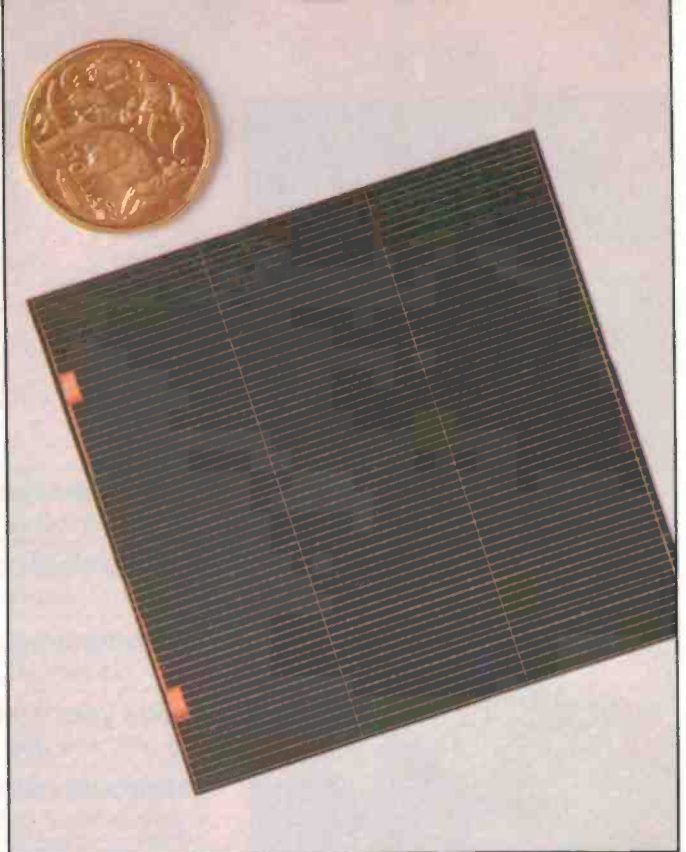

A high efficiency laser-grooved cell from the JMRC.

lar's production line. Their process uses a laser to cut very narrow and deep slots in the silicon which are then plated full of copper. This results in a highly conductive metal grid that obscures only 2% of the

silicon surface. BP Solar is moving towards mass production of these laser-grooved solar cells and pilot production should begin next year.

Wiring the CBD

Melbourne's Central Business District telecommunications system will be able to transmit more information at greater speed because of the replacement of the existing copper cable network with fibre optics.

Olex Cables has won a bid to supply Telecom with 44 kilometres of optical fibre cable for the new system. It's currently being installed in existing cable ducts.

Manager of Olex's Fibre Optics Division, Mr Brian Wright, says the new system will give Melbourne's CBD a long overdue, high-quality communications system. "The fibre optic cable network will allow for high-speed, high-quality information transmission and will give Telecom a strategic presence in optical fibre wideband networks and switching systems in Melbourne's CBD.



A sample of the Olex optical fibre cable used by Telecom for the Melbourne CBD telecommunications project.

"It will also allow Telecom to develop engineering expertise in working with optical fibre cable distribution, wideband office networks and wideband switching systems," Mr Wright said.

The multimode optical fibre network consists mainly of

30-fibre cable with some sections of 12-fibre and 60-fibre cable. The cable sheath is constructed of polyethylene and is filled with jelly. Each fibre used inside a building will also have a flame-retardant coating for safety purposes.

The fibre-optic network is being installed alongside existing copper cables, and will run in a loop through the Batman, Lonsdale, Exhibition and Russell Street exchanges.

Olex will supply 95% of the fibre needed for the project. Total cost is \$440,000.

Studying the greenhouse

Scientists have long known that the atmosphere acts as a greenhouse, letting in sunlight and preventing much of the heat from escaping. The greenhouse effect has been expanding for the past 50 years and will increase with the continued use of fossil fuels that release carbon dioxide into the atmosphere, blocking heat from escaping to space.

The anticipated change in the greenhouse effect caused by increased carbon dioxide is less than about 1 per cent. Scientists believe that even this small amount of change will be significant and could be associated with droughts and rising sea levels. However, reliable estimates of how the Earth's climate will be altered by the greenhouse effect are not yet possible.

Winds and ocean currents are another important influence on the Earth's climate because they are closely related to the flow of energy from the sun to the Earth and space. Some scientists think that changing cloud patterns will alter the energy flow and influence the amount of heat stored in the ocean, thereby modifying the movement of heat from one part of the ocean to another.

Earth's energy budget has been studied for decades with

sounding rockets, balloons and satellites. However, the studies have been limited by incomplete coverage and sporadic observations.

Now NASA is starting to see results from some long term satellite studies. Preliminary data from NASA's Earth Radiation Budget Experiment (ERBE) suggests that clouds reflect more heat than they retain. Clouds appear to cool Earth's climate, possibly offsetting the atmospheric greenhouse effect.

The ERBE instruments measure Earth's heat budget, the amount of sunlight that reaches and is absorbed by Earth and the amount of energy radiated back to space. Even small changes in any component of the budget can have important effects on weather and climate. The instrument's accuracy in identifying clouds and clear parts of the atmosphere is helping to resolve many scientific questions about the future of Earth's climate.

ERBE is a three-satellite project that began in October 1984, when ERBS was deployed into orbit from the shuttle, Challenger.

A second ERBE instrument package is aboard NOAA-F, a National Oceanic and Atmospheric Administration weather satellite launched into

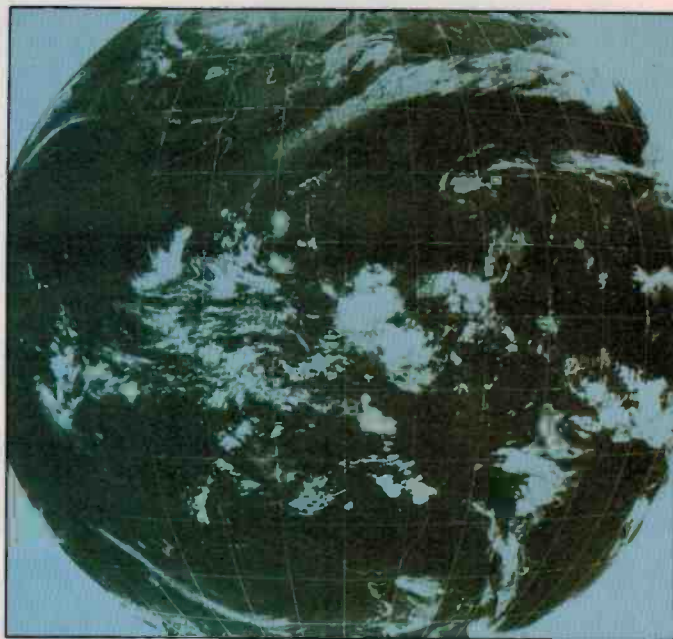

polar orbit in December 1984. A third ERBE package is scheduled to be sent into polar orbit aboard the NOAA-G satellite later this year.

The ERBE instruments measure the average monthly heat budget on regional, zonal and global scales, track the seasonal movement of heat from the tropics to the poles and determine the average daily variation in heat on a 620-mile regional and a monthly scale.

Each ERBE package contains two radiometer instruments called a scanner and a non-scanner. The scanner is a narrow field-of-view scanning radiometer that makes shortwave

measurements of reflected solar energy and longwave measurements of Earth-emitted energy.

The non-scanner has two wide field-of-view sensors that view the entire disc of Earth from limb to limb, two medium field-of-view sensors that view a 10-degree region of Earth and a solar monitor that measures the total output of the sun's radiant energy.

For the next several years, a team of scientists from around the world will continue to examine ERBE data in an attempt to improve understanding of the global heat flows that interact to keep Earth's climate in balance.

BWD spreads

Corporate Development, part of the BWD Industries group, has formed a joint venture with the Queensland Industry Development Corporation (QIDC), aimed at assisting the development of high technology companies in Queensland.

Both the QIDC and Corporate Development will have equal representation on the board of the new joint venture company to be named Queensland Corporate Development.

The purpose of the joint venture is to identify small to medium companies in Queensland which have the potential to be further developed in the various fields of high technology, with particu-

lar emphasis on manufacturing for both the Australian and export markets.

It is intended that Queensland Corporate Development will take equity positions in such companies with the full agreement of the present proprietors. The joint venture will offer further technological, manufacturing, marketing and financial expertise and facilities.

The QIDC hopes to play an active part in the development of technology-based industries in Queensland by adding further employment, investment and export opportunities. Given the current parlous state of the Queensland economy, such developments are sorely needed.

ETI schools competition

The final judging of the ETI schools competition will take place mid November and winning schools will be notified. One hundred and five

schools in Australia and 35 in New Zealand have entered the contest. Full details of the competition winners will appear in February ETI.

Engineers richest graduates

According to a study by Jenny Baldwin of Monash University, graduate engineers are now top of the money making stakes, beating lawyers, computer scientists and other high status professionals.

The study looked at the average salaries earned by graduates in their first jobs.

The average engineer starts on \$22,000. Law graduates can expect around \$21k, while computer grads may have to do with a measly \$20k.

The good news for those who believe there are far too many accountants in the country already is that they must make do with \$19k.



Sound facts in detail.

Ortofon have always dedicated themselves to pursuing the world's finest sound reproduction.

So when they discovered that the existing moving magnetic systems missed much of the sound detail, they did something about it.

They designed, developed and patented a new cartridge principle that could pick up as much detail as possible, accurately, from the record groove.

(Of course, as one of the recognized world leaders in sound reproduction, Ortofon were well-qualified in this area.)

They called it the VMS Principle.

The VMS Principle (Variable Magnetic Shunt) utilizes a light tubular armature of magnetic conducting material.

This is attached to the cantilever and encircled by a powerful ring magnet. When the cantilever moves the armature closer to the ring magnet, the armature short-circuits part of the magnetic field, generating a voltage in the coils.

And the result is an increased high frequency tracking ability, low distortion and superb

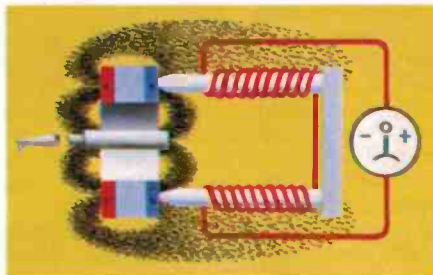

Symmetrical flux fields with the armature in the central (neutral) position. These flux fields emanate from the magnet positioned in front of the pole pins. As the fields are in balance, there are no changes in flux around and inside the coils. Therefore, no voltage is generated.

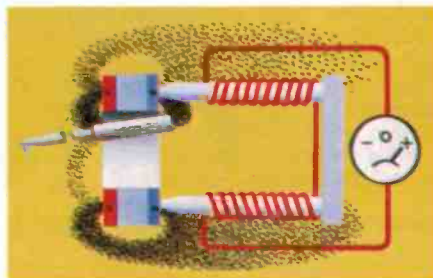

When the cantilever moves, the armature is brought closer to the ring magnet and acts as a shunt, short-circuiting part of the magnetic field. As a result, the flux field in front of the pole pins varies, and a voltage is generated in the coils.

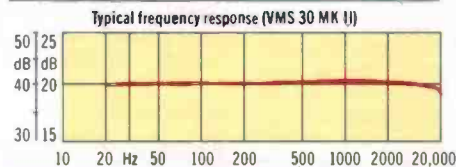

Technical data	VMS 30 MK II
Weight	5 g
Type of stylus	Fine Line
Equivalent stylus tip mass	0.45 mg
Frequency response	20-20,000 Hz
Output voltage at 1000 Hz per 5 cm/sec	5 mV
Channel separation at 1000 Hz	27 dB
Channel balance at 1000 Hz	2 dB
Compliance static, vertical	28 µm/mN
Compliance dynamic, lateral (10 Hz)	22 µm/mN
Recommended tracking force	13 mN (1.3 g)
Tracking force range	10-16 mN (1.0-1.6 g)
Tracking ability at 315 Hz lateral	90 µm
Vertical tracking angle	20°
FIM distortion	1% (13 mN)
DC resistance	800 ohm
Inductance	600 mH
Recommended load resistance	47 kohm
Recommended load capacitance	400 pF

transient reproduction – right down to the very last detail.

As if that wasn't enough, the VMS also reduced sensitivity to hum pick-up and minimized distortion and non-linearity in the magnetic system.

Presumably, the cost of an Ortofon VMS Magnetic Cartridge would be high.

Surprisingly, it's not. In fact, it's especially affordable.

Check the facts on the VMS 10E MK II, 20E MK II and 30 MK II at your hi-fi or Ortofon dealer.

And while you're there, find out how to home-test your stereo equipment with the Ortofon Pick-up Test Record.

It's another sound fact in detail.

Distributed by:
Scan Audio Pty. Ltd.
 52 Crown Street,
 Richmond, Vic. 3121
Melbourne: 429 2199
Sydney: 871 2854
Brisbane: 57 7433
Perth: 361 5422

ortofon
 accuracy in sound

Ian J. Truscotts
**ELECTRONIC
WORLD**

For all your components!
Test gear, data books.
Huge range of active
and passive components.

FLUKE Multimeters
Amidon Ferrite Products

Are you pulling out your
hair trying to find parts
for the PLAYMASTER
AM/FM tuner kits???

Give us a call! We have most
parts (incl. semi's) in stock.

30 Lacey Street,
CROYDON, VIC. 3136
Ph: 723-3860/3094

Mail Orders Welcome

 **Rockwell**
SUPER SPECIALS

NMOS	WAS	NOW
R68000P8 8MHZ (QUIP & PLCC AVAIL)	\$21.24	\$12.01
R6504P 1MHZ	\$8.56	\$3.06
R6504P 1MHZ	\$7.30	\$2.45
R6505P 1MHZ	\$7.30	\$2.45
R6520AP 2MHZ (= M68B21)	\$5.34	\$1.98
R6522P 1MHZ	\$6.82	\$3.98
R6522AP 2MHZ (= NEC 765)	\$7.62	4.59
CMOS		
R65C02 P1 1MHZ	10.48	5.36
R65C21 P1 1MHZ	5.88	3.52
R65C21 P3 3MHZ	-	4.59
R65C24 P1 1MHZ	6.67	3.67
R65C24 P3 3MHZ	-	4.59

BE EARLY AS THEY CAN'T LAST AT THESE PRICES.
AND STOCK IS LIMITED.

MIN QTY 100 PLUS P & P PRICES EX TAX

**energy
CONTROL**

Energy Control Pty Ltd
PO Box 6502, GOODNA QLD 4300
Ph: (07) 376 2955
Telex: AA43778 ENECON
PO Box 12153, Wellington Nth NZ
Ph: (644) 84 3499, Telex: NZ30135 AUDITOR

**Believe
it or not:
your
CD player
will sound
even better
with
QED Incon
connecting
cables.**

The stunning musical potential
of Compact Disc can be lost in the
first link - the interconnecting cable.

New technology QED Incon
cable allows a CD player to develop
its full potential by preventing the
performance loss that occurs with
conventional connecting cable.

Stereo images are more stable
with greater definition and depth,
and the sound is noticeably more
powerful and clear.

An interesting characteristic of
Incon cable is its directionality; it
improves the sound in one direction
more than the other.

Hear for yourself! Most QED
dealers will supply QED Incon on
"purchase or return", so you can
hear the difference on your own hi-fi
system.

Detailed information from:
Leisure Imports, PO Box 245,
Cremorne NSW 2090. Tel. (02)
908 3944; and QED Hi-Fi dealers.

QED
The Leader in Cable Technology

**ADVERTISERS'
INDEX**

Audio Engineers	100
Australian School of Electronics	102
Baltec Systems	88
Bose	17,71
Control Data	101
Convoy	25
Crusader Electronics	IFC,3
Diamond Systems	88
Disco World	94
DuPont	109
Elmeasco	108
Emona	53
Energy Control	88
Entercom	4
ES Rubin	14
Geoff Wood Electronics	76
Goldring	27
Hi-com Unitronics	53
ICOM	71,94
IEC	9
IEI	79
Imark	31
Jaycar	44,45
Leisure Sound	9
Lovelock Luke	84
Prepak Electronics	85
Quantum	16
Rod Irving Electronics	12,13,20,21,92,93
Scan Audio	8, 103
Scientific Devices	102
Scope	111
Sheridan Electronics	63
Sony	112
St Lucia	94
Telecom Employment Office, NSW	103

Icy hot line

Recently a PABX system left Phillips' plant at Moorebank NSW on a long migration south.

The Phillips DLS1105 was headed for the Department of Science centre at Kingston, Tasmania to be shipped to the Australian research station at Davis, in the Antarctic.

An essential piece in the Davis station upgrading of local telephone and international communications, the DLS1105 will be linked by satellite with the Antarctic Division's PABX back at Kingston — which is a Phillips D1200.

Peter Magill, communications engineer with the Department of Science, explains that the Davis PABX will have 50 extensions with one tie-line to Kingston.

"Because the Davis winter complement of 22 rises to 50 or 60 during summer," says Peter Magill, "we have allowed for expansion of the tie-line facility as traffic requires."

Government purchases aid exports

Recommendations for a more dynamic approach to purchasing by the government, in order to help Australian firms open up new opportunities in international markets, have been put to the Committee of Review on Government High Technology Purchasing Arrangements.

The proposals were advanced in a joint submission by the Department of Industry, Technology and Commerce and the Department of Local Government and Administrative Services.

Major recommendations in the submission are:

- more widespread use of investment analysis (including risk analysis) in high technology purchasing to assess the potential costs and benefits of undertaking product development as opposed to direct purchase;
- the seeking of expressions of interest before proceeding



The Davis Antarctic Station where the Phillips system is headed.

to full tendering as a general rule in high technology purchases, to reduce industry's costs in responding to tenders;

- measures to streamline and improve purchasing procedures to facilitate local industry's competitive entry into government markets;
- forward procurement planning and regular briefing sessions by government agencies to inform companies of the government's future needs;
- a program to contract to

local industry strategic research and development activities arising out of the Government's high technology needs; this would effectively redirect to the extent of \$50 million over five years the research and development component of existing high technology purchases by the Commonwealth, to the benefit of local industry;

- a \$5 million fund to facilitate the trial and demonstration within government departments and authorities of high

technology Australian products with international market potential to prove the performance of local products.

The proposed initiatives would have significant impact on those high technology industries most involved in supplying the Government's needs. These include communications equipment, computer hardware and software, micro-electronics and electronic components, aerospace and scientific and medical equipment.

Receiver specs for TV planning

A specification issued recently setting out performance levels for household television receivers is believed to be only the second of its kind developed in the world.

The document specifies the performance levels of a typical domestic television receiver and antenna in Australia.

The Department of Communications has developed the document in consultation with manufacturing and broadcasting industry bodies.

The specification is only advisory but is expected to be a strong inducement to manufacturers to observe specified performance levels and thus bring about valuable improvements in receiver quality, DOC Minister Michael Duffy said.

The Minister said that the data gathered for the specification may be used as input for the eventual development of a television receiver performance standard. It was hoped that a

draft standard would be available in 1987.

One section of the specification notes that planning of television services can only proceed on the universal availability of UHF and VHF tuning facilities. "The UHF band is being used more and more for television services around Australia and it will be in everyone's interest for manufacturers and importers to cease putting VHF-only sets on the market," Mr Duffy said.

"Buyers of television receivers should be aware that although VHF-only sets are a little cheaper, they are certainly not getting a bargain."

The Minister said it was noteworthy that to the Department's knowledge, no other country in the world apart from West Germany had produced such a specification.

Copies of it are available from Department of Communications offices in all States, the Northern Territory and the ACT.

NEW FACES



This month we welcome a new staff member, Terry Jack Kee. Terry was born and raised on a plantation in the wilds of Africa. One day, while caught between a lion and a rampaging bull elephant he saw a lissom young native girl with resistors hanging from her ears singing a strange and evocative lullaby as she swayed across the veldt. (Heavy duty poetic writing from the ed).

Being but an impression-

able young lad he decided to dedicate all his life to finding out about these things. Months later, Terry surfaced in England, studying young girls, resistors and mysterious hums for all he was worth.

And our Terry was no sluggard. Before you could say 'Bob's yer Uncle', there he was, with a Masters degree and the whole world his oyster. This being the case he buried himself in the BBC, where they eat young engineers for breakfast.

But something was missing. The problem was the sun, or lack of it. Confronting the tube on yet another grey day, (more poetic writing) he decided to go find a bit of warmth, so he rode right on down to the airport and fronted the nice lady in the ticket office, who tried to sell him a ticket to Vienna. But he knew what he wanted, and next day came flying through the window at ETI, where he landed on the editor's desk and said: "hire me".

The space station

The US House of Representatives has earmarked \$7.7b this financial year for NASA to begin work on the space station.

But NASA's plans have been cut back in view of the Challenger disaster to allow for construction of a station that can be built with fewer trips into space and less money from the government.

Original plans called for a 'twin keeled' structure rather like a cube, with living quarters and laboratories at each vertex. This structure has been cut in half to the so-called 'single keeled' option, so that it now consists of a long boom, with pressurized modules at either end, and solar panels, antennae and various non-pressurized experimental packages either bolted to the keel or attached to outriggers.

One consequence of the moves is that plans to internationalize the space

station have been sharply curtailed. The European Space Agency and Japan were to have supplied pressurized laboratories for the twin keel. Now both orders have been delayed until the middle of the next decade, at the earliest.

Only the Canadian contribution remains. The Canadians are building the remote manipulators that will crawl along the keel and do the heavy moving and lifting. Canada has specific expertise for the job, developed in work on the space shuttle manipulator arm.

According to James Fletcher, NASA's administrator, constructing the space station will take only 31 shuttle flights. The first construction crew will go up in 1993. By the fifth mission the keel will be laid out, and by the eighth, in mid-1994, both pressurized modules will be ready for work. The rest of the trips will be for lifting scientific and military payloads up to the station.

HOW TO FIND ELECTRONIC INSPIRATION

The very best jobs for Electronic Engineers and Technicians can only be found with the very best recruitment consultancy - QANTUM.

Talk to Ron Crause on (02) 922 7900, for details of the most exciting career opportunities around.

LEVEL 4 90 MOUNT STREET NORTH SYDNEY NSW 2060

QANTUM

FREE POSTAGE FOR ALL ORDERS OVER \$75 & UNDER 3KG!!



ARGUS 726 ADJUSTABLE MAGNIFIER WITH LAMP
Absolutely perfect for close up work! Intricate PCB's, projects, etc. will be a breeze under this superb, adjustable magnifying lamp.

- Magnifies 1.75 times
- 40 watt incandescent lamp
- 2 spring-balanced arms, extendable to 95cm
- Adjustable head for optimum viewing angle.
- Comes with desk clamp (interchangeable with base)
- Fantastic Value!!

Cat. A15046 Our price \$89

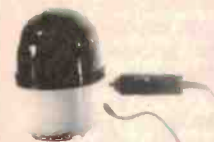

STROBE LIGHTS 12V
Available in 3 colours, red, blue and yellow. These units have a magnetic base and are fitted with 4 metres of cable terminating in a cigarette lighter plug. Ideal for displays, parties, attention getting, motor racing emergencies/breakdowns etc.

Cat.No.	Description	Price
A15046	Blue	\$32.95
A15047	Red	\$32.95
A15045	Amber	\$32.95



BREADBOARD SPECIALS

Why pay more?
Cat.P11000 100 holes \$2.75
Cat.P11005 640 holes \$10.75
Cat.P11007 640+100 holes \$13.00
Cat.P11009 840+200 holes \$17.50
Cat.P11010 1280+100 holes \$19.95
Cat.P11011 1280+300 holes \$32.50
Cat.P11012 1280+400 holes \$36.75
Cat.P11015 1920+500 holes \$57.50
Cat.P11018 2560+700 holes \$64.95

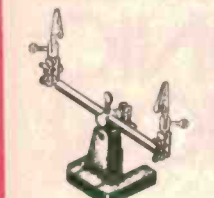

PC BOARD HOLDER
Better than an extra pair of hands! A must for all PCB work.
Cat. T12444 \$9.95



HIGH EFFICIENCY RADIAL FIN HEATSINK
Black anodised with a thick base plate, this radial fin heatsink can dissipate large amounts of heat for maximum efficiency. Designed by Rod Irving.

105x30mm	Cat. H10520	\$ 3.50
105x75mm	Cat. H10525	\$ 3.50
105x100mm	Cat. H10534	\$ 4.90
105x140mm	Cat. H10529	\$ 6.50
105x150mm	Cat. H10535	\$ 6.75
240x 3/2"	Cat. H10538	\$ 7.95
105x195mm	Cat. H10542	\$ 9.90
105x200mm	Cat. H10543	\$ 9.90
105x225mm	Cat. H10546	\$10.50
105x300mm	Cat. H10549	\$12.00
105x600mm	Cat. H10560	\$24.95



DIGITAL SPEEDO/ DIGITAL TACHO/ SPEED ALERT

• Digital readout (LED) for both tach and speedo.
• Alarm with sound at variable preset speed.
• Audible beeper and visual indicator.
• In built light indicator for night illumination.
• Designed for 12 volt negative earth electrical systems.
• Speeds: 0 - 199kph
• Tachometer: 0 - 9900kph
• Speed alert: 40 - 120kph
• Complete with mounting hardware.
Cat. A15064 R.R.P. \$89.95
OUR PRICE \$74.95



CODE KEY PAD

• Telephone type digital keypad.
• Four digit, changeable code.
• Over 5000 possible combinations.
• Power consumption: 5mA standby, 50mA alarm.
• Two sector LED and 1 arm LED.
• Wrong number lockout.
• 12V DC operation.
• Relay output.
• Panic button.
• Normally open tamper switch.
• Dimensions: 145 x 100 x 37mm
• ACP3 compatible.
Cat. A13014 R.R.P. \$79.95
SPECIAL, ONLY \$69.95

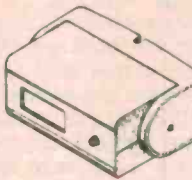

PASSIVE INFRA RED DETECTOR

Compact P.I.R. with adjustable corner or wall mounting bracket, dual pyroelectric infra red sensing element gives a coverage 2 x 14 zones 2m high and 10m wide.
• Sensitivity adjustment control
• Detecting range 12-15 metres at 90 degrees
• Detecting zones 9 long (up), 5 short (down)
• LED indicator for walk test: (can be disabled)
• Shielded against RF interference
• Relay output NC or NO at 30V (AC-DC) 0.5A max.
• Integral NC tamper switch
• Operating voltage 10.5 - 16V DC
• Current 20mA with LED 25mA
Cat. A15071 \$45



PROGRAMMABLE 24 HOUR TIME SWITCH

• 48 switching possibilities per day
• 240V AC, 2400 watt, 10 amp
• Suitable for turning on: Heaters/Coolers pool filter electric blankets cooking appliances waking you, even making the coffee! lights etc for security while you're away from home!
• Bargain Price!
Cat. M22002 only \$19.95



10W HORN SPEAKERS

White durable plastic, 8 ohms
Cat. C12010 Normally \$11.95
SPECIAL, ONLY \$9.95



ARLEC SECURITY BEAM

This compact security system transmits an invisible, modulated beam of infrared light which can be directed across a doorway, path or any other to be monitored. Anyone walking through the beam immediately causes an audible warning to sound. Suitable for shops, homes, factories etc.
FEATURES:
• Small compact design
• Infrared modulated beam
• Prismatic reflector allows up to 10% misalignment
• Effective range is 2 - 8 metres
• Low voltage (9V) operation via S.E.C. approved adaptor
• Negligible power consumption
• Simplified wiring
• Solid state electronic circuitry
• Produces audible warning
• Easy installation
• 12 months guarantee
Cat. A15060 \$89.95



MINI UTILITY CASE

Features a clear plastic lid for instant inspection of contents. Up to five, adjustable lower compartments, plus a self elevating upper tray for smaller items.
Dimensions: 110 x 210 x 43mm.
Cat. H10087 \$7.95



RITRON 19" RACK CASE

Tremendous Value! Dimensions 480(W) x 134(M) x 250(D)mm.
Cat. H10415 Normally \$47.95
SPECIAL, ONLY \$42.95



POWERFULL MINI DRILL

Featuring a powerful 6000 r.p.m. motor, this lightweight (1130g) drill is ideal for many jobs. Perfect for PCB work! Has a 0.8 to 1.2mm chuck and 1mm drill bit. Requires 12V 1 AMP. (use with M19010)
Cat. T12302 \$17.95



TRANSISTOR NIPPERS

Normally \$13.95
Cat. T12070 \$11.95



MICRO NIPPERS

Normally \$13.95
Cat. T12050 \$11.95



BRAND NEW FANS

Quality, new fans for use in power amps, computers, hotspot cooling etc. Wherever you need plenty of air 240V 4 5/8" Cat. T12481 \$14.95
115V 4 5/8" Cat. T12463 \$14.95
240V 3 1/2" Cat. T12465 \$14.95
115V 3 1/2" Cat. T12467 \$14.95
10+ fans (mixed) only \$10 each!
FAN GUARDS TO SUIT
4 5/8" Cat. T12471 \$3.95
3 1/2" Cat. T12475 \$3.95



ARLEC SUPER TOOL

A versatile 12V electric tool for...
• Sanding
• Engraving
• Grinding
• Polishing
• Cutting
• Drilling
• Milling
• Erasing, etc.
Features:
Operates on safe, low 12 volts from mains electricity via AC adaptor (supplied). Light and easy to handle with touch switch and lock for continuous running. High torque motor, 10,000 R.P.M. Can drill 2mm holes in steel, 2 year guarantee
Contents:
• 12V Super Tool
• Plugpack AC adaptor
• 1 spherical milling cutter
• 1 wire brush
• 1 grinding wheel
• 4 drill bits, 0.6, 0.8, 1.0, 1.2mm
• Set of 5 chuck collets
• 6 eraser sticks
• Instruction sheets
Cat. T12300 \$59.95

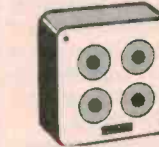

PIEZO SIREN

• 4 piezo units in a high impact plastic cabinet
• Input 12V DC - 200mA
• Output 115dB at 1m, dual tone
• Compact size 105 x 85 x 45mm
• Smart design suits interior use
Cat. S15071 \$23.95



FREE STANDING, FOLD UP MAGNIFIER

An economical priced "hands free" magnifier, lets you take care of all those tricky fine detailed jobs so often encountered in electronics, or any of many other practical uses, such as home, work, hobbies etc.
Cat. T12083 \$14.95



RITRON KEYLESS CAR ALARM

The first shipment sold out immediately to the trade. They didn't reach our own retail stores!
• Activated and disarmed by ignition key so you never forget to turn it on.
• Multi-function, built in siren or external siren, car signal horn output.
• Easy to install, no door switch required.
• Automatic reset after 60 seconds (avoids noise pollution)
• Special sensor protects Stereo or CB.
• 12V DC
Cat. S15054 Normally \$39.95
NOW \$29.95



PANEL METERS GALORE!

We have a great range of panel meters at great prices!
Cat.No. Description Price
Q10500 MU45 0-1mA 12.50
Q10502 MU45 50-0-50uA 12.50
Q10504 MU45 0-100uA 12.50
Q10510 MU45 0-5A 12.50
Q10518 MU45 0-1A 12.50
Q10520 MU45 0-1A 12.50
Q10525 MU45 0-20V 12.50
Q10530 MU52E 0-1A 14.50
Q10533 MU52E 0-5A 14.50
Q10535 MU45 0-5V Pmetre 14.95
Q10538 MU65 0-50uA 16.95
Q10540 MU65 0-1mA 16.95
Q10550 MU65 0-100uA 16.95
Q10560 MU65 0-20V 16.95



METEX MULTIMETERS

These instruments are compact, rugged, battery operated, hand held 3 1/2 digit multimeters. Dual-slope A-D converters use C-MOS technology for auto-zeroing, polarity selection and over-range indication. Full overload is provided.

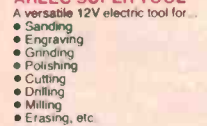

ARLEC SUPER TOOL
A versatile 12V electric tool for...
• Sanding
• Engraving
• Grinding
• Polishing
• Cutting
• Drilling
• Milling
• Erasing, etc.
Features:
Operates on safe, low 12 volts from mains electricity via AC adaptor (supplied). Light and easy to handle with touch switch and lock for continuous running. High torque motor, 10,000 R.P.M. Can drill 2mm holes in steel, 2 year guarantee
Contents:
• 12V Super Tool
• Plugpack AC adaptor
• 1 spherical milling cutter
• 1 wire brush
• 1 grinding wheel
• 4 drill bits, 0.6, 0.8, 1.0, 1.2mm
• Set of 5 chuck collets
• 6 eraser sticks
• Instruction sheets
Cat. T12300 \$59.95

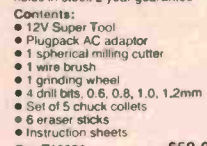

METEX 3800 MULTIMETER

This instrument is a compact, rugged, battery operated, hand held 3 1/2 digit multimeter for measuring DC and AC voltage, DC and AC current. Resistance and Diode, for testing Audible continuity and transistor hFE. The Dual-slope A-D Converter uses C-MOS technology for auto-zeroing, polarity selection and over-range indication. Full overload is provided. It is an ideal instrument for use in the field, laboratory, workshop, hobby and home applications.
Features:
• Push-button ON/OFF power switch
• Single 30 position easy to use rotary switch for FUNCTION and RANGE selection
• 1 1/2" high contrast LCD
• Automatic over-range indication with the "1" displayed.
• Automatic polarity indication on DC ranges.
• All ranges fully protected plus Automatic "ZEPHO" of all ranges without short circuit except 200 ohm Range which shows "000 or 001"
• High Surge Voltage protection 1.5 KV/3 KV.
• Diode testing with 1 mA fixed current
• Audible Continuity Test.
• Transistor hFE Test.
SPECIFICATIONS
Maximum Display: 1999 counts
3 1/2 digit type with automatic polarity indication.
Indication Method: LCD display.
Measuring Method: Dual-slope in A-D converter system.
Over-range indication: "1" Figure only in the display.
Temperature Ranges: Operating 0°C to +40°C
Power Supply: one 9 volt battery (006P or FC-1 type of equivalent)
Cat. Q91530 Normally \$99.95
SPECIAL \$89.95



METEX 3530 MULTIMETER

This instrument is a compact, rugged, battery operated, hand held 3 1/2 digit multimeter for measuring DC and AC voltage, DC and AC current, Resistance and Diode, Capacitance, Transistor hFE and Continuity Test. The Dual-slope A-D Converter uses C-MOS technology for auto-zeroing, polarity selection and over-range indication. Full overload is provided. It is an ideal instrument for use in the field, laboratory, workshop, hobby and home applications.
Features:
• Push-button ON/OFF power switch
• Single 30 position easy to use rotary switch for FUNCTION and RANGE selection.
• 1 1/2" high contrast LCD.
• Automatic over-range indication with the "1" displayed.
• Automatic polarity indication on DC ranges.
• All ranges fully protected plus Automatic "ZEPHO" of all ranges without short circuit except 200 ohm Range which shows "000 or 001"
• High Surge Voltage protection 1.5 KV/3 KV.
• Capacitance measurements to 1pF
• Diode testing with 1 mA fixed current
• Audible Continuity Test.
• Transistor hFE Test.
SPECIFICATIONS
Maximum Display: 1999 counts
3 1/2 digit type with automatic polarity indication.
Indication Method: LCD display.
Measuring Method: Dual-slope in A-D converter system.
Over-range indication: "1" Figure only in the display.
Temperature Ranges: Operating 0°C to +40°C
Power Supply: one 9 volt battery (006P or FC-1 type of equivalent)
Cat. Q91540 Normally \$129
SPECIAL \$119



WELLER WTCPN SOLDERING STATION

The WTCPN Features:
• Power Unit 240 V AC
• Temperature controlled iron, 24 V AC
• Flexible silicon lead for ease of use
• Can be left on without fear of damaged tips!
The best is always worth having.
Cat. T12500 R.R.P. \$149
SPECIAL, ONLY \$129



ANTISTATIC SOLDER SUCKER

• Light weight
• Sturdy construction
• Easy to remove tip
• Excellent value for money!
Cat. T11281 \$13.95

FREE POSTAGE FOR ALL ORDERS OVER \$75 & UNDER 3KG!!

FREE POSTAGE FOR ALL ORDERS OVER \$75 & UNDER 3KG!!

FREE POSTAGE FOR ALL ORDERS OVER \$75 & UNDER 3KG



"SNAP TOGETHER" PLASTIC CASE

Top and bottom simply snap together (no screws required). Removable front and back panels. Size: 186(W) x 125(D) x 50(H)mm. Cat. H10116 \$7.95

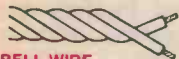

BELL WIRE

Red and white twisted conductors. 2 x 1 strand 0.17mm Sheath: O.D. 2 x 1.35mm. Cat. W 1-9 rolls \$19.00/m 10+ rolls \$17.50/m



HIGH INTENSITY ALPHANUMERIC RED DISPLAY

Interlockable 2" display module with 35 high intensity, 5mm pixels per module allowing vast scope for custom displays.

Brightness: 3000 ucd. $I_p = 10mA$
 PIN 1 Row 5A PIN 6 Row 3A
 PIN 2 Row 7A PIN 9 Row 1A
 PIN 3 Col. 2C PIN 10 Col. 4C
 PIN 4 Col. 3C PIN 11 Col. 3C
 PIN 5 Row 4A PIN 12 Row 4A
 PIN 6 Col. 5C PIN 13 Col. 1C
 PIN 7 Row 6A PIN 14 Row 2A
 Cat. No. 1-9 10+
 Z10196 \$7.95 \$6.95

NICADS!

Save a fortune on expensive throw away batteries this Christmas with these quality Nicads and Rechargers!



NICADS!

Size Desc. 1-9 10+ 100+
 AA 0.5 A.H. \$2.50 \$2.25 \$1.95
 C 1.2 A.H. \$7.95 \$6.50 \$6.25
 D 1.2 A.H. \$7.95 \$6.50 \$6.25



UNIVERSAL BATTERY CHARGER AND TESTER

Save money on expensive batteries with this universal battery charger. Features include meter tester, and provisions for D, C, AA, AAA, N, button and cell batteries, 9V and 6V (square types). Comes complete with detailed instructions. Cat. M23533 \$29.95



PUSH BUTTON DIALLERS

Tired of old fashion dialling and re-dialling engaged numbers? These convenient push button diallers include last number redial (up to 16 digits) and instructions for an easy changeover. Cat. A12030 NORMALLY \$19.95 SPECIAL, ONLY \$14.95



TELEPHONE EXTENSION CABLE UNIT

Allows 15 metres of telephone extension cable to be neatly wound into a portable storage container. The reel sits on a flat base and has a handle to wind cable back on to it after use. No tangles - no mess! Ideal for the workshop, around the house, office, pool etc. Cat. Y16013 \$24.95

MERRY CHRISTMAS FROM ROD IRVING ELECTRONICS!!



TOLL FREE ORDER NUMBER 008 33 5757 (STRICTLY ORDERS ONLY) INQUIRIES TO (03) 543 7877

Ho!

DIRECT IMPORT!



ECONOMY TRANSFORMERS

1-9 10+
 2155 240V 6-15V 1A Cat. M12155 \$9.95 \$8.95
 2156 240V 6-15V 2A Cat. M12156 \$14.95 \$13.95
 2840 240V 9V CT Cat. M12840 \$5.95 \$4.95
 2851 240V 12-6V CT 150mA Cat. M12851 \$5.95 \$5.50
 2860 240V 15V CT 250mA Cat. M12860 \$5.95 \$4.95
 6672 240V 15-30V 1A tapped Cat. M16672 \$14.95 \$13.95



ELECTRET MIC INSERTS

With pins for easy board insertion. Cat. C10170
 1+ 10+ 100+
 \$1.95 \$1.70 \$1.50



HOOK UP WIRE

Cat. No. Description
 W11251 13/12 TND BLK
 W11252 13/12 TLD BROWN
 W11253 13/12 TLD ORANGE
 W11254 13/12 TLD YELLOW
 W11255 13/12 TLD GREEN
 W11256 13/12 TLD BLUE
 W11257 13/12 TLD WHITE
 PRICES PER 100 METRE ROLL
 1-9 10+
 \$6.95 \$5.00
 \$5.35 \$4.50

W11260 14/20 RED
 W11261 14/20 BLACK
 W11265 14/20 BLUE
 W11268 14/20 WHITE
 PRICES PER 100 METRE ROLL
 1-9 10+
 \$12.00 \$10.00
 \$10.80 \$9.00

W11270 24/20 RED
 W11272 24/20 BLACK
 W11274 24/20 GREEN
 PRICES PER 100 METRE ROLL
 1-9 10+
 \$14.00 \$12.00
 \$12.60 \$10.80

W11280 32/2 BROWN
 W11282 32/2 BLACK
 PRICES PER 100 METRE ROLL
 1-9 10+
 \$20.00 \$18.00
 \$18.00 \$16.20

1/2" HIGH INTENSITY RED LED DISPLAYS

(Available in Common Cathode and Common Anode)

Dimensions: Overall: 12.7mm across, 19mm high Display: 12.7mm(H) x 7.3mm(W) Segment Width: 1.2mm Brightness: 3400 ucd. $I_p = 10mA$
COMMON CATHODE:
 Pin 1 Segment E Pin 6 Segment B
 Pin 2 Segment D Pin 7 Segment A
 Pin 3 CC Pin 8 CC
 Pin 4 Segment C Pin 9 Segment F
 Pin 5 Segment Op Pin 10 Segment G
 Cat. No. 1-9 10+
 Z10190 \$1.95 \$1.75

COMMON ANODE:
 Pin 1 Segment E Pin 6 Segment B
 Pin 2 Segment D Pin 7 Segment A
 Pin 3 CA Pin 8 CA
 Pin 4 Segment C Pin 9 Segment F
 Pin 5 Segment Op Pin 10 Segment G
 Cat. No. 1-9 10+
 Z10191 \$1.95 \$1.75

DIRECT IMPORT!

HIGH INTENSITY RED LED BAR GRAPH

Dimensions: Overall: 63mm across, 5mm high LEDs: 10 x 5mm x 1mm
 Cat. No. 1-9 10+
 Z10180 \$2.95 \$2.75



UNIVERSAL SOLDERING IRON STAND

Cat. T11302 \$5.95



SOLDER ROLLS

Absolutely top quality, unlike our opposition's! 60/40 Resin cored.
 Cat. No. Description Price
 T31000 .71mm 250gm \$8.95
 T31002 .71mm 500gm \$15.95
 T31010 .91mm 250gm \$7.95
 T31012 .91mm 500gm \$14.95
 T31020 1.6mm 250gm \$7.50
 T31022 1.6mm 500gm \$13.95
 T31030 .71mm 1 metre \$1.50
 T31032 .91mm 1 metre \$1.25
 T31034 1.6mm 1 metre \$1.00

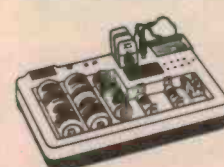

DELUXE UNIVERSAL BATTERY CHARGER AND TESTER

Save money on expensive batteries with this universal battery charger. Features include meter tester, and provisions for up to 8 pieces of any size, (D, C, AA or AAA type batteries) at once, plus positions for a button and cell battery. Two times 9V, and one times N type batteries. Recharging lead with alligator clips. 9V clip and 4-way universal. Select currents from 2.5-3V 150mA, 1.2-1.5V 80mA, 1.2-1.5V 25mA, 6-9V 14mA, 12V 50mA. Includes detailed instructions. Cat. M23535 \$39.95



CANNON TYPE CONNECTORS

Cat. No. Description Price
 P10960 3 pin line male. Was \$3.90 NOW \$2.90
 P10962 3 pin chasis male. Was \$3.00 NOW \$2.40
 P10964 3 pin line female. Was \$4.50 NOW \$3.25
 P10966 3 pin chasis female. Was \$4.95 NOW \$3.45

FERRITE AERIAL ROD

200mm x 9mm
 Cat. L11401 Normally \$2.75 SPECIAL, ONLY \$1.50



POT CORES

FX2242 Assembly, 2 halves, 36mm diameter L12100 \$9.95
 Former to suit FX2242 L12101 \$0.95
 FX2243 Assembly, 2 halves, 24mm diameter L12110 \$9.95
 Former to suit FX2243 L12111 \$1.00
 E Core, 2 halves L12115 \$8.95
 Former to suit E Core L12116 \$4.95
 Complete E Core assembly, (including end plates and bolts) L12117 \$18.95

Ho!

Great Christmas Ideal



RECHARGEABLE LANTERN

● Up to 1,000 recharges
 ● No more expensive batteries
 ● Beam length 1,050 feet
 ● Cannot be over charged
 ● Shoulder strap included
 ● 240V charge lead connects direct
 ● 12V Car lighter recharging lead (ideal for camping, travel, boating etc.)
 ● Red safety shade cover
 Cat. A15053 only \$29.95

Great Christmas Ideal



RECHARGEABLE FLASH LIGHT

● Up to 1,000 recharges
 ● No more expensive batteries
 ● Beam range 150 metres
 ● Size: 160(L) x 60(W) x 60(H)mm
 ● Weight: 140 gram
 ● Shoulder strap included
 ● To recharge simply unclip the handle which contains the power pack and plug directly into a 240V power point.
 ● Charging time: approx. 10 hours (when fully discharged)
 ● Operating time approx. 80 minutes (when fully charged)
 ● Output/Built: 2.4V
 Cat. A15052 only \$15.95

Great Christmas Ideal



RECHARGEABLE POCKET LIGHT

● Compact and very convenient
 ● No more expensive batteries
 ● Up to 1,000 recharges
 ● To recharge, simply remove the rear cover and plug directly into a 240V power point.
 ● Charging time: approx. 15 hours (when fully discharged)
 Cat. A15051 only \$13.95



SPEECH SYNTHESISER CHIPS

SPO256A-AL2: Speech synthesiser chip, needs programming to work. \$16.95
 CTS256-AL2: Contains the code recognition circuit to enable the project to plug directly on the printer port, or into an IBM PC. \$29.95

A SET OF EACH \$44.95



IC STORAGE CASE

Electro static charge proof plastic IC case with conductive sponge. Dimensions: 75 x 130 x 19mm. Cat. H10095 \$8.95



TEXT TOOL SOCKETS

P17016 16 pin \$14.50
 P17024 24 pin \$14.50
 P17028 28 pin \$19.50
 P17040 40 pin \$22.50



ANTI GLARE SCREEN

Half the price of other brands!! Relieve eye strain and headaches and increase productivity with these Anti Glare Screens. Suitable for 12" monochrome and colour monitors. Cat. X99995 \$24.95

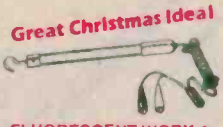

FLUORESCENT WORK & EMERGENCY LIGHT

● Suits cars, boating, caravan, camping etc.
 ● Shatterproof, glare free
 ● Cigarette lighter plug and alligator clips
 ● 12V DC, 8 watt, transistorised
 Cat. A15052 \$25.95

SAVE

IC SPECIALS!
 555 \$0.50 10+ 100+
 4116 \$3.95 0.40 0.35
 4164 \$3.95 \$3.75 \$3.50
 2716 \$8.90 \$8.50 \$8.30
 2732 \$8.25 \$7.95 \$7.50
 2764 \$6.25 \$5.95 \$5.00
 27128 \$6.95 \$6.50 \$6.25
 6116 \$2.95 \$2.75 \$2.50
 41256 \$5.95 \$5.50 \$4.95
 6264 \$6.50 \$5.50 \$5.25
 27256 \$11.50 \$10.50 \$10.00

WORLD MODEM CHIP

Cat. U21614 Normally \$49.50 Save \$20, SPECIAL \$29.95
MEL9501
 Have you blown up your Apple drive by plugging it in backwards or not turning off the power while changing bauds? We have the MEL9501 chip! SPECIAL, ONLY \$29.95

Ho!

Rod Irving Electronics

48 A Beckett St, MELBOURNE Phone (03) 663 6151
 425 High St, NORTHCOPE Phone (03) 489 8866
 Mail Order and Correspondence: P.O. Box 620, CLAYTON 3168
 Telex: AA 151938



MAIL ORDER HOTLINE 008 335757 (TOLL FREE)

(STRICTLY ORDERS ONLY)

LOCAL ORDERS & INQUIRIES (03) 543 7877

POSTAGE RATES:
 \$1 \$9.99 \$2.00
 \$10 - \$24.99 \$3.00
 \$25 - \$49.99 \$4.00
 \$50 - \$99.99 \$5.00
 \$100 - \$199.99 \$7.50
 \$200 - \$499 \$10.00
 \$500 plus \$12.50
FREE POSTAGE FOR ORDERS OVER \$75 & UNDER 3KG!

The above postage rates are for basic postage only. Road Freight, bulky and fragile items will be charged at different rates.

Certified Post for orders over \$100 included free!
 Registered Post for orders over \$200 included free!

All sales tax exempt orders and wholesale enquiries to:
IRTRONICS WHOLESALE
 56 Renner Rd, Clayton, Ph. (03) 543 2166 (3 lines)

Errors and omissions excepted
 *Apple and IBM are registered trade names



FREE POSTAGE FOR ALL ORDERS OVER \$75 & UNDER 3KG!!

FREE POSTAGE FOR ALL ORDERS OVER \$75 & UNDER 3KG!!

The year of audio

1986 was seen as the year that audio would finally make a comeback as one of the dominant product groups in the electronics industry. Compact disc players would lead the rush, with hi-fi components a close second.

While not as bullish as some had predicted, the market is still looking pretty good. According to information from CESA, the Consumer Electronics Suppliers Association, component systems and 3-in-1 sales are up about 8.3% on last year's figures. The hi-fi flyer has, indeed, been

compact disc player where sales have more than doubled over the corresponding six month period last year. In fact this phenomenal growth in compact discs has more than compensated for the sales drop in other areas of hi-fi.

Sales of amplifiers, receivers, turntables and tape decks have all dropped in unit terms by between 13% and 18%. Total hi-fi systems have also dropped in unit terms by approximately 18% whilst music centres are down by 7%.

Tuners have not declined in

sales by as much as the other components and this could easily be attributed to AM stereo tuners achieving a good level of sales.

At the other end of the scale equalizers have suffered a big drop in unit sales (approximately 34%).

The complete reverse in component sales can be said of hi-fi speakers. For the six month period, hi-fi speakers were 23% up on last year. Undoubtedly compact disc players have caused many consumers to go for better quality speakers to match their CD players' dynamic range.

NASA tank conversion

NASA has awarded a seven-month, \$93,000 contract to Martin Marietta to study the feasibility of converting a Space Shuttle external tank to an orbiting telescope.

According to NASA's Max Nein, the proposal to transform the external tank into a gamma ray imaging telescope (GRIT) to study gamma ray sources in the universe, appears possible. Studies have determined that the spent tanks, 47 metres long and 8 metres in diameter, could be carried into orbit rather than discarded just before the shuttle achieves orbit. Components of the telescope would be carried in the shuttle's cargo bay along with other payloads. Because the telescope would require periodic maintenance, it will probably orbit near the planned space station, 400 km above Earth.

The proposal was initiated by Dr David Koch at the Astrophysical Observatory of the Smithsonian Institute.

Once in space, residual propellants would be expelled from the tank and astronauts could assemble telescope components within the liquid hydrogen tank. They could enter the tank via an existing 36-inch aft manhole port or through tank modification. The tank would then be pressurized to provide the needed environment for the gamma ray detection technique.

In operation, gamma rays would be converted by a lead plate into positrons and electrons which travel the length of the telescope emitting light. The light would be imaged onto a detector by a large mirror spanning the diameter of the tank. Since gamma rays reflect the highest energy processes, gamma ray astronomy is essential to understanding the evolution of stars and the universe and to the physical processes occurring in pulsars, quasars and black holes.

Nein said NASA plans to conduct a separate gamma ray survey using the orbiting Gamma Ray Observatory (GRO). The gamma ray imaging telescope would follow up the work of the GRO by enabling NASA to conduct even more detailed gamma ray studies.

Don't pay too much for connectors

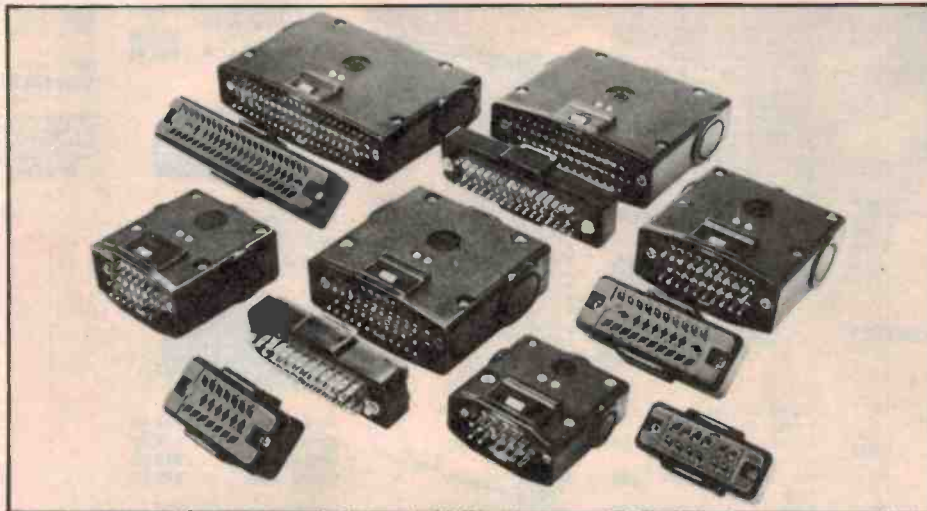

Not all multipole connectors are priced the same. These SC series multipole connectors are as little as half the price and equally as good if not better than similar connectors.

Features include provision for 3 cable entry positions in the housing, a pushbutton for easy locking and release and polarized plug and socket for correct connection. All connectors come complete with housing and are available with 8, 12, 16, 20, 24, 28, 34, 45 or 60 contacts.

Call E.S. Rubin and be pleasantly surprised at how little you can pay for a multipole connector.

E.S. RUBIN ELECTRICAL

Head Office: 73-77 Whiting St. Artarmon NSW 2064.
Phone (02) 439 2333 Telex 121175 Fax (02) 439 2278
Vic. 138-140 Berkeley St. Carlton 3053. Phone (03) 347 6588 Telex 30948
SA: 49 Woodville Rd. Woodville 5011. Phone (08) 268 1111 Telex 82529
WA: 7 Rosslyn St. West Leederville 6007. Phone (09) 382 2619 Telex 94623

Please send me information on Dianich Connectors

Name _____ Position _____

Company _____

Address _____

Send to: E.S. Rubin Pty Ltd
P.O. BOX 92 Artarmon
N.S.W. 2064

South Africa on SW

As South Africa finds world media channels less and less sympathetic it has increasingly turned to shortwave broadcasts to disseminate its views.

Established in 1966, Radio South Africa originally used 250 kW transmitters, then upgraded to 500 kW ones. It is now heard worldwide except in Australia and New Zealand. Reception is difficult in this region due to the signal crossing the auroral zone.

Johannesburg's first radio broadcast was made 29 December, 1923 by the South African Railways. In 1924 the Scientific and Technical Club took over transmissions on the Witwatersrand then in September the same year in the Cape and Peninsula Broadcasting Association began broadcasting in Cape Town.

Listeners in Durban were introduced to wireless three months later.

Revenue, however, was a problem and in 1927 the Schlesinger Organization incorporated the three stations into the South African Broadcasting Company. Financial difficulties continued to limit the spread of radio and not long after, a government enquiry was ordered into all aspects of South African broadcasting. The result was the establishment in 1936 of the SABC in the terms of a new Act. SABC accordingly celebrates its 50th anniversary this year.

The new national radio service originally broadcast in English only, but the Act provided for a parallel Afrikaans service. By 1937 transmissions were being broadcast in both languages.

In the 1940s SW broadcasts



Verification card from Radio RSA.

from Cape Town, Durban and Johannesburg were monitored by the writer. The 5 kW transmitters used were given away for 20 kW ones transmitting from Paradys near Bloemfontein which were used until the opening of Radio South Africa in 1966.

Until the 70s studios were located in the centre of Johannesburg from where they moved to a complex at Auckland Park.

Radio RSA broadcasts in 11 languages for 208 hours per week. It receives over 100,000 letters from listeners per year. English broadcasts are 0200-0256 UTC on 5980, 6010, 9615 kHz; 0300-0426 UTC on 3230, 4990, 5980 kHz; 0630-0730 UTC on 5980, 7270, 9585 and 11900 kHz. Other audible transmissions are 2100-2156 UTC on 7270, 9585 and 11900 kHz.

— Arthur Cushen

Communications software booming

Software-driven intelligent products hold the key to substantial export sales for Australian electronics companies, according to the Australian Electronics Industry Association (AEIA).

While software development is usually associated with the computer industry, the electronics industry has been researching and developing "intelligent" communications equipment, using software programs, since the early 1960s.

Major companies such as Ericsson and STC, for example, now devote about 30% of their R&D workforce to software development on various products.

Software programs are being used for a range of telecommunications needs, from network control and packet switching to testing and diagnostic network maintenance, as well as in a myriad of other electronics products such as electronic funds transfer (EFT), office automation equipment, and the whole Telecom public telephone network.

This R&D effort is now paying dividends in the form of technologically advanced products with widespread export potential.

At STC, a range of energy

management systems has been produced which Technical Director, Bruce Jones, claims are the first of their kind to be developed in Australia: office automation systems that allow computers to work through small business systems; electronic funds transfer at point of sale (EFTPOS) equipment, and the new Credit Card Public Phone.

"Australia is at the leading edge of EFTPOS development and our work in developing communications software for the network has good local and export potential," Mr Jones said.

In the shorter term, STC is creating opportunities by the use of enhanced software equipment such as its PCM multiplex and optical systems.

Another company, Ericsson, is so excited about the current and potential export sales of three software-driven products it has developed in Australia that it has set up an export division to handle them.

The three products are the ASDP 162, an automatic telephone call distributor, the FDS 10, a specialized application of the ASDP system, and the AXE 104, a rural public telephone exchange system.

According to Mr Brian McKay, Ericsson's Director of Corporate Relations, export sales from these three products are expected to exceed \$50 million by 1988, well above Ericsson's current export sales level of \$20 million.

"These products have used new software programs to create new applications and open new markets," Mr McKay said. "The original FDS 10 queuing system, the ASDP 162, for example, has been on the market for 10 years, and 73% of its sales now come from overseas.

"We have now launched the FDS 10 version of the product to the money market, which has an obvious need for fast, accurate communications and reliable data.

"The AXE 104 is another good example of modern computer programming. It uses the same hardware technology as the original AXE public exchange (which has been the building block of the telephone system in Australia and in 68 other countries) but completely different software, and a completely new processor with a new high-power operating system.

"This software, which has been totally developed in Australia, allows the smaller

AXE 104 to emulate the larger exchange's capacity, at a cheaper price. Because the software is totally compatible with the original AXE, the AXE 104 immediately has the potential to be exported to at least 68 other countries. It's a prime example of a product built in Australia for the world market."

AWA is another telecommunications company which sees strong export potential for its software-driven products. Chief among these is AWANET, an integrated services local area network which is soon to be installed in Sydney's Police Control Centre, and which has follow-on applications for traffic control and other police work.

Industry sources claim there will be vast opportunities for new peripheral products in the telecommunications market, particularly as Telecom pushes ahead with its changeover to an all-digital telephone network and introduces the Integrated Services Digital Network (ISDN), which will allow any combination of voice, text, data, graphics and video to be used over a single telephone line.

NEWS DIGEST

PRIZES, PRIZES, PRIZES



Mr Sommerville receiving his \$10,000 worth of gear from Mr Mark Kelly of Sony.

Mr Gary Sommerville of Punchbowl (Sydney) was the lucky winner of the \$10,000 Sony Audio Visual System in a recent computerized draw which involved subscribers to ETI.



Brad McMaster getting it from David Cartwright (TI).

Lucky person number two is Brad McMaster of Seaforth (Sydney again) who won the Texas Instruments one chip micro evaluation board.



Merv Nixon from AWA Information & Control with the winning ticket and Peter Hayes from ETI.

And going interstate, Arthur Pounsett of Norlane in Victoria is the proud new owner of the Seiko wrist terminal he won in the ETI-AWA competition.

NOTES & ERRATA

Project 284, VCR alarm, Nov '86: The piezo electro transducer specified for this project also includes an oscillator in one package. We used Dick Smith Part No L7024 in the prototype. L7027 may also be used with a 2k7 resistor in parallel.



Dr Myles Harding and Dr David Jupp with another winner, Dr Dieter Plate, of the Division of Textile Industry.

CSIRO medals 1986

Research work in the widely differing fields of diamond recovery, remote sensing, industrial computer systems and wool textiles has been recognized in the awarding of CSIRO medals.

They were presented recently by the chairman of CSIRO, Dr Keith Boardman, at a meeting in Melbourne of the chiefs of CSIRO's 43 research divisions and units. Amongst those receiving medals were two we've noted.

Dr David Jupp came to the then Division of Land Use Research in 1976 with a background in mathematics which he applied to spatial analysis of natural resource data.

He played the primary role in developing remote sensing research in the Division, and the BRIAN (Barrier Reef Image Analysis) system is the realization of the novel methods and algorithms he created.

The joint undertaking by the Great Barrier Reef Marine Park Authority, CSIRO and the Australian Survey Office in applying BRIAN to reef and shallow water mapping was led by Dr Jupp. The significance of the success of this effort is recognized worldwide.

His further development of microBRIAN has produced one of the most powerful and versatile microcomputer based image analysis systems. This system is marketed by Microprocessor Applications (see ETI, July 1986).

Dr Myles Harding has been responsible for conceiving and developing the key elements in two projects which have a clear lead over existing technology and promise very substantial markets both in Australia and overseas.

The first of these developments is a high speed industrial vision processor now being manufactured and marketed by Vision Systems (see ETI, July 1986). The other is a discrete event computer simulation package which has been applied successfully to some major new Australian manufacturing facilities and for which a commercial enterprise is currently being established.

Although he had no previous experience in either technology, in late 1981 Dr Harding agreed to lead a project to develop VSLI (very large scale integrated) circuit implementation of an industrial vision system. Within a very short time he had developed and verified new algorithms for connectivity analysis. A worldwide market survey was commissioned and this confirmed that these developments were well ahead of the existing technology and promised significant improvement in cost/performance when compared with the most advanced systems currently available. Vision Systems is now marketing the vision system.

During 1984, in response to a specific request from PA Technology, Dr Harding developed a simulation program to model a complex palletizing operation for WD&HO Wills. Following the success of this work the same approach has been applied to a number of large industrial systems. The techniques developed by Dr Harding have been shown capable of simulating complex plants and processes impractical to simulate with existing methods. Many companies have indicated a desire to market this software. ●

Propagation conditions

A correspondent recently wrote complaining that some higher priced receivers failed to perform adequately. He was finding it difficult to hear signals on weekends too. This prompts me to outline ionospheric conditions that control the reception of short-wave signals — regardless of the price of receiver.

The present low sunspot count means the sun's surface is clean with little activity and a consequent lower ion concentration in the ionospheric layers. When the concentration is not high enough, radio waves are not reflected but are absorbed and 'lost' in the layers. Long distance AM and shortwave transmissions are only possible when reflected by the ionosphere.

The ionosphere is 400 kilometres thick and has four identifiable layers. The first is the D layer, 40 kilometres thick and with the lowest ionization. It starts at about 50 kilometres from the Earth's surface. The D layer is entirely a product of sunbeams and exists only in daylight hours. Because of its low ionization it reflects only long waves.

The next layer, the E layer, is 100 to 150 kilometres up. It too is the product of sunbeams but it survives at night, reflecting medium waves after sunset and making continental broadcasting possible.

Above the E layer, about 200 kilometres up, lie the F one and two layers. These two layers merge into one layer after sunset. The ion content and the height of the F two layer depend on both the time of day and the season. Usually it has the highest degree of ionization and is localized at a height of 250 to 400 kilometres. This layer reflects high frequency shortwaves which, with multiple reflection, are carried over the longest distances. Occasionally, there are so many reflections that the waves 'ball' around the world resulting in an echo effect. When the sun's cycle reaches its maximum activity point, extremely low power high frequency shortwave stations can be received in distant regions.

The sun's cycle lasts about 11 or 11 and a half years, with maximum activity in the third or fourth year gradually decreasing to a minimum in the following seven or eight

years. The last maximum period was in 1979-80 with an average of 155 sunspots per day. The number dropped to 140 per day in 1981, 116 in 1982, 67 in 1983, 44 in 1984 and 24 in 1985. The low sunspot count forces more stations to lower frequencies with consequent crowding and disturbance. So to those who were listening to absolutely nothing on 9 February this year during the worst disturbance of the ionosphere in 25 years, it wasn't your receiver's fault.

Listeners are able to receive up to date information on propagation conditions from WWV Boulder, Colorado, or WWVH in Hawaii at 18 minutes past each hour. These Standard Time and Frequency Stations operate on 5000, 10000 and 15000 kHz and announce the time each minute. There are also several standard announcements concerning the weather, shipping and other information.

Two programs on shortwave cover this information in layman's language, both originating from Radio Australia Studios in Melbourne. At the conclusion of Radio Australia's "Talkback" program, Mike Bird gives a review of

past week propagation conditions and forecasts the coming week based on information from IPS Radio & Space Services, Sydney. "Talkback" is broadcast Saturday 0310 and 1610 UTC and Sundays 0530, 0910, 1230 and 2040 UTC.

The same type of information is available on Radio Nederland's "Media Network" program broadcast on Thursday at 0750 UTC on 9630 and 9715 kHz and repeated at 1050 UTC on 9650 kHz. Jonathan Marks of Radio Nederland discusses by telephone with Mike Bird in Melbourne the present propagation situation.

Those listeners in Australia wishing to receive the latest information on propagation conditions can phone the Ionosphere Prediction Service in Sydney on (02) 269-8614 which has details of the present situation and predictions for future reception conditions. The tapes are changed daily at 1000 UTC.

This interesting service will be appreciated by many who in the past have listened to WWV, but would like to get the information from a source in the South Pacific.

— Arthur Cushen

LATIN AMERICAN NEWS

COSTA RICA: A new station in Costa Rica called Radio for Peace is being planned by a United States group. The 10 kW transmitter will be located at a University Campus in Costa Rica. The antenna has been completed, according to Radio Nederland, and program preparation is under way. Most of the material will be in English and Spanish and later other languages will be added. As soon as finance permits the transmitter power will be increased, but for the start it is expected that Radio for Peace will cover the Caribbean area. Part of the program will be by sponsorship to keep the station in operation.

AWR Latin America has been testing on 15460 kHz and regular broadcasts are expected to be 1600-1800 UTC in English and 1800-2200 UTC in Spanish, and then a com-

binaton of four other languages up to 2400 UTC. 11870 kHz is assigned also to the station.

GUATEMALA: AWR in Guatemala has extended its transmissions and is now heard 1100-1300 UTC on the regular frequency of 5980 kHz. It has been heard in Australia and New Zealand at that time.

HONDURAS: A new station in Honduras has been heard on 4755 kHz opening at 1200 UTC, and broadcasts are now on a regular basis after a period of tests. The test broadcasts were heard around 0930 UTC. Identified as HRRI and first observed by Wally Singleton of Dunedin, New Zealand. Subsequent reception of the regular broadcasts have been heard in Australia and the station identifies following the National Anthem. According to "Sweden Calling DXers," HRRI is operated by the International Rescue Committee. The schedule is 1200-0200 UTC, and the

station's full address is: c/Comite Internacional de Rescate, Bvde Cangrejal, Colonia Naranjal, Frente a la Casa Dr Vasquez, La Celba, Atlantida.

PERU: Another station on 4755 kHz is Radio Huanta 2000, which broadcasts from Huanta, Peru. This station commences operation at 1030 UTC and has generally faded out before the new Honduras station opens on the frequency. Radio Huanta 2000

broadcasts bright Latin American music with a typical morning program format.

This item was contributed by Arthur Cushen, 212 Earn St, Invercargill, New Zealand who would be pleased to supply additional information on medium and shortwave listening. All times quoted are UTC (GMT) which is 10 hours behind Australian Eastern Standard Time, and areas observing daylight saving time should add a further hour.



DECEMBER

Hong Kong CommuniTech & Computer '86 is on 3 to 6 December. Contact Australian Exhibition Services on (03) 267-4500.

The third 'mathematics-in-industry' study group will be held at Monash University, Melbourne, from 1 to 5 December, 1986. Further information is available from Dr F.R. de Hoog, CSIRO Division of Mathematics and Statistics, GPO Box 1965, Canberra, ACT 2601. (062) 82-2011.

Microbits '86, an introductory Microcomputer Interfacing Principles course in conjunction with QIT, will be held 1-5 December. Enquiries should be directed to Q Search on (07)223-2196.

The **11th Optical Fibre Technology Conference** will be held 1 to 4 December. Contact the Institute of Radio & Electronics Engineers on (03) 606-6581 for more information.

A seminar on **integrating voice and data** is on 3 to 5 December at the Gazebo, Sydney. Contact Management Technology Education on (02) 290-3555 or (03) 67-7117.

The **Pacific Region Conference on Electrical Engineering Education** is on 15 to 17 December at Vue Grand, Queenscliffe, Vic. Contact John Hulska at RMIT on (03) 660-2453 for more information.

The **Intelligent Autonomous Systems Conference** is on 8 to 11 December in Amsterdam. Contact Secretariat, Conference IAS, C/- Congressbureau "Van Neutegen", PO Box 27783, 3003 MB Rotterdam. (010) 433-3179.

JANUARY

Information Online '87 will be held 27 to 29 January at the Hilton, Sydney. Contact Kay Paterson on (02) 332-4622.

PTC87, Pacific Telecommunications Users, is on 18-21 January at Sheraton Waikiki, Honolulu. Contact PTC Council, 1110 University Ave, Suite 308, Honolulu, Hawaii 96826, US.

FEBRUARY

Finance '87 Melbourne, an exhibition of money-handling technology, will be held at the World Trade Centre, Melbourne, 10 to 13 February. For further information contact BPI Exhibitions on (02) 266-9799.

MARCH

A series of seminars will be held in conjunction with the **International Technology Exhibition** in Canberra 3-7 March. For more information contact Total Concept Exhibitions on (02)938-2033.

Hewlett-Packard Precision Architecture is on display at the **South Pacific Area Conference of Computer Users** at the Brisbane Hilton 17-19 March. Contact Graham Coote on (07)57-7007 or Chris Kelly on (07)371-6984.

An **International CAD/CAM Congress** on current realities and future directions will be held 17 to 20 March in Melbourne. Contact ACADS/FACE Congress Secretariat, 576 St Kilda Rd, Melbourne, Vic 3004. (03) 51-9153.

PC87, the Eighth Australian Personal Computer Show, is on 17 to 20 March at Centrepoint in Sydney. Contact Australian Exhibition Services on (03) 267-4500.

The **Queensland Electronic Distributors Association** will hold its next exhibition 24-25 March at the Brisbane Entertainment Centre. Contact Bob Hunt (07)854-1911 or Bob Heelan (07)277-4311.

An international **CAD/CAM Congress** on current realities and future directions will be held 17 to 20 March in Melbourne. Contact ACADS/FACE Congress Secretariat, 576 St Kilda Rd, Melbourne, Vic 3004. (03)51-9153.

The **Fourth South Pacific Area Conference of Computer Users, SPARC '87**, will be held in Brisbane 17-19 March and is calling for papers. Contact Graham Coote on (07)57-7077.

The dates and venues for the two PC87s are as follows: **Eighth Australian Personal Computer Show**, Centrepoint, Sydney, 18-21 March, 1987; and **Ninth Australian PC Show 'Communications 87'**, 'Office Technology 87', Royal Exhibition Building, Melbourne, 1-4 June, 1987.

Labex '87, International Lab and Equipment and Products exhibition is in Brisbane at the Science Pavilion, RNA Exhibition Grounds, 31 March to 2 April. Contact BPI on (02) 266-9799.

APRIL

ATUG '87 4th Australian Telecommunications Exhibition & Conference will be held at the Hilton Hotel in Sydney 7 to 9 April. Contact Riddell Exhibitions on (03) 429-6088.

The **fourth workshop on small computer systems**, organized by the Queensland Institute of Technology, is on 13-15 April and calling for papers. Contact Dr C. Chesmond, QIT Dept of Elec Eng, on (07) 223-2484.

MAY

Photographics '87, an exhibition of the equipment and technology of photographics will be held 23 to 26 May at the RAS Showgrounds in Sydney.

Ausgraph '87 is on 11-15 May in Perth. Contact Conference Secretariat on (03)387-9955.

JUNE

Videotex '87 Exhibition & Conference is on in Melbourne over three days in June. Contact Riddell Exhibitions on (03) 429-6088.

Communications '87, the Australian International Office Technology Exhibition, is on 1 to 4 June at the Royal Exhibition Building, Melbourne. Contact Australian Exhibition Services on (03) 267-4500.

PC87, the Ninth Australian Personal Computer Show is on 1 to 4 June at the Royal Exhibition Building, Melbourne. Contact Australian Exhibition Services on (03) 267-4500.

Office Technology '87 will be held 1 to 4 June in Melbourne. Contact Australian Exhibition Services on (03) 267-4500.

The **1987 Computing Systems Conference** will be held 17 to 19 June in Brisbane. Contact the Institute of Engineers, Australia, 11 National Circ, Barton, ACT 2600. (062)73-3633. **Videotex '87 Exhibition & Conference** is on in Melbourne over three days in June. Contact Riddell Exhibitions on (03)429-6088.

Videotex '87 will be held 30 June to 2 July at the Sheraton Hotel, Auckland. Contact the Secretariat on (649)68-6955.

The **Third National Space Engineering Symposium** will be held 30 June to 2 July at the Australian Defence Academy in Canberra. Contact The Conference Manager on (062)73-3633.

AUGUST

Nelcon '87, National Electronics Conference will be held 24 to 28 August at Auckland University, New Zealand. Contact B.S. Furby on (02) 957-3017.

Kits! Kits! Kits! Kits! Kits! Kits!



SOLDERING IRON TEMPERATURE CONTROL KIT
An important factor in good soldering technique is the correct choice of soldering temperature. If you have put off buying a temperature controlled soldering iron because they are so expensive, your problems are solved with this low cost soldering iron temperature controller kit. It provides fully regulated, adjustable temperature control over a reasonably wide range and will work with just about any conventional 240V soldering iron rated from 20W to 75W.
(ETI 1532, ETI Sept. '86)
Cat. K55320 \$24.95



PARAMETRIC EQUALISER
Does your music system want a new frequency response? Does your guitar or keyboard need some equalisation to brighten the sound? Well, here is a module which can be used by itself on individual instruments or ganged to equalise your music system.
(ETI 1406, ETI August '86)
Cat. K54060 \$16.50



DIGITAL CAPACITANCE METER Mk.2
Updated from the EA March '80 issue, this Digital Capacitance Meter checks capacitor values from 1pF to 99.99uF over three ranges. Its main features include a nulling circuit and a bright 4 digit LED display.
*Note: The RIE kit contains quality silk screen printed and prepunched front panel AND an exclusive High Intensity Display!
(80cm3a, EA August '85)
Cat. K80030 \$69.50



HUMIDITY METER
This project can be built to give a readout of relative humidity either on a LED dot-mode display or a conventional meter. In addition it can be used with another project as a controller to turn on and off a water mist spray in a hothouse, for example.
(ETI May '81) ETI-256 (Includes humidity sensor \$19.50)
Cat. K42560 \$39.50



ELECTRIC FENCE
Mains or battery powered, this electric fence controller is both inexpensive and versatile. Based on an automotive ignition coil, it should prove an adequate deterrent to all manner of livestock. Additionally, its operation conforms to the relevant clauses of Australian Sine 3129. (EA Sept. '82) 82EF9
Cat. K82092 Normally \$19.95
SPECIAL, ONLY \$14.95



ELECTRONIC MOUSETRAP
This clever electronic mousetrap disposes of mice instantly and mercifully, without fail, and resets itself automatically. They'll never get away with the cheese again!
(ETI Aug. '84) ETI 1524
Cat. K55240 \$34.95



TELEPHONE APPLIANCE CONTROLLER
This clever project lets you dial your home number and switch a mains appliance on or off, without paying for the phone call. You can use it to turn on outside lights, a spa or an electric blanket.
(80666, EA June '86)
Cat. K86061 \$54.95

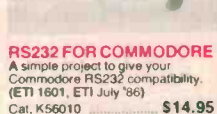

RS232 FOR COMMODORE
A simple project to give your Commodore RS232C compatibility.
(ETI 1601, ETI July '86)
Cat. K56010 \$14.95



TRANSISTOR TESTER
Have you ever desoldered a suspect transistor, only to find that it checks OK? Trouble-shooting exercises are often hindered by this type of false alarm, but many of them could be avoided with an "in-circuit" component tester, such as the EA Handy Tester. (EA Sept. '83) 83TT8
Cat. K83080 Normally \$18.95
SPECIAL, ONLY \$14.95

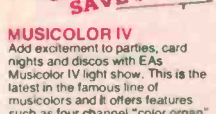

MUSICOLOR IV
Add excitement to parties, card nights and discos with EAs Musicolor IV light show. This is the latest in the famous line of musicolors and it offers features such as four channel "color organ" plus four channel light chaser, front panel LED display, internal microphone, single sensitivity control plus opto-coupled switching for increased safety.
(EA Aug. '81) 81MC8
Cat. K81080 \$99

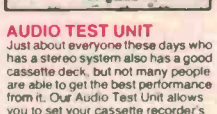

AUDIO TEST UNIT
Just about everyone these days who has a stereo system also has a good cassette deck, but not many people are able to get the best performance from it. Our Audio Test Unit allows you to set your cassette recorder's bias for optimum frequency response for a given tape or alternatively, it allows you to find out which tape is best for your recorder.
(81A010) (EA Oct. '81)
Cat. K81101 \$59.50



PARALLEL PRINTER SWITCH KIT
Tired of plug swapping when ever you want to change from one printer to another? This low-cost project should suit you down to the ground. It lets you have two Centronics-type printers connected up permanently, so that you can select one or the other at the flick of a switch.
(ETI 666, Feb. '85)
Cat. K46660 \$79.95



MULTI SECTOR ALARM STATION
Protect your home and possessions from burglars with this up to the minute burglar alarm system. It's easy to build, costs less than equivalent commercial units, and features eight separate inputs. Individual sector control, battery back up and self-test facility.
Specifications:
• Eight sectors with LED status indication.
• Two delayed entry sectors.
• Variable exit, entry and alarm time settings: entry delay variable between 10 and 75 seconds; exit delay variable between 5 and 45 seconds; alarm time variable between 1 and 15 minutes.
• Resistive loop sensing: suits both normally open and normally closed alarm sensors.
• Battery back-up with in-built charge circuit.
• Built-in siren driver.
The RIE kit includes a superb printed and prepunched metal case and inside metal work, plus a gel battery! Unbeatable VALUE!
Cat. K85900 Normally \$129
SPECIAL, \$119



DIGITAL SAMPLER KIT
Digital sampling is at the core of many of the special sound effects used by modern musicians. A trigger input (usually a construction drum pad) triggers a prerecorded sound from the digital sampler. This sound has been recorded into the 4K of onboard memory and can be digitally manipulated so that it sounds completely different on playback. The unit has controls for gain, regeneration and mixing. It also gives a choice of a number of different triggering methods.
(ETI 1402, May/July '86)
Cat. K41420 \$119



DELUXE CAR BURGLAR ALARM
Stop your car from being one of the 70,000+ stolen cars stolen each year with this "state of the art" car burglar alarm. Features include key switch operation, delayed entry and exit, automatic reset, and provision for an auxiliary battery. Further more, of the 10 most important features listed by NRMA, this EA Deluxe Car Alarm has 9 of them!
(84ba5, EA May '84)
Cat. K84050 \$79.50



VIDEO FADER CIRCUIT
Add a touch of professionalism to your video movies with this simple Video Fader Circuit. It enables you to fade a scene to black (and back again) without loss of picture lock (sync) or colour.
(EA Jan '86, 85F10)
Cat. K86010 \$19.95

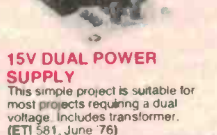

15V DUAL POWER SUPPLY
This simple project is suitable for most projects requiring a dual voltage. Includes transformer.
(ETI 581, June '76)
Cat. K45810 \$34.95

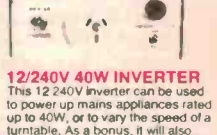

12/240V 40W INVERTER
This 12 240V inverter can be used to power up mains appliances rated to 40W, or to vary the speed of a turntable. As a bonus, it will also work backwards as a trickle charger to top up the battery when the power is on.
(EA May '82) 82IV5
Cat. K82050 \$69.95



BIT PATTERN GENERATOR KIT
In applications where you are required to look for a particular byte of information in a serial or parallel data path, short of a logic analyser or a storage oscilloscope, there is not a lot to help you. However, this Bit Pattern Generator gives you a simple and economical way to detect and display specific bytes of data. It may be used on both parallel and serial data paths.
(ETI 1172, May '86)
Cat. K41720 \$54.95
(Serial/Parallel Kit)



FREQUENCY STANDARD
Get the equivalent of a rubidium frequency standard by draping a piece of wire over the back of your TV set! Believe it or not your humble television can provide an extremely stable and accurate reference frequency. The wire acts as a transducer to pick up electromagnetic radiation from the back of the set. Normally you would need to spend thousands of dollars to achieve accuracy beyond the "parts per thousand" you expect from ordinary meters. With this simple project, an extremely accurate 1MHz signal can be derived for very little outlay.
(ETI 1174, July '86)
Cat. K41740 \$24.95



MICROBEE SERIAL-TO-PARALLEL INTERFACE
Most microcomputers worth owning have an "RS232" connector, or port, through which serial communications (input/output) is conducted. It is a convention that, for using on a printer, the BASICLIST or LPRINT command assumes a printer is connected to the RS232 port. Problem is, serial interface printers are more expensive than parallel Centronics interface printers. Save money by building this interface.
(ETI Jan '84) ETI 675
Cat. K46750 \$59.50

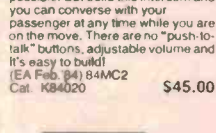

MOTORCYCLE INTERCOM
OVER 300 SOLD!
Motorcycling is fun, but the conversation between rider and passenger is usually just not possible. But build this intercom and you can converse with your passenger at any time while you are on the move. There are no "push-to-talk" buttons, adjustable volume and it's easy to build!
(EA Feb. '84) 84MC2
Cat. K84020 \$45.00

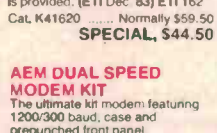

30V/1 A FULLY PROTECTED POWER SUPPLY
The last power supply we did was the phenomenally popular ETI-131. This low cost supply features full protection, output variation from 0V to 30V and selectable current limit. Both voltage and current metering is provided.
(ETI Dec. '83) ETI 162
Cat. K41620 Normally \$59.50
SPECIAL, \$44.50

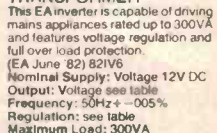

12-240V DC-AC INVERTER INCLUDING 300 WATTS TRANSFORMER
This inverter is capable of driving mains appliances rated up to 300VA and features voltage regulation and full over load protection.
(EA June '82) 82IV6
Nominal Supply Voltage 12V DC
Output: Voltage see table
Frequency: 50Hz +/- 0.05%
Regulation: see table
Maximum Load: 300VA
Current Limiting: 30A (primary)
Efficiency: see table



FOUR CHANNEL MIXER
This four channel mixer project gives professional quality with impressive specifications.
SPECIFICATIONS:
Max. input sensitivity -50dB (2.5mV)
Signal to noise ratio: -78dB relative to +4dB
Distortion: 0.03% at +4dB, 2kHz
Input Impedance: 3k ohm nominal
Output Impedance: 100 ohms
Frequency Response: 10Hz to 30kHz (-+1dB)
(ETI 1404, ETI July '85)
Cat. K54040 \$99

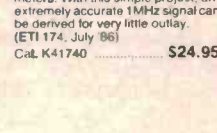

CRYSTAL CONTROLLED TV PATTERN GENERATOR
Anyone wishing to obtain the maximum performance from a colour TV receiver needs a pattern generator. Why not build this superb unit which provides five separate patterns; dot, crosshatch, checker board, grey scale and white raster? Note: The RIE kit includes a large ABS type case!
(80pg6, EA June '80)
Cat. K80033 Normally \$67.50
SPECIAL, \$62.50



PLAYMASTER 300 WATT AMPLIFIER
This module will deliver up to 200 watts into an 8 ohm load and up to 300 watts into a 4 ohm load. Comprehensive protection is included and a printer circuit board brings it all together in a rugged easy-to-build module. It can be built in either fully-complementary or quasi-complementary versions, so audio transistor shortages should be no problem at all.
(80PAG) (EA July '80)
Cat. K80060 Normally \$109
SPECIAL, ONLY \$99 (Heatsink not included)

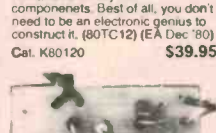

LOW-COST BIPOLAR MODEL TRAIN CONTROLLER
Here is a simple model train control for those enthusiasts who desire something better than the usual rheostat control. It provides much improved low speed performance and is fully overload protected, yet contains relatively few components. Best of all, you don't need to be an electronic genius to construct it.
(80TC12) (EA Dec. '80)
Cat. K80120 \$39.95

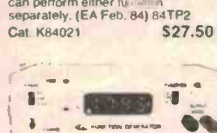

PHONE MINDER
Dubbed the Phone Minder, this handy gadget functions as both a bell extender and pager unit, or it can perform either function separately.
(EA Feb. '84) 84TP2
Cat. K84021 \$27.50



FUNCTION GENERATOR
This Function Generator with digital readout produces Sine, Triangle and Square waves over a frequency range from below 20Hz to above 160Hz with low distortion and good envelope stability. It has an inbuilt four-digit frequency counter for ease and accuracy of frequency setting.
(EA April '82, 82AF3A/B)
Note: The RIE Function Generator has a high quality screen printed and prepunched front panel!
Cat. K82040
Cat. K82041 \$109

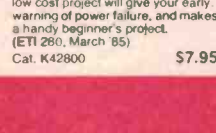

LOW BATTERY VOLTAGE INDICATOR
Knowing your batteries are about to give up on you could save many an embarrassing situation. This simple low cost project will give your early warning of power failure, and makes a handy beginner's project.
(ETI 260, March '85)
Cat. K42800 \$7.95



1W AUDIO AMPLIFIER
A low-cost general-purpose, 1 watt audio amplifier, suitable for increasing your computers audio level, etc.
(EA Nov. '84)
Cat. K84111 \$9.95

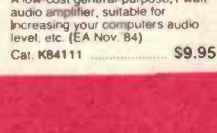

12-240V DC-AC INVERTER INCLUDING 300 WATTS TRANSFORMER
This inverter is capable of driving mains appliances rated up to 300VA and features voltage regulation and full over load protection.
(EA June '82) 82IV6
Nominal Supply Voltage 12V DC
Output: Voltage see table
Frequency: 50Hz +/- 0.05%
Regulation: see table
Maximum Load: 300VA
Current Limiting: 30A (primary)
Efficiency: see table

TOLL FREE
MAIL ORDER NUMBER
008 33 5757
 (STRICTLY ORDERS ONLY)
 INQUIRIES TO (03) 543 7877



Great Christmas Idea!

JUMBO 5 1/4" DISK STORAGE
 If you've got lots of disks, you'll appreciate the extra capacity of this disk storage unit when it comes to locating "that" disk!

Features:

- 100 disk capacity
- Smoked plastic cover
- Lockable (2 keys supplied)
- 9 Dividers/spacers

Cat. C16027 only \$24.95

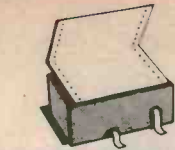

COMPUTER PAPER
 Quality paper at a low price! 2,500 sheets of 11 x 9 1/2", 60 gsm bond paper.

Cat. C21001 Normally \$44.95
SPECIAL, ONLY \$37.95



Great Christmas Idea!

TTL MONITORS
 Fantastic resolution! Enjoy a crisp, sharp image with the latest Ritron TTL monitor! IBM* compatible, green display, swivel and tilt base.

Cat. X14510 Normally \$289
 Amber Cat. X14512 Normally \$289
SPECIAL, ONLY \$269



Great Christmas Idea!

IBM* COMPATIBLES
from \$895*

Assembled & Tested in Australia!
 Incredible deals to suit everyone! Including special package deals!
 *256K RAM, single drive, graphics, and disk controller cards. \$895

256K RAM: Colour Graphics, Disk Controller Card, 1 parallel port, 2 disk drives and 3 months warranty. only \$1,195

640K RAM: Colour graphics, Multifunction Card, Disk Controller Card, 2 serial and 1 parallel ports, 2 disk drives and 3 months warranty. only \$1,295



SAVE \$9

CENTRONICS GENDER CHANGERS

- Female to Female.
- Saves modifying or replacing non-mating Centronics cables.
- All 36 pins wired straight through.

Cat. X15660 Male to Male
 Cat. X15661 Male to Female
 Cat. X15662 Female to Female

Normally \$33.95
Our Price \$24.95



Great Christmas Idea!

5 1/4" DISK STORAGE
 Efficient and practical. Protect your disks from being damaged or lost!

Features:

- 50 disk capacity
- Smoked plastic cover
- Lockable (2 keys supplied)
- Dividers/spacers

Cat. C16030 only \$19.95

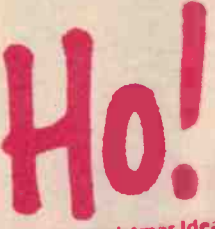

Great Christmas Idea!

RITRON 2 MONITORS
 Stylish, swivel base monitor, available in amber or green.

Green Cat. X14506 Normally \$235
 Amber Cat. X14508 Normally \$239
SPECIAL, ONLY \$199



PRINTER LEAD FOR IBM*

- To suit IBM* PC XT and clones.
- 25 pin "D" plug on computer end
- Centronics 36 pin plug
- Length 2 metres

Cat. P19029 R.R.P. \$44.95
SPECIAL, ONLY \$19.95



Great Christmas Idea!

IBM* AT COMPATIBLE!

Assembled & Tested in Australia!

- 6 MHz
- 80286 CPU
- 8 slots
- 1 M/Byte main board
- 1.2 M/Byte Floppy disk drive
- 20 M/Byte Hard disk
- Colour graphics display card
- Floppy and Hard disk controller card
- Printer card and RS232
- 200W Power supply
- Keyboard
- Manual

All this for just \$3,995
 (Monitor not included)



TELEPHONE ADAPTOR

- Australian plug to U.S. socket
- Length 10cm

Cat. Y16026 \$6.95



Great Christmas Idea!

CANON A-40 PRINTER

- Serial Impact Dot Matrix
- 140 C.P.S
- Near Letter Quality Mode
- 1.4K Buffer

Cat. C20040 \$525



PAPER TAMER

- Restores order to the top of your desk or work area.
- Made of white plastic coated steel
- Stores up to 900 continuous sheets
- Allows perfect paper feed
- Allows easy examination of print out

..... \$44.95
 (Printer and paper not included)



IBM* AT COMPATIBLE!

Includes hard disk controller card, Cat. X20010 WAS \$1,250
SPECIAL, ONLY \$995
 *IBM is a registered trade mark.

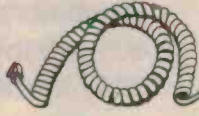

TELEPHONE CURL CORD

- U.S. plug to U.S. plug
- Replacement hand set cord
- Length 4.5 metres

Cat. Y16023 \$7.95



Great Christmas Idea!

INTR A RGB COLOUR MONITOR!
 Size: 14 inch
 Sync. Horiz. Scan Freq: 15.75 KHz
 Sync. Vert. Scan Freq: 50 Hz
 Band width: 18 MHz
 Dot Pitch: 31mm
 Resolution: 640 x 200 dots
 Display Format: 80 x 25 Characters
 Display Colours: 16 colours
 Input Connector: 9 pin D type

Cat. X14520 only \$695



2 & 4 WAY RS232 DATA TRANSFER SWITCHES

If you have two or four compatible devices that need to share a third or fifth, then these inexpensive data transfer switches will save you the time and hassle of constantly changing cables and leads around.

- No power required
- Speed and code transparent
- Two/Four position rotary switch on front panel
- Three/Five interface connections on rear panel
- Switch comes standard with female connector

2 WAY Cat.X19120 \$125
 4 WAY Cat. X19125 \$145



SAVE \$5

RS232 GENDER CHANGERS

- Saves modifying or replacing non-mating RS232 cables.
- All 25 pins wired straight through

Cat. X15650 Male to Male
 Cat. X15651 Male to Female
 Cat. X15652 Female to Female

Normally \$19.95 each
Our Price \$14.95



Great Christmas Idea!

20 M/BYTE HARD DISK DRIVE FOR IBM* AND COMPATIBLES
 Includes hard disk controller card, Cat. X20010 WAS \$1,250
SPECIAL, ONLY \$995
 *IBM is a registered trade mark.



IBM* COMPATIBLE DISK DRIVES

Tired of paying up to 100% more for Japanese Disk Drives? We now have "direct import" Taiwanese disk drives at much lower prices!

Cat.No.	Description	Price
C11801	500K	\$199
C11803	1 M/Byte	\$239
C11805	1.6 M/Byte	\$259



NEW!

IBM* XT & AT COMPATIBLE EXTENDED KEYBOARD (105 KEYS)

These new keyboards are both XT and AT compatible!

- 20 Dedicated function keys
- Enlarged "Return" and "Shift" key
- Positive feel keys
- Low Profile Design, DIN standard
- Separate Numeric and Cursor control keypads
- Additional Functions...
 Key-in-lock, Audio Beep, Previous Word, Next Work, Fast Repeat, Line Feed, Pause, Clear Screen, Reset.

Cat. X12022 only \$249

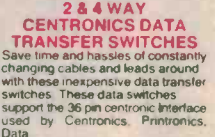

2 & 4 WAY CENTRONICS DATA TRANSFER SWITCHES

Save time and hassles of constantly changing cables and leads around with these inexpensive data transfer switches. These data switches support the 36 pin centronic interface used by Centronics, Printronics, Data Products, Epson, Star, Micronics, and many other premier manufacturers.

- No power required
- Speed and code transparent
- Two/Four position rotary switch on front panel
- Three/Five interface connections on rear panel
- Switch comes standard with female connector
- Bale locks are standard

2 WAY Cat.X19130 \$125
 4 WAY Cat.X19135 \$145



Great Christmas Idea!

MICRODOT DISKS
 100% certified and error free guaranteed!
 Where else can you get 100% guaranteed disks at these prices?!

1-9 boxes 10+boxes

5 1/4" S/S (C12440) \$14.95 \$13.95
 5 1/4" D/S (C12445) \$17.95 \$16.95

Bulk and dealer inquiries welcome please phone (03) 543 2166



Great Christmas Idea!

APPLE* COMPATIBLE SLIMLINE DISK DRIVES

Japanese Chinnon mechanism, Cat. X19901
 Normally \$225
NOW \$195



5 1/4" DISK SPECIALS!
 All prices 10 disk boxes!

Model	1-9	10+
XOEX S/S/D/D	\$29.95	\$29.95
D/S/D/D	\$38.95	\$36.95
High Density	\$99	\$90

VERBATIM DATA LIFE
 S/S/D/D \$27.95 \$26.95
 D/S/D/D \$34.95 \$32.95

3 1/2" DISK SPECIALS!
 STOP PRESS!
 PRICES SLASHED ON 3 1/2" DISKS!
 SAVE \$10 PER BOX!!

Verbatim S/S	\$54.95
Verbatim D/S	\$59.95
Xidex S/S	\$55.95
Xidex D/S	\$79.95

NEED HIGH DENSITY DISKS FOR YOUR IBM AT?
 "Buy your High Density disks at below recommended retail prices from Rod Irving Electronics and SAVE!!"
 R.R.P. \$113 Our Price \$99

rod Irving Electronics
 48 A Beckett St, MELBOURNE
 Phone (03) 663 6151
 425 High St, NORTHCOTE
 Phone (03) 489 8866
 Mail Order and Correspondence:
 P.O. Box 520, CLAYTON 3168
 Telex: AA 151938

MAIL ORDER HOTLINE
008 335757
(TOLL FREE)
 (STRICTLY ORDERS ONLY)

LOCAL ORDERS & INQUIRIES
(03) 543 7877

POSTAGE RATES:

\$1 - \$9.99	\$2.00
\$10 - \$24.99	\$3.00
\$25 - \$49.99	\$4.00
\$50 - \$99.99	\$5.00
\$100 - \$199	\$7.50
\$200 - \$499	\$10.00
\$500 plus	\$12.50

FREE POSTAGE FOR ORDERS OVER \$75 & UNDER 3kg!!

The above postage rates are for basic postage only. Road Freight, bulky and fragile items will be charged at different rates.

Certified Post for orders over \$100 included free!
 Registered Post for orders over \$200 included free!

All sales tax exempt orders and wholesale inquiries to: RITRONICS WHOLESALE, 56 Renner Rd, Clayton, Ph. (03) 543 2166 (3 lines)

Errors and omissions excepted.

*Apple and IBM are registered trade names



FREE POSTAGE FOR ORDERS OVER \$75 & UNDER 3kg!!

TESTING SPEAKER CABLE

For years now we have been plagued by readers abusing us for running speaker cable ads that "insult the intelligence"; and then by distributors of cable for not supporting them editorially. Lacking any authoritative, independent test results that would prove cables really do make an audible difference, we decided to create our own.

IF YOU HAVEN'T visited your local hi-fidelity retailer recently, you may well be unaware of the wide range of speaker leads now offering. These range from thin scraggy figure '8' flexes with electrical characteristics comparable to 'bell wire' at one end of the spectrum, to 'super duper' thick speaker wires at the other. The differences between these mundane and esoteric cables don't end with their appearances; prices range between 20¢ per metre for the light duty speaker cable (with typically 14 strands of 0.14 mm wire in each conductor) up to \$65 per metre for the most expensive of the imported speaker cables. These claim wonderful features such as oxygen-free single crystal copper and other physical characteristics which supposedly make the 'whistles blow and bells ring'.

The general approach of the marketplace towards these cables has been to exhibit an unusual degree of scepticism, the fundamental reasons for which are not hard to find: if the loudspeakers work well with a cable selling for 20¢ per metre, how much more performance can you expect from a cable costing 10 times that figure, let alone 100 times or 300 times that figure?

Thinking this over, we decided to put speaker cable under the microscope. We wanted to settle a number of debates: firstly, are there objective differences between the electrical properties of cables, and if so, are they likely to be significant? Equally important, we wanted to know if there are subjective differences between cables, ie, whether you can hear a difference. If so, do the objective and subjective tests match up, and can you predict which ones will be better for your system?

Objective testing

To understand the way we did the objective testing, it's firstly necessary to understand a little bit of basic loudspeaker theory.

A loudspeaker is a transducer, used to convert electrical into audio energy. A typical three-way loudspeaker system (ie, one with loudspeakers and matching cross-overs) has an electrical equivalent circuit that looks like Figure 1. This is, as you will observe, a

relatively complex circuit with pure resistance and a series of additional circuit elements which consist of parallel resistors, inductors and capacitors.

Because the impedance characteristics of the capacitors and inductors vary with varying frequency, the overall impedance frequency relationship as measured at the speaker terminals tends to be a relatively non-linear curve (see Figure 2). Such a curve



THE PANEL

George Butrumlis: Professional musician. Band credits include Le Prix and Black Sorrows. He was previously musical director at George Patersons advertising agency and currently appears in *Lennon: The Musical*.



Darren Challis: Student. Son of audio reviewer Louis Challis. His main claim to fame, according to Dad, is the ability to hear TV line frequency through three closed doors.

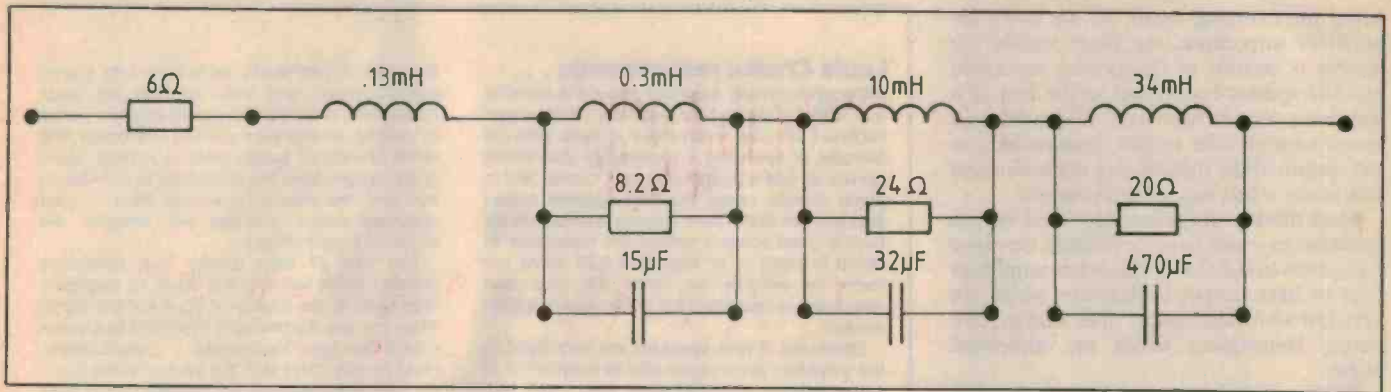

Figure 1. Network used to simulate a typical three-way loudspeaker system.

Louis Challis & ETI staff

is typified by a lower (or lowest) level which is called the speaker characteristic impedance, and which may typically vary between two and 16 ohms, depending on which brand or model of speaker you happen to own.

The speaker is powered by an amplifier which usually has a very much lower output impedance than the characteristic impedance of the speaker. The ratio of these two impedances is called the damping factor. The



The new Time/Energy speakers give you crystal clear music and unheard-of separation between instruments.



The Time/Energy distortion of conventional speakers results in a blurring of the music.

Figure 3. Time/energy distortion, or 'smear'.



Richard Muecke: Freelance recording engineer. Previous credits include the Divinyls *What a Life* LP. He was previously an engineer at Paradise Studios.



Glen Phimister: Recording engineer. Operations manager at Studio 301.



Meredith Rogers: Consultant. Previously employed as an acoustic engineer.

SOUND REVIEW

better the damping factor, ie, the lower the amplifier impedance, the more readily the system is capable of dampening unwanted residual speaker movement at the end of a transient. Some American reviewers and manufacturers refer to this characteristic as the control of the time/energy distortion and this is not a bad way of describing it.

Most modern amplifiers now have output impedances which lie somewhere in the range 0.01 ohms to 0.3 ohms. The better amplifiers tend to have output impedances which are very low while the cheaper ones tend to have output impedances which are somewhat higher.

If your amplifier has an output impedance of 0.01 ohms and your speaker lead has an impedance of 0.5 ohms (or even 1 ohm) then the source impedance seen at the speaker terminals will be significantly different from that of the amplifier alone. It will, in fact, depend critically on the characteristics of the speaker cable. Such musings at least provide a viable mechanism by which speaker cable might make a difference to the sound of an amplifier. The question then is: is it really the case that the damping factor is critical to the way an amplifier/speaker combination performs?

For more than three generations since the first dynamic speakers were developed, our peer group has impressed on us that the damping factor is an important parameter. Unless we keep it down, the loudspeaker's voice call will not faithfully repeat the

Louis Challis recommends . . .

Although originally sceptical about the benefits that can be derived or expected from super cables, I am now much more at ease with the concept of spending a reasonable (but small) portion of one's budget on good, better, and in some specific cases the best speaker cables that you can find. There is every justification for buying good speaker cables the resistance of which is equal to or less than 0.02 ohms per metre or similarly for which the total lead resistance is less than 0.2 ohms (both wires in series).

Obviously, if your speakers are very close to the amplifier, you may be able to economize to some degree, although even then I still recommend good cable even if only because the amount of cable you would need to buy is so pitifully little.

One of the fundamental questions that I have not addressed in this assessment relates to how the speaker lead should be terminated and more specifically whether you should purchase commercial spade lugs, gold-plated plugs, solder

the ends of your leads to reduce both fraying and corrosion, and even whether the leads themselves should be tin-plated or silver-plated to reduce accelerated surface corrosion that some brands of cables tend to exhibit. Obviously, pragmatism, the availability of a soldering iron and the type of terminals fitted to your speakers and/or amplifier will influence the situation in each case.

The use of high quality low resistance speaker leads will make a small to negligible difference in the quality of your audible signal when you use the best amplifiers and to a lesser extent the best loudspeakers. Unfortunately, most people don't own the best amplifiers, nor the best loudspeakers. My measurements have confirmed that the majority of people (and particularly those whose speakers exhibit 'funny' impedance curves and/or are relatively remote from the amplifier) have more to gain from using better speaker leads than you may have imagined.

I have now decided to upgrade my long speaker test leads and practise what I preach.

original electrical signal following a transient voltage excursion.

I believed that principle for years without really being sure whether it was justified or not. Well! Our measurements have confirmed that it is and that unless your speaker cable impedance is relatively low, the result will be a modification of the electrical signal. This typically shows up as a 'smear-

ing' of the signal so that the transients are no longer clean and sharp (see Figure 3). You are also exposed to a time domain distortion which you may not have realized existed.

We fed two separate loudspeakers, one English and one American, with bursts of sine waves. These were at or near the lowest resonant frequency of the speaker (but still well within the normal audible range). I was able to confirm that these speakers are afflicted by significant 'smear' or time/energy distortion in their output signals when the impedance increases by as little as 0.5 ohms in the speaker leads (see Figure 3).

The tests

I found it interesting to observe these effects at low, medium and particularly at high frequencies for, although the effect can be produced more readily at higher frequencies, it is not nearly as audible.

If you add one extra cycle to a signal at a low frequency, ie, at 50 Hz, you produce a 20 millisecond signal which is audible, and which I found an extra 0.5 ohms of speaker lead impedance can produce. At higher frequencies, although readily visible on an oscilloscope, it requires more than one extra cycle of signal to reach the threshold where you can audibly discriminate between the two signals or detect the extended signal smear that such carry-over produces.

The second series of tests that I undertook were to measure the characteristics of a sample of six commercial speaker leads, each nominally 10 metres long with impedances ranging between 0.01 ohms per metre to 0.06 ohms per metre (see Table 1). For good measure, I added a coaxial cable with a total resistance of 5 ohms and 11.700 pF of capacitance.

The first obvious result of the physical

TABLE 1. THE CABLES WE TESTED

Name	Model	Distributor	Price/ metre	Total ohms	Total C (pF)	Length (m)	Ohms/ metre	Capacitance/ metre
A: speaker cable	none	Sheridan Electronics	0.30	0.61	555	10.74	0.057	51.6
B: Audio Technica	LC-OFC	Goldring Audio	22.00	0.20	435	10.01	0.02	43.4
C: Monster	XP	Convoy	4.50	0.27	678	10.7	0.025	63.5
D: Kimber	4TC+8TC	Audio Q Imports	65.00	0.15	1316	9.97	0.015	132.4
E: QED	79	Leisure Sound	6.00	0.14	1005	10.47	0.013	96.2
F: Monster Cable	Cable	Convoy	6.95	0.1	683	10.5	0.0095	64.9

TABLE 2.

Name	Volume	Noise performance	Bass response	Treble response	Middle response
A: speaker cable	-1	-1	-2	-6	1
B: Audio Technica	-3	3	2	-1	3
C: Monster XP	-4	4	-2	-6	3
D: Kimber	2	2	0	6	-2
E: QED	4	-4	0	1	-3
F: Monster Cable	2	-4	2	6	-2

Composite results for all the cables obtained in the following way: If a respondent preferred a certain cable in the A/B test, it was given +1. The poorer one was given -1, and answers of 'unsure' or 'no difference', were scored at 0. Then the results were added together to give an overall rating for a particular cable in any of the five categories above. The results from the five respondents were then added together to give these results.

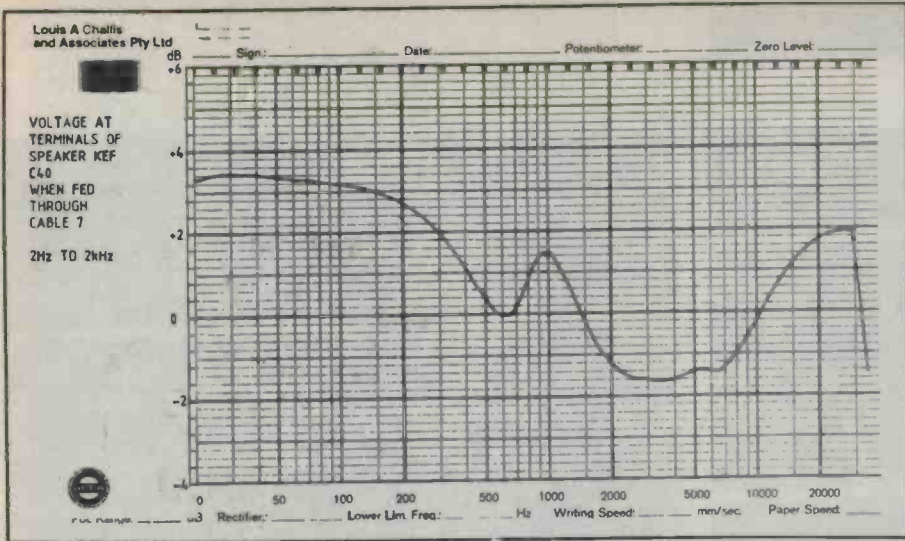
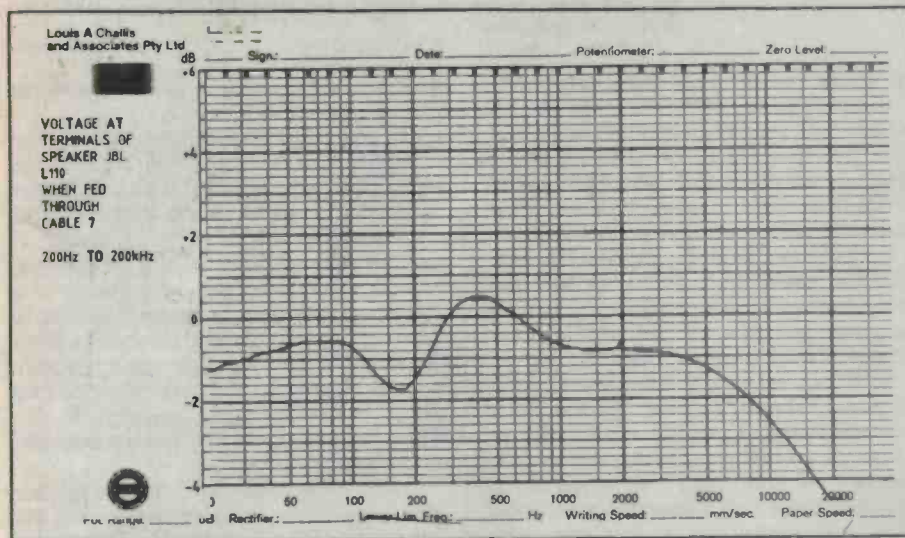

Figure 4. Louis having fun! Frequency response in the audio band of speaker being driven by coaxial cable. The graph is almost entirely due to the cable, since all the other cables in the test produced responses that were essentially flat within the audio band.



testing was the extent to which a high resistance speaker lead, particularly a long one, can cause smear. My assessment also showed that longer cables and lower quality amplifiers further exacerbated this problem.

I decided to extend the testing to assess the variations in supply voltage at the terminals of the two speakers by using a sweep oscillator covering the ranges 2 to 2000 Hz and 200 Hz to 200 kHz. In each case the results were plotted with a level recorder using an expanded scale (0.2 dB per division) for each of the cables.

On a whim, I added some standard 75 ohm coaxial cable, with 5.13 ohms resistance and 11.7 nF of capacitance.

The results produced were disconcerting and displayed a degree of non-linearity which is totally unacceptable (see Figure 4). However, this is not the sort of cable that most people use for their speakers and the capacitance imposed on the amplifier is considerably more than any amplifier manufacturer would recommend.

The variations produced by cable A were

also measurable and although not necessarily audible in terms of a signal level change, they would add to the other electrical effects, particularly at lower frequencies. Even with a selected short test cable whose resistance was only 0.025 ohms and with 116 pF of capacitance, the voltage at the speaker cables started to droop at 150 kHz. The obvious conclusion to be drawn is that if your loudspeaker has a very low fundamental impedance, displays high resonant frequency impedances and/or is driven by an amplifier whose damping factor is lower than that which I used, then you are likely to experience a non-uniformity of signal with respect to varying frequency at your speaker terminals. The degree of non-uniformity will vary from case to case; I deliberately chose to use one of the best amplifiers for the purpose so as to minimize that problem.

The last series of tests performed involved driving an artificial loudspeaker (shown in Figure 1) and the two previously used loudspeakers with a series of off-set pulses, each with a pulse width of 0.2 ms. These

Four Simple Ways to Improve the Sound of Your Music

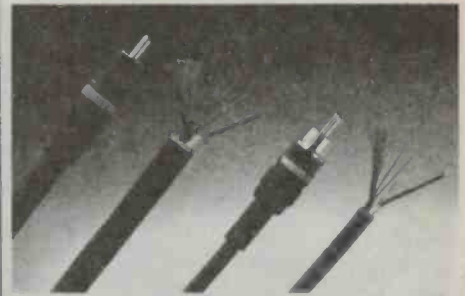

Monster Cable's Interlink Reference A and Interlink Special Featuring "Bandwidth Balanced"™ Technology

Interlink Reference A Our Finest Cable Design lets you Re-discover your Favorite Music.

Interlink Reference A is recognized worldwide as the best sounding interconnect available. Winner of International Audio Review's "Engineering Achievement Award" and flagship of the Interlink Series, Interlink Reference A sets a new standard for audio cable performance. The finest example of our "Bandwidth Balanced"™ design features 3 wire networks to provide ultra-wide bandwidth and absolute phase coherency over the entire audio spectrum. Audiophiles agree. The sonic improvements are worth every penny.

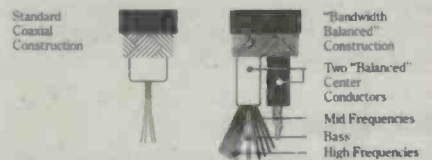

Interlink Special High Technology Puts Big Performance into a Small Package.

Based on the same "Bandwidth Balanced" technology incorporated in Interlink Reference A, Interlink Special is smaller and more flexible. Extended frequency extremes, superb transients, incredible instrument clarity, and an outstanding 3-dimensional image, make Interlink Special second only to one.

Interlink 4 A Price/Performance Breakthrough...

Now Monster Cable's "Bandwidth Balanced" technology is yours in a very affordable, compact package. Using dual inner conductors, each with 2 wire networks, Interlink 4 delivers sound quality that other "audiophile cables" can't match at any price. We invite comparison with the competition.

Interlink CD Fulfilling the Promise of Digital Conventional cables run out of breath when trying to cope with today's digital sound. The detailed resolution, awesome dynamic range, and powerful bottom end available from digital are lost when you use ordinary interconnect cables. Interlink CD controls high frequency phase shifts to produce a richer musical sound while minimizing the harshness found in some CD program material. Connect yours with Interlink CD.

interlink

Write for a free brochure.

Convoy International Pty. Ltd.
400 Botany Road,
Alexandria, 2015
Tel: (02) 698 7300

MONSTER CABLE®

SOUND REVIEW

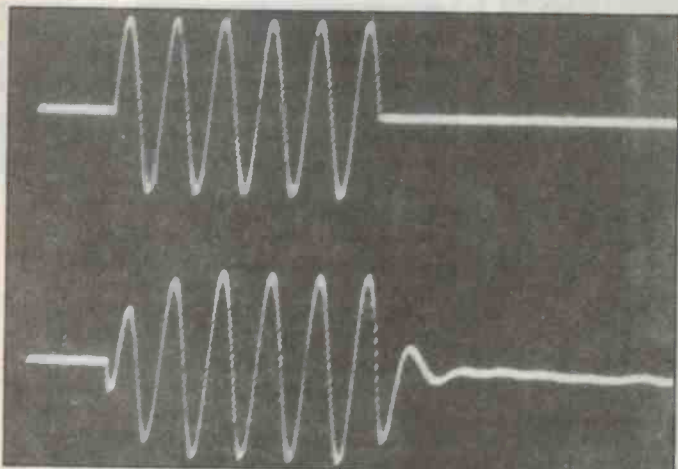

Figure 2. Tone burst of 70 Hz. The upper trace is the input. The lower trace is the output after being passed through a total lead resistance of 0.73 ohms.

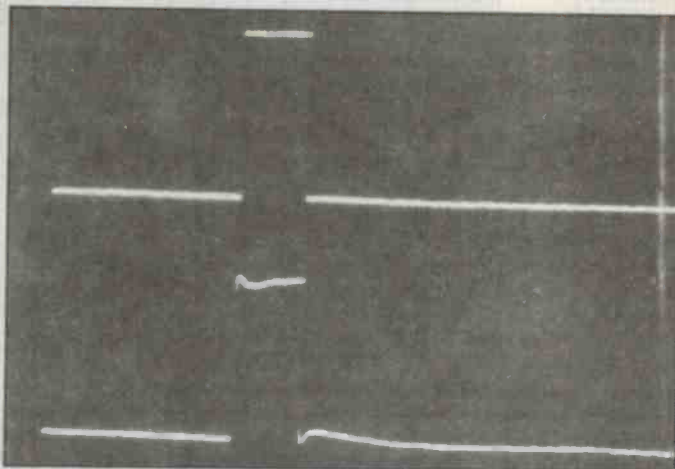

Figure 5. Impulse test for cable A, with total resistance approaching 1 ohm. The upper trace is the amplifier output. The lower trace is at the terminals of the KEF C 40 speaker.

revealed that as soon as the speaker lead resistance approaches 1 ohm, the high frequency ringing effects become quite pronounced and the resulting signal fed to the speaker is no longer a faithful reproduction of the original (see Figure 5).

Subjective tests

To try to tell whether cables make an audible difference to an amplifier/speaker combination, we set up a panel of five people who deal professionally with sound, and might therefore be expected to have reasonably discriminating ears.

There were six cables to be tested labelled A to F, and referred to as such throughout the tests. We decided the best strategy would be to do a series of A/B tests, so that respondents could be asked to make a simple evaluation of 'better' or 'worse'. This meant each person would have to listen to 15 pairs of cables, a considerable load, but more reliable than asking them to try to order six cables at one time.

This test structure also allowed us to test each respondent's replies for internal consistency. So, if A was better than B, and B better than C, then A must be better than C. Clearly, a respondent who claimed to hear differences, but was inconsistent, would not be as reliable as one who always got it right.

Respondents were asked to differentiate volume, absence of noise, and quality of treble, mid range, and base response.

We varied the order in which the cables were presented, to try to control any bias that might otherwise creep in.

In order to eliminate any preconceptions, the respondents were not told beforehand what they were testing, merely that they were listening to a comparison of "high quality hi-fi systems". The test set-up was hidden behind a theatrical 'black', a large opaque drape. The only part of the test set-

up visible was the front of the speakers.

In addition, any of the test team who had contact with the respondents before the test, were not told about the labelling of the cables or the order of presentation, so that it was impossible for them to know which particular cables were being presented.

Actually, the blind was so good that even after the tests were complete, we had little idea which cable had performed best. That only emerged after we had done a bit of statistical work on the results.

To do the test we alternated two passages of music, Handel's *Music for the Royal Fireworks* and Vivaldi's *Four Seasons*. Although probably not ideal, the opening passages of both tracks have significant dynamic range and a structure that would allow easy assessment of bass and treble response.

First, 30 seconds of music was played then cables changed at the power amplifier and the speaker and the same 30 seconds of music replayed. With a little practice, it proved possible to effect the change in about 10 seconds.

The passages of music alternated with every comparison. In addition we played the passages in a different order to each respondent, so that cables A and B were tested with the Vivaldi on the first respondent, and with the Handel on the second. In this way we hoped to control any spurious effects imposed by our choice of music or the order of presentation.

Subjective results

Our audio experts claimed to hear differences in a majority of tests, despite a gap of about 10 seconds between pieces, which would not maximize their ability to judge differences.

To quantify the results, we awarded 1 point to a cable judged better in each test, -1 to one judged inferior and 0 if the cables

were judged the same, or if the respondent was unsure of the answer.

The results are displayed in Table 2. The possible range is ± 30 . If all respondents had consistently agreed that any particular cable was better or worse it could have amassed 30 points in either direction. If respondents disagreed among themselves, or were inconsistent, or were unsure of a difference, then the nett result should be 0.

What information can we extract from the Table? Firstly, no cable came remotely close to the maximum in any dimension we tested, indicating either considerable disagreement among the panel or considerable doubt within themselves.

Some confidence that this is a fair assessment of the situation comes from the fact that the strongest difference shown in the table is in the treble response, which is what one would expect on the basis of the theory sketched above.

In all the other areas the results seem a little inconclusive. If this was a random sample test to decide if there were differences in sound quality, the tests would be definitely inconclusive. More respondents would be needed to support an hypothesis that there were significant differences.

However, if instead we view the tests as being the vote of five audio experts, then we can conclude that some cables can sound superior to the listener.

Put another way, it would seem from our table that there was little difference between cables. However, the response of many of our panel members when we pulled aside the curtain and showed them what we were doing, was that they were surprised by the extent of the difference they had heard.

A generalized rule therefore might be, that speaker cable does make a difference, but it's small, and it's difficult to say exactly what it is. ●

Goldring means many different things...

**Styli, cartridges, cassette
cleaners, headphones, jack leads
and a myriad of high quality
audio and video accessories.**

...now it means something extra...



audio-technica®

**Goldring is now sole distributor for the
magnificent Audio-Technica range of
superior audio products. Quality
products for the connoisseur of sound.**

*For further information about these and other
Goldring products please contact:*



GOLDRING® **AUDIO INDUSTRIES**

Sydney:
Goldring Audio Industries
Suite 1, 89 Chandos Street,
St. Leonards, 2065
(02) 439 3100

Newcastle:
Jensen Distributors
35 Downie Street
Wickham, 2293
(049) 69 1333

Melbourne:
Goldring Audio Industries
46 Gladstone Street,
South Melbourne, 3205
(03) 690 4333

Western Australia:
S.J. Pontague & Associates
432 Murray Street,
Perth, 6000
(09) 321 4567

Brisbane:
Goldring Audio Industries
40D Milson Street
Cooparoo, 4151
(07) 398 8044

South Australia:
Goldring Distributors
25 Hutt Street,
Adelaide, 5000
(08) 224 0266

Tasmania:
Tasmanian Record Company
10 Cameron Street
Launceston, 7250
(003) 31 5588

VLSI DEVICE TESTING

Brian Dance M.Sc.

The modern silicon circuit design engineer can perform all of his design and circuit testing work while using a graphics computer terminal. Ten to 20 years ago he would have been sitting at a work bench, holding a soldering iron, while constructing and testing much simpler circuits. Plessey is leading the way in new very large scale integrated circuit testing procedures.

IDEALLY THE VLSI designer should be able to exhaustively test his integrated circuits for 100 per cent fault coverage. Unfortunately such testing is a practical impossibility, since modern VLSI silicon chip complexity is doubling about every 18 months (see Figure 1). Nevertheless, it is vitally important for the designer to strive to obtain the highest degree of fault coverage possible within a reasonable testing time.

Testing is regarded as the Achilles heel of the VLSI industry to the point that it has become one of the first considerations in VLSI design. Testability problems may account for as much as 20 per cent of chip design time in some cases. This article briefly outlines the nature of the problem and discusses the philosophy adopted by Plessey for the testing facilities in its new Plessey Megacell semicustom system.

Principles

The testing of VLSI memory devices is carried out by feeding suitable test signal patterns to the device inputs. In relatively simple devices all of the memory states can be examined by testing every location in the memory. A device with n memory elements has 2^n possible states which ideally should all be tested. If there are 22 memory elements in a device, the number of states is $2^{22} = 4194304$. These can all be tested in just under 0.5 seconds using a 10 MHz clock rate test pattern inputting a test vector every 100 nanoseconds.

If, however, a device contains 32 memory elements, the number of possible states rises to $2^{32} = 4.29 \times 10^9$. If a 10 MHz test pattern is employed, the time for exhaustive testing approaches 500 seconds or about eight minutes. A 42-memory element device with $2^{42} = 4.39 \times 10^{12}$ states would need a time of nearly 5×10^5 seconds or over five days of continuous testing with a 10 MHz clock pattern. This is out of the question for device production.

The time for exhaustive testing increases

as the square of the chip complexity. VLSI chips may, therefore be partitioned into simpler units, each of which may have no more than 5000 individually testable logic gates.

If a device is not to be exhaustively tested the designer may obtain a certain degree of fault coverage through the use of either deterministic patterns or random patterns. Deterministic patterns are devised by the designer of the circuit using his knowledge of the device structure. For example, he knows how to find a limited set of test vectors, perhaps a maximum of 2000, which can be used to test with a 10 MHz clock in parallel in a little over one millisecond or serially in some 30 to 40

milliseconds.

Random test patterns can be generated either by using circuitry on the chip being tested or by means of external circuitry. They are employed when it is not easy to get well defined test vectors. A random test pattern for a particular chip comprises a fixed sequence of pseudo-random numbers, the complexity of the pattern depending on both the chip complexity and on the fault coverage required.

Fault simulators are extremely computer intensive with computer time increasing very rapidly as the device increases in complexity. Simulation times for classic simulators of a device with a complexity of the order of 1000 logic gates is likely to be measured in minutes, whereas that for 5000-gate devices could take hours of the central processor unit's time. Simulation times increase as the square of the chip complexity and testing is often limited by the fault simulation process.

Megacell

The Plessey Megacell system is a semicustom, cell-based hierarchical VLSI design

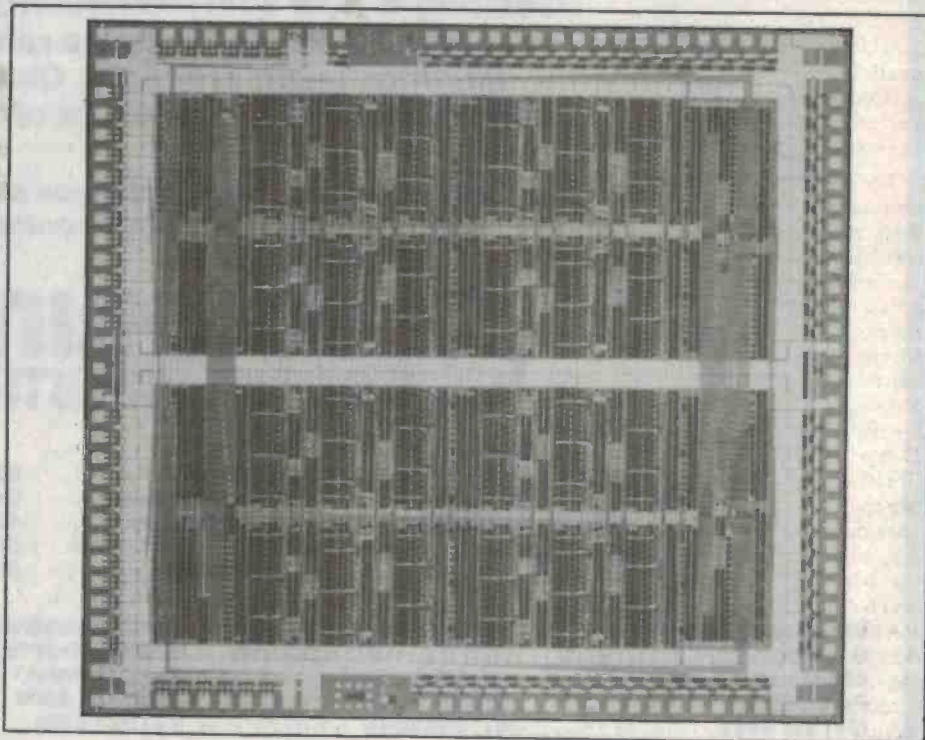

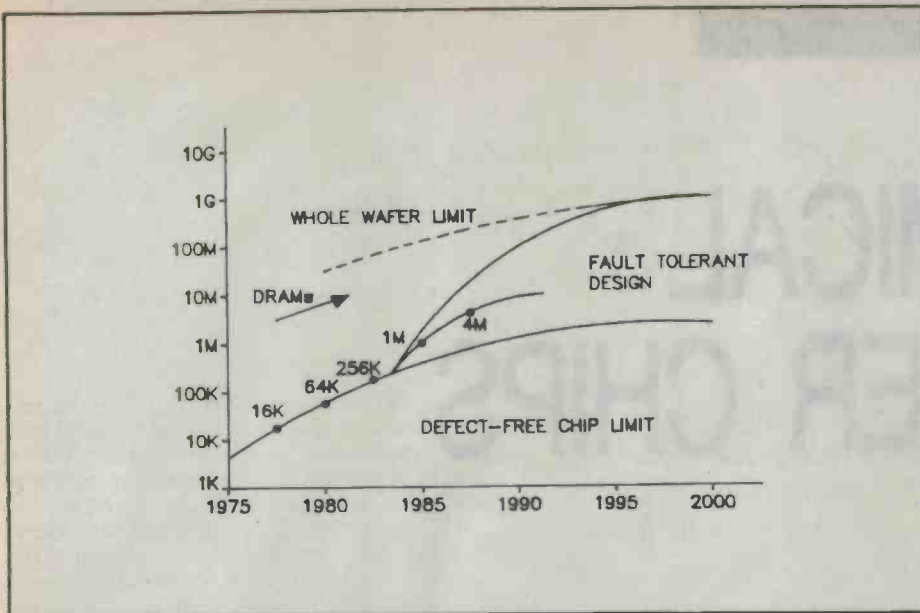

Figure 1. Increase of chip complexity over time (courtesy Plessey).

technique. It has been planned as a complete software tool set which enables engineers to create, lay out and test chips, and to control design projects from schematic capture to mask making without the assistance of chip design experts. Megacell currently employs 2-micron CMOS technology. However, it is planned to implement the system with 1.5-micron and with 1-micron CMOS technologies now under development so as to improve the speed capability and the chip complexity. Current designs are limited to about 30,000 gates or some 120,000 transistors per chip. However, Megacell has been developed with the specific objective of being able to cater in due course for chips with over 100,000 gates. Extensive software aids are available to enable system designers to produce their own VLSI designs without the necessity of understanding the detailed operation of their silicon circuits.

The increasing chip complexity is causing semi-custom designers to favour cells rather than gate arrays, but large numbers of specialized cells must be designed and verified at high cost for a range of applications if designers are not to be restricted to only standard-size cells. For Megacell, Plessey had adopted a three-tier hierarchy of Microcells, Paracells and Supracells. Microcells are standard low level logic cells such as the gates, latches and D-type flipflops similar to those in gate array libraries. Supracells are pre-designed and pre-characterized LSI cells. Paracells are parameterized cells, often of intermediate size, which are automatically generated by the Megacell system in response to parameters supplied by the system designer. A RAM or a ROM, for example, could be designed by specifying the word length and the number of words. The software constructs the cell and adds it to the user library. Thus a large range of applications can be handled by a fairly small cell library.

Megacell test features

The Megacell design system provides the chip designer with a means of partitioning VLSI devices into testable units. It does this by providing the option of using two functions: test registers and test interface units. The test registers are placed between the various testable units of the chip and can be programmed either for normal chip operation or for the test modes. The registers are controlled through the test interface units which also provide a means of inputting and outputting test data.

The Megacell test registers are programmable for operation in various test modes, the test patterns being serially loaded in and out through test registers. Once the test pattern has been loaded, it can be employed in a straight scan path mode. However, the registers can also be configured as either pseudo-random pattern generators or as a parallel signature analyser where data is loaded into a register to initialize it. In partial testing, the process can be stopped if it is taking too long.

The response to the test patterns is fed into a signature analyser register at the output; many successive input operations should result in a certain final state which is predictable by computer. Although Megacell has signature analysis built in as an option for the designer to use if he so wishes, Plessey recognizes it is not a universal solution. A mixture of scan path and signature analysis, often referred to as BILBO (built-in logic block observability) is often the optimum and both can be mixed on the same chip. The choice of scan path or BILBO is not predetermined during chip design and can be made at the time of testing.

Suitable control signals fed to the on-chip test interface unit can be employed to specify the particular type of test and test sequence for each of the testable units on the chip.

The test registers perform a useful function in normal chip operation even when testing is not being undertaken. They can be used as parallel data latches — a frequent requirement in chips designed for synchronous operation.

Testing flexibility

One of the main aims of the Megacell system has been to provide device designers with maximum flexibility in testing. Megacell leaves the designer free to choose whether he wishes to use the testability tools provided and, if so, how he will use them. The designer decides what is to be a testable unit, but he is not under any constraint to use a particular form of testing. It is recognized that some people prefer to adopt their own approach to testability.

Plessey claims that the flexibility and user-friendliness of the Megacell system are unique. Although many other commercial systems offer scan path facilities no others are known which offer signature analysis tools. The ability to offer the designer the choice of testing techniques is claimed to be original to the Megacell system.

Megacell can be used to design fully self-testing chips. That is, the test pattern can be generated on-chip and the response to these patterns can be analysed on-chip to provide a single go/no-go signal.

Self testing chips require that a part of the silicon be allocated to the testing facility. Plessey Research (Caswell) has designed devices in which the built-in self test area amounts to under 5 per cent of the total chip, but even 20 per cent to 30 per cent may be justified in some cases for production testing.

However, self testing is not employed merely for ascertaining if chips coming from the production line are satisfactory. It can also be employed to detect defects occurring during system operation in the field. The system manufacturer may require goods inward testing, system production testing and field support system testing. Although a testing overhead of only 5 per cent may be too expensive for some chip manufacturers, the trade-off limits may be very different for the equipment manufacturer. The end-user can specify that a chip shall be completely self testing; Megacell can satisfy this requirement, but does not impose it as a requirement. A self testing facility can be part of the end-user specification different from production testing.

The British Alvey program includes work on built-in self testing for VLSI design and it is hoped to extend this to wafer scale integration in due course. Plessey Research (Caswell) Ltd is participating in the Alvey, Esprit and CATE work which aims to improve our understanding of VLSI chip testability problems. ●

BIOCHEMICAL COMPUTER CHIPS

Collette Snowden

Collette Snowden is Information Officer at the University of Adelaide.

Advances in existing computer technology continue to occur at a hectic pace, but even more spectacular change is possible with the advent of biochemical computer chips.

IMAGINE THE BIGGEST super-computer of today reduced to the size of five sugar cubes, or truly microscopic replacement parts for the human body. Practical production of molecular-sized chips would make this possible.

Pioneering work in the field of molecular electronics which would make such ideas feasible is being carried out at the University of Adelaide by Michael Groves, a PhD student in the Department of Computer Science.

Groves has produced theoretical proof that wave-like particles, known as solitons, can be used to emulate the logical circuits of computers.

Solitons, although still regarded as theoretical despite a good deal of evidence to support their existence, would offer the necessary properties required to build computers using molecular components rather than existing solid-state silicon components.

The implications of this theory are vast, and developed to a practical stage are capable of revolutionizing computer technology.

Biochemical circuits would offer immense reductions in size, even in comparison to the most modern silicon chips.

The components in the proposed biochip would be linked by single strands of polyacetylene, which is a plastic capable of conducting electricity and which consists of a chain of carbon atoms with alternating double and single bonds between them.

It is believed that when a soliton passes along a polyacetylene chain it reverses the arrangement of the double bonds and as there can be only two arrangements of the bonds (single-double or double-single) their position can be used to store binary (0 or 1) information.

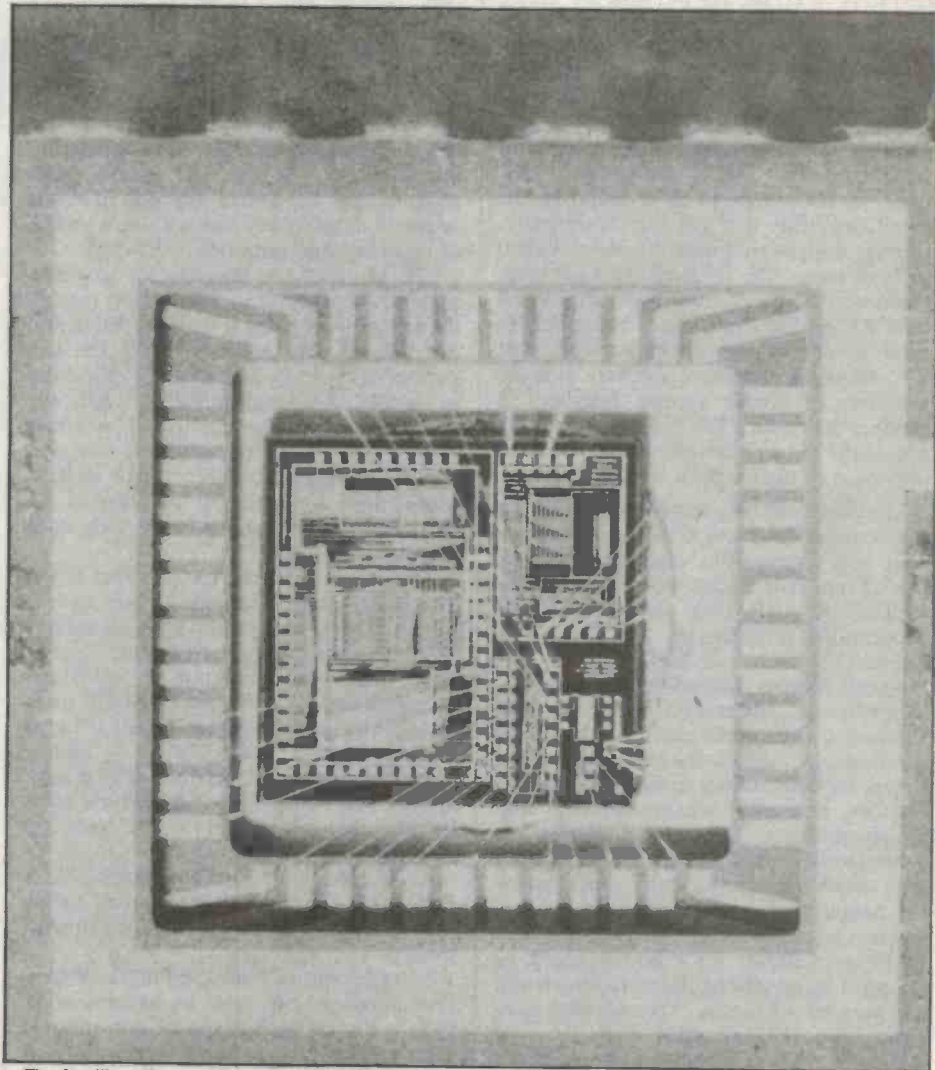

The familiar silicon variety. Here four chips are fitted into a space of five square mil.

The use of biochips would also lead to significant power savings because the two arrangements of double bonds indicate whether a chain is on or off, and the passage of a single electron (in the form of a soliton) would represent a chain going from on to off or off to on, instead of the need in conventional circuits for a constant current to indicate whether a wire is on or off.

The basis of Michael Groves' work is that given a switch, a way to generate solitons and a way to join polyacetylene chains together, it is possible to make gates, memories and other necessary components required to form a computer.

Further impetus has been given to the search to find a workable biochip by the need to find computer components smaller than those currently available because conventional chips have reached a stage where they cannot be miniaturized much further. One of the main problems with existing chips is their tendency to over-heat and 'cross-talk'. The chemical biochip would eliminate this problem and lead to further miniaturization.

The implications inherent in the use of biochips have led to an increased interest in the idea of building electronic circuits by chemical means in recent years. Interest too has been fanned by the advent of conducting polymers and greater knowledge of how biological systems form large molecules. Furthermore, semiconductor research is rapidly approaching practical and theoretical limits in attempting to form smaller and more powerful circuits on silicon.

"As my theoretical work progressed, the nature of the basic components required became clearer and the structures for them became simpler. I am also aiming to mathematically verify the working of a soliton circuit. This theoretical work is now largely completed," Groves has explained.

He said that the next stage would be to start on the practical work and the long road to creating a biochip.

"The first step will be to make the soliton switch but I have developed quite simple structures for the switch that should be quite easy to make."

Once the switch is made the next step in the development of a biochip would be to join the switches together in simple gates and verify their workings by chemical means while they are in solution.

"This is an important new idea I have developed because it enables chemical computation to be demonstrated and studied before the problem of how to make electrical connections to tiny molecules is solved; these gates can be connected together into larger and larger structures which are eventually connected to external electronics," he said.

Groves asserts that biochips could be

constructed in test-tubes by chemical means.

"Though the molecules required are very small compared to conventional electronics, they are very large and complex in chemical terms. We know it is possible to construct much larger molecules because they exist in everyday biology. Remember that trees and whales are formed entirely by chemical means," he said.

"The components for biochips could be constructed and joined together using the self assembly properties of proteins and possibly even using cells to act as little factories. One of the advantages offered by the use of cells as biochip factories is that every time a cell is divided another factory is born."

All the chemicals required to form the components proposed by Groves are common and cheap and with the possibility of more than a billion components in each gram of starting material he believes the cost per unit would be extremely small.

Greater savings would also be possible because the mass production of electrical components could be accomplished by one worker in a few months in a chemical laboratory.

"Making the switch should take less than a year so I am looking for funding myself and possibly a chemical assistant," he said.

Groves' research has received attention overseas in journals such as *High Technology*, *Science News* and *The Economist*.

Interest in biochips in Australia has been sadly lacking whereas in Japan the Government has announced a \$30 million fund to coordinate the biochip research efforts of their major electronic companies. The Japanese Ministry of International Trade and Industry has devised the basic development plan of bio-elements and made the plan a new theme for the Research and Development Project of Basic Technology for Future Industries.

The Japanese MITI plans to do theoretical basic research for 10 years and achieve understanding by the joint efforts of government and industry with participation by electronics, electrical and chemical firms.

In Britain \$11 million has been allocated to biochip research. Significant research efforts are also being made in the United States particularly at the Naval Research Centre in Washington where Dr Forrest Carter is one of the foremost figures in the field of molecular electronics.

However, the contribution of researchers like Michael Groves could place Australia in the forefront of this important area of computer technology. ●

Reprinted from *Ascent* published by the Department of Science.

I M A R K

for JAPANESE ICs & TRANSISTORS

OEM Quantity prices available

NEC

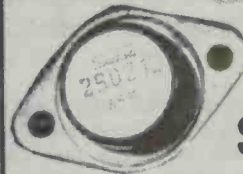
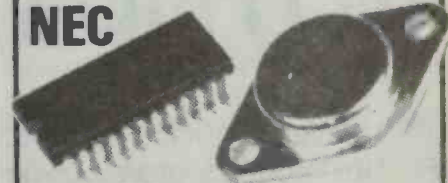

SANKEN



OKI

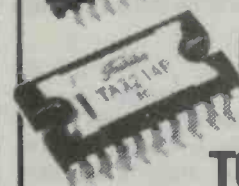

TOSHIBA



HITACHI

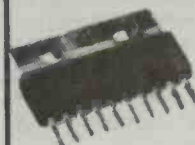
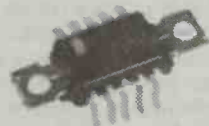

SANYO

MITSUBISHI



MATSUSHITA



FWJITSU

Send for listing

I M A R K

PTY. LTD.

167 Roden St., West Melbourne,
Victoria 3003

Phone: (03) 329 5433 Telex AA37753

INSTRUMENTING WITH PCs

The ultimate tool of the electronics trade is beginning to look like the PC. But the variety of arrangements it can be used in make it anything but the end of the line.

Jon Fairall

WHEN IBM entered personal computing it was a major tragedy for PC connoisseurs. The speeding engines of change that had taken the personal computer from a backyard toy to a major performer were finally halted. Innovative and exciting computer companies around the world bit the dust. It was a disaster.

That, at least, is the view from the computer makers' side. From the viewpoint of the serious user, however, it looks a little different. To be sure, the development of new product has been slowed, and you only have to compare one of the new 16-bit machines like Commodore's Amiga with your typical clone to see what might have been. But on the other hand we now have a standard.

The emergence of this standard has been one of a number of trends that are starting to change the nature of the instruments we use in day to day electronics.

The new instruments look unfamiliar. For the most part they are simply black boxes, a few connectors, and an LED on the front panel to tell you it's on. But they do the job, and they do it well. So, where have these strange devices come from, and do they really point to the future?

The standard

The existence of the standard has meant that the cutting edge of technology has moved from hardware to software. Stuck with a particular architecture, engineers have come up with new and exciting software that makes the typical PC look very smart indeed.

The result has been a whole list of industry standard software, like Lotus, Wordstar and dBase II. The innovation cycle has slowed to the extent that it's become possible to train non-specialist staff: secretaries, bank clerks, lawyers, in the mysteries, not of computers, but of a particular hardware/software combination.

Computers have snuck up on the world, and the world has barely noticed.

The new standard has also attracted working engineers. For the first time it has become possible to invest in software development with reasonable confidence that the target market will have access to suitable hardware. The result is increasingly that testing procedures, once involving dedicated expensive equipment, are being designed around the PC.

For instance, the last year has seen the emergence of cheap, usable computer aided design (CAD) packages. All of a sudden it's

possible to pick up CAD packages for hundreds, instead of hundreds of thousands, of dollars. Packages like Smartwork or Protel (reviewed in ETI September and October, '86 respectively) sell for less than \$1000. As time has gone by, more and more of the features that were once the realm of top-end units have become available on PC-based packages. Nowadays it's possible to get features like auto routing and logic testing on PC-based CAD for under \$20,000.

Another development, really an extension of the CAD work, has been the emergence of PC-based microcomputer development systems. The story here is the same. Not very long ago, these were dedicated units with big price tags. Now we are beginning to see such units hanging off the back of a PC, and the price is tumbling.

For instance, Philips has just released a system called PMDS-111 that uses a PC and a box of software to give high level language debugging and real time emulation up to 16 MHz. It has cross-compilers, assemblers, debug processors and all the other tools of the development engineer built in.

Processors

While all this has been going on, the winds of change have been blowing through the instrument industry. The big trend is towards the use of microprocessors in test equipment to give them a degree of intelligence. There seem to be two engines driving this trend. One moves towards greater flexibility in the instrument, the other towards reducing the complexity of specific tests.

A product of the first trend might be any of a number of the processor-controlled oscilloscopes, signal generators or counters that are now pouring out from the instrument makers. The processor can be used to make the instrument easier to use, to display the information more precisely or to interface to other pieces of equipment. For instance, it's quite common now to find oscilloscopes that can drive a plotter to give a hard copy of a waveform, or that will set themselves intelligently to display a given input.

The other side of the coin is to use the processor to bundle together a number of different instruments to create one composite



The HP Instrument System (reviewed ETI September '85).



Analyse 8-, 16- and 32-bit microprocessors with your PC.

instrument for specific purposes. This is a newer trend, confined at the moment to a few instruments from some of the larger makers. Marconi, for instance, has just released a cellular radio test set that will perform all of the measurements necessary to test a cellular radio. It functions like an amalgam of 12 separate instruments in one box.

Control

Another trend worth noting is the emergence of the idea of controlling instruments through control busses, of which the IEEE488 and its proprietary derivatives must be the most common.

This leads naturally to the idea of the automatic test station, in which a computer can be made to control the instruments, get a read-out and display it in some way for the operator. The details of this set-up are frequently very complex, but the fundamental architecture is simple enough. A board under test is inserted into a jig. The central computer might instruct a signal generator to inject a particular frequency into an input. The oscilloscope will read the output, and feed the required dimensions back to the master, where a go/no go decision will be made and the results displayed to the operator.

IEEE488 has been around for a number of years, and the structure of the bus and its peripherals is starting to get extremely sophisticated. For instance, Scientific Devices, the Melbourne-based instrument distributor, is now selling devices that will allow one controller to operate four separate busses, or conversely, one instrument to be time-shared between a number of different bus architectures. You can expand the bus by up to 14 instruments at a time, optically couple them if interference or noise is a problem, or use twisted pairs when it is not. Scientific Devices is also selling an interface that will

allow 16 analogue and 32 digital inputs and 16 relay outputs to be controlled directly from the bus.

The PC

So to the latest trend, emerging slowly from these ideas about the shape and function of instruments. It's the arrival of test instruments that hang off the PC like any other peripheral. The philosophy is simple. The PC can do certain things rather well. It's an ideal operator's input device, and an excellent display tool. It can also be programmed for sequential and conditional operation. So, to make a useful instrument out of it, all that's necessary is a bit of hardware to turn a measurement from the outside world into something the computer can understand. In this way it's possible to create oscilloscopes, multimeters, generators and all the other paraphernalia that clutter up a lab bench.

All this is starting to come together now in the form of the PC instrument controller. A number of products have already reached the market that display many of these features. For instance, in the middle of last year Hewlett-Packard was first on the market with its "Instruments System".

The HP development consisted of a digitizing oscilloscope, a counter, a function generator and a multimeter, all in separate modules that hang off the back of either HP's own clone, the HP-150 or the IBM-PC itself. It used a 20M hard disk and 5¼ floppy for data storage. One advantage of using the HP computer is that it comes with a touch screen, which makes operating the devices extremely easy.

The system can be operated in two modes. Firstly there is a manual mode, in which the operator can select the instrument, and then set it up, using the touch screen or the keyboard. Secondly, and more powerfully, the instruments can be programmed using a

standard GW BASIC resident in the system.

One of the most powerful features is that the software allows one to interface directly with standard software, like Wordstar, Lotus or VisiCalc. This makes data message, the production of reports and so on, a simple matter.

The future

The question is does this represent the future? There are a number of alternatives: stand alone instruments, hooked up to a dedicated controller via a bus; multifunctioning instruments in one box; or adaptations of general purpose computers into instrument functions via add-ons.

If there is a lesson to be learned from history, it would be that the PC rules. By analogy with CAD, we would expect the ability of the PC to increase so that more and more of the functions presently only available on expensive equipment become available at cheaper and cheaper prices. Programming is a trivial exercise, and we may expect it to become even more so as time passes.

In general, the problem with the bus approach is that it is horrendously expensive. The cost is the cost of an ordinary instrument, plus the cost of installing bus interfaces. Then there is the cost of writing software to do a particular job on a particular board. Given the short product life cycles that plague the electronics industry at the moment, the economics of doing this must be very unattractive.

However, the PC offers one practical advantage of great value: it consists of stand alone instruments. In a practical working environment, it might be of great value to have a simple CRO that can be part of an instrument network one minute and work as a stand alone the next. It can also be expanded or upgraded at will for the same reason. ●

READER SERVICES: All enquiries regarding back issues, photocopies of articles, artwork or technical enquiries must be directed by mail to ETI Reader Services, PO Box 227, Waterloo, NSW 2017. Enclose cheque or money order to the appropriate value with your request. Relevant charges including postage within Australia and New Zealand are: back issues \$4; photostat copies, \$4 per article or \$8 if project spreads over more than one issue; artwork, \$5 per board or panel up to 10 cm² or equivalent, \$10 for larger boards.

TECHNICAL ENQUIRIES: No enquiries by telephone will be accepted. Readers have two options: to submit a written enquiry with \$5 money order or cheque and receive a postal reply; this service is limited to projects published within the last five years; alternatively they may forward enquiry without money and expect a published reply in the Feed Forward columns at the editor's discretion.

GENERAL INQUIRIES: For all inquiries about back issues, subscriptions, photocopies of articles, artwork or submitting articles, call (02) 663-9999 or write to: ETI Reader Services, 180 Bourke Rd, Alexandria, NSW 2015 (PO Box 227, Waterloo, NSW 2017).

CONTRIBUTIONS: Submissions must be accompanied by a stamped, self-addressed envelope. The publisher accepts no responsibility for unsolicited material.

COPYRIGHT: The contents of *Electronics Today International* and associated publications is fully protected by the Commonwealth Copyright Act (1968). Copyright extends to all written material, photographs, drawings, circuit diagrams and printed-circuit boards. Although any form of reproduction is a breach of copyright, we are not concerned about individuals constructing projects for their own private use, nor by bands (for example) constructing one or more items for use in connection with their performances. Commercial organisations should note that no project or part project described in *Electronics Today International* or associated publications may be offered for sale, or sold in substantially or fully assembled form, unless a licence has been specifically obtained so to do from the publisher, The Federal Publishing Company, or from the copyright holders.

LIABILITY: Comments and test results on equipment reviewed refer to the particular item submitted for review and may not necessarily pertain to other units of the same make or model number. Whilst every effort has been made to ensure that all constructional projects referred to in this edition will operate as indicated efficiently and properly and that all necessary components to manufacture the same will be available, no responsibility is accepted in respect of the failure for any reason at all of the project to operate effectively or at all whether due to any fault in design or otherwise and no responsibility is accepted for the failure to obtain any component parts in respect of any such project. Further, no responsibility is accepted in respect of any injury or damage caused by any fault in the design of any such project as aforesaid.

Editorial

Perhaps the most interesting single problem facing the electronics industry today relates to the funding of research and development: how should it be done, who should do it and who should get the results? There is a tendency to think that this type of debate is a purely Australian concern. It's not. It is being constantly argued around the world by countries big and small.

In some countries the debate takes an interesting twist. In communist countries it's mixed up with ideological questions about control of the economy in general. In the US, on the other hand, the debate is couched in terms that make it difficult to know that support for electronics is being discussed at all.

In the American view it's ideologically unsound for the government to give hand-outs to private companies for any reason other than that of national defence. The government has no role in the market place, except perhaps as the umpire.

The event that brought this into focus was President Reagan's Strategic Defence Initiative (SDI), and the failure of arms control talks at Reykjavik.

The question to ask is: "Why doesn't arms control work?" And the answer is, at least partially, because it's not in anyone's interest to make it work. Both the US and the Soviets have huge infrastructures built up for military expenditure. With those billions of dollars goes power and prestige, and the creation of a large section of the community with a vested interest in the continued flow of that money.

The view, until recently, was that military spending made very good economic sense. After all, the US boomed during the war, and it's boomed ever since in times of stress. It's when the international scene is quiet, and military spending is down, that depressions set in.

But increasingly there are people starting to question the military and economic might view. Long range planners see the powerhouses of Asia breathing down Uncle Sam's neck, and they worry. Already, the US is surrendering world dominance in industry after industry. In electronics alone, the Japanese have taken over as integrated circuit masters and threaten as computer makers. No American even tries to make consumer electronics any more.

And increasingly comes the realization that military money doesn't really buy civilian products, except in rare cases. To be sure, the Pentagon made the Boeing 747 possible, and Aussat, but it doesn't produce better cars, or TVs. Indeed, it is notable that the countries that now threaten the economic might of the US are ones that have little indigenous military R&D.

In fact, the new wisdom is that military spending sucks money out of the system that might otherwise be available for propping up companies while they research economically viable new products.

Unfortunately, the Japanese have no problem with hand-outs, and use them to build up industry after industry. Neither do the Europeans. The Russians, of course, thrive on it. Even in Australia we are at last beginning to understand the benefit of an R&D grant.

So the US is presented with a problem: in a world where everyone gives hand-outs for the production of a better mousetrap, how can US companies compete? The answer is surely not to build an X-ray laser in the hope that someone will turn it into a mousetrap. Ideology, of course, is a powerful blindfold, but the Americans have a wonderful history of adjusting theirs so they can see a pot of gold.

This Month

ETI celebrates the end of an eventful 1986 on a high note. We have the first 16-bit computer project published in this country, developed by a couple of enthusiastic engineers from Sydney. For those of you who like things that go 'bang' when you turn them on, we have the rest of our 300 W power supply article, the biggest power supply article ever published. And for those who like it sweet, Neale Hancock, who left recently to go to AWA microelectronics, discusses his swan-song, a rather nice little noise reduction system.

Discerning readers will notice that all this month's projects were designed and built in Australia by Australians, as indeed has been every project this year. As competing magazines increase the overseas content of their projects, we at ETI are more determined than ever to bring you the best of home grown talent on our project pages.

We think it's a policy that will pay off in the long run. Apart from anything else, we find ourselves a major source of projects for overseas magazines. ETI projects were published overseas on 14 different occasions last year — in the UK, Germany, France, Brazil, the US, Indonesia, Canada and Holland.

Congratulations are in order, both to our own engineers, and to our many contributors.

Next Month

To start 1987, we will be bringing out our first year book, already in frenzied preparation as I write this. It will be a compendium of great holiday reading on all that's new and wonderful, with some great research tools for the rest of the year, not least being a complete list of projects back to 1971.

Merry Christmas from all the staff at ETI.

Jon Fairall
Editor

Letters to the Editor

ON TURBINE ENGINES

I REFER TO F. Martin's letter (ETI September '86) proposing a timing unit that will maintain engine idling speed for up to two minutes after switch-off. This is in order to provide a turbo-boosted engine with sufficient lubricating oil after the turbine has been working to prevent damage to the turbine's bearings.

While I cannot see any intrinsic technical problem in designing an electronic timing unit for that purpose, I think that I would feel uncomfortable with an engine that did not stop immediately after the ignition was turned off. Suppose a fault develops in the timing unit. You leave the car parked while you go off to work. The switch is turned off, the doors are locked, the engine is idling. However, you come back eight hours later to find the engine still running. Another example: you drive your car into the garage at night, lock the doors and off to supper. The engine runs for up to two minutes and the garage becomes filled with toxic carbon monoxide gas. Little Johnny goes into the garage unaware of the danger. The possibility is just a little disconcerting, is it not?

I don't own a car with a turbo-boosted engine, nor do I consider myself knowledgeable on turbo systems. However, I would suggest that a preferable approach to the problem is a system which would maintain a flow of oil to the turbine after the engine has stopped. Several possibilities suggest themselves: perhaps the simplest is a reservoir which stores oil temporarily under pressure generated by the engine's own oil pump. There is no reason why an enterprising handyman or hobbyist could not construct something along this line from readily available parts.

Just a thought for what it may be worth.

H. MacInovich
Gulgong, NSW

MORE ON MULTITRACKS

CONGRATULATIONS on the inclusion of excellent reports by Louis Challis on many varied types of audio equipment. Mr Challis' reports during the last 10 years or so have impressed me as being technically sound, honest, fair, and informative.

In regard to tests on audio cassette decks, however, I feel that two important points should be made:

- 1) the speed of a cassette deck, with or without external control, is always internally adjustable;
- 2) the frequency response and distortion of a particular deck are directly related to the bias setting, which is always internally adjustable, and sometimes externally adjustable with a 'bias fine-tuning' control.

I was disappointed, in reading the four-way test of the portable multitrack recorders in the October '86 issue, to see

several unfavourable test results, which are the result of the way the machines were set up at the factory, and not a true measure of each machine's ability. I do not sell any of the machines tested, but believe it is important to fully explore their potential in order to fully inform the reader. There is obviously a limit to the time that can be spent reviewing equipment, and this particular test would have been very exacting. Nonetheless, where adjustable performance falls outside the desirable limits, adjustments should be made, or failing that, the report should indicate that such adjustments are possible. To be specific, it would have only taken a few minutes to correctly set the speed of the Vesta Fire and Fostex units internally. That would not have affected any other results, of course, but would have not created the impression that these units would always run fast.

A little more time-consuming is bias adjustment. Without doubt, most reviewers would claim that this is outside the scope of their job and that if the factory or distributors do not supply adequate set-up equipment then the customer should know about it. Partly true, but that can also prevent people obtaining the most suitable tool for their work because of a misunderstanding.

In the course of my service work in the last seven years I have found very few new cassette decks perform as well as they could. Some, in fact, were abysmal, but within an hour or so were able to produce exceptional results. The tolerances of settings are so precise that if you follow service manual settings for bias current, you are *unlikely* to achieve the best, or even satisfactory results. The only reliable way to ensure correct performance from an audio cassette deck is to make minor bias adjustments between short recordings of appropriate tones, and monitor the playback level on appropriate equipment. If you try to make the response too flat up the top end, or test with the wrong input level, you end up with increased distortion.

It is obvious, when examining the frequency response of the Vesta Fire MR-10, that the unit was under-biased. This resulted in a rising high frequency response, and excessive distortion. Increasing the bias slightly would produce a flat response and acceptable distortion. It is unusual to see a cassette deck under-biased; mostly they are over-biased which causes a drop in the high frequency content when recording, especially with Dolby B. This explains why so many people do not use Dolby B. This explains why so many people do not use Dolby B. This explains why so many people do not use Dolby B, since they can hear a difference between the original and the reproduction. Properly biased, even with Dolby B, there should be no discernible tonal difference. I am pleased to report that in the last year especially, more new cassette decks are properly set up out of the carton, or at least acceptable to a good ear.

Trevor Graetz
Walla Walla, NSW

Club Call

A monthly letter for VZ users featuring BASIC, Assembly and hardware details is available if you send SAE to PO Box 154, Dural, NSW 2158.

Minimart

FOR SALE: SONNY SCANNER ICF-2001 PLL synthesized AM/FM/SSB/CW and many more features. Exc condition \$240. (08)268-6469.

FOR SALE: COMPLETE set of 75 ETI magazines from September 1980 to November 1986 \$250. Jim Berry, 619 Burbridge Rd, West Beach, SA 5024.

Idea of the Month

Bar graph display

This bar graph display uses bandpass filters to separate frequencies in the audio spectrum, and shows the corresponding amplitudes. As such, it could be termed the visual equivalent of a graphic equalizer, allowing one to see the effects of boosting or cutting various frequencies.

The incoming signal is amplified by a factor of 20 by the non-inverting amplifier, IC1a. This input signal should be 200 mV or greater. The output from IC1a is then fed to the input of each of the filters via a 1k trimpot. The trimpot is used to control the signal level going to each filter. Various frequencies are separated out by the first order filter. The formula used to determine the value for centre frequency of each filter is set out below. The output from the filters is used to drive the LEDs and any number of filters may be used.

A voltage drop is applied by the 1N914 diode before the output signal drives the LEDs. The resistors in parallel with the LEDs ensure that they light up in turn, according to the voltage applied. The 33µ capacitors provide the LEDs with some persistence, by holding a voltage on them.

A 9 volt supply is required when using red LEDs, however, some modifications are required if green or yellow LEDs are to be used. Firstly, a 12 volt power supply is required, also the 1N914 diodes will need to be replaced with resistors.

J. Moxham
Urrbrae, SA

Values of C1, 2, 3, etc are determined by the cutoff frequency desired and are calculated with the formula:

$$f_o = \frac{1}{2\pi C\sqrt{R1.R2}}$$

where C = C1, C2, etc.
R1 = 10k
R2 = 47k

For example, if three filters were needed for high, mid and low frequencies, say 100 Hz, 700 Hz and 7 kHz, values of

C would be respectively 0.068µ, 0.01µ and 0.001µ. of should lie between 10 Hz and 10 kHz.

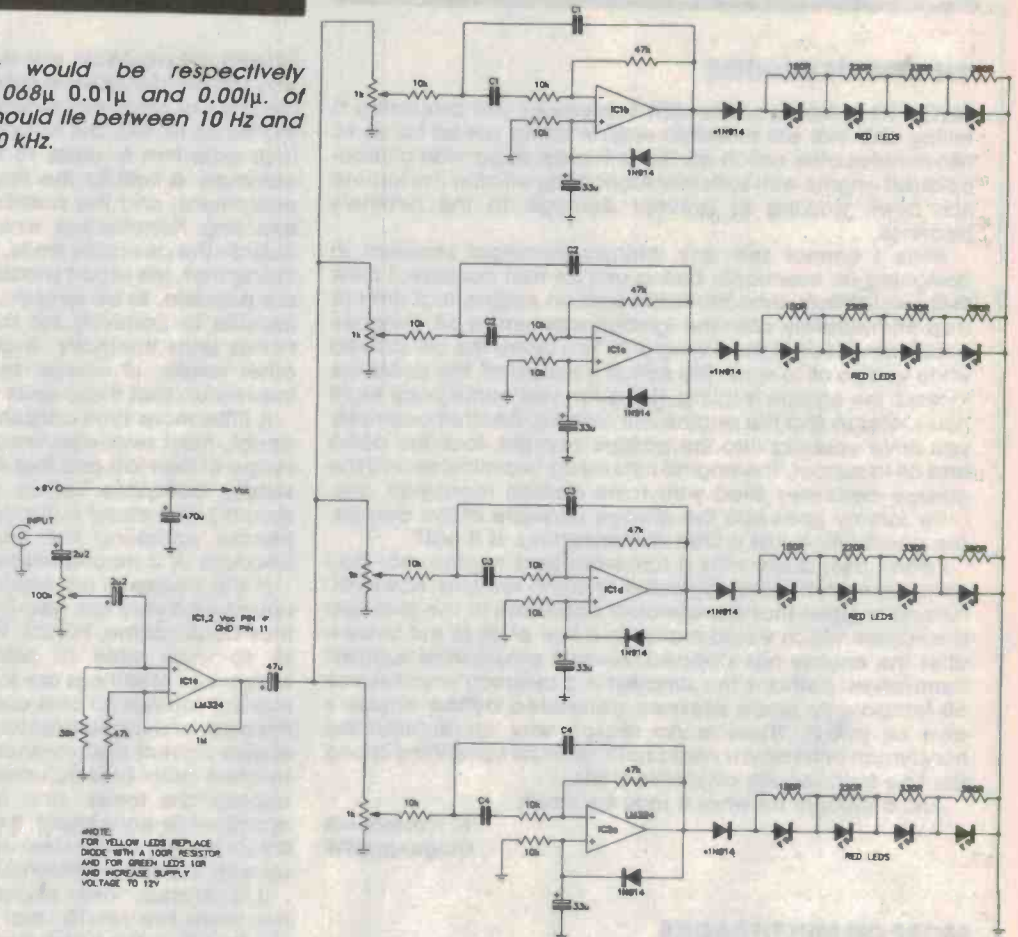

NOTE: FOR YELLOW LEDs REPLACE DIODE WITH A 100K RESISTOR AND FOR GREEN LEDs 10K AND INCREASE SUPPLY VOLTAGE TO 12V

Touch switch

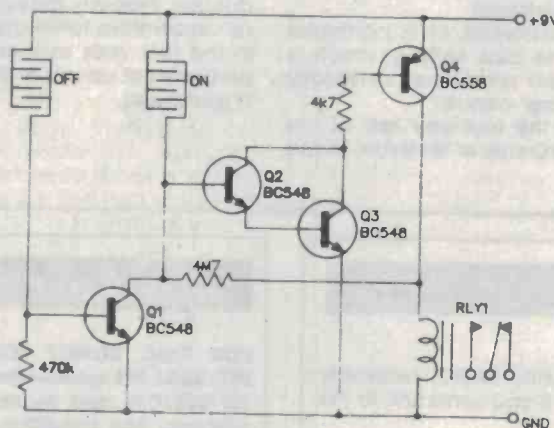

In this useful touch switch, the ON and OFF lines are used to switch the circuit either way, and may be implemented as tracks on a pc board. When the ON tracks are touched, the Darlington pair of Q2 and Q3 is turned on. The output from the Darlington pair switches on the relay. The circuit is latched on via the 4M7 feedback resistor.

When the OFF tracks are touched, a voltage is placed onto the base of Q1, turning it on. When Q1 is turned on, the latching current that holds Q2 ON is removed, turning the Darlington pair off. When this happens the relay turns off.

Sean Rodden
Forrestville, NSW

Feed Forward needs your minds. If you have ideas for circuits that you would like to enter in our idea of the month contest, programs for the computing columns or just want a word with the editor, send your thoughts to:

Feed Forward
ETI, Federal Publishing,
PO Box 227,
Waterloo, NSW 2017

Contributors can look forward to \$20 for each published idea/program which should be submitted with the declaration coupon below.

Programs MUST be in the form of a listing from a printer. You should indicate which computer the program is for. Letters should be typewritten or from a printer, preferably with lines double spaced. Circuits can be drawn roughly, because we have a draughtsman who redraws them anyway, but make sure they are clear enough for us to understand.

'Idea of the month' contest

Scope Laboratories, which manufactures and distributes soldering irons and accessory tools, is sponsoring this contest with a prize given away every month for the best item submitted for publication in the 'Ideas for Experimenters' column — one of the most consistently popular features in ETI Magazine. Each month, we will be giving away a Scope Soldering Station (code ETC601) worth approximately \$191.

Selections will be made at the sole discretion of the editorial staff of ETI Magazine.



RULES

The winning entry will be judged by the Editor of ETI Magazine, whose decision will be final. No correspondence can be entered into regarding the decision.

The winner will be advised by telegram. The name of the winner, together with the winning idea, will be published in the next possible issue of ETI Magazine.

Contestants must enter their names and addresses where indicated on each coupon. Photostats or clearly written copies will be accepted. You may send as many entries as your wish.

This contest is invalid in states where local laws prohibit entries. Entrants must sign the declaration on the coupon that they have read the above rules and agree to abide by their conditions.

COUPON

Cut and send to: Scope-ETI 'Idea of the Month' Contest/
Computing Column, ETI Magazine, PO Box 227,
Waterloo NSW 2017.

"I agree to the above terms and grant *Electronics Today International* all rights to publish my idea/program in ETI Magazine or other publications produced by it. I declare that the attached idea/program is my own original material, that it has not previously been published and that its publication does not violate any other copyright."

* Breach of copyright is now a criminal offence.

Title of idea/program

Signature Date

Name

Address

Postcode

Crossing lines

Each player in this two player game is an ever growing line. The object of the game is to stay alive longer than your opponent by either forcing

him/her into a wall or by skilful driving. One player uses the keyboard, the other the joystick.

Peter J. Blain
Toormina, NSW

```
00010 CLS:LORES
00100 FOR A=-2032 TO -10 STEP 16
00110 POKE A+2,(PEEK(A+1) AND 153)
00120 POKE A+2,(PEEK(A+2) AND 153)
00130 POKE A+3,(PEEK(A+3) AND 153)
00140 POKE A+6,(PEEK(A+6) AND 153)
00150 POKE A+7,(PEEK(A+7) AND 153)
00160 POKE A+8,(PEEK(A+8) AND 153)
00170 POKE A+11,(PEEK(A+11) AND 153)
00180 POKE A+12,(PEEK(A+12) AND 153)
00190 POKE A+13,(PEEK(A+13) AND 153)
00200 POKE A+14,(PEEK(A+14) AND 153)
00205 NEXT A
00210 CLS
00220 PRINT "WELCOME TO THIS GAME"
00230 INPUT "ENTER NAME OF PLAYER (1) "N1$
00240 INPUT "ENTER NAME OF PLAYER (2) "N2$
00250 IF N1$=N2$:PRINT "SELECT DIFFERENT NAMES":GOTO 230
00260 PRINT "A ...UP":PRINT "Z ...DOWN":PRINT "...RIGHT":PRINT "...LEFT"
00270 PRINT "MIT ANY KEY TO PLAY"
00280 LET B1$=KEY$:IF B1$="" THEN 280
00290 OUT 1,255
00300 LET X=77:LET Y=0
00310 LET C=77:LET D=47
00320 LET H=1
00330 LET Q=2
00340 CLS
00350 PLOT 0,0 TO 127,0 TO 127,47 TO 0,47 TO 0,0
00360 LET A1$=KEY$
00370 IF A1$="A":LET H=1
00380 IF A1$="Z":LET H=2
00390 IF A1$=" ":LET H=3
00400 IF A1$=" ":LET H=4
00410 IF H=1:LET Y=Y+1
00420 IF H=2:LET Y=Y-1
00430 IF H=3:LET X=X+1
00440 IF H=4:LET X=X-1
00450 IF POINT(X,Y) THEN 600
00460 SET X,Y
00470 A=IN(0)
00480 A=143-(A AND 143)
00490 B=(A AND 1):IF B THEN LET Q=1:GOTO 530
00500 B=(A AND 2):IF B THEN LET Q=2:GOTO 530
00510 B=(A AND 4):IF B THEN LET Q=3:GOTO 530
00520 B=(A AND 8):IF B THEN LET Q=4:GOTO 530
00530 IF Q=1:LET D=D+1
00540 IF Q=2:LET D=D-1
00550 IF Q=4:LET C=C+1
00560 IF Q=3:LET C=C-1
00570 IF POINT(C,D) THEN 640
00580 SET C,D
00590 GOTO 360
00600 CLS:PLAY 2131513113151617151412
00610 CLS
00620 PRINT N1$ " WON"
00630 GOTO 270
00640 CLS:PLAY 111111141414141111111114131211
00650 PRINT N2$ " WON"
00660 GOTO 270
```

Machine joystick

This program is in machine language. It enables you to control a sprite object with a joystick in port 1. It's possible to vary the speed of the sprite by changing the systems command.

To move two pixels at a time change the system command to SYS(943); three pixels change to SYS(940); four pixels change to SYS(937).

Shane Carney
Corrimal, NSW

```
10 PRINT CHR$(147): POKE 53280,0: POKE 53281,0:V = 53248:X = 100:Y = 10
15 FOR X = 828 TO 736: READ A: POKE X,A: NEXT
20 FOR S = 12286 TO 12350: POKE S,255: NEXT
25 POKE 2040,192: POKE V + 21,1: POKE V + 39,7: POKE V,X: POKE V + 1,Y
30 FOR S = 0 TO 1000:SYS(S28): NEXT S: GOTO 30
35 DATA 173,1,220,74,175,3,206,1,208,74,175,3,233,1,208,74,176,42,173
40 DATA 0,208,208,31,173,16,208,41,1,208,16,173,16,208,9,1,141,16,208
45 DATA 169,80,141,0,208,76,234,234,173,16,208,41,254,141,16,208,206
50 DATA 0,208,96,234,234,74,176,32,238,0,208,240,30,149,80,205,0,208
55 DATA 208,20,173,14,208,41,1,240,13,173,16,208,41,254,141,16,208,169
60 DATA 0,141,0,208,96,234,234,173,16,208,9,1,141,16,208,96,234,234
```

LOTTO NUMBER SELECTOR

S. K. Hui

Shake, rattle and rolling in dough! This lotto number selector uses the wonders of modern science to crack the jackpot.

DOES FILLING in the lotto form give you a headache? In front of you is a maze of blank squares waiting to be filled in. Do they swim before your eyes, while you go cross-eyed and around the twist? If this is your problem, relax, relief is in sight with the lotto selector, the all-singing, all-dancing, black box that will lead you to fortune, if not fame.

The actual number picked by the circuit depends on how fast and long you shake the unit. So when you win next time, you will be able to accept some of the credit. Fortune favours the bold! Good luck next Monday!!

Design approach

My first reaction to this project was to use a counter to generate the number. It was a simple-to-build, cheap, nothing-could-go-wrong approach. But it's not random, since the numbers follow one another sequentially.

To generate a pure random number a pseudo-random number generator seemed to be a much better bet. A classic pseudo-random number generator consists of a multi-stage shift register with an exclusive NOR gate feeding back to the input of the shift register.

A first glance at the design on paper appeared to show that this approach would not lead to a greater chip count than the counter approach. But, in fact, it would. Since I am not a great gambler myself, I have an excuse for not seeing that earlier.

However, lotto numbers only go from one to 40. So there are two problems. Clearing the shift registers to one instead of zero is one. The other is detecting the number 40. In a random shift register, more chips will be required to carry out the detection than in a counter. Space, weight, and price are very important considerations in any project so these factors put an end to the pseudo-random number generator idea.

Back to scratch one and the counter idea. Although the counter circuit offers the



advantage of simple detection, it still faces the problem that it's not random. This is complicated by the fact that the circuit needs to have an automatic battery saver, ie, it will turn itself off, and it needs to display the frozen number for some considerable time.

These problems remained unsolved until the idea of throwing a die flashed through my head. The solution is surprisingly simple. Two mercury reed switches are used, one to control the power supply to the circuit and the other to control the clock. The clock is formed by a simple oscillator, which is disabled when the mercury switch

is closed.

It's possible to change the state of both switches in a quite random fashion by shaking the unit up and down. Provided the clock period is much shorter than the period between the switches changing state, you will have a fully random result in the sense that every number will have an equal, and totally unpredictable, chance of being selected as soon as you stop shaking. The clock is disabled and the winning number is displayed on a pair of seven segment LEDs.

Unfortunately, the other mercury switch controlling the power to the circuit can't be used as a normal on/off switch. We can't have power applied to the circuit when the switch is closed and removed when the switch is open. For a start, power will be applied in a series of quick pulses; not very satisfactory from the point of ensuring long life for the components. Secondly, the circuit itself will probably behave in unpredictable ways; and thirdly, it would mean that the user would have to ensure that the switch was on when he or she held the display still in order to read the number.

The answer is to use a charge pumping circuit. This is an ingenious little idea that allows you to 'pump' up the voltage applied to the circuit until it reaches a level at which it will start operating. The voltage will stay at that level until you stop 'pumping', and then slowly decay. So in operation, you will find that when you start shaking it, the LEDs will slowly appear in their 88 configuration. As you continue to shake they will get brighter until they reach normal operating voltage. As soon as you stop shaking the 88 will change into a number between 01 and 40, then slowly fade away to nothing.

The design means no switches. It also means that the battery remains connected. However, we have been able to ensure that the current drain in this off-condition is only 10 μ A, so the battery should last for almost its entire shelf life. ▶

Construction

As usual, first check your pc board carefully for bridged or broken tracks. Repair any before you proceed. The next step is to obtain a box with dimensions 130(l) x 43(h) x 68(w) mm. This should be readily available in the electronics shops. Fit the bare board onto the floor of the box and mark the position of the four mounting holes. Remove the board and drill them out. Countersink them on the outside of the box to get a neat appearance. To fix the board use standard countersunk 6BA, 1/4-inch screws. Put the screws through their holes and fix them with nuts. Land the pc board back onto the box to ensure the screws go through the mounting hole of the pc board comfortably.

Next, cut a rectangular window on the surface of the box for number display purposes. Cutting dimensions and locations

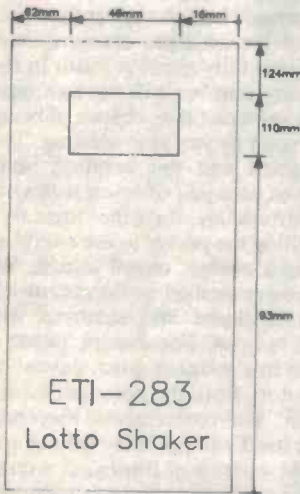

Figure 1. Cutting diagram for front panel window.

are given in Figure 1. First scratch the rectangular hole to be cut with a sharp nail or pin. Use a small drill bit (12 mm diameter typically) to drill holes around the interior edge of the rectangular window. Cut out the middle piece with scissors or a scalpel. The edge is then smoothed with a needle file. To cover the rectangular hole with a red filter for easier reading of the LED digits, a small piece of red transparent perspex should be cut out to a size just slightly bigger than the window. It should then be glued onto the floor of the box with Superglue to cover the window.

If you feel this is just a little too much mechanical work for an electronics project,

relax. Now we can get on with the circuit board. To cut the price I didn't specify a plated-through board, which means that you will have to use wires to achieve the same result. The good news is that there are only 12 of them. Solder the diodes and resistors onto the board but don't insert the capacitors for the time being. Many of the resistors and diodes have their pins acting as feedthrough wires, so you must solder the top and bottom onto the board.

Next come the ICs. Again, many of the pins need to be soldered on both sides of the board. To avoid the trouble of remembering which need to be soldered, I suggest you do all of them. Take a short break between

soldering each pin to allow time for it to cool down. Overheating can result in permanent damage. Be careful with the polarity of the chips and diodes.

When you come to transistor, Q1, try to handle it without touching the pins. Static charge from your fingers could easily damage a high input impedance MOSFET transistor such as a VN46AF. No heatsink is required. The VN46AF should be laid flat on the board as shown in the picture.

Finally, solder the two 7-segment LEDs. No IC sockets are needed. Note that the LEDs are soldered on the solder side of the board only.

Due to the height of the capacitors, they

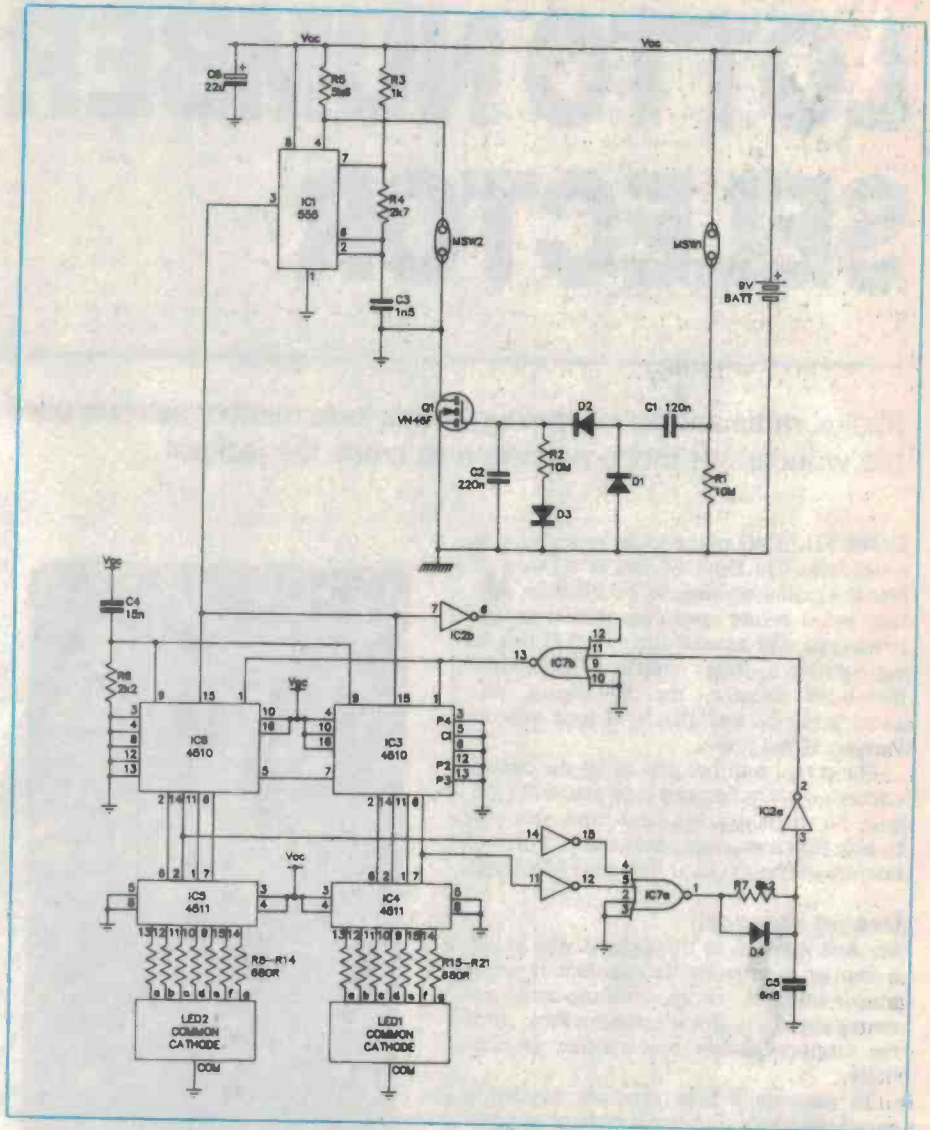

ETI-283 — HOW IT WORKS

The circuit is built around a counter with a power supply. The special feature of the power supply is that it is controlled by a charge pump circuit consisting of R1, R2, C1, C2, D1, D2 and D3. The rest of the circuit is basically an oscillator driving a counter with a feedback circuit formed by IC2 and IC7 to detect the number 41. Output of the counter drives a BCD to 7-segment decoder for displaying the output of the counter.

PUMP CHARGE CIRCUIT

Assume initially, there is no charge in capacitors C1 and C2. Transistor Q1 is off. When you start shaking the unit, mercury switch MSW1 opens and closes. Use the formula for the capacitor:

$$C \frac{dv}{dt} = I$$

Since current cannot flow instantly, dv/dt must be zero initially. This means the rate of change of voltage, as opposed to current, across the capacitor plates is initially zero. Thus, the first closure of the contacts induces a voltage of 9 V on both plates of the capacitor. The charge induced on one side of C1 is absorbed by C2. The charge on the other side is discharged through R1 as soon as the contact opens (due to shaking). Using the same equation as above, it's not hard to see that when the contact opens, a negative voltage of 9 V is induced onto the other plate of the capacitor. This negative voltage causes D1 to conduct and clamps the negative voltage to zero. Diode D2 prevents the charge stored in C2 from flowing back to earth through D1.

As a result of shaking, MSW1 opens and closes its contacts, and a train of positive 9 V pulses appears on the node where C1, D1 and D2 meet. These pulses pump charge into C2 according to the formula:

$$C_2 V = Q$$

so the voltage across C2 begins to rise. As the switch opens and closes, the voltage keeps rising until it's higher than the turn-on voltage of Q1 (which is around 2 V max). Transistor Q1 conducts, acting like a switch. It connects the circuit ground to the true ground, thus energizing the circuit.

That's not the whole story however. Remember the circuit has to turn off itself when left unattended. So a discharge circuit for C2 is included, which consists of R2 and D3. The time from the last pulse to the circuit shutting down is directly proportional to the time constant of the discharge circuit. Therefore, it has to be chosen carefully to ensure the time constant is not too long or too short. Too long means the delay time before shut-down is long, hence wasting power. On the other hand if it is too short, the charge pumped into C2 will leak (discharge) away too quickly. In this case, the circuit will never turn on, since it will never reach the turn on voltage.

The discharge time constant is determined by the product of C2 and R2, which works out to be around 2.2 seconds with the values chosen. On the other hand, the time constant for the charge pumping circuit is much shorter; multiplying R1 and C1 gives 1.2 seconds only.

Another factor to consider is that R1 determines the standby current of the unit. The larger the value, the smaller the standby current. Since the standby current is always applied to the battery it is important this be as small as possible.

When it comes to choosing a suitable value for C1, we need to consider two problems; firstly, C1 should discharge completely every time the switch opens. If it doesn't then the charge applied to C2 will be reduced, and the box will need to be shaken more vigorously as a result. This implies a small value for C1. The value of C1, however, is constrained by the fact that the amount of charge passed to C2 depends solely on the size of C1.

But the discharge rate is set in part by R1 as well, and the bigger it is, the longer the period. Unfortunately, the value of R1 is fixed by the standby current requirement, and should be as large as possible.

So, the net result is that we want both C1 and R1 to be both big and small at the same time. Clearly, in a situation like this, the final result is a compromise between all the competing desires, and is best determined empirically. After a lot of fiddling around, I settled on 120 nF as a suitable value.

COUNTER AND DISPLAY CIRCUITS

The counter is made up of two 4-bit decade counters. Normally, the clock pulse only triggers IC3, so that will count up while IC4 stays the same. The carry-out pin on IC3 (pin 7) will become active whenever IC3 reaches the ninth count. It is connected to the clock on IC4, so the result is that IC4 only increments on the tenth clock pulse.

So say IC4 is at zero and IC3 is at nine. The next clock pulse will change IC3 back to zero (because it's a decade counter) and increment IC4 to 1. The carry-out pin of IC3 (pin 7) will become active whenever IC3 reaches the ninth count. It is connected to the clock on IC4, so the result is that IC4 only increments on the tenth clock pulse.

IC3 and IC4 have a total of eight bits output, and so it's possible to go up to 256 before repeating. Lotto numbers, however, only go up to 40, so it's necessary to have some kind of detection circuit to reset the counters to zero when the count gets up to 40. The detection circuit consists of IC2, IC7 and R7, D4, and C5. Referring to the schematic diagram, output of IC7a will go high as soon as the counter gives an output of 41. This high charges up C5 through D7 and triggers IC7b. The output of IC7b immediately goes high and resets the counters to 01. Since the output of the counter is no longer at 41, the detector circuit is no longer activated and IC7a output immediately goes low.

Now, D4 is reverse biased and becomes open-circuited. The charge stored in C5 can only discharge through R7, and then only slowly. So IC7b is maintained active for a short period, even after IC7 is deactivated. This ensures a clean, definite reset to the counter. This short delay period has a time constant equal to the product of C5 and R7.

The output of the counter drives IC4 and IC5 for display purposes. Calculating the value of the limiting resistors is fairly simple. Since an operating segment needs a voltage around 1.8 V and a current of about 10 mA, and we are using a 9 V battery for supply, Ohm's law gives:

$$\frac{9 - 1.8}{10 \times 10^{-3}} = 720 \text{ ohms}$$

Therefore, 680 ohms was chosen.

also have to be mounted on the soldering side of the board. This keeps all the low profile components on one side of the board, enabling the LEDs to be placed at a close distance to the red filter. Again, the capacitors are all laid flat with their pins soldered on both sides if necessary. Now the only thing left is a few hookup wires which connect the board to the mercury switches and the 9 V battery.

The battery is fixed onto the lid of the box with double-sided spongy tape (see the picture). A battery clip is soldered onto the board. Cut four pieces of hookup wire each about 150 mm in length. They have one end soldered to the board and the other to

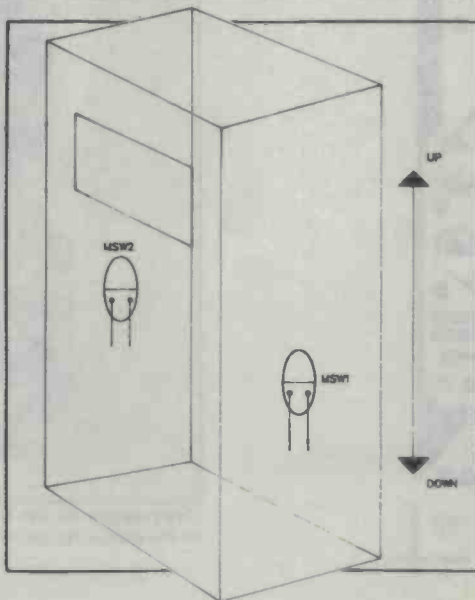
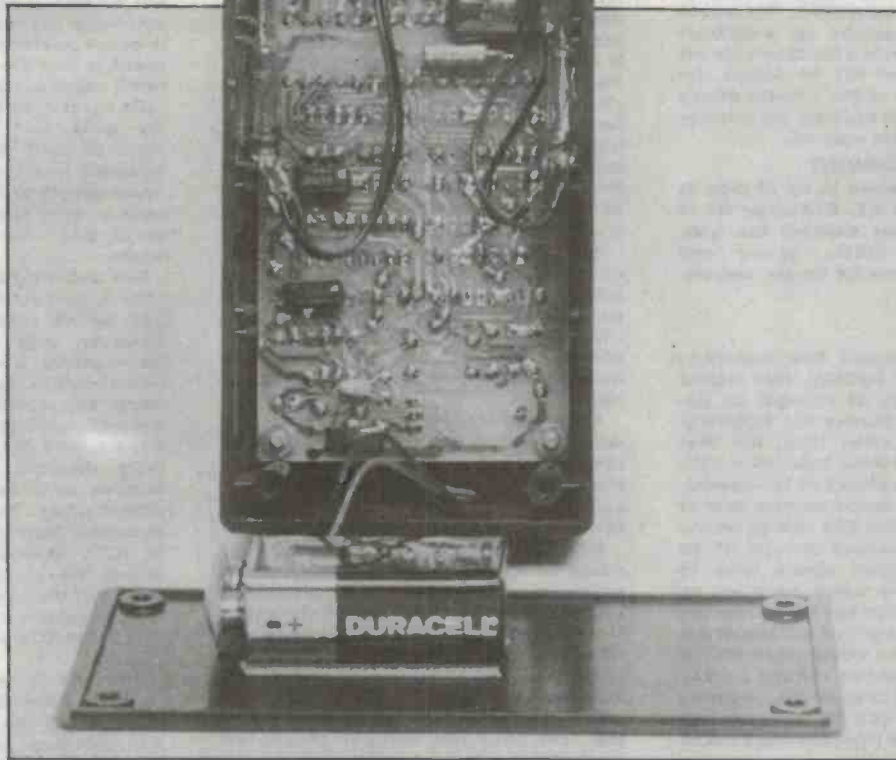

Figure 2. Mounting mercury switches.

the mercury switch. The two mercury switches are mounted on the side walls of the box as shown in Figure 2. Glue or masking tape could be used to fix them but note that the switch must be closed when the box is in an upright position in order to disable the clock.

Before committing yourself to gluing the mercury switches, you must make sure the circuit works. Due to the relatively large size of the switches and limited space in the box, once the switches are glued onto the side wall of the box, they will be obstacles to removing the board. Therefore, it is important to mount the board before you glue the switches.

Project 283



The two mercury switches are mounted on the walls of the box with Superglue. The 9V battery is fixed onto the lid of the box with double-sided spongy tape.

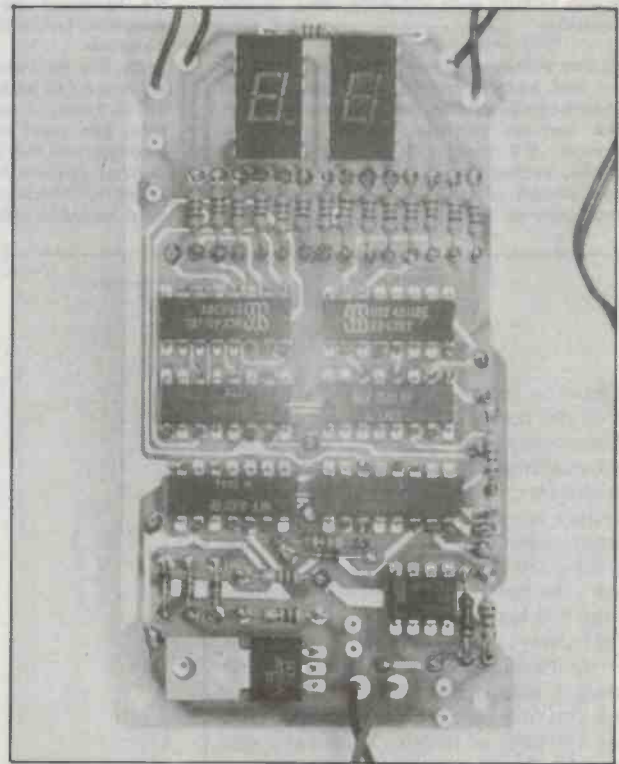
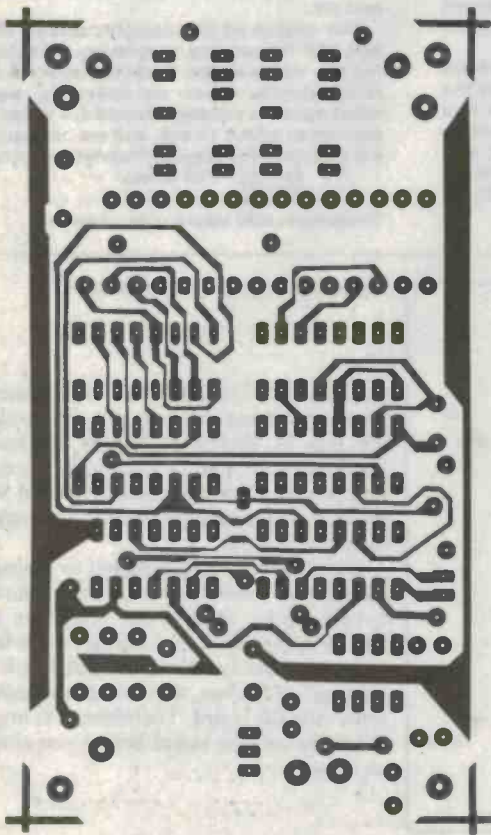

Components on the front side of the board should be kept at low profile. No sockets are needed for the two 7-segment LEDs.



ETI-283 LOTTO SHAKER

ETI-283 — PARTS LIST

Resistors all $\frac{1}{4}W$, 1%, unless noted

R1, 2	10M
R3	1k
R4	2k7
R5	5k6
R6	2k2
R7	8k2
R8-21	680R

Capacitors

C1	120n	greencap
C2	0 μ 22	tantalum
C3	1n5	greencap
C4	15n	greencap
C5	6n8	greencap
C6	22 μ	electro

Semiconductors

D1, 2, 3, 4	1N914
LED1, 2	0.3 inch tall common cathode 7-segment display
IC1	555 timer
IC2	4009B
IC3, 6	4510B
IC4, 5	4511B
IC7	4002B
Q1	VN46AF

Miscellaneous

Two mercury switches (MSW1, MSW2); hookup wire; 130 x 43 x 68 mm plastic box; 9 V battery clip; double-sided pc board; 4 x 6BA, $\frac{1}{4}$ -inch countersunk mounting screws with 12 nuts; small piece of red perspex (26 mm x 36 mm) filter.

Price estimate: \$19
(not including the battery)

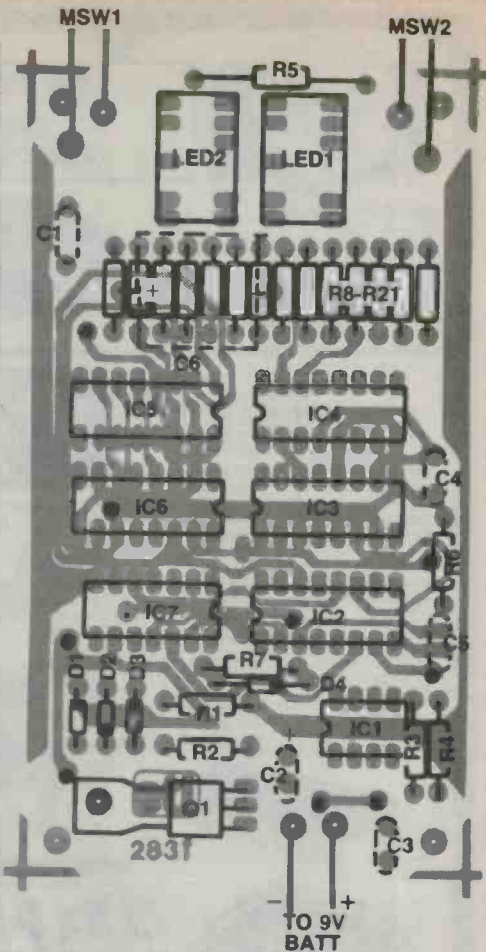

ALL CAPS SOLDERED TO UNDER SIDE OF BOARD

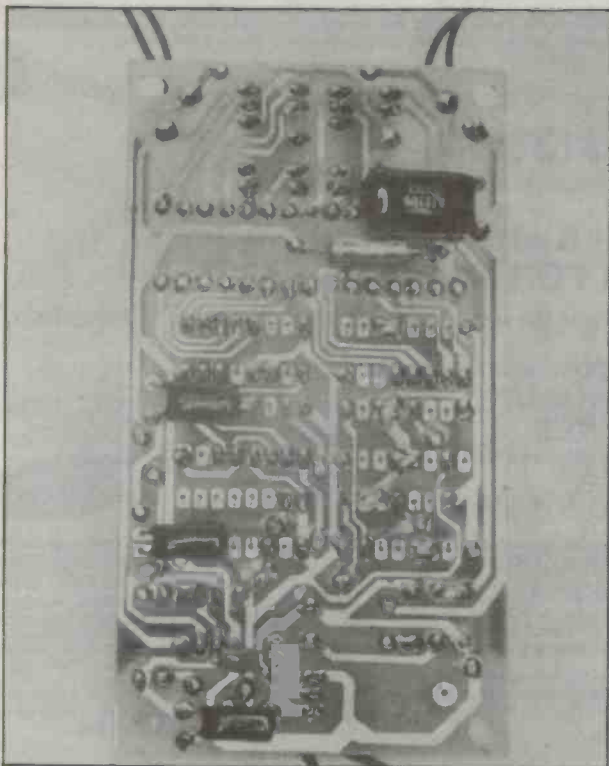

The high profile components like capacitors should be mounted on the rear side of the board. Watch out as some of their leads are to be soldered on both sides of the board.

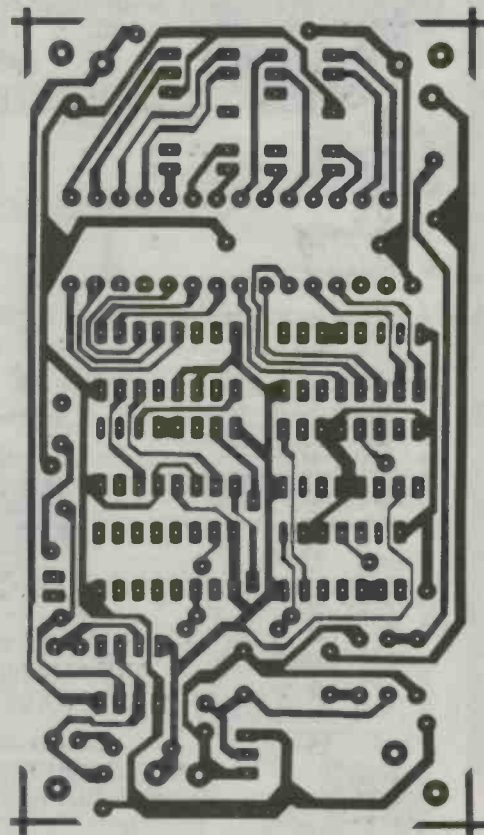

JAYCAR
NEW FOR
1987

LOW DISTORTION
AUDIO
OSCILLATOR

See EA December 1986
Cat. KA-1680

\$139.00



Z80
MICROPROCESSOR
SELLOUT

By today's standards the old Z80 is a pretty pedestrian CPU. Nowadays we only stock the 4MHz 'A' version. But guess what? We have found a cache of old Z80 parts! They were once hard to get and will become hard to get in the future. So at the prices shown below grab a few spares while you can! Standard 1.7MHz.

Z80 CTC Cat. ZZ-8036
1-9 \$2.00 ea 10+ \$1.50 ea
Z80 PIO Cat. ZZ-8037
1-9 \$3.00 ea 10+ \$2.00 ea
Z80 DMA Cat. ZZ-8038
1-9 \$6.00 ea 10+ \$5.00 ea



BRISBANE OPEN
THURSDAY UNTIL
8.30 pm

TWEETY PIE -
116dB

This incredible little piezo screamer (measures 57(L) x 33(H)) emits a 116dB wail. It's deafening! As used in the screacher car alarm kit.
Cat. LA-5255

\$16.95



THE ULTIMATE

AEM 6000 POWER AMPLIFIER

The 6000 series power amplifier by David Tillbrook is the culmination of over 7 years work on power amp design using Mosfet technology.

SPECIFICATIONS:

Output Power 240W RMS per channel into 8 ohms
(360W RMS into 4 ohms)
Damping Factor >300 (100Hz 8 ohms)
THD <0.005% @ 1kHz @ 200 watts
S/N Ratio 400Hz - 20kHz noise bandwidth
>118dB 'A'-weighted

WE WILL NOT BE RELEASING THIS KIT UNTIL FEB 1987
The Jaycar kit includes:

- 300VA toroids
 - Metal work identical to prototype
 - Original die cast heatsink
- Commercial equivalents cost between \$2,500 & \$3,500
Cat. KM-3020

\$998.00

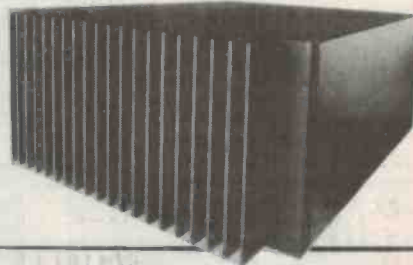

A VERY
MERRY
CHRISTMAS
FROM
JAYCAR



HILLS TV ANTENNAS



Jaycar now has available the
Rolls Royce of TV antennas
- Hills.

TRUCOLOUR
UHF ANTENNA

The ultimate in UHF aerials. Hills new 18 element antenna for long range reception. Covers band 4 (520 - 620MHz), and has all the features of the Pathfinder.
Cat. LT-3184

\$89.50

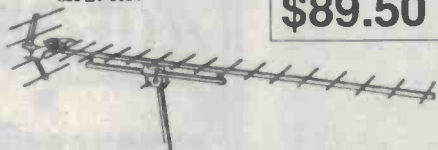

PATHFINDER UHF/VHF

Designed for perfect pictures in metropolitan and fringe areas. Features include new UHF Dipole design. Ellipsoidal boom for strength, all elements and boom anodised for long life. Element insulators are ultraviolet stabilized for long life. Complete with Balun. The very best antenna.
Cat. LT-3152

\$139.50

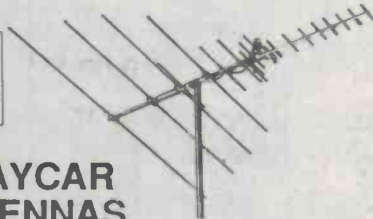

HILLS AND JAYCAR
No.1 FOR ANTENNAS

While you are home over the Christmas break why not get on the roof and update your TV reception...

ERASA VIDEO LABELS

Got a Video? Do you have hassles with trying to remove sticky title labels from cardboard video boxes? Erasa Labels consist of a full length label which you stick on once, and a special pen. When you record over a tape, simply rub the label with a damp cloth and reuse.

12 Video Labels & Pen

**ONLY
\$4.99**



WHAT A
GREAT IDEA



ULTRA LIGHT
WALKMAN
PHONES

Quality phones at a realistic price.
Cat. AA-2016

ONLY \$8.95

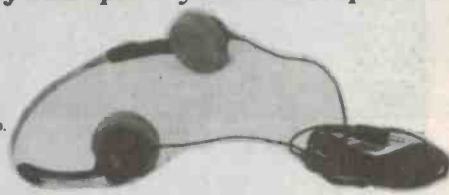

QUARTZ CRYSTAL
CLOCK MOVEMENT

◆ Very compact ◆ Powered by one 1.5V AA battery that lasts for 1 year
◆ 56mm square, 15mm deep ◆ Very accurate.
Fit your own custom clock face. Great for novel applications such as fitting to pictures. Supplied with 3 sets of hands.
Cat. XC-0100

Includes
3 sets
of hands



\$12.95

TURN YOUR SURPLUS
STOCK INTO CASH!!

Jaycar will purchase your surplus stocks of components and equipment. We are continually on the lookout for sources of prime quality merchandise.
CALL GARY JOHNSTON OR BRUCE ROUTLEY NOW ON (02) 747 2022

TELECOM APPROVED 240V/12-24V
POWER SUPPLY Cat. MP-3600 **\$24.95**

We have made a scoop purchase of a high grade mains power supply. It will give 12 or 24V at 150mA in standard form (regulated). A 4 page application note is supplied FREE to convert it to a variable power supply, higher current, (a different transformer is required) or a NiCad charger. Brand new in boxes, limited quantities. Features
• transient suppressors fitted • fuse protected • fully isolated 240V

CABLE TIES

Length	Qty	Price	Cat. No
100mm	20	\$1.20	HP-1200
150mm	15	\$1.75	HP-1201
200mm	15	\$1.95	HP-1202

NEW FOR 1987

2 NEW SIZES



HEAVY DUTY SWITCHING REGULATOR



This month, the final part of our articles on a heavy duty switcher. It contains all you need to build the brute.

Ian Thomas

Part 2

THE CONSTRUCTION OF the power supply involves a certain amount of brute force and ignorance combined with some moderately fancy electronics. Because the power supply is capable of quite high power outputs the mechanical construction revolves around getting rid of waste power or, much better, contriving that waste power not be generated.

The mains input transformer is a Ferguson type PF4244, a damn great lump of iron and copper about the size of a brick (well — perhaps a little smaller!), and probably the greatest heat source in the whole case. This is not immediately apparent when the thing's turned on as it has a thermal time constant of a couple of hours (literally!), but it does get quite warm even when running under no load. Unfortunately this heat source is stuck inside the case where there is no ventilation.

The next great heat source is the diode bridge connected to the transformer output. This need not be stuck inside the case and, in fact, was deliberately heatsunk to the outside air, but more of this later. The rest of the regulator has only a moderate amount of heat to dissipate and so it is all mounted on the regulator board inside the case.

When assembling the power supply the first thing to attend to is the mains input, fuse and switch. This is the most important part of the power supply so far as care is concerned, as the rest of the system can do spectacular things if you make a mistake but the mains side *can kill you*. For safety reasons I chose to bring the mains into the case through an IEC mains connector. This means in practice that when you inadvertently trip over the mains cord you pull the plug out of the back of the power supply

rather than pulling 10 kilos of iron down on your head (clearly a preferable option!).

The case I used is a Horwood instrument case, just the right size to accept the mains transformer, measuring approximately 255 × 205 × 100 mm. Both the top and bottom covers are just held on with sticky tape when you get it but self tapping screws are included (although not enough!!!). Remove both covers and you are ready to get serious. Cut holes in the rear of the case to fit the connector complete with screw holes, and directly under it cut another to take the fuseholder. On the top left hand side of the front panel drill a 1/4" hole to take the mains switch and under it cut another to accept the power on LED.

I most vigorously recommend using a double-pole mains switch as I have *absolutely no faith whatever in the electricians switching the active in the power point*. If power comes into an instrument and then is switched on both mains lines you can turn it off and work on it in reasonable confidence that there is no possibility of meeting your ancestors. Now back to the wiring. I found it convenient to strip back the outer insulation sheath from a few feet of ordinary 7.5 amp flex for the mains wiring wire.

After the IEC connector and fuseholder are screwed in place, strip and solder a piece of brown lead to the pin marked A on the IEC connector. The one I purchased (from Geoff Wood Electronics, Sydney) had connector pins that were inserted after soldering which made life a lot easier. The wire could be soldered to the pin, taped safely with insulating tape and then inserted in the plastic shell. This lead should then be stripped back and soldered to one terminal of the fuseholder as it is most desirable that

the fuse be in the active lead. From the other pin of the fuseholder another much longer piece of brown insulated wire may be connected and run off towards the front panel. The body of the fuseholder should be well insulated after connecting the two wires. I used a good sized piece of heat-shrink tubing I had slipped over the wires before soldering them to the fuseholder terminals.

A second lead, this time insulated blue, should be connected to the IEC connector pin labelled N and run off to the front panel. I neatly clamped down both leads to the side of the case in several places. As a matter of both convenience and neatness I always try to keep all wiring nicely in place. Nothing looks sloppier than a piece of electronic equipment that looks like an explosion in a spaghetti factory. To complete the wiring of the IEC connector a piece of yellow/green earth wire should be soldered to the centre pin labelled E and connected directly to the instrument case. To abide by the letter of the law you cannot use a screw that is used to hold the case together here; it should be a separate screw for the job.

The free ends of both the brown and blue wires should be connected to the centre terminals of the front panel mains switch. Extensions of the brown and blue wires should be connected to two outer terminals *on the same side* on the mains switch. Make sure that there is plenty of free space between all terminals on the switch (240 volts!) and then cover it with heat-shrink tubing. Finally terminate the two wires in a terminal block near the mains switch *in such a way that you can get to the screws when the transformer is in place*. The terminal block will serve to connect the



transformer mains side. This pretty much finishes the area where exceptional caution is needed.

With all the mains wiring out of the way it is time to start fitting all the bits and pieces into the case. Place the lower cover where it would normally go on the case and rest the transformer in position on the left hand end of the case. Make sure it clears the wiring around the rear panel but leave as much space as possible towards the front. Mark where the transformer sits, remove the bottom panel from the case and screw down the transformer. Leave all leads loose at this stage.

The next major mechanical step is the main diode bridge. I chose to keep all electronic components inside the case rather than simply mounting the diodes directly on the heatsink. This makes things a bit more complicated but allows the whole diode bridge to be made as a separate subassembly. I mounted the four diodes that make up the rectifier bridge on a piece of L-shaped aluminium extrusion, 1" x 1.5", and just shorter than the case is high. The diodes are clamped to the 1.5" side and the 1" side is screwed to the rear panel. Directly opposite the bracket on the rear panel is screwed a finned heatsink which protrudes into the outside air (see photo). L-shaped extrusions are readily available at hardware stores.

If you can get them it makes life a lot neater and tidier to get two of the diodes with their polarity reversed — that is two have their anodes connected to the case and two have their cathodes connected to the case. This most assuredly makes wiring easier.

Locate just where you want the diodes to sit on the bracket by using the mica washers.

The diodes should be evenly spaced along the 1.5" side of the bracket near the outer edge (so you can get to the screws that hold the bracket on). Drill four holes to accept the studs large enough to allow the insulating bushings to be inserted and deburr them thoroughly.

Each diode must be individually insulated from the aluminium bracket by the mica washers and plastic spacers that normally come with the diodes. The adjacent photograph shows just how the diodes should be mounted with the electrical mounting tag on the side away from the main diode body. At this point it is appropriate to draw your attention to the fact that high current diodes look like great big bolts but *they are not*. The bodies of the diodes are made out of copper which is as weak as yesterday's cornflakes. If you start heaving on the thread like it must carry the harbour bridge you *absolutely will* strip the thread and ruin the diode. I found the safest way to judge when it was tight enough was to watch when the spring washer provided with the diode was compressed flat.

Mount the four diodes on the bracket with two of the same polarity at either end. The studs of the diodes whose case is the cathode (pointy end) become the positive terminal of the bridge. When actually mounting the diodes be sure again that there are no burrs around the edge of the holes and use heatsink grease on all mounting surfaces. Solder the two terminal lugs together and connect a 150 mm length of heavy wire (red insulated wire is nice if you have it). When wiring up the bridge and in fact the whole power supply main current paths you will have to use extra heavy duty wire. I used 7 x 0.67 mm stranded cable for all connections which seemed to do fine.

Solder the terminal lugs of the other two studs whose anode (blunt end) is connected to the case and connect a piece of heavy (once again blue is nice here) 150 mm long to make the negative output.

As a matter of interest here it's always a good idea to try to observe the colour conventions as much as possible. This is because quite often someone else may go poking around inside your machine and it gives them a hint as to what is going on. This goes doubly for any mains wiring and, I think, should be done by law.

The transformer connections to the bridge are made by connecting a piece of heavy wire from one end diode around the next diode and connecting it to the third. This lead may be continued on as it connects to one lead of the transformer secondary. Repeat the process starting from the other end to make the other connection for the transformer. Both leads that go to the transformer should be at least 150 mm long. Any colour is fine here as the wiring is symmetric.

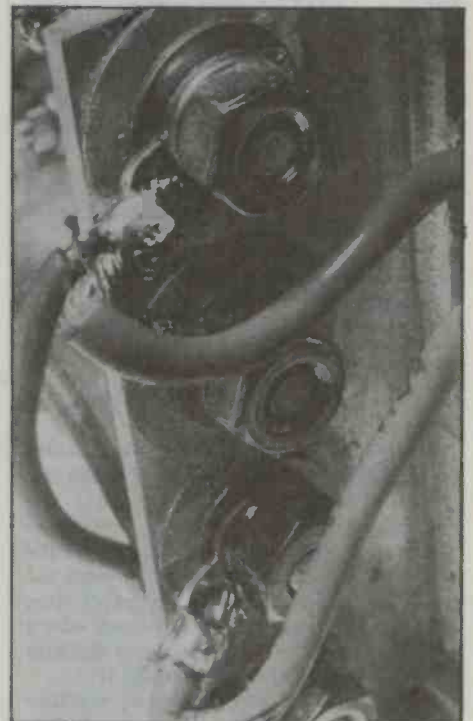

Diode wiring on the inside of the back panel.

The diode bridge can now be attached to the case. It mounts vertically in the centre of the inside of the rear panel with a heatsink mounted on the outside (see photo). The easiest way to do this is first to drill three mounting holes in the heatsink. The heatsink can then be used as a drilling template for the holes in the rear panel and bridge. 4BA screws are readily available and for these you'll need a 9/64" drill. It is also ▶

Project 1533

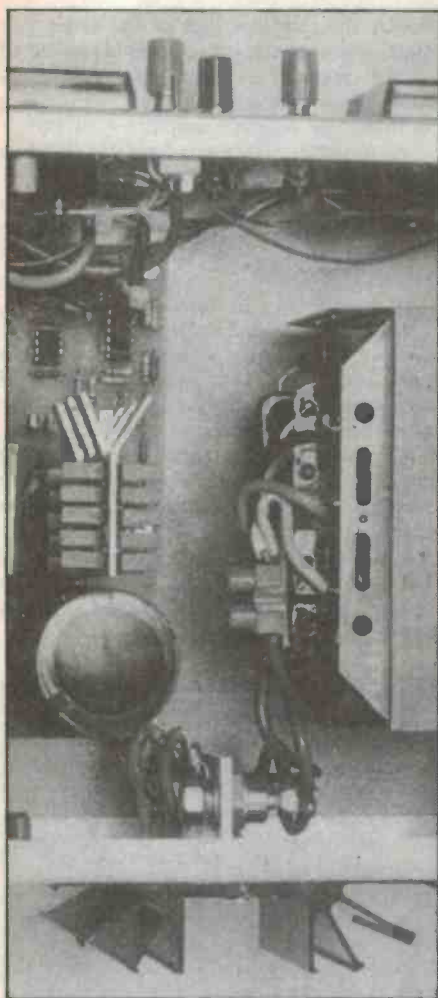

Notice the diode bridge and its associated heatsink at the top.

the right size for 3.5 mm screws for those lucky enough to get them.

Drill three or four evenly spaced holes down the centre of the heatsink mounting area and deburr them. Next hold the heatsink firmly up against the rear panel where you want it to go (*exactly in the centre*) and drill *one* end hole through the panel. Deburr the hole in the panel then position the diode bridge and mark where the hole should be. Remove the bridge and drill a hole where you've marked it.

Next screw the whole shibang together using one screw in the hole you've drilled; locate everything just right and run the drill through all the other holes *but don't bash it through the diodes — they break!* Pull everything apart and deburr all the holes. Finally smear heatsink grease on all mating surfaces and screw down the heatsink and diode bridge to the rear panel. The red and blue bridge output leads can be terminated in a 20 amp terminal block mounted on the rear panel to tidy things up. Make sure the terminal block is right at the top of the case so you can get a screwdriver in to use it! The

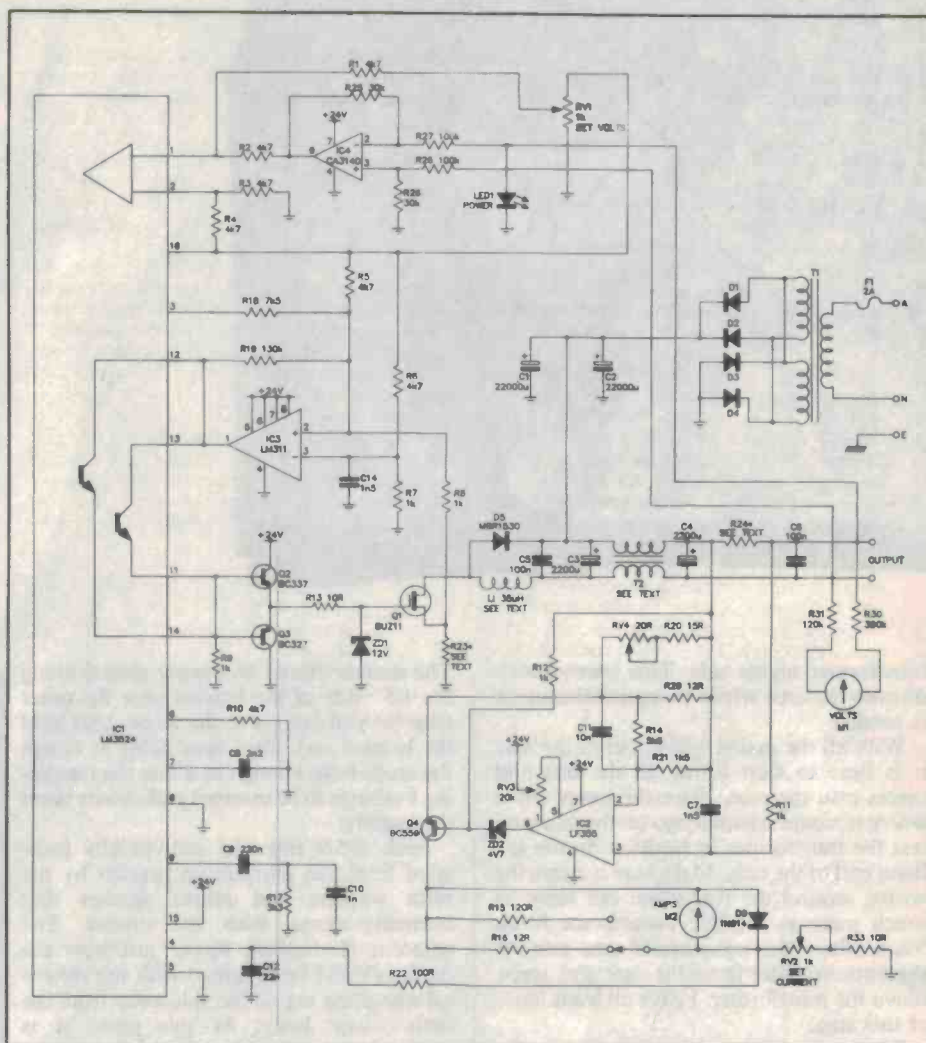

leads from the bridge to the block should be kept as short as possible (remember 1 milliohm equals 0.4 watts!!).

The meters I chose to use were cheapie 50 microamp ones. The main problem with these was that the front panel scales were wrong. This was rectified by pulling the meters apart and removing the scales. I painted out the scale numbers and the word microamps with office whiteout. After it had thoroughly dried I filled in the correct numbers and units with a \$2.50 Letraset bought from the local newsagent. The result was just a little rough looking but definitely got the message across.

The rest of the bits and pieces can now be mounted on the case. Mount the meters, control pots, output terminals and power on LED on the front panel and the case is just about ready to receive all the business parts.

The bottom of the case should first be drilled to take everything. Fit it to the case and then (flexing your mighty muscles) place the transformer where you want it to

go. It should just clear the left hand side of the case and just miss all the rear panel wiring. Give yourself as much room as possible at the front as there's a bit of wiring to be done there. The leads should come out of the transformer to the sides rather than to the front and back. Mark a few holes on the case bottom from the transformer and then remove it. Next, using the printed circuit board you've made or bought or whatever, mark out the mounting holes in all four corners.

A possible problem may arise here. In the prototype I used Philips' printed circuit mounting capacitors (see Parts List). These are great devices but seem difficult to procure from component suppliers. All this means you may have trouble getting the neatsy pcb mounted capacitors I used. In this case you'll probably have a damn great lump of a capacitor to mount. The golden rule is that the capacitor must be about 40,000 or 50,000 microfarads and 25 volt-rated. Mounting it on the board isn't necessary, just nice and easy.

The power supply is a simple switching down-converter. It uses a conventional transformer TR1 to give isolation from mains and step down the 240 volts ac to 16 volts ac. The transformer output voltage is then rectified by a high current diode bridge D1-D4. The power is then filtered by the two electrolytic capacitors C1 and C2 to give an unregulated dc output of 22 volts dc.

In order to regulate this voltage down to the desired output voltage without excessive losses, a power MOSFET, Q1, is used as a switch which is either on with a very low resistance or off and is switched between these two states at about 100 kHz. When Q1 is on current is allowed to flow from the negative unregulated rail through Q1 and L1 into the output filter capacitors, C3 and C4. The current rises linearly with time and is proportional to the voltage across the inductor. If the process were allowed to continue indefinitely eventually the output capacitors would charge up to the unregulated mains voltage, but it is not.

After a few microseconds the control circuitry turns Q1 off again. A certain amount of current is flowing through L1 which represents energy that must be recovered. The drain voltage of Q1 rises extremely rapidly when Q1 turns off and forces the high power diode D5 to turn on. The current that was flowing through the FET and inductor now flows through the diode and inductor. Because the voltage across the inductor is now of the opposite polarity, the current decreases with time. The control circuitry will continue to turn Q1 on and off in such a way as to preserve the desired output voltage and current.

For very low output voltages the transistor will only be on for a very short time and most of the output current will flow through the diode. For high output powers the transistor will be on for a much longer part of the overall duty cycle and will draw more power from the unregulated negative rail. Thus the down-converter draws just as much power from the unregulated supply as is needed and none is wasted.

The gate of the power MOSFET Q1 'looks like' a very large capacitor and in order to switch it quickly very high current must be supplied. However, this current must only be supplied during the actual switching time and when the transistor is either on or off no power is needed. Thus the two TO92 transistors, Q2 and Q3, are sufficient to provide the necessary drive current. R13 and diode ZD1 ensure that the maximum gate voltage for the FET is never exceeded.

Under normal operating conditions the main control IC, IC1, generates a pulse width modulated control signal out of pins 11 and 14. These are, in effect, two emitter follower output transistors that can be used to drive a balanced output or paralleled up as here to drive a single ended converter. The collectors of these two transistors are normally connected to the positive rail. However, for control purposes they may be used to remove gate drive if desired as is done in this circuit. R10 and C8 set the frequency of oscillation of the whole system independent of other effects.

If you do have a different sort of capacitor then your board will be smaller and both should fit in OK. Locate everything on the case bottom and drill all the necessary holes. The transformer can then be permanently screwed to the case bottom and the case bottom screwed onto the case. Wire the transformer 240 volt input into the mains connector near the switch, trimming leads

High power MOSFETs cannot tolerate extreme overcurrents for very long. This can cause a problem as during power up the inductor current (and hence the FET current) can rise to rather high values. To avoid possible damage to the FET, the current flowing through it is sensed by the resistor R8 and comparator IC3. When the current rises too much the comparator output goes hard negative from its normal positive state and removes the drive from the FET gate. Positive feedback is provided around the comparator by resistor R19 to hold the FET off until the switching cycle is complete. At the end of the cycle IC1, the control IC, delivers a pulse out of pin 3 to reset the comparator.

The control IC, an LM2524, refers all voltages to its negative rail which creates problems as the power supply output is from the unregulated positive input to an artificially generated voltage out below the positive rail. IC4 solves this problem by monitoring the output voltage of the whole power supply and generating a dc control voltage referred to the negative rail of between 0 and 5 volts dc for a 0 to 16 volt power supply output. The voltage control pot RV1 has the control IC's reference imposed across it and adjusting the pot generates a voltage of between 0 and the reference 5 volts.

These two voltages are summed together by resistors R1 and R2 and applied to one input of the error amplifier on the control IC. The control integrated circuit amplifier generates a dc control voltage which appears on pin 9 from this control amplifier on the IC whose inputs are pins 1 and 2. The reference +5 volts from the control IC is applied to the other input of the error amplifier through two resistors R3 and R4 (this is necessary as the common mode input on the error amp is very restricted). The whole control loop always adjusts the output voltage so the voltage on pin 1 is equal to the voltage on pin 2 and, hence, the output voltage is controlled by the voltage control pot.

A second control loop is necessary to control the power supply output current. Six small pieces of copper wire are in series with the positive output of the power supply and form a current sense resistor. IC2 is a low offset op-amp which in combination with Q4 and the sense resistor form a constant current generator whose output is proportional to the power supply output current. Resistors R14, R21 and C11 form a phase lead network to compensate for the very poor frequency response of the current limit input on the control IC.

Pins 4 and 5 of the control IC are the current limit inputs. When pin 4 is taken 0.2 volts positive with respect to pin 4 (ground) the regulator starts to shut down. Thus if a variable resistor is placed in series with the collector of Q4 and the output of the power supply loaded then only enough current can flow to produce a 0.2 volt drop across the variable resistor before the power supply current limits. This forms a second control loop which is only able to act when the power supply output is sufficiently loaded.

as necessary.

The transformer has two secondary windings that may be used in parallel (as now) or in series. The parallel connection allows much higher current at the cost of an extra diode drop in the rectified dc out. Before paralleling the windings it's a good idea to find out which wire is which (my transformer came with absolutely no informa-

tion whatever), otherwise you may connect them in parallel-opposed. There are two windings so find one end of each with a continuity checker. If there's no continuity then they're separate windings. Clip the ends together and turn the beast on. Measure the ac voltage between the unconnected ends. If it's 36 volts or so the windings are parallel-opposed and you must reverse one winding. If there's almost no volts then the connection's correct.

Trim the transformer windings off with about 50 mm free and bare back the ends for 15 mm or so. You'll have to scrape off the enamel as it is a special high temperature type that can't be taken off with a soldering iron. Twist the ends you want to parallel (I checked them again to be sure) and solder about 10 mm. Insert the twisted ends into a 10 amp connector and connect up the free ends of the leads from the diode bridge to the other end. It was my original intention to stick the connector down somewhere but I found that the leads were so stiff it was totally unnecessary and the connector could just be left where convenient. Now I know why power leads like this are called busbars — they're bars you can hang a bus off! You now have unfiltered 24 volts dc at 15 amps rated.

For now this completes the brute force and ignorance side of things. The next part is to assemble the printed circuit board and control circuitry.

pcb and control circuitry

The only problem here is that old one of high currents. For your information pcb laminate comes with varying grades or thicknesses of copper foil. My prototype used material with a heavier 2 oz copper. If you can get some so much the better. If you can't then things will get just the teensiest bit hotter in the case when the power supply's running full bore.

If you can't get the pcb-mounting filter capacitors then the end of the board with all the copper can be deleted. If you can then fine and make the board exactly as shown. There are several components on the main board that have to be made. The first and most important is the main inductor. The core for this is a TDK type PQ 35-35 inverter core. The coil has to carry *all* the output current so a lot of copper is needed. Most of the current is dc but there is still a considerable component of ac so I chose to make up my own stranded cable.

I used seven strands of 0.8 mm enamelled wire about 1.6 or 1.7 m long and twisted them together into a cable. The actual length needed is only about 1.4 m but you'll have ragged ends that need to be trimmed. Twisting the wire together really takes several people as the wire displays an extraordinary perversity to tangle up. The method I used was to firmly twist the start ▶

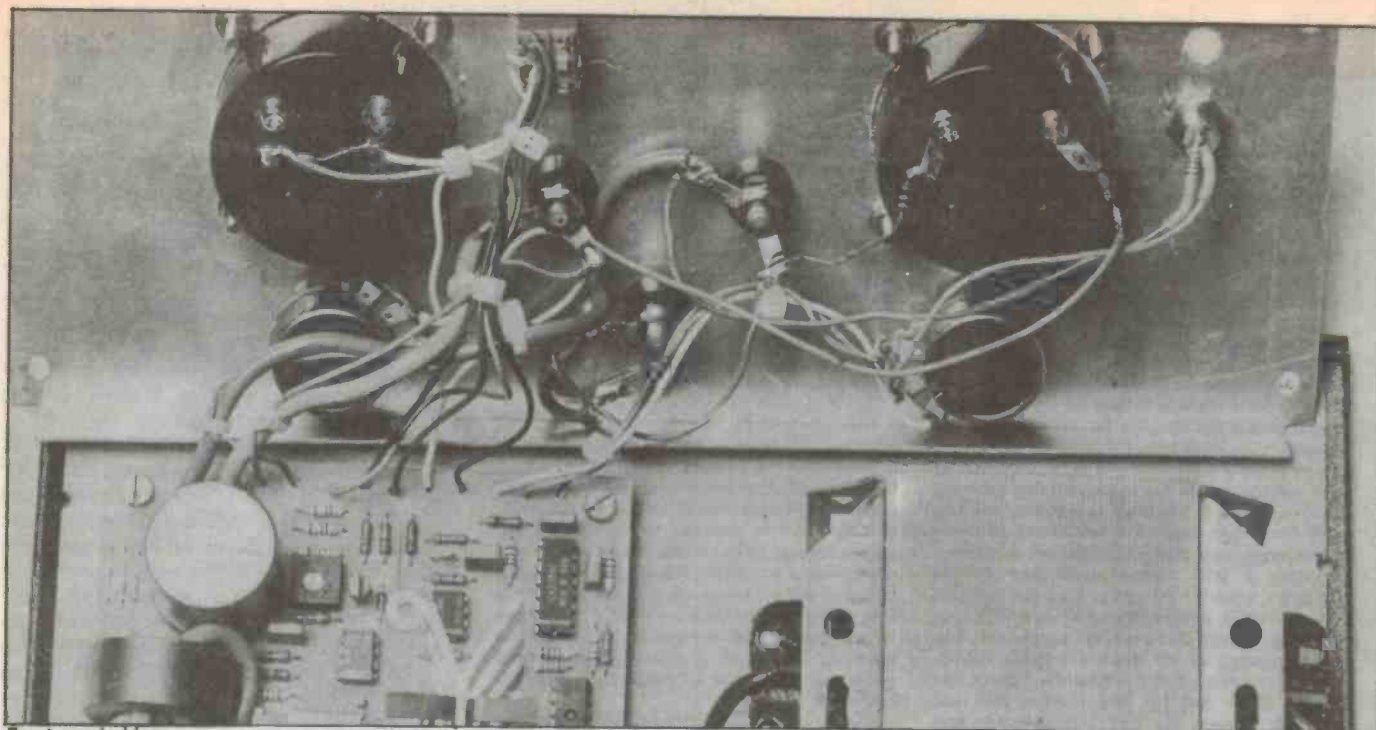

Front panel wiring.

of all seven strands together and stick them in the chuck of an 'eggbeater' drill. I then threaded the free ends of the wire through seven holes in a piece of matrix board in as near to a hexagon as possible with the seventh wire in the centre. The free ends of the wire *must* be kept taut as otherwise they twist around each other. When the drill chuck is rotated the wires are twisted together to form a cable. If the matrix board is moved back so the distance between the twisting wires and the board is kept constant a neat cable will be formed. It sounds complicated but it really works.

Once the cable's been made, it's an easy job to wind it on the former. The coil former has two rows of six pins so the seventh strand must be terminated on top of one of the others but no problems. Spread out the start of your beautiful cable (after trimming off the ratty bit where you got the knack) and tin all the ends. Solder them to all the pins on one side of the coil former then wind two layers of closely spaced

turns. You should fit in 16 to 18 altogether. Terminate the end down the other side in the same manner as the beginning and the coil winding is complete.

The ferrite core would saturate if it were simply assembled around the winding. This means that (a) it would get very hot and (b) wouldn't work anyway so it must be avoided. This is done by spacing the two core halves apart with some sort of *insulating* material. Anything will do; plastic draughting film is good; good stiff cardboard is fine too but it must be 1 mm or 40 thou thick. This is not a particularly critical dimension and $\pm 20\%$ is fine but some spacer is absolutely necessary. Cut out pieces of the material you choose to exactly the same shape as the mating surfaces of the core halves and assemble them in place. Use the clip provided to hold the whole lot together and you're ready to place the coil in the board.

The next component to be made is the heatsink to cool the main switching FET

and Schottky barrier diode. I would much have preferred to use heatsinks that were available from hobbyist suppliers but couldn't find one big enough. Also the data provided by the stores weren't exactly specific ("great for those bigger jobs" !!!!! — most detailed! Really all that's needed for a heatsink is *one* number — the terminal resistance in degrees C per watt. Surely that wouldn't waste too much printing ink!!).

I used a piece of 1.6 mm aluminium cut-out to the drawing in Figure 3. After cutting, fit it to where the transistor and diode are already mounted and mark where the mounting holes come on the board from the heatsink mounting tab and on the heatsink from the semiconductors. Remove the heatsink and drill appropriate holes to mount the semiconductors, bearing in mind that the tabs must be insulated from the heatsink. Next, mark off where there is free space on the heatsink and mount three small TO220 secondary heatsinks as shown in the photo. Keep them as far to one side

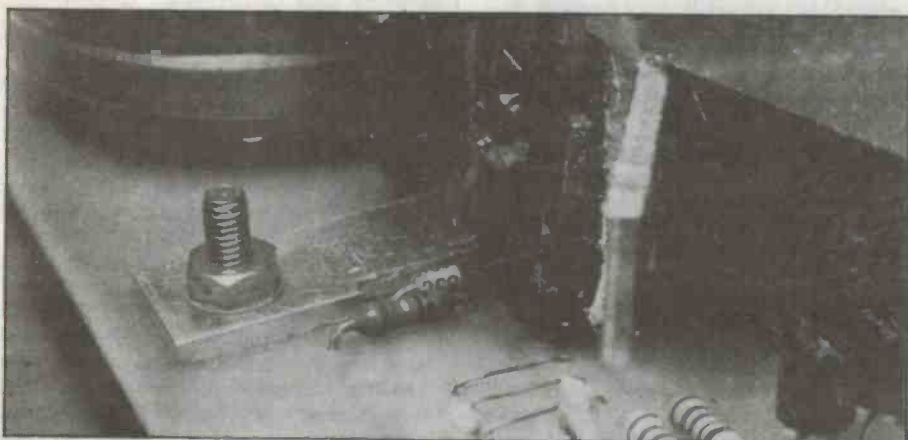

The heatsink.

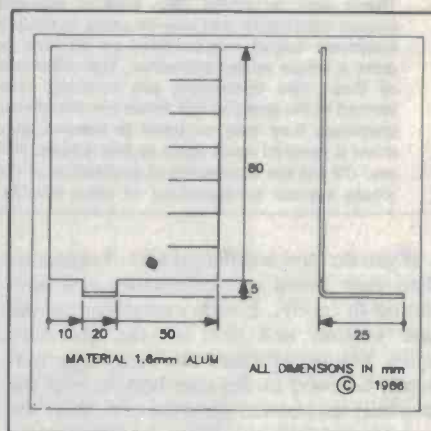

Figure 3. Heatsink measurements.



The main inductor.

as possible as the free area of the heatsink has to be split with a hacksaw and bent to form fingers, once again as shown in the photo. The whole idea of heatsinks is to get heat away from the hot devices and get it into the surrounding air. To this end as many fingers as possible are good — hence all the added bits and slitting. You may wish to improvise further and it is really a case of 'more is better' so long as you can get the lid on!

After you've made the heatsink, mount it on the board and attach it with a screw through the long foot that sticks out through the diode and FET. The diode and FET can then be mounted on the board with minimum lead lengths. Both devices must be screwed to the heatsink with insulating spacers. After mounting and screwing down the power semiconductors check that the tabs are insulated from the heatsink.

The next device that has to be made is the toroidal rf stopper. Just about any ferrite toroid will do here. It only has to be able to take six turns of the heavy duty wire used to hook up the whole power supply. If the ends of the windings can be connected directly to the holes in the board then the core is wound correctly.

The last (and easiest) components that have to be made are two current sense resistors. The first is in the source of the FET and is used to detect extreme current overloads that may arise. Here the resist-

ance is not all that critical so I made the pieces of copper wire rather short. This means that when they get hot (as they will because they're small) their resistance will change. This is because copper shows a positive temperature coefficient of about 0.4% per degree C. It doesn't matter for the overload sense as we are only interested in *much* too much. The wire is 8.5 thou diameter or 0.216 mm and three strands are used in parallel. The wire should be cut to length and tinned before being inserted in the board or you'll lift the copper laminate trying to tin the enamelled wire in position.

The second current sense resistor is used for current limit information as well as driving the meter circuit so it needs to be more stable. The same wire is used as before but this time six strands are used to avoid getting the copper too hot. In the model only three strands of a heavier wire were used which is OK if you have reels of all sorts of wire available, but a bit of a pain if you don't.

The rest of the board is straightforward. Be sure to get the ICs in the right way round, particularly the electrolytics (they're a bit pricy). Once the board is assembled you're ready to start assembly of the whole beast. All the wires to the front panel are arranged along the front end of the board. Follow the circuit diagram carefully and connect the voltmeter through its resistors to the output terminals; the ammeter and current control

pot with ammeter range change switch and resistors to the board as shown; and, most importantly, the output to the feedback from the output terminals. A diode must be connected across the ammeter so that when current ranges are switched the ammeter isn't destroyed! The last thing to attend to is to wire up the power on LED complete with ballast resistor. I wired it up from available wiring on the front panel to the unregulated plus and minus rails (they're both available).

Two heavy leads should be connected to the plus and minus inputs to the board and then to the connector on the rear panel that has the outputs from the diode bridge. As a final check trace out all the wiring you've installed and make sure that it follows the circuit design exactly. Start right at the mains input socket and work through the mains switching, transformer, diode bridge and on to the pcb. Trace out all the front panel wiring insuring that the diode is across the current meter in the right direction. It may come to pass that either or both of the control pots are in the wrong way. This is fine and won't cause any harm and you can reverse it (them) when you test the unit. After all this is done the power supply is just about ready for the really exciting part — the testing.

Testing the power supply

To be quite candid this is the part I really dislike — probably because it can show up mistakes so dramatically. You actually have to plug a mains cord into the back of the thing and turn it on. The first step is to do exactly that. If the green power LED comes on then you've passed the first test. If the whole thing doesn't catch fire and burn to the ground then you've passed the second test. Now comes the serious stuff. First check that you've got about 22 to 23 volts dc on the rear panel connector that brings power to the board. Next check that the voltage regulation is working by connecting a couple of 220 ohm resistors in parallel across the output terminal. These are to ensure that the output capacitors have somewhere to discharge to when the output voltage is reduced. Now vary the voltage control pot and ensure that the output voltage does indeed vary. If it does and goes the right way (clockwise rotation increases the voltage) then at least the voltage control circuitry's working. The voltage should vary between 0 and 16 volts on the voltmeter.

At this point it's a good idea to check the voltmeter calibration. The best you can really do is check it against the very best voltmeter you can find or borrow. A 3½-digit DVM is more than enough. If there's a bad problem then you may have to change one of the resistors in series with the meter but I found that meter non-linearities ▶

far outweighed calibration errors.

The next part of the regulator circuit to check is the current sensing and current limit. First wind the output voltage down to zero and the current limit control fully anticlockwise (minimum current if you wired it correctly). There are two trimpots that must be adjusted to set the current metering. The first controls the LM355 offset and hence the output meter zero. With the output open circuit (the resistors placed across the output earlier removed), adjust RV3 until the output ammeter set on the 0-2 amp range just reads zero. You should find that for trimpot settings overly anticlockwise the current reading rises rapidly. Don't worry, it's only the reading and 10 amps isn't actually going somewhere. Set the pot so the meter is on the verge of showing something.

Next, place a short circuit across the output. This should cause no current to flow. Select the 0-2 amp range on the current range switch and slowly increase the voltage out (just a little bit is enough). About 100 mA should show on the ammeter and this is fair dinkum current. Adjusting the set current control should vary the current on the ammeter and, once again, it is the real thing coming out of the power supply terminals.

First check that you have adequate control over the 0-2 amp setting (it should take about 3/4 pot rotation to get it up to 2 amps) then switch to the 20 amp range. Slowly wind it up to full bore and make sure that nothing bizarre happens, then wind it back. It isn't calibrated yet and you don't know just how much current is really flowing. I used a piece of 7/0076 hookup wire with alligator clips on either end as the short circuit and when I wound the output up to 20 amps it got very hot!

The next step is to calibrate the current meter. What is needed is to set up a known

current out of the power supply and adjust RV4 until the ammeter reads the same current. I will assume that you have a good current meter that accurately reads 2 amps (or in my case 1.999 amps). Wind both controls fully anticlockwise and then connect the ammeter across the output terminals. Adjust up the output voltage until stable current is flowing. At this point the outside ammeter in my case read about 130 mA. Next wind up the output current until the power supply ammeter reads 2 amps. Adjust RV4 until the ammeter you are calibrating against reads the same and the job is done.

It is quite possible that the range of RV4 may not be enough. This is because RV4 is adjusting for variations in the resistance of the current sense pieces of copper wire. If this is the case it may be necessary to fiddle R20 or R29 until correct calibration is achieved. Cutting, tinning and soldering in the pieces of wire results in a very uncertain resistance value.

The final step in checking out the power supply is to run it under full load and make sure nothing gets too hot. This is not as easy as it sounds as you have to get rid of an awful lot of power in the load. I made up an awful mess of steel wire on a wooden frame to approximate the full load resistance which sort of worked but tended to catch fire. A sufficient test for overheating is to run it at full current for a while and check that nothing overheats. From this point on it is probably OK to be a bit pragmatic about the whole thing and say that the current and voltage limits work fine so the whole regulator should be right.

Connect a short circuit across the output and wind the current limit up to 20 amps. Check that the heatsink carrying the power FET and diode doesn't get too hot. Hot it will certainly get but not too hot. If this is all OK then you've built a power supply. ●

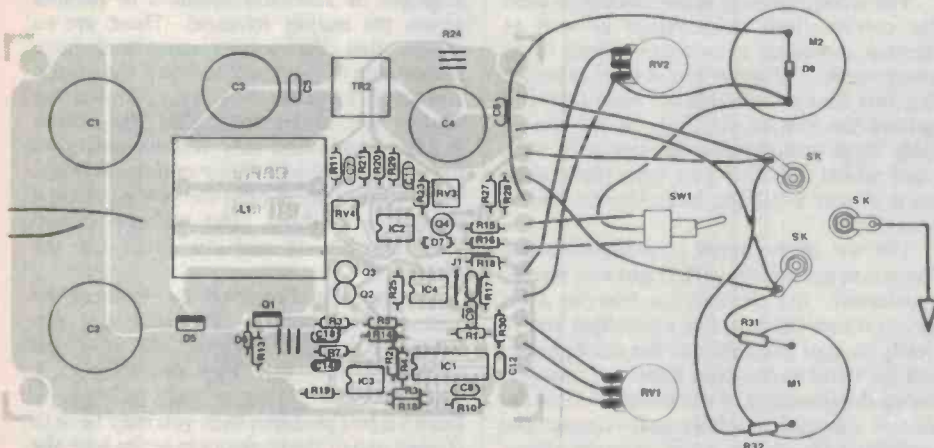

ETI-1533 — PARTS LIST

Resistors.....all 1/4 W, 2% metal film unless noted

R1, 2, 3, 4,	
5, 6, 10	4k7
R7, 8, 9,	
11, 12	1k0
R13, 18	10R
R14	5k6
R15	120R
R16, 29	12R
R17	3k3
R18	7k5
R19	130k
R20	15R
R21	1k5
R22	100R
R23, 24	see text
R25, 26	30k 1%
R27, 28	100k 1%
R30	390k 1%
R31	120k 1%
RV1, 2	1k linear log front panel mounting
RV3	20k pcb mounting cermet trimpot
RV4	20R pcb mounting cermet trimpot

Capacitors

C1, 2	22m Philips Type 2222-051-46223 or equiv
C3, 4	2m2 ERO type EYF T2
C5, 6	100 n ceramic monolythic
C7, 14	1n5 ceramic plate
C8	2n2 metallized polyester
C9	220n metallized polyester
C10	1n metallized polyester
C11	10n metallized polyester
C12	22n metallized polyester

Semiconductors

IC1	LM3524
IC2	LF355N
IC3	LM311N
IC4	RCA CA3140E
Q1	BUZ 11
Q2	BC337
Q3	BC327
Q4	BC559
D1, 2	20 A 50 V cathode to stud
D3, 4	20 A 50 V anode to stud
D5	15 A 30 V Schottky barrier TO220
ZD1	18 V 0.4 W Zener
ZD2	5.6 V 0.4 W Zener
D6	1N914
LED1	green LED

Transformers

TR1	Ferguson TF4244
TR2	see text

Miscellaneous

ETI-1533 pc board; 255 x 205 x 100 mm case; 1 x SPDT; 1 x DPDT toggle switches; 2 x knobs; heatsink; 3 x banana sockets; 4 x rubber feet; 2 x 50 mA panel meters; cable ties; mains wire and hookup wire; heatshrink tubing; 4 x BA nuts and bolts; screws to fit transformer; 2 A fuse; fuseholder; Euro IEC connector; 2 x terminal lugs; 2 x 20 A terminal blocks; 1" x 1.5" L-shaped aluminium extrusion; Scotchcal front panel.

Price Estimate: \$250

KIKUSUI OSCILLOSCOPES

COS 5041 40MHz

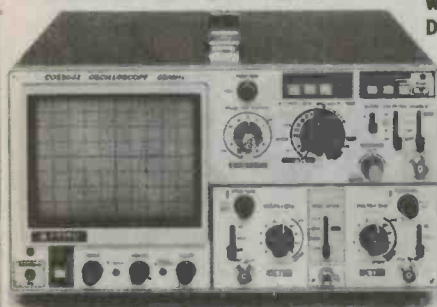

KIKUSUI COS 5041

- 2 Channel 40MHz band-width
- 1mV/Div
- 20ns MAX sweep speed
- Built-in DELAY-LINE
- Trigger LEVEL LOCK
- Variable HOLD-OFF

DELAY
with
DUAL TIME BASE

The economical 40MHz CRO that has more than just a trigger delay BUT a full DUAL TIME BASE that allows ANY portion of a displayed wave-form to be MAGNIFIED. Ideal for the workshop.

\$1,745

+ Sales Tax



Other quality KIKUSUI oscilloscopes —

- COS-5020 20MHz 2CH.
- COS-5042 40MHz 3CH, delay.
- COS-5060A 60MHz 3CH, delay.
- COS-5100 100MHz 3CH, delay.

Oscilloscopes with digital storage.

- DSS-5020A 20MHz real + 400kHz storage.
- DSS-5040 40MHz real + 10MHz storage.

ESCORT MULTIMETERS

DMMs with ROTARY SWITCH range selection:

EDM-70B \$55

3½ digits, — 0.5% — 6 functions:
DCV, ACV, DCA, OHM, Diode Testing,

EDM-1111A \$103

3½ digits — 0.5% — 9 functions: DCV, ACV, DCA, ACA, OHM, Capacitance, Diode Test, Buzzer, Transistor Test.

DMMs with PUSH BUTTON SWITCH range selection:

EDM-1346A \$250

4½ digits — 0.05% — TRMS — 8 functions: DCV, ACV, DCA, ACA, OHM, Frequency, Diode Test, Buzzer, Data Hold.

EDM-1135 \$141

3½ digits — 0.1% — Peak Hold — 6 functions: DCV, ACV, DCA, ACA, OHM, Diode Test.

EDM-1118 \$125

3½ digits — 0.5% — TRMS — 8 functions: DCV, ACV, DCA, ACA, OHM, dB, Diode Test, Buzzer.

EDM — 1116A \$104

3½ digit — 0.5% — 9 functions: DCV, ACV, DCA, ACA, OHM, Capacitance, Transistor Test, Diode Test, Buzzer

EDM-1105A \$78

3½ digits — 0.8% — 7 functions: DCV, ACV, DCA, ACA, OHM, Transistor Test, Buzzer.

ALL MULTIMETERS — ADD SALES TAX

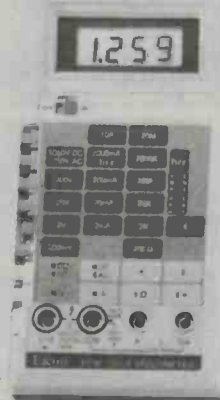

EMONA INSTRUMENTS

DIVISION OF EMONA ENTERPRISES PTY LTD

Showroom and Sales:

1st Floor, 720 George Street

SYDNEY 2000. PHONE: (02) 212-4599

HI-COM UNITRONICS INT. PTY. LTD.

7 President Lane,
Caringbah, NSW. 2229.

Post & Package Charge



Mail Order Hotline
(02) 524 7878

Less than \$50 \$3.50
\$50-\$99 \$4.50
\$100-\$250 \$7.00
Above \$250 \$10.00
Heavy Items EXTRA

KIT SPECIALS

MODEM

ETI 684 INTELLIGENT
MODEM KIT WAS \$420

PLUS: NOW \$399

- * 0.47F Supercap Extra \$10.00
- * Screened Front & Rear Panel
- * Full Constructional Manual
- * A Communication Program For Your IBMPC/XT
- * Gold Plated Through Holes PCBs With Sockets For All ICS
- * Auto Answer, Autobaud, Autodial, 300/1200/75
- * 8K RAM (Optional 48K), Cassette Output,

DUAL SPEED MODEM KITS
300/300, 1200/75 Viatel,
RS232 O/P W/Power
Supply Screened Front
Panel Included \$150

SIMPLE DUAL SPEED
MODEM ONLY \$110

CAR ALARMS

PROTECT YOUR CAR WITH THIS OPTICAL
CAR ALARM SWITCH ETI 343

Both Transmitter/Receiver \$84.00
Transmitter Extra \$18.00

COMPUTERS

NEW TURBO 1024K IBM/XT
COMPATIBLE COMPUTER



- * NEC V-20 CPU Running at 4.77 & 8 MHZ
- * 1024K RAM On Board, W/384K As VDisk
- * 300% Faster Than Standard 8088 Type Computer
- * 2 Serial/1 Parallel/Game Ports
- * 2 Japanese Drives, 150W P/S, Keyboards Etc
- * Only \$1499 Plus 20% Sales Tax

STANDARD 640K IBMXT COMPATIBLE WITH 8088CPU \$1250 + 20% S/T
FAST VERSION 640K COMPATIBLE WITH V-20CPU \$1270 + 20% S/T
Z-NIX MOUSE \$140 \$110 IF BUYING A COMPUTER!!!
CODE TO SPEECH CARD \$140 KIT \$120

COMPONENTS & CABLES

75452	\$2.20	UA709	\$1.00
7603	\$3.70	765	\$13.70
1488	\$1.30	TBA820	\$1.00
1489	\$1.30	8304	\$6.20
2102	\$7.70	81C55	\$7.60
AN240	\$1.20	8088	\$22.00
AN6912	\$1.20	8088-2	\$26.00
2708	\$7.90	V-20 CPU	\$32.00
2716	\$5.50	8087 5MHZ	\$260.00
2732	\$7.00	8237	\$18.00
2764	\$8.00	8253-5	\$6.50
27128	\$11.50	8253-2	\$6.50
27256	CALL	8253-5	\$6.50
4164-15	\$2.90	8255-2	\$7.00
41256-12	\$8.50	8284	\$6.50
41256-15	\$8.00	8288	\$18.00
6802P	\$7.50	8259	\$6.50
6802L	\$7.50	8259-2	\$7.00
6821	\$5.00	82508	\$19.50
6850	\$4.00	58167	\$22.00
		NE555	\$0.60
		XR558	\$3.20
		TMS1100	\$5.50
		PAL16LBN	\$9.50
		PAL12L6CN	\$11.50
		9216	\$11.00

MAIL ORDER HOTLINE (02) 524 7878

An introduction to the world of 16-bit computing. The ETI-1616 is the highest performance computer design ever published in a magazine.

16-BIT

Andrew Morton & Paul Berger

THE TROUBLE WITH most kit computers is that once built, tested, and shown off at the local computer club, the user realizes that, as far as a personal computer is concerned, it's not particularly useful, and the exercise is rationalized as being "very educational".

The 1616 does not suffer from that problem. It sports similar features and specifications to the latest personal computers, like the Amiga and Atari ST, and the classic design architecture of the Apple II and IBM PC. The difference is that it's a kit computer. Building your own will, firstly, allow an insight into the workings of the system, and secondly, significantly reduce the overall cost. The fact that it's a kit does not detract from the performance or features of this machine.

The 68000

When we started the initial design of the 1616 (the nameless wonder at that stage), we looked around at the various microprocessors used in popular computers. Eight-bit processors were out of the question. They simply were not powerful enough. The Intel 8088/86 (as used in the IBM PC) was an obvious choice, but that would mean that the machine would inevitably be just another IBM-compatible. We didn't think the world could handle another one and the 8088 is barely a 16-bit microprocessor anyway.

The Motorola 68000 is by far a better choice. Most of the new computers are using it including the Apple Macintosh, Commodore Amiga and Atari ST.

The 68000, a true 16-bit microprocessor, has a 16-bit data bus and a 24-bit address bus (giving access to 16 megabytes of memory). Some people call it a 32-bit processor because of its 32-bit wide registers and internal data path.

We thought its architecture was very broad and strong. In addition, we wanted something to support graphics, which the 68000 does particularly well. Our view was that superior graphics is one of the main reasons for upgrading to 16-bit. So 68000 it was!

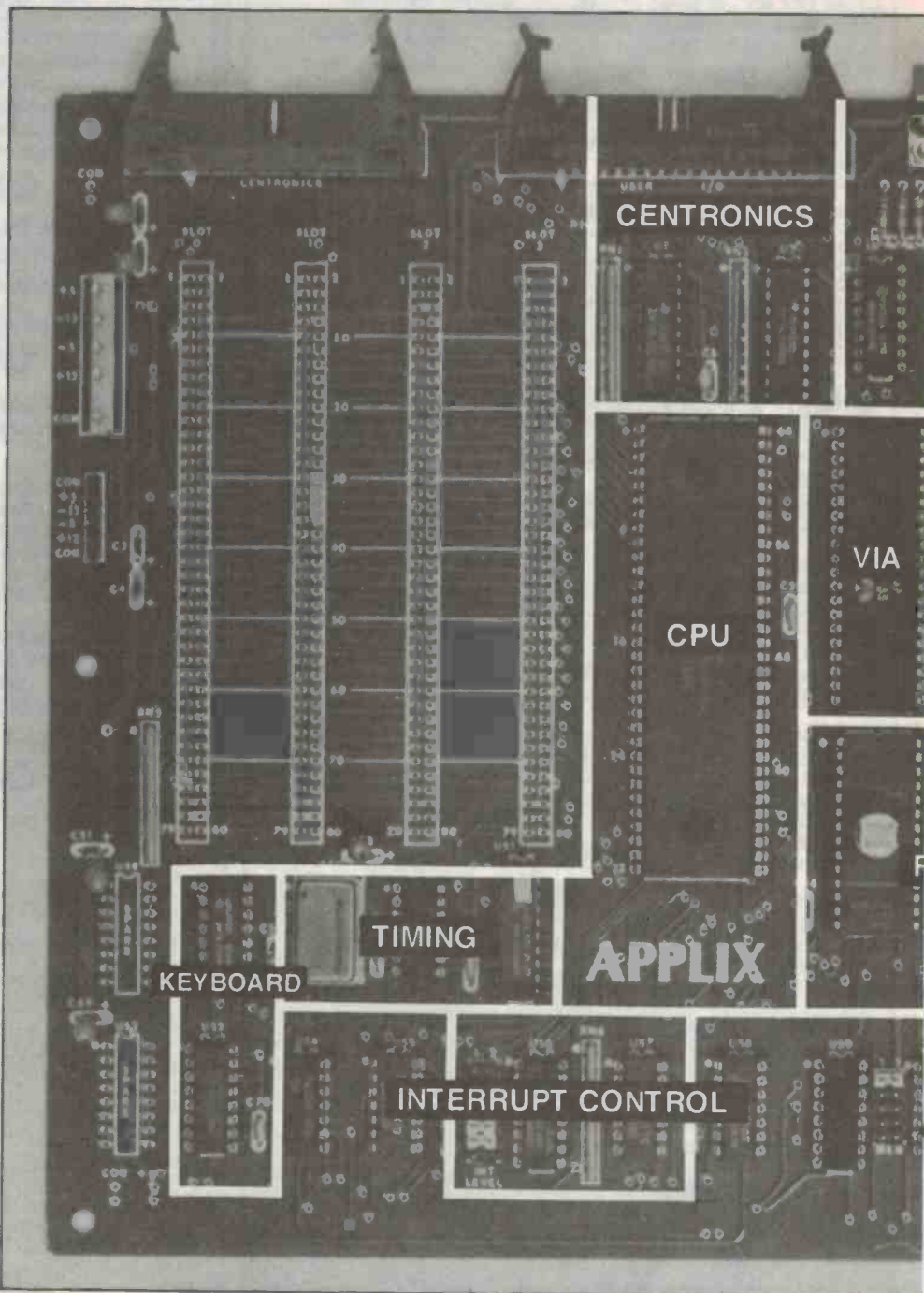

COMPUTER

The 1616 was designed by Paul Berger and Andrew Morton after extensive discussion with ETI staff early in 1986. Berger and Morton run a computer supply and design company called Applix Ltd in the Sydney suburb of Beverly Hills. They are currently working on enhancements to the 1616.

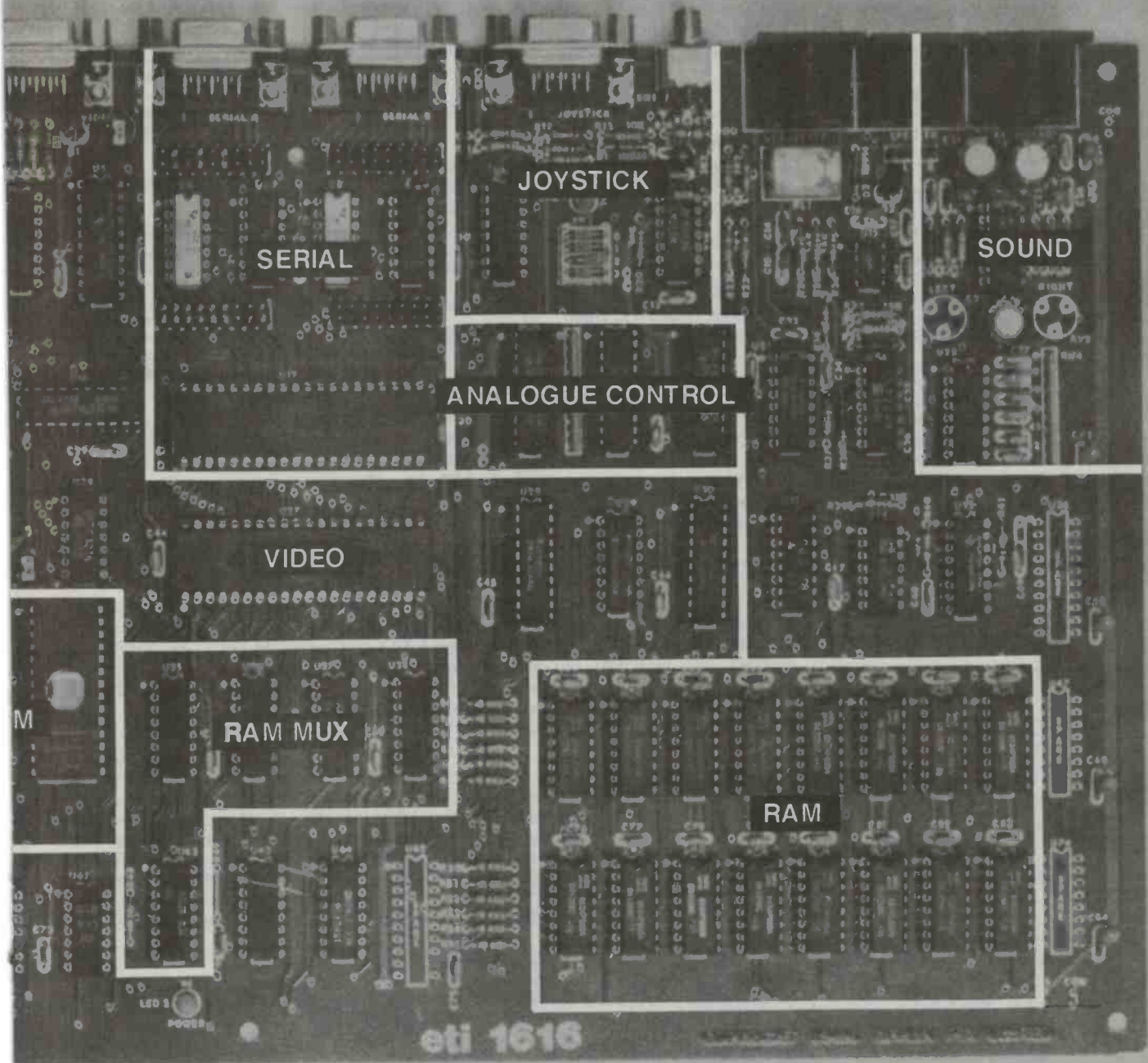

Project 1616

Design criteria

Look at the popular Apple II and IBM PC computers. They both have a motherboard with processor, RAM, ROM, video and lots of expansion slots. Both work in their minimal form and can be expanded to complete systems as required, or finances allow.

The 1616 takes this basic form one step further. It is a single board design which serves as a solid foundation on which to build a complete, low cost, useful personal computer.

The design is based on a mixture of what we wanted, what was needed and what was available. For example, once we had chosen the 68000 processor (which has a 16-bit data bus), and since standard memory chips are only one bit wide, it was obvious that we needed 16. The design could take either 64K or 256K chips so that we would end up with 128K and 512K respectively. As it turns out, 128K is a bit squeeze so the standard on-board RAM is 512K.

Similarly, since ROM chips are eight bits wide, we needed two. Using today's high capacity ROM chips we ended up with a total on-board ROM of 128K bytes.

We wanted to pack as many features onto the motherboard as possible. We drew up a list of necessary and desirable options and went through them one by one, putting them in and taking them out.

We just had to have colour graphics, and sound was attractive. Joystick? Of course! Everyone is into communications nowadays, so serial ports are a must. This also allows the computer to be used as a terminal to something bigger (or smaller). We didn't want to limit the serial ports to RS232, so the design allows the serial ports to also be used for networking, hooking up a mouse, a MIDI interface, RS422, etc. One would eventually want to add a printer so a parallel printer port is in.

All that's left is mass storage. It's tape! This was a major decision. Obviously, a

drive is attractive, however, it has a problem. A disk controller on the motherboard raises the complexity considerably. We thought it best to leave this to an expansion board and do the job properly. A tape system allows you to use the computer at its minimum level without having to go out and buy a disk drive immediately. We have tried to make the tape system as workable as possible, using the available memory as a RAM disk. It is very fast (over 3000 bits per second) and very reliable, and uses a standard cassette recorder.

The other necessary peripherals are also bog standard. The 1616 requires an IBM keyboard, and an Apple power supply. The real thing, or any cheap clone, will do the trick.

Hardware

The 1616 hardware consists of 68 integrated circuits mounted on a 394 mm x 210 mm double sided, plated through printed circuit board. It is powered by an external power supply providing +5 V, +12 V, -5 V and -12 V similar to that used in the Apple II. The design may be broken up as follows.

Processor/memory/video

The heart of the system is, of course, the 68000 microprocessor. Video generation is controlled by a 6845 CRT controller chip. The 32K bytes of video display data is obtained from the on-board memory and is entirely bit mapped, hence there is no need for a character generation ROM. The display bit map may be located at any 32K address boundary, allowing the use of multiple display pages.

The dynamic memory is refreshed by the continuous reading performed by the video circuitry. A 16R8 PAL (programmable array logic) device, clocked at 30 MHz, resolves the contention between the 68000 and the video circuitry during memory accesses. This same PAL provides most of the system's timing requirements.

Video data is read 16 bits at a time from main memory and is clocked serially to the video output stage.

Video output

The serial bit stream is converted into a four-bit format suitable for display on an RGBI (red/green/blue/intensity) or composite monochrome monitor by another 16R8 PAL and associated circuitry. A control input to the video PAL selects between either 320 or 640 pixels per line.

In 640 mode, a four x four bit register file chip provides a palette of any four colours from the possible 16. A latch provides the border colour around the display area. In 320 mode, 16 colours are available.

6522 VIA (versatile interface adaptor)

The 6522 VIA chip provides the computer with eight bits of general purpose parallel

ETI-1616 SPECIFICATIONS AT A GLANCE

Microprocessor

Motorola 68000, 16/32-bit microprocessor (16-bit external data bus/32-bit internal data path and registers) running at 7.5 MHz.

Memory

512K bytes dynamic RAM using 16 standard 41256 memory chips. Expandable to 4.5 megabytes total on board. 8M directly addressable in expansion units of the board.

ROM

Up to 128K bytes of on-board ROM.

Graphics

Four modes as standard; 320 x 200 16 colours, 640 x 200 any four of 16 colours, software or hardware scroll. Standard 16-colour RGBI interface or composite video with 16 shades of grey.

Sound

Stereo sound with output to hi-fi and on-board amplifier for direct connection to speakers.

Mass storage

On-board high speed, block orientated cassette interface with motor control. 'RAM disk' support software in ROM.

Keyboard

Uses standard IBM-style detachable keyboard.

Expansion ports

Four 80-pin expansion slots with all 68000 signals; for memory expansion, floppy and hard disk interface, etc. Centronics compatible parallel printer port. Dual serial (RS232 as standard) ports using standard Z8530 SCC, with programmable baud rates up to 1 megabit. Analogue two-button joystick port using standard Apple-type controllers. User port; general purpose analogue and digital I/O port for experimenting (ie, EPROM programmers, speech input, etc).

In-built software

Powerful monitor, full screen editor, assembler, terminal emulation, communications and operating system (graphics support, etc).

I/O and is used for various functions including cassette, keyboard, sound, Centronics, video and interrupt control.

Analogue input/output

This section includes sound generation, joystick control, general purpose analogue I/O and cassette I/O. Most of these functions use the eight-bit digital-to-analogue converter chip and CMOS analogue multiplexers.

Serial input/output

The 1616 communications chip, the Zilog 8530 SCC (serial communications controller), provides dual synchronous and asynchronous data transfers at a wide range of programmable baud rates. The board has been designed to comply with the RS232C standard, but provision has been made for implementation of virtually any line discipline by the use of an appropriate interface card.

The expansion ports

The 1616 has four 80-pin expansion connectors which make available power supplies, all of the 68000's signals and clocks. These permit peripheral cards such as memory expansion and disk controllers to be connected.

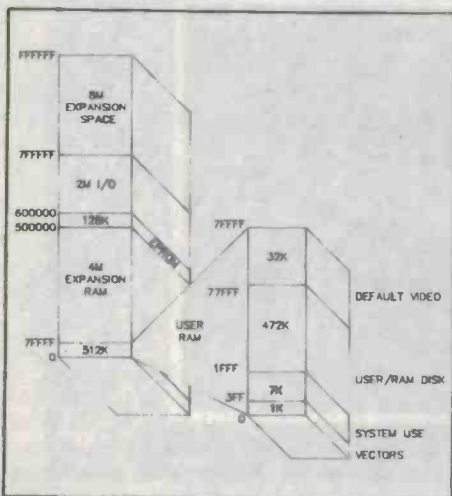

Figure 2. Memory map.

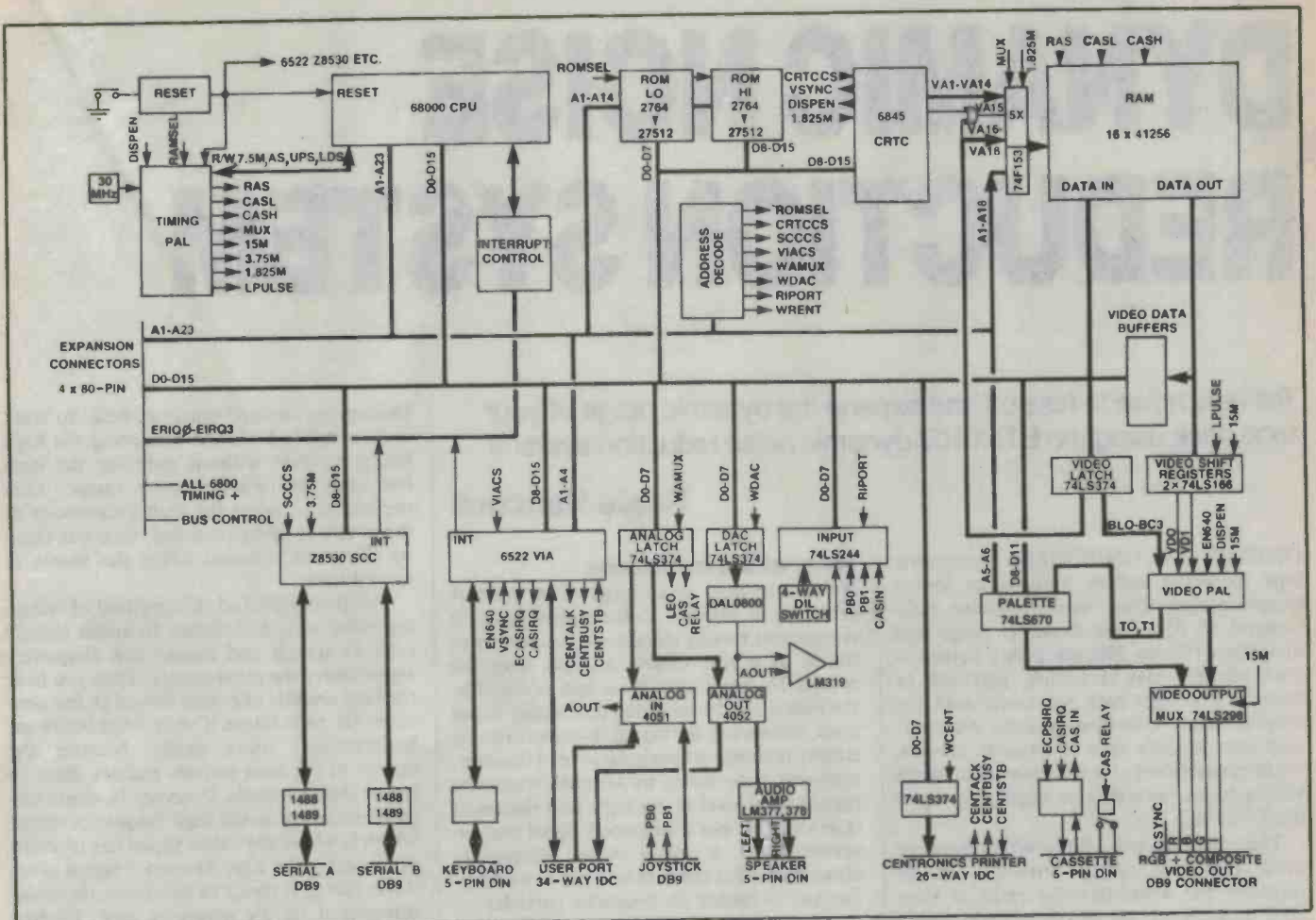

Figure 1. ETI-1616 block diagram.

Software

The 64K bytes of software contained in the 1616 ROM went through a similar evolution to the hardware, but there was one other factor involved: time. When designing a computer system, the hardware is usually the easiest part and takes relatively little time. Making the hardware actually do something is the difficult part. That's where the software comes into play.

Most of the 1616 software is written in the C programming language with portions written in 68000 assembler for maximum speed.

A key feature is the RAM disk file management software. This brings the 1616's operating system closer to a disk system than to a tape one. From 128K to 347K of memory may be used for storing files.

To understand the software better, it can be logically divided into the following sections:

Diagnostic functions. These routines are invoked by the setting of the sense switches. They force the 68000 to perform simple operations which aid the testing of the board during construction.

System control and device drivers. These manage all input/output devices, most of which are buffered and interrupt-driven. This includes serial I/O, parallel output, keyboard input, cassette I/O, RAM disk file management, video output and system timer ticks, etc.

System routines. These are a collection of routines which application programs may call for:

- communicating with I/O device drivers;
- reconfiguring I/O device drivers;
- installing/removing device drivers and system routines and monitor commands;
- invoking the line editor and command interpreter;
- file access.

Operating system. This interprets and acts upon commands typed in by the users. These commands include:

- memory examining, moving, filing, comparing and searching;
- calculator and base conversion;
- time and date set and display;
- cassette loading and saving;
- serial port programming;

- function key programming;
- system status display;
- invoking pull screen editor and assembler.

All the operating system commands support full I/O redirection. The output and input for the execution of the command may be directed to and from devices and RAM disk files.

Full screen editor. This is a fast WordStar-like editor which operates upon RAM-based files.

Assembler. A resident assembler which reads standard Motorola mnemonics from a RAM disk text file, producing executable 68000 code.

Communications and terminal emulation. For transferring files and communicating with other computers.

Full details of the design will be published in up and coming issues of ETI. The hardware, software and full construction and operating instructions will be published in February, March and April next year. Details of supply of the 1616 will be available in the February issue.

DYNAMIC NOISE REDUCTION SYSTEM

Tell tape noise to hiss off and expand the dynamic range of your tape deck using the ETI-1407 dynamic noise reduction system!

Neale Hancock

DESPITE ITS CONVENIENCE magnetic tape recording suffers from some severe disadvantages. Poor signal-to-noise ratio (around 55 dB), poor dynamic range and distortion (1% to 3%) are pretty common trade-offs for easy recording, playback or erasure. The fight back has come with the various noise reduction systems incorporated into modern tape or cassette players. Unfortunately not all of us have them or are willing to buy new players to get one. Enter the ETI-1407.

The magnificent ETI-1407 dynamic noise reduction system enables you to improve the signal-to-noise ratio of your tape deck by up to 18 dB without treble attenuation. It expands dynamic range allowing you to make recordings from compact discs, and depending on how you use it you can also eliminate some distortion.

Wherefore problems

Noise on tape recordings is a relative problem, ie, relative to the audio signal. It is apparent mostly during quiet passages of music as a hiss clearly audible over the music. To make tape noise less noticeable, the music can be recorded at a higher input level, increasing the signal-to-noise ratio by simply increasing the signal level. However, magnetic tape tends to saturate when the input signal level is too high, and the result is as often as not a distorted signal and, in severe cases, a signal which disappears altogether. This effect is referred to as drop-out and is caused by magnetic particles on the tape not being able to accept high signal levels. So back to low input levels.

High frequency hiss, the most noticeable form of tape noise, can be removed by turning down the treble control of your hi-fi, right? But that gets rid of all the high

frequencies in your music as well. So what is required is a way of removing the high frequency hiss without reducing the high frequency content of your music. One method is to boost the high frequencies as the music is being recorded, then cut them by the same amount when the music is played back.

The theory behind this method of reducing noise runs as follows. In audio signals such as speech and music, low frequency signals have the most energy. Thus you hear the bass sounds of music played in the next room (or next house if your neighbours are headbangers) more easily, because the energy of the bass sounds enables them to travel through walls. Conversely, noise has greatest energy in the high frequency range, which is where the audio signal has its least. So boosting the high frequency signal gives it the energy it needs to overcome the noise introduced by the magnetic tape. Cutting both the signal and noise on playback restores the musical signal to its original form, but with reduced noise.

This method of noise reduction is known as pre-emphasis/de-emphasis and is used in FM broadcasting. A graphical representation of its effect on noise is illustrated in Figure 1.

Whilst pre-emphasis may give the audio signal the boost it requires to overcome noise, it also places greater demands on the limited dynamic range of the tape. The boost given to high frequencies can be as much as 20 dB and when this is added to 90 dB odd of signal (in the case of recording from CD), your humble cassette tape will have a rupture trying to cope with 100 dB of dynamic range! To enable signals with 110 dB of dynamic range to be squeezed onto a tape capable of handling only 60 dB, the signal has to be compressed during recording, then expanded at playback to recover the signal's dynamic range.

So the signal flow for a dynamic noise reduction system runs as follows: input signal is pre-emphasised, then compressed and recorded onto tape; when played back from the tape the signal is expanded then de-emphasised. This sequence is shown in block diagram form in Figure 2.



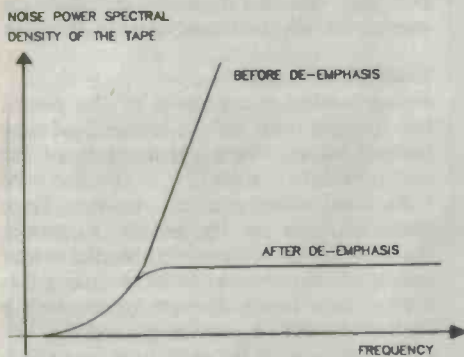
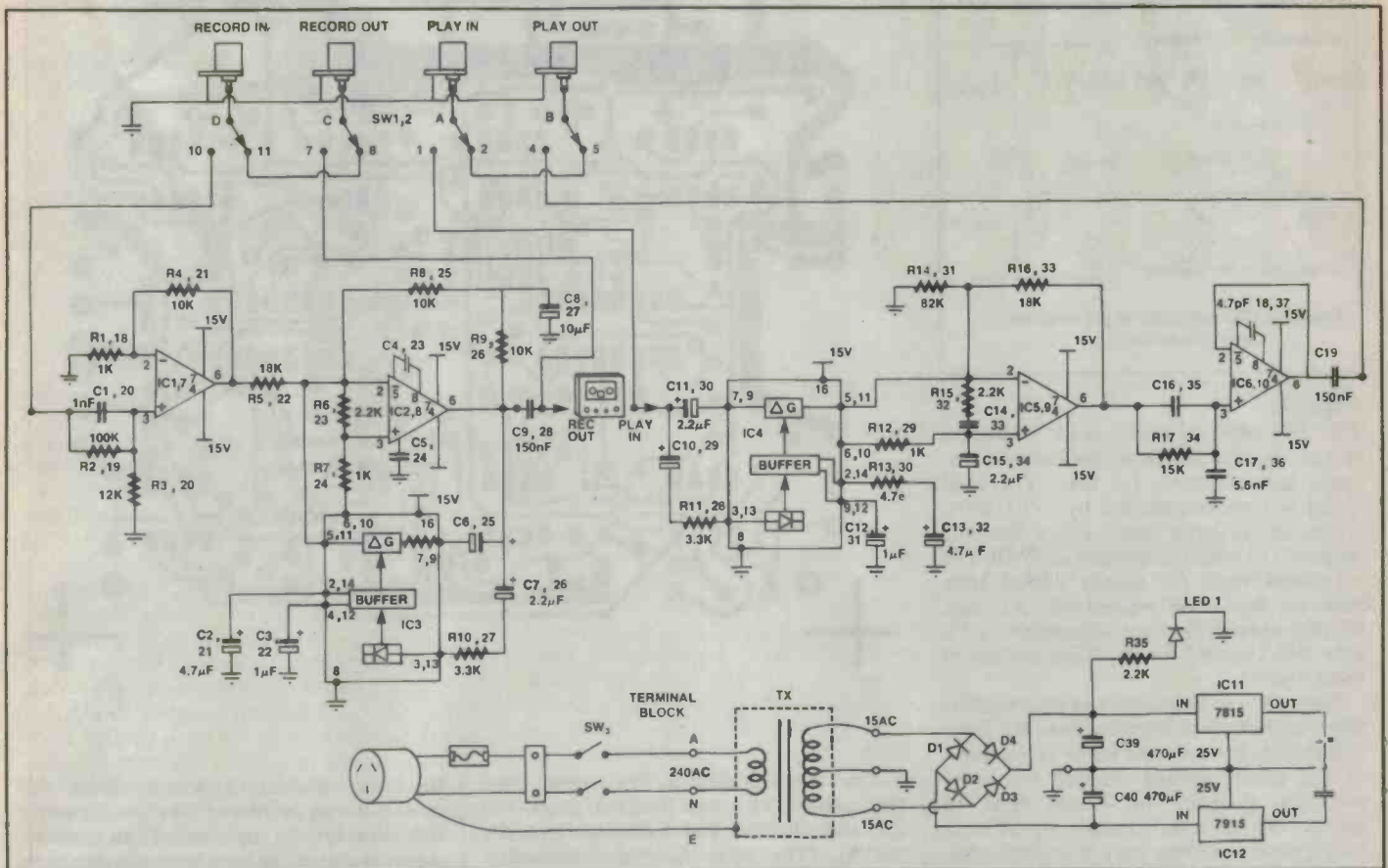

Figure 1. Noise power spectral density/frequency.

ETI-1407 — HOW IT WORKS

As this circuit has two channels there are two part numbers for each component. For convenience sake only the higher value component will be referred to.

IC1 provides 20 dB of pre-emphasis to the incoming signal, the amount of gain is set by the resistor pair, R1 and R4. The combination of C1 and R3 sets the lower breakpoint of the pre-emphasis filter (see Figure 3) while the upper breakpoint is set by R2 and C1.

The output from the pre-emphasis stage goes to the compressor stage which consists of IC2 and IC3. Pin 7 of IC3 is the input to the variable gain cell and pin 3 is the rms detector input. The rms detector and the variable gain cell interact to compress the dynamic range of the signal. The current output from pin 5 of IC3 is the compressor output, which is converted into a voltage via the op-amp IC2. R8, R9 and C8 set the compression ratio at 2:1. C3 sets

the attack time of the compressor to 40 ms while C2 sets the recovery time to 200 ms. The output from this stage is recorded onto tape.

The signal played back from the tape is expanded by 2:1 via IC4 and IC5. This expansion ratio is set by R16. Pin 7 of IC4 is the signal input into the expander, while pin 3 is the rms detector input. The output from pin 5 of IC4 is converted to a voltage via the op-amp, IC5. Capacitor C12 sets the attack time constant whilst C13 sets the release time constant, both of these are the same as for the compressor stage.

The de-emphasis filter consists of IC6, C16, C17 and R17. This filter removes the 20 dB boost created by the pre-emphasis filter. C16, C17 and R17 set the cut-off point, and are chosen to match the response of this filter with the response of the pre-emphasis filter. The output from this stage goes to the amplifier.

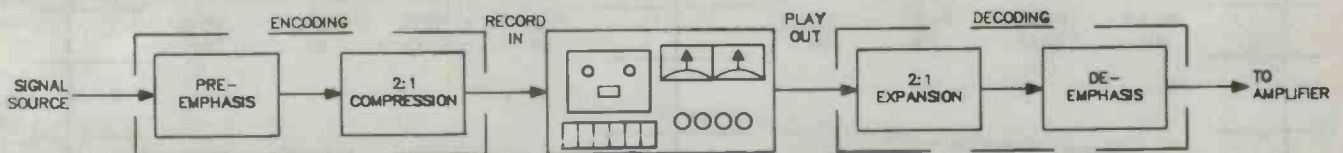
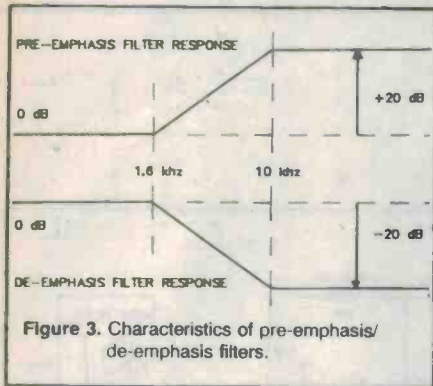

Figure 2. Block diagram of noise reduction system.

Project 1407



Circuit

The ETI-1407 dynamic noise reduction system applies 20 dB of pre-emphasis to audio signals above 1.6 kHz. The total signal is then compressed by a 2:1 ratio, which means that a signal with a dynamic range of 110 dB is compressed to 55 dB. The expansion ratio for signals played back from the tape is correspondingly 2:1, then the de-emphasis filter cuts signals above 1.6 kHz. (See Figure 3 for the characteristics of these filters.)

Since the pre-emphasis and de-emphasis filters are both first order and have the same breakpoint, there should be no coloration of the sound passing through the noise reduction system. This is the ideal. In practice the filters do have slightly different breakpoints and there may be a slight peak or dip in the frequency response. To minimize the size of this irregularity, 1% resistors are used to set the breakpoints. In two units which I tested, the mismatch led to a 2 dB boost to the treble above 10 dB which is not detrimental to the recorded music. In effect, it makes up for some of the deficiencies in the tape's frequency response.

The desired amount of pre-emphasis and de-emphasis is applied via first order active filters. NE-5534 low noise op-amps are used to ensure that the system itself contributes as little noise as possible. An NE-572 programmable compandor compresses and expands the audio signal via a variable gain cell coupled with a level detector. To convert the current output from the NE-572 into a voltage, an external low noise op-amp is required.

The NE-572 has a low noise floor (typically 6 μ V), a wide dynamic range (110 dB) and relatively low distortion (typically 0.05%). (The noise floor and distortion figures for the NE-572 are much better than for its predecessor, the NE-571.)

Hum and noise contributed by the noise reduction system was measured at -86 dB for hum and -92 dB for noise with a reference signal of 1 kHz at a 0.7 voltage rms. Distortion for the same input conditions was around 0.1%, which is negligible compared to the distortion contributed by the tape deck. With the noise reduction system connected up to a tape deck, noise was reduced by around 16 dB. This level made it possible to achieve a dynamic range of 74 dB compared to a 58 dB dynamic range obtained without noise reduction.

While the ETI-1407 is effective in removing unwanted noise without noticeably affecting the signal, it does have one limitation: signals recorded onto tape via

the noise reduction system (encoded signals) can only be played back via the noise reduction system (decoded). If an encoded signal is played back without any decoding then it will hardly be dynamic and will suffer an excess of treble. Alternatively, if a normally recorded signal is decoded, the music will lack treble and be over-dynamic.

Construction

Before soldering anything to the circuit board, check it for defects such as broken or bridged tracks. Begin construction of the circuit board by soldering in the five wire links. Next solder in all the resistors. Since many of them are 1%, be sure to mount them in the correct locations. As the colour coding of 1% resistors can be confusing it is a good idea to check their values with a multimeter before you insert them.

Next mount all the capacitors, but check that the electrolytic capacitors are polarized correctly.

The low noise op-amps (ICs 1,2,5,6,7,8,9) ►

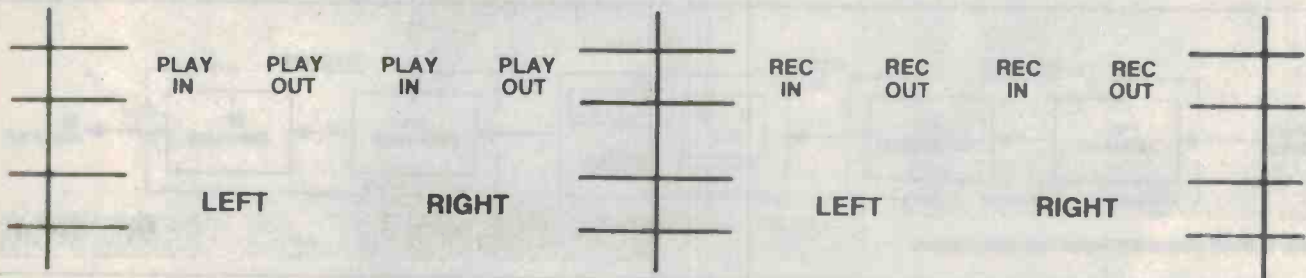
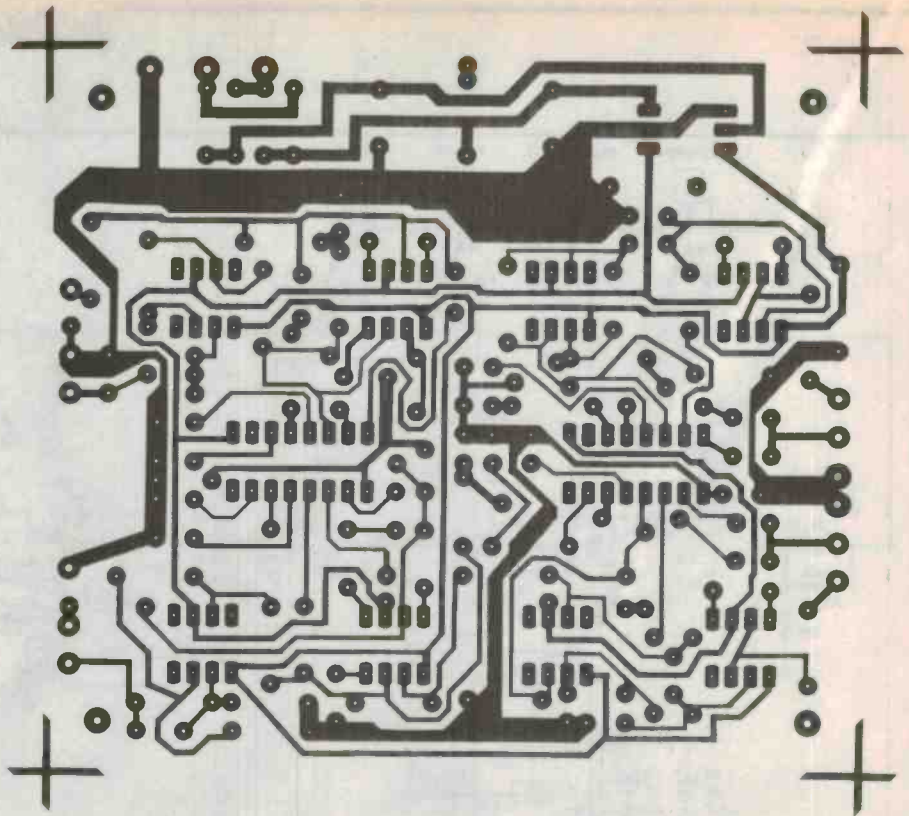

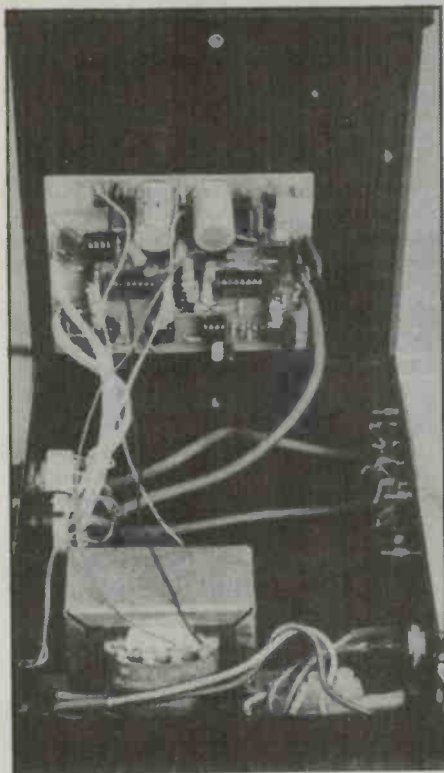
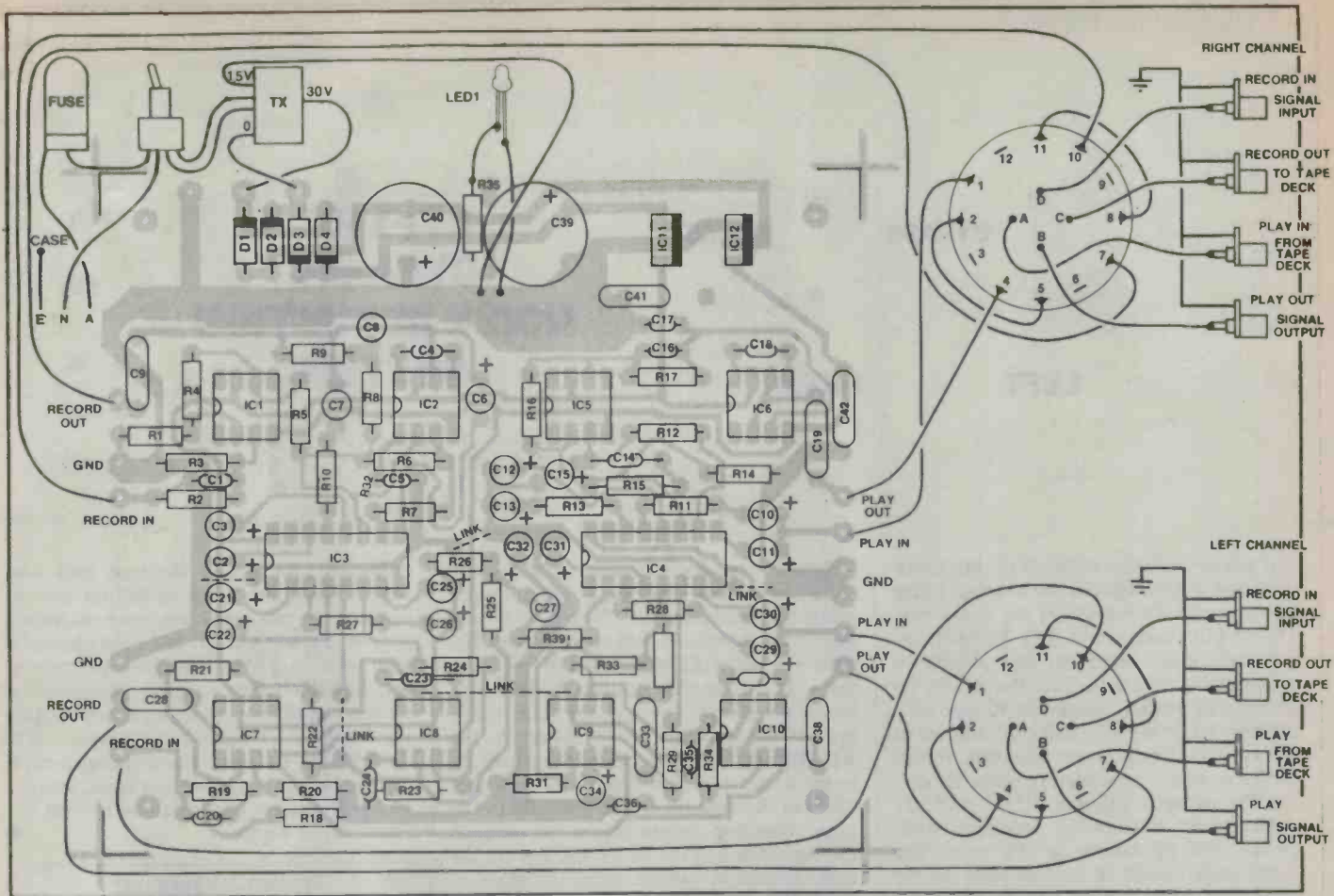

Parts mounted in the box.

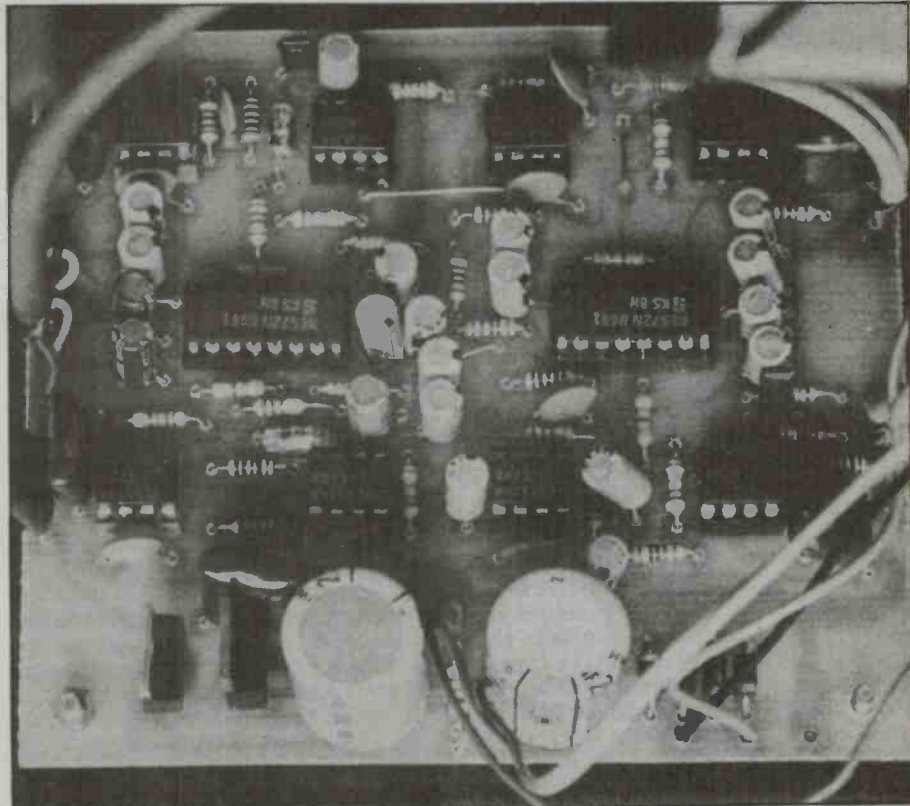

The board.



and 10) can now be soldered in, but check their orientation against the overlay. Make sure they are all orientated the same way. The 16-pin companders (ICs 3 and 4) are not particularly cheap, so they should be mounted in IC sockets. Once the sockets are soldered in, push a compander IC into each of them, but make sure that it is oriented in the same direction as the op-amps. Finish off the pc board by soldering in the diodes, and the voltage regulators (ICs 11 and 12).

Mount the transformer, terminal block, switch and fuseholder in the case. The power cord should be held in place on the rear panel with a cable clamp. The leads from the power cord should be connected as follows: the active (brown) to the fuseholder and from the fuseholder to the terminal block; the neutral (blue) straight to the terminal block; and the earth (green) bolted to the transformer. The reason for connecting the earth lead in this fashion is not only for safety but also to get rid of some of the electromagnetic radiation from the transformer. The active and the neutral are then connected to the transformer via the on/off switch. For the sake of safety, cover the solder joints which connect the transformer to the fuseholder and to the switch with a plastic sleeve or some insulating tape.

The input and output sockets can now be connected to the bypass switches, SW1 and SW2, via two short lengths of four core shielded wire. These switches can be configured for a number of different polling arrangements, but for our needs four-pole two-position will do. The switch can be set to this configuration by changing the position of a ring which fits around the shaft of the switch. The ring has a pin on its perimeter which fits in a hole to select the number of positions required. The bypass switches can then be connected to the pc board via some short lengths of shielded wire. Connect the shield of the wire linking the switch to the pc board. Finally link the transformer to the pc board and connect the LED to the pc board via flying leads.

Before you apply power to the noise reduction system, check the pc board for dry joints and solder bridges. Install a 250 mA fuse in the fuseholder and apply power. The supply rails should be within 150 mV of 15 volts. If they're not, double check the pc board for shorts. Connect the REC OUT port of the noise reduction system to the REC IN of your tape deck and the PLAY IN to the noise reduction system to the PLAY OUT of the tape deck. The REC IN to the noise reduction system is now the input to the tape deck and the PLAY OUT from the noise reduction system takes the place of the output from the tape deck.

The ETI-1407 dynamic noise reduction system can also be used with multitrack recorders but should be carefully monitored to prevent unpleasant overloading effects.

If you require noise reduction for a four track recorder, simply construct two ETI-1407 circuit boards, leaving off the power supply from the second board (specifically, C39, C40, R35, LED1, IC11 and IC12). Then connect the +15 volt, -15 volt and ground lines from one board to another. Both circuit boards can be mounted in the one case and the bypass switches should then be labelled ONE to FOUR instead of LEFT and RIGHT.

Testing

Commence testing by recording a piece of music (preferably with very quiet as well as very dynamic parts), turning the left hand switch to the BYPASS position and the right hand switch to the IN position. Replay the music listening alternatively to the left and right channels, especially in the quiet parts. The channel with the noise reduction should have much less hiss. If this channel sounds more distorted take note of the recording level and make future recordings at a lower level.

If you don't succeed in recording anything on the tape, check the wiring which connects the rotary switches to the input and output sockets and to the pc board. Also check that you have connected the noise

reduction system and the tape deck correctly. Since the noise reduction system consists of an encoding and decoding section for both the left and right channels, each section can be checked separately to diagnose the cause of a fault. The encoding section can be checked by inputting a signal into the REC IN socket and listening to it at the REC OUT socket. The decoding section can be checked by inputting a signal into the PLAY IN socket and listening to it at the PLAY OUT socket.

ETI-1407 — PARTS LIST

Resistors		all 1/4 watt, unless noted
R1,7,12,18,24,29	1k 1% metal film	
R2,19	100k 1% metal film	
R3,R20	12k 1% metal film	
R4,8,9,21,25,26	10k 1% metal film	
R5,16,22,33	18k	
R6,15,23,32,35	2k2	
R10,11,27,28	3k3	
R13,30	4R7	
R14,31	82k	
R17,34	15k 1% metal film	
Capacitors		
C1,20	1n greencap	
C2,13,21,32	4μ7 16 V electro	
C3,12,22,31	1μ 16 V electro	
C4,5,18,23,24,27	47p ceramic	
C6,7,10,11,15,25,26,29,30,34	2μ2 16 V electro	
C8,27	10μ 16 V electro	
C9,19,28,38	150n greencap	
C14,33	270p ceramic	
C16,35	820p ceramic	
C17,36	5n6 greencap	
C39,40	470μ 25 V electro	
C41,42	220n greencap	
Semiconductors		
D1-4	1N4004	
LED1	red, 5 mm	
IC1,2,5,6,7,8,9,10	NE-5534 low noise op-amp	
IC3,4	NE-572 dual compander	
IC11	7815	
IC12	7915	
Miscellaneous		
2 x 4-pole 2-position rotary switch; 1 x DPDT toggle switch; 1 x mains transformer with 0, 15 and 30 volt outputs; case to suit; ETI-1407 pc board; 2 x 4 way RCA panel connectors; 4-core shielded cable.		

Price estimate: \$95-\$100

Prices so low, you'd think we were Santa Claus!!

International Walkie Talkies – perfect for the kids!!

A pair of these fantastic little communicators will keep the kids quiet! Price for the pair. (Does not include batteries).

only \$25 pair

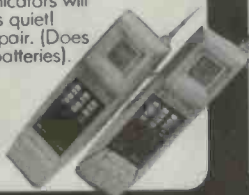

Professional Logic Probe

Professional Kamoden Logic Probe has all the features.

- Works from 3-18V
- Frequency range DC to 10MHz
- Detects pulses to 30 nanoseconds
- Red LED for high and Green LED for low logic levels

only \$36.00



Arlec 12V/4A Battery Charger

Perfect for the car, boat or caravan.

- Hefty 4A output
- Large, easy to read ammeter
- Protection with automatic circuit breaker
- Double insulated for safety
- 2 year guarantee

only \$37.95



Fans at Cool Prices

Keep your equipment running cool. Super efficient 'muffin' style fan. 80mm (W) x 80mm (H) x 42mm (D). 220/230 V operation 50/60Hz 9W, 2650 RPM. Going for a song for Xmas!!

only \$19.95



'D' Connectors at Deelightful Prices

Best prices in Australia on this lot!! 'DA' Type. All plastic, solder tail, right angle 0.025 (0.64) sq. post

- 25 Way Male (DA10352) — \$1.50
- 15 Way Male (DA10252) — \$1.50
- 15 Way Female (DA11252) — \$1.95 or \$2.95 the pair.
- 9 Way Male (DA10152) — \$1.25
- 9 Way Female (DA11152) — \$1.50 or \$2.50 the pair.

BACKSHELLS

- D25 (moulded black) — \$1.10
- D25 (metallised plastic) — \$2.00
- D15 (moulded grey) — \$1.20
- D15 (metallised plastic) — \$2.00
- D9 (moulded grey) — \$1.00
- D9 (metallised plastic) — \$1.50

METAL BODIES

- DC37 Way Plug, Socket and Backshell — \$5.00
- DD50 50 Way Plug, Socket and Backshell — \$7.00

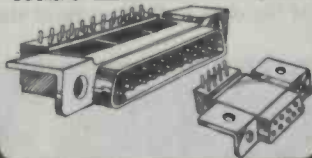

Complete Phone extension System



\$29.95

Video Image Stabiliser – fix those videos good!!

If you want good results with prerecorded videos this is what you need. You get immediate stabilised control over prerecorded tapes, removing all trace of the dread copyguard signal.

only \$65



240V – 100V Stepdown Tranny

manufactured by DYNE, this sturdy transformer is rated at 100VAC/2A and has three parallel American style outlets. Worth \$110.00

only \$40.00

150 ohm/ 25W Wirewound Rheostats

only \$1



Resistor Sellout



All are 1/4 watt carbon film, pre-formed (end mounting type). Total of 1100 resistors

100 each of the following values: 62 ohm, 100 ohm, 110 ohm, 120 ohm, 150 ohm, 15K ohm, 16K ohm, 18K ohm, 20K ohm, 22K ohm, 24K

only \$15 the lot!!

ARLEC Super Tool –

A precision power tool with a multitude of uses, Perfect for drilling, polishing, engraving or erasing.

- Complete with 8 tools, 6 eraser sticks and a collet chuck with five collets for a variety of tasks.

\$54.95



Electret microphone inserts.

only 95c

Perfect for repairing mics and building all kinds of 'bugs' 10mm dia. x 10mm high. 3-9V operation.

Darlington Transistors

What a bargain!! NPN Silicon Darlington Transistors BD679. 80V 4Amp 40W. Datasheet supplied

10 for \$3.00



9 piece Toolset

Essential for every hobbyist. Includes: Micro Cutter Mini knife Tweezers 2 Phillips screwdrivers 4 jeweller's screwdrivers (1.0, 1.2, 1.8 and 2.4mm) Complete with handy zippered pouch – the perfect gift.

only \$13.50

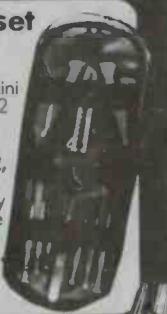

Save on NiCad Batteries

Pack of 4 x AA size 450mAh nicads. Perfect when you're sick of paying out for batteries – just recharge them. Normally \$13.00.

only \$10.00

save \$3.00

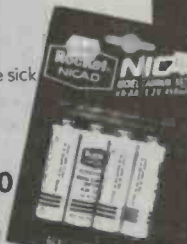

Crouzet Synchronous Motors

A motor drive system for accurate time driving in instrumentation, machine and process control. 1000s of uses including robotics, 240V AC, 50Hz, 2.8W/15mA. Direction: Anti-clockwise, 60 RPM.

only \$7.50

GRAB THEM WHILE YOU CAN!!



Transistors at Santa Claus Prices

10 x 2SA999 (NPN 50V)
10 x 2SB888 (PNP 50V)
Moulded TO18 type package.
The twenty for only:

\$1.50

Pressure Mats at Low Pressure Prices

175mm x 530mm.

only \$6.50



SHERIDAN ELECTRONICS Pty Ltd

164-166 Redfern St., Redfern NSW 2016

Phone (02) 699 5922, 699 6912

Mail Orders to: PO Box 229

Redfern NSW 2016

Note: We accept Bankcard, Mastercard & VISA. However we cannot give quantity discounts on Credit Card purchases or account orders. Minimum for account orders is \$50.00. Minimum order is \$10.00 exclusive of postage and packing. All prices include Sales Tax.

ALL PRICES ARE FOR THIS MONTH ONLY OR UNTIL STOCKS ARE SOLD.

We wish all our customers, past, present and future a merry Xmas and Seasons Greetings.

Mail Charges:

\$5.00-\$9.99	\$3.50
\$10.00-\$24.99	\$4.50
\$25.00-\$49.99	\$6.50
\$50.00-\$99.99	\$8.00
\$100 or over	\$9.00

Large or overweight articles sent Skyroad Freight.

Trading Hours:

Mon-Fri	9am – 5.30pm
Thurs.	9am – 6.30pm
Sat.	9.30am – 1.00pm

RS232

This month, the communications 'standard'.

TWO MONTHS AGO, I introduced the ASCII code, which standardizes the numbers that computers use to represent particular characters. Although the computer world is not all that hot on standards — manufacturers tend to invent their own when they think they have a chance of crushing all opposition — the RS232 standard is still probably the most widespread method of connecting peripherals (other bits of equipment) to computers.

RS232 (or, to give it its full title, RS232C) sets out a method for getting eight-bit binary numbers — bytes — from one piece of equipment to another. Typically, a computer will have an RS232 socket which can be connected by a cable to an RS232 socket on a printer. Although the printer and computer might be from different manufacturers, the printer will still work with the computer thanks to the RS232 standard. Most of the time.

I added that last sentence because although the original RS232 document spelt everything out fairly well, that was in 1969, and a lot has happened to hardware since then. In those days, people were talking about mainframe computers, where all of the actual computing is done in a box with no screen attached, wired up to terminals — screens with no processing power — via RS232 links.

That's part of the problem. Another is the sheer age (in computer industry terms) of the RS232 document. Over the years, various groups have added to the *de facto* standard without adding to the written standard. Manufacturers have used some of the unused pins in the original standard for special signals from their own printers to their own computers, and some of those conventions have worked their way into everyone's conception of the standard.

In short, a lot of confusion exists over RS232.

However, it's not as bad as all that. You can still buy a printer and a computer and connect them together via an RS232 cable, and the combination will usually work.

RS232 communication is 'serial', which means that the information is sent down one signal wire only. This means that the eight bits that make up one byte have to be sent one at a time in sequence. An alternative arrangement is to use 'parallel' communications methods such as the Centronics printer connection standard, which is a bit like the computer's internal data bus which I dealt with in earlier articles. There are eight signal wires from the computer to the printer and the computer sends a byte at a time.

Both serial RS232 and parallel Centronics standards are widely used for computer/printer connection, and most computers and most printers have sockets for both. Although there is a general trend towards Centronics for printer connection, there are a number of other peripherals

which will probably always use RS232.

Connector

The physical layout of an RS232 connector is probably the best-kept part of the standard. It's in the form of a 'D-connector', which is a 25-pin plug a few cm across in the shape of a flattened letter 'D', with two rows of pins (see Figure 1).

This series is too short to cover the internal operation of RS232 in any great detail — that would take a mini-series all of its own. However, I will explain all of the important software-related parts, and leave you to look up the rest in one of the many technical books or articles already published, should you ever need to know any more about it.

Each bit of the data to be sent from the



Figure 1. An RS232 connector (the left-hand one) on the side of a computer. It's not as simple as it looks!

Phil Cohen

computer to the printer is represented on the signal line by either a 'high' voltage between +3 V and +12 V representing a '0', or a 'low' voltage between -3 V and -12 V representing a '1'. So by setting the signal line to +12 V and -12 V the computer can tell the printer that individual bits are either 1 or 0. Remember that (contrary to common sense) the *high* voltage represents 0 and the *low* voltage represents 1!

That's the essence of it — the rest of the complication is in making sure that the printer knows which bit the computer is talking about. Let's take as an example the computer sending the bits for a letter 'A'. Now in the ASCII code (see ETI October 86), the letter 'A' is represented by the number 65. The eight-bit binary code for 65 is 01000001, so this would appear on an oscilloscope as shown in Figure 2.

Notice that the least-significant bit is sent first (ie at the left of the diagram), and that 1s are represented by a *low* voltage.

RS232 communication is 'synchronous', which means simply that the timing of what happens is critical, and that both ends (ie, the computer and the printer) must know what part of the character is being sent at any given time.

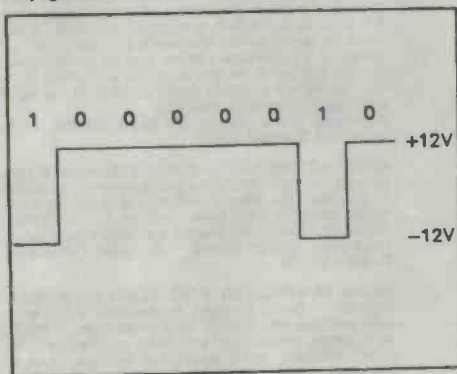

Figure 2. The letter 'A' sent through an RS232 cable, as it would be seen on an oscilloscope. Notice that the least-significant bit (a '1') is sent first.

Baud rates

So both ends have to be sending and expecting the same bit at the same time. This is achieved partly by the use of a number of standard 'baud rates', such as 300 baud, 600 baud, 1200 baud, and so on.

The 'baud' is defined as the sending and receiving of one bit of information each second, so that 300 baud means sending 300 bits per second. Now, there is a subtle difference between bits per second and baud, but we will ignore it for the time being.

At a speed of 300 baud, each bit of the data is sent in 1/300th of a second, so that to send a complete character of 8 bits takes around 8/300 of a second.

With the baud rate set, both the computer and the printer know when each bit of the character is being sent. But then there's the problem of starting the sending and receiving at the same time, and of allowing for minor variations in the measurement of speed at both ends.

When sending a long document, it is quite possible for the printer to get out of step with the computer. Even a very small speed difference will cause problems.

So some more bits are usually added to the data. These are known as the 'stop bits', and there are usually one or two of them. The stop bits are normally always '1', and they allow the printer to work out when it's out of step with the computer and take appropriate action. If when it expects one of the stop bits, it sees a '0', it knows something's wrong.

Another little complication is called 'parity'. This is a second way of checking that everything's working OK. In sending information, it is always very important to know when the message you received is incorrect, even if you don't know what the correct message was — it can always be sent again.

Parity means that the number of 1s sent is always either an odd number ('odd parity') or an even number ('even parity'). This is achieved by adding yet another bit to the data, called the 'parity bit', which is either 1 or 0 to make the total count of 1s up to either an even or an odd number.

Now, you may think that all of this — either one or two stop bits, sometimes even parity, sometimes odd, sometimes none, different baud rates — is confusing and doesn't look like a standard at all. You are quite right.

Although when you plug your computer into a new printer it almost always works first time, sometimes it does not. More often, when you try to use RS232 to let a computer communicate with another computer, things get *very* sticky indeed. Using a computer to communicate over the 'phone (which uses a variation on the RS232

theme) is just as complicated.

Moral

The moral of the story is that if you want to buy a computer to do something which involves the non-standard use of RS232 (ie, for other than simple connection of a printer), get the supplier to do all the hard work of setting the machine(s) up. Don't buy until you've seen your device working!

By comparison, the Centronics standard of parallel communication is much simpler. In essence, the computer sets the eight data lines to high or low voltages, corresponding to the pattern of bits in the character to be sent, then it sends a pulse down another wire, and the printer recognizes the character and prints it. It works faster than RS232 and works more often!

Glossary

- Baud:** a data transmission rate of one bit per second.
- Baud rate:** the number of baud that a particular communication path is set up for.
- Binary:** using 1s and 0s alone to represent numbers.
- Bit:** Binary digit, one digit which is either 1 or 0.
- Centronics:** a printer manufacturer whose printer communication method has become a *de facto* standard.
- D-connector:** the type of plug/socket commonly used for RS232 connections, with 25 pins and a shell in the shape of a flattened letter 'D'.
- Even parity:** see 'parity'.
- Least-significant bit:** the right-most digit in a binary number.
- Odd parity:** see 'parity'.
- Parallel:** using more than one signal wire for the same character at the same time.
- Parity:** a system of checking that the received character has no errors, by adding a bit (called the 'parity bit') which is either 1 or 0 to make up the number of 1s in the character to an odd number ('odd parity') or an even number ('even parity').
- Parity bit:** see 'parity'.
- Peripheral:** a piece of equipment which is to be connected to a computer.
- RS232C:** a standard for serial communications.
- Serial:** using only one signal wire for sending information.
- Stop bit(s):** a bit or bits added to the end of a character being sent using serial communications. The stop bit is of known state (either 1 or 0 all the time), and allows the receiving equipment to make sure it is in step.
- Synchronous:** relying on both the sender and receiver being precisely in step to get the message across. ●

Electronics Today

INTERNATIONAL

MINI MATRIX BOARD PROJECTS

This selection of 20 useful projects to build is an excellent introduction to constructing electronic projects. Those without any experience in electronics will find it easy to read and simple to follow. (Usually \$6.75) 102pp.

D0062B

\$2.00

EASY-TO-UNDERSTAND GUIDE TO HOME COMPUTERS

Confused by all those computer terms? This clearly written book from the editors of Consumer Guide tells exactly what computers are, how they work and why they are so amazingly useful, all in plain English. Here is all of the information needed to understand and use computers, and even to start programming. A special buying section compares the most popular home computers. This book is your ticket to the computer age! Spiral bound, 96pp.

H0066G

\$8.50

AN INTRODUCTION TO MSX BASIC

For those wanting to learn to program, Microsoft Extended (MSX) Basic offers a powerful and flexible version of the most popular computing language. This comprehensive introduction starts with the basics and progresses by stages to the more advanced programming techniques and includes coverage of advanced multicolour, sprite graphics, and the programmable sound generator. 88pp.

K0047B

\$6.95

SPOTLIGHT ON COMPUTER AWARENESS

An introduction of speaking confidently about how computers work, their applications, their history (from abacus to IBM) and employment prospects in computer related fields. Includes a comprehensive glossary. 84pp.

H0145P

\$6.95

ALMOST EVERYBODY'S PERSONAL COMPUTER BOOK

Written for the computing beginner to break the enormous barrier of jargon and mystique that seems to surround computers. With a highly readable approach, the author introduces the basic concepts and develops them into a general discussion on personal computers including choosing and caring for a PC. Also offers an introduction to BASIC programming. 160pp.

H0144Z

\$8.95

THE ART OF PROGRAMMING THE 1K ZX-81

The features of the ZX-81 are explained in some detail as background to programming. These include the random number generator, graphics facilities and timer. PEEK and POKE are also explained. The well-written section on programming should make anyone with a 1K ZX-81 a whiz! (Usually \$6.75). 86pp.

K0226B

\$2.00



THE USER'S GUIDE TO COMMODORE 64 & VIC 20

The editors of Consumer Guide have compiled a thorough introduction to the Commodore 64 and Vic 20 computers, software and peripherals. With colour illustrations and a clearly written text, this reference will guide the newcomer through all phases of learning how to use the computer: From setting the system up, learning what each key does, expanding the system with peripherals, to buying new software. Specific exercises are included for each of the keys. Spiral bound, 80pp.

H0065G

\$8.50

THE BEST VIC/COMMODORE SOFTWARE

Trying to find the most suitable software for personal computers can be frustrating. The editors of Consumer Guide have compiled comprehensive reviews of VIC 20 and Commodore 64 programs based on ratings by user groups; further evaluation is given by the editors and Commodore software experts Jim and Ellen Strasma. Each review describes the program's purpose and features, detailing both the good points and bad. Each program has been rated for ease of use, clarity of written and on-screen instructions, and overall performance. The program's price, publisher, format and hardware requirements are also included. The reviews are presented in sets by topic: Word Processing, Business, Home, Education, Networking, Strategy Games, Arcade Games and Programming Aids. Spiral bound, 192pp.

K0052G

\$8.50

THE BEST APPLE SOFTWARE

Trying to find the most suitable software for personal computers can be frustrating. The editors of Consumer Guide have compiled comprehensive reviews. Guide have compiled comprehensive reviews of Apple II, II Plus and IIE programs based on ratings by user groups; further evaluation is given by the editors and Apple software expert Roe Adams. Each review describes the program's purpose and features, detailing both the good points and bad. Each program has been rated for ease of use, clarity of written and on-screen instructions, and overall performance. The program's price, publisher, format and hardware requirements are also included. The reviews are presented in sets by topic: Word Processing, Business, Home, Education, Networking, Strategy Games, Arcade Games and Programming Aids. Spiral bound, 160pp.

K0060G

\$8.50

LOOK! NEW TITLES:

BASIC ELECTRICITY AND DC CIRCUITS — Oilva & Dale. A step by step approach for the beginning student. Starts with first concepts and terms, and covers basic mathematics (required in the study of basic electricity and direct current circuits. Ideal for self-paced, individual learning. Hardcover, 240 x 185mm, 924 pages. Illustrated. EA0001 \$29.95

FUNDAMENTALS OF MICROCOMPUTER DESIGN — Don L. Cannon. This book teaches the basic concepts of microcomputers in a way that can be used in a variety of ways by technical engineers, computer scientists, programmers and technicians to acquire a thorough understanding of the very heart of system design, software and hardware. Softbound, 230 x 165mm, 584 pages. EA 002 \$33.95

VIDEO FILM MAKING — Keith Brookes. This book describes in clear, jargon-free language, what video film making equipment is currently available. It advises the newcomer on the selection of the outfit best suited to his individual needs. It gives practical step by step instruction on how to set about making films, ranging from the simple family record, to the most complex, fully edited production. Softbound, 245 x 185mm, 176 pages. Photos, line illustrations. EA0003 \$29.95

BASIC AC CIRCUITS — Fulton & Rawlins. A step by step approach for the beginning student, technician or engineer. The easy to understand format includes, stated learning objectives, worked out examples, practice problems and quizzes to measure progress. Hardcover, 240 x 190mm, 560 pages. Illustrated. EA0004 \$35.95

RADIO CONTROLLED FAST ELECTRIC POWER BOATS — David Wooley. A complete and essentially practical reference to all aspects of the subject: hulls, props, construction and fitting out, motors, batteries, trimming, radio installation and the controls you need, battery charges and battery charging. This book will appeal to the expert as well as the beginner. Softbound, 210 x 148mm, 112 pages, over 80 photos, drawings, circuits, tables, etc. EA0005 \$14.50

ELECTRONIC INDIA

Thomas E. King VK2ATJ

There's more industry to India than films! Electronics is booming and communications is a passion. It's even true to say that in India the DXer reigns!

WHEN 'freedom at midnight' came to India on 15 August 1947, news of the country's independence from England came via newspapers which had been printed on imported British presses and radios built in British factories. Today, many of the same people who witnessed the historic event can read newspapers which were printed by modern offset machines of Indian design and manufacture, listen to stylish Indian-

built transistor radios or watch transmissions beamed through indigenously conceived and constructed satellites to locally manufactured television receivers scattered across the vast subcontinent of India. And if a family doesn't happen to be home for a particular telecast they can record it on one of the different models of video cassette recorders currently being built in India.



India's best known ham family, Mangala, VU2DZM, Banu, VU2DZY, and Indira, VU2DZZ is headed by Mall VU2DZ, President of the Federation of Amateur Radio Societies of India.

Transforming itself from an almost totally dependent country to a totally self-sufficient nation in just under 40 years is no ordinary feat, but then India is no ordinary country!

In 1947 the industrial core of the fledgling country was the steel and tea industries, the cotton mills, and minerals and mining. Today Indian enterprises in the private and public sector design and engineer complex industrial projects in diverse fields covering special steels and superalloys, nuclear fuels, non-ferrous metals, fertilizers and chemicals, power plants and transmission lines, heavy machinery, railways, dams, roads and bridges. India manufactures ships, automobiles, locomotives, jet planes, machine tools, power generators and transmission lines, tractors, trucks, turbines, boilers, high precision ball bearings, heavy electrical plants, centrifugal pumps, gas cylinders, drilling equipment, gears and gearboxes, construction equipment and industrial cooling towers. In 1986 India possesses expertise, experience and manufacturing capabilities comparable with some of the most advanced countries in the world.

India's accelerated pace of industrial development has been accompanied by a corresponding growth in technological and managerial skills needed for operating complex industrial enterprises. Today there are nearly 1000 research and development institutions in the country which employ over a million persons. In addition, there are the India-wide technical institutes for the training of engineers, supervisors and craftsmen. Such facilities have created the third largest reservoir of scientific and technical manpower in the world (after the USA and USSR). About 160,000 qualified scientific and technical personnel each year enter such areas as crystallography, biotechnology, meteorology and electronics.

Electronics

India's electronics industry has continued to receive considerable interest from Prime Minister Rajiv Gandhi since he assumed office in October 1984. The youthful and progressive head of State of the world's second most populous, seventh largest and ninth most industrialized country feels that development of the electronics industry is "critical for India's growth".

The production of electronics in India

has increased fivefold over the decade between 1974/75 and 1984/85. But this growth seems small when compared to the increase planned for the next five years! A production target (excluding export production) of Rs 100,000 million or around \$A13,000 million has been set for the end of the seventh Five Year Plan in 1990. (The output of the electronics industry in 1984/85 was about \$A2,577 million.)

To achieve such unprecedented growth the government has adopted a number of stimulatory measures, some of them quite radical. They include:

- liberalization of the licensing policy relating to electronic components with the issue of 'broad band' licences to cover a multitude of items from colour TVs and tape recorders to electronic toys and electronic test and measuring instruments;
- a computer policy which allows manufacture of mini and microcomputers by any Indian company;
- free access to technology;
- the establishment of electronics industries in any of a number of permissible locations.

As well, a greater emphasis is being placed on the role of the Indian Investment Centres in attracting foreign private investment in India. (This Indian Government organization is a service agency assisting in the establishment of joint ventures in India and abroad, technical collaborations and third country ventures between Indian and foreign entrepreneurs.)

A regional office in Singapore (directed by Mrs S.B. Barwa, 138 Robinson Road, Hong Leong Centre, 16th floor, Singapore 0106) has been recently set up to cater to the potentially large number of entrepreneurs from South East Asia, as well as expected investors from Australia. No minimum investment is required so it's anticipated that even individuals with a small capital reserve will be interested in investing in the electronic future of India.

To date only a few Australian companies have decided on ventures in India, but a package of incentives including cash, tax breaks, a 25 per cent investment allowance and concessional rates of duty for new materials starting at 15 per cent (as compared to normal duty of 150 per cent!) has been designed to lure Australian money.

Radio

As India's technical and manufacturing abilities become more sophisticated, so too does the country's 3000-strong amateur radio community. VU2RJI, Ranjiv, for instance, was the first AMTOR operator in the country when his 'amateur teletype over radio' signals began from Madras. Equally impressive is the modern set-up of VU2RX, Vasant and VU2XYL, Usha who



Usha, VU2XYL, a keen supporter of amateur radio activities in Bombay is as active in the air as she is on the air!

are among the most active amateurs in Bombay. And then, of course, there's the extensive radio room of the Gandhi family operated by Priyanka, VU2PRG, Sonia, VU2SON, and Rajiv, VU2RG. Both the Prime Minister and his wife, who have been licensed since 1975, are occasionally active on Sundays from their #7 Race Course Road, New Delhi home.

While the very latest ICOM, Kenwood and Yaesu amateur radio equipment features in a slowly increasing number of Indian amateur stations, the vast majority of amateurs in the country either have home brew shortwave stations or possess no equipment at all. With current equipment costs in India amounting to some Rs 15,000 (or about \$A1950) including air freight from Japan, and with the average 'middle class' income around Rs 1500 to 2500 a month, it's easy to understand why commercial equipment is simply not affordable. (Despite this, the number of amateurs in India is much greater than in all of her neighbours combined, the total ham population in Burma, Bangladesh, Bhutan, the Maldives, Nepal, Pakistan and Sri

Inspecting the latest Indian-built fighter bomber, the MIG-27, is Prime Minister Rajiv Gandhi who as VU2RG is one of the world's most technologically minded heads of State.



Lanka is less than 200 enthusiasts.)

The majority of amateurs who don't have their own equipment have joined radio clubs. Currently there are some 60 clubs ranging from tiny groups with a handful of members such as the club in Goa to several clubs with 80 to 100 enthusiasts as in Bombay or Delhi. One of the largest clubs in India is the massive Madras Amateur Radio Society with its 400 plus members, half of whom are licensed amateurs.

Amateurs in Madras like all other short-wave hobbyists in the country have undergone training either through club classes or by home study and then examination at one of the 19 monitoring stations of the Wireless Planning and Co-ordination Wing of the Ministry of Communications. Exams for the three different types of amateur radio licence are held monthly in Delhi, Bombay, Calcutta and Madras and four to six times a year at the smaller regional wireless monitoring stations.

The theory portion of the essay/multiple choice type of exam consists of questions from general radio theory, international and Indian regulations and operating procedures. A pass of 60 per cent and a Morse code speed of 12 words per minute is required for the Advanced Amateur Licence. Fifty per cent and 12 wpm is required for the Grade 1 Licence and 50 per cent and 5 wpm for the novice-like Grade 2 Licence.

Even if the Morse test is failed on this exam, an individual can apply for a Grade 2 Restricted Licence which permits voice-only use and a maximum of 5 watts on 144 MHz.

Two metres

The 144-146 MHz (2 metre band) is becoming increasingly popular particularly in New Delhi (where one repeater is operational), Madras with its 30 or so hams on the band and Bombay where 145.5 MHz is a popular simplex frequency for the city's estimated seventy 2 metre users. (During unusual band conditions in Bombay's hot summer season it's not uncommon for low power 2 metre stations to span the Arabian Gulf and contact other VHF hams in Muscat and Dubai.)

Part of the reason for the surge of interest in 2 metres in major centres has been a rise in urban income which has allowed purchase of hand-held VHF units (at a cost of around \$300). Another reason for the band's popularity is equipment portability, for mobility is the key during times of need.

Indian hams have been frequently called upon to provide relief communications. Several years ago a field team of VU2 volunteers operated battery and generator powered equipment to link flood-stricken Morvi, Gujarat with Rajkot, Ahmedabad, Baroda and Bombay.

More recently a veteran pilot (VU2AID) and 11 other amateurs played a major role



Under simulated emergency conditions the Bangalore Amateur Radio Club earlier this year conducted a week long field exhibition to demonstrate amateur radio activities to scouts at the World Scout Jamboree.

during the Bhopal disaster in 1984. Setting up eight stations to aid the civil authorities in relief work, the party handled official messages as well as welfare queries from parents, relatives and friends.

Emergencies don't always involve so many people or grab so many global headlines, however. Such was the case in late June when VU2VSN, Subramanyam in Bellary and VU2RBI, Bharathi in Hyderabad were tuning their receivers across the 7 MHz, 40 metre band and heard a faint distress call transmitted from the ship "Yathi" in the Andaman Sea off Port Blair. Radio operator HP3YM/MM, Bruce was seeking help. Co-ordinating communication activities, Bharathi contacted the State Chief Secretary, the Relief Commission and other officials including monitoring stations of the Ministry of Communications. A communications network comprising other amateur stations was established and maintained until the vessel was located and secured by naval authorities.

Amateur bodies

ARSI is the internationally recognized body which liaises with the Geneva-based International Amateur Radio Union. It operates a QSL Bureau, holds second Sunday of the month get-togethers at its Delhi Flying Club headquarters, and maintains a training program. But with about 400 members it is the smallest of the three national organizations.

In March 1985 the National Institute of Amateur Radio in Hyderabad received the first instalment of an approximate \$1.2 million grant in aid for the development of all aspects of amateur radio in India. Headquartered in Hyderabad in the cyclone-prone State of Andhra Pradesh, the NIAR has been responsible for the training of over 500 amateurs, many of whom have in turn provided relief communications during disasters which strike the State's lengthy coastline. A program to train teachers who conduct amateur radio courses has been implemented by the NIAR which

currently has about 1000 members. The NIAR has a small number of paid staff (the only amateur radio organization in the country with paid staff) who conduct classes, organize seminars and displays and produce amateur-related publications.

With some 2000 members across India and about 60 affiliated clubs, the Federation of Amateur Radio Societies of India is the largest hobby radio association in the country. FARSIS members receive the country's only amateur magazine which for many years has been voluntarily edited by businessman Chauhan, VU2MV. They have government representation on issues ranging from duty concessions and mobile licences and use of another QSL bureau. Through affiliated clubs they have access to educational material including locally produced Morse code cassettes and an introductory book to amateur radio.

Headed by FARSIS President, Mali, VU2DZ, the 20 year old organization hopes to achieve several goals over the next few years: the setting up of a nationwide microwave link for an emergency communication network using existing microwave and TV towers; faster issue of licences; the introduction of amateur radio in the educational curriculum; the manufacture of an all-band, all-mode HF Indian transceiver for around Rs 3000 and a single band SSB/CW transceiver for around Rs 100 by one of the State-owned electronic agencies.

Malsi also feels that India's increasing technical sophistication can further assist the amateur community. "The piggy back launch of an amateur-built satellite positioned over the subcontinent," said the energetic amateur from Madras, "would not only provide reliable communications from the Middle East to Singapore using portable and low powered equipment but it would demonstrate to the electronics, communications and ham world that India is already willing and able to accept the challenges and promises of the 21st century".

Compact discs and spacious sound from Bose®

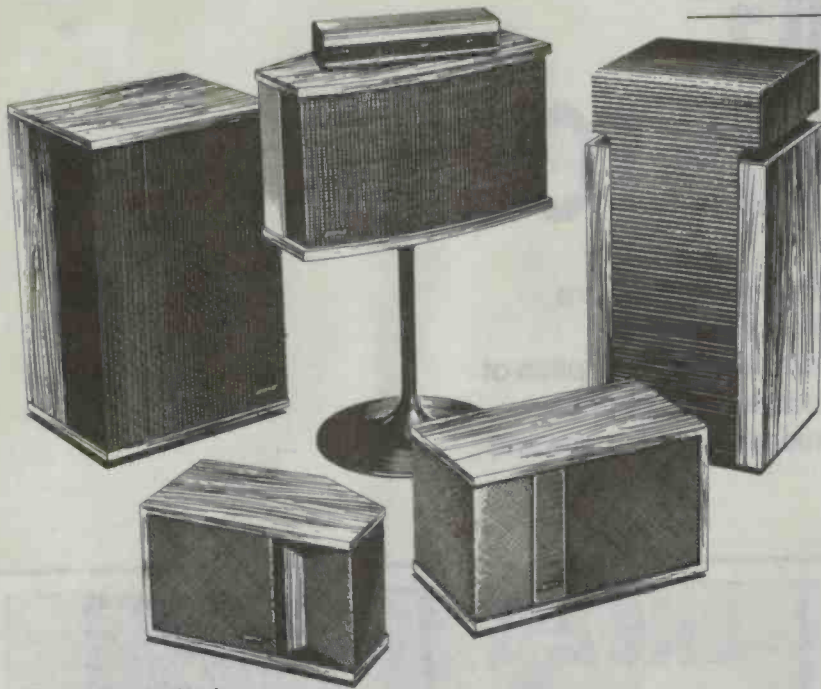

You've seen all the claims about compact discs, now it's time to put them to the test. Go into your local Bose dealer and listen to a compact disc played through a Bose Direct/Reflecting® Speaker System. Only Bose speakers produce a combination of reflected and direct sound, similar to what you hear at a live concert. They create an imaginary concert stage which recreates the spacious, lifelike performance captured by these new compact discs. So go into your local Bose dealer, and judge for yourself. Reading may be believing, but listening is proof.

BOSE®
Better sound through research.

Bose Australia Inc.
11 Muriel Ave., Rydalmere N.S.W. 2116 Tel: (02) 684 1022

January 1986 Electronics Today INTERNATIONAL Yearbook

Special
Compendium
Issue

The January edition of ETI will be a yearbook containing over 160 pages to entertain and inform the electronics community. It will be divided into 11 chapters on subjects of importance in electronics including CAD; components; semiconductors; technology; fibre optics; instruments; satellites; data communications; computer software; pcb shops; rf reviews; hi-fi; plus listings of ETI kits and who stocks them.

This year book will be your guide to what's happening in your field of electronics and will provide handy lists of suppliers.

AUSTRALIA'S DYNAMIC ELECTRONICS MONTHLY!

SIGNALLING AFRICAN HISTORY

Throughout the 1960s maps of the African continent were redrawn and relabelled. The shaking off of colonial rule engendered a spirit of native nationalism seen in the adoption of African language names for the newly independent countries. Verification cards from the period document these changes and make good historical references.

Arthur Cushen

IT SEEMS THE philosophy of most newly independent countries is to make their views known to the world by installing a powerful shortwave service. Or so it seems in Africa where almost all the new states operate on shortwave. Newcomers such as The Ivory Coast, Uganda and Gabon have an international service, while the so-called regional stations for internal reception offer the shortwave listener the chance to hear many new countries.

In volatile Africa new countries have appeared, some have been absorbed, while others have changed their names, all in the recent past. Gone are countries such as Belgium Congo, Abyssinia, Northern Rhodesia, Nyasaland, Bechuanaland and the like.

Algiers, the site of operations of the Voice of America in 1945, later became known as Algeria, while Portuguese Angola disappeared on 11 November 1975 to be replaced by the People's Republic of Angola. Abyssinia, now Ethiopia, was first noted in 1958 as the Voice Ethiopia, and then heard widely when ETLF operated from the area until the station was nationalized in 1974.

The Belgium Congo (which eventually became Zaire) was the centre of much radio activity during the war. OTC operated during the 1940s, then Radio Congo Belge to 29 June 1960, when the country gained independence. Leopoldville, the capital, became Kinshasa and during the early 1960s after the revolt in Katanga a new breakaway country could be heard.

Bechuanaland, famous for its station at Mafeking on 5900 kHz using 200 watts,



Verification cards from Angola trace the days of private radio stations in the 1940s when they were operated mainly by Radio Clubs.

became Botswana in 1966. Basutoland, another small country in Southern Africa, was renamed Lesotho in October, 1966.

Across the Congo River from Belgium Congo was the French territory and site of General De Gaulle Free French Radio at Brazzaville. In a verification letter from the station it was reported that General De Gaulle selected two professional newspapermen and ordered them to create Radio Brazzaville Broadcasting Station. Brazzaville commenced operation on 5 December 1940 as Free French Radio, and operated on 11970 kHz with 5 kW. On 27 November 1958 the station became Congo People's Republic.

The Cameroons previously under British rule changed on 11 February 1961 to the United Republic of Cameroons. The French province, Dahomey, too emerged a new country and has been known as Benin since 30 November 1975, while the former French Somaliland became Affairs and Issas and then, on 26 June 1977, Djibouti.

Britain's interest in Egypt is well known and many broadcasting stations operated in the area during World War II. Stations such as SUX operated by the Psychological Warfare Branch in 1945 were frequently heard. SUX later moved to Palestine as JCKW near Jerusalem, while another station JCJC, whose location could not be disclosed according to a verification card in 1944, used 7840 kHz.

Gold Coast was frequently heard after its initial broadcast, and our verification from Accra was received in 1941 when the station carried Free French broadcasts. By 1948 the station had the call ZOY on 4915 kHz. The country's new name, Ghana, was first used from 5 March 1957.

Kenya is one country that has retained its British name. Broadcasts from Nairobi were operated by Cable & Wireless Ltd on station VQ7LO. A 1940 verification confirms reception with this call sign. Today stations are operated by a government agency, under the slogan "Voice of Kenya".

Libya operated several Forces stations for the British Army and, in fact, a verification in July 1953 stated "...your reception [which] causes no end of stir on the station here. It is now mentioned casually in all our bar conversation...". These broadcasts originated from Tripoli, and used 250 W on 4780 kHz. Today the country is known as Libyan Arab Jamahiriya.

Morocco, once a French colony, also included the International Zone of Tangiers, the site of many commercial stations until 29 October 1956 when it was incorporated into Morocco. Later Morocco incorporated Spanish Morocco.

Malawi came into existence in 1964 when the Broadcasting Corporation was formed from the old Federal Broadcasting Corporation then part of Northern Rhodesia.

Madagascar in 1968 changed its name to Malagasy Republic but reverted to its original name in December 1975.

Nigeria was heard operating an experimental station under British Colonial rule in 1950 with a power of 300 W. Later it became the Federal Republic of Nigeria.

Rhodesia at first retained its colonial name even after Northern Rhodesia and Nyasaland adopted their new names, but in 1979 Rhodesia changed to Zimbabwe. Until 30 June 1962 Rwanda-Urundi was a united country but now both parties are independent countries. South West Africa has become Namibia.

The three Somalilands have had interesting changes of government. French Somaliland is now Djibouti, while British Somaliland and Italian Somaliland became the Democratic Republic of Somalia on 30 June 1960. Hargeisa Radio (British Somaliland), heard in 1947, first opened in 1942 at Harar, Abyssinia and later increased power from 200 W to 600 W. On being taken over by the Government, power was increased to 1000 W. Italian Somaliland, broadcasting from the capital Mogadishu, was heard in 1952 on 7420 kHz with 300 W, and now both stations are incorporated under the Somalia broadcasting organization.

Tanganyika later became Tanzania when that country and the Island of Zanzibar were united to form Tanzania on 25 April 1964. At the extreme southern tip, the Union of South Africa became the Republic of South Africa on 30 May 1961.

This information has been collated from verification cards and letters confirming reception from stations over this period. In itself this forms an excellent picture of the changing pattern of history in Africa. It shows how essential documents such as these can be in preserving the radio history of broadcasting in Africa. The coverage of countries is by no means complete but it includes those which are heard widely and present an interesting change in the political history and growth of the dark continent.

Other minor changes

When we look at the rest of the world we find around Asia the map has changed. Gone are French Indo-China, Goa, Manchukuo, Chosen, Palestine, Persia and many more names.

Our near neighbours in the Pacific have changed, with the New Hebrides, Gilbert and Ellice Islands, Formosa, Dutch East Indies changing their names or becoming independent in the past 40 years. The Philippines' change of status meant that call sign changes were made from KZRM to DZRM, losing the American prefixes.

In the Americas things have been more stable, although Dutch and British Guiana have changed names. Change of govern-



Panama is a country no longer operating on shortwave but in the late 1930s it had many relays of mediumwave stations on shortwave.

ment has often put a new emphasis on shortwave broadcasting. In the 1930s almost all stations in Latin America were privately owned and operated. Fifty years ago Panama had many shortwave stations; today there are none. Cuba had many commercial stations, but since the Castro regime they have all been nationalized. Throughout South America, government-operated Radio Nacional stations have appeared in Brazil, Chile, Ecuador, Peru, Columbia, Venezuela and Paraguay. There have been many changes in the Caribbean as colonies have gained independence but this mainly affects mediumwave broadcasting.

Archives material of things that happened over the past 60 years is now being collected. Listeners are becoming aware of the value of retaining any historic material for deposit with a museum or Radio Archives Group for future use. ●

NEW PRODUCTS



Yamaha DSP-1

About 20 years ago, engineers at the British audio company QED claimed it was impossible to tell QED's amplifiers from those judged to be the best in the world. They carried out their test and proved their point.

The argument runs like this. For about the last 20 years, it has been possible to build amplifiers with vanishingly small amounts of distortion, say 0.001 or 0.002%. But the human ear can't hear distortion less than about 1%. So QED's argument was that if you can't hear the distortion, you can't hear any sound generated by the amplifier. So the amplifier doesn't contribute anything to the process. QED.

Of course, there are good systems and bad systems as we all know. But the things that 'colour' a hi-fi system are by and large the distortion in the pick-up and speakers (maybe several%), and peculiarities of individual rigs in terms of

maintains hum and so on.

Most modern amplifiers can be connected up with almost total disregard for hum problems. With the advent of the compact disc, distortion at the front end has disappeared. We are, in fact, approaching audio perfection, limited only by the imperfections of the speakers.

So where does hi-fi go from here? One possibility for the future was revealed at this year's summer Consumer Electronics Show (CES). It was the Yamaha DSP-1, a digital sound processor, and it has just been released in Australia.

As anyone knows, for reasons that have nothing to do with distortion, a hi-fi set

sounds different from the real thing. Why? The real thing has ambience, that is, the sound you hear in a concert hall is a function not only of the instrument and your ear, but also the surroundings in which you and the instrument are interacting.

Sound comes to you in a straight line; it also bounces off walls, the floor, carpets, the roof, the people around you, everything, in fact. Every reflection generates a different path to your ear; every one an echo of the original sound.

The sum total of all these echoes is ambience, a kind of smoothed out blur of jumbled frequencies your brain decodes as an instrument played in a specific type of room.

None of this happens when you listen to a hi-fi in your lounge room. That's the difference.

Now Yamaha has tried to

create a unit that will put ambience back in. Using its considerable VLSI design experience, it has integrated sufficient circuits to be able to ask the unit to take the pure input from a CD player, and add reflections to it.

The DSP-1 creates early reverberations of the floor 50-80 ms before the direct noise hits you. It decays it away in a sequence of multiple reflections. What's more it does this in 16 different patterns according to the most popular types of listening environments. As well, the unit possesses user control over room size, liveness, reverb time and so on.

The question, of course, is whether it works or is a gimmick. ETI will be running a review early in the new year to let you know, but preliminary hearing tests at Yamaha's place say it's the greatest thing since sliced bread. Look out for it.

New Beeb

Barson Computers has released the BBC Compact computer from the UK. Barson is hoping the Compact will emulate the success of the BBC model B, which has been widely used by education authorities in Australia and New Zealand.

Instead of going to 16-bit megachips, BBC has adopted a philosophy of tailoring the Compact to the audience it knows and understands. As a result, the BBC does not appear particularly well configured from a hardware point of view.

However, it comes with Logo, BASIC, a word processor, a spreadsheet, networking, music and colour graphics capacity built in. The company blurb sheet advises:

"the user will find everything he is ever likely to need right in the box".

Since Barson claims the Compact is 100% compatible with software written for its earlier products, it is expected that the huge educational software library that has been built up around BBC machines will be a major selling point.

The price of \$1332 includes 128K of RAM, a 640K 3.5 or 5.25 inch floppy drive, mouse, printer interface and all the software. Barson also says that a low cost version (\$970) is available for networking with the Econet interface, a locally designed product especially built to allow optimum use of earlier model Beebs in school LANs.



Scott Brownell of Barson: The BBC compact has it all.

Data logger

Data Electronics of Melbourne has sent us some publicity on its highly successful data logger called the Datataker.

According to the company, it's now in service in 18 countries. Included in the list of customers is the West German military, the Danish Atomic Energy Commission, the Swedish Bureau of Standards, General Motors, Volvo and NASA.

The Datataker is fully programmable with all its software in ROM. It has 24K of memory, 54 channels, both analogue and digital inputs and outputs, a real time clock, and the ability to do a reasonable amount of mathematical manipulation on the data before it's sent down the line. It can be used to average results, calculate polynomials or do thermocouple linearization.

Some of the applications include monitoring the temperature inside Telecom's ex-

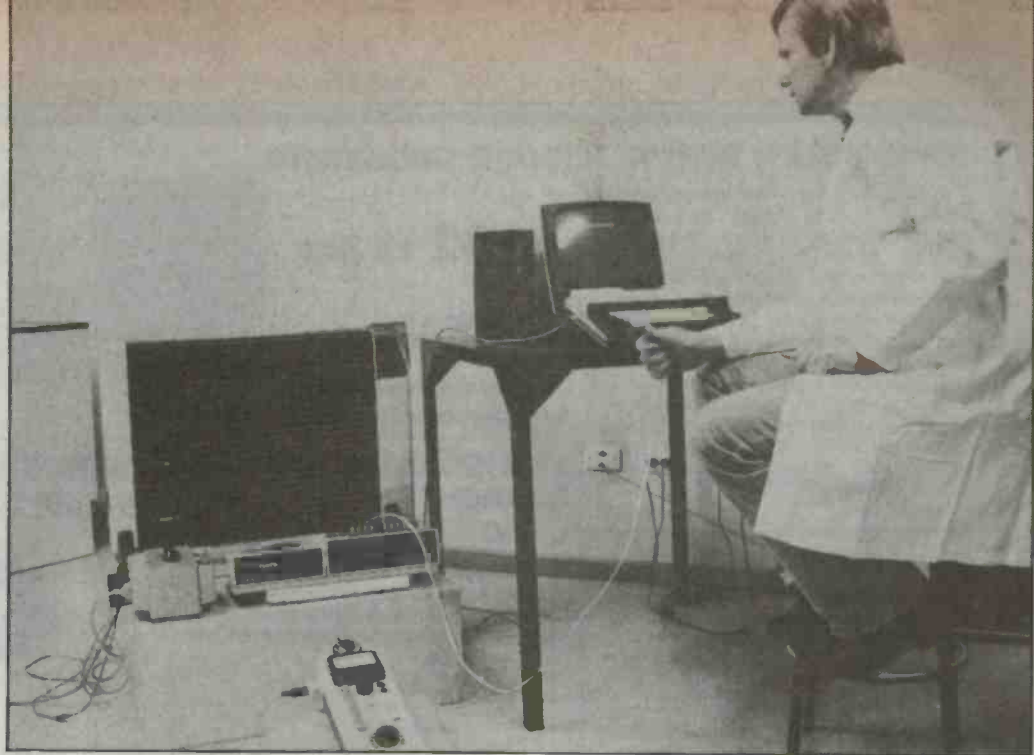

perimental passively cooled rural exchange buildings. The Datataker is used to measure the temperature of the thermocouples every two minutes, and compute a half hourly average. The contents of the datalogger is then downloaded to an IBM PC in

Melbourne headquarters every 10 days, where it is used to prepare a graph of the building's performance.

At the Subaru technical centre in the US, Datatakers are being used to test automotive exhaust components. The giant Kennecott mining

company is using 30 of them for monitoring environmental quality at mines in Utah and New Mexico. Vulcan Australia is using them as part of its prototype testing procedures.

For more information, contact Data Electric on (03) 222-3241

Laser disc moves

Pioneer continues as the only company significantly supporting video disc technology. It has released some new product in the form of the first 8-inch portable video disc player, and continues to support the disc in interactive training and entertainment uses.

The new product, hot out from the US, is the LDV3000. It is designed to play 8-inch NTSC standard discs and comes with a 100 Vac power source. Users will have to supply both a special NTSC set and transformer (available from Pioneer) until a local PAL version is generated.

The LDV3000 can be operated in three different ways. Level 1 uses a remote control unit to achieve normal function under the direct control of the operator. In Level 2 it can be controlled by a program actually on the disc. In this mode the player first reads the program on the disc and loads it into internal RAM. The unit then functions under the control of this program. Level

2 is the level at which the unit would function as a demonstration or training tool.

Level 3 is a more sophisticated version of level 2, in which the program is stored in a separate computer. The computer then uses a port on the back of the unit to talk to V3000. All the functions available on the remote control, as well as some specialist escape codes, are available from the port.

The advantage of level 3 is that the program may be made as long and as complex as required. Presumably in most operations where a high degree of user friendliness is required, the unit would operate as level 3.

The V3000 will sell for a surprisingly low \$1200 excluding tax.

Meanwhile Pioneer is also anxious to push some of the discs it has made itself to advertise the potential of video disc. The discs cover five fields of medical imaging: X-ray, nuclear, ultrasonic, endoscopic and nuclear

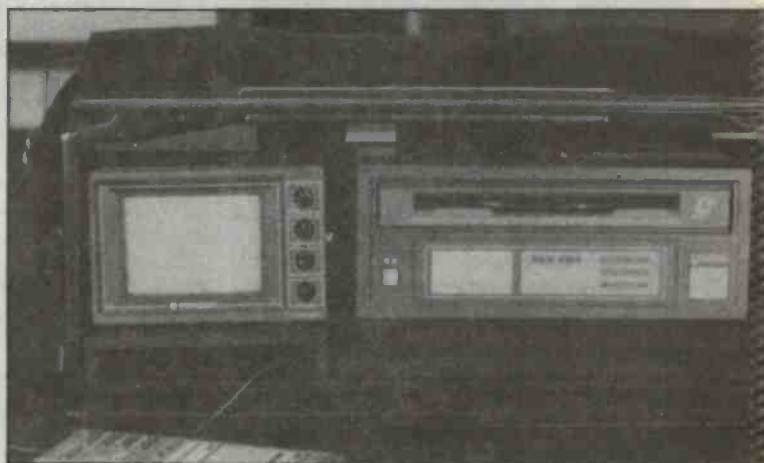

The Pioneer LD-V3000. A new small portable video disc player

magnetic resonance.

Computer systems used in the medical field have become important recorders of information. They typically record all kinds of symptoms of the various diseases. With the Laserdisc this can be turned into a visual data base as well, so that doctors can see what various conditions look like.

Another use being pushed by Pioneer is in computer literacy. Advanced Systems of Australia, a Sydney-based firm, has just started using video disc to train its staff in the use of computer mainframes.

Enquiries to Graham Ham on (03) 580-9911 about the V3000 or any of the other developments in Laserdisc.

WOOD FOR CHIPS ... WOOD FOR CHIPS ... WOOD FOR CHIPS ... WOOD FOR CHIPS ... WOOD FOR CHIPS ... WOOD FOR CHIPS ... WOOD FOR CHIPS ... WOOD FOR CHIPS ...

WOOD FOR CHIPS ... WOOD FOR CHIPS ... WOOD FOR CHIPS ... WOOD FOR CHIPS ... WOOD FOR CHIPS ... WOOD FOR CHIPS ... WOOD FOR CHIPS ... WOOD FOR CHIPS ...

20MHz SCOPE WITH ALTERNATE TRIGGERING

The GOS-522 is an ideal general purpose scope which we've selected because of its excellent triggering functions. Two channels with big 150mm (6") screen and internal graticule. Fast 20ns/div sweep speed for high precision. Features alternate triggering mode to ensure stable display of both channels - saves a lot of knob twiddling!! Trigger circuit is dc coupled too for low frequency signals. Trigger level lock and variable hold-off all add to ease of use. Auto, normal and single shot sweep modes. Call in for a demo, you will be delighted with the performance and the price - GOS-522 \$855 inc tax (\$732 ex tax) and that includes FREE PROBES and a 12 month warranty.

\$ 732 EX TAX
\$ 855 inc tax

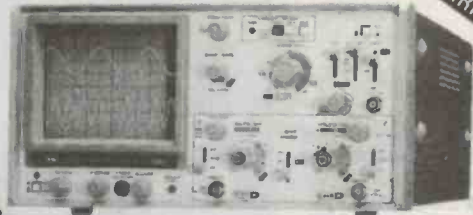

12 MONTH WARRANTY

Compact and easy to operate for hobbyists and professionals

CHECK TRANSISTORS, CAPACITORS AND CURRENT TO 10A

One multimeter does the lot - Vdc from 200mV to 1000V, Vac from 200mV to 750V, Adc from 200uA to 10A, Aac from 20mA to 10A, Ohms from 200ohm to 20Megs, Diodes, Continuity beeper, Capacitance from 2nF to 20uF. Plus measure hFE for PNP and NPN transistors from 0 to 1000. Single rotary dial for unambiguous range selection. Auto-polarity 3 1/2 digit display. Bright yellow case so you won't lose it! EDM1111A \$118.88 inc. tax (\$103.03 ex tax).



HANDY POCKET MULTIMETER

Measures only 126mm x 70mm x 24mm yet incorporates full 3 1/2 digit multimeter including a continuity buzzer. Single rotary switch for fast convenient operation. Checks diodes too. Measures Vdc from 200mV to 1000V, Vac 200 and 750V, Adc from 200uA to 2A, Ohms from 200ohm to 2Meg. Special 1.5V battery test range with 1mV resolution and a continuity range which beeps when resistance is below 100ohm. Bright yellow case so you can't mislay it!! EDM-70B \$64.40 inc. tax (\$55.52 ex tax).

ADJUSTABLE VOLTAGE & CURRENT REGULATOR L200C

Handles output currents up to 2A and voltages in the range 32V down to 2.85V. Thermal overload and short circuit protected. Input over-voltage protected to 60V. Only \$3.50.

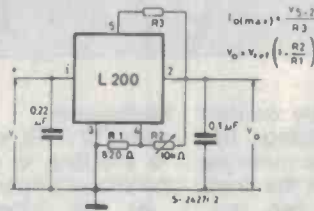

Programmable voltage regulator with current limiting

OPEN FRAME LOW PROFILE IC SOCKETS

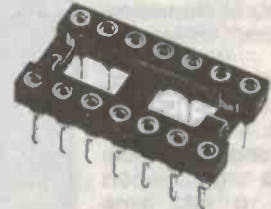

Highest quality glass filled polyester with MACHINED contacts. Four finger GOLD PLATED contact. Terminals are tin plated for easy soldering. Open frame ensures good cooling, easy cleaning and checking. Available in 8 to 40 pin configurations. 8 pin 56¢, 14 pin 98¢, 16 pin \$1.12, 18 pin \$1.26, 20 pin \$1.40, 24 pin \$1.68, 28 pin \$1.96, 40 pin \$2.80.

FUNNEL ENTRY FEATURE

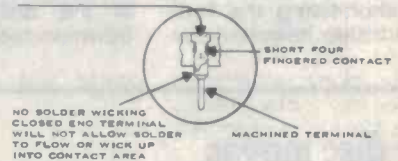

SINGLE IN-LINE SOCKETS & ADAPTORS



SIP sockets feature four finger GOLD PLATED beryllium copper contacts with tin plated brass terminals. 20 pin strip can be easily snapped apart to form shorter lengths. Maintains spacing when mounted end to end or end to side. Socket Strip \$2.00 Adaptor Strip \$2.50

TALK TO GEOFF ABOUT YOUR INSTRUMENT NEEDS

5V POWERED DUAL RS232 TRANSMITTER/RECEIVER MAX232

Yes it meets all RS232C specs but only needs a 5V supply because it has built-in converters for the +10V and -10V power supplies. Can also be used as a voltage quadrupler for input voltages up to 5.5V.

Also contains 2 drivers and receivers. Uses low power CMOS. Handles 30V input levels and provides a +9V output swing. Ideal for battery powered systems. \$12.96

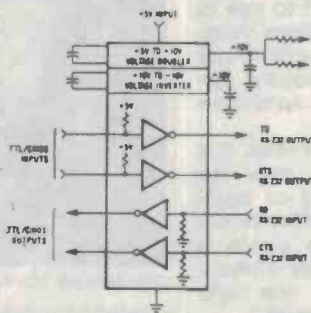

8.30 to 5 Monday to Friday, 8.30 to 12 Sat. Mail Orders add \$5.00 to cover postal charges.

All prices INCLUDE sales tax.

Tax exemption certificates accepted if line value exceeds \$10.00.

BANKCARD, MASTERCARD, VISA, CHEQUES

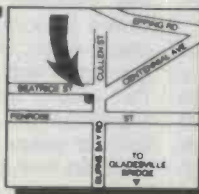

GEOFF WOOD ELECTRONICS P/L (02) 427 1676

229 BURNS BAY RD. TWX 71996
(CORNER BEATRICE ST.) P.O. BOX 671
LANE COVE WEST N.S.W. LANE COVE N.S.W. 2066

OR CASH CHEERFULLY ACCEPTED

specialising in electronic components for the professional and hobbyist.

JRC releases

JRC has released a number of new products in Australia through its agents Associated Calibration Laboratories. They include a counter, a graphics terminal, and RF power meter and a photo printer.

The Model NJL-900 is a microprocessor controlled frequency counter. It has 12 digits and measures frequencies from 10 Hz through to 18 GHz. Not only will it do frequency measurement, it also displays parts per million and generates a marker frequency anywhere in its range. It's also GPIB programmable.

ACL is also handling a range of graphics terminals from JRC. The first of these is the IPS-100. It features a screen resolution of 1024 x 780 pixels with 896K of internal RAM and 256K of ROM. It has a 10M hard disk and a 1.2M floppy integrated into it and talks to the rest of the world via RS232 or Centronics ports. Other terminals are available with up to 32K by 32K pixels of screen memory.

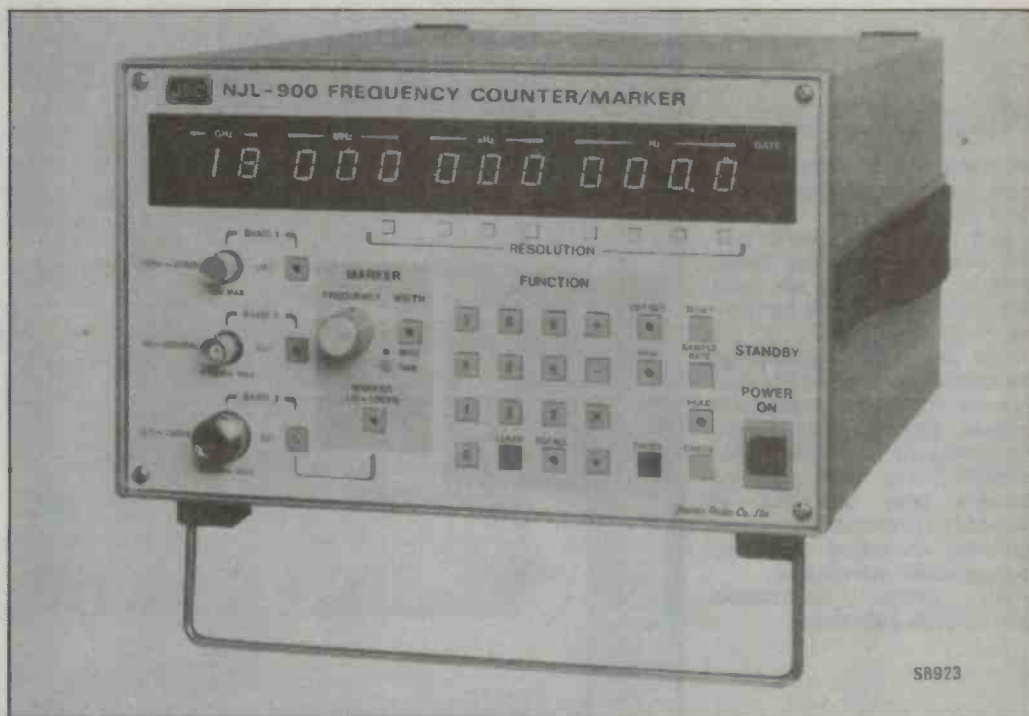

10 to 18 billion: a high performance frequency counter from JRC.

The power meter is the NJL70W, which operates in the range from 10 MHz up to 26.5 GHz. It can measure from -70 dBm up to +20 dBm in conjunction with an NJL71

power sensor.

A rather more novel product is the video-to-colour photo-printer called the Videofix 85. It is designed to reproduce still pictures from a video

display. The unit uses a flat colour CRT and an RGB colouring process to produce copy in just 20 seconds.

For further enquiries contact ACL on (03) 842-8822.

Combustion analyser

Novatech has just released details of its new model 1431 combustion analyser. It is designed to measure oxygen levels in non-habitable environments like the inside of boilers, flues, kilns and furnaces. The device is built to withstand 1400°C.

There is a local indication of oxygen level via an indicator on the front panel. One other parameter can also be selected. However, if the unit cannot be seen, there is provision for getting the information out via relay contacts which can be used to signal alarm conditions to some remote site.

The analyser can be used with heated or unheated zirconia oxygen probes. It provides automatic on-line gas calibration of the probe and filter purging. It also does a self calibration routine every two seconds.

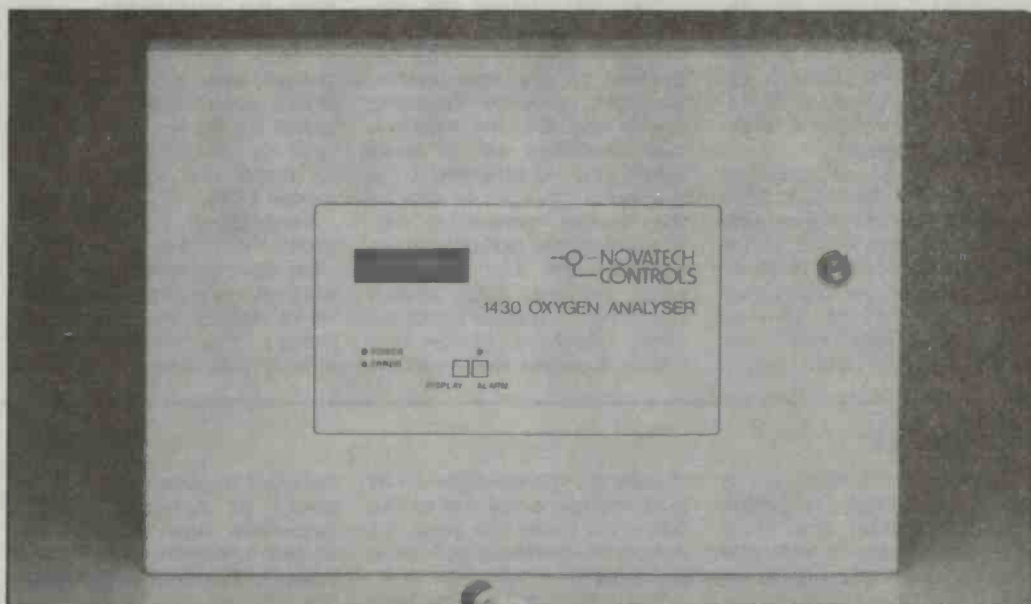

The Novatech alarm. The box will protect it up to 1400°C.

The 1431 has an internal keyboard for selecting the output range and so on, as well as maintenance and commissioning functions. The

instrument is processor-controlled and can be programmed directly at its keyboard.

It was designed and built by

Novatech in Melbourne around a CSIRO oxygen sensor. For further information contact Novatech on (03) 645-2377 or (02) 758-1122. ▶

NEW PRODUCTS

More Tek CROs

Tektronix has announced two new oscilloscopes, the 2245 and 2246.

Both feature a four-channel, 100 MHz configuration. Sensitivity is claimed to be 2 mV with 2% vertical and horizontal accuracy.

The 2246 offers pushbutton measurement capability and cursors. Both have auto-level trigger, providing automatic triggering of any signal with sensitivity to 0.25 div at 50 MHz and 0.5 div at 100 MHz. A 10:1 hold-off range provides excellent triggering on complex waveforms.

For further information phone (02) 888-2066.



Colour electrostatic plotters

Datamatic recently announced a family of three multi-pass colour electrostatic plotters from Calcomp that feature a palette of 1024 colours, 400-dot-per-inch resolution, integrated vector-to-raster conversion and electronic registration.

The 5800 Series contains three models; the 5825, 5835 and 5845. The models accommodate media widths of 24, 36 and 44 inches respectively, and can generate plots up to 500 feet long. They all feature 400-dot-per-inch resolution for continuous colour

representation and a crisp image.

The 5800 plotters are non-impact imaging devices. They use an electronic charge deposited on specially treated dielectric media, including paper and film. The media is then exposed to a liquid toner, which is attracted to the electronic charges or dots on the media, producing permanent visible text or images.

There are four separate toner stations. Each station contains a different colour; cyan, magenta, yellow and black. Together, these colours

produce seven pure colours, which can be mixed to produce 1024 hues and shades.

For a full-colour drawing, a plot must make four passes over the image head, one pass for each colour. A monochrome plot can be completed with a single pass. Single pass paper speeds include 0.7 inches per second (ips) for model 5825, 0.5 ips for model 5835 and 0.4 ips for model 5845.

Registration marks are drawn with the first colour pass. For maximum accuracy, the plot is electronically registered during the next three passes. This eliminates the integrity problems associated

with mechanical registration processes and provides 0.1% vertical and horizontal accuracy.

The plotters use vector-to-raster data conversion. They accept random vector data via an on-line interface from the host computer or via magnetic tape input. Then they convert the data and output colour raster plots. The vector-to-raster data conversion and integrated colour separation activities reduce the processing burden to the host computer.

For more information contact Datamatic on (02) 888-1788.

LED brake

A report in *Electronics* (18 September 1986) suggests that new model cars may soon be equipped with LED brake lights. The emergence of LEDs with about 10 times the efficiency of normal LEDs is making the car industry sit up and take notice.

The Japanese will be the first to bring the technology onto the market. Toyota demon-

strated an LED tail-light on its SFX8 experimental car at the Tokyo car show last year. It's not clear when they will arrive in Australia.

Bright LEDs are made from aluminium gallium arsenide (AlGaAs). Normal LEDs deliver about 1.5 lumens/ampere (L/A), but the new devices can hit 15-20 L/A. To form a usable unit, they need to be

bundled together in packs of about 50. Although initially expensive, the volumes required (apparently about equal to the total existing LED market) would drive prices through the floor in the long term.

The advantages of going to LEDs are several. They have a life expectancy longer than that of the car, and unlike

incandescent bulbs would be immune to anything but a direct hit. They would also afford a great deal of flexibility for designers in terms of shape and layout.

There could also be a cost advantage. However, many of the practicalities of manufacturing extremely large volumes very cheaply have yet to be ironed out.

Sprague resistor networks

Penn Central has announced the release of a family of surface-mounted resistor networks from Sprague. The 834 is a 14-pin package, the 836 a 16-pin. Resistances span 22 ohms up to 1 meg. Various designs are available, including pull up/down, theverin terminators and interface networks.

Apparently, Sprague intends to release similar ca-

pacitor networks, RC networks, translators and R/2R networks. Penn Central has also announced the release of the type 678D miniature aluminium electrolytic capacitor. Available in either 10 mm or 18 mm configurations, they are claimed to have exceptional CV products.

For further details contact Mark Riley on (02) 648-1661.

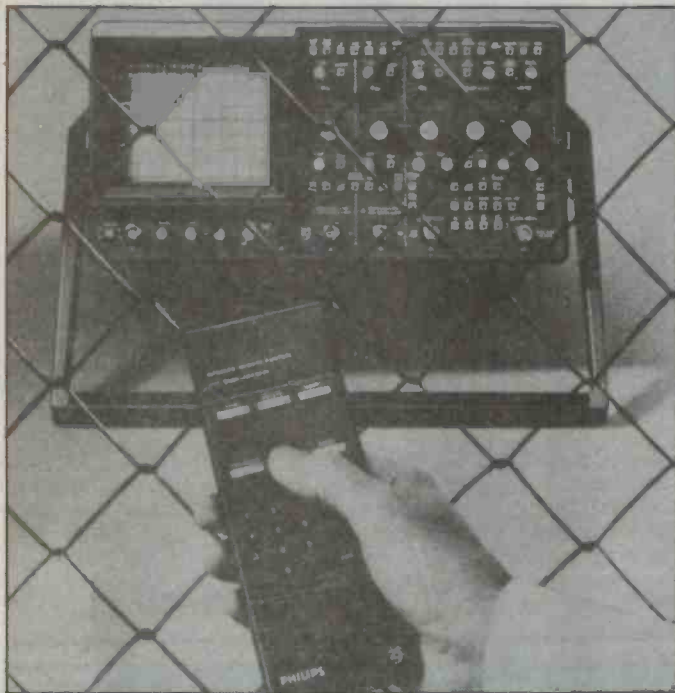

The Philips PM3296: look Ma, no hands!

Philips releases

Phillips has released a number of new instruments this month. A compact, low distortion oscillator called the PM5110 was one of them. It uses RC techniques to generate a sine wave with only 0.03% distortion between 300 Hz and 20 kHz. It can generate both sine and square waves between 10 Hz and 100 kHz. Maximum output is 6 V.

A TV-style remote control oscilloscope called the PM3296 was another of the releases. It's based on the highly successful PM3295. The 350 MHz CRO is specifically designed for operation in hostile places like environmental

chambers where there is a desire to separate the operator from the CRO. According to Phillips publicity it's also useful when the operator is stuck half way up an equipment rack and wants to leave the instrument on the floor.

The PM5192 has been introduced as a low cost fully programmable 10 kHz to 20 MHz frequency synthesiser. It's designed for both individual and systems operation with an IEEE488 bus interface and 19-inch rackmount configuration. It is claimed to offer eight figure accuracy and long term stability.

HomeWatch

PROFESSIONAL COMPUTERISED SECURITY KIT



Deluxe kit illustrated.

2 Kits available—Standard or Deluxe. 4 sector Control with switch selection of its many pre-programmed functions. Quality components for reliability. Comprehensive instructions included.

Literature, prices and further information available from:



I.E.I. (Aust) Pty. Ltd.

15-17 Normanby Rd, Clayton, Vic, 3149
Tel (03) 544 8411. Telex AA35780

248 Johnston St, Annandale, NSW, 2038
Tel (02) 692 0999

31 Phillips St, Thebarton, SA, 5031
Tel (08) 352 2066

NEW PRODUCTS

Local clones

Melbourne based, Datatel, is now assembling what it describes as IBM-compatible personal computers at its Melbourne headquarters. The company buys its components overseas to bring back and assemble into its DPC-88 and DAT-286 PCs, taking encouragement from the government's attempts to promote manufacturing in this country.

The Datatel DPC-88 is a fast turbo XT unit which provides an increase of almost 40% in the speed of program execution over the normal PC-XT.

Standard configuration of the DPC-88 includes 256K RAM, an 8 MHz 8088 microprocessor, dual slimline 360 KB disk drives, colour graphics card, parallel printer port, 150 W power supply, enhanced 5151 style keyboard controller to support four floppy disk drives with rear panel connector, security lock and flip top cabinet.

The Datatel DAT-286 is an AT-compatible having a standard configuration of 512K RAM, 80286-10 microprocessor, single slimline 1.2MB disk drive, 20MB hard disk, high resolution colour graphics card, parallel printer port, and 200 W power supply. It has dual floppy disk and hard disk controller, enhanced 5151

style keyboard, security lock, and slide-top cabinet.

Both units are supplied with MS-DOS 3.1. Other options include hard disks, tape streamers, RAM expansion boards, multi-function cards

and enhanced graphics adaptors. According to Datatel, any of the hundreds of expansion boards available for the IBM PC/XT/AT can be expected to perform correctly in these units.

Prices are from \$1316 plus tax for the DPC-88 and from \$4283 plus tax for the DPC-286.

For further information contact Datatel on (03) 690-4000 or (02) 439-4211.

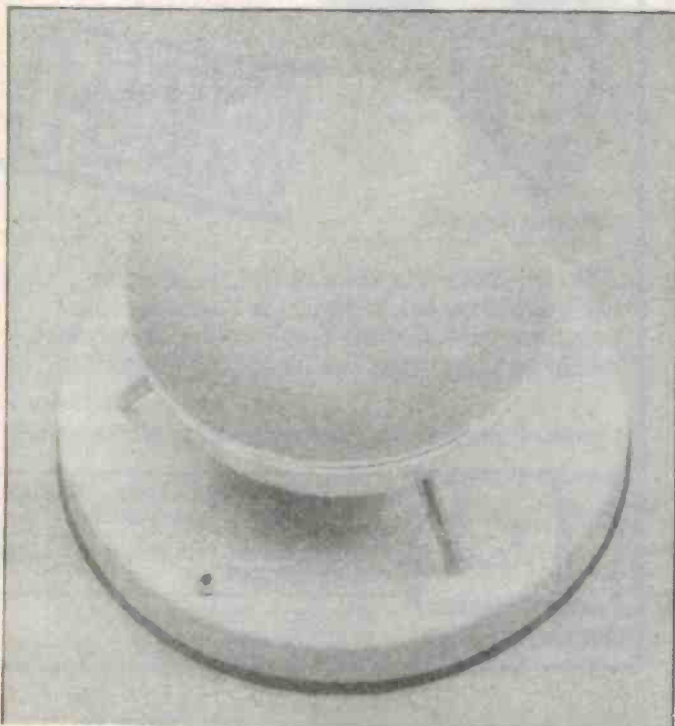

Spherical sound

Audio Telex is importing an unusual sound system into the country from the US. It's called the Soundsphere, and is produced by Conic Systems of Stamford.

The manufacturer claims 200 W capacity, a frequency response from 40 Hz to 20 kHz and a maximum sound level of 120 dB. They are specifically designed for large spaces where a wide disper-

sion pattern and good efficiency are important criteria.

The claimed dispersion is 360 degrees in a horizontal plane and 270 vertically. Company publicity indicates that they are preferentially hung from the ceiling in the middle of factories, shopping malls and the like.

For further enquiries phone Audio Telex on (02) 633-4344.

Round sound: the sound sphere.

PC CAD

Hewlett-Packard has got into the low cost CAD act at last with a package called PC CAD based on its recently introduced Vectra PC. Actually, at \$35k it's not really cheap, but compared with what HP has been offering up to now it's low-end stuff.

The package ties the Vectra into a new plotter called the HP 7570 Draftpro. At \$11k it's a down-market derivative of the more expensive plotters HP has been building up to now.

The Draftpro uses the same type of technology as earlier HP offerings. The paper is positioned by two grit wheels that make it possible to move the paper back and forth with extreme accuracy. This then becomes the vertical movement axis. Horizontal movement is provided by the pen arm itself which is attached to a bar running across the top of the printer.

The advantage of doing things this way is that both movements have extremely low mass, thus little inertia. This makes it possible to build a plotter that is at once fast and accurate. Under normal conditions there is a trade off.

To make things happen requires some software. The system will run almost any IBM-compatible software, but HP recommends only a small range, Autocad and Versacad among them.

HP is hoping that the launch of PC CAD will enable it to get a slice of the burgeoning CAD market and its market analysis indicates that the CAD market will grow very rapidly at the bottom end, while the demand for high price sophisticated CAD will remain slug-

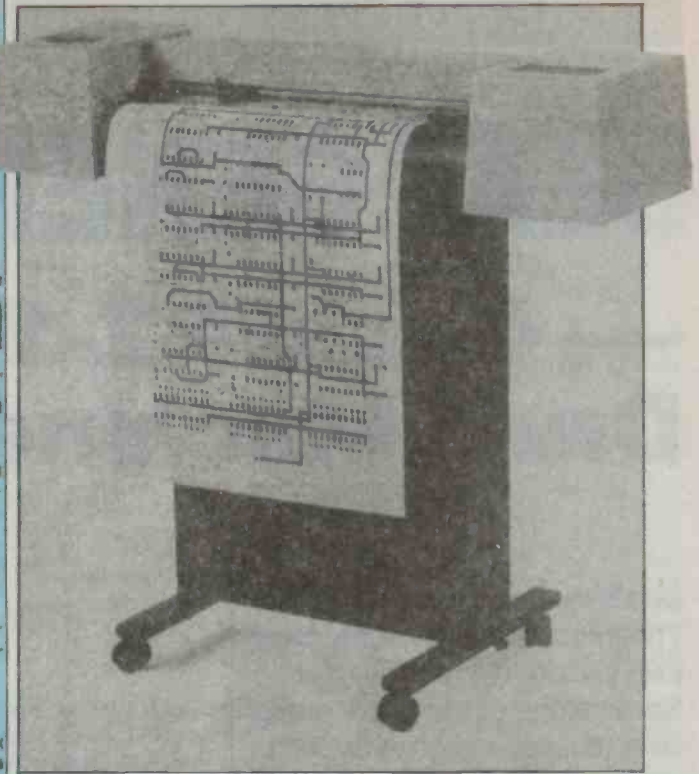
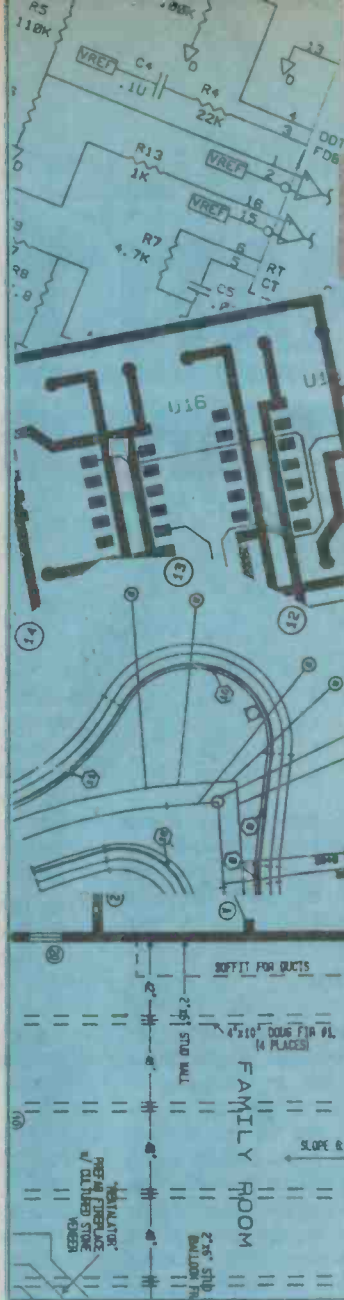

gish.

The reason is simple enough: there are plenty of people around who want to use CAD, but don't have the work to justify six-figure sums just to make their draftsmen happy. In the last year,

however, with the arrival of cheap IBM-compatible software in force, it has become possible to put together a respectable CAD system for under \$10k. This is a price the market will wear, a fact reflected in demand.

The problem for HP might be that the price is still too high, at three or four times some of its cheaper rivals. HP hopes that its reputation for customer support and engineering excellence will lure the public in.

Wave soldering without flux residue

Wave soldering is the process which has made possible low cost mass production of electronic circuitry. But it suffers from one irritating problem: after soldering the board is left with residues of the soldering flux which often have to be

removed using energy-consuming equipment. And this equipment either uses expensive solvents or creates problems in effluent disposal. Even if the residues do not have to be removed they are often a nuisance, interfering

with pin contact in bed-of-nails testing.

Multicore Solders has come up with a new flux, the X-32, which, it claims, avoids these problems because it leaves no residue. Multicore found that most of the solid material in the flux could be left out leaving only small amounts of certain activators in a solvent

base. These non-halide activators are decomposed and volatilized by the heat of soldering to leave the board free of detectable residues when it comes off the wave soldering line.

For further information about the new process phone (02) 667-0244 or (03) 489-0222.

BEAT GENERATION

— Casio RZ-1 Sampling Drum Machine

Neale Hancock

One two, some sampling to do
Three four time and some more
Five six, drum sounds to mix
Seven eight, patterned or straight
Nine ten, sounds good by then

COMBINE THE TWO most widely accepted forms of music technology, sampling and drum machines, and you have the RZ-1. Add Casio's sensible pricing, and you have the first affordable sampling drum machine.

Making rhythms

Too much importance can be placed on the sounds generated by a drum machine, and not enough placed on ease of programming, that is, to the task of actually inputting the rhythm patterns to the drum machine. Casio has made programming the RZ-1 very straightforward, thanks to a well laid out front panel and easily accessed parameters.

Programming a rhythm pattern into a drum machine entails the placement of beats in the rhythm pattern with drum

sounds (that is, snare, bass, hi-hat, sound sample 1, etc). The cluster of buttons just to the left of the display is used to program the rhythm patterns into the RZ-1. Rhythm patterns can be programmed in two different ways, in real time and in step time.

Real time rhythms

Real time programming of the RZ-1 is performed by inputting the beats while the drum machine is running. A particular drum sound is selected by pressing its corresponding front panel button at the time you want it played in the rhythm pattern. Alternatively, beats can be input from drum pads or a keyboard via MIDI.

The RZ-1 assists in the placement of the beats with an internal metronome and the auto-compensate function. The internal metronome helps you to keep time by marking four beats in the bar and accentuating the first beat. The auto-compensate function corrects any timing mistakes made while inputting the drum beats.

The auto-compensate function divides the musical bar into a number of different note lengths (namely 1/2, 1/4, 1/6, 1/8, 1/12, 1/16, 1/24, 1/32, 1/48 and 1/96) then

corrects the drum beats to fit them. For instance 1/96 allows 96 different locations for drum beats in the bar, allowing rhythmically proficient percussionists to do their thing. The 1/6, 1/12, 1/24 and 1/48 note lengths allow triplets (three beats in the space of two) to be written into drum patterns, giving them a liveliness.

Step time rhythms

Step time programming of the RZ-1 is done by manually stepping through the rhythm pattern and inputting the beats at the required places. The beats are input by pressing the button labelled with the desired drum sound at the position where it is required. The number of steps in the rhythm pattern is set using the auto-compensate function whilst the drum machine is in step time mode. Programming the RZ-1 with rhythm patterns in step time is very simple, thanks to a logically laid out front panel and a good selection of single function buttons.

Play/record, delete, auto-compensate, beat selection (eg, 4/4, 3/4 time, etc) and copying functions are enabled using the PATTERN key in conjunction with a key corresponding to the function. The cluster of buttons to the left of the display is used to perform these tasks. The delete function permits whole patterns, parts of patterns as well as single beats to be erased. The copy

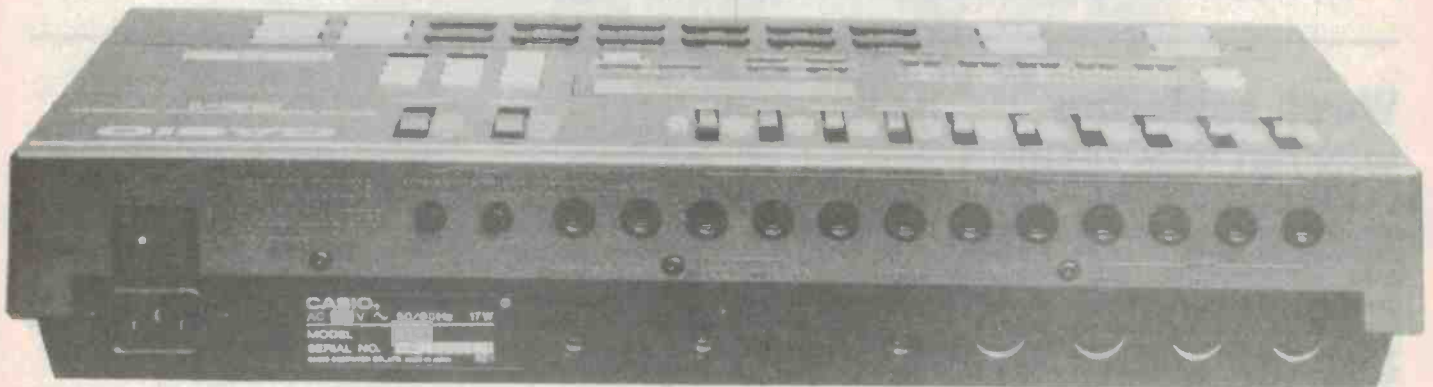

From the rear.

CASIO

DIGITAL SAMPLING RHYTHM COMPOSER

RZ-1

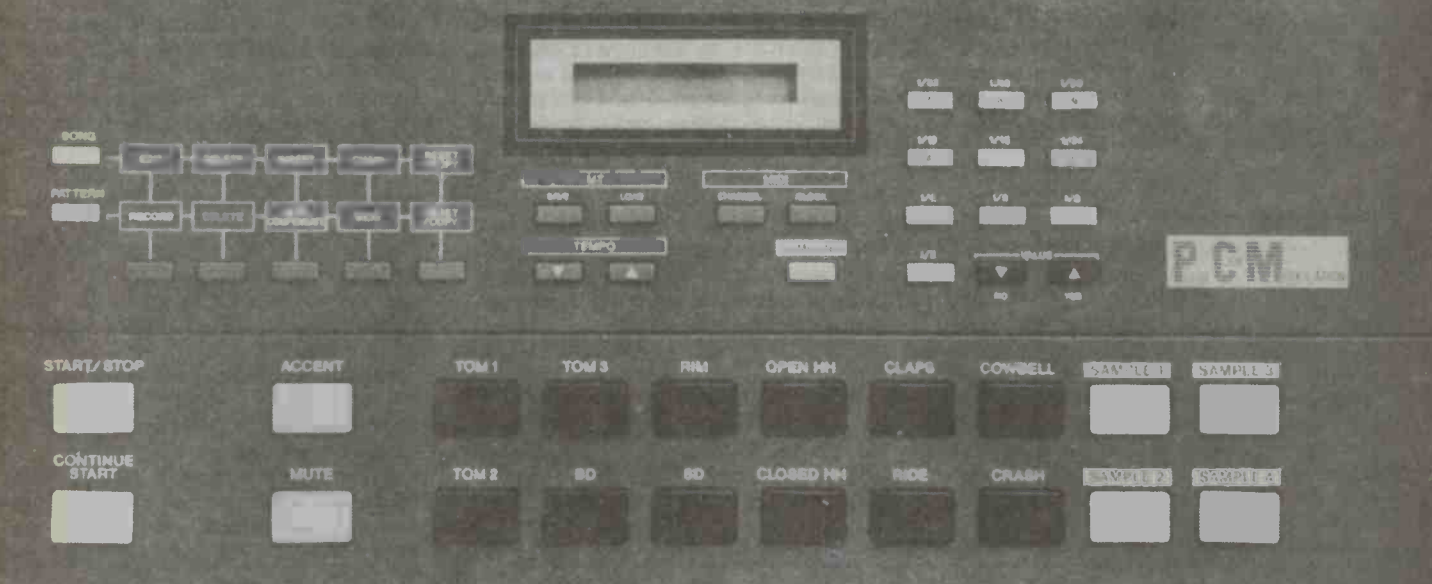
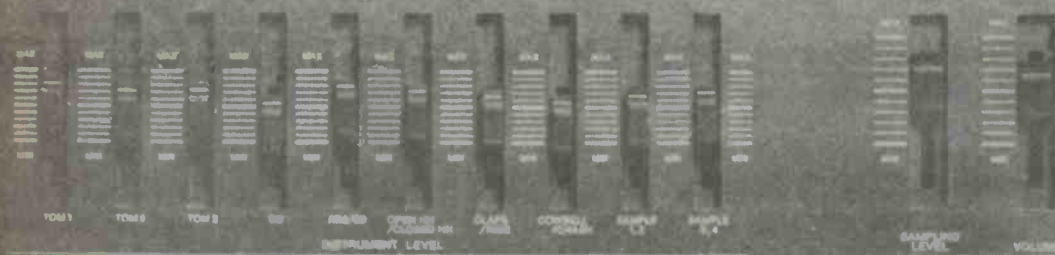

function enables existing rhythm patterns to be copied, then modified to create new patterns.

Making songs

After a number of rhythm patterns have been written, they can be put together to create a song. Keys that are used for writing rhythm patterns (eg, PLAY/RECORD, DELETE, AUTO-COMPENSATE, etc) can be used to create songs as well. This is done by pressing the SONG key instead of the PATTERN key. Arranging the patterns to form a song is simplicity itself, due to easily accessed parameters and good documentation on the display.

When the SONG key is pressed, edit/play, delete, insert, chain and copy functions are used to arrange the patterns into songs. While none of these functions is unique, their virtue is in how easy they are to access. As their names suggest, the delete and insert functions allow patterns to be inserted in or deleted from a song. Delete can also be used to erase whole songs. The chain function allows different songs to be linked together while copy allows a selected song to be copied exactly into another song.

The storage capacity of the RZ-1 is quite impressive, allowing 100 rhythm patterns and 20 different songs (each with a maxi-

mum of 99 steps) to be stored. If you exceed the internal memory, all the song and pattern data can be stored on cassette via the cassette interface. This interface is operated via MT, SAVE and LOAD.

Other features of the RZ-1 include a backlit LCD display (to allow the RZ-1 to be used in those dingy inner-city pubs!), a 10-digit keypad as well as increment/decrement keys for data entry and tempo control. These features impressed me because they allow the values of the parameters to be easily changed. A lot of companies reduce the number of keys on their drum machines, increasing the difficulty in programming, supposedly in order to reduce cost.

Sampling

The RZ-1 can sample four 0.2 second samples, two 0.4 second samples or one 0.8 second sample. To achieve this flexibility the memory is broken up into four blocks, or two blocks or not at all. The sampling rate is 20 kHz, giving a bandwidth of about 10 kHz. Although 8-bit sampling is used, it sounds much better, which suggests that some form of companding is used to give the drum sounds a greater dynamic range.

Sounds can be input into the RZ-1 via a microphone or from a line level source (a

cassette deck for instance). There is a common socket for microphone or line input, and either source can be selected via a switch. There is a slider to control the level of the input signal and an LED to indicate that sampling is being performed.

To sample a sound with the RZ-1 all that is required is to plug in the source, set the input level and push the two buttons. Hit a couple of things together and the resulting sound will be automatically sampled. One or two attempts may be required to get the optimum sample (a sample that is loud enough to override any noise but not so loud that it is distorted). It surprises me that Casio did not include a bar graph display to show the input level of the incoming signal. The inclusion of such a display would assist in setting the optimum level for sampling.

The sample can have either its low frequencies or high frequencies boosted using the tone control knob on the rear panel. The use of this facility is somewhat limited because samples 1 and 2 share one control, and samples 3 and 4 share the other.

I chose to test the sampling ability of the RZ-1 with some dynamic sounds containing lots of high frequency harmonics, so I used a range of hammered metal objects such as aluminium plates, coffee tins and an ▶

SOUND REVIEW

ETI Series 5000 heatsink (I knew there was a good use for it!). To my surprise the quality of each of the sampled sounds was very good. Using the tone control to boost the high frequencies helped achieve a good sounding sample but it also added some noise.

The 0.2 seconds allowed by the RZ-1 for sampling a sound was not quite long enough to capture it all. For instance, when the sound of a hammered piece of metal was sampled, the ringing of the metal was cut off. However, the shortened metallic samples sounded very punchy when used in a rhythm pattern, therefore they were fine for up-tempo songs.

Preset sounds

The RZ-1 also has 12 preset drum sounds — namely, bass, snare, high, mid and low tom-toms, rimshot, open and closed hi-hats, handclaps, cowbell, ride and crash cymbals. Three levels of dynamics can be applied to these from the front panel: accent, normal and muted. The best of the preset sounds are the rimshot, open hi-hat and ride cymbal which is excellent. The other sounds are of a reasonable quality, but lack the punch one would expect (even when accentuated).

There are 10 outputs for the samples and the drum sounds, each with a separate volume control. The three toms and the bass drum each have their own outputs. The other sounds are grouped into the following sharing arrangements: rimshot with snare, closed hi-hat with open hi-hat, handclaps with ride, crash with cowbell. As for the sampled sounds, samples 1 and 2 are grouped, as are samples 3 and 4.

The inclusion of separate outputs is a big plus for the RZ-1, as this allows each drum sound to be mixed separately, and separate mixing allows equalization and effects (such as reverb, echo, phasing, etc) to be used on individual drum sounds. Taking the sound from these outputs and equalizing them separately can also help rectify their sonic shortcomings. For situations where it is not possible to have separate outputs (not enough mixing desk channels, or no desk at all), the sounds can be internally mixed and output in mono or stereo.

MIDI and other interfacing

The RZ-1 has MIDI IN, OUT and THRU on its rear panel. The MIDI OUT enables the RZ-1 to transmit MIDI clock information, allowing it to set the tempo of all the sequencers in the MIDI system. The MIDI

OUT can also output a note value for each of the drum voices, which enables it to drive external MIDI sound modules.

The MIDI IN allows the RZ-1 to receive MIDI clock information, enabling it to have its tempo set by the MIDI system master. The MIDI IN also allows rhythm patterns to be programmed into the RZ-1 from a MIDI keyboard and drum voices to be manually played from a MIDI keyboard.

The RZ-1 can be remotely started and stopped via a footswitch that plugs into the rear panel. This facility is ideal for 'live' situations or when you are recording and wish that you had a third hand. The MT function that allows playing and voice data to be transferred to and from cassette tape is accessed via a rear panel DIN socket.

Overall, I would say that the RZ-1 is good value for money due to its user friendliness and sampling ability. The quality of the preset sounds is a bit of a worry, but the ability to process them separately helps to counter this.

The recommended retail price for this drum machine is around \$1300, which is quite reasonable considering the Australian dollar's demise against the Japanese yen. Also, it is worth remembering that the price of RZ-1 is similar to that of non-sampling drum machines of similar specs. ●

Remove flux with a brilliant combination and brilliant consistency... FREON* TMS & UNISONICS

FREON TMS. The No. 1 fluorocarbon solvent for removal of flux from printed circuit boards. Worldwide.

No wonder. FREON TMS is extremely effective. Reliable. And simple to use.

It meets the industry's most stringent flux removal standard: MIL P-28809.

So you're assured of a large safety margin. Even if you don't require this optimum standard.

What's more, this gives you provision for future needs.

FREON TMS fluorocarbon solvent is easy to use with any type of system: Spray, in-line, batch, ultrasonic or non-ultrasonic cleaning.

Start removing flux with brilliant consistency today.

Please send me your "Trouble Shooting Guide to Defluxing with Du Pont FREON Solvents."

Name

Title Company.....

Address.....

Telephone.....

LOVELOCK LUKE PTY. LTD.

19-21 Buckland St., Broadway. Tel: (02) 211 2811



If it doesn't
say Du Pont
it's not FREON

*Registered by



M&F/6017

Don't miss some fantastic Christmas bargains!

Merry Christmas and Happy New Year to all!

Professional SOUND
1/2 PRICE! STEREO H'PHONES
 Were \$9.99 **Now \$5.99**

UHF to VHF CHAN 3/4 TV SIGNAL CONVERTERS
 Non-tunable, suit UHF output VCR's and video games etc!
\$39

PC-XT CASES
 Hinged lid, all hardware, few only.
\$99

IBM EXPANSION CHASSIS
 ADD HARD DISK, UP TO 3 x FLOPPY DISKS etc.
 5 x PC/XT/AT expan. slots
 60/100w power supply
 Cooling fan \$620 \$530
 Connectors Tax Free plus computer interface.

MINIATURE 12v DC DIL RELAYS
 Single pole, 1KA ea \$2
 Electrothermal 10+ \$1.90

BELT-DRIVE TURNTABLE!
 SCOOP PURCHASE! BELOW NORMAL COST!
 As made for AWA, 2 speed, 33/45 RPM, strobo platter, magnetic cartridge, 12vdc 240v pack, add \$5
\$29

MOTORIZED SLIDE-IN TURNTABLE DRAWER
 TO SUIT ABOVE BELT-DRIVE TURNTABLE - includes 12v supply
\$60

WANTED TO BUY... USED TEST EQUIPMENT & COMPUTER PRODUCTS

- AVAIL ONLY WHILE PRESENT STOCKS LAST!**
- 6.5mm stereo panel mount sockets 2 for...\$1.00
 - 3PDT rocker action switch, buy 4 for...\$1.00
 - Assorted non-ohm resistors pack 100...\$1.50
 - H1-stab resistors 15 and 25 ast pak 30/\$1.00
 - 1.2V 500mAh nicad batteries AA size ea...\$1.95
 - BDY38 (similar 2N3055) power trans 2 for \$1.00
 - Ignition noise filter kit CB/car radio...\$2.50
 - Molex IC socket pins, handy to have 100/\$1.75
 - 30 metres Insul hook-up wire, 5 colours \$1.95
 - Flashing red LED's, 100% g'teed, 2 for...\$1.00
 - NPN 40V unmarked T05 silicon trans 20/...\$1.00
 - VHF trans MRF-6D3 (similar 2N5590) 2 for \$9.95
 - Electrolube spray-can (similar WD40) ea \$3.50
 - 2200uF 64v Philips cap electros ea...\$1.75
 - SCR 100V 1A T0-5 TS1232 from STC, 4 for \$1.00
 - SCR 200V 10A T066 TS1218 from STC, 4 for \$2.00
 - Mica washer + insulators T03, 20 for...\$1.00
 - Mica washer + insulator T0220 tab 20for \$1.00
 - PCB mount fuse-clip for 3AG fuse 12 for \$1.00
 - MN3054 60V 4amp T0-66 transistor...3 for \$2.00
 - B0237 tab transistor...5 for \$2.00
 - Mini Philips screwdrivers set of 4...\$3.20
 - Burglar alarm reed switch + magnet N.C. \$2.50
 - Alarm module entry/exit N.O./N.C. 12V...\$15.00
 - Vibration/glass break sensor N.O./N.C...\$5.00
 - 12v to 6,9,12vDC 300mA car volt convert \$2.50
 - Compression power mike for CB/2way...\$15.00
 - H1-F1 moving coil magnetic cartridge...\$19.95
 - 12V car cassette tape head demagnetizer \$2.00
 - 240V AC tape head demagnetizer...\$5.00
 - 3 speakers ON-OFF stereo switch-box...\$9.50
 - TV/aerial/computer switch-box TV-9...\$4.95
 - TV aerial VHF/UHF masthead mixer...\$8.90
 - 5K log 45mm mono slider potentiometers...\$2.50
 - Bourns 1K 10 turn cermet trimpot...\$1.95
 - 2" extra-strong ferrite bar magnets...ea.\$2.35
 - 12 way plastic elect. terminal block...\$1.95
 - Crystal hi-impedance earphone...\$1.95
 - Magnetic lo-impedance earphone...\$1.00
 - 24V DC relay DPDT 140 ohm coil 25A cont \$4.00
 - 220V AC DPDT miniature cradle relay...\$2.95
 - Video to RF TV modulators VHF CH 1 out...\$3.95
 - Stereo speaker vol cont Bohm 100W L-pad\$15.50
 - BZY93 24V 20 watt zener diode stud mtg...\$1.00
 - BC328 30V 500mA T0-92 transistor 10 for \$1.00
 - 3" cone tweeters 25W 8 ohm, were \$5 now \$2.50
 - 5" mid-range 25W 8 ohm, were \$10 now \$5.00
 - Crossover capacitors suit above, ea set \$1.00
 - Battery test meter all 1.5V + 9V batts...\$4.50
 - 3 pos 10amp rotary switch with knob...\$1.00
 - Mini PVC tuning gang for trans radios...\$1.00
 - 58mm (2 1/4") 8 ohm mini speakers...\$1.80
 - Co-ax cable wire stripping tool...\$2.00
 - 2 pin mains power lead and mini socket...\$1.95

MINIATURE LAPEL MICROPHONES
 CONDENSOR MIKE \$15.00 EA
 FM WIRELESS \$18.00 EA

FM WIRELESS Microphone
 only \$17
 Freq. 88-108MHz
 Range to 100 metre
 Response 50-MHz

FM WIRELESS MIKE and RECEIVER
 for P.A. etc 3710mhz
 Crystal controlled for stability-range 100 metres maximum.
 Set \$95 9v batt oper.

DIGITAL SPEEDO+ TACHO for Cars
 0-199 KPH 0-9900 RPM
 12v neg gnd.
 Bright LED Display with SPEED SENTRY MONITOR \$69
 Buzzer and light indicates excessive speed - adjust
 SPEED WARNING TOO!

UHF CONVERTER for SBS CHAN 28
 Tunable UHF 4/5 to VHF channel 1 \$69

NATIONAL B/W VIDEO TAPE RECORDERS
 Used, but in good working order!
 \$80 ea EXTRA.
 Also monitors & audio/visual gear.
 Ideal for amateur use.

CENTRONICS PARALLEL GENDER CHANGER
 36 Pin Socket to end-all pins wired through.
 \$25
 RS232 PATCH-BOX \$22 Male/Female - 25 jumper leads
 RS232 SWITCH-BOX \$29 Male/Female - DIP switches
 RS232 MINI-TESTER \$33 Male/Female - dual colour LED's
 GENDER CHANGER \$18 Male/male or female/female
 IBM PRINTER CABLE \$24

FUJIFILM FLOPPY DISK
 THIS MONTH ONLY
 5 1/4" SSDD 10 for \$29
 5 1/4" DSDD 10 for \$39
 5 1/4" DSAD 10 for \$75
 8" DSDD 10 for \$55
 3 1/2" SSDD 10 for \$65
 3 1/2" DSDD 10 for \$85
 LIFETIME GUARANTEE! Certified 100% error-free.
 TAX FREE PRICES AVAIL!

NEW PRINTER SWITCH(A-B) BOXES
 WITH DATA TESTER LEADS
 2x IN 1x OUT or VICE VERSA!
 Ideal for computer to 2 printers or printer to 2 computers - no power required!
 RS232 SERIAL \$105 + Tax \$126
 CENT. PARALLEL \$105 + Tax \$126

STEREO SOUND FROM YOUR TV!
 Connect your TV to your Hi-Fi for simulated stereo sound.
 \$19
 were \$39.95 each

ULTRASONIC CAR ALARMS
 Complete and self-contained, just add siren or horn, auto reset, entry/exit delays, LED light.
 \$55

12v DC CAR ALARM FLASHING LIGHT
 Comes on when the ignition is off!
 \$12.90

LM3900 OR EQUIV RCA 3-401
 Regular price \$39 EA
 \$29 EA
C106 SCR 10v 50v 4A 32c 2c

ALARM CONTROL PANEL
 4 INPUTS - N.O. and N.C. instant or delay.
 6 LED STATUS INDICATORS
 Entry and Reset ADJUSTABLE DEL
 Inbuilt 24HR PANIC or FIRE alarm circuit.
 NEW, IMPROVED MODEL!
 \$119 Dry cell or rechargeable 12v battery operation, heavy duty lockable steel cabinet, input siren and DC 12v power outputs. IDEAL FOR HOMES, SHOPS, OFFICES!

New Passive INFRA-RED Detectors
 12v DC, LED light N.O./N.C. contacts
 Includes mounting bracket
 2 MODELS - 12m Wide beam \$109
 25m Narrow beam \$159

DIGITAL CODE KEYPAD
 Relay output - 12vdc
 3 LED indicators
 4 digit adjust. code, overriding number lockout
 suitable for all alarms \$65 each

IEC. POWER LEADS
 QTY 1-10 \$1.50 ea
 QTY 20+ \$1.25 ea
 Length - average 1-6M

LGE DC MOTORS
 POWERFULL 3,000 RPM
 6V-12V DC
 47mm diam 60mm long
 ONLY \$5

BASIC ALARM MODULES
 N.O./N.C. INSTANT and DELAY CIRCUITS, SIREN and BELL OUTPUTS, 12V DC OPERATION.
 was \$29.95
 HALF PRICE \$15

NEW FANS
 High quality from C.I.C. Co Taiwan Ltd
 \$20 ea
 10+ \$16 ea
 3" (80mm) 3" (80mm)
 115v 240v
 5" (120mm) Super-quiet Long life Guaranteed

Ex-Computer Caps
 100,000uf 10v 33,000uf 40v
 30,000uf 15v 20,000uf 45v
 25,000uf 20v 10,000uf 50v
 15,000uf 25v 22,000uf 50v
 50,000uf 25v 20,000uf 50v
 24,000uf 30v All tested EA
 22,000uf 35v and g'teed \$5

DB25 SOCKETS
 High Quality gold-plated contact pins!
 Only while stocks last!
 \$1.50 EA

ASSORTED POTS
 20 MIXED VALUES \$3
 Linear, log, our choice!
 100 MIXED VALUES \$15
 Dual, switched, all new
 250 MIXED VALUES \$25
 Bonus bulk package!

VIDEO CASSETTE TAPE HEAD CLEANERS
 VHS or BETA only \$5 while they last!
 PACK/POST: \$3 plus 5% order value - extra for heavy item!

PRE-PAK electronics p/1
 1 to WEST ST. LEWISHAM, NSW
 569-9797
 PHONE NOW!

SUCCESSFUL IMPACT

— laser printer review

A new Australian printer is an unusual event. That it uses the most advanced printer technology, is comparatively cheap and looks good, are all extra plusses.

Jon Fairall

IN 1984, Micropro Design, a small peripherals manufacturer merged with Impact Systems, a Sydney based printer vendor. It was an extraordinarily fertile union. From its R&D department has come a string of designs and, most importantly, a series of printers.

The latest Impact printer is the L400. It's fast, silent, puts out a quite stunning variety of type shapes, does superb graphics and is not overly expensive. It's very good.

The secret: laser printing. The technique in laser printing is to scan a laser beam across a photosensitive paper like that used in a photocopier machine. In fact, laser printers like the Impact often use ordinary photocopy paper. As it scans across the paper, the beam is modulated by an electronic signal running at 3 MHz. This produces a resolution on the paper of about 11 dots per millimetre. It takes about 1.5 ms to do a horizontal scan so an entire page is created in about five seconds.

Some things follow immediately from this method of printing. For a start, because the marks on the page are made up of extremely fine points, there is nothing standing in the way of a full graphics capacity.

Another thing: there are no impacting points, so it's silent in operation. In fact the loudest noise is the paper advance mechanism.

At the core of the new technology is the 'laser engine'. Laser engines contain the laser and the scanning mechanism. However, these are quite useless on their own. They need to be matched with a paper transport mechanism, a box, and most importantly of all, a controller.

The function of the controller is to take the commands coming down from the host computer and turn them into a code that

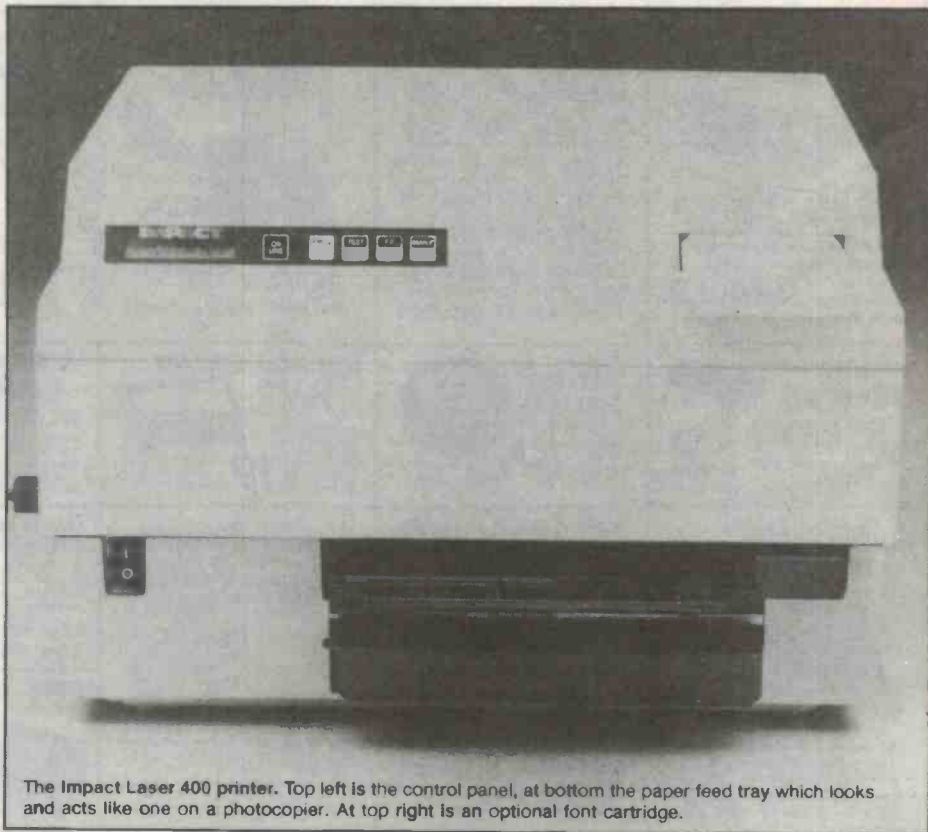

The Impact Laser 400 printer. Top left is the control panel, at bottom the paper feed tray which looks and acts like one on a photocopier. At top right is an optional font cartridge.

can be used to control the laser engine. This involves a number of tasks. For instance, the more compatible the printer is with existing printer commands, the bigger the range of letter shapes (fonts) and sizes, the easier it will be to sell.

If the printer is to have any special characteristics of its own, it helps if these can be accessed with as little fuss as possible. Indeed, it helps if the whole device is easy to operate.

Functions

Impact Systems has achieved all these aims with its printers. There are five buttons on the front of the box of the L400 from which the device can be programmed, using a simple menu driven system. From left to right: the ON-LINE/OFF-LINE button connects the printer to the computer. When off-line, the operator can program the device. Next to it, the PROG button readies the printer for pro-

gramming.

Third is the TEST button. This initiates a self test routine provided the unit is off-line. If in program mode, pressing this causes a scroll through the menu. Various menus allow page formatting, changing the emulation mode, storing fonts, and so on.

A fourth button is marked FF which when off-line will perform a form feed. However in program mode, this allows you to select the sub-menus. From the emulation menu, for instance, you might choose between Diablo, Qume, Epson, HP or the Impact's own command set.

The fifth button is labelled MAN F, and allows you to achieve manual feed of the paper. (Why bother, I ask myself.) In the program mode this button allows selection of the various available parameters.

In practice, this is dead simple to operate. Once you understand the hierarchy of the buttons you can dispense with the manual and have fun teaching yourself what all the settings do. It's not the logical way to do it, but you make friends with your printer so much faster, and it's much more dignified than consulting the book.

One of the most interesting features the printer offers, which is available independently of its standard emulation modes is the Impact command language. In this operation, the printer requires a special lead-in character (LIC), to recognise a command sequence. The LIC can be set from the front panel.

Once set, the computer can control the printer directly by sending the LIC down the line. It is in this mode that the power of the machine becomes really apparent. By sending the LIC plus a control group which usually consists of two letters you can get at the power of the on-board computer. The range of tricks is far greater than we have space for here, but a pot-pourri:

PC: allows one to print special characters, usually the ASCII codes less than 20 which are normally used for foreign language extensions.

MP and ML: select portrait or landscape orientation for the printing on the page.

LP: allows you to select line pitch within the document. Other commands select character pitch.

TF: Change Font. You can change the size, shape, density and anything else you like about the printed characters within the document.

Graphics

Impact has also integrated a comprehensive graphics facility into its printer. For instance, it's possible to define a unique set of characters using the Font Transfer command TF. For the purposes of the ex-

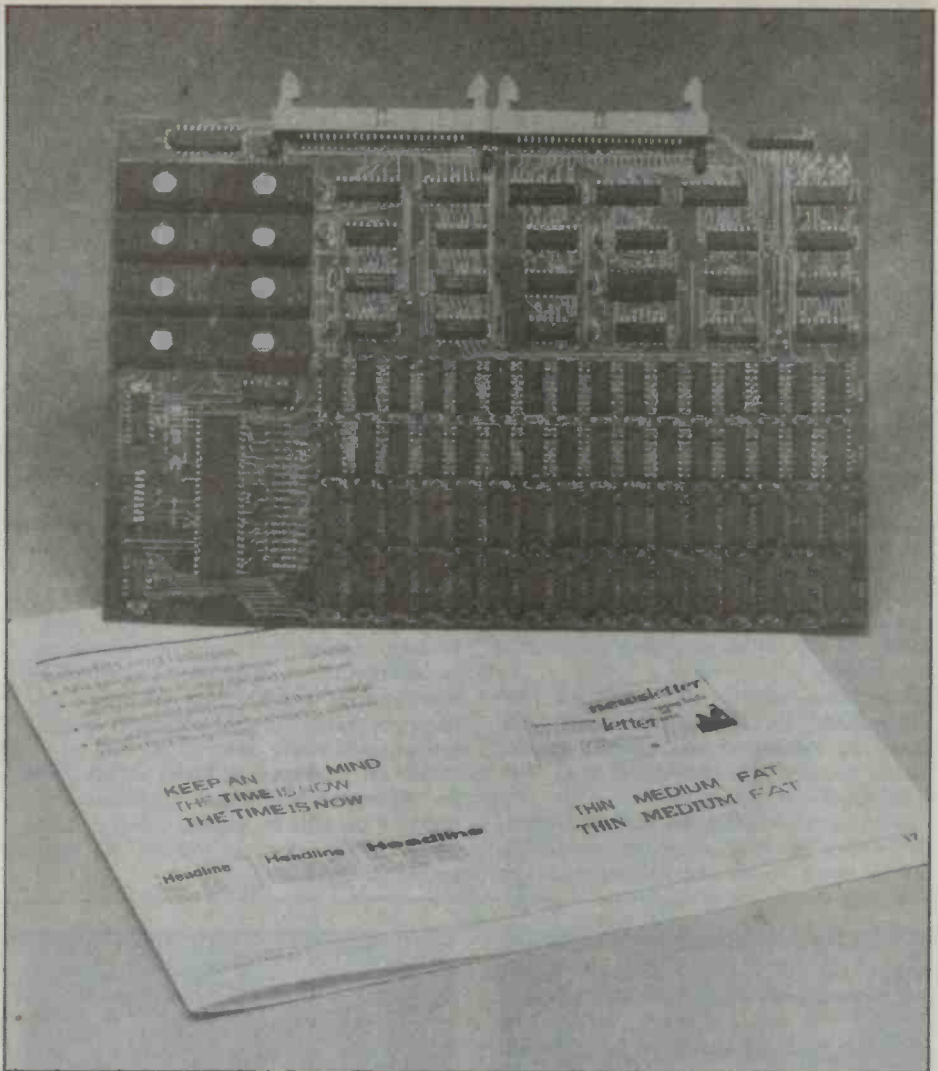

For full blown graphics mapping, Impact is also selling a 2048 Kbit ROM option for the printer.

ercise, each character is divided up into 32 x 32 dots (equals 1024 bits). Whether a particular dot is on or off then depends on the state of a bit in the 128 bytes necessary to describe the character.

Graphics cells can be defined and sent to the printer. These consist of 32 x 32 contiguous dots. Additional commands allow vertical or horizontal lines, boxes and fills. The fill pattern can be any one of the 12 available. A further command can be used to control the position of the cursor. This means that graphics characters can be positioned anywhere on the paper.

A special use of graphics is in the generation of forms. A special set of commands allows one to position the cursor anywhere, print text or graphics and so on. Composition of a form begins with the Forms Start command, FS. Any printable character or command can then be used to create the form, followed by a Form Finish, FF, command. The form created can then be summoned with the Form Start, FS, command. From then on ordinary text coming down the line from the computer will be printed with the image of the form

automatically superimposed.

It may well turn out that this sort of facility is one of the most important that laser printers offer. The ability to mix and match fonts, place text anywhere on the page, do diagrams and graphics characters, leads naturally to desk top publishing. It's no longer good enough to write a letter. Now you create a work of art.

These capabilities require a considerable amount of processor and memory overhead. None of it represents an overhead for the computer, however. It's all done by the sophisticated management of the controller on board.

One way of handling things might be to create a full bit image (analogous to a frame store in a digital TV). However, to do so would require about a megabyte of memory. A meg of memory, even in these days, is not cheap.

Another alternative would be to store only a single line of characters at a time. The actual dot pattern that drives the printer is created from an on-board font stored in ROM. This could be implemented with less than 5K of RAM, but the trouble is that it makes the printer as ▶

EQUIPMENT REVIEW

rigid in its operation as a daisywheel. In a daisywheel printer, you are limited by the font on the daisy at any one time. To change fonts, you change daisies. Likewise in this scheme. You must change ROM to change fonts. Since a comparable daisywheel is much cheaper, there would be little benefit.

Impact went for an alternative somewhere between these two approaches. It has managed to preserve most of the freedom of a complete memory mapping of the page, while only paying a small price in terms of memory size.

In the Impact 400/800, the controller is based around two 68000 processors. One, the command processor, looks after all the interfacing to the host, the front panel, the display and the laser engine. It is provided with 128K for input buffering and 256K of EPROM for operating system and font storage.

Most importantly, the command processor builds up 'task' buffers in its 128K RAM by talking to the host computer. These describe the characters, their font type and their positions.

The second 68000, the font processor, looks after the position of the actual dots on the page. It can access information in

the task buffers by reading the command RAM. It is controlled by 16K of EPROM and has 128K or 256K of its own RAM to play with.

The font processor takes the information from the task buffers and, directed by the program in EPROM, assembles 'scan' lines. Scan lines are sections of memory, the bits of which directly control the presence of dots on the page. For instance a logic 1 results in the laser being on, a 0 in it being off. One complete line requires 2500 bits (dots), and the buffer is constructed so that eight lines are assembled at once.

This system has a number of advantages. Firstly, a very large number of fonts can be created and called up at will by the command processor. There is room for up to 15 separate fonts, including bold, italic, inverse, rotated and magnified variations. In addition they can be added to at will by downloading directly from the host computer, or using EPROM cartridges. Superscripts, subscripts, overprinting and so on create no problem. A heavy dependence on software rather than hardware also makes it possible to emulate other printers rather easily, and to update to other standards quickly.

Versions

The L400 is exceptionally cheap for a laser printer, at around \$4000. It's a slightly derated version of the L800 which is somewhat more expensive and has been in production for a few months already. The differences are in the number of library fonts provided internally, the L400 has only two versus the L800's 12; and in pages per minute, the L400 is limited to only four per minute. However, upgrades are available once you have the basic unit.

Production of the L400 started in June with initial manufacture at a subcontract assembly plant at Penrith to the west of Sydney, and final assembly at Impact's Chatswood plant. Production started at 100 a month and is ramping up to 500 a month by year's end. Current production of the company's L800 is already at around 500 per month.

Is it worth a second look? Most definitely. Laser printers like the L400 will replace daisywheels within the near future for letter quality work, and it's easy to see why. If you plan on getting anything more than an *el cheapo* needle printer for \$300 give this one a look. For a demo get in touch with the local Impact office in capital cities around the country.

THE RIGHT TOOLS FOR MICROPROCESSOR DEVELOPMENT



SINGLE CHIP DEVELOPMENT TOOLS FROM CYBERNETIC MICRO SYSTEMS

- Program, execute debug code on your PC.
- Award winning simulator dynamically displays source flow.
- Demo disk & manual available.

	RAM	ROM	TRIGGER	STOP	THRESHOLD	Z
RAM	✓	✓	✓	✓	✓	✓
EPROM PROG.	✓	✓	✓	✓	✓	✓
SIMULATOR	✓	✓	✓	✓	✓	✓

OTHER DEVELOPMENT TOOLS:

- Cross Assemblers for all processors (inc. 68xx) \$CALL
- GTEK 7228 Universal EPROM Programmer \$1140
- PROTEL PCB V2.0 PCB Layout CAD System \$890
- PC-compatible, 640K RAM, Dual Floppy \$1285
- MICE-II In-Circuit Emulators \$CALL
- Compilers for all languages, CP/M, MS-DOS \$CALL

We offer technical support for all products.

47 CASTLEMAINE ST. MILTON Q. 4064
Phone: (07) 369 5900 Telex: AA 40894

BALTEC SYSTEMS

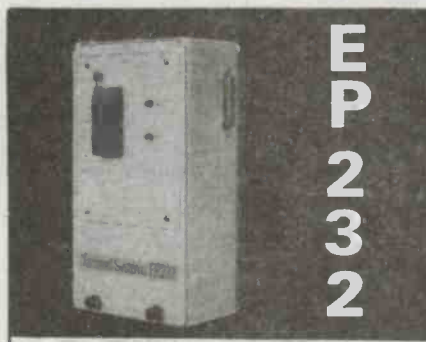

EP232

The EP232 turns your PC or CPM computer into a versatile EPROM PROGRAMMER able to program all common EPROMS up to 27512.

- Software provided gives a comprehensive set of commands.
- Simple interface via RS232 port.
- TTL PROM programming modules available.
- Locally made EP232 costs a fraction of imported programmers.
- CALL FOR DETAILS
Diamond Systems (03) 714 8269
P.O. Box 105, Hurstbridge 3099



FORTH DEVELOPMENT SYSTEM UPGRADE KIT-2

- EC-1F11/12. DAUGHTER BOARD KIT FOR EC-1F11 FOURTH DEVELOPMENT SYSTEM (ETI 696) ADDS 24 I/O LINES. WAS \$92.00. SPECIAL PRICE WITH R65F12 AQ, QUIP SOCKET, PCB \$54.00 BUILT AND TESTED \$79.00
- EC-1F12. TARGET SYSTEM (ETI. 697) LOW COST 2 MHZ MINIMUM MICRO COMPUTER SYSTEM. FEATURES 38 I/O 18K MEMORY MAP EXTENDABLE TO BEYOND 4M BYTE. RS232 I/F, WATCHDOG, NICD BATTERY BU. IDEAL FOR INDUSTRIAL CONTROL AND INSTRUMENTS. PCB \$29.00 SPECIAL KIT WITH R65F12AQ, QUIP SOCKET, & PCB WAS \$79.20 SPECIAL KIT \$49.00 BUILT AND TESTED WITH 8K RAM \$129.00
- EC1F11/AD. ANALOGUE I/O ADAPTOR CARD (ETI. 1605) FOR EC-1F11 FORTH DEVELOPMENT KIT. 8CH 11 BIT DYNAMIC RANGE ADC. 2CH 8 DAC, WATCH DOG. IDEAL FOR REAL TIME CONTROL. WAS \$139.00 SPECIAL KIT PRICE WITH R65F12 AQ & QUIP SOCKET & PCB. \$89.00

energy CONTROL

Energy Control Pty Ltd
PO Box 6502, GOODNA QLD 4300
PHONE: (07) 376-2955, TELEX: AA43778 ENECON
PO Box 12153, Wellington North
New Zealand.
PHONE: (644) 84-3499, TELEX: NZ 30135 AUDITOR



Innovation House, multi-tenant lease accommodation at Technology Park, Adelaide.

SOUTH AUSTRALIA: THE TECHNICAL STATE

There's a burgeoning high tech industry in the South that not all Australia knows about. SA is a place where education and industry meet and apparently prosper.

ADELAIDE IS known for many things: an atmosphere that fans call 'laid back', and critics 'sleepy'; lots and lots of English migrants; the Arts Festival; the Grand Prix. It's also perhaps the only state capital in

Australia where they really believe in a technology-led recovery.

In some circles Adelaide is known as much as anything for microelectronics, for robotics, for electro-optics, for biogenetic

engineering. The South Australian scene is small, a strange conglomeration of skills stuck on the edge of a desert, so it gets noticed. In fact, the South Australian government really has managed to as- ►

semble centres of expertise the equal of anything in the rest of the world.

History

The things that make South Australia special in a technological sense really started after the second world war in a way that reflects precious little credit on Australia. The British, feeling left behind in the nuclear race, needed somewhere to let off their bombs. While the British dallied over their decision (Australia or Canada?), the Prime Minister raced around Whitehall begging and pleading with whoever would listen to come and drop bombs on Australia.

They did. From the late '40s to the late '50s, the desert heat of Australia became a testing field for all that was new and horrendous in other peoples' weaponry. From Woomera flew Blue Steel and Blue Streak, Bloodhound and Seaslug; names to conjure with; designed to kill; destined to rust in some mouldy underground bunker in the heart of mother England.

There were some advantages for the Australians, however. Over the years a home grown centre of expertise grew up in rocketry and space activity. But when imperial ambition died in the mid '50s so did the desire for a rocket range on the other side of the world. The British got on their ships and went home, and the Australian space industry, such as it was, was strangled at birth.

Today, Woomera is a shadow of its former glory. The Americans maintain a facility there that's part of their Defence Space Communications Network, but it's destined to be superseded within the next few years by satellite communications. After that: nothing, unless a reborn Australian space industry does something really surprising.

But the ties between Adelaide and the Defence and Technology culture of Woomera could not be broken quite that easily. A huge infrastructure of manufacturing, scientists, technology of all kinds, had been created to service the rocket range from Adelaide. There was a who's who of the British aircraft industry: Bristol Aircraft; English Electric, Fairey. The major British electronic contractors, like Thorn, EMI and Mullard were there too.

Denied their original reason for existence, they took a long hard look at the place, the people and, no doubt the economics of the operation, and stayed. The scale of operations was smaller, for a while very much smaller, but there was sufficient work for them to survive and prosper in the long run.

DRCS

The other major legacy from Woomera was the DRCS, the Defence Research Centre at

Salisbury.

Its list of credits is impressive. In 1952 the Jindivik, still in use as a pilotless target aircraft, was developed there; in 1954 the world's first wire guided anti-tank weapon; in '57 the Skylark sounding rocket; in '59 the Ikara rocket torpedo, still in service with the Royal Navy and the RAN. In 1967 the first and only Australian satellite, Wresat, was launched atop a US Redstone rocket from Woomera. In 1975 the Barra sonobuoy was released. So far its sales have earned \$100m, mainly from Britain.

Today, DRCS has a staff of about 2700, currently over half the total staff of the Defence, Science and Technology department. It is the largest scientific laboratory in the Southern Hemisphere, and one can only assume its comparative invisibility on the Australian scene is due to the paranoia that surrounds military endeavours.

Current interest centres on a laser depth sounder operating from marine aircraft, an over-the-horizon radar and a unique rocket, designed to hover close to ships to attract incoming missiles. The latter development has much interested the Royal Navy, especially survivors of HMS Sheffield. There's even talk about licensed construction in the US.

DRCS also provides many services for local industry, for instance, there are three laboratories capable of doing precise testing of mechanical, electrical and environmental parameters. Products can be tested against vibration, noise, mechanical stress and so on.

The '70s

In the meantime, the state went after a multitude of industries with large requirements for unskilled or semi-skilled workers. By the mid-'60s, most of the major car makers and 'metal benders' had some representation in South Australia. There was a particularly strong representation by the automotive trade. General Motors was perhaps the most significant, certainly the longest lasting, most enduring.

There was also a considerable presence from companies that produced a major part of the nation's output of household appliances, electronic machinery and components.

Then in the early '70s disaster struck. There was a general downturn in manufacturing, caused partially by the international climate, partially by a sudden draconian increase in the cost of oil, and exacerbated by the policies of the government. The whole of Australian manufacture suffered in the ensuing carve up, none more so than in South Australia.

The car manufacturing industry had always been a marginal industry in this country, supported by government pricing

policy rather than any rational economics. With oil prices rising and demand for cars falling, it came increasingly under pressure. Chrysler left, and other major makers and subcontractors followed.

Recovery

With its industrial base contracting, the government turned to two areas for rescue; mining was the short term answer, the revitalization of industry the long term solution.

Mining was a natural; the state has vast reserves of precious minerals. Unfortunately, some of it is also uranium. The road to a mining-led recovery has been at the expense of many a demonstrator in the back of a paddy waggon.

The road to a technology-led recovery has been somewhat slower, less sensational, but no less significant. After years of debate the government decided the most appropriate way of signalling its intentions was to set up a Technology Park, modelled on the parks that were springing up in the US.

The idea was that industry of a certain type would be homogeneously located in a particular area, and close to a University. The site should have been close to the University of Adelaide, but since that was built out, the government decided to locate the park next to the South Australian Institute of Technology's new campus at The Levels.

The South Australian government did the site planning and land acquisition during 1982-83, and set up the first building in early 1984. It's managed by the Technology Park Adelaide Corporation (TPAC), an independent board with representatives drawn from government, academia and industry. The board then rents out space to interested companies. Special legislation was built into the TPAC enabling act to select tenants who conform to their vision of the type of concern required at the park.

By almost any count it's been successful. There are currently about 30 odd companies located there, with several other significant ones in the immediate vicinity. According to TPAC Executive Director, Barry Orr, plans are now well advanced for the fourth multitenant building on the site, reflecting the fact that development has proceeded faster than was originally anticipated.

Among the more notable companies currently in residence are the VLSI designers Austek and Integrated Silicon Design, the South Australian Centre for Remote Sensing, electro-optical engineers, Laserex, and Vision Systems, who build specialist computer imaging equipment.

Built into the fabric of the Park are specialist services likely to be in demand by the types of corporation setting up there. For instance, SAIT runs Techsearch from



GMH plant at Elizabeth.

the Park, which specializes in personnel services for specialist technical support and consultancy. It also makes available SAIT's fabrication and test facilities which are reasonably extensive, including access to design and manufacturing for hybrid and bipolar devices. Techsearch also provides access to heavy duty computing, research and accounting services. It can even tell you how to get money from a venture capitalist.

The Park is also home to the Adelaide Innovation Centre. Manager, John Taylor describes it as the most effective centre of its type in Australia. It specializes in guidance and referral for inventors, and in doing business plans for inventors and organizations who want to know how to turn a good idea into a business.

There has been a considerable degree of criticism of TPAC: that it's a government bureaucracy with a trendy function; that all these companies would have located in Adelaide anyway. It's difficult to make an objective appraisal of whether this is true or not. What can be said is that the existence of the Technology Park at least encourages

entrepreneurs in the view that high technology investment is not entirely silly. If it accomplishes that task it's sufficient justification.

The '80s

The clean out of the '70s destroyed many old established firms and slimmed down many others. The Philips plant at Hendon, for instance, which used to manufacture virtually every component made by Philips factories overseas in the '50s and '60s, today is a specialty house making hybrids and bipolar integrated circuits.

The one good effect was to ensure that those companies that did survive did so because they had a sound economic base and an understanding of where the market was going. The old British aircraft companies amalgamated into British Aerospace Australia (BAeA). Fairey Aircraft transferred its entire ownership to Australia in 1969 to become Fairey Aircraft Australia (FAL). Together with the other established companies like Thorn-EMI, they began to

chase the main buyers of Australian electronics: Telecom and the Defence Department.

They have been successful enough at it to become some of the largest employers in the state. BAeA today, for instance, is working on parts of the FA18A fighter, the F111 and the Orion sub-hunter aircraft for the RAAF, doing a study on a satellite communications system in Queensland, and even working on some home grown space projects once again: ERS-1 (see ETI November '86) and Endeavour, the test bed for the FUSE project (see ETI September '86).

Adelaide is not only attractive to the electronics giants, however. The state is an attractive home to a number of smaller companies: Protronics, Meyer Kreig, Entertainment Audio, and so on. By no means household names, they nevertheless manage to make a very nice living out of selling and distributing around Australia. Isn't SA a long way from everywhere? Not according to Entertainment Audio's Peter Messer: "The client is only ever a phone call away", he says. ●



ECONOMY 4 CHANNEL MICROPHONE MIXER (MM1)

Its size and simplicity makes this mixer very portable and easy to operate.

SPECIFICATIONS:

- 4 low impedance 600 ohm microphone inputs.
- Individual gain control for each microphone.
- Master volume control.
- Power on LED.
- Inputs/Outputs - 6.3mm mono sockets.
- DC operated (9V battery only).
- Input impedance 600 ohm.
- Output impedance 1.5kohm.
- Signal/noise ratio 55dB.
- Frequency response 20Hz to 20kHz plus or minus 2dB.
- Weight 320 grams.
- Dimension 148 x 46 x 86mm.
- Torque variable range 1-22dB.
- Input sensitivity 1mV.
- Output level 90mV (at input 5mV).
- T.H.D. 0.01%.

Cat. A12001

\$44.95



12 CHANNEL STEREO MIXING CONSOLE (MX1210)

Loaded with professional features but simple to operate. A 3 position attenuation switch with -15dB, 0dB, +15dB, together with separate mic. and line inputs allows perfect matching with any input signal. Foldback with the pre-fade send or on stage monitoring. Includes bass and treble controls plus a left and right 5 band graphic equaliser. Other features include effect return panning, P.P.I. overload indicators and stereo headphone monitoring. Ideal for disco's with 2 stereo disc inputs with cross fade. A high quality 12 channel mixer for the professional enthusiast.

SPECIFICATIONS

- Inputs:**
- 12 x Mic -46dB at 47k ohm
 - 12 x Line -20dB at 20k ohm
 - 12 x Phono -52dB at 50k ohms (approx 2mV at 1kHz)
 - Effect Return -20dB at 50k ohm
- Outputs:**
- PGM Out 0dB at 10k
 - F/B Out 0dB at 10k ohm
 - Effect Send 0dB at 10k ohm
 - Rec. Out -4dB at 10k ohm
 - Headphones +10dB at 600 ohm (100 - 1k ohm)
- Equaliser (Channel):** Bass+ -12dB (100Hz), Treble+ -12dB (10kHz)
- Equaliser (Master):** 100/330/1k/3.3k/10kHz, (5 band stereo) + -12dB
- Frequency Response:** 20 - 20kHz (+1dB, -3dB)
- S/N Ratio (IHF-A):** 120dB
- T.H.D.:** 0.15% at 1kHz
- Peak Indicators:** 12 x LED
- Power Supply:** 240V AC 50Hz
- Power Consumption:** 8W
- Dimensions:** 662(W) x 356(D) x 105(H)mm
- Weight:** 8kg
- RRP \$1,256 **OUR PRICE \$1,150**

16 CHANNEL STEREO MIXING CONSOLE (MX1610)

The same general description as the MX1210 but with the advantage of more channels.

SPECIFICATIONS

- Inputs:**
- 16 x Mic -46dB at 47k ohm
 - 16 x Line -20dB at 20k ohm
 - 16 x Phono -52dB at 50k ohm (approx 2mV at 1kHz)
 - Effects Return -20dB at 50k ohm
- Outputs:**
- PGM Out 0dB at 10k
 - F/B Out 0dB at 10k ohm
 - Effect Sound 0dB at 10k ohm
 - Rec. Out -4dB at 10k ohm
 - Headphones +10dB at 600 ohm (100 - 1k ohm)
- Equaliser (Channel):** Bass+ -12dB (100Hz), Treble+ -12dB (10kHz)
- Equaliser (Master):** 100/330/1k/3.3k/10kHz, (5 band stereo) + -12dB
- Frequency Response:** 20 - 20kHz (+1dB, -3dB)
- S/N Ratio (IHF-A):** 120dB
- T.H.D.:** 0.15% at 1kHz
- Peak Indicators:** 16 x LED
- Power Supply:** AC117/220/240V, 50/60Hz
- Power Consumption:** 8W
- Dimensions:** 750(W) x 356(D) x 105(H)mm
- Weight:** 9kg
- RRP \$2,330 **OUR PRICE \$2,095**



DISCO MIXER WITH GRAPHIC EQUALISER (MX1)

This stereo mixer is especially designed for discotheques and radio studios. It is a versatile rack or console mounting mixer with varied features which enable high quality broadcasts through its 3 microphone inputs, 3 phono inputs or 3 line inputs.

- 6 channel monitoring system
- 9 point dual LED output level display
- Output panpot
- 3 outputs
- Adjustable talkover with LED display
- Master level control

SPECIFICATIONS

- Input:**
- Talk Mic. 47k ohms nominal 5mV
 - Mic. 2,3 47k ohms nominal 5mV
 - Phono 1,2,3 47k ohms nominal 5mV
 - Line 1,2,3 37k ohms nominal 300mV
 - Output 1k ohm nominal 0.775V
 - Rec. Out 1k ohm nominal 250mV
 - Line Out 1k ohm nominal 250mV
- Frequency Response:**
- Talk Mic. 150Hz - 7kHz -3dB
 - Mic. 2,3 15Hz - 30kHz -3dB
 - Phono 1,2,3 20Hz - 20kHz + -2dB
 - Line 1,2,3 15Hz - 100kHz -3dB
 - S/N Ratio: (IHF-A, input short)
 - Talk Mic. -73dB/5mV
 - Mic. 2,3 -73dB/5mV
 - Phono 1,2,3 -76dB/5mV
 - Line 1,2,3 -80dB/300mV
- Crosstalk:** Better than 60dB/1kHz
- T.H.D.:** Less than 0.1%/1kHz
- H.P. Out Level:** 55mV/80 ohms - 1k ohm
- Eq. Frequency:** 60/250/1k/4k/12kHz + -12dB
- Talk Over Level:** -14dB
- Meter Level:** 0dB = 0.775V/1.5V
- Power Consumption:** 15 watts
- Power Supply:** 240V 50Hz
- Dimensions:** 482(W)x222(H)x130(D)mm
- Net Weight:** 4.5kg
- R.R.P. \$865 **OUR PRICE \$765**



UNIVERSAL MIXER WITH CUE CONTROL (MM3)

- Microphone inputs 2 high or low impedance.
- Two stereo phono inputs magnetic or ceramic.
- 1 stereo line input for tape or tuner.
- Cue function with LED indicator for each input.
- Tape recorder output connections.
- Dual VU meters to monitor output and cue level.
- Mono/stereo mode selector.
- Battery test button to check their condition.
- DC or AC adaptor operation.

Input Sensitivity: Mic. low 0.7mV at 600 Ohm, Mic. High 3.5mV at 50k ohm
Phono Mag. 2.5mV at 50k ohm, **Phono Cer.** 150mV at 100k Ohms
Tape Tuner: 150mV 50k ohms
S/N Ratio: More than 55dB
T.H.D.: Less than 0.5%
Frequency Response: 20 - 20kHz + -2dB
Output Level: 300mV
Recording Output: 120mV
Power Source: 9V DC (PP100/9)
Dimensions: 265 x 195 x 70mm
Weight: 1.8kg

RRP \$199

OUR PRICE \$179

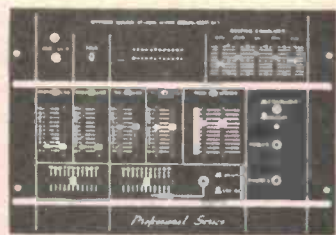

UNIVERSAL STEREO MIXER WITH GRAPHIC EQUALISER (MM4)

The MM4 is our most flexible mixer. Incorporating the most advanced IC technology for performance and reliability. Built in graphic equaliser virtually eliminates the need for a pre-amplifier. Features 4 stereo program and 2 microphone inputs.

SPECIFICATIONS:

- Input Sensitivity:**
- Mic. 1.5mV at 10k ohm
 - Phono. 1.5mV at 50k ohm
 - Line 75mV at 50k ohm
- Rated Output:**
- Amp 1V/600 ohms
 - Rec. 1V/600 ohms
- T.H.D.:** Less than 1% at 1kHz
- Hum and Noise:**
- Mic. -52dB
 - Phono -62dB
 - Line -65dB
- Frequency Response:**
- Mic. 30 - 16kHz (1dB)
 - Phono 30 - 20kHz (RIAA + -dB)
 - Line 20 - 30kHz (-1dB)
- Power Source:** 240V AC 50Hz
- Size:** 360 x 260 x 85mm
- Weight:** 2.9kg

EQUALISER SECTION

Control of Frequency: 60Hz, 250Hz, 1kHz, 3.5kHz, 12kHz
Control Range: + -12dB boost or cut - centre detent
Headphone Output: (Cue) 150mV at 75 ohm at 0.5% T.H.D.
Talk Switch: -14dB

R.R.P. \$399

OUR PRICE \$379



MULTITRACK MIXING CONSOLE (MX842)

With balanced and Cannon inputs the MX842 is a complete multitrack mixing console. The four group out with stereo master configuration is designed for both studio and P.A. applications, either with a four track recorder or live P.A. mixing with the advantage of four sub groups. It is well equipped with all functions needed to produce first class results.

FEATURES:

- Balanced line inputs
- Cannon and 6.35mm inputs
- 240V operated, fuse protected
- Comprehensive headphone monitoring

- Inputs:**
- 8 x Mic -46dB/18k ohm (Cannon)
 - 8 x Line -20dB/15k ohm (6.35)
- Outputs:**
- 2 x Master: Max. output +18dBV (Cannon)
 - 4 x Group: Max. output +18dBV (6.35mm)
 - 1 x Master Effect Send: Gain 18dBV (6.35mm)
 - 2 x Recorder: Gain 18dBV (6.35mm)
 - 1 x Headphone Output: 2mW/8kohm, 30mW at 500ohms
- Frequency Response:** 20-20kHz + -2dB
- S/N Ratio:** 120dB
- T.H.D.:** Less than 0.15% at 1kHz
- Peak Indicators:** 5 point master level control
- Power Consumption:** 15W
- Power Supply:** 240V AC 50Hz
- Dimensions:** 622(W) x 105(H) x 356(D)mm
- Weight:** 6.8kg
- R.R.P. \$1,425 **OUR PRICE \$1,275**



ARLEC "DISCO LITE" CONTROLLER

Give your parties a professional touch with the arlec "Disco Lite". Simply plug your light(s) into the "Disco Lite" and you've instant party life!

3 DIFFERENT MODES!
Music Mode: Place the "Disco Lite" in range of the speakers and it flashes the lights to the beat of the music!

Strobe Mode: Simply adjust to desired speed! Great for mime or theatre! The Christmas season or advertising!

Dim Mode: Allows you to dim the lights to create moods, effects etc.

Cat. M22003 \$49.50

Made by Piezo (Azden) of Japan, this device will turn any microphone fitted with a Cannon Type male socket into a wireless microphone. The receiver will plug into any 6.35mm microphone input. Both transmitter and receiver can be tuned from 76 - 81MHz.
Freq. Response: 50 - 16kHz
Tunable: 76 - 81MHz
Field Strength:
 Transmitter 10uV/100 metres
 Receiver 15mV (1.00%)
Battery: Transmitter LR44 (1.5V)
 Receiver 3 x UM4 (4.5V)
 Instructions: Japanese (English not available)
 Cat. A10520 R.R.P. \$199
Our price, only \$189

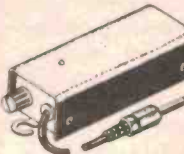

MICROPHONE ECHO ADAPTER (SM100)

Gives microphones "depth". Invaluable when using them in "dead" room/halls etc.
 ● Echo effects may be varied
 ● Volume control
 ● Power on LED
 ● Fits in line
 ● Standard 6.5mm socket and plug
 ● Power 9V battery
 ● Input low impedance
 ● Output 30mV (max)
 ● Signal/noise ratio 40dB
 ● Delay time up to 60m seconds
 ● Frequency response 50 - 15kHz
 ● Cord length 75cm
 ● Weight 220 grams
 ● Dimensions 115 x 32 x 44mm
 Cat. A10530 \$44.95



CRYSTAL LOCKED WIRELESS MICROPHONE AND RECEIVER

MICROPHONE SPECIFICATIONS:
 Transmitting Frequency: 37.1MHz
 Transmitted System: crystal oscillation

Microphone: Electret condenser
Power Supply: 9V battery
 Range: 300 feet in open field
 Dimensions: 185 x 27 x 38mm
 Weight: 160 grams

RECEIVER SPECIFICATIONS:
 Receiving Freq. 37.1MHz
Output Level: 30mV (maximum)
Receiving System: Super heterodyne crystal oscillation
Power Supply: 9V Battery or 9V DC power adapter

Volume control
Tuning LED
 Dimensions: 115 x 32 x 44mm
 Weight: 220 grams
 Cat. A10452 R.R.P. \$113
Our price, \$99

Audio Audio Audio Audio

MAIL ORDER TOLL FREE
008 33 5757
 (STRICTLY ORDERS ONLY)
 INQUIRIES TO (03) 543 7877



CAR REPLACEMENT SPEAKERS
 All are rated at 4 ohm, Nominal 3W, Maximum 5W with 3 inch magnets, and feature dust proof covers.
 5" x 7" Oval Cat.C10757 \$11.95
 4" x 6" Oval Cat.C10746 \$10.50
 5" Round Cat.C10705 \$8.95
 6" Round Cat.C10706 \$10.95



CAR ANTENNA BOOSTER
 • In-line installation
 • 12V boosts 100%
 Cat. A12073 \$7.95



STEREO VOLUME CONTROL
 30W RMS, wire wound, ceramic base with heatsink
 Cat. A \$29.95

STEREO VOLUME CONTROL
 10W RMS, wire wound, ceramic base with heatsink
 Cat. A \$29.95

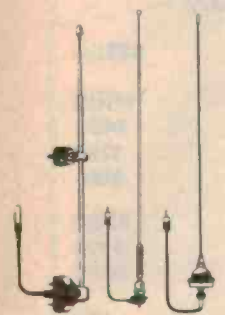

CAR ANTENNAS MODEL CA-1
 • 4 section
 • 860mm length
 • Top key lock down
 • 1.2 metre lead
 Cat. A12061 \$5.95

MODEL CA-2
 • 3 section
 • 1.4 metres extended
 • 1.2 metre lead
 • Spring based
 Cat. A12062 \$13.95

MODEL CA-3
 • Stainless
 • Top cowl
 • 1 section whip
 • 1 metre length
 • 1.2 metre lead
 Cat. A12063 \$7.95

MODEL CA-4
 • Pillar mount
 • 3 section
 • Fits Toyota, Nissan, Mazda
 Cat. A12060 \$6.95

MODEL CA-5
 • Roof, boot, mount anywhere
 • 830mm length
 • 3 section, tuned for FM
 • 2 metre lead
 Cat. A12065 \$12.95

MODEL CA-6
 • Rubber duckie
 • 1 section flexible rubber
 • Flexible spring base
 • Adjustable ball
 • 1.2 metre lead
 Cat. A12066 \$11.95

MODEL CA-7
 • Black, 1 section whip
 • Top cowl
 • 1 metre length
 • 1.2 metre lead
 Cat. A12067 \$7.95



CAR ANTENNAS (POWERED)

MODEL ACA-1
 • Semi automatic
 • 5 section
 • 1 metre stainless steel
 • 1.2 metre feeder cable
 • 12V DC
 Cat. A12070 \$34.95

MODEL ACA-2
 • Fully automatic
 • 5 section
 • 1 metre stainless steel
 • 1.2 metre feeder cable
 • 12V DC
 Cat. A12071 \$49.95

MODEL ACA-3
 • Semi automatic, flush head
 • 5 section
 • 1 metre stainless steel
 • 1.2 metre feeder cable
 • 12V DC
 Cat. A12072 \$59.95

CROSSOVER NETWORKS
 Crossovers are essential for multiway speaker systems, otherwise your bass will be degraded by inter-modulation distortion and cone break up, and your treble will be distorted by bass components. These crossovers are designed to channel only the frequencies that each driver can properly handle. Read the specifications to choose the correct one for your need.



2 WAY 60 WATT CROSSOVER NETWORK
 • 6dB attenuation
 • Cross over point 3,500 Hz
 • Impedance 8 ohms
 Cat. A16001 \$7.95

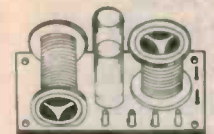

3 WAY 60 WATT CROSSOVER NETWORK
 • 6dB attenuation
 • Cross over point 800 and 5,000 Hz
 • Impedance 8 ohms
 Cat. A16003 \$12.95



3 WAY 100 WATT CROSSOVER NETWORK
 • 12dB attenuation
 • Cross over point 800 and 5,000 Hz
 • Impedance 8 ohms
 Cat. A16005 \$28.95



2 WAY MID SIZED SPEAKER SYSTEM
 Labyrinth enclosure assures adequate bass at low volume. Polypropylene woofer with aluminium voice coil. Finished in walnut cabinet with removable black grille.
SPECIFICATIONS:
 Speakers: 6 1/2" woofer and 2 1/2" tweeter
 Power Input: 30W RMS 86dB/Wm
 Impedance: 8 ohms
 Frequency Response: 60 - 20kHz
 Size: 345(H) x 230(W) x 280(D)mm
 Weight: 3.8kg each
 Cat. C10766 \$179



3 WAY MINI BOOKSHELF SPEAKER SYSTEM
 Aluminium diecast cabinet. Superb sound for it's size with polypropylene cone for bass driver. Finished in black/grey with black mesh grille and comes complete with mounting bracket.
SPECIFICATIONS:
 Speakers: 4 1/2" woofer, 2" midrange, 1" dome tweeter.
 Power Input: 30W RMS 86dB/Wm
 Impedance: 8 ohms
 Frequency Response: 70 - 20kHz
 Size: 186(H) x 116(W) x 120(D)mm
 Weight: 2kg each
 Cat. C10764 \$169



1" DOME TWEETER SPEAKER
 Mylar diaphragm
SPECIFICATIONS:
 Sensitivity: 96dB
 Frequency Response: 2-20 kHz
 Impedance: 8 ohms
 Power RMS: 15 watts RMS
 Magnet Weight: 5.4cz.
 Size: 96mm diameter
 Cat. C10234 \$10.95



2" HORN TWEETER SPEAKER
 Mylar diaphragm, aluminium voice coil
SPECIFICATIONS:
 Sensitivity: 95dB
 Frequency Response: 1.5-20 kHz
 Impedance: 8 ohms
 Power RMS: 10 watts RMS
 Magnet Weight: 2.5oz.
 Cat. C10232 \$8.95



4" EXTENDED RANGE SPEAKER
 Rubber edge, black cone
SPECIFICATIONS:
 Sensitivity: 90dB
 Frequency Response: 90-8 kHz
 Impedance: 8 ohms
 Power RMS: 8 watts RMS
 Magnet Weight: 5.3oz.
 Cat. C10220 \$13.95



5" MIDRANGE SPEAKER
 Sealed back, foam edge, black cone, silver dust cap
SPECIFICATIONS:
 Sensitivity: 98dB
 Frequency Response: 500-8 kHz
 Impedance: 8 ohms
 Power RMS: 10 watts RMS
 Magnet Weight: 5.4oz.
 Cat. C10230 \$12.95



6 1/2" TWIN CONE FULL RANGE SPEAKER
 Foam edge, black cone, black whizzer cone
SPECIFICATIONS:
 Sensitivity: 89dB
 Frequency Response: 60-15 kHz
 Impedance: 8 ohms
 Power RMS: 10 watts RMS
 Magnet Weight: 5.3oz.
 Cat. C10222 \$14.95

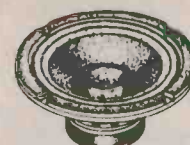

8" TWIN CONE FULL RANGE SPEAKER
 Foam edge, black cone, black whizzer cone
SPECIFICATIONS:
 Sensitivity: 98dB
 Frequency Response: 45-16 kHz
 Impedance: 8 ohms
 Power RMS: 30 watts RMS
 Magnet Weight: 13oz
 Cat. C10224 \$23.95



8" WOOFER HIGH POWER SPEAKER
 Cloth edge, dark grey cone, rubber mounting seal, cloth dust cap
SPECIFICATIONS:
 Sensitivity: 90dB
 Frequency Response: 60-4 kHz
 Impedance: 8 ohms
 Power RMS: 50 watts RMS
 Magnet Weight: 20oz.
 Cat. C10226 \$34.95

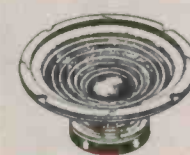

10" WOOFER HIGH POWER SPEAKER
 Cloth edge, dark grey cone, rubber mounting seal, cloth dust cap
SPECIFICATIONS:
 Sensitivity: 93dB
 Frequency Response: 50-2.5 kHz
 Impedance: 8 ohms
 Power RMS: 100 watts RMS
 Magnet Weight: 30oz.
 Cat. C10228 \$59.95

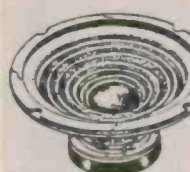

12" WOOFER HIGH POWER SPEAKER
 Cloth edge, dark grey cone, rubber mounting seal, cloth dust cap
SPECIFICATIONS:
 Sensitivity: 97dB
 Frequency Response: 28-4 kHz
 Impedance: 8 ohms
 Power RMS: 50 watts RMS
 Magnet Weight: 30oz.
 Cat. C10229 \$69.95



DUAL ATTENUATOR
 • LED indicator
 • Mid-high range for 3 way systems
 • Impedance 8-10 ohms
 • Power handling 18 watts RMS
 Cat. A16013 \$17.95



EXTENSION SPEAKER 1
 Slimline walnut cabinet with mounting holes and volume control.
SPECIFICATIONS:
 Speaker: 5"
 Impedance: 8 ohm
 Magnet: 3oz
 Nominal Power: 3W/5W maximum
 Size: 245(L) x 150(W) x 65(D)mm
 Cat. C????? \$44.95



STEREO FADER CONTROL
 Allows front/rear control. 30W RMS, ceramic base with heatsink
 Cat. A \$25.95

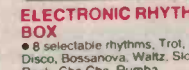

ELECTRONIC RHYTHM BOX
 • 8 selectable rhythms, Trot, Rock, Disco, Bossanova, Waltz, Slow Rock, Cha Cha, Rumba
 • Power 9V battery or AC adaptor
 • Volume control
 • Rhythm tempo control, 10 steps
 • Power on LED
 • Footswitch facilities
 • Output level 150mV (max)
 • Weight 750 grams
 • Dimensions 190 x 52 x 132mm
 Cat. A12048 \$89.95

PORTABLE MINI P.A. AMPLIFIER

A completely portable system, sets up anywhere in seconds. Inputs for microphone, electronic organ and cassette players. Variable echo makes this an ideal unit for buskers and budding singers.
SPECIFICATIONS:
 Output power: 1W RMS, 2W max.
 Frequency Response: 100-15kHz
 Speaker: 5" Full range, 4 ohms
 Echo Time: Variable 5-52msec
 Power Source: 6x 'D' size batteries (position for power adaptor also)
 Size: 280(H) x 120(W) x 180(D)mm
 Weight: 1.3kg
 Cat. A12022 \$89.95



MINI HAND HELD MEGAPHONE

Suitable for schools, sports meetings, boats, etc. Portable, lightweight and effective with anti howling dynamic microphone. High power output, low power consumption.
SPECIFICATIONS:
 Size: 150mm diameter
 Power output: 24 watt maximum
 Effective Distance: 120 metres
 Power source: 6 x 'AA' batteries
 Power duration: 6 hours
 Weight: 0.6kg
 Cat. A????? \$69.95



Rod Irving Electronics
 48 A Beckett St, MELBOURNE
 Phone (03) 663 6151
 425 High St, NORTHCOTE
 Phone (03) 488 8866
 Mail Order and Correspondence:
 P.O. Box 620, CLAYTON 3168
 Telex: AA 151938



MAIL ORDER HOTLINE
 008 335757
 (TOLL FREE)
 (STRICTLY ORDERS ONLY)

LOCAL ORDERS & INQUIRIES
 (03) 543 7877

POSTAGE RATES:

\$1	\$9.99	\$2.00
\$10	\$24.99	\$3.00
\$25	\$49.99	\$4.00
\$50	\$99.99	\$5.00
\$100	\$199.99	\$7.50
\$200	\$499.99	\$10.00
\$500 plus		\$12.50

FREE POSTAGE FOR ORDERS OVER \$75 & UNDER 3KG!!

The above postage rates are for basic postage only. Road Freight, bulky and fragile items will be charged at different rates.

Registered Post for orders over \$100 included free
 Registered Post for orders over \$200 included free

All sales tax exempt orders and wholesale inquiries to: RITRONICS WHOLESALE, 56 Renner Rd, Clayton Ph. (03) 543 2166 (9 lines)

Errors and omissions excepted



FREE POSTAGE FOR ALL ORDERS OVER \$75 & UNDER 3KG!!

ATTENTION

**We
Have
Moved!**

WE ARE NOW THE appointed Queensland Distributors for all **NATIONAL PANASONIC** spare parts.

ALSO stocking what we believe to be the most comprehensive range of electronic components accessories, tools and test equipment in Queensland today.

SUPPLYING professionals and hobbyists alike, for the service of most types of electronic equipment for the manufacturing, installation and replacement parts industry.

WE have keen and professional staff eagerly waiting to help.

**SO FOR ALL YOUR
ELECTRONICS
REQUIREMENTS**

**PHONE NOW
(07) 52 3762**

**ECONOMIC
ELECTRONICS**

**24 CAMPBELL STREET
BOWEN HILLS, 4006.**

TELEX: AA42883 FAX: (07) 52 2862

Also

**SOUTHPORT ELECTRONICS SHOP
11 DAVENPORT ST, SOUTHPORT
PH: (075) 321 3622**

"WHICH RADIO DO I NEED?"

**...THE ANSWER IS
IN THE PALM
OF YOUR HAND**

Whatever task you have to do the ICOM IC-40 is the one that can handle it.

It's ideally suited for farming, transport, sports, bushwalking & boating. Whatever the communication problem you need to solve this is the radio that's being

proven every day in a million different uses.

Contact your local dealer for a demonstration of the most advanced CRS portable available in Australia.



Please post to:

ICOM AUSTRALIA PTY. LTD.
7 DUKE STREET WINDSOR 3182.
VICTORIA.

Name _____

Address _____

City _____ Postcode _____

or phone ICOM on (03) 51 2284



The World System



Showrooms:

300 Main Street, Lilydale
P.O. Box 509, Lilydale, 3140
Melb. Vic. (03) 735-0588
673 High Street, Preston
(03) 470 5822

AMPLIFIERS
ZPE Series II (600W) **\$2500**

DISCO MIXERS
Citronic SM 350 **\$1100**
Arista with equaliser **\$450**

JUMBO STROBE **\$195**
Scanner **\$150**

HELICOPTER
2 ARM Spinner **\$300**
4 ARM Spinner **\$498**
6 ARM Spinner **\$580**



PINSPOT
Par 36 **\$59**
Par 56 **\$130**



MIRROR BALLS
MB 008-8" **\$58**
MB 012 **\$88**
MB 014 **\$120**
MB 018 **\$160**
MB 020 **\$198**

SMOKE MACHINES
Great for Special Effects
Hand Held 240V **\$375**

Dynamite 1200 Smoke Machine
Has remote control lead to operate off-stage. We are so excited about this that full money back guarantee will be valid for 10 days from purchase date

Our own product **\$1800**
Fluid—1 litre **\$15**

MIRROR BALL MOTORS
AC 240V **\$39**
Heavy Duty **\$100**

ROLLING LIGHTS
8 x 4515 lamps **\$1800**

AUDIO CHASER **\$700**
(DW4LC4000)
Musicolor and chaser all in one!!
Our own product



COSMO
24 lamps **\$2600**
Half Ball rotary light
6 lamps **\$780**

LAMPS all colours, so cheap!
No Warranty on Breakages
ES 240V 60W box of 25 **\$100**
BC 240V 40W box of 100 **\$90**
BC 240V 25W box of 100 **\$75**

Prices subject to change without notice. Items for hire or sale. Power Cords not included. Send S.A.E. with 60 cents postage for free price list

We have Piezo tweeters, Etone speakers, Rope lights and many other products.

Do You Want To Be An Agent?

IC0014

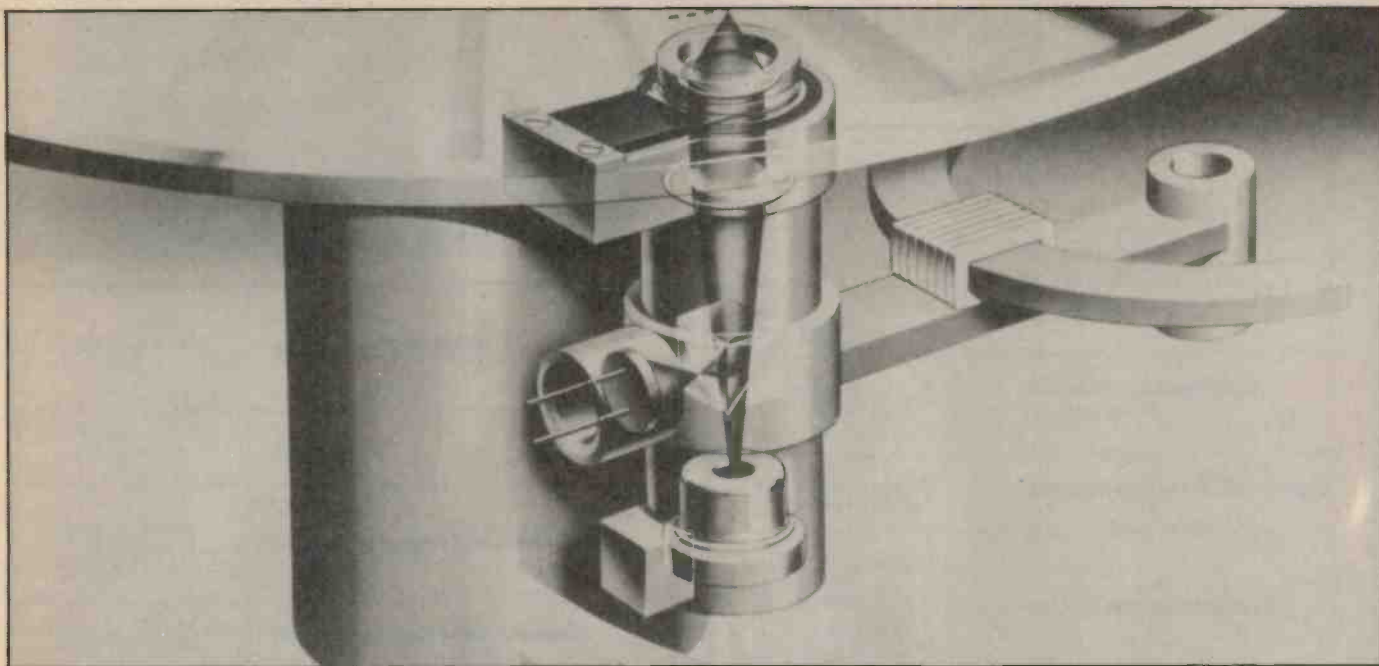

BUYERS GUIDE TO COMPACT DISC PLAYERS

WELCOME TO OUR compact disc buyers' guide. On the following pages we have listed all the compact disc players we could find in Australia. There's getting to be quite a few, so this should help you through the jungle.

During the last year or so compact disc players have moved from being the most esoteric of devices to being the mandatory next step. Soon after the introduction of the first units, Sony was trying to mimic its Walkman with a small portable; CD players were appearing in place of cassette units in car rigs; they were even popping up in the latest ghetto blasters. As a result, we have broken our table down into the four most common categories for hi-fi units: portable units, players specifically for use in motor cars, mantel models that become just another hi-fi component and a ghetto blaster class for combination units.

In composing the table, we have tried to include the features most likely to be of interest when buying a compact disc player. You will notice straight away that the performance characteristics like frequency response and signal-to-noise ratio (SNR) have been consigned to the bottom of the list. The reason is not that they are unimportant, simply that you can't really use them to decide between units. All compact disc players have figures way in excess of any other music source, and

extremely close to each other.

As an example, you may notice that some manufacturers claim 94 dB SNR, others 96. The most educated ear in the country will not tell the difference. On the other hand, everyone will tell the difference between that and typical tape performance, which might well be 20 dB worse.

Slightly more controversial, but only slightly, are the columns labelled 'DAC levels' and 'oversampling'. 'DAC levels' refers to the number of levels of discrimination in the digital signal. In machines that use 16-bit sampling there are 65,536 levels. In machines with 14-bit words, there are 16,384. This means that an individual excursion of the waveform consists of, at most, 16 or 65 thousand steps.

This step structure of a supposedly smooth wave is called aliasing. Since the sampling is done at 44.1 kHz, the first harmonic comes in at 22 kHz, perilously close to the top of the audio band. In order to avoid any interference, an anti-aliasing filter is included in the basic CD player design. Essentially, this is a brick wall at about 21 kHz. The problem here is to avoid phase errors being induced in the top of the audio band by a filter with such a sharp cut off. One solution is to be very clever in your filter design. Another is to go to oversampling, in which the sampling is done at twice or four times the normal rate. This leads to

a less dramatic filtering requirement.

From a purist's point of view several problems result. An argument is often made that you can actually hear the 'aliasing noise' on the waveform, especially in 14-bit machines. Alternatively, that you can hear the phase distortion in undersampled machines, or that the presence of the brick wall filter gives CD an unnatural sound since none of the ultrasonic harmonics are being transmitted.

There is probably a grain of truth in all this. Given a perfectly optimized listening area, the best speakers money can buy and no expense spared in cables and connectors (see our 'cables' feature) an average listener can probably discern some of these differences. In an ordinary living room, the difference between 14- and 16-bit sampling might just be discernible. Whether it's worth paying for is another question.

What is worth paying money for? Some of the biggest differences are in ergonomics and appearance. This seems to be a point manufacturers are aware of, as they rush to configure the CD player in ways that will attract the market. The exact features depend very much on the application.

In automotive ergonomics, one of the more interesting developments is the disc jockey type unit, where the player can be loaded with, say, 10 discs at a time. (See, for instance, the Sony Bootmount review in

1986 CD PLAYERS BUYERS GUIDE

PORTABLE			
Brand	JVC Philips Realistic Sanyo Sony Technics Toshiba	Model	XLR10 CD10/EM2310 CD3000 CP10 DSST DS0-2 SLXP7/K XR-P9RC
Price (\$)	649 504 530 369 699 499 499 554	Dimensions (mm)	126x32x127 130x50x210 127x37x175 127x41x187 127x34x133 126x27x126 126x32x126 126x39x178
Weight (gm)	440 900 520 90 570 510 520 520	Warranty (years)	1 1 1 1/2 1 1 2 3
12V Input	r y y y y y r y	Battery (Type/Volt/No)	BNR10K LM2/1.5/6 C/1.5/6 Nic/7.2-8.4 Nic/6/1 Nic/6/1 C/1.5/6
Line Output (V)	1.9 1.6 1 1.6 1.6 2 1	X Oversampling	1 1 1 1 1 1 1 2
Frequency Response at -3dB	4Hz-20kHz 20Hz-20kHz 5Hz-20kHz 5Hz-20kHz 20Hz-20kHz 20Hz-20kHz 4Hz-20kHz at -0.5dB 5Hz-20kHz	Signal to Noise Ratio at 1kHz (dB)	>90 73 90 90 90 >90 >90
Total Harmonic Distortion at 1kHz (%)	0.006 <0.008 0.01 0.01 0.008 0.008 <0.004 0.1	DAC Levels	16k 65k 65k 65k
Remote Control	r r r r r r r y	Keys	n/a n/a n/a n/a n/a n/a n/a 14

AUTOMOTIVE			
Brand	Kenwood Pioneer Sony Yamaha	Model	KDC9 DEX775 CDXP1 CDXJ10 CDXR7 YCD1000
Price (\$)	1492 1399 999 1999 1249 699	Dimensions (mm)	180x50x140 180x50x150 327x134x221 178x50x155 180x50x180
Weight (kg)	1.8 2 5.6 2.5 1.55	Warranty (years)	1 1 1 1 1 1
X Oversampling	1 1 1 1 1 2	Frequency Response at -3dB	5Hz-20kHz 10Hz-20kHz 5Hz-20kHz 5Hz-20kHz 20Hz-20kHz
Signal to Noise Ratio at 1kHz (dB)	90 90 >90 85 90 92	DAC Levels	65k 65k
Total Harmonic Distortion at 1kHz (%)	0.005 0.005 <0.005 0.02 0.005 <0.05	Magazine Disc Capacity	n/a n/a n/a 10 n/a n/a

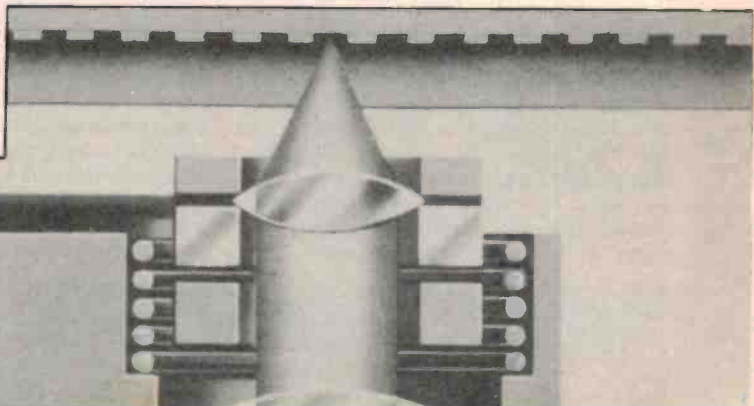

1986 CD PLAYERS BUYERS GUIDE

COMPONENT		Brand	Model	Price (\$)	Dimensions (mm)	Weight (kg)	Warranty (years)	Remote Control	Keys	Line Output (V)	Headphone Jack	Loading	X Oversampling	Frequency Response at -3dB	Signal to Noise Ratio at 1kHz (dB)	Total Harmonic Distortion at 1kHz (%)	DAC Levels
		Accuphase	DP80/DC81	10,000	475x270x373	30.5	5	y	25		n	front	2	4Hz-20kHz at -0.3dB	106	0.002	65k
		Aiwa	DX550	470	330x80x306	3.7	3	n	n/a	2	n	front		5Hz-20kHz	93	0.004	
			DX770	590	330x72x307	3.4	3	n	n/a		n	front		2Hz-20kHz	93		
		Aka i	CD-M515	499			1	n	n/a		n	front	1	5Hz-20kHz		0.006	
			CD-A70	699	440x79x260	3.9	1	y	26	2	y	front	2	5Hz-20kHz	95	0.003	
			CD-A3011	499	440x79x260	3.5	1	n	n/a	2	y	front	1	5Hz-20kHz		0.006	
		Dennon	DCD1500	1264	434x89x350	6	2	y	20	2	y	front		5Hz-20kHz	96	0.0025	
			DCD1300	899	434x89x350	5.4	2	y	20	2	y	front		5Hz-20kHz	96	0.003	
			DCD500	649	434x92x305	3.6	2	n	n/a	2	y	front		5Hz-20kHz at -0.5dB	95	0.004	
			DCD700	699	434x92x305	3.6	2	y	24	2	y	front		5Hz-20kHz at -0.5dB	95	0.004	
		Harman/Kardon	HD500	1399	443x103x335	5.8	5	y	10	2.4	y	front	1		100	0.01	
		JVC	XLV330B	649	435x83x288	4	1	y	23		y	front		5Hz-20kHz	93	0.004	
			XLV22B	529	340x83x288	3.4	1	n	n/a		n	front		5Hz-20kHz	93	0.004	
			XLV220B	529	435x83x288	4	1	n	n/a		y	front		5Hz-20kHz	93	0.004	
		Kenwood	DP770	769	340x74x351	4.9	3	n	n/a	2	y	front	1	5Hz-20kHz	95	0.002	65k
			DP750	550	420x80x309	4.1	3	n	n/a	2	y	front	1	5Hz-20kHz at -0.5	96	0.003	65k
			DP1000	880	440x88x313	6	3	y	10	2	y	front	4	4Hz-20kHz at -0.5	85	0.0015	65k
			DP2000	1299	440x95x313	9.1	3	y	10	2	y	front	4	2Hz-20kHz at -0.5	86	0.001	65k
		Luxman	D-103	1195	453x84x313	5	5	n	n/a	2	y	front	1	5Hz-20kHz	96	0.003	
			D-105	1599	453x84x313	6	5	n	n/a	2	y	front	1	5Hz-20kHz	96	0.003	
			D-100	1095	436x85x313	4.4	5	y	14	2	y	front	1	5Hz-20kHz	90	0.005	
		Marantz	CD45	399	320x90x300	3.5	2	bus	n/a		n	front	4	20Hz-20kHz	>100	0.002	
			CD56	499	420x90x300	4	2	bus	n/a		n	front	4	20Hz-20kHz	>102	0.0015	
			CD65	599	420x90x300	4	2	bus	n/a		y	front	4	20Hz-20kHz	>102	0.0015	
		Mitsubishi Electric	DP-107	507	340x92x290	3.6	1	n	n/a	2	y	front	2	5Hz-20kHz at -1dB	98	<0.003	65k
			DP-603	526	335x86.5x287	3.6	1	n	n/a	2	n	front	2	5Hz-20kHz at -1dB	98	0.004	65k
		NAD	5355	1100	420x84x310	5	3	y	7		n	front		5Hz-20kHz	98	0.005	
			5330	799	420x84x310	5	3	n	n/a		n	front		5Hz-20kHz	98	0.005	
		Nakamichi	OM6-4	2200	430x100x322	7.1	2	y	13	2.5	y	front	2	5Hz-20kHz	100	0.0055	
			OM6-3	1750	430x100x322	6.6	2	y	13	2.5	y	front	2	5Hz-20kHz at -0.5dB	97	0.007	
			OM6-511	2700	435x100x308	7.3	2	n	n/a	2	n	front	4	5Hz-20kHz at 0.5dB	104	0.0025	65k

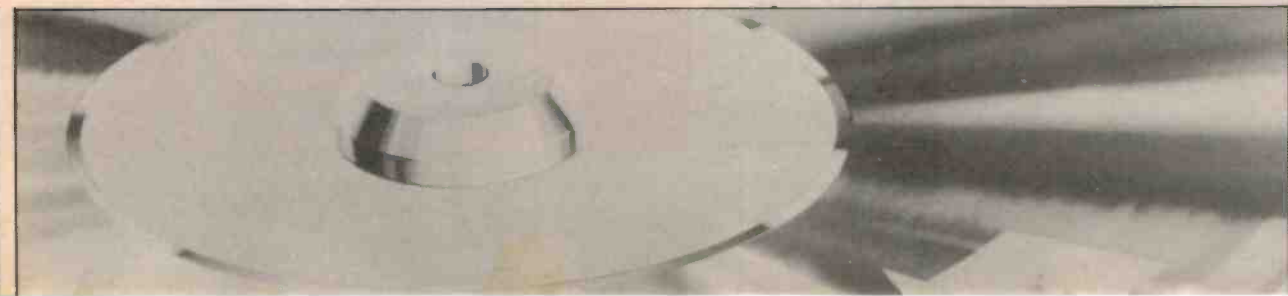

NEC	OM6-711	3500	435x100x308	7.4	2	y	24	2	y	front	4	5Hz-20kHz at -0.5dB	104	0.0025	65k
	CD500E	399	430x75x270	4.4	1	n	n/a	2	n	front	1	5Hz-20kHz	95	0.007	65k
Onkyo	CD-509E	499	430x90x320	5	1	y	10	2	y	front	1	5Hz-20kHz	90	0.01	65k
	DX320	1199	435x92x357	5.8	5	y	22	2	y	front	2	2Hz-20kHz	96	0.003	65k
	DX120	499	435x92x350	4.6	5	n	n/a	2	n	front	2	5Hz-20kHz	96	0.003	65k
Philips	DX220	899	435x88x357	4.8	5	y	15	2	y	front	2	5Hz-20kHz	96	0.004	65k
	CD650	999	420x86x300	4	1	opt	25	2	y	front	4	2Hz-20kHz	>101	<0.0015	
	CD304	639	420x90x300	8	1	y	13	2	y	front	4	2Hz-20kHz	>96	<0.003	
	CD450	649	320x86x300	3.1	1	y	11	2	n	front	4	2Hz-20kHz	>100	<0.003	
Proton	CD150	429	320x86x300	3.1	1	opt	10	2	n	front	4	2Hz-20kHz	>100	<0.003	
Realistic	830R	699	420x86x285	3.6	1	y	10	2	y	front	4	10Hz-20kHz	100	0.003	16k
	CD1400	500	370x70x265	3.6	1	y	8	1.8	n	front	1	5Hz-20kHz at -1dB	92	0.005	65k
	CD2200	400	319x83x306		1	n	n/a	1.8	n	front	1	5Hz-20kHz at -1dB	92	0.005	65k
Revox	B225		450x109x332	8.5	1	opt	30	2	y	front	1	20Hz-20kHz at -0.6dB	96	<0.006	65k
Rotel	CDX7	499	340x85x295	3.3	3	y	10	2	y	front	1	50Hz-20kHz	95	0.004	
	RCD850	549	435x94x290	3.5	3	n	n/a	2	y	front	1	5Hz-20kHz	98	0.004	
Sansui	PCV750	699	430x82x309	4.8	2	n	n/a	2	n	front		5Hz-20kHz	100	0.003	65k
Sanya	CP710	489	420x75x270	3.4	1	y	8		n	front		5Hz-20kHz at -0.5dB	96	0.005	
	CP08	399	335x67x270	2.9	1	n	n/a		y	front		5Hz-20kHz	96	0.005	
	CP640	399	420x75x270	3.4	1	n	n/a		n	front		5Hz-20kHz	96	0.005	
Sharp	DX620H	599	430x80x299	4.4	1	y	20	2	y	front		5Hz-20kHz		0.005	
	DX111H	499	330x80x312	3.7	1	y	n/a	2	n	front		5Hz-20kHz		0.005	
	DX120H	599	330x80x312	3.7	1	y	20	2	y	front		5Hz-20kHz		0.005	
Sony	COP-35	449	355x80x280	3.8	1	n	n/a	2	n	front	1	2Hz-20kHz	97	0.004	
	COP-40	499	430x70x280	4.1	1	n	n/a	2	n	front	1	2Hz-20kHz	96	0.004	65k
	COP-55	799	430x80x290	4.2	1	y	13	2	y	front	2	2Hz-20kHz	98	0.003	65k
	COP-65	799	355x80x290	3.9	1	y	35	2	y	front	1	2Hz-20kHz	96	0.004	65k
	COP-7F	629	215x55x250	2	1	opt	13	2	y	top	1	20Hz-20kHz	90	0.008	65k
	COP-203ES	999	430x80x285	4.2	1	y	36	2	y	front	2	2Hz-20kHz	98	0.003	65k
	COP502ES-2	1799	430x80x335	8.5	1	y	36	2	y	front	2	2Hz-20kHz	96	0.0025	65k
	COP-303ES	1399	430x85x335	6.8	1	y	36	2	y	front	2	2Hz-20kHz	96	0.003	65k
	D-700	599	130x48x193	1.6	1	n	n/a	1.6	n	front	1	20Hz-20kHz	85	0.0095	65k
Technics	SL-P50P	6999	430x200x530	19	2				y	front	1	20Hz-20kHz at -0.5dB	>96	<0.005	65k
	SL-P500K	999	430x87x272	4.6	2	y	27	2	y	front	2	4Hz-20kHz	>102	<0.0012	65k
	SL-P300/K	719	430x77x265	4.2	2	y	27	2	y	front	2	4Hz-20kHz at -0.2dB	>100	<0.0015	65k
	SL-P100/K	599	430x77x265	4.2	2	n	n/a	2	n	front	2	4Hz-20kHz at -0.3dB	>100	<0.0015	65k
	SL-PJ11K	499	315x75x267	3.5	2	n	n/a	2	n	front		4Hz-20kHz at -0.3dB	>96	<0.002	65k
Toshiba	XR-30	499	420x80x309	4.1	3	n	n/a	1	y	front	2	5Hz-20kHz at -0.5dB	>90	0.003	65k
	XR-V12	479	340x80x309	3.4	3	n	n/a	1	y	front	2	5Hz-20kHz	>90	0.003	65k
	XR-J9	389	250x47x130	1.3	3	n	n/a	1	y	front	2	5Hz-20kHz	>90	0.01	65k
Yamaha	CDX700	699	435x107x347	4.2	5	y	20		y	front	4	5Hz-20kHz at -1dB	100	0.004	
	CDX500	599	435x107x347	4.2	5	y	10		y	front	2	5Hz-20kHz at -1dB	100	0.004	
	CDX5	399	340x80x280	3	5	n	n/a		y	front	2	5Hz-20kHz at -1dB	100	0.004	
	CDX900*	999	437x107x347	6.5	5	y	24		y	front	4	dc-20kHz	110	0.003	

BRAVO ULTRA 500!

Rarely, if ever have critics been so unanimous in their praise

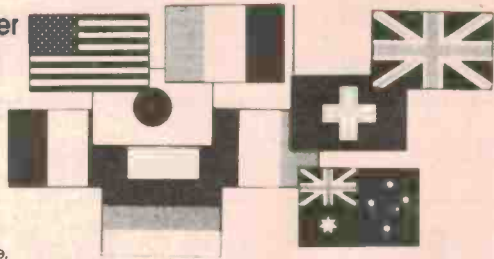

AUSTRALIA

"Make no mistake, Shure Ultra 500 cartridge is about the best thing around in phono cartridges... Shure's claims were fully substantiated and an unquestionable credit to the designers." *Electronics Today*

BELGIUM

"The sound blows your mind: clarity, presence, long and rounded bass, warm and crisp non-aggressive highs and, what the others lack: a distinct separation of music levels." *Panaudio-Video*

FRANCE

"It shows... exceptional cleanness of sounds, total absence of distortion, amazing ease with which the most complex messages are played back... We rediscover numerous records." *La Nouvelle Revue du Son*

GERMANY

"Compared to the reference MC-systems of the highest top category a juror even took with 'absolute certainty' the Shure system for a MC-system—which means that this exclusive group now has to admit an MM representative to its elite ranks." *Stereoplay*

ITALY

"Overall the most prestigious among Shure pickups... It seems that Shure want to cater to the most demanding audiophiles." *Audio Review*

JAPAN

"Recently there have been strong hints that MM (Moving Magnet) cartridges are surrendering to MC (Moving Coil) products. However, as is typical of a manufacturer as famous as Shure, they have arrested the trend by developing the new ULTRA series." *Stereo's Best Choice Stereo*

"Amazing, a truly wonderful cartridge. I was shocked rather than merely surprised... Indeed, in whatever environment the recording is performed the reproduction is very penetrating." *Swing Journal*

SWITZERLAND

"Absolutely top class. In terms of sound neutrality, this system is in a class of its own." *Electronic Sound*

UNITED KINGDOM

"I have praised Shure cartridges in the past, but this ULTRA 500 model is far the best performer to come from that stable." *Gramophone*

UNITED STATES OF AMERICA

"... It is my feeling that it (ULTRA 500) has no real competition... Moving-coil cartridges tend to be pretty mediocre in some respects... their major failing are in spurious coloration, where the ULTRA 500 excels... Its sound is gorgeously smooth and effortlessly clean, even at the highest recorded levels, and its low-end performance is as good as anything I've heard." *Stereophile*

"... unquestionably... among the best ever made... These cartridges create the illusion that one is hearing the master tape at the studio... at least as good as some cartridges costing upward of \$1,000." *New York Times*

"For sheer accuracy of reproduction, it has little real competition." *High Fidelity*



AUDIO ENGINEERS PTY. LTD
342 Kent Street, Sydney, NSW 2000
Ph: (02) 29-6731

AUDIO ENGINEERS (QLD) **MARKETEC PTY. LTD.**
Cnr. Jane & Buchanan Sts, 51 Scarborough Beach Rd,
West End, Qld 4101 North Perth, WA 6000
Ph: (07) 44-8947 Ph: (09) 242-1119

AUDIO ENGINEERS (VIC)
Ph: (03) 850-4329

WIN A TOSHIBA CD PLAYER WORTH \$559



The Toshiba XR-P9RC is a compact little unit that comes with ac adaptor and remote control, and can be neatly incorporated into your hi-fi system.

Features include 16-program random memory; repeat; manual search; and up/down track selection.

All you have to do is answer the following questions correctly and hope yours is the first correct entry drawn! The competition closes 31 January 1987.

CONSOLATION PRIZES

Six runners up will receive a Goldring CD715 Cleaning kit valued at \$19.95.

Questions

★ How long is the warranty on all Toshiba compact disc players?

★ How would you best describe the shape of the Toshiba XR-P9RC? (wedge, oblong, cuboid)

★ How many C-type batteries does the XR-P9RC take?

(See the Buyers' Guide for clues.)

Entries should be posted to:
Toshiba/ETI Competition,
Federal Publishing Co,
PO Box 227,
Waterloo, NSW 2017

ETI EMPLOYMENT

Electronics Today International introduces the most cost effective method of recruiting technical staff — the ETI employment pages.

The technically literate are scarcer than a laptop Cray, more valuable than gallium arsenide and about as hard to attract as deuterium to tritium nuclei!

Reach them, talk to them, employ them through ETI.

For as little as \$225* you can reach 56,000 professionals, managers or skilled workers[†], 29,000 technicians[†], 7000 electronics engineers[†] and 5500 programmers/analysts[†]. Which makes us *the* national publication for electronics employment advertising.

For information and bookings call:

Mark Lewis, Sydney	(02) 693-6666
Virginia Salmon, Melbourne	(03) 662-1222
Dane Hansen, Adelaide	(08) 212-1212
Estelle de San Miguel	(09) 481-3171
John Easton, Auckland	79-6648

* Sixth of a page

† Roy Morgan Research Centre Study

If you're into computers you could have a job for life.

If you're interested in the finer points of digital electronics and computers, the computer industry needs you.

Enrol now into Control Data Institute's Computer Engineering course and you could be working in the ever-expanding computer industry in as little as 8 months.

Control Data Institute's flexible study programmes will allow you to study full-time or part-time in subjects such as **Electronics, Microprocessors, Mini Computers, Data Communication, Terminals, Disk Drives, Line Printers and Machine Language Programming.** Or if you choose, you can study individual subjects.

You can even get exemptions if you have some experience in the electronics field. And at the end of your



course of study, you qualify with a Diploma in Computer Engineering.

Control Data is accepting enrolments now for their Computer Engineering courses in Sydney and Melbourne. The demand for Control Data Engineering Graduates has never been higher.

For further information call Control Data Institute now. You can attend special monthly free engineering information seminars or phone Wendy Mason in Sydney on (02) 438 1300 or Sherrill Maconachie in Melbourne on (03) 268 9666 for a personal appointment.

**CD CONTROL DATA
INSTITUTE**
YOUR CAREER BEGINS HERE

An education service of Control Data Australia Pty. Limited.
Burrows Doble Lawrence CDA 1640

LABORATORY POWER SUPPLIES

APLAB offer a complete range of regulated DC bench/rack power supplies combining high precision and regulation capabilities with continuously adjustable outputs.

Designed with single, dual and multiple outputs, these power supplies can be used in either constant voltage or constant current mode of operation.

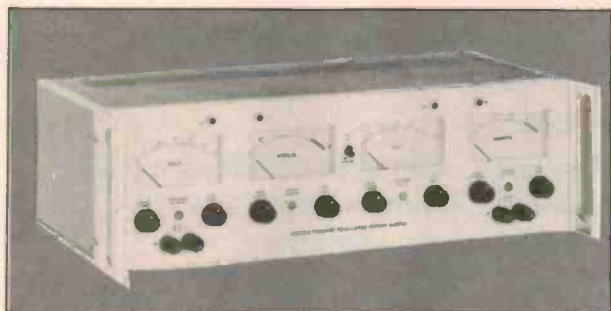

Standard models include:

SINGLE OUTPUT

OUTPUT: Output VOLTAGE: Current
0-30V 0-1A to 30A
0-70V 0-2A to 10A

DUAL OUTPUT
0-30V 0-1A to 2A

MULTIPLE OUTPUT
0-30V 0-2A to 5A



SCIENTIFIC DEVICES AUSTRALIA PTY. LTD.

VIC. 2 JACKS RD., SOUTH OAKLEIGH, 3167
PHONE: (03) 5793622 TELEX: AA32742
NSW: 559A WILLOUGHBY RD., WILLOUGHBY 2068
PHONE: (02) 952064 TELEX: AA22978
S.A. 31 HALSEY RD., ELIZABETH EAST, 5112
PHONE: (08) 2556575 TELEX: AA88125

**EX
STOCK**

Master the Microprocessor

Learn how Microprocessors
really work
... the practical way.

The Purpose of this Course

There is a considerable expanding and world-wide demand for people with a real knowledge of microprocessors and general computer technology. Such people are needed to design and evaluate systems and to assess and develop the enormous range of possible applications, both present and future of microprocessors and to understand the installation and servicing of the main types of equipment of which they may form the most vital component.

(A microcomputer has already been produced to replace the mechanical programmer on a domestic washing machine for example.)

This Course provides the necessary basic information to enable a student to really understand the functioning of microprocessors and their supporting circuitry,

usually referred to as the "hardware". This is backed up by showing how to program a microcomputer (or produce its "software") in the most fundamental form of computer language called "machine code". No previous knowledge of computers is necessary, though a little basic knowledge of electronics plus digital and logic circuits will be found helpful.

A special introductory short course is available to provide this background information, if required by an individual student on the course without extra fee.

Student — Tutor Contact

A qualified Tutor is available to every Student throughout this Course in order to deal with any queries which may arise and to assess certain questionnaires which are issued to Students throughout the period of training.

Certificate
Issued to all Students completing the Course successfully. Course covers main requirement of the City and Guilds Certificates in Computers.

Practical Self Study Course



How the Course is organised

The basis for the practical work in the Course is the Microcomputer.

This is supplied completely assembled and ready to use.

The Course text is carefully arranged in sequence so that each new section follows logically from previous work. Hardware description and programming technique progress together, so that the Student is discouraged from treating them as distinctly separate subjects.

Following each section of descriptive text, detailed instructions are given in order to use the Microcomputer to provide a practical demonstration of each new function or technique. This provides a very powerful way of learning precisely how the system operates, and enables any possible ambiguities in the Student's mind to be quickly resolved.

FREE COLOUR BROCHURE

Post coupon now. The Australian School of Electronics Pty Ltd, P O Box 108, Glen Iris, Victoria, 3146.

Please send your brochure without any obligation to:

Name

Address

ETI 10/86

Postcode

TELECOMMUNICATIONS TECHNICIANS

Keep
Australia
talking

Want a challenging career with real job security and continuous career development? It's yours with Telecom Australia, the organisation responsible for Australia's rapidly-developing telecommunications network.

We are looking for skilled, motivated men and women who can help us establish, maintain and operate the latest telecommunication technologies in the Sydney city region. In particular, we need specialists in the fields of:

- Digital/analogue data and voice transmission
- PABX installation and acceptance testing
- Installation or maintenance of subscriber equipment ranging from single service telephones to complex PABX switchboards and Intercommunications systems.
- Installation or maintenance of switching equipment and transmission systems ranging from step by step and ARF Crossbar to processor controlled systems.

Qualifications needed

You'll need to be an Australian citizen or a permanent resident of Australia, and possess one of the following qualifications:

- Tradesman's Certificate or Tradesman's Rights Certificate in the discipline of Telegraph

- Mechanic or Radio Tradesman.
- Electronics and Communications Certificate or Electronic Engineering Certificate and four years' relevant experience.
- Trained as a Telecommunications Technician or Telecommunications Tradesman with Telecom Australia.
- Appropriate B or C level Certificate Examinations of the City and Guilds of London Institute.

Promotion opportunities

Telecom Australia offers motivated people excellent opportunities to qualify for advancement to the Technical Officer structure and beyond by way of external Certificate studies or Telecom's training program.

Salary and Benefits

We offer a negotiable salary range of \$18,276 to \$22,111 pa depending on your qualifications and experience. Benefits include security of employment, a career structure, superannuation after a qualifying period, generous leave entitlements including maternity leave and a nine-day working fortnight.

Interested?

Call the Sydney Recruitment Officer, Telecom Australia, on (02) 266 9290 or call in person to the 15th Floor, 309 Kent St, Sydney.



Telecom Australia

An Equal Opportunity Employer

ARM20309

Your Computer has just taken the hassle out of buying a computer —



Available at your Newsagent now!

Or simply send \$4.50 plus \$1.50 post and packing to The Federal Publishing Co, PO Box 227, Waterloo 2017 NSW.

To build better speakers one should always start with the better drivers.

There are drivers, and there are drivers; finally, there are Dynaudio drivers. If your ears and your pleasure demand the ultimate in detailed musical reproduction, then it is generally agreed that the starting point involves Danish produced Dynaudio drivers.

Dynaudio drivers are used in some of the most esoteric speakers in the world. Names such as VANDERSTEEN, SNELL, DUNTECH, CONRAD JOHNSTON, GOLD RIBBON and THIEL most perfectly illustrate the point.

One from the above list of 6 speakers is at the moment being hailed as 'the most technically and musically accurate speakers in the world' by a most highly respected international reviewer.

Such acclaim in the realms of superb results is due to the fact that each Dynaudio driver is specifically hand made - each one is an individual masterpiece of performance and design. Dynaudio drivers feature voicecoil sizes up to 4", hexagonal shaped voicecoil wiring, magnetic oil in the air gap, and power handling to a peak of 1000 watts. Response is perfectly smooth over the entire spectrum, and the drivers are eminently suitable for all 6db/octave cross-overs.

For more information, please write to: Australian Sole Distributor:

SCAN AUDIO Pty. Ltd. 52 Crown Street, Richmond, Victoria, 3121. Telephone (03) 429 2199. Telex 39201.



Genuine O.E.M. enquiries welcome.

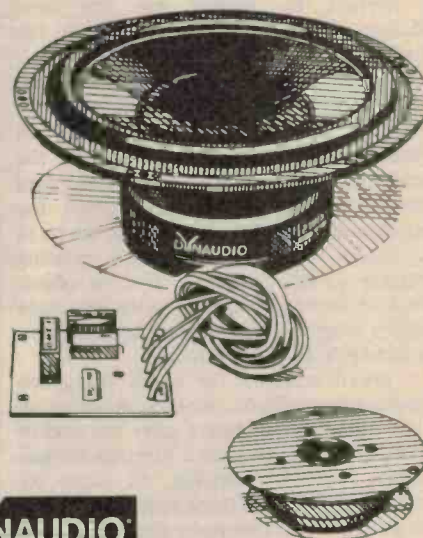

RACECAM AT THE INDIANAPOLIS 500

Barrie Smith

Long term expertise with mobile cameras has led TV station ATN in Sydney to export its brainchild to the US. The result is Racecam.

ATN-7 SYDNEY first placed cameras in race cars competing in the James Hardie 1000 of 1979. In June of this year an Australian team supplied the in-car coverage of the 1986 Indianapolis 500 for the American Broadcasting Company.

Geoff Healey, head of the Racecam development team, ATN-7 Sydney, described the challenges faced by the boys from Epping and how they achieved success.

"Mike Fisher, an engineer with the American Broadcasting Company, was visiting Sydney for the 1984 Society of Motion Picture and TV Engineers Conference. He saw the footage from one of our Bathurst Racecams, and was suitably impressed. On his return to the US, he suggested to his sports department that we be invited to tender for the next Indianapolis 500. This event, like the Bathurst, is carried live across the country."

On 25 December, 1985, they had a deal. The camera system was redesigned from the ground up, with the intention of enhancing the coverage of one of the world's major one day sports events. Said Healey: "It epitomizes the lengths the contemporary sports producer will go to in his efforts to present a more exciting spectacle to his audience. It's an object lesson in future trends in sports coverage possible with the new technologies becoming available to the producer."

In previous years the event had been broadcast as an edited one hour program, in prime time, several hours after the end of the race. For the first time a live telecast was planned, with 30 cameras, 12 video recorders, pre-recorded track sequences, complex graphics and computer readouts of the race in progress. To this was added live audio and vision pickup from three competing cars.

The race

Each Memorial Day holiday the race draws a crowd of 400,000. The investment by competing teams and sponsors is on a scale understood only by America's Cup competitors. The winner's prize is \$3.5 m, plus another few million for the prestige.

Each year specialist UK car creators, such as March and Lola, design new models for the race. The hulls are built from carbon fibre and aluminum honeycomb, and cost around \$500,000 each. Power supply is the overhead cam DFX Cosworth V8, with single turbocharger. Capacity is 161 cubic inches, weight in excess of 700 kg, with an output of 700-750 hp, exceeding the shove of Formula One cars. This year the drivers were lapping the four kilometre circuit at around 340 kph. To survive the 200 laps, and afford the driver some measure of protection from the track's horrendous accident record, the cars are built very strong.

To ensure close competition the promoter, the United States Auto Club, fits each car's intake manifold with a pressure limiting blow-off valve. When the turbocharger builds up manifold pressure this opens at a preset level controlling the engine power output.

The driver has a tube leading from this valve into his helmet, so that he can hear the valve operating. He drives at maximum throttle setting just before the valve blow-off, ensuring he gets top speed and best fuel consumption. He has a limited fuel supply available to him.

Treated like Hollywood stars, the cars are maintained by full-time teams with enormous budgets and backup behind them. As Geoff Healey says: "They are state-of-the-art pampered beauties, polished up and repolished, doted over like no others in the world".

Problems

For several years the network had tried to install cameras in the Indy cars, but been prevented by the seemingly insurmountable problems of high temperatures, excessive shock and vibration, interference from the high energy ignition systems and lack of access to the cars' chassis.

The track throws up grit and oil, and chunks of hot rubber — no friends of delicate lenses and the requirement for a clear image.

Radio frequency wavebands were crowded at the track, limiting radio control of Racecam's lens aperture, colour balance, etc. Microwave links between the production crew and drivers were very limited, and subject to uncontrolled interference. Because Healey's team were new to the scene, they went to the trouble of getting full FCC licensing for their transmission. They arrived at the track to find they were the only ones 'legal', and caused enormous problems by operating over everybody's 'illegal' channels.

The Machinists' Union's two entries were using 12 UHF channels, which were obliterated completely by one of Racecam's telemetry channels. "The Machinists' Union were not at all happy with this."

The team found that five weeks prior to the race was nowhere near enough for thorough preparation. Access to the cars was very limited, as engines were often changed at the last moment, parts arrived at the last minute and everything seemed in a state of crisis.

Another major problem was caused by the position of the camera. There was a conflict between the director's desire for the most effective camera angle and the aerodynamics of the car. At the speeds achieved at the Indy, aerodynamics are a critical determinant of the way the car handles. A camera mounting can disturb the airflow over the body, causing oversteer at speed. In extreme conditions it can cause the car to lose traction.

The solution was to mould the cameras into the body of the car while they were being built. In this way the most effective camera angle could be achieved, while not detracting from the competitiveness of the car. The price to be paid was that the camera at Indy, unlike the Bathurst mounts, was



Danny Sullivan's red car is equipped with camera in the above-ported fairing behind the driver.

fixed looking fore and aft, and it could not pan or tilt.

Safety was critical to all this, of course. It was essential to the design of the camera and its mountings that the bits and pieces be able to withstand the forces of a major smash without disintegrating. The speed of the cars, and their proximity to the crowd, make for a lethal mix. Indeed, the Indy cars can turn a carelessly mounted camera into a low flying missile with ease. And this is not an academic argument either. Crashes, and morgue wagons, are by no means rare at Indy.

Solutions

Fortuitously, just as the need for a good Racecam was being realized, the first of the Charge Coupled Device (CCD) cameras came on to the market. They offer many of the features required in a race camera including solid state reliability, and most importantly, far greater immunity to vibration than their tube-based competitors. Because of the level of integration of the electronics, they are also small and light, reducing mounting problems to a minimum.

A commercially available camera was chosen after many tests. It offered 250 line resolution, in the US standard TV format, NTSC, with good colour rendition. However, it was considerably modified in the workshops. To reduce the size of the camera unit still further the optics and the imaging chip were located on the mounting. The rest of the video circuitry was placed elsewhere. This reduced the mounting protruding

about the body of the car to just the lens and a single integrated circuit.

Using the latest in CCD technology, it was possible to eliminate all the complex optical filter and splitters normally associated with a TV camera. The colour decoding into red, green and blue is done via a filter on the substrate of the chip itself.

From the camera the signal is taken to a transmitter where it gets frequency modulated at the standard ENG frequencies of about 2 GHz. The exact power, and indeed the design of the transmitter is something Healey is coy about. It's less than 10 W, he says, which is what the competition uses, and uses some rather clever design techniques to give reliable reception. The antenna is circularly polarized and enables the signal from the car to be transmitted up to a helicopter flying above.

The helicopter, carrying translating equipment, sends the signal down to an outside broadcast (OB) unit. At the OB unit, it's mixed in with other signals from the cars, cameras at trackside and in planes and helicopters above the track. In the OB van, the picture the viewer will finally see is assembled by the director and vision mixers before being sent back to the main studio, usually by land-line, for distribution to the rest of the network.

There is also a down-link to the camera to allow control by an operator at trackside. This telemetry, as it's called, was simplified for Indy because there was no need to control the panning and tilting of the camera. However, it's still necessary to control black level, colour balance and so

on.

In Sydney, considerable research and testing on Racecam was done at the CSIRO's National Materials Handling Bureau. The camera's vibration isolating mounts were developed, using the Bureau's shake table. The team was also helped by a well known racing driver, with advice on specific excitation frequencies and wheel rotation velocities encountered in racing cars.

Mid-summer heat and high turbo exhaust temperatures were accommodated in advance by testing equipment and batteries in the Bureau's environmental chamber. Interference from ignition systems was researched and prevention incorporated into the design by heavy screening with metal foil.

The Indy 500 track is roughly oval-shaped, two straights 1200 metres long, and two shorter at 800 metres each. The track area contains a golf course, a museum and garages for the cars. Metal is everywhere — surrounding fences and high grandstands with tin roofs — making rf uplinks very unpredictable. The director needed signals at all times from all Racecam equipped cars, wherever they might happen to be on the track. As Healey confessed, "This called for some interesting microwave calculations".

Space in the cars was at a premium; in one car the transmitter was installed beneath a driver's seat, and the communication uplink placed in the car's nose cone, a very vulnerable position. "We had to be prepared to write off microwave links," he said. ●

SUBSCRIBE

receive **A FREE PRECISION**
and your chance to **WIN A**



CONDITIONS OF ENTRY

1. Entries close last mail February 27, 1987.
2. Entry to the prize draw is achieved by returning a completed subscription card and payment. Entry is open to both new and renewal subscribers.
3. Entry is open to all residents of Australia other than the employees and immediate families of The Federal Publishing Company Pty Ltd and Daihatsu and their associated agencies and publications.
4. The draw will take place on March 4, 1987, and the winner will be notified by mail and the result published in The Australian newspaper date March 13, 1987, and a later issue of the magazine.
5. Prizes must be taken as offered. There is no cash alternative. Prizes are not transferable and cannot be altered in any way.
6. The vehicle prize of a Daihatsu Charade includes all on-road costs, including third party insurance and registration.
7. Federal Publishing will arrange delivery of the vehicle within Australia within one month of the winner being drawn. If delivery is required outside of Australia, this becomes the responsibility of the winner.
8. Permit No. T.C. 86/2203 issued under the Lotteries and Art Unions act 1901; Raffles and Bingo Permits Board Permit No. 86/1013 issued on 15/9/86; ACT Permit No. TP86/650 issued under the Lotteries Ordinance, 1964.

• The Pace • The Feel • The Space • The Ride

• The Luxury • The Style • The Eco

NOW!

SCREWDRIVER SET "CHARADE" from "DAIHATSU"

FREE SCREWDRIVER SET *with all new or renewed subscriptions*

- ★ Chrome plated and presented in plastic storage case.
- ★ Free running top on each driver gives operator ease of use.
- ★ Consists of 4 blade drivers from 1.4 mm to 2.9 mm and 2 Phillips screwdrivers, No. 0 and No. 1.



LIMITED OFFER, SO POST SUBSCRIPTION CARD TODAY!!
(If card missing, please phone (02) 693-6666 and ask for the Subscriptions Department).

"Daihatsu. 
That's who."

*See Subscription
Coupon*

• The Ride • The Space • The Feel • The Pace

• The Options • The Safety

Fluke. First Family of DMMs.

When accuracy, performance and value are important, professionals the world over look to Fluke — the first family of DMMs.

Reliable Fluke-quality 3½- or 4½-digit DMMs fit every need — from design engineering to industrial troubleshooting.

There's the low-cost 70 Series — the most DMM you can get for the money. The tough 20 Series — totally sealed and built to survive the dirtiest, grimeiest, roughest jobs. The reliable 8020B Series — made to withstand the rigors of the field service environment. The precise 8060A Series — the most powerful and complete test and measurement system available in a handheld package. And, of course, the versatile Bench/Portables that carry on the Fluke tradition for precision and durability in lab-quality bench instruments.

Fluke comes in first again with the world's largest selection of quality accessories to help extend the capabilities of your DMM even further.

There's no need to look anywhere else. Uncompromising Fluke design and leading edge technology are the reasons why attempts at imitation will never fool the millions of professionals that accept nothing less than a Fluke.

FROM THE WORLD LEADER
IN DIGITAL MULTIMETERS.

FLUKE[®]

ELMEASCO

Instruments Pty. Ltd.

N.S.W. 15 McDonald St, Mortlake. Tel: (02) 736 2888
VIC. 12 Maroondah Hwy, Ringwood. Tel: (03) 879 2322
QLD. 192 Evans Rd, Salisbury. Tel: (07) 875 1444
S.A. 241 Churchill Rd, Prospect. Tel: (08) 344 9000
W.A. 46-48 Kings Pk Rd, West Perth. Tel: (09) 481 1500

Talk to your local distributor about Fluke

• A.C.T. Actiec Pty Ltd (062) 80 6576 • George Brown 80 4355 • N.S.W. Ames Agency 699 4524 • George Brown (02) 519 5855 Newcastle 69 6399 • Bryan Catt Industries 526 2222 • D.G.E. Systems (049) 69 1625 • David Reid 267 1385 • W.F. Dixon (049) 61 5628 • Macelec (042) 29 1455 Ebson 707 2111 • Selectro Parts 708 3244 • Geoff Wood 427 1676 • N. TERRITORY Thew & McCann (089) 84 4999 • QUEENSLAND L.E. Boughen 369 1277 • Colourview Wholesale 275 3188 • Fred Hoe & Sons 277 4311 • Nortek (077) 79 8600 • St Lucia Electronics 52 7466 • Selectro Parts (Old) 394 2422 • S. AUSTRALIA Protronics 212 3111 • Trio Electrix 212 6235 • A.W.M. Wholesale • TASMANIA George Harvey (003) 31 6533, (002) 34 2233 • VICTORIA A.W.M. Electrical Wholesale • Radio Parts 329 7888 • G.B. Telespares 328 3371 • Browntronics 419 3986 • R.K.B. Agency 82 7704 • A.J. Ferguson 347 6688 • SIRS Sales (052) 78 1251 • Mektronics 690 4593 • W. AUSTRALIA Atkins Carlisle 321 0101 • Dobbie Instruments 276 8888 • Calms Instrument Services 325 3144 • Willis Trading 470 1118

When mainframe power gets this small, Du Pont Electronics will have helped get it there.



Model of computer is an artist's conception.

Du Pont technology has been helping electronic companies worldwide to develop smaller, more reliable and less costly products for over 20 years.

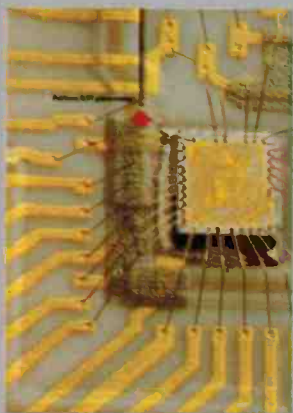

For example, in 1964 Du Pont's thick film technology helped computer companies develop a new, ceramic circuit which contributed significantly to the reduced size and enhanced performance of computers. Today, this technology permits instant

communication between the most complex semiconductor devices for even greater miniaturization.

Du Pont's photopolymer-based dry film technology enabled easier production of high-density, high-reliability printed wiring boards. More recently,

this technology led to improved solder masking which also increased circuit density and reliability.

The interconnection of smaller and smaller circuits is aided by Du Pont's connector technology. One result of this technology is the modular jack which links keyboards and personal computers to data transmission networks.

Du Pont's significant contributions often result from developmental "partnerships" in which customers draw on Du Pont's unmatched resources to solve problems faster and move into production quickly and reliably.

Whether you need materials or components for today's products or scientific resources to help create tomorrow's, DU PONT can help.



Write to:

Du Pont Electronics
22-25 Paul Street North
North Ryde NSW 2113

Phone:

887 1333 in Sydney, or
from elsewhere in Australia
(008) 22 6326 for the
price of a local call.



Stress

The British are a funny lot. The Dregs hack was browsing through a recent copy of *New Scientist* magazine, which reports the latest in British research, when he was struck by an article announcing the intentions of a group of researchers led by one Cary Cooper, who far from being a Hollywood stud, is a professor of organizational psychology at the University of Manchester.

It transpires that the holiday habits of his fellow Britons intrigues the said Cary, and so he has outfitted a number of them with telemeters which will allow a calculation of the amount of stress they endure. What Professor Cooper intends to prove is that going on holiday actually increases stress levels. If you want to reduce stress levels, stay at work.

According to the researchers, it's no good trying to find a stress-free holiday, since that only makes matters worse. If you go a whole month without stress, you'll be so laid back by the time you report once again to the coal face, that you won't be able to work as well as usual.

The scientists are also trying to research another holiday problem. Apparently, British holiday makers head off to Majorca, where the weather is more like an Australian Christmas than an English one. The researchers say that hot blooded British couples, full of wine and food, are falling into bed in the early afternoon, not to have a sensible stress free siesta like the natives do, but to improve their interpersonal relationships.

This, according to the report is a Bad Mistake. The British come out top for fatal heart attacks in Majorca, inspired it is said by over exertion.

Eco paradise

Every cloud has a silver lining. According to Russian researchers the lake next to the Chernobyl power station is now the most polluted in the world. Presumably the fish are not happy. However, Russian ecologists are smiling, because they now have the world's greatest supply of radioactive tracers. The Russians expect to become world leaders in the study of food chains and cycles, by following decay products from one animal to the next.

The news has not made pigeon fanciers any happier though. Apparently, the pigeon's homing mechanism was affected by the nuclear fallout and for a while there they were flying all over the place.

Cancer

Does everything cause cancer? Following the news night after night one might be forgiven for believing that there are few human activities that don't seem impli-



A typical British couple: looking forward to the afternoon siesta.

cated in one way or another. Now, in the US, it's been discovered that taking long hot showers leads to greater exposure to toxic chemicals in the water. The chemicals evaporate out of the water and are inhaled, both by the showerer and by people in the rest of the house.

According to Dr Julian Andelman of the University of Pittsburg, levels of toxic chemicals will be four times greater in a shower lasting ten minutes than in one

lasting five minutes. In addition, you receive 100 times more of the chemical by breathing it in rather than drinking it.

The situation is even worse than it appears because one of the biggest toxigens in US drinking water is chloroform, which has been shown to induce cancer in animals. According to the US environmental protection agency, between 200 and 1000 human cancer deaths are caused in this way every year.

We just thought you'd like to know. ●

SCOPE

60W SOLDERING SYSTEM

Illuminated Temp. readout monitors actual tip temperature.

Select the tip temp. required.

Zero Voltage switching for maximum component safety.

Ceramic encapsulated element for lowest earth leakage.

60 Watts of back-up power -30W Pencil optional.

Burnproof & flexible lead

Floating earth model available with plug-in lead and clip.

MODEL: ETC60LFE



CODE: ETC60L

INFINITELY ADJUSTABLE 200°-470°C with zero voltage protection



Screw type connector prevents accidental plug removal.



30 Watt Soldering Pencil is an optional tool to replace 60W standard tool. Special miniature tips are available.

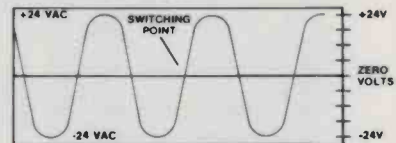

Damaging Spikes and induced tip voltages likely to damage MOS devices are virtually eliminated by Z.V.S.* circuitry.

* ZERO VOLTAGE SWITCHING OF HEATER

Anti Seize tip retention design - reduced risk of thread seizure by removing locking nut to cooler end of barrel.

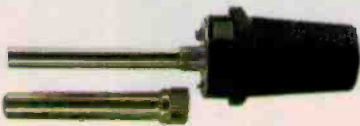

TIPS FOR 60 WATT IRONS

REPLACEMENT TIPS

* FITTED AS STANDARD

TIPS FOR 30 WATT PENCIL

0.8mm Face Width	0.8mm	0.4mm	1.6mm	3.2mm*	1.2mm	1.2mm	0.4mm	1.6mm*	2.0mm	0.8mm

Code SF 0.8/21 DF 0.8/22 DF 0.4/23 DF 1.6/24 DF 3.2/25 DF 1.2/26 SF 1.2/27 ZF 0.4/51 SF 1.6/56 SF 2.0/57 ZF 0.8/59

WANT MORE INFORMATION THEN CONTACT

VICTORIA

ELECTROTOOL (03) 848 1811
 RADIO PARTS (03) 329 7888 (03) 211 8122 (060) 21 8177
 TELEPARTS (052) 21 7085
 SCHOOL OF ELECTRONICS (03) 288 7051
 McGRATHS (03) 663 1122
 ALL ELECTRONICS (03) 662 3506
 ELLISTRONICS (03) 561 5344
 BALLARAT ELECTRONICS (053) 311 947

S.A.

GERRAD & GOODMAN (08) 269 1811
 BEEJAY (08) 277 9499
 GRAPHIC ELECTRONICS (08) 363 0277

TAS.

GHE ELECTRONICS (003) 316533 (002) 34 2233

W.A.

ATKINS CARLYLE (09) 481 1233
 COVENTRY MOTOR REPLACEMENTS (09) 276 0111

N.S.W.

C.L.C. AGENCIES (02) 750 4005
 D. JH. COULTER (049) 671 455
 EBSON PTY. LTD. (02) 707 2111
 PROMARK ELECTRONICS (02) 439 6477
 DAVID REID ELECTRONICS (02) 267 1385
 SELECTRO PARTS (02) 708 3244
 T.V. PARTS (02) 747 6707

QLD.

ST LUCIA (07) 52 7466
 SOUTHPORT ELECTRONICS (075) 32 3632
 BAS-AUDIOTRONICS (07) 44 7566
 COLOURVIEW (07) 275 3188
 DELSOUND (07) 839 6155
 SOLEX ELECTRONICS (077) 72 2015
 STEVENS ELECTRONICS (079) 51 1723
 CAIRNS INSTRUMENTS (070) 51 1849
 ROBCO EQUIPMENT (077) 72 2633
 SELECTRO (07) 848 8197



BOX 63 MIDDRIE,
 VIC. 3042
 TEL. (03) 336 1566
 TLX: AA36318

The Sony Disc Jockey lets you drive from Sydney to Melbourne without changing a disc.



No other compact disc player for your car can play ten compact discs at the touch of a button, continuously.

This one can even play them in any order you like.

Another advantage is that the Disc Jockey is kept in the boot along



Disc Jockey

with your collection of music.

This means the only thing on your dashboard is the controls.

And on our flexible stand even they can be tucked away out of sight.

The Disc Jockey is well protected from heat and vibrations.

And as it's stored in the boot it's also well protected from thieves.

You can find all the advantages the Sony Disc Jockey has over ordinary compact disc systems at your nearest Sony Dealer.

Call in and ask for a test drive.

SONY
THE LEADER IN DIGITAL AUDIO.