

JULY 1984

\$2.50\* NZ \$2.95



# ELECTRONICS TODAY INTERNATIONAL

**BONUS**  
Dick Smith catalogue  
**WIN AN AIRCRAFT!**

## Australia's Advanced Technology Telescope

## Printers — choosing & using

## Robots & the future of work

### Build:

Paging amp  
system

25 watt UHF  
booster amp

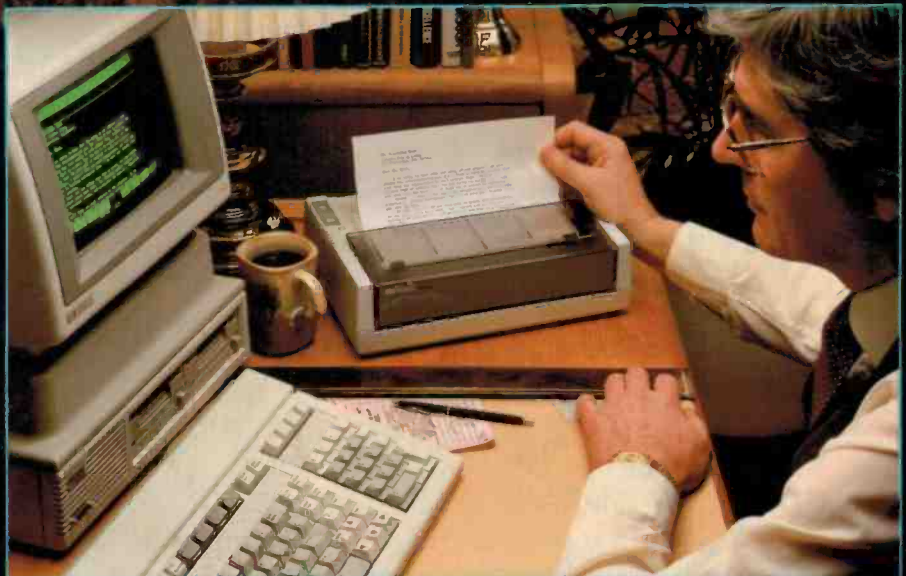

## New Commodore Column!

# IT'S BEEN WORTH WAITING FOR.



Pioneer's extraordinary second generation Compact Disc Player is here.

Time flies. Only 18 months ago, the hi-fi world was stunned by Pioneer's Compact Audio Disc player. Its laser and digital technologies introduced near-perfect stereo sound reproduction. "How will they top that?", they asked.

With the extraordinary new PD-70, Pioneer's second generation Compact Disc player.

We started by making the compact disc player more compact. The PD-70 loads horizontally (not to mention automatically), making system mounting much more practical.

The PD-70 is also an incredibly stable compact disc player. Comprehensive internal damping and robust construction means the PD-70 won't "skate" during operation.

The PD-70 is more intelligent too. Its memory can be programmed to repeat tracks up to 10 times and that programme can be interrupted or amended at any time.

The PD-70's 16-bit Digital Binary Display is the most sensitive and versatile metering system yet devised.

It breaks signal values down into 6dB increments - and switches to a "peak metering" mode at the touch of a button.

And, because all of the displayed information is both sourced and expressed digitally, the PD-70 can claim to have the most accurate metering display system available.

The PD-70's specifications speak for themselves: Dynamic range has been improved to 95dB. Signal-to-noise ratio has been improved to 95dB. T.H.D. is down to 0.004%, 1kHz.

Compact Disc has taken the next step. Pioneer's new PD-70 gives you music that is virtually distortion free, and laser technology means that your music need never deteriorate.

Pioneer's PD-70 means simply better stereo sound; a step closer to musical perfection.

In our opinion, that's always worth waiting for.

 **PIONEER**

Leads the world in Sound and Vision.



## QUICK INDEX

**W**HEN GOVERNMENTS proceed with hasty or ill-advised decisions, the community pays in many ways for many years. The 1950s Huxley Committee's decisions on television channel allocations is a case in point. We're still paying, some twenty years later, for the reshuffle in channels that took place in the early 1960s to correct problems that arose with the initial channel frequency recommendations.

Allocating TV channels in the 'international' FM broadcast band has been the main contention since day one. The Minister for Communications, Mr Michael Duffy, recently announced that channels 3, 4 and 5 are to receive new frequency allocations, clearing 'Band II' for the expansion of FM broadcasting services. Main stations required to move from Ch. 3, 4 or 5 are to be allocated alternative VHF channels, or where this is not possible, they would move to UHF (as would some translators).

The Government has also agreed to the *eventual* transfer of Ch 5A stations to other channels. This allocation has long been a thorn in the side of non-broadcast services such as defence, weather and scientific satellites and radio amateurs. To move 5A involves moving distance measuring equipment (DME) to the internationally used UHF band, creating room for two new VHF TV channels — 9A and 12. A Task Force is to be set up within the Department of Communications to oversee the moves. A timetable for all the clearances and transfers is to be announced later this year.

What was it the Pope said to Michaelangelo as he laboured long over the Sistine Chapel decorations? "When will you make an end?"

### A CHANGE OF FACE

From next month, our cover will look distinctly (and, we hope, distinctively) different. Turn to page 13 this issue for a preview.

Roger Harrison  
EDITOR

## SERVICES

**TECHNICAL INQUIRIES:** We can only answer readers' technical inquiries by telephone after 4.30pm Mondays to Thursdays. The technical inquiry number is (02) 662-4267. Technical inquiries by mail must be accompanied by a stamped, self-addressed envelope. There is no charge. We can only answer queries relating to projects and articles as published. We cannot advise on modifications, other than errata or addenda. We try to answer letters as soon as possible. Difficult questions may take some time to answer.

**COPYRIGHT:** The contents of *Electronics Today International* and associated publications is fully protected by the Commonwealth Copyright Act (1968). Copyright extends to all written material, photographs, drawings, circuit diagrams and printed-circuit boards. Although any form of reproduction is a breach of copyright, we are not concerned about individuals constructing projects for their own private use, nor by bands (for example) constructing one or more items for use in connection with their performances. Commercial organisations should note that no project or part project described in *Electronics Today International* or associated publications may be offered for sale, or sold in substantially or fully assembled form, unless a licence has been specifically obtained so to do from the publisher, The Federal Publishing Company, or from the copyright holders.

**GENERAL INQUIRIES:** For all inquiries about back issues, subscriptions (\$24.00 for 12 months/12 issues), photocopies of articles, artwork or submitting articles, call (02) 663-9999 or write to: ETI Reader Services, 140 Joynton Avenue (PO Box 227), Waterloo, NSW 2017.

**CONTRIBUTIONS:** Submissions must be accompanied by a stamped, self-addressed envelope. The publisher accepts no responsibility for unsolicited material.

**LIABILITY:** Comments and test results on equipment reviewed refer to the particular item submitted for review and may not necessarily pertain to other units of the same make or model number. Whilst every effort has been made to ensure that all constructional projects referred to in this edition will operate as indicated efficiently and properly and that all necessary components to manufacture the same will be available, no responsibility is accepted in respect of the failure for any reason at all of the project to operate effectively or at all whether due to any fault in design or otherwise and no responsibility is accepted for the failure to obtain any component parts in respect of any such project. Further, no responsibility is accepted in respect of any injury or damage caused by any fault in the design of any such project as aforesaid.



## FEATURES

Advanced Technology	
Telescope .....	14
Robots and the future of work ...	22
Perth Show Preview .....	28
Printers consumer review .....	56
PROLOG .....	73
A linguists reply to	
Dr Kobayashi .....	51

## AUDIO/VIDEO

Aiwa cassette deck review .....	34
---------------------------------	----

## COMPUTING

6800 microprocessors .....	82
Chip 8 column .....	85
Microbee column .....	88
Commodore Column .....	92

## PROJECTS

1420: Paging Amp .....	108
1523: Electronic scales. Part 2 ...	117
738: UHF Amp .....	141

## ELECTRONICS

Short circuits: Pseudo Zener .....	130
Ideas for Experimenters .....	128
Idea of the month .....	129

## COMMUNICATIONS

738: UHF Amp .....	141
--------------------	-----

## NEWS

News Digest .....	10
Sight & Sound .....	33
Computing Today .....	41
Equipment .....	95
Component .....	103
Communications .....	135

## GENERAL

Advertisers' Index .....	5
Mail order books .....	77
Shoparound .....	154
Over the counter .....	157
Mini-Mart .....	160
Dregs .....	162

## EDITOR

Roger Harrison VK2ZTB

## ASSISTANT EDITOR

Jennifer Whyte B. App. Sc.

## EDITORIAL STAFF

Jon Fairall B.A.

Geoff Nicholls B.Sc./B.E.

Peter Ihnat B.E., B.Sc.

Robert Irwin

## ASSOCIATES

David Tilbrook VK2YMI

Jonathan Scott

B.Sc./B.E. (Hons) VK2YBN

## DRAUGHTING

David Currie

## PRODUCTION

Peter Maxwell

Mark Davis

## ADVERTISING SALES

John Whalen (National)

Steve Collett

## ART DIRECTOR

Ali White B.A.

## ART STAFF

Toni Henson

Brian Jones

Vicki Jones

## READER SERVICES

Carmel Gatt

## ACOUSTICAL CONSULTANTS

Louis Challis and Associates

## MANAGING EDITOR

Jamieson Rowe

## HEAD OFFICE

140 Joynton Avenue, (PO Box 227)

Waterloo, NSW 2017.

Phone: (02) 663-9999 Sydney.

Telex: 74488, FEDPUB.

## ADVERTISING OFFICES AND AGENTS:

### Victoria and Tasmania:

Virginia Salmon and Mel Godfrey, The Federal Publishing Company, 23rd Floor, 150 Lonsdale Street, Melbourne, Vic. 3000. Phone: (03) 662-1222 Melbourne. Telex: 34340, FEDPUB.

### South Australia and Northern Territory:

The Admedia Group, 24 Kensington Road, Rose Park, SA 5067. Phone: (08) 332-8144 Adelaide. Telex: 82182, ADMDIA.

### Queensland:

Geoff Horne Agencies, PO Box 247, Kenmore, Qld 4069. Phone: (07) 202-6813 Brisbane. Telex: AA41398 HORNAG.

### Western Australia:

Cliff R. Thomas, Adrep Advertising Representative, 62 Wickham Street, East Perth, WA 6000. Phone: (09) 325-6395 Perth.

### New Zealand:

Chris Horsley, 4A Symonds Court, Symonds Street, Auckland. Telex: NZ60753, TEXTURE. Phone: 39-6096. Auckland.

### Britain:

Peter Holloway, John Fairfax and Sons (Australia) Ltd, Associated Press House, 12 Norwich Street, London EC4A 1BH. Phone: (01) 353-9321 London. Telex: 262836, SMHLDN.

### Japan:

Genzo Uchida, Bancho Media Services, 5th Floor, Dai-ichi Nisawa Building, 3-1 Kanda Tacho 2-chome, Chiyoda-ku, Tokyo 101. Phone: (03) 252-2721 Tokyo. Telex: 25472, BMSINC.



## ELECTRONICS TODAY INTERNATIONAL

is published monthly by the Electronics Division of the Federal Publishing Company Pty Limited, 140 Joynton Avenue, Waterloo, NSW 2017. Typeset and printed by ESN-The Litho Centre, Sydney. Distributed by Gordon and Gotch Limited, Sydney. Cover price \$2.50 (maximum and recommended Australian retail price only, recommended New Zealand price, \$2.95). Registered by Australia Post, Publication No NBP0407. ISSN No 0013-5216.

COPYRIGHT © 1984, THE FEDERAL PUBLISHING COMPANY

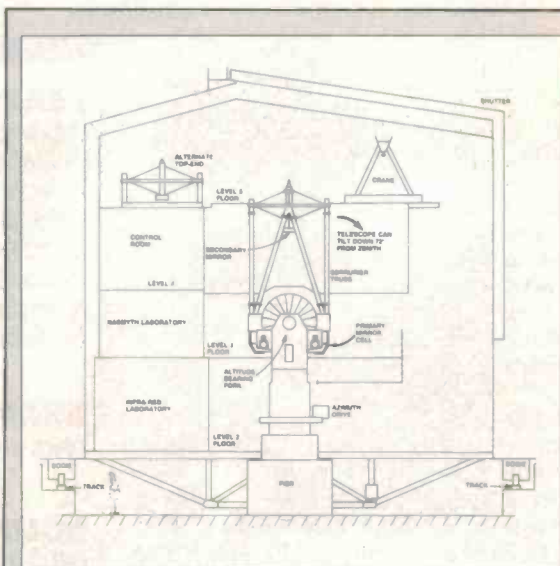

## Australia's Advanced Technology Telescope

Cover. Photograph courtesy Mount Stromlo and Siding Spring Observatory. Design by Ali White.



## Printers — types, technologies — grand survey



## Paging amp/sound system to build

## NEWS

NEWS DIGEST	10
SIGHT & SOUND	33
COMPUTING TODAY	41
EQUIPMENT	95
COMPONENT	103
COMMUNICATIONS	135

## COLUMNS

CHIP-8	85
MICROBEE	88
COMMODORE	92

## DEPARTMENTS

IDEAS FOR EXPERIMENTERS	128
IDEA OF THE MONTH	129
SHORT CIRCUITS	130
SHOPAROUND	154

This page is to assist readers in the continual search for components, kits, printed circuit boards and other parts for ETI projects and circuits. If you are looking for a particular item or project and it is not mentioned here, check with our advertisers.

## MINI-MART 160

• We'll publish up to 24 words (maximum) free of charge for you, your club or your association. Copy must be with us by the first of the month preceding the month of issue. Please — please — print or type advertisements clearly, otherwise it may not turn out as you intended! Every effort will be made to publish all advertisements received; however, no responsibility for so doing is accepted or implied. Private advertisements only will be accepted. We reserve the right to refuse advertisements considered unsuitable.

• Conditions: Your name and address plus phone number (if required) must be included with the 24 words. Reasonable abbreviations, such as 25 W RMS or 240 Vac, count as one word. Advertisements must relate to electronics, audio, communications, computing, etc — general advertisements cannot be accepted. Send your advertisement to:

ETI Mini-Mart,  
P.O. Box 227,  
Waterloo NSW 2017.

MAIL ORDER BOOKS	77
DREGS	162



# CONTENTS

## FEATURES

- Australia's Advanced Technology Telescope** 14  
State-of-the-art design and instrumentation at Siding Spring Observatory.
- Robots and the future of work** 22  
Barry Jones: Can Australia avoid joining the ranks of the third world?
- Printers: All you ever wanted to know . . .** 56  
Full run-down on how they work, how to choose and a market survey.
- ProLog — programming in logic** 73  
The syntax and semantics of a new language for computing

## PROJECTS

- 1420: Paging amp/sound system** 108  
A four-input, 150 watt output sound system for clubs, halls etc.
- 1523: Electronic Scales, Part 2** 117  
Continuation of last month's feature project — construction.
- 738: 25 watt UHF booster amp** 141  
A low-cost booster for UHF mobile rigs.

## REVIEWS

- Aiwa cassette deck review** 34  
Top-of-the-range sound and facilities from Aiwa.
- Ritron monitor review** 81  
A look at a new, low-cost green/amber monitor.

## ADVERTISERS' INDEX

AED	53
Active Electronics	131
Altronics	78-79, 106-107, 120-121, 158-159
Applied Technology	90, 91
Aust Government	6, 7, 24-25
Avtek Electronics	8, 9
Daneva	67
Delsound	113
Dolphin Computer	68
Centre Industries	64
Dick Smith	18-19, 42-43, 72, 100-101, 152
Ellistronics	138-139
Emona	65
Energy Control	65
Exlight	148
Ferguson	136
GCS Computers	51
GFS	134
Hi-com Unitronics	69
Hewlett Packard	46-47
Homelec	12
Hitech Light & Sound	154
Imark	134
Inst Diag Engineers	69
Jaycar	70-71, 97, 114, 115, 126, 127, 150-151
Kensor	136
Mayer Kreig	50
Magraths	132
Minitool	50
Nashua	40
Neotronics	94
Oscwell	66
Parameters	OBC
Paris Radio	45
Philips	29
Pioneer	IFC
Promark	116
Prepak	133
Rod Irving	38, 48, 54-55, 62-63, 137, 140, 153, 155, 156, 161
Rose Music	IBC
Soanar Elect	105
Sanyo	30
Scientific Devices	64
Scope Laboratories	39
Six Up	148
Sony (Aust)	32
STC Canon	50, 66
Stewart Elect	84
Telmar	147, 149
Truscott Elect	68, 125
Warburton Frankl	59
Wireless Institute	134
Geoff Wood	102
Woomera	69

## NEXT MONTH



**ELECTRONIC MOUSE TRAP**  
"Mouse plague!", shouted the newspaper headlines, as if it was something you didn't know already. The breaking of the drought and the abundance of natural feed has brought on a genuine plague — city and country. Tried to buy a mouse trap lately? On the tenet that 'build a better mousetrap and the world will beat a path to your door', Ian Thomas has devised an electronic mouse trap that despatches the beasts

swiftly and perhaps a little more humanely than other methods.

### STEREO TV REVIEW

The introduction of stereo TV means a subtle, yet far-reaching, change in direction for this standard piece of lounge furniture. Five stations have, so far, broken the ground and more will introduce it within a year. We will tell you how the system works.

# *Will your*



*Studying a degree course doesn't automatically lead to professional employment. Except with the Royal Australian Air Force. You can undertake a Science degree while securing a future. If you have matriculated or are currently undertaking your matriculation, are an Australian citizen or eligible to apply for Australian citizenship, are under 20 on the 1st February of your intended year of entry and are able to meet our selection requirements you will be offered a career that will lead you to becoming an Officer and a Pilot. Studying at the RAAF Academy as well as the new Australian Defence Force Academy.*

*With the military training that will stand you apart from other students.*

*And you will receive excellent pay while you study. So don't be left wondering what to do with your degree. Join Australia's Air Force and get your career off to a flying start.*



# *Are you good*



# *degree end up in the air?*



Study for a degree and become a Pilot in the Air Force.  
Applications are now open, clip this coupon and mail it to:  
Air Force Careers Officer  
G.P.O. Box XYZ  
in your State capital or your nearest Recruiting Centre.

Name \_\_\_\_\_

Address \_\_\_\_\_

Postcode \_\_\_\_\_

Birthdate \_\_\_\_\_

# *enough?*

Authorised by the Director General of Recruiting, Department of Defence.

AFA 70. DPS. 123





# It's AVTEK's Birthday

## The Multi Modem The Finest Modem in its Class

Now you can afford a modem with all the features. By using the just released LSI 'World Modem' chip we are able to offer the performance you would normally only get with modems costing 3-4 times the price. The Avtek Multimodem is designed in

Australia to suit both the Australian and International standards. Working at both 300 and 1200 baud, it provides all the currently available protocols, whether you wish to communicate down the road or across the world.

### Kit Form

Ideal for private line use and Amateur Radio operators for Packet Radio. This kit is complete to the last nut and bolt and includes pre-punched and silk screened front and back panel.

only \$249<sup>00</sup>

### Free Pack and Post this month only

### Fully Built and Tested

The fully assembled and tested version can be legally plugged into any phone socket to replace your standard phone. It comes complete with a telephone hardwired into the modem.

only \$329<sup>00</sup>

### Custom

OEMs please enquire - we can probably build you a 'custom' unit to your exact requirements for a fraction of the price you would expect to pay.



Fully Telecom Approved

### Specifications:

**Data** CCITT V.21 & V.23, Bell  
**Standards:** 103 & 202  
**Data Rates:** 300, 600 and 1200BPS  
**Backward Channel** 75 PBS in conjunction with 1200 BPS  
**Computer Interface** CCITT V.24 (RS232C)  
**Power** 240VAC/3W  
**Front Panel Controls** Mode switch (12 position rotary), Connect Switch (3 position toggle), Tests Switch (3 position toggle).

**Front Panel Indications** Connect LED, Data Carrier Detect, Received Data, Request to send, Clear to send, Transmit Data, Ring Detect, Test switch off normal, POWER.

## Thermistor Bargain

Philips type 56R 2232-660-91009. Refer Philips catalogue for specs. Thousands of uses. Going at a giveaway price.

\$1<sup>00</sup> for 25!!



## Robotics Motor

Back in Stock by Pub Dema

Perfect to drive your automated helper around.

Nominally 24 volt, but runs perfectly on 12VDC. These motors put out incredible torque - try and stall one!

- ★ Output speed at 12V no load approx 100m/A
  - ★ Stalled current approx 200mA
  - ★ Size overall 55mm long by 35mm wide
  - ★ Shaft length 20mm
  - ★ Shaft diameter 4mm
- These superb motors are made by Canon We are selling them at approximately 30% of the normal price.

\$9<sup>99</sup> each

\$31<sup>00</sup>

for 4.

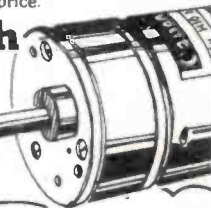

# We're Slicing Prices -

## Neutrik Connectors - the Best for Less

Replacing the standard 'Cannon' connectors. Neutrik connectors offer a higher standard of performance together with a number of revolutionary features, making them right choice where you need the ultimate in reliability and ease of use.

A revolutionary collet type cable grip provides a reliable grip on both thick and thin cables and a touch lock device allows you to quickly and easily remove and insert the cables. Construction is to the highest standard - made in Switzerland!!

### Prices:

**3 pin** 1-9  
Line Male 3.50  
Line Female 3.50  
Chassis Male 3.20  
Chassis 3.50  
Female  
Chassis Male 2.50  
non locking

Chassis Female non locking 2.50

Line Male 4.95  
right angle  
Line Female 4.95  
right angle

### 4 pin

Line Male 4.50  
Line Female 5.50  
Chassis Male 3.50  
Chassis 3.50  
Female

### 5 pin

Line Male 6.50  
Line Female 7.50  
Chassis Male 5.50  
Chassis 5.50  
Female

### 6 pin

Line Male 8.95  
Line Female 10.95  
Chassis Male 7.50  
Chassis 7.50  
Female

### Mains Type

Line Male 6.50  
Line Female 6.50  
Chassis Male 6.50  
Chassis 6.50  
Female



## Huge saving on T05 Heatsinks

Others are selling these black anodized aluminum heatsinks for 95¢ each! Look at our tiny price:

\$1.50

for 10!!

## Best Prices on Gel Cells

We've bought a large shipment of US made Technacell brand Gell Cells. These maintenance free rechargeable batteries are ideal for cyclic and standby use. They may be placed in any position.

### 6V/4 AH

Available in quick disconnect spade terminals or spring terminals. Weight 2lbs. Max discharge current 60A (spade terminal type).

The spring terminal model has a built in circuit breaker to protect against short circuit.

Size: 108(H) x 67 x 67mm

Normally \$17.95

only \$16<sup>15</sup>

## 2500uF/35V Electro

These super useful capacitors include bracket. They normally sell for over \$2.00 each.

50¢ each.

## 2661-3 USARTS going for a song \$14<sup>99</sup>

Worth over \$25.00 each. Look at our incredible price.

### 6V/8 AH

Spade terminals. Size 140(H) x 110 x 66mm normally \$22.95<sup>00</sup>

only \$20<sup>65</sup>

### 12V/4.0 AH

Spade terminals. Weight 4.06lbs. Maximum discharge 60A. Terminals may be used as solder lugs.

Size: 96(H) x 130 x 67mm

Normally \$25.95<sup>00</sup>

only \$23<sup>35</sup>



10up (any mix) Deduct 10%



# Sale!!

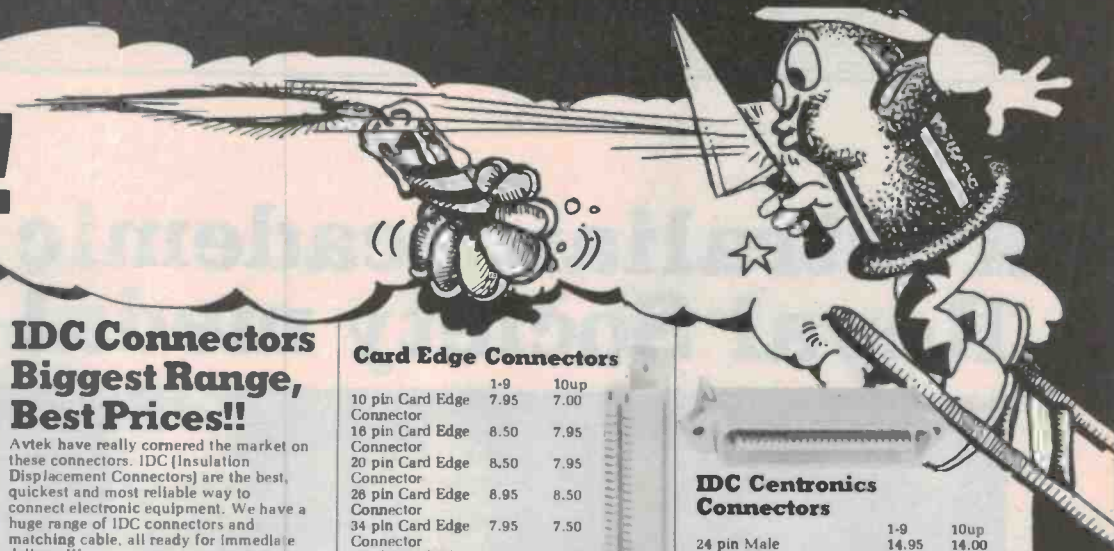

## D Connectors - Massive Birthday Savings

Our prices on top quality D connectors are the lowest around but for our birthday special we have reduced them a further 20%. Work out the price from the list below then deduct 20%. For this month only!!!

### 'D' Connectors Solder Type

DE9S Male 9 pin	1-9	10up
DE9S Female 9 pin	2.50	2.20
DE9 Backshell 1 piece	2.95	2.70
DE9 Backshell 2 piece	2.00	1.80
DA15P Male 15 pin	2.95	2.50
DA15S Female 15 pin	3.50	3.00
DA15 Backshell 1 piece	2.00	1.80
DA15 Backshell 2 piece	2.95	2.50
DB25P Male 25 way	4.50	3.95
DB25S Female 25 way	4.95	4.30
DB25 Backshell 1 piece	2.00	1.80
DB25 Backshell 2 piece	2.95	2.50

20% OFF THESE PRICES!

10% OFF THESE PRICES!

### 'D' Connectors PC Mount

Male 9 pin PCB Mnt	1-9	10up
Female 9 pin PCB Mnt	3.25	3.10
Male 15 pin PCB Mnt	3.95	3.75
Female 15 pin PCB Mnt	3.95	3.75
Male 25 pin PCB Mnt	4.95	4.00
Female 25 pin PCB Mnt	4.50	4.10
Female 25 pin PCB Mnt	5.50	5.00

## IDC Connectors Biggest Range, Best Prices!!

Avtek have really cornered the market on these connectors. IDC (Insulation Displacement Connectors) are the best, quickest and most reliable way to connect electronic equipment. We have a huge range of IDC connectors and matching cable, all ready for immediate delivery!!!

### IDC Connectors P.C. Mount Headers

10 pin Straight Header	1-9	10up
16 pin Straight Header	3.75	3.50
20 pin Straight Header	4.75	4.50
26 pin Straight Header	5.50	5.00
34 pin Straight Header	6.75	6.00
40 pin Straight Header	7.75	7.00
40 pin Straight Header	8.75	8.00
50 pin Straight Header	9.75	9.00

10 pin Right Angle Header	1-9	10up
16 pin Right Angle Header	3.75	3.50
18 pin Right Angle Header	4.75	4.50
20 pin Right Angle Header	5.50	5.00
26 pin Right Angle Header	6.75	6.00
34 pin Right Angle Header	7.75	7.00
40 pin Right Angle Header	8.75	8.00
50 pin Right Angle Header	9.75	9.00

### Wire Wrap Headers

34 Pin Right Angle	1-9	10up
50 Pin Right Angle	7.95	7.00
	12.95	11.95



### Card Edge Connectors

10 pin Card Edge Connector	1-9	10up
16 pin Card Edge Connector	7.95	7.00
20 pin Card Edge Connector	8.50	7.95
26 pin Card Edge Connector	8.50	7.95
34 pin Card Edge Connector	8.95	8.50
40 pin Card Edge Connector	7.95	7.50
50 pin Card Edge Connector	11.50	11.00
50 pin Card Edge Connector	12.00	11.50

### Female Socket Transition Connectors IDC Type

10 pin socket	1-9	10up
14 pin socket	4.50	4.00
16 pin socket	5.00	4.50
18 pin socket	5.25	4.50
20 pin socket	5.50	5.00
24 pin socket	6.00	5.50
26 pin socket	6.50	6.00
34 pin socket	7.50	7.00
36 pin socket	7.95	7.50
40 pin socket	8.50	7.95
50 pin socket	9.95	8.75

### IDC DIP Plugs

8 pin plug	1-9	10up
14 pin plug	2.95	2.50
16 pin plug	1.95	1.50
18 pin plug	2.25	2.00
20 pin plug	3.95	3.20
22 pin plug	3.95	3.20
24 pin plug	3.95	3.20
40 pin plug	6.50	5.95

### IDC Centronics Connectors

24 pin Male	1-9	10up
24 pin Female	14.95	14.00
36 pin Male	14.95	14.00
36 pin Female	15.95	15.00
50 pin Male	15.95	15.00
50 pin Female	17.95	17.00
50 pin Female	17.95	17.00

### 'D' Connectors IDC Type

9 pin Male	1-9	10up
9 pin Female	8.50	8.00
15 pin Male	8.95	8.50
15 pin Female	9.95	9.00
25 pin Male	10.95	10.00
25 pin Female	11.95	11.00
37 pin Male	12.95	12.00
37 pin Female	15.95	15.00
50 pin Male	18.95	18.00
50 pin Female	20.95	19.95
50 pin Female	22.95	21.95

## IDC Cables

Grey		Colour	
Price per metre			
10 way	\$1.25	16 way	\$2.20
16 way	\$1.75	25 way	\$3.95
26 way	\$2.50	34 way	\$4.95
34 way	\$3.45	<b>Twisted Type (Low Noise)</b>	
50 way	\$5.25	26 way	\$5.95
60 way	\$6.25		

# Get in for Your Cut!!

## Book Bargains

### Motorola M6800 Programming Reference Manual

Includes description of M6800 Program visible registers, Interrupts and Stack operations, Address Modes, Instruction set, Commands for EXbug, MIKbug, MINIbug II, MINIbug III. Also has descriptions of MPU, ROM, RAM, PIA and ACIA. Normally selling for \$9.95

only \$3.95

### Motorola Linear Interfacing Manual

Includes full technical details of the huge range of Linear ICs including: Memory/Microprocessor Support, Driver Receivers, Communication Interface, Voltage Comparators, Data Conversion, Voltage References. Cross referenced with package information and applications notes. A must for every professional or hobbyist. Normally selling for \$11.95. This month:

only \$4.95

### The Joys of Minis and Micros

A collection of articles from 'Computer Decisions' covering the use of the small computer for business. Cuts through the advertising hype to enable the business man to make the right decisions. Normally \$14.95

now only \$4.95



### PASCAL with Style

'Programmers can write programs that work first time.' This is the theme of this valuable text. Samples of programs used to illustrate the point. Normally selling for \$14.95

only \$4.95

### BASIC with Style

Intended for BASIC programmers who want to write carefully constructed, readable programmes. Rules for writing more accurate, error free programs. An excellent guide to program design and efficiency. Normally selling for 14.95

only \$4.95

### Using Microcomputers in Business

Written by a consultant to owners of small businesses this book is essential reading for any purchaser of microcomputer systems or software. Normally \$14.95

now only \$4.95

## The Electro-optical Components Data

The Texas Instruments data book covers photodiodes, avalanche photodiodes, low noise amplifiers, photodetector modules, infrared emitting and transmitting diodes. Includes devices designed for fibre-optics waveguide coupling. Normally \$5.95.

This month only: \$1.95

## Save 40% on 1793 Disk Controller IC

We have limited stock of 1793 disk controllers at huge savings. These normally sell for \$45.00. For this month there:

only \$25.00



# AVTEK

(ELECTRONICS) Pty Ltd

119 York Street, Sydney 2000  
Phone (02) 267 8777

Mail Orders to: P.O. Box Q302 Queen Victoria Building, Sydney 2000

### Postage and Packing

Divide the value of your order by 20(5%) to get post and packing value and then add \$2.00 - it's that simple. All bankcard orders can only be sent to a normal address (not a P.O. Box). All Bankcard orders will be sent by registered post (add \$3 to P&P charges)

**Dear Westies:** We regret to inform customers that we have closed our Enfield branch due to lack of interest!!



# Australian academic wins Royal Society medal

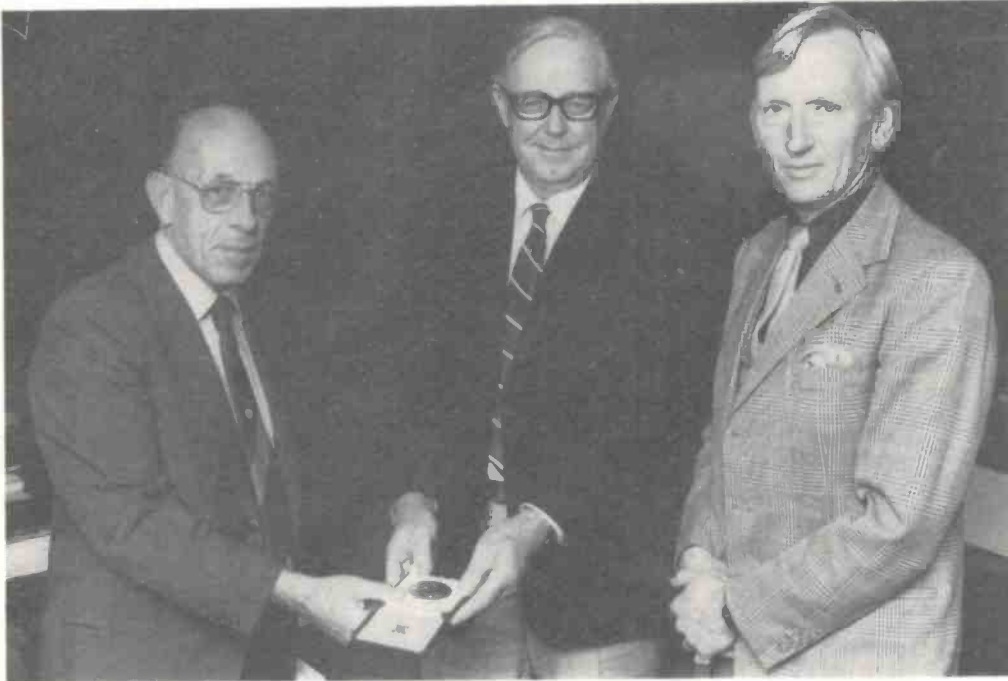

Professor Ward receives his award. The Hughes medal was presented to Prof. Ward (left) by the British Consul-General in Sydney, Mr M. S. Berthoud.

**The 1983 Hughes Medal of the Royal Society has been awarded to Professor John C. Ward of Macquarie University. The honour is regarded as second only to the Nobel Prize.**

## Japanese satellite in trouble

**T**echnical failures discovered in what would have been Japan's first operating broadcast satellite have cast a shadow on Japan's ambitious plans for satellite development for information networks.

Satellite operators have detected a malfunction in a transponder on the Yuri IIa broadcast satellite, launched by the National Space Development Agency (NASDA) in January.

It was the second of three transponders to fail, following another breakdown on March 23. The cause of the problems hasn't been established. The satellite was assembled and launched by NASDA, using transponders that came in a sealed 'black box' from General Electric Corp. of the US. The transponders use special tubes

manufactured by the French company Thomson-CSF.

Toshiba Corp. was the main Japanese contractor for the satellite, which included 70 per cent foreign-made and 30 per cent domestic-made parts. Officials of both the government-owned Japan broadcasting corporation and NASDA maintain that the malfunctions aren't permanent breakdowns and there's still hope for repairs.

However, the local media reported Tuesday that repair to the devices would be difficult and the problems could affect scheduled experiments on high-grade image broadcasting and advanced facsimile broadcasting that were to use the Yuri IIa.

In addition, the failure of the Yuri IIa may affect plans to develop communications satellites domestically.

The Royal Society was founded in the Middle Ages to advance the physical sciences. All the most famous British scientists have been members, including Newton, Boyle, Compton and Ryle. The voyages of discovery that finally uncovered Australia were undertaken at the instigation of the society.

Professor Ward is only the

third Australian (after Sir Mark Oliphant and John Pawsey) to receive the Hughes Medal. It was awarded for his 'distinguished and influential contributions to Field Theory, particularly to quantum electrodynamics and the Salem-Ward theory of weak interaction'.

The work ranks in importance with Maxwell's theory of electromagnetism and the quantum theory due to Einstein, Bohr, Heisenberg and others in explaining the fundamental properties of matter.

Established by the Royal Society in 1902, the Hughes Medal is awarded annually for original discovery in the physical sciences, particularly electricity and magnetism, or their applications.

Professor Ward was born in 1924. He has worked at Princeton and John Hopkins Universities in the US. Since 1966 he has been Professor of Physics at Macquarie University.

He has contributed much to physics, including work on particle theory, statistical mechanics, solid state physics and biology.

He was elected to the Royal Society in 1965 and has received recognition by the Institute of Physics and the American Physical Society.

Previous recipients of the Hughes Medal include A. H. Compton, Enrico Fermi, Max Born, Sir Harrie Massey, Viscount Cherwell, Freeman Dyson and Sir Martin Ryle. Many recipients have also become Nobel Laureates.

## How-to videos

**E**ducational Video Productions of Melbourne has produced and are distributing a series of educational videos covering electronic techniques.

The videos were designed with the assistance of TAFE and leading Australian electronic companies to meet the need for step-by-step instructional programs. They show in simple terms the procedure of taking a circuit idea from a schematic through to the finished stage, including the crucial process of soldering.

There were created with the

recently introduced TAFE 'basic electronics certificate' in mind.

The tapes vary in running time but the average is 22 minutes long. Professional studio facilities, presenters, directors and writers were involved throughout to achieve professional broadcast quality material.

The tapes are \$39.95 each (tax exempt) or \$43.53 each (tax inclusive). For further information contact Educational Video Productions, 57 Burwood Rd, Hawthorn Vic 3122. (03)819-4983.



## Space antenna

Part of a huge, orbiting space antenna that could usher in the age of worldwide communication using simple hand-held radios has been built by engineers in California.

The full antenna, when deployed in space, would be so powerful that it could pick up weak signals from Earth and rebroadcast them at much higher amplification to other parts of the globe. Small battery-powered transmitters and receivers are all that people would need. It may even be possible to communicate with radios small enough to be

strapped onto someone's wrist.

So far engineers have built four 'ribs' of an antenna that could be wound inside a central drum, carried into orbit by the space shuttle, and then unfurled in space.

The system would be part of a 55 metre diameter antenna. Forty eight ribs, made of graphite epoxy and weighing about 9 kg each, would be needed to support a gossamer thin web of gold-plated molybdenum wire which would act as the reflecting surface. Gold is applied to the molybdenum yarn in a layer only about a dozen atoms thick.

## Hi-Tech expo

The Department of Trade is seeking advanced technology firms to participate in an exhibition in the UK in November '84.

The International Exposition for Technology Transfer is being sponsored by the British government and Control Data Corporation of the USA.

The exhibition will be open to

private inventors, academic institutions, government agencies and major companies.

This will be one of the first exhibitions of this type in Britain, and the Australian government is keen to introduce Australian technology to the British.

Firms or individuals with technology suitable for this type of expo should contact Brian Usback at the Department of Trade on (062)72-2513.

## WAIT for robots



An ASEA robot arm has now been installed in the Electrical and Electronic Engineering Department of the Western Australian Institute of Technology. This industrial robot from Sweden was sold to WAIT at a special discount for education.

It is already being used for three jobs for local industry; it is hoped that it will raise revenue as well as being a teaching tool.

The Electrical and Electronic Engineering Department is planning to establish a significant Robotics Centre within 12 months. Postgraduate courses in Electronic Engineering already include units in robotics which cover industrial robots, safety and fail-safe measures, and artificial intelligence in robots. These units are popular with paying extension students from industry.

## Robot Olympics?

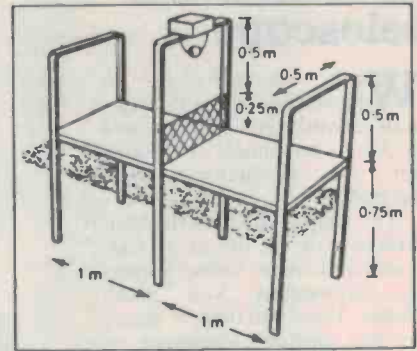

Personal robots from the United States and Britain will compete against each other in a ping-pong match. The competition, which will take place in 1985 will be held at the Computer Fair exhibition in London. It is the brainchild of Dr John Billingsly from Portsmouth Polytechnic.

The main challenge of this sporting tussle, which will engage some of the best brains of the countries' scientists and engineers, will be to develop cheap sensors to enable the robot to 'see' and return the ball to its opponent.

Billingsly said, "In the first year I only expect the robots to

return the ball once. In the second year the robots should be playing rallies, and in the third year they will be playing positional shots."

The contest organisers are expecting to see robots built by enterprising individuals rather than large manufacturers. They also warn potential entrants to rid themselves of preconceived ideas about bat shape.

The table will be 0.5 m wide with a frame at each end which limits the playing area. A mechanism over the centre frame will serve the ball toward the serving robot which then returns the ball so that it bounces once in its opponent's side of the court.

## Chip troubles

How much longer will chips go on getting better? Today's microelectronic circuits already crowd a half-million transistors on a piece of metal no larger than a fingernail, and it will soon be possible to build chips that contain a million or more transistors. But as the number of transistors on a chip rises, so does the difficulty of finding a market large enough to justify the cost of building the circuit.

Perhaps more important, the time required to design the chip also increases, so that the market could be gone before the chip is ready. In fact, designing a new integrated circuit other than a microprocessor or a memory is today more of a feat than manufacturing it.

Computer programs, however, are coming to the rescue. The latest class of programs, called silicon compilers, enables designers to specify what a circuit should do and, in a general

way, how it should be done. The computer takes it from there.

As yet, there are few silicon compilers. The programs can design only a limited variety of chips at present. And some large makers of integrated circuits are sceptical.

To reduce design time, new types of integrated circuits — called gate arrays and standard cells — have been developed. Both types offer the designer a choice of standard circuit elements that a computer automatically connects once the designer specifies what job the circuit is to perform. Silicon compilers go further, not only doing the wiring for the designer but also selecting the circuit elements on his behalf.

Although compilers are fast, one disadvantage is inefficiency. The programs aren't yet able to use the space on a chip as economically as the best human designers can do with only minimal help from a computer.

## Bicentennial telescope

Work commenced in November '83 on the Australian Synthesis Telescope, and is due to be completed in time for the bicentennial celebrations.

The project involves the construction of six dishes at Culgoora and one at Siding Springs in mid-western New South Wales. These will then be linked to the existing telescopes at Parkes and possibly Tidbinbilla, to provide the very long base line of the synthesis telescope.

Project director is Dr R. H. Frater, whose previous experience with state-of-the-art radio telescopes includes the Fleurs synthesis telescope, near Sydney, which he worked on in the early seventies.

Large synthesis telescopes represent the next stage in the development of radio astronomy. They are a generation beyond the huge dishes, like the one at Parkes, that have dominated astronomy during the last thirty years.

The synthesis telescope will behave like a single dish 300 km across.

Results from the Australian Telescope will directly complement the US Very Large Array telescope, a similar synthesis design. It is expected that both instruments will remain in the forefront of astronomical discovery well into the twenty-first century.



## Polaroid videoprinters

The Polaroid VideoPrinter Model 4 — with its larger format companion the Model 8 — represents a major new direction for the company, best known for its pioneering role in instant photography.

The VideoPrinter Model 4 uses analog technology to record video images on Polaroid. The new system processes Polaroid positive transparency films in minutes, without a darkroom, chemical baths or strict temperature controls.

Both the Model 4 and Model 8

VideoPrinters are self-contained peripherals which connect to a host system's analog video signal and can operate in parallel with a video monitor. They connect in minutes to most computer or video systems, without hardware or software modification.

The system delivers virtually distortion free, accurate colour copies superior in quality to images photographed directly from the screen and frequently better than the video image itself.

Automatic settings for bright-

ness, contrast and colour balance can be manually adjusted to achieve complete tonal control or dramatically modify the image. Other capabilities of the Model 8 include negative imaging, mirror reversal, the production of colour printers from black and white signals and black and white prints on colour film.

For more information contact Polaroid, 31 Waterloo Road, North Ryde NSW 2113. (02)887-2333.

## ONE OF OUR THERMOSTATS HOLDS TWO DEGREES

Temperature differentials of between 2° and 15°C are available with Homelec Thermostatic Controls

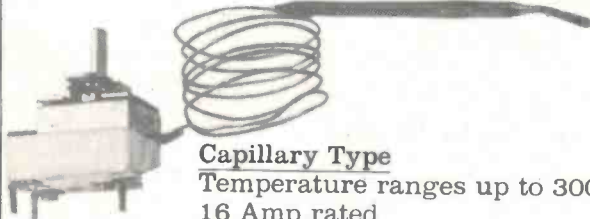

### Capillary Type

Temperature ranges up to 300°C  
16 Amp rated  
Knobs and Bezels available.

### Stem Type

7 in. and 11 in. Stem  
Temperature ranges up to 80°C  
with or without over temp. limiter.

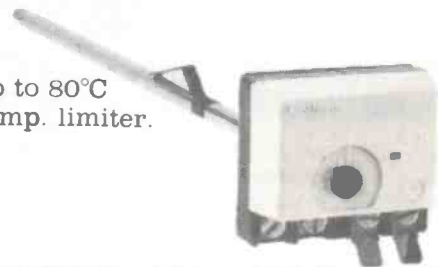

The widest range at the narrowest prices from: The Thermostat Specialists

**Homelec Products Pty. Ltd.** 1073 Victoria Road, West Ryde 2114. Tel. (02) 85-2922

Also from: Haan Australia, Tel. (03) 82-4582 and Email Grimwood and their distributors (all states)



**ETI'S BOLD NEW LOOK**

**NEXT MONTH!**

# Electronics Today

When you see us on the news stands next month, we're going to be different! As part of our continuing plans to improve the magazine, August's front cover will have a bold new 'banner'.

Instead of the familiar banner you've seen for the last few years, here's the banner you'll see.

Great, isn't it! We believe that this new banner is more in keeping with our bigger, brighter and more dynamic image.

**PLUS MORE FEATURES THAN EVER!**

## **Consumer electronics**

August's issue won't just have a prettier face, either. Inside you'll find a major feature on the Consumer Electronics Show in Perth, with a comprehensive coverage of the firms with stands — and their exciting new products.

## **Computing**

For computing enthusiasts, we've got a feature explaining the ins and outs of the Unix operating system. Also an article on extending the BASIC of a low cost VZ-200 computer. PLUS all the regular columns . . .

## **Build-it-yourself projects**

When it comes to projects, August features a new 150-watt Bass Guitar Amplifier design which features an inbuilt five-band graphic equaliser. There's also a new electronic mousetrap, to help with the current mouse plague (tried to buy a mousetrap lately?)

## **Audio**

Compact disc player prices are dropping! We'll be looking at the new \$599 compact disc player from Yamaha. Interested in stereo TV? We'll be taking a look at how it works.

## **Shortwave radio**

We haven't forgotten the keen shortwaver, either. There's an interesting story on the new proposals to broadcast on shortwaves direct from space satellites.

So it's all happening in next month's Electronics Today — Australia's dynamic electronics magazine.

**eti**

**DON'T MISS US!**



# Australia's Advanced Technology Telescope

Roger Harrison

This wholly Australian designed and assembled optical telescope, built for the 'bargain basement' cost of about \$3.2 million, will offer astronomers one of the most advanced and efficient facilities for research and training available in the world; today and in the future.

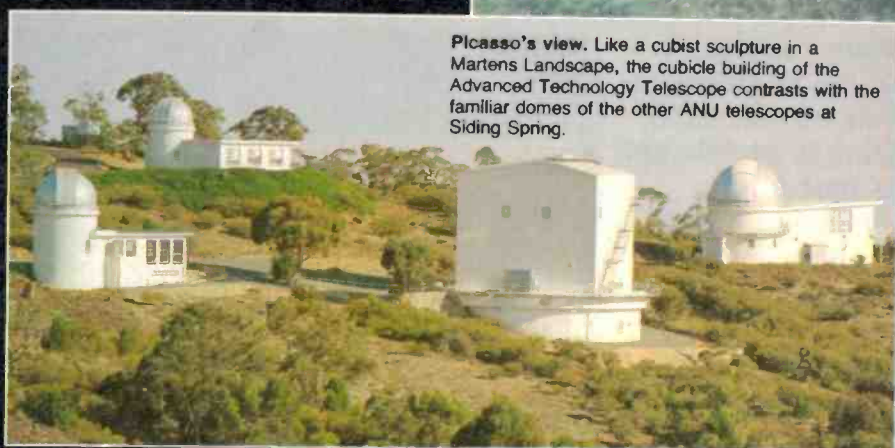

Picasso's view. Like a cubist sculpture in a Martens Landscape, the cubicle building of the Advanced Technology Telescope contrasts with the familiar domes of the other ANU telescopes at Siding Spring.

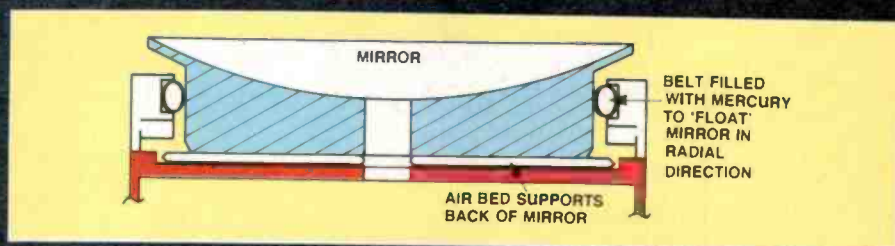

Figure 1. Mounting details of the primary mirror (scale exaggerated). An 'air bed' supports the rear of the mirror while a belt filled with mercury 'floats' it in the radial direction.

## MOUNT STROMLO & SIDING SPRING OBSERVATORIES

Mount Stromlo and Siding Spring Observatories (MSSSO), part of the Research School of Physical Sciences of the Australian National University (ANU), operate from two sites:

**Mount Stromlo Observatory.** Located on a site overlooking the national Capital, Canberra, this is the headquarters of the complex. It was

THE PRIME MINISTER, Mr Bob Hawke, A.C. M.P., inaugurated the Australian National University's 2.3 metre Advanced Technology Telescope on 16 May 1984, ushering in a new era for Australian astronomy and astronomers. At the ceremony, Mr Hawke said: "The ANU is to be congratulated for its initiative in developing this telescope which sets new international standards in astronomical engineering and is the most advanced optical telescope ever built.

"There are good reasons for Australians to be proud of this achievement.

"The design and development of the telescope is very much a co-operative Australian venture. Apart from several components which could not be manufactured in Australia, construction took place in the ANU's own workshops and involved a large

number of Australian engineering firms, supply and service companies and consultants.

"The astronomers, engineers and technicians at Mount Stromlo and Siding Spring Observatories, with the support of the ANU and co-operation of industry, have created a facility which clearly demonstrates Australia's capacity to contribute to the advancement of high technology.

"The telescope is a particular tribute to the entrepreneurship of Professor Mathewson, for it is he who sought out the elements from a variety of sources and has been responsible for their synthesis into an impressive price of research equipment."

### Why?

Four main factors led to the construction of the Advanced Technology Telescope

(ATT). Firstly, an acute shortage of observing time hampered the ANU's Research School of Physical Sciences' work in the field of astronomy; secondly, the need for a large telescope versatile enough to take full advantage of modern instrumentation. There was also lack of advanced facilities for the training of students. Coupled with a desire to stimulate the development of astronomy in Australia, these factors provided the drive to design and build the new telescope.

Professor Don Mathewson, Director of Mount Stromlo and Siding Spring Observatories (MSSSO), devised the bold concept in the late 1970s and has seen it through to 'first light', achieved on 15 May this year. The original specifications, as outlined by astronomers and engineers at MSSSO, called for a versatile, precise, efficient



**Siding Spring observatory from the air.** The ANU telescopes are visible in the foreground. The large dome to the right houses the Anglo-Australian 3.9 metre telescope. The UK Schmidt facility is at far left.

established in 1924 by pioneer Australian astronomer, Dr W. G. Duffield, as the Commonwealth Solar Observatory. It was transferred to the ANU in 1957. Mount Stromlo is equipped with five optical telescopes. It has unique facilities for high-dispersion spectroscopy using the 1.9 metre reflector which was, until 1974, the largest telescope in the southern hemisphere.

**Siding Spring Observatory.** Located in the spectacular Warrumbungle Ranges near Coonabarabran, North-Western NSW, this facility was established in 1962 by Dr Bart Bok who did a great deal to stimulate the development of astronomy in Australia. There are four ANU telescopes at Siding Springs: The 2.3 metre Advanced Technology Telescope, a 1 m reflector plus 60 cm and 40 cm reflectors. The ANU also hosts the 3.9 metre Anglo-Australian Telescope, completed in 1974 and one of the most advanced and powerful observing instruments in the world, along with a 1.2m Schmidt camera owned by the UK Science and Research Council and the University of Uppsala's 20 cm Schmidt camera.

With a staff of 140, and extensive scientific and technical facilities, the ANU observatories together constitute one of the world's major astronomical research establishments.



telescope, to be equipped with advanced astronomical instrumentation, but costing a fraction of the price of a conventional telescope.

In all respects the new telescope meets the original aims of its creators, in many ways it surpasses those aims. The dream has been translated into reality, a reality that is an inspiring example of the capabilities of Australian scientists, engineers, and technicians — the concept is bold, the design is elegant, the implementation professional.

### General features

I travelled to Siding Spring during late Easter, several weeks before the telescope was inaugurated. What confronted me there was a facility remarkably different from the other, conventional, telescopes on the mountain. Instead of the familiar domed

building, there stood a cubical building. Despite its dominating size, it is in fact smaller and considerably less costly than a conventional domed building would be for a telescope of its size. During use the telescope inside rotates, the building rotating with it, slaved to the telescope drive.

In a conventional telescope facility, the domed section of the building rotates as the telescope follows the apparent motion of the object being viewed. Instrumentation is mounted on the telescope, excepting when Coudé optics are used where the light is reflected out of the telescope and mount by a series of mirrors.

In the ATT, the instrumentation can be conveniently mounted in the building as a result of the design of the telescope optics and the building control.

A 2.3 metre diameter mirror is the heart

of the new telescope. The front surface of this 'primary' mirror has been precisely ground and polished to a concave shape and coated with a reflective layer of aluminium. Light falling on the primary mirror is reflected up to a smaller secondary mirror suspended near the top of the telescope. The secondary mirror reflects the light back down to the astronomical instruments mounted at the three focal points.

The primary mirror, which weighs two tonnes, is supported from behind by an air-bed. A tubular band, containing mercury, encircles the mirror and supports it against sideways forces. (See Figure 1). The mirror cell is connected to the telescope's centre ring, and then to the top-end structure that supports the secondary mirrors, by a carefully engineered arrangement of tubular struts called a Serrurier truss. This truss



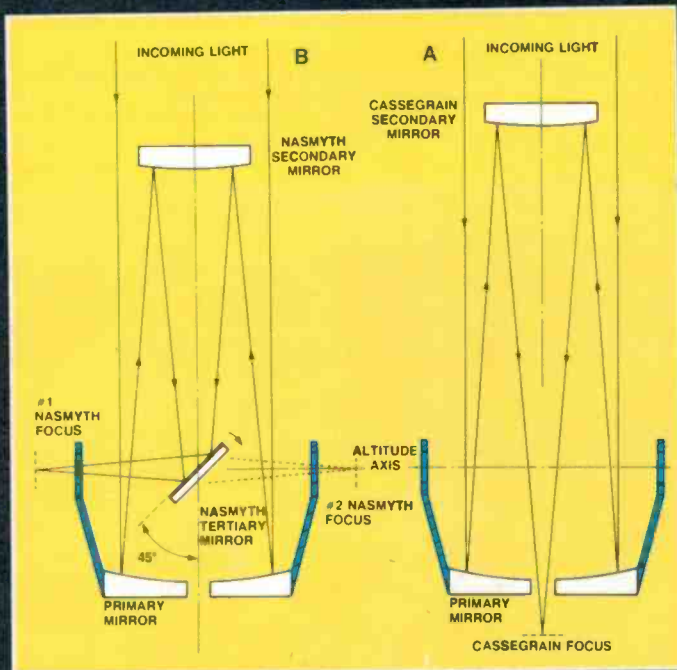

Figure 2. The telescope optics is capable of operating in two modes — Cassegrain (A) and Nasmyth (B). The latter has two focal positions, obtained by flipping the tertiary mirror. Note that the scale here is exaggerated.



Down the barrel. View from the top-end of the telescope. The four electric motor-driven top-end clamps are clearly visible. The primary and tertiary mirrors are not in place here.

maintains the mirrors in alignment as the telescope is tilted. Gravity, acting on the upper truss system causes it to 'droop' ever so slightly, which would throw the secondary mirror out of alignment, moving the focus point. The same goes for the heavy main mirror and its mount. The Serrurier truss, however, reduces the droop to negligible amounts while maintaining alignment of the mirrors.

The optics of the ATT make it an extremely flexible instrument. There are two configurations — Cassegrain and Nasmyth. The Cassegrain configuration is shown in Figure 2a. Light falling on the primary mirror is reflected back up to the secondary mirror. This directs the light straight down through a hole in the centre of the primary mirror to the 'Cassegrain focus'. It is intended that instrumentation for making observations in the infra-red will be mounted at this focus, at the rear of the mirror mount. Infra-red observations can be carried out day and night.

In the Nasmyth configuration, shown in Figure 2b, the converging beam of light from the secondary mirror is intercepted by a tertiary mirror and deflected out along the horizontal azimuth axis of the telescope mount. There are two Nasmyth foci, one on each side of the telescope. The observer can switch rapidly from one to the other by simply rotating the tertiary mirror. The Nasmyth focal stations remain stationary with respect to the rotating building, so large instruments and experimental equipment can be easily mounted there.

The primary mirror is made of Cer-Vit — a glass-like material that has a very low coefficient of expansion over a wide temperature range. It was purchased as a 'blank' from Owens-Illinois, who cast it, and ground to shape by the Norman Cole company, both of the USA. The University of

Arizona, OSC (USA) performed the optical testing.

The telescope has two complete top-end structures to accommodate the two different optical systems; one for the Cassegrain secondary mirror, one for the Nasmyth sec-

ondary mirror. The top ring is held in place by several small electric motor-driven lock mechanisms. These can be released and the top-end changed in twenty minutes so that the telescope configuration may be changed during an observing period.

### THE DIFFERENT TELESCOPE MOUNTS

All telescopes need to be mounted so that they can be conveniently pointed at the object of interest and then rotated to compensate for the rotation of the Earth. There are two fundamental ways of doing this. The traditional method is known as the *polar mount*. As can be seen from the illustration on the left, the main axis is the *polar axis* which runs parallel to the Earth's axis and points, in the southern hemisphere, to the *south celestial pole*. This is a point in the sky about which the stars seem to rotate. The *declination axis* permits setting the telescope on the object. Once this is done, a drive mechanism rotates the telescope about the polar axis, slowly from east to west, maintaining the telescope on the chosen object despite the rotation of the Earth.

The illustration on the right shows the *altitude-azimuth* mount, or alt-azimuth mount as it is more commonly called. Here, one axis is vertical (azimuth) and the other horizontal (altitude). To maintain the telescope on the chosen object, both axes need to be driven. Obviously, this is a more complex drive system. Although attempted in the past, the complexity of alt-azimuth drive systems generally thwarted successful construction. Computer control of the drive system has changed that.

Figure 3. There are two main methods of mounting a telescope — polar (A) and alt-azimuth (B).

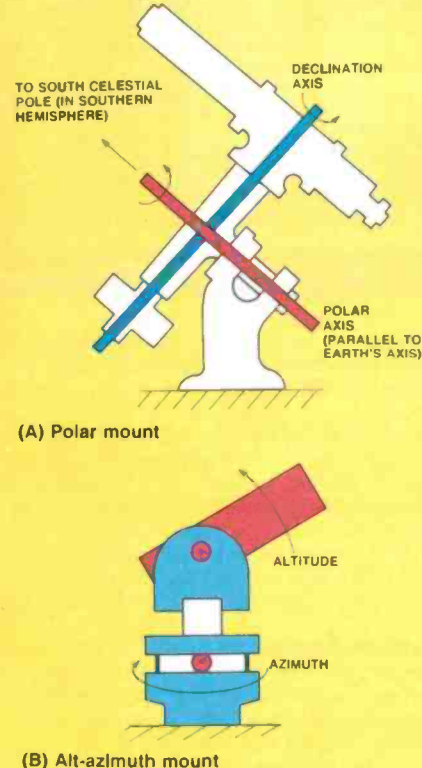



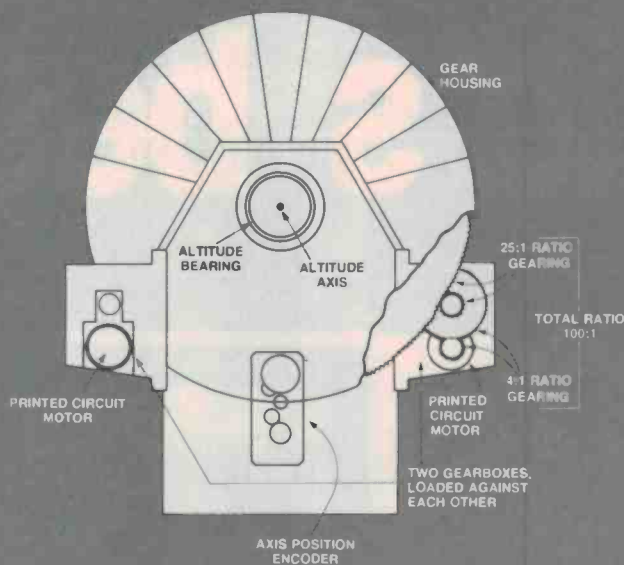

Figure 4. Details of the altitude drive mechanism. The two printed circuit motors are driven in opposite directions, 'loading' the two gearboxes against each other. Reducing the drive to one allows the other motor to move, driving the axis in the required direction. The azimuth drive is identical.

### Telescope mount and drive

The telescope mount is 'alt-azimuth'. That is, it has one horizontal axis-of-rotation (the *altitude* axis) and one vertical axis (the *azimuth* axis). The basic scheme is shown in Figure 3b. Even though the moving parts weigh some 30 tonnes, the telescope can be slewed and pointed with extreme precision. More of that shortly.

The alt-azimuth drive was chosen as it offers simpler design and provides a constant load on the bearings. The bearings are pre-loaded and oil-lubricated with a pressurised system.

Two identical spur gear systems with printed circuit motors provide the drives for the two axes. This is a departure from previous practise. Drive systems for polar mounts almost invariably employ a worm gear and wheel system with a reduction ratio of 360:1, 720:1 etc. The ATT drive system employs a two-stage reduction of 100:1, which requires an extremely precise drive and servo mechanism.

The altitude drive is illustrated in Figure 4. Two printed circuit motors and their gear boxes are mounted 120° apart. The two motors have drive applied all the time, but rotate in opposite directions, 'loading' the gearboxes against each other to eliminate backlash. To move the telescope in any direction, the drive to the appropriate motor is reduced, allowing the other motor to move. The whole telescope assembly is carefully balanced so that the drive only has to act against inertial forces. During use, the telescope only moves at 15 arc-seconds per second, which is quite slow.

The telescope can be swung from the zenith (straight up, or 0° altitude) through to 72° altitude (18° above the horizon). The telescope cannot be swung any lower than that for two reasons. Firstly, the mirror would tip forward out of its housing (disas-

ter!). Secondly, astronomers prefer to view objects as high as possible as the atmosphere distorts the image and the less of it you look through, the lower the atmospheric effect.

The gear systems were made by MAAG of Switzerland and the bearings by Rothe Erde of West Germany.

The drive motors are servo-controlled, linked to a modern, high-speed computer. Positional feedback is provided by axis position encoders that measure the rotation of the telescope about its axis. The encoders, from the Baldwin company USA, are accurate to 0.05 seconds of arc, dividing one full rotation into 64 800 000 individual steps.

A Digital Equipment VAX 11/780 computer is the overall controller. This computer is connected to sensors and actuators on the telescope, the building, and the astronomical instruments. The control-computer can slew the telescope to the required position on the sky, set the acquisition camera accurately on the astronomical object, and operate the astronomical instruments.

The telescope control-console incorporates an image-processing computer that assists the observer in acquiring his programme objects. Compact, low-light-level television cameras attached to the astronomical instruments generate pictures that are displayed at the console. Objects can be selected by moving a small, computer-generated marker on the screen to the required position. The telescope will then set automatically to the position indicated.

One of the advantages of such a strongly computer-based design is that major changes to the operating characteristics of the telescope and its ancillary equipment can be made simply by altering the control programs. As a result, the telescope and its control systems can evolve in time, without

any changes being made to mechanical or electronic components. A telescope that can evolve, to meet changing observational needs, promises to be a highly versatile and efficient scientific tool.

### The building

The cubical building is constructed on a circular steel base assembly. This is supported by four two-wheel bogies that run around a circular steel track beneath the building. A polygonal cement skirt encloses the track. Two of the bogies are driven by shunt-wound dc electric motors that run at stall torque when the building is in motion. As the motors run quite hot in this mode of operation, they have to be forced-air cooled. A section drawing of the telescope and building is shown in Figure 5.

The building itself is 14½ metres square. The steel-section frame is clad in 'Stramit', a lightweight, low-cost aluminium building material. It is painted white to reflect heat during the day. Being a lightweight material, it does not absorb much heat and can be cooled rapidly at night so that the building may be maintained close to outside air temperature during observations. Any rising hot air from the building causes distortion of the optical path, degrading the stability of the image during observations. Thermal considerations of the whole building were an important part of the design. The building is maintained to within a fraction of a degree of outside air temperature by huge fans which draw in air from the outside and blow it up through the building during use.

The main purpose of the building is to preclude any winds from buffeting the telescope during use for this would markedly degrade the image stability. A sliding 'shutter' opens for viewing. This rides on tracks on the outside of the building, driven by an electric motor. It takes 57 seconds to open.

The telescope and building can be rotated plus-and-minus 270° — chosen so that astronomers have full access to the sky. The azimuth drive is mounted on a concrete pier beneath the centre of the building. This pier is set several metres into the bedrock below. Overall weight of the building is 150 tonnes. A 'cable wrap' inside the pier carries all power, data and telephone cables up the centre of the telescope mount into the building. This prevents fouling or tensioning of the cables while the building is in motion. It can rotate plus-and-minus 320° while the building and telescope has a limit of +/- 270°. The cable wrap idea was 'borrowed' from that used in the CSIRO's Parkes 64 metre radio telescope.

The telescope drive is the prime drive in the whole system. A linear variable differential transformer (LVDT) sensor on the building provides servo feedback to the control computer regarding the position of the building in relation to the telescope. There can be a difference of up to 4° between the telescope and the building positions.

Inside, there are floors at four levels and a number of rooms. An infra-red laboratory is located on the level 2 floor (Figure 5). A Nasmyth laboratory is located on level 3 and the control and computer rooms are located on level 4.

On level 5 is stored the alternate top-end. ▶

# Australia's best

## NOW AT . . . **COMPUTER CITY** IN 46 STORES

Come on in to Dick Smith Electronics COMPUTER CITY for the very best!

You'll find a computer to suit your needs - from the beginner to the business user . . . and everything in between.

You'll find friendly, helpful staff - experts in their fields. They'll be able to answer your questions with authority and accuracy.

You'll find our computers on display - working - where you can try them out. Nothing beats actual 'hands on' experience.

But most of all, you'll find the reassurance of dealing with Australia's leading computer retailer - 50,000 owners can't be wrong - with the technical back-up, the service back-up and the software back-up that the department stores simply can't match.

Trust Dick Smith Electronics COMPUTER CITY for YOUR computer.

### The Challenger

The IBM PC compatible that beats the IBM . . . on price, on performance, on features, on expandability . . . on everything!

The Challenger is the computer for the small to medium size business (it has 10 times the memory of Dick Smith Electronics first mainframe computer!)

But it's more than that: because it is compatible with IBM PC software and hardware, it makes a superb scientific or industrial computer . . . or even a low-cost IBM terminal. And you'll save a fortune!

### The CAT

Why waste hundreds of dollars buying an Apple computer when you can buy The Cat . . . Dick Smith Electronics' latest computer masterpiece! It's twice as fast as the Apple IIe. It has a bigger and better BASIC. A larger keyboard. Super hi-res colour graphics. More sound channels. Just compare the two computers and judge for yourself! (Ask for our free comparison brochure).

Compatible with most Apple IIe software, The Cat is THE computer for education, for the student at home, for the hobbyist, for dedicated functions in industry . . . even for the small business.

### VZ-200

The ideal computer for the beginner who wants a computer to grow with: Dick Smith Electronics incredible VZ-200. It's the low-cost way to go computing - without buying an 'orphan' or dumped computer with no back-up.

The VZ-200 has a great range of low-cost software from games to small business utilities. And it's also very popular with amateur radio operators because of its very low noise level.

If you're starting out, you'll start out best with a VZ-200.



## THE NEW DICK SMITH **CHALLENGER**

### System Unit

The 'works' of the computer . . . keyboard, CPU, 128K RAM, input/output ports, etc. Ideal for cassette-based applications as it is with nothing more to buy. Includes Centronics parallel printer port, cassette port, joystick & light pen ports plus RF, video and RGB outputs.

Cat X-8600 All this for only . . .

# \$995

### Expansion Unit

Far more than mere expansion!

As well as three IBM compatible expansion slots plus two true 16-bit slots, you get twin slimline disk drives and an RS-232C communications port.

### PLUS free software!

We also include a range of quality software worth over \$1000. . . .

Microsoft MS-DOS & GW Disk BASIC,  
Perfect Writer, Perfect Filer and Perfect  
Calc PLUS user manuals! Cat X-8610

Expansion unit and software . . .

# \$1995

This makes the Challenger more than a match to the IBM PC - much more. Yet the IBM PC expanded to this level costs well over \$7000. Compare the Challenger - and Save!

**TOTAL SYSTEM ONLY . . . \$2990**  
YOU SAVE OVER \$4000 ON THE IBM PC!!!



# value computers



Apple IIe compatibility... but near half the price! That's The CAT. It's the best of both worlds: the very latest and most powerful hardware, plus the ability to run a very broad range of tried-and-proven software, particularly schools & business programs. And because we import direct, there's no middleman to force up the price. It really is outstanding value for money.

Check the CAT out at your nearest Dick Smith Computer City. It purrs.

Basic CAT Computer  
Cat X-7500

**\$699**

That's near half the price of the Apple with similar features!



New shipments arriving to meet huge demand... it's incredible!

\* Computers shown are with extra-cost options.



OVER 20,000  
ALREADY SOLD!

## VZ-200 Computer Bargain!

This fantastic colour computer that's received rave reviews - now at this incredibly low price due to our high volume purchase power! Stocks are plentiful now, but at this price they won't last!

- **VZ-200 COLOUR COMPUTER** **\$99**  
Complete with USER manual, BASIC manual & Demonstration Cassette. Ready to plug into your TV set. Cat X-7200
- **DATASETTE** **\$69<sup>50</sup>**  
Specially designed recorder for loading and saving programs. Cat X-7207 **ONLY**
- **16K EXPANSION MODULE** **\$79**  
Expands your memory to 24K which is essential for serious programming. Cat X-7205 **ONLY**
- **PRINTER INTERFACE** **\$31**  
Lets you connect your VZ-200 to most standard Centronics-type printers such as our X-7208 below. Cat X-7210 **WAS \$49.50**
- **PRINTER PLOTTER** **\$169**  
Fantastic 4 colour printer that is an X-Y plotter as well! Cat X-7208 **WAS \$299**
- **JOYSTICKS** **\$39<sup>50</sup>**  
A pair of sturdy, super responsive joysticks that add a whole new dimension to action games. Easy to operate. Cat X-7212 **ONLY**
- **PROGRAMME 4-PACK SPECIAL** **NOW \$19<sup>95</sup>**  
3 sets to choose from — Educational (X-7292), Financial (X-7293) and Entertainment (X-7291). **Separately \$50**

PLUS manuals and books of programmes.  
**DICK SMITH ELECTRONICS**  
See page for full address details





Figure 5. Skeletal 'cut-away' view of the ATT building showing the four internal levels, control room and laboratories. The whole building rotates on a track encircling the base, supported on four bogies, two of which are driven by dc electric motors. The figure at left gives approximate scale.

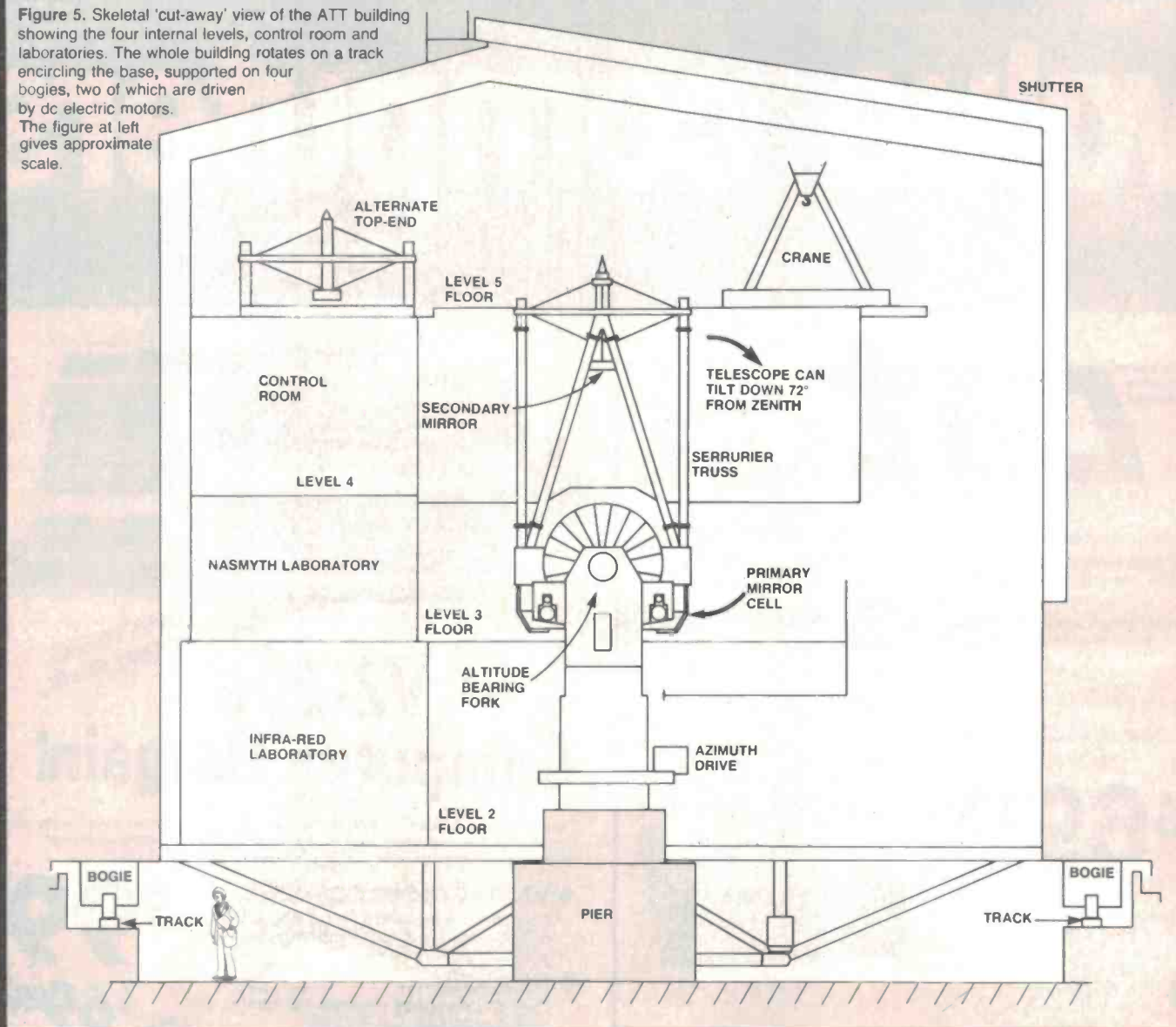

The crane for swapping top-ends is here, too. Instrumentation attached to either Nasmyth focus is mounted on the altitude bearing forks, with easy access from the level 3 floor where sundry instrumentation and equipment can be planted. Cassegrain focus instrumentation is mounted on the rear of the mirror cell. As detection instrumentation is predominantly electronic these days, subsequent signal processing and analysis equipment can be mounted in the nearby laboratory rooms.

The control and laboratory rooms are maintained at comfortable working temperatures during use. There's no point working in the cold when you don't have to! Lighting is arranged to retain astronomer's visual dark adaption while working. No fluorescent lights are used at such times, illumination of work areas being provided by dimmed incandescent lamps.

### Instrumentation

The Australian National University is at the forefront of astronomical instrumentation

development. Engineers and scientists from the ANU have developed a Photon Counting Array (PCA) using charge-coupled devices (CCDs) that is very much a state-of-the-art device. It was developed as part of the Starlab project (see ETI, May 1982, *Starlab — Australian-Canadian Ultraviolet Telescope*, pp 14-20). A charge-coupled device will generate electrons when struck by a photon — a particle of light. Excellent sensitivity and resolution can be obtained using such an array. Digital processing of the signal can enhance performance many times over, much more so than with optical photographic methods.

Spectrographic analysis of astronomical objects is of great importance in astronomy, providing many clues to the processes that occur in star systems. It is intended that spectrographic instruments will be mounted at either of the Nasmyth focci. Because the image rotates as the telescope moves to follow the apparent motion of the stars, an instrument 'field rotator' attached to the altitude bearing serves to 'de-rotate' the

image during observations as well as providing a facility to 'line-up' the image in a spectrograph slit.

The VAX 11/780 computer in the ATT building and other signal analysis/processing equipment can be used for on-line processing of the data. In fact, this can be done remotely, via a data link-up between the Siding Spring site and the Mount Stromlo facility at Canberra. This link-up can also provide remote telescope control. A 9600 baud DECNET terminal is installed in the ATT building at Siding Spring, linked by a permanent Telecom landline to Mount Stromlo.

### Finale

Such is the success of the project's bold and radical approach that it has attracted international attention with visits from American, British, Dutch, Italian and Japanese scientists and engineers interested in building similar telescopes.

It is expected that the ATT will play a key role in the exploration of the universe.





Below. Building drive. The building rides on four bogies, two of which are fitted with dc electric motor-drives, like this one.



Far left. Up the barrel. View from the rear end of the telescope. The altitude drive is in the right foreground, the primary mirror cell is visible in the left foreground. Note the small size of the drive motors (see Figure 4).

Left. Cable wrap. All the power, data and telephone cables, attached to the 'fixed' outside world, are brought up the centre of the telescope pier and into the building via this cable wrap. As the building rotates, the cable wrap twists, preventing the cables being strained or fouled. The cables all pass down from the pier on the outside of the ring visible at the bottom of the picture, then up the inside of the ring to the telescope building.

Below. Control console. This is the astronomers' control console. It was designed and manufactured by the ANU's own workshop.



Complete computer control may allow, in the not too distant future, astronomers in different parts of the world to make use of the facility through satellite hookups. This sort of possibility offers considerable attractions, not just for Australian astronomical research. In concluding his address at the inauguration of the ATT, Mr Hawke said, "... I should like to pay tribute to the manifest commitment to excellence apparent in so much of the work of those associated with space activities. Your endeavours, in quite unprecedented fashion, probe the frontiers of human knowledge and experience. This telescope provides no better proof."

As acknowledged by the Prime Minister, the telescope owes its existence to the efforts of a large number of people. The astronomers who initiated the project, the officers of the Australian National University who provided the funding, the staff of MSSSO who created the reality, the staff of the Research School of Physical Sciences who assisted in the production, and the indi-

viduals and companies throughout Australia and overseas who provided a wide range of services.

For MSSSO the telescope has been the epitome of an 'in-house' project. The scientific staff produced the original inspiration and specifications. The engineering teams worked steadily for a full five years to prepare detailed designs and drawings of thousands of components. The craftsmen of the mechanical, optical, and electronic workshops have converted those drawings into the final product, using all the skills at their command. The software engineers have written thousands of lines of computer code. The administrative and secretarial staff have provided the necessary logistic support for the technical work. Finally, to close the loop, the scientists have monitored and guided the development of the project. During the last year the pace has quickened to meet the final production schedules, but the team has not faltered.

The existence of the 2.3 metre telescope is a testimony to inspiration and hard work.

All those who have contributed to its completion can be proud of the accomplishment, whether they are members of the MSSSO team, the staff of the Australian National University, or the wider community. They will always share in the credit that the telescope brings to Australia.

### Acknowledgements

In researching and writing this article, I would like to acknowledge the generous cooperation and assistance of a number of people. Firstly, my thanks go to Professor Don Mathewson, Director of MSSSO, who smoothed my path, introduced me to those who could best assist my task and arranged my visit to Siding Spring at relatively short notice. At Siding Spring, a number of staff gave generously of their time: Mary Gillingham, Andrew Arms and Herbert Wehner. Dr Barry Newell of ANU provided much-needed liaison, technical drawings and the magnificent photographs you see used on the front cover of this issue and throughout the article. ●



BARRY JONES TALKS ON

# ROBOT

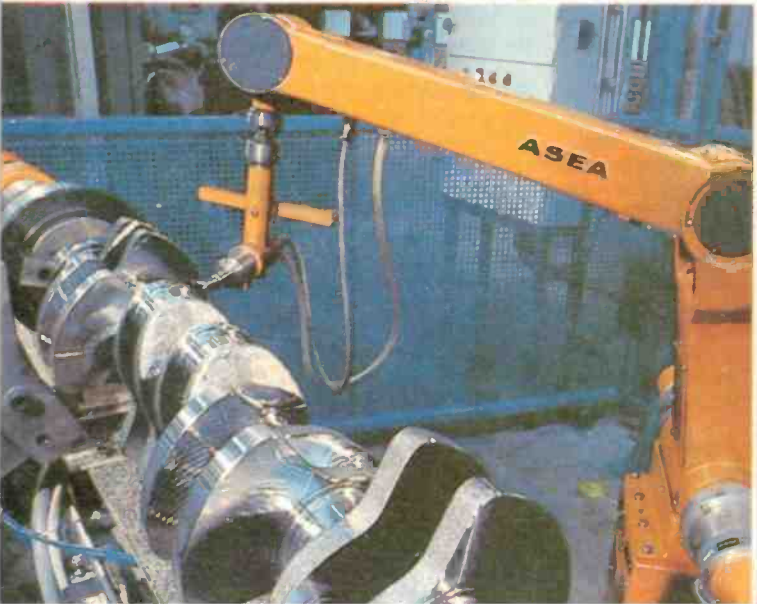
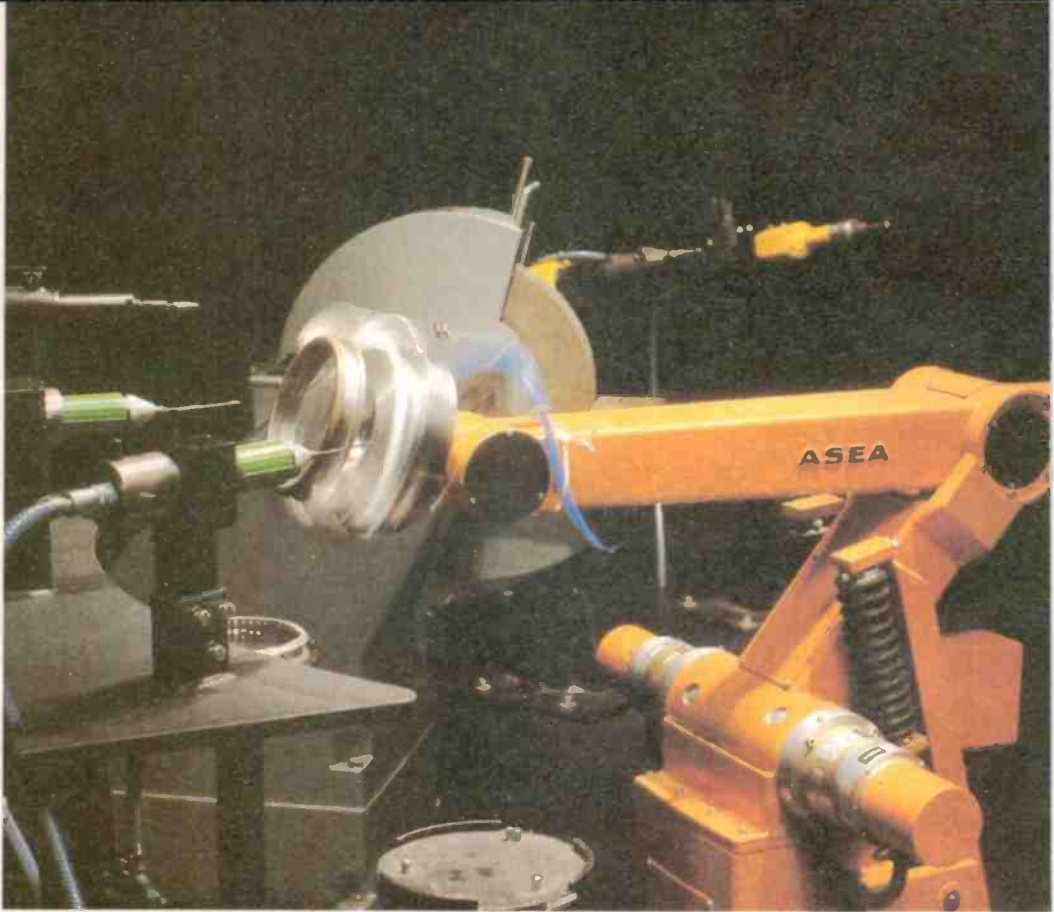
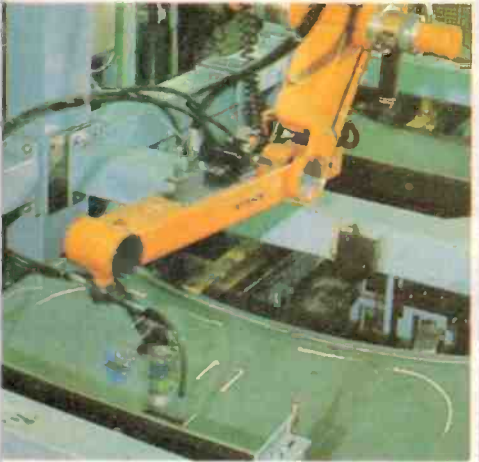
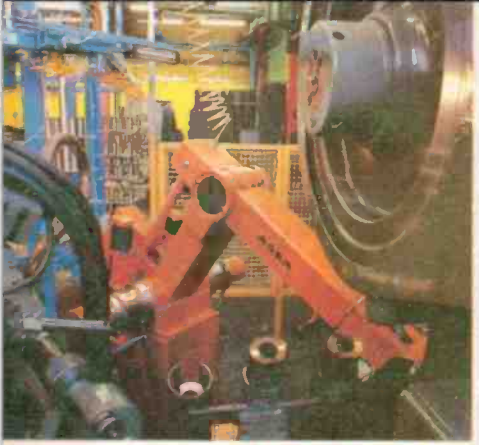



# S

## and the future of work



The Hon. Barry O. Jones, MP, Minister for Science and Technology.

"If you robotise you lose 75% of the work force. If you fail to robotise you lose 100%, because the firm goes out of business."

BARRY O. JONES, MP, Minister for Science and Technology, was quoting union leaders in the United States during his address to the Australian Robot Association.

The Australian Robot Association held its Annual General Meeting, followed by dinner, at the Hilton International in Sydney on Saturday, April 7th.

Barry Jones was guest of honour at the dinner and addressed the Association and answered questions on the topic, 'Robots and the future of work'.

"As you know, in our Recovery and Reconstruction policy the Labor Party identified robotics as one of our sixteen 'sunrise' industries which deserved public support for future development.

"Of all the new technologies, the word

'robotics' probably has the most adverse reaction in most, if not all, of the trade union movements where the robot is perceived as a Threat with a capital 'T'.

"Robots are seen as a major threat to the future of work, or certainly to the traditional view of work.

"We have a strongly ingrained cultural belief in which 'work' is equated with 'process work'. Old views die hard. The stereotype idea that the typical Australian works on a production line in a factory is still very strongly held although labour force statistics prove to the contrary.

"After speaking at a dinner with some industry executives I asked eight senior people at my table: 'Of the 2 060 000 new jobs created in Australia in the period 1965-



Take me to your union leader. Australia's Prime Minister, Bob Hawke, meets Matsushita's robot early this year in Japan. ▶



# What's a bright young lad

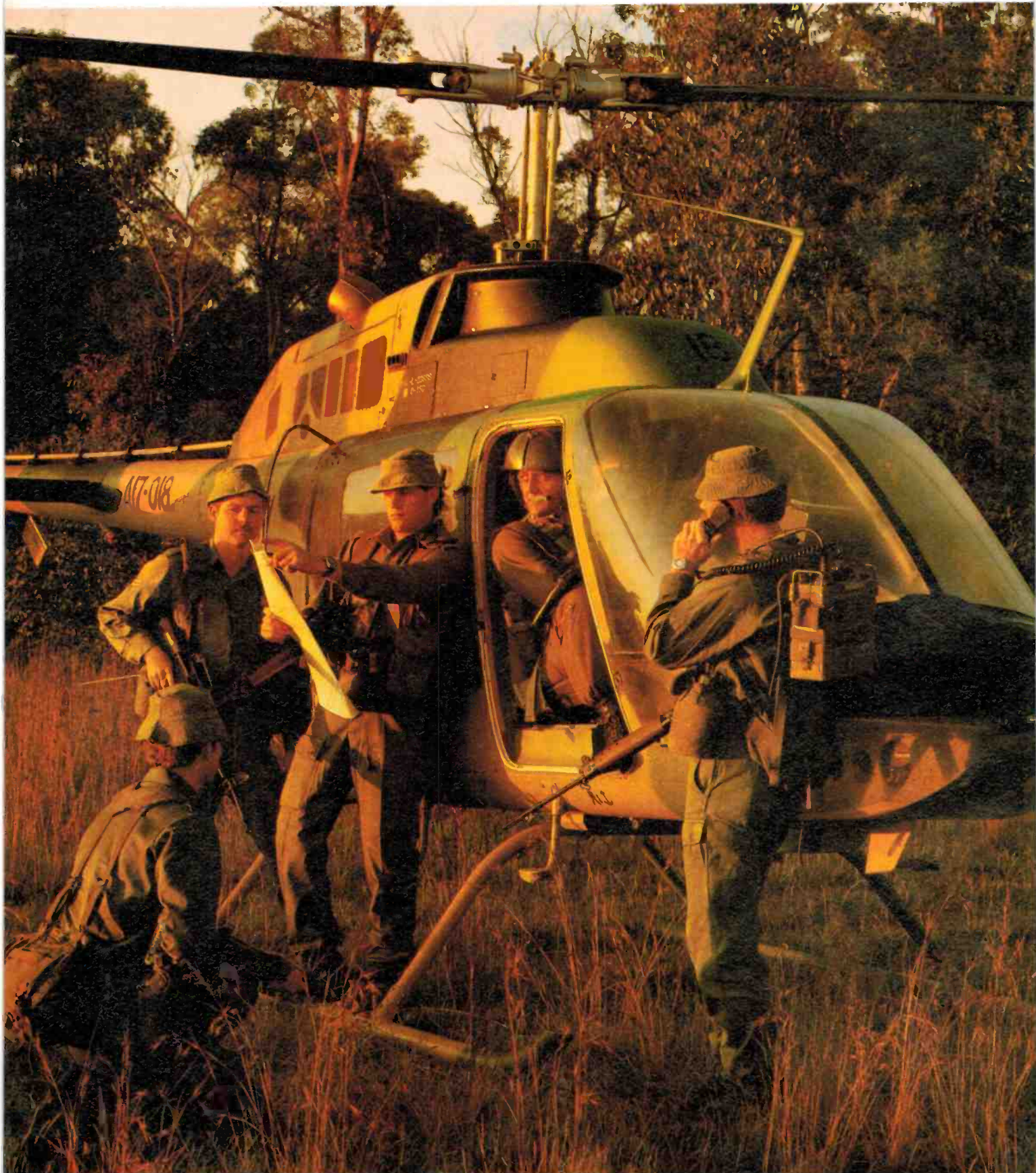



# like you doing in the Army?

The simple answer of course, is that he's busy taking on all the responsibilities that come to young men bright and dedicated enough to succeed as Army Officers.

After that it gets a little tricky. Largely because once a young man completes his initial 44 weeks training at Officer Cadet School, Portsea, and graduates with a commission, his career can take a multitude of directions.

He might for example choose to enter an Infantry Battalion and become a Platoon Commander in charge of 30 men. In which case he'll obviously learn and be involved in different things to a man who flies a helicopter and commands a smaller crew. The same applies in areas like Armour, Artillery, Signals, Survey, Transport and Intelligence to name just a few.

There is, however, common ground on which every Officer stands. Irrespective of his rank or career choice.

All Officers are constantly involved in improving their ability to make rational decisions, bring out the best in their men and achieve professional results. They're regularly faced with new situations, new problems to solve and challenges that test them both mentally and physically. So they can ill-afford to rest on their laurels. Once you become an Officer, the learning process never stops. There's always something to do and a better way of doing it.

In short, life as an Army Officer is exhilarating, varied and very satisfying. You're given every opportunity to realize your potential as a leader, and be recognised for your achievements.

If you're aged between 18½ and 23 on the first day of the month in which the course commences (or up to 25 with a degree or diploma), have your HSC or equivalent

(at a level acceptable to the Army) and would like to know more about what bright young lads do in the Army, contact your nearest Army Careers Recruiting Centre or fill in the supplied coupon.

**There are two courses per year: Applications close mid-March for a July entry and early August for a January entry.**

For more information post coupon to GPO Box XYZ, in your Capital city. Sydney 2195555. Parramatta 635 1511. Newcastle 25476. Wollongong 286492. Albury 552248. Lismore 216111. Canberra 822333. Melbourne 6979755. Geelong 21 1588. Bendigo 438008. Ballarat 31 1240. Brisbane 2262626. Townsville 724566. Adelaide 212 1455. Perth 3256222. Hobart 347077. Launceston 31 1005.

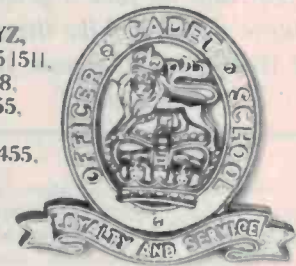

Name \_\_\_\_\_

Address \_\_\_\_\_

Postcode \_\_\_\_\_

Phone \_\_\_\_\_

Birthdate \_\_\_\_\_

Educ. Std. \_\_\_\_\_

**Army Officer. A leading profession.**

All enquiries treated in confidence.

OCS 15, DPS, 44



# THE FUTURE OF WORK

82, what percentage were in manufacturing? The answers they offered were 25%, 30%, 30%, 30%, 35%, 40%, 70% and 80%. The actual figure is -7.3%, representing a net loss of 150 000.

"Our views on the centrality of manufacturing as an employment area are amazingly durable. This may reflect the goods orientation of our economic thinking — that only tangibles have value — and the traditional and erroneous prejudice of British economists that services don't create value and that the only things worth producing hurt if you drop them on your foot.

"There is currently a widespread fear that we face a general collapse of work. Like the reports of Mark Twain's death, this is premature.

"If it was about to happen in employment generally we could expect some early warning signs by now.

"However, there are some major, high specific areas where work has collapsed or is collapsing:

- unskilled male work
- juvenile work (male or female)
- work in economic monocultures — areas dominated by a narrow economic base — mining, steel, heavy manufacturing, fruit, sugar.
- Disadvantaged educational areas; places with the wrong postcode where schools act as a filter system to keep people out, where they certify and institutionalise a sense of incapacity.
- Some areas dominated by particular ethnic groups, especially where a high proportion of workers are in farming, manufacturing or construction.

"There has been a major shift away from physical work to mental work, from labour intensive physical tasks making and constructing things, towards more sophisticated

---

***"There is currently a widespread fear that we face a general collapse of work. Like the reports of Mark Twain's death, this is premature."***

---

tasks involving the manipulation of symbols (words, sounds, images, numbers). This fundamental shift is away from the production of tangible commodities, towards the production of intangibles — things which are not tied to a particular geographical location, which can be transmitted through the air or through a wire.

"The demand for unskilled labour has fallen dramatically except in the market supply of quasi-domestic activities.

"That is, the eating and drinking business, child care, cleaning and related tasks. We would be foolish to assume that such demand will ever return.

"There are two surprising factors — the rising labour participation rate and the stability of the 40 hour week. The labour participation rate, that is, the number of people aged 15 years or more in work or actively seeking it, has actually risen to record heights — about 62%.

"In the golden age of full employment the participation rate was only around 55%, overwhelmingly male. Since then women have entered the labour force in unprecedented numbers. Part time work has increased and 'moonlighting' and 'underground' (cash) work have to be taken into account too.

"The other surprising factor has been the extraordinary stability of hours worked.

---

***"The demand for unskilled labour has fallen dramatically except in the market supply of quasi-domestic activities."***

---

The 40 hour week became law in 1947 and has been operating for 37 years, by far the longest period without a change in hours in our industrial history, a remarkable fact considering the revolution in production we have undergone.

"It is true that in many industries the 38 hour week is now standard, largely through sweetheart arrangements and not because of a decision of the Conciliation and Arbitration Commission. However, for full time Australian workers the average working week (including overtime) is 41.6 hours.

"Will there be more or less work, in absolute terms, in the late 1980s and 1990s? We don't know yet. Society itself adjusts and evolves appropriate employment patterns. For example, Australia has the world's shortest working year of 229 days. Japan has the shortest working life time, 35-37 years, despite record and growing longevity.

"If there is one message that I would like to see left behind, engraved on my tombstone, it is this: 'Employment levels are essentially culturally determined'. It is postcodes that determine life chances and life outcomes far more than technology.

"Although I believe that societies have the capacity to determine appropriate employment levels there are enormous problems involved in retraining and significantly upgrading skills in the short term.

"We need to recognise that there are two completely different elements in changing the composition of the labour force.

- the decline of employment in process work and the production of tangible goods (and in this area, robots will speed up the process).
- the increase in employment in services where activity soaks up time.

"In the US new technologies enable fewer steelworkers on the production line, assisted by robotic techniques, to turn out far more than ever before, while an increasing number of hairdressers are performing highly personalised services aimed at specific customers on a one-to-one basis.

"The trend away from the employment of tangibles reflects the impact of the 'post industrial phenomenon'.

"In technologically advanced societies like Britain, the US, Germany and Japan, there have been three major stages in labour force trends.

"First, there is the traditional society where a majority of people spend most of their time, effort and earnings in producing or consuming necessities such as food, water and shelter.

"Second, with the Industrial Revolution, there is a dynamic growth in urbanisation and in the number of people employed in industry, with a sharp increase in energy usage and the creation of new industries making consumer durables, and equipment for transport, power generation, entertainment and communication.

"Third, there is the post-industrial transition where few people are *making* things and far more are *doing* things. Employment is dominated by the production of increasingly marginal, discretionary and interdependent services such as information, eating out, beauty care, entertainment, welfare, leisure and tourism.

"Robotisation will make enormous inroads into employment in process work in the 1980s. In Japan Nissan requires only 67 production line workers to manufacture 1300 cars per day. In 1984 the Kawasaki Company will open the largest machine tool factory in the world at Florence, Kentucky

---

***"Technological change destroys jobs. Lack of technological change destroys jobs absolutely."***

---

where it will employ six people. In 1985 the Japanese will open the first completely automated factory with no labour force at all.

"The fear of the unskilled about the impact of technology is largely justified, but there is no comfort in the view that rejecting technological innovation will preserve jobs. It will not. We cannot rely on an obsolescence-led recovery.

"Technological change destroys jobs. Lack of technological change destroys jobs absolutely.

"At Australia's present stage of technological development it is faced with a problem of 'truncated development' where much of the high volume production is dominated ▶



by subsidiaries of foreign corporations; strategic decisions about industry are made overseas. The limitations — the truncation — were programmed from the beginning.

"The role of local producers is to be mere assemblers and packers of products designed by people overseas who are cleverer than we are. This leads to a branch office

---

***"We fail to recognise the significant shift in world trade generally, and that the trend is towards high value-added 'brain-based' goods."***

---

mentality, a passive and derivative technological culture, where the commanding heights are totally dominated by overseas interests.

"We cannot ask local representatives of overseas corporations to do the impossible and compete internationally. It is like asking invertebrates to show more backbone; they are not equipped to do it.

"It is an essential part of our industrial strategy that we assert our 'technological autonomy'; not, of course, as a 'unilateral declaration of independence' which would be absurd, but so that we could aspire to the contribution which is made to world technology by Sweden, the Netherlands and Switzerland, to name only three countries that have smaller populations than we do.

"We are specialists in shipping out high bulk low value-added goods — wheat at up to \$172 per tonne, iron ore at \$21, coal at \$55 — and we wonder why our share of world trade diminished so dramatically in the 1970s. We are inclined to say, 'It's just the recession', and leave it at that.

"We fail to recognise the significant shift in world trade generally, and that the trend is towards high value-added 'brain-based' goods.

"We measure our exports in tonnes. Our industrial contemporaries measure theirs in grammes. In the dollar value of agricultural products generally, excluding fishing and forestry, the United States comes No. 1 in the world. The Netherlands comes No. 2. They have used research to produce very high value-added products — seeds, bulbs, flowers, fine fruits, cheese, sera, vaccines and horticultural products — with a dollar value about twice that of ours.

"Australia has fallen in twenty years from No. 6 in per capita income among OECD members to No. 16. There are five priority areas which must be addressed urgently if we are to overcome the problems of 'truncated development'. Time is running out for us.

**"1. Raising our skill base.** In 1950 3.5% of our labour force entrants had tertiary quali-

fications and the Japanese figure was less than 1%. Australia's figure is now 8%. The number of Japanese with tertiary qualifications has increased to 35%, a 4000% increase. In the Republic of Korea it is predicted, confidently, that by 1985 40% of its labour force entrants will have degrees or diplomas.

**"2. Bridging the gap between research and management.** People in these two sectors do not relate to each other personally, intellectually or economically. They do not talk the same language. The lack of personal contact, made so obvious at the National Technology Conference last September, is at the core of the problem.

**"3. Moving from low to high value-added products.** The Canadians have done it in communications technology with some remarkable focussing of national effort in the past five years. Australia performs very badly in the dollar value of high technology exports. In 1980 the OECD average of high technology exports per head per year was \$468 (US). Switzerland ranked first of 24 nations with \$2584, followed by the Netherlands with \$1378 and Sweden with \$1087. Canada's figure was \$325, New Zealand's \$107 and Australia's \$81. We ranked 21st of 24 — only Greece, Iceland and Turkey were lower.

**"4. Creating stronger/more appropriate economic infrastructures.** Historically we have done well in research, poorly in development of research-based products (except in agriculture) and appallingly in marketing.

"Apart from the Hills Hoist, plastic wine casks and Violet Crumbles the inventory is bare.

"We have produced some wonderful industrial materials including PSZ (Partially Stabilised Zirconia), and our own custom made computer chips. But where are the

---

***"Apart from the Hills Hoist, plastic wine casks and Violet Crumbles the inventory is bare."***

---

Industrial entities which can use them appropriately?

"Under tariff protection, many local companies have gone straight from the crib to the wheelchair without ever having been able to stand up and move on their own. The larger companies have been mostly under foreign ownership, classic illustrations of 'truncated development' that have been programmed not to compete; structural incapacity and non-competitiveness has been built into them.

**"5. Overcoming regional problems.** We are dogged by the problems of over-specialised regional economies devoted to heavy industry e.g. steel, coal and motor manufacturing and tinned fruit. Alternative areas of employment are not emerging.

"Workers face an unpleasant dilemma. Technological change is adding significantly to unemployment for the poorly educated, but existing modes of employment continue to exploit a fair-sized number of unskilled proletariat in unpleasant jobs. About one

---

***"Post-industrial technology can provide enormous increases in output and raise consumption levels appreciably while decreasing the need for a large labour force."***

---

worker in five is still physically disadvantaged by working conditions.

"However, we must reject the facile optimism that suggests that all displaced workers will find new and agreeable jobs in the brave new world. We appear to be exploiting much of the working class and unemployed an increasing part of it simultaneously.

"Post-industrial technology can provide enormous increases in output and raise consumption levels appreciably while decreasing the need for a large labour force.

"It is essentially a matter of choice whether the results of this change provide hardship or benefit for society.

"If we adopt a high-productivity plus low-employment mix, it will be necessary to provide economic, social and psychologically satisfying alternatives to work for the less gifted. This will involve the following moves on the part of society:

- recognition that work need no longer be the primary mechanism for the redistribution of wealth.
- education based on the personal needs of each individual rather than the industrial needs of the community.
- encouraging individuals to recognise the value of individually determined time use.
- developing new forms of participation and recognition.

"None of these alternatives will be easy. But they are inescapable, and must be tackled immediately.

"Herbert Marcuse argued that post-industrial socialism — that is, communism — will adopt feminine values or it will not exist at all. This implies a cultural revolution replacing the principle of performance, the ethic of competition, accumulation and the rat race (the mouse race in Australia) with the values of reciprocity, tenderness, spontaneity and love of life in all its forms."

If you are interested in joining the Australian Robot Association contact Michael Kassler and Associates Pty Ltd, 9 Queens Ave, McMahons Point NSW 2060. (02)922-5026. ●



# Preview to the Perth Electronics Show

Over 100 000 visitors are expected to crowd Perth's Claremont Showgrounds during the first week of August, elbowing each other in the crush to see what's new in audio, video, home computers, home security and car sound etc.



Strike up the band! Rising star in the home electronics galaxy is the electronic keyboard. Lowrey will be showing off their latest lines.



It figures. Major force in last year's show was Futuretronics. The Atari 600XL and 800XL home computers will figure prominently this year, they say.

Video plus. The new plus for video recorders is hi-fi sound. Hitachi, wishing to forge to the foreground in this market, will have their new machines on-show.

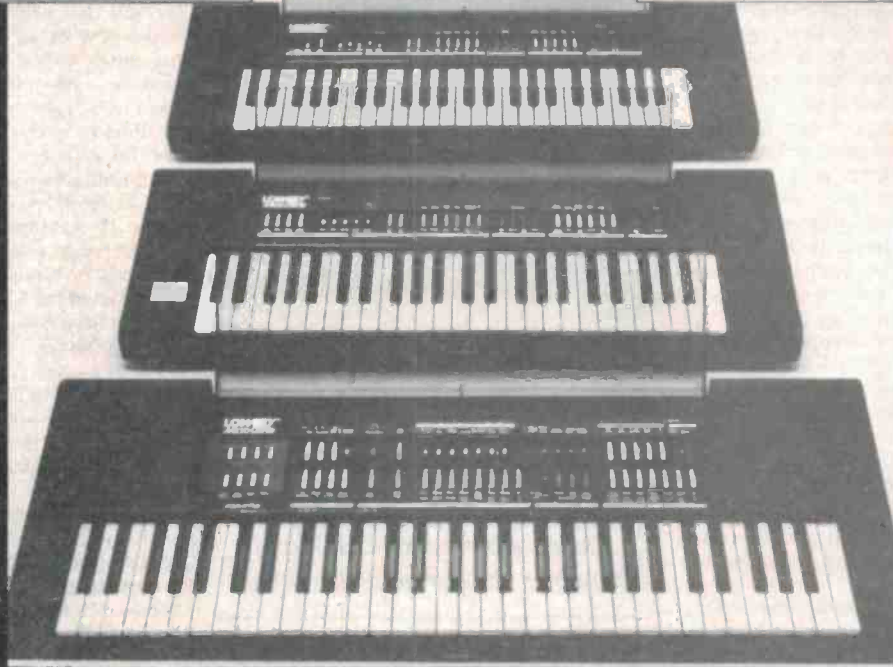

OVER 100 exhibitors, about 20% up on last year, will be displaying recently released consumer electronics products of all descriptions. Many are expected to show as yet unreleased equipment, using the show to 'test the market', as had been done in past years.

Futuretronics will be showing off the Atari 600XL and 800XL models, no doubt hoping to lure potential buyers with news of their increased warranty period. From here on the Atari will be covered by a twelve months warranty instead of the old three month period.

The Hitachi stand will be jam packed full

of nice new goodies. The VT 7E infra-red controlled, fully portable, 4 head, 2 speed, video recorder will be there, as will the VT 88E hi-fi video. The VKC870E video camera with low-light capabilities and auto-focus should also attract the interest of videophiles. On the audio side, Hitachi hope to have the new DA 800 compact disc player and the HA 6 power amp available.

Pfaff will be taking their all-singing all-dancing, does-everything-but-talk sewing machine, the Creative 1469 to the show. The on-board processor allows the user to choose 16 stitch sequences delivered through 13 different needle positions, in 100

different patterns. It goes without saying that it can do buttonholes (seven different ways) and blind stitches (two types).

The organ specialists, Lowrey, will be out in force. Of particular interest will be the Genius Model G100, a small and deceptively simple looking electronic keyboard that can sound like a piano, guitar or accordion with equal ease. They will also have the portable Genie range on display complementing the top-of-the-range 'Holiday'.

Pioneer are launching a complete range of new automotive sound components. ●



# Phone for telecommunications component innovations

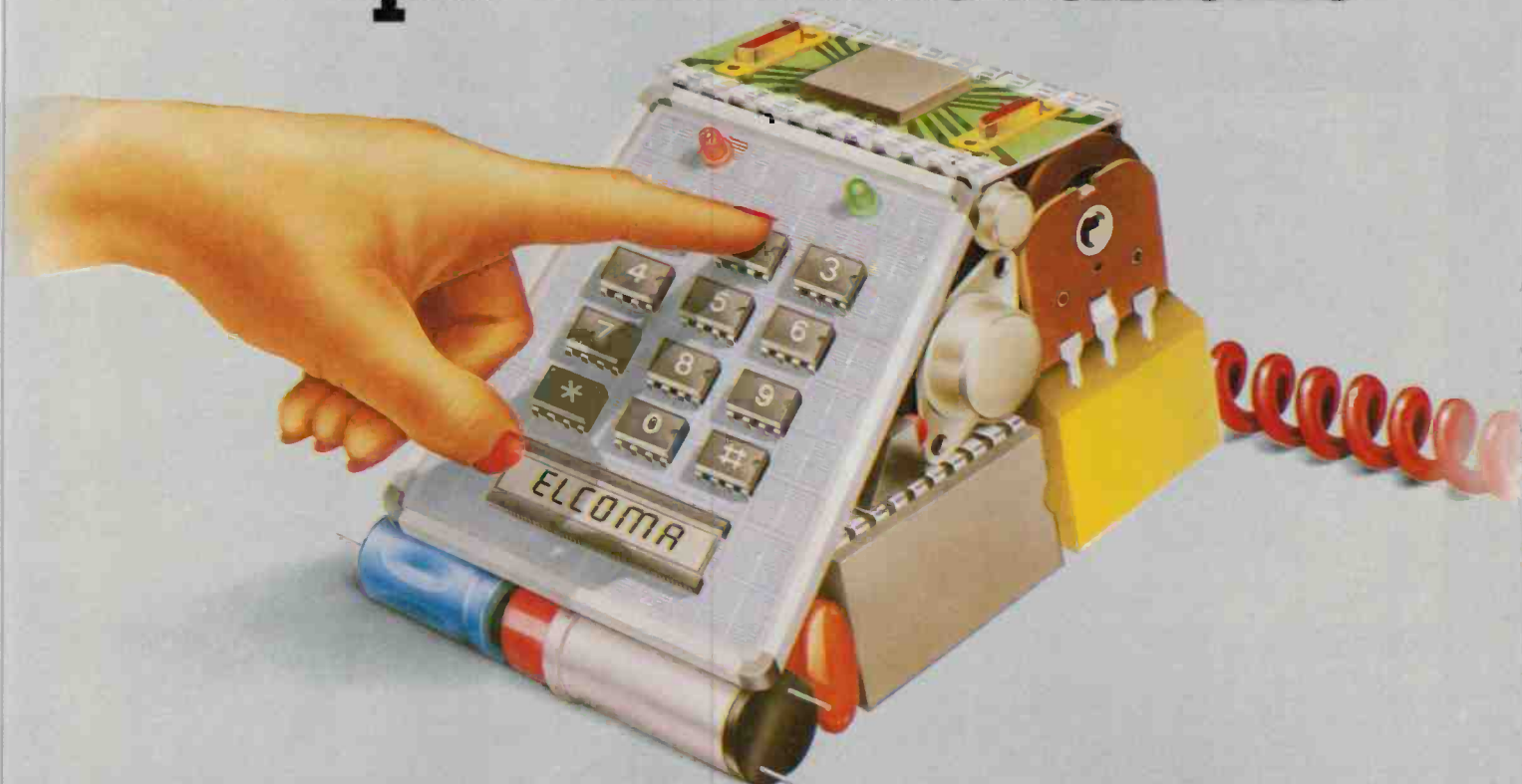

Telecommunication equipment manufacturers face constant pressure for more and more user features. These pressures are accompanied by complex technical problems imposed by the highly sophisticated integration of business communications and information systems.

"New" equipment frequently becomes obsolescent, virtually from the first production run.

Elegant technical solutions, design flexibility and inherent reliability stem from the very latest "chip" and component technologies. So the long-term winners will be the companies who employ the most up-to-date and reliable electronic technology right from the start - moving their new designs smoothly into production.

This is where Elcoma fits in. It is precisely the

area in which we shine - innovation and reliability.

Our research laboratories in the UK, West Germany, France, Holland, Belgium and the USA are long established and internationally acclaimed centres of fundamental research.

Considering that our catalogues contain 200,000 products for all branches of the electronics industry - and our turnover, globally, exceeds our nearest competitor by over 50% - it is highly likely that Elcoma are already efficient suppliers to your needs.

If not, why not use your telephone to take advantage of our experience?

Sydney	427 0888	Melbourne	542 3333
Adelaide	243 0155	Perth	277 4199
Brisbane	44 0191		

*We make electronics in Australia*



Electronic  
Components &  
Materials

**PHILIPS**



# CRYSTAL CLEAR

Sound from the Sanyo Compact Disc Player.

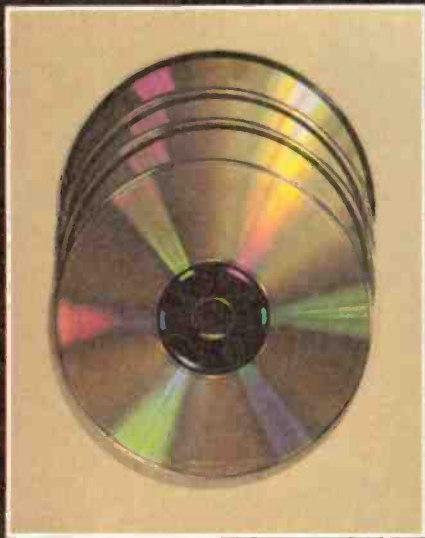

COMPACT  
**disc**  
DIGITAL AUDIO

Sanyo CP400, the compact digital disc player that brings the finest crystal clarity of sound into your home. Forget the problems that come with conventional record turntables; Rumble, wow and flutter will be words from the past.

More and more discs are being released every day through all the major companies, from classical to pop and rock. Music to please every ear.

The Sanyo CP400 boasts microcomputer assisted soft push controls \* 16 selection programmable auto search \* Track sequence arrangement \* 16-LED pick-up location indicator \* Pause, access, reset, replay, fast forward and fast reverse \* Full function wireless remote control and many more features.

Listen to the crystal clear Sound of Sanyo. You probably won't believe your ears - But that's life.



 **SANYO**  
*That's Life!*



## 8mm — Chicago to decide

The Summer Consumer Electronics show in Chicago is going to be decisive in determining the immediate future of 8 mm video. Industry chiefs from both the US and Japan will be watching reaction to a range of new products in order to determine marketing strategy.

US companies have been more enthusiastic about the future of the product than their Japanese competitors. General Electric, Kodak and Polaroid are all selling models at prices from US\$995 up.

In Japan, however, a group of influential retailers has expressed concern at the timing and the wisdom of introducing 8 mm video onto the Japanese domestic market. Retailers are concerned that the product will sell in direct competition to video cassette recorders.

There is also concern that the technology for 8 mm video is still being developed. Standards for 8 mm cameras were only recently established at the sixth meeting of the 8 mm Video Conference in Tokyo. They decided to adopt the dual rotary azimuth head and fixed and rotary sound signal recording methods.

The recording time standard is to be 90 minutes for 525 line systems or 60 minutes for 625 lines. Both coated and metal evaporation tapes will be used. Big losers were the French, whose Timeplex system was abandoned by the conference.

There has been a considerable amount of technology transfer between the various companies involved in the development of 8 mm video, so the Japanese can probably afford to hold back on domestic production.

Matsushita, for instance, is closely tied in with Kodak. Toshiba is actually manufacturing several video-related products that Polaroid will distribute under its own name. At present, no Japanese company has plans to release 8 mm equipment with its own badge.

But all this could change if there is an enthusiastic response in Chicago.

## 3D TV converter kit

Abdy Hoffman, a company in Hamburg, West Germany, is hoping to revolutionise television viewing with a 3D television converter kit which can be installed in an ordinary television set to give the picture 3D characteristics.

The Abdy 3D adaptor works by anaglyphic delay which means that it splits off and delays the TV transmission's red colour signals so that they appear on the screen a fraction of a second after the blue signals. The result is a TV picture that looks blurred and reddish to the naked eye. However, when viewed through a special pair of red and green glasses provided with the Abdy 3D kit, the TV picture appears to have added depth.

Unlike most previous experiments with 3D television, the

Hoffman technology works at the point of reception, not at the expensive transmission stage. This means that the viewer has a choice of watching an ordinary television broadcast or, with the flick of a switch, one with the 3D special effects.

Abdy Australia is distributing this kit as an add-on component which will be sold by retailers and selected TV service shops. The kit works with RGB drive colour TV receivers but not with colour difference drive receivers.

The cost of the system, including anaglyphic glasses and without installation, will be about \$130. Installation can be arranged for about \$35.

For more information contact Abdy Australia, 457 Sydney Rd, Balgowlah NSW 2093. (02)949-2454.

## Car cassette

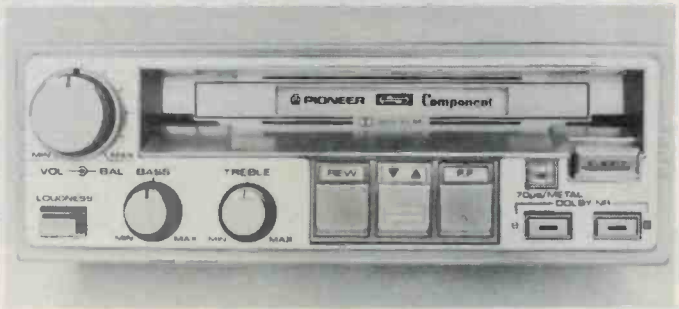

The new KP818G cassette deck from Pioneer.

Pioneer has released its new KP818G top-of-the-line cassette deck, featuring Dolby C noise reduction and a wired remote control.

It is intended as a companion to the nine-band CD9 graphic equaliser which joined the Pioneer car stereo component range late last year.

The provision of a Dolby C circuit in addition to the familiar Dolby B system, combined with

the inclusion of a Ribbon Sten-dust Head, allows the KP818G to achieve 70 dB signal-to-noise ratio and expands the frequency range and reproduction quality. The deck also features full metal tape compatibility.

The Pioneer KP818G has a recommended retail price of \$385. For further information contact Pioneer Electronics, 178-184 Boundary Road, Braeside Vic 3195. (03)580-9911.

## Latest in Sennheiser headphones

When Sennheiser introduced the first open stereo headphones in 1968, the sales estimate for the entire year was 950 units. However, about three million of the HD 414 headphones were sold.

In February 1984 Sennheiser introduced the successor to the HD 414 which has been designated the HD 414 SL. There

have been improvements in both user comfort and technical design.

A lighter swing coil has perfected pulse reproduction so that the HD 414 SL can cope with the signal of the CD era in an outstanding fashion.

For more information contact R. H. Cunningham Pty Ltd, P.O. Box 4533, Melbourne Vic. 3003 (03)329-9633.

The new Sennheiser HD 414 SL.

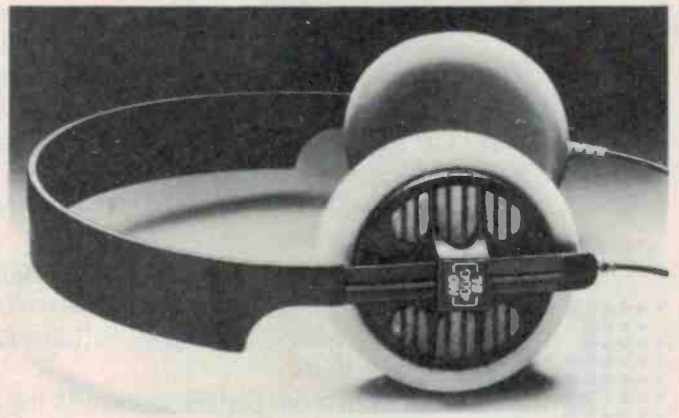





CDP-101

COMPACT  
disc  
DIGITAL AUDIO

# Hear digital perfection.

## Introducing the Sony Compact Disc Player.

When we used our long experience in digital technology to create the CDP-101 Compact Disc Player, we wanted to give you something more than the world's clearest sound.

**WIRELESS REMOTE CONTROL** Full-function remote control.

**3-WAY MUSIC SEARCH**  Instant direct access to any selection with the 10-key pad on remote control unit.  AMS (Automatic Music Sensor) allows access to the beginning of next or previous selection.  2-speed bi-directional search to find any desired music passage.

**REPEAT FUNCTION** Program to repeat the entire disc, one selection, or a specific portion of music.

**3-FUNCTION DIGITAL READOUT DISPLAY**  Selection number.  Time lapse of selection being displayed.  Remaining time on the disc.

**LINEAR SKATE DISC LOADING** Just press the button, platter control and cueing are automatic.

Get even more perfect sound with the Sony Digital Audio Component System, "Precise Series".

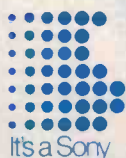

**SONY**

AUD 0391



## Fast sound maker

**T**rio-Kenwood Corporation will again be participating in the Le Mans endurance car race as the main sponsor of the Kremer Racing Team.

Following a brilliant performance at Le Mans last year, Trio-Kenwood Corporation, under the leadership of its president Mr Kazuyoshi Ishizaka, is to sponsor the Kremer Team in the '84 race that is scheduled in June.

Last year, the Kenwood Team came in a very close third behind the Porsche Factory Team with an exceptional performance by the internationally known drivers Philippe Alliot and father and son combination, Mario and Michael Andretti.

## Two new Naks

**N**akamichi is introducing two new cassette decks onto the Australian market. The BX-150 two head cassette deck and the BX-100 two head cassette deck are priced competitively with decks in the low/middle end of the market but the maker claims superior performance based on a design philosophy that emphasises the four essentials: transport, heads, electronics and quality control.

The BX-150 and BX-100 feature Nakamichi's tried and proven Single-Capstan 'Silent Mechanism'. The makers claim unusually low wow and flutter because of the functional independence of the capstan, reel,



## Sanyo Laser

The new Sanyo CD player the CP300.

**C**ompact Disc (CD) Players use a laser to play a small disc capable of playing up to one hour of pre-recorded material. This technology removes the possibility of distortion through wear and provide enhanced dynamic range. Sanyo's CP-300 boasts a dynamic range of more than 90 dB, making it the per-

fect sound source for the audiophile's hi-fi system.

This slim-style CD Player features a horizontal slide loading system and soft-push controls, the functions of which are carried out by a microcomputer. To save both the player and discs, the auto-eject function is activated if the disc is loaded

incorrectly.

A 16-selection programmable auto search system saves time and effort in locating tracks, and programming is done by a one-touch control. A flashing LED indicates the number of the track that is being found or played.

and transport drives and the inherent quality of each.

Three high-performance DC motors power the transport system: one for the capstan, one to provide take-up torque, and a third to operate Nakamichi's motor-driven cam control system.

Both decks feature Dolby-B noise reduction with defeatable MPX filter; The BX-150 also includes Dolby-C NR. Suggested retail price of the BX-150 is \$499. The BX-100 is worth \$399.

For more information, contact **Geoff Matthews, Marketing Director, Convoy International, 400 Botany Road, Waterloo NSW 2017. (02)698-7300.**

## They Shure are!

**S**everal new Shure products are now available from Audio Engineers. The Shure Automatic Microphone System (AMS) consists of the AMS8000 or AMS4000 mixer used with Shure AMS microphones.

The system is suitable for multiple-microphone public address and recording systems. It is claimed that it will solve many problems associated with multiple-microphone installations by turning on only those microphones in use. When a person

speaks within 60° of each side of the front of a microphone it will turn on.

The AMS8000 mixer has eight microphone inputs and the AMS4000 mixer has four microphone inputs.

The Model AMS22 condenser microphone is designed for use only with the Shure automatic microphone system. It is a low-profile surface-mount unit with a hemi-cardioid polar pattern.

The SM83 professional omnidirectional condenser lavalier microphone has been designed to provide sound reproduction in professional broadcasting, film and related sound reinforcement applications. It has an electronically created dip at 730 Hz to overcome the chest resonance phenomenon and an acoustically generated high-frequency boost above 3 kHz.

Another Shure product is the FP31 compact, portable microphone mixer specially designed for electronic news gathering and electronic field production use, including film, video and remote broadcast applications.

For more information on these products contact **Audio Engineers Pty Ltd, 342 Kent St, Sydney NSW 2000. (02)29-6731.**

## Danish speaker stands

**S**can Audio in Melbourne are now introducing a range of fully imported loudspeaker stands from Denmark.

Many high quality loudspeakers are often put directly on the floor. This results in a boomy bass reproduction due to reflection of the lower frequencies from the floor.

The new speaker stands lift the speakers 160 mm to 300 mm from the floor. A special adjustment controls the tilting of the speakers backwards. The speaker stands also feature four small adjustable feet which make it possible to compensate for an uneven floor.

The new speaker stands,

called Mini, Midi and Maxi, are all made in aluminium profiles and are thus very rigid. Speakers up to 35 kg can be used on them. The recommended retail prices are respectively, \$65, \$80 and \$95 per pair.

More information is available from **Scan Audio, P.O. Box 242, Hawthorn Vic. 3122. (03)819-5352.**



# AIWA F990 cassette recorder

A processor controlled, automated cassette deck from Aiwa. It has an unusual panel layout in front of one of the best tape movements available today. Subjectively, this is hard to beat.

Louis Challis

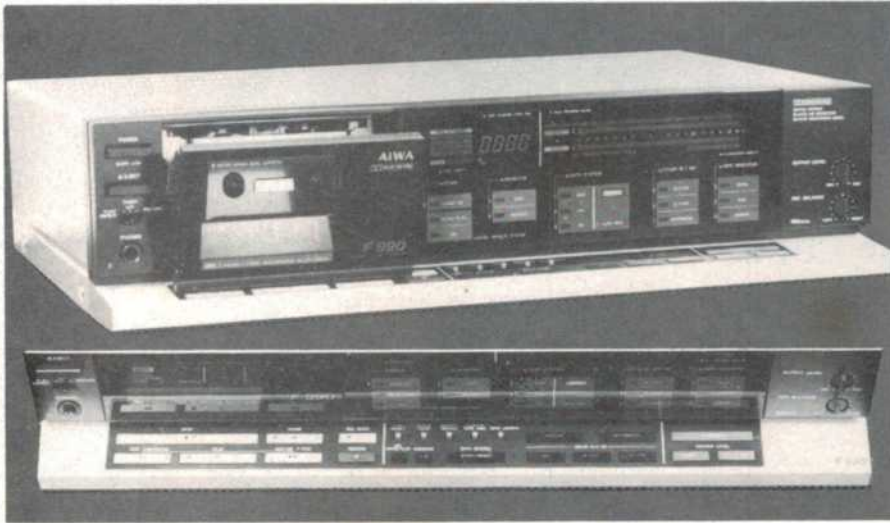

OVER THE LAST three years we have seen a remarkable trend in what we perceive to be the Japanese design philosophy for compact cassette recorders. Whilst Sharp and Nakamichi have tended to set the ground rules in this particular area, we have noted with interest that Aiwa have also introduced a number of unusual and innovative concepts. These were initiated in their 6900 series recorder, at the time of its release one of the finest cassette recorders on the market. In the intervening period many other manufacturers have copied the Aiwa concept and introduced machines with many 'look-a-like' characteristics.

The Aiwa Stereo Cassette Deck is a particularly good example of the extent of electronic sophistication in the latest generation of cassette recorders achieved by generally sensible and innovative utilisation of microprocessors.

The philosophy underlying the design of this recorder is to provide as many automated facilities as convenient whilst still providing a machine which requires the minimum degree of familiarisation by the user. This concept can be self-defeating as there are some functions that should not be automated where the automation results in a positive loss of effective control.

The F990 cassette recorder provides such automation but loses some flexibility, as I discovered during the course of my assessment. As if to underscore that viewpoint the appearance of the F990 is quite different to any of the previous cassette recorders that I have reviewed. The most significant difference between this and other cassette recorders being the number of flashing lights and

semi-automated or automated controls.

The first difference that I noticed is that the controls are organised not just on two levels as practised in many cassette recorders, but in two distinct planes, one vertical and one horizontal. The vertical plane incorporates the least often used controls and most often viewed displays, whilst the horizontal plane incorporates the most often used controls whose use necessitates the users proximity to the unit, unless you're using the optional remote control (which was not supplied with the unit).

The front panel is an attractive combination of plastic and metal with the emphasis being on black plastic and smoked finishes, so that the illuminated displays stand out more sharply. At the extreme left hand of the front panel are the power and the smoothly operating cassette well ejection button. Immediately below this is the timer play/repeat and record control which allows you to automatically play, repeat or record when the unit is switched on by an externally programmed timer.

The cassette well and the drive in the F990 are undoubtedly one of the paragons of the currently available cassette recorders. One significant difference between this unit and others is its use of a three head recording-play-back configuration with what are described as "pure amorphous alloy heads". This head configuration is supplemented by an automatic demagnetising system which demagnetises the heads each time you switch on the recorder. This obviates the problems that most cassette recorders have with a slow but steady operational magnetisation of the heads (which is a com-

mon problem with all conventional magnetic tape recorders).

Most of the remaining areas of the front panel are taken up by displays, which although they look complex at first sight, soon separate themselves into a series of primary display areas.

At the top left hand corner of the main display is a four-digit counter which can be switched to also indicate the remaining playing time in minutes and seconds. To achieve this aim you have to use a tape length switch on the lower horizontal escutcheon which you sequentially push to set the appropriate illuminated bezel to indicate C60, C90, C120 or C46 configurations. The cassette recorder has no other way of knowing how much tape or what length of tape is actually inside your cassette.

At the top centre of the unit is a fluorescent display on which is located a series of red segments. These are programmed to indicate the recording level setting chosen by means of a digitally programmed attenuator on the main sloping panel. These controls replace the normal rotary attenuator and provide a series of ten, 2 dB steps for setting the input signal levels. Below the attenuator display are two blue fluorescent displays which provide the peak programme meter function and which cover the range -22 to +10 VU. This display incorporates a temporary peak hold function (typically three seconds) so that instantaneous transients levels can be compared against the average recording levels.

In a large display section which is located below the timer and peak programme meter is a display also indicates whether the automatic selection and detection of tape equalisation has been correctly carried out. This provides information about a series of electronic functions that few other cassette recorders currently incorporate. The first of these is the "ADMS" or Automatic Demagnetising System. The second is the "INTRO PLAY" system which when selected in conjunction with the play and either fast forward or rewind searches for the first eight seconds of each recording. It then plays at normal speed before searching for the next eight seconds of the next recording. During this search mode the "INTRO PLAY" light flashes.

The next feature is the "MUSIC SENSOR" system which locates blank sections recorded on the tape before and after each recorded section. When the MUSIC SENSOR button is selected and PLAY button is selected with either FAST FORWARD or REWIND buttons, the recorder will find the start or the next or last number, to allow it to be rapidly reviewed and played.

This particular electronic control can experience a number of different problems which interfere with its normal operation. If the recording contains extended passages at low volume, or if the blank passages before



And after recorded sections are either extremely long or extremely short in duration, it can be 'fooled'.

The most complex automated system incorporated in this recorder is the Automatic Tape Adaption System (ATAS). This is provided to adjust the cassette recorders operating parameters (bias and equalisation) to match the characteristics of the recording tape actually being used. This ATAS system involves the clever utilisation of a microprocessor to optimise the recording parameters in a simple but very rapid step-by-step process. To activate the process all you have to do is load the tape and press the DATA SYSTEM start/reset button. The adaptation system then checks four parameters.

The first of these is the recording sensitivity which is checked by feeding in a 400 Hz test signal. The playback output must exceed a predetermined limit. The second stage involves checking the bias adjustment by feeding in a combined 400 Hz and 10 kHz test signal. The recorder adjusts the bias so that the 10 kHz play back level is at the same level as the 400 Hz signal. The third adjustment is the recording sensitivity adjustment which involves feeding in a 400 Hz test signal at -17 VU and then internally adjusting the recording chain so that the playback signal matches the -17 VU signal. Finally, equalisation is optimised by feeding in a 13 kHz test signal at -17 VU. Equalisation is adjusted so that play back output level is set to the optimum point. This whole cycle takes only 14 seconds and after completion the display proudly proclaims "READY".

If you don't change your tape and you continue utilising the same brand, the optimised settings are retained for the given type of tape for up to 24 hours. Even turning off the recorder does not result in the loss of the settings.

The next automated facility provided in the recorder is the automatic (as well as the manual) selection of Dolby B or C noise reduction systems.

When recording a tape on this recorder for the first time, the recording chain encodes one of two infra-sonic signals to tell the recorder during subsequent replay which choice of noise reduction (Dolby B or C) was made. On replay the cassette recorder automatically selects the proper noise reduction system. Obviously, this only works with cassettes recorded on this type of machine and pre-recorded cassettes have to be manually selected.

Another unusual feature in this recorder is the incorporation of the Dolby HX Professional automatic adjustment system ('HX PRO'). This particular system was developed by Band & Olfsen of Sweden. It works on the basis that at the highest recording levels the high frequency components are attenuated as a result of the interaction of the high frequency signal. The Dolby HX PRO system overcomes this problem by reducing the bias signal in the presence of high level and high frequency

signals to ensure a flatter frequency response. This improves the critical 3-10 kHz region where a drooping frequency response would otherwise occur. This is the first non-professional recorder in which I have seen the Dolby HX professional system and it works exceedingly well.

One feature that did not immediately strike me as being such a good one is the incorporation of an automatic tape format detector. This is intended to set the bias and equalisation conditions for record and replay in accordance with the presence (or absence) of the appropriate detection slots on the back of the cassette casing. Regrettably this recorder is not designed to provide for user adjustment and consequently old tapes without the appropriate slots will not receive the appropriate bias and equalisation.

Instead of a normal recording level control (a rotary or sliding potentiometer) the right hand side of the deck incorporates three buttons. These provide either fully automatic and internal selection of recording level, or provide either fully automatic and internal selection of recording level, or provide a manual adjustment by means of a pair of up/down buttons which control the attenuator in a series of ten precise 2 dB steps.

The only other significant controls on the front panel are the output level control and the recording level balance control, each of which is a small rotary attenuator.

The rear panel incorporates two unbalanced microphone sockets with standard tip-and-sleeve format and a 1 mV sensitivity for microphones with impedances lying between 200R and 10K. The inputs and outputs utilise four RCA type coaxial sockets. The back panel also incorporates a multiplex filter switch for removing the pilot tone signal from FM broadcast recordings and a remote control socket for which no other data is provided.

The inside of the unit features one large "mother" printed circuit board to which are attached six satellite boards. As well as these there are two other supplementary printed circuit boards behind the front panel. These boards cumulatively contain 61 ICs, 116 transistors, 138 diodes, 20 LEDs, one and two fluorescent plasma displays.

The extent of interwiring required to interconnect all the circuitry on the boards reminds me of the first radio I built more than 30 years ago. Admittedly this recorder is far more complex than the equipment I built, but the extent and number of wiring harnesses required in this particular recorder is far more than I would have expected and much greater than I have seen on any other recorder in recent years.

One feature which surprised me was the extent of the temperature rise on one of the internal heatsinks at the rear of the main printed circuit board. I suspect that the thermal rating and efficiency of this particular sink is lower than desirable.

The main cassette drive mechanism is

exceedingly well executed and the solenoid controls are extremely efficient and rapid in their operation. The designers have gone to considerable trouble to reduce the effects of mains flux leakage and the control of residual hum. The wiring and internal electrical design meet all the safety features specified by the double insulated standards in AS3100-1982 and AS3159-1980.

### On test

Objective testing of this particular cassette deck provided some of the most interesting and unusual results we have seen for some time. The first and undoubtedly the most outstanding feature of this deck is its replay frequency response. Utilising a TDK-SA reference tape provided a frequency response that was  $\pm 3$  dB from 15 Hz to 12 kHz at 0 VU, 13 Hz to 21 kHz at -10 VU and 13 Hz to 21 kHz at -20 VU. With a pre-encoded Dolby B reference tape, the frequency response of 0 and -10 VU was remarkably linear but the differences between the reference Dolby encoder and the decoder in this machine is quite apparent and even more evident at -20 VU. Even so, the frequency response is still quite good although the mid-frequency non-uniformity is quite apparent between 600 Hz and 2 kHz.

With a pre-encoded Dolby C reference tape however, the differences between the respective encoding and decoding circuits became quite pronounced. At zero VU the measured frequency response was particularly good. At +10 VU there is an obvious droop in low frequency and high frequency responses resulting in a slight reduction in overall bandwidth. At -20 VU there was an obvious marked difference between the encoding circuit of the reference tape recorder and the decoding circuit of this particular tape recorder. The resulting frequency response is almost unacceptable on an objective assessment basis.

It is interesting to note that in the record-to-replay test sequence the frequency response at both low frequency and most particularly, at high frequency is not quite as good as I would have expected based on the electronic potential that is promised. Thus, although the frequency response is remarkably flat, at -20 VU it only extends typically to 18 Hz or 20 Hz at the low end and approximately 17 kHz at the top, almost irrespective of the tape formulation chosen.

Given the time available I decided to evaluate the record-to-replay frequency response with "Maxell UDXL 2" tape at the three recording levels and with Dolby OUT, Dolby B and Dolby C.

With the automated ADMS system activated, and selected prior to the record/replay process for each tape, the frequency linearity achieved by the ADF990 cassette recorder is quite outstanding.

The frequency responses are, by and large, almost ruler flat from 30 Hz to 9 kHz and the responses at -10 and -20 VU are equally good, providing a true 17 or 18 kHz ▶



# SOUND REVIEW

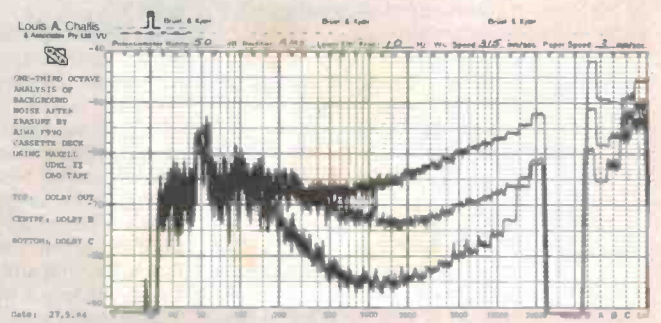
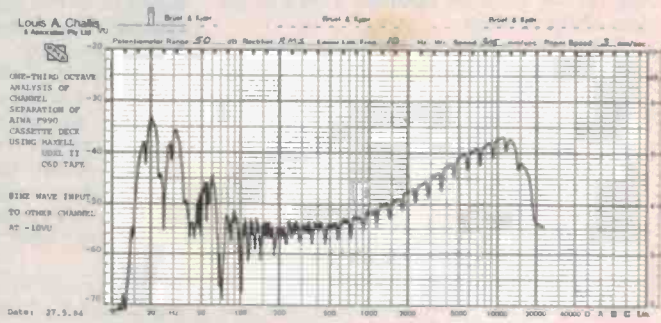
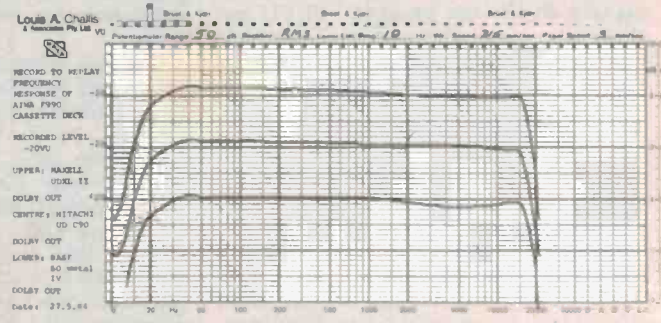
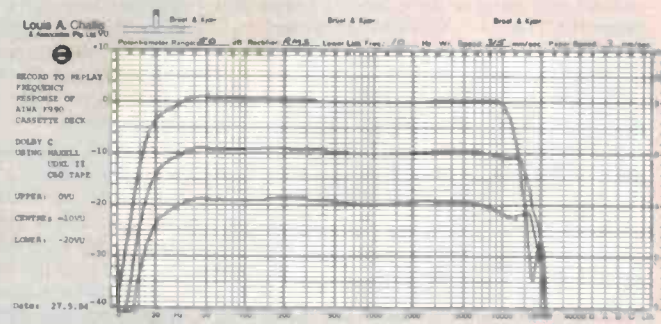
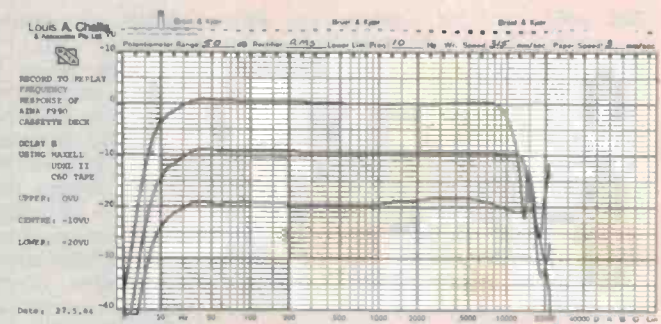
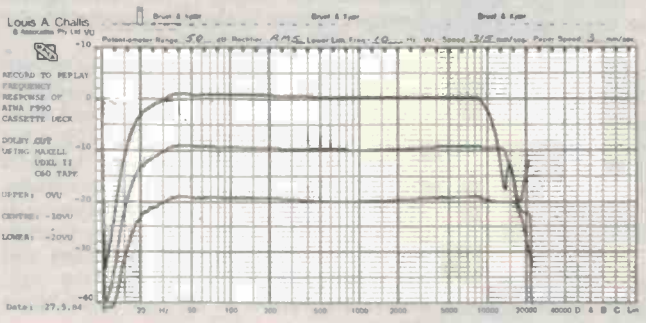
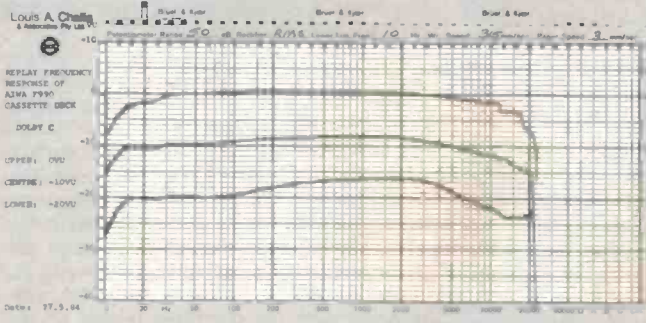
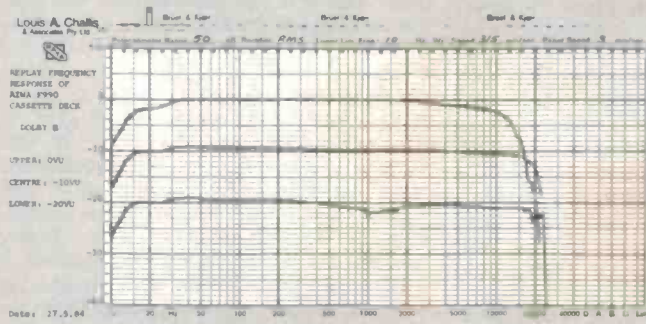
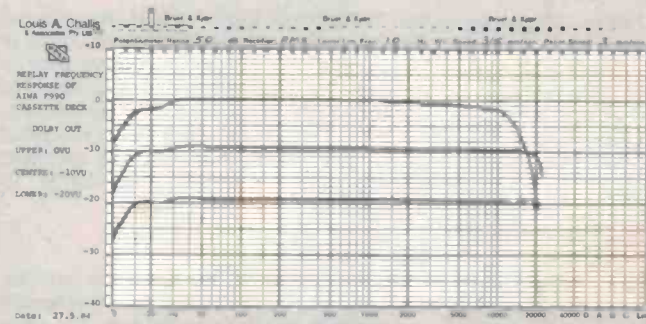

effective bandwidth. With Dolby B the response is nearly as good, although there is a slight lift in frequency response in the 2-10 kHz region. With Dolby C the results are generally acceptable although there is a small droop in the frequency response between 9 kHz and 15 kHz.

Taken overall these frequency responses are exemplary, although not quite as good as I would have expected from the manufacturer's literature. It should be pointed out that the frequency responses quoted in the literature does not talk in terms of -3 dB levels.

**AIWA F990**  
 Dimensions:  
 420 mm wide  
 by 110 mm high  
 by 280 mm deep.  
 Weight:  
 5.5 kg  
 Price:  
 \$749  
 Manufacturer:  
 Aiwa Company,  
 Japan.



MEASURED PERFORMANCE OF AIWA MODEL F990 CASSETTE RECORDER

S.N. 31212028

REPLAY FREQUENCY RESPONSE AT -20VU

Tape	Dolby	Lower - 3dB	Upper - 3dB
		Point	Point
TDKSA	OUT	13 Hz	21 kHz
	B	13 Hz	18 kHz
	C	15 Hz	6 kHz

RECORD TO REPLAY FREQUENCY RESPONSE AT -20VU:

Tape	Dolby	Lower - 3dB	Upper - 3dB
		Point	Point
MAXELL UDXL II	OUT	19 Hz	17 kHz

SPEED ACCURACY:

-3.6%

WOW AND FLUTTER:

<u>WOW:</u>	Average	0.05% Peak to Peak
<u>FLUTTER:</u>	Unweighted	0.04% RMS
	Weighted	0.02% RMS

HARMONIC DISTORTION:

Tape:	MAXELL UDXL II			
		100Hz	1kHz	6.3kHz
OVU:	2nd	-43.5	-56.3	-52.9
	3rd	-48.2	-62.0	-40.8
	4th	-65.4	-64	-59
	5th	-65.7	-62.3	-
	T.H.D.	0.7%	1.9%	0.95%
-6VU:	2nd	-50.3	-57.4	-55
	3rd	-54.7	-61	-52
	4th	-66.5	-62.5	-56
	5th	-68	-64	-
	T.H.D.	.36%	0.19%	.35%

MAXIMUM INPUT LEVEL:

(for 3% third harmonic distortion at 1kHz)

Tape: Maxell UDXL II +10 VU (Dolby Out)

DYNAMIC RANGE:

Tape:	Maxell UDXL II		
Dolby Out	56 dB(unweighted)	59 dB(A)	
Dolby B	61 dB(unweighted)	68 dB(A)	
Dolby C	64 dB(unweighted)	75 dB(A)	

ERASURE RATIO:

(for 1kHz signal recorded at 0VU)

Tape:	Maxwell UDXL II	-90.5 dB
Tape:	BASF 69 Metal IV	-84.5 dB
Date:	27-5-84	

**One problem**

It was during the subjective evaluation of the record to replay frequency response that I experienced my first and only problem with this recorder. The problem relates solely to the automatic tape selector function which is incorporated in this deck. This tape selection function operates perfectly when you are utilising the current generation of tapes (i.e. tapes produced within the last two to three years). It is incapable of correctly functioning if you own or utilise tapes that were produced more than three years go. Surprisingly as I discovered, all but two of my metal tapes were pre-1982 vintage! Most of my other cassette tapes were either purchased, recorded or provided by the tape manufacturers with test tape material prior to 1981 when the industry standards for the holes to activate metal type or chromium type tape selector switches were ratified.

Whilst I was able to overcome the problem by selecting from these tapes that I do have with the correct selector hole incorporated, I experienced a short period of distress whilst I wondered what I was going to do to evaluate the automatic tape selector function capabilities of the deck. As the deck has no other way of selecting the appropriate bias and equalisation, you would be disadvantaged when trying to achieve the full potential of this deck using your old tapes.

The other measured performance characteristics of this recorder are particularly good. The wow figure is quite low 0.08% peak-to-peak whilst the flutter is only 0.04% RMS unweighted or 0.02% RMS weighted.

The speed accuracy is a trifle low at

-3.6% which is the only objective test result at variance to normal tolerance. The distortion figures are all low; lower than 1% for the three test frequencies at 0 VU and at -6 VU. The maximum output level for 3% distortion, even with UDXL type 2 tape, is +10 VU, which is particularly good. The dynamic range of the recorder is thus 56 dB unweighted and 59 dB A-weighted with Dolby out, whilst at the other end of the spectrum is 64 dB unweighted and 75 dB A-weighted with Dolby C, which is excellent.

The erasure ratio is a very healthy -90 dB with UDXL2 and an excellent -84.5 dB with a BASF F60 metal type IV tape. The channel separation is particularly good being better than -50 dB at mid-frequencies and better than -33 dB at all frequencies from 20 Hz to 20 kHz.

Taken overall, the objective performance of this machine is exceedingly good with its most outstanding feature undoubtedly being its replay frequency response.

**Subjectively**

The subjective testing of this machine was far more pleasurable than I would have expected. The machine provides a quality of reproduction which is truly outstanding. Using a series of pre-recorded cassette tapes specially provided by other manufacturers, as well as a series of special recordings that we produced precisely for this purpose last year, it was very evident right from the outset that the recorder incorporates a series of user functions and achieves a level of sound reproduction which is quite outstanding.

After a period of two days of putting the machine through its paces the following points are very clear:

1. That the replay response is superlative and utilizing properly recorded or pre-recorded tapes, the machine provides a performance which is just about top of its class.
2. That most of the automated functions are well engineered, well executed and in the main, carefully thought out.
3. That the automatic selection of tape type without recourse to some over-ride function, is a disadvantage for people who do not own newly purchased tapes, or who own a series of previously well recorded tapes with either chromium dioxide or metal formulation.
4. The intro-play capability, the record-mute capability and the counter tape time capability are three functions which anybody (myself included) would welcome on a new cassette recorder and should be regarded as almost being a mandatory requirement.
5. The MS rewind/review capability button is something that I do not think I would often use. But I do acknowledge it could be useful on many occasions when searching for a specific piece of recorded material on what is likely to be a poorly annotated pre-recorded cassette.
6. Last, but not least, the data operation indicator with the automated bias calibration equalisation and level setting function is a tremendous advance in automated electronics and is most probably the *piece-de-resistance* of this particular machine.

At a recommended retail price of \$749 this recorder constitutes excellent value for those hi-fi purists who, like me, are searching for a machine that does much more than the average cassette recorder and provides performance to match. ●



SAVE 20% THIS MONTH SAVE 20% THIS MONTH SAVE 20% THIS MONTH

# TRANSFORMER AND PLUG PACKS

TAKE 20% OFF ALL THESE PRICES THIS MONTH ONLY

OFFER EXPIRES  
JULY 15, '84

## ECONOMY IMPORTED MODELS

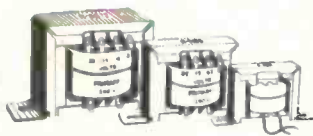

M12155 Trans  
240V 6-15V 1A  
tapped ..... \$5.95 \$4.95

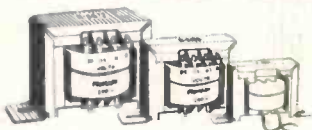

M12156 Trans  
240V 6-15V 2A  
Tapped ..... \$7.95 \$6.95

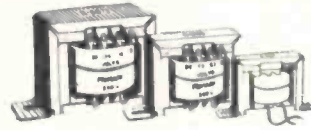

M12851 Trans  
240V 12.6V CT  
150MA ..... \$3.95 \$2.95



M16672 Trans  
240V 15-30V 1A  
Tapped ..... \$8.95 \$7.95

## FERGUSON TRANSFORMERS

### PRINTED CIRCUIT BOARD MOUNTING



M21002	PL9/5VA 4.5-0-4.5V @ 0.56A	9.95
M21004	PL12/5VA 6-0-6V @ 0.42A	9.95
M21006	PL15/5VA 7.5-0-7.5V @ 0.33A	9.95
M21008	PL18/5VA 9-0-9V @ 0.28A	9.95
M21010	PL24/5VA 12-12V @ 0.21A	9.95
M21012	PL30/5VA 15-0-15V @ 0.17A	9.95
M21014	PL40/5VA 20-0-20V @ 0.1A	9.95
M21016	PL16/15VA	13.95
M21024	PL18/12VA 9-0-9V @ 0.67A	14.95
M21026	PL24/12VA 12-0-12V @ 0.5A	14.95
M21028	PL30/12VA 15-0-15V @ 0.4A	14.95

### LOW PROFILE CHASSIS MOUNTING

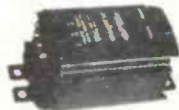

M21030	PL12/20VA 6-0-6V @ 1.67A	17.95
M21032	PL15/20VA 7.5-0-7.5V @ 1.33A	17.95
M21034	PL18/20VA 9-0-9V @ 1.11A	17.95
M21036	PL24/20VA 12-0-12V @ 0.83A	17.95
M21038	PL30/20VA 15-0-15V @ 0.67A	17.95
M21040	PL40/20VA 20-0-20V @ 0.50A	17.95
M21042	PL1.5-18/20VA 1.5-18V @ 1.11A	27.95
M21044	PL12/40VA 6-0-6V @ 3.33A	19.95
M21046	PL15/40VA 7.5-0-7.5V @ 2.67A	19.95
M21048	PL18/40VA 9-0-9V @ 2.22A	19.95
M21050	PL24/40VA 12-0-12V @ 1.66A	19.95
M21052	PL30/40VA 15-0-15V @ 1.33A	19.95
M21054	PL40/40VA 20-0-20V @ 1.0A	19.95
M21056	PL30-9/40VA 15-0-15 & 9V for MP	27.95
M21058	PL12/60VA 12V @ 5.0A	24.95
M21060	PL15/60VA 15V @ 4.0A	24.95
M21062	PL18/60VA 9-0-9V @ 3.33	26.95
M21064	PL24/60VA 12-0-12 @ 2.5A	26.95
M21066	PL30/60VA 15-0-15 @ 2.0A	26.95
M21068	PL40/60VA 20-0-20 @ 1.5A	26.95
M21070	PL30-9/60VA	29.95

## GENERAL PURPOSE TRANSFORMERS Conventional Construction

### Universal Mounting Brackets



M21090	PF2565 12.6-0-12.6 @ 0.5A	28.50
M21092	PF 3577 28-0-28V @ 2A	37.50
M21094	PF3763 35-0-35V @ 5.0A	79.95
M21096	PF3767	26.50
M21098	PF3788 30V, 27V, 24V, 18V, 6V @ 4A	47.50
M21100	PF3993 20-0-20V @ 1.5A	29.50
M21102	PF4244 16-0-16V @ 9A	53.50
M21104	PF4354	69.50
M21106	PF4361/11 35-0-35V @ 2.5A	47.50
M21108	PF4362 35-0-35V @ 4A	59.50
M21110	PF4363 47-0-47V @ 3A	59.50
M21112	PF4673	52.50
M21114	PF4405 9v @ 10A	49.95

## A.C. PLUG PACKS

### A.C. Plug Adaptor



M21140	PPB4/1000 AC Plug Pack	19.95
M21142	PPB8/1000 AC Plug Pack	19.95
M21144	PPB12/500 AC Plug Pack	19.95
M21146	PPA12/670 AC Plug Pack	18.95
M21148	PPA12/450 AC Plug Pack	18.95
M21150	PPC12/1250 AC Plug Pack	24.95
M21152	PPC18/830 AC Plug Pack	24.95

## ARLEC TRANSFORMERS

### Series AL7VA

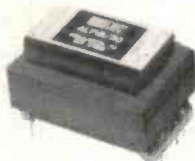

M21180	AL7VA/6V 6V @ 1.16A	9.95
M21182	AL7VA/9V 9V @ 0.77A	9.95
M21184	AL7VA/12V 12V @ 0.58A	9.95
M21186	AL7VA/15V 15V @ 0.46A	9.95
M21188	AL7VA/18V 18V @ 0.38A	9.95
M21190	AL7VA/24V 24V @ 0.29A	9.95
M21192	AL7VA/30V 30V @ 0.23A	9.95
M21194	AL7VA/40V 40V @ 0.18A	9.95



### CONVENTIONAL

M21200	2150 6.3V @ 2.5A or 12.6V @ 1A	24.95
M21204	5502 22V @ 2.5A or 44V @ 1.25A	22.50
M21206	5503 17V @ 11.5V @ 4A	34.50
M21208	5504 15V @ 2A	14.95
M21212	5508 6.3 @ 4A or 12.6 V @ 2A	22.50
M21214	5578 Stepdown 115V 40VA	43.50
M21216	5579 6.3V AC @ 1A	7.95
M21218	5755 40V AC CT @ 2A	17.95
M21222	6625 25V AC @ 0.5A	9.50
M21228	7243 4 Tapes, 19V to 50V @ 2A	37.50
M21230	7309 12V AC @ 2.5A	17.50
M21234	7311 24V AC @ 4.2A	29.40
M21238	9585 240V AC-240V AC @ 1A	67.50
M21240	9789 240V AC-240V AC @ 2A	159.00
M21246	60202 7 Taps, 12V-30V @ 3A	34.50
M21248	60203 2X15-30V @ 2A	39.50
M21250	60291 12.6V @ 7A or 25.2v @ 3.5A	29.50

## MODERN TRANSFORMER



PCB pins, spacing 25mm, Equipment to Line, 15mm between Equipment pins, 25mm between Line pins.

M10230	600-6000HM (45035) Modern Trans	19.50 17.50
--------	---------------------------------	-------------

## AUDIO TRANSFORMERS

M21120	OP590	49.50
M21122	OP592	39.50
M21124	MT522	39.50
M21126	MT620	9.95
M21128	MT627	14.95
M10216	1KCT/8 O/P Trans	1.00 0.90
M10226	500CT/8 O/P Trans	1.00 0.70

## PLUG PACKS

### Power Pack

240V AC to 3, 4.5, 6V DC — 300mA 1.6 metre cord with unique plug adaptors Sizes, 2.5, 3.5 phone plug and 2.5mm DC plug

M19003

\$9.95



M19003 Plug Pack 3, 4.5, 6V-300MA ..... 9.95

### Plug-in Power Pack

240V AC to 3, 4.5, 6V DC — 300mA 1.6 metre cord with unique plug adaptors Sizes, 2.5, 3.5 phone plug and 2.5mm DC plug

M19001

\$9.95



M19001 Plug Pack 6, 9, 12VDC-300MA ..... 9.95

### Power Pack

240V AC to 6, 9, 12V DC — 500mA 1.6 metre cord with unique plug adaptors Sizes, 2.5, 3.5mm phone plug and 2.5mm DC plug

M19005

\$14.95



M19005 Plug Pack 6, 9, 12V-500MA ..... 14.95

### DC/DC Converter

800mA 6, 9, 12V with multi-plug adaptor — fused output

M19020



M19020 DC/DC Plug Pack 6,9-12V in ..... 9.95

ROD IRVING ELECTRONICS, 425 High St, Northcote, Vic; 48-50 A'Beckett St, Melb, Vic. Phone (03) 489 8866, (03) 489 8131. Mail Order Hotline (03) 481 1436.

Mail Orders to P.O. Box 235, Northcote 3070, Vic. Minimum P&P \$3.00. Errors and omissions excepted.

Please address tax exempt, school, wholesale and dealer enquiries RITRONICS WHOLESALE, 1st Floor, 425 High St, Northcote 3070, (03) 489 7099, (03) 481 1923, Telex AA38897.

BARGAIN PRICES AT ROD IRVING ELECTRONICS



# THE PENCIL IRON WITH REAL POWER - MiniScope

10W - 70W  
POWER UNDER  
YOUR CONTROL

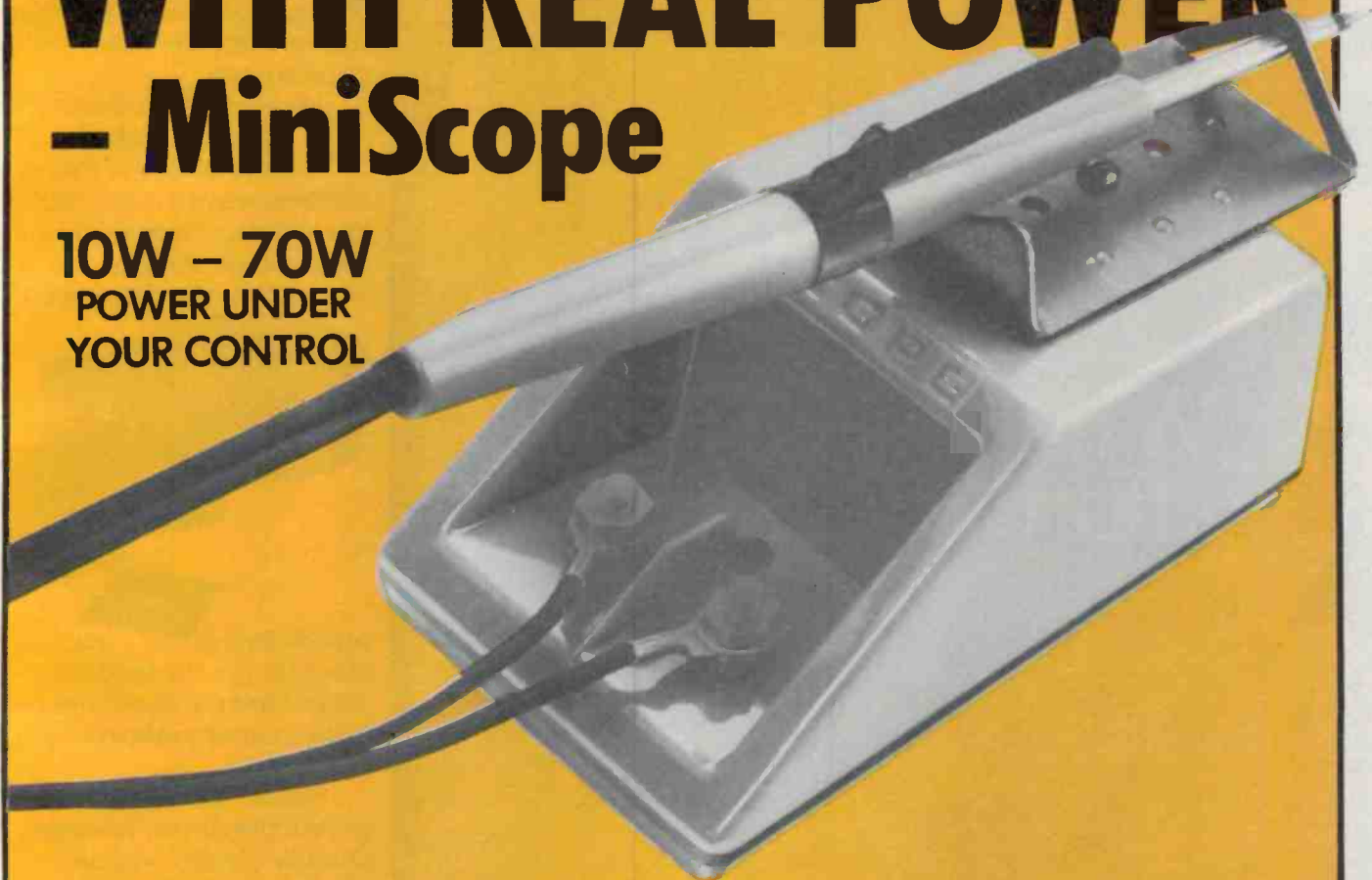

All the advantages of a miniature soldering station - without the power restrictions.

Ideal for precision circuitry when operating in the 10W-20W range or for the heavier job.

You can call up \*real power - up to 70W in just a few seconds.

- Comfortable shape
- Light weight
- Isolated from mains
- Fast 5-second head
- Manual temperature control
- Safe 4 volts
- Automatic switch off
- Owner maintenance simple & quick

#### NSW

Pauls Merchants (02) 709 2311  
Dick Smith Stores  
BBC Hardware (most stores)  
David Reid (02) 267 1385  
Sheridan Electronics (02) 699 6912  
AVTEK Electronics (02) 267 8777  
John R. Turk All Branches  
J. Blackwoods (02) 609 0030

#### VICTORIA

Radio Parts (03) 329 7888  
Magraths (03) 347 1122  
Dick Smith Stores  
Ellistronics (03) 602 3499  
Geo. Brown (03) 419 3355  
W.A.  
Atkins Carlyle (09) 277 0511  
Dick Smith Stores

#### QLD

Dunlop IBC (07) 392 0011  
Repco (07) 221 1044  
Dick Smith Stores  
Elphinstones (07) 52 0171  
St. Lucia (07) 52 7466  
TAS  
GHE Electronics (002) 34 2233  
Dick Smith Stores (003) 31 6533

#### S.A.

Gerard & Goodman (08) 223 2222  
Protronics (08) 212 3111  
Bee Jay (08) 352 5959  
Dick Smith Stores  
Graphic Electronics (08) 42 6655  
A.J.F. Electrical (08) 269 1244



**SCOPE**  
BOX 63 NIDDRIE  
VIC 3042  
TEL (03) 338-1566  
TLX AA38318





**When you can't  
afford mistakes.**

There really is a  
difference in disc pack and  
diskette brands.

It's in the way they are  
made.

Because the computer  
industry cannot afford  
variation in quality of disc  
packs and diskettes,  
Nashua looked for, and found  
a way to ensure absolute  
consistency.

Here's how we do it.

Quality Circles.

At Nashua we've found  
the best way to attain this  
'consistency' is to ensure  
that at each stage of  
production our disc packs



and diskettes are  
statistically checked to  
make sure the quality is  
'built-in' every step of  
the way.

Rather than long  
production lines, we have  
'Quality Circles' – small  
groups of people whose job  
it is to make sure that each  
Nashua disc pack and  
diskette is right in the first  
place.

The result is a product  
with such consistency that  
it is chosen by those people  
who can't afford mistakes.

Phone Sydney 958 2044,  
Melbourne 428 0501,  
Brisbane 369 4244,  
Adelaide 42 0021,  
Perth 328 1888,  
Darwin 81 6204.



**Nashua**

There really is a difference.



# Cat challenges mouse, claims granny Smith



**D**ick Smith has just released its long-awaited Apple-compatible personal computer, the Cat. They claim the Cat will sell in Australia for many hundreds of dollars less than comparable PCs like the Microbee and Apple 11c.

The Cat is based around the 6502A CPU, as used in the Apple. It comes with 32K of ROM and a genuine memory-mapped screen. In addition, the Cat offers as standard a parallel printer interface, 80-column text, a full keyboard with eight function keys, and a numeric keypad. There is a joystick port and an RGB output port.

The Cat is manufactured in Hong Kong by Video Technology (makers of Dick's VZ-200) and shipped to Australia direct by DSE. It uses two VLSI maxi chips to avoid the legal problems currently being

encountered by manufacturers with Apple compatible computers. According to DSE, the Cat will run all the Apple software currently available.

The launch of the Cat has coincided with an increased emphasis on computing by DSE. Within the next few months a series of 'computer city' areas will be created within Dick Smith stores across the country.

These will be laid out on the familiar department store lines of the existing shops, but will have qualified sales staff for advice and after-sales back-up, the company says.

## NEW LIFE FOR CHIP-8 LANGUAGE

TWO RECENT RELEASES, one for the Microbee and one for Tandy's MC-10 Colour Computer, promise to inject a new lease of life into the CHIP-8 language.

CHIP-8 is a simple beginners' language. Originally developed by RCA for their eight-chip 'trainer' micro, the VIP system VP-111 and adapted to kit computers such as the ETI-660 Learners' Micro and Michael Bauer's 'Dream'.

It uses around 30 simple mnemonic commands which are easy to learn and use. It is a video-oriented language, runs faster than most other high level languages and is simpler to learn than machine code. It is ideal for games and graphics manipulation, although screen resolution is limited.

Melbourne-based software producer, Dreamcards, has just released a ROM-based version of CHIP-8 for the Microbee. It features enhanced facilities that take advantage of the Microbee's PCG graphics and can be conveniently embedded in Microworld BASIC REM statements. The new CHIP-8 interpreter gives you 112 cursors which can be loaded with data to set up a hi-res pattern. The number of cursors available make for very sophisticated graphics.

You also get alphanumerics with one simple instruction plus an autorepeat facility. In addition, there are "half tone" cursors which can be mixed on-screen with any number of hi-res cursors and alphanumerics. A wide range of sound effects is possible, rivalling many hardware sound units, Dreamcards claim. You get two joystick commands, too.

On top of all that, the 'Bee CHIP-8 incorporates extended maths and I/O functions, page addressing, an execution rate control and an instruction that writes binary data to an imaginary CHIP-8 screen memory aid for converting programs designed for other computers. It all comes with a well-written and very comprehensive manual. Details from Dreamcards, 8 Highland Court, Eltham North Vic 3095. (03)439-4467 (a.h.)

CHIP-8 for the popular and inexpensive Tandy MC-10 Colour Computer will shortly be available from the 'Dream' originator, Michael Bauer. Our information indicates the language will be extended to support the full 128 x 96 pixel four-colour graphics of the MC-10. Further details from M. J. Bauer, P.O. Box 221, Ivanhoe Vic. 3079.

## Sex changes

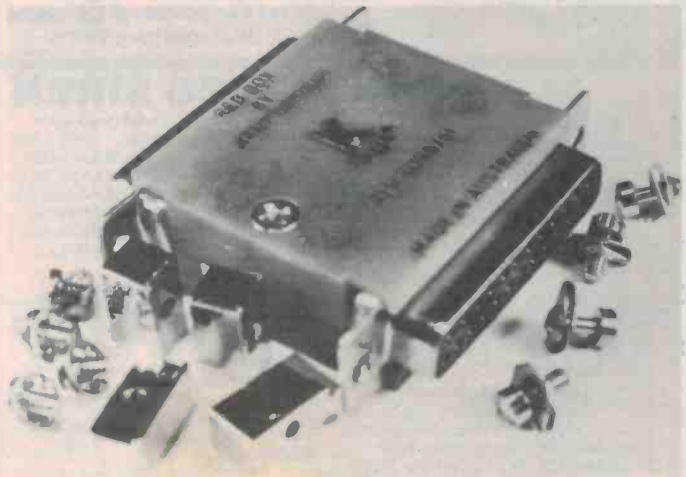

**A** Melbourne Company has released a locally made cable-end sex changer for RS 232 data communication links.

The Red Box Gender Mender is available as a double male or double female, wired-through pin to pin. It comes complete with two sets of male, and exclusive anti-rotation female, screw

locks.

The Gender Mender can be quickly fitted to any cable or panel situation, changing the sex of the connector and providing the required retaining facility.

For more information contact Kent Design, P.O. Box 325, Malvern Vic 3144. (03)509-8751.



# WIN A PLANE!

**FULL DETAILS  
IN THE  
MAILER  
IN THIS  
ISSUE**

## 2 LEVEL CHESS MASTER

Unbelievable! A chess game that fits into the palm of your hand. Amazing micro-circuit miniaturisation has made it possible.

Ideal for playing or learning chess. LCD display.

**Fantastic Value!**

**\$49<sup>00</sup>**

Cat Y-1018



2 Level

## 50 ohm UHF COAX

Top quality RG213 mil spec co-ax. Ideal for UHF - ultra low loss. Sure it's more expensive than RG8: ever tried using RG-8 at UHF???

Cat W-2099



**MIL SPEC**

**\$2<sup>35</sup>/m**

## MASSIVE 25 AMP

Heavy duty hook-up wire

You asked for it! 41/0.32mm cable with thousands of uses: power supplies, battery charges, etc. Very flexible, two colours.

Red: Cat W-2286  
Black Cat W-2288

**75¢ per m**

(100m rolls only \$65!!)

## PIEZO SIREN

**\$14<sup>95</sup>**

Hold onto your hats! This will blast them off at short range! 6 to 20V DC - and what a blast. Intruder alarms, tell-tales, truck back-ups, etc. Cat L-7025



## Disk Storage Box

Watch out for dirt & gremlins: they'll ruin your valuable diskettes. Store them in this protective case. Holds 30.

Cat X-3530

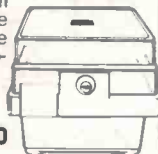

**\$34<sup>50</sup>**

**SCOOP PURCHASE!**



WORTH \$10 or more!

**\$4<sup>95</sup>**

Cat M-9565

## 9V @ 2A PLUGPACK

What a bargain! Manufacturers loss is your gain: they made too many - we bought them cheap. And we pass the saving on to you! Massive 2A AC - ideal for many projects (put the rectifier inside the project!)

## NEW PCB Mounting terminals

The easy way to connect to a pcb: they solder to the board, and wires are screwed into terminals. Simple! Choice of three sizes:

3-way Cat H-6745 \$1.10ea (10 up \$1.00ea)

6-way Cat H-6748 \$1.55ea (10 up \$1.40ea)

8-way Cat H-6750 \$1.65ea (10 up \$1.50ea)



## BARGAIN VALUE MULTI- METER

**\$69**  
WAS  
**\$79<sup>50</sup>**



Here's top value! Save over

\$10 on one of the most popular multimeters ever sold in Australia....

The Dick Smith Q-1136.

Cat Q-1136

Much, much more than just another multimeter.

It features a huge 100,000 ohms per volt sensitivity, with ranges from 10uA to 10A and 0.5V to 1kV DC PLUS 10A AC, 5V to 1kV AC plus four resistance ranges.

But even more: it also measures transistor Hfe and Ico -NPN and PNP- and diodes. Amazing? You Bet!



## HEADLIGHT ANTI FORGETTER

It's so annoying! You leave the lights on - and cop a bat flattery. No longer: fit this light reminder and it jogs your memory. Easy to fit - cheap battery insurance!

**\$9<sup>95</sup>**

Cat A-8509

## Pro-quality Radio Control

**ONLY \$199**

Cat Y-1245



Ask the experts: they'll tell you (a) get away from the crowded 27 & 29MHz bands and (b) go for FM! Here's the radio control the experts use - a 36MHz, 5 channel capacity FM system with full digital proportional control.

Comes complete with 3 servos, receiver, battery container & cables - ready to install into your plane, boat, buggy, etc. If you're really into radio control - get into this one!!







## Mighty mouse

The emerging dominance of IBM in the microcomputer industry has spawned a huge market for add-on equipment designed to improve the performance and expand the capabilities of IBM micros as sold in their original configurations.

But all is not roses for add-on equipment suppliers. IBM, streamlined and free of the fetters imposed on it for so long by the now-dropped Justice Department antitrust suit, is playing Mr Nice Guy to no one.

The new IBM stands ready and willing to do battle for any and all markets, including the ones created by its own micro-

computers.

IBM is likely to counter the add-on equipment suppliers in two ways. First, it is likely to turn more and more to bundling add-on equipment into original offering configurations. By 1994 fully one-third of all potential IBM add-on equipment sales will be pre-empted by bundling.

The second way is by direct head-to-head competition. Here, IBM will have the enormous advantage of its name and reputation. By 1994, IBM is expected to have 85% of the communications board add-on market, 70% of the memory board market, 50% of the add-

on storage equipment market and 40% of add-on display device sales.

The input device known as the mouse gives a particularly dramatic example of how IBM's presence will affect competitors' sales. The mouse is going to be the surprise winner of the '80s, thanks to increased demand for windowing, for which the mouse is ideally suited.

Although only 25 000 mice were sold as add-on devices for IBM micros in 1983, the number will climb to 100 000 in 1984 and to an astonishing two million by 1989, with the accompanying generation of \$300 million in

revenues.

But the bottom will fall out of the mice market after that. By 1994, sales of add-on mice will be down to the 500 000 level. The reason: IBM's bundling of mice into the original offering configuration. Of the total of 7.5 million IBM PC-compatible mouse sales in 1994 fully 7 million will be bundled by IBM. And mouse manufacturers, having expanded production mightily in the heady '80s, will wake to find themselves caught in a mouse trap of IBM's making, while Big Blue walks off with the cheese.

## Program copyright

The Australian Computer Retailers Association (ACRA) welcomes the announcement that legislation will be introduced to amend the Copyright Act to include computer software in the definition of 'literary works'.

ACRA is pleased that ownership of software will be formalised in law, because had such recognition not been given, the improvement of existing software and the creation of new software would have almost ceased in Australia. Without the potential for monetary reward, personal recognition and satisfaction, there would be no incentive for programmers.

The association has urged that the computer industry, the Federal Government and international bodies will need to draft totally new legislation to define man's intellectual relationship with computers.

## Insurance for hackers

Owners of electronic equipment and small computers will find it very simple to purchase inexpensive cover with New Zealand Insurance. This is because the company has broken with tradition, and owners will no longer always be required to hold a maintenance

agreement for the equipment being insured.

The new 'electronicsurance' package will cover electronic equipment up to a value of \$75 000 a unit and computers up to \$40 000 a unit. The extensive coverage includes loss or damage caused by accident and negligence, theft, electrical breakdown, mechanical breakdown, water damage, lightning, earthquakes, data reconstruction costs (up to \$5000) and increased operating costs (up to \$10 000).

The policy also provides for replacement of damaged equipment with new equipment when less than five years old.

For further information contact Ray Cooksley of NZ Insurance, 20 Bond St, Sydney NSW 2000. (02)232-0122.

## Computer Patch

Does your computer installation look like a birds nest? If it does, you might be interested in the Australian-made matrix patch panel. The panel is wall mounted and so avoids unsightly cabling. It provides an aesthetically pleasing monitoring display in computer and communication rooms.

The panel has horizontal slots (each slot represents a computer input) and vertical lines (representing the peripheral outputs, i.e: 16 slots by 16 lines, or, 16 computer inputs to 16 peripheral outputs. Each panel comes with

16 patch pins. Wherever a patch pin is inserted, it joins a computer input to a peripheral output.

The patch pin can be supplied with certain additional options, such as monitoring LEDs; colour coded tabs for line identification, security protection and VDU monitoring facilities.

By daisy chaining additional units a virtually unlimited number of lines can be switched. For more information contact **Communtron, 35-37 College Street, Gladesville NSW 2111. (02)896-1655.**

## Squeezing the competition

IBM is in the process of using its increasing dominance of the business computer market to secure its position in the large-company teleprocessing network business. According to a new research report from International Resource Development Inc, a US consulting firm, recent IBM announcements of the 3270-PC and XT-370 are reinforcing the suspicion among plug-compatible manufacturers of 3270-type terminals that IBM is in the process of implementing a product strategy which will make the large corporate users return to the IBM fold.

A key element of IBM's strategy is to implement a token-passing local network architecture to interlink 3270 terminals, personal computers and PABX systems. The initial

local network products, being developed by IBM under the code name 'Alligator' will be on the US market by mid-1984, according to the IRD report.

An offshoot of the IBM strategy will be to make the design of an efficient 3270/LAN/PABX hookup something of a spider's web of twisted-pair wiring, coaxial cable and black-box-controllers. IBM salesmen and applications engineers will take advantage of this complexity to discourage customers from self-engineering their data communications and terminal networks. This in turn will make it more difficult for the plug-compatible 3270 vendors to learn of sales opportunities for their products, and increase the likelihood that the customer will buy all-IBM, rather than putting together mixed-vendor networks.

More than fifty companies offer terminals, protocol converters or other products for 3270 networks. Most of these products, according to IRD, are either directly plug-compatible with one or another of the IBM family of 3270 products or else, as in the case with protocol converters, provide compatibility to otherwise incompatible terminals. Continued growth is expected in the market, with the total installed base of 3270 terminals (IBM and compatibles) topping seven million in 1990, compared with three million today. However, the market environment for the plug-compatible vendors is expected to be difficult, as the impact of IBM's new network architectures is felt.





## Tasman Printer Interfaces

A small Tasmanian company has just released news of new Spectrum interfaces. The Tasman interfaces allow the Sinclair Spectrum computer to be used with any printer using either the Centronics or RS-232 standard connections.

The interfaces come with driving software which allows all normal characters plus special print styles, control characters and graphics to be utilized,

depending on the capability of the printer. Concise instructions for making optimum use of the interfaces are supplied with the units.

Tasman also produce a word processor for the Spectrum called Tasword 2.

For further information, contact the distributors Dolphin Computers, 99 Reserve Rd, Artarmon NSW 2064. (02)438-4933.

## Tandy baby expansion

Did you know that Tandy's new MC-10 baby colour computer, which sells for less than \$100 on special, is based on Motorola's 6803 (enhanced 6800)?

Coupled with a suitable expansion board, it makes an ideal starter system for hobbyists, or a second (perhaps dedicated) system for seasoned

micro users.

An expansion board is now available which accommodates a mixture of RAM and EPROM devices (6116, 6264, 2716 thru 27128), up to 36K in total, plus a 6821 PIA for control applications. A short form kit comprising a double-sided pc board, buss edge connector and documentation is priced at \$40 (incl.

post within Aust.).

Future offerings will include a machine code monitor and CHIP-8 language EPROM, which will support the MC-10's 128 x 96 pixel colour graphics mode (not accessible from BASIC).

Please write for details to M. J. Bauer, P.O. Box 221, Ivanhoe Vic 3079.

## CLASSIFIED

### VZ-200 USERS

An independent newsletter is available monthly.

\$1 per issue — \$10 per year.

Issue #1: 20 extra functions, including ON-GOTO, STRINGS, 2nd DOUBLE PRECISION.

J. Waters, 30 Seventh Ave., Cheltenham, S.A. 5014



## The CCT 100 Intelligent Terminal for Intelligent decision makers.

### SPECIFICATIONS

#### Keyboard

- Detachable, compactive, typewriter-style keyboard
- N-key rollover with auto repeat capability
- 4 LED indicators for caps lock, on line, block mode and keyboard lock/protect
- Audible keyclick enable/disable
- Auto repeat enable/disable
- Keyboard lock enable/disable
- Repeat rate 20 characters per second
- 5 cursor control keys, 10 editing function keys with 14-key numeric key-pad

#### Communication

- Code: 128 ASCII characters
- Baud rate: 75, 110, 150, 300, 600, 1200, 1800, 2400, 4800, 9600, 19200
- Parity: odd, even, mark, space
- Operating Mode: full duplex, half duplex or block mode
- Interface: EIA RS-232C or 20-mA Current Loop

#### Emulation

- LEAR SIEGLER ADM 3A ADM 5A, HAZELTINE 1500, ADDS VIEWPOINT

#### Screen Presentation

- Display format: 24 lines x 80 characters
- Display unit: 12-inch, non-glare CRT
- Character type: 7 x 9 dot matrix
- Refresh rate: 50/60 Hz
- Character set: 96 ASCII characters, 15 graphic symbols, 32 control character symbols
- 5 screen attributes: blink, underline, blank, reverse, dual intensity
- Cursor type: selectable slow, fast blinking or steady cursor, block, underline or invisible cursor.

#### External Control

- |                          |                              |                                   |
|--------------------------|------------------------------|-----------------------------------|
| • Power on/off           | • Refresh rate               | • EIA or 20-mA Current Loop       |
| • Contrast adjustment    | • Half duplex or full duplex | • Reverse video or standard video |
| • Baud rate              | • Auto line feed             | • End of message                  |
| • Parity and data format | • Auto new line              | • Emulation mode                  |



**ONLY \$699**

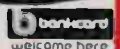

AVAILABLE FROM OFFICES AND SHOWROOM **PARIS RADIO ELECTRONICS**, SHOP 1, 165 BUNNERONG ROAD, KINGSFORD, NSW 2032. TEL. (02) 344 9111. TELEX AA22579.



# HP presents the Datacom problems



Hewlett-Packard's 4951A and 4955A Datacom Analyzers are the product of the very same technical excellence that has entrenched Hewlett-Packard at the forefront of the computer industry.

Each of these units offers total capability and ease of use with softkey guided measurements, intelligent memory, and advanced triggering facilities.

When you're faced with Datacom problems, you only have to turn to Hewlett-Packard's genius for ready made solutions...

**HP4951A.** Specifically designed for field service of computer and communications equipment, network installation and trouble shooting.

**Auto Configure.** Press a single softkey and the HP4951A will automatically determine the protocol, data code, speed parity and error checking.

**Truly Portable.** A rugged, 6kg package incorporating BERT and NONVOLATILE MEMORY complete with accessory pouch, front panel cover and it fits under an airline seat.

**Remote Testing Capability.** Remotely transfer data and set-ups between two HP4951As or the HP4955A and a slave HP4951A. Tests networks in both directions.

**Optional Mass Storage Tape.** Convenient built-in storage for up to 265K bytes of information including data or special programs.

**Value and Performance.** Leading edge technology and performance from HP with a price and support package you cannot afford to ignore.



# complete solution to & network development.



**HP4955A.** Manufactured for design of computer and communications equipment, network management or development and trouble shooting.

**High Speed.** Monitor, simulate and trigger up to 72 kbps, so you have the flexibility necessary for future Datacom needs.

**Multiple Display Formats.** Dedicated to easily identifying protocol problems at the physical interface, frame and packet levels.

**Basic Programming Option.** Network statistics, emulation, display control for your special needs and network protocols.

**Protocol Decode Software.** Featuring SNA, DDCMP, BSC/X.25, ASCII-7/X.25, CCITT No. 7 and simultaneous frame and packet displays gives you even more problem solving power.

I am interested in learning more about HP's Datacom Analysers.

Name: \_\_\_\_\_ Title: \_\_\_\_\_

Company: \_\_\_\_\_

Address: \_\_\_\_\_

Postcode: \_\_\_\_\_

Please send me further information

Please arrange for a demonstration

Return coupon to Hewlett-Packard, Instrument Marketing,  
31-41 Joseph St., Blackburn, Vic. 3130

**Nothing else quite measures up.**



**HEWLETT  
PACKARD**

Melbourne: 8952895. Sydney: 8871611. Adelaide: 2725911. Perth: 3832188.  
Brisbane: 304133. Canberra: 804244. Auckland: 687159. Wellington: 877199.

LBV5920 HEP90381





# SERIES 5000

SPECIAL PRICES THIS MONTH

As designed by ETI

INDIVIDUAL COMPONENTS TO MAKE UP A SUPERB HI-FI SYSTEM. DIRECT IMPORT AND A MORE TECHNICALLY ORIENTED ORGANISATION BRING THESE PRODUCTS TO YOU AT LOWER PRICES THAN OUR COMPETITORS.

### EXTRA FEATURES OF OUR KITS

#### POWER AMPLIFIER

KIT PRICE \$319 P&P \$12.00

• 1% Metal Film Resistors are used where possible • Prewound Coils are supplied • Aluminium case as per the original article • All components are top quality • Over 400 Kits now sold • We have built this unit and so know what needs to go into every kit • SUPER FINISH Front panel supplied with every kit at no extra cost to you. • We are so confident of this kit that we can now offer it assembled and tested so that people who do not have the time can appreciate the sound that this amplifier puts out. This is done on a per order basis delivery approx. four weeks after placement.

A + T Only \$449

#### PREAMPLIFIER

KIT PRICE \$289 P&P \$12.00

• 1% Metal Film Resistors are supplied • 14 metres of Low Capacitance Shielded are supplied (a bit extra in case of mistakes) • English "Lorlin" Switches are supplied no substitutes as others supply • We have built and tested this unit and so

A + T Only \$449

know what needs to go into every kit • Specially imported black anodised aluminium knobs • Again as with the power amp we are offering this kit A & T at a price which we do not believe there is a commercial unit available that sounds as good. Same delivery as the power amp.

### PREAMPLIFIER SPECIFICATIONS

Frequency response: High-level input: 15Hz-130 kHz, +0, -1 dB Low-level input — conforms to RIAA equalisation, ± 0.2 dB  
1kHz < 0.003% on all inputs (limit of resolution on measuring equipment due to noise limitation).  
Distortion: High-level input, master full, with respect to 300 mV input signal at full output (1.2V): > 92 dB flat > 100 dB A-weighted.  
MM input, master full, with respect to full output (1.2V) at 5 mV input, 50 ohm source resistance connected: > 86 dB flat > 92 dB A-weighted.  
MC input, master full, with respect to full output (1.2V) and 200 µV input signal: > 71 dB flat > 75 dB A-weighted.  
S/N noise:

On Special at \$259  
Normally \$289

\*All parts available separately for both kits.

Please note that the "Superb Quality" Heatsink for the power amp was designed and developed by Rod Irving Electronics and is being supplied to other kit suppliers. This product cost \$1,200 to develop so that your amplifier kit would have a professional finish as well as sound.

## POWER AMPLIFIER

On special this month  
\$289

### SPECIFICATIONS 150W RMS into 40hms

Power output: 100W RMS into 8 ohms (± 55 V supply).  
8 Hz to 20 kHz, +0 -0.4 dB 2.8 Hz to 65 kHz, +0 -3 dB. NOTE: These figures are determined solely by passive filters.  
Frequency response: 1V RMS for 100W output.  
Input sensitivity: -100dB below full output (flat).  
Hum: -116 dB below full output (flat, 20 kHz bandwidth).  
Noise: -0.001% at 1 kHz (0.0007% on prototypes) at 100 W output using a ± 56 V supply rated at 4 A continuous. < 0.003% at 10 kHz and 100 W.  
2nd harmonic distortion: < 0.0003% for all frequencies less than 10 kHz and all powers below clipping.  
3rd harmonic distortion: Determined by 2nd harmonic distortion (see above).  
Total harmonic distortion: -0.003% at 100 W, (50 Hz and 7 kHz mixed 4:1).  
Intermodulation distortion: Unconditional.  
Stability:

## (MX-1200 MICROPHONE/AUDIO MIXER



MX 1200 \$699 this month only!

NB — THIS UNIT IS BUILT AND TESTED NOT A KITSET

NORMALLY \$799

This unit features 12 microphone line inputs with pan, bass, treble, effect and fold back controls for each channel • LED peak indicators for each channel • 2 turntable inputs with cross-fade and individual output controls • master equaliser for bass, midrange and treble • variable headphone output etc. etc. • complete with carrying case

#### SPECIFICATIONS:

INPUTS  
Level/impedance Mic 45 db 1k  
Line 22 db 18k x 12  
Phono 52 db 50k STEREO x 2 (2mV) at 1kHz  
Effect Return (Aux) 20 db 50k x 8  
OUTPUTS  
Level/impedance L & R 0 db 2k  
Effect Send 0 db 2k x 2  
Head phone Stereo +10 db 600 (100 1k)  
EQUALISATION  
Channel  
Bass +15db  
Treble +15db  
Master  
Bass +12db  
Treble +12db  
Middle +12db

#### FADER & CONTROLLERS

12 channel fader, Slide 60mm LOG 25%  
2 Master fader, Slide 60mm LOG 15%  
12 F B Volume, 300, LOG  
17 B Master level, 300, LIN  
12 Effect Send, 300, LIN  
1 Effect Return, 300, LOG 15%  
2 Phono, 300, LOG 15%  
1 Head Phone, 300, LOG 15%  
S/N: 50dB  
FREQUENCY RESPONSE: 20-20 kHz  
TOTAL HARMONIC DISTORTION: Less than 0.1%  
METER 2 illuminated VU Meters 0db = 0.775V  
PEAK INDICATOR 12 LED Peak indicators  
VOLTAGE 240 VAL 50Hz  
POWER CONSUMPTION: 7.2 watts  
DIMENSIONS: 430 (W) x 386 (D) x 108 (H) mm (supplied complete with carrying case)

ON SPECIAL THIS MONTH \$289

## THIRD OCTAVE GRAPHIC EQUALIZER

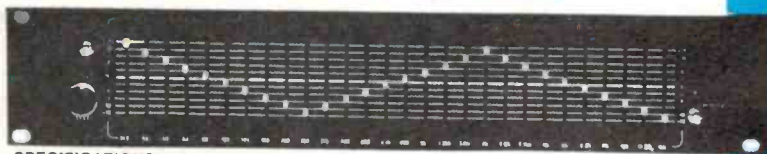

SPECIFICATIONS E.T.I. Dec. 1982  
Bands: 28 Bands from 31.5 Hz to 16 kHz  
Noise: < 0.008 mV, sliders at 0, gain at 0 (-102 dB),  
20 kHz bandwidth  
Distortion: 0.007% at 300 mV signal, sliders at 0, gain at 0, max 0.01%, sliders at minimum.  
Frequency Response: 12 Hz-105 kHz, +0, -1 dB, all controls flat  
Boost & Cut: 14 dB

1 unit  
\$189

## SERIES 4000 SPEAKERS

- 8 speakers with crossovers ..... \$499
- Speaker boxes (assembled with grill and speaker cutout) ... \$299
- Crossover kits ..... \$199
- Complete kit of parts (speakers, crossovers, screws, inner-band, boxes) ..... \$799
- Assembled, tested, ready to be hooked up to your system ..... \$849

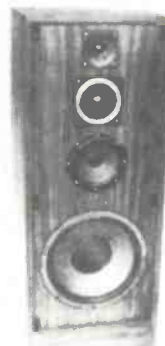

2 units  
\$359

WE BELIEVE THAT WE ARE NOW THE ONLY ONES TO SUPPLY COMPLETE SPEAKER KITS ASSEMBLED AND TESTED FOR THOSE WHO HAVEN'T GOT TIME \$849 EX STOCK.

PLEASE WRITE FOR CONSTRUCTION NOTES, THESE COMPLIMENT THE SERIES 5000 AMP RANGE AND ADD THE FINAL TOUCH.

## ROD IRVING ELECTRONICS

425 High St., Northcote, Vic. 48-50 A'Beckett St., Melb., Vic.  
Phone (03) 489 8866, (03) 489 8131, Mail Order Hotline (03) 481 1436  
Mail orders to P.O. Box 235 Northcote 3070 Vic.  
Minimum P & P \$3.00. Errors & omissions excepted.

Please address tax exempt, school, wholesale, and dealer enquiries to:  
**RITRONICS WHOLESALE**  
1st floor 425 High St. Northcote 3070 (03) 489 7099 (03) 481 1923  
Telex AA 38897



## Apple modem

**N**etComm has released its wholly Australian designed and built multi-function modem for Apple computers.

The modem is the first in a range of modem products and

one of very few with proper Auto Dial, Auto Answer and Auto Disconnect facilities. It offers Apple computer users a true multi-function capability.

The unit may be pre-set with a series of hardware switches but may then re-configured under

program control. This means the modem may be used to connect the apple to virtually any remote computer service.

The modem is controlled by an on-board microprocessor with in-built RAM and EPROM. The modem complies

fully with Australian CCITT standards but may be re-configured for use with the US Bell standards.

A Telecom approved slimline touch dial 'phone handset is supplied with the modem and can be used for voice conversations. Auto re-dial is built-in.

For more information contact Data NetComm, 33 Ryde Road, Pymble NSW 2073. (02)498-5577.

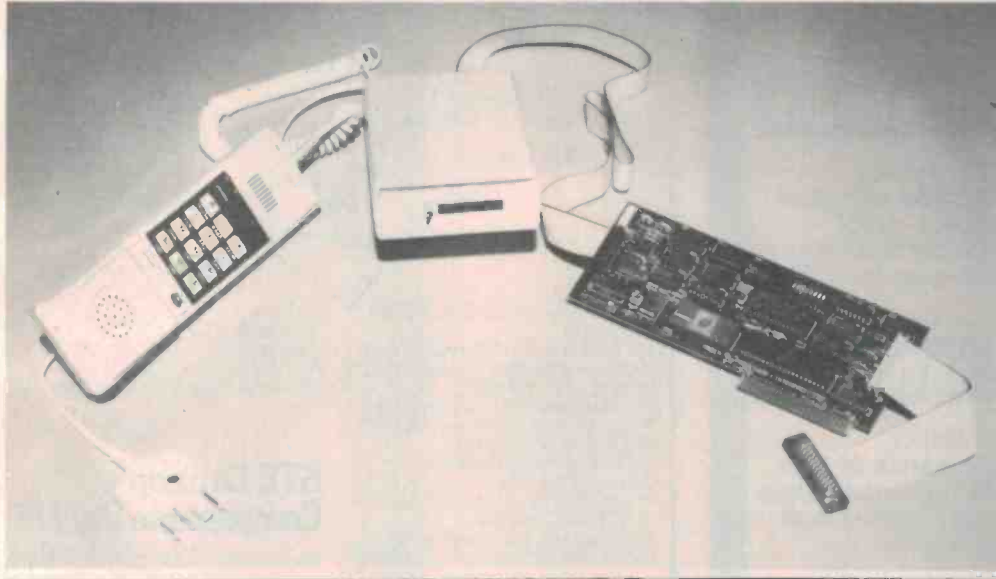

## First steps to 'thinking' computer

**R**esearchers working on Japan's national project for the development of a fifth generation computer have built a key device, according to a report in the Asian Wall St Journal of 11 May.

The device, called a 'relation database machine', will help researchers create the second of two major pieces of hardware in the new computer.

The fifth generation computer would be able to make 'intelligent guesses', educate itself, understand human languages and suggest solutions for specific problems, a spokesperson for the Institute for New Generation Computer Technology said.

Japan launched the 10-year project in 1982 under the auspices of the Ministry of International Trade and Industry (MITI). Forty scientists are on loan to the Institute from Japan's eight major computer makers.

## 8/16-bit business computer

**I**n a move to significantly expand the range of applications software available for its systems, Vector Graphic has introduced an 8/16-bit business computer capable of reading IBM-PC, PC XT and other software floppies.

The standard Vector 4-S includes a 16-bit CP/M-86 operating system, a CP/M simulator to run 8-bit CP/M-based soft-

ware packages, an 8-bit Micro-soft BASIC interpreter, and other software development tools. GSX-86 graphics is included, generating monochrome graphics with up to 16 levels of grey. An optional Aydin Controls colour monitor produces sharp screen displays with up to 16 selectable colours; an optional flatbed plotter creates charts and graphs with up to eight colours.

Vector Graphic describe the Vector 4-S as a complete information management system designed for use anywhere there is a need to gather, analyse, or manipulate information and to obtain printed reports, invoices, or statements.

For more information contact Dicker Data Projects Pty Ltd, 78 Captain Cook Dr, Caringbah NSW 2229. (02)525-2122.

## Pc boards

**E**nergy Control has just released news of a range of new circuit boards. Part number EC 545 is a colour RGB CRT controller based on the 6545A controller. EC 364 is a 64K EPROM module with an RM 65 compatible buss.

They also have a single board controller module, an intelligent peripheral controller and a high isolation interface I/O module.

The products are available together with their data sheets from the distributors, Energy Control, P.O. Box 6502 Goodna, Qld 4300. (07)288-2455.

## Lynx eats mouse

**A**ssociated Controls has released a cursor controller that acts like the mouse, called the Lynx. The Lynx is a trackball, i.e. the user controls the movement of the cursor by rotating a ball mounted on a low profile stand.

The stand has three buttons that can be user defined, and communicates with the computer via an RS232 interface. Baud rates between 300 and 19 200 can be set.

For more information contact Energy Control, 55 Fairford Road, Padstow NSW 2211. (02)709-5700.



## Tandy BASIC

**N**ow available from Tandy are two new languages to update the capabilities of the TRS-80.

'OS 9 Disk Operating System' is a real time operating system that accesses the entire memory of their new extended colour computer.

'Basic 09' is a Pascal-like version of BASIC, with much faster execution times than conventional BASICs.

'OS 9 Disk Operating System' is available for \$99.90 while the 'Basic 09' costs \$149.50.

Contact Tandy for details at 91 Kurrajong Ave, Mt Druitt NSW 2770. (02)675-1222.



## PROFESSIONAL QUALITY ELECTRONIC COMPONENTS



**COPAL**  
Dip Rotary Coded  
Switches. Sealed BCD  
and hexadecimal coded  
miniature rotary  
switches.



**Hirschmann**  
MS100 Probe.  
Test probe with lead  
and touch proof  
handle for scanning of  
voltages up to 1000 V.



**Hirschmann**  
Fibre Optics.  
OSMA series of high  
quality universal single  
pole connectors and  
components.

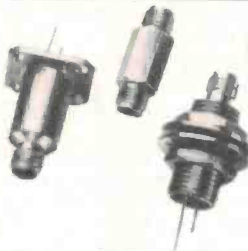

**Hirschmann**  
PMK-100 Test Lead  
Pack with 1 x KLEPS 30  
and 1 x ML100



**Hirschmann**  
PMK-409N Test Lead  
Pack with 2 x PRUF 2  
and 2 x ML100



# MAYER KRIEG & CO.

248 ANGAS ST., ADELAIDE, S.A. 5000.

For further information and data sheets contact your local distributor.  
NSW: Mayer Krieg (02) 684 1900; M. Ruddy (02) 476 4066. NEWCASTLE:  
DGE Systems (049) 89 1625; QLD: E.C.Q. Electronics (07) 376 5677; Fred  
Hoe (07) 277 4311. SA: Anelco Electronics (08) 294 2600. TAS: D & I  
Agencies (002) 23 2842. VIC: Mayer Krieg (03) 579 5722. WA: Pro-Spec  
Distributors (09) 382 5011. NZ: Channelmaster (9) 59 9003.

# Crystal Precision

Premium quality  
'AT' cut crystal units  
for communication,  
time keeping,  
instrumentation and  
all other applications  
where absolutely  
precise timing  
is essential.

Manufactured  
in accordance with  
IEC, MIL and JIS  
standards.

Required range  
of crystals in holders  
available.  
Series HC-18/U.

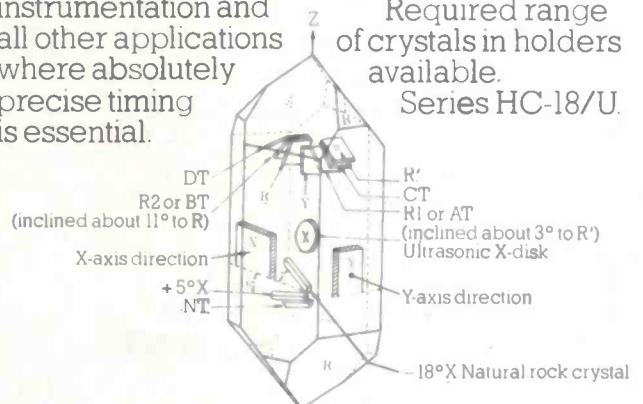

STC Cannon Components Pty. Ltd.  
VICTORIA  
248 Wickham Rd., Moorabbin, 3189.  
Phone: (03) 555 9566 Telex: AA30877  
NEW SOUTH WALES  
605 Gardeners Rd., Mascot, 2020.  
Phone: (02) 693 1666 Telex: AA26304  
WESTERN AUSTRALIA  
396 Scarborough Beach Rd.,  
Osborne Park, 6017  
Phone: (09) 444 0211 Telex: AA93748  
SOUTH AUSTRALIA  
68 Humphries Tce., Kilkenny, 5009.  
Phone: (08) 268 7088 Telex: AA88095

QUEENSLAND  
Gabba Towers, 411 Vulture St.,  
Woolloongabba, 4102  
Phone: (07) 393 0377 Telex: AA43025

**STC Cannon  
Components Pty. Ltd.**  
An Australian Company of **ITT**

LEXICON 3082

# LOGCON



MD - XXX SERIES for Motion Detectors  
and Speed Switches  
AT - SERIES Timers and Alarm.  
MDC - 4 Timers include Multi-Range  
Miniature 4-digit  
Multi-Range  
PSV - 1 3-Phase Monitor  
Relay. Monitors for  
High and Low Voltage,  
Voltage Balance, Rotation  
Plus High and Low  
Frequency.

**Regulated Voltage Inverters -  
Ideal Computer "No-Break" Supplies  
Special Functions to Order  
AUSTRALIAN MANUFACTURE**



**minitool**

AUSTRALIA PTY. LTD.  
134A AYR ST.  
DONCASTER (03) 850 9887



# Ritron monitor

A highly recommended all purpose monitor at the lower end of the market.



## Evan McHugh

THE RITRON MONITOR is 300 mm wide, 300 mm high and 300 mm deep. It is basically a box without legs, so it has no ability to tilt and swivel.

The monitor handles 80 characters by 25 lines with relative ease, although there is obvious separation of pixels on the vertical. Reverse video is legible but not pleasant, as the horizontals are much bigger than the verticals in the letters. This problem can be reduced by turning down the brightness. However, it also occurs frequently in other machines, even in ones that are in much higher price ranges.

The monitor has a vertical scan of 800 lines and a vertical resolution of 640 pixels. The screen is just under 300 mm across the diagonal.

The screen of the Ritron monitor is treated to reduce glare and reflections, so that the overall impression is matt. Two types of screen are available; the usual green screen costs \$179 and the amber screen is \$199. The recommended screen to go for is the amber, not just because it is the latest trendy idea, but because the eyestrain caused by prolonged use of a monitor does appear to be less with an amber screen — when used correctly.

The practice of turning the brightness up to full intensity will both increase the possibility of eyestrain and other physical problems, and probably 'burn' the screen in a very short time. Set the screen intensity to complement the ambient light level; it saves both your eyes and the screen.

Flicker is not noticeable. There is a small amount of slewing and curve at the edges of the display, but this can be reduced through adjustment.

The front panel of the screen is a low-glare grey plastic trim which gives a good contrast. At the front of the monitor, where it should be, is a flip-down door containing all controls — including ones often stuck somewhere inside the box or inaccessibly round the back. These adjust focus, horizontal width, horizontal hold, vertical size,

vertical linearity and vertical hold; there are also the usual brightness and contrast controls. With these controls you are able to adjust the size and shape of characters to a high degree.

The on/off switch is also located on the front panel, just beside the door to the adjustment controls. A red LED above the on/off switch indicates power status.

At the rear of the monitor are the video input and a video output sockets which allows parallel connection of monitors. Both are BNC sockets. The housing is metal with a grey trim.

## Comments

In normal operation this machine is quite satisfactory. The screen looks good, and things happen quickly and smoothly. As such it is highly recommended as an all-purpose workhorse monitor.

However, we used it for quite a long period of time, and found a slight instability (possibly a one-off fault in the review unit), so it would be as well to check the clauses of the warranty pretty carefully before buying. A small amount of pressure on the top of the box caused the screen image to disappear. Also, just after turn-on, there was an occasional flicker of the screen as I banged away on the keyboard. Sensitive!

The suspicion I developed was that all was not perfectly well inside the box. To avoid the inconvenience of having it croak on you one day with no possibility of comeback, check your warranty — and perhaps the availability of service and replacement parts.

In spite of this quibble, the Ritron is a good monitor. If you are looking for a flicker-free, all-purpose monitor in this price range, it is well worth considering.

You can get the Ritron monitor from two Rod Irving Electronics stores: **Ritronics**, 425 High St, Northcote Vic. 3070, and **C-Tech**, 48-50 A'Beckett St, Melbourne Vic. 3000.

You need not own a bank to have a personal computer. Look at our prices.



64K Z80 & 6502 CPU IBM look-a-like case detachable keyboard 188 function keys, 10 user define keys \$480



12" green & amber monitors high frequency, from \$120.00



Teac Floppy disk drivers suitable Apple II, with Direct Drive from \$230



Dot matrix printers using continuous and sheet paper \$265  
Daisy wheel printer, letter quality \$510.00



Floppy Disks 5 1/4" and 8" S/S, D/S, S/D & D/D, from \$2.10

Add-on Cards, 80 column, Parallel cards, RS232 Serial card, Disk card (2), Pal card, Printer card, Clock card, Eprom writer card, Speak card.

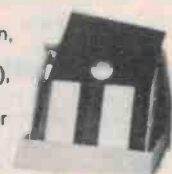

Also stepping motors  
Servo motors  
Synchronous motors  
Digital Instruments  
Presettable counters  
Tachymeters &  
Panel meters

Ring or send 60c postage for free catalogue.

## GCS

G.C.S. Sydney — 67 Blackshaw Ave., Mortdale. 2223. Phone 570 1225  
Wollongong — 46 Charles Road, Fairy Meadows. Phone (042) 84-5544.  
Enquiries from agents and distributors invited.



# A linguist's reply to Dr Koji Kobayashi

The interface between modern communications systems and human beings is a meeting of radically different 'minds' and languages. Dr Koji Kobayashi in his article on *Computers and Communications* (ETI, May '84) approached that interface as an expert on the machines and their capabilities. Known facts about the other side of the divide — human language systems and their mental backup — remain a closed book to most people, including alas, electronics and communications experts it seems?

**Thor May**

Department of Linguistics,  
University of Newcastle, Newcastle NSW

DR KOBAYASHI has hinted that simultaneous translation between Japanese and English is just around the corner. Indeed, he is confident that his own corporation has the resources to put it all together. I am afraid somebody may be conning him. That is a harsh suggestion, but it wouldn't be the first time a magic translation machine has been flogged to an eager client.

In the early 1960s a group of American linguists had a wonderful scam going; it was in a good cause. They talked the Pentagon around to funding research into machine translation. The generals thought that instant translations of Pravda would be coming along in no time. It took them about a decade to realise that the product had a hundred year lead-time! While the party lasted some useful work was done, although a few of the researchers were as naive as their benefactors.

## Look at reality

Let's look at the reality. The first daunting fact is that a machine which is able to provide proper translations between natural languages will, by any reasonable use of the word, no longer be merely a machine. It will be a sensing, feeling, thinking creature, capable of independent ideas and actions. In other words, it will have that baffling amalgam of experience and potential which we normally associate with the human mind. Anything less will render it incapable of interpreting the full significance, the *meaning*, of our subtle and shifting systems of signals.

Suppose that in an engineering sense the necessary stack of microchips can be jiggled together (always remembering, however, that the human central nervous system,

which is being emulated by our language machine, has a range of possible contacts amongst its cells which exceed the number of atoms in the known universe); then what sort of software design problem would the researchers really be faced with?

Well, first of all, they would have to understand the parameters of the systems they were trying to model; in this case, natural language systems and human knowledge systems. Surely there are people around who can provide that sort of information? Everyone knows a language. At least one. Any fool can learn to speak as a child.

Now this is the point, unfortunately, at which linguists and the rest of humanity cease to understand one another. You probably learned a few conscious rules of grammar at school. You may even have a word processing program which does a rough

check of your sentence structures, or one of those clever voice synthesisers for your home computer. You will, therefore, think me misguided or a charlatan to insist that at the current rate of research we are not within generations — human generations — of understanding the set of rules and constraints in any natural language (English, Japanese, you name it . . .) needed to write that marvellous computer program that will freely translate one language into another.

## Phonology not the problem

The problem is not the sound systems (phonology). Sound vibration is only one possible medium for carrying language. Alphabet writing on paper is another, binary codes yet another. Within the brain the mediums are electrical and chemical. But language itself is an abstract thing, a maze of interlocking symbol systems. ►

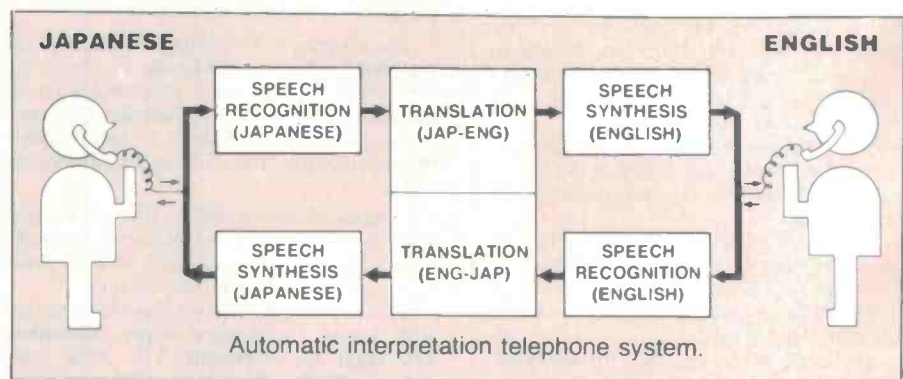



## COMPUTERS AND COMMUNICATIONS

We know that those systems are highly organised since you and I understand one another, more or less. But switching mediums freely as they do, and not being absolutely constrained by the laws of time and space, as the 'visible' systems of physics and biology are, language systems have evolved in unique ways to levels of complexity that have so far defied comprehensive analysis.

Language is a constant stage show for all the tricks of the mind, yet those of us watching have been unable to see behind even the simplest sleights of hand by that cosmic magician, our inner being. In fact, I am prepared to lay odds with Dr Kobayashi, or anybody else, that natural language will ultimately provide the greatest of all challenges in the universe to the ingenuity of human science.

### Clocking the code

Fine minds, you might think, would compete for the glory of cracking those miraculous language codes. Well, they mostly haven't. Of course, there are other people doing related work in Artificial Intelligence, Neuro-Biology, Psychology, and so on. But like all the best mysteries, this one has been seen by few eyes. The disguise is brilliant because it hides behind that most familiar of things, our own voice. Worldwide there are, at the outside, a few thousand people doing any sustained work in some branch of theoretical linguistics. Most of them can't make a full living at it.

(The word 'linguist', by the way, is a bit like 'engineer'. There are many kinds of linguists, as different as civil engineers and garage mechanics. I am talking in this article about that very small group of scientists concerned with investigating the universal structures of natural language).

The vast majority of theoretical linguists would not claim any knowledge of, or even interest in, computer simulation. Their territory is the human mind, or abstract models thereof. There is no doubt, however, that their work will ultimately be turned to extra-human language production.

A very few large American corporations have employed or contracted a theoretical linguist or two as a long-term investment; (e.g. Dr Paul Postal at IBM; Dr Joan Bresnan at Xerox). Rather more people have jobs as 'computational linguists' but their work, by and large, consists of finding clever ways to extract information from exponentially expanding data banks.

Japan, with a handful of honourable exceptions, has very, very little trained talent in the field of theoretical linguistics. Outside of Tokyo University (and perhaps Sophia University), there is scarcely a credible Department of Theoretical Linguistics in that country. That is, unless Dr Kobayashi has a tribe of linguists hidden in a cave on the Izu-Shoto (islands). The much vaunted fifth generation computers being developed in Japan are, it seems, likely to be pretty dumb after all!

### On the rocks

Is the communications revolution going to shatter against the rock of natural language then? Yes and no. Things are not utterly hopeless. As many readers will know, elements of linguistic knowledge are already being successfully used in electronic products and communications procedures. Voice recognition is becoming more and more sophisticated. Computers, even now, can be taught to recognize and produce simple messages using elementary fragments of human grammars.

One would expect this process to continue and accelerate. There are even existing programs to provide 'rough' language translations between natural languages. They often produce absurd outcomes, but sometimes prove a useful prop for the memories and pen hands of overworked human translators. It is not surprising that non-specialists so readily make the quantum leap from these admirable achievements to the belief that Luke Skywalker's talking robot pal, C3PO, will turn up in the next Christmas stocking.

Professional linguists themselves have too often dismissed computers as being irrelevant and unusable for their present purposes. (Many were made sceptical by the Pentagon scam mentioned earlier). Solving the Universal Language Puzzle is rather like playing with a thousand-sided Rubik's cube. To keep track of all the 'coloured squares' is beyond the mental ability of any single player and friendly computers should certainly help your neighbourhood linguist to stay on the right side of sanity.

### Consequences of a C3PO

Finally, it must be said that many of my colleagues would regard the prospect of a true language-using machine with the sort of trepidation that those scientists on the Manhattan Project knew a generation ago. They have a point. The consequences of a C3PO, when it finally arrives, will surely be more devastating than any atom bomb. Humanity will then have taken command of evolution. We will have created a creature equal to ourselves. Dr Kobayashi, you may be waiting a while for that instant Japanese-English telephone conversation. ●

### Further reading

Akmajian, A. & Heny, F. (1975); *Introduction to the Principles of Transformational Syntax*, MIT Press.

Bresnan, J. (ed.) (1982); *The Mental Representation of Grammatical Relations*, MIT Press.

Chomsky, N. (1976); *Reflections on Language*, Temple Smith.

Lyons, J. (1977); *Semantics*, Vols. 1 & 2, Cambridge University Press.

Michie, D. (1974); *On Machine Intelligence*, Edinburgh University Press.

# S100 MEANS AED

We are Australia's largest supplier of IEEE 696 S100 cards, supplies, cabinets & parts.

We are also the manufacturers of the acclaimed IEEE S100 Universe Supercomputer

**CPU's** 8085/8088 8MHz, 8086 10MHz, 80286, 68000, 16032, Z80 . .

**Memory** 48k/64k/128k/256k/  
1 Megabyte 8MHz without wait states  
10MHz with 1 wait.

**I/O Cards** Full range of serial & parallel, including our super intelligent 256k buffered serial and parallel I/O processor card, A/D-D/A.

**Video** S100 80x24 terminal cards, Terminal cards with graphics, graphics cards, CAD graphics 3 card sub-system with its own slave 8088 CPU supports AUTOCAD software.

**Disk Controllers** High speed DMA, floppy and hard, also memory mapped types, NEW floppy and hard file I/O processor with revolutionary super speed B.S.D.M.T. 4 times faster than D.M.A. also provides buffered I/O Interrupts and clock calendar.

**Busses** 10/20 slot terminated shielded design operates to 12MHz

**Power Supplies** Full range of S100, Floppy and Hard disk supplies.

**Cabinets** S100 desk top, 19" Rack, card cages, minimal chassis, S100 cabinet for 10 slots + 8" Floppy + Winchester - as in UNIVERSE system 1, Single & dual 8" floppy cabinets, Winchester cabinets, S100 roll around module as in UNIVERSE system 2.

Special O.E.M. Prices available  
Write for our Free S100 Catalogue

AED  
COMPUPRO  
MORROW ● TRANSEND  
GRAPHIC DEVELOPMENT LABS  
MACROTECH ● VECTOR ● ETC  
AED COMPUTERS  
PO Box 1195 Parramatta NSW  
(02) 689 1744 Telex AA70664



# "BIG BOARD II"

**Over 1,000 sold**

Jim Ferguson, designer of the "Big Board" distributed by Digital Research Computers, has produced a stunning new Computer, "Big Board II". It has the following features:

**4 MHz Z80-CPU AND PERIPHERAL CHIPS**

The Ferguson computer runs at 4 MHz. Its monitor code is lean, uses Mode 2 interrupts, and makes good use of the Z80-A DMA chip.

**64K DYNAMIC RAM + 4K STATIC CRT RAM + 24K (E)PROM OR STATIC RAM**  
 "Big Board II" has the three memory banks: the first memory bank has eight 4164 RAMs that provide 60K of user space and 4K of monitor space. The second memory bank has two 5128 SRAMs for the memory-mapped CRT display and space for six 2732 As, 2Kx8 static RAMs, or pin compatible (E)PROMs, the third memory bank is for RAM or ROM added to the board via the STD bus. Whether bought as a bare board, a full kit, or assembled and tested, it comes with a 450nS2732A EPROM containing the monitor.

**MULTIPLE-DENSITY CONTROLLER FOR SS/DS FLOPPY DISKS**

The new Ferguson single board computer has a multiple-density disk controller, it can use 1793 or 8877 controller chips since it generated the signal with TTL parts. The board has two connectors for disk signal with 34 pins for 5.25" drivers, the other with 50 pins 8" drives.

**VASTLY IMPROVED CRT DISPLAY**

The new Ferguson SBC uses a 6845s CRT controller and 8002 Video Attributed controller to produce a display that will rival the display of quality terminals. Characters are formed by a 5 x 7 dot matrix on 15.75 KHz monitors and 7x9 dot matrix on 15.75 KHz monitors. The display is user programmable with the default display 24 lines of 80 characters.

**STD BUS CONNECTOR**

The Ferguson computer brings its bus signals to a convenient place on the PC board where users can solder a DSTO, bus cards can be plugged directly into it, and it can as well be connected by bus cable to industry-standard card cages.

**A Z80-A S10/0 = TWO ASYNCHRONOUS/SYNCHRONOUS SERIAL PORTS**

**TWO Z80-A CTCs = EIGHT PROGRAMMABLE COUNTERS/TIMERS**

The new Ferguson computer has two Z80-A CTCs. One is used to clock data into and out of the Z80-A S10/0, while the other is for systems and application use.

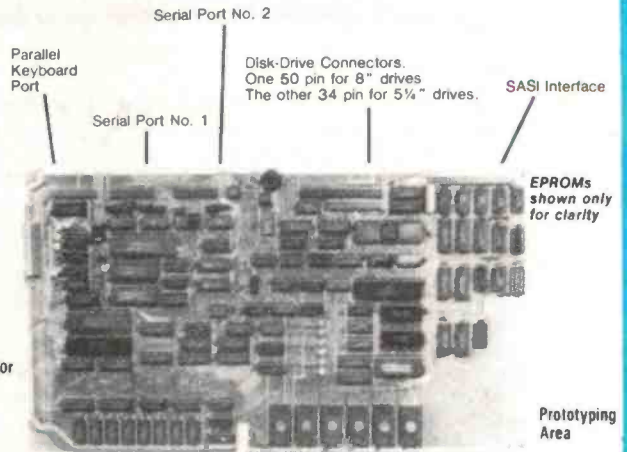

STD Bus Connector

EPROMs shown only for clarity

Prototyping Area

**PROM PROGRAMMING CIRCUITRY AND SOFTWARE**

The new Ferguson SBC has circuitry and drivers for programming 2716s, 2732(A)s, or pin-compatible (E) EPROMs. Software \$25 extra.

**CP/M**

CP/M with Russell Smith's CB10S for the new Ferguson computer is available for \$230. + TAX  
 The CB10S is available separately for \$65. + TAX  
 Actual board size: 39.6cm x 22.2cm. 5 inch B10S being developed. Approx price \$95. + TAX

**Kit Price**

**\$695 inc tax Less 10% for 3+**

**\$895 Assembled and Tested**

**KIT PRICE FOR THIS MONTH**

**\$649.00**

## NEW SINGLE BOARD PRODUCTS AND PRICING

### THE 6809 "UNIBOARD"™ SINGLE BOARD COMPUTER KIT

PERFECT FOR COLLEGES, OEM'S, INDUSTRIAL AND SCIENTIFIC USES!

**64K RAM! DOUBLE DENSITY FLOPPY DISK CONTROLLER!**

FEATURES THE POWERFUL, THIRD GENERATION, MOTOROLA 6809 PROCESSOR!

Many software professionals feel that the 6809 features probably the most powerful instruction set available today on ANY 8 bit micro. Now, at last, all of that immense computing power is available at a truly unbelievably low price.

**FEATURES:**

- ★ 64K RAM using 4116 RAMs.
- ★ 6809E Motorola CPU.
- ★ Double Density Floppy Disk Controller for either 5-1/4 or 8 inch drives. Uses WD 1793.
- ★ On board 80 x 24 video for a low cost console. Uses 2716 Char Gen Programmable Formats. Uses 6845 CRT Controller.
- ★ ASCII keyboard parallel input interface. (6522)
- ★ Serial I/O (6551) for RS232C or 20 MA loop.
- ★ Centronics compatible parallel printer interface. (6522)
- ★ Buss expansion interface with DMA channel. (6844)
- ★ Dual timer for real time clock application.
- ★ Powerful on board system monitor (2732). Features commands such as Go To, Alter, Fill, Move, Display, or Test Memory. Also Read and Write Sectors. Boot Normal, Unknown, and General Flex™.

PC BOARD IS DOUBLE SIDED, PLATED THRU SOLDER MASKED, 11 x 11-1/2 IN.

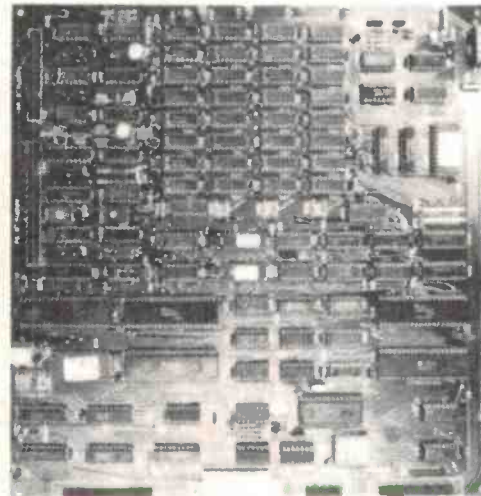

BLANK PC BOARD \$199.95 + tax WITH PAL'S, AND TWO EPROMS.

FOR 5-1/4 OR 8 INCH SOURCE DISKETTE ADD \$25 + tax

\$599.00 incl tax COMPLETE KIT! FULLY SOCKETED.

ALL OPTIONS ARE STANDARD. NO EXTRAS TO BUY!

**PLEASE ALLOW 4 WEEKS FOR DELIVERY**

**YOUR CHOICE OF POPULAR DISK OPERATING SYSTEMS:**

FLEX™ from TSC ..... \$209  
 OS9™ from Microware ..... \$289

Specify 5-1/4 or 8 inch



## PARABOLIC MICROPHONE \$15



EA NOVEMBER '83

Build a low cost parabola, along with a high gain headphone amplifier to help when listening to those natural activities such as babbling brooks, singing birds or perhaps even more sinister noises. The current cost of components for this project is around \$15 including sales tax, but not the cost of batteries or headphones.



## TV PATTERN GENERATOR \$25

Make sure your TV is up to the mark with this low cost Pattern Generator which uses just seven ICs and gives three patterns: Dot, crosshatch and blank raster. The current cost of parts for this project is approximately \$25 which includes sales tax but not the cost of a modulator or 9V mains plugpack.

EA NOVEMBER '83

**GREAT VALUE**



## ETI-268 NICAD FLOAT CHARGER \$9.00

ETI MARCH '83

Keep your NiCad batteries in tip-top condition with this cheap, simple charger.



## ETI-1512 ELECTRIC FENCE TESTER \$24.50

ETI FEB '83

No more checking the 'feel' of a fence with a blade of grass (and maybe ending on your ...). This project tells you how much your fence energiser delivers and can be used for fault-finding on a fence.



## ETI-1516 MODEL ENGINE IGNITION SYSTEM \$41.50

ETI JUNE '83

Get sure starts every time and no more glow plug burnouts on your model engines.

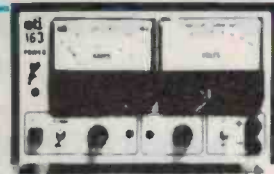

## ETI-163 LAB SUPPLY \$169

Fully variable 0-40V output, limited 0-5A supply current and current limiting range 0-0.5A/0-5V. Not a conventional series regulator, but a not a ... dissipation is reduced by a unique relay switching system switching between taps on the transformer secondary.

ETI MAY '83

**ON SPECIAL THIS MONTH**

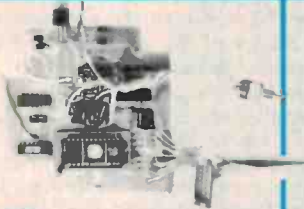

## ETI-668 MICROBEE EPROM PROGRAMMER \$47.50

Simple, low cost programmer for the MicroBee can program 2716s, 2732s and 2764s.

## ETI-153 TEMP PROBE \$19.95

ETI JUNE '83

Can measure temperature from -50°C to +150°C. It simply plugs into your multimeter—great for digital multimeters. Accuracy of 0.1°C resolution of 0.1°C.



## ETI-323 HEADLIGHT DELAY UNIT \$17.50

Park your car and turn off the lights. Can't see where you're going? Press the button and the headlights come on to light your way, switching off automatically after 50 seconds. This is a simple, easy to build, low cost project.

ETI MAY '83



## ETI-1515 DRILL/BLENDER SPEED CONTROLLER \$27.50

This project provides a full range of speed control for appliances having universal ac motors. Once the speed is set, the motor will maintain that speed from no-load to heavy-load. Great for drills, blenders, grinders, etc.

ETI APRIL '83



## ETI-162 30 V/1 A FULLY PROTECTED POWER SUPPLY \$47.50

The last power supply we did was the phenomenally popular ETI-131. This low cost supply features full protection, output variation from 0V to 30V and selectable current limit. Both voltage and current metering is provided.



## ETI-654 APPLE II ANALOGUE/DIGITAL INTERFACE \$159.00

ETI MARCH '83

This project will give your Apple a set of 8-bit digital inputs and outputs plus one analogue input and one analogue output. Applications include: driving a robot, recording science experiment results, etc. (digital only shown).



## ETI-688 BIPOLAR PROM PROGRAMMER \$47.50

ETI JUNE '83

Every digital workshop should have one! Can be used to program the popular fusible-link PROMs like the 74S188 288 82S23 and 82S123 etc.



## ETI-461 GENERAL PURPOSE BALANCED INPUT PREAMP \$20.00

ETI DEC '83

This project can be used as a balanced mic amp, with low impedance input a low or high impedance input differential amplifier or a balanced input instrumentation amplifier.



## ETI-164 ZENER TESTER \$9.50

ETI MAY '83

A simple, low cost add-on for your multimeter. This checks zeners and reads out the zener voltage directly on your multimeter. It can also check LEDs and ordinary diodes.



## ETI-334 AUTO TESTER \$17.00

ETI JAN '83

Just the thing to keep in the glovebox or toolkit to find those nasty electrical bugaboos that occur at awkward times. Simple to build, simple to use.



## ETI-335 PUSHBUTTON-PROGRAMMABLE WIPER CONTROLLER \$28.50

ETI MARCH '83

No more fiddling with knobs and not getting the delay between wipes that you want—this windscreen wiper controller is simply programmed with two pushbuttons to provide the wiping delay you need.



## ETI-733 RADIOTELETYPE CONVERTER FOR THE MICROBEE \$20.00

ETI APRIL '83

Have your computer print the latest news from the international shortwave news service. Just hook up this project between your shortwave receiver's audio output and the MicroBee's parallel port. A simple bit of software does the decoding. Can be hooked up to other computers too.



# Printers: All you ever wanted to know about printers, but were too afraid to ASCII

Jon Fairall

In the second of an occasional series of consumer articles for the electronics enthusiast, Jon Fairall looks at the printer market, what's happening, where its going and how to buy one.

THERE COMES a time in the life of every computer buff when he or she starts writing programs that won't fit onto a video screen. Troubleshooting is a nightmare of scrolling back and forth looking for the problem. Or maybe, you would dearly love to use your computer as a typewriter and send letters that people can actually read. Are you just a frustrated author who will never begin that great novel until you have a wordprocessor in the study?

If any or all of this applies to you, then you need a printer.

So, how to buy one? The problem is that printers are not simple machines. In their own way they are as complex as the computers that drive them. The market place is also complicated with brand-names and printer types competing for your attention in bewildering profusion. And of course, the bottom line is that there is also a bewildering array of prices.

The good news about the bottom line is that it dropped through the floor during 1983! Just one year ago a printer was an expensive add-on to the average home system. Now it is possible to buy a very rea-

sonable quality printer for the same order of price as the micro itself. Certainly, for less than \$1000 you can buy a printer that will give you quality indistinguishable from a high quality office typewriter. If your priorities are different you can have high quality colour graphics, or maybe briefcase portability and battery operation.

## A POTTED HISTORY

Printers as an add-on to the micro computer were developed in rough parallel with the micros themselves. During the 1960s they began to appear in increasing numbers. In 1968 the Shinshu Seiki Corporation in Japan began marketing the EP101, a small, light unit that was immediately successful with the home market. By 1975 Seiki was preparing to market a successor to the EP101 and, at the same time, were looking for a new name for their printer division. So the son of EP was produced by Epson, and no doubt a lot of money was made by all concerned.

Predictably, it wasn't long before someone else tried to muscle in on the act. The main competition came from the Shinwa Corporation. Shinwa's marketing strategy

has been to allow its distributors to put their own name on the printer, with the result that what at first sight appears to be a bewildering profusion of types turns out to be identical printers with slightly different control panels and very different prices! The Admate DP80, the CP80, the Fax80, the Amust 80DT are all identical machines boxed-up to look slightly different. Even the manuals are the same once you get past page one.

Whether this is fair to the consumer is a question we can put to one side, because whatever the morals of the situation might be, the results of the competition for the consumer have been breathtaking.

As you can see from the table on p.60, prices for all these printers are at rock bottom, even where there is a fair degree of variation in them. Even some of the proprietary labels are getting in on this act. Commodore's latest offering, the 1526, for instance, employs an identical printing mechanism to the xx-80 type machines but has customised buffering and interfacing inside to make it compatible with the Commodore computers and their software.

There have been other price pressures on the market as well. All these printers are dot matrix types (more about the different types later). But during the last year daisy-wheels have come on the market that sell for prices very close to that of the dot matrix types. So the dot matrix distributors have cut prices even further. There are also some

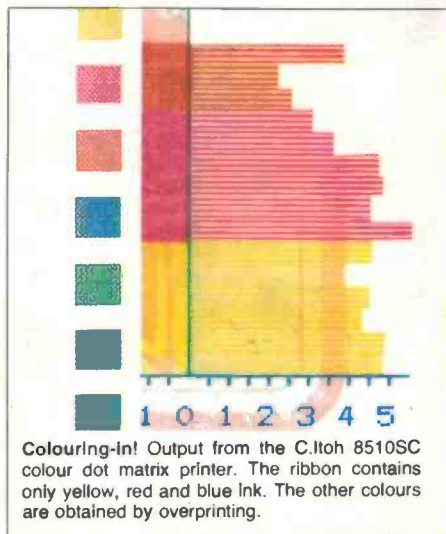

Colouring-in! Output from the C.Itoh 8510SC colour dot matrix printer. The ribbon contains only yellow, red and blue ink. The other colours are obtained by overprinting.

## COLOUR — THE WAY OF THE FUTURE

One of the most promising developments in the printer market is the development of colour printers. They add a whole new dimension to the use of printers for graphics. They have tremendous value in business applications because of their ability to put out colourful, and thus easily assimilated, graphs and diagrams. There is also an enormous market waiting for cheap colour machines, composed of people who just want to have fun with them at home.

At present the cheapest way of getting into colour is via printer/plotters. These suffer from the limitations mentioned in the main text, but they do offer impressive graphics capacity at a very reasonable price. Colour is obtained by using a number of pens, either stored on the side of the board, as in the Roland machines, or slotted into a rotatable drum as in the Toyo models. These pens are selected as required.

Another method, albeit considerably more expensive, is to adapt a Dot Matrix printer, as

C.Itoh have done. These machines, distributed by Warburton Frankl in Sydney, are standard Matrix printers except that they have a colour ribbon on their head. The carriage has been adapted so that it can move up and down under software control to bring the different colours under the needles. There are three colours on the ribbon: blue, red and yellow. A whole spectrum of colours can be created by overprinting each line. Printing a line first in yellow, then in red yields orange, for instance. As can be seen from the print sample from the C.Itoh 8510SC the method works surprisingly well, although there is a slight register problem. (Register refers to the ability of a multi-run printing system to overprint in exactly the right position).

The third alternative is the colour inkjet. This is a brand new development, so new in fact, that despite our best efforts we couldn't get hold of one for this survey. They are being distributed by Anderson Digital Electronics for around \$800 and promise breathtaking graphics capabilities. ADE expect to begin marketing later in the year.



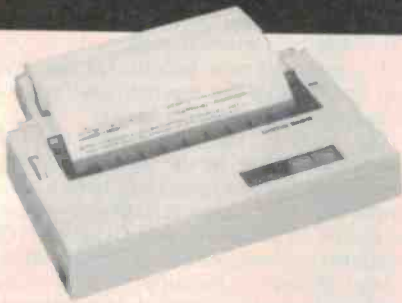

Brother HR-5. A tiny 303x175x65 mm ac/dc machine with thermal or dot matrix options.



Silver-Reid EXP 500. A solid daisywheel printer.

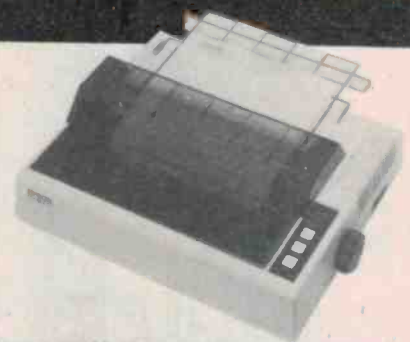

Epson RX 80. The baby of the Epson Range. It offers high quality design with respectable printing at a reasonable cost.



H-P Thinkjet. It comes in a little square box that hides some really advanced features.



EP-44. A revolutionary typewriter from Brother with a display that shows the last 15 characters as they are typed. It also has a Centronics socket on the side so it functions as a printer. The keyboard would not please a professional typist but it is excellent for a 'peek and poke' merchant. Print quality is disappointing given the other advanced features.

Figure 1. A daisywheel printing system. The hammer is immediately in front of the arrow. The daisy itself is clearly visible in its perspex tray.



new technologies appearing on the market that have significant advantages in terms of noise and speed. One of these is the inkjet, which Hewlett Packard has just introduced.

The net result of all of this has been to squeeze the thermal printers, which used to be the cheapest, almost into non-existence. Now, it is possible to pick up small thermals for less than \$200. Admittedly, they are only small format machines, but they are quite adequate for program listings where only 40 columns are required.

## THE TYPES OF PRINTER

Broadly speaking, there are three types of printer available: those that make a mark with a solid hammer, called a font, those that do it by making a pattern of dots, called a matrix and printer/plotters, which use a pen to draw the letters.

### Daisywheels

Conventional typewriters fall into the first category, but the system of cranks and levers they usually employ is far too slow and cumbersome for electronic control. The solution favoured for printers is called the *daisywheel* (See Figure 1). In this system a spoked wheel, called a 'daisy', carries the pattern of each individual letter on the end of its spokes. Printing is enabled by rotating the wheel until the appropriate spoke is underneath the hammer. When the hammer fires it drives the spoke forward, thus putting the impression of the letter onto the paper via an inked ribbon.

The resulting printer is usually not particularly fast, and always very noisy, but it has the great advantage of producing beautiful type, as you will see from the print samples in the table. The shape of the printed character (i.e.: the font) can be changed by changing the daisywheel.

### Printer typewriters

A sub-group of the daisywheel printers is composed of the printer typewriters. Essentially these are daisywheel (or sometimes thermal) printers with a typewriter keyboard on them. They can be operated in either printer or typewriter mode at the flick of a switch. Generally there is a buffer between the typewriter and the printer, the contents of which can be viewed on a display contained on the machine.

### Matrix Printers

These printers can be subdivided into a number of categories. For a start, there are the dot matrix types. In these, there is a print head that travels up and down the platen. On the head is a column of small needles. To print, a needle is fired forward by an electromagnet. The needle hits an inked ribbon and squeezes it up against the paper, thus creating a tiny dot. The firing of the needles is controlled by a character generator chip in the printer, which, upon reception of the appropriate code from the

host computer generates the correct sequence of needle firings to put a recognisable character on the paper.

In virtually all dot matrix printers it is possible to override the functions of the character generator and control the firing of the needles individually from the host computer. This is known as graphics mode.

In the graphics mode the printer interprets the data being sent to it as a binary control code for the individual needles. Thus, if the printer receives 8F(hex), i.e.: 10001111, it will fire the first, fifth, sixth, seventh and eighth needles as it passes over the designated position. Using this mode it is possible to have total control over the appearance of the page. It can be used to produce whatever graphics you may wish, or a screen dump, in which the entire contents of the video screen are printed onto the paper.

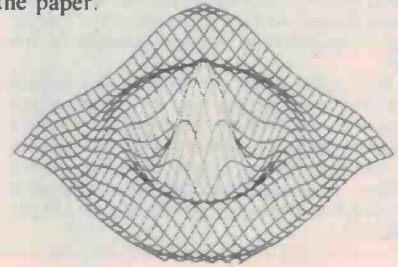

All a plot! Dot graphics example from the Dick Smith BX-80. Typical of the output from the Shinwa-type machines operating in the bit graphics mode. (Thanks to Peter Bauer from DSE Broadway.)

### Thermal Printers

A second type of matrix printer is the thermal type. Thermal printers utilise the heat sensitive qualities of specially treated paper. When a point on the paper is raised to a certain band of temperatures it will not burn, but discolours in a predictable fashion. A common type on the market for instance, turns black when exposed to a temperature of about 165 degrees C.

The thermal printer's head contains a vertical row of heating elements that travel very close to the paper as the head moves across the platen. When one of these elements is subject to a pulse of current it heats up, exposes the paper to its heat, and leaves behind a small dot. Thus, it functions exactly like the dot matrix type, except that, since there is no impact mechanism there is no noise.



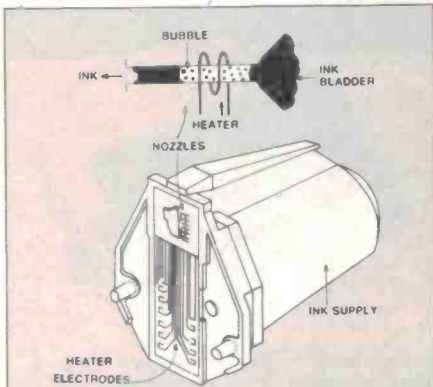

Fire! Ink cartridge from the H-P Thinkjet.

## INKJETS

The inkjet is the latest refinement in the story of dot matrix printers aimed at the home user. A number of the biggest companies, including Canon and H-P, are in the process of bringing them onto the market during 1984. They are claimed by their manufacturers to have significant advantages in terms of speed and noise over conventional dot matrix types of a similar price.

While details of Canon's version are still sketchy, the H-P version is available now. The inking system itself consists of a small cartridge that drops into a slot in the laterally moving head. The cartridge consists of a rubber bladder filled with ink, a heating mechanism and a column of 11 nozzles. Ink is drawn into the nozzle by capillary action. When required, the ink waiting in the nozzle is vapourised by a tiny heater wrapped around it. The vapourised ink forms a bubble which expands rapidly, driving a precisely controlled quantity of ink out of the nozzle, and onto the page. As the bubble collapses the nozzle refills with more ink from the bladder and is again ready for use. As the ink is used up the bladder collapses, providing constant pressure on the ink.

H-P claim some remarkable performance specifications from the machine, including 150 cps, and almost totally silent operation. Indeed speed is going to be one of the big selling points of inkjets as they try to take some share of the market. Canon claim that their inkjet will be able to complete printing of an A4 page in just six seconds.

## Inkjet types

A variation on this theme is the inkjet printer (see box). This is the most modern answer to the continuing quest for speed, silence and flexibility in printers. The first inkjet to be marketed in Australia for under \$1000 was launched earlier this year by Hewlett Packard as the 'Thinkjet'. Canon has one that should be available here by the end of the year, and small quantities of a colour model are already available from Anderson Digital for around \$800.

Even further down the track is the laser printer. Laser printers have been available to commercial users for quite a while, but Canon hope to be able to release a small unit for domestic use later on this year. It will be called the LBP-CX.

## Printer/plotters

The third major type of printer is the printer/plotter. Plotters are devices that are used for making line drawings under processor control. Printer/plotters are a development of this idea in which a character generator is fitted to the unit, making it possible to generate the full range of ASCII characters. As you can see from the print sample from the Toyo TP-40 sold by Dick Smith, the result is quite acceptable letter quality printing. In fact, watching the TP-40 in action is to watch servo motor control of very high order, as both the pen-head and the platen have to be moved together to create the characters. The only problem with this particular unit is its small size, which restricts its use in the text mode.

## INTERFACING

Interfacing, or connecting, your printer to your computer ought to be a matter of taking your printer home and plugging it in. Often it is, but as we found when doing this survey, in a surprising number of situations it is not that simple. One would expect that there would be a single standard to which all computers and all printers would conform. Such is not the case however. There are at least two major types of interface and a host of variations to them.

Even so, it should be possible to buy off-the-shelf interfaces to fit most situations. The Alphacom printers manage to do this with a series of neat little boxes that plug into the back of the machine and make it compatible with most computers.

The reasons for this state of affairs appear to be lost in the mists of history. Some manufacturers no doubt have a tradition of doing things in a certain way, and see no reason to change things. Others see the standards as limiting their ability to offer a greater diversity of functions. And of course there is always the question of commercial advantage.

But the situation is not one of complete anarchy. In general, there are two types of interface, either serial or parallel. With a parallel interface, data from the computer data bus is fed, via a buffer, to an output port. The buffer functions to prevent any peripheral device, like a printer, from loading the bus and so interfering with the normal housekeeping functions within the computer.

The buffer has eight output lines, plus a few control lines, which are connected via a ribbon cable to the input port of the printer. Beyond the input port there is another buffer which does a similar job for the printer.

A serial interface is a far more complex system all together. The buffer here also functions as a parallel to serial converter, i.e. it takes the parallel data from the bus and converts it into a string of bits which it sends down a line one at a time. The buffer must also generate stop and start pulses to allow the printer to recognise the beginning and end of each byte.

The parallel interfaces seem to offer the least trouble. The industry standard is called the Centronics interface, and it specifies a set of TTL logic conditions for the transmission of data from the host computer to its peripherals. Apart from the eight data signals which appear on pins two to six, there is also a strobe signal on pin 1 which indicates to the printer when it should read the data. There is an acknowledge signal on pin 10 and a busy signal on pin 11. Pin 16 contains the chassis ground, and pins 17 to 30 the logic ground. The remaining pins, up to number 36 are concerned with minor housekeeping matters.

The serial interface is by no means as simple. The industry standard is called the RS 232. The problem with it is that every manufacturer seems to have his own interpretation of RS 232. So voltage levels vary and the functions available on individual pins vary.

All is not lost however. Many of the minor problems that come up with RS 232 interfaces are well understood, and printer manufacturers offer the option of changing various parameters of the interface with the aid of DIP switches, usually located inside the print head compartment, or else on the back of the cabinet. To understand what these are, it is necessary to understand a little about the problems of transferring data in serial mode.

When you do things in the parallel mode, the one control signal that is really vital is the strobe, which tells the printer when the combination of bits on the input is valid. In



Interfacing. One solution to interfacing. The boxes contain an Intel 8049 processor programmed to carry out the conversion from the computer's protocols to something the printer can handle. The printer here is an Alphacom M1d1. (From Oscwell International.)



# When is 180 CPS faster than 200 CPS?

**W**hen you have this little beauty on hand. **Throughput speed** is what counts: C.Itoh's new low profile dot matrix printer is a high speed performer, prints out with a throughput of 100 LPM (draft mode with pica character).

You'd expect to lose visual quality? No way! C.Itoh's print resolution is sharp, defined, unbeatable — throughout the print head's 100 million-plus character life.

8510S is rugged, sturdy as it is fast, built to take the punishment with heavy duty castings and high quality metal parts throughout. Plastic parts are all high stress.

It's a colourful character: there's even a colour model which gives you up to seven colours, with high resolution graphics of 144 x 160 dots per square inch on all models.

And if you want to use all the features

of your IBM personal computer, C.Itoh has two special versions designed just for the IBM PC.

So make sure you ask the **throughput** of your new printer. And take a close look at C.Itoh. It answers all the questions.



*For further information contact your Warburton Franki Data Products office.*

## WARBURTON FRANKI

A DIVISION OF THE ANI CORPORATION LTD (INCORPORATED IN N.S.W.)

- ADELAIDE (08) 356-7333 • BRISBANE (07) 52-7255 • HOBART (002) 28-0321
- MELBOURNE (03) 699-4999 • PERTH (09) 277-7000 • SYDNEY (02) 648-1711
- AUCKLAND N.Z. (09) 50-4458 • WELLINGTON N.Z. (04) 69-3016





Name	Distributor	r.r.p	Measured speed (cps)	Measured loudness (dB)	Print matrix	max columns	comments	
<b>THERMAL PRINTERS</b>								
Alphacom Pony	Oswell	\$190	20	<20	7 x 5	40	ultra small and quiet printer	
Alphacom Middl	Oswell	\$290	32	33	7 x 6	80		
Brother HR5	Brother	\$299	27	<20	9 x 9	80	Available with a.c./d.c. supply	
Star sbx-80	Case Communications	\$358	22	<20	5 x 9	80		
<b>DOT MATRIX PRINTERS</b>								
Commodore MPS 801	Commodore	\$399	30	34	6 x 7	78	Only compatible with Commodore machines	@ABC
C.ltoh M8510S	Warburton-Frankl	\$1139	80	40	9 x 9	132	Colour version available	/012
Epson RX 80	Epson Australia	\$558	89	28	9 x 9	137	Wide version available	! "% & ' "
Star Gemini	Case Communications	\$39	33	35	9 x 9	136	Wide version available	! " # \$ %
WP 1100	NSA	\$559	34	36	9 x 11	80		! " # \$ %
<b>Shinwa Dot Matrix Types</b>								
Admate DP 80	Applied Technology	\$399	32	34	7 x 6	142		
Amust 80DT	SAE	\$299	"	"	"	"		
BX80	Dick Smith	399	"	"	"	"		
CP 80	Rod Irving	399	"	"	"	"		
1526	Commodore	\$499	"	"	"	"		
FAX 80	Electrical Equipment	\$414	"	"	"	"		
Special prices on these printers are readily available, especially from mail order houses. Shop around!								
<b>DAISYWHEELS</b>								
HR-15	Brother	\$849	23	33	N/A	165	Typewriter keyboard available	
Juki 6100	Rod Irving	\$995	10	34	N/A	220		
Silver Reid EXP 500	Pacesetter Peripherals	\$880	13	32	N/A	151		" # \$ %
Uchida	Electrical Equipment	\$660	10	31	N/A	180		! " # \$ %
<b>PRINTER/TYPEWRITERS</b>								
EP-44	Brother	\$399	—	<20	24 x 18	80	Thermal head	OR
<b>INKJET PRINTERS</b>								
HP 2225	Hewlett-Packard	\$795	—	<20	11 x 12	80		
<b>PRINTER/PLOTTERS</b>								
Toyo TP-40	Dick Smith	\$299	4	<20	N/A	80		GHJKL



40 PRINT#4,"\*\*\* NORMAL UPPER CASE";CHR

BIT-MAP GRAPHICS ALLOWS YOU TO PRINT 620 DOTS OVER THE 80 CHARACTER LINE

20 LPRINT CHR\$(27);"L";CHR\$(160);

!"#\$%&'()\*+,-./0123456789:;<=>?@ABCDEFGHIJKLMN~~OP~~QRSTUVWXYZ[\]^\_`abcdefghijklmno

HIJKLMN~~OP~~QRSTUVWXYZ[\]^\_`abcdefghijklmno

6789:;<=>?@ABCDEFGHIJKLMN~~OP~~QRSTUVWXYZ[\]^\_`abcdefghijklmnopqrstu

./0123456789:;<=>?@ABCDEFGHIJKLMN~~OP~~QRSTUVWXYZ[\]^\_`abcdefghijklmnopqrstu

()\*+,-./0123456789:;<=>?@ABCDEFGHIJKLMN~~OP~~QRSTUVWXYZ[\]^\_`abcdefghijklmno

()\*+,-./0123456789:;<=>?@ABCDEFGHIJKLMN~~OP~~QRSTUVWXYZ[!]"#\$%&'ijklmnop

'#\$%&'()\*+,-./0123456789:;<=>?@ABCDEFGHIJKLMN~~OP~~QRSTUVWXYZ[\]^\_`abcdefghijklmno

'#\$%&'()\*+,-./0123456789:;<=>?@ABCDEFGHIJKLMN~~OP~~QRSTUVWXYZ[\]^\_`abcdefghijklmno

'#\$%&'()\*+,-./0123456789:;<=>?@ABCDEFGHIJKLMN~~OP~~QRSTUVWXYZ[\]^\_`abcdefghijklmno

'#\$%&'()\*+,-./0123456789:;<=>?@ABCDEFGHIJKLMN~~OP~~QRSTUVWXYZ[\]^\_`abcdefghijklmno

%&'()\*+,-./0123456789:;<=>?@ABCDEFGHIJKLMN~~OP~~QRSTUVWXYZ[\]^\_`abcdefghijklmno

CDEFGHIJKLMN~~OP~~QRSTUVWXYZ[\]^\_`abcdefghijklmnopqrstu

!"#\$%&'()\*+,-./0123456789:;<=>?@ABCDEFGHIJKLMN~~OP~~QRSTUVWXYZ[\]^\_`abcdef

The Quick Brown Fox Jumped Over The Lazy Fat Lazy Dog.

,./0123456789:;<=>?@ABCDEFGHIJKLMN~~OP~~QRSTUVWXYZ[\]^\_`abcdefghijklmnopqrs

+./0123456789:;<=>?@ABCDEFGHIJKLMN~~OP~~QRSTUVWXYZ[!]"#\$%&'\_°abcdefghijklmnopqrs

way to test this is to type into it the words that one would normally use

These dot matrix utility printers use HP's disposable ink jet printhead

BNMqwertyu wertyu ioplkjhgfdsaz gfdasazxcvbnmSQWERTY QWERTYUIOPASDFGHJKL



TAKE 10% OFF ALL THESE TOOL PRICES FOR THIS MONTH

## JUMPER LEADS

Set of 10 Jumper leads approx 450mm long. High quality.



W12000

\$4.95

## TWEEZERS



Needle Nose T12375 1-9 10+  
\$1.20 .90



Duck Bill T12377 1-9 10+  
\$1.20 .90

## OFFSET SCREWDRIVER

Flat blade one end with Phillips at the other. Ideal for those hard to get at screws.



T12121



\$2.95

## Sheetmetal Bender

T12400

How often have you wished that you could afford a Pan Brake Bender. Well this unit is a close second for your workshop. Your own chassis, boxes, brackets, are all possible with the unique slotted clamping bar that allows complex corner bends.

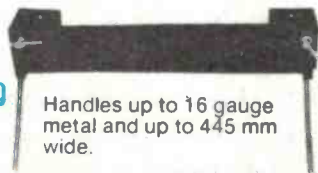

\$79.50

Handles up to 16 gauge metal and up to 445 mm wide.

## Jewellers Screwdriver

T12200

\$4.95



## Wire Stripper

T11520

\$9.95



## Tapered Reamer

T12370

Great for enlarging holes that are a bit too small. Enlarges from 5-20mm.

\$6.95



## Needle File Set

T12350

An indispensable part of your tool kit designed especially for electronic work or areas where a precise finished job is needed. Lasts for years.

This set contains 5 files; Flat, Half Round, Triangular, Square, and Round.

\$9.95



## Alignment Screwdriver

T11401

T11402

\$1.50

100mm Shaft 200mm Shaft

Spring steel tip plastic shaft is absolutely essential for alignment work around E.H.T. or other high voltages.



## Chassis Punch

T12360

Absolutely essential for an enthusiast, prototyping technician or serviceman. Cuts holes in metal up to 16 gauge or 1.6mm. Essential for building kits. Punch Sizes: 16mm, 18mm, 20mm, 25mm, 30mm.

\$18.95

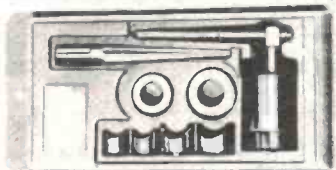

## Allen Keys Set

T11410

\$2.50



## Neon Test Screwdriver

T12222

Neon lights up to tell you if voltages are present over 90 volts (AC DC) essential for people working on mains circuits who know how a power point or extension cord is wired.

\$1.50

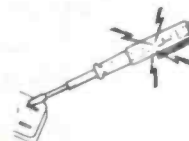

## 6000 RPM Mini Drill 12V DC (Drill Bits)

MINI DRILL T12302

.6mm T12319  
.8mm T12320  
.9mm T12324  
1.0mm T12325

\$14.95



ALL \$1.50

12V DC operated great for PC work 1.2mm check capacity. Comes complete with 1mm Drill Bit.

## Pearl Catch

T12380

Dropped something in an odd spot? This Pearl Catch is what you need to get it out. Great for picking up small screws, pins, nuts, washers, resistors, etc. Also can be used for holding items in place.

\$3.95



## Alignment Tool Set

T11400

Ever tried to adjust an IF can or coil using the wrong sort of tool or filed down knitting needles then breaking the slug. This set of tools will pay for themselves many times over, both in time and stopping you obtaining ulcers.

\$3.95



## Pin Vice

T12352

It's infuriating when all you need to do is drill one hole a little bit bigger and haven't got a drill that fits in your tool box. Buy one of these for drilling circuit boards, will hold drill bits, taps, files, etc. up to 3mm.

\$7.95

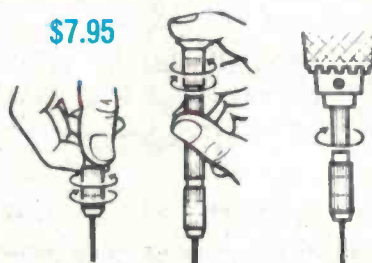

## Hand Nibbler

T12355

Easily operated hand NIBBLER cuts any shape hole in sheet steel—aluminum—copper—or plastic. Metal remains flat and straight after cutting. Does not add strain or distortion to edges. Cuts holes in preformed sheet metal (air-ducts, chassis, etc.) without distorting original form. Cuts in all directions.

Any design—angle—radius. Follows scribe lines easily. Best possible tool for cutting template and model parts from thin metal.

Capacity Steel .6mm  
Aluminium 1.5mm

\$16.95

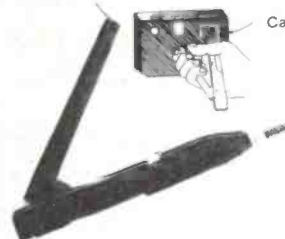

## HEAT STOPPERS

A set of straight and bent spring loaded clamps

T12440

\$3.50

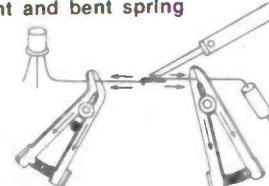



# OFF ALL TOOL PRICES — SAVE! SAVE! SAVE!

SAVE 10% SAVE 10% SAVE 10% SAVE 10% SAVE 10% SAVE 10%

## HEAVY DUTY DIAGONAL CUTTERS AND WIRE STRIPPERS

**\$7.95**

T12035



Jaws line up perfectly and will not twist or distort through use. The sharp cutting edges have two small holes. One is 1.2mm (0.05") and the other is 1.6mm (0.06").  
Finish: Chrome plated with plastic insulated handles.

## MICRO LONG NOSE CUTTING PLIER

**\$8.95**

T12060

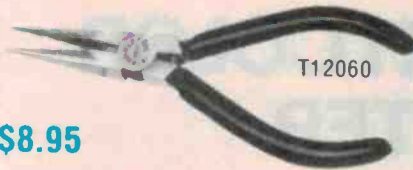

Very fine point for delicate work in very confined areas.  
Size: 125mm (5")  
Finish: Polished head with plastic insulated handle with spring.

## TRANSISTOR NIPPER

T12070

**\$7.95**



Specially designed for cutting copper wire in small gauge and for delicate and intricate high precision works in electronics. The width of joint portion is 3/8" (10mm). Confidently recommended for assembling and repairing transistor radios, TV, Printed Circuit Boards, etc.  
Finish: Polished head with plastic insulated handles.

## MICRO NIPPER

115mm

For delicate and intricate high precision electronic works.  
Polished head with insulated handle.

T12050

**\$9.95**



## FLAT NOSE PLIER

T12001

**\$7.95**



Tip top of jaws are slender and flat. For repairing precise instruments, measurement apparatus, etc.  
Finish: Plastic insulated handles.  
Size: 115mm (4 1/2"), Polished head. (A) 0.9 x (B) 0.8mm

## HEAVY DUTY SIDE CUTTING PLIERS

T12045

**\$16.95**

25mm JAWS  
150mm LENGTH



## MICRO ROUND NOSE PLIERS

115mm IN LENGTH

Smooth jaws are round and tapered to a fine point (1.5mm x 3.5mm).  
It can provide excellent precision work result.

T12075

**\$8.95**



## UNIVERSAL SOLDERING IRON STAND

T11302

1.9 \$5.95  
1.0+ \$4.95



## SOLDER

We carry a wide range of sizes and rolls of solder, as one size is not sufficient for every type of soldering job. (All are resin cored, Aust. made, 60/40 5 core solder.)

CAT NO	SIZE	ROLL WEIGHT	PRICE	
			1.9	10+
T31000	.71mm	250gm	\$8.95	\$7.95
T31002	.71mm	500gm	\$14.95	\$13.00
T31010	.91mm	250gm	\$7.95	\$6.95
T31012	.91mm	500gm	\$13.95	\$12.50
T31020	1.6mm	250gm	\$6.95	\$5.95
T31022	1.6mm	500gm	\$12.95	\$11.95

## MINIATURE SCREWDRIVERS

Unobtrusive keep one in your top pocket. Great for screw on items like record players (needles and cartridges)

T12100	PRICE	PRICE	
		1.9	10+
1.6mm x 55mm O/A LENGTH	.50	.40	
T12102 MINIATURE PHILIPS	.60	.50	

## STUBBY SCREWDRIVERS

83mm IN LENGTH

T12110 FLAT BLADE  
T12115 PHILIPS HEAD

PRICE  
1.9 10+  
1.40 1.20  
1.40 1.20



## PHILIPS SCREWDRIVERS

BLADE SIZE	BLADE LENGTH	OVERALL LENGTH	PRICE	
			1.9	10+
T12170 00	75mm	130mm	.60	.50
T12175 0	100mm	175mm	.90	.80
T12180 1	125mm	210mm	1.20	1.00
T12182 3	150mm	256mm	1.75	1.40

## MEDIUM DUTY FLAT BLADE (4.5mm BLADE)

T12140	PRICE	PRICE	
		1.9	10+
BLADE LENGTH 75mm	.70	.60	
T12145 BLADE LENGTH 150mm	.80	.60	

## HEAVY DUTY SCREWDRIVERS

T12150	PRICE	PRICE	
		1.9	10+
5.5mm BLADE	1.40	1.20	
T12155 6.0mm BLADE	1.65	1.40	
T12156 8.0mm BLADE	2.00	1.75	

## NARROW FLAT BLADE (2.6mm BLADE)

T12125 BLADE LENGTH 100mm  
T12130 BLADE LENGTH 20mm

PRICE  
1.9 10+  
.55 .50  
.65 .55



## FULLY ADJUSTABLE MAGNIFYING GLASS



Flexible arm magnifier best suited for your desk, bench or machine. Ground and polished 90mm glass lens in metal frame with ball joint and flexible arm, which can be angled in any direction.  
Length of flexible shaft: 190mm  
Power: 2.2X

T12085 **\$24.95**

## PRECISION SCISSORS

Made from stainless steel for delicate work and non-slip cutting.

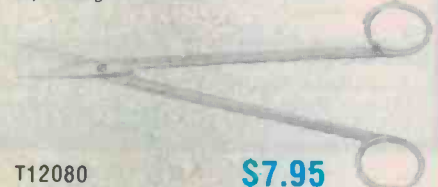

T12080 **\$7.95**

## SURGICAL TYPE CLAMP

All stainless steel made. Box joints for added durability. 125mm long. Has to position snap — lock. Excellent heat sink and clamp. Allows quick disconnect and reconnect for temporary connections.

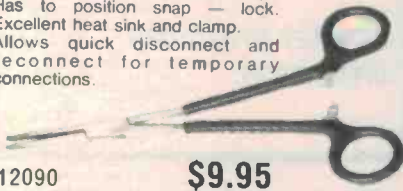

T12090 **\$9.95**

ROD IRVING ELECTRONICS, 425 High St, Northcote, Vic; 48-50 A'Beckett St, Melb, Vic. Phone (03) 489 8866, (03) 489 8131. Mail Order Hotline (03) 481 1436.

Mail Orders to P.O. Box 235, Northcote 3070, Vic. Minimum P&P \$3.00. Errors and omissions excepted.

Please address tax exempt, school, wholesale and dealer enquiries RITRONICS WHOLESALE, 1st Floor, 425 High St, Northcote 3070, (03) 489 7099, (03) 481 1923, Telex AA38897.



# 8 PEN MULTI COLOR PLOTTER

at an affordable price

**NEW**



## National A-3 Type Digital Plotter VP 6802A

### 1. MULTICOLOR HIGH SPEED PLOTTING

**EIGHT COLOR GRAPHICS AT 450mm/sec (18 inch/sec)**

The high plotting speed of 450mm/sec (18 inch/sec), the variety of pens (fibre, ball point, plastic tip) and colors allows great versatility in the creation of graphs.

### 2. SIMPLE PROGRAMMING A VARIETY OF INTELLIGENT FUNCTIONS

The high level of intelligence built into this Digital Plotter greatly simplifies the programming required to generate the complicated engineering drawings or business charts.

### 3. RELIABLE PAPER SECURITY

**ELECTROSTATIC PAPER HOLDING**

The highly reliable, electrostatic paper-holding method guarantees secure paper holding, which is applied by simple switch operation.



### 4. QUIET MOVEMENT AND SAFETY

**DESIGN CONSIDERATION ON MECHANICAL CONSTRUCTION AND SOFTWARE PLUS PROTECTIVE COVER**

The detachable plastic cover assures durability and safety while suppressing the movement noise substantially.

### 5. CONTINUOUS PLOTTING

**AUTOMATIC CHART ADVANCE "OPTION"**

By combining the automatic chart advance option, this plotter can function in a totally unattended mode. This makes it possible to build up fully automatic drawing system which does not need any human care.

### 6. COMPUTER INTERFACES

**THREE TYPES**

Eight bit parallel, RS-232-C and GP-IB interfaces are able with VP-6802A. The above interfaces allow the plotter to be used as a computer graphics device as well as an instrumentation graphics device.

## Scientific Devices Australia Pty. Ltd.

2 Jacks Road, South Oakleigh Vic. 3167 Phone: (03) 579 3622  
31 Halsey Road, Elizabeth East, S.A. 5112 Phone: (08) 255 6575  
559A Willoughby Road, Willoughby N.S.W. 2068 Phone: (02) 95 2064

# CICADA 300 Baud DATA MODEMS



- CICADA 300
- CICADA 300T with telephone
- CICADA 300 for use with Commodore 64 and Vic 20 computers



187 Allambie Road,  
Allambie Heights,  
NSW 2100.  
P.O. Box 184, Brookvale,  
NSW 2100.  
Telephone: (02) 451-5555  
Telex: AA22671

*Dealer enquires welcome.*



the serial mode this type of function is not necessary, but a number of other protocols are. For a start the printer must know how many bits constitute a word. This is usually a switch selectable function, with one side of the switch being seven, the other eight.

It must also know which of these bits to read as data. Many systems employ the first or least significant bit as a parity check, in which case it must not be read as part of the data. Parity checking is a system in which either the high or low signals are made to have either an even or odd number, depending on the system used. A system is said to have even parity if it requires that there be an even number of ones (or zeros) and odd parity if there should be an odd number.

Unfortunately, RS 232 does not specify the method of parity checking, and since, in fact, it is of very little use in small scale systems operating in low noise environments, many manufacturers have decided to do without parity checking altogether.

The result of all this is that there can be three dimensions for error to occur in parity checking. It can be that there is a mismatch in the type of parity, i.e: even instead of odd parity. There can be an error in terms of the logic level, i.e: high instead of low, and there may be a mismatch inasmuch as one or the other of the elements in the system may expect parity checking when none occurs.

Clearly it is necessary to specify the voltage level at which all of this occurs. The specification requires that Centronics all be

at TTL levels, i.e: 5 V, while the RS 232 should be held at plus or minus twelve volts, with plus or minus three volts being indeterminate. However this doesn't always happen. Sometimes this type of problem is introduced deliberately by a manufacturer in order to force the user to make the 'correct' purchase decision. Commodore is a case in point. Their computers have an RS 232 compatible output, but with voltage levels of 5 volts. There are no prizes at all for guessing who makes printers with 5 volt RS 232 inputs!

Another thing to bear in mind when checking for compatibility is the speed of data transmission. This is referred to as the baud rate and it must be the same for both machines. One baud equals one character per second. In general this is a switch selectable function with 300 baud and 1200 baud as the most common options on small systems.

If the manuals are available most of these problems can be sorted out in fairly short order, by either resetting the switches inside the printer or rewiring the cable that comes with it. If none of this will make the beast run, there are a number of things you can do. One is to go back where you bought the thing and say "help" in a very loud voice. Another is to read some of the articles that have appeared in ETI over the years on curing interface problems. Most of the common faults can be found in the article "Beating the RS 232 blues" (August 1982) or the article on the RS 232 troubleshooter that appeared in the following edition.

## PRINTERS

### WHICH IS BEST

As is often the case with surveys of this kind, it is impossible to give a unique answer to this question. The decision depends on individual needs and an assessment of the advantages and disadvantages of each type of machine. In our survey we assumed an absolute maximum limit of \$1000 in price, which should include most of the printers that would be used by the home or small business consumer. A brief look at the table and reading the above description of the different printers will show you at once that some types do some things better than others.

The first decision a prospective user must make is the prospective use. Do you want to be able to type office quality letters, do graphics, program listing or what? When you have thought about this a list of priorities will emerge that should allow you to start asking intelligent questions. If your primary requirement is for general document printing, for instance in a small office, then you will need a daisywheel, unless the slow throughput is a problem. If it is, then you may like to look at some of the more expensive dot matrix printers, or maybe some of the more exotic technologies, like the inkjets. These all put out quite presentable print but at considerably faster speeds. Dot matrix types are perfectly adequate for memos and inter-office correspondence.

## MPF-III

Apple IIe compatible

### EMTEK EX-80



Printer Bargain

\$290\*

- 80 characters/sec
- Dot matrix
- Bit image graphics
- Bi-directional
- Single sheet or continuous Tractor Feed
- Centronics parallel interface (serial interface optional)
- Graphics

#### Print Types

- † Enlarged
- † Italic
- † Compressed
- † Underlining
- † Double strike
- † Sub script
- † Superscript

### FULL RANGE OF COMPUTERS AND PERIPHERALS SAVE \$\$\$

### AGC HM-123



GREEN \$154\*

AMBER \$156\*

- 360° Swivel display
- Super high resolution
- Crisp 80 chr. display
- Non-reflective screen
- Resolution 1000 lines
- 22 MHz band width
- F.C.C Class B approved
- Attractive styling

## EMTEK-PC™

16 bit IBM compatible

### SAKATA SP 1000



\$399\*

For the office the Sakata SP-1000 offers 100 CPS speed as well as the features below to make your office application more efficient.

- Clearly formed dot matrix characters — 9-11 dots
- 12 variations of character printing within the same line including graphic printing
- Paper cutting edge 2cm from printing position
- Print-on fanfold, single sheet and roll paper
- Back feeding of paper
- Bi-directional printing
- Operator replaceable print head (no special tools required)
- Longer ribbon life (2.5 million characters)
- Centronics parallel and RS-232C Serial interfaces both included.



## EMONA COMPUTERS PTY LTD

"THE TECHNOLOGY HOUSE"

National Australia Bank Bldg,  
2nd Floor, 661 George St., Sydney, N.S.W.  
Ph: (02) 212 4815 or 212 3463 Tlx: 74500

ALSO AVAILABLE FROM:

NSW A.U.Z. Electronics, Merrylands, 637-6474  
G.E.D. Gladesville, 816-2211  
LST Computers, Crows Nest, 43-2771  
HiCom Unitronics, Caringbah, 524-7878

VIC Radio Parts Group 329 7888

Advanced Technology Computers, 233 9733

TAS George Harvey Electronics, Hobart, 34-2233

George Harvey Electronics, Launceston, 31-6533

SA International Communications Systems P/L 47 3688

ACT Electronic Components P/L 80 4654

QLD Ballec Systems 369 5400

Genuine dealer enquiries welcome.

(Add 20% to all prices if applicable)

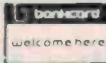

MICROPROCESSOR REG TRADEMARK OF MULTITECH INDUSTRIAL CORP  
APPLE Reg Trade Mark of APPLE Computers Inc  
Prices shown are for N.S.W. Additional transport charges may be involved for other states.

APPLE Reg Trade Mark of APPLE Computers Inc

CP/M Reg Trade Mark of Digital Research Inc  
EMTEK: Reg'd Trademark of EMONA COMPUTERS P/L



## PRINTERS

Beware of taking the manufacturer's word for the speed at which various printers print. There are two measures that can be used here. One is the speed at which the printer actually prints the characters. The other is the speed at which it can put material through, i.e.: it includes the time taken for carriage return and line feeds. Manufacturers quote their speed in terms of characters per second (cps), and for the Shinwa type machines you will find quoted figures in the region of 80 cps quite common. If you look at our table you will find our measured figures are considerably slower. The difference is a measure of the difference between throughput and cps. The measured figures are not nearly as impressive as the quoted specifications, but since you are probably more interested in how long it will take to print a document *in toto* rather than how fast it will print the individual letters, the latter is probably a more valid measure.

On the other hand, you might be only marginally interested in print quality or speed. It may be that the biggest requirement you have is for troubleshooting programs that are too long to be adequately handled on a video terminal. In these circumstances a 40 column thermal is ideal, or maybe you would wish to stretch your pocket just a little and go for a Shinwa type

dot matrix printer. This is certainly a very popular choice, since it gives passable letter quality and very flexible graphics characteristics at a reasonable price.

If your primary requirement is graphics then printer/plotters must be a viable option. They possess the disadvantage of low flexibility in as much as they cannot be used with anything but the correct format paper. On the other hand, their graphics capacities are far in excess of anything available for comparable prices and they have colour capability.

### Paper handling

Another point worth considering is the arrangements that have been made for paper handling. There are two main types: tractor feed and friction feed. Tractor feed uses the familiar computer paper with the sprocket holes down the side. These fit into sprocketed wheels that usually sit in a little assembly above and behind the unit. The advantage of tractor feed is that it is possible to buy the correct forms in long chains called fan-folded paper. Friction feed is the type that is used in typewriters in which the paper is squeezed between some rollers, and fed through in single sheets. 'Sheet feeders' are available that do away with the necessity of hand inserting paper sheet-by-sheet when printing out multiple copies of documents.

In general the friction feed is harder to operate than the tractor feed, but it is indispensable if you are writing letters and don't want to use computer paper. However,

tractor feed paper with 'clean tearing' perforations is available. Once the sheets are separated and the sprocket strips removed, its difficult to tell apart from ordinary paper sheets.

Whichever way you go, the paper requirements are just one of a number of on-going costs you need to be aware of. There is the cost of ink, for instance. A wide variety of inking systems are used in printers. The IBM type, in which the ribbon is packaged in a non-reusable cartridge, is one of the most common. There are countless variations on this theme, and very little standardisation, so every time you need a replacement you will need to go back to the original distributor. Some of the machines we looked at used old-fashioned typewriter ribbons, which get away from these problems, but only at the cost of your ink-stained fingers. You can do away with ink altogether, of course, and go thermal, but then you must pay for the special paper.

In the longer run there are more significant expenses. Thermal print heads, for instance, suffer from the stresses inherent in any system that involves an operating pattern of rapid heating and cooling. The needles in dot matrix heads are another problem area. Under stressful operating conditions they can seize up inside their shafts. These are expensive conditions you can expect every five years or so.

When you buy a product as complex as a printer, it is advisable to give some thought to peripheral areas such as the operating manual and after-sales service. The manuals

**Now there's a printer to match almost every home or business computer.**

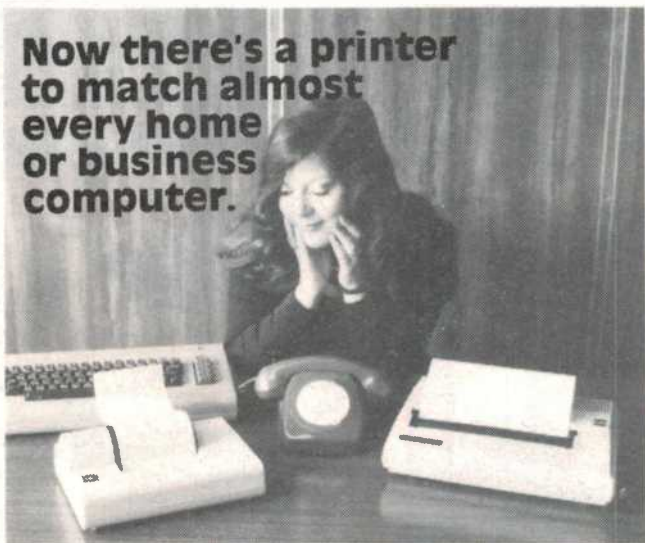

Introducing the PONY (40 characters per line) and the MIDDY (80 characters per line) Dot Matrix Thermal printers. Fast, reliable, efficient. Easy to use & install. Both compatible with Commodore & Atari computers via appropriate interface. Own a professional printer at a realistic price.

PONY printer \$226.80 incl. compatible Commodore or Atari interface. MIDDY printer \$333.60 incl. compatible Commodore or Atari interface.

Send now for brochure and mail order form. 30 day money back guarantee. 3 month warranty. Order before August 31st for free delivery anywhere in Australia.

Available direct or through your local computer dealer

**OSWELL**

Trade enquiries welcome.

Oswell International Australia Pty Ltd, P.O. Box 443 Gladesville NSW 2111

Commodore 64 & VIC 20 are registered trade marks of Commodore Business Machines Inc. USA

Atari is a registered trade mark of Warner Communications USA



'M' series.  
One of the most extensive ranges of toggle and pushbutton switches available in the world. UL/CSA approved.

STC Cannon Components Pty Ltd .  
VICTORIA  
248 Wickham Rd Moorabbin 3189  
Phone (03)5559566 Telex AA30877  
NEW SOUTH WALES  
605 Gardeners Rd Mascot 2020  
Phone (02)6931666 Telex AA26304  
WESTERN AUSTRALIA  
396 Scarborough Beach Rd  
Osborne Park 6017  
Phone (09)4440211 Telex AA93748  
SOUTH AUSTRALIA  
68 Humphries Tce Kilkenny 5009  
Phone (08)2687088 Telex AA88095

Time to switch!



'E' series.  
Compact, economical range of toggle and pushbutton switches. UL approved.

QUEENSLAND  
Gabba Towers 411 Vulture St  
Woolloongabba 4102  
Phone (07)3930377 Telex AA43025

**STC Cannon Components Pty. Ltd.**  
An Australian Company of **ITT**



# at the leading edge

**FLOPPY DRIVE  
UPDATE**

## **U.S. FLOPPY MANUFACTURERS SIGN 3¼" ACCORD**

**Micro Peripherals** Incorporated have signed with U.S. east coast start-up, **Tabor**, to manufacture their 3¼" **1 Megabyte** microfloppy, thus making them the third supporter of this standard.

Incidentally, the drive dimensions match those of the miniature **25 Megabyte** winchesters soon to be released by **Miniscribe**.

Disk manufacturers, **Dysan**, **3M** and **Brown Disk** are manufacturing the soft jacket media and claim considerable cost advantages over their rivals. The product is designated 320 series and will be in Australia in June, 1984.

## **CHINON SHIPPING 3½" FLOPPY DRIVES**

Not to be left out of the standards race, **Chinon** Industries, manufacturers of both 5¼" drives and the HMM standard 3" drives, are now volume producing a **250 KByte** single sided drive to take the **Sony 3½"** disk made popular by **Hewlett-Packard**, **Apple** and **ACT Apricot**. Unit prices will be around **\$170** plus tax.

Later this year **Chinon** will release their **1 Megabyte** version for sale to Australia. **Verbatim** have announced their manufacturing plans for 3½" media.

## **3.2 MEGABYTES ON A 5¼" DISK?**

"No Worries"! says **MPI**. Their **Model 1722**, recently released, packs **3.2 Megabytes** onto the new standard high capacity disk. Head alignment is done through a servo system which ensures high speed track access with excellent data retrieval quality.

Destined to become a universally accepted back-up medium for the new half height 5¼" winchesters from **Miniscribe**, the **1722** requires only three disks to off-load a full 10 Megabytes of data.

Priced at around \$500, the Model 1722 uses the same controller needed for 8" drives and is very competitive with tape back-up costing up to three times as much.

**daneva australia pty ltd**

66 Bay Rd. Sandringham, Vic. 3191  
P.O. Box 114, Sandringham, Vic. 3191  
Telephone 598-5622. Telex: AA34439

Sydney: E&M Electronics (02) 51-5880  
Adelaide: DC Electronics (08) 223-6946  
Brisbane: Baltec (07) 369-5900



**daneva**



we obtained with the printers were almost all poor. Some were just plain terrible. Many were written in Honda English of greater or lesser degrees of incomprehensibility. Those that we could understand seemed to assume that the user already knew how to operate the machine and that all that was necessary was a listing of a few commands. It is interesting to speculate how many people have bought printers and only use them to 1/10th their potential simply because they can't understand the manual. The outstanding exception is this depressing area was the Commodore manual, which gave a clear, concise explanation of how to operate the printer.

Since it is unlikely that this situation will change in the near future the relationship you develop with the supplier of your unit is important. It is a good idea to ask questions and to have a good idea of what you are doing before you leave the shop. In this context you might give some thought to the fact that some of the best deals around are from mail order places like Micro-Educational of Newcastle or SAE systems, who manage to do fantastic deals, particularly on the Shinwa machines, but whose after sale back-up is about as remote as their office. If you've an electronics or computing background and are prepared to do your own interfacing and servicing or maintenance, you can take advantage of great savings. If you're a computer neophyte, take the conservative route. It's the oldest story in the book: You pay yer money, and yer takes yer chance!

## Distributor List

1. Anderson Digital Equipment. 9 Pioneer Avenue, Thornleigh NSW 2120. (02)848-8533. Distributors of the soon-to-be-released colour Inkjet printers.
2. Applied Technology. 1A Patterson Ave, Waitara NSW 2077. (02)487-2711. Makers of the Microbee computer. They import the Admate DP-80 printer specifically for the Microbee.
3. Brother Industries. 49 Herbert Street, Artarmon NSW 2064. (02)439-7344. Brother produces a wide range of electrical goods, including sewing machines and some innovative printers.
4. Case Communications. 3 Rodborough Rd, Frenchs Forest NSW 2086. (02)451-6655. Distributors of Star printers in Australia.
5. Canon Australia. 37 Waterloo Rd, North Ryde NSW 2113. (02) 887-0166. Distributors of many electrical products including, in the near future, a low cost laser printer.
6. Commodore Australia. 5 Orion Road, Lane Cove NSW 2066. (02)427-4888. Distributes printers as peripherals to its other devices.
7. Dick Smith. P.O. Box 321, North Ryde NSW 2113. (02) 888-3200. Sells the Toyo TP-40 printer/plotter, the BX 80 and other printers.
8. Epson Australia. 17 Rodborough Rd, Frenchs Forest NSW 2086. (02)452-5222. Distributors of a wide range of printers for domestic and commercial users. Epson is the US subsidiary of Shinshu Seiki Corporation of Japan.
9. Electrical Equipment. 456 Kent St, Sydney 2000. (02) 290-2155. Distributes a Shinwa machine called the FAX 80 as well as daisywheels.

10. Hewlett-Packard Australia. 31 Joseph St, Blackburn Vic. 3130. (03)895-2895. Makes a large number of hard copy printout systems that can be readily interfaced to other brands.
11. Micro Educational. 17 Park Road, Garden Suburb Newcastle NSW 2288. (049)43-6805. A mail order company offering impressive discounts on some types of printers.
12. NSA. 200 Pacific Highway, Crows Nest NSW 2065. (02)923-1522. Distributors for Copal and Shinko printers, among others. NSA is part of the Hitachi group.
13. Oscwell International. P.O. Box 443, Gladesville. (02)816-3311. Distributor in Australia and New Zealand of Alphacom thermal printers.
14. Pacesetter Peripherals. 28 Chandos Streets, St Leonards NSW 2065. (02)439-4655. Distributors of Silver-Reid printers.
15. Polykit Electronics. 202 High Street, Northcote Vic. 3070. (03)481-7052. Distributors of the CP 80 and Juki 6100 printers. Retailers as Rod Irving Electronics and C-Tech.
16. Roland Corporation. 23 Cross Street, Brookvale NSW 2100. (02)938-3911. Makers of a wide range of printer/plotters for the domestic and commercial markets. Its DXY 101 and 800 models will be of particular interest to domestic consumers.
17. SAE Systems. P.O. Box 402, Zillmere Qld 4034. (07)263-4762. A mail order house offering particularly good deals on computer related gear.
18. Warburton Frankl. 199 Parramatta Road, Auburn NSW 2144. (02)648-1711. Distributors of C.Itoh printers.

Ian J. Truscotts

## ELECTRONICS WORLD

For all your  
Electronic  
needs

- KITS
- COMPONENTS
- TOOLS ETC.

Resellers of Dick  
Smith, Alltronics

Call in and browse around

Cnr. Bayswater & Eastfield Phone  
South Croydon 723 3860

COLOUR CRT  
PRICES SLASHED



\$486.00  
(51+)

KD1401 High Resolution RGB Monitor  
330mm (14") 0.31mm dot dia., P22 phosphor  
Separate RGB, H Sync (#), V Sync (#).  
18MHz Bandwidth, Resolution 720Hx240V, 70W

\$547.00 (1+)

KD1410 Medium Resolution similar to above  
with 0.64mm dot dia.

\$286.00 (1+)

\$254.00 (51+)

Contact us for attractive prices on  
peripherals and 68000/6502 EC's.

**energy  
CONTROL**

P.O. Box 6502, Goodna, QLD, 4300  
BRISBANE — AUSTRALIA  
Phone: 61-7-288 2455/288 2757  
Telex: AA43778 ENECON

DISTRIBUTORS FOR...  
Rockwell  
Synertek

**sinclair**

## ZX Spectrum PRINTER INTERFACES



Connect your Spectrum to a full sized printer with these quality interfaces from Tasman. Cable, plug and driving software included. Centronics (parallel) or RS-232 (serial) available to suit full facilities of most printers, including Amstruc, Brother, Epson, Star, Tandy colour, etc.

Parallel .....\$105.00  
Serial .....\$96.00

Tasword 2, professional word processor for the  
48K Spectrum .....\$42.00

Lots more hardware and software for Sinclair and  
Commodore. Send S.A.E. for catalogue.



Australian distributor  
**dolphin computers**

(02)438-4933. Tlx: 20677

Mail orders P & P \$5.00 Sydney, \$6.50 Australia.

★ Dealer enquiries welcome ★

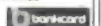



# Modems! Modems! Modems!

## Direct Connect Telecom Approved

If you need communications for your computer system. We design and manufacture the most complete range of modems available in Australia for all data communications needs. The following speeds and protocols are supported ex-stock:—

1. 300 bps Full Duplex asynchronous CCITT V.21
2. 1200 bps Full Duplex Synchronous and asynchronous CCITT V.22 and Bell 212A
3. 1200/75 bps Full and Half Duplex asynchronous CCITT V.23 and Bell 202

All modems approved for switched or leased lines. Custom configurations available. Latest digital technology employed in all modems.

For More Information Contact:

## WOOMERA ELECTRONICS P/L

P.O. Box 32 Camberwell  
(03) 82 1523 (03) 82 1694

# F.I.Diag.E

Formed in 1981 in recognition of the special knowledge and skills required by persons involved in fault diagnosis, plant management and maintenance engineering.

If you sort out troubles in machines, plant, systems, structures, jet engines, diesel engines, petrol engines, braking systems, transmission systems, boilers, cars, tractors, ships, coal mines, steel mills, gold mines, process plant, packing machinery, pumps, generating sets, turbines, oil rigs, computer systems, alarm systems, printing plant, chemical plant, etc . . .

You should become a **FELLOW (F.I.Diag.E)**

At the present admission is based solely on competence and capability without regard to age or academic attainments.

To obtain further particulars send a fully stamped and addressed envelope to:

**INSTITUTION OF  
DIAGNOSTIC ENGINEERS**  
3 WYCLIFFE STREET,  
LEICESTER. (5) ENGLAND. UK.

also  
P.O. Box 419, RINGWOOD,  
Victoria 3134 AUSTRALIA

## COMPUTER — MPF III

Apple IIe COMPATIBLE (NOT COPY!)



CPU's  
6502  
Z80

Built-in 64K RAM, 24K ROM, 80 COL. printer cards, 90 keys detachable w/edit & 1 key BASIC, comprehensive operation & progr. manuals. IDEAL FOR SCHOOLS, HOME & BUSINESS.

SALES TAX EXEMPTION AVAILABLE (All prices incl. tax)

MPF III 64K computer.	\$839
Dual Disk Drives MPF case	\$815
Z80 card, RS232 & D/D card	\$72 ea.
MPF III Joystick	\$30
Printer cable	\$17
AGC swivel base monitors, 22MHz non-reflect. screen amber	\$295 \$195
green	\$295 \$190



## DOT MATRIX PRINTERS

**SP1000** ~~\$395~~ \$480  
9 x 11 dots, 100 CPS, parallel and serial int/, frict./tractor, 12 char. variations, built-in Japanese & European char.

**EMTEK EX80** ~~\$450~~ \$348  
7 x 8 dots, 80 CPS, bi-dir., tract./friction, Italic, double strike, enlarge, underlined, superscript etc.  
PRINTER HEAD (for both) \$58  
Ribbon cartridge (2.5 million character) \$15

## MISCELLANEOUS

Virtual Disk Card — 192 K for APPLE II \$383.00

## ROBOT ARM

6 moving joints, max. load 500 gm, direct interface with MPF III or other computer printer output, command prog'm included. \$1878.00

## ALARM EQUIPMENTS

CONTROL PANELS (complete with keys, power supply & rech. battery)  
SUPER 4-SECTORS dialer output, membrane switches, 6Ah Batt. \$249  
2-SECTORS \$219  
SLIM LINE 2-SECTORS \$169

## PASSIVE INFRA-RED DETECTORS



PIR1000 50' x50' super sensitive, selected by Auth. for Public buildings. was \$145 \$119

SI8610 Dual lens 40x40' or 80x8' was \$105 \$169

SI8710 35' x35' zones was \$125 \$99

PHOTO BEAM DETECTOR \$89

PRESSURE MATS fr. \$10

HORNS 5W \$9.50 8W \$12.50;

15W \$13.50;

HORN COVER \$18 REED SW. from \$2.80

PLUS MANY OTHERS

## INSTRUMENTS OSCILLOSCOPES



(Dual Trace, latest models)

Meguro MI1252 35MHz,

1mv-10V/div.,

X-Y op., Z-axis mod. trig.

delay 1µs-100ms. \$899.00

MI1251 20MHz, 1mv-20V/div X-Y

& Z axis mod. test components

R, C, L & diodes. \$829.00

RADICAL MI1250 20MHz

1mv-5V/div., X5 mag.,

X-Y op., CHOP & TV, 3 sweep

mode 4 trig. source \$564.00

GOODWILL MI1245 (1 channel, 75mm CRT) 10MHz 5mv-5V/div. \$299.00



Transistor CURVE TRACER measure all spec. of any TR \$155.00

High Voltage Probe 40KV, 1000M ohms I/P imp. \$49.00

DIGITAL FREQUENCY COUNTERS

120MHz \$275; 550MHz \$468;

1GHz \$720

LOGIC PROBES \$19.50; \$27.00

DIGITAL MULTIMETERS;

DC REGULATED

POWER SUPPLIES UP TO 500VA

## SPECIAL COMPONENTS

6116P-4

32 channels remote cont'l IC's

SL480 \$7.80 SL490 \$8.50

SL486 \$8.50

ML926-9 \$8.00 each.

MN3001 BBD echo effect \$12.50

MEMORY SAVE BATTERIES (PCB Mount)

3.6V 110mAh \$8.90

2.4V 110mAh \$6.90

TOROIDAL TRANSFORMERS

full range,

dual sec. volt. 6-55V

up to 20A RMS full load

15-625VA fr. \$21.50 to \$110.50

## MEMBRANE KEYBOARDS



Keys	4	12	16
Keyboards	\$4.80	\$7.80	\$9.20
Face Plate	\$0.70	\$1.20	\$1.60
Overlay	\$0.70	\$1.20	\$1.60
Bezels (black)	\$2.70	\$3.30	\$3.90
Colour Patches	80c		
Letterset	\$3.50 per sheet		

MECHANICAL KEYBOARDS

12 keys \$9.00

16 keys \$9.80

AUTO ALARMS

HAWK 4-digit CAR ALARM \$69

AUTO TALKING ALARMS \$199

SIREN HORN \$25

ULTRASONIC \$190

TRADE ENQUIRIES WELCOME

## HICOM UNITRONICS INT. P/L

7 President Lane, Caringbah, NSW 2229. (Next to McDonalds)

Phone (02) 524-7878

BANKCARD WELCOME

## POST & PACKING

Under \$25	\$2.00
\$25-\$50	\$3.00
\$50-\$100	\$5.00
Over \$100	\$6.00
Heavy items	\$10.00



# MASSIVE PRICE BREAKTHROUGH! ELECTRONIC BELT DRIVE TURNTABLE BSR QUALITY

Jaycar has made a sensational purchase of Belt Drive Turntables - BELOW Manufacturers Cost!! Because of our buy we can pass them on to you at a MASSIVE SAVING.

The Turntables are made In England by B.S.R. They are unmounted and suitable for Disco Consoles, 3-in-1's etc. They are also ideal as replacements for existing 3-in-1 sets. (See specifications).

But there is an aspect that is really amazing! You can work the Turntable from 9-12V DC. This means that you can run the unit from a car or truck!! (The AA0292 model can of course run on 240V mains).

The Turntable features quality Belt Drive operation, lightweight Transcription type arm, Cueing facility and Stereo Ceramic cartridge with Diamond Stylus. The platter has calibration markings to check speed. A simple neon on 240V will "strobe" to the markings). Whilst the 33 & 45 rpm speed has been accurately set in the factory, you have the facility to make pitch adjustments underneath the turntable.

The DC Motor Drive (as used in the best turntables) is electronically controlled!

Each unit comes with complete instructions. Quantity limited! You will have to hurry to avoid disappointment.

## SPECIFICATIONS:

- ★ Dimensions 330(W) x 285(D) x 60(H)mm overall
- ★ Platter diameter 280mm
- ★ 2 speed - 33 & 45 rpm (Internally adjustable)
- ★ Pick-up arm, counterbalanced type with cueing facility
- ★ Pick-up ceramic (stereo) with diamond stylus
- ★ Turntable operation - auto stop, will return to rest automatically. Turntable chassis is sprung on all corners with transit screws & clips
- ★ Output stereo RCA sockets underneath unit
- ★ Weight 1.5kg

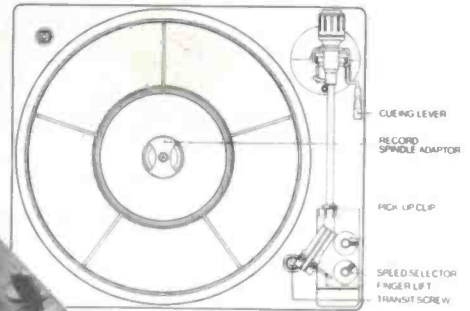

Check the price! Cat. AA-0290  
(Requires 9-12V DC @ 500mA)

**ONLY \$29.95**

240V version - (Includes 12V 500mA adaptor)

Cat. AA-0292 **ONLY \$39.95**

(Due to the weight of the unit post and packing is \$5 NOT \$4.50).

## CACOPHONY SALE!! MASSIVE SCOOP PURCHASE HUNDREDS OF APPLICATIONS FROM ONLY 75¢!!!!

Jaycar has bought the entire surplus stock of a coaxially mounted electric bell - as used in the Telecom 'Gondola' telephone! This unique bell is actually TWO bells - one mounted coaxially inside the other. The striker is mounted between the rims of the bells and is electromechanically driven. The unit runs on AC from about 17-48V.

The exciting part, however, is the price! We purchased the bells FAR BELOW MANUFACTURERS COST - so YOU REAP THE BENEFIT!!

Cat. LA-5270  
START YOUR OWN CACOPHONY!!  
1-9 \$1.50 ea: 10-24 \$1.25 ea:  
25-99 \$1.00 ea: 100+ 75¢ ea

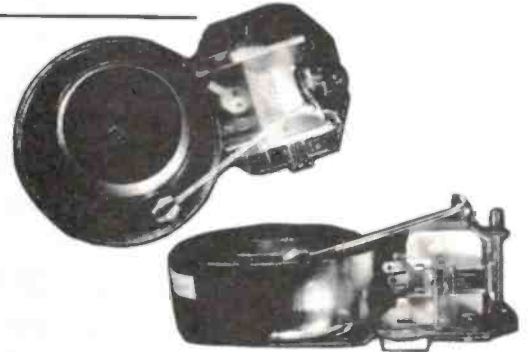

## NEW!!

### LARGE COLOUR LED DISPLAYS!

Jaycar is proud to announce a NEW range of 7 segment LED displays featuring LARGE digits and alternate colours!

#### NOTE THE LOW PRICES!!

Cat. No	DESCRIPTION	1-9	10+
ZD1870 0.4" (10mm) Com Anode Red		\$1.00	0.95
ZD1875 0.6" (15mm) Com Anode Red		\$2.50	\$2.25
ZD1880 0.6" (15mm) Com Cath Green		\$2.95	\$2.50
ZD1885 0.6" (15mm) Com Cath Yellow		\$2.95	\$2.50

All devices have connection data supplied.

## JEWELLER'S SCREWDRIVER SET BARGAIN!

A vinyl case containing 6 pieces of high quality plated Jewellers screwdrivers. AN ABSOLUTE MUST in every workshop.

GRAB ONE IN MAY AT A BARGAIN PRICE!  
NORMALLY \$3.95 - THIS MONTH \$2.95  
SAVE 25% - Cat. TH-2005



## USELESS LITTLE TRANSFORMERS

Help us get out of a dilemma! What are we going to do? we purchased the entire manufacturers stock of what is basically a transformer with fairly limited applications. It is small (measuring 25x19x18mm) and has a ferrite core. The primary has 1300 ohms (not centre tapped) and secondary 8 ohm impedance. We estimate that it could pass about 800mW before saturation.

WE HAVE 15,000 OF THEM!!!

So we have a dilemma!

You can have a BAG OF 10 FOR \$2.00  
You can have a BAG OF 50 FOR \$5.00  
You can have a BAG OF 100 FOR \$8.00  
You can have a BOX OF 1000 FOR \$50.00!!  
THAT'S AS LOW AS 5 CENTS EACH!!

Cat. MM-2540

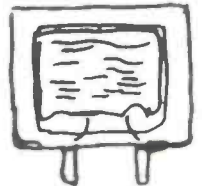

## 240V CASSETTE HEAD DEMAGNETISER

We have made a massive scoop purchase of this popular item. Normally \$8.50 each

**\$5.95 - SAVE \$2.55**

## "JET PHONE" ADAPTOR - NEW - IDEAL FOR AIR TRAVELLERS!!

How many times do you travel by air? If you are a regular traveller in economy, you will be undoubtedly familiar with the plastic 'pneumatic' type of stereo headphones. Well, we think that they are hopeless!

They are uncomfortable (in our opinion) and unless you get a good fit, the sound quality is poor. Wouldn't it be nice to be able to use your OWN high quality headphones in flight?

NOW YOU CAN!!

The Jaycar AA-2040 JET PHONE ADAPTOR plugs into the two air sockets on the armrest. You then plug your headphones into the adaptor for comfortable HI FI sound!!

BRILLIANT AND INEXPENSIVE!!

**ONLY \$8.95**



## NEW!! RESISTOR NETWORKS STAGGERING LOW PRICES

Jaycar has secured a massive scoop purchase of quality resistor networks at unbelievable prices!!

The networks are wired as per schematic illustration, and all values in each device are the same. As very few hobby circuits feature networks at the moment, we feel that this product will only appeal to the service and OEM industry. If you are a user of resistor networks, send us a note and we will send you a specific list of stock with prices.

(We have probably the largest stocks and range in Australia). In the meantime we offer a "service pack" of networks at a bargain basement price. Each pack contains 50 assorted networks (Single in-line packaged) in resistor values ranging from 680R to 1 Meg. (At least two of each network).

COST OF THE PACK?

**ONLY \$10!!**

Cat. RR-3380

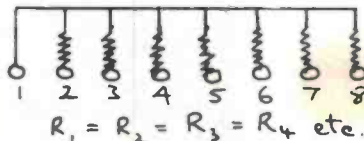

## ASK FOR A NEW CATALOGUE!!

Mail Order customers, if you have not seen our new catalogue, boy are you missing out! If, (or when) you next buy from us by mail order just ask for a catalogue. It will be sent FREE with your order!! you have one and want one for a friend, that's fine too! Just ask!



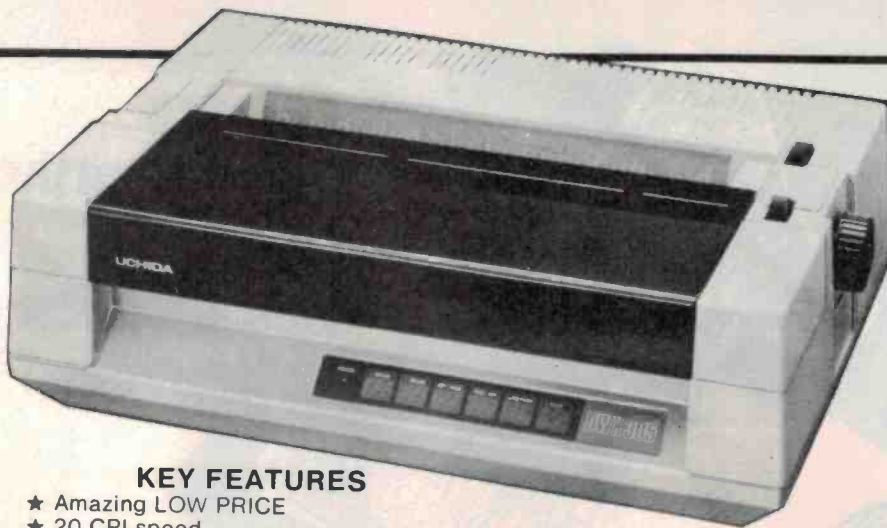

### KEY FEATURES

- ★ Amazing LOW PRICE
  - ★ 20 CPI speed
  - ★ QUME Daisy Wheel Compatibility
  - ★ Word Processor standard character set
  - ★ Special technology to prevent "prism notch"
  - ★ Centronics standard interface
- GRAB ONE NOW WHILE THEY LAST!**  
**THEY COMPARE WITH \$2000 PRINTERS**  
**BUT ONLY COST A FRACTION - HURRY!**  
 Cat. XP-4620

## DAISY WHEEL SENSATION!!

Unbelievable price break-through for a letter-quality PRINTER!!

**ONLY ~~\$699~~ NOW \$599 SAVE \$100**

## MICROBEE SOFTWARE SELLOUT!!

If you missed out on our 1st software Sale last month, then here's your second chance. Save around 35% off our normal prices. Once again, if buying by mail order, please specify 2nd and 3rd alternatives so that you can avoid disappointment.

**QUANTITIES ARE STRICTLY LIMITED**

Cat. No.	Description	Was	Sale Price
XS-7001	Mytek BEEZ80	\$22.00	\$14.50
XS-7006	Mytek TRS BEE	\$32.50	\$21.00
XS-7007	Mytek MUSIC B	\$22.00	\$14.50
XS-7012	Mytek BACKGAMMON	\$18.50	\$13.00
XS-7017	Mytek DEBUG	\$18.50	\$13.00
XS-7018	Mytek COMPOSER BEE	\$22.00	\$14.50
XS-7009	Mytek METEOR RESCUE	\$18.50	\$13.00
XS-7016	Mytek TAPE DOCTOR	\$18.50	\$13.00
XS-7513	Learning Can Be Fun 1A	\$14.95	\$ 9.95
XS-7514	Learning Can Be Fun 1B	\$14.95	\$ 9.95
XS-7515	Learning Can Be Fun 1C	\$14.95	\$ 9.95
XS-7516	Learning Can Be Fun 2A	\$14.95	\$ 9.95
XS-7511	Learning Can Be Fun 2B	\$14.95	\$ 9.95
XS-7512	Learning Can Be Fun 2C	\$14.95	\$ 9.95
XS-7531	Keplers Laws	\$14.95	\$ 9.95
XS-7537	Word Adventure	\$14.95	\$ 9.95
XS-7544	Geo Tech Drawing 1 & 2	\$14.95	\$ 9.95
XS-7548	Survivor	\$14.95	\$ 9.95
XS-8611	Extended Turtle	\$29.50	\$18.50
XS-8750	Multiplication Tables	\$12.95	\$ 7.50
XS-8751	Fractions	\$18.95	\$11.95
XS-8752	Teachers Master	\$24.50	\$14.50
XS-8753	Number Hangman	\$15.95	\$ 8.50
XS-8754	Algebra 1	\$15.95	\$ 8.50
XS-8755	Measurement	\$15.95	\$ 8.50
XS-8201	Psychotec	\$15.95	\$ 8.50
XS-8402	Penetrator	\$19.95	\$13.50
XS-7540	Reels	\$14.95	\$ 9.95
XS-7543	Wonder Words	\$14.95	\$ 9.95
XS-7547	Sketch Pad	\$19.95	\$11.50
XS-8204	Duo One	\$15.95	\$10.00
XS-8403	Mine Drop	\$15.95	\$10.00
XR-6560	Mytek Word Processor Tape	\$37.00	\$21.50
XR-6565	Mytek Word Processor 1 ROM	\$42.00	\$29.50
XR-6570	Mytek Word Processor 2 ROM	\$42.00	\$29.50
XA-5570	MicroBee Carry Case	\$12.50	\$ 7.50

### ASK FOR A NEW CATALOGUE!!

Mail Order customers. If you have not seen our new catalogue, boy are you missing out! If, (or when) you next buy from us by mail order just ask for a catalogue. It will be sent FREE with your order! If you have one and want one for a friend, that's fine too! Just ask!



# Jaycar ELECTRONICS

Incorporating  
**ELECTRONIC AGENCIES**

**NUMBER 1 FOR KITS**

**SHOWROOMS**

**SYDNEY**

117 YORK STREET

Tel: (02) 264 6688 & (02) 267 1614

Telex: 72293

**CARLINGFORD**

Cnr. CARLINGFORD & PENNANT HILLS ROAD

Tel: (02) 872 4444

**CONCORD**

115-117 PARRAMATTA ROAD

Tel: (02) 745 3077

**HURSTVILLE**

121 FOREST ROAD

Tel: (02) 570 7000

## MAIL ORDERS

& CORRESPONDENCE

P.O. BOX 185

CONCORD, 2137

Tel: (02) 745 3077

## POST & PACKING CHARGES

\$5 - \$9.99	\$1.50
\$10 - \$24.99	\$3.20
\$25 - \$49.99	\$4.50
\$50 - \$99.99	\$6.50
\$100 - \$198	\$8.00
Over \$199	\$10.00

**COMET ROAD FREIGHT ANYWHERE IN AUSTRALIA ONLY \$12.00**

## SHOP HOURS

CARLINGFORD, CONCORD & HURSTVILLE

Mon - Fri: 9 am - 5.30 pm

Sat: 9 am - 12 pm

Thurs Night: 8.30 pm (Not Concord)

## SHOP HOURS SYDNEY

Mon - Fri: 8.30 am - 5.30 pm

Sat: 8.30 am - 12 pm

Thurs Night: 8.30 pm

## MAIL ORDER BY

bankcard

**VIA YOUR PHONE**





**OVER  
1,000,000  
KITS SOLD  
MAKES US NO. 1**



**FUNWAY 3  
Bonus Pack**



**ONLY  
\$24<sup>90</sup>**

And what value!  
Buy this pack with two  
of the most popular  
kits in the Fun Way  
Three book . . . and we  
throw in the book FREE!

Yes, you get both the Electronic Cricket project plus the Miniature Amplifier project together valued at \$24.90, and as a bonus, the Fun Way Three book itself at no extra charge!

Fantastic gift idea . . . also makes ideal school project material. And this book gives details on how to really dress up your kits for top presentation . . . and top marks.

Whether you want to learn more about electronics, or just have fun building interesting circuits, you won't do better than Fun Way Into Electronics. And with Fun Way 3, you really move up into the electronics 'big time'. This fantastic bonus pack will get you started!

Cat K-2670

**Others  
promise it, only  
Dick Smith  
Electronics  
delivers.**

**Kit service  
second to none**

**Fluoro Starter**

**\$4<sup>50</sup>**



This substitute electronic starter solves the problem of lights going blink, blink, blinky blink and gives you a smooth rapid start EVERY time you switch on. And all the parts are housed in a starter case! Outlasts conventional starters by far!  
Cat K-3082

(Does not include starter case.)

**PLAYMASTER**

**Graphic Equaliser**

**\$129**



Get total control and flexibility with your sound system. With cut and boost of up to 13dB per channel you can make up for deficiencies in your listening area or sound source or even create special effects. Features professional quality brushed aluminium front panel.  
Cat K-3500

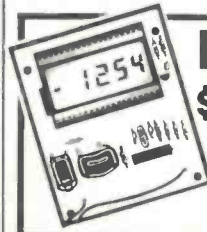

**LCD PANEL METER**

**\$29<sup>50</sup>**

A versatile accurate panel meter using a large liquid crystal display for low power consumption. The PC board design allows for maximum flexibility to cater for varied mounting arrangements. The low cost makes it ideally suited as a readout device on many projects, at both amateur and professional level. Cat K-3450

**Two Up**

**\$9<sup>95</sup>**

Australia's national game - now done electronically because King George pennies are hard to get!  
Cat K-2661



**MINI SYNTH**

Wow! A real musical synthesiser, with decay, frequency doubling & halving, tremolo. . . unique circuit uses you as the note generator!



**\$19<sup>95</sup>**

Cat K-2669

**Now 48 stores throughout Australasia**

**DICK SMITH ELECTRONICS**



See page for address details.



**PANEL DISCUSSIONS**

Due to the vast differences of perspective in PROLOG, its theoretical foundation in mathematics and logic, and its relative youth and lack of development, this article will have several panels like this one. The panels will illustrate points, compare implementations and list ramifications; in fact, anything that is not absolutely necessary in the text.

The intention is to do more than just teach and illustrate the language, but to convey the unique characteristics which are essential to writing the 'real' PROLOG.

The panels are for the reader who is not interested merely in an overview of the language, but who wishes to gain a deeper understanding of it.

The suggested approach to the PROLOG articles is this. Read the text through fairly swiftly, spending time on the examples and making sure you understand them. Look at the cat.1) panels as you come across them. They will give you some background to what you are about to read, while providing a respite from the onslaught of definitions and allowing time for them to sink in. Then, to learn the language thoroughly, reread the lot and do the exercises provided.

**HISTORICAL BACKGROUND**

Alain Colmerauer, of the Artificial Intelligence Group at the University of Marseilles, France, had been working on a system of rewriting rules to be used in the production of grammars for their English/French translation program. He then became more interested in the process of deduction in the context of the semantics of French. He collaborated on the definition of a programming language capable of expressing these deductive attributes of language.

The language is PROLOG, and it took off immediately in quite a few diverse applications, including robotics, speech recognition and symbolic differentiation and integration. Two other researchers immediately saw the potential for the language and became its pioneers. I am referring to David Warren at the University of Edinburgh, and Robert Kowalski at the University of London.

The appearance of the original PROLOG is a far cry from the syntax used here. Although this syntax is now fairly universal, there are a multitude of variations — as discussed in the panel 'Current Implementations'. The background extends through the mathematical axioms of predicate calculus and first order logic, the logic techniques of resolution theorem proving, and the assertion and proof emphases of modern software engineering discipline — as can be seen in the panel 'Not a Programming Language'.

The applications and implementations have exploded in scope and ambition. The language has taken Europe by storm, is well established in Australian tertiary institutions, and is now sweeping the United States. The teaching of the language has progressed from a mere alternative to LISP in Honours level Artificial Intelligence courses to the second computing language taught in various Australian computer science curricula. It has also become the introduction to computers in certain overseas primary schools.

# PROLOG

## — programming in logic

PROLOG is more like automatic programming, or program proving, than programming in the conventional sense. It expresses relationships and goals, rather than algorithms or procedures, and has applications in artificial intelligence, pattern recognition and data bases. This article introduces you to the standard syntax and semantics of PROLOG.

**David M. W. Powers**

Dept of Computer Science  
University of New South Wales

**FOR EXPERIENCED PROGRAMMERS**  
it may, in fact, take a lot of unlearning to learn PROLOG. The transfer from Fortran to Algol, or from BASIC to Pascal, does not involve as fundamentally great a change of perspective, or thought or style; in a sense PROLOG is more advanced than these earlier 'new directions' in computing.

For inexperienced programmers it is easy to learn and absorb the essential ideas of PROLOG. The transfer required is from your understanding of the goal as expressed in words, to the expression in a 'logical shorthand' of the relationships involved; PROLOG expresses relationships and goals, rather than algorithms and procedures.

PROLOG is not a programming language. It is more accurately a specification language, and the PROLOG system automatically seeks to find a solution meeting your specifications.

The simplest place to start with PROLOG is in the storage, representation and querying of a simple database.

**Facts — the unit clause**

Suppose we want to represent a simple library catalogue and show the author and publication date of various works. Let us say that each entry is to have three pieces of information — author, date and title — in this order. We can then represent a catalogue entry in PROLOG by: entry ("Charles Dickens", 1859, "A Tale of Two Cities").

The process of storing our catalogue goes something like this. ':' is the system prompt which is printed whenever PROLOG is expecting input. 'cat.1' is a label added to the printout to allow reference to the example in the text — it is 'catalogue example 1'.

```

: entry("Jonathan Swift", 1704, "A Tale of A Tub").
: entry("Jonathan Swift", 1726, "Gullivers Travels").
: entry("Daniel Defoe", 1719, "Robinson Crusoe").
: entry("Daniel Defoe", 1722, "Captain Singleton").
: entry("Charles Dickens", 1837, "The Pickwick Papers").
: entry("Charles Dickens", 1838, "Oliver Twist").
: entry("Charles Dickens", 1839, "Nicholas Nickleby").
: entry("Charles Dickens", 1841, "The Old Curiosity Shop").
: entry("Charles Dickens", 1843, "A Christmas Carol").
: entry("Charles Dickens", 1845, "The Cricket on the Hearth").
: entry("Charles Dickens", 1850, "David Copperfield").
: entry("Charles Dickens", 1859, "A Tale of Two Cities").
: entry("Charles Dickens", 1861, "Great Expectations").

```

**Not just another programming language**



# PROGRAMMING IN LOGIC

Each entry is a unit clause, or fact, consisting of a compound term whose principal functor is the atom 'entry'. The term has three arguments, that is, it has an arity of three. The first and third arguments are strings and the second is an integer.

The data structure of PROLOG is the term, and there are both simple and compound terms. A simple term is a constant; either an integer, an atom or a string. A compound term has a functor and arguments. Each argument is itself a term, while the functor is an atom.

The atoms are the building blocks from which PROLOG programs are made. They are usually just words. Strictly speaking, integers and strings are also atomic, but it is convenient to distinguish them.

PROLOG also has a third kind of term, the variable. Variable names are similar to atom names except that some convention is used to distinguish between them. The

usual convention is that variable names start with a capital letter while atoms start with a lower case letter. The remaining characters of the names may be any alphanumeric characters, i.e.: any digit, upper case or lower case letter.

However, there may also be a number of other allowable characters, such as underscore, '\_'. A string is any sequence of printable characters enclosed in matching quotes, single or double or either, according to your whim).

## Interrogation — the question

PROLOG's use of its variables makes it unique among computer languages. A PROLOG variable is bound rather than assigned to — and under certain circumstances it may be unbound and rebound. Consider the following questions and the system's responses:

```
cat.2)
?- entry("Charles Dickens", 1839, Title).
   % What did Dickens write in 1839?
   Title = "Nicholas Nickleby"
cat.3)
?- entry(Author, 1839, Title).
   % What books were written in 1839 and by whom?
   Author = "Charles Dickens"
   Title = "Nicholas Nickleby"
cat.4)
?- entry("Daniel Defoe", Date, Title).
   % What did Defoe write and when?
   Date = 1719
   Title = "Robinson Crusoe"
   Date = 1722
   Title = "Captain Singleton"
cat.5)
?- entry(Author, 1837, Title1), entry(Author, 1839, Title2).
   % Who wrote books in both 1837 and 1839 and what were they?
   Author = "Charles Dickens"
   Title2 = "Nicholas Nickleby"
   Title1 = "The Pickwick Papers"
cat.6)
?- entry("Charles Dickens", 1843, "A Christmas Carol").
   % Did Dickens in 1843 write "A Christmas Carol"?
   ** yes
cat.7)
?- entry(Author, 1739, Title).
   % What books were written in 1739 and by whom?
   ** no
```

Note that, apart from inside a string, an initial capital letter indicates a variable (and a comment is introduced by '%'). As you can see, every entry matched by a term of a question has resulted in a binding to the variables involved, and the system has automatically printed out each binding.

In example 'cat.4' there were two possible sets of bindings and both sets were printed. In the case of example 'cat.5', any set of variable bindings had to give rise to a match for both terms. Where no bindings were made to variables, the system simply answered the question with a yes/no response ('cat.6', 'cat.7').

An unbound variable is like a blank

mould ready to accept the imprint of whatever it is matched against. When the context of a variable is successfully matched, the variable will be bound to the term in the corresponding position. Thus a bound variable carries the stamp of its match, and has become indistinguishable from the original.

In processing a question, the system uses each term successively (from left to right) as a goal, seeking to match the goal against the clauses in the database. Due to the variables involved this is not just a case of matching character by character, but involves finding the appropriate substitutions (bindings) for the variables, so as to make the terms identical. This process of unification is nonethe-

less not much more complex than the straightforward exact match.

If the matching of a goal against a particular clause fails at some point, then any variables bound during the match must be unbound, and the search for a match will then continue with the following clause, if any. But if there are no more clauses, and no match has been found, the goal fails. However, if ever a match is found, the goal succeeds. In fact, if a number of matches exist they will all be found and the goal will succeed as many times.

Where the goal is the sole goal of a question, the effect will be that the bindings for each match are printed. Thus if a number of solutions exist (as with the third question presented above) PROLOG will find and print them all.

If more than one goal is specified (as in example 'cat.5') then all of them must be simultaneously satisfied by the one set of bindings, in order for a solution to exist. To achieve this, the later goals are attempted using each of the possible matches for the earlier goals. The backtracking algorithm which PROLOG uses to juggle all these bindings will be explained further in a later article.

## Proofs — the command

It will be observed that the goal looks like, and corresponds roughly with, a procedure call in a conventional programming language. There are, however, some big differences. The principal functor of a goal is known as a predicate. The term predicate comes over from first order logic, and a predicate differs from a procedure in that a predicate specifies a logical relationship which holds for the goal i.e.: upon which success is predicated. A procedure specifies an algorithmic method for achieving the goal i.e.: how to proceed.

For this reason PROLOG is more like automatic programming, or program proving, than programming in the conventional sense. In PROLOG the system's in-built algorithms are employed, in a deterministic manner, to achieve the goal state specified by the programmer e.g.: to prove the fact that an (unknown) author (or authors) wrote two (unknown) titles whose publication dates are known ('cat.5'). In the process, the unknowns are identified.

The question is but one of three related contexts in which a goal may appear. The second is the command, which differs from the question in that no automatic printing of variable bindings occurs, and in that only a single way of achieving the goal is found. A command simply succeeds or fails according to whether or not a proof is found.

Thus, if a command is employed any printing to be done has to be achieved through side-effects; the usual purpose of a command is to achieve particular side-effects. In addition, since it is seeking to establish the truth of the goals rather than to print a list of solutions, it will cease its



search as soon as it has found one set of satisfying variable bindings.

A number of special in-built predicates exist to provide input and output functions. Consider these commands and responses:

```
cat.8) :- entry("Daniel Defoe", Date, Title).
        % No output.
cat.9) :- entry("Daniel Defoe", Date, Title), nl,
        write(Title), nl.
        % Write one title only.
"Robinson Crusoe"
```

In example 'cat.9' the predicates 'nl' and 'write' are used to move to a new line and write out the term specified. Note that without these special predicates and their side-effects ('cat.8') no output is produced.

Employing them ('cat.9'), the first solution to be found has its title written out, but the other solution isn't found. This illustrates that the bindings achieved by the first goal mean that the variable 'Title' is indistinguishable from the string "Robinson Crusoe" when the system moves on to prove the subsequent goals.

### Implications — the non-unit clause

The question and the command are both directives. Together with the clause these comprise the sentences of the language. We have already met the unit clause (facts — see 'cat.1'), and we now meet the non-unit clause or implication.

```
cat.10) :- do :- entry("Daniel Defoe", Date, Title),
              nl, write(Title), nl.
cat.11) :- author(Title, Author) :- entry(Author,
              Date Title).
```

### NOT A PROGRAMMING LANGUAGE

Here are some of the factors which distinguish PROLOG from other computer languages:

- developed for language research
- developed out of theorem proving research
- encompasses automatic programming
- encompasses program proving
- non-algorithmic — declarative
- non-prescriptive — descriptive
- non-procedural — declarative/denotative
- allows easy documentation
- allows readable self-modifying programs
- allows customized/expansible database access formats
- has pedagogical advantages as a first computing language
- has potential for multiprocessing
- has potential for generalisation
- used for artificial intelligence applications
- used for pattern recognition applications
- used for database applications
- used for parsing applications
- used for expert systems
- used for symbolic algebra
- underlies Japanese fifth generation computer systems development

Many of these points will be expanded or exemplified more fully during this series of articles.

The ':' may be read as 'neck' or 'if'. The effect of the first of these clauses is to define the head goal 'do' in terms of the goals 'entry', 'write' and 'nl' which comprise the body of the clause. The effect is that the goal 'do' will succeed if the goals in the body all succeed. The command

```
cat.12) :- do.
"Robinson Crusoe"
```

is now equivalent to the command 'cat.9' shown earlier. What we are seeing here is a second way in which a goal can be achieved. Not only can a goal succeed by finding substitutions to make it match one of the facts (i.e. a unit clause), but it will also succeed by finding substitution to make it match the conclusion (the head) of an implication (a non-unit clause) if it, in addition, succeeds in satisfying all the conditions of the implication, i.e. all the goals in the body of the clause.

The second non-unit clause exemplified above ('cat.11') defines the predicate 'author' with the semantics

```
(the) author (of) Title (is) Author.
Hence the meaning of the entire clause is
'(me) author (of) Title (is) Author
if (there is)
(an) entry (for a work by) Author (at
some) Date (entitled) Title'.
```

Note the distinction between the atom 'author' and the variable 'Author'.

We can now use 'author' to find out who wrote "Oliver Twist":

```
cat.13) :- author("Oliver Twist", Author).
        % Who is the author of Oliver Twist?
        Author = "Charles Dickens"
```

Do you see what I have done here in defining the predicate 'author'? I find it a helpful mnemonic device to keep in mind a phrase describing the predicate such that the functor and argument roles appear in the chosen order.

Since the order can be chosen arbitrarily, failure to choose a sensible convention and use it consistently may result in you forgetting which way round the arguments are meant to go — or worse, yet, accidentally inverting them from time to time.

There are a couple more twists to this story. We can use our predicate 'author' backwards as well, to find out what books a given author has written:

```
cat.14) :- ?- author(Title, "Jonathan Swift").
        % What books is Swift the author of?
        Title = "A Tale of A Tub"
        Title = "Gullivers Travels"
```

In English we can also talk about who wrote something, as I did before, and of course we are really talking about who its author is. In PROLOG we can freely define new predicates in terms of any available predicates — whether they are defined as built-ins, facts or implications; whether they

The ghostly background. At left — LOG, at right — PRO(fessional)LOG!

### FAMILY TREES — examples

Here is a PROLOG example involving another database — a small family tree. Can you work out what is happening and why? Try to put the relationships into English so as to reflect the order of arguments.

```
fam.1)
        % The cast (by sex).
        % -----
        female("Susan").
        male("Richard").
        male("Michael").
        male("George").
        female("Helen").
        male("Anthony").
        female("Natalie").
        male("John").
        female("Elizabeth").
fam.2)
        % The relationships.
        % -----
        father("Susan", "George").
        father("Richard", "George").
        father("Michael", "George").
        mother("Susan", "Helen").
        mother("Richard", "Helen").
        mother("Michael", "Helen").
        father("George", "Anthony").
        mother("George", "Natalie").
        father("Helen", "John").
        mother("Helen", "Elizabeth").
fam.3)
        % Childhood rules.
        % -----
        child(Parent, Child) :- father(Child, Parent).
        child(Parent, Child) :- mother(Child, Parent).
        son(Parent, Child) :- male(Child), child(Parent,
        Child).
        daughter(Parent, Child) :- female(Child),
        child(Parent, Child).
fam.4)
        ?- son("George", Who).
        % Who is a son of George?
        Who = "Richard"
        Who = "Michael"
fam.5)
        ?- child(Who, "Susan").
        % Whose child is Susan?
        Who = "George"
        Who = "Helen"
```

are defined earlier or later; and even if they include the predicate currently being defined or extended. Hence we can store an implication to the effect that

```
'(the person who) wrote Title (is) Author'
if
'(the) author (of) Title (is) Author'
```

```
viz:
cat.15) :- wrote(Title, Author) :- author(Title,
        Author).
        % Whoever wrote Title is the author
        of Title
cat.16) :- ?- wrote("Oliver Twist", Author).
        % Who wrote Oliver Twist?
        Author = "Charles Dickens"
cat.17) :- :- wrote(Title, "Jonathan Swift").
        % What are the books Swift wrote?
        Title = "A Tale of A Tub"
        Title = "Gullivers Travels"
```



# PROGRAMMING IN LOGIC

## CURRENT IMPLEMENTATIONS

Since the original Marseilles interpreter, there have been quite a number of implementations of PROLOG produced. Although they appear to be heading towards some sort of standard syntax, close to that used here, there are significant differences.

Also one of the most recent PROLOG interpreters has departed quite radically from this syntax — this is Micro-PROLOG, the first implementation produced for personal computers. This system, from Logic Programming Associates Ltd, London, is available for Z80-based microcomputers and is becoming available for the 6502 and others shortly.

Other implementations have been produced in university research environments and are not readily available for personal computer users, although announcements of several other micro implementations are expected soon. The other systems that I know about in any detail are all based on DEC hardware, although the UNIX implementations should be easily portable to other systems.

Whereas the original Marseilles implementation was a direct takeover of notation from Resolution Theorem Proving, the common notation (as used in this article) is oriented towards user convenience and comprehension.

The Micro-PROLOG implementation uses an 'internal syntax' which is LISP-like and oriented towards the convenience of the implementor (simplifying the internal parsing). It also provides an English-like 'surface syntax' for the convenience of the novice computer user. This surface syntax is transparently converted into the 'internal syntax' by a PROLOG program which may be invoked by the user.

A fuller 'Comparison of Implementations' will be given in a later article. For now, no execution of PROLOG is necessary, but the examples and exercises should be worked through by hand. Suggestions about getting access to a PROLOG system will also be given later.

Now that we have been introduced to all the different types of sentence and we have seen quite a few examples, there is one essential point about variables that must be driven home. You will have noticed that in the examples I gave I have repeatedly made use of the same variables: 'Author', 'Title' and 'Date'. There has been no confusion because a variable is not, I repeat, *not* a particular location somewhere inside the computer's memory.

On the contrary, a variable name is significant only within a *single* sentence. The name of a variable is used to distinguish between different variables within the one sentence, to identify when any term to which the variable is bound must match in a number of contexts in the one sentence, and to label what is being printed in response to the one question.

Every sentence has its truth bound up only in the relationships expressed within it, whether fact, implication, or directive, irrespective of any usage of the same variable names elsewhere.

Thus the fact that two variable names are the same only means that the same variable binding is being referred to if and only if, when and only when, they occur in a single

usage of one and the same sentence. In fact, whenever a sentence is used in the search process, a fresh set of variables is employed.

This is important because, as we will discover in the next article, the one sentence can be used more than once in the course of executing a single directive or matching a single goal.

## Recapitulation — syntax and semantics

Let's just run over the types of sentence again quickly. A sentence is defined as having a head, a neck and a body, although in various circumstances each one of these can be empty or omitted.

It will be observed that a sentence with an empty body is a unit clause, and is used with the neck omitted. A sentence with an empty head is a directive; a question if the neck takes the form '?' (query), and a command if it takes the usual form ':-'.

A sentence with both head and body non-empty is a non-unit clause. A sentence cannot have both head and body empty.

This completes your introduction to the standard syntax of PROLOG. The semantics have also been outlined, but will be summarized again now.

A directive succeeds if there exist one or more substitutions for which every one of the goals succeeds. A goal matches if it is unifiable with the head of one or more clauses. In the case of a unit clause a match means immediate success.

But for a non-unit clause success also depends on the existence of a substitution (a set of bindings consistent with existing bindings) for which every one of the goals in the clause body succeeds.

The program is a conjunction of clauses, all declared to be true for all substitutions of variables; each unit clause representing a simple fact and each non-unit clause representing an implication. It will prove helpful if you read the neck, ':-' as 'if'. Also the alternative (but less common) notation '<' conveys the idea most helpfully.

Although the complete syntax and semantics of pure PROLOG has been covered, there is still a certain amount of 'syntactic sugar' which augments the logical syntax of PROLOG. These enhancements only make it more convenient for the programmer and do not actually augment the power of the language — they are all basically just concessions to readability.

There also remain a number of in-built predicates, two of which have been introduced already ('write' and 'nl'). Many of these vary from implementation to implementation, but some are universally available, even though they may differ in name or precise syntax.

These extensions to the basic framework of PROLOG will be introduced, as required, in future parts. Part 2 will delve into recursion in PROLOG and will introduce the list. For now you are left with a number of graded examples to try. ●

## FAMILY TREES — exercises

How did you go at figuring out the family tree examples given in a previous panel? There was one place where you may not have been sure what was going on (but I hope you worked it out eventually), and that is the way in which 'child' is defined.

Someone is a child of someone else if the 'someone else' is his/her father; and someone is a child of someone else if the 'someone else' is his/her mother. You may have thought it strange that I used 'and' back there. But I want to emphasize that *both* rules are always true — it is not that one rule is true or the other is true, since both are true. Which rule succeeds will depend on what goal is being matched.

Note the way in which in 'fam.5' both 'child' rules are used successfully, so that both parents are found.

Here is a graded list, easiest first, of predicates you might like to define so as to extend the family database: the facts about your own family tree (include surnames or a distinguishing initial or number if a number of people have the same first name); the implications for

1. 'parent', 'grandmother', 'grandparent', 'grandson', 'grandchild' (these are simple, you should be able to find both one line and two line solutions in each case).

2. 'husband', 'wife', 'spouse' (these are possible, as it stands, only for parents — if these are childless couples in your extended family you may have to introduce some facts defining the predicate 'married').

3. 'sister', 'brother', 'sibling', 'aunt', 'uncle' (try these before reading the remainder of this comment) ... now that you have a solution see if it says sibling ("Susan", "Susan") is true and returns "Richard", "Michael" and "George" for brother("George", Brother), see if you can fix up your predicates by making use of the built-in predicate 'ne' which is defined so that ne(X,Y) succeeds if X is not equal to Y and fails if they are equal).

4. 'ancestor' and 'descendant' (these involve recursion — which we will be looking at in the next article — but see if you can figure it out anyway by remembering that any predicate may be made a condition in any predicate definition — even its own!).

To finish off with something a little easier, how about figuring out what facts and implications you could add to allow for pets, or addresses etc.

## BIBLIOGRAPHY

W. F. Clocksin and C. S. Mellish, "Programming in Prolog", Springer-Verlag, Berlin, 1981. One of the better and simpler PROLOG texts.

Alain Colmerauer, "Metamorphosis Grammars", pp 133-189 in "Natural Language Communication with Computers" by L. Bolc, Springer-Verlag, Berlin, 1978. This is the account of the initial definition and application of PROLOG. It uses the original PROLOG syntax.

Robert Kowalski, "Logic for Problem Solving", North Holland, New York. The most highly recommended text for coming to grips with PROLOG, but not the simplest. It places PROLOG firmly in the full context of Theorem Proving and Logic Programming, and extends to more general and powerful systems, their advantages and disadvantages, and their implementation problems and strategies.



# Mystery Book Offer!

Buy 3...and get 1 free!



Choose any 3 of the great titles shown, and we'll give you an additional electronics book (we can't tell you the title, because that's the mystery!) as a free gift.

#### MODERN OP-AMP CIRCUITS

**DF065B** \$6.75  
A collection of widely varying circuits and projects based on the op-amp ICs.

#### PRACTICAL TRANSISTORISED NOVELTIES FOR HI-FI ENTHUSIASTS

**GF382B** \$2.95  
Includes quadrophony, stereo headphone adaptor, phasing stereo loudspeaker systems, high impedance four-channel mixer and speaker gain control. Limited supplies.

#### SINGLE IC PROJECTS

**DF058B** \$5.50  
Simple to build projects based on a single IC. A few projects use one or two transistors as well. A stripboard layout is given for each project plus special constructional and setting up info. Contents include low-level audio circuits, audio power amps, timers, op-amps and miscellaneous circuits.

#### FIRST BOOK OF PRACTICAL ELECTRONIC PROJECTS

**CF035B** \$4.95  
Full constructional data, circuits, components lists for many practical projects including audio distortion meter, guitar amp, metronome, etc.

#### POPULAR ELECTRONIC PROJECTS — BOOK 1

**CF039B** \$6.95  
A collection of the most popular types of circuits and projects to interest most electronics constructors. The projects cover a wide range and are divided into four basic types: radio, audio, household and test equipment.

#### SECOND BOOK OF CMOS IC PROJECTS

**EF081B** \$5.95  
Leading on from 50 CMOS IC Projects, this second book provides a further selection of useful circuits of a simple nature. Contents have been selected to ensure minimum overlap between the two books.

**This month only!**

# Babani Bargain Pack!

5 books for just \$17!

Bought individually, these quality publications would normally cost you \$24.90. Buy them as this special bargain pack, and you'll save almost 1/3 on the regular price!

#### FUN AND GAMES WITH YOUR ELECTRONIC CALCULATOR

**MX370B** \$2.50  
A collection of 101 jokes and riddles, several mind-boggling games for two or more players, and a dictionary of words with their corresponding numbers.

#### ELECTRONIC HOUSEHOLD PROJECTS

**DX048B** \$5.95  
Most useful and popular projects for use around the home. Includes two-tone buzzer, intercom, smoke and gas detectors, baby alarm, freezer alarm, etc. etc.

#### YOUR ELECTRONIC CALCULATOR AND YOUR MONEY

**MX246B** \$4.75  
Starts with a basic revision of percentages and decimals, then deals with mortgages, cars, insur-

ance, fuel, shopping, tax, etc. There's a section on investment and one on the calculator in a small business.

#### CHOOSING AND USING YOUR HI-FI

**GX385B** \$4.95  
Provides basic information on the technical specifications of hi-fi equipment. Offers advice on what to look for in equipment in order to obtain real high-fidelity sound and reproduction.

#### MINI-MATRIX BOARD PROJECTS

**DX062B** \$6.75  
This book provides a selection of 20 useful circuits which can all be built on a mini-matrix board which is just 24 holes by 10 copper strips in size. Simple and easy for those with not much experience in electronics.

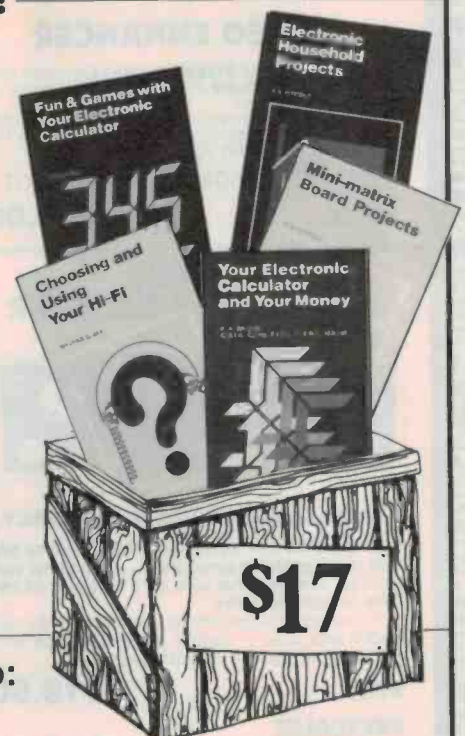

Simply fill out the reply-paid card insert and send to:

ETI BOOK SALES, 140 JOYNTON AVENUE,  
WATERLOO NSW 2017

**This month only!**

All prices of publications are subject to change without notice.

**MORE GREAT BOOKS ON PAGES 83, 98, 99**



# FOR 30<sup>c</sup> POST AN ORDER TO ONE OF ALTRONICS COMPETITORS

— naturally you won't have a clue as to whether they've got the items you need available. And of course, be prepared to wait, wait, patiently wait sometimes for weeks!  
**Why waste your valuable cash? Altronics staff are waiting for your call now (up to 6pm eastern standard time).**

## YOUR CHOICE OF LID — ABS OR ALUMINIUM

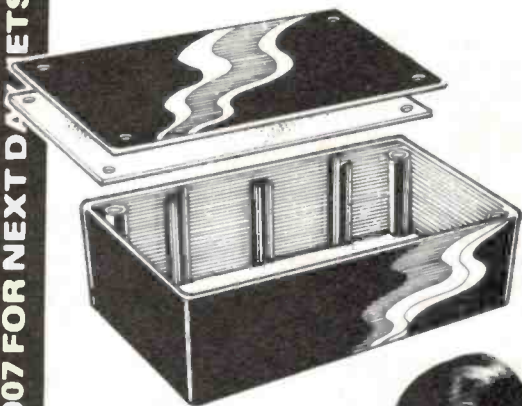

**NOW IN ABS**  
 "STILL THE SAME PRICE"



### NEW DELUXE JIFFY BOXES

Give your projects a professional finish with these new jiffy boxes featuring all ABS construction (easy to drill and work — unlike some others). Snap in PCB guides — recessed front panel screws.

BOX	DIMENSION	PRICE	10up
H 0201	150x90x50	\$2.95	\$2.65
H 0203	130x68x41	\$2.40	\$2.10
H 0205	83x54x28	\$1.75	\$1.60

### STANDARD JIFFY BOXES "ALUMINIUM LID"

Black plastic body with 22g. aluminium lid and 4 self-tapping screws supplied. Unique horizontal PCB "Snap In" mounts as well as vertical card guides.

H 0101	150x90x50	\$2.75	\$2.45
H 0102	195x113x60	\$3.75	\$3.40
H 0103	130x68x41	\$2.20	\$1.95
H 0105	83x54x28	\$1.60	\$1.50



### VIDEO ENHANCER

Here's a simple but effective Video Enhancer that is super easy to build at a fraction of the cost of commercial models. Unit sharpens picture detail, and can actually improve the quality of a copy by amplifying the top end of the video signal.

AT LAST A VIDEO ENHANCER KIT  
 K5825..... **\$35.00**



### STEREO SYNTHESIZER

Synthesize realistic stereo from virtually any monophonic source by simply connecting this unit between the source and your stereo amplifier.

- Quality Philips MN3001 (not second source dropout).
- Provision for 2 different signal sources.
- Selection of either source via front panel switch.
- Normal or stereo sound selection.

K5810..... **\$55.00**



### VIDEO AMPLIFIER

Brilliant new kit from EA. Super cheap and Super Effective. Whilst our K5830 is suitable primarily for VCR use this video amplifier is best suited to use with computers. The EA documentation supplied is extremely well written and provides details for installation into television sets.

NO MORE SMEARY COLOURS, SIGNAL BEATS OR RF INTERFERENCE  
 K5850..... **\$14.95**

### 7 DIGIT FREQUENCY COUNTER



#### UNBELIEVABLE 0.005% ACCURACY

- Frequency and Period measurement to 500 MHz (with optional prescaler) • High input sensitivity. Professional unit at a fraction of the cost of built up units.
- IC sockets provided throughout • Low age rate 10,000 MHz XTAL • Quality ABS plastic case with deluxe front panel • Specified LSI.

K2500..... **\$119.50**  
 PRESCALER  
 K2501..... **\$26.00**  
 DECIMAL POINT  
 K2502..... **\$7.50**

### FUNCTION GENERATOR

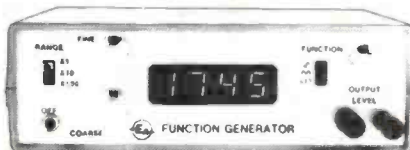

The most essential piece of test gear (second only to a good multimeter) on any hobbyist's bench is some kind of audio signal generator. This design utilizes the latest circuit techniques to produce stable, low distortion waveforms.

A truly versatile unit at a bargain price.

- 4 digit frequency readout (eliminates tiresome dial calibration) — typical accuracy  $\pm 2\%$  • 3 overlapping ranges x1, x10, x100 • 600 OHM Nominal Output — continuously variable 3MV — 2.5V P-P
- Distortion — sinewave: less than 0.7% @ 1KHz
- Linearity — triangle wave: better than 1% @ 1KHz
- Squarewave rise time — 6V/μs maximum output
- Amplitude stability — better than 0.1dB on all ranges.

K2505..... **\$85.00**  
 K2510...(DFM adaptor)... **\$12.00**

### DIGITAL CAPACITANCE METER



#### with Deluxe Instrument Case

#### NEW DELUXE FINISH

We are pleased to announce the release of the Digital Capacitance Kit housed in our Deluxe H0480 ABS Instrument Case.

This Superb Test Instrument Kit now complements our top selling Digital Frequency Counter and Function Generator Project Kit. Electronics Australia Project. Measures capacitance of both polarized and non-polarized capacitors from 1 picofarad to 99.99 microfarads in 3 ranges. Check values of unmarked capacitors, especially those little trimmers that are never coded. Select precise values for filters and timing networks within ease.

EXCLUSIVE TO ALTRONICS  
 Each kit includes precision measured capacitors for accurate calibration of each range.  
 K2521..... **\$55.00**

BANKCARD HOLDERS — PHONE ALTRONICS TOLL FREE 008-999-007 FOR NEXT DAY SET SERVICE DELIVERY

BANKCARD HOLDERS — PHONE ALTRONICS TOLL FREE 008-999-007



OR FOR **15¢** PHONE YOUR ORDER TOLL FREE ON 008-999-007

We will immediately confirm stock availability. We will also confirm the very hour your order will be dispatched (over 95% of orders leave the same day). **With Jet Service delivery we deliver next day to capital cities and suburbs** — Country areas please add 24 to 48 hours. **Available bankcard holders only** — sorry non-bankcard holders must post a cheque or money order — even so, we promise to deliver quicker than any other supplier in Australia.



**EASY TO INSTALL ★ BUILT IN SIREN DRIVER — DIRECTLY DRIVES LOW COST 8 OHM HORN SPEAKERS, SIREN HORNS AND MECHANICAL BELLS ★ LOW POWER 12V DC OPERATION.**

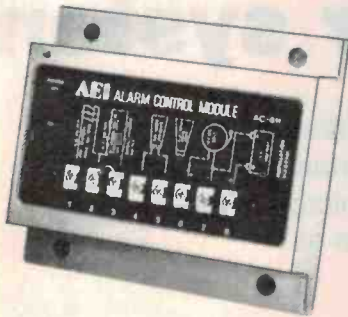

S5042. Only **\$39.50**

The AC-811 is a low cost professional burglary protection system which detects the presence of an intruder who breaks into your home, office or business. The system also allows connection of emergency panic buttons, wall vibration switches, smoke and heat sensors, as well as freezing or flooding detectors to form a complete protection system.

**EXIT / ENTRY DELAY  
BOTH N.C. AND N.O. CONTACTS  
Ideal for homes, offices,  
factories, shops, caravans,  
any area requiring complete  
protection.**

**TOP QUALITY  
MAINS LEADS**

MADE IN AUSTRALIA

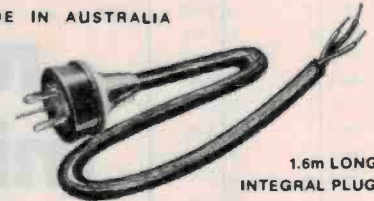

1.6m LONG  
INTEGRAL PLUG

BLACK IN COLOUR

**BE QUICK—LIMITED STOCKS**

A2400 ..... **\$1.50**  
100 up ..... **\$1.20**

**SUPER  
TYPE  
GLUE**

HIGH BONDING  
STRENGTH STICKS  
IN SECONDS

T3010 **\$1.95**

**SAVE  
A  
DOLLAR**



**MICROPHONE TRANSFORMER  
MU-METAL SHIELDED CAN**

Primary: 200 OHM

Secondary: 50 K OHM

A high quality item eminently suited to mixers, PA amplifiers and where an ultra low "hum" pickup level is desired.

M 0701 ..... **\$17.50**  
10 or more. . . . **\$16.40**

**BRIDGING/ISOLATING  
TRANSFORMER MU-METAL  
SHIELD CAN**

Use for coupling audio modules — prevents earth loops, hum etc. Essential coupling device where DC isolation is required.

Nominal  
Impedance  
Radio  
19K/10K (1:1)

M 0702 . . . **\$17.50**  
10 or more **\$16.40**



**MINIATURE  
PUSH BUTTON**

6mm mounting hole  
125V/3A Rating

S 1060 Push to make contacts .45  
10 up .40  
S 1070 Push to break contacts .50  
10 up .45



☆ **PROTOTYPE SOLDERLESS BREAD BOARDS** ☆

**MINI STRIP 100 HOLES**

P 1000 ..... ~~\$2.50~~ **\$1.95**

**640 HOLES**

P 1005 ..... ~~\$9.80~~ **\$8.50**

**640 + 100 HOLES**

P 1007 ..... ~~\$11.95~~ **\$10.00**

**640 + 200 HOLES**

P 1009 ..... ~~\$13.98~~ **\$12.00**

NON-CORROSIVE  
NICKEL ALLOY CONTACTS  
RELIABLE FOR  
50,000 INSERTIONS

There's a limit to just how many times you can resolder components while prototyping before you either destroy the component or lift a track from the vero.

These solderless breadboards enable circuits to be literally thrown together in an instant, yet all components remain reusable.

A necessity in all research laboratories to save on expensive development costs.

- ☆ Standard 0.1 inch spacings.
- ☆ Accepts all LSI's, semis, transistors, diodes, LEDs and passives.
- ☆ 22-30 gauge solid hook up wire for interconnections.
- ☆ Boards are "Keyed" to enable easy expansion.



**400 + 1280 HOLES**

ACCEPTS UP TO 16  
x 16 pin D.I.L. IC'S

SCREW  
TERMINALS FOR  
PS CONNECTIONS  
P 1012

~~\$29.50~~ **\$26.00**



**500 + 1920 HOLES**

ACCEPTS UP TO 24 x 16 pin  
D.I.L. IC'S

METAL BACKING PLATE FOR  
SHIELDING OF SENSITIVE  
CIRCUITRY  
P 1015

~~\$45.00~~ **\$38.00**

BANKCARD HOLDERS — PHONE ALTRONICS TOLL FREE 008-999-007 FOR NEXT DAY JETSERVICE DELIVERY

BANKCARD HOLDERS — PHONE ALTRONICS TOLL FREE 008-999-007 FOR NEXT DAY JETSERVICE DELIVERY



# The 6800 microprocessor series

## Part 3 — the VIA

Peter Ihnat

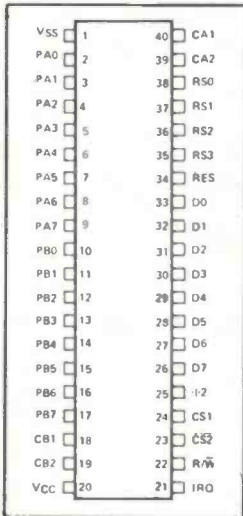

Figure 1a

# General purpose, minimum component microprocessor system

A microprocessor dedicated to controlling some piece of equipment needs to have certain I/O facilities. For a general purpose dedicated microprocessor these facilities need to be as versatile as possible.

MOST manufacturers of microprocessor ICs do not design the microprocessors themselves as individual components but rather as the heart of a family of ICs. The individual members of a family are capable of performing specific tasks and are able to communicate with each other with a minimum amount of interconnection. Some of the specific tasks include parallel I/O, serial I/O, timers and counters, memory, etc. As mentioned in Part 1 of this series (*The 6800 Microprocessor Series*, March 1984 ETI), it is possible to use various components from different microprocessor families if care is taken with a signal compatibility.

During the design of the ETI-662a General Purpose Microprocessor System (April 1984 ETI), I selected the Synertek SY6522 Versatile Interface Adapter (VIA) from the 6500 family to be the interface IC. This is a good example of the compatibility possible between some families (the processor belonging to the 6800 family).

### The SY6522 VIA

The Synertek 6522 VIA is certainly a versatile I/O device. It's features include:

- two 8-bit bi-directional I/O ports,
- two 16-bit programmable timer/counters,
- serial data port,
- automatic handshaking capability,
- latched output and input registers,
- seven interrupt conditions.

### Pin functions

The VIA is a 40-pin device available as the 1 MHz SY6522 or the 2 MHz SY6522A. Its external pin connections fall into one of two categories — those which connect to the microprocessor's busses and those which connect to the outside world (see Figure 1a).

### Connection to the micro

Exactly half of the VIA's pins are involved in interfacing with a processor's control, data, address and power supply busses. These enable data to be correctly transferred between the processor and its VIA.

The power supply connections to the VIA are pins 20 and 1 (+5 V and 0 V, respectively) and the power consumption is 700 mW.

Pin 34 is the reset input and is normally driven by the same power-on-reset circuitry as the processor. This results in all the inter-

nal registers (except timer latches, counters and the shift register) being cleared, peripheral interface lines placed in the input state and interrupts disabled at switch-on.

Pins 22 and 25 are R/W and E respectively. They connect to the equivalent pins on the processor and allow for correct data transfer between the processor and VIA. The R/W line indicates the direction of data transfer — a low indicating that the processor is writing to the VIA and a high indicating that one of the VIA registers is being read. The E signal is simply the system clock and is used to synchronise all data transfers. It is

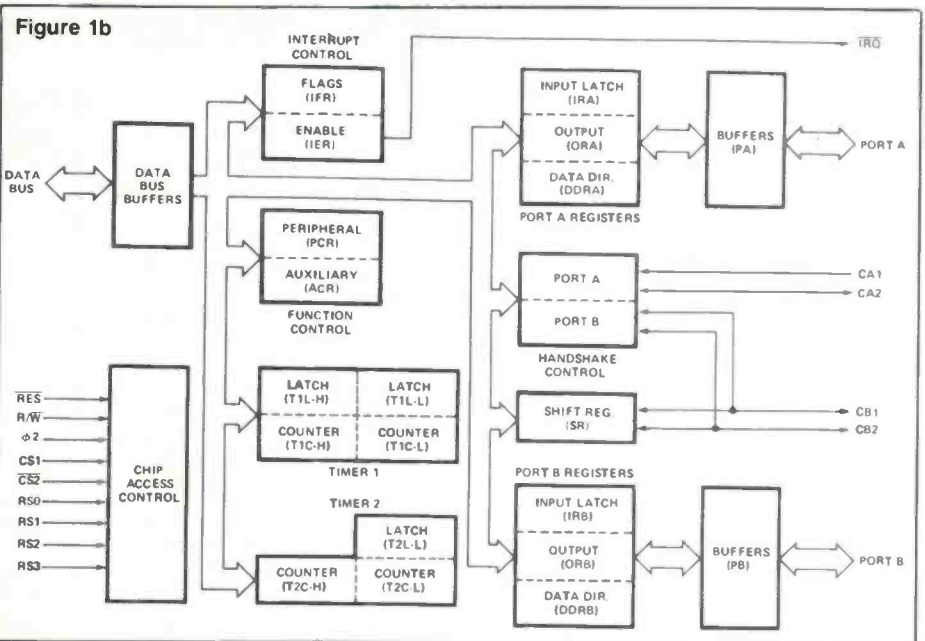
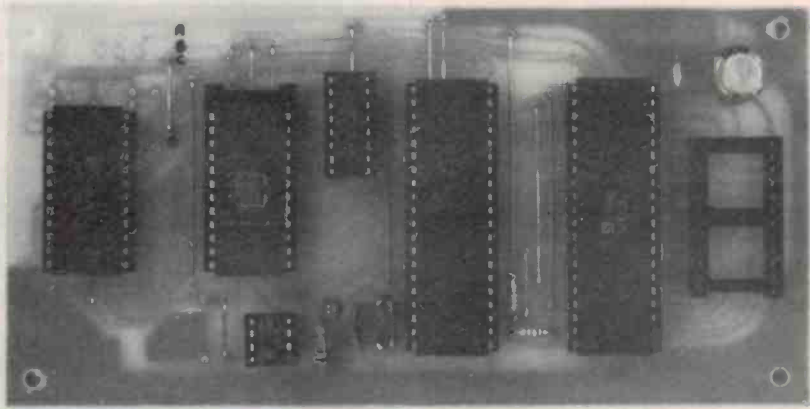

Figure 1b





also used as a timing signal for the two timer/counters. More of this later.

Pins 26 to 32, inclusive, comprise the eight bi-directional data lines. It is along this buss that data travels between the processor and VIA. When the VIA is not being accessed, the lines go into the high impedance state so as not to load the data buss and interfere with other data transfers.

Pins 35 to 38 are the register select inputs RS3, RS2, RS1 and RS0. When connected to four of the microprocessor address lines they allow one of the VIA's sixteen registers to be selected for data transfers. Two enable lines are also available for connection to the system's decoding circuitry so that the VIA can be positioned somewhere in the microprocessor address space. In other words, these six lines are used to give each of the VIA's sixteen internal registers a different address so that information can be written to or obtained from them. Note that the device is enabled when CS1 is high and CS2 is low.

Pin 21 is the final microprocessor/VIA control signal and is the interrupt request output (IRQ). This line usually connects to IRQ on the microprocessor and goes low when an interrupt condition exists in the VIA.

### Connection to the outside world

The remaining 20 lines comprise Port A, Port B and their handshake lines. Both ports consist of eight lines which can be individually programmed to function as inputs or outputs. They each appear as a TTL load in input mode and can drive one standard TTL load in output mode. Port B, in addition, is capable of sourcing 1 mA at 1.5 volts in the output mode and can directly drive transistor circuits.

The handshake lines are known as CA1, CA2 for Port A and CB1, CB2 for Port B. They can act as interrupt inputs or handshake outputs as selected by certain registers (discussed later). The difference between them is that CA1 and CB1 are inputs only — CA1 having a high input

impedance and CB1 appearing as a TTL input.

Lines CA2 and CB2, on the other hand, can be inputs or outputs — in input mode they appear as TTL inputs; in output mode they can drive a standard TTL load.

Under certain conditions CB1, CB2, PB6 and PB7 take on different functions and these will be discussed in the next section.

### Functional description

As mentioned previously, there are sixteen registers in the VIA. Most of these are used to set up its operating properties, the rest are involved with actual data transfer. Figure 1b shows the overall internal structure and Table 1 lists the functions of each of the registers. Let's look at them now in detail since they hold the key to the operation of the device.

The first two registers, R0 and R1, are Ports B and A respectively. It is through these two registers that data flows to and from the outside world — these registers are actually connected to the 16 I/O pins of the VIA.

To specify which bits in Port A and B will be inputs or outputs, a couple of "data direction" registers are provided. These are registers R2 (data direction register B or DDRB) and R3 (data direction register A or DDRA). A zero (0) stored in a bit of a data direction register causes the corresponding port pin to act as an input. A one (1) causes it to act as an output. Let's look at an example.

To set-up Port A as, say, 4 output lines (bits 7, 6, 5 and 4) and four input lines (bits 3, 2, 1 and 0) simply store \$F0 (11110000 in binary) in register R3. If data is now written to register R1, the upper four bits will appear on pins 6 to 9 (PA4 to PA7) of the VIA. If data is read from register R1, then the logic levels on pins 2 to 5 (PA0 to PA3) is the information read. Simple, isn't it!

Since the I/O ports are most often used for transferring data in parallel form, either to a printer or from a keyboard, it is possible to implement handshake control of data transfers with the 6522 VIA. Port A control lines (CA1, CA2) handshake on both a read and write operation, whereas Port B lines (CB1, CB2) handshake on write only.

With the read handshake as an example, the peripheral device (e.g. keyboard) must generate the equivalent of a "data ready" signal to indicate to the processor that valid data is present on the port. This signal normally interrupts the processor which then reads the data causing a "data taken" signal to be generated. The peripheral device responds by making new data available, and ▶

Table 1

Register Number	RS Coding				Register Desig.	Description	
	RS3	RS2	RS1	RS0		Write	Read
0	0	0	0	0	ORB/IRB	Output Register "B"	Input Register "B"
1	0	0	0	1	ORA/IRA	Output Register "A"	Input Register "A"
2	0	0	1	0	DDRB	Data Direction Register "B"	
3	0	0	1	1	DDRA	Data Direction Register "A"	
4	0	1	0	0	T1C-L	T1 Low-Order Latches	T1 Low-Order Counter
5	0	1	0	1	T1C-H	T1 High-Order Counter	
6	0	1	1	0	T1L-L	T1 Low-Order Latches	
7	0	1	1	1	T1L-H	T1 High-Order Latches	
8	1	0	0	0	T2C-L	T2 Low-Order Latches	T2 Low-Order Counter
9	1	0	0	1	T2C-H	T2 High-Order Counter	
10	1	0	1	0	SR	Shift Register	
11	1	0	1	1	ACR	Auxiliary Control Register	
12	1	1	0	0	PCR	Peripheral Control Register	
13	1	1	0	1	IFR	Interrupt Flag Register	
14	1	1	1	0	IER	Interrupt Enable Register	
15	1	1	1	1	ORA/IRA	Same as Reg 1 Except No "Handshake"	

Figure 2  
REG 12 — PERIPHERAL CONTROL REGISTER

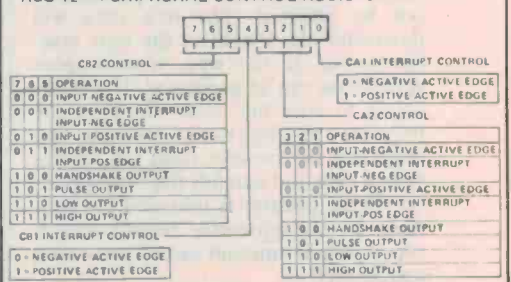



# The 6800 microprocessor series

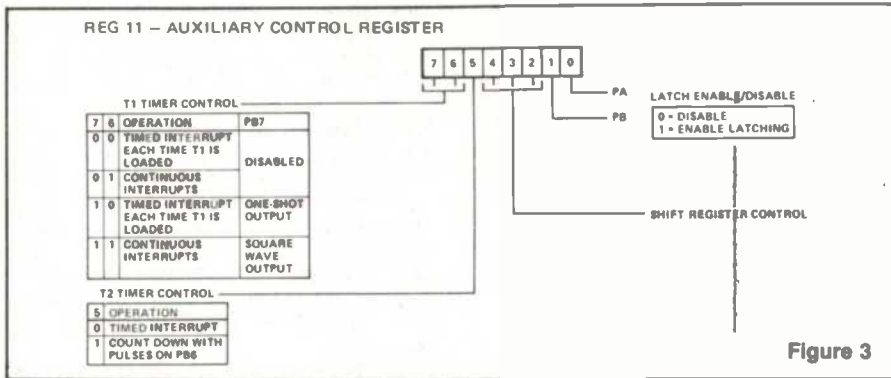

Figure 3

so forth until data transfer is complete.

The "data taken" signal can be either a pulse or a level and the "data ready" signal normally sets an internal interrupt flag which may interrupt the processor or may be polled under program control.

Figure 2 illustrates the register responsible for selection of operating modes for CA1, CA2, CB1 and CB2. It is register R12, the Peripheral Control Register.

There are two timers available for use in the 6522. Their operations differ slightly so it's probably best to examine each separately. Timer one (T1) consists of two 8-bit latches and a 16-bit counter. The latches are used to store data which is to be loaded into the counter. After loading, the counter decrements at the E signal clock rate (1 MHz). When zero is reached, an interrupt flag will be set and IRQ will go low if the interrupt is enabled (discussed in detail later). At this stage, one of four possible operations may occur:

1. the timer will disable further interrupts (called "one-shot" mode since a single interrupt is produced);
2. the timer will transfer the contents of the latches into the counter and begin decrementing again;
3. the timer operates as for condition (1) but will put a low on peripheral line PB7 during the decrement period. In other words, a single negative pulse is produced, the length of which is equal to the number of microseconds it takes to decrement the counter; and
4. the timer operates as for condition (2) but inverts the output signal on PB7 each time it reaches zero. This effectively produces a square wave output on PB7. If new data is written into the latches before zero is reached (time-out), the current time-out period will not be affected. The new data will determine the length of the next time-out period. In this way, very complex waveforms can be generated. It is interesting to note that both timers in the 6522 are "re-triggerable" meaning that reloading the counter from the latches before time-out extends the timing period. If the counter is reloaded continuously by the processor before zero is reached then time-out can be prevented completely!

Figure 3 shows R11, the Auxiliary Control Register. Its two most significant bits control the four modes of operation of timer one. The tricky part with initialising the timer has to do with loading its latches and counter. The high and low order bytes of the counter cannot be loaded directly but can be read at any time.

To initialise the counter, firstly the low order byte is written to either register 4 or 6. This results in the byte being placed in the lower byte of timer one's latch. Next, the high order byte is loaded into register R5. This causes —

- (a) the high order byte to be loaded into the higher byte of the latch and the counter,
- (b) the low order byte of the latch to be transferred to the low byte of the counter.
- (c) the interrupt flag to be reset and
- (d) the countdown to begin.

If, instead, the byte was loaded into register R7, then *no transfer to counter takes place*. The value is simply placed in the latch's high order byte.

Timer two (R2) also has two 8-bit latches and a 16-bit counter of which the low-order latch is write only, the low order counter is read only and the high order counter is read/write. It has two modes of operation selected by bit 5 of the Auxiliary Control Register. Its "one-shot" mode is similar to timer one where an interrupt is generated when the counter reaches zero. The counters then "roll-over" to all ones

(\$FFFF) and continue decrementing so that it is possible to determine how long it's been since time-out.

The setting of the interrupt flag, however, is disabled after the initial time-out so that the next decrement through zero has no other effect. The interrupt flag can be reset by reading the counter's low order byte or by writing to its high order byte (which also loads both high and low bytes from the latches).

Timer two's second mode of operation is as a pulse counter. Basically, it counts a predetermined number of negative-going pulses on peripheral line PB6 (these pulses actually decrement the counter instead of the E signal). The interrupt operates as for the first mode.

The Shift Register (R10) is linked to the CB2 and CB1 pins, has a built-in modulo-8 counter (shift register counter) and has eight modes of operation. The operating mode is selected by bits 4, 3 and 2 of the Auxiliary Control Register (see Figure 4).

The first mode is SR DISABLED.

The second mode is SHIFT IN UNDER CONTROL OF T2. Data is shifted into the register, low bit first, from CB2 at a rate determined by the low order byte of T2. Timing pulses are generated on the CB1 line to synchronise transfer with an external device. The shifting operation is triggered by reading or writing the Shift Register and after eight shifts, the shift register interrupt flag will be set.

Mode 3 is SHIFT IN UNDER CONTROL OF E SIGNAL. This is identical to mode 2 except that the shift rate is 1 MHz.

Mode 4 is SHIFT IN UNDER CONTROL OF EXTERNAL CB1 CLOCK. Here, CB1 becomes an input and allows an external device to shift data into CB2 at its own pace. The interrupt is set after eight shifts but note that this does not stop the shifting operation. Reading or writing the shift register resets the interrupt flag and initialises the shift register counter to count another eight pulses.

Mode 5 is SHIFT OUT FREE-RUNNING AT T2 RATE. This is very similar to the next mode except that the shifting operation is not stopped after eight shifts and the interrupt flag is never set. Note that bit 7 of the Shift Register is recirculated back into bit 0 and so the bit pattern stored there will be continuously output.

Mode 6 is SHIFT OUT UNDER CONTROL OF T2. With each read or write of the shift register, the SR counter is reset

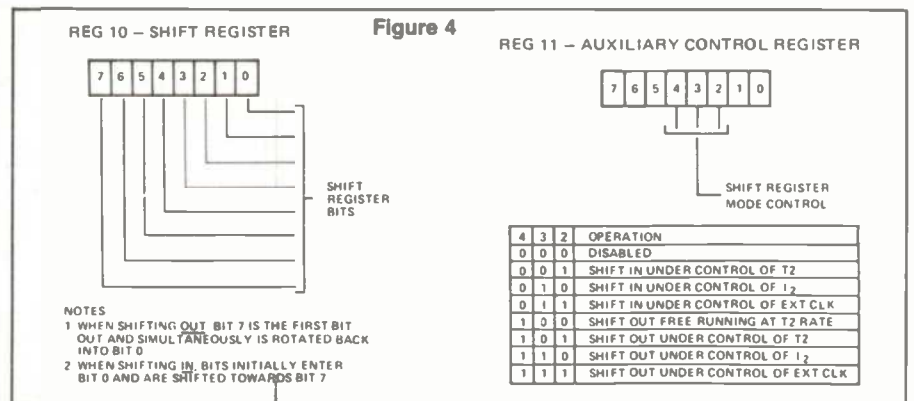

Figure 4



# EXCITING BOOKS

Six great titles . . . superb reading for anybody interested in

## ELECTRONIC MUSIC & AUDIO/VIDEO!

### SINGLE-CAMERA VIDEO PRODUCTION GO379P \$25.95

Step-by-step diagrams and illustrations show you how to produce low-budget, high-quality video programs. Chapters on audio, lighting, shooting, editing, graphics and set design.



### INTRODUCTION TO ELECTRO-ACOUSTIC MUSIC GO127P \$24.95

This book assumes no previous technical knowledge. It discusses the relationship between the technology and the composition of electro-acoustic music.

### AN INTRODUCTION TO VIDEO GO124B \$6.95

This book is written in layman's language and is for anyone who is thinking about buying or renting (or who has just bought or rented) a video recorder and wants to get the best out of the machine.

### THE MUSICIAN AND THE MICRO GO280A \$8.95

A straightforward and practical guide for keen musicians, teachers and those who work in the music industry, covering the exciting world of microprocessors and computerised musical instruments.

### WORKING IN THE MUSIC BUSINESS GO279A \$11.95

Gives realistic insights into the work and lifestyles found in the music business, and would be of interest to anyone considering work in recording studios, record companies, music publishing, etc.

### ELECTRONIC SYNTHESIZER PROJECTS GO133B \$5.95

For the electronic music enthusiast, an invaluable reference. This book is full of circuits and information on how to build analogue delay lines, sequencers, VCOs, envelope shapers, etc. etc.

Highly recommended . . . our best-ever books on

## TEST EQUIPMENT AND FAULT-FINDING



### HOW TO GET YOUR ELECTRONIC PROJECTS WORKING F0114B \$6.95

Helps you to overcome the problems of a circuit that doesn't work by indicating how and where to start looking for many of the common faults that can occur when building up a project.

### PRACTICAL REPAIR AND RENOVATION OF COLOUR TELEVISIONS F0116B \$6.55

This book shows how to obtain a working colour television for very little outlay by repairing and renovating a set that has been 'written off' by a dealer. Includes practical details of how to construct your own CRT tester/rejuvenator and cross-hatch generator.

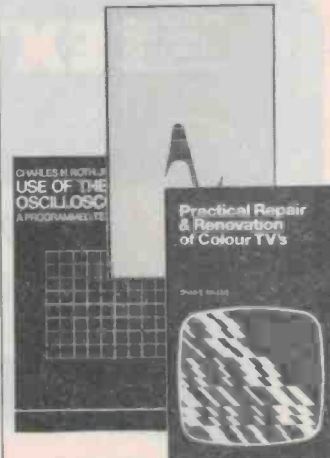

### HOW TO BUILD YOUR OWN SOLID-STATE OSCILLOSCOPE F0282B \$6.95

This book comprises a project divided into sections for builder to individually construct and test — then assemble into complete instrument. Includes short section on scope usage.

### WALL CHART — TRANSISTOR RADIO FAULT-FINDING F0115B \$2.95

Used properly, this chart should enable the reader to trace most common faults quickly. Selecting the appropriate fault, the reader simply follows the arrows and carries out the suggested checks until the fault is cleared.

### ELECTRONIC TEST EQUIPMENT CONSTRUCTION F0122B \$5.95

Describes construction of wide range test gear, including FET amplified voltmeter, resistance bridge, field strength indicator, heterodyne frequency meter, etc.

### USE OF THE DUAL-TRACE OSCILLOSCOPE F0259P \$33.25

This programmed text breaks down the process of operating a scope into a series of logical steps, from the deflection of the electron beam to proper use of the triggering controls to measure the phase difference between two waveforms.

Simply fill out the reply-paid card insert and send to:  
ETI BOOK SALES, 140 JOYNTON AVENUE, WATERLOO NSW 2017

**MORE GREAT BOOKS ON PAGES 77, 98, 99**



# 6800 series

and the eight bits are shifted onto CB2 (timing pulses are generated on CB1). After eight shifts, the shifting function is disabled and the interrupt flag is set.

Mode 7 is SHIFT OUT UNDER CONTROL OF E SIGNAL. This is as for mode 6 except shift rate is 1 MHz.

Mode 8 is SHIFT OUT UNDER CONTROL OF EXTERNAL CB1 CLOCK. This is very similar to mode 4 where an external device controls the shift rate.

The final two registers are the Interrupt Flag Register (R13) and the Interrupt Enable Register (R14). Seven of the bits in the IFR represent the status of each of the

seven interrupting conditions possible with the VIA.

If an interrupt condition exists, for example eight shifts of the shift register or a time-out of one of the timers etc, then the appropriate bit in the IFR will be set to a one (1) if that interrupt is enabled. The bit can be cleared by either resetting the interrupt condition, for example rewriting the shift register or reloading the counter etc, or by writing a one to that bit in the IFR. Bit 7 is not a flag but represents the logic level on IRQ and is set if any of the other seven bits are set.

This allows a processor to poll all the interrupts by simply checking the bit. It can only be cleared by clearing the other seven flags in the IFR or by disabling all active interrupts.

For each bit in the IFR, there is a corresponding bit in the IER (R14). This allows individual control of each of the seven interrupting conditions. To enable an interrupt, the processor needs to set the appropriate bit while writing a one into bit 7 (refer to Figure 5).

For example, to enable timer 1 and the shift register, simply load R14 with \$C4 (11000100). If any of the other interrupts were enabled prior to this, then they will still be enabled. In other words, writing a zero to a bit of the IER while having a one in bit 7 has no effect on that bit. To clear a specific bit of the IER the processor needs to write to R14 with a zero in bit 7. A one in any other bit position will clear the corresponding bit whereas a zero will have no effect.

For example, let's assume that interrupts for timer 1 and the shift register are enabled. The IER will contain 01000100. To enable interrupts for timer 2 as well, simply write 10100000 to the register after which it will contain 01100100. To disable SR interrupts, write 00000100 to R14 which will leave it with 01100000.

After all this you should realise that the 6522 is certainly a versatile Interface Adapter.

Some of the sections may need re-reading in case it didn't all click (or should that be beep?) the first time through but I recommend that you obtain the manufacturer's data sheet if any problems do arise or if any serious work needs to be done. Happy interfacing!

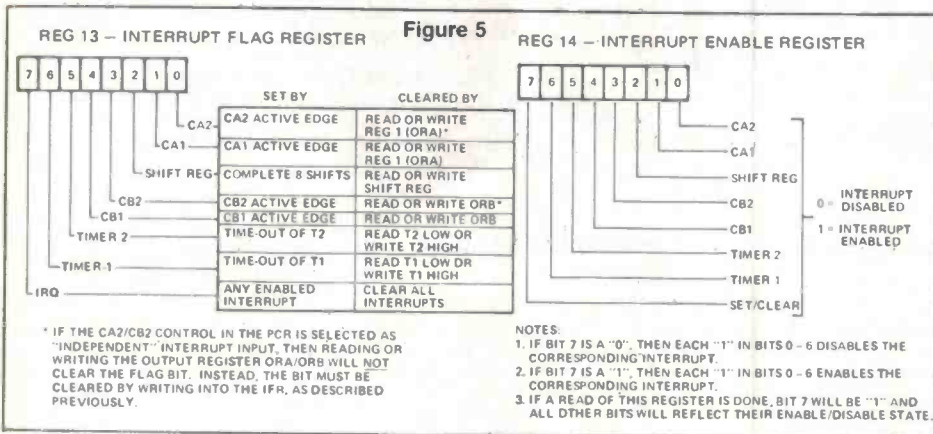

# TEXT TOOL ZERO INSERTION FORCE SOCKETS



## ZIP DIP II Sockets

TEXT TOOL'S versatile ZIP DIP II socket features a flat top plate for easy insertion and extraction. Contacts are on .1" increments for standard sizes, thus mating with standard layouts. All standard sizes from 14 to 40 pins are available from stock at realistic prices.

Pins	Stock Number	Price
14	PB01	9-81
16	PB02	7-19
18	PB03	8-72
20	PB04	9-36
22	PB05	14-52
24	PB06	7-94
28	PB07	8-00
40	PB08	14-00
64	PB29	39-52



## ECONO-ZIP Sockets

For applications requiring low cost for not so often used sockets the ECONO-ZIP is the answer. A simple mechanism is used with contacts and body of standard TEXT TOOL materials. Ideal for use on P.C.B.'s within equipment for PROMS or EPROMS. Available immediately in 16, 24, 28 and 40 pin, others to follow.

Pins	Stock Number	Price
16	PB20	7-15
24	PB24	7-00
28	PB25	9-11
40	PB26	11-66
64	PB28	16-75



## ZIP-STRIPS

Combine all the usual TEXT TOOL features into a useful socket for testing non-standard packages or pinned board assemblies. The ZIP-STRIP handles may be ganged for ease of use.

Pins	Stock Number	Price
10	PB17	11-58
20	PB18	15-35
32	PB27	17-43

All above prices plus 20% sales tax  
Add \$3 pack and post

**Stewart Electronics**

44 Stafford St., Huntingdale 3166. Phone: (03) 543 3733 Telex: 369013  
437 City Rd., Sth. Melbourne. Phone: (03) 690 8333



**LISTING :**

```
0600 6c1e 6d0e 6e06 620f 6500 26cc 26f8 26e2
0610 6700 6600 6306 26cc 6005 e0e1 7cfe 6007
0620 e0a1 7c02 6006 e0a1 7dfe 600e e0a1 7d02
0630 6009 e09e 163e 3e06 7e01 6001 e09e 1644
0640 3e00 7eff 26cc 26e2 7401 4420 26f8 270e
0650 26e2 7601 f600 f218 4764 6501 46ff 1698
0660 5ca0 1616 5db0 1616 5e90 1616 6020 f000
0670 f218 7002 3080 166e 7705 3732 1684 08e1
0680 08e1 6302 3764 168e 6501 08e1 6304 3796
0690 1616 08e1 08e1 6300 00e0 6a18 6b0a a6c8
06A0 f733 f265 f029 deb5 f129 7a05 deb5 f229
06B0 7a05 deb5 6008 e09e 16b4 00e0 8030 b6e0
06C0 08e1 08e1 08e1 1600 ---- -- a80e fe1e
06D0 f065 a736 f01e 80c0 7008 dcdff f21e d0df
06E0 00ee a8de f91e f065 a808 f01e 80a0 7008
06F0 dabf f21e d0bf 00ee 6400 ca0f 8ea4 7a0a
0700 cb07 8bb4 7b0a c907 4907 6903 00ee c00f
0710 4501 c007 4000 7a02 4001 7afe 4002 7b02
0720 4003 7bfe 4004 79ff 4005 7901 49ff 6901
0730 4907 6905 00ee 0000 0000 0000 0302 0300
0740 0000 0000 0000 0000 0000 0080 8080 0000
0750 0000 0000 0000 0000 0007 0404 0407 0000
0760 0000 0000 0000 0000 c040 0404 c000 0000
```

```
0770 0000 0000 0000 0f08 0808 0808 0f00 0000
0780 0000 0000 00e0 2020 2020 20e0 0000 0000
0790 0000 001f 1010 1010 1010 101f 0000 0000
07A0 0000 f010 1010 1010 1010 f000 0000 0000
07B0 3f20 2020 2020 2020 2020 3f00 0000 00f8
07C0 0808 0808 0808 0808 08f8 0000 007f 4040
07D0 0404 0404 0404 0404 407f 0000 fc04 0404
07E0 0404 0404 0404 0404 fc00 ff80 8080 8080
07F0 8080 8080 8080 8080 fffe 0202 0202 0202
0800 0202 0202 0202 02fe 0000 0000 0000 0001
0810 0000 0000 0000 0000 0000 0000 0000 0000
0820 0000 0000 0000 0000 0000 0000 0303 0300
0830 0000 0000 0000 0000 0000 0080 8080 0000
0840 0000 0000 0000 0000 0007 0707 0707 0000
0850 0000 0000 0000 0000 c0c0 c0c0 c000 0000
0860 0000 0000 0000 000f 00f0 00f0 0000 0000
0870 0000 0000 00e0 e0e0 e0e0 e0e0 0000 0000
0880 0000 001f 1f1f 1f1f 1f1f 1f1f 0000 0000
0890 0000 f0f0 f0f0 f0f0 f0f0 f000 0000 0000
08A0 3f3f 3f3f 3f3f 3f3f 3f3f 3f00 0000 00f8
08B0 7f8f 7f8f 7f8f 7f8f 7f8f 0000 007f 7f7f
08C0 7f7f 7f7f 7f7f 7f7f 7f7f 0000 fcfc fcfc
08D0 fcfc fcfc fcfc fcfc fc00 001e 3e5a 7896
08E0 b4e9 61d4
```

## LOOP THE BLOCK

This is a game in simulated 3D which involves trying to manoeuvre a square loop around a square block. The block shifts randomly around the screen, changing size as it does so, and reappears at a random position from time to time. For each 'capture' (signalled by a sound effect) five points are earned. After fifty points have been gained the background colour changes.

After the second colour change the moving block gets more agitated, making it quite difficult to get to the final black phase.

During the game, a descending tone is heard — when it gets to the lowest possible pitch, time runs out and your score is displayed. Press '8' for another game.

To control the loop, use the keys as follows:

- '1' — shrink
- '9' — expand
- '5' — left
- '6' — up
- '7' — right
- 'E' — down

Tim Parish, Myrtle Bank SA

## '660 KONG

This simplified version of a popular arcade game has two levels of play and features simple animated graphics. The object is to make your way to the top left-hand corner of the screen and jump over the barrier to rescue the damsel in distress.

To run right, press '3' and to run left, press '1'. To climb a ladder, you must first position yourself to the left of the ladder, facing it. Pressing '2' will then start you climbing (hold it down to continue up and hop on to the next floor), but there is no turning back! Three barrels are continuously rolled down the floors and ladders and you must jump these by pressing '0'. As you will discover, the barrels are not the only hazards!

At the end of each attempt to reach the damsel, your cumulative score is displayed, based on the floor reached and the time elapsed since starting that attempt (the less the better). After three attempts, the path becomes even more hazardous and you have another three attempts.

Appropriate sound effects are included — you should recognize the tunes! The game is in colour, so it takes a few moments for the display to come up. Pressing '8' will start a new game.

Tim Parish, Myrtle Bank SA

THIS COLUMN is for those readers who own a small microcomputer system that runs the "CHIP-8" language. This was developed for 8-chip 'trainer' micro systems, such as the RCA VIP (VP-111) system, Michael Bauer's 'Dream' and the ETI-660 Learner's Microcomputer (published in 1981).

A useful little newsletter for hobbyists running a CHIP-8 system is compiled, published and distributed by Frank Rees, 27 King St, Boort Vic 3537.

We have been asked for hardware mods and expansions for the '660, such as full ASCII keyboard, BASIC, 32K RAM etc. As you can now buy a whole computer for less than such expansion of the '660 would cost, there's not much point. However, we have a couple of interesting things in the pipeline...

**LISTING :**

```
0600 00ff 0bb2 00ff 0bc1 6003 6100 6200 6308
0610 6418 2b90 6005 6103 6302 6403 2b90 6004
0620 6107 6201 6301 6406 2b90 6006 6100 6207
0630 6308 6401 2b90 620f 2b90 6217 2b90 00ff
0640 00ff 00ff a775 c275c 281a 28aa 80e0 27e0 6188
0650 f100 dbcb a975 f065 4d03 16b0 185e 7d01
0660 4b02 167a 6101 e19e 167a 6e00 3d01 6e04
0670 7bfe 6600 6000 f118 16ca 4b3a 1694 6103
0680 e19e 1694 6e08 3d01 6e0c 7b02 6601 6000
0690 f618 16ca 6100 e19e 16c2 1998 6000 6e10
06A0 4600 6e34 6144 f100 fd18 7cfa 6d03 16ca
06B0 7b04 4600 7bfb 7e01 3a02 16ca 6a00 6d00
06C0 7c06 6e18 3601 6e14 6d00 a975 f055 80e0
06D0 27e0 dbcb 4d02 6d00 1978 a7ba 26f0 a7ba
06E0 f555 26f0 a7c0 f555 26f0 a7c6 f555 164a
06F0 f555 8010 27e0 d457 3200 1724 4517 1714
0700 3507 1730 342c 170e c001 3000 6201 4410
0710 6201 1730 341c 171e c001 3000 6201 4430
0720 6201 1730 7502 4517 6200 4527 6200 173c
0730 74fe 7104 3517 173c 7404 71f8 4517 1746
0740 412c 611c 174a 4118 6128 3400 1752 6432
0750 6507 8010 27e0 d457 2b22 00ee a992 6000
0760 6100 6900 f155 00ee 00ff a656 6019 610e
0770 d011 6023 d011 6013 611e d011 6029 d011
0780 a92c 6006 611d d011 603d d011 603a 612d
0790 d011 00ee 6f0a 8fb5 6714 4fd1 17ce 4b3a
07A0 17ce 00ee 4b1e 6001 6724 4900 00ee 4b3a
07B0 17ce 4b38 17ce 00ee 00ff ---- ----
07C0 ---- ---- ---- ---- ---- 00ff 6001
07D0 a96b db7a 7702 f700 f018 3798 17d4 1a6a
07E0 b7e2 a8e6 00ee a8ee 00ee a8f6 00ee a8fe
07F0 00ee a906 00ee a90e 00ee a916 00ee a92a
0800 00ee a931 00ee a938 00ee a93f 00ee a946
0810 00ee a94e 00ee a956 00ee 00e0 6000 611e
0820 a929 d011 7008 3040 1822 6000 612e d011
0830 7008 3040 182e 6000 610e d011 7008 3040
0840 183a 4901 2768 601e 611e a8d8 d01e 6032
0850 d01e 610e 602a d01e 600e d01e 00ee 4c06
0860 1a40 3c16 1874 19ec 4600 1882 4b0e 6001
0870 4b2a 6001 4600 1882 3c26 1882 27a4 4b32
0880 601a 4000 165e 6102 e19e 18a4 f118 7001
0890 7c0f 7d01 6e2c 4d01 6e30 30df 18a4 6000
08A0 7b04 7cfe 4001 165e 16ca a975 6000 6100
```

```
08B0 f055 a990 f155 2a14 6b02 6c26 6d00 6e0c
08C0 6a00 a8fe dbcb a91e 6039 6103 d01b 6720
08D0 6007 a95e da07 00ee fe02 0002 0002 0002
08E0 0002 0002 0002 3030 1078 1010 2824 3030
08F0 1078 102a 4420 1818 103c 10a8 4408 1818
0900 103c 1010 2848 1818 5438 12fe 8000 3030
0910 1030 5010 1030 3030 2030 2820 2030 1c2c
0920 3c3c 9cfc 7c1c 1c38 78ff 3854 9292 9254
0930 3838 44a2 928a 4438 3844 82fe 8244 3838
0940 448a 92a2 4438 1818 101c 1018 0400 1818
0950 1418 1010 0804 3030 5438 90fe 0200 c1c1
0960 81e1 8181 c110 d1ff 088b f728 7a54 a854
0970 a854 a854 a807 00ff a990 f165 7101 3108
0980 198a 6100 7001 4064 1e6c a990 f155 16da
0990 ---- ---- ---- 6f0a 81b0 81f5 3f00
09A0 198a 6100 4600 16c2 6fd6 81f4 3f01 169c
09B0 4601 16c2 169c 81c0 80c0 7010 29e4 dbcb
09C0 29e4 db18 7101 29e4 9100 19d0 db18 19c0
09D0 a965 4600 a968 7105 db13 6020 6404 61a0
09E0 2b08 1a8b a916 4600 a90e 00ee 4b1c 19b6
09F0 4b1e 19b6 4b20 19b6 4b30 19b6 4b32 19b6
0A00 4b34 19b6 3901 1868 4b12 19b6 4b28 19b6
0A10 2794 1868 a7ba 6120 6200 6432 6507 f555
0A20 6424 f555 6418 f555 a931 d457 6424 d457
0A30 6432 d457 00ee 4b18 19b6 4b22 19b6 00ee
0A40 4b02 1b16 4b0c 19b6 4b0e 19b6 4b10 19b6
0A50 4b28 19b6 4b2a 19b6 4b2c 19b6 4901 2a36
0A60 3b06 1862 27e0 dbcb 1a8b 6007 80c5 3f01
0A70 1a7a 6519 4b02 6523 1a84 6017 80c5 6505
0A80 4f01 650f a990 f065 8505 4f00 6500 1b4c
0A90 6318 6400 a994 f133 f265 f029 d345 f129
0AA0 7305 d345 f229 7305 d345 6288 f215 f207
0AB0 3200 1aae 1b62 6410 2a8e 2a8e 1a6a 600e
0AC0 6150 2b08 6160 2b08 6007 6148 2b08 600e
0AD0 6150 2b08 6160 2b08 00ee 6014 6140 2b08
0AE0 2a8e 600a 6156 2b08 600c 6140 2b08 6010
0AF0 2b08 2a8e 00ee 613a 2b08 600a 6145 2b08
0B00 6018 6140 2b08 00ee f418 f100 f015 f507
0B10 3500 1b0e 00ee 6014 27e0 dbcb 6420 2ada
0B20 1a6a 8040 70fc 80b5 3f00 00ee 8040 7005
0B30 80b5 3f01 00ee 8050 70f9 80c5 3f00 00ee
0B40 8050 7006 80c5 3f01 00ee 1a8b a992 f165
0B50 7001 8154 3003 1b5c 6000 7901 a992 f155
0B60 1a90 3902 1646 6008 e09e 1a66 1644
```



## 3D MAZE

Peter Easdown, Kew NSW

This program is a three dimensional maze game for the hires screen, but can only be used on a '660' which has been modified to obtain a 64 x 64 pixel display. See Bill Kreykes article 'Experimenter's modifications to the '660' in ETI, February 1984.

The aim is to collect as many treasures as possible and make your way to the exit. When the program is run it displays a title page and asks you to press key '1'. The keys are then displayed with a description of what they do. A more detailed description of the keys is:

Key '8' will move you forward one step in the direction you are facing.

Key '4' will turn you around on the spot in 90° intervals to the left.

Key '6' will turn you around on the spot in 90° intervals to the right.

Key '2' will turn you around in a 180° arc so that you now face the directly opposite direction.

Key 'A' will show your position on the map which is conveniently on the screen at all times. This help call can only be attained once. Just press key 'A' again to get out of this mode.

Key 'F' will quit the game, but first it will ask 'SURE?'. If you do intend to quit just press 'F' again, otherwise press any other key.

The screen is divided into three main sections, A, B and C. A is where you look to see the 3D representation of where you are. B is the map of the maze with the exit at the top of the screen. C is the message area.

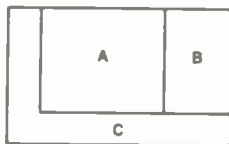

Screen layout. Diagram out of scale.

When playing there are always four treasures somewhere in the maze. When you come across one a box will appear on the ground (in the 3D picture) and the word 'TREASURE' will flash across the bottom of the screen. To take the treasure simply press Key 'D'.

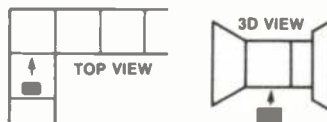

In these diagrams you are looking in the direction of the arrow from the point marked by the black box.

There is always one dud treasure in the maze; although all treasures have some magical property, the dud has the worst. When you take a dud, (you don't know it's a dud until you do) the words 'DUD TREASURE' will flash across the bottom of the screen and all of your treasures, including the dud, disappear and reappear elsewhere in the maze. The magical properties of the other treasures aren't as bad; sometimes they will just turn you around.

The routines that draw the 3D images are located from 0616-071C and from 0F10-0F62. These routines simply plot lines to make parts of the images.

The map is not really there to help you; it's the key to working out what type of room you are in. The routine located at 086A-0974 and 0F64-0FF8 plots small shapes on the map at your location to work out what type of picture to draw; it is then drawn by doing the appropriate picture routines. Unfortunately, by using this method you can usually see where you are.

As the program needed utmost speed and the map was needed at all times I couldn't afford to clear the

whole screen for each move, so I wrote a MCSR to clear just the picture section of the screen. I have supplied a disassembled listing for those who understand the 1802 instruction set. With minor changes it could be made to clear any portion of the screen, or even to fill portions of the screen.

When playing the game the picture could be a bit misleading. When you come to a junction of any type you will first see it from a distance. Remember, you may not turn immediately down the other passage, you must first go forward to the junction then turn to face the way you wish to go.

Due to the length of the program I will copy it onto a tape for anyone who is interested. Just send your name and address to Peter Easdown, c/- Post Office, Kew NSW 2439 with \$6 which covers postage and the cost of a good quality tape.

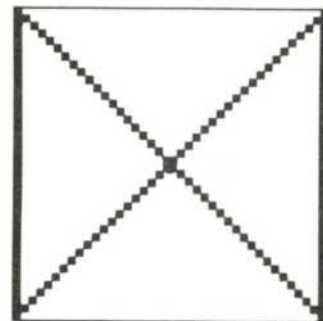

No junction. Passage just leads on.

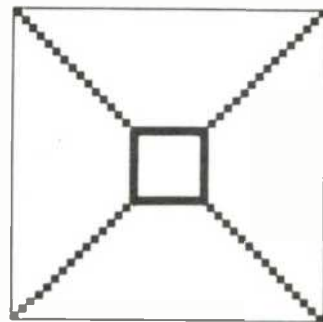

Dead end.

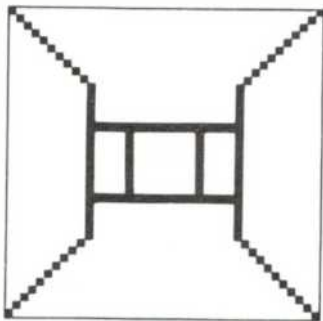

Junction. Turns left and right.

## 3D MAZE

600	1D3C	6100	A85B	6005	D011	00FF	00FF	7101	7C0	0F0F	0F0C	0F0C	0F0F	417F	7F00	7777	F007
610	3128	1606	1BC6	610F	A85B	6014	D011	601D	7D0	FCFF	DFC3	DB1B	FBFB	3BFB	03FF	6028	6100
620	D011	7101	3119	161A	6015	610F	D011	6118	7E0	A976	D01F	A773	7008	D01F	7008	A782	D01F
630	D011	7001	301D	162A	00EE	6006	6101	652B	7F0	710F	A7AF	D01F	70F8	A7A0	D01F	70F8	A791
640	A85B	D011	D511	7001	7101	75FF	310F	1642	800	D01F	710F	A7BE	D01A	7008	A7C8	D01A	7008
650	6006	6126	652B	D011	D511	7001	71FF	75FF	810	A7D2	D01A	0DEE	1F23	45F9	8A8C	F800	C00F
660	3118	1656	00EE	6014	A64D	F055	6013	A661	820	702D	C11F	A9D2	D011	3F00	1985	1C5C	281E
670	F055	263A	600F	A64D	F055	6018	A661	F055	830	8700	8810	00EE	281E	8900	8A10	00EE	281E
680	00EE	600F	610A	A85B	D011	7101	311E	1688	840	8B00	8C10	00EE	281E	8D00	8E10	00EE	6013
690	6010	610F	6518	D011	D051	7001	3014	1696	850	611F	A816	D017	00EE	C040	C080	40C0	80C0
6A0	00EE	602B	6101	6526	A85B	D011	D051	70FF	860	E040	40E0	40C0	4080	C080	4600	18D6	4601
6B0	7101	75FF	301D	16AA	6006	6101	6526	D011	870	1912	4602	1944	8020	8130	70FF	71FF	A867
6C0	D051	7001	7101	75FF	300F	16BE	00EE	6022	880	D013	3F01	18C6	D013	1FD2	D012	3F01	18CA
6D0	610A	A85B	D011	7101	311E	16D4	601E	610F	890	D012	7101	A85A	D012	3F01	18CE	D012	A85E
6E0	6518	D011	D051	7001	3022	16E2	00EE	6006	8A0	D011	3F01	18D2	D011	2616	163A	00FF	2616
6F0	6101	6526	A858	D011	D051	7001	7101	75FF	8B0	198A	00FF	2616	26EE	16CE	00FF	2616	26A2
700	3014	16F6	602B	6101	6526	D011	D051	70FF	8C0	1682	00FF	1666	D013	18AC	D012	18B2	D012
710	7101	75FF	3022	170A	00EE	26B8	170A	F804	8D0	18BA	D011	18C2	8020	8130	700F	71FF	A860
720	BEF8	81AE	F800	5E1E	8EFA	0FFF	0532	388E	8E0	D012	3F01	190E	D012	1F64	D012	3F01	18CE
730	FA0F	FF0D	3238	3024	1E1E	1E1E	9EFF	053A	8F0	D012	7001	A85A	D012	3F01	18CA	D012	A85E
740	248E	FA0F	FF01	3A24	8EFA	FOFF	C03A	24F8	900	D011	3F00	18A6	18D2	00FF	D011	1602	D012
750	04BE	F880	AE0E	FAFC	5E1E	1E1E	1E1E	0EFA	910	18AC	8020	8130	71FF	A864	D013	3F01	18C6
760	0F5E	1E1E	1E9E	FF05	3A55	8EFA	FOFF	C03A	920	D013	1F8E	D012	3F01	18CE	D012	7101	A858
770	55D4	FFFF	F007	FFFF	8F8F	EF80	FFFF	00DF	930	D012	3F01	18CA	D012	7001	A85E	D011	4F01
780	08DF	FF01	7F77	7741	5D5D	5DDD	D11F	F003	940	18A6	18D2	8020	8130	70FF	A862	D012	3F01
790	7B0D	0D0D	0D0C	0F0E	0E0E	0E0F	0F0F	0F0F	950	190E	D012	1FB2	D012	3F01	18CA	D012	7001
7A0	DFC0	F7F7	37F0	F7FF	F000	7D7D	455D	5D7B	960	A85E	D012	3F01	18CE	D012	A85E	7101	D011
7B0	1BF8	FFFF	1FDF	C3DF	1FB8	FBFB	03DF	0F0F									



# CHIP 8 COLUMN

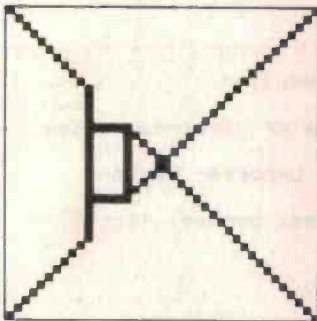

Junction. Turns left and leads on.

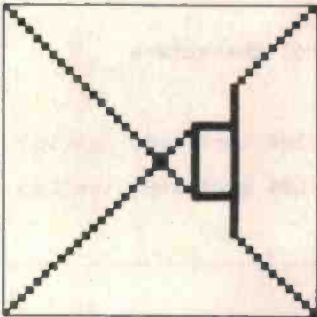

Junction. Turns right and leads on.

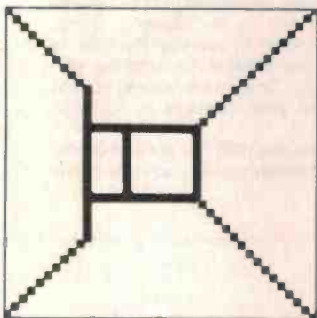

Junction. Turns to the left.

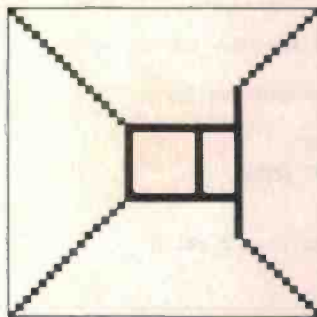

Junction. Turns to the right.

970	4F01	18A6	18D2	0D0D	0C0D	0D0D	0D0D	0D0D	C80	F029	D675	7604	F129	D675	7604	F229	D675
980	0D0C	0D0D	0DD0	1118	1E31	271A	2682	16CE	C90	6600	7706	2A2C	6706	6620	AA10	29C0	2A20
990	5270	1998	9380	1B60	5290	19A0	93A0	1B60	CC0	0000	E79F	06DD	88A8	2A22	BFDA	F7DB	E54F
9A0	52B0	19A8	93C0	1B60	52D0	00EE	93E0	1B60	CE0	F3CF	F7DB	E92E	BFDA	0820	0000	F24F	F6DF
9B0	00EE	0F13	3801	E018	0335	A9B2	F755	00EE	CF0	924F	924F	F3CF	F24F	E925	0000	F7DB	924F
9C0	F165	A9F8	8200	8310	64E0	6580	29F2	8020	D00	924F	E925	F7EB	F3CF	F7DB	711D	B6DE	F7EB
9D0	29EC	8020	8004	8152	3100	7001	29E8	8030	D10	E3CF	711D	F7DB	F6DA	D6DD	F3CF	711D	F24F
9E0	29F0	8030	29EA	1A62	8004	8004	8004	8004	D20	F7DB	F7C8	F3CF	0003	F7C8	F7EB	F3CF	711D
9F0	8004	8042	F055	DOEE	6080	4020	COA0	F7DB	D30	711D	0000	9000	9248	9000	0003	6610	6700
A00	D6DD	F3CF	B7DA	B75A	924F	F6DF	F7C8	F7EB	D40	6800	ACD2	F81E	29C0	2A20	7802	3810	1D42
A10	711D	E925	B6DE	B7A5	E789	4905	0003	0028	D50	770C	6600	ACD2	F81E	29C0	2A20	7802	3830
A20	D675	7604	00EE	29BA	6610	672B	AA12	29C0	D60	1D54	7706	6614	ACD2	F81E	29C0	2A20	7802
A30	2A20	AA0E	29C0	2A20	AA02	29C0	2A20	A9FE	D70	3842	1D66	7706	6614	ACD2	F81E	29C0	2A20
A40	29C0	2A20	AA10	29C0	2A20	AA14	29C0	2A20	D80	7802	3848	1D78	7604	ACD2	F81E	29C0	2A20
A50	AA0E	29C0	2A20	AA02	29C0	2A20	A9B2	F765	D90	7802	3856	1D88	770C	660C	ACD2	F81E	29C0
A60	00EE	A9F8	00EE	29BA	6600	672B	AA0A	29C0	DA0	2A20	7802	386A	1D9A	FO0A	3001	1DA8	00B0
A70	2A20	AA06	29C0	2A20	AA1C	1A58	29BA	6600	DB0	6618	6700	6800	2B3C	29C0	2A20	7802	3808
A80	672B	AA00	29C0	2A20	AA14	29C0	2A20	AA00	DC0	1DB6	7706	6600	2B3C	29C0	2A20	7802	3828
A90	29C0	2A20	7604	1A2C	29BA	6610	6700	AA10	DD0	1DC6	7706	6600	2B3C	29C0	2A20	7802	3842
AA0	29C0	2A20	AA14	29C0	2A20	AA0E	29C0	2A20	DE0	1DD6	6600	7706	2B3C	29C0	2A20	7802	385E
AB0	AA02	29C0	2A20	AA18	1A58	29BA	6600	672B	DF0	1DE6	7706	6600	2B3C	29C0	2A20	7802	3878
AC0	AA16	29C0	2A20	AA0A	29C0	2A20	AA14	29C0	E00	1DF6	7706	6600	2B3C	29C0	2A20	7802	3898
AD0	2A20	7604	A9FE	29C0	2A20	AA0E	29C0	2A20	E10	1E06	7706	6600	2B3C	29C0	2A20	7802	38B8
AE0	AA02	29C0	2A20	7604	AA04	29C0	2A20	AA02	E20	1E16	7706	6600	2B3C	29C0	2A20	7802	38C8
AF0	29C0	2A20	AA0E	29C0	2A20	AA02	29C0	2A20	E30	1E26	FO0A	3001	1E32	00E0	1602	AE42	F81E
B00	AA1A	1A58	29BA	6600	672B	AA10	29C0	2A20	E40	00EE	B75A	F3CF	B7A5	711D	F7DF	0820	0000
B10	AA0C	29C0	2A20	AA08	29C0	2A20	A9FE	29C0	E50	BFDA	F6DF	B6D5	F3CF	0000	F349	F6DF	F7EB
B20	2A20	AA12	29C0	2A20	1B00	6000	610A	AF00	E60	B7FA	F7DB	F7EB	D6DD	0003	96F3	0820	0000
B30	F11E	FO55	7101	3110	1B2E	1BB2	AFOA	FO65	E70	E925	B6DE	F7EB	F6DA	0800	924F	F3CF	F349
B40	3000	00EE	6001	2C60	2ABA	A9DE	D231	F200	E80	E925	0003	F3DF	0820	0000	E925	B6DE	F7EB
B50	F218	D231	600A	EOA1	1B5C	1B4C	2ABA	00EE	E90	F6DA	0000	F7EB	E92E	F2DF	B7DA	E925	0003
B60	2A26	284E	1A26	FO55	2A7C	00EE	5270	1B74	EAO	E7CF	0820	0000	E925	B6DE	F7EB	F6DA	0000
B70	9380	1BA8	5290	1B7C	93A0	1BA2	52B0	1B84	EBO	4925	F7DF	F6DF	F780	0003	F7DB	0820	0000
B80	93C0	1B9C	52D0	00EE	53E0	00EE	284E	2846	ECO	711D	B7DA	F6DF	B7FA	0000	924F	F6DF	F24F
B90	AFOB	FO65	7001	AFOB	FO55	00EE	284E	283E	EDO	F7DB	E925	E92E	F6DF	F6DA	D6DD	0820	0000
BA0	1B90	284E	2836	1B90	284E	2A7C	AFOB	6000	EE0	E925	F7DB	B75A	F3CF	0000	E925	F7EB	F3CF
BB0	2B66	2846	283E	2836	282E	00EE	2A98	FO0A	EFO	F7DB	711D	B6DE	F7EB	F3CF	F349	0820	0000
BC0	300F	00EE	1C74	27DC	6308	622E	6603	2B2A	FO0	F6F4	B6DE	E92E	E925	0003	0000	0000	0000
BD0	071E	286A	2A66	2C66	2A66	400D	2B6C	400F	F10	2666	600F	610A	651D	A85B	DO11	DO51	7001
BE0	2BBC	400A	2B3C	4004	76FF	4006	7601	4002	F20	7101	75FF	3015	1F18	2682	6014	610F	A85B
BF0	2C00	4008	2C1E	46FF	6603	4604	6600	1BD0	F30	DO11	7101	3119	1F2F	00EE	2666	601D	610F
CO0	3600	1C08	6602	00EE	3601	1C10	6603	00EE	F40	6518	A85B	DO11	DO51	7001	71FF	7501	3023
C10	3602	1C18	6600	00EE	4603	6601	00EE	4600	F50	1F42	26CE	601D	610F	A85B	DO11	7101	3119
C20	73FF	4601	7201	4602	7301	4603	72FF	A9D2	F60	1F58	00EE	1FF2	A864	DO13	3F01	1F80	DO13
C30	D231	4F01	1C3A	D231	1C6C	D231	4600	7301	F70	7001	A867	DO13	3F01	1F84	DO13	A858	1F88
C40	4601	72FF	4602	73FF	4603	7201	2B04	6080	F80	DO13	1F10	DO13	1F3A	70FF	7101	18EA	A862
C50	FO15	FO07	3000	1C52	2B04	00EE	DO11	00EE	F90	DO12	3F01	1FAA	DO12	7101	A860	DO12	3F01
C60	AFOA	FO55	00EE	2990	FO0A	00EE	322E	00EE	FA0	1FAE	DO12	A85C	71FF	1924	DO12	1F10	DO12
C70	3301	00EE	00E0	6600	6700	AA16	29C0	2A20	FBO	1F3A	A864	00FF	DO13	3F01	1F84	DO13	7001
C80	AA0A	29C0	2A20	AA14	29C0	2A20	7604	AA12	FC0	A867	DO13	3F01	1F80	DO13	70FF	00FF	A85C
C90	29C0	2A20	AA0A	29C0	2A20	2A20	AA06	29C0	FDO	1956	70FF	A862	DO12	3F01	1FAE	DO12	7101
CA0	2A20	7604	AFOB	FO65	AFOC	FO33	AFOC	F265	FEO	A860	DO12	3F01	1FAA	DO12	71FF	7001	A85E
									FF0	188A	4301	1F7C	71FF	1F66	0000	0000	0000

## CLEAR SCREEN ROUTINE

71E	LDI	04	F804						74B	SMI	CO	FFCO	75E	LDN	E	OE
720	PHI	E	BE	736	BR	24	3024	74B	SMI	CO	FFCO	75F	ANI	07	FA07	
721	LDI	81	F881	738	INC	E	1E	74D	BNZ	24	3A24	761	STR	E	5E	
723	PLO	E	AE	739	INC	E	1E	74F	LDI	04	F804	762	INC	E	1E	
724	LDI	00	F804	73A	INC	E	1E	751	PHI	E	BE	763	INC	E	1E	
726	STR	E	5E	73B	INC	E	1E	752	LDI	80	F880	764	INC	E	1E	
727	INC	E	1E	73C	GHI	E	9E	754	PLO	E	AE	765	GHI	E	9E	
728	GLO	E	8E	73D	SMI	05	FF05	755	LDN	E	OE	766	SMI	05	FF05	
729	ANI	OF	FA0F	73F	BNZ	24	3A24	756	ANI	FC	FAFC	768	BNZ	55	3A55	
72B	SMI	05	FF05	741	GLO	E	8E	758	STR	E	5E	76A	GLO	E	8E	
72D	BZ	38	3238	742	ANI	OF	FA0F	759	INC	E	1E	76B	ANI	FO	FAFO	
72F	GLO	E	8E	744	SMI	01	FF01	75A	INC	E	1E	76D	SMI	CO	FFCO	
730	ANI	OF	FA0F	746	BNZ	24	3A24	75B	INC	E	1E	76F	BNZ	55	3A55	
732	SMI	OD	FF0D	748	GLO	E	8E	75C	INC	E	1E	771	SEP	04	D4	
734	BZ	38	3238	749	ANI	FO	FAFO	75D	INC	E	1E					

(RETURN)



## LINE INPUT

P. Lukes, Toowoomba Qld

The MicroWorld INPUT function is rather limited. It will not accept embedded commas or quotes, and worse still, it accepts the codes for ESC and TAB without any visual indication. This applies both to string and numeric input. For INPUT K, enter '1 TAB 2', and the result will be '182'. A string can have these codes unknowingly embedded in it and then fail a test for equality or length.

The following routine can avoid these problems. The I0\$ is a dummy, which is not used for further processing. L0\$ is the correct input, and it is assembled by taking the valid characters directly from the I/O buffer starting at 1832 dec., and terminated when Carriage Return is encountered. In a running program it would be advisable to set the dummy to null immediately after input (INPUT I0\$:I0\$=""), to avoid cluttering up the string space.

Once the normally prohibited quotes and commas are in the string, there is no problem with further processing and the string can be printed to tape or printer. It can be re-INPUT from tape by using the same procedure.

The assembly of long strings takes some time, but the routine could be speeded up by compressing it or coding it in machine language. The KEY function could be used to accept any valid keyboard input, but it would not work with tape input.

```
01000 cls:Print"MicroBee 'LINEINPUT' LKS 840314"
01010 I0$="":on error goto 1040:rem In case of unpaired quotes
01020 B=1832:L=184:rem B=I/O buffer start, L=buffer length
01030 Print"Input string with leading spaces, commas, quotes : "
      :input I0$
01040 Print:L0$="":for A=B to B+L:K=peek(A)
01050 if K=13 then next* A 1090:rem Exit on CR
01060 if K>96 and K<123 then let K=(K and 95)
      :rem Convert letters to upper case (optional)
01070 if K>31 then let L0$=L0$+chr$(K)
      :rem Assemble lineinput without control characters
01080 next A
01090 Print"INPUT : "      tab(20) chr$(190) I0$ chr$(188) len(I0)
01100 Print"LINEINPUT : " tab(20) chr$(190) L0$ chr$(188) len(L0)
01110 goto 1030
```

## BANNER

M. Anderson, Perth WA

The program uses the PCG RAM to print a one line message by testing the bits of the first, second, third, etc, bytes of all the characters in the message, and printing that character if the respective bit is set.

Using the PCG RAM instead of the character ROM means that you can print your own oversized PCG characters by making the modifications described (as is, the program is configured to invert inverse characters).

With a bit of ingenuity, I managed to print a poster size picture of the man in the 'Roulette' game, (Microbee demo cassette) by running 'Roulette' to setup the PCG, and then BANNER to print the relevant characters (encl.). To print preceding spaces you will need to put your message in quotation marks.

The Z80 code subroutine (RBIT) is poked from the DATA in line 230 and simply rotates each byte to test the next bit.

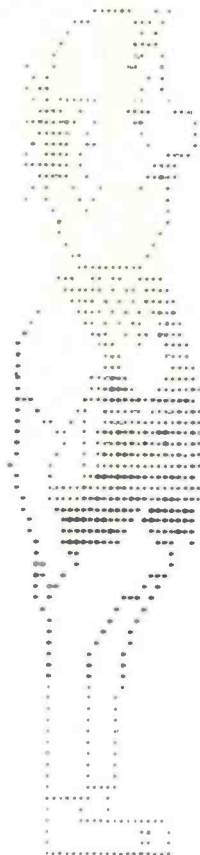

```
00100 REM BANNER B=I-G printing for little printers !
00110 REM - by MJ Anderson
00120 REM The USR function in line 220 assumes the pcg chrs are
00130 REM initialised to INVERSE. To print large PCG chrs., change
00140 REM the IF USR(7000) statement in line 220 to IF NOT USR(7000)
00150 REM and to print control chrs., change the CHR(L) to ""*
00160 PRMT( ):INPUT "Output to device#":D:OUTL#D:CLS
00170 IF D=0: M=64 ELSE LET M=80 :REM # chrs/line, 64 for VDU, 80 for others
00180 M=M/8:FOR I=7000 TO 7018:READ J:POKE I,J:NEXT I
00190 CURS 0:INPUT "MESSAGE ":M0$:IF LEN(M0$):M:PLAY1:GOTO 190
00200 FOR I=0 TO 15:FOR J=1 TO LEN(M0$)
00210 L=ASC(M0$(J,J)):P=63489+L*16+I:POKE 7018,PEEK(P)
00220 FOR K=0 TO 7:IF USR(7000):LPRINT " "; ELSE LPRINT CHR(L):
00230 NEXT K:NEXT J:IF LEN(M0$)(M):LPRINT
00240 NEXT I:LPRINT:GOTO 190
00250 DATA 58,106,27,203,23,50,106,27,48,4,1,255,255,201,1,0,0,201,0
```



**BOOK REVIEW**

**Wildcards, Volume Two**, by Peter Ford, Ash Nallawalla and Bob Burt; published in 1983 by BF & N Publishing, P.O. Box 85, Williamstown Vic. 3016.

**Wildcards, Volume Two**

Tom Moffat, Fern Tree, Tasmania

*Wildcards, Volume Two*, is a follow-on from the original *Wildcards* (obviously); a collection of tips and tricks for the Microbee, combined with some solid instruction in programming, both in BASIC and machine code.

It's just as good as the first volume, although not quite as 'startling' — the first *Wildcards* hit like a bombshell, giving the MicroBee user a much needed dose of instruction where virtually nothing existed before.

*Wildcards, Volume Two*, now has the unenviable task of following its own act. But the authors have launched into the task and produced another winner.

Starting off the new book are a few machine code routines just to whet the Microbee user's appetite. One I tried was a routine to make the screen dissolve away to all spaces (blanks), with each displayed character decrementing down to the finish.

The effect is dramatic, as the book claims, but it looks suspiciously like my screen does when the computer crashes. So I don't think I'll be using the effect as a permanent feature in my programs — it's too scary! There are also some routines to scroll the screen left and right.

After a few 'hints and kinks' *Wildcards, Volume Two*, gets into its main instructional feature — a good discussion of sorts and shuffles. It uses a series of BASIC programs to demonstrate how various types of sorts work, with most of the action taking place on the screen so you can see what's happening.

I tried out the first program, and it worked straight off. It takes a random series of numbers and puts them in order. When the program runs, the list of numbers appears in a vertical line down the centre of the screen, with a message off to the side saying 'Sorting...'. The numbers then begin to change position before your very eyes! But seriously, it's a good demonstration of how the sort works, with the column of numbers eventually ending up in order.

The chapter progresses through string sorts, exchange sorts, shell sorts, to a quick sort. They all start with the first program and modify or build on it, saving the instructee a lot of typing.

The chapter finishes with a couple of shuffles, which are really sorts in reverse. One thing missing, I feel, is a discussion of searches in the same chapter.

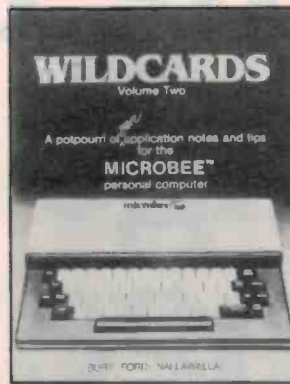

Without even asking we received two reviews of this book. Tom Moffat, in Tasmania, and Mike Hennessy, in Papua New Guinea, have given us their opinions — now you can make up your mind about this book.

It seems they should all go together, somehow. Maybe in the next volume.

The 'Applications' chapter presents several 'useful' as compared to 'demonstration' programs. Among them are routines to convert Microbee BASIC programs to and from NOS-BASIC. This

**Wildcards, Volume Two**

Mike Hennessy, Lae, Papua New Guinea

The authors claim the book is a potpourri of application notes and tips for the Microbee personal computer, and it is just that.

This volume has fallen together in a better organised fashion than Volume One, which was obviously a rush job. The quality of the printing is also far superior to the earlier volume.

Nine chapters are presented; some are tantalisingly short e.g. machine language, and some are laboriously long, e.g. sorts and shuffles. There is less of a tendency to scatter short routines throughout the book, and 39 programs are listed in the rear index to keep you busy for a very long time.

The best part for the machine language buffs is the extensive memory map of the Microbee in the appendix. The section of sorts and shuffles became a bit involved. The routines presented were all well known as algorithms, e.g. shell sort, shuttle interchange, the differences being that they have been coded in Microworld BASIC and machine language, and applied in suitable demonstration programs i.e. Card Shuffle.

In the chapter on applications an excellent sound

generator program is presented that should enable you to produce a range of sound effects for your programs. Other applications include a spread sheet and data base — all lengthy programs but worthy of the effort of keying them in.

The utilities chapter is far too brief, the most useful listings being the screen dumps for the C-10th 8510A and Star DP-510 printers. Nothing new was presented in the chapter on graphics, although some good demonstration programs using recursive plotting were presented.

There is a fair section on conversion between Microworld and other BASICs, with several pages devoted to NOS-BASIC that tended to become a bit esoteric. This appeared to be a pet hobby horse of one of the authors.

What's missing? Well, there is nothing on the use of colour; and disk drives, modems, flight pens and other peripherals receive only a passing mention.

I received the Impression the authors were struggling to fill this volume and my suspicions were confirmed when I discovered the questionnaire and the plea for program submissions at the end of the book.

At \$16 I thought the book expensive but a must for Microbee enthusiasts. If there is a *Wildcards Volume Three* my suggestion is that it be accompanied, as an option, by a cassette of the programs in the book.

**DYNAMIC PCG DISPLAY**

H. Beilharz, Kareela, NSW

This little program allows you to see the programmable character generator (PCG) working while a program is running. I have found it invaluable for debugging graphics programs.

Lines 100 to 140 change the start of screen pointer in the 6545 VDU chip so that we shift the screen by two lines, i.e. we lose the top two lines of the normal screen and insert two new lines at the bottom. This

means that the bottom two lines will not be affected by scrolling or clear screen (CLS). The main disadvantage is that we miss what is happening on the top two lines of the normal screen. This is no problem with the BASIC prompt, just press Return twice to move the prompt down. The real problem is that error messages usually appear on these two top lines, still we can't have everything can we?

Lines 150 to 170 poke characters 128 to 255 into the two new lines.

Type in the program, then RUN it. Now it can be deleted as the screen will stay set up until RESET

(warm start). Now to test, type INVERSE then UNDERLINE then LORES and watch the character set change. Now load any program that uses HIRES graphics to really see the PCG in action.

```
100 DATA 120,211,12,121,211,13,201
110 FOR A=0 TO 6
120 READ I:POKE 63000+A,I
130 NEXT A
140 USR(63000,3456)
150 FOR A=0 TO 127
160 POKE 62464+A,128+A
170 NEXT A:END
```



# Meeting the challenge of change



Four award winning models to choose from.

microbee really is "meeting the challenge of change" with two ROM and two DISK based models, each guaranteed expandable to any level. From arcade games through to word processing and business management, you can choose the level of development to suit your needs.

Tomorrow looks equally bright for microbee owners . . . . with new technology and advances . . . . with reports and literature on new software and peripherals . . . . and with training courses for each level of development.

HI RES Economy Green Screen Monitor



## 16K Educator \$449

Now with WORDBEE!

The microbee Educator is specifically designed for the education market and has been chosen by NSW, Western Australia, Queensland and the Australian Schools Commission as a computer for use in schools.

microbee Educator boasts high quality graphics and sound effects capability, exceptional performance at a realistic price plus powerful software designed for Australian curriculum needs.

## 32K Personal Communicator \$499

microbee's top selling portable computer now features:

Telcom 1 firmware WORDBEE, Microworld BASIC, machine code MONITOR, ADM-3A terminal emulation, self-test in 28K of ROM with 32K of CMOS battery backed user memory, high resolution PCG GRAPHICS, SERIAL AND PARALLEL I/O ports, programmable cassette interface and direct monochrome video output.

A vast library of educational, entertainment and utility software is now widely available.

Microworld BASIC supports full high resolution graphics, colour if required, music, I/O data can be directed at will and best of all, MW BASIC is a breeze to program yourself.

The low cost

BEEMODEM can be added enabling your microbee (via your phone line) to communicate with other computers worldwide!

## Software and your microbee

Whichever microbee model you choose there is a vast and growing array of software to use with it . . . . some built-in and included in the price of your computer. Games and family entertainment, education programmes, communication, information systems, personal and business finance, word processing and much, much more.

Ask at your microbee Computer Centre for the current range of software included with each model or ask for the catalogue of "Software Available".

## Options and Peripherals

Advanced "State of the Art" peripherals and options are available to interface with your microbee such as:

- microbee HI RES Economy Green Screen Monitor . . . \$149.50
- Adjustable Monitor Stand . . . \$19.95
- BEEMODEM . . . . . \$149.50
- microbee MB80 Dot Matrix Printer Parallel . . . . . \$399.00
- Serial . . . . . \$449.00 (Includes cables)
- microbee High Resolution Anti Glare Ergonomically Designed Amber Screen Monitor . . . \$249.00



# Now with Dynamic RAM to meet today's user demands

## 64K Advanced Personal Computer

(with Single 400K Disk Drive  
and all manuals) **\$1,595**

The microbee 64K Advanced Personal Computer with a Single 400K Disk Drive is the ultimate configuration for the serious enthusiast.

It is supplied 'bundled' with world class software such as CP/M, MICROSOFT BASIC, MULTIPLAN, WORDSTAR and a powerful library of support programs. Comprehensive user manuals are also supplied. No wonder this model microbee is regarded as the most powerful and best price/performance computer in its class.

## microbee 128K

(with Dual 400K Disk Drives  
and all manuals) **\$1,995**

Designed for the serious home and small business user, the package consists of the microbee with 128K of dynamic RAM controlled by the proven Z80A processor plus a dual 400K disk drive, with the increased power more sophisticated programs can be executed including a whole host of bundled software for word processing, terminal emulation and communication with other computers worldwide, spreadsheet analysis and networking.



**microbee 128K  
Computer with  
Dual Disk Drive**

### microbee computer centres

1 Pattison Ave,  
Waitara 2077, N.S.W.  
Phone (02) 487 2711

729 Glenferrie Rd,  
Hawthorn 3122, Vic.  
Phone (03) 819 5288

141 Stirling Highway,  
Nedlands, W.A.  
Phone (09) 386 8250

Coolman Court,  
Weston A.C.T. 2611.  
Phone (062) 88 6384

151 Unley Road,  
Unley 5061, S.A.  
Phone (08) 272 1384

455 Logan Road,  
Stones Corner, Qld 4120  
Phone (07) 394 3688

Koala Crescent,  
West Gosford 2250.  
Phone (043) 24 2711

Authorised Dealers in:—  
**NSW:** Carlingford,  
Coffs Harbour, Concord,  
Hurstville, Lismore,  
Sydney.

**QUEENSLAND:**  
Townsville, Cairns,  
Milton.

**VICTORIA:**  
Melbourne.

**SOUTH AUSTRALIA:**  
Adelaide, Edwardstown,  
Port Lincoln.

**WESTERN  
AUSTRALIA:**  
Mount Tom Price.

**TASMANIA:**  
Launceston

**ACT:**  
Belconnen, Weston.



**microbee**

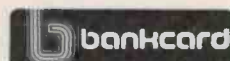

welcome here

**DIRECT ORDERS  
PHONE (02) 487 2711  
TELEX AA72767**

**APPLIED  
TECHNOLOGY  
RETAIL PTY LTD**



# LANDER

M. Spiteri, Seaford Victoria

Another version of those perennial lander programs that exercise the minds of computer users from six to sixty.

This one features user definable graphics and uses the keyboard (A,W,D,X) to control the craft. Fuel is divided into 45 units.

VIC 20

```
5 PRINT"PLEASE WAIT...."
10 GOSUB1000
20 POKE36879,8:PRINT"SUFR LANDER"
21 PRINT"=====
30 PRINT"YOU HAVE TO LAND YOUR SPACECRAFT
ONTO THE
35 PRINT"LANDING SPOT. YOU HAVE 45 FUEL TANKS"
40 PRINT"WHICH RUN OUT QUICKLY. YOU HAVE
TO BE FAST"
45 PRINT"WHIT A KEY...."
50 GETA$:IFA$=""THEN50
55 PRINT"GAME ENDS WHEN EITHER
60 PRINT"1) YOU LAND."
65 PRINT"2) YOU CRASH."
70 PRINT"3) YOU RUN OUT OF FUEL"
80 PRINT"4) CONTROLS:"
85 PRINT"UP X:DOWN"
86 PRINT"LEFT D:RIGHT"
87 PRINT"WHIT A KEY TO START!"
88 GETA$:IFA$=""THEN88
90 POKE36878,15:POKE36877,190
100 POKE36879,8:PRINT"FU=45"
110 FORA=8054TO8185:POKEA,1:NEXT:FORB=38774TO38905:
POKEB,2:NEXT
120 FORA=8032TO8039:POKEA,2:NEXT:FORB=38752TO38759:
POKEB,2:NEXT
130 FORA=8043TO8053:POKEA,2:NEXT:FORB=38753TO38773:
POKEB,2:NEXT
140 POKE8040,3:POKE37860,2:POKE8042,4:POKE37862,2:
POKE8041,5:POKE37861,1:P=7747
150 CO=30720
160 PRINT"FU=FU-1"
161 IFFU=0THENFORI=255TO190STEP-1:POKE36876,I:NEXT:GOTO340
170 IFFU<15THENPRINT"FU FUEL SHORTAGE!"
PRINT"POKE36876,190"
180 POKEFCO,5:POKEP,6
190 GETA$
200 IFA$<"W"ANDA$<"A"ANDA$<"X"ANDA$<"D"THEN160
210 POKEP,32
220 P=P+(A$="A")-(A$="D")
230 P=P+(A$="W")*22-(A$="X")*22
240 IFF=8041THENFORI=190TO255:POKE36876,I:NEXT:POKE36877,0:
POKE36876,0:GOTO270
250 IFF=8031THENFORI=255TO190STEP-1:POKE36876,I:NEXT:
POKE36877,0:POKE36876,0:GOTO300
260 GOTO160
270 POKE36879,25:PRINT"WELL DONE!!":PRINT"YOU
LANDED SAFELY!!"
280 PRINT"FU FUEL LEFT":FU:GOTO400
300 FORI=0TO255STEP4:POKE36879,I:NEXT:POKE36879,25
305 PRINT"GAME OVER"
310 PRINT"YOU RECKLESS PILOT!"
320 PRINT"YOU CRASHED!":GOTO400
340 FORI=0TO255STEP4:POKE36879,I:NEXT:POKE36879,25
345 PRINT"GAME OVER"
350 PRINT"YOU ENERGY WASTER!":PRINT"YOU RAN OUT OF
FUEL!":GOTO400
360 PRINT
400 POKE36878,0:POKE36877,0:POKE36876,0:PRINT"ANOTHER GO?"
410 GETA$:IFA$<"Y"ANDIFA$<"N"THEN410
420 IFF$="Y"THEN20
430 PRINT"GOODBYE!"
435 GOTO435
1000 POKE52,28:POKE56,28
1005 FORI=7168TO7679:POKEI,PEEK(I+25600):NEXT:POKE36869,255
1010 FORZ=7176TO7223:READX:POKEZ,X:NEXT:RETURN
1020 DATA255,191,251,255,223,255,247,255
1030 DATA32,98,247,255,247,223,251,255
1040 DATA128,192,224,240,184,236,190,255
1050 DATA1,3,7,13,31,55,125,255
1060 DATA0,0,0,0,126,24,24,24
1070 DATA24,24,60,126,255,219,255,36
```

READY.

READY.

```
0 REM DRIVING TEST
2 PRINT"POKE36879,8:POKE7680,42
3 FORT=1TO22:KL=KL+22:POKE7680+KL,42:POKE7701+KL,42:POKE8164+T,42:POKE7680+T,42
NEXT
5 PRINT"DRIVING TEST":PRINT"
6 PRINT"STEVEN VINNOS":PRINT"ARPAHONG"
7 PRINT"HIGH SCHOOL":PRINT"INSTRUCTIONS":PRINT"KY/N"
8 GETS$
9 IFS$="V"THEN12
10 IFS$="N"THENS$=""GOTO29
11 GOTO 8
12 PRINT"THIS IS A GAME THAT TESTS OUT YOUR SKILLS AT DRIVING."
13 PRINT"YOU HAVE ONLY ONE CHANCE TO GET THROUGH THE TRACK,AS YOU DO IN REA
L LIFE"
14 PRINT"THE KEYS THAT YOU USE TO CONTROL YOUR CAR IS":PRINT"
15 PRINT"K UP:J LEFT:K RIGHT:H DOWN"
16 PRINT"PRESS ANY KEY TO CONTINUE"
17 GETS:IFR$=""THEN17
18 PRINT"THE SPEED YOU TRAVEL AT IS NOT VERY FAST SO YOU SHOULD PASS T
HE"
19 PRINT"WHO IS GOING TO DO THE DRIVING":INPUTS$
20 PRINT"TRY NOT TO HIT ANY OF THE WALLS OR OBSTACLES"
22 PRINT"PRESS ANY KEY TO START"
28 GETS:IFR$=""THEN28
29 PRINT"
30 FORR=1TO20:Q=Q+22:POKE7724+Q,101:POKE7745+Q,103:POKE7724+R,99:NEXT
60 FORB=0TO22:POKE8164+B,100:NEXT:POKE7735,81:POKE7867,81
70 FORS=0TO16:POKE8123+S,67:NEXT:POKE8117,122
80 FORH=1TO15:L=L+22:POKE7770+L,93:NEXT:POKE7770,100:FORH=1TO6:POKE7770+H,64:NEX
T
91:POKE7799,66:POKE7820,64:FORI=1TO5:POKE7861+E,64:NEXT
92 FORP=1TO5:S=S+22:POKE7718+S,66:NEXT:POKE7821,126:POKE8164,123:POKE8185,108
95 POKE8122,124:POKE7745,124:POKE7840,66:POKE7817,64:POKE7816,64:POKE7724,126
110 FORG=1TO10:F=F+22:POKE7816+F,66:NEXT
115 POKE8058,124:POKE7777,123:POKE7818,123:POKE7816,108:POKE7862,124
120 FORV=1TO4:POKE8058+V,64:NEXT:FORI=1TO2:A=A+22:POKE8063+A,66:NEXT
135 POKE8162,27:POKE8161,101:POKE8063,126
140 FORS=1TO2:POKE8016+S,64:NEXT:POKE8019,123
150 FORR=1TO8:A=A+22:POKE7955+A,66:NEXT:FORV=1TO4:POKE7950+V,67:NEXT
166 FORT=1TO4:POKE7928+T,64:NEXT:POKE7950,74:POKE7928,85:POKE8109,81:POKE7955,81
167 POKE7933,81:FORU=1TO2:POKE7867+U,64:NEXT:POKE7870,123:POKE8114,81
168 FORG=1TO10:G=G+22:POKE7849+G,66:NEXT:FORR=1TO9:P=P+22:POKE7870+P,66:NEXT
172 FORI=1TO2:POKE7872+E,64:NEXT:POKE7872,81
174 FORV=1TO2:Z=Z+22:POKE7806+Z,66:NEXT:FORO=1TO2:POKE7803+O,64:NEXT:POKE7806,12
3
180 POKE7741,80:POKE7758,123:POKE7832,95:POKE7786,86:POKE7782,108:POKE7824,123
190 FORT=1TO3:POKE7917+T,64:NEXT:POKE7921,81:FORR=1TO3:POKE7960+R,64:NEXT:POKE79
60,81
200 FORI=1TO3:POKE8005+I,64:NEXT:POKE8009,81
211 FORT=1TO3:POKE8050+T,64:NEXT:POKE8053,81:FORP=1TO2:Q=Q+22:POKE8006+Q,66:NEXT
301 POKE8050,81:POKE8006,81:PRINT"IS DRIVING":POKE36878,15:POKE36875,134
305 POKE36878,15
310 CLR:POKE8160,115
311 TI$="000000"
320 GETS$
321 PRINT"RIGHTS:(TI$,2)
322 IFTI$="000016"THENPOKE7997,78
330 IFR$=""THENR$=H$
340 IFR$="I"THENV=-1:W=113
350 IFR$="J"THENX=-1:W=115
360 IFR$="K"THENX=+1:W=107
370 IFR$="H"THENV=+1:W=114
371 P=(9160+X+22*V)
372 IFR$=""THEN1000
375 IFFPEEK(P)=99 ORPEEK(P)=66ORPEEK(P)=64ORPEEK(P)=103THEN1000
376 IFFPEEK(P)=101ORPEEK(P)=81ORPEEK(P)=108ORPEEK(P)=117ORPEEK(P)=93THEN1000
377 IFFPEEK(P)=126ORPEEK(P)=123ORPEEK(P)=108ORPEEK(P)=124ORPEEK(P)=67THEN1000
378 IFFPEEK(P)=67ORPEEK(P)=85ORPEEK(P)=80ORPEEK(P)=95ORPEEK(P)=86ORPEEK(P)=78THEN
1000
379 IFFPEEK(P)=27THEN1999
390 POKE8160+X+22*V,W
390 FORI=1TO15:NEXT
400 POKE8160+X+22*V,32
410 M$=R$
420 GOTO 320
1000 POKEP,102:FORI=128TO250:POKE36876,I:POKE36875,T:NEXT:POKEP,32
1010 POKE36876,0:POKE36875,0
1020 PRINT"YOU HAVE NOT PASSED THE DRIVERS TEST":PRINT"
1030 PRINT"YOU CRASHED AND KILLED TWO PEOPLE"
1040 PRINT"AND YOU ALSO RAN OVER A BLIND OLD WOMAN WITH A WALKING STICK !!!"
1050 PRINT"YOU WANT ANOTHER GO (Y/N)"
1060 GETS$
1070 IFF$="N"THENEND
1080 IFF$="Y"THEN1086
1085 GOTO1060
1086 PRINT"
1090 PRINT"THIS TIME TRY AND BE A LITTLE BIT MORE CAREFUL"
1100 FORH=1TO2000:NEXT:CLR:GOTO10
1999 POKE36875,0
2000 PRINT"YOU HAVE PASSED A VERY DIFFICULT DRIVING TEST:CONGRATULAT
IONS"
2091 PRINT"CELEBRATING COULD BE A GREAT IDEA!!"
2010 PRINT"YOU WANT ANOTHER GO (Y/N)"
2020 GETA$
2030 IFTI$="N"THENEND
2040 IFTI$="Y"THENCLR:GOTO10
2050 GOTO2020
```

READY.



## DRIVING TEST

Steven Komnlinos

VIC 20

This program utilizes the graphics capacity of the VIC-20 to set up a driving test for your edification and delight. Although it looks easy, the originator claims never to have got to the end.

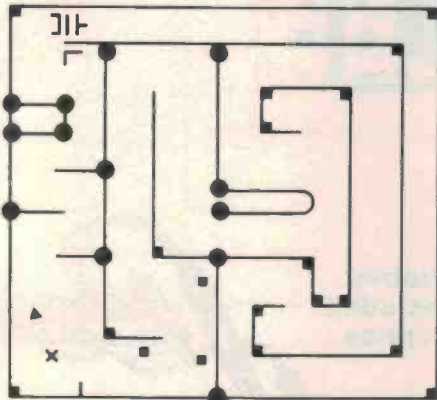

## MESSAGE INVERTER

Keith Zerna,  
Modbury Heights,  
SA.

VIC 20

This program will print your message on-screen upside down! While, at face value, the program is seemingly useless, it is a bit of fun and good for learning about the PEEK and POKE commands.

When entering the program, you enter your message at line 140 in the PRINT statement. You cannot use numbers, only letters. When run, your message will appear on the screen with all the letters upside down.

```

50 A=7175
60 R=0
70 FORT=ATOR-7STEP-1:R=R+1
80 X(R)=PEEK(T+25600)
90 NEXT
100 R=0
110 FORT=A-7TOR:R=R+1:POKET,X(R):NEXT
120 IFR<76:72THENR=A+8:GOTO60
130 PRINT"J",
140 PRINT"YOUR UPSIDE DOWN LETTERS!!!"
150 PRINT"R":
160 POKE36869,255:FORT=1TO150
170 GOSUB220:NEXT
180 POKE36869,240
190 FORT=1TO150
200 GOSUB220:NEXT
210 GOTO160
220 GETA:IFA#=""THEN240
240 IFA#=""THENRETURN
250 GOTO220
    
```

READY

## BOOK REVIEW

*Using the 64* by Peter Gerrard; published by Duckworth, UK; distributed by ANZ Book Co, 10 Aquatic Drive, Frenchs Forest NSW 2086; Rrp \$29.95.



Peter Gerrard, former editor of *Commodore Computing International*, is the author of two top-selling adventure games for the Commodore 64 and a regular contributor to several magazines.

The preface of *Using the 64* states that the book is designed for those who would like to do a little more with their Commodore 64 than draw pretty pictures on the screen, or make it speak to them in a collection of weird and wonderful bleeps and bumbles.

The book certainly does show the reader how to do these things but the information, with many examples of programs to illustrate points and features, will help the reader to go further in exploring the Commodore 64. In fact, I would go as far as to describe this excellent book as the Commodore User's Bible.

Gerrard commences with a swift gallop through the BASIC language. He started with the absolute basics of the Commodore 64, introducing the keyboard and describing the functions of the special keys, e.g. the RUN/STOP and RETURN keys. The basics are very well explained and the most complex part of the language is expressed in such simple and explicit terms that even the beginner can understand with no difficulty.

Gerrard then tackles the dreaded machine code in half the time that he took over explaining BASIC. This is not such a handicap as it might seem with learning another language, since Gerrard has explained machine code in a simple, brief way. He defines all the terms that need to be known and then gives an example of how each works.

Once the basics of machine code have been explored, Gerrard sets about putting them to use in highly complex situations such as creating new words or writing interrupts. In the final part of the machine code section some useful machine code programs are included. Such as: Hard copy dumps the screen out to the printer; Defining function keys which does as its name implies and allows the user to define his function keys to do anything; and Old which reclaims a program which was accidentally lost when NEW was entered.

Then follows a detailed look at the remarkable colour, graphics and sound features of the 64. The first chapter on colour is only five pages long. This is because he only covers how to change the colour of the cursor and place characters on the screen, changing their colour by using the POKE statement.

In the next chapter, Gerrard sets about explaining high resolution graphics and 'sprites'. In this chapter he includes a game called 'Trap' which you type in and play. The program demonstrates elementary use of the graphics capabilities of the 64 in an amusing and entertaining way.

There is a quick explanation of each graphics mode and how each works. He goes into a detailed explanation of the redefinable graphics characters which is the basis of all graphics systems, and also explains multi-coloured characters and extended background mode which all leads on to high resolution graphics.

High resolution graphics is dealt with in much the same way as he does with user-defined characters. All the relevant locations that are needed are there in an easy to understand fashion.

Sprites are the next topic in the chapter. Included is a listing of a sprite generator, so if you cannot understand the concept of sprites then you can use the sprite generator to create them. There is also another listing of a game in the chapter which you can type in and play. Gerrard covers sprite collision, colour, expansion, multicolour and many other sprite features.

Chapter six is about the '64 sound. As he says, the '64 has a remarkably gifted sound capability, aided by the 'sound interface device' (SID) chip. This is explained extremely well in this book. The SID chip is examined in great detail later on in the book along with all the other chips.

In this chapter a more practical use is explored. Subjects covered include explanations on attack, decay, sustain and release (ADSR), using multiple voices, calculating musical notes (a table is included to make this job easier), different waveforms, enveloping, filtering and a few songs to play. All together, this chapter is an excellent guide to learn how to use the '64 sound.

There is a short but highly detailed chapter on peripherals including basic saving and loading to and from disk to direct access on disk. Printers and tape decks are also given a run. Program listings are also found in the chapter, mainly for the disk drive.

Gerrard then comes to the main core of the book and his masterpiece, a detailed look at the '64 chips. He firstly deals with the well known Video Interface Chip (VIC). Many memory maps are supplied. The next chip Gerrard deals with is the SID chip. Included are pin configurations, block diagrams and control register maps.

Finally, Gerrard deals with the central processing unit (CPU) and the input/output chips. This chapter is covered in great detail and is so easy to read you do not have to be a technical genius to understand it.

The appendices are many and detailed. Every thing that is covered in the book is in one of the appendices in brief.

Overall, I found this book to be very easy to read and very comprehensive. Every one who reads it, whether they be beginners or veterans, would gain some more knowledge about the Commodore 64.

Gerrard has certainly produced an excellent book which is truly entertaining and informing. It could easily be the '64 user's bible.

Mark Lingane, Perth WA



**IN STOCK NOW**

# MORE SCOPE. LESS MONEY.

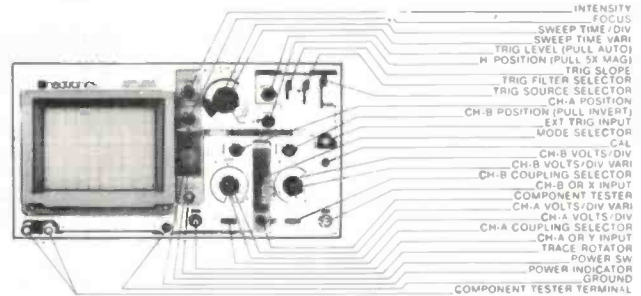

**\$495.00**  
TAX FREE

**Price Breakthrough**  
The Neotronics Model OS620 is a powerful 20MHz dual trace oscilloscope with performance and features normally found on scopes costing \$200-\$500 more. We sell at lower profit margins and import directly from the manufacturer. You reap the benefit!!

**Compare the Features**  
The Neotronics OS620 is a precision measuring instrument. The tube is 150mm flat screen/ internal graticule type with 2kV acceleration potential. The bandwidth is a full 20MHz on both channels. Others offer round faced tubes, plastic graticules, less bandwidth, yet cost more! Intensity modulation is built in.

**\$574.20**  
INC. TAX

**Built-in component tester**  
The component tester allows you to make full use of the OS620. With no additional test gear, you can check resistors, capacitors and zener diodes as well as trouble shoot solid state circuits. Testing signals are available via the COMP. TEST terminals.

Probes included in price.



**Probes included**  
Most users will need a set of probes. These are sold as very expensive 'extras' with some other brands - often costing over \$60.00 a pair (we think this is a bit like selling a car and then saying it's extra for the tyres!). The Neotronics OS620 comes complete with a pair of high quality probes.

### Check these specs

- Vertical sensitivity: 5 mV/div to 20V/div. 12 ranges
- Operating modes: ch-A, ch-B, dual, add, invert ch-B.
- Rise time: 17nsec
- Time base speed: 0.5µsec to 0.5s/div. 19 Ranges (plus 5X mag.)
- Trigger source: Int, ch-A, ch-B, line, ext and auto.
- Trigger coupling: AC, HF reject, TV line and TV frame.
- X-Y operation: Ch-A becomes Y axis, Ch-B becomes X axis.
- Trace rotation on front panel.

**neotronics**

FOR HIGH TECHNOLOGY ELECTRONICS

314 Lower Plateau Road, Avalon NSW  
2107 Australia PO Box 289, Newport  
NSW 2106. Phone: (02) 918 8220.  
Telex: AA 70842



**BUY DIRECT  
AND SAVE**



**DELIVERED ANYWHERE  
IN AUSTRALIA FOR \$7.50**

**Phone on the Hotline  
(02) 918 8220**

Avoid disappointment. Order your OS620 by Bankcard or MasterCard on the phone. Just call up, reverse the charges and we'll take your order. Shipping is only \$7.50 anywhere in Australia - including packing and insurance.

**Full 12 month warranty.** Your OS620 is fully guaranteed for a full year.

Prices correct and goods expected in stock at time of going to press.



# West German 50 MHz CRO



**T**he West German company, Norma Messtechnik, has released its model S1004 50 MHz oscilloscope through Paton Electronics. This high sensitivity, rapid timebase instrument is suitable for applications in the laboratory, in production and quality control, as well as for servicing and education in all branches of electronics, the company claims.

The S1004 has several unusual display facilities and trigger types. It displays wave forms of considerable complexity at high brightness and excellent beam focus, they say.

The S1004 is simple and fast to operate. Automatic timebase and trigger facilities put a steady image of optimum timespread on the 80x100 mm screen, Messtechnik say.

The image tube works at an acceleration voltage of 11 kV and produces a particularly bright and sharply focused beam on screen, the company says. The automatic focusing system keeps the beam well focused even if the image brightness changes. The measuring raster is attached to the inside and may be lit; it makes for parallax-free readings.

A newly developed automatic time-range circuit will always display 1.5-5 cycles of the signal applied, irrespective of its frequency. The automatically selected or manually set deflection co-efficient is shown on an LED display in milliseconds,

microseconds or nanoseconds.

The TV trigger permits triggering to the first or the second frame or to the line frequency. More detailed examination of the TV signal is possible with the help of the delay function.

For more information contact Paton Electronics, 90 Victoria Street, Ashfield NSW 2131. (02)797-9222.

## Air powered screwdrivers

**T**he APD series screwdrivers from Ellistronics are designed to handle a broad range of fastening and unfastening applications from delicate instrument assembly to electronic chassis and cabinets. These precision tools are built with a gear type driving mechanism that generates exceptional power from within an extremely compact, lightweight housing.

The tools feature automatic start with a forward push of the

## Data test units

**P**rincipal units in the range of Halcyon data test instruments are the 801A Data Monitor, 802A Data Link Monitor, and 803B Data Link Analyzer. All three feature Halycon's exclusive Automonitor which automatically detects the speed, protocol, bits-per-character, and parity of the line under test. The 801A also has a powerful trapping capability that can be user programmed for selective monitoring and troubleshooting.

The 802A is a progression of the 801A, featuring increased capabilities for gathering network statistics, including an integral mass storage tape for data and programs, and larger CRT display.

The top of the range is 803B Data Link Analyzer, which has complete emulation and moni-

tor capabilities, with convenient programming provided by a full ASCII keyboard.

Also included in the Halcyon range are statistical multiplexers and the H4896 Synchronous Modem. The multiplexers are capable of concentrating up to 60 channels over a single phone link, and providing complete network reconfigurations and system-level diagnostics from a single, central location.

The modem likewise provides high performance over a wide range of conditions on both domestic and overseas transmission lines, and is designed for full-duplex point to point applications.

For more information contact Magna Techtronics, 14 Whiting Road, Artarmon NSW 2026. (02)438-3377.

## New car alarm

**A**Talking Auto Alarm is the latest product from Powersonic Australia.

It's a keyless system that, when activated, not only emits an eardrum popping siren (120 decibels), but also a synthesised voice that cries "burglar burglar" in a frenzied tone.

If the 120 dB siren does not frighten the intending car hijacker, the voice will certainly scare the pants off him. No thief could successfully carry out his work with "burglar burglar" screaming in his ear.

Powersonic Australia has joined operations with Bestek

International of California to market this new 'Talking Auto Alarm' on the Australian market.

It is marketed through leading auto electricians, spare parts shops, electronic shops and selected petrol stations, who all have a unit for demonstration purposes and stock to service all customers.

The unit retails for \$199.

For further information you can contact Mr John Q. Nia, Powersonic Australia, Shop 43, 61-89 Buckingham St, Surry Hills NSW 2010. (02)699-2722.

APD series air powered screwdrivers.



bit upon contact with the screw, instant reverse, torque control and extremely low noise level which enhances their use in a laboratory or cleanroom environment.

A complete inventory of bits and spare parts is available. Tools and accessories are available from Ellistronics Pty. Ltd., 797 Springvale Road, Mulgrave Vic 3071. (03)329-7500.



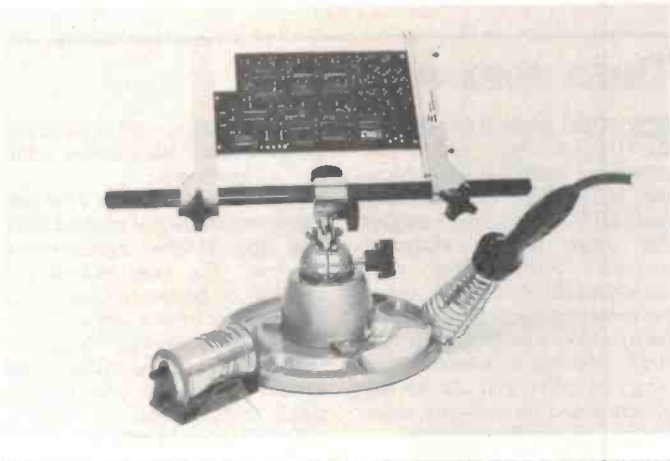

## PC board work centre

**A** new combination of Scope Panavise components produces a pc board work station with many features designed for professional service technicians. Pc boards up to 300 mm wide can be held vertically, horizontally or at any intermediate angle, by two retaining arms. They both slide independently. One is spring loaded for fast board changes.

The 180° swivel and lock base

lets the operator adopt any board position. The base with non-skid pads accommodates small parts, a tip wiping sponge and safety iron stand for any iron up to 15 mm Ø plus a solder reel dispenser.

All parts are rigidly connected to allow one handed portability. Recommended trade price is \$123 plus tax.

For further information contact Ian Pittman, Scope Laboratories. (03)338-1566.

## New 300 baud modem

**C**entre Industries, a division of the Spastic Centre of NSW, has announced the addition of a new 300 baud data modem to the Cicada 300 series.

To be marketed as the Cicada 300C or 300CT (with integral telephone), the new modem provides inter-computer communications over the switched telephone network or private lines and is specifically designed for use with the Commodore 64 and IC 20 computers.

Both models offer substantial

savings since neither requires the use of an interface adapter or power pack. Additionally, the modem can easily be installed by the end-user. Designed to conform in all respects to the recommendations of CCITT-V21, the two modems hold Telecom approval no. C83/37/1113.

More information can be obtained from Centre Industries, 187 Allambie Road, Allambie Heights NSW 2100. (02) 451-5555.



## Six-trace oscilloscopes

**T**wo new models in the TRIO range of oscilloscopes feature three channels which can be displayed simultaneously using the main sweep while individual delayed waveforms of these

channels can also be displayed, providing a total of six traces. The CS-1060 has a bandwidth of 60 MHz and the CS-1040 has a bandwidth of 40 MHz.

Other features include sensi-

tivity down to 1 mV/div, a 150 mm rectangular, high resolution 16 kV CRT and eight divisions of dynamic range for accurate, undistorted waveform display. They also have vertical-axis signal output (for a frequency counter, etc), automatic synchronizing of video signals and a trace rotation control for compensating for the earth's magnetic field.

Parameters has also released the new TRIO CS-1022 with dual traces and operating up to 20 MHz.

The front panel layout was redesigned for the CS-1022 sweep multiplier allows a user to magnify the sweep at the touch of a button to view parts of complex waveforms. The accuracy of this scope is guaranteed to +3% over a temperature range of 0°C to 40°C.

For further information contact Parameters Pty Ltd, P.O. Box 573, Artarmon NSW 2064. (02)439-3288.



## Intelligent DMM

**P**erth based Radio Spares has become distributors for the Thurlby 1905a programmable 5½-digit DMM.

Radio Spares claim exceptional resolution for its new product. It can measure 1 mV in 200 V. Input impedance is 10M on the voltage ranges, except for the lower two, where it rises to 1000M.

The 1905a has a programmable filter that can be used to filter unwanted noise from the input.

Voltage can be expressed in dBv, dBm or dB<sub>r</sub>, given an appropriate reference point. Output can be scaled, averaged or offset, and maxima or minima stored for later retrieval.

For further information contact Radio Spares Components, 28-30 Northwood St, W. Leederville WA 6007. (09)381-4799.



**BELOW  
MANUFACTURER'S  
COST!!**

**ONLY  
\$125  
COMPLETE  
MASSIVE SAVING  
OF \$74**



Mail Order By  
**BANKCARD**  
Via Your Phone



AS REVIEWED  
OCT '82  
EA (p.26-28)  
ETI NOV '82 (p.26)

CAT. XC2010

**NEW IMPROVED  
MODEL!**

**FULL 90 DAY  
WARRANTY**

At \$199 the Voyager Car Computer represented absolutely outstanding value for money. No one else had such a low priced, FULL FUNCTION car computer. The Voyager is the only low-cost unit that will give you full consumption (the most important feature in a car computer) in both metric litres/100km AND good old MILES PER GALLON!

At \$199 many, many hundreds have been sold. NOW you can grab one absolutely complete for only \$125 — a saving of 37% or \$74!

The Voyager comes absolutely complete with all fitting hardware — even down to a roll of insulation tape! Installation generally takes between 4 and 6 hours depending on vehicle.

The Voyager is available from the following dealers at your convenience.

- |                      |                       |
|----------------------|-----------------------|
| Jaycar Sydney (City) | 264 6688/267 1614     |
| Jaycar Concord       | 745 3077              |
| Jaycar Carlingford   | 872 4444              |
| Jaycar Hurstville    | 570 7000              |
| Zap Electronics      | Parramatta<br>Hornsby |
| or by mail order to: |                       |
| Jaycar               |                       |
| Box 185              |                       |
| Concord 2137         |                       |
| Rod Irving           | (03) 347 9257         |
| Melb A'Becket St     | (03) 489 8131         |
| Norricote            | (09) 328 1599         |
| Altronics Perth      |                       |

**Spare Flow Sensors:** Jaycar will be supporting this product for many years to come. To avoid problems changing cars, why not buy a spare fuel flow sensor? They are about the only things that wear out.

Cat. XC2036 **ONLY \$29.50**

**VOYAGER OPERATING FEATURES**

- Instantaneous fuel consumption from sec to sec as you drive.
- Distance travelled since the Log computer was last re-set.
- Fuel used since the Log computer was last re-set.
- Average fuel consumption since the Log computer was last re-set.
- Instantaneous speed as you drive from sec to sec.
- Clock with 12 hour format. Can be operated as a stopwatch.
- Overall dimensions: 20cm x 7.1cm (9cm deep)
- DISPLAY: 5 digit 0.4" high.
- Five programmable speed alarms.
- Straightforward calibration.
- Metre and Imperial conversion.
- Light sensor automatically adjusts brightness of display.
- Average speed over the trip.
- Elapsed time since the Trip computer was last re-set. Can be used as a split lap timer.
- Distance travelled since the Trip computer was last re-set.
- Lights left on alarm.

**VOLTAGE REGULATORS**

We have had a large demand to expand our range of Voltage Regulators. So here's two new ones in TO-220 flat plastic packs.

**7809 Positive 9 volt 1A**  
Cat. ZV-1509 \$1.05 ea - 10 up 95¢ ea

**7824 Positive 24 volt 1A**  
Cat. ZV-1524 \$1.05 ea - 10 up 95¢ ea



**uniden®**

Very popular HF/FM receiver with digital readout and scanner facility. Cat. DR-6010  
**NORMALLY \$299**

**WORLDWAVE RADIO  
MODEL CR-2021**

**\$239  
SAVE \$60**

**Jaycar  
ELECTRONICS**

**MOTOROLA PIEZO TWEETER**

This piezo tweeter is designed for Hi Fi use. It has two drivers incorporated in the one housing, which is relatively flat. Dimensions: 120 x 95 x 15mm thick

**NORMALLY  
\$24.00**

**JULY \$16.00  
each  
LIMITED STOCK**



**LOW COST 3½ DIGIT LCD  
PANELMETER - DPM10**

This DPM is electrically identical to the DPM that is used in many LCD kits. We imported this unit by mistake and do not wish to keep it as part of our normal range. If you want a quality 3½ digit DPM at an unrepeatable price - **HURRY!!**

Equivalent to units costing \$39.95  
Specifications similar to DPM50  
Cat. QP-5516

**ONLY \$29.95**



**SEE OUR DOUBLE  
PAGE ADS FOR FULL  
JAYCAR DETAILS**

**GUITAR SUSTAIN**

SEE EA JULY 1984  
Perfect for guitarists and bass players who want more sustain or bite in their guitar sound. Cheap and easy to build and about a ¼ the price of commercial units.  
Cat. KA-1553

**\$24.50**



**GREEN SCREEN  
MONITORS - BACK!!**  
Micron Series 2 - Non glare  
screen - Cat. XM-4500 **\$219.50**

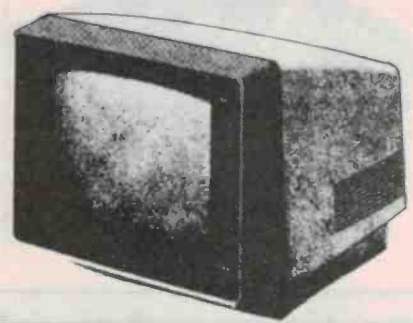



# BOOK SALES

## KIDS AND THE APPLE H0300P \$25.75

How to write programs for the Apple computer, including action games, board games and word games.

## COBOL FOR BEGINNERS H0140P \$33.95

It is a solid text for introductory programming courses in Cobol, using a format that is easy to understand, yet comprehensive enough to make supplementary readings unnecessary.

## MICROSOFT BASIC J0406A \$24.50

Presents a complete introduction and tutorial on programming in BASIC using Microsoft BASIC, Release 5.0. Covers branching and loops, strings, editing, arrays and files, and arithmetic in BASIC.

## BASIC FOR EVERYONE K0187P \$22.40

Some 350 pages of BASIC information for all purposes.

## HOW TO GET STARTED WITH CP/M K0174A \$22.95

This practical book eases the reader into the essentials of the system, giving an overview of the operating system, an idea of what it will be like to use and what it can do for the reader.

## UNDERSTANDING COMPUTERS H0148A \$20.95

For people who use small computers, this book starts with the most elementary gates and works up to the complete computer. Gives an understanding of the languages and how they operate in the computer.

## NAILING JELLY TO A TREE H0149A \$25.50

This guide to software teaches you about machine language, assembly language programming and BASIC. The emphasis is not on learning to write programs but on learning to use the thousands of available programs that have already been written.

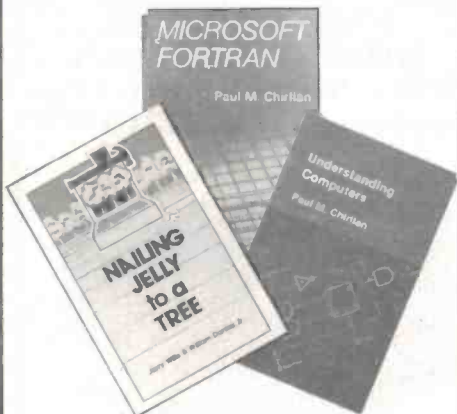

## INTRODUCTION TO WORD-PROCESSING H0151A \$17.95

Written for the non-technical reader, this book tells about the concepts common to all word-processing systems, then analyses all features.

## FROM CHIPS TO SYSTEMS: AN INTRODUCTION TO MICROPROCESSORS H0152A \$29.75

Explains exactly what a microcomputer system is and how it works. Introduces fundamental concepts and covers all aspects of microprocessors and related components: internal operation, memories, interfacing and system development, etc.

## DON'T (OR, HOW TO CARE FOR YOUR COMPUTER) H0153A \$19.95

A guide to computer and peripheral preservation. Specific advice for the computer, floppy disks, hard disks, the CRT terminal, the printer, tape units, the computer room, software and documentation.

## USING THE IBM PERSONAL COMPUTER J0319P \$21.50

This all-purpose beginner's book is a complete guide to the IBM-PC.

## USING THE OSBORNE 1 COMPUTER J0327P \$21.50

How to get the most out of the Osborne 1 portable computer.

## PROGRAMMING THE 6502 K0227A \$22.95

Principles of assembly-language programming for the 6502 microprocessor are taught in this introductory text. Includes a discussion of trade-offs between hardware and software and detailed explanations of the 6502's internal registers and bus operation. Third edition.

## THE ART OF PROGRAMMING THE 1K ZX81 K0226B \$6.75

This book explains how to use the features of the ZX81 including its random number generator, graphics and timer. PEEK and POKE are explained and you should learn enough to develop programs of your own.

## HOW TO WRITE AN IBM-PC PROGRAM K0184P \$23.25

Virtually identical to *How to Write an Apple/TRS-80 Program*. Changes have been made to allow for differences in the two machines and variations in BASIC.

## APPLE FILES K0190P \$21.95

This book is for people who know some BASIC and would like to expand and apply this knowledge by using the capabilities of the Apple. Includes programs for the stock market, inventories, grades and medical records.

## PASCAL PROGRAMS FOR SCIENTISTS AND ENGINEERS K0181A \$23.50

More than 60 of the most frequently used scientific algorithms, with program implementation in Pascal.



# A computer book to suit everyone...

## Z80 USER'S MANUAL J0331P \$22.75

An all-in-one guide to Z80 pin definitions, CPU control signals, support chips, interfacing peripherals, addressing modes and much more.

## USING THE UNIX SYSTEM K0185P \$24.95

This book by Richard Gauthier, of RGL, has been written for people with some knowledge of computers, but with no specific knowledge of Unix. It is also of value to current Unix users.

## DIGITAL CIRCUITS WITH MICROPROCESSOR APPLICATIONS J0166A \$46.50

An introductory text, this book provides readers with the basic ideas and tools needed to analyse and design digital circuits and computer systems. Discusses microprocessor computer organisation, machine-language number systems and gate circuits.

## IAPX 88 BOOK J0162P \$20.25

This book from Intel itself describes the unique Intel 8088 microprocessor in total detail. Invaluable for all involved with the 8088.

## MICROSOFT FORTRAN J0291A \$24.95

Various techniques involved in MicroSoft programming are explained, including structural programming and top down programming. Compiler, editor and linker are discussed, along with the various uses of the printer, disk and video terminal.

## THE C PUZZLE BOOK K0375P \$23.00

Includes C programs that each explore a particular aspect of C, detailed descriptions of how the programs work and tips on writing successful C programs.

## INTRODUCTION TO PASCAL K0198P \$22.95

The design and construction of Pascal programs, involving a wide range of basic computer algorithms in a practical context. Second edition.

## COMPUTER PROGRAMS IN BASIC K0192P \$18.25

Fully indexed guide to more than 1600 BASIC computer programs published in personal computer magazines for microcomputers, mini-computers and mainframe computers. Compiled by Paul Friedmann, first published in 1981.

## EXPERIMENTS IN ARTIFICIAL INTELLIGENCE FOR SMALL COMPUTERS J0168P \$14.25

Artificial intelligence is the capability of a device to perform functions normally associated with human intelligence. With this book, a small computer with extended BASIC and some knowledge of BASIC language, you can conduct experiments in artificial intelligence.

## PRACTICAL COMPUTER EXPERIMENTS J0172B \$5.95

How to build typical computer circuits using discrete logic. Useful intro to devices such as adders and storers as well as a general source book of logic circuits.

Save time and trouble — fill out the reply-paid coupon



### BEGINNER'S GUIDE TO DIGITAL ELECTRONICS

**C0029B** \$4.95  
Covers all essential areas including number systems, codes, constructional and sequential logic, analogue/digital/analogue conversion.

### LONG-DISTANCE TELEVISION RECEPTION (TV-DX)

**N0250B** \$6.95  
Written by the British authority, the book includes many units and devices made by active enthusiasts. A practical and authoritative introduction to this unusual aspect of electronics.

### SOLID-STATE SHORTWAVE RECEIVERS FOR BEGINNERS

**C0044B** \$5.95  
Design and construction of several solid-state shortwave receivers giving high level of performance yet utilising few components.

### ESSENTIAL THEORY FOR THE ELECTRONICS HOBBYIST

**A0013B** \$5.95  
Supplies the electronics hobbyist with the background knowledge which will exactly suit his specific requirements. Minimum maths.

### ELECTRONIC DESIGN WITH OFF-THE-SHELF ICs

**E0099P** \$17.50  
It contains virtually all the information you need to design and build electronic circuits, systems and subsystems with readily available ICs. Shows how to interface them into highly complex systems.



### MICROPROCESSOR INTERFACING TECHNIQUES

**J0167A** \$29.95  
Teaches you how to interconnect a complete microprocessor system and interface it to the usual peripherals. The hardware and software skills needed to effectively interface peripheral devices are covered along with various buss standards and A/D conversion. Third edition.

### SOUND-SYSTEM ENGINEERING

**G0129P** \$35.50  
Dealing with audio systems as a whole, it includes installing and equalising the sound system and interfacing the electrical and acoustic systems, instrumentation, the acoustic environment and designing for acoustic gain.

### PRACTICAL ELECTRONIC CALCULATIONS AND FORMULAE

**B0027B** \$9.95  
For the practical person's workbench. Bridges the gap between the technical theory and cut-and-dried methods which work but leave the experimenter unfulfilled. There's a strong practical bias. High maths avoided where possible.

### RADIO CONTROL FOR BEGINNERS

**C0034B** \$5.95  
How complete systems work with constructional details of solid-state transmitters and receivers. Also included — antennas, field strength meter, crystal controlled superhet, electro-mechanical controls. Section dealing with licensing, etc, is not applicable to Australia.

### ELECTRONIC CALCULATOR USER'S HANDBOOK

**M0245B** \$5.50  
Presents formulae, data, methods of calculation, conversion factors, etc, for use with the simplest of most sophisticated calculators. Includes the way to calculate using only a simple four-function calculator, trigonometric function, hyperbolic functions, logarithms, square roots and powers.

### HANDBOOK OF ICs EQUIVALENTS AND SUBSTITUTES

**B0281B** \$6.95  
Contains full interchangeability data on more than 9500 ICs with possible alternatives and equivalents shown. Covers many types of digital and linear ICs. Recently reprinted.

### ELECTRONIC TROUBLESHOOTING HANDBOOK

**F0257P** \$11.50  
This workbench guide shows you how to pinpoint transistor troubles in minutes, how to test almost everything electronic and how to get the most out of low-cost test equipment.

### INTERNATIONAL TRANSISTOR EQUIVALENTS GUIDE

**B0018B** \$9.95  
Contains a huge amount of information on modern transistors produced by more than 100 manufacturers. Wherever possible, equivalents are subdivided into European, American and Japanese types.

## ...Plus great buys on ETI Bestsellers!

### HOW TO MAKE WALKIE-TALKIES

**D0056B** \$6.95  
This treatise on low-power transmitter-receivers (walkie-talkies) covers many aspects, from licensing requirements and bands, through practical circuitry and construction to the types of aerials that may be used.

### ELECTRONICS SECURITY DEVICES

**D0059B** \$6.95  
Besides including both simple and more sophisticated burglar alarm circuits using light, infra-red and ultra-sonics, this book also gives circuits for gas and smoke detectors, flood alarms, fire alarms, doorphones, etc.

### HOW TO BUILD SPEAKER ENCLOSURES

**G0131P** \$9.50  
A guide to the 'whys' and 'hows' of constructing top-performance loudspeaker enclosures.

### MODEL RAILWAY PROJECTS

**D0054B** \$6.75  
Projects include such things as controllers, signals and sound-effects units. Construction stripboard layouts provided for projects.

### WALL CHART — HOW TO IDENTIFY UNMARKED ICs

**B0019B** \$2.95  
This chart shows the reader how, with just a test-meter, to go about recording the particular 'signature' of an unmarked IC which should enable the IC to be identified with reference to manufacturers or other data.

### BASIC for accountants

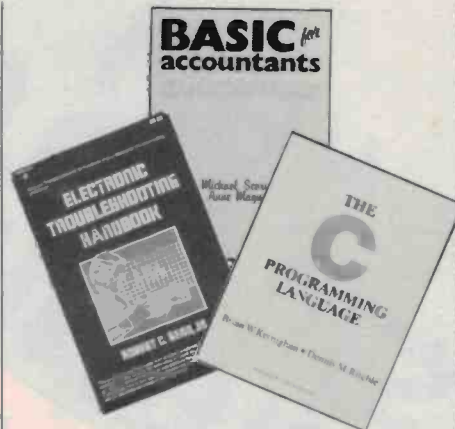

### THE CP/M HANDBOOK (WITH MP/M)

**K0173A** \$24.95  
Contains a step-by-step description of all the CP/M command features. Designed for the beginner, the book progresses to detailed explanations of the file transfer, debugging and CP/M text-editing programs.

### PROGRAMMING THE Z80

**K0231A** \$26.95  
This book will enable every reader to write complete application programs for Z80-based computer systems. Includes exercises to measure progress and comprehension at each level of programming.

### THE C PROGRAMMING LANGUAGE

**K0272P** \$26.95  
C is a general purpose 'low-level' programming language. It is not specialised to any particular area of application, but its absence of restrictions make it convenient and effective for many tasks.

### BASIC FOR ACCOUNTANTS

**L0234P** \$11.95  
Shows accountancy students and accountants how to use a computer to perform the repetitive tasks associated with record keeping, calculating and report writing. Using the BASIC language attention is concentrated on debtors, inventory and general ledger systems.

### BEGINNING BASIC

**H0146A** \$24.95  
Intended for beginners with no computing experience, one should be able to intelligently program in BASIC in a short time.

### INTERFACE PROJECTS FOR THE APPLE II

**J0158P** \$17.95  
A series of interface projects that are easily built and enable the user to realise the computer's potential through project construction. Projects are primarily hardware-orientated, with some software supporting the hardware.

### STARTING FORTH

**K0177P** \$25.00  
A clear and complete guide to Forth, this book covers fundamental principles and then a full set of high-level Forth commands. It concludes with advanced techniques and style.

All prices of publications are subject to change without notice.

**MORE SPECIALS ON PAGES 77, 83**



**HELP!  
\$70,000,000  
STOLEN THIS YEAR!**

**ONLY \$99**

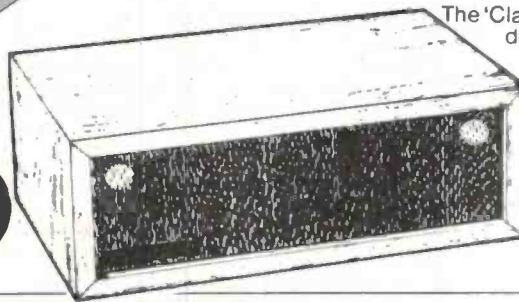

**SELF CONTAINED  
ULTRA-SONIC  
BLASTER!**

The 'Claytons' alarm: the ideal alarm for those who don't want to put in alarms! This one is fully self contained, including siren speaker. Just place it on the shelf and its invisible ultrasonic rays detect movement. Fantastic for single room protection; can also be used as a sensor on a master alarm console. Includes sensitivity control, operates from external 12V battery, from mains via optional plug-pack with internal battery back-up. Has provision for external speaker, sensors, etc. Cat L-5108

**Bookshelf  
Control  
Module**

**Easy to install**

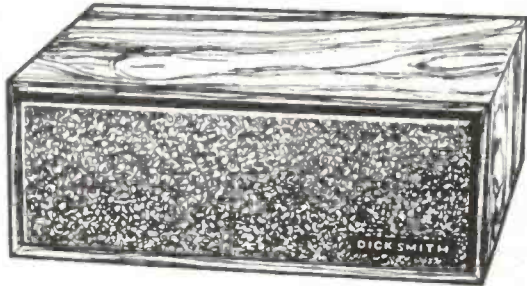

A great alarm system for the home, flat, etc -- because it doesn't look like an alarm! So anyone entering your property could easily be fooled into thinking this was a small speaker - until they were caught! This module has another big advantage too - it's fully self contained. While there is provision for external horn speaker, it has its own speaker built in, hidden behind the 'speaker grille' front panel. AC/DC operation: optional AC adaptor can be fitted to use mains: unit automatically switches back to battery if mains is interrupted. Built-in test LED for checking that the system is working before you leave. Cat L-5102

**LOW  
COST  
PROTECTION** **\$59<sup>50</sup>**

**INNOCENT  
VICTIMS OF  
BURGLARIES  
'VIOLATED'**

**VICTIMS of burglaries feel violated when their home has been ransacked, according to a psychologist.**

**By PAM LESMOND**

"They feel as though their home is no longer their castle - it's extremely upsetting, especially if things have been overturned or messed up," Dr Lyn Barrow said.

Dr Barrow said if the victim suffers another burglary they can become extremely nervous and frightened.

Dr Barrow said burglary victims suffer from enormous stress after repeated attacks. "People living alone, especially elderly women, are prone to severe stress."

He said some people become too scared to leave their homes because they fear it will be ransacked.

"I think we should be looking at the reasons why people need to steal rather than imposing harsh sentences," Dr Barrow said.

Another psychologist, Dr Robert Spillane, said people rarely believe they will fall victim to a burglary attack.

'The Sun'  
9th May,  
1984



# And just take a peek at our great range of sensors . .

**NEW**

## TOP QUALITY

### SWISS MADE PASSIVE INFRARED DETECTOR

The very latest: Swiss made quality detector actually senses human radiation — even from across a room! Virtually no false triggering, ultra reliable. Simple connection to our Security Centre (L-5100) and Bookshelf Control Module (L-5102).  
Cat L-5010



**GREAT VALUE!**

**\$119**

## MICROWAVE MOVEMENT DETECTOR

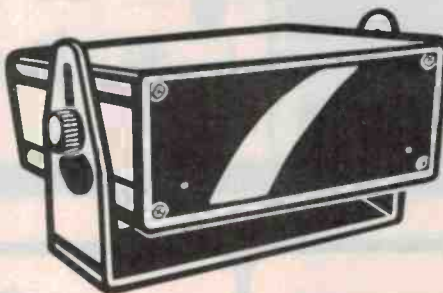

**21st CENTURY INTRUDER PROTECTION**

Want to catch them in the act? Silent, invisible microwaves detect any movement in the target area and trigger the alarm device. 12V operated. Range up to 15 metres, attaches to any alarm system!  
Cat L-5000

**Silent Invisible Movement Detector**

**\$95**

### Ultra Loud Gonger

Give em the gong! A great new addition to our range. Huge 8 inch fire bell with massive gonger, 12 volts operate at 300mA. Suitable for most alarm systems.



**\$34<sup>95</sup>**

Cat L-5280

### Reed Switch/Magnet Set

Mounted so the magnet holds the switch closed, if the door is opened, switch opens. Attaches to most alarm systems.  
Cat L-5210



**\$275**

### Earsplitter

Scare the pants of them with this high efficiency horn speaker.



**\$10<sup>25</sup>**

Cat C-2705

### Barrel Key Switch



Barrel type key switch with two keys, used at entry-exit point for turning the alarm system on-off.

**\$7<sup>25</sup>**

Cat L-5290

### WARNING STICKER



**\$1<sup>00</sup>**

Cat L-5310

### HEAT/FIRE SENSOR

Most alarms have provision for a fire sensor. Take advantage of it and protect your home and property! Use any number of sensors in likely 'hot spots'.  
Cat L-5254



**\$7<sup>95</sup>**

### Pressure Mat

An ultra thin mat for placing under carpets, in walkways, etc. N.O. in the standby state, goes closed circuit when walked on.  
Cat L-5270

**\$19<sup>50</sup>**

## FREE!

Your home is on the 'hit' list — your valuables property may be the gleam in a crooks eye tomorrow!

You need help!!!

Here it is:

our specially written guide to installing a professional alarm system.

That's right every home now needs protection — and we'll show you how to install an alarm that will deter even the persistent pest.

The guide is FREE with any purchase of \$1.00 or more for July only! Ask for your copy

when you're in a Dick Smith Electronics store or with your next mail order.



## 100% Hidden Magnetic (Reed) Door & Window Switches

What a great idea! Ideal for all alarm systems — usable in wood, aluminium & other doors/windows. Just drill a 10mm hole for switch in jamb and the magnet in door or window. They push in and are covered by window/door when closed — no one knows they're there!

Operates between 8 & 10mm

Set of reed switch & magnet plus four mounting screws.

Cat L-5212

**\$3<sup>95</sup>**



**No. 1**

**In Australasia**

# DICK SMITH ELECTRONICS



See page 152 for full address details



WOOD FOR CHIPS ... WOOD FOR CHIPS ... WOOD FOR CHIPS ... WOOD FOR CHIPS ... WOOD FOR CHIPS ... WOOD FOR CHIPS ... WOOD FOR CHIPS ... WOOD FOR CHIPS ...

WOOD FOR CHIPS ... WOOD FOR CHIPS ... WOOD FOR CHIPS ... WOOD FOR CHIPS ... WOOD FOR CHIPS ... WOOD FOR CHIPS ... WOOD FOR CHIPS ... WOOD FOR CHIPS ...

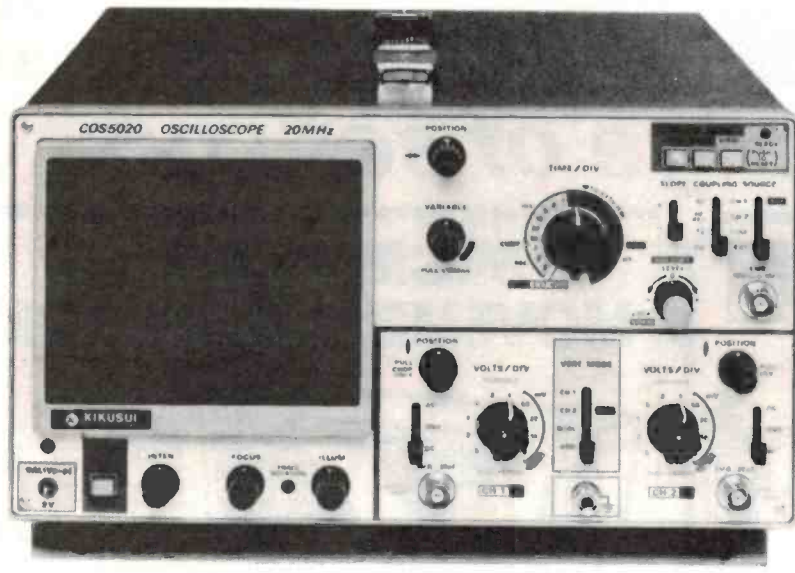

# KIKUSUI 20MHz DUAL TRACE SCOPE

## \$469.00 INC PROBES

Compact and easy to operate for  
hobbyists and professionals

- 5mV/div sensitivity
- Hold-Off function
- CH1, CH2, Dual, Add, X-Y modes
- Intensity modulation
- 5mS to 2uS sweep delay
- 0.2uS to 0.5S/div sweep range

### GFG-8016D FUNCTION GENERATOR

## \$319.00

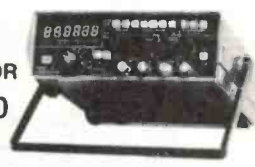

Generates sine, triangle, square, pulse and ramp waves

- 0.2 to 2MHz • 20Vp-p open circuit output
- VCF input - 10V gives 1000:1 ratio • Built-in 10MHz Counter (6 digit)

### GAG-808A AUDIO GENERATOR

## \$199.00



Covers 10Hz to 1MHz

- 20Vp-p open circuit output • Sine and Square wave outputs • External sync • 600 ohm output impedance

### GPS-3030 POWER SUPPLY

## \$193.00

Provides 30V at 3A

- Short circuit protected • Auto constant voltage, constant current indication • High line and load regulation

### GPS-3060 POWER SUPPLY

## \$334.00

Provides 30V at 6A

- Similar to GPS3030

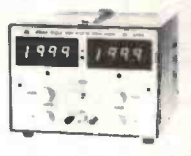

### DCM-100 CAPACITANCE METER

## \$92.00

Measures capacitance from 200pF to 2000 uF

- 3 1/2 digit LCD display
- Crystal time base
- Front panel zero adjustment • Internal calibration adjustment
- Protection against charged capacitors

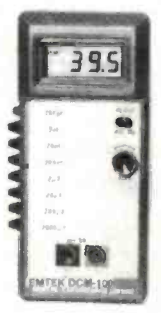

### B-123 1580 tie points



### A-TEK BREADBOARDS

- Ideal for experimenters
- B212 under NSW Govt contract • No soldering or un-soldering • Nickel plated contacts • Blocks snap together for easy expansion

### B-124 1490 tie points



### B-212 840 tie points



B-212 - 840 tie points  
**\$16.00**

B-123 - 1580 tie points  
**\$22.00**

B-124 - 1680 tie points  
**\$23.00**

B-135 - 2420 tie points  
**\$33.00**

B-147 - 3260 tie points  
**\$44.50**

### AT301 LOGIC PROBE

Checks TTL and CMOS circuits

- Multi-LED readout
- Memory function for single shots and low rep events • 50nS detectable pulse width
- 10MHz max input
- Overload protected
- Runs off 5-15V, 25-40mA



**\$22.00**

### C16 IC CLIPS

## \$4.40



Simplifies checking of ICs

- Suits 16pin DIP spacing
- Gold plated clip contacts

### B-147 3260 tie points



8.30 to 5 Monday to Friday. 8.30 to 12 Sat.  
Mail Orders add \$3.00 to cover postal charges.  
Next day delivery in Sydney add \$5.00.  
All prices EXCLUDE sales tax.  
Tax exemption certificates accepted if line value exceeds \$10.00.



## GEOFF WOOD ELECTRONICS PTY LTD

Incorporated in N.S.W.  
656A Darling St, Rozelle 2039  
(One door from National Street)  
Tel: 810 6845



specialising in electronic components for the professional and hobbyist.



## New hybrid amplifier module

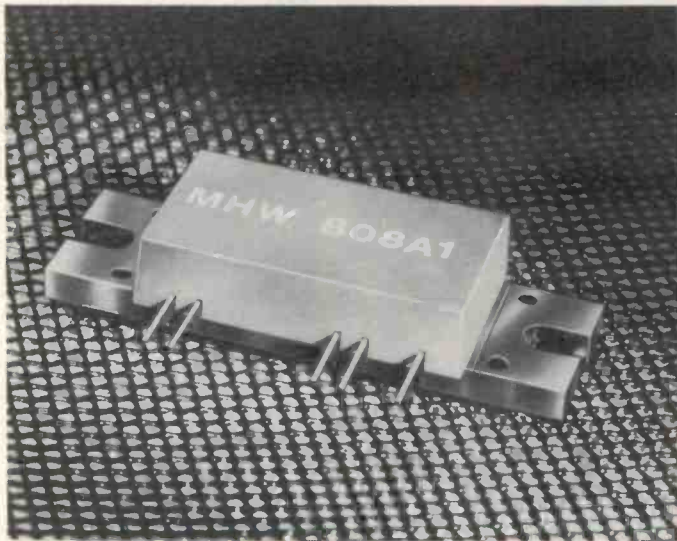

**A** new series of three-stage common emitter hybrid amplifier modules, designed for 800 MHz cellular mobile radio applications, has been introduced by Motorola.

The three elements in the series are called the MHW808A1, MHW808A2 and MHW808A3. They have a typical power output of 7.5 watts and a typical power gain up to 25 dB. Its class A input stage allows automatic gain control over 35 dB in output power range.

The amplifiers are constructed with thin-film interconnections and gold-bonded silicon-nitride-

passivated transistors to provide for small size and high reliability.

The series employs three common emitter stages cascaded to provide over 35 dB of gain. The devices are specified at 12.5 volt, UHF characteristics.

For more information contact Motorola, 250 Pacific Highway, Crows Nest NSW 2065. (02)438-1955.

## High performance micro

**T**he first prototype samples of the new super microprocessor, the 80286, have arrived in Australia.

Especially suited to multi-user, multi-tasking systems, the SAB 80286 incorporates memory protection that supports operating systems and task isolation, as well as program and data privacy within tasks. The 8 MHz version has the capability to handle a throughput of up to six times that of a standard, 8086. The SAB 80286 features a memory management system that will map one Gigabyte of virtual address space per task into 16M of physical memory.

SAB 80286 is upward compatible with 8086 and 8088 software. Other design features of 80286 include two 8086 upward compatible operating modes; 8086 Real Address mode and Protected Virtual Address mode.

A range of clock rates will be available, although the higher speed versions (8 MHz) should be more popular, due to reduced cycle times aiding higher throughputs.

For more information contact Promark Electronics, 366 Whitehorse Road, Nunawading Vic 3131 (03)878-1255.

## Australian solid state relays

**S**olid state relays designed and developed in Australia are now available from Promark Electronics. Initially available in an industry standard compact, vertical package, the first models are designed as 2 A and 5 A 240 V devices. They use the latest opto-coupled, zero voltage crossing device to trigger a triac. A current limiting device (with reverse protection) allows input voltages of 3-15 volts without external resistors.

A unique feature of these devices is the availability of an

optional snubber and/or metal oxide varistor, to limit inductive loads. This enables large users of solid state relays to have devices tailored to suit their individual requirements. This custom facility will be expanded to include higher current devices as required, with the next production model likely to be rated at 24 A.

Further information and design details are available by contacting Promark Electronics, 366 Whitehorse Road, Nunawading Vic 31341. (03)878-1255.

## Marconi to second source Intel chip

**I**ntel Corporation, one of the world's leading microcircuit designers and volume manufacturers, has entered into an agreement with the GEC Group to allow Marconi Electronic Devices of Lincoln, eastern England to second source one of its integrated circuits.

This is the first time Intel have signed such an agreement with any UK company. The agreement sets out that Intel and Marconi will dual source a telecommunications integrated circuit in CHMOS. The circuit, a combination Codec and Filter (Combo) is used in large quantities in most telecommunications systems now being developed or manufactured throughout the world.

Samples of the integrated circuit are expected to be made available from Marconi during the first half of 1985.

The availability of Combo circuits over the next 3-5 years may well be a major factor in many of the UK's key telecommunications programmes. Intel expect this arrangement with Marconi to be of considerable benefit to the UK telecommunications industry.

## Hybrid regulators

**E**lectromark has announced the release of the latest hybrid regulators from ILP Electronics.

The HR 314 and HR 614 provide a constant 13.8 volt dc output at three or six amps respectively. The modules are encapsulated in a heat sink and are short circuit proof. They require a dc input of between 16 and 30 volts.

For more information contact Electromark, 43 Anderson Road, Mortdale NSW 2223. (02)570-7286.

## Drafting Aids

**A**ssociated Controls Pty Limited has recently been appointed Australian Distributor for the complete supply of printed drafting aids manufactured by Draft Material Co. Limited of Japan. This Company is Japan's largest supplier of printed circuit drafting aids and holds a 70% share of the Japanese market.

A wide selection of artwork tapes, die-cut symbols, templates and other materials are available to assist the PCB draughtsman.

Further information can be obtained from Associated Controls Pty Ltd. (03)561-2966.



## RF capacitors

**I**TT Jennings has released the latest technical data on their range of RF capacitors.

They are marketing Titanate capacitors for use in high kVA rating applications.

The company also offers complete environmental and RF testing of its products to any desired specification.

The capacitors and technical data on them are available from **STC Cannon Components, 248 Wickham Rd, Morabbin Vic. 3189. (03)555-9566.**

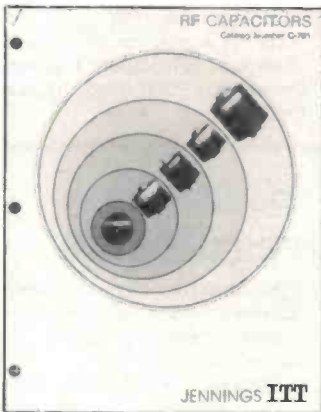

## Ultra thin toroidal transformer

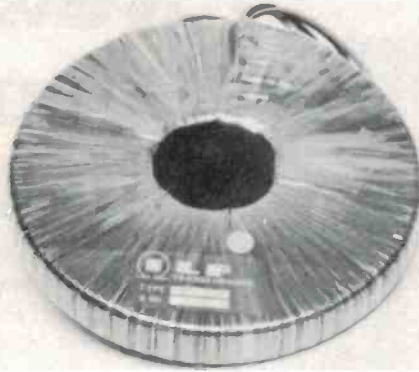

The new low profile transformer from ILP.

**E**lectromark has just released a new slimline transformer, the X92878.

At the request of Mr Bob Barton — design engineer at Sydney's Channel 7, ILP Transformers produced the new transformer to fit in a single unit 19" rack. The transformer has a rating of 160 VA  $\pm$ 30 V. Diameter is 155 mm and thickness of less than 35 mm. Mounting is by 20 mm M8 central insert.

More details from **Electromark, 43 Anderson Road, Mortdale 2223. (02)570-7287.**

## Booster

**E**lectromark has announced the release of two booster amplifiers for mono and stereo output boosting. They are coded C15 and C1515 respectively. They are both designed to take the signal from an existing output, and boost it to 15 W rms. The 3 dB points are claimed to be at 15 Hz and 30 KHz. For more information contact **Electromark, 43 Anderson Street, Mortdale 2223. (02)570-7286.**

## High contrast LCD

**A** new, high contrast liquid crystal display range has been released onto the Australian market. Although available overseas, this type of display has been previously unavailable in Australia.

In addition to the increase in contrast, these displays feature special seals to resist high humidity levels. They are suitable for a wide range of operating temperatures, both above and below previous limits.

Dichroic displays are available, offering designers a wide range of colours. A variety of

reflectors or transreflectors are also available.

The displays are available in both static-driven and multiplexed form, featuring many wanted symbols such as "Lo Batt" and over-range indicators. Custom designs are readily achievable, with three weeks turn-round-time offered on custom displays. A comprehensive range of compatible driver IC's is also readily available.

For more information contact **Promark Electronics, 366 Whitehorse Road, Nunawading Vic 3131. (03)878-1255.**

## The right connections

**W**hen you're dealing with low level signals in professional audio applications, such as in public address stage sound systems, the right connector makes all the difference between a smooth running, reliable system and the frustrations of intermittent sound loss.

The 'industry standard' connector is the well-known 'XLR'. Benelec Pty Ltd stock two line and two chassis mount XLRs amid their huge range of audio and RF connectors.

They have an in-line male connector (catalogue number 4-561), an in-line female

(4-563), a panel mounting male (4-562) and a panel mounting female (4-564). All are three-pin types for balanced line applications.

For further information about these and their other range of connectors, contact **Benelec at P.O. Box 21, Bondi Beach 2026 NSW. (02)665-8211.**

## Shield your zipper

**'Z**ippertubing' provides a simple solution to problems caused by birds nests of wires and cables that sometimes seems to create themselves despite the best intentions of designers.

It consists of a flame, dirt and temperature resistant jacketing that can be zipped up around recalcitrant cables. A new, shielded, version of this product is now available.

Marketed in Australia by **Adimex Trading**, shielded Zipper-tubing is an effective way to solve problems caused by EMI and RFI. There is provision to ground the shielding as determined by the system design.

According to the manufacturer, shielded zipper-tubing conforms to the American FCC, European VDE and MIL specifications.

For more information, contact **Adimex Trading, P.O. Box 219, Ringwood, Victoria.**





## A-D converter

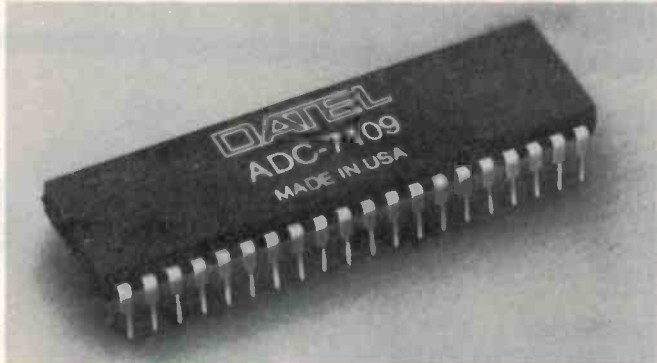

Datal's new ADC-7109 is a low cost, high performance, low power integrating A/D converter designed to interface with a wide variety of microprocessors.

Completely self-contained, the ADC-7109 includes a buffer amplifier, integrator, comparator, 12-bit binary counter and three-state outputs which enable the device to be interfaced to virtually any 8 or 16-bit microprocessor data buss.

In the byte-organised parallel mode, the ADC-7109 can interface with the data busses of microprocessors such as the

Motorola MC6800 and the Intel 8080 and 8048. In this mode, 14 data outputs provide 12 magnitude bits, polarity and over-range.

The outputs can be grouped in two 8-bit bytes, each activated by its own byte-enable signal and a master chip-enable line. A UART handshake mode is also provided to allow operation with industry-standard UART's in the serial data transmission mode.

For more information contact Elmeasco Instruments, P.O. Box 30, Concord NSW 2137. (02)736-2888.

## Multiple colour LCDs

Seiko Instruments began selling its multiple colour LCDs on May 1 in Japan. The eight colour displays have 64 x 160 picture elements that can be black, white, green, blue, purple, cyan, red and yellow. The displays come in modules that measure 170 mm x 100 mm and 200 mm deep.

Seiko uses a special macro-molecule electrodeposition technology to construct the displays.

The makers are hoping to use the modules as replacements for video displays in personal computers. They are planning a four colour version of the module with 640 x 200 pixels to be ready by the end of the year.

## Teledyne semiconductor manual

Promark Electronics, Australian distributors of Teledyne Semiconductor products, has the new 1984 Teledyne Data Acquisition Products Design Handbook.

The last manual from Teledyne Semiconductor was in 1981. Emphasis in the new book is on data acquisition and related products, including Teledyne's range of high quality A/D converters based on the industry standard 7106/7126/

7135 series.

As well as extensive data on the individual products, specific sections also cover cross referencing, packaging, handling precautions and quality assurance. A large section of the book covers applications of the devices.

To obtain this handbook contact Promark Electronics, 366 Whitehorse Rd, Nunawading Vic. 3131. (03)878-1255.

# What is better than NiCad for memory back-up?

## NEC



COMPARATIVE SIZE

# SUPERCAP of course!

Unlike NiCad —

- It never needs replacing or maintenance.
- It does not exhibit discharge memory.
- It can be wired either way. Lack of polarity enables this.
- It can be soldered onto P.C.B.s with other components.
- It can be charged at high and low current rates, i.e. microamps to amps.
- It is completely safe. It will not explode under extremes of temperature, nor will it leak.
- It is small and compact.

Catalogue No.	Cap. (Farad)	Rated V. (V.D.C.)	Max. W.V. (V.D.C.)	Max. ESR* (Ω at 1 kHz)
FA0H105Z	1.0	5	5.5	2.5
FZ0H223Z	0.022	5	5.5	50
FZ0H473Z	0.047	5	5.5	40
FZ0H104Z	0.1	5	5.5	45
FZ0H224Z	0.22	5	5.5	25
FZ0H474Z	0.47	5	5.5	13
FZ0H105Z	1.0	5	5.5	7

\*Equivalent series resistance

TECHNICAL INFORMATION AVAILABLE ON REQUEST

# SOANAR

SOANAR ELECTRONICS PTY. LTD.

INCORPORATED IN VICTORIA

30-32 Lexton Road, Box Hill, Vic., 3128, Australia.

VICTORIA: 895 0222

N.S.W.: 789 6744

STH. AUST.: 297 0811

QUEENSLAND: 852 1131

WEST. AUST.: 381 9522

TASMANIA: 31 6533



# FOR 30<sup>c</sup> POST AN ORDER TO ONE OF ALTRONICS COMPETITORS

— naturally you won't have a clue as to whether they've got the items you need available. And of course, be prepared to wait, wait, patiently wait sometimes for weeks!  
**Why waste your valuable cash? Altronics staff are waiting for your call now (up to 6pm eastern standard time).**

SERVICE DELIVERY

**WAS \$199  
SAVE \$74**



**ONLY \$125**

## FAMOUS VOYAGER CAR COMPUTER

AS REVIEWED  
EA OCT '82 P26-28  
ETI NOV '82 P26

**COMPLETELY BUILT AND TESTED**

MADE IN ENGLAND! — QUALITY!

Contains equivalent of thousands of transistors — uses massive custom LSI chip to achieve low price.

Never before has such a comprehensive car performance computer been offered at such a low price! Once again miracle microprocessor technology has enabled us to pass enormous savings on to you!

But don't let the low cost fool you. The "Voyager" car computer is the most comprehensive product that we have seen. No other car computer matches this one at even twice the price! You could buy a \$20,000 Holden and not get a better car computer!

Just check the features. We are sure that you will calculate that the "Voyager" represents outstanding value!

**FEATURES:** \* Instant fuel consumption in litres/100km and MPG! (most others have only one of the above) just switch from one to the other as you drive along. \* Instant speed, time and other fuel data. \* Visual and audible excess speed alarm.

**INSTALLATION:** The "Voyager" comes complete with an unbelievable array of mounting configurations, on dash, under dash or stalk mount. All installation hardware is supplied (even a roll of Insulation tape!) as well, of course, as the speed and fuel sensors. A lavishly illustrated installation manual is provided as well as a comprehensive operators manual.

## THE BUY OF '84 .....

Quality BSR P246

**SEMI AUTOMATIC TURNTABLE**  
Under \$30.00



- \* 2 SPEEDS
- \* DIAMOND NEEDLE
- \* CERAMIC CARTRIDGE
- \* LOW NOISE 10" BELT DRIVE PLATTER
- \* 12V DC OPERATION — POWER FROM MOST AMPLIFIERS — OR M 9005 PLUG PACK

**\$29.50**

Fully imported from the UK and representing outstanding value. Ideal for use in Disco Units and for upgrading existing 3 in 1's etc.

LIMITED STOCKS - SO BE QUICK

## LOOK AT THIS

**INCREDIBLE SAVINGS**  
On our Super Popular  
National Semiconductor  
Data Books

SAVE A MASSIVE 40%



**BUY THE SET FOR ONLY \$28**

Was Now Only

B1010	LINEAR DATA VOL 1 ..	\$12.50	\$6.50
B1011	LINEAR DATA VOL 2 ..	\$12.50	\$6.50
B1015	LOGIC DATA .....	\$ 9.95	\$8.50
B1030	CMOS DATA .....	\$11.50	\$8.50

## PROFESSIONAL AUTOMATIC WIRE STRIPPER

Automatically adjusts to insulation / wire diameter.  
This absolutely brilliant stripper is the finest we've ever used.



**\$9.50**

## GO ANYWHERE 12-240V POWER



**MASSIVE 300 WATTS**

These great Inverter kits enable you to power 240V appliances from a 12V DC power source. Tremendous for camping, fishing etc. Install into your Car, Boat or Caravan.

A fully regulated and overload protected design, featuring XTAL locked frequency. Use to power hi-fi, TV sets, even electric drills for short time periods.

**MANY OF THESE KITS ARE NOW IN USE FOR EMERGENCY LIGHTING PURPOSES.**

ALTRONICS' KIT features \* Gold plated edge connector and PCB huss \* Low age rate XTAL \* Sockets for all IC's \* High Efficiency Transformer.

K6750..... (EA JUNE '82) ... **\$199.50**

(\$10 DELIVERY AUSTRALIA WIDE)

## 40 WATT MODEL

Suits small appliances, ie. Turntables, Tape Decks, Shavers etc. Variable frequency adjustment enables speed control of turntables. Works as a trickle charger when mains power is available.

EASY CONSTRUCTION \* VALUE PLUS

K6700..... **\$55.00**



## FULLY APPROVED DC PLUG PACKS

Eliminate the need for batteries, when testing or operating projects.



**INSULATED TO ASC 126**

M9000

240v AC — 3, 4.5, 6, 7.5, 9,  
12v DC @ 300mA

ONLY..... **\$12.50**  
4 OR MORE..... **\$11.00**

M9005

240v AC — 6, 9, 12v DC  
@ 500mA

ONLY..... **\$14.95**  
4 OR MORE..... **\$13.50**

BANKCARD HOLDERS — PHONE ALTRONICS TOLL FREE 008-999-007 FOR N

BANKCARD HOLDERS — PHONE ALTRONICS TOLL FREE 008-999-007 FOR N



OR FOR **15<sup>c</sup>** PHONE YOUR ORDER TOLL FREE ON 008-999-007

We will immediately confirm stock availability. We will also confirm the very hour your order will be dispatched (over 95% of orders leave the same day). **with Jet Service Delivery we deliver next day to capital cities and suburbs** — Country areas please add 24 to 48 hours. **Available bankcard holders only** — sorry non-bankcard holders must post a cheque or money order — even so, we promise to deliver quicker than any other supplier in Australia.



**POWERFUL 6000 RPM  
MINI DRILL  
FOR PC WORK**



Tons of Torque. Just the shot for PCB work. 12V DC operated from external Power Pack 1.2mm chuck capacity. Supplied c/w 1mm drill bit.



T2302 now only ..... **\$10.00**  
Drill Bits:  
T2320 (0.8mm) ... **\$1.25**  
T2326 (1.0mm) ... **\$1.25**

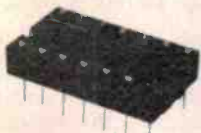

**IC SOCKETS  
DIL  
LOW PROFILE**

	ea.	10+	25+
P 0550 8 Pin	.18	.15	.10
P 0560 14 Pin	.20	.18	.15
P 0565 16 Pin	.20	.18	.15
P 0567 18 Pin	.30	.25	.20
P 0568 20 Pin	.50	.45	.42
P 0569 22 Pin	.60	.50	.47
P 0570 24 Pin	.45	.40	.35
P 0575 40 Pin	.65	.55	.45



**HEATSINK COMPOUND  
BUY THE BULK 150g PACK —  
IT'S 378% MORE ECONOMICAL!**

Heat conducting paste facilitates heat transfer from semi to Heatsink. One tube good for up to 30 T-03 package semiconductors.



H1600 ... 7.5 gm Pack ..... **\$1.80**  
H1610 ... 150gm Pack ..... **\$9.50**

**DIODES SLASHED**

	Were	This Month	100+
IN4002	8c	6c	5c
IN4004	10c	8c	7c
IN4007	14c	10c	9c

**PROFESSIONAL QUALITY  
SOLDER SUCKERS**

Not to be compared with inferior 'Hobby types'. Saves countless hours in fault finding and repair of complex PCB's. **SINGLE HANDED OPERATION SELF CLEANING PLUNGER**



T1240. only **\$11.95**  
T1241. Replac tip. **\$1.95**

**COMPONENT JOYSTICKS  
Standard type  
(non-centering)**

- Resistance 100K ohm
- Lever movement 60°
- Metallic knob
- For TV games, RC units
- Life 300,000 cycles



K 9680 **\$4.95**

**Self Centering Type**

Resistance 5K ohm suit ETI project for microbee "Proportional Analogue Joystick" Dec 1983

K 9689 **\$17.50**

**PRICE SLAUGHTER  
ON GENUINE HITACHI  
MOSFETS (PRIME SPEC)**

Z1510 2SK 134  
Z1512 2SJ 49

**\$5.90** EA  
**\$5.50** 10up.

**2N3055'S  
SLASHED**



QUALITY "SGS"

Z1174 **\$1** EA

**LEDS**

Z 0140	Led 3mm Red	.14	.10
Z 0141	Led 3mm Green	.20	.18
Z 0143	Led 3mm Yellow	.22	.20
Z 0150	Led 5mm Red	.14	.10
Z 0151	Led 5mm Green	.20	.18
Z 0152	Led 5mm Yellow	.22	.20
Z 0154	Led 5mm Orange	.25	.22
Z 0159	Led 5mm Flashing		
	FRL4403	.49	.45
Z 0160	Led Rectangular Red	.22	.19
Z 0162	Led Rectangular Green	.25	.22
Z 0164	Led Rectangular Yellow	.25	.22
Z 1072	Led Infra Red CQY89A	.55	.52

**SUPERB KIT  
POWER SUPPLIES**

If you're thinking of buying a power supply then buy from us, we are the experts on power supply kits and carry a supply to suit most enthusiast and professional requirements. .... READ ON.

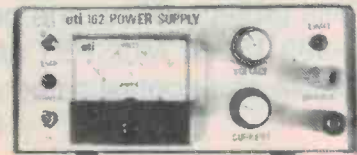

**BENCH STANDARD**

- \* 3-30v Output @ 1 Amp.
- \* Fully Regulated, Fully Protected from Thermal Overload and Short Circuits.
- \* ETI Design.

K3205. .... (PICTURED) ..... **\$49.50**

**HIGH CURRENT**

**MICROCOMPUTER PS**

- \* + 5 Volts @ 3 Amps. + + 12 Volts @ 2 Amps.
  - 12 Volts @ 200 milliamps.
- This universal design has enough grunt to power most disk drives.

K3350. .... **\$59.50**

13.8 VOLTS @ 10 AMPS HAM'S & CBER'S  
Save the expense of a Mains Powered Rig.

K3250. .... **\$89.50**

**HIGH CURRENT — DUAL METERING**



**EA SWITCH MODE DESIGN**

- \* 2-50 volts at massive 175 watts.
- \* CLEVER DESIGN — a fully mains isolated supply with a "Switchmode" low voltage circuit.
- \* Easy to build.

K3300. (EA MAY, JUNE '83). **\$139.00**

(10 TURN VOLTAGE CONTROL OPTION) ... **\$10.00**

(± 12V OPTION) ... **\$12.50**

**ETI SERIES REGULATOR DESIGN**

- \* 0-40 Volts @ 5 Amps — that's 200 watts.
- \* Current limiting 0-5 Amps variable.
- \* Specifications Second to None.
- \* Free from the hum and noise sometimes associated with other techniques.

A PROFESSIONAL SUPPLY

K3325. .... (PICTURED) ..... **\$175.00**

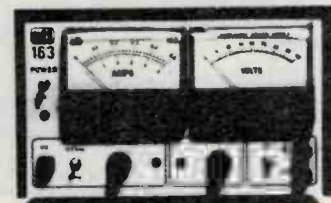

FEATURING: VARIABLE CURRENT LIMIT-DUAL METERING

BANKCARD HOLDERS — PHONE ALTRONICS TOLL FREE 008-999-007 FOR NEXT DAY JETSERVICE DELIVERY

BANKCARD HOLDERS — PHONE ALTRONICS TOLL FREE 008-999-007 FOR NEXT DAY JETSERVICE DELIVERY



# Modular paging amplifier/sound system

Geoff Nicholls

This project utilizes the preamp described in May and the ETI-499 150 W MOSFET power amplifier to implement a cost effective and sophisticated paging system for clubs and large halls.

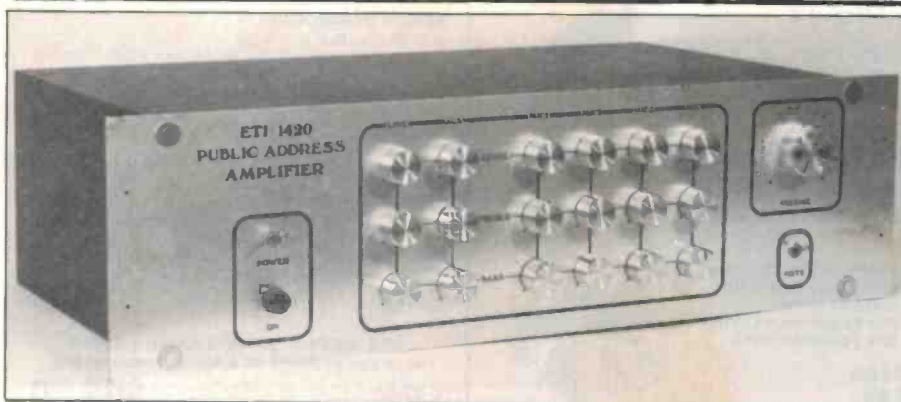

THE DESIGN philosophy of the ETI-1420 has centred largely on not reinventing the wheel. We have used, with slight modifications, two existing projects that fulfil all the necessary requirements to build a first rate paging system. The only re-design necessary has been associated with making the two projects work together.

This project was conceived as a high quality public address amplifier offering six inputs with independent level, bass and treble controls. It should be suitable for use as a paging amplifier in a club or hotel installa-

tion or as a sound reinforcement amplifier for a small band or a church hall.

The prototype was constructed using a 5¼ by 19 inch rack case which produces a very professional looking unit, although the electronics may be fitted into a cheaper case if desired. The amplifier has a balanced output which can be used to connect other slave amplifiers or to send to a mixer. It should also be possible to use the balanced output to bridge two ETI-499 MOSFET power amps to produce 300W into 8 ohms, although we haven't tried it.

## SPECIFICATIONS ETI-1420 PAGING AMPLIFIER

Measured from preamp inputs to power amp input

### Sensitivity

Input levels required to drive the power amp to full power output. Tone controls 'flat'.

Line input ..... 200 mV RMS balanced

Aux. input ..... 70 mV RMS

Mic. input ..... 600  $\mu$ V RMS balanced

### Signal/Noise Ratios

Line/Aux. inputs ..... -72 dB, hum and noise

Mic. Inputs

open ..... -57 dB

560R load ..... -54 dB

Line output ..... 2 V RMS (nom.)  
balanced

Six ETI-1421 preamps provide the front end of the amplifier. With slight modifications it proved possible to provide a variety of input characteristics. Four of the inputs provide a balanced input for 500  $\mu$ V signals, one provides a balanced input for 70 mV signals and the sixth one has an unbalanced input for 200 mV. All the inputs are individually controllable with separate level, bass and treble controls. There is also a master volume control to set the gain of the mixer stage.

The '1421 modules are suitable for low impedance balanced microphones only. In order to provide a balanced line input it is necessary to reduce the gain in one of the preamps to unity. This is achieved by changing R3 and R4 to 1k 1% and substituting a 22 pF ceramic capacitor for C3.

To use the '1421 as an unbalanced amplifier it is necessary to delete IC1 and its associated components (R1-R4, C2, C3, C12, C13) and connect the input signal straight across RV1. If more gain is required then R6 may be increased as required.

We have included a mute facility on the amplifier to allow the controller to shut down all except one channel. This would allow priority calls to override other inputs. Paging for telephone calls is a case in point.

The power amp is the ETI-499 MOSFET amp first described in March 1982. In this application it is used to drive an OP597 output transformer. This is used to step the output voltage up to 100 V. The OP597 is made for Auditek Australia of Sydney by Ferguson Transformers. Supplies should be available in most capital cities. In the event of problems, contact their Sydney offices (see Shoparound column this issue).

The previous P.A. amp (the ETI-498) used the OP590 which is inferior to the OP597 in that it is an autotransformer and thus does not isolate the line output from the power amp or provide a balanced output.

### Construction

The most difficult aspect of the project is the metalwork, which will take several hours to mark out and fabricate. It is important to get all the dimensions correct, especially with the front panel since the input boards are mounted by the pc-mount pots so any errors are likely to make it difficult to fit them properly. The 19" rack cases are expensive, so take care! Before any holes are made I suggest you try putting all the



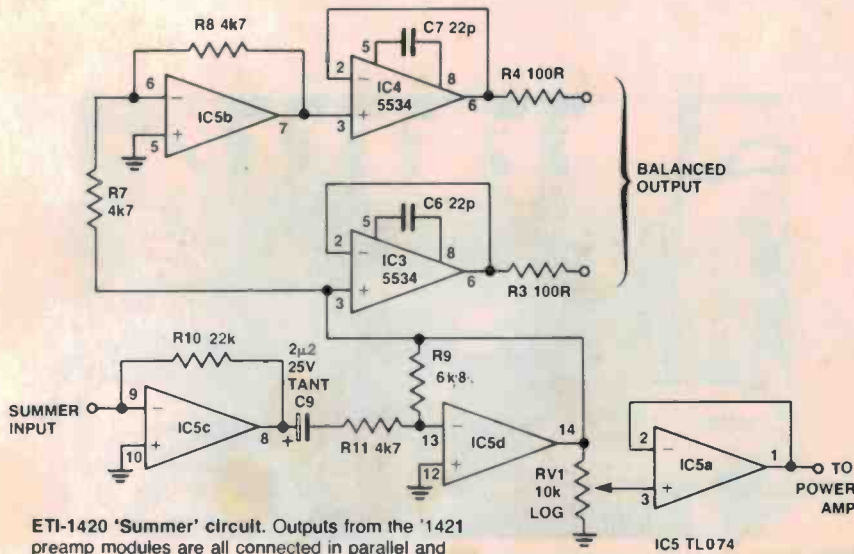

ETI-1420 'Summer' circuit. Outputs from the '1421 preamp modules are all connected in parallel and summed at the '1420 Input.

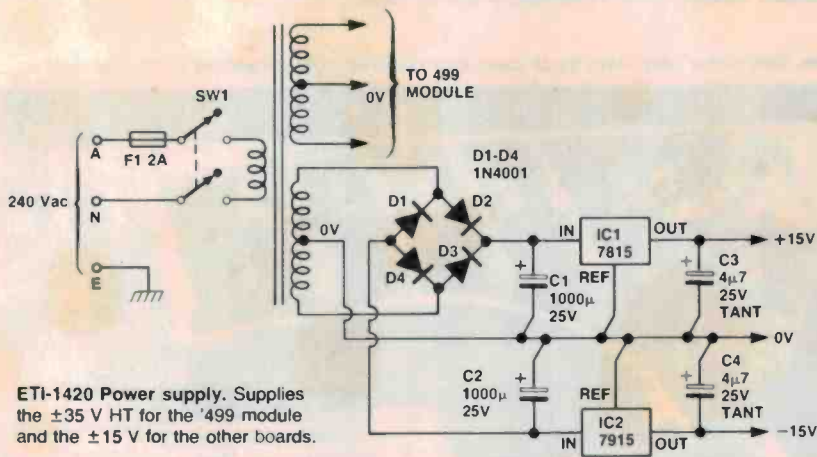

ETI-1420 Power supply. Supplies the  $\pm 35$  V HT for the '499 module and the  $\pm 15$  V for the other boards.

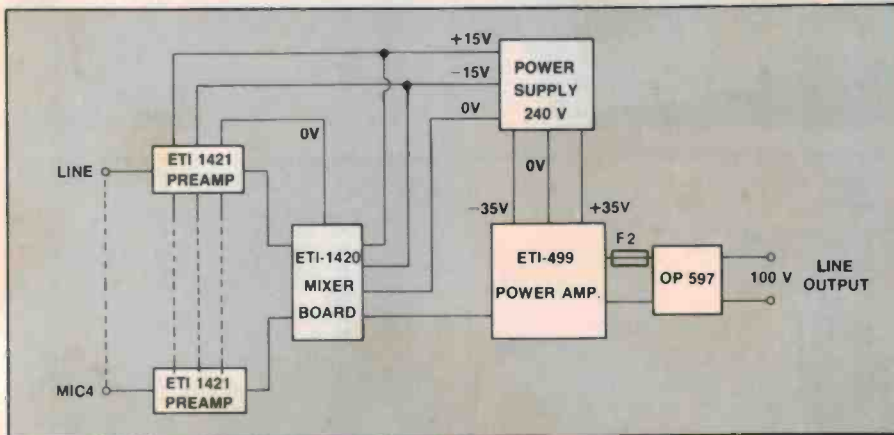

ETI-1420 Block diagram

modules and transformers in the box to see if any clearance problems occur. Read through the rest of the construction before removing any metal and you'll avoid problems later.

The prototype was fitted into a rack that has corner bars and a light gauge cover, so it was necessary to make up brackets to mount the transformers along the sides so

the unit is well balanced and easy to carry. Other styles of cases will require other mounting techniques, so be prepared to improvise here.

Mark out and drill the front panel. I used one of the ETI-1421 PCBs as a template while drilling the input pot shaft holes to ensure the pots would fit properly. I suggest everyone do this. Don't drill through the

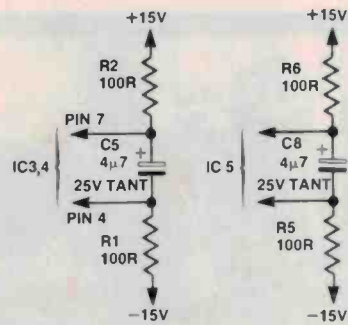

## HOW IT WORKS ETI-1420

The project consists of six input preamplifiers, a mixing stage with a balanced output, the MOSFET power amplifier, the 100 V line output transformer and the power supply transformer.

### MICROPHONE PREAMPLIFIERS

ETI-1421 modules are used for the six preamplifiers. Four of them are wired for low impedance balanced microphones as in the ETI-1421 article in May 84, except that coupling capacitors C7, C12 and C13 are not needed, and should be replaced by links. The other two input preamps are wired to provide a balanced high level input and an unbalanced high level input.

The balanced high level input (the LINE input) has the differential amplifier gain set to unity by changing R3 and R4 in the ETI-1421 to 1k0 1% and by adding C3, a 22 pF ceramic capacitor, to compensate the 5534 for unity gain. Once again C7, C12 and C13 should be replaced by links.

The unbalanced high level input (the AUX input) is implemented by deleting the differential amplifier stage and connecting the input signal directly across RV1 in the ETI-1421 preamp. The gain of this input may be adjusted by varying R6. Again, C7 should be deleted.

The muting is arranged so that all inputs except MIC1 are disabled when the mute switch is operated. This is done by paralleling the mute inputs on the five boards and wiring them to the front panel switch.

### MIXER STAGE

Each of the preamplifier boards has output resistors (R14, R15) to feed the current-summing virtual-earth mixer IC5c on the ETI-1420 board. The mixer stage is ac coupled to the inverting op-amp stage IC5d which drives the master volume pot. and the balanced driver. IC5b inverts the signal for the out of phase driver IC4. The balanced output could be used in a bridging amplifier if desired.

The ETI-1420 pcb also carries the power supply components for all the preamplifiers. The standard 3-terminal regulators deliver + and -15 V from the two 15 Vac windings on the PF4361/1 transformer.

### POWER AMP

The ETI-499 MOSFET power amp module was described in ETI March 1982 and is used in this project. It will deliver 150 W RMS into 4 ohms when used with the PF4361/1 transformer. The output from the '499 drives the primary of the OP597 line output transformer to step the voltage up to 100 V, and provide a balanced and isolated output.



# Project 1420

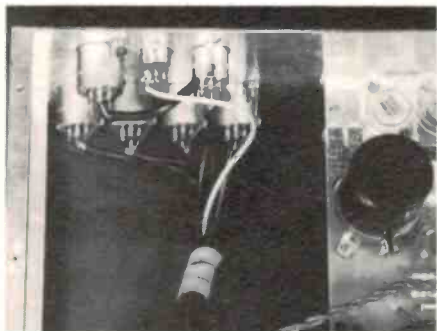

**Socket wiring.** Showing how the input and output sockets wiring is routed.

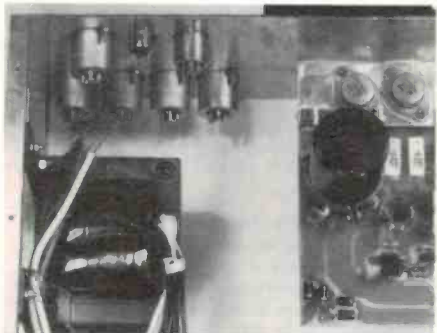

**Output tranny mount.** Two pieces of flat metal strip are used to mount the OP597 100 V line output transformer.

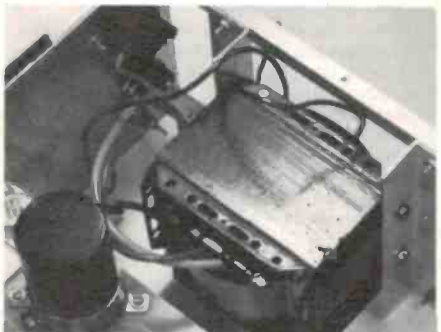

**Power tranny mount.** Two pieces of 13 mm aluminium angle are used to mount the PF4361/1.

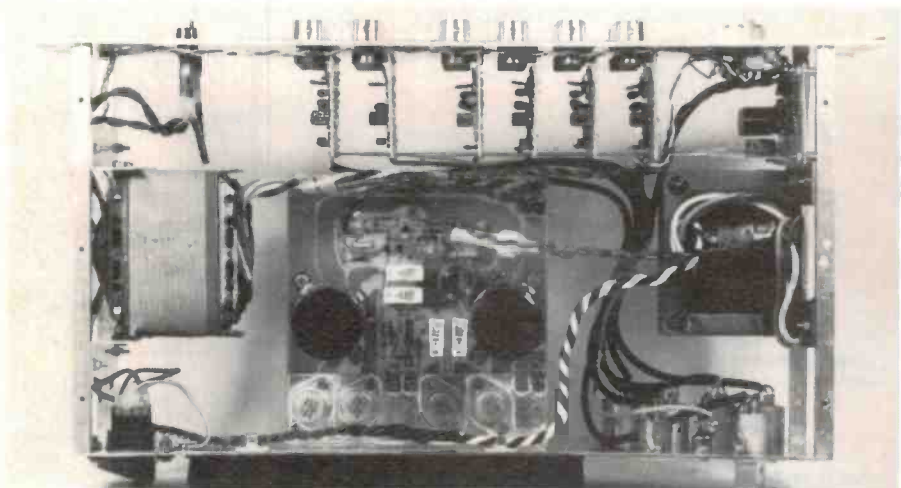

**Above.** Internal view of the completed project (from the bottom) showing general routing of wiring. A twisted-pair of heavy duty hookup wire is used on the '499 input; likewise the output (note line fuse). The '499 module heatsink mounts horizontally on the rear panel.

**Below.** View of rear panel (from top of case), showing wiring routing to sockets on the rear panel.



## ETI-1420 'summer' board overlay

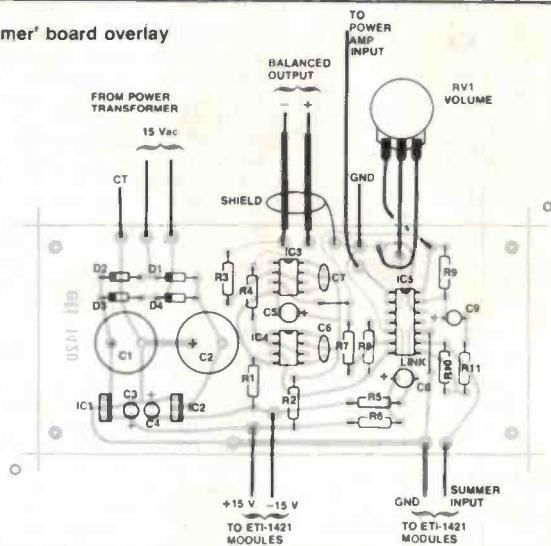

## PARTS LIST ETI-1420

- Resistors**.....all 1/2W, 5%  
 R1, R2, R3, R4,  
 R5, R6 ..... 100R  
 R7, R8, R11 ..... 4k7  
 R9 ..... 15k  
 R10 ..... 6K8  
 RV1 ..... 10k Log
- Capacitors**  
 C1, C2 ..... 1000µF 25 VW RB  
 Electro  
 C3, C4, C5, C8 ..... 4µ7 25 VW Tantalum  
 C6, C7 ..... 22 pF Ceramic  
 C9 ..... 2µ2 25 VW Tantalum
- Semiconductors**  
 IC1 ..... 7815  
 IC2 ..... 7915  
 IC3, IC4 ..... NE5534, LM5534  
 IC5 ..... TL074, µA774  
 D1-D4 ..... IN4001, IN4002
- Miscellaneous**  
 4 ETI-1421 Low Z balanced mic preamps  
 1 ETI-1421 Balanced line preamp  
 1 ETI-1421 Unbalanced aux. preamp  
 1 ETI-499 MOSFET power amp module



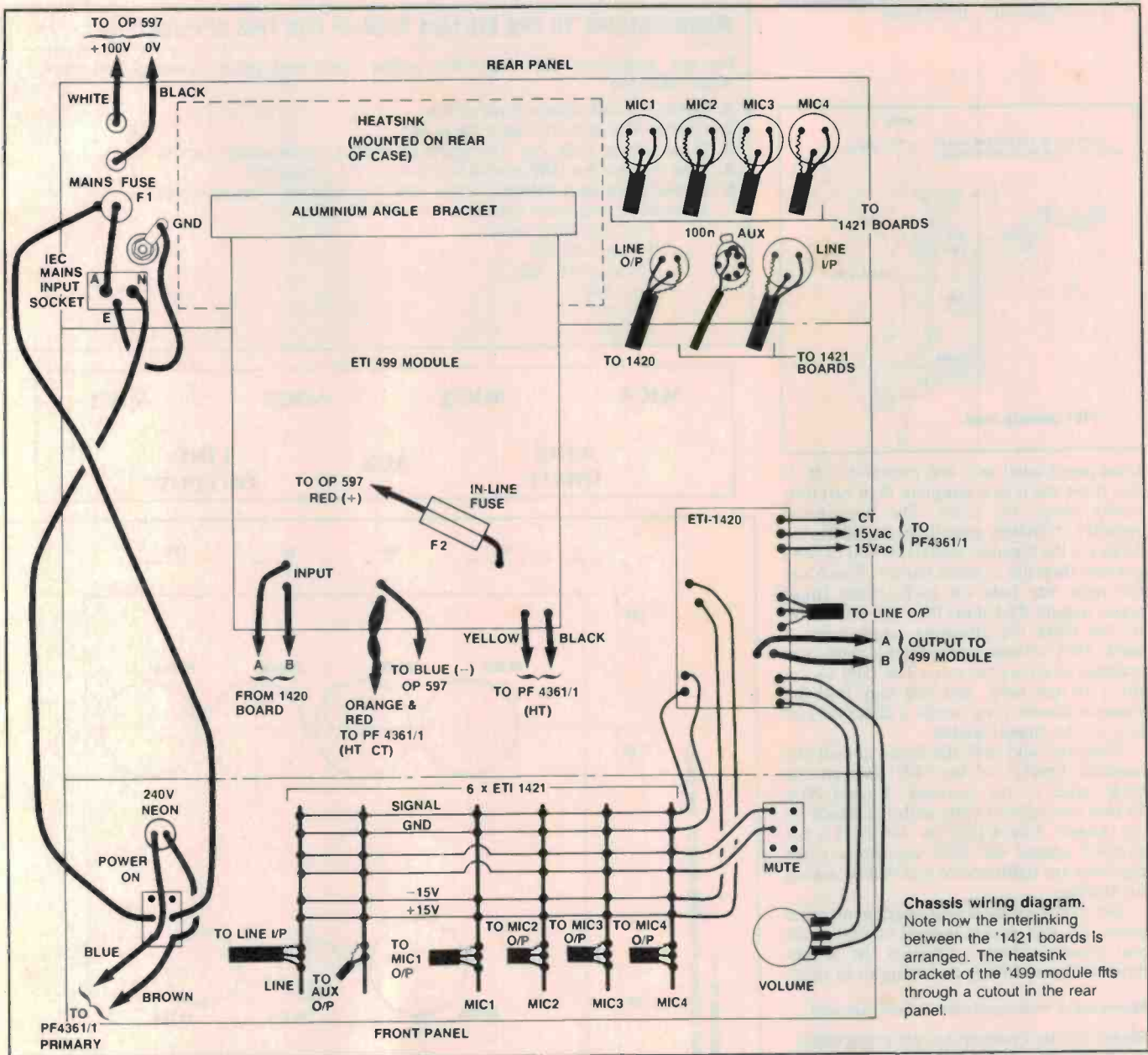

**Chassis wiring diagram.**  
Note how the interlinking between the '1421 boards is arranged. The heatsink bracket of the '499 module fits through a cutout in the rear panel.

- 1 power transformer PF4361/1
  - 1 line output transformer OP 597 (see text)
  - 5 3-pin Cannon chassis sockets
  - 1 3-pin Cannon chassis plug
  - 1 5-pin DIN chassis socket
  - Radial fin heatsink, 225mm x 105mm (DSE H-3426)
  - 1 chassis fuse holder 3AG
  - 1 2A fuse
  - 1 in-line fuse holder
  - 1 8A fuse
  - 2 toggle switches DPDT 250 Vac
  - 1 Euroconnector 3-pin mains male chassis socket
  - 1 250 Vac neon in bezel
  - 18 small knobs
  - 1 large knob
  - 19" by 5" rack box
  - ETI-1420 Front panel
  - Brackets to mount transformers, etc.
  - Heavy duty hook-up wire
  - 2 screw terminals (for 100 V line)
  - Balanced microphone cable
- Price estimate: \$200-\$220**

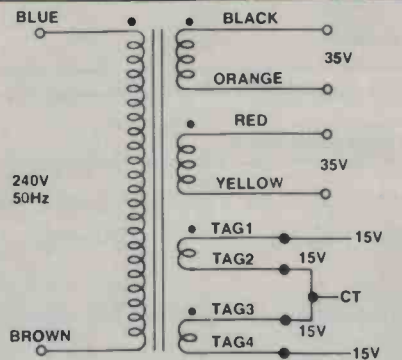

#### PF4361/1 CONNECTIONS

The lead-out wires from the power transformer are colour-coded as shown here. This should help you identify where the wires terminate on the '499 and '1420 modules. The high tension centre-tap (HT CT) is formed by joining the orange and red leads at the '499 pc board.

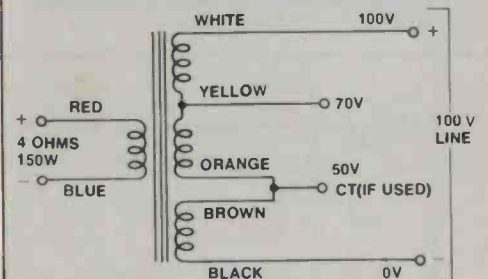

#### OP597 CONNECTIONS

Colour-coding for the lead-out wires on the 100 V line output transformer. The orange and brown wires must be joined. Note that this transformer gives a true balanced 100 V line output, unlike an autotransformer (as used on the ETI-498 Outdoor PA). The white and black wires go to the output terminals on the rear panel, above the mains fuse.



# Project 1420

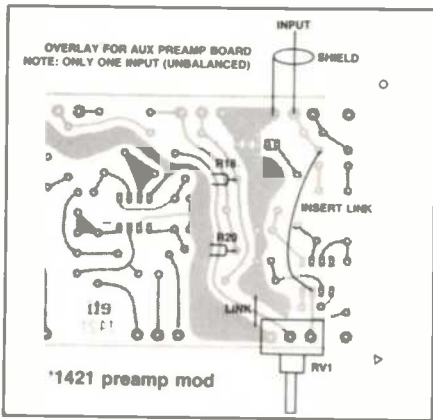

front panel label as it will probably tear. If you must use it as a template then carefully centre punch the holes. The back panel requires a chassis punch set to make the holes for the Cannon sockets. If you haven't got one then life is much harder. Punch out the right size hole for each socket (most types require 25.4 mm) then put the socket in and mark the attaching screw holes. I used 6BA countersunk screws with star washers to secure the nuts. The DIN socket fits a 16 mm hole, and you may find the Cannon chassis plug needs a different size hole to the chassis socket.

Mark out and drill the holes to bolt the heatsink bracket of the '499 through the back panel to the heatsink. I used 2BA 19 mm cheesehead bolts with the heads on the outside. Check that the '499 PCB is not stressed against the filter capacitors when the bolts are tightened or you will be asking for trouble.

The mains wiring is simplified if you use a mains 'EURO' socket instead of a flex cord and grommet/clamp, although the socket requires some drilling and filing to fit neat-

**Above right.** Rear panel label artwork (full size).

**Socket drilling.** Input/output socket drilling details on the rear panel. Mounting details for the '499 and its heatsink, plus the power input socket, mains fuse holder and output terminals are not given as these will depend on the individual components used.

## MODIFICATIONS TO THE ETI-1421 PREAMP FOR THIS APPLICATION

For this application, we recommend a few component value variations and other, minor, changes.

1. Delete C7 and replace it with a link.
2. Change R12 and R13 from 10k to 4k7.
3. R6 should be 150k, not 100k (parts list correct, circuit value in error).
4. Note that, for the LINE and AUX preamps, R5 is different.
5. Should there be a shortage of the 100k/A pots used in the tone controls, use these alternative component values.

RV2 and RV3: 250k/A  
 R7 and R8: 82k  
 R9 and R10: 33k  
 R11: 8k2  
 C5: 2n7  
 C6: 1n

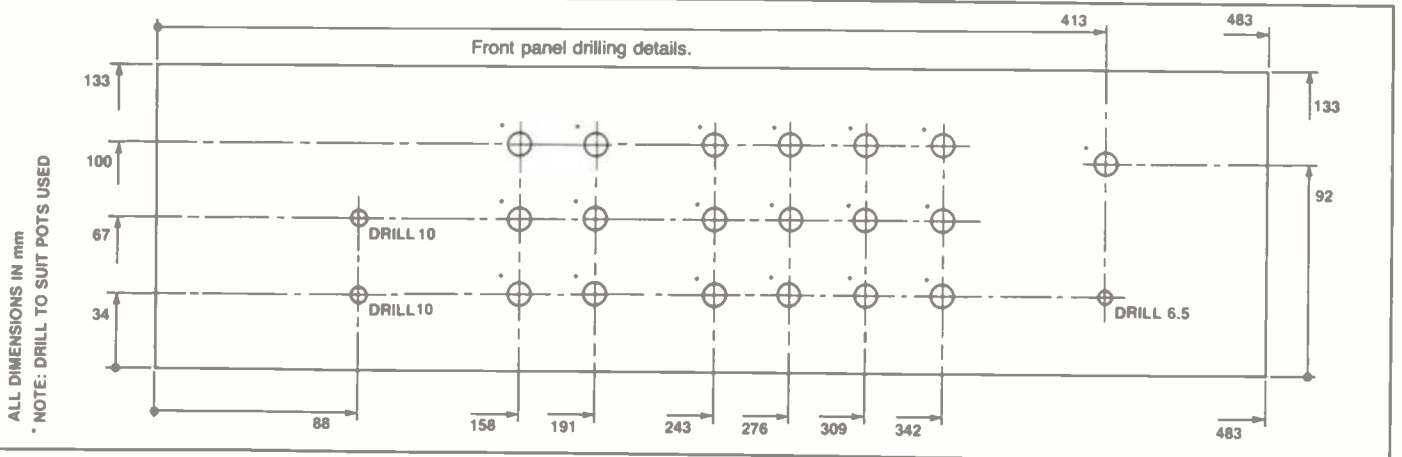
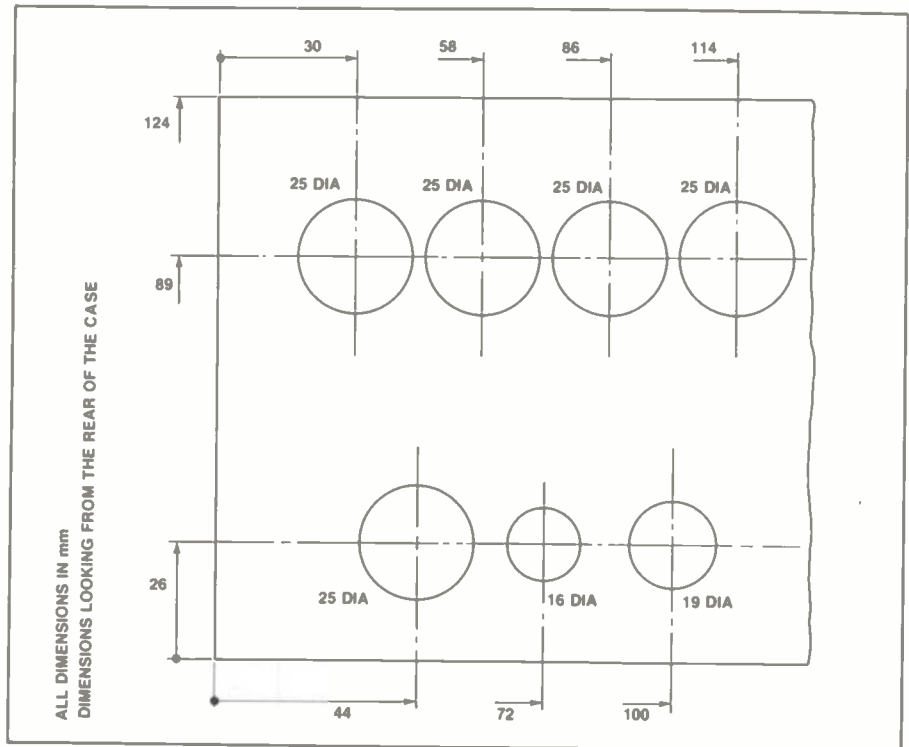



**ETI 1420  
PUBLIC ADDRESS  
AMPLIFIER**

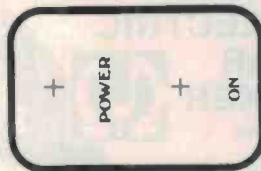
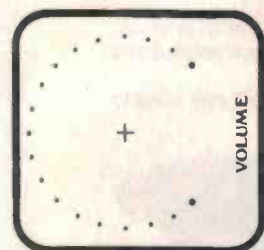
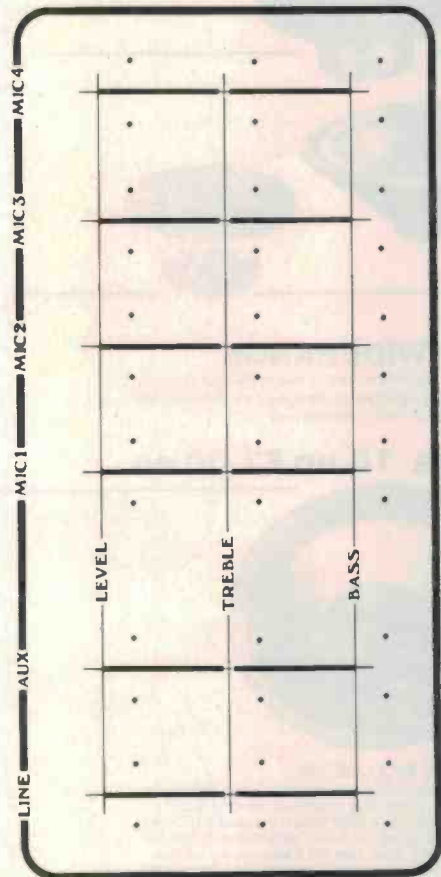

ly. The main advantage is that the cord may be completely removed and the amplifier carried without any trailing wires. The 'EURO' socket uses crimp style pins which are fixed to the wires and then pushed into the plastic moulded case where they catch. Whatever mains cord you use it is imperative that the metal case is connected to the earth pin through heavy duty green/yellow wire.

The back panel is completed by mounting the mains fuseholder near the 'EURO' socket and the terminals for the 100V line. The ETI-1420 pcb mounts on the side of the case near the volume control pot between the front panel and the OP597 transformer. I used 6BA screws and 6 mm spacers to support the board.

The OP597 is wound with an isolated primary winding designed for a 150 W into 4 ohms power amp — ideal for the ETI-499 module. Three separate secondary windings are provided to allow 50, 70 or 100 V outputs: the black-brown pair deliver 50 V, the orange-yellow pair deliver 20 V while the yellow-white pair deliver 30 V. Note that the two wires marked yellow are brought out in one plastic sleeve. The yellow wires should be soldered together and insulated. Then do the same to the orange and brown wires. The 100 V output then comes from the black and white wires, white to positive. The primary positive is the red wire.

An in-line fuse holder is used in the power amp output wire to the OP597 to protect the power amp.

Left. Front panel artwork, 50% actual size.

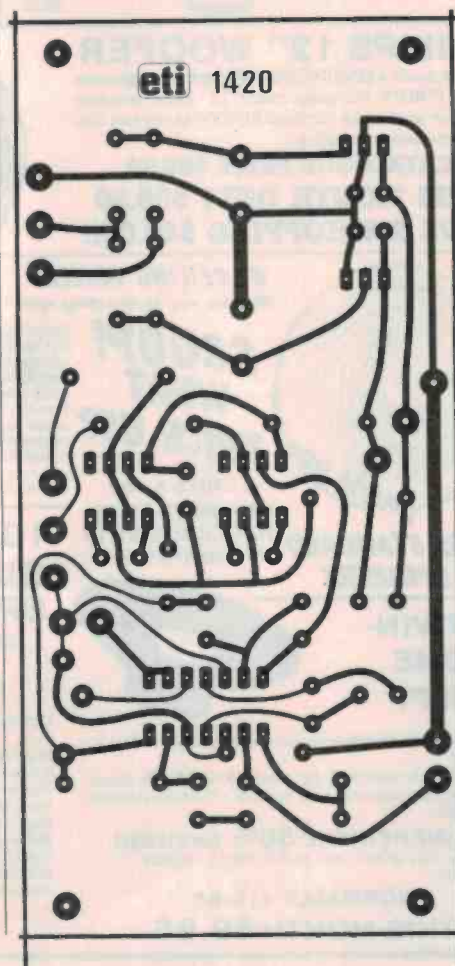

**AUSTRALIAN IMPORTERS**

**CLIFF**



**CH-1**  
CABINET HANDLE  
102 x 48mm



**SRP**

**PF-1**  
CABINET FEET  
37mm



**CH-2**  
LARGE  
CABINET HANDLE  
165 x 210mm



**CF-1**  
CABINET CORNER

**PCB SPACERS**

12.5mm 19mm 25.4mm 31.7mm



**TPI TERMINAL**

4mm, SCREW, 15A, 250V.A.C.



**KNOBS SCREW & PUSH FIT**  
K9, K10, K11, K12.

ABOVE AVAILABLE IN PUSH FIT  
WITH SEPARATE  
COLOURED CAPS



**KNOBS SLIDER**

**DELSOUND PTY. LTD.**

1 WICKENHAM TCE., (CNR. WHARF ST.)  
BRISBANE 4000  
(07) 229-6155. TELEX AA44442

**MOST  
ELECTRONIC PARTS  
& COMPONENTS**



# Jaycar ELECTRONICS

Incorporating  
**ELECTRONIC AGENCIES**

**NUMBER 1 FOR KITS**

**SHOWROOMS**

**SYDNEY**

117 YORK STREET

Tel: (02) 264 6688 & (02) 267 1614

Telex: 72293

**CARLINGFORD**

Cnr. CARLINGFORD & PENNANT  
HILLS ROAD

Tel: (02) 872 4444

**CONCORD**

115-117 PARRAMATTA ROAD

Tel: (02) 745 3077

**HURSTVILLE**

121 FOREST ROAD

Tel: (02) 570 7000

## MAIL ORDERS & CORRESPONDENCE

P.O. BOX 185

CONCORD, 2137

Tel: (02) 745 3077

## POST & PACKING CHARGES

\$5 - \$9.99	\$1.50
\$10 - \$24.99	\$3.20
\$25 - \$49.99	\$4.50
\$50 - \$99.99	\$6.50
\$100 - \$198	\$8.00
Over \$199	\$10.00

**COMET ROAD FREIGHT  
ANYWHERE IN AUSTRALIA  
ONLY \$12.00**

## SHOP HOURS

CARLINGFORD, CONCORD &  
HURSTVILLE

Mon - Fri: 9 am - 5.30 pm

Sat: 9 am - 12 pm

Thurs Night: 8.30 pm (Not Concord)

## SHOP HOURS SYDNEY

Mon - Fri: 8.30 am - 5.30 pm

Sat: 8.30 am - 12 pm

Thurs Night: 8.30 pm

## MAIL ORDER BY



 **bankcard**

**VIA YOUR  
PHONE**



# JAYCAR - No1 FOR SPEAKERS

## SENSATIONAL DEALS ON 3-WAY SPEAKER SYSTEMS!!

A massive scoop purchase of factory distress stock has enabled us to pass on unbelievable prices on quality speaker systems. The component speakers in these systems are normally incorporated into cabinets for many well known national brand HI FI companies.

Each speaker is factory guaranteed for 90 days, however we doubt whether you will ever need to worry about it.

### 8" 3 WAY SYSTEM

Superb 8" woofer with foam surround suspension and heavy magnet assembly with sealed back midrange and tweeter. System impedance 8 ohms. Power handling 40 watts rms. Crossover capacitors and connecting diagram and recommended 8" cabinet detail drawing supplied.

Cat. CS-2453 (2 required for stereo)

**\$29.95/set**



### 10" 3 WAY SYSTEM

Once again, a high quality 10" woofer with higher power, sealed back midrange and tweeter. System impedance 8 ohms. In addition a quality Pioneer 3-way crossover is provided at no extra charge. Connection instructions are also provided as well as recommended 10" cabinet plans.

Cat. CS-2454 (2 required for stereo)

INCLUDES PIONEER 3-WAY CROSSOVER!!

**\$39.95/set**



### 6" WIDERANGE

4 ohm impedance. Suitable for cars, or two in a box for extension speaker system. Very high quality curvilinear cone. Normally sells for \$6.95 each. Less than 1/2 normal cost!

Cat. AS-3011

**\$2.99 ea 10 up \$2.50 ea**



### PHILIPS 12" WOOFER

We have made a MASSIVE SCOOP purchase of genuine quality PHILIPS European made 12" HI FI woofers. These are used in the fabulous ET4000 series kits. 100 watts rms power handling.

CATALOGUE PRICE \$99.50

**THIS MONTH ONLY \$59.50**

**SAVE A WHOPPING \$40.00!!**

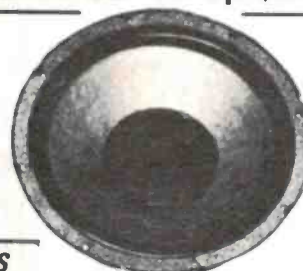

### 8" CEILING GRILLES

- Will they ever be this cheap again?

**SCOOP!  
WHAT  
PRICE US?**

1-4 UNITS \$1.50  
5-19 UNITS \$1.25  
20-49 UNITS \$1.15  
50 + UNITS 99¢

**TAKES STANDARD  
8" SPEAKERS**

### 8" TWIN- CONE HI FI



20 watts rms with whizzer cone. Air suspension type. Low free air resonance.

Normally this speaker sells for around \$19.95. The Jaycar massive scoop purchase enables you to buy them this month at only \$9.95.

**AN INCREDIBLE 50% SAVING!!**

The stock WONT LAST AT THIS PRICE - HURRY!!

Cat. CE-2330

**NORMALLY \$19.95**

**THIS MONTH \$9.95**

### PRICES INCLUDE TAX

Once again - a massive scoop purchase with a difference. We have purchased a very large quantity of 'reject' grilles. They are rejects because they have small flaws in the mouldings. Most people however cannot pick the flaws if allowed to examine the grille. Imagine what the flaws look like if held up on the ceiling! Naturally we are offering a massive saving over normal units which we also sell. Exactly the same units (sans flaws) have been sold throughout Australia in the 10's of 000's. The perfect ones sell for around \$2.95 - at least one company sells them for well over \$3.00

PA INSTALLERS - GO FOR IT!

### 10" ELECTRIC GUITAR SPEAKER

CATALOGUE  
PRICE  
**\$39.95**



Quality Pioneer brand - check the specs! Check the price!!  
**HURRY**

Impedance .....	8 ohms
Voice Coil dia .....	1 1/2"
Power Rating .....	60W (RMS)
Resonant Frequency .....	80Hz
Sensitivity .....	98(dB/W)
Response .....	80Hz - 7,000Hz
Total Flux .....	61,100 Maxwell
Flux Density .....	8,300 Gauss
Net Weight .....	1,540 grams

**ONLY \$29.95**



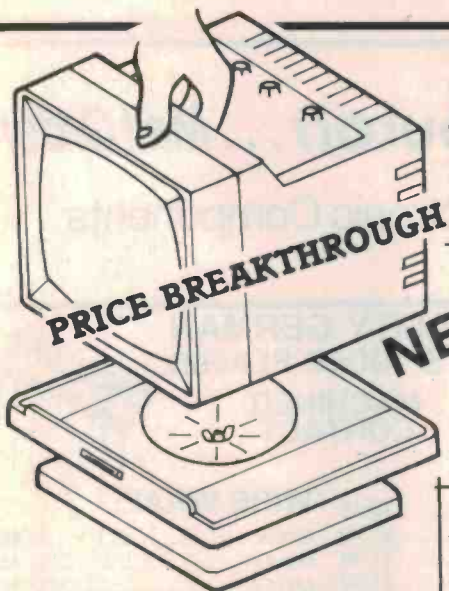

## TILT-BASE FOR MONITORS

Now you can mount your monitor on a swivel/tilt base to maximise the viewing angle (and reduce glare) of your computer monitor. Until now tilt bases were expensive or only fitted to expensive monitors. Now you can have one in your home for under \$30!!!  
Cat. XM-4540

**\$29.95**

**PRICE BREAKTHROUGH**

**NEW**

## FLOPPY DISK STORAGE CASE

Fantastic price breakthrough. A must for serious P.C. users. Will take up to 50 x 5¼" floppies in sets of 10. Compartments lift up and lock in place for easy identification of disk files. ABS resin case. Dimensions: 400mm long 180mm wide by 170mm high. Translucent plastic lid. Quality!  
Cat. XC-4780

**NEW**

**ONLY \$59.95**

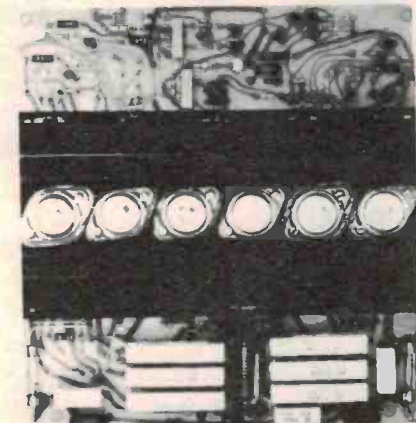

## PRICE SLASHED!!

### 300 WATTS OF MUSIC POWER!

Limited Stock Be Quick  
(Kit Form)

For professional sound reinforcement, musician or home hi-fi, this one really delivers the power. A superbly designed power amp module that only needs a simple power supply, case, connectors and hardware to be up and running - at a fraction of the price of commercial units. See EA June 1980.

This kit includes all parts to build the module. Additional kits below provide the power supply and speaker protector. Team this with one of our 19" rack cases, a Sprite fan and some hardware, and you've got a high performance 300W mono amp ideal for any use. Specs are: Output power 300W rms into 4 ohms (200W into 8 ohms) - Frequency response 20Hz - 20kHz - 1dB - Hum and noise 95dB below 100W - Distortion below 0.2% at full output.

**Module Kit complete . . . . . Cat. KA-1115**  
**WAS \$85 - NOW \$59**

**Power Supply/Transformer . . . . . Cat. KA-1116**  
**WAS \$79.75 - NOW \$59.00**

**Speaker Protector . . . . . Cat. KA-1117**  
**WAS \$12.95 - NOW \$9.95**

## MICROBOTS® BACK!

We have secured another shipment of the two most popular Micro Robot kits. **SEE REVIEW IN EA MARCH '84!**

## LINE TRACER ROBOT KIT

NORMALLY \$39.95

**\$29.95**

**HURRY!**  
Cat. KJ-6684

## MICROBEE DUST COVER

This great new, clear cover will keep dust and grime and all the nasties off your MicroBee. Contacts on the keys will last much longer. Can be removed in a moment. Antistatic treated to repel dust.  
Cat. XA-5575

**\$9.50**

## SMOKE DETECTORS BACK!!

### BARGAIN OF THE CENTURY

Once again we have made a scoop purchase of ionisation chamber type smoke detectors.

When we had this product before we sold many thousands at our ridiculously low prices. We sold out of course but **NOW THEY'RE BACK!!**

The smoke detector is completely self-contained, is round and measures a compact 115mm diameter and 40mm deep. Fixing screws and masonry plugs are provided along with 9V battery and very comprehensive instruction manual.

The "Smoke Sentry" once sold for \$49 and frankly was a flop at that price. Despite the fact that every home should have at least one, people considered that their children and their own lives were not worth that amount.

But now you have **NO EXCUSE!** Once again Jaycar has made a **MASSIVE SCOOP PURCHASE** of **SMOKE DETECTORS** below importers' cost! We pass the savings on to you!

If you missed out before **HURRY** this time. Don't be disappointed!!  
Cat. LA-5090

1-9 Pcs

**\$19.95**

10+

**\$17.95**

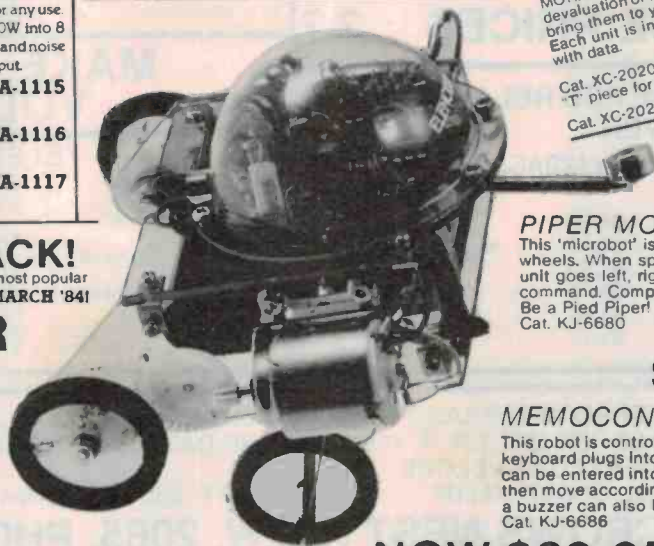

## PIPER MOUSE

This 'microbot' is powered by 2 DC motors that drive wheels. When special ultrasonic whistle is blown, the unit goes left, right, straight ahead according to your command. Complete, including perspex dome cover! Be a Pied Piper!  
Cat. KJ-6680

**NOW SAVE**  
**\$34.95 \$5.00**

## MEMOCON CRAWLER

This robot is controlled by a keyboard (which is supplied). The keyboard plugs into the robot. Up to 256 discrete commands can be entered into the robot's memory (RAM). The robot will then move according to programmed instructions. Lights and a buzzer can also be programmed to operate as well.  
Cat. KJ-6686

**NOW \$69.95 SAVE \$10.00**

## NEW - NEW - NEW - NEW - NEW LOW COST 3½ DIGIT LED PANEL METER KIT

build it yourself and save a fortune! ★ Massive 16mm high digits ★ Very few external components ★ Plus/minus 199.9mV full scale ★ Input impedance 10 to 12 ohms ★ Requires only 5-6V @ 150mA! ★ Guaranteed to reset to zero at zero input voltage ★ Auto reverse polarity indication ★ IC sockets included ★ Instruction sheet shows application ★ Notes to build Digital Thermometer, Capacitance Meter, Frequency Counter etc.

**STAGGGGGGERING VALUE AT \$29.95**

**JULY ONLY SAVE \$5.00!!!!**

**ONLY \$24.95**

Cat. KJ-6670  
**COMPLETE WITH ATTRACTIVE BEZEL AND INBUILT FILTER!!**

## BARGAIN 4700 CAN CAPS

4700uF/40V quality Philips upright chassis mount caps. Screw terminals.  
Cat. RU-6707

**\$10 VALUE**

**ONLY \$1.50 ea**

## MORAY FLOW SENSORS BACK - BACK IN STOCK!!

The original unit as used in the EA Car Computer (Aug '82). Due to pressure of demand another batch of genuine MORAY fuel flow sensors has been acquired. Despite devaluation of the Australian \$ and inflation, we can STILL bring them to you at our August 1982 price of \$59!! Each unit is individually calibrated and comes complete with data.

Cat. XC-2020

"T" piece for fuel bypass systems

Cat. XC-2021

**\$59**

**\$3.95**



# Mail Order... Promark Distributors... Mail Order

Your First Choice for High Technology Electronic Components  
(Founded 1976)

## "D" Range Connectors

Gold plated solder pot tails GERMAN MADE

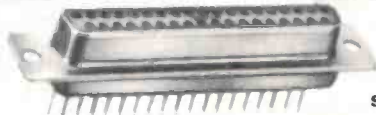

plug	socket
9 way ADS 9L .....\$1.95	9 way ADF 9L .....\$2.40
25 way ADS 25L .....\$4.30	25 way ADF25L .....\$4.80

## PIN HEADER

A8D .....\$1.20		<b>GOLD PLATED WITH CAP</b>
A14P .....\$1.50	A24P .....\$3.10	
A16P .....\$1.70	A40P .....\$5.05	

## FINEST QUALITY GERMAN IC SOCKETS GOLD PLATED

**MACHINED CONTACT**



PCB

AR6 .....\$0.68	
AR14 .....\$1.10	
AR16 .....\$1.20	
AR18 .....\$1.30	
AR20 .....\$1.62	
AR22 .....\$1.82	
AR24 .....\$2.05	
AR28 .....\$2.05	
AR28 .....\$2.12	
AR40 .....\$3.12	

WIRE WRAP

AR6W .....\$0.90
AR14W .....\$1.85
AR16W .....\$2.25
AR18W .....\$2.38
AR20W .....\$2.55
AR22W .....\$2.75
AR24W .....\$3.05
AR28W .....\$3.25
AR40W .....\$4.05

## SPECTROL TRIMMERS, POTS AND DIALS

3/4" rectangular 20 turn cer. met type 43P 100R, 200R, 500R, 1K, 2K, 5K, 10K, 20K, 50K, 100K, 200K, 500K, 1M ..... all \$1.50	
3/8" single turn cer. met type 63P, 50R, 100R, 500R, 1K, 2K, 5K, 10K, 20K, 100K, 1M ..... all \$0.85	
Precision 10 turn wire-wound pot type 534, 500R, 1K, 2K, 5K, 20K ..... all \$10.50	
100K .....\$17.50	
3 digit dial to suit 534, mod 15 .....\$25.50	

## BARGAIN PRICED BRIDGES

35 Amp 400 PIV  
Type 3504

1 Amp 400 PIV  
Type WO 4

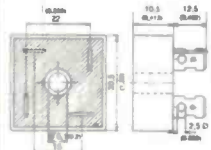

\$4.75 ea.

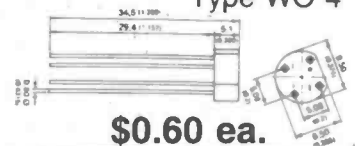

\$0.60 ea.

## E.C. POWER FERRITES

Includes 2 corehalves, bobbin and clamp

EC35 .....\$3.50	EC52 .....\$6.15
EC41 .....\$3.95	EC70 .....\$9.75



## SUBMIN R. F. CHOKES



ALL  
VALUES  
50c

2.2 Microhenry	100 Microhenry
3.3 Microhenry	220 Microhenry
4.7 Microhenry	330 Microhenry
10 Microhenry	470 Microhenry
22 Microhenry	1 Millihenry
33 Microhenry	3.3 Millihenry
47 Microhenry	4.7 Millihenry

**! SPECIAL !**  
Voltage Converter

**TSC7660**  
for modems, etc.  
**\$3.80**

## CHECK THESE PRICES ??

### SIEMENS MINIATURE PCB RELAYS 1 AND 2 CHANGE OVER

Contacts 1 Amp, max voltage 120AC,  
plugs in IC socket.

1 c/o 6V type 6V103 .....\$2.50
1 c/o 12V type 12V103 .....\$2.50
1 c/o 24V type 24V103 .....\$2.50
2 c/o 6V type 6V104 .....\$3.75
2 c/o 12V type 12V104 .....\$3.75
2 c/o 24V type 24V104 .....\$3.75

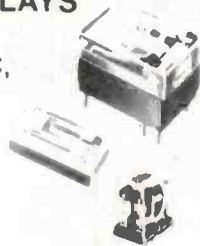

## ★ MAKE YOUR OWN VOLTMETER ★

### TELEDYNE I.C.'S.

3 1/2 digit LCD DVM IC TSC7106 .....\$16.50	Superlow power 3 1/2 digit LCD DVM TSC7126 .....\$19.50
3 1/2 digit LED DVM IC TSC7107 .....\$16.50	Dual power MOSFET driver TSC450 .....\$ 4.95
12 bit CMOS A/D for uP TSC7109 .....\$19.50	15 bit CMOS A/D TSC800 .....\$35.50
4 1/2 digit CMOS DVM IC TSC7135 .....\$22.50	Ultra linear VCO TSC9400 .....\$ 6.45
4 digit LCD driver TSC7211 .....\$10.50	Stable VRef 1.22V TSC9491 .....\$ 2.45
4 digit LED driver TSC700 .....\$ 8.65	Super stable VRef 5V TSC9495 .....\$ 7.70

ALL COMPONENTS OFFERED ARE BRAND NEW, PREMIUM GRADE DEVICES. SALES TAX IS INCLUDED  
FREIGHT CHARGE IS \$3.50 PER ORDER. IF YOU REQUIRE DATA AND APPLICATIONS ON ANY ITEM SEND  
A STAMPED SELF-ADDRESSED ENVELOPE.

D.I.S.C.O.U.N.T.S. ... TOTAL ORDER VALUE ... up to \$50 NETT; \$50 to \$100, less 10%; \$100 and over, less 15%.

**P.O. BOX 381 CROWS NEST N.S.W. 2065. PHONE (02) 439 6571**

BANKCARD WELCOME

\* PRICES VALID TO 1-11-84 \*

(No discount on B/Card Sales)



# Digital readout electronic scales

Part 2

Ian Thomas

THE FIRST PROBLEM with this project is getting the printed circuit board made. With all due respect to readers' undoubted skills in photo-lithography, the strain gauges really are just about out of reach of 'kitchen sink' technology. When I made the first simple one-beam test board I had no end of trouble with

(a) taping up 20 thou tracks at 15 thou spacing to generate the artwork

(b) making sure the photoresist had no pinholes and

(c) trying to etch the board evenly on both sides.

As it was I managed to scratch the resist which cut about four tracks in the meander line pattern. I can say from experience it's a sod of a job trying to bridge the gaps with solder. Just the taping is a tedious enough job.

If you want to make your own board I strongly recommend that you do the artwork at twice full size and have it reduced. This way you can use '40-thou' tape and interleave it with '30-thou' tape for the spaces. When the complete strain gauge is taped, the 30-thou tape is removed and gives a very even pattern. The ends are then joined to give the meander line. This was exactly how I made the prototype artwork.

Since I didn't fancy taping separate artworks for both sides I used the same strain gauge artwork for both sides and overlaid it with the pattern for the electronics during photography. Dick Roodenberg of Gladesville (Sydney) was very helpful here and is most reasonably priced. You could probably photograph the artwork at the back of this article OK too, but really, it's not the sort of thing to be taped up one-to-one and have come out successfully. (Transparencies of the artwork are available — see 'Shoparound' this issue.)

Much the same argument applies to the board etching. Life really is too short to spend hours fiddling with chemicals to have a damn great scratch across the strain gauge grid and a ruined board. It's also absolutely essential to use '1/2-ounce' copper to increase the strain gauge resistance.

Most of the ready resist-coated boards use '1-ounce' material which is not good. Probably the easiest way is to buy a ready-made board and cut it out yourself or photograph the artwork and have a board made.

Needless to say it absolutely, totally, utterly essential that you use glass epoxy board. If you tried to use paper phenolic the cantilevers would probably break off the first time you sneezed at them. They just would not be strong or springy enough

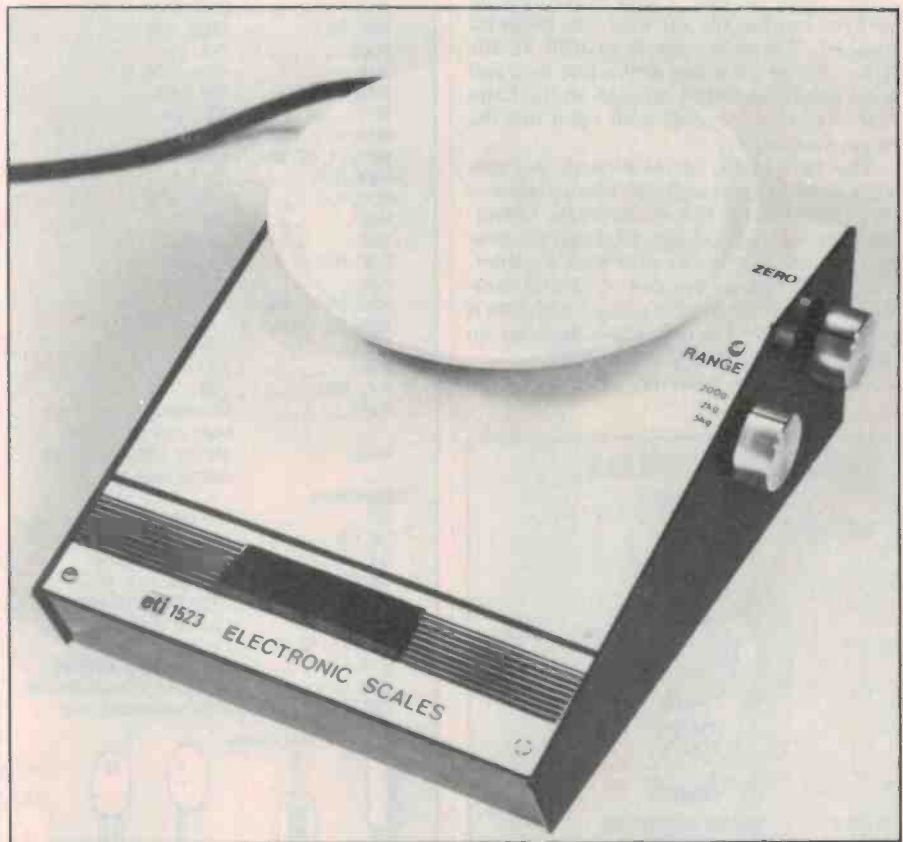

Now we get down to the 'nitty gritty' of constructing the instrument. No fancy tools are needed, but a fret saw or small jig saw makes cutting the pc board to shape easy.

(don't forget the base material of the board is the "reference spring" of the whole scale).

Once you've got a board, by whatever means, the first thing is BE CAREFUL OF THE STRAIN GAUGE PATTERNS. You've got to be continually aware that *they are easy to ruin*. If you've just got a board with the outside guillotined off square the first thing is to cut out the load beams and, in the centre, the piece of board that is used to mount the weighing pan. I used a piece of hacksaw blade with a handle made from masking tape for this job. To separate out the three beams there are three triangles with 30°, 30° and 120° vertices to be cut out, each of which requires three cuts.

To start each cut, drill five 3 mm diame-

ter holes using the pads provided. The holes may not run together completely so, using fine long nosed pliers *gently and carefully* break out the material between them. Then, holding the board between two pieces of softwood in a vice, cut along the copper tracks that delineate the edge of the board. You should leave most of the track in place with the hacksaw. After you've made the three cuts for one triangle and the bulk of the excess board has been removed, then dress the cut edges back with a fine warding file. You've got to cut right into the corners to ensure that all the strain gauge is flexed; for this I bought a fine needle file shaped in a shallow wedge.

During all this, never hold the board directly in the jaws of the vice or you will ►



cut through the strain gauges. Repeat the process for the other two triangles and when you're dressing them off be sure to dress back the centre bit as well. When this is finished you should have removed all of the copper track that marks the edge of the board *but no more*.

The last step is to cut along the ends of the beams to free them up and also free the centre piece as well. Clean everything up with the warding file and that's the tricky bit finished. The next step is to drill all the holes. About a 0.8 mm drill is fine here and it's a good idea to run through all the holes first with the fine drill then open out the larger ones later.

The base plate, as mentioned, is 2 mm thick aluminium exactly 160 mm square and when you drill the nine holes for the mounting pillars it's a good idea to clamp the base plate to the board and drill both together. I've found that no amount of careful measuring is quite as good as using a template if one is available. For this reason there are no dimensions given for the nine holes.

Once the fine holes are drilled you can

## TOROID WINDING DETAILS



- Toroid:** Neosid #28-680-36 or #28-080-36
- Primary:** 4 m of 0.33-0.35 mm enamelled copper wire, closewind on 120 turns, centre-tapped.
- Secondary:** 10 turns of 0.5-0.64 mm enamelled copper wire, wound over primary.

Take the 4 m of primary wire and double it in half. Twist the fold for a good 30-40 mm to make the centre tap. Commence winding from the centre tap, laying on 60 turns winding in one direction. Then wind on the other half — winding in the same direction. Lay the turns close to one another on the inside of the core and the windings should fit neatly. Use sticky tape to hold down the two ends when you're finished.

Tackle the secondary next. Start the winding adjacent to the primary centre tap. Wind on 10 turns in the same direction as the primary. Distribute the turns evenly around the circumference of the toroid.

Note that, in the drawing above, the primary winding has been shown in a thicker line than the secondary for reasons of clarity. The secondary winding actually uses a heavier gauge wire.

## PARTS LIST — ETI-1523

<b>Resistors</b> .....all 1/2W, 5% unless noted	C22.....220p metallised poly.
R1.....33k, 2%	C23, C26.....39µ/10 V tant.
R2.....1M	C24, C27.....100n ceramic bypass
R3, R4.....390R	C25.....330µ/6 V tant.
R5, R6.....2k2, 2%	<b>Semiconductors</b>
R7.....47k, 2%	Q1, 2, 3, 4, 5, 6.....BC337
R8.....22k1, 1/2%	IC1.....4001B
R9.....22k6, 1/2%	IC2.....4013B
R10, R11.....22R, 2%	IC3, 5, 6.....CA3240E TL082 etc.
R12, R14.....1k00, 1/2%	IC4.....4053B
R13.....7k5, 2%	IC7.....MM74C935N, ADD3501
R15.....100k, 1/2%	IC8.....7805
R16.....10k, 1/2%	DSP1-4.....FND500, HDSP-5503 or equiv.
R17.....10R, 2%	<b>Miscellaneous</b>
R18, R19.....47k, 2%	TR1.....Neosid toroid core type
R20, 21, 22, 23.....475k, 1/2%	28-680-36 (nylon coated)
R24, R25.....22k1, 1/2%	or 28-080-36 (plain) wound
R26, R27.....47k5, 1/2%	with about 4 m of
R28.....8k2, 2%	0.33-0.35 mm enamelled
R29.....200R, 2%	copper wire, plus sec.
R30, R31.....100k, 2%	TR2.....Ferguson PL12/5 VA pc
R32.....39R	mount transformer
R33, 34, 35, 36.....1k	
R37, 38, 39, 40, 41,	
42, 43.....100R	
R44.....3R3	
R45, R46.....15R	
RV1.....1k cermet trimpot,	
horizontal pc mount.	
RV2.....50R or 500R linear pot.,	
cermet (see text)	

<b>Capacitors</b>	
C1.....6p8 ceramic plate	
C2, C3.....1n metallised film	
C4.....10µ/16 V electro.	
C5, C6.....470p ceramic plate	
C7, C16.....100µ/25 V RB electro.	
C8, C9.....10µ/10 V electro.	
C10, 11, 12, 13.....1µ metallised poly.	
C14, 15, 17.....100n ceramic bypass	
C18, C19.....2200µ/16 V axial electro.	
C20, C21.....470n metallised poly.	

ETI-1523 (double-sided) and '1523ps (power supply) pc boards; case — Bimbox model 6007 (Jaycar Cat. No. HB-6240); Scotchcal front panel; 6 mm or 8 mm dia. by 80 mm long bolt with two nuts; six 30 mm wide brass hinges; 150 mm dia. 'Decor' pot stand; 2-way pc mount terminal block; mains cable, cable clamp grommet and mains 3-pin plug; two knobs; hookup wire; heavy gauge aluminium plate, 160 mm square; nine brass standoffs, 25 mm long, tapped 4 BA; bolts to suit (18 off); 100 mm shielded cable and 100 mm of twin shielded cable; four 12 mm long tapped spacers with bolts to suit; etc.

**NOTE:** The main, double-sided, pc board requires 1/2-ounce copper, not the usual one-ounce variety.

**Price estimate: \$105-\$120**

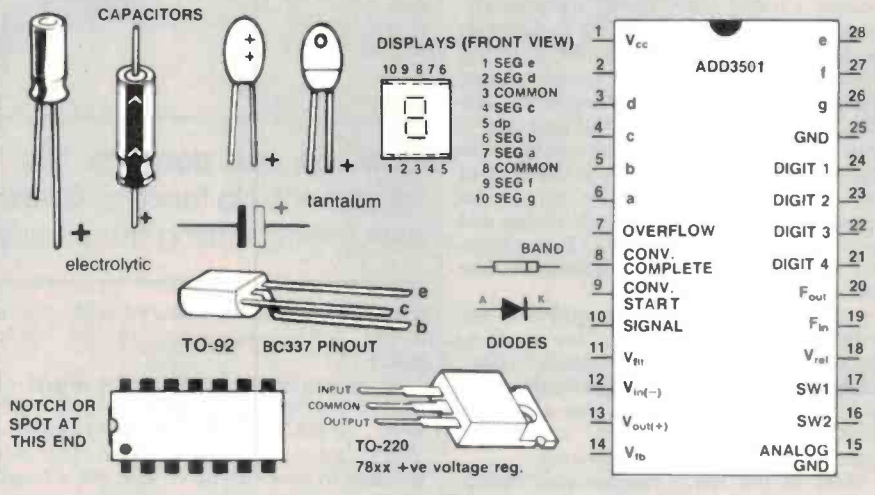

open out the nine mounting holes with a 9/64" drill and while you're there, drill the holes in the mounting plate as well. The last step is to cut out the notches for the box mounting pillars if you're using the same box I did (Jaycar Cat. Nos. HB-6240/1/2).

Unless you're fortunate enough to have a

split rail power supply, the first thing you'll have to build is the power supply board for the scales, so you've got something to work with. This is pretty straightforward though. Just drill all the holes to about 1.6 mm (1/16"), except for the mounting holes which are, once again, 3.6 mm (9/64").



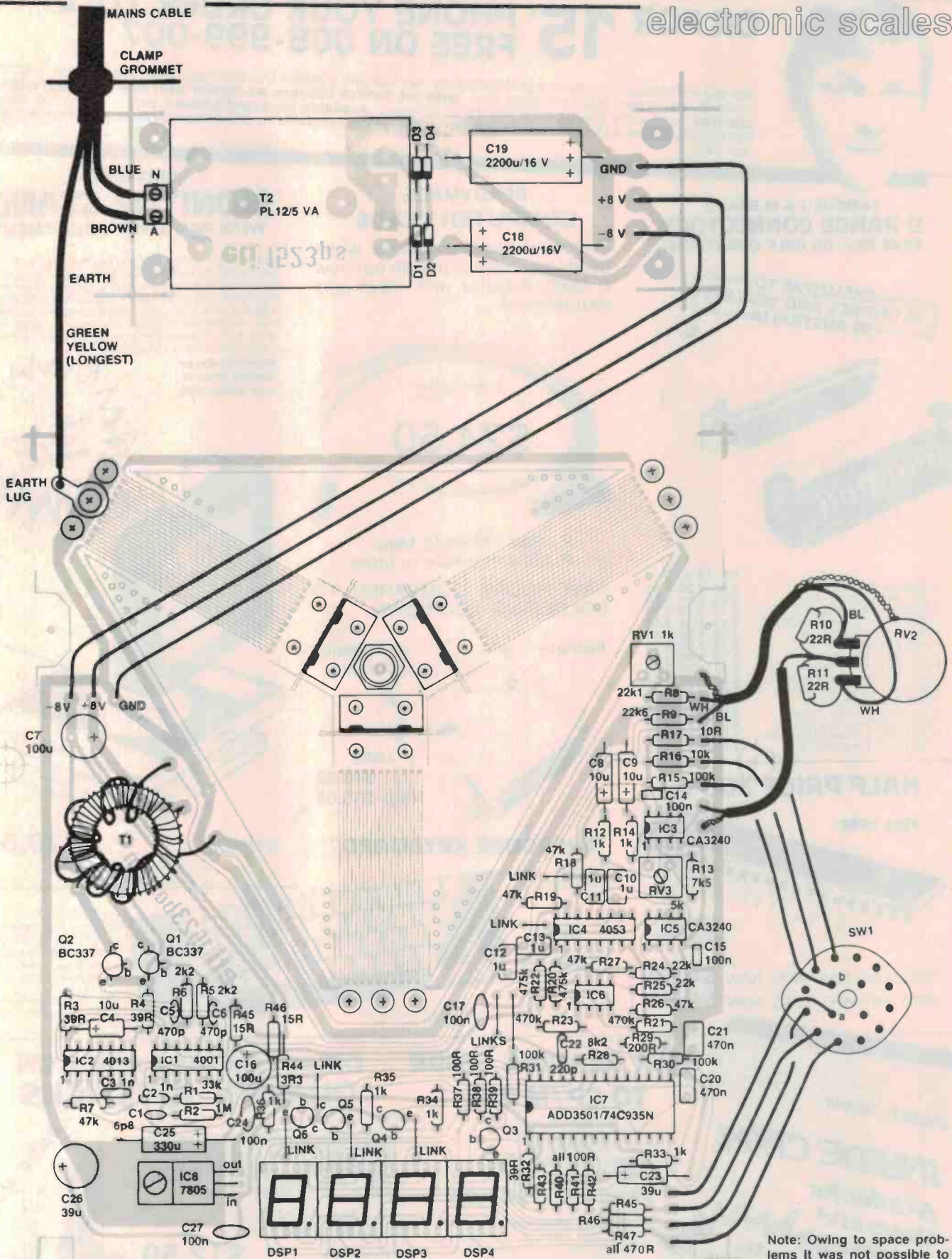

Note: Owing to space problems it was not possible to print full size artwork in this issue. (See Shoparound page 154)



BANKCARD HOLDERS — PHONE ALTRONICS TOLL FREE 008-999-007 FOR NEXT DAY JETSERVICE DELIVERY



# OR FOR 15¢ PHONE YOUR ORDER TOLL FREE ON 008-999-007

We will immediately confirm stock availability. We will also confirm the very hour your order will be dispatched (over 95% of orders leave the same day). With Jet Service Delivery we deliver next day to capital cities and suburbs — Country areas please add 24 to 48 hours. Available bankcard holders only — sorry non-bankcard holders must post a cheque or money order — even so, we promise to deliver quicker than any other supplier in Australia.

## FAMOUS J & M BRAND D RANGE CONNECTORS SAVE 25% ON BULK QUANTITIES!

EXCLUSIVE TO ALTRONICS AND DEALERS IN AUSTRALIA



P0880 DB 9 Male 9 Pin	2.90	2.20	1.95
P0881 DB 9 Female 9 Pin	2.95	2.70	2.50
P0882 DB 9 Male PCB Mnt	3.25	3.10	2.98
P0883 DB 9 Female PCB Mnt	3.95	3.75	3.60
P0889 DB 9 Backshell Cvr	2.00	1.8J	2.30
P0890 DB15 Male 15 Pin	2.95	2.90	2.29
P0891 DB15 Female 15 Pin	3.50	3.00	2.80
P0892 DB15 Male PCB Mnt	3.25	3.10	2.98
P0893 DB15 Female PCB Mount	3.95	3.75	3.60
P0895 DB15 Backshell Cvr	2.85	2.90	2.30
P0900 DB25 Male 25 Pin	4.50	3.95	3.60
P0901 DB25 Female 25 Pin	4.95	4.50	3.98
P0902 DB25 Male-PCB Mnt	4.50	4.10	3.85
P0903 DB25 Female PCB Mount	5.50	5.00	4.70
P0905 DB25 Backshell Cvr	2.00	2.50	3.98

## HALF PRICE Z80 A FULL SPEC

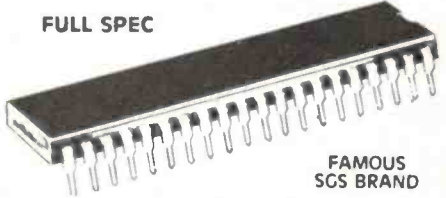

FAMOUS SCS BRAND  
Z9001 CPU WAS \$8.95 NOW \$4.50  
Z9005 PIO WAS \$8.95 NOW \$4.50

## READYMADE COMPUTER LEADS

Two new computer leads, when used in conjunction with our new P 0860 Adaptor will meet any requirement.



1.8m long  
\$24.50

P 0862 Male to Male  
P 0864 Female to Male

SAVE HOURS COMPARED TO SOLDERING YOUR OWN

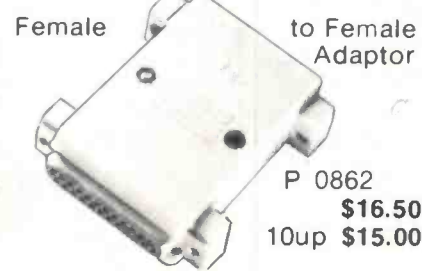

P 0862 \$16.50  
10up \$15.00

## UNIVERSAL MONITOR STAND WITH PAN & TILT ADJUSTMENT

This brilliant monitor stand enables you to swivel left/right and tilt up/down le. to position monitor to any desired position. Hence viewing position is enhanced and screen glare eliminated. Our D1100 stand is a professional, sturdy and exceedingly well engineered product designed to physically work with all stand alone monitors. Until now you would have to pay \$50 or more —

Altronics direct Import price is now under \$30.

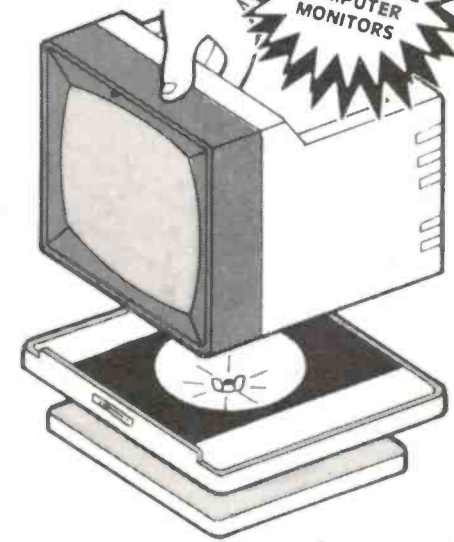

SUITS ALL STAND ALONE COMPUTER MONITORS

D1100..... \$29.95

Also suits portable TV sets eg. in hospital bedside use.

## "MICROBEE KEYBOARD"

Fully assembled

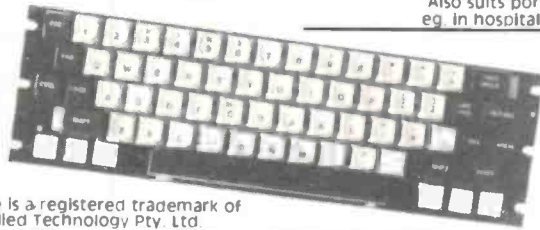

D1510 \$29.95

Microbee is a registered trademark of Applied Technology Pty. Ltd.

Full 60 Key Qwerty Computer Keyboard exactly the same type as has been used up to now with the famous Microbee

SPST keys. Complete with mounting plate

## EASY READING GUIDE TO CP/M 2.2

As a learning tool — IT'S INVALUABLE  
As a Reference — IT WILL TAKE PRIDE OF PLACE NEXT TO ANY CP/M SYSTEM

B9080. ONLY \$41.95

Devoted primarily to CP/M 2.2 this manual is equally applicable to most other CP/M systems. Cortesi divides the book in two sections, an absorbing, explanative, tutorial covering setup and operating procedures and a comprehensive reference section.

## DIRECT IMPORT PRICE ON QUALITY JOYSTICKS

SELF CENTERING TYPE \* HEAVY DUTY SUCTION CUPS — STAYS IN PLACE \* SILVER PLATED SWITCH CONTACTS PISTOL GRIP \* VERY RESPONSIVE

TO SUIT COMMODORE VIC-20, ATARI, etc.  
D1410..... \$12.50

FOR MICROBEE  
D1420..... \$19.50

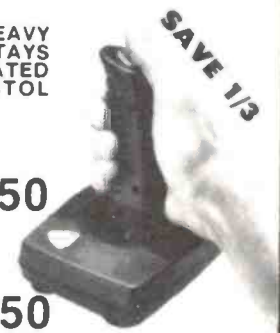

SAVE 1/3

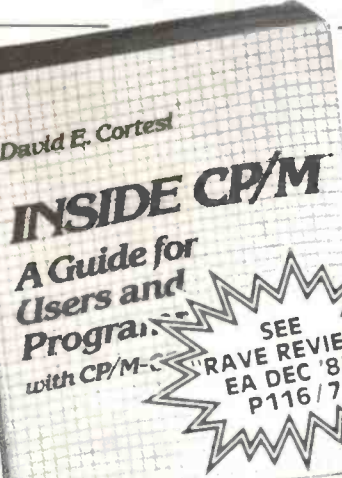

SEE "GRAVE REVIEW" EA DEC '83 P116/7

BANKCARD HOLDERS — PHONE ALTRONICS TOLL FREE 008-999-007 FOR NEXT DAY JETSERVICE DELIVERY



# FOR 30¢ POST AN ORDER TO ONE OF ALTRONICS COMPETITORS

— naturally you won't have a clue as to whether they've got the items you need available. And of course, be prepared to wait, wait, patiently wait sometimes for weeks! Why waste your valuable cash? Altronics staff are waiting for your call now (up to 6pm eastern standard time).

## MICRON SUPER 80

WAS \$699 in 1983

FREE CARTON OF PAPER THIS MONTH CAT D1160 \$39.50 VALUE

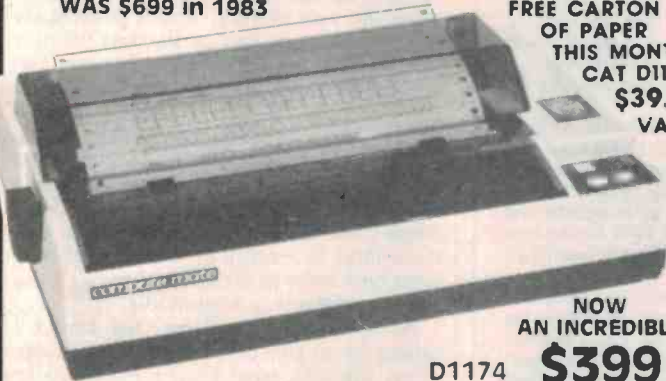

NOW AN INCREDIBLE D1174 \$399

Your "Super 80" printer will enable you to print letters, reports, graphics generated pictures, etc and importantly for the programmer, Hard Copy of program listings. Operating under software control from any general purpose micro-computer the Super 80 features 13 different print types including emphasized (LETTER QUALITY). Bidirectional print action ensures smooth, quiet operation.

228 ASCII Characters, Handles 4" to 10" Paper STANDARD CENTRONICS INTERFACE

## Superlative MICRON SERIES II MONITORS

**SPECIFICATIONS:**  
**Screen** — Green phosphor. **Front Controls** — Power on/off, character brightness/intensity, display centering. **Rear Controls** — Background intensity, vertical and horizontal adjustment etc. **Input impedance** — Switch 75/10K Ω. **DC Socket** — 12V DC output at 1.1 amp — power your micro direct from the monitor. **Bandwidth** — 10Hz-22MHz. **Resolution** — 1050 lines minimum at centre screen.



★ 1050 lines resolution at centre screen. ★ 22MHz bandwidth. ★ Video input impedance switch allows networking use. ★ Incredible — repeat Incredible — resolution.

Guaranteed (we mean it) to out perform any other low cost monitor in Australia.

D 1114 Micron Series II Hires . . . . . \$199.50

D 1115 Micron II Non-Glare Hires . . . \$219.50

## NEW MODEL DATA CASSETTE UNCONDITIONALLY GUARANTEED TO SAVE/LOAD THE RAWEST OF DATA EVERYTIME!



D1122 ..... only \$49.50

- A recorder designed solely for the purposes of data storage now at an unbelievable price
- SLIDE VOLUME CONTROL a must for quick checking of levels
- TAPE COUNTER a must for easy location of programmes
- INBUILT PIEZO TRANSDUCER enables you to listen audibly to tape
- 6V DC operation - USE WITH M9000 PLUG PACK ensures low hum level
- ROBUST CONSTRUCTION OF BOTH INTERNAL MECHANISMS AND EXTERNAL CASE

## BONUS OFFER

10 FREE MICRON C20 DATA CASSETTE TAPES (CAT D1141) INCLUDED WITH EVERY DATA CASSETTE PLAYER PURCHASED THIS MONTH

(NOT AVAILABLE FROM DEALERS — SHOP AND MAIL ORDER ONLY)

BANKCARD HOLDERS — PHONE ALTRONICS TOLL FREE 008-999-007 FOR NEXT DAY JETSERVICE DELIVERY

BANKCARD HOLDERS — PHONE ALTRONICS TOLL FREE 008-999-007 FOR NEXT DAY JETSERVICE DELIVERY

TOP QUALITY LINED PRINTER PAPER TRACTOR FEED

AT LAST AT AN AFFORDABLE PRICE

TO SUIT SUPER 80 240mm WIDE  
 D1160 \$39.50  
 380mm D1165 \$47.50

2000 SHEETS PER BOX

★ FREE IF PURCHASED WITH PRINTER

## EPROM PROGRAMMER (ETI JAN '83)



K9668 \$55.00  
 Versatile, low cost and easy to build. Plugs straight into the microbee I/O port. Suitable for 2716 2732 2532 2732A and 2764 Eproms. Burn your games programmes and eliminate cassette loading time.  
**KIT FEATURES** Sockets for all other IC's 1 x 2716 supplied — get started straight away. Front Panel and Mains ISEC approved transformer. 28 pin and 16 pin wire wrap sockets to flush mount personality plugs (2 included) and ZIF socket (included). DR\*\* plug. Complete to last nut and bolt.  
 (See Review ETI AUGUST 1983)

## RADIOTELETYPE DECODER (ETI APRIL '83)



K9733 \$19.50  
 Display RTTY encoded messages on your video Monitor. Receive up to date weather information international News before the Papers, all sorts of coded military info. Simple circuit uses PLL techniques. Single PCB construction. Kit includes DB15 Plug and backshell for connection to microbee. Shielded pre-tinned PCB.

## MICROBEE® LIGHT PEN (ETI AUGUST '83)



K9649 \$19.95  
 PROVIDES DIRECT PERSONAL CONTACT WITH YOUR BEE!  
 AT LAST — a light pen for the Bee. This pen works in the low-resolution graphics mode and connects directly to the I/O port. Complete kit including DB15 2m CORD. Fully documented with software example.

## FAX-DECODER (ETI SEPT '83)

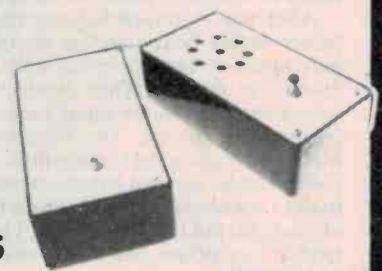

K9733 \$24.50  
 This project allows you to decode the signals of shortwave stations transmitting radiofax maps, weather maps, satellite pictures etc and then re-encode them on your dot matrix printer.  
 • Complete kit of parts includes DB15 Ribbon Cable.  
 • SOFTWARE LISTING



### LOW NOISE EARTHING

It can't be emphasised too much how important a proper approach is to earthing in sensitive instruments. Books could be written about it (and almost certainly have). If it is done correctly things work pretty painlessly, but if the rules are broken you've got Buckley's chance of sorting out all the problems. To give you an idea of how this design was approached, it's interesting to look at the layout of the board and explain why certain things were done.

One of the first rules is that if you have a known crud generator (here we have three beauties!) then the crud must be contained and not allowed to insinuate itself on supply lines. In this case the three are the CMOS oscillator and divider (not so bad), the inverter itself (a truly magnificent spike generator) and the digital part of the DVM chip (a true recipe for disaster!)

If you look at the layout you will see that positive and negative rails for the inverter feed nothing else but the inverter and are run straight to a large filter capacitor before going anywhere else. This means any high level ac currents are contained within the inverter area itself and aren't allowed to impose themselves on the supply rails for the rest of the circuitry. The inverter was deliberately run from the positive and negative rails so no spikes had a chance to get onto earth lines.

Much the same applies to the CMOS oscillator except that the supplies are decoupled by resistors and have their own massive bypass capacitor. To be quite candid I whooped here in the prototype and didn't bother with the resistors but the electrons have absolutely no respect and the spikes from the oscillator got everywhere. The decoupling resistors went in!

The third and worst noise generator is the DVM chip itself. National know their stuff so there are two earths on the chip to enable all the bad things to be kept in their place. You will see on the layout that the earth for the digital section of the DVM starts at the input to the whole board and runs down the side of the board away from any sensitive areas to the 5 V regulator and display. It is connected to *nothing* except the digital circuits and their associated filter capacitors.

This earth can be thought of as the "dirty earth" and it is unthinkable to take it anywhere near any analogue circuitry (the term "unclean" is totally appropriate!).

Even with all this care it was still necessary to bypass the 5 V rail with a monster 330  $\mu\text{F}$  tantalum capacitor plus a not-so-monster one on the 8 V input to contain the crud. National Semiconductor recommend a special 5 V regulator with very good high frequency attenuation to get away from the expansive tantalum capacitor but they aren't easy to get.

The "clean" earth starts from the common node of the two strain gauge bridge arms and runs straight around to the linear section of the circuit. It's kept as far away as possible from all the bad, dirty digital stuff and is connected to one point which is the reference earth for the high gain ac amplifier (that's where the two 10  $\mu\text{F}$  capacitors are connected).

The secondary of the inverter is floating and connected only to the resistors which form the other half of the bridge via two tracks that run parallel, and as close as possible to the "clean" earth. Even here it is not assumed that the two ends of this earth are at the same potential; it is merely hoped that the potential difference is the same for the signal lines as for the earth line.

As the two gain blocks in the amplifier have nearly the same earth (they are only 5 mm apart) no contaminating signal should be able to get in here. The amplified ac signal is not considered to be referred to any earth but is only a voltage difference between two capacitors. It would probably work OK to not connect the "earth" ends of the capacitors to anything but I didn't try it. The voltage difference between the two capacitors is then connected to the differential amplifier discussed earlier whose reference earth is — lo and behold! — the reference earth for the DVM.

There are no absolute earths at all in the system but only local earths which tie things together where they matter. If you decide to build the scale and want to see that this isn't all theoretical, just try shorting the analogue and digital earths of the DVM together and watch the whole thing fall in a heap (it isn't destructive, just educational!).

Assemble all the bits being sure to get the diodes and capacitors in the right way. I think it's an investment in good health and long life to use a mains screw-type connector to get mains onto the board — they're readily available at Jaycar and other electronics suppliers — and could save a nasty accident with frayed bits of copper.

After you've completed assembly of the power supply board *tape-up the tracks that have mains on them* or cover with Araldite, Silastic, or the like. Then connect a three-core mains lead to the input connector and power it up to test. The Ferguson mains transformer gives out more than its rated voltage under no load but this is normal — I found I got about  $\pm 10$  volts. Turn the mains off and pull out the plug as well; I have little faith in electricians putting the switch in the active lead!

The next step is to wind the toroidal transformer. The core is a Neosid type 28-

680-36 (nylon coated) or 28-080-36 (plain) and either will do. You will need about four metres of 13 or 14 mil (0.33 to 0.35 mm, say 28 B&S) enameled copper wire for the primary winding. Try and get 'Solder-eze' or 'Leumex' enamel which can be stripped with a soldering iron to make things easy. Some stores that have high expenses like helicopter fuel sell wire that has to be stripped with emery paper and it's a damn nuisance. Fold the wire double and twist the fold tightly for about 20 mm or so to form the centre tap.

The actual winding should be done in a room where there are no dogs, cats, rabbits, guinea pigs or small children as you'll have wire all over the place and things just love to get tangled in it! Thread one end of the wire through the core until you reach the centre tap, then commence winding turns through the core and laying them *neatly* hard against each other. As there is only

just enough space for the required 120 turns you must make absolutely sure that each turn is hard up against the next and that each is nice and tight. It's easiest to wind one half of the toroid completely first then wind the second half. Once the wire has been partly wound onto the core it gets easier to handle but always be careful not to allow the wire to kink. This is particularly prone to happen just as the last bit of a winding is being pulled onto the core and once kinks are in they are very hard to get out.

If by some terrible miscalculation you wind 60 turns on one side then find that you can only fit on 55 or so on the other side don't despair. A few turns more or less doesn't matter. The important thing is that there must be *exactly the same number of turns both sides of the centre tap*. Not even one turn difference is allowable.

As a matter of interest, the toroid I wound (or to give credit where credit's due — my wife) did have a one turn difference and it produces a very noticeable asymmetry in the output waveform. As an aside, this is because each side of the winding is switched on for exactly the same time and if the number of turns is different the only way the core magnetising current can balance up is for the core to partially saturate on one side; which is exactly what happened.

After the primary winding is completed solder the twisted centre tap right up to the winding (if you do it before it makes it too easy to break the wire), then tin the two ends of the wire up to where they go onto the core.

Winding the secondary is rather more tricky but a lot easier. It is very important that the secondary be wound in the correct polarity. People hold toroids in all sorts of ways when winding them so it's hard to know just how the primary was wound, but the important thing is for the secondary to be wound in the same sense as the primary. That is, if you wound the primary with the wire through the toroid towards you, do exactly the same for the secondary. The transformer is tested before it can do any damage but it's nicer to get it right first time (up yours, Murphy!)

The secondary is only 10 turns of somewhat stouter wire than the primary, 20 to 25 mil (0.5 to 0.64 mm, say 22-24 B&S) wire is fine. At a pinch you could use the same size wire as the primary but it makes things awfully hard to tell apart. Start the winding a few millimetres away from the primary centre tap and wind away from it evenly distributing the 10 turns around the core so that the last one puts you a few mm on the other side of the centre tap. Tin both ends of the secondary and that's the end of the tedious stuff.

In order not to have any spectacular and expensive accidents it's best to assemble and test the board in sections. Before you start soldering on the board though, a word of warning. This is only 1/2-ounce copper on



the board so it's a lot easier to damage than normal 1-ounce boards. Take it easy with the soldering iron.

Starting with the strain gauge drive circuit, ICs 1 & 2, assemble the complete circuit up to the two toroid drivers, Q1 and Q2. Also assemble the input filter capacitor C7 and don't forget the driver power supply filter resistors and capacitor. Then connect up the power supply board you've already built via three pieces of suitably-coloured wire about 200 mm long, taking care that you get the polarity correct. Then check that the polarity of the electrolytics and ICs are correct (both will tolerate reverse polarity for about five nanoseconds!).

Then plug in your carefully tested and *mains protected* power supply and turn it on. Quickly test that the supply rails are both up OK and that nothing has burst into flames. Then, if you have a CRO, check that there is a square wave at about 5 kHz on the two input pins, 12 and 13 of IC2 (the CD4013). If you don't, then check that the voltage on both pins is  $0 \pm$  about 1 volt. If so, then probably all is well. You should get the same answer on pins 10 and 11 of IC1, the transistor drive gates.

Now comes the interesting bit, namely, connecting up the drive transformer. At this stage it is prudent to leave the leads long until you are sure that all is well. First, insert a piece of wire, about 30 mm long, and solder it to join the earth point which is common to the two strain gauges. Leave most of it sticking out the top of the board as a convenient earth test point. This point is about 30 mm South-West of the power input if the centre of where the display goes is due South and right on the inside edge of the board.

Next, using your trusty ohmmeter, check that you don't have trouble with the strain gauges. They should measure between 10 and 12 ohms for each side, an open circuit means you've got trouble. If by some horrible mischance you do have an open circuit then you'll have to find it by visual inspection (a magnifying glass will almost certainly be necessary). Try to repair the damage with a piece of fine wire and solder. On the first test board, I did have an open (read several) and I found it almost impossible to bridge the gap with solder. The gaps that I bridged went open circuit under load (both tensile and current). A bit of wire is safer.

If all is well, connect the centre tap of the transformer to the point nearest to the earth point and the two ends of the primary to the pads connected to the transistor collectors (solder on the wiring side — the top don't go nowhere!).

Then power up the board again and listen carefully (*really!*). You should hear a faint but distinct whistle from the toroid due to magnetostriction as it is cycled. If not, there is something wrong with the transformer or drive transistors. If all is well proceed to make sure that the polarity of the drive to the strain gauge is correct.

### IAN THOMAS — a short biography

He was raised in Sydney's outer western suburbs (Penrith) in the days before the urban sprawl had reached out that far and Penrith still retained some of the character of a country town. After completing high school at Penrith High he went on to Sydney University to study Electrical Engineering in 1963. After two successful years he took the obligatory year off and transferred to the Science faculty to obtain his B.Sc in 1965. He transferred back to Engineering in 1966 and in 1967 completed his Engineering degree.

In 1968 he was employed by AWA in their Research Laboratories at North Ryde as a design engineer. Since then he has been working at North Ryde in various areas and has made full use of the vast opportunities for obtaining experience in almost all fields of electronics. His experience includes 18 months designing integrated circuits (actually laying out the emitters, bases, etc which is invaluable in explaining some of the less desirable unpublished characteristics of commercially available ICs!).

Since his boyhood Ian has been fascinated by electronics and from the day he actually heard noises from his first crystal set (using a real piece of galena — he's a purist at heart) he was doomed to his current career. He's always felt that his work should be a source of fun as well, so his home has strange machines readily available to perform menial tasks.

His approach to design is the same as his approach to life — decide what is really needed then do it with no consideration to the currently accepted norms and fashions. This is well illustrated by his attitude to a tidy work area (it isn't). When he can't find something he tidies up until he finds it, then stops and carries on with what he was doing. This system forms a self regulating arrangement where the exact optimum time is spent maintaining order so things are neither so chaotic that all progress ceases nor so neat that flicking solder from the iron becomes a major crime.

If you have a CRO this is dead easy. The output of Q1 (the inside transistor) and the top input to the strain gauge should be in *antiphase*. Measure the polarity of the two secondary leads and label them "IN" and "ANTI" or somesuch. If you don't have a CRO, a high impedance voltmeter set to ac will do fine. Measure the voltage between the collector of Q1 and the two secondary outputs. One should measure about 15 V and the other about 18 V. The higher voltage lead is in antiphase and the lower is in phase. Solder the two secondary leads onto the board and make sure that there is no problem, then shorten up all the wires and mount the toroid tidily on the board. It's a good idea to stick it down with some silicone stickum (e.g. Silastic) so things can't move around and break wires.

Having survived this, you can assemble the ac amplifier area of the board. Insert ICs 3, 4, 5 and 6, making sure they are in the right way and then assemble all the components around them. The type of op-amps you use isn't that important just as long as they're FET-input devices. Make sure that the polarity of the two electrolytics is cor-

rect, not so much because reverse polarity will damage them (it's only about 5 mV) but because the cans may capacitively pick up noise if you reverse them.

After nine years at AWA Ian decided enough was enough so far as working was concerned, so he emptied out his bank account and took off overseas for a year wandering around the world. For the whole year he saw nothing whatever of electronics (there isn't a great demand for remote controlled toilet flushers 15 000 feet up in the Himalayas). After he returned he was drawn as if by some horrible fascination (and the dollars!) back to AWA North Ryde.

Since then, he has continued to learn new tricks and further develop old ones with AWA's backing. Last year he decided that all the toys he'd built for himself owed him something, so he approached Roger Harrison to ask about the financial rewards for becoming a part time writer and project developer. After a ritual period of sordid haggling (Roger, you didn't stand a chance — you were up against skills developed in Indian bazaars!) an agreement was reached and the first article was written which appeared in last month's ETI (Project 275, Bathroom Strip Heater Time-out).

Since his return to Australia, Ian has spent most of his time developing microprocessor-based audio test equipment for the broadcasting industry, which introduced him to the principles of active filter synthesis. This interest has remained as a hobby and he often spends a recreational evening playing with such wonders as Jacobian elliptic integrals on his calculator. More recently he has become involved with RF power amplifier design, and has already designed a 25 watt 440 MHz amplifier for ETI. He is now toying with a 100+ watt aether bender on the same band.

Ian's pet peeves include non-cooperative public servants, Australian electronic component suppliers who don't carry stocks and editors who delay payment for articles (hint!). His deep loves include a nice cold schooner with condensation running down the side, Mel Brooks movies and, most of all, his beautiful Thai wife.

Wire in the trimpot RV1 and then connect up the two 22 ohm resistors R10 and R11 between the centre tap of the pot and the two ends. Alternatively, if you can get one, use a 50 ohm cermet pot, whereupon R10 and R11 are unnecessary. Connect the pot to the board using about 100 mm of two-core screened lead (this prevents capacitive pickup to the input).

You're now ready to see if you got the polarity of the drive transformer secondary correct. Power up the board again and make sure that all is well then measure the dc volts on the output of IC6 pin 1. If it reads about +2 V all is well, but if it reads -2 V then you blew it and got it backwards!

Before you start reversing windings from the drive transformer it's a good idea to check that the ac amplifiers are working OK by monitoring pin 7 of IC6. You should be able to adjust this to zero by adjusting the trimpot RV1; RV2 will give fine adjustment.



As a last check, hold the board firmly and bend one of the strain gauges away from the components. The output of pin 7 should go positive (fast and far!). If pin 1 is negative and pin 7 moves negative, then merely reverse the secondary winding of the drive transformer and all is well. If you can't zero the output try shorting the input to the ac amplifier, this should bring pin 7 of IC6 close to zero. If not, you've got problems with the amplifier or synchronous switching circuit. Find and fix is all I can offer.

If all is OK, then turn off the power and carry on to assemble the DVM part of the circuit. Start by assembling the 5 V regulator and all its associated capacitors. Turn it on and check that it works OK before assembling the rest of the DVM section (the DVM chip is relatively expensive and it would be so aggravating to cause one to disassemble). Then carry on and assemble the rest of the board including the displays.

Now turn it on and see the pretty numbers come up! It'll probably come up with '000' or 'OFL' depending on whether the zero set is too low or too high. At this stage it isn't worth bothering with the decimal point or gain switching as there's plenty to do yet. Check that you can in fact adjust to zero OK, just to be sure then you can start on the mechanical stuff.

## Mechanicals

The first thing to do is prepare the case to accept the board. You will find that there are six totally useless little mounting pillars moulded into the bottom of the case. Remove them. I used a wood chisel and hammer, which worked fine. Clean the bottom of the case off smooth then take the piece of sheet aluminium and measure out the notches needed to clear the mounting posts in the case. The two pairs of groups-of-three holes go in the rear corners of the case. Cut out the notches and make sure that the plate fits comfortably and flat in the bottom of the case then hold it so there is about 2 mm clearance along the sides and at the back and drill three or four holes right through the plate and case. Anywhere will do as long as they don't come within 5 mm of the holes already drilled for the mounting pillars. Use a drill the right size so self-tapping screws will cut a thread properly, then open out the holes in the case to clear the self-tappers.

Next, countersink the nine board mounting holes deeply on the opposite side to that of the board and mount the nine 25 mm spacers on the mounting plate. Make sure that the screws are tight and you've finished that bit.

The next thing to assemble is the mounting for the weighing pan and post. Open out the six holes at the ends of the cantilever beams with a 3 mm ( $\frac{1}{8}$ " ) drill and repeat the process with the epoxy glass centre piece. Also enlarge the hole in the centre piece to clear the centre post that supports the weighing scale. Next come the hinges. Screw the hinges together in pairs back-to-

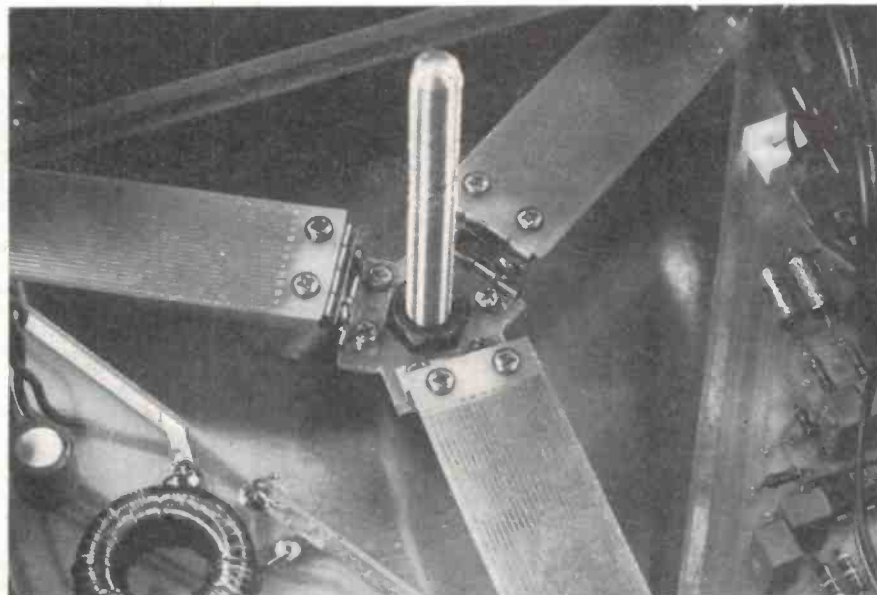

View of load assembly. Showing how the pc board centre piece and the cantilevers are coupled via the brass hinges.

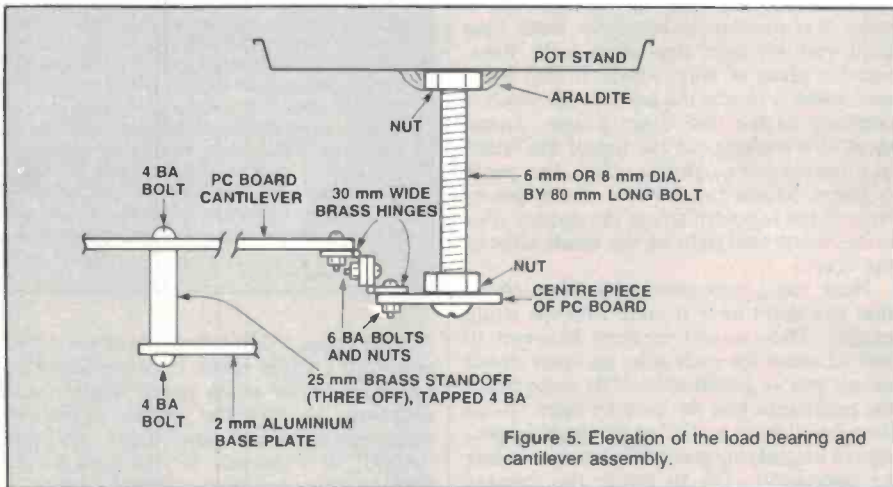

Figure 5. Elevation of the load bearing and cantilever assembly.

back, as shown in Figure 5, with 6 BA x  $\frac{1}{4}$ " or 2.5 mm x 5 mm screws.

Now comes a rather tedious job, namely, freeing up the hinges. Put plenty of oil on them and, holding them by the ends, work them back and forward as far as they will go. Keep this up until they're completely free and will just hang under gravity.

This is important because if it isn't done properly then the final scale will show stiction effects and will not return to zero all the time.

Finally, screw the three pairs of hinges to the bottom of the three cantilever beams and the centre piece to the ends of the hinges (see photo) using twelve more of the small machine screws. Last of all the whole board can be mounted on its nine spacers and it's ready to start testing.

## Testing

Before you're able to test and calibrate the scale you'll need some accurate or accurately measured weights. If you have access to an accurate balance then you can weigh some convenient objects and use them. I used small food cans for the light weights but however you get them, you will need weights of about 180 grams, 1.8 kilos and, if possible, about four kilos. One possible answer is to go down to your friendly local butcher or greengrocer and ask to weigh them on his scales (if he gets all twitchy you know where not to shop in future!).

If you turn on the scales you will find that the zero adjust is hopelessly unstable and moves if you even wave your hand near it, but fear not, this is normal. It is because air currents over the strain gauges change their



temperature and hence their resistance. To fix this, wrap all three gauges completely in cotton wool at least 5 mm thick. The scale should then settle down after a few minutes and the zero will only change by 0.1 gram every minute.

With the electronics out of its case, even air currents over the bridge balance resistors will cause some drift but when everything is finally in its box these problems disappear. If you want, you can prepare the actual weighing pan before testing (I didn't bother).

I used a base from a plastic flower pot which was just the right size (and price!) and glued a nut, which fitted the threaded post, onto the centre of the bottom with Araldite (lots of Araldite). Don't use Araldite with brass nuts though — it doesn't like copper or copper alloys. Also, be sure that the nut has absolutely no grease or oil on it before gluing it.

Finally, the testing. Turn on the scale and give it a few minutes to warm up then adjust the zero set until it flickers between 000 and 001 (it can be -5 kg and still read 000). Then place the 180 gram weight on it and adjust RV3 until the scale reads correctly. The scale is now calibrated (there, wasn't that easy!) RV3 should be fairly close to the centre setting and if you can't get a correct reading at all, then there's a problem with the strain gauges or gain setting resistors R15, R16 and R17.

The scale is now 90% operational and all that remains to be done is to connect the range switch up and mount the whole thing. The range switch is a two (or more) pole, three-position rotary switch which selects R16, R17 or nothing to vary the gain of the second gain block between 100, 10 and 1 (actually 101, 10.1 and 1.01, but who cares!).

A second section of the switch is used to select the appropriate decimal points on the display. Use about 100 mm of ordinary insulated hookup lead to connect the gain switching resistors to one section of the switch. The common terminal of the switch is connected to pin 6 of IC3 and the 10k resistor R16 goes to the centre terminal of the switch to select the middle or 2 kg range. Resistor R17, the 10 ohm resistor, selects the high or 5 kg range and the terminal that selects the 200 gram range is left open circuit.

Also, wire up the decimal point resistors using lengths of hookup wire about 150 mm long. The common contact of this switch section goes to the +5 volt rail (there's a pad provided near the decimal point pads and resistors).

If you can't follow the wiring diagram, rather than laboriously explaining which pad selects which decimal point, the easiest way is for you to select each gain range, in turn and try the terminals on the switch to get the right ones. For the 200 gram range the display should show '00.0', for 2 kg '0.00' and for 5 kg '0.00'. Connect the appropriate leads and things are almost ready to finally go in the box.

First, drill the two holes in the side of the box to accept the switch and zeroing pot then assemble the main board and mounting plate into the case with three self-tapping screws into the holes already drilled.

Tighten it down then carefully locate the power supply board on the inside of the rear of the case as far up as it will go without fouling the top of the case when it is put on. The power supply transformer must not interfere with the cotton wool insulation on the strain gauges at all. Mark the position of the four mounting holes and drill them with a 3.6 mm (9/64") drill. Attach four 6 mm (1/4") spacers to the four corners of the board and then screw in the power supply itself.

Next, cut an appropriate hole to the left of the power supply board and run in the mains lead you intend to use. To abide by the law you must have some way of clamping the flex so it can't be pulled out.

Use a 'clamp grommet'. Strip off about 40 mm of the outer cover from the flex you are going to use and feed it through the hole and clamp it. Then bare about 5 mm of the active and neutral leads and screw them into the cable clamp. Solder a lug onto the earth lead and screw it tightly under the centre screw, holding down the main board. That's the power connected. Then put in the zeroing pot and range switch with the zeroing pot towards the back (as far away as possible from the crud from the display).

Now all that remains to be done is to cut out the holes in the top cover and attach it and you've just built yourself a set of scales. Measure off exactly where the display comes through the top cover and cut a hole about 62 mm x 19 mm (but measure it off the case carefully — don't guess it) to clear the display. You also need a hole about 20 mm in diameter to clear the weighing pan shaft. Attach the front panel label to the top cover or label it as you see fit and the mechanics are completed.

Before sealing things up it's time for final calibration. Power up the project and give it a minute or so to settle down then select the 200 gram range and adjust the zero exactly. The display should be flickering between '700.0' and '00.0'. Place the accurate 180 gram weight on the pan and ensure that the display reads correctly. Adjust RV3 if necessary to pull it right into line and it's finally calibrated. Change ranges and check with the heavier calibrated loads if you have them.

Remove the weighing pan, screw on the top panel and replace the pan and your electronic weighing scales are complete!

The scales will always take a minute or so to warm up and settle down as the two strain gauges must be equal in temperature to about 0.001°C, or at least steady in temperature. Also, the zero set will have to be used often as temperature variations do occur. Loads over 5 kg may cause the scale to hit bottom but this does not damage. It may be necessary to recalibrate the scales every few months if you really want accuracy. Happy weighing, people!

# NOW a Production Quality 20W Iron that air cools your fingers..

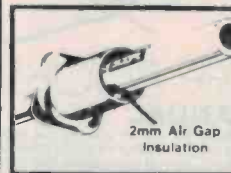

**AIRCOOLED GRIP**  
-for continuous soldering  
comfort - hour after hour.

**FREE**  
TUBE OF  
SOLDER  
WITH  
EVERY  
IRON  
THIS  
MONTH

\$17.50  
Including Tax

SCOPE  
COMMODORE  
Model PH20  
20W - 240V

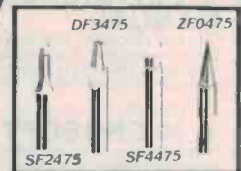

**4 INTERCHANGEABLE TIPS** -let you match the tip's heat transfer rate to each job. All 370°C\* idling temp.

1. Aircooled Grip
2. Interchangeable Tips
3. Long Life iron plated tips (4 shapes available)
4. 370° C Tip (Idling)
5. Safety Stand Available

**IAN J. TRUSCOTT**  
ELECTRONICS

27 THE MALL  
SOUTH CROYDON, 3136  
Telephone : (03) 723 3860





# 4 STATION INTERCOMS

PRICES SLASHED!!

Battery operated wire connected intercoms. The economical low noise way of communicating.

Complete with connecting wire - 1 master and 3 slaves.

**NORMALLY \$39.95 THIS MONTH ONLY \$29.95 - SAVE \$10**

Cat. AI-5504

## CONDUCTIVE PLASTIC BAGS

Manufacturer's distress stock - you reap the Benefit!

Jaycar has made a scoop purchase of heavy duty conductive plastic bags with inbuilt zipper closer. Each bag measures a generous 280 high x 205 wide. They will accommodate complete S-100 boards, RAM cards etc. You can store your precious ICs in them safely. (The bag would hold hundreds of ICs). Quantities strictly limited. First in first served. Cat. ZB-9990

1-4 BAGS \$2.00  
5-9 BAGS \$1.50  
10 Up BAGS \$1.00  
(each)

**NOW 20¢ ea.**

## MICROBEE BOOKS

### ★ USERS MANUAL

Is your manual old and tattered? Or do you want a spare manual? This manual has orange coloured guide pages to find the chapter easy. Neatly bound in an attractive cover and an asset to have beside your MicroBee. Excellent value.

Cat. XB-9002 ..... \$15.95

### ★ AN INTRODUCTION TO MICROBEE PERSONAL COMPUTERS AND PROGRAMMING

Just started learning BASIC? Then this is the book for you. With easy to read text and excellent examples it makes an ideal book for anyone wishing to learn to program the MicroBee.

Cat. XB-9003 ..... \$14.95

### ★ WORDBEE USERS MANUAL

This manual explains fully all of the facilities available to you using Wordbee. It explains everything from the basic commands through to preparing large documents and lots more. Unrivalled value.

Cat. XB-9001 ..... \$7.95

### ★ EDITOR/ASSEMBLER MANUAL

This manual covers all topics needed for your MicroBee Editor/Assembler. This includes full descriptions of error messages and has a program which you are guided through by the manual for "hands-on" experience.

Cat. XB-9000 ..... \$7.95

### ★ MICROSOFT BASIC

This neatly bound book contains all commands supported by Microsoft BASIC interpreter for CP/M-80. Each command is dealt with individually and commented on such as Purpose, Syntax and examples. An excellent book.

Cat. XB-9000 ..... \$29.95

### ★ MICROBEE ENGINEERING NOTEBOOK

This notebook contains hardware modifications, improvements etc. Some of the modifications include printer interfaces, cassette motor control, 64K ROM pack, Joystick and lots more. Definitely value for money.

Cat. XB-9020 ..... \$2.00

### ★ WILDCARDS Vol. 1

A potpourri of application notes and tips for the MicroBee. This book has received rave reviews from all computer publications. A must for all MicroBee owners.

Cat. XB-9010 ..... \$15.00

### ★ WILDCARDS Vol. 2

A potpourri of more application notes. Vol. 2 continues from Vol. 1, and again is a must.

Cat. XB-9011 ..... \$16.00

## COMPUTER CASSETTES

Exceptionally good quality, leaderless blank cassettes in the usual plastic cases.

Cat. XC-4710	C10	1-9 \$1.20	10 up \$1.10
Cat. XC-4715	C20	1-9 \$1.30	10 up \$1.20
Cat. XC-4720	C30	1-9 \$1.50	10 up \$1.40

## JOYSTICKS

These quality units are the self centering type with heavy duty suction cups which definitely keeps it in place. It has silver plated switch contacts, a pistol grip and is super responsive.

Cat. XA-5630 without plug

\$19.50

Cat. XA-5610 suit MicroBee

\$29.50



## XIDEX FLOPPIES

It has been brought to our attention that one major advertiser is showing a picture of XIDEX floppies but actually selling a cheaper floppy in small quantities.

### JAYCAR ONLY STOCKS XIDEX

The XIDEX disks are supplied in a magnificent snapshot case when purchased in boxes of 10.

Cat. XC-4770 5 1/4" double sided double density soft

sector ..... 1-9 \$5.95 ea

Box of 10 \$55.00

Cat. XC-4775 5 1/4" single sided double density soft

sector ..... 1-9 \$5.50 each

Box of 10 \$53.50

## NEW - MOTORCYCLE INTERCOM

(Ref: EA March 1984)  
Now you can talk freely and safely to your pillion passenger with this handy kit!  
Cat. KA-1533 \$39.95

## NEW! - DELUXE CAR BURGLAR ALARM

(Ref: EA May 1983) Great new design from EA. This one is very sophisticated. (Auxiliary battery extra) Complete kit of parts.  
Cat. KA-1550 \$69.50

# CONTACTLESS HALL-EFFECT "BREAKER POINTS"

SEE EA DECEMBER 1983

A professionally engineered electronic ("breakerless") contact breaker system.

Yes, only Jaycar has a complete Hall-Effect triggerhead assembly designed to adapt to an extensive number of cars. Each kit contains the following:

- HALL EFFECT TRIGGERHEAD
  - MAGNETIC ROTORS FOR BOTH 4 & 6 CYLINDER CARS
  - OVER 6 CAM-LOBE ADAPTORS
  - OVER 12 DIFFERENT ADAPTOR PLATES FOR YOUR PARTICULAR DISTRIBUTOR
  - OTHER HARDWARE (i.e. SCREWS etc)
  - YOU CAN REMOVE THIS SYSTEM AND RE-EQUIP YOUR CAR WITH THE ORIGINAL BREAKER POINTS WHEN YOU SELL THE CAR!
  - AS EASY TO INSTALL AS A SET OF POINTS
  - INSTRUCTIONS (SIMPLE-TO-FOLLOW) INCLUDED
- This set is designed to fit most European and Japanese cars. In fact it will also fit most Australian cars fitted with Lucas, Bosch, Motorcraft, AC Delco or Autolite electrics. If you wish to check first, please send SAE for car/distributor list.

Because we have no way of knowing, you get the fitting set for ALL of the distributors available. Basically you end up with a jar full of parts you don't need to use! (Perhaps for your next car?)

Quite frankly, we are amazed that we can supply such a comprehensive kit for this price. To produce a kit that will adapt to the dozens of different distributors around is amazing!

Remember, once you have installed a breakerless system it will never wear out and that part of your system will remain in tune FOREVER.

Cat. KJ-6655

PLEASE NOTE: This system must be used in conjunction with an electronic ignition. The Hall-Effect device will not switch enough current to replace the contact breaker points on their own!

# \$29.95

## TRANSISTOR ASSISTED IGNITION

REF: EA JANUARY 1983

Latest version of this fantastically popular kit! The Jaycar kit comes COMPLETE down to the plastic TO-3 transistor covers, genuine heatsink and DIECAST BOX - as used in the original EA unit.

Beware of flimsy kits that use sheetmetal boxes. This kit is designed to be used with contact breaker points. If you want Hall-Effect breakerless option may we suggest the KA-1505 version of this kit shown elsewhere on the page.

Cat. KA-1506 \$35



ETI340 CAR ALARM  
Ref: ETI April 1984

# \$69.50

A versatile security system that provides full protection for almost any vehicle. This unit will protect your valuable vehicle from virtually any sort of interference - from hubcap stealing to being towed away! It does not rely on voltage or current sensing to trip the alarm, but "resonance microphones". It can also protect "perimeter accessories" like driving lights and racks. The project meets the major requirements of car alarms set down by the NRMA. We

## TRANSISTOR ASSISTED IGNITION HALL-EFFECT "BREAKERLESS" VERSION

REF: EA DECEMBER 1983

This kit is virtually identical to the KA-1506 except that it contains the Interface electronics for the KJ-6655 Hall-Effect triggerhead.

Cat. KA-1505 \$36.95

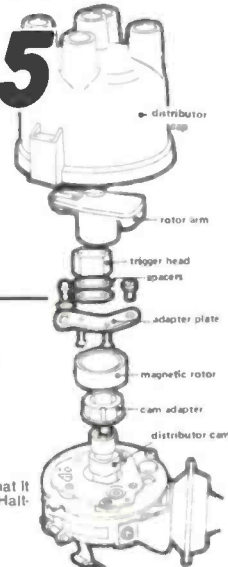

believe that this alarm is one of the most comprehensive that we have seen. Once again Jaycar has taken the no compromise approach.

The Jaycar kit includes two of the specified resonance microphones, original die-cast box etc. (we supply "chocolate block" multiway connectors as well).

The complete kit is only \$69.50 inc. sensors. Extra sensors are available for \$10 each Cat. AM-4000



## IONISER KITS COMPLETE KIT

- High efficiency emitter head - Fits completely inside a high quality ABS box (NOT a metal lid) - Only 2-core mains flex protrudes from the box - You can pay over \$80 for a built-up inferior unit!  
Cat. KJ-6511

## SHORTFORM KIT

- runs directly from 240V mains  
- low power consumption  
- produces high intensity electric field  
- output around 7.5kV  
- will not necessarily produce ozone in standard form  
- Ideal for those who wish to 'try' an ioniser at an economical price.  
Cat. KJ-6510

NORMALLY \$45  
THIS MONTH ONLY

**\$29**  
SAVE \$16

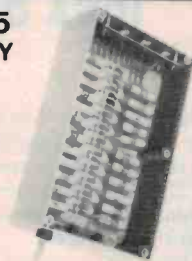

NORMALLY \$24.50

**\$15.00**

## UNIDIRECTIONAL ELECTRET MIC INSERT



This is a brand new direct import unit that is ideal for the EA Parabolic Microphone project in November 1983 EA. Average sensitivity around 7dB BETTER than the common low cost electret insert.

The insert has a front-to-back ratio of 1.5:1. The power requirements are the same as for the low cost mic insert. Each insert is supplied with a comprehensive data sheet which includes connection details, specifications and frequency response graph.

Cat. AM-4012 ..... **\$3.95**

## JAYCAR JVE-1

### VIDEO DETAIL ENHANCER

#### SPECIFICATIONS:

- Maximum enhancement not less than +8.3dB @ 2MHz
- Enhance disabled (Bypass) response, DC to 5MHz -0.5 +1.0dB
- Colour subcarrier 0dB notch frequency, tunable to 4.43-MHz. -/+0.5dB, all settings
- Amplifier group delay, less than 0.075uS.
- Signal handling capability not less than 1.35 volts p-p. (Sync. is clipped first)
- Power 12V AC @ 100mA
- Controls: ON/OFF, ENHANCE, ENHANCE/BYPASS SWITCH CORE/GAMMA CONTROL
- Input connector, RCA socket
- Output connector, RCA socket x 3

#### DESIGN FEATURES:

- A unity gain notch at the colour subcarrier frequency, whose purpose is to prevent chrominance to luminance errors at high enhance levels.
- A closed loop configuration with lead lag compensation to achieve stable, well defined gain.
- DC coupling, eliminating large capacitors in series with the video signal and achieving DC response for applications requiring it.
- Low output impedance prior to termination resistors, enabling up to three outputs to exist and be used or left unterminated.
- A level dependent closed loop response or Gamma control ('Core').
- Clip on negative going signals at -67 volts into 75 ohms to prevent sync. errors owing to overshoot.

Cat. AV-6501

**\$69.95**

12 Volt AC plugpack

Cat. MP-3020 ..... **\$16.95**

## PIN HEADERS

AND SOCKET TERMINAL STRIPS FOR PCB'S  
Great for PCB mass termination.  
8 WAY LAUNCHER 0.1" PITCH VERTICAL

Cat. HM-3210 ..... **\$1.50**

8 WAY LAUNCHER 0.1" PITCH RIGHT ANGLE

Cat. HM-3215 ..... **\$1.75**

8 WAY CONNECTOR SOCKET

Cat. HM-3220 ..... **\$1.95**

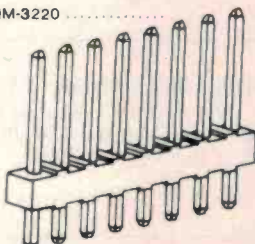

## NEW FOR '84 MICRON PROFESSIONAL QUALITY 20W 240V SOLDERING IRON

This great new iron has all the features of those costing a lot more.

- 370° fixed temperature
- High efficiency patented heating element
- Iron clad, chrome plated, long life interchangeable tips.

Cat. TS-1550

**\$19.50**

## MICROWAVE LEAK DETECTOR

If you own a microwave oven, your peace of mind is worth the price of this kit. Extremely simple and foolproof to build and use. Gives a positive indication of the security of your oven's seal.

REF: ETI 724

**\$14.95**

Cat. KE-4013



## 2708 EPROM

### ARE WE CRAZY?

- You normally can't get them!!
- They normally sell for \$7.95 from us (which is cheap)
- Limited Quantity
- Offer strictly limited

**ONLY \$4.95**

Cat. ZZ-8450

## CROSSHATCH/DOT GENERATOR

REF: EA NOVEMBER 1983

For those TV servicemen, hobbyists, videophiles and those keen on computer graphics, a pattern generator is mandatory if the best picture is to be obtained from your screen. The kit is crystal locked and will produce blank raster, dots and a crosshatch pattern (in white).

The unit gives direct video out and RF modulated video out. The Jaycar kit comes complete with front panel case and RF modulator.  
Cat. KA-1530

**\$28.95**

Beware of inferior kits that do not contain all parts.

# Jaycar ELECTRONICS

Incorporating  
**ELECTRONIC AGENCIES**

**NUMBER 1 FOR KITS**

## SHOWROOMS

### SYDNEY

117 YORK STREET

Tel: (02) 264 6688 & (02) 267 1614

Telex: 72293

### CARLINGFORD

Cnr. CARLINGFORD & PENNANT

HILLS ROAD

Tel: (02) 872 4444

### CONCORD

115-117 PARRAMATTA ROAD

Tel: (02) 745 3077

### HURSTVILLE

121 FOREST ROAD

Tel: (02) 570 7000

## MAIL ORDERS & CORRESPONDENCE

P.O. BOX 185

CONCORD, 2137

Tel: (02) 745 3077

## POST & PACKING CHARGES

\$5 - \$9.99	\$1.50
\$10 - \$24.99	\$3.20
\$25 - \$49.99	\$4.50
\$50 - \$99.99	\$6.50
\$100 - \$198	\$8.00
Over \$199	\$10.00

**COMET ROAD FREIGHT  
ANYWHERE IN AUSTRALIA  
ONLY \$12.00**

## SHOP HOURS

CARLINGFORD, CONCORD &  
HURSTVILLE

Mon - Fri: 9 am - 5.30 pm

Sat: 9 am - 12 pm

Thurs Night: 8.30 pm (Not Concord)

## SHOP HOURS SYDNEY

Mon - Fri: 8.30 am - 5.30 pm

Sat: 8.30 am - 12 pm

Thurs Night: 8.30 pm

## MAIL ORDER BY



**VIA YOUR  
PHONE**



**VISA**



## IDEA OF THE MONTH

### Low cost appliance timer

Steve Garland

I originally designed this timer for controlling irrigation systems, particularly systems where frequent short duration applications are required. It proved very cheap, easy to make and reliable. Subsequently it has proven equally valuable for longer period timing applications, turning lights on and off each day, turning open field irrigation systems on and off twice a week and so on. In short, this timer will lend itself to any application where cheap reliable control is required.

The basis of the timer is Exars' 2240 programmable timer/counter. This is actually a 555 with its output wired to a binary counter. Eight outputs are available and they change state in the normal binary fashion on every pulse from the 555. The timing period of the 555 is set by an RC network on pin 13 of the XR 2240.

The counter is arranged in a 'wire'or' configuration through

the DIL switch. When the counter outputs match the switch outputs the output pin of the 2204, pin 10, goes high and counting is inhibited until the next trigger pulse.

The timer uses two of these counters, one to measure interval and the other duration. To initiate circuit action, SW3, the start button, is depressed. This puts a negative going pulse onto pin 11 of IC2. The rising edge of this triggers the IC. Pin 10 goes low and switches off Q2. This drives the collector up almost to the supply rail, turning on Q3, and thus the relay. It also acts as a positive going voltage on pin 11 of IC1, and so triggers it. The circuit operation of IC1 is now identical to IC2. The positive going voltage on pin 11 initiates the count sequence, pin 10 goes low, turning off Q1 and turning LED2 on. Incidentally this also puts a low voltage back onto pin 11 of IC2, thus effectively resetting its trigger circuits.

The result of this is that both counters are counting at the

same time. However, they are not counting at the same rate. IC2 (the duration timer) reaches its turn off count long before the interval timer (IC1). When this happens pin 10 of IC2 goes high and so turns the relay off.

The circuit will now wait for IC1 to finish counting. This defines the 'interval' When it is finished pin 10 rises rapidly, becoming a rapid positive going voltage for pin 11 of IC2, and it thus has exactly the same effect as the original start pulse. The whole sequence repeats itself again.

The duration of the two timers is set by a combination of the timing period defined by the RC network on pin 13 and the setting of the DIL switches.  $T=RC$  subject to the limitation that R should be between 1k and 1M and C between 7n and 1000 $\mu$ . Pin 1 will, in fact, change states at this rate, pin 2 at twice the duration and so on. With eight outputs it is possible to derive accurate timing intervals 255 times longer than RC. This

gives an approximate timing limit of about 70 hours.

Construction is quite straightforward, paying attention to polarity of diodes and capacitors. Make sure that the choice of filter capacitor is rated above the rectified voltage, i.e.: >12 V for 240 V switching circuit and >32 V for 24 V switching circuit. The manual override switch must be a DPDT with adequate current capability and standard size (not mini) to enable sufficient separation between leads when soldered. Be sure to connect the output leads to the poles, with both mains leads at one throw and both relay leads at the other. This setup provides isolation between the two streams, but it is still necessary to pair the active and neutral leads on each pole to reduce the risk of short circuit and to comply with the standard wiring convention.

The choice of relay, manual override switch, fuse and wire gauge is decided by the output requirement. Usually 5 A at 240 V is adequate for your

## IDEAS FOR EXPERIMENTERS

### Range extension

Barry Bown of Lalor Victoria sent us this idea.

A problem with multimeters is that the 5, 10, and 50 volt range selection do not allow very accurate determination of voltages that lie just outside the range, like 12 volts.

He uses a 10 volt zener to convert the five volt range into a 10-15 volt range. In a similar way, almost any range can be obtained with the correct selection of zener values and meter range.

Meter Range	Zener Voltage	Extended Range
5 V	10 V	10-15 V
10 V	10 V	10-20 V
5 V	5 V	5-20 V
5 V	15 V	15-20 V



### Low voltage alarm

J. Chubb of Kingsford NSW sent us his useful little circuit. It will light a LED when the supply voltage is above a certain level, and flash it when the batteries need replacing.

The values shown are for 9 V operation. Flashing starts at about 7V5 and the lamp won't light at all below 2 V.

The circuit consists of a 555 timer connected in the bistable mode and driving a LED. The trick is to connect a zener diode between pin 7 and ground. In normal operation pin 7 oscillates between one-third and two-thirds of the supply rail voltage  $V_{cc}$ . If  $2/3 V_{cc}$  is greater than the zener voltage then the function of the 555 will be inhibited.

Thus to customise the circuit for your own requirements, decide on the minimum voltage that will operate the equipment correctly, and multiply by  $2/3$ . This is the zener voltage. R may

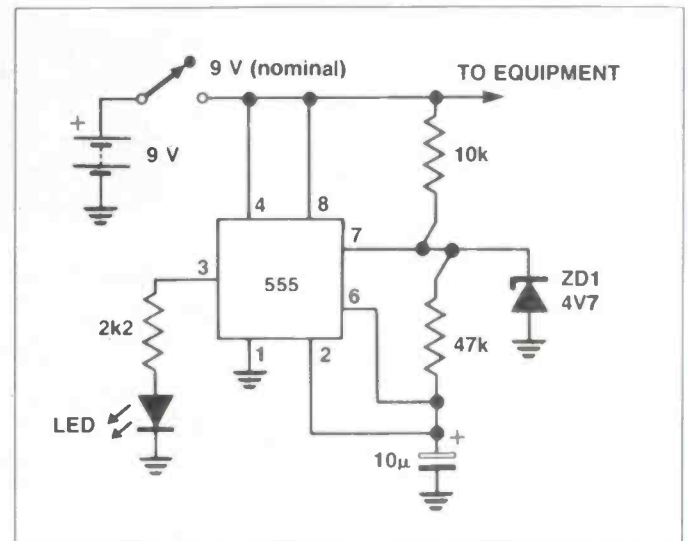

also need to be changed to suit the particular LED you use.

As originally constructed the indicator drew 7 mA at 9 V,

falling to 5 mA at 7 V. If these values are likely to cause problems try the CMOS version of the 555, the 7555.



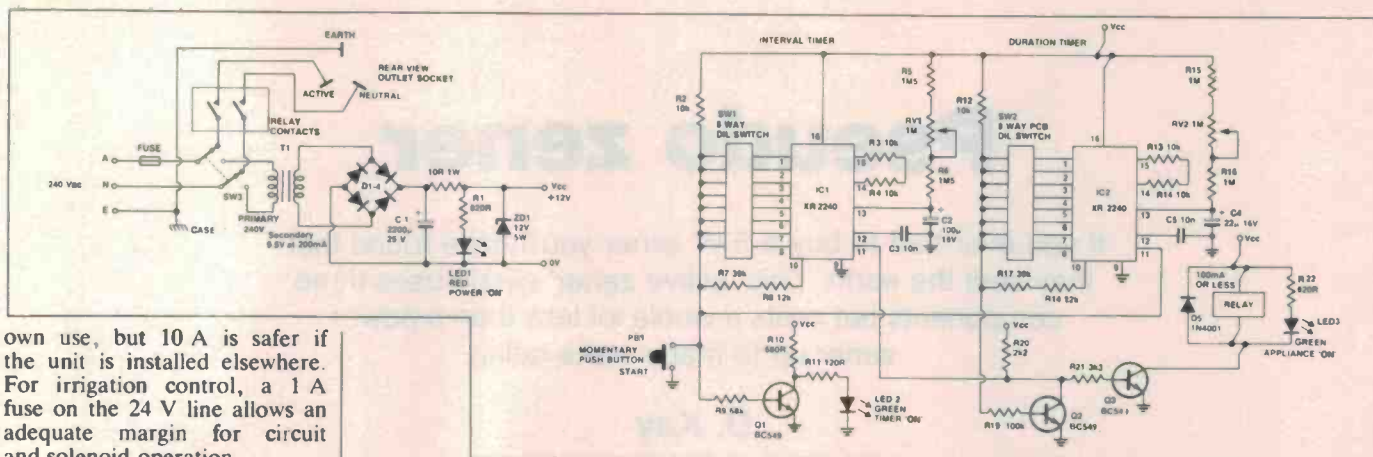

own use, but 10 A is safer if the unit is installed elsewhere. For irrigation control, a 1 A fuse on the 24 V line allows an adequate margin for circuit and solenoid operation.

I generally use a 185x70x160 mm metal cabinet (such as sold by Dick Smith) for housing the unit as it provides a good amount of room inside for isolating the mains and transformer and can be directly earthed. For external applications, the timer can be housed in a rigid PVC junction box, with supply and output run through conduit, transformer and PCB fastened with nylon bolts and all holes sealed

with silicone.

Once construction is completed, confirm the 12 V supply. Then turn on switch 1 of each DIL switch, grab a stopwatch or watch with seconds clearly displayed and power on. The red LED only should be on. If one of the timers has accidentally fired (either green LED is on) turn the power off and on again. When ready, depress the 'start' button and start timing immediately that

you release it. Timing extends until the moment that the 'appliance on' LED cuts out. Adjust RV2 and repeat until the required duration is obtained.

Repeat the above for the interval period, adjusting via RV1 and timing from when you release the start button until the 'appliance on' LED lights for the second time. Having completed this, bundle up your timer and you are

ready to roll.

If the timer is being dedicated to one purpose with constant interval and duration periods, you can streamline the project (and the cost) by hard-wiring the timer output connections, deleting the manual override, mounting the fuse in a PCB holder and connecting the appliance leads directly to the relay, bringing the all-up cost of components down below \$30 for 240 V at 5 A.

## 'IDEA OF THE MONTH' CONTEST

### COUPON

Cut and send to: Scope/ETI 'Idea of the Month' Contest, ETI Magazine, P.O. Box 227, Waterloo NSW 2017.

"I agree to the above terms and grant *Electronics Today International* all rights to publish my idea in ETI Magazine or other publications produced by it. I declare that the attached idea is my own original material, that it has not previously been published and that its publication does not violate any other copyright."

\* Breach of copyright is now a criminal offence.

Title of idea .....

Signature .....

Name .....

Date .....

Address .....

Postcode .....

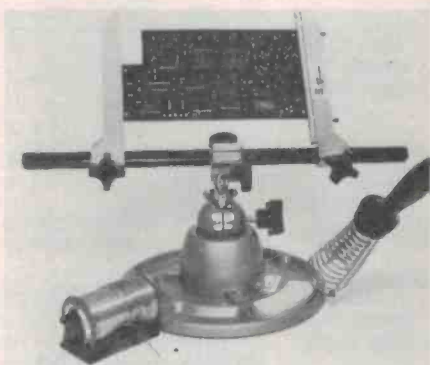

Scope pc board Work Centre

PRIZE WORTH \$123!

Scope Laboratories, which manufactures and distributes soldering irons and accessory tools, is sponsoring this contest with a prize given away every month for the best item submitted for publication in the 'Ideas for Experimenters' column — one of the most consistently popular features in ETI Magazine. Each month we will be giving away a pc board Work Centre consisting of the Model 315 adjustable pc board holder with capacity to accept 300 mm boards, Model 300 180° swivel and lock base which can be attached to the Model 312 tray base with wet sponge receptacle, Model 371 solder spool holder and Model STS 3 soldering iron safety stand. Please note prize does not include solder or scope TC60 temperature controlled iron shown above. The prize is worth \$123!

Selections will be made at the sole discretion of the editorial staff of ETI Magazine. Apart from the prize, each winner will be paid \$10 for the item published. You must submit original ideas of circuits which have not previously been published. You may send as many entries as you wish.

### RULES

This contest is open to all persons normally resident in Australia, with the exception of members of the staff of Scope Laboratories, The Federal Publishing Company Pty Limited, ESN, The Litho Centre and/or associated companies.

Closing date for each issue is the last day of the month. Entries received within seven days of that date will be accepted if postmarked prior to and including the date of

the last day of the month.

The winning entry will be judged by the Editor of ETI Magazine, whose decision will be final. No correspondence can be entered into regarding the decision.

The winner will be advised by telegram the same day the result is declared. The name of the winner, together with the winning idea, will be published in the next possible issue of ETI Magazine.

Contestants must enter their names and addresses where indicated on each entry form. Photostats or clearly

written copies will be accepted but if sending copies you must cut out and include with each entry the month and page number from the bottom of the page of the contest. In other words, you can send in multiple entries but you will need extra copies of the magazine so that you send an original page number with each entry.

This contest is invalid in states where local laws prohibit entries. Entrants must sign the declaration on the coupon that they have read the above rules and agree to abide by their conditions.



## Pseudo zener

If you ever had to buy a 5 W zener you'll have found that they cost the earth. This 'active zener' circuit uses three components but costs a whole lot less than a power zener up to many watts rating.

### D. Kay

THE CIRCUIT CONSISTS of a transistor Q1 which dissipates most of the power and a zener diode ZD1 which supplies a reference voltage. When the voltage on the collector is greater than the total voltage across the zener and the transistor's base-emitter, Q1 will start to conduct, lowering the voltage on the collector. The circuit will reach a point of equilibrium where only enough current flows into the base of Q1 via ZD1 to maintain the collector-emitter voltage.

A zener diode is usually operated reverse biased i.e. positive is applied to the cathode. However, when it is forward biased it will conduct with only less than one volt (approximately 0.65 V depending on the current) across it. To simulate this in the artificial zener a diode D1 can be used although in most applications this is not necessary.

Transistor Q1 still has to dissipate the power that would otherwise be dissipated in an expensive zener. There is no way of avoiding this dissipation and it should be remembered when heatsinking Q1.

Table 1 enables you to select the transistor type depending on the zener diode that you require. Information is given as to whether or not the transistor needs to be heatsinked. If Q1 does require heatsinking the maximum temperature of the mounting base is given; if Q1 does not need to be heatsinked then the maximum ambient operating temperature is stated.

As an example, a pseudo zener of 33 V at 400 mA is required (33 V is part of the standard zener ranges). If you look down the 40 V column (the lowest voltage in the table above the voltage required) and across the 500 mA row (the lowest current above the 400 mA required) you will find that you need a 2N3055 transistor heatsinked and with a mounting base temperature that is less than 170°C. The zener diode that is used as a reference needs to have a voltage rating of 32.35 V.

$$\begin{aligned} ZD1 &= V1 - 0.65 \text{ from table} \\ \therefore ZD1 &= 33 - 0.65 \\ \therefore ZD1 &= 32.35 \text{ V} \end{aligned}$$

The nearest zener diode easily available has a voltage rating of 33 V which gives a nominal V1 of 33.65 V and a maximum of 33.8 V.

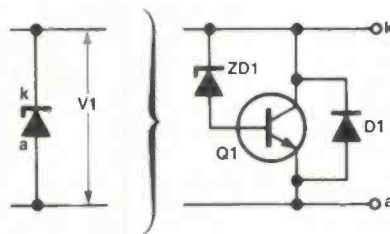

$$\begin{aligned} V1 (\text{max.}) &= ZD1 + 0.8 \text{ V from table} \\ \therefore V1 (\text{max.}) &= 33 \text{ V} + 0.8 \text{ V} \end{aligned}$$

This excludes the tolerance of the zener diode and assumes the transistor is at 25°C. The temperature coefficient of the transistor is approximately  $-2 \text{ mV}/^\circ\text{C}$ .

The 33.8 V maximum voltage is a pessimistic rating and should be less; 0.8 V in 33 V is only one part in 42 anyway.

	8 V	16 V	40 V	
Transistor Heatsink Max. temp.	BD137 no 50°C ZD1 = V1 - 0.65 V1 < ZD1 + 0.80	BD137 no 50°C ZD1 = V1 - 0.65 V1 < ZD1 + 0.80	BD137 no 50°C ZD1 = V1 - 0.65 V1 < ZD1 + 0.80	25 mA
Transistor Heatsink Max. temp.	BD137 no 50°C ZD1 = V1 - 0.67 V1 < ZD1 + 0.84	BD137 no 50°C ZD1 = V1 - 0.67 V1 < ZD1 + 0.84	BD137 yes 110°C ZD1 = V1 - 0.67 V1 < ZD1 + 0.84	50 mA
Transistor Heatsink Max. temp.	BD137 no 50°C ZD1 = V1 - 0.77 V1 < ZD1 + 0.88	BD137 yes 110°C ZD1 = V1 - 0.77 V1 < ZD1 + 0.88	BD137 yes 110°C ZD1 = V1 - 0.77 V1 < ZD1 + 0.88	100 mA
Transistor Heatsink Max. temp.	BD137 yes 110°C ZD1 = V1 - 0.73 V1 < ZD1 + 0.90	BD137 yes 110°C ZD1 = V1 - 0.73 V1 < ZD1 + 0.90	2N3055 yes 188°C ZD1 = V1 - 0.65 V1 < ZD1 + 0.68 1 watt zener	200 mA
Transistor Heatsink Max. temp.	BD137 yes 110°C ZD1 = V1 - 0.81 V1 < ZD1 + 1.00	2N3055 yes 188°C ZD1 = V1 - 0.65 V1 < ZD1 + 0.80	2N3055 yes 170°C ZD1 = V1 - 0.65 V1 < ZD1 + 0.80 1 watt zener	500 mA
Transistor Heatsink Max. temp.	2N3055 yes 188°C ZD1 = V1 - 0.70 V1 < ZD1 + 1.00 1 watt zener	2N3055 yes 170°C ZD1 = V1 - 0.70 V1 < ZD1 + 1.00 1 watt zener		1 A
Transistor Heatsink Max. temp.	2N3055 yes 170°C ZD1 = V1 - 0.80 V1 < ZD1 + 1.30 1 watt zener			2 A

Table 1. Pseudo-zener cross-referenced with the required transistor. Unless stated the zeners are rated at 400 mW.





# ACTIVE ELECTRONICS

289 LATROBE STREET, MELBOURNE 3000 PH. 602 3499

9am-5.30pm MON-THURS 9am-8.30pm FRIDAYS 9am-12noon SATURDAY

**BUY DIRECT FROM OUR CITY STORE!**  
OR MAIL ORDER

## DLP1 LOGIC PROBES



model DLP-1 Probe Logic ONLY

Max Input 1.5 MHz  
Strong Aluminium case

**\$10.50**

LEDs HI-LOW-PULSE  
80cm leads  
KEY to LEDs on back of probe  
Input Impedance 300k

## COMPUTER COOLING FANS



**\$13.50**

79.5 (3")  
SQUARE  
115 VOLT

## SPECIAL WB2N BREADBOARD

LOWEST PRICED TOP QUALITY BREADBOARD



2N 200 - 640 Holes

**\$8.95** each

## WE STOCK A FULL RANGE OF KITS

DESCRIPTION	PRICE	DESCRIPTION	PRICE	DESCRIPTION	PRICE
K4084 CAR ALARM ETI 084	12.50	K3301 10 TURN OPT-K3300	10.00	K5850 VIDEO AMPEA KIT	14.95
K1000 SHORTWAVE ANTENNA	9.95	K3302 +/- 12V OPT-K3300	12.50	K6005 DRILL SPEED CONTR	13.95
K1106 RADIO MIC. KIT 106	6.50	K3325 40V/50A P/SUPP ETI	175.00	K6300 FLUORO STARTER EA	4.95
K1107 ELECTRONIC DIE	7.50	K3350 MICRO P/SUPP KIT	59.50	K6320 TOUCH LAMP DIM EA	19.50
K1123 ALIEN INVADERS	13.95	K4010 TRANS ASSIST IGN.	35.00	K6321 REMOTE FR DIMMER	9.00
K1492 SOUNDBENDER KIT	29.50	K4084 CAR ALARM ETI 084	12.50	K6700 12/240 INVERT 40V	55.00
K1501 NEG IRON GEN KIT	39.50	K4232 COURTESY LIGHT EX	3.95	K6750 12/240 INVERT 300	199.50
K1583 ALCOHOL BREATH	29.95	K4320 BATT COND INDICAT	4.95	K9649 LIGHT PEN MICROBE	19.95
K1607 SOUNDGEN PACK KIT	17.50	K4324 TWIN RNG LED TACH	24.50	K9668 EPROM PROC. MICROB	55.00
K1724 MICROWAVE LEAK DT	14.50	K4326 EXP SCALE LED MET	9.50	K9671 CENTR IF MICROBEE	29.95
K1798 TV MASTHEAD AMP	33.50	K4330 CURRENT CAR ALARM	29.50	K9673 MULTIPROM BRD M.B.	99.50
K1822 CUDLIPP CRICKET	12.50	K4334 AUTO TESTER ETI	14.50	K9674 JOYSTICK MICROBEE	24.50
K1824 VOICE OP RELAY	12.50	K5001 PREAMP SERIE 5000	275.00	K9675 JOYSTICK MICROBEE	35.00
K2105 BENCH AMP ETI 453	14.50	K5005 MOSFET PWR 5000	319.00	K9680 JOYSTICK MICROBEE	4.95
K2500 DIG FREQ COUNT 50	125.00	K5025 GRAPH. EQUALR 5000	199.50	K9690 LIT. BIG BRD KIT-2	474.00
K2501 500MHZ PRESCALE	26.00	K5050 SPKR PROT. STEREO	79.50	K9691 8 INCH CPM 9600 B	144.00
K2502 DEC PNT KIT-K2500	9.50	K5051 SPKR PROT. MONO	22.50	K9692 8 INCH CPM 1200 B	144.00
K2505 FUNCT. GEN EA KIT	89.50	K5412 LED BARGRAPH DISP	16.50	K9693 5 INCH CPM 9600 B	144.00
K2521 LED CAP METER EA	55.00	K5510 GEN PURP PRE AMP	8.50	K9694 5 INCH CPM 1200 B	144.00
K2525 TRANS/FET TEST EA	19.75	K5530 BAL DIF PREAMP	18.50	K9695 LIT. BIG BRD KIT-1	150.00
K3205 PWR SUPP 30V 1A	49.50	K5800 MUSICOLOUR IV KIT	89.50	K9733 RTTY COMP DECODER	19.50
K3220 DUAL TRACK PWR SP	89.50	K5810 STEREO SYNTH VCR	55.00	K9736 FAX DEC. MICROBEE	24.50
K3250 13.8V/10A PWR SUP	89.50	K5825 VIDEO EDHANCER EA	35.00	K9760 VIDEO RF MOD ETI	17.50
K3300 BENCH P/SUPP DL M	139.50	K5830 VIDEO DISTR AMP	45.00	K9834 COMP MUSIC SYNTH.	26.50

WE STOCK OVER 2000 DIFFERENT SEMI-CONDUCTORS, TEST GEAR, INSTRUMENT CASES, TRANSFORMERS, RESISTORS, CAPACITORS, ETC. WE STOCK THE BIGGEST RANGE FOR THE HOBBYIST IN MELBOURNE.

**NOTE. ALL PRICES INCLUDE SALES TAX**

### POST AND PACKING CHARGES.

	ORDER VALUE	P&P
POST & PACKING FOR GOODS SENT BY STANDARD MAIL IN AUSTRALIA ONLY	\$5 - \$9.99	\$1.00
	\$10 - \$24.99	\$2.00
	\$25 - \$49.99	\$2.50
	\$50 - \$99.99	\$3.00
	\$100 OR MORE	\$3.50

MAIL ORDER & SHOP SALES

MAIL ORDER & SHOP SALES

MAIL ORDER & SHOP SALES

MAIL ORDER & SHOP SALES

MAIL ORDER & SHOP SALES







# Your computer

MAGAZINE FOR BUSINESS AND PLEASURE

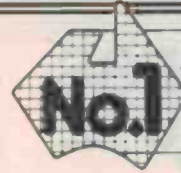

**AUSTRALIA'S  
TOP-SELLING  
COMPUTER  
MAGAZINE**  
AUDITED SALES



**In July 1984:**

## Computers & Music

In the last couple of years computers have started to play a larger and larger part in the creation and playing of music — more and more music programs are being written for all the popular microcomputers, and all sorts of peripherals, interfaces and enhancements are coming onto the market to help you make music through your computer. 'Your Computer' leads you through the maze of musical computing.

### 2 New Systems

A new Apple and a new Tandy — in one issue! Apple's latest release is the portable IIc, ideal for use both at home and in business, while the Tandy 2000 shows all the signs of being Tandy's best computer ever. Read all about them, and much more, in July's 'Your Computer'.



**\$2.50 at your newsagent**

# BUMPER BARGAIN TIME!

**PENCIL II  
COMPUTER  
WITH 22  
SOFTWARE  
PROGRAMS**



**\$299**

A New 780 based home computer with a full set of programs to get you started. Includes THE MAN (extra 10k or 64k avail), 6 user key.

**FLOPPY DISK  
DRIVE  
CLEANERS**



Packs of 6  
5 1/4 INCH OR 8 INCH

**\$25 \$29**

CLEANS AND PROTECTS YOUR VALUABLE HEADS - FOR SS OR DS DRIVES EACH CLEANER MAY BE USED UP TO 15 TIMES!

**Computer Case**



Professional METALWORK to house YOUR COMPUTER

• FOR EXISTING SYSTEMS ARE YOU TIRED OF LOOKING AT THE "GUTS" OF YOUR HOME-BREW CPU'S?  
• FOR NEW SYSTEMS DO YOU WANT TO BUILD YOUR COMPUTER, BUT CAN'T HACK-UP THE ALUMINIUM?  
• FOR DEM'S, GOVT DEPTS, ETC. CAN'T WAIT FOR CUSTOM-BUILT ONE-OFF PROTOTYPES? WE'D EX-STOCK DELIVER!  
• THEN YOU NEED TO BUY OUR HIGH QUALITY COMPUTER CASE SIZE 430x180x510MM DEEP. Various options are available for most combinations of 5 1/4 and 8 floppy drives and 5 1/4 hard disks. Call and let us know what you want. We'll fix you up.

**\$199** EACH

PACK/POST \$2 PLUS SZ OF ORDER

**C20 COMPUTER  
TAPES**



2x10 Min  
**\$1.50** EACH

• Best Quality  
• Low Background Noise  
• Fully Guaranteed  
• or money refunded

**EXTENSION  
LEAD**



3 meters  
**\$3.99**

**FOR JOYSTICKS  
DB-9 PLUG  
TO  
DB-9 SOCKET**

**Big SHOT  
JOYSTICK  
CONTROLLER**



**\$15** ea

WITH RAPID-FIRE CIRCUITRY

**NEW Relays**

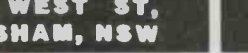

**\$1**

**12 VOLT DC  
STROBE  
FLASHER**



Solid State!  
**\$18**

SAVE 20%  
ORANGE, BLUE or RED

**VIDEO  
DUBBING  
KITS**

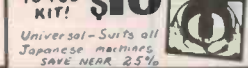

10 PCB KIT!  
**\$15**

Universal - Suits all Japanese machines  
SAVE NEAR 25%

**12V  
SEALED  
RECHARGEABLE  
BATTERIES**

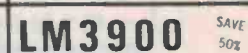

FOR ALARMS, ETC.

1-2AH 2-6AH 4-5AH  
**\$17 \$30 \$40**

**LM3900**

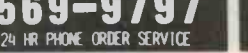

FANTASTIC LOW PRICES. BUY NOW!  
**50c**

RCA3401 EQUIVALENT.  
10 for \$4.50

## APPLE CARDS



**APPLE® 100% COMPATIBLE PRODUCTS**

- 16K RAM CARD FOR GREATER MEMORY ..... \$ 75
- 2-80 CP/M CARD RUNS CP/M PROGRAMS ..... \$120
- SUPER SERIAL CARD IDEAL FOR SPREADSHEETS ... \$190
- 80 COLUMN CARD IDEAL FOR SPREADSHEETS ... \$110
- PAL COLOUR CARD FOR GAMES, GRAPHICS ... \$100
- PARALLEL PRINTER CARD BEST AVAILABLE ... \$110
- WILD COPY CARD ULTIMATE DISK BACKUP .... \$ 99
- SPEECH SYNTHESIZER CARD WITH SPKR . \$ 75
- COOLING FANS ATTACHES TO SIDE OF COMPUTER \$ 55
- JOYSTICKS HEAVY DUTY, SELF-CENTERING, ADJ. \$ 49
- SLIM-LINE DISK DRIVES TEAC DRIVES ... \$365
- DISK DRIVE CARDS RUNS 1 OR 2 DRIVES ... \$ 79
- RS232 SERIAL CARD FOR PRINTERS, ETC ... \$110
- EPROM PROGRAMMER CARD MOST TYPES ... \$ 95
- POWER SUPPLY SWITCH-MODE REPLACEMENT .... \$ 89

**FANS** Ex-computer

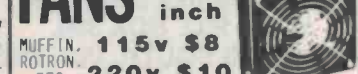

5 inch  
MUFFIN, 115v \$8  
ROTRON.  
ETC. 220v \$10

**MOVING COIL  
CARTRIDGE**

- Standard 1" mounting.
- Smarvis Cobalt magnets for high output. Transformer not needed.
- Freq. response 15Hz-35kHz.
- Huge 7.5A output (18W/50ma/A)
- Tracking Force: 7.0 grams.
- 0.1mm Diamond stylus.
- Complete mounting kit incl.
- Stylus easily replaced (\$15.00)

MODEL MC100  
SAVE OVER 20%  
**\$19.50**

DISCOUNTS SHOWN ARE OFF OUR REGULAR PRICES. SPECIALS AVAIL. JULY ONLY!

**PRE-PAK  
electronics p/l**

**1a WEST ST,  
LEWISHAM, NSW**

**569-9797**  
24 HR PHONE ORDER SERVICE

**Phone or mail order  
BANKCARD accepted**



# WIRELESS INSTITUTE OF AUSTRALIA

FOUNDED 1910

The W.I.A. represents the Radio Amateur at Local, National and International level and offers following services:



- ★ Monthly "AMATEUR RADIO" Magazine, included in membership fee.
- ★ Most REPEATERS have their licence, power and site cost paid by the institute.
- ★ World wide QSL-service.
- ★ Assistance to members in legal problems arising out of the pursuit of their hobby.
- ★ A Weekly Sunday Broadcast to Amateurs and Short Wave Listeners.
- ★ Assistance in dealing with Interference Problems (TVI-RFI etc.)
- ★ Novice and full call courses.
- ★ Trial Novice and AOCB theory exam papers.
- ★ Advice on Radio Mast approvals
- ★ The ONLY representation of the RADIO AMATEUR in legislative matters.



Join the 8,600 Amateur members in the W.I.A. by forwarding this coupon to:

W.I.A. P.O. BOX 300, CAULFIELD SOUTH, VIC. 3162

Please forward a membership application form and further details to:

Mr, Mrs, Miss, Ms .....

Address .....

Callsign .....

Postcode .....

## PROGRAMMABLE POCKET SCANNER

—MICROCOMM—  
**SX-150**

PROFESSIONAL POCKET SCANNER WITH OVER 45,000 CHANNELS & 160 MEMORIES

26 to 88, 138 to 176 and 380 to 514 MHZ



The Microcomm SX-150 represents the latest developments in State-of-the-art LSI CMOS technology as applied to scanning monitor receivers. It incorporates many features, a lot of which are not even found in today's larger base scanners.

For example the SX-150 has 160 memory channels which can be programmed in either of two modes. The first allows you to manually program the entire 160 channels. The second mode provides for manual programming of the first 40 channels with the top 120 reserved for use by the SX-150 while in its SEARCH mode. It uses these channels to automatically store frequencies on which it has found signals during the search phase.

The SX-150 also features a Priority Channel (for that important frequency). An LCD display providing readout of all receiver functions including an accurate crystal controlled 24 hour clock.

Supplied complete with rechargeable Nicad batteries, charger, and rubber duck antenna, the SX-150 is a must for anybody with an interest in monitoring.

PRICE **\$449**  
+ \$12 P&P

AUSTRALIAN DISTRIBUTOR  
**GFS ELECTRONIC IMPORTS**  
Division of GD & JA WHITER PTY. LTD.

17 McKeon Road, Mitcham, Vic. 3132  
PO Box 97, Mitcham, Vic. 3132

Telex: AA 38053 GFS  
Phone: (03) 873 3777 3 Lines

## Just for Listening!!!



### SAIKO SC7000

Computerized Programmable Scanning Receiver



#### AMAZING FUNCTIONS . .

- 70 Memory channels.
- Scans the Aircraft Band, the UHF Band and the VHF (High and Low) Band.
- 2.5 KHz channel steps on VHF and Aircraft Bands.
- 240 volt and 12 volt operation.
- Tape Recording Connections.

You may want to listen for many reasons whatever the reason, the SAIKO SC7000 offers a truly "state of the art" receiver with micro-processor technology and far more features than competitive receivers.

**I M A R K**  
PROPRIETARY LIMITED

167 RODEN STREET, WEST MELBOURNE, VIC. 3003, AUSTRALIA.  
PHONE: (03) 329 5433. TELEX: AA37753 IMARKO



# 1986 a 'banner year' for amateur satellites

**W**orldwide, 24 hour-a-day satellite communications by radio amateurs may be a reality before the end of the eighties, according to a report in the US-based *Westlink Report* late May.

The Amateur Satellite Corporation (AMSAT), announced in April that it was negotiating for a major new launch opportunity early in 1986. This was to have a payload capacity equal to or exceeding that of the highly successful OSCAR 10 satellite launched in 1983. OSCAR 10 currently provides across-the-globe contacts for radio amateurs employing its VHF and UHF transponders.

AMSAT's announcement said, in part, "... this opportunity could be used to orbit the Phase 3C satellite, which is planned along the same technical lines as the OSCAR 10.

"In fact, 1986 could be a banner year in amateur satellites with as many as six new satellites launched.

"Besides the Phase 3C OSCAR, the French ARSEN, Japanese JAS-1 and the digital 'store-and-forward' PACSAT may all be orbited during 1986."

The Russians are also tipped to join the flurry in 1986 with a

series of new Radio Sputnik packages.

Meanwhile, preliminary discussions have taken place in the US on the possibility of launching what is termed a "constellation" of geostationary amateur satellites to provide global coverage. These spacecraft would operate in either the 1.2 or 2.4 GHz bands, or a combination of the two, to be launched 1986-87. Potential user support is crucial as the geostationary option is a costly one and broad user support from the world's amateur community is necessary.

AMSAT is inviting comments on what benefits might result from such an undertaking and what level of financial support might be realistically envisioned. Based partially on responses, AMSAT will assess the viability of such a program. Comments should be addressed to AMSAT, P.O. Box 27, Washington DC 20044 USA.

## UOSAT II lives!

**F**ollowing an international effort by teams in the US and Britain during May, UOSAT II was commanded on-air on Monday 14 May.

The satellite, built by a team at the University of Surrey (UK), mysteriously stopped transmitting early in March and stubbornly denied efforts to bring it back to life.

During the second weekend in May, radio amateurs from Stanford University in California managed to pick up feeble signals at an outpost in Greenland.

The signals were from UOSAT's receivers and so weak that even the giant dish at Jodrell Bank in the UK had been unable to trace them.

The Surrey University team tried to regain control on the 144 MHz command frequency, but were unsuccessful. Upon trying 438 MHz just after midnight on Monday 14 May, the main beacon responded with a strong signal. Surrey reports the craft is in good order and in the right orbit.



Margaret Howard, presenter of BBC World Service's Letterbox programme.

## BBC world service

**T**he BBC World Service to Australia up to September 29 is now being carried on additional frequencies, extending daytime coverage for winter reception in the South Pacific area. The BBC World Service operates 24 hours a day and the schedule for Australian listeners is 0600-1515 and 2000-0015 UTC. There is a short transmission at 0300 on 153-80 kHz from the Singapore relay base, to give lunch time reception in the Sydney area. At 0600 the main transmissions are on 9640, 11955 and 15070 up to 0915. From 0900 a service is available on 11750, 15310 and 21550 kHz. Morning reception in Eastern Australia of the BBC World Service from 2000UTC is available on 9410, 9570 and 15070 kHz. New Zealand listeners have additional transmissions from 0300 onwards on 9410, and later on 5975, while early morning broadcasts commence at 1600 with 15070 and 15310 kHz providing the first hour's broadcast. After 1800 5975, 9410 and 9655 are scheduled to New Zealand and the South Pacific.

interesting broadcast material and they are used by many international stations to broaden the knowledge of the listener in the background of the stations broadcasting, its personalities and its programmes, and of course information about the country is always a point of interest. One of the most popular mailbag sessions is 'Letterbox' broadcast in the BBC World Service on Sunday at 0515 and repeated at 2015 in which Margaret Howard answers the questions posed by listeners throughout the world. The programme draws upon the vast resources of the BBC when questions are asked about engineering or programme background, and generally the producer of the programme is interviewed so that an authoritative answer is available. Margaret Howard has recently devoted more time to BBC domestic radio, but still is the host of this popular weekly programme in the World Service. As well as the two Sunday broadcasts 'Letterbox' can be heard on Friday at 1415 and Saturday 2315UTC.

Letters from listeners make

Arthur Cushen



## Radio Japan expands service

The Japanese broadcaster, Radio Japan, recently began using its first overseas relay base when it leased eight hours a day broadcasting time from the African Number One transmitter at Moyabi in Gabon. These transmitters will carry Radio Japan's programme to Africa and the Middle East and are linked by satellite from Tokyo to Paris, and then carried over a further satellite to the transmitters at Moyabi. Radio Japan is issuing two special verification cards to commemorate the use of this relay station, one card shows the North Pole centred on the verification and traces a programme service by satellite to Paris and Gabon. The second verification shows a map of Africa and details about the relay station, Africa Number One.

Radio Japan's engineers are now looking at building two new relay bases — one in Thailand

and the other in Panama. The relay station in Thailand will be located near Bangkok, and will be used to beam programmes for reception in Asia. The site of the Panama relay station has yet to be determined and this shortwave broadcaster will be used also by the Panama authorities for a shortwave service when not carrying Radio Japan's transmissions to North, Central and South America.

Radio Japan's transmitter site at Yamata is to be upgraded as these facilities have been in use since 1952 when Radio Japan recommenced its shortwave service after its close down at the end of World War II.

Radio Japan's surveys indicate that with the use of higher powered equipment in Japan and the three overseas relay bases they will be able to serve a world wide audience, but their engineers feel that parts of the

USSR, Alaska and Canada may have marginal reception.

Radio Japan is operated by NHK (the Japanese Broadcasting Corporation), and in the 1930s used the slogan, Radio Tokyo, when verifying reception reports. Since the 1952 reopening of the station, broadcasts have been rapidly expanded to offer both regional services, and the General Overseas Service, which carries news in English and Japanese on the hour, every hour.

Radio Japan broadcasts in 21 languages and their session 'let's Learn Japanese' is available, not only in English, but in 20 of their language broadcasts.

The regional service to Australia and New Zealand is broadcast 0845-0945UTC on 11875 and 15235 kHz. The transmission highlights include 'Hullo Australasia' on Sunday and 'Radio Japan DX Corner' on Monday.

Arthur Cushen

## Distress radio

Telmar Communications has released a distress alarm with a difference.

The product is designed to operate in an existing radio system as would an ordinary radio. To ensure excellent range, the UHF distress transmitter delivers over 300 mW. A unique code is usually imbedded in the carrier, to be detected by the company's normal base station, and thus raise an alarm.

Telmar has been successful in obtaining approval for this product as a portable radio and licencing is therefore quite straight forward. Naturally this transmitter then becomes a part of the usual radio system.

Information about this transmitter may be obtained, by writing to Telmar Communications, 604 City Road, South Melbourne Vic 3205. (03)690-8666.

## PROBLEMS WITH YOUR POWER SUPPLY?

A Line Tamer ensures constant voltage and interference suppression for your computer... gives a nominal 240V from fluctuating supplies as low as 190V... eliminates spike voltages caused by lightning etc.

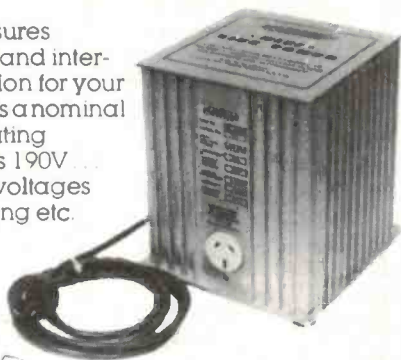

**YOU NEED A LINE TAMER®**

There's a Line Tamer to suit your installation. Send for data.

Ferguson Transformers Pty. Ltd.

331 High Street, CHATSWOOD 2067 Tel: (02) 407 0261

Telex: AA25728. Melbourne (03) 328 2843

Registered Trade Mark of Ferguson Transformers Pty Ltd

**FERGUSON**

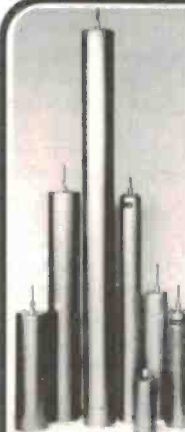

**FILTERS - DIPLEXERS - MULTICOUPLERS 40-960 MHz**

- \* high efficiency resonators
  - \* welded aluminium construction
  - \* invar temperature compensation
  - \* multicouplers custom-built
  - \* professional quality
- at reasonable prices
- \* fastest deliveries in the west

**KENSOR PTY. LTD.**

12 Hehir Street, Belmont 6104,

West Australia

Telephone : 4782333

Telex : AA95914



**ON DISPLAY**

**ROD IRVING ELECTRONICS PRESENTS**

# "RITRON"

**EX STOCK**

★ **LOW PRICE** ★ **HIGH QUALITY** ★ **12 MONTHS WARRANTY** ★

## DUAL TRACE OSCILLOSCOPES



**MODEL OS-645**  
15KV  
45 MHz  
&  
1mV/div

- ★ **WIDE FREQUENCY BANDWIDTH (70MHz-6dB)**
- ★ **OPTIMAL SENSITIVITY**  
All the steps of vertical deflection factors are multiplied 5 times for the highest sensitivity of 1mV/div; 10MHz.
- ★ **DELAYED TRIGGERING SWEEP**  
Any point of the waveform is addressed as a triggering start. So, any waveforms can be substantially and brightly magnified, thanks to the 5KV bright CRT.

- ★ **EXTREMELY BRIGHT DISPLAY**  
The metal-back CRT (PDA) provides brightest trace display.
- ★ **DELAY LINE (for BS-625)**  
Approximately 20 nsec before triggering point is displayed for real analysis of rise times.
- ★ **SCALE ILLUMINATION**
- ★ **SINGLE SWEEP**  
A triggered sweep of a single waveform can be displayed.
- ★ **TV-SYNC**  
TV composite signals can be easily synchronized.
- ★ **MAGNIFIERS**  
Both vertical and sweep time are simply magnified to 5 times (1mV/div, 40nsec/div).
- ★ **X-Y, or X-Y-Z OPERATION**  
Simply by turning the SWEEP TIME/DIV knob to CH-B, this functions as a very high sensitivity X-Y oscilloscope (1 mV/div) with intensity modulation.
- ★ **HF REJ**  
High frequency noises can be rejected for the stayble triggering by use of the low pass filter built in the triggering circuit.

**COMPLETE MODEL RANGE SPECIFICATION CHART:**

MODEL	SCREEN	SENS	SIG TRIG		B'WIDTH	T'BASE	WITHOUT TAX PROBES	WITH TAX EXEMPT PROBES	CAT No.	COMMENTS
645	150mm	1mV	Y	Y	45MHz	0 2uS 0 5Sdiv	\$995.00	\$895.00	\$1055	012110 (70MHz-6dB)
620	150mm	5mV	N	N	20MHz	0 5uS 0 5Sdiv	\$495.00	\$425.00	\$549.00	012105 (45MHz-6dB)
615S	95mm	5mV	N	N	15MHz	0 5uS 0 5Sdiv	\$695.00	\$615.00	\$759.00	012100 AC-DC Operation

**POINTS TO REMEMBER:**

- Ex Stock
- 12 Month Warranty
- High Quality Components
- Direct Import
- Flat Face Internal Graticule Screen
- On View at our 2 Stores
- Our Eighth Year Of Business

**BELOW MANUFACTURER'S COST!!**

**ONLY \$125 COMPLETE**  
MASSIVE SAVING OF \$74



Mail Order By **BANKCARD**  
Via Your Phone

**FULL 90 DAY WARRANTY**

At \$199 the Voyager Car Computer represented absolutely outstanding value for money. No one else had such a low priced **FULL FUNCTION** car computer. The Voyager is the only low-cost unit that will give you full consumption (the most important feature in a car computer) in both metric litres 100km **AND** good old **MILES PER GALLON!**

At \$199 many, many hundreds have been sold. **NOW** you can grab one **absolutely complete** for only \$125 — a saving of 37% or \$74!

The Voyager comes absolutely complete with all fitting hardware — even down to a roll of insulation tape! Installation generally takes between 4 and 6 hours depending on vehicle.



The Voyager is available from the following dealers at your convenience

Jaycar Sydney (City) 264 6680/267 1614  
Jaycar Concord 745 3077  
Jaycar Carlingford 872 4444  
Jaycar Hurstville 570 7000  
Zap Electronics Parramatta  
Hornsby

or by mail order to Jaycar Box 185 Concord 2137

Rod Irving Melb A'Beckett St (03) 347 9257  
Northcote (03) 489 8131  
Altronic Perth (09) 328 1599

**Spare Flow Sensors:** Jaycar will be supporting this product for many years to come. To avoid problems changing cars, why not buy a spare fuel flow sensor? They are about the only things that wear out

Cat XC2036 **ONLY \$29.50**

AS REVIEWED  
OCT '82  
EA (p.26-28)  
ETI NOV '82 (p.26)

CAT. XC2010

**NEW IMPROVED MODEL!**

**VOYAGER OPERATING FEATURES**

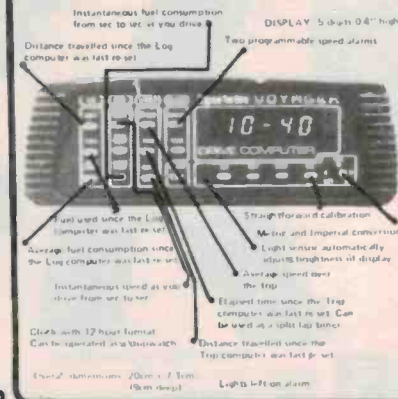

**ROD IRVING ELECTRONICS, 425 High St, Northcote, Vic; 48-50 A'Beckett St, Melb, Vic. Phone (03) 489 8866, (03) 489 8131. Mail Order Hotline (03) 481 1436.**

Mail Orders to P.O. Box 235, Northcote 3070, Vic. Minimum P&P \$3.00. Errors and omissions excepted.

Please address tax exempt, school, wholesale and dealer enquiries **RITRONICS WHOLESALE, 1st Floor, 425 High St, Northcote 3070, (03) 489 7099, (03) 481 1923, Telex AA38897.**



# ELLISTRONICS

PTY LTD

797 SPRINGVALE RD. MULGRAVE, MELBOURNE, VIC. 3170. PH:(03)561 5844 TELEX AA37758 LSTRON  
 SUITE 18. 47 FALCON ST. CROWS NEST, SYDNEY N.S.W. 2065 PH:(02)922 3220 TELEX AA37758 LSTRON



DATA  
**\$7**  
 BOOK

## CMOS BUY

## BIG SAVINGS

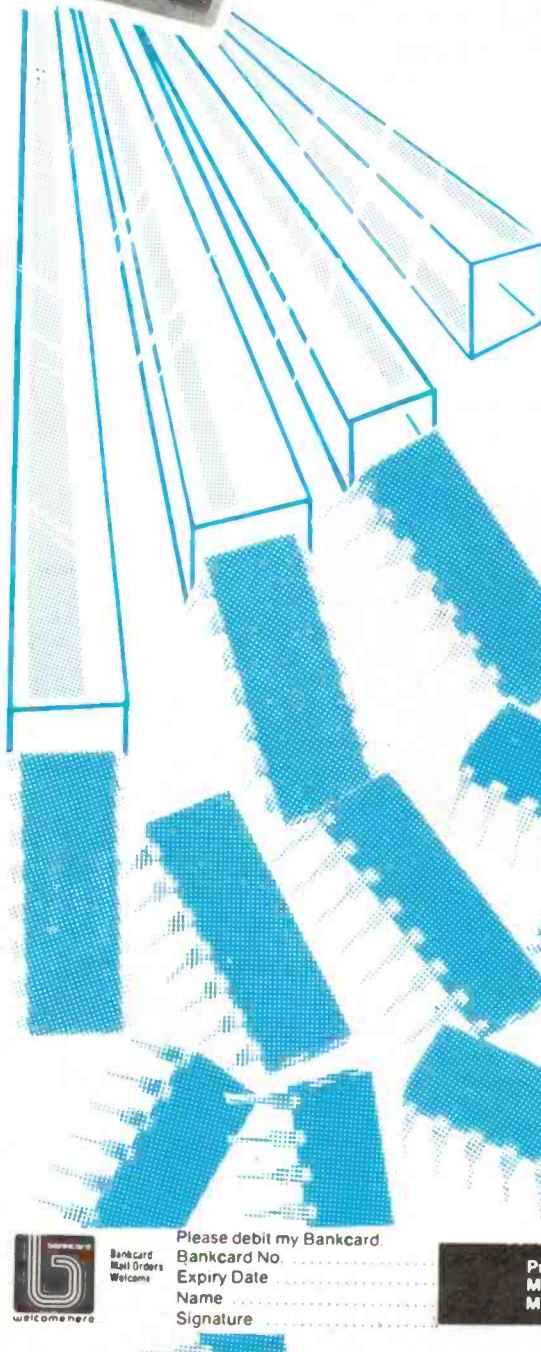

	100	500	1,000		100	500	1,000
<b>COUNTERS</b>				<b>DECODERS/ DEMULTIPLEXERS</b>			
4017BPC	.78	.58	.49	4028BPC	.59	.43	.38
4020BPC	.76	.56	.49	4511BPC	.86	.56	.54
4022BPC	.69	.53	.48	4555BPC	.64	.45	.39
4024BPC	.58	.39	.35	4556BPC	.48	.45	.42
4029BPC	.65	.54	.47	<b>DIGITAL MULTIPLEXERS</b>			
4040BPC	.76	.57	.49	4019BPC	.35	.33	.29
4510BPC	.80	.58	.53	4512BPC	.53	.47	.42
4516BPC	.80	.58	.54	4539BPC	.72	.65	.58
4518BPC	.90	.69	.59	<b>ANALOG SWITCHES &amp; MULTIPLEXERS/ DEMULTIPLEXERS</b>			
4520BPC	.70	.49	.46	4016BPC	.55	.43	.38
40161BPC	.89	.78	.69	4051BPC	.79	.59	.49
40163BPC	.76	.60	.55	4052BPC	.60	.57	.43
40193BPC	.90	.65	.58	4066BPC	.45	.32	.28
<b>REGISTERS</b>				4067BPC	1.50	1.28	1.20
4006BPC	.52	.48	.43	<b>LATCHES</b>			
4014BPC	.62	.49	.44	4042BPC	.55	.45	.39
4015BPC	.65	.55	.49	4044BPC	.60	.44	.39
4021BPC	.75	.56	.49	4723BPC	1.05	.99	.85
4035BPC	.55	.44	.42	4724BPC	.99	.89	.82
4731BPC	6.50	5.60	5.20				

**ELLISTRONICS  
 NOW IN SYDNEY.  
 922 3220**



Bankcard  
 Mail Orders  
 Welcome

Please debit my Bankcard  
 Bankcard No. ....  
 Expiry Date .....  
 Name .....  
 Signature .....

Prices subject to change without notice. Phone or write for quantity discounts.  
 MAIL ORDERS: To ELLISTRONICS, 797 SPRINGVALE RD MULGRAVE 3170  
 Minimum pack and post \$2.00. Phone (03) 561 5844



# ELUSTRONICS

PTY LTD

797 SPRINGVALE RD. MULGRAVE, MELBOURNE, VIC. 3170. PH:(03)561 5844 TELEX AA37758 LSTRON

SUITE 18. 47 FALCON ST. CROWS NEST, SYDNEY N.S.W. 2065 PH:(02)922 3220 TELEX AA37758 LSTRON

## MORE PAY LESS

## WITH TUBE LOTS

### COMPLEX GATES

	100	500	1,000
4007UBPC	.28	.24	.20
4030BPC	.35	.28	.25
4070BPC	.28	.23	.20
4086BPC	.32	.28	.26
4093BPC	.55	.38	.32
40014BPC	.60	.44	.39

### FLIP-FLOPS

4013BPC	.55	.42	.37
4027BPC	.58	.38	.34
4076BPC	.64	.50	.44
40174BPC	.65	.51	.46
40175BPC	.85	.68	.65

### MEMORIES

4703BPC	11.23	9.96	9.36
4725BPC	4.95	4.78	4.50

### FREQUENCY GENERATOR

4702BPC	9.20	8.20	7.70
---------	------	------	------

### MULTIVIBRATORS, PHASE-LOCKED LOOPS/TIMERS

4047BPC	.75	.54	.47
4528BPC	.79	.78	.68

### TRANSLATORS

4104BPC	2.20	1.70	1.50
---------	------	------	------

### ARITHMETIC OPERATORS

4008BPC	.65	.50	.47
40085BPC	.90	.85	.78

### NAND GATES

4011BPC	.28	.24	.19
4012BPC	.27	.23	.20
4023BPC	.31	.27	.23

### AND GATES

4081BPC	.34	.27	.23
---------	-----	-----	-----

### OR GATES

4071BPC	.34	.27	.23
---------	-----	-----	-----

### INVERTORS/BUFFERS

4049BPC	.55	.36	.31
4050BPC	.42	.32	.28
4069UBPC	.35	.27	.23
40097BPC	.62	.56	.50
40098BPC	.80	.72	.66

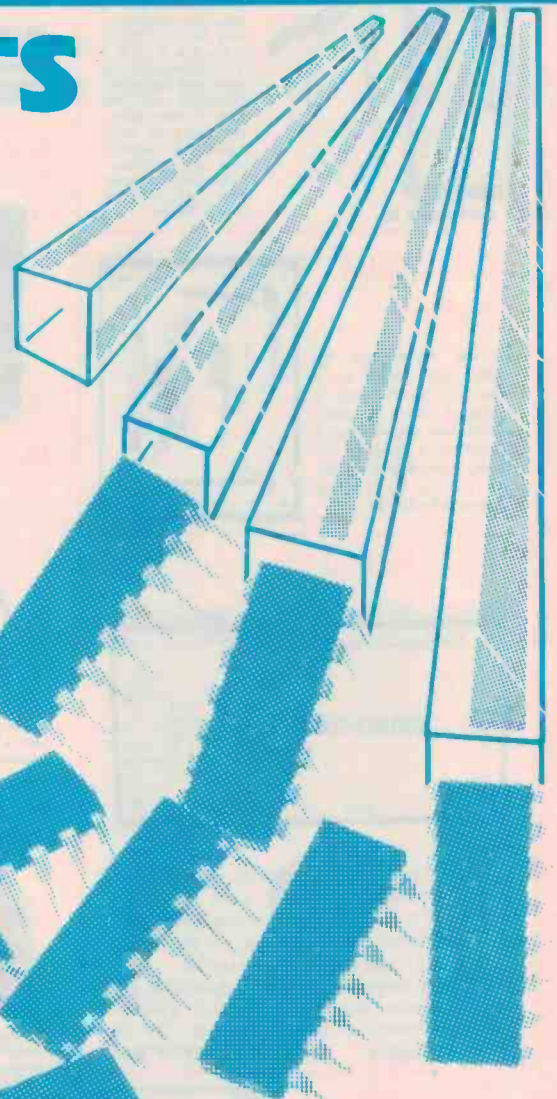

**PRICES PLUS 20% SALES TAX  
IF APPLICABLE.**

PRODUCTS MANUFACTURED BY

**FAIRCHILD**

A Schlumberger Company

ONE OF THE WORLDS LEADING  
SEMICONDUCTOR MANUFACTURERS



# ROD IRVING ELECTRONICS

425 HIGH ST, NORTHCOTE 3070 VIC

PHONE (03) 489 8866

100's SOLD

## VIDEO ENHANCER \$35

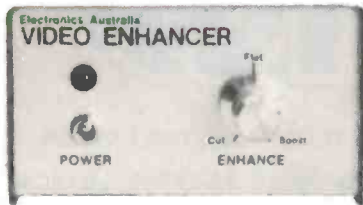

Like tone controls in a hi-fi amplifier, touch up the signal with this Video Enhancer. EA OCTOBER 83

## NAIL FINDER \$10



Essential for the home handyman the Nail Finder will help locate timber studs behind Gyprock or plasterboard wall surfaces as well as locating pipes and wiring buried in walls. EA OCTOBER 83

## SPEED SENTRY \$21

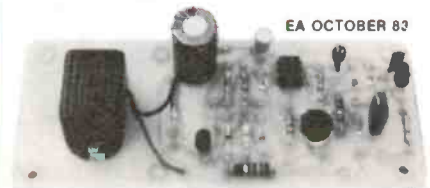

Paying speeding fines can be a painful business. Build this Speed Sentry and avoid further pains in the wallet.

1000's SOLD

## TRANSISTOR TESTER \$15

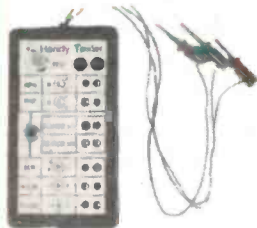

Have you ever desoldered a suspect transistor, only to find that it checks OK? Troubleshooting exercises are often hindered by this type of false alarm, but many of them could be avoided with an "in-circuit" component tester such as the EA Handy Tester. EA SEPTEMBER 83

## MOTORCYCLE INTERCOM \$40



EA Feb 84  
Motorcycling is fun but conversation between rider and passenger is usually just not possible. Build this intercom and you can converse with your passenger at any time while you are on the move. **OVER 300 SOLD**

## 50V 5A LABORATORY POWER SUPPLY



New switchmode supply can deliver anywhere from three to 50V DC and currents of 5A at 35V or lower. Highly efficient design. EA May, June 1983 **82 PSS \$140.00**

## SLIDE CROSS FADER



## CAR IGNITION KILLER



Our kit includes the metal box **\$16.95** EA Feb 84

## CAR ALARM \$29.00



This Car Alarm uses the battery earth strap as a sensor to detect when a "courtesy" light or other electrical load occurs when a thief enters a vehicle. The circuitry is simple and immune from false triggering problems. ETI July 81

## PHONE MINDER \$25

EA Feb 84



Dubbed the Phone Minder, this handy gadget functions as both a bell extender and paging unit, or can perform either function separately.

Most car burglar alarms are easily circumvented, but not our cunning "Ignition Killer". This sneaky antitheft device uses a 555 timer to place an intermittent short circuit across the points. Until disabled by its hidden switch the circuit effectively makes the car undriveable — a sure deterrent to thieves!

## VIDEO AMPLIFIER \$15



EA AUG 83

Bothered by smeary colours, signal beats and RF interference on your computer display? Throw away that cheap and nasty RF modulator and use a direct video connection instead. It's much better.

The Video Amplifier features adjustable gain and provides both normal and inverted outputs. Power is derived from a 12V DC plugpack supply. **INCLUDES JIFFY BAG**

## ±12V RAILS FOR LAB POWER SUPPLY

EA July 1983

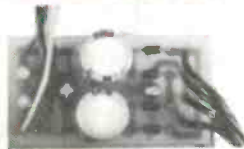

**\$13**

An inexpensive addition to the 50V 5A Lab Power Supply which should prove its worth many times over. It provides additional fixed ±12V outputs for lower power applications.

## Electric fence \$19.50



Check our prices

SEPTEMBER EA 1982

Mains or battery powered, this electric fence controller is both inexpensive and versatile. Based on an automotive ignition coil, it should prove an adequate deterrent to all manner of livestock. Additionally, its operation conforms to the relevant clauses of Australian Standard 3129.

## LOW OHMS METER \$34.50



How many times have you cursed your Multimeter when you had to measure a low-value resistance. Well alas, with the "Low Ohms Meter" you can solve those old problems and in fact measure resistance from 100 Ohms down to 0.005 Ohms. ETI 158 November 81

## Driveway Sentry

**\$32**



Activated by your car's headlights, the "Driveway Sentry" will turn on a driveway or garage light so that you can make a safe exit from your car on the darkest of nights. At the end of five minutes, it will automatically turn the light off again.

## EA GUITAR BOOSTER

**\$17.50**



JUNE EA 1982

48-50 A'BECKETT ST, MELBOURNE 3000 VIC

PHONE (03) 347 9251

Mail Order Delivery Instructions: Minimum Pack and Post \$3.00 for Australia Post. Please allow extra for bigger orders and Certified, Airmail or Registered Post. Minimum order is \$5.00. Please address orders to Mail Order Department, PO Box 235, NORTHCOTE, 3070, VICTORIA. PHONE (03) 481 1436.



# A 25 watt booster amp for UHF mobile rigs

Ian Thomas

THE READY availability and good general performance of compact mobile amateur UHF FM transceivers has led to something of a 'boom' in activity on the 430 MHz band. Repeaters have begun to spring up in increasing numbers and general development of the band is paralleling that of the two metre (144-148 MHz) band in the early 70s. And that's all to the good.

There's just a *little* fly in the otherwise sweet-smelling ointment, though. Most rigs available off the shelf (and that's where most operators start these days) have relatively low power output. That's fine as the designers have to keep down the cost, size and heat output. While gain antennas are available for mobile operation, there's a limit to the size of antenna you can hang off your vehicle. For effective mobile operation, repeaters notwithstanding, you need a modicum of power output, if not as much as you can get! The solution is an add-on 'booster' amp.

With FM operation, a signal increase of 3-6 dB can mean the difference between 'scratchy' reception and virtually noise-free copy. Hence, it makes sense to boost your output by a minimum of, say, 4-5 dB. UHF RF power transistors which take a 10 W input generally have gains in the 4-6 dB region, which suits our purpose nicely. Problem is, the higher the gain, the more money you pay per watt of output power.

Some time ago, your beloved Editor (Roger Harrison, or VK2ZTB to the cogniscenti) indicated he was interested in doing a UHF booster amp project while we were engaged in a discussion about RF design. Cost was a major consideration, so a suitable RF power device had to be found as its cost would be a major part of the overall cost. As it happened, Geoff Wood (of Geoff Wood Electronics fame — see *Over the Counter*, February '84 ETI), had on-hand a large quantity of 25 Watt Motorola UHF transistors and was looking for a project to wrap around them. Great minds think alike, as they say! The devices themselves weren't your state-of-the-art mickey-mouse transistor, but then, the price tag wasn't in that league either (like \$10!). Just what the Editor ordered!

The idea of having a bash at RF power amp design appealed to me, so when I had time I gave the matter some thought. This project is the result.

Samples were duly obtained. They were branded SRF1078 which, with a little research, turned out to be another name for 2N6136s. The appropriate Motorola data book gave a wealth of information on their

When you're running a UHF mobile rig, you need all the power you can get — repeaters notwithstanding. Most rigs run about 10 W out. This project will boost that to around 25 W, giving your signal quite a 'lift'. It's easy to build and get going and won't break the bank.

parameters, so we were away!

After some fiddling with data books, Smith Charts and a heavy duty soldering iron, I came up with a working prototype that virtually performed spot-on first go.

It's a fairly conventional design as far as UHF amps are concerned. 'Stripline' matching sections are used on the input and output to match the transistor to the 50 ohm input and output standard. The base is de-grounded via a quarterwave stripline section and dc is shunt-fed to the collector via another quarterwave stripline. Trimmers are used on the input and output so that you can adjust the amp for best input and output match. I attached BNC sockets to the input and output, enabling the project to be adapted to a variety of applications.

The project can be used, for example, as a simple 'insertion amplifier' in a power amp chain — its simplest configuration. As a booster amp for an FM mobile, antenna changeover switching needs to be added. Some schemes are suggested later, showing simple amp in/out switching or Tx/Rx switching in conjunction with a low noise preamp. You can please yourself on this score.

## Design considerations

Since the transistors are moderate performance, low-price devices the rest of the design could not use any expensive or exotic components or materials. The SR1078/2N6136 has a guaranteed gain of 4 dB, which means that a transmitter with a

10 Watt output will very nicely drive the transistor to 25 watts output. Since the gain was so low great care had to be taken with the design to minimise losses or the thing would act more as a heater than an amplifier!

At 430 MHz any design must, of necessity, use some form of transmission line approach as one wavelength at 430 MHz is only 69.8 cm in free space. If connections in a circuit are longer than one or two *hundredths* of a wavelength then the effect of their length can no longer be ignored and must be allowed for in the design. Thus, capacitor leads, transistor leads and connections to coax sockets must either be non-existent or taken into account in the design. For this reason, UHF transistors are housed in special packages and components like capacitors are produced having no leads at all!

The transistor comes in a stripline opposed emitter (SOE) package that is specifically intended to be used with microstrip. Since the design was to be cheap, the microstrip had to be fabricated from epoxy-glass laminate rather than the more expensive teflon-glass board (which is nigh on unobtainable because the local agents are only interested in big orders and apparently couldn't care less about providing a service).

Epoxy-glass was really never intended to be used in microstrip circuits and, as a result, its parameters are not controlled. This means both the board thickness and dielectric constant will vary considerably ▶

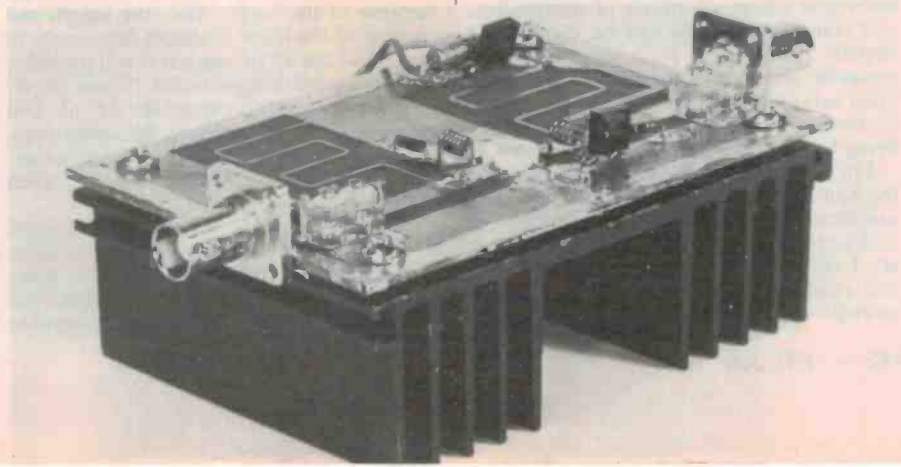



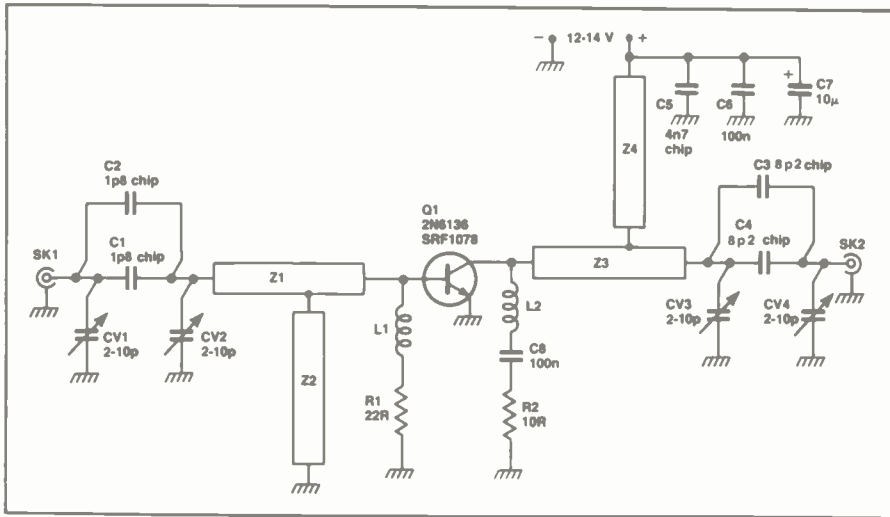

from sample to sample (and probably across one sample too for that matter) so the design must allow for all possible spreads. With teflon-glass board, both the thickness and dielectric constant are controlled making design much easier.

Also with epoxy-glass board, material dielectric losses are starting to become apparent at 400 Hz-odd. So, the design couldn't contain too-long runs of transmission line that carry the full input and output power in order to minimise line losses. Accordingly, I kept the striplines to around

Designing power amplifiers at RF is mostly an exercise in designing matching networks to transform the 50 ohm input and output impedances into the very low input and output impedances of the transistor itself. In order to get all the input power into the transistor the input matching network must transform the amplifier input impedance (assumed to be 50 ohms) into the complex conjugate of the transistor input impedance given by the manufacturer to obtain maximum power transfer. Exactly the same considerations apply to the output network and in fact the two networks are very similar.

Motorola give the transistor impedances as large signal series equivalent impedances but they can sometimes be given in parallel resistances and capacitances. It doesn't matter how they're specified as they can be converted readily from one form to the other by simple algebra and are entirely equivalent.

Since the design of the matching networks must use, or at least allow for, finite transmission line lengths I chose to do the designs using Smith Chart techniques. The Smith Chart is a device invented by (would you believe) one Mr Smith. It is a graphical technique where all effects of components and transmission lines can be clearly and visually computed. It is an incredibly powerful and effective method and has the great advantage that the whole design can be seen at a glance on a graph rather than being lost in a jumble of mathematics.

I'm not going to go into the derivation of the Smith Chart here as there are plenty of excellent books available on the subject and, to be quite honest, I can't remember it all. I strongly recommend you get a book and read up on it a bit if you want to attempt any designs of your own — it's

worth it.

Before any design is attempted it's a good idea to get some idea of what is and isn't possible in terms of realisable components. At 430 MHz we're in an area where parasitic effects can dramatically alter the apparent value of a component. A good example of this is the effect of a piece of wire. If we consider a short length of wire above a ground plane as a lumped inductor then its inductance can be calculated from the formula.

$$L = \frac{\mu}{2\pi} \ln\left(\frac{4h}{d}\right) \text{ Henrys/metre}$$

This assumes that  $h > 1.5d$ . As the permeability of free space is  $\mu_0 = 4\pi \times 10^{-7}$  we can tidy things up a bit and say

$$L = 0.0051 \ln\left(\frac{4h}{d}\right) \text{ microhenrys/inch}$$

where 'h' is the spacing of the wire above the ground plane and 'd' is the wire diameter.

That is, a piece of connecting wire  $\frac{1}{4}$ " long and  $\frac{1}{4}$ " above a groundplane has an inductance of about 5 nH or at 430 MHz, an impedance of 3.5 ohms! This means that at these frequencies a short circuit is an exceedingly difficult thing to build, about which I will say more later.

The effects of wire inductance don't end with crook short circuits though. If we have a 10 pF capacitor with about  $\frac{1}{4}$ " lead length (not hard to have) then the capacitor will have an impedance of about  $-j34$  ohms. But, the leads in series with it will have an impedance of  $+j14.8$  leaving a total impedance of  $-j19.2$  ohms for the capacitor plus its leads. This means the capacitor will not look like 10 pF but more like 17.7 pF because of the leads. Also, the length and spacing of the leads is almost impossible to control so our 10 pF capacitor will probably look like something between 15 and 30 pF.

For larger value capacitors (47 pF and greater) the capacitor may be series resonant with its leads and look like a short circuit (one way of building one) or even inductive.

Even this isn't the end of the bad news though. Because the capacitor and its leads are forming a partial resonant circuit there are circulating current flowing between the inductance and capacitance which increase

the losses in the combination so our 10 pF looks larger and much lossier. As losses don't help gain at all (apart from cooking the capacitor) using capacitors with leads seems to be not on.

This is the reason that the amplifier cannot possibly be built using conventional mounting methods and all UHF circuits are built with components mounted on the wiring side of the board. However, all is not lost and easy solutions are available.

If leads have intolerable effects the answer is to use capacitors that don't have leads. They're called *chip capacitors*, tiny ceramic blocks with solder on each end. A conventional dipped silver mica capacitor would be expected to have a parasitic inductance of about 5 to 10 nH, but chip capacitors have parasitic inductances of about 0.5 nH. Even better, they're readily available in Australia from IRH, who market the Murata range, and from Vitramon, who market their own. Both brands are pretty much the same and are very reasonably priced. Their only disadvantage is that they are so incredibly, fiddlingly *small* —  $1\frac{1}{4} \times 1\frac{3}{4}$  mm! You really do have to have care and patience when soldering them in the circuit.

The next problem I had to sort out before commencing the actual design was what trimmer capacitors to use. That there had to be trimmers was a certainty. With the variability of the board material, some adjustment was bound to be necessary. All that I've said about lead inductances for fixed capacitors applies to trimmers as well, but with trimmers, at least the desired capacitance can be set if it's within the range of the capacitor. However, the killer here is the degradation of Q because of circulating currents.

When an amplifier is running at 25 watts out the trimmer doesn't have to get in the way of much of it to be melted to an amorphous blob. There are some truly impressive trimmers available (well not really available in Australia — see my earlier remarks on local agents). Gold-plated, machined from solid brass and works of art, but their price is pretty impressive too! To use them would mean the trimmers in the matching network would cost five times as much as everything else in the amplifier!

Philips however, make a range of very small trimmers that seemed to be OK if they were mounted with their leads bent out sideways and soldered directly onto the board rather than being soldered through the board as they were designed to. They are readily available and quite cheap so they had to be tried. In the final amplifier they probably are a major source of losses but they really are the only cheap alternative.

The last component problem to be cleared up is the form the inductors in the matching networks should take. I've been labouring the point that no matter what is done, if there is a piece of wire in the circuit then it will have a large inductance associated with it. The trick is to make this inductance controllable and predictable. 'U-shaped' pieces of wire could be used as inductors and quite a few amplifiers have been built using them. I liked the idea of using the lengths of transmission line needed to connect into and out of the tran-



sistor better so the inductors in the final amplifier are in fact simply tracks on the board with carefully calculated width and length.

### Designing the matching networks

The first point to be considered is the actual mechanical layout for the amplifier. The heatsink for the amplifier is about 110 x 75 mm so I decided to make the microstrip printed board the same size. Since the mounting area for the transistor on the heatsink is in the centre, this automatically placed the transistor in the centre of the board. In fact, for reasons that will be discussed later it was offset to one side slightly from the exact centre but it's still on the centre line of the long axis.

As the input and output connectors were intended to be placed at the two ends of the board, this meant that the tracks connecting the connectors to the transistor base and collector would have to be about 50 mm long. Since these tracks have to carry the full input and output power they should be as wide as possible to minimise ohmic copper losses. The base and collector leads from the transistor are 5.6 mm (0.22") wide so I decided to make the microstrip leads connecting to them the same width, thereby preserving a constant characteristic impedance along the line (ignoring the change in track metal thickness where the transistor leads are soldered). Taking the actual matching network configuration for granted for the moment, I had to allow about 10 to 12 mm at either end of the board. The space left gave two lengths of microstrip 40 mm long by 5.6 mm wide. These lengths form a major part of the matching networks.

The actual design of the networks starts

with the input and output impedances of the transistor itself. We start with the input matching network and, taking a Smith Chart (you can buy a pad of them from Aarque or some technical supply houses but if you do, try to get the ones with both admittance and impedance of the one chart — it makes things a hell of a lot easier).

The large signal input impedance is given as  $1.3 - j4.11$  ohms at 470 MHz (for the sake of the exercise) so the first thing to do is mark this in on the Smith Chart. As the Smith Chart is in admittances the series impedances can be converted to admittances using the formulas given in the accompanying box. If you're lucky enough to have a chart with both admittances and impedances it can be plotted directly. The input admittance works out to be about  $63 - j220$  mmho.

The next thing to be worked out is the characteristic impedance of the 0.22" wide microstrip. To do this we use the somewhat daunting formula

$$Z_0 = \sqrt{\frac{377h}{\epsilon_r \times W [1 + 1.735\epsilon_r^{-0.724} (\frac{W}{h})^{-0.836}]}}$$

where

W = the width of the microstrip line

h = the dielectric thickness

$\epsilon_r$  = the dielectric constant of the board material

Also, a correction factor must be applied for W when the conductor has a finite thickness and is:

$$W_{\text{eff}} = W + \frac{t}{\pi} (\ln \frac{2h}{t} + 1)$$

where t is the thickness of the conductor. For normal one ounce copper it is 1.4 thou and the fibreglass is about 0.060" thick.

Cranking through all this we get  $W_{\text{eff}} = 0.222$  so for very wide conductors the correction factor is negligible but for narrow lines it is not, as we will see when working out the bias stub lengths. Finally, we plug in the value for  $W_{\text{eff}}$  in the first formula and using a value of 4.5 for  $\epsilon_r$ , we get the  $Z_0$  of the line to be 31.6 ohms. As I mentioned earlier, this value will vary a bit from board to board so there's not a great deal of point in working it out to 17 significant figures.

Once we know the  $Z_0$  of the line we can, using the Smith Chart, work out the effect of the transmission line. As the Smith chart is normalised for 20 millimho (50 ohms) it is necessary to denormalise it to the 31.6 ohms of the transmission line. The centre of the Smith Chart corresponds to exactly 50 ohms so if we redefine this point to be 31.6 ohms then all other impedances must also be multiplied by 50/31.6 before they are plotted on the redefined chart. Thus the  $1.3 + j4.11$  (input Z) on a 50 ohm chart becomes  $2.06 + j6.5$  on a chart normalised to 31.6 ohms. This is marked in as point "B" on Chart A. Next we need to know the electrical length of the 40 mm of transmission line. This is worked out by first calculating the wavelength in free space from

$$\lambda_0 = \frac{c}{\text{freq}} = \frac{3 \times 10^8}{4.7 \times 10^8} = 0.638 \text{ metre}$$

where c is the velocity of light in free space

Next, the wavelength, assuming all the

#### PARALLEL-TO-SERIES AND SERIES-TO-PARALLEL IMPEDANCE CONVERSION

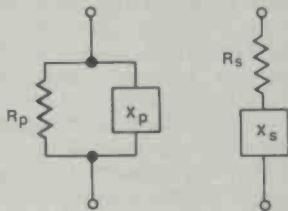

Series to parallel equivalent

$$R_p = R_s \left( 1 + \frac{X_s^2}{R_s^2} \right)$$

$$X_p = \frac{R_s \cdot R_p}{X_s}$$

Parallel to series equivalent

$$R_s = \frac{R_p}{1 + \frac{X_p^2}{R_p^2}}$$

$$X_s = \frac{R_s \cdot R_p}{X_p}$$

SYSTEMS



ENCODERS



PAGERS



TRANSMITTERS



Designers,  
Manufacturers  
& Distributors  
of Innovative  
Communications  
equipment.

**TELMAR**  
COMMUNICATIONS

604 City Road  
South Melbourne  
Victoria 3205

Telephone (03) 690 8666



power in the microstrip is carried in the dielectric in the TEM mode (which it isn't) from the formula

$$\lambda_{\text{TEM}} = \frac{\lambda_0}{\sqrt{\epsilon_r}} = \frac{0.638}{2.12} = 300.8 \text{ mm}$$

or near enough to 300 mm

Finally, a correction factor must be worked out to allow for the increase in propagation velocity because some of the energy is carried in air and is

$$K = \left[ \frac{\epsilon_r}{1 + 0.63(\epsilon_r - 1) \left[ \frac{W}{h} \right]^{1.225}} \right]^{1/2}$$

evaluating with  $\epsilon_r = 4.5$  we finally get  $K = 1.120$ , therefore the actual wavelength in the microstrip is

$$\lambda_{\text{real}} = \lambda_{\text{TEM}} \times K = 300 \times 1.120 = 336 \text{ mm}$$

Therefore, our 40 mm of line is equal to 40/336 or 0.1191 of a wavelength.

From point B on the Smith chart we must draw a constant VSWR circle in the direction towards the generator (the transistor base impedance represented by point B is the load) for 0.1191 of a wavelength to give point C on the chart. This point is still normalised to 31.6 ohms so to convert back to 50 ohms read off the impedance and multiply it by 31.6/50. Then replot the point on the chart, which is now back to a normal 50 ohms, to give point D.

I made the 31.6 ohm normalised impedance after rotation  $5 + j60$  ohms or  $1.3 - j16.7$  millimho. Therefore, after normalising back to 50 ohms the impedance is  $3.16 + j37.9$  ohms or, as admittance,  $2.05 - j26.4$  mmho. This is the actual admittance at the end of the input transmission line.

Next we consider the effects of the input trimmer capacitor CV2. As this capacitor is adjusted the impedance at its circuit node will follow a circle of constant conductance along the curve marked D-E'-E. When the amplifier is being tuned we can place E' anywhere we want on the circle within the constraint that the trimmer capacitor is a 2-10 pF device, so the minimum rotation is given by 2 pF and is 5.9 mmho (marked as E'). The maximum rotation is given by 10 pF and is 29.5 mmho (marked as E).

Next, we turn our attention to the input connector which is (hopefully!) exactly 50 ohms and is represented by the point in the exact centre of the chart. This is the impedance of the pin sticking out of the connector but there is a piece of copper ribbon connecting it to the board which has a series impedance that it would be prudent to allow for.

If we say the inductance of the connecting ribbon is somewhere between 0 and 10 nH, then there is a series Z of  $+j0$  to  $+j30$  ohms. This is plotted on the chart as curve F-F' which is a constant reactance circle and we know the impedance on the board is somewhere in this arc.

### Other aspects

As the transistor is operated in class C its base must be connected to ground for dc. All that is needed is a quarter wave line from the input microstrip to ground. As the input dc currents aren't all that large I chose to use microstrip line 1.3 mm wide. For bias stubs like this it isn't all that important what the characteristic impedance is as it's a short circuit at one end and an open circuit at the

other (if we get the length right).

First we work out the effective width of the line using the formula given earlier to get

$$W_{\text{eff}} = 0.050 + \frac{0.0014}{\pi} (1n \cdot \frac{12}{.0014} + 1) = 0.0524"$$

The correction factor for the increase in propagation velocity must also be worked out again and is

$$K = \left[ \frac{4.5}{1 + 0.63(4.5 - 1) \left[ \frac{0.0524}{0.06} \right]^{1.225}} \right]^{1/2} = 1.192$$

so finally, we get a wavelength for 1.3 mm wide track as  $300 \times 1.192$  or 358.5 mm. Therefore, the quarter wave bias stub is 89.6 mm long.

This is too long to be included as a straight run so it's folded into a meander line. The golden rule here is to make sure that the meanders are at least three dielectric thicknesses apart to avoid interaction and to mitre the corners to avoid reflections at the bends.

The same process is repeated for the collector dc feed stub, except that I chose a 1.8 mm track here because the earth end has to be ac earth but the positive rail for dc. The chip capacitors I had for bypassing were 0.1" long by 0.070" (2.5 x 1.8 mm) wide so the chip capacitor that ac-earthed the end of the stub was the same width as the stub and (more or less) preserved its characteristic impedance to ground.

Repeating the calculation for K, we get  $K = 1.176$  and hence one wavelength = 353.6 mm or a quarter wavelength of 88.4 mm.

This completes the electrical design and all that remains to be done is to lay out the board following the calculated dimensions. The tuning microstrips were continued almost to the ends of the board and gaps cut in them 1.3 mm (0.050") wide where the four tuning chip capacitors were to go.

As much of the board was left covered with 'earth plane', as it can't be emphasised too much how important a good solid earth is for the transistor. The SOE transistor package has two emitter leads on opposite sides of the device and both must be soldered massively to huge solid areas of ground plane. You can see on the layout that the ground is taken all along one side of the board to earth the emitter to the trimmer capacitors of the matching networks and on the other side a 20 mm wide strip of ground ties the transistor to the earth for the base and collector stubs.

Some final remarks on the design of the layout before going on to the construction: The transistor is operating in class C and as such generates quite a bit of power at higher harmonics. Since the output is asymmetric it is to be expected that a fair bit of this power would be at the second harmonic. However, not coincidentally, the dc feed stubs are a high impedance for the fundamental but at the second harmonic are half wavelength long and look like a short circuit again. This means that they act to suppress the generation of second harmonic power and this was one of the major reasons for their choice. The second thing that should be mentioned is that all the rather awesome formulae that have been invoked only deal with the effects that we want and I've tacitly ignored all sorts of bad things that can happen (and

do!).

All the practical notes on this type of amplifier mention that they're prone to oscillation at 20-80 MHz and this little beast proved no exception. To suppress these oscillations it's necessary to add on networks in both the collector and base circuits that're high impedance at 70 cm but are lossy as the lower frequencies. This is another good reason to keep the impedances low around the transistor ports — we can add on oscillation suppression components without worrying too much about changing the matching conditions.

I found it necessary to put damping on both the collector and base (although either is enough, both seemed a good idea) and, fortunately, only a few turns of air-spaced inductor give a nice high Z at the operating frequency. However, if you find that your amplifier draws a couple of amps for no drive power you have joined those who've been blessed with a 30 MHz oscillator instead of a 440 MHz amplifier! But more of this in the construction section.

Next, we consider how the input trimmer CV1 will modify the impedance arc F-F'. Once again, the trimmer is a 2-10 pF capacitor so the parallel admittance is 5.9 to 29.5 mmho. If the series inductance is zero, (unlikely) then varying CV1 will trace out a constant conductance arc H-G. If it is the maximum 10 nH, varying CV1 will trace out an arc H'-G'. This defines an area on the chart H-G-G'-H, which is the impedance on the board under the input connector that we want to transform to the impedance E'-E at the end of the input microstrip.

To do this, we add in the series capacitors C1 and C2. Two capacitors in parallel are used to try and distribute the current and lower losses, although it may not be necessary. The two capacitors are each 1.8pF so we have a total capacitance of 3.6 pF, or an impedance of 94 ohms.

Adding in series capacitors causes the impedance from E'-E to be rotated along arcs of constant reactance to I'-I. Thus, if CV1 is adjusted to the correct value then C1 and C2 will transform the impedance at the end of the 31.6 ohm microstrip to the impedance under the input connector and the transistor base impedance will be transformed to the desired 50 ohms.

The complete, correctly adjusted transformation process is: The microstrip rotates the transistor base impedance from point A to D, CV1 rotates the impedance from D to E", C1 and C2 rotates it to I", where correctly adjusting CV1 changes it to F". Finally, the parasitic input inductance transforms the impedance to F, the 50 ohm input impedance.

When designing matching networks like this there are really almost infinite possible combinations of network configurations that can be chosen. I chose this one for three main reasons. The first was that I didn't want to have components close to the transistor as, on the microstrip, impedances are low and currents are high. This means that voltages are low and as the dielectric loss of the epoxy glass board can be represented as a parallel resistance to ground from the microstrip, preserving low impedance minimises this loss. Also, adding in ▶



Values shown on both charts are 'normalised' to 1.0 at the chart centre. For plotting the input impedance, chart centre represents 50 ohms. For calculations involving the input and output striplines (Z1 and Z3 on the circuit), the chart centre has been 're-normalised' to 31.6 ohms. All values should be multiplied accordingly.

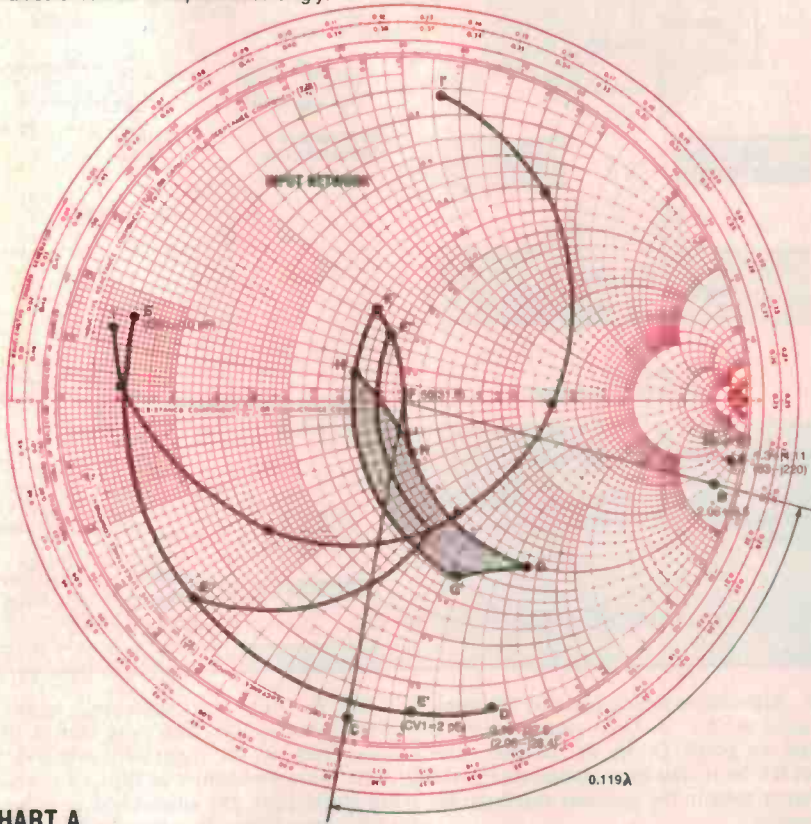

CHART A

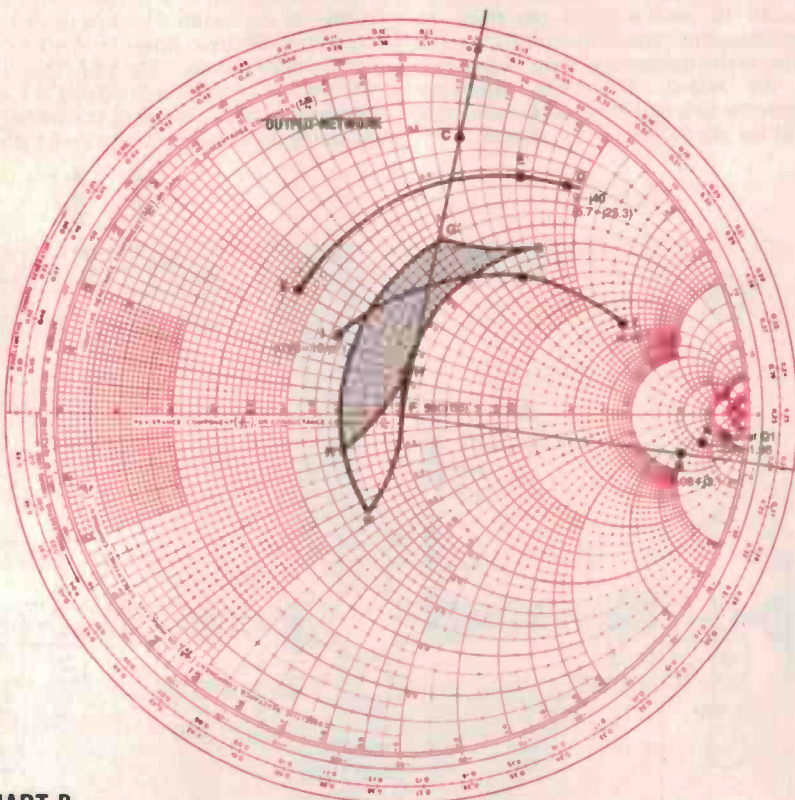

CHART B



BANG! CLUNK! SPLASH!

No matter what happens, the NIROS 707 will keep you talking on frequency.

Its rugged stainless steel construction won't rust, overheat, rot, crack or down.

Such uncompromising Danish quality ought to cost a fortune. NIROS costs less than at least one other top-selling professional transceiver.



## NIROS 707

Clip this out and send to: Freepost 32  
 NO STAMP REQUIRED Telmar Communications  
 604 City Road  
 South Melbourne 3205  
 Please provide more information on the NIROS 707.

NAME \_\_\_\_\_

ADDRESS \_\_\_\_\_

PHONE \_\_\_\_\_

**TELMAR**  
 COMMUNICATIONS

TC001



capacitors near the transistor base would make grounding problems that much harder.

The second reason for the chosen network was that I wanted all trimmer capacitors to have one end at earth potential so they could be adjusted without the adjustment tool changing things. A very common matching network is to have C1-C2 a trimmer and delete CV1. It would work just fine

### PARTS LIST — ETI-738

<b>Resistors</b> .....	all 1/2W, 5%
R1.....	22R
R2.....	10R
<b>Capacitors</b>	
C1, C2.....	1p8 ceramic monolithic chip capacitors, Murata type GR39 or Vitramon type VJ0805A1R8D.
C3, C4.....	8p2 ceramic monolithic chip capacitors, Murata type GR39 or Vitramon type VJ0805A8R2D.
C5.....	4n7 ceramic monolithic chip capacitor, Murata or Vitramon.
C6, C8.....	100n radial lead monolithic or disc ceramic capacitor.
C7.....	10μ/20 V tant., radial leads.
CV1,2,3,4.....	1p8-10p Phillips film trimmers, type 2222-809-05002.
<b>Semiconductors</b>	
Q1.....	Motorola SRF1078 (2N6136)
<b>Miscellaneous</b>	
L1, L2.....	4 1/2 turns self-supporting, 0.020" diameter enamelled copper wire wound 0.1" (2.5 mm) inside diameter.

ETI-738 pc board (double-sided); suitable heatsink (e.g. D.S.E. no. H-3460 or H-3422); BNC chassis mount sockets — two off; four 4BA bolts and eight nuts; coaxial changeover relay(s) as required; chassis to suit (if required), etc.

**Price estimate: \$28-\$35**  
(less chassis and relays)

but then both sides of the trimmer would be 'hot' and tuning it up would be a pain.

The third reason for preserving a low impedance in the microstrip is that it makes the design of bias networks for the transistor that much easier. As the transistor must have correct dc conditions applied to it as well as the correct matching conditions, we have to be able to make dc connections to the base and collector that don't disturb the RF conditions. If we are connecting to a low impedance point then a merely moderate parallel bias impedance at RF is OK. If the microstrip were a moderate impedance then we would have to expend some effort to make bias circuits that were very high impedance or allow for the bias impedance in the design. But more about bias later.

The design of the collector matching network follows exactly the same procedure as the input except that the source and load are reversed so all the arcs on the Smith Chart go in the opposite direction. The collector impedance is  $3.2 + j1.96$  ohms which, after denormalising to  $31.6$  ohms goes to  $5.06 + j3.1$  ohms. Rotating this impedance by 0.1191 (the length of the 40 mm output stripline) gives an impedance of  $9 - j40$

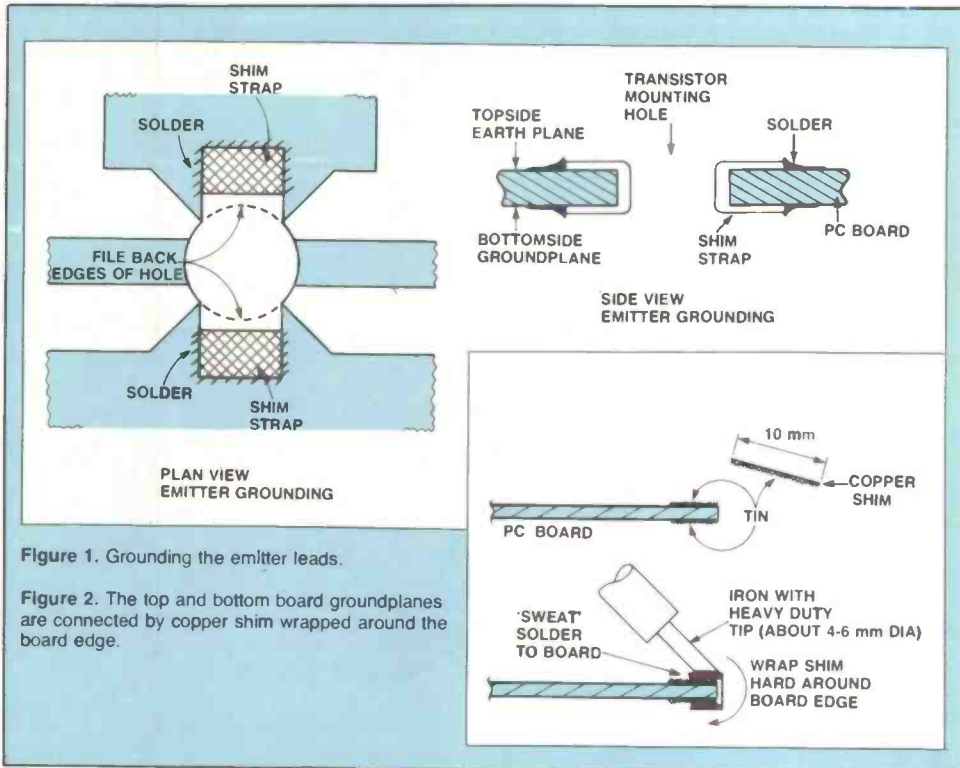

ohms. After normalising back to 50 ohms, this goes to  $5.7 - j25.3$  ohms which is marked as point D on the output chart (Chart B). Note that the rotation due to the microstrip goes in the opposite direction for the output.

Next, the 2-10 pF trimmer CV3 generates an impedance arc along circles of constant reactance to the arc I-I', which intersects the area mapped out from the output impedance transformed by CV4 and the stray series inductance of the connection onto the board. The only difference between the two matching networks is that C3 and C4 are 8.2 pF for the output.

Given that the matching networks seemed to be OK, the next matter to be sorted out was the input and output dc circuits. As wavelengths at these frequencies are quite short, the easiest way to generate a dc connection with a very high ac impedance is to use a quarter wave transmission line with one end connected to the circuit and the other end at ac ground. This corresponds on the Smith Chart to describing a complete half circle from the  $Z=0$  point to the  $Z=\infty$  point. The only things that limit the impedance are losses in the transmission line and tolerances preventing the line being an exact quarter wavelength.

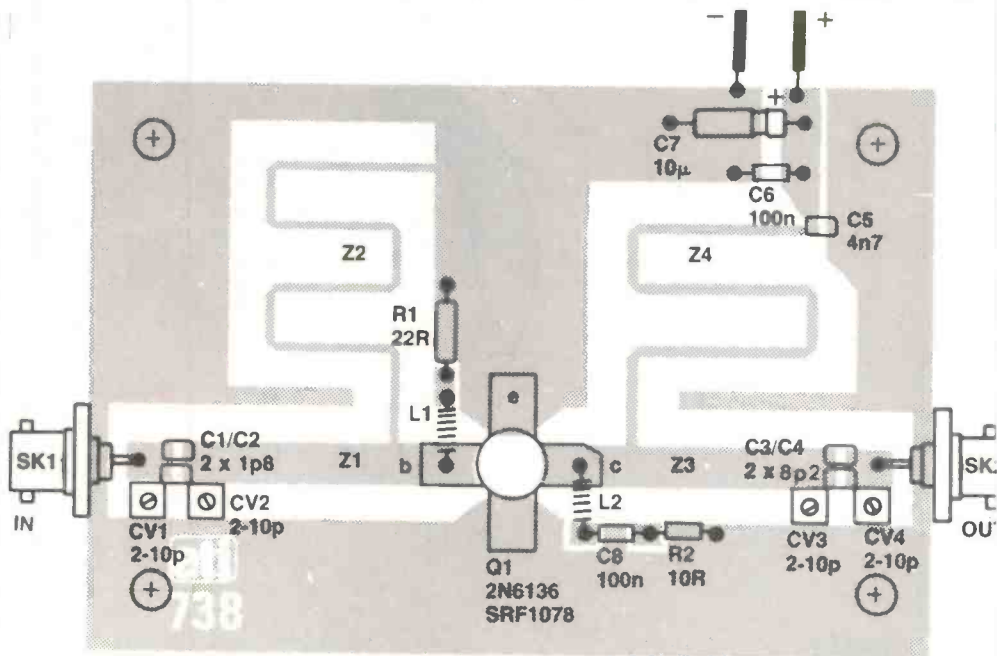



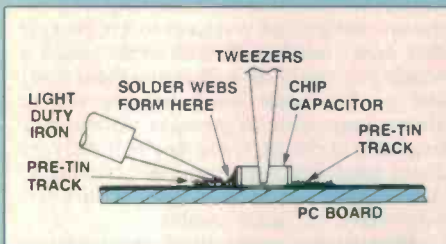

Figure 3. How to solder the chip capacitors in place.

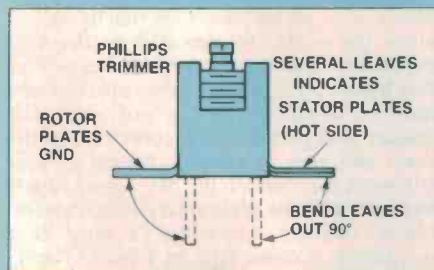
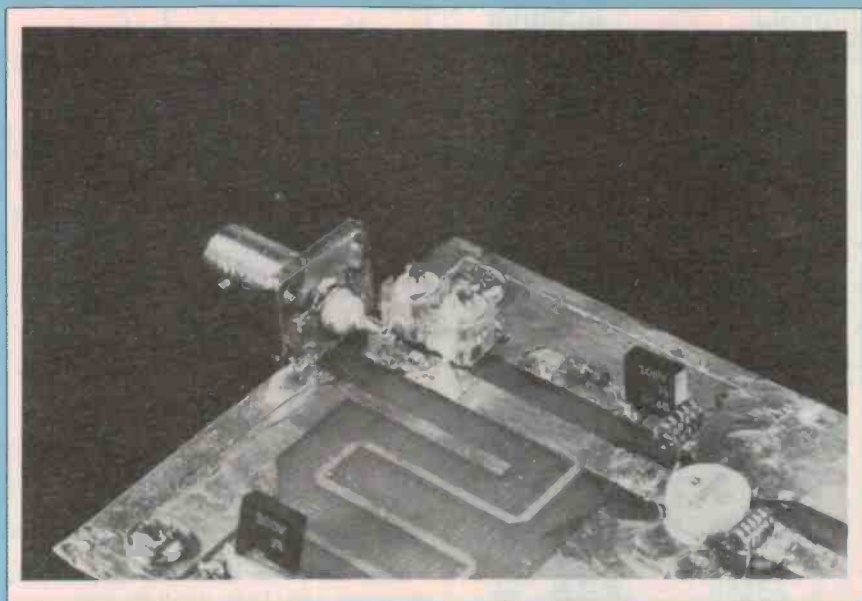

Figure 4. Bending the trimmer leads



Output line. View of the amp's output stripline section, showing the link to the BNC socket, the two trimmers and chip caps. Note the collector dc feed stripline.

## Construction

The first thing to make is the printed board. The dimensions of all the critical tracks are given as components so if you want, you can tape up your own artwork. Try to stick as close as possible to the dimensions given or use the artwork provided but make the board two or three mm longer than the heatsink you intend to use so you can mount the input and output connections. The other side to the board *must absolutely* be solid, uninterrupted copper. Apart from being a good ground it is an essential part of the microstrip transmission lines! Make sure the two rectangular pads for the hot ends of CV1 and CV4 are big enough for the trimmers to be mounted without fouling CV2 and CV3 but no bigger. Also make sure that the two gaps that're bridged by C1/C2, and C3/C4 are exactly 1.3 mm wide so the chip capacitors can be mounted correctly. The same applies to the collector bypass capacitor C5, but the spacing of the other two collector bypasses, C6 and C7, is less important. Alternatively you could buy a ready-made board.

Once the board is etched trim it off neatly to the corner marks and drill a small hole where the transistor goes. Then, carefully locate it where it is to be finally mounted on the heatsink and clamp it firmly with a couple of G clamps. Next, drill the four mounting holes using a 2.4 mm drill right through the board and the heatsink making absolutely sure that you miss the heatsink fins and go into the spaces between them. The holes should be about 5 mm from the sides of the board and about 12 mm from the ends, but this will depend on the heatsink you use. Remove the board from the heatsink and open out the mounting holes to 3.6 mm. Next, open out the hole in the pc board for the transistor to a neat 10 mm. If you have a drill to do this, so much the bet-

ter but probably you'll have to use a rat-tail file. However, if you do it make sure it is centred correctly. Next, carefully cut out the two sides of the transistor mounting hole where the emitter leads are soldered according to the sketch in Figure 1 so the emitter leads can be earthed to the back of the board solidly. Cut two bits of copper foil about 5 mm wide by 10 mm long so they neatly fit into the two flats you've just cut for the emitter grounds. Form them tightly around the edge of the hole and solder them into position using lots of solder to be sure they're completely connected, but not so much that there's excess solder all over the board. This part is quite important as it connects the emitters to both the upper and lower groundplanes.

Next, attach the input and output connectors to the board. I didn't want to get involved with fancy mounting brackets so I simply soldered the connectors directly to the edge of the board using lots of solder.

The usual electronics soldering iron really isn't hot enough to do this so I clamped the connector in a vice with the flange side where the board is to be attached on top. After pre-tinning the connector, I held the board against it in the spot where it was to be mounted and applied a fine gas flame to the flange of the connector. This should be done with excruciating care as you only have to touch the flame to the board or the connector dielectric to, at best, make a hell of a mess and, at worst, ruin things completely.

When things are hot enough, pour in heaps of solder to make two good solid webs on both the ground-plane and wiring sides of the board then hold the board *exactly* vertical until the solder sets. The connector output pin should be over the edge of the pad on the board so it doesn't foul the trimmer capacitors.

I used BNC connectors as any minor mismatch they may cause can be tuned out with the matching networks. But unfortunately, BNC connectors are normally used with RG58C/U coax which is becoming lossy at these frequencies. If you intend to use longish runs of coax into and out of the amplifier you may choose to use type N or some other connectors which suit less lossy cable. Whatever you use, I think the direct soldering method has a lot to recommend it, as you get about the best possible electrical connection to the grounds on both sides of the board.

In order to complete the earthing on the board, cut long strips of copper foil about 10 mm wide and neatly tin one side all over. Next, work your way all around the edges of the board, tinning and groundplane and wiring side grounds in to about 5 mm from the edge. Next, cut the strip of copper foil so it's the same length as the board and hold the soldered side so it overlaps the edge of the board about 4 mm. Apply a soldering iron to sweat the foil onto the board (See Figure 2). If you line things up right you should be able to simply slowly run the iron along the foil to solder it to the board. Next wrap the foil *hard* around the edge of the board and repeat the process on the other side. The foil then solidly connects the groundplane side to the earth on the wiring side and gives the best earth I could come up with.

Repeat this process all round the edges of the board leaving a gap for the power supply where it comes to the edge of the board and taking the foil right up to the sides of the connectors. When you've finished, the only edge of the board that should be visible is about 10 mm where the +12 volts comes out. Once everything seems to be stuck down nicely it's a good idea to run around all the joints with a bit more solder to make



ALSO AGENTS FOR THE POPULAR RANGE OF CITRONICS PRODUCTS



(SHOWROOM BY APPOINTMENT)  
**729 6337**

SPECIALISING IN  
 DISPLAY ADVERTISING, ENTERTAINMENT AND SPECIAL EFFECT LIGHTING \* HOME/SMOKE LIGHT - TVZ AND 200V \* POLYCARBONATE TUBE LIGHT \* STAIN LIGHT PANELS \* INFINITY PANELS \* QUORQ MACHINES \* PAPERPIES \* SCANNERS \* HELICOPTER LIGHTS \* REMOTE BALLS AND MOTORS \* GLOBE LAMPS \* SPECIAL NEON LIGHTS \* VARIOUS TYPES OF LONG LIFE ENERGY SAVING LAMPS AND GLOBES \* GLOBE FLASHING DISPLAY BOXES \* ELECTRONIC LIGHTING CONTROLLERS - CHASSIS, MICROLOUN, MANTOX, STAIRBUSH \* QUORQ \* NEON LIGHT \*

AGENTS FOR THE NEW "LINE LITE" PLUS MANY OTHER EXCITING LIGHTING PRODUCTS

P.O. Box 634, Dandenong, Vic., 3175

IMPORTERS  
 MANUFACTURERS  
 DISTRIBUTORS

- Write for FREE Catalogue -

# 6UP

The Australasian journal for those interested in the bands six metres and up!

The Winter '84 issue theme is **VHF/UHF Components and Construction**. Read all about *The Design and Construction of a 60 W 70 cm Amplifier*, or perhaps *The Ins and Outs of Microstrip*. Maybe *Capacitor Considerations at VHF/UHF* might take your fancy or the continuation of our 'classic' *Meteor Scatter Propagation* will hold your interest. If you're into *satellites*, read about the 'banner' year coming up.

6UP — the practical, forthright, no-holds-barred quarterly for the VHF/UHF enthusiast.

Did you miss the Autumn '84 issue? Then subscribe now. Just \$15 for a year's subscription to the magazine that 'tells it like it is'.

Send your cheque or money order to the publishers: Teknldata, PO Box 844, North Sydney NSW 2060. For a 'taste test', send \$3.50 plus 90c post and handling to receive the Autumn 1984 issue on 'Antennas and Propagation'.

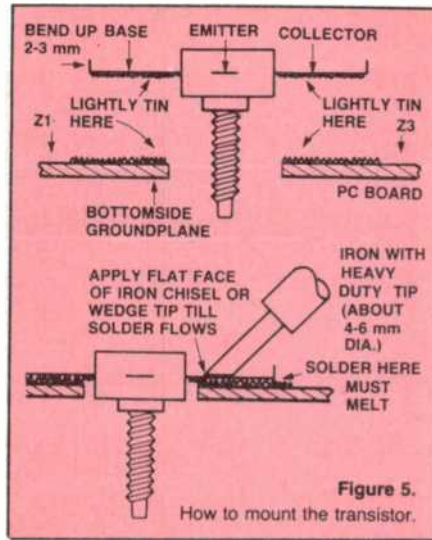

Figure 5. How to mount the transistor.

sure; there's no such thing as too good an earth!

Now comes the fiddly bit; mounting the chip capacitors. First, tin all the areas where any components are to be attached but don't leave great waves of solder — it isn't necessary and can do harm. Then, using a fine pair of tweezers, pick up the chip capacity to be mounted and hold it firmly in place over the gap in the track on the board. The two tinned ends of the capacitor should neatly overlap the tracks and it should be held hard down against the board.

Touch a soldering iron tip firmly against the track right next to the end of the capacitor to be soldered *but don't try to touch the end of the actual capacitor* (See Figure 3). The idea is to melt the solder tinning and carry the heat to the capacitor that way. As the track gets hot enough a neat little web of solder should form around the tinned end of the capacitor. Immediately remove the heat and allow things to cool. Solder the other end by just touching the iron next to the end but *don't* press down on the body of the capacitor or you may damage it.

With chip capacitors too much heat for too long *must* be avoided as you can cause the solder tinning to leach off the end com-

pletely. When you're working with these devices it's essential that you only take out the one device that you want to use because *they aren't labelled*. If you forget which is which you might as well throw them away and go buy some more because they're almost impossible to measure without putting them in circuit. Once they're in they are damn near impossible to take out again! After all these dire warnings I'm sure you won't have too much trouble.

After all the tuning fixed capacitors are attached, do the 4.7 nF collector bypass capacitor the same way and that's the fiddling finished.

Next attached the four trimmers by bending their leads hard out from the body (Figure 4) and mounting them as seen in the photo. Use plenty of solder but try not to allow the solder to run over to the chip capacitors. The lead that has three or four fine leaves is the stator of the capacitor and *must* be connected to the 'hot' side. The thicker gold plated lead is connected to the rotor and goes to ground. Attach all four trimmers then add on the two power supply bypasses and the preliminary board assembly is complete. Capacitor C6 must be a monolithic ceramic type as I inadvertently used a tantalum in the first model (once) and the RF currents blew it to pieces. Dramatic!

Next, the board has to be mounted on the heatsink. I tapped the four mounting holes with a 4 mm tap for the mounting screws. If you have one, this is a nice way to do it but self-tappers could be used as the screws carry no heat or power. Screw down the board component side up with spacers exactly 2.5 mm wide between the board and the heatsink. This space is absolutely critical as if the spacers are too high you will neatly pop off the top of the transistor when you bolt it in and if they're too thin you can't get smooth connections between the transistor and the microstrip. I actually rummaged around in my junk screw box and found four nuts the right thickness and drilled the threads out of the centre. You could use several washers instead, but however you do it, it must be right.

Screw down the board then drill the hole

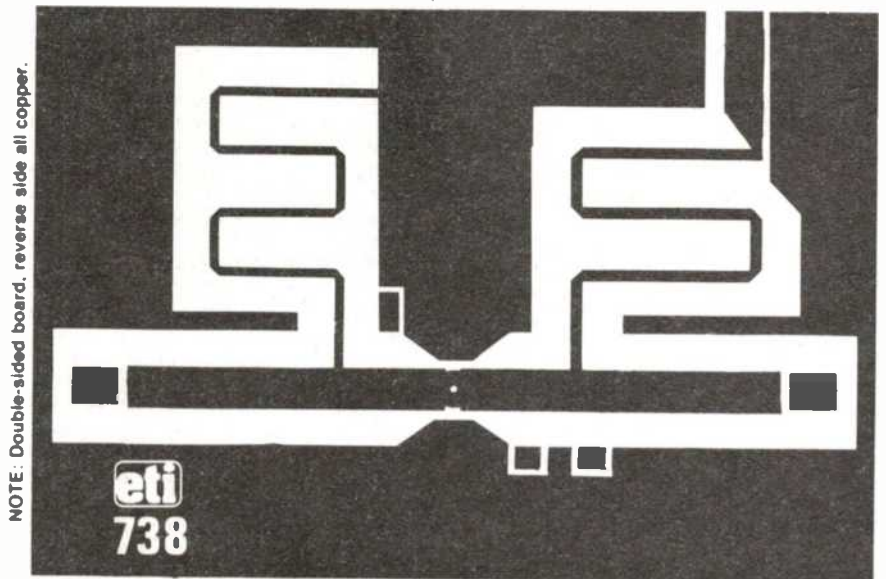

NOTE: Double-sided board, reverse side all copper.



for the transistor if you didn't do it when you drilled the mounting holes. The transistor mounting hole must be exactly in the centre of the hole in the board and have no burrs that interfere with heat conduction. Drop the transistor into its hole and make sure all the leads align nicely with the earth and microstrip. Bend up the end of each lead about 2 mm. If all is well remove it. Lightly tin the underside of each lead and smear the mounting base with heatsink compound. Pre-tin the striplines. Bolt the transistor in position with the base and collector leads exactly aligned (the collector is the lead with one corner clipped off at 45°). *Don't overtighten it* as the stud is only copper and painfully easy to strip.

With the transistor screwed down, the four leads should lie dead flat against the board; if the soldered copper foil for the emitter earths causes the emitter leads to stand proud remove the transistor and remove excess solder from the emitter earthing and try again. When all is perfect, carefully flow solder all around and under all four leads. (See Figure 5).

All that remains to be done now is to make and connect the two oscillation suppression networks and the amplifier is finished. To wind the inductors I used a #42 drill shank as a mandrel (a complete set of number drills is an invaluable asset when winding inductors at these frequencies). Anything hard and round with a diameter of about 2-2.5 mm will do fine. The collector inductor has about 3½ turns of 0.5 mm wire but almost any wire will do so long as it's strong enough to be self supporting.

Bend the ends of the coil so one end sits nicely right in the middle of the collector lead and the other sits on the pad cut in the groundplane and solder it in. Next, bend the leads of the 100 nF bypass capacitor out hard against the body and cut them off about 2 mm long. Solder the capacitor in and bend the leads of a 120 ohm resistor with a slight kink in them so when they are soldered onto the board the resistor body is about 1 mm from the board, and solder in the resistor.

The same process is repeated with the inductor and resistor for the base but the base has no capacitor as both ends are at the same dc potential. The base inductor is the same in all respects as the collector but the base resistor is 22 ohms. When all this is done you're ready to power the thing up and make it work!

### Tuning and adjusting

This process is always fraught with tension and drama as if you slip up it isn't too hard to wipe out the whole thing so be careful where you poke your screwdriver! Adjust all trimmers to about the mid-position, connect up your output load and signal source (turned off!) and finally the power supply set to about 12 volts. If at all possible, adjust the signal source to a lower power setting than the full 10 watts and arrange for the supply current to be monitored. Turn on the dc power then apply input power for just a few seconds then turn it off again. The amplifier should draw one or two amps when the input power is on but none when it is off. If it continues to draw dc power when the input is shut down then congratulations,

you've built an oscillator! If all is well, apply power again and adjust CV3 and CV4 for maximum power into the load.

At this stage it is assumed that some power is getting into the transistor but if no power comes out at all it may be necessary to adjust CV1 and CV2 until there is some output. I found that CV2 was by far the most sensitive and adjusting this should get results. Finally, adjust up CV1 and CV2 for maximum power then re-adjust CV3 and CV4. Go to maximum input power and repeat the whole process and you should then be getting a full 25 watts out of the booster.

Some helpful hints are as follows if the amp oscillates: L1 may be reduced to 2½ turns and this will stop almost anything but you will lose 0.2 or 0.3 dB of gain as the 22 ohms robs the base of input power. Likewise, L2 may also be reduced but here the problem tends to be that the 10 ohm resistor burns. You may have to use a larger resistor. I haven't included a ferrite bead in the power supply lines as it didn't seem to be necessary, but if you're having trouble, give it a shot. Lastly, if the 10 ohms in the collector tends to disappear in a cloud of smoke, but everything else seems to go OK, then you almost certainly have oscillation trouble. The only way enough power can get through L2 to do the deed is for there to be a lot of power at the lower frequencies.

### Test results and conclusions

After the original model was built and checked at dc it was tested at over the range 435 MHz to 475 MHz. All the original testing was at 470 MHz which is where the transistors are specified. After the routine amount of trouble with instabilities, everything worked fine and serious testing began. At the higher frequencies I was never able to get the full 4 dB gain given by the manufacturer and had to settle for a bit over 3.5 dB or about 22.5 watts for a fixed 10 watts in with no reflected power. However, at 438 MHz the gain was up to 4.1 dB to give nearly 26 watts out for ten in. The slightly off performance at 470 MHz was attributed to dielectric losses on the board and probably the trimmers were contributing too. It's rather hard to tell as when the amplifiers running everything gets a bit hot.

As far as amplifier bandwidth is concerned I was able to achieve 10 MHz virtually dead flat, and 36 MHz at the -1 dB output level.

Because of the quarterwave bias stubs, the second harmonic rejection was excellent at about -60 dB, but the third was not so good at -26 dB. Perhaps a filter may be needed if the antenna rejection is not enough.

Finally, the amplifier seemed to pretty well meet all requirements. The best one of all is the price; if you shop around a bit you should get all the bits for about \$1/watt! ●

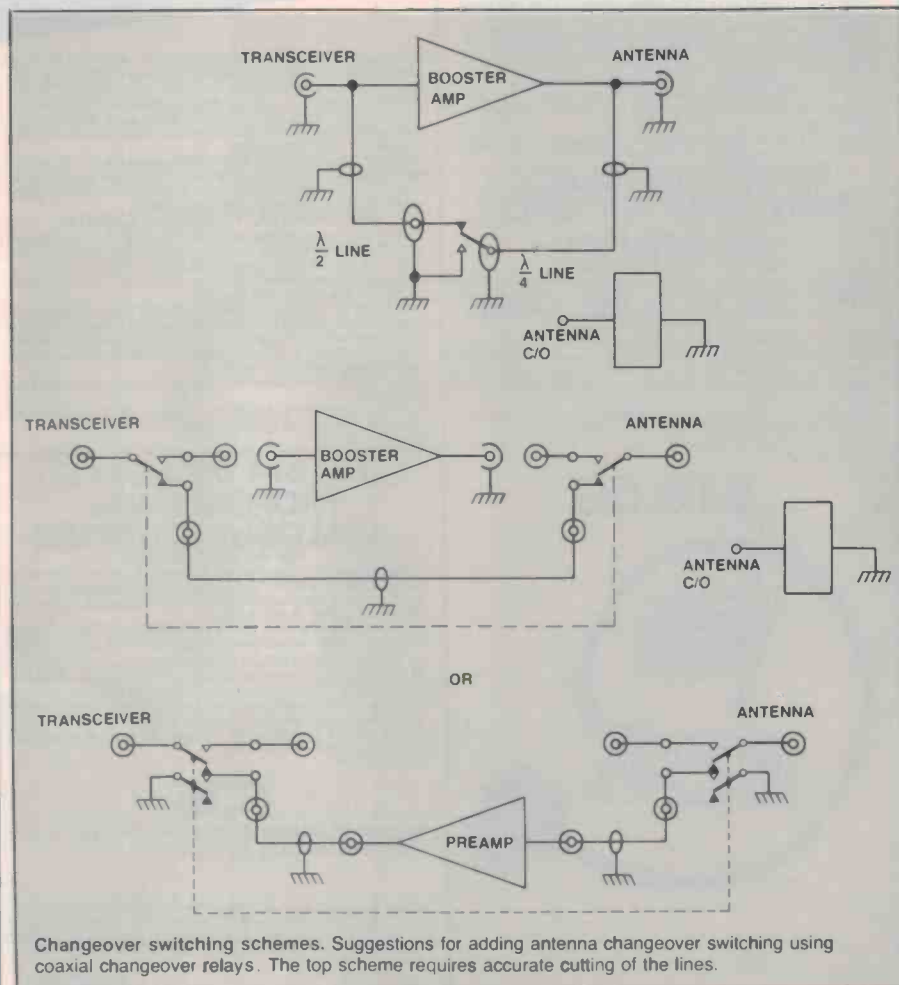

Changeover switching schemes. Suggestions for adding antenna changeover switching using coaxial changeover relays. The top scheme requires accurate cutting of the lines.



## 5000 POWER AMPLIFIER

# "BLACK MONOLITH"

REF: ETI JAN/MARCH 1981



In "2001" Arthur C. Clarke's Black Monolith symbolised awesome power - intelligence.

So too do the 5000 "BLACK MONOLITH" Power Mostet amp kits from Jaycar.

Why would you choose a Jaycar "BLACK MONOLITH" 5000 Power amp kit over conventional kits? Because you too, are intelligent.

You have seen the specs, and you know that this amp IS the best. You want the best because (whether you know it or not) you are a perfectionist. You won't be conned by cheap and nasty compromises to David Tilbrook's brilliant design. You will want to know if there have been mods to the original design. (There have - and only Jaycar kits reflect them). But let's be specific about the improvements.

\* Completely redesigned flag heatsinks for the Driver Transistors. Thoroughly endorsed by David Tilbrook. (The original ones were so small the bias current bias set high for low distortion).

\* Ventilation grilles in the covers. These were not included in the original design.

\* Blind tapped holes in the exclusive "Superfinish" front panel. Heavy gauge screws used for stronger connection of the heatsink bracket to the panel.

\* Jig drilled, EXTRUDED, deburred and black anodised heatsink bracket in heavy gauge. All other kits we have seen, a flimsy punched out piece of sheet metal is supplied. Not even anodised! This is one of the most critical components in the kit.

\* Beryllium Oxide heatsink washers supplied. A tube of heatsink compound is also supplied - with enough left over to use elsewhere.

\* "Superfinish" Front Panel. Despite what others may claim ours is still the best.

\* Dual 3 pin DIN 30V Power Outlets. This extra power outlet enables you to power extra 5000 series components as they arrive on the scene.

\* And all of the extra features of our normal Superfinish 5000 amp. like: Metal 1% film resistors. Prewound chokes. Fibreglass PCB's. Heavy duty earth braid. Quality capacitors. Original chassis-bar design. Flux shoring straps on the transformers etc. etc.

The Jaycar "BLACK MONOLITH" is worth far more than the inferior kits around the market today. However, in some cases, it costs more!

Remember you only get out of a product what you put in to it and the performance of Jaycar kits is measured - IN RESULTS.

## COMPLETE "BLACK MONOLITH" KIT ONLY

Cat. KE-4200

# \$319.00

## ETI 733 RTTY DECODER

REF: ETI APRIL 1983

This simple project allows you to hook up your MicroBee to a communications receiver (or a similar good quality receiver) and print radioteletype messages on your VDU screen. A simple bit of software does the decoding. The kit can be adapted for use on other Z80 based systems.

The Jaycar kit includes box, centre-zero meter, DB15 plug and software listing as well as other kit instructions. A bargain and simple to build.

Cat. KE-4654

# \$19.50

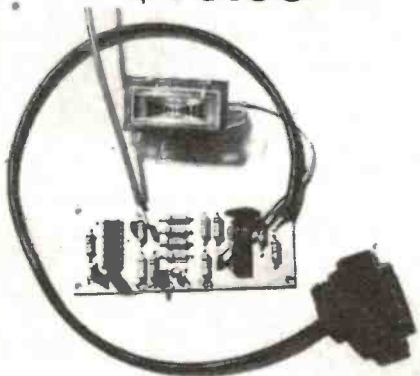

## "BLUEPRINT"

REF: ETI JUNE/OCTOBER 1981

The refinement to this preamp has been incredible. At one stage we had two versions of the preamp but people were only interested in the Blueprint.

Why is the Blueprint so good? Well, there are many reasons but a few of the main ones. Firstly, we use a far, far superior screened cable in the kit. It is much lower in capacitance than the cheap imported excuse for screened cable found in ALL other versions that we have seen. This cable is made in Australia especially for us and costs over 5 times more than the imported junk. When you consider that over THIRTY FEET of screened cable runs around inside the preamp you will appreciate the low capacitance cable. High capacitance cable in signal lines could effect high frequency performance.

## 1/3 OCTAVE EQUALISER

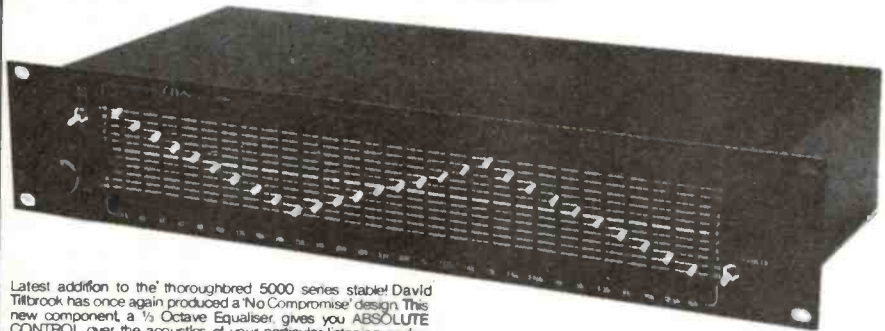

Latest addition to the thoroughbred 5000 series stable! David Tilbrook has once again produced a 'No Compromise' design. This new component, a 1/3 Octave Equaliser, gives you ABSOLUTE CONTROL over the acoustics of your particular listening environment. You get 3 SEPARATE CONTROLS for each and every octave of audio bandwidth to virtually eliminate the subtle nuances that are particular to your listening area.

1/3 Octave Equalisers have been used by professional engineers in Recording Studios and live concerts for over a decade now. It is no accident that the advent of the 1/3 octave equaliser and studio quality live sound recording have gone hand in hand.

### BUT FOR YOU THERE'S A CATCH!!

For Hi Fi stereo one of these units is not enough. They are mono so you will need one for each channel. Quite a lot of money really, but worth it if you want the best. Remember that whilst this unit is designed to operate in the 5000 system it will work with other Hi Fi equipment, line level in, line level out.

The Jaycar kit includes a fully pre-punched plated chassis, pre-punched heavy gauge front panel silk-screened to match the other 500 components. It is absolutely original but includes such refinements as quality LC sockets, UNBRAKO socket head fixing screws, and brushless-look toggle switches.

You can purchase the kits one at a time at \$199 each or, two, \$389 - a \$10 saving.

If you are one of the hundreds of happy 5000 users, we are convinced that you will be just delighted with this unit.

Cat. KE-4204

## ETI 674 MICROBEE PROPORTIONAL ANALOGUE JOYSTICK

REF: ETI DECEMBER 1983

Most computers offer joysticks as options but most aren't as sophisticated as this one. Your average joystick or games controller, is nothing more than four switches. This means that you can only go "full on" or "full off" in any direction.

NOW consider the 674. Whilst this LOOKS the same as other joysticks, you can for example move the stick say, 24 degrees from 12 o'clock (or North). The dot or object will follow EXACTLY. If you move quickly, the dot moves quickly. If you move the stick slowly the dot just CREEPS along! You can even write your name with the dot! Once again, the project is designed specifically for the MicroBee which Jaycar supports as a computer dealer.

The kit comes complete with software listing, high quality self centering joystick and Jiffy case.

Cat. KE-4674

# \$35

Beware of apparently cheaper kits that do not have self centering joysticks.

2. Deluxe kit includes all of the above PLUS 3 extra "Personality" plugs, case with front panel and mains transformer, fuse, 240V plug etc. Also included are two sockets with extra long pins so that they can mount flush with front panel as well as extra components for 2764 programming.

Cat. KE-4651

# \$55

## 5000 CONTROL PREAMPLIFIER

We use a specially selected version of the LM394 ultra-matched transistor for the moving coil preamp. We employ HARD (not soft gold plated) RCA input sockets on ALL INPUTS (previously just M.C.). Probably a bit extravagant (except M.C.), we think, but nice. A pair of solid metal, gold plated RCA line sockets are provided to connect to your M.C. cartridge. Special Nylon mounting grommets are provided for all input and output sockets. Far superior to squashy and perishable rubber grommets provided in other kits. Extra touches like roller-tinned PCB's (to reduce dry or noisy solder joints), 1% metal film resistors, quality LC sockets where practicable, low noise selector switches, special rear panel, solid machined matching Aluminium knobs and specially polished rectangular (multicoloured) LEDs add up to a classic kit.

Like the Black Monolith the Blueprint is the intelligent choice. Even if you were a millionaire and could afford anything you probably would do no better spending virtually any amount of money more.

## THE BLUEPRINT IS UNBELIEVABLE VALUE FOR MONEY AT ONLY

# \$299

## FOR THE COMPLETE KIT

Cat. KE-4202

SIGNAL TO NOISE  
FREQUENCY RESPONSE  
BOOST/CUT  
DISTORTION

### SPECIFICATIONS

-102dB with respect to 1 Volt  
12Hz - 105kHz to -1dB

14dB (28dB total)

1.00Hz - 0.007%

1kHz - 0.007%

10kHz - 0.008%

(essentially irrespective of cut or boost)

Approx. 100mA @ ±15V

(requires 30V AC CT)

Output short-circuit proof

CURRENT  
CONSUMPTION(DC)

FEATURING THE FANTASTIC  
5534 IC AND STATE-OF-THE-ART  
J-FET OP AMPS

# ONLY \$199

# \$39.95



## ETI 668 uBEE EPROM PROGRAMMER

REF: ETI FEBRUARY 1983

This simple, low cost unit just plugs into the MicroBee's I/O port and enables you to save programs in any of 5 different EPROMs (2716, 2732, 2532, 2732A & 2764), which can be used in your MicroBee or any other microprocessor based system. As your MicroBee I/O port is effected with a Z80 PIO chip, this programmer can be used with any other system employing the same I/O.

Jaycar has two versions of this kit.  
1. Lowest possible cost shortform. Includes 2 x "Personality" plugs, 28 pin IC socket (as well as sockets for other ICs) Cannon DB15 plug, wire etc.  
Cat. KE-4650



## REPLACEMENT CASSETTE PLAYER HEADS

O.K. so you have had that high quality cassette deck for some time now. You were thinking of updating to one of those fancy 3-head microprocessor decks but... well they ARE expensive!

Why not give your current deck a new lease of life? If your deck is more than 3 years old and has had a bit of work it's quite possible that the record/play head is worn. This can lead to poor HF performance. Or it may have never been any good in the first place. Or you may want

better performance than the head in your car cassette player can give. Jaycar now stocks replacement, very high quality cassette deck heads to suit most machines - especially Japanese. They are made in the U.K. by MONOLITH. Amazingly most cassette deck heads are standard fittings (EIAJ). So even if you want to just refurbish that cheap player that you use to load programs into your computer Jaycar has the replacement head.

Cat. AC-1950 Mono record/playback	\$14.95
Cat. AC-1952 Stereo record/playback	\$17.95
Cat. AC-1954 Stereo record/playback for use with Dolby	\$24.95
Cat. AC-1956 Stereo record/playback glass ferrite faced	\$36.50
Cat. AC-1958 Mono or Stereo Erase	\$7.95

(All record/playback have mounting hole centres on 17mm pitch and 1/2.5mm from face of head).

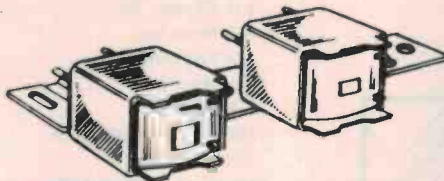

## BISHOP GRAPHICS

You can now make "Professional Quality" PC Artworks and Boards in your own home. Of all the problems associated with Printed Wiring Board prototypes, preparation time and suitable apparatus stand out. With pre-coated laminate using the "DUPONT" product "RISTON" most of these difficulties are eliminated. "RISTON" is a negative acting dry film resist which is applied to machine cleaned laminates by means of a special precision hot roller applicator. The resulting "RISTON" coated laminate is then enclosed in a black polythene envelope, and is ready for use.

This means that the time involved in preparation of the copper surface, applying the resist, oven baking initially to dry the resist and post baking after development is therefore eliminated. Also important, is that the pre-coated "RISTON" is sensitive to 320 to 400nm ultra violet light sources thus special darkroom facilities are not required. Both the time involved and the facilities are needed for using pre-coated "RISTON" are minimal, but consistently high quality results can be expected with a very low reject rate due to breakdown during etching.

With each order for Bishop Graphics we supply free a booklet on how to do it, as well as handy hints on what not to do, what you'll need to finish the job etc.

### PRE-SPACED PADS

HG-9906	0.100" diameter 1.58mm	240 pads	\$3.65
HG-9907	0.100" diameter 1.91mm	140 pads	\$3.65
HG-9908	0.156" diameter 2.54mm	150 pads	\$3.65

### DIL PATTERNS

HG-9909	14 PIN	32 Symbols	\$3.65
HG-9910	16 PIN	32 Symbols	\$3.65
HG-9911	18 PIN	28 Symbols	\$3.65
HG-9912	24 PIN	12 Symbols	\$3.65
HG-9913	28 PIN	12 Symbols	\$3.65
HG-9914	40 PIN	8 Symbols	\$3.65

### DIL PATTERNS - NARROW CUT

HG-9918	14 PIN	32 Symbols	\$3.65
HG-9919	16 PIN	32 Symbols	\$3.65
HG-9920	40 PIN	8 Symbols	\$3.65

### BLACK ARTWORK TAPE

HG-9930	0.026" wide x 20 yards	\$2.60
HG-9931	0.031" wide x 20 yards	\$2.85
HG-9932	0.040" wide x 20 yards	\$2.85
HG-9933	0.050" wide x 20 yards	\$2.85
HG-9934	0.062" wide x 20 yards	\$2.95
HG-9935	0.080" wide x 20 yards	\$2.95
HG-9936	0.093" wide x 20 yards	\$2.95
HG-9937	0.100" wide x 20 yards	\$2.95
HG-9938	0.125" wide x 20 yards	\$2.95
HG-9939	0.200" wide x 20 yards	\$2.95
HG-9940	0.250" wide x 20 yards	\$3.95

### DONUT PADS

HG-9941	0.080" OD x 0.031" ID	96 symbols	\$2.95
HG-9942	0.100" OD x 0.031" ID	96 symbols	\$2.95
HG-9944	0.125" OD x 0.031" ID	96 symbols	\$2.95
HG-9945	0.156" OD x 0.031" ID	96 symbols	\$2.95
HG-9947	0.200" OD x 0.031" ID	108 symbols	\$2.95
HG-9948	0.250" OD x 0.031" ID	128 symbols	\$2.95

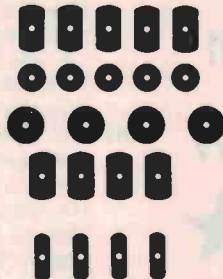

## RACK CABINETS

Beautifully crafted all Aluminium rack cabinets with top and bottom removable panels. Plain or black finish. Ventilated lid. Deluxe brushed anodised front panel. Supplied in flat pack but takes only minutes to put together. Dimensions conform to International Standard.

Cat. No.	Finish	Price 1-4	Price 5 up	Front panel ht.
HB-5411	Natural	\$45.00	\$42.50	44mm
HB-5413	Natural	\$55.00	\$52.50	44
HB-5415	Natural	\$59.95	\$55.00	88
HB-5410	Black	\$45.00	\$42.50	88
HB-5412	Black	\$55.00	\$52.50	132
HB-5414	Black	\$59.95	\$55.00	132

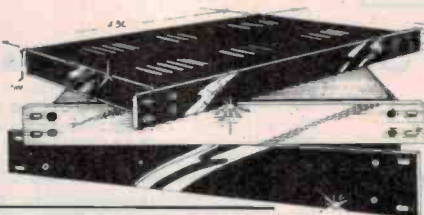

### MAGAZINE BINDER

Keep your precious (and expensive!) magazines protected and in order for easy reference. Smart royal blue colour with gold lettering. Heavy gauge, richly chromed metal fittings.

Cat. BB-7000

\$4.95 ea  
10 up \$4.50 ea

### VIDEO ENHANCER

REF: EA OCTOBER 1983

The Jaycar kit includes the box and Scotchcal label

\$35



Cat. KA-1118

# Jaycar ELECTRONICS

Incorporating  
**ELECTRONIC AGENCIES**

**NUMBER 1 FOR KITS**

**SHOWROOMS**

**SYDNEY**

117 YORK STREET

Tel: (02) 264 6688 & (02) 267 1614

Telex: 72293

**CARLINGFORD**

Cnr. CARLINGFORD & PENNANT  
HILLS ROAD

Tel: (02) 872 4444

**CONCORD**

115-117 PARRAMATTA ROAD

Tel: (02) 745 3077

**HURSTVILLE**

121 FOREST ROAD

Tel: (02) 570 7000

## MAIL ORDERS & CORRESPONDENCE

P.O. BOX 185

CONCORD, 2137

Tel: (02) 745 3077

### POST & PACKING CHARGES

\$5 - \$9.99	\$1.50
\$10 - \$24.99	\$3.20
\$25 - \$49.99	\$4.50
\$50 - \$99.99	\$6.50
\$100 - \$198	\$8.00
Over \$199	\$10.00

**COMET ROAD FREIGHT  
ANYWHERE IN AUSTRALIA  
ONLY \$12.00**

### SHOP HOURS

CARLINGFORD, CONCORD &  
HURSTVILLE

Mon - Fri: 9 am - 5.30 pm

Sat: 9 am - 12 pm

Thurs Night: 8.30 pm (Not Concord)

### SHOP HOURS SYDNEY

Mon - Fri: 8.30 am - 5.30 pm

Sat: 8.30 am - 12 pm

Thurs Night: 8.30 pm

### MAIL ORDER BY

bankcard

VIA YOUR  
PHONE

VISA





OPENING THIS MONTH IN  
**MELBOURNE VIC & CAMPBELLTOWN NSW**

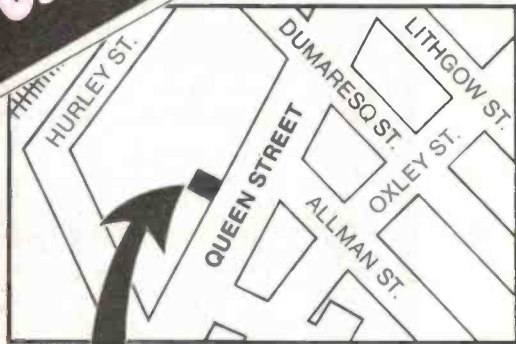

Shop 38  
 Campbelltown Mall  
 Queen Street  
 Campbelltown, NSW

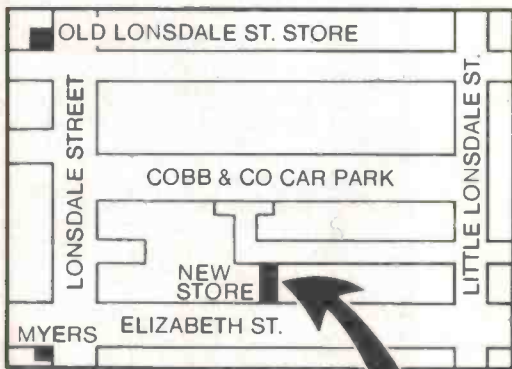

291-293 Elizabeth St.  
 Melbourne, Vic



Now 48 stores  
 in Australasia!

## STORE LOCATIONS

<b>NSW</b>	Cnr. Swift & Young Sts. Parramatta Rd & Melton St T55 Terrace Level 613 Princes Hwy Oxford & Adelaide Sts 531 Pittwater Rd 147 Hume Hwy 162 Pacific Hwy 315 Mann St 4 Florence St Elizabeth Dr & Bathurst St 173 Maitland Rd Lane Cove & Waterloo Rds George & Smith Sts The Gateway, High & Henry Sts 818 George St 6 Bridge St 125 York St Tamworth Acde & Kable Ave 263 Keira St	<b>ALBURY</b> 21 8399 <b>AUBURN</b> 648 0558 <b>BANKSTOWN SQ</b> 707 4888 <b>BLAKEHURST</b> 546 7744 <b>BONDI JCT</b> 387 1444 <b>BROOKVALE</b> 93 0441 <b>CHULLORA</b> 642 8922 <b>GORE HILL</b> 439 5311 <b>GOSFORD</b> 25 0235 <b>HORNSBY</b> 477 6633 <b>LIVERPOOL</b> 600 9888 <b>NEWCASTLE</b> 61 1896 <b>NORTH RYDE</b> 88 3855 <b>PARRAMATTA</b> 689 2188 <b>PENRITH</b> 32 3400 <b>RAILWAY SQ</b> 211 3777 <b>SYDNEY</b> 27 5051 <b>SYDNEY</b> 267 9111 <b>TAMWORTH</b> 66 1961 <b>WOLLONGONG</b> 28 3800
<b>ACT</b>	96 Gladstone St	<b>FYSHWICK</b> 80 4944
<b>VIC</b>	Creswick Rd & Webster St Cnr Hawththor Rd & Nepean Hwy 260 Sydney Rd Nepean Hwy & Ross Smith Ave 205 Melbourne Rd 291-293 Elizabeth St. Bridge Rd & The Boulevarde Springvale & Dandenong Rds	<b>BALLARAT</b> 31 5433 <b>BRIGHTON (EAST)</b> 592 2366 <b>COBURG</b> 383 4455 <b>FRANKSTON</b> 783 9144 <b>GELONG</b> 78 6766 <b>MELBOURNE</b> 67 9834 <b>RICHMOND</b> 428 1614 <b>SPRINGVALE</b> 547 0522
<b>QLD</b>	293 Adelaide St 166 Logan Rd Gympie & Hamilton Rds Cnr Gold Coast Hwy & Welch St Bowen & Ruthven Sts Ingham Rd & Cowley St. West End	<b>BRISBANE</b> 229 9377 <b>BURANDA</b> 391 6233 <b>CHERMESIDE</b> 359 6255 <b>SOUTHPORT</b> 32 9863 <b>TOOWOOMBA</b> 38 4300 <b>TOWNSVILLE</b> 72 5722
<b>SA</b>	Wright & Market Sts Main South & Flagstaff Rds Main North Rd & Darlington St	<b>ADELAIDE</b> 212 1962 <b>DARLINGTON</b> 298 8977 <b>ENFIELD</b> 260 6088
<b>WA</b>	Wharf St & Albany Hwy William St & Robinson Ave Centreway Acde, Hay St	<b>CANNINGTON</b> 451 8666 <b>PERTH</b> 328 6944 <b>PERTH</b> 321 4357
<b>TAS</b>	25 Barrack St	<b>HOBART</b> 31 0800
<b>NT</b>	17 Stuart Hwy	<b>STUART PARK</b> 81 1977

### Dear Customers.

Quite often, the products we advertise are so popular they run out within a few days. Or unforeseen circumstances might hold up shipments so that advertised lines are not in the stores by the time the advert appears. And very occasionally, an error might slip through our checks and appear in the advert (after all, we're human too!) Please don't blame the store manager or staff; they cannot solve a dock strike on the other side of the world, nor fix an error that's appeared in print. If you're about to drive across town to pick up an advertised line, why not play it safe and give them a call first - just in case!

Thanks.

Dick Smith Electronics

### MAJOR RESELLERS

● **Atherton Qld:** Maarten's Music Centre, 55 Main St 91 1208 ● **Ballina NSW:** A. Cummings & Co. 91-93 River St 86 2285 ● **Bowral NSW:** Barry Gash Electronics, 370 Bong Bong St 61 2577 ● **Broken Hill NSW:** Hobbies & Electronics, 37 Oxide St, 88 4098 ● **Bundaberg Qld:** P.M. Electronics Takalvan St 72 8272 ● **Calms Qld:** Electronic World Shop 27 K-Mart, Westcourt Plaza, Mulgrave Rd, 51 8555 ● **Campbelltown NSW:** Fishers' Chip' Shop, Shop 3, 274-276 Queen St, 27 1475 ● **Coffs Harbour NSW:** Coffs Harbour Electronics, 3 Coffs Plaza, Park Ave 62 5684 ● **Darwin NT:** Ventronics, 24-26 Cavanagh St 81 3491 ● **Deniliquin NSW:** Deni Electronics, 220 Cressy St 81 3672 ● **East Maitland NSW:** East Maitland Electronics 99 High St 33 7327 ● **Echuca Vic:** Webster Electronics 220 Packerham St ● **Gladstone Qld:** Purely Electronics Shop 2 Cnr Herbert & Auckland Sts 72 4321 ● **Goondiwindi Qld:** Border T.R.C., 50 Marshall St 171 2353 ● **Gosford NSW:** Tomorrow's Electronics & Hi Fi 63 William St 24 7246 ● **Inverell NSW:** Lyn Willing TV 22A Evans St 22 1821 ● **Launceston Tas:** Advanced Electronics 5A The Quadrant 31 7075 ● **Lismore NSW:** Decro Electronics 3A/6-18 Carrington St 21 4137 ● **Mackay Qld:** Stevens Electronics 42 Victoria St 51 1723 ● **Maryborough Qld:** Keller Electronics 218 Adelaide St 21 4559 ● **Morwell Vic:** Morwell Electronics 95 George St 34 6133 ● **Mt Gambier SA:** Hutchesson's Comm 5 Elizabeth St 25 6404 ● **Mildura Vic:** McWilliams Electronics 110A Langthre Ave 23 6410 ● **Port Macquarie NSW:** Hall of Electronics, Horton Centre, Horton St 83 7440 ● **Nelson Bay NSW:** Dales Dynamics Cinema Mall Stockton St ● **Orange NSW:** M & W Electronics 173 Summer St 62 6491 ● **Port Lincoln S.A.:** Basshams T.V. & Computerworld 22 Liverpool St ● **Rockhampton Qld:** Purely Electronics 15 East St 21 058 ● **Shepparton Vic:** G.V. Electronics Centre 189B Cono St 21 8866 ● **Townsville Qld:** Tropical TV 49 Fulham Rd, Vincent Village 79 1421 ● **Wagga NSW:** Wagga Wholesale Electronics 89 Forsyth St ● **Whyalla SA:** Mellor Enterprises Shop 2 Forsythe St 45 4764

### STORE HOURS

All Dick Smith stores are open for trading during the normal trading hours for their particular area (either 9-5.30 or 8.30-5). Many stores are also open for late night trading. Please ring the store concerned for their particular hours.



welcome here

### SPEEDY PHONE/BANKCARD ORDER SERVICE

Just phone your order and Bankcard details - it's so simple!

**(02) 888 2105**

Orders only on this number.

Enquiries: **(02) 888 3200**

### HEAD OFFICE & MAIL ORDER CENTER:

P.O. Box 321, North Ryde  
 NSW 2113  
 Tel: (02) 888 3200

### Post & Packing Charges

Order Value	Charge
\$5-\$9.99	\$2.00
\$10.00-\$24.99	\$3.50
\$25.00-\$49.99	\$4.50
\$50.00-\$99.99	\$6.00
\$100 or more	\$8.00

Terms available to approved applicants through...



# DICK SMITH ELECTRONICS





MAIL ORDER

MAIL ORDER

MAIL ORDER

Why buy from a mail order only house when we have two shops for convenience and a highly efficient mail order service?

5% off for order over \$100 10% off over \$500; 12% off over \$1000 OFFER APPLIES TO ITEMS ON THIS PAGE ONLY

MAIL ORDER

MAIL ORDER

MAIL ORDER

Table of electronic components including resistors, capacitors, and diodes with part numbers and prices.

Table of electronic components including integrated circuits, transistors, and diodes with part numbers and prices.

MAIL ORDER

MAIL ORDER

MAIL ORDER

ROD IRVING ELECTRONICS

425 High St., Northcote, Vic. 48-50 A Beckett St., Melb., Vic. Phone (03) 489 8866, (03) 489 8131, Mail Order Hotline (03) 481 1436

RITRONICS WHOLESALE

Please address tax exempt, school, wholesale and dealer enquiries 1st floor 425 High St. Northcote 3070 (03) 489 7099 (03) 481 1923 Telex AA 38897

MAIL ORDER

MAIL ORDER

MAIL ORDER

OFFER EXPIRES JULY 15, 1984



## SHOP AROUND

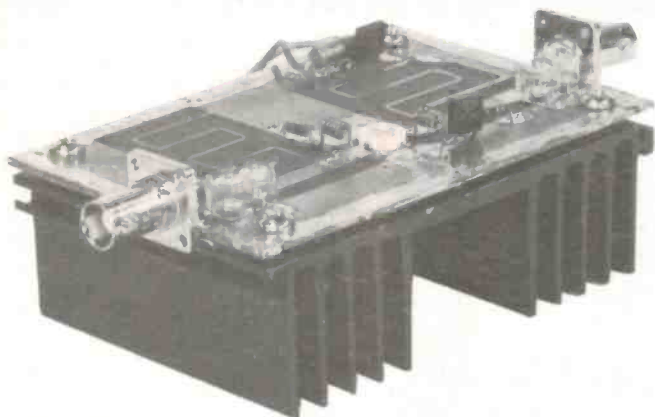

### ETI-738 Booster amp

If you have problems with the SRF1078/2N6136, the original source in Australia is Geoff Wood Electronics in Sydney.

Chip capacitors are distributed by IRH, 53 Garema Cir-

cuit, Kingsgrove, NSW (02) 750-6444 and Ultramon Capacitors, 45 Railway Parade, Kogarah (02) 588-5844.

The trimmers are Philips types, stocked by the George Brown Group.

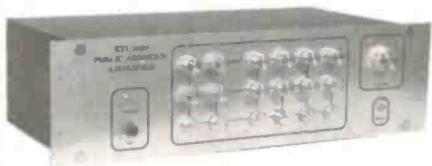

### ETI-1420 Paging Amp

Parts will be readily accessible from most major retailers. If you have trouble with the OP597 try Auditec, 10 Waitara Ave, Waitara NSW 2077 in Sydney or Zephyr Products, 421 Warrigal Road, Moorabbin Vic 3189 in Melbourne.

### ETI-1523 electronic scales.

Parts for the scales can be obtained from all the usual suppliers with attention to the following: the Bimbox 6007 case is stocked by Jaycar in Sydney. The CA3240E op-amps are available from Rod Irving in

Melbourne and Geoff Wood in Sydney.

The 74C935N/ADD3501 and the metalised poly capacitors will probably be held by Geoff Wood. Semikron in Sydney also has a range of the capacitors. The Neosid core is manufactured and distributed by Neosid Pty Ltd, 23 Pervical St, Lilyfield NSW 2040. (02)660-4566.

### Artwork

Unfortunately this month it has not been possible to include all the artwork for this month's projects in the magazine. They just won't fit! However, for those making their own pc boards or front panels from the ground up, same size positive or negative transparencies are available from our 'Artwork Sales'. Please address requests for this service to:

'ETI-xxx Artwork'  
ETI Magazine  
P.O. Box 227  
Waterloo  
NSW 2017.

When ordering, make sure you specify positive or negative, according to the requirements of your photoresist. Your cheque or money order should be made payable to 'ETI Artwork sales'. Prices for this month's projects are:

ETI-1523 . . . \$20  
ETI-738 . . . \$3.40  
ETI-1420 . . . \$20

This will buy all the artwork necessary for the projects, including front and rear panels and pc

board modules.

You might also care to know that almost every pc board (and most front panels) ever published by ETI may be obtained from:

All Electronic Components  
118 Lonsdale St  
Melbourne Vic 3000

and

RCS Radio  
651 Forest Rd  
Bexley NSW 2207

For pc boards produced in recent years, the following suppliers either keep stocks on hand or can supply to order:

Acetronics  
112 Robertson Rd  
Bass Hill NSW 2197  
(02)645-1241

Bilco Electronics  
Shop 2, 31 Pultney St  
Dandenong Vic 2175

Jaetronics  
58 Appian Drive  
St Albans Vic 3021

Jaycar  
117 York St  
Sydney NSW 2000

Jemal Products  
P.O. Box 168  
Victoria Park WA 6100

Mini Tech  
P.O. Box 9194  
Auckland NZ

Rod Irving Electronics  
425 High St  
Northcote Vic 3070

4 × 1000W MUSICHASER

\$225.00

POST FREE  
ANYWHERE IN  
AUSTRALIA



WRITE OR CALL FOR  
FURTHER INFORMATION  
ON OUR EXTENSIVE RANGE  
OF SOUND AND LIGHTING EQUIPMENT

- ☆ SENSITIVITY CONTROL
- ☆ ZERO VOLTAGE TRIGGERING
- ☆ DRIVES NORMAL + INDUCTIVE LOADS
- ☆ 3 CHASE MODES
- ☆ 12 MONTHS WARRANTY



DISCO SOUND AND LIGHTING SPECIALISTS  
63 HARDGRAVE ROAD, WEST END, 4101  
POSTAL ADDRESS: P.O. BOX 377, WEST END, QLD, 4101  
PHONE: (07) 44-4971

**HI-TECH LIGHT AND SOUND**





# PRE-STOCKTAKE SALE

ENDS 15TH JULY 1984

## PANEL MOUNTING RCA SOCKETS



P10232	2 way	1-9	10+
		.35	.30
P10234	4 way	.45	.40
P10236	6 way	.60	.50

## VIDEO RF MODULATOR UNBELIEVABLE PRICE

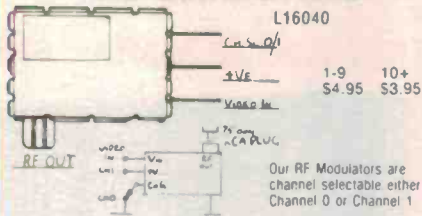

1-9	10+
\$4.95	\$3.95

## DELUXE METAL CABINETS

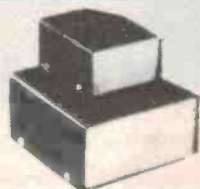

A "STEEL" AT THESE PRICES

H10442	150x61x103mm	1-9	10+
		3.95	2.95
H10444	184x70x160mm	4.95	3.95

## CANNON TYPE CONNECTORS DIRECT IMPORT PRICE



P10960	3 PIN LINE MALE	1-9	10+
		1.90	1.60
P10960	3 PIN CHASSIS MALE	1.90	1.60
P10964	3 PIN LINE FEMALE	2.50	2.10
P10966	3 PIN CHASSIS FEMALE	2.90	2.20

## 1/4 WATT 5% RESISTORS E24 VALUES CARBON FILM

\$1.00 per hundred That is 0.75 of a cent each  
\$7.50 per thousand But Must Be The Same Value

## 34 WAY EDGE CONNECTORS FOR DISK DRIVES

SCOOP DIRECT IMPORT PURCHASE

1-9	10+
\$5.95	\$4.95

## HIGH CLASS INSTRUMENT KNOBS



Half price this month

H10060	35mm	50
H10061	24mm	45
H10062	20mm	40
H10063	15mm	38

## KEY SWITCHES



1-9	10+
\$3.95	\$3.75

## MINIATURE PCB RELAYS



Massive 3A contacts at 24VDC or 100VAC Nominal 12V  
Coil but will work OK from 9-15V

SPECIFICATIONS	S.P.D.T.	D.P.D.T.
Nominal Coil Voltage	12V	12V
Contact Current (max)	3A	3A
Contact Voltage (max)	125VAC	60VAC
Coil Resistance	400 ohm	300 ohm
PRICE		
1-9	\$1.20	\$1.50
10-24	\$1.00	\$1.20
25-99	\$0.80	\$1.00

## ECONOMY TOGGLE SWITCHES



S11010	SPDT	1-9	10+
		1.00	70
S11020	DPDT	1.20	80

## HORN SPEAKER



WOW \$6.95

C12010

5" A B S Material Horn Speaker 8 ohm Freq. Range 600-5000Hz Max Power 8 W

## BRIDGES & DIODES

6A 400V Bridge \$1.50

	1-9	10+	100+
IN5404	.20	18	14
IN5408	.25	20	15



## DISCOUNTED PANEL METERS BUT BE QUICK FOR THESE



PANEL METERS	NORMALLY	THIS MONTH
Q10500	MU45 0-1mA	9.75 6.95
Q10502	MU45 50-0-50uA	9.75 6.95
Q10504	MU45 0-100uA	9.75 6.95
Q10505	MU45 0-50uA	9.75 6.95
Q10518	MU45 0-1A	9.75 6.95
Q10510	MU45 0-5A	9.75 6.95
Q10515	MU45 0-10A	9.75 6.95
Q10520	MU45 0-20V	9.75 6.95
Q10525	MU45 0-30V	9.75 6.95
Q10535	MU45 VU	10.95 8.95
Q10530	MU52E 0-1mA	10.95 7.95
Q10533	MU52E 0-5A	10.95 7.95
Q10538	MU65 0-50uA	13.95 7.95
Q10540	MU65 0-1mA	13.95 7.95
Q10550	MU65 0-100uA	13.95 7.95
Q10560	MU65 0-20V	13.95 7.95

## IC SOCKETS (LOW PROFILE) HOW CHEAP CAN THEY GO



	1-9	10-99	100-999	1000+
8 Pin	15	14	12	9
14 Pin	16	15	14	10
16 Pin	17	16	15	11
18 Pin	18	17	16	13
20 Pin	29	28	27	26
24 Pin	35	33	32	28
40 Pin	45	40	35	30

## 5 WATT RESISTORS

WE ARE OVERSTOCKED YOU REAP THE SAVINGS

1-9	10-99	100+	1/2 PRICE
.25	22	20	

## MORE PANEL METER BARGAINS

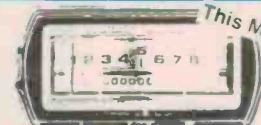

This Month \$2.95

Normally 1-9 10+  
4.50 3.95

Q10400  
250 uA Sensitivity Panel cut-out 36mm x 16mm  
Mounting hole centres at 49mm



This Month \$2.95

Normally 1-9 10+  
4.95 4.50

Q10405  
250 uA Sensitivity centre 'O' very useful for balanced circuit and applications needing a centre 'O' or null indication



2 1/4" Speaker  
Only \$1.00



Errors & omissions excepted.

## ROD IRVING ELECTRONICS

425 High St., Northcote, Vic. 48-50 A'Beckett St., Melb., Vic.  
Phone (03) 489 8866, (03) 489 8131, Mail Order Hotline (03) 481 1436  
Mail orders to P.O. Box 235 Northcote 3070 Vic. Minimum P & P \$3.00.

Please address tax exempt, school, wholesale, and dealer enquiries to: **RITRONICS WHOLESALE**  
1st floor 425 High St. Northcote 3070 (03) 489 7099  
(03) 481 1923 Telex AA 38897



# NEW KITS FOR THIS MONTH

## THIS MONTH'S KITS

### ETI-738 25 WATT UHF BOOSTER AMP



Boost your UHF rig's output—you need all you can get! This low cost transmitter booster amp will give your signal quite a lift without breaking the bank. Great for FM or ATV rigs.

### ETI-1420 PAGING AMP/SOUND SYSTEM

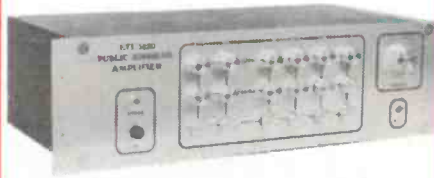

Just the thing for clubs, pubs, halls etc. Project features two low level inputs (one balanced, one unbalanced). Each input has level, bass and treble controls. The power amp employs the popular and reliable ETI-499 150 watt MOSFET module to drive a 100V line output.

### TV PATTERN GENERATOR

**\$67.50**



Anyone wishing to obtain the maximum performance from a colour TV receiver needs a pattern generator. Why not build this completely new design which provides five separate patterns: dot, crosshatch, checkerboard, grey scale and white raster.

### AUDIO TEST UNIT FOR CASS DECKS

**\$47.50**



EA October 81

### MIXER PREAMP TRANSFORMER

**\$26.50**



Easy construction and versatile operation, this Preamp was for coupling with the 300W "Brute" Power Amp. ETI 467 July 80

### CAR BURGLAR ALARM

**\$70**

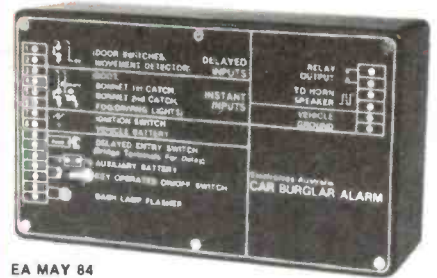

EA MAY 84

### CRYSTAL MARKER (INC 1MHZ X)

**\$34.50**  
ETI 157 October 81



### MUSICOLOR IV

**\$84.00**



Add excitement to parties, card nights and discos with EAs new Musicolor IV light show. This is the latest in the famous line of Musicolors and it offers features such as four channel "Color Organ" plus four channel light chaser, front panel LED display, internal microphone, single sensitivity control plus opto-coupled switching for increased safety. EA August 81



### HEADPHONE AMPLIFIER

**\$28**

EA MARCH 84

### TRANSISTOR ASSISTED IGNITION

EA November 79



**\$34.50**



EA APRIL 84

### VCR SOUND PROCESSOR

**\$69.00**

Give the sound from your VCR a lift with this new VCR Sound Processor. Main features include an effective stereo simulator circuit, a 5-band graphic equaliser, and noise filtering.

## ROD IRVING ELECTRONICS

425 High St., Northcote, Vic. 48-50 A Beckett St., Melb., Vic.  
Phone (03) 489 8866, (03) 489 8131, Mail Order Hotline (03) 481 1436  
Mail orders to P.O. Box 235 Northcote 3070 Vic. Minimum P & P \$3.00.

Please address tax exempt, school, wholesale, and dealer enquiries to: **RITRONICS WHOLESALE**  
1st floor 425 High St. Northcote 3070 (03) 489 7099  
(03) 481 1923 Telex AA 38897





Northcote store. Beautiful downtown High St, No. 425.

### Rod Irving Electronics

425 High St, Northcote Vic 3070. (03)489-7099.



Heeeeere's Rod! With kits festooning the wall behind him.

This occasional column introduces readers to those people on the other side of the counter in the electronics retail business — where you buy your equipment and component requirements. It serves to 'put a face' to the people who own and run the businesses you may deal with in the course of your job or pursuing your hobby, and to give some background on the business itself.

WHEN YOU STEP INSIDE Rod's Northcote store, you have to stand still, take a deep breath and look *slowly* around — just to take in the magnitude, multitude, breadth and variety of the electronics lines cascading down the walls, festooned from the shelves and glistening behind glass. It's a veritable Aladdin's cave! (Now *there's* a good name for a . . .).

Flipping through the 'phone book-like semiconductor data catalogues, one gets quite blasé about the huge variety described. However, when confronted by the 'wall of ICs' — the distinct characteristic of a Rod Irving store, you get a graphic picture that leaves you in no doubt about the breadth and variety of ICs and other semiconductors available.

"I don't think any other electronics retailer stocks the range and variety we do," says Rod, who's youthful, fresh-faced looks deceive you into thinking he's a choir-boy, just popped in after practice at St Stephens down the road. It beats us how anybody could work so hard over the last seven years, building up such a sizeable business, and not get a *few* grey hairs and a furrowed brow.

Legend has it that Rod started his business in his garage (as all good electronics entrepreneurs do). Finding it a little cramped, he found himself a store in High

St, Northcote, an inner-city suburb on the north side of Melbourne, a few blocks from his present store. As the fledgling micro-computer business began to blossom in the late 70s, Rod plunged right in and launched the "Big Board 1". This single-board, multi-featured computer kit enjoyed not a little success. The Big Board 2 superceded it about two years ago.

From the start, Rod Irving Electronics has specialised in kits and components. He carries pc boards and panels for pretty well every project published over the last five years or so. If it's not in stock, you can have it made for you, providing the artwork's available. Rod is a major supplier of the famous ETI 'Series 5000' hi-fi projects. In fact, he manufactures the power amp's heatsink front panel used on all kits now.

In December 1982, Rod opened a store at 48 A'Beckett St, at the 'top' end of the city (i.e: the end nearest the Carlton brewery). A'Beckett St in Melbourne is fast becoming akin to that famous short strip of York St in Sydney where there's a whole bunch of electronics retailers cheek-by-jowl. Under the banner of "C-Tech Pty Ltd", the store is run by Rod's partner, Greg Boot and specialises in computer gear, software and peripherals, as well as wholesale distribution.

A substantial proportion of Rod Irving's business comes from mail order. He'll ship just about anything, from a single resistor to a complete computer system.

It's easy to tell from Rod's advertisements or from walking into his stores that here is a business that stocks electronic parts in *breadth* and *depth*. Whether you're just after the run-of-the-mill things, like half-watt resistors, or the esoteric, like UHF power amp modules or a specialised

video controller chip, then you stand a good chance of finding it at Rod Irving's. The phenomenal range of project kits and pc boards stocked would take some beating (we've only ever found *one* competitor . . .) Take the tram from the city, right up the High Street, Northcote, and let Rod do it right for youououou . . . ! (as they say on the used-car ads on TV).



City store. In the heart of A'Beckett St.



# FOR 30¢ POST AN ORDER TO ONE OF ALTRONICS COMPETITORS

— naturally you won't have a clue as to whether they've got the items you need available. And of course, be prepared to wait, wait, patiently wait sometimes for weeks! Why waste your valuable cash? Altronics staff are waiting for your call now (up to 6pm eastern standard time).

## NEW HITACHI F SERIES SQUARE SCREEN DUAL BEAM CRO

V-212 DC to 20 MHz, 1 mV/div, DUAL-TRACE

We are proud to include Hitachi's latest oscilloscope in our range of test equipment.

It features: • Thin, light and compact design (310W x 130H x 370D mm, 6 kg) • Large 6 inch rectangular, internal graticule CRT • Vertical

mode triggering selection to provide stable triggering of each channel • High accuracy  $\pm 3\%$  • High sensitivity 1mV/div • Stable, low drift design • TV sync separation circuit built-in • Convenient X-Y mode for phase difference measurements • Tilting ball supplied.

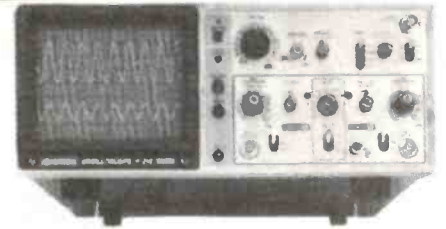

FREE FREIGHT ANYWHERE IN AUSTRALIA

Q0152..... **\$699.00**

## MICROWAVE OVEN LEAK DETECTOR



### ETI PROJECT

Completely passive project receives microwaves via an antenna which develops a voltage across a detector diode driving the meter. Monitor your microwave oven with this easy to build kit. All components mount on single PCB, including the meter. Genuine Hewlett Packard Hot Carrier Diode supplied.

K1724..... (still only) **\$14.50**

## THE DAZZLING MUSICOLOR IV PROJECT



Combination Colour Organ and Light Chaser. Four channel colour organ. Internal micro-phone or connect to speakers for colour organ operation. (The lights connected to each channel pulse in beat to the music proportional to portion of frequency spectrum concerned.) Four chaser modes forward and reverse. Output lamp load capacity a massive 2400 watts — that's 100 party globes. Full instructions and every last nut and bolt included. Great for parties, shop signs, display windows etc.

K5800..... **\$89.50**

## MULTIPROM INTERFACE

44K OF PROGRAM STORAGE



A sensational new kit for the MICROBEE, requires no modification to the computer except for the fitting of a 50 pin expansion socket. This project is easy to build and will allow you to store and software select up to 44k of eprom storage — acts like a mini disk drive system with the speed of RAM. Extra units may be added to further increase storage.

The Altronics Kit comes complete in every way

- ★ Full set of IC sockets.
- ★ Double sided, plated through board.
- ★ Assembled connection lead to Microbee.
- ★ Fully documented.
- ★ Cassette monitor Included (plus sourcefile).

THE MICROBEE KIT OF 1983

K9673..... **\$99.50**

## 8 INCH WIDE RANGE DUAL CONE SPEAKER

200mm (8 In.). 10 Watts Max. power Input. Public Address, Background Music. Ideal HI FI extension speaker. Includes transformer holes at 51mm. Over 30,000 sold in Australia! Mounting holes 140 x 140mm.

C2000..... **\$9.50 ea**  
10 Up..... **\$8.70**

## 8 INCH CEILING SPEAKER GRILL

C0800..... **\$2.75**  
10 Up..... **\$2.00**

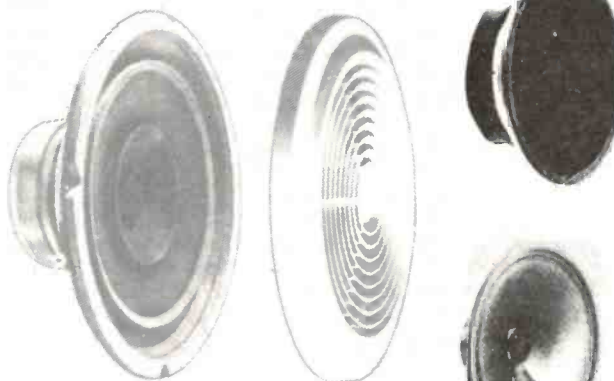

## MINI SPEAKER 57mm

200 MW 8 OHM  
Large Ferrite Magnet.  
Ideal replacement speaker.  
Great for hobby projects.

C 0610... **\$1.95**  
10 Up... **\$1.50**

## MINI SPEAKER 82.5mm (3¼ in.)

3 watt 8 OHM  
Mounting Holes at 71mm centres.

C 0612... **\$4.75**  
10 Up... **\$4.25**

## 165 mm (6½ in.)

Dual Z 4/8 OHM  
3 Watt RMS  
Mounting holes at 112mm.

C 0620... **\$7.95**  
10 Up... **\$7.25**

## INCREDIBLE VALUE BULK PACKS

ALL COMPUTER SELECTED

SUPER PRICE

**\$5 each**



R3501..... **.25W Resistor Pack**  
Av. contents 300..... **\$12 Value**

## FUSE HOLDER M205

20 x 5mm Fuse

S5990..... **90c**  
10 UP..... **80c each**

## FUSE HOLDER 3AG

32 x 6.3mm Fuse

S6000..... **95c**  
10 Up..... **85c each**



BANKCARD HOLDERS — PHONE ALTRONICS TOLL FREE

NEXT DAY JETSERVICE DELIVERY NOW WITH PREPUNCHED SCREENED FRONT PANEL

PHONE ALTRONICS TOLL FREE 008-999-007 FOR NEXT DAY JETSERVICE DELIVERY



OR FOR **15<sup>c</sup>** PHONE YOUR ORDER TOLL FREE ON 008-999-007

We will immediately confirm stock availability. We will also confirm the very hour your order will be dispatched (over 95% of orders leave the same day). **With Jet Service Delivery we deliver next day to capital cities and suburbs** — Country areas please add 24 to 48 hours. **Available bankcard holders only** — sorry non-bankcard holders must post a cheque or money order — even so, we promise to deliver quicker than any other supplier in Australia.

**INSTRUMENT CASES**

Our superb Instrument cases will give your projects the professional appearance they deserve.

	WAS	NOW	10+
H0480	\$13.50	\$11.50	\$ 9.50
H0482	\$17.50	\$15.00	\$12.25

OEM's — Manufacturers — Bulk Users. Your product will look like it's straight out of "Hewlett Packard's" factory with these brilliant low cost cases. Contact our Wholesale Department for Bulk Prices.

**KEY OPERATED SWITCH**

HALF PRICE! BE QUICK



19.5mm mounting hole required. Supplied with two keys. Hundreds of applications for security type applications.

\$2500 **\$3.50**

**H0480**  
Size: 200W x 160D x 70H

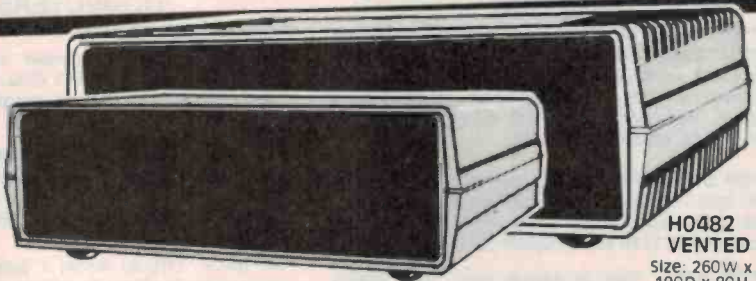

**H0482 VENTED**  
Size: 260W x 190D x 80H

- \* Internal mounting posts enable a wide combination of PCB's, Transformers, etc. to be accommodated (screws supplied).
- \* Removable front and rear panels. Attractive textured finish one side and plain the reverse side. (Enables direct engraving, silk screen printing etc. to plain side.)

- \* Top and bottom split apart for ease of construction or service. Integral feet included.
- \* Great for test Instrument and other high grade projects.
- \* PCB guide rails provided internally allow vertical PCB positioning to several locations.

**LOGIC PROBE**

**Q1272**  
WAS \$29.50



**ONLY \$19.50**

- \* Directly powered from circuit under test (5V) \* Tested to 12.6 MHZ \* DTL/TTL — CMOS Threshold selector \* Circuit loading 30UA approx. \* High-Low — pulse or memory led indication. Impulse

mode pulse length is extended to enable visual observation. In memory mode any detected level is continuously displayed until reset.

**ALTRONICS**

105 STIRLING ST. PERTH — FOR INSTANT SERVICE

**008 999 007** TOLL FREE

**(09) 328 1599** PERTH METRO AREA & AFTER HOURS RECORDED SERVICE  
All Mail Orders: Box 8280, Stirling St, Perth, WA 6000.

**ALTRONICS RESELLERS**

Please note that resellers may not have all the items advertised in stock, and as resellers have to bear the cost of freight, prices may be slightly higher than advertised. ALTRONICS resellers prices should however represent a considerable saving over our competitors' prices.

WA	VICTORIA	QUEENSLAND	SA	NSW	COFFS HARBOUR
<b>COUNTRY</b>	<b>CITY</b>	<b>CITY</b>	<b>CITY</b>	<b>CITY</b>	Coffs Harbour Electronics . . . . . 52 5684
ALBANY	All Electronic	Delsoud P/L . . . . . 229 6155	Protronics . . . . . 212 3111	Avtek Electronics . . . . . 267 8777	<b>GOSFORD</b>
BP Electronics . . . . . 41 2681	Components . . . . . 662 3506	<b>SUBURBAN</b>	Gerard & Goodman . . . . . 223 2222	David Reid Electronics 267 1385	Tomorrows Electronics . . . . . 24 7246
<b>ESPERANCE</b>	Ellistronics . . . . . 802 3499	<b>FORTITUDE VALLEY</b>	<b>SUBURBAN</b>	Jaycar . . . . . 264 6688	<b>KURRI KURRI</b>
Esperance Communications . . . . . 71 3344	MaGraths Electronics . . . . . 347 1122	St. Lucia Electronics . . . . . 52 3547	<b>BRIGHTON</b>	Radio Despatch . . . . . 211 0191	Kurri Kurri Electronics . . . . . 37 2141
<b>GERALDTON</b>	<b>SUBURBAN</b>	<b>PADDINGTON</b>	Brighton Electronics . . . . . 296 3531	<b>SUBURBAN</b>	<b>NEWCASTLE</b>
Geraldton TV and Radio . . . . . 21 2777	<b>BENTLEIGH</b>	ECO Technics . . . . . 369 1474	<b>CHRISTIES BEACH</b>	CARLINGFORD	D.G.E. Systems . . . . . 69 1625
<b>KALGOORLIE</b>	Absolute Electronics. 557 3971	<b>SALISBURY</b>	Force Electronics . . . . . 382 3366	Jaycar . . . . . 872 4444	George Brown & Co. . . . . 69 6399
Today's Electronics . . . . . 21 5212	<b>BOX HILL SOUTH</b>	Colourview Wholesale 275 3188	<b>KESWICK</b>	<b>CONCORD</b>	<b>NOWRA</b>
<b>MANDURAH</b>	Eastern	David Hall Electronics. 208 8808	Freeway Electric	Jaycar . . . . . 745 3077	Vimcom Electronics . . . . . 21 4011
Kentronics . . . . . 35 3227	Communications . . . . . 288 3107	<b>COUNTRY</b>	Wholesalers . . . . . 297 2033	<b>DEE WHY</b>	<b>PENRITH</b>
<b>WYALKATCHEM</b>	<b>CHELTENHAM</b>	<b>CAIRNS</b>	<b>PROSPECT</b>	David Ryall Electronics . . . . . 982 7500	Acorn Electronics . . . . . 21 2409
O & J Pease . . . . . 81 1132	Talking Electronics . . . . . 550 2386	Thompson Instrument Services . . . . . 51 2404	Jensen Electronics . . . . . 269 4744	<b>ENFIELD</b>	<b>PORT MACQUARIE</b>
<b>NT</b>	<b>FOOTSCRAY</b>	GLADSTONE	REYNELLA	Avtek . . . . . 745 2122	Hall of Electronics . . . . . 83 7440
<b>DARWIN</b>	Acron Electronics . . . . . 689 1911	Purley Electronics . . . . . 72 4321	Force Electronics . . . . . 381 2824	<b>HURSTVILLE</b>	<b>RAYMOND TERRACE</b>
Venronics . . . . . 81 3491	<b>SOUTH CROYDEN</b>	<b>NAMBOUR</b>	<b>TASMANIA</b>	Jaycar . . . . . 570 7000	Albark Electronics . . . . . 87 3419
<b>ALICE SPRINGS</b>	Truscott Electronics . . . . . 723 3860	Nambour Electronics . . . . . 41 1604	<b>CITY</b>	<b>LEWISHAM</b>	<b>RICHMOND</b>
Ascom Electronics . . . . . 52 1713	<b>COUNTRY</b>	<b>PALM BEACH</b>	D & I Agencies . . . . . 23 2842	PrePak Electronics . . . . . 569 9770	Vector Electronics . . . . . 78 4277
Farmer Electronics . . . . . 52 2967	<b>BENDIGO</b>	The Electronics Centre. 34 1248	<b>GEORGE HARVEY</b>	<b>MATTRAVILLE</b>	<b>TAMWORTH</b>
<b>ACT</b>	Lindrea & Johnson . . . . . 41 1411	<b>ROCKHAMPTON</b>	Hobart . . . . . 34 2233	Creative Electronics . . . . . 666 4000	Landlink Communications . . . . . 65 4622
<b>CITY</b>	<b>MILDURA</b>	Purley Electronics . . . . . 2 1058	Launceston . . . . . 31 6533	<b>COUNTRY</b>	<b>TOULKLEY</b>
Electronic	Electronic and Digital Services . . . . . 23 3380	<b>TOOWOOMBA</b>	<b>ALBURY</b>	Webb's Electronics . . . . . 25 4066	TES Electronics . . . . . 96 4144
Components . . . . . 80 4654	<b>SHEPPARTON</b>	Hunts Electronics . . . . . 32 9677	<b>BATHURST</b>	<b>WINDANG</b>	Madjenk Electronics . . . . . 96 5086
Scientronics . . . . . 54 8334	GV Electronics . . . . . 21 8866	<b>TOWNSVILLE</b>	Sound of Music . . . . . 31 4421	<b>WINDSOR</b>	M & E Electronic
Australis . . . . . 47 5172		Solex . . . . . 72 2015	<b>BROKEN HILL</b>	Communications . . . . . 77 5935	Crystal TV . . . . . 4803

RESELLERS WANTED IN ALL AREAS (including WA).  
Phone: STEVE WROBLEWSKI (09) 381 7233 for details.

BANKCARD HOLDERS — PHONE ALTRONICS TOLL FREE 008-999-007 FOR NEXT DAY JETSERVICE DELIVERY

BANKCARD HOLDERS — PHONE ALTRONICS TOLL FREE 008-999-007 FOR NEXT DAY JETSERVICE DELIVERY



# MINI-MART

Where readers can advertise  
For Sale/Wanted/Swap Join.

## AUDIO

**FOR SALE.** TWO 1/3 OCTAVE 5000 series graphic equalizers (ETI Nov. 1982). Jaycar kits. Complete, fully wired. Self-powered. \$150 the 2 units. Bern Monaghan, PO Box 259, Bendigo Vic. 3550. (054)43-6308.

**FOR SALE.** GOODMAN 2 way speaker in large 16 cubic foot enclosure. 12 Inch 301 dual cone, 18 inch high range pressure driver, XO/950 crossover, \$270 ono. (02)869-1840.

**FOR SALE:** Two prototype very high quality fixed-bias valve amplifiers. Ideal for electrostatic or 'difficult' speakers. Reason for sale — uneconomic to mass-produce. Sydney (02)51-2221; Melbourne (03)49-3782

**FOR SALE.** Complete, tested 'Blueprint' preamp. Jaycar kit. \$320 ono. Phone David on (002)57-0180 after 3.30pm.

**FOR SALE.** J.H. belt driven turntable, with cover and base. J.H. formula 4 uniplivot arm, XLM low mass cartridges, 15 Hz to 20 kHz. Mind condition, \$190. John Hunt (02)869-1840.

**FOR SALE.** RCA professional monitor using Goodman bass driver, 18 inch high and mid range, pressure unit, 2 way XO/950 crossover, 50 Wrms, incredible sound, \$220 ono. John Hunt (02)869-1840.

**FOR SALE.** ALTEC LANSING studio monitor. 605 duplex, 14 inch dual cone driver, 30 Hz to 18 kHz, 60 Wrms, variable high attenuator, large vented enclosure, superb sound. Sacrifice for \$290 ono John Hunt (02)869-1840.

**FOR SALE.** NAKAMICHI 550 portable cassette recorder. Many superlative features such as trimming. Low battery consumption. Excellent condition, with accessories, \$500. Full critical demonstration available. (045)66-4394.

## MISCELLANEOUS

**FOR SALE.** SONY b/w vision mixer. 6 Video I/Ps, mix, 6 wipes, int/ext key, syncs int/ext. Service manual, extender card, \$150 ono. M. Hartman. (02)630-6313.

**FOR SALE.** HERO 1 educational robot. Complete with arm, speech synthesiser and all documentation. Cost over \$3000. Unwanted prize. Russell Martyn (08)382-5971.

**WANTED.** Discarded I.F. module from colour TV. Phillips model K12A. J. Perdenia, 15 Bovey St, Cooper's Plains, Qld. 4108.

**MEETING:** Sydney FORTH group meets every second Friday of the month at the University of NSW, John Goodsell Building, (commerce) Room LG19 at 7pm.

## COMMUNICATIONS

**FOR SALE.** TIME MARK GENERATOR and copy of radio and electronic laboratory handbook by Scroggie and Johnstone. David, P.O. Box 316, Manly NSW 2095. (02)938-3417.

**WANTED:** Correspondence with TV-DXers on setting up a receive station and TV-DX in general. Richard Jary, 18a Carlton Crescent, Kogarah Bay NSW 2217. (02)546-6905.

## COMPUTERS

**FOR SALE.** S100 Computer system, DGZ80 CPU, ETI-640 VDU, ETI-681 PCG, 48K RAM, keyboard, power supply and monitor, only \$400 ono. A. Hulsh, (047)30-1805.

**FOR SALE:** ATARI 400. 32K RAM, BASIC plus assembler language. Datacassette, tapes, cartridges, books. All as new \$600. Peter Gray, 19 Wallace St, Kotara, Newcastle, NSW 2288. (049) 57-3354.

**FOR SALE:** TRS-80 Model 1 software. Over 40 games, write to Craig Sedgwick, 7 Eyre St, Chifley, NSW 2036.

**FOR SALE.** MICROBEE software. Wimbledon Tennis. Tape and listing only \$5. Order now or send SAE for catalogue. T. Knowler, 9 Waterman Place, Fraser, ACT 2615.

**FOR SALE:** S100 boards, I/O two serial and nine parallel \$225. Z80 CPU board with serial port, \$299 (new price \$410). Manuals. (07)354-1349 after 6 pm.

**FOR SALE.** Shugart 8" drive new \$200, ETI 632 VDU and keyboard mounted in case \$100. SC/MP demo unit \$50. R. Adams, Reid's Way, Wooragee Vic 3747. (057)28-7217.

**FOR SALE.** VIC 20 (8K) Monitor, stand, datasette, many books, programs. Items retail in excess of \$1000. Urgent sale. Sell for \$450. Craig Wegg, 36 Baird St, Arrarat Vic 3377 (053)521-1472.

**FOR SALE.** 8 HM6116P-3 CMOS 2K RAM by eight bit chips. Excellent for 16K conversion for ZX 81 or Microbee. Cost \$90, will sell for \$55. Frank Papadopoulos, 13 Kroombit St, Dulwich Hill NSW 2203. (02)558-8636.

**FOR SALE ZX SPECTRUM software.** Space Raiders, Penetrator (48K), Haunted Hedges, Schizoids, Planet of Death. \$13 ono. Frank Papadopoulos, 13 Kroombit St, Dulwich Hill NSW 2203. (02)558-8636.

**FOR SALE.** APPLE program. Teach yourself mathematics. Send disk and \$5. Ian McGregor, 33 Cremin Street, Mt Gravatt, Brisbane NSW 4122. (07)343-2459.

**FOR SALE TI99/4A Home computer with extended basic, speech synthesiser and game cartridge.** Retail value \$430. Will sell for \$350 ono. Phone Peter(076)93-7119.

**FOR SALE.** MICROBEE software: Mrs Pacman, excellent graphics and sound, three different mazes, floating fruits, \$14.99. Khanh Doan, 718 Beauford St, Mt Lawley WA 6050.

**FOR SALE.** TELETYPE model 15. 110 V 50 Hz, as used in ETI Oct. 83. Has RS232 interface, software for 6502 Superboard and 120 page manual. \$50 Knoxfield. (03)763-5983 a.h.

**FOR SALE.** SORCERER MK II 48k, sub-system disk drive, WORD PROCESSOR PAK, 24K Extended BASIC, lots of other software. \$1900 K. Meyer, 26 Station St, Schofields NSW 2762. (02)627-2510.

**FOR SALE:** DICK SMITH WIZZARD, 8 Cartridges plus BASIC, data cassette, book of programs. Sell \$500 ono. Michael Janoska (08) 258-4960.

**FOR SALE:** BURROUGHS B800 16-bit minicomputer, 128K memory, printer, circuit diagrams, spares, Urgent sale, bargain at \$400. Kevin, (063)33-5290 (free call) b.h.

**FOR SALE.** ZX 81 Memotech HRG. Near new. \$70. John (02)599-1180.

**FOR SALE.** VIC 20 program library. High quality games, utilities, educational and miscellaneous programs available. Send SAE to Chris Groenhout, 25 Kerferd St, Watson ACT 2602 for list.

**FOR SALE:** SORCERER Mk 2. 48K with Green Screen monitor, Exidy double density disk drives with software and all accessories. \$1300. H. W. Gilbert, 65 Wilks St, Cairns, Qld. 4870. (070) 54-5861.

**FOR SALE.** EXCALIBUR BASIC Monitor. Display formats include Hex, Decimal and ASCII. Cassette \$9.95 including postage. L. Adney, 5 Baringa Ave, Seaforth, NSW 2092. (02) 949-1730.

**FOR SALE:** DGZ80, DG640, cassette interface, keyboard, bare S100 motherboard plus software dissem, edit assem, BASIC and three games tapes, all documentation, \$250. Paul (085)56-8340.

**FOR SALE:** ETI-660. 3K. Colour expansion. Excellent condition \$120 ono. TI59 programmable calculator, including manual, recharger, case \$75. Benjamin Begg, 18 Sturt Ave, Toorak Gardens, SA 5065. (08) 31-0310.

**FOR SALE:** NEC Advanced Personal Computer. Dual Disk monochrome Includes word processor, Spreadsheet and BASIC disks plus extras. \$4000. Paul Cameron, 193 Chuculba Crescent, Giraiang, ACT 2617. (062) 41-3926.

**FOR SALE.** CASIO PB-100 software: arcade and adventure games. Send SSAE for free catalogue to J. A. Scott, 904 Hamilton Rd, McDowall Qld. 4053.

**FOR SALE.** ACT VIC 20 bimonthly magazine. Many interesting articles and programs. June issue \$2.00. Bimonthly \$12 per year. Write to Chris Groenhout, 25 Kerferd St, Watson ACT 2602.

**FOR SALE.** MICROBEE Parallel "Centronics" printer cable, ready-to-go. No messy interface board, electronics contained in rear of Centronics plug, one metre cable \$36.00. David (02)47-9153 after 6pm.

**FOR SALE:** 9 slot S100 card cage. Power supply \$120, 16K static ram \$100 \$80, Big-Z Jace Z80 S100 CPU board with 10 and ROM \$120 ono R.H. (02)398-7224.

**FOR SALE.** SUPERMON for Atari. Stick-port printer-handler. Includes revision 'B' O.S. with extras such as CR. 13/13/14/15 and much more. For full information write now. RR for 400/800 \$89. For 600/800 XL \$99. Supermon, P.O. Box 507, Beenleigh, Qld. 4207. (07)209-7891.

**WANTED:** INFORMATION about the System 80. Software, anything else of interest. Contact R. Schatz, P.O. Box 17, Koorawatha, NSW 2807.

**WANTED:** ADDRESSES of suppliers of Commodore 64 software. Write to D. Hamilton, 32 Miro St, Young NSW 2594.

**WANTED.** TRSDOS for a model 1 level 2 TRS-80 with manuals. Paul Spresser, 2nd Field Supply Battalion, Lavarack Barracks, Townsville Qld 4813. (077)71-7760.

**WANTED MICROCOMPUTER evaluation kits, working or not (e.g. Motorola D2, D3, dream) any others, or peripheral devices considered.** J. Facci, 14 Fashoda Street, Hyde Park SA 5061.



**SWIVEL BASE MONITORS FROM \$179 THIS MONTH**

**WHAT'S NEW AT  
ROD IRVING ELECTRONICS**

Ritron 11 Monitors are now available to increase our range of Data Displays. They feature a unique adjustable swivel base that tilts forward or back 30 degrees and swivels right to left 60 degrees. Technical specifications are listed below:

**SPECIFICATIONS — CRT SIZE:** 12 inches non-glare 90 degree deflection. **INPUT SIGNAL:** 1.0-2.5V p-p composite video signal. **INPUT IMPEDANCE:** Normal 75ohm, high approx 50K ohm. **INPUT TERMINALS:** RCA, phone jack. **RISE TIME AND FALL TIME:** Less than 25 us. **VIDEO BANDWIDTH:** 20 MHz ± 3dB. **SCANNING FREQUENCY:** Horizontal, 15.75KHz ± 0.5KHz; Vertical, 50Hz/60Hz; Horizontal Retrace Time, Approx 8.5us; Vertical Retrace Time, Approx 800us. **PHOSPHORS AVAILABLE:** Amber, Green. **RESOLUTION:** Centre, 1000 Lines; Corner, 800 Lines; Geometric distortion, 2% or less; Linearity, less than 2%. **CONTROLS:** Front, POWER ON/OFF, brightness contrast; Rear, V-Hold, H-Hold, V-Line, V-Size.



**AVAILABILITY:** Green Phosphor in Stock \$179.00  
Amber Phosphor Early March \$199.00  
**SCHOOL AND DEALER ENQUIRIES WELCOME**

**APPLE™ COMPATIBLE DISK DRIVE SPECIFICATIONS**

**HIGH-SPEED ACCESS, HIGH ACCURACY POSITIONING** Instead of plastic CAM positioner or lead screws positioner, a high microprecision metal band positioner is adopted in the mechanism to position the head.  
**BRUSHLESS DC DIRECT-DRIVE MOTOR** Direct drive means that there is no improper belt seating, so the variations in speed and friction-producing side loading can be eliminated, which allows motor running lifetime to be over 10,000 hours.  
**MOTOR CLOSED LOOP SERVO** Hall effect devices are utilized as speed control sensor in DC motor system, so motor can run stably and accurately.  
**SLIM, HALF-HEIGHT DRIVE** The disk drive is only 41mm high, it is only half the size of conventional models.  
**NO CONTACT WRITE-PROTECTED SENSOR** Photo coupler is used as write-protected sensor. It means no damage, long lifetime and good reliability for disk media.

**GENERAL SPECIFICATIONS**  
Capacity (formatted) 163K (20K bytes more than the original)  
No. of tracks 40 tracks (5 tracks more)  
No. of sectors track 13 to 16 sectors  
Disk rotation speed 300 rpm  
Track density 48TPI  
Track to track time Less than 6 msec

**\$349.00**

**INCLUDES CONTROLLER CARD**

**BARE DRIVE & CASE**

**\$299.00**



**New Silent Drives On The Way—Ring For A Price**

**OTHER CARDS ALSO AVAILABLE. ASK AT OUR CITY STORE.**

**DO YOU NEED A CASE FOR A SINGLE BOARD COMPUTER**

This stylish low profile case will give your system the professional look it needs. This case comes complete with an encoded, parallel output keyboard. The keyboard is in its own case attached via a coiled connector, so it can be placed for maximum comfort. Sit one of our new swivel monitors on top and make your system look like it's worth thousands. Cut outs are for 2 x 5 1/4in Slimline disk drives. **GREAT FOR SINGLE BOARD COMPUTERS, TERMINAL CARDS, ETC.**

**CASE AND ENCODER KEYBOARD \$249.00 Tax Ex \$199.00**

**Dimensions:**  
Box W 450mm D 295mm H 110mm  
Box Cat. No. X11080

**Dimensions:**  
Keyboard W 450mm D 195mm H 40 (28mm)  
K/B Cat. No. X11081

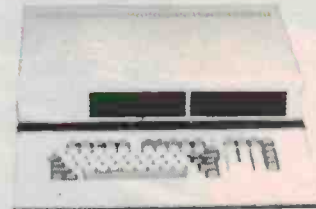

ERRORS AND OMISSIONS EXCEPTED

**NEW VIDEO MONITORS**  
Get a clear honest image!  
Computer data and graphic displays never looked better, brighter, sharper.  
**High Resolution**  
• Recommended Display Characters: 1920 (80x24)

**SCHOOL AND CLUB BULK BUYS**  
Please ring for pricing

**GUARANTEED for 12 months by Rod Irving**

- High quality non-glare CRT
- Compact and Lightweight with all Controls Inside Front Panel
- All units 100% Factory Burned in
- 800 lines centre resolution
- Suitable for Apple™ — and other computers. (Apple is a registered trademark of Apple Computer Company Inc)
- Green or Orange Phosphor available
- 18MHz
- First shipment arriving middle of June, 1983
- Direct Import Price for June

Green Phosphor \$189 (\$162 Exempt)  
Orange Phosphor \$199 (\$179 Exempt)

**'THE PRINTER PEOPLE' SPECIALS**

**AS REVIEWED BY EA NOVEMBER '83**

**THESE ARE THE REAL THING. NOT A CHEAP SUBSTITUTE.**

**A NEW PRINTER NOW!  
CP-80/I,  
80-COLUMN  
IMPACT PRINTER**

**SPECIFICATIONS**

**Functional Specifications**

Printing method — Serial impact dot matrix. Printing format — Alpha-numeric — 7 x 8 in 8 x 9 dot matrix field. Semi-graphic (character graphic) — 7 x 8 dot matrix. Bit image graphic — Vertical 8 dots parallel horizontal 640 dots serial line.  
Character size — 21mm (0.083")-W x 2.4mm (0.09")-H 7 x 8 dot matrix.  
Character set — 228 ASCII characters. Normal and italic alpha-numeric fonts, symbols and semi-graphics.  
Printing speed — 80 CPS 640 dots/lines per second.  
Line feed time — approximately 200 msec at 4.23mm (1/6") line feed.  
Printing direction — Normal — Bidirectional logic seeking. Superscript and bit image graphics — Unidirectional left to right.  
Dot graphic intensity — Normal — 640 dots 190.5mm (7.5") line horizontal. Compressed characters — 1,280 dots 190.5mm (7.5in) line horizontal. Line spacing — Normal — 4.23mm (1/6"). Programmable in increments of 0.35mm (1/72") and 0.118mm (1/216").  
Columns/line — Normal size — 80 columns. Double width — 40 columns. Compressed print — 142 columns. Compressed double width — 71 columns. The above can be mixed in a line.  
Paper feed — Adjustable sprocket feed and friction feed.  
Paper type — Fanfold Single sheet. Thickness — 0.05mm (0.002") to 0.25mm (0.01"). Paper width — 101.6mm (4") to 254mm (10").  
Number of copies — Original plus 3 copies by normal thickness paper.

**Mechanical Specifications**

Ribbon — Cartridge ribbon (exclusive use), black.  
MTBF — 5 million lines (excluding print head life).  
Print head life — Approximately 30 million characters (replaceable).  
Dimensions — 377mm (14.8")-W x 295mm (11.6")-D 125mm (4.9")-H incl sprocket cover.



**500 NOW SOLD**

**NEW DELUXE PRINTER NOW SUPPLIED**

**Parallel CP 80 \$379**

**Serial CP80 \$559**

**2000 Sheets "Keen Edge" Paper \$39.50**

**GREAT VALUE**

**ROD IRVING ELECTRONICS**

425 High St., Northcote, Vic. 48-50 A Beckett St., Melb., Vic.  
Phone (03) 489 8866, (03) 489 8131, Mail Order Hotline (03) 481 436  
Mail orders to P.O. Box 235 Northcote 3070 Vic.

Minimum P & P \$3.00. Errors & omissions excepted. Please address tax exempt, school, wholesale and dealer enquiries

**RITRONICS WHOLESALE**

1st floor 425 High St. Northcote 3070 (03) 489 7099 (03) 481 1923  
Telex AA 38897

**DEALER ENQUIRIES ESPECIALLY WELCOME ON ALL THESE PRODUCTS**



# DREGS



Here at ETI, the recent SMPTE conference made us reflect on the history of television. In the beginning (as all proper pontifical palliatives begin) television was monochrome. Looking for a sales gimmick the Americans converted to NTSC colour (never twice the same colour). The French, running a good second, managed to generate the SECAM system (Something Essentially Contrary to the American Method). The British, last as usual, staggered home with the PAL system (peace at last!).

Speaking of which, I must remark that one of my pet hates is Jargon. You might have heard of 'high' technology (what Barry Jones is fond of), 'low' technology, (what Indians have when they're not launching satellites), and 'state of the art' (what Big

Ben will have when they put out an edible meat pie). But what, I want to know, is "recumbent technology". New Scientist magazine says that it is a term applied to the development of bicycles whose riders lie on their backs instead of sitting up on a saddle. I think it is a discovery made by the two gentlemen from the gas board who spent two days digging a three metre long trench outside my house.

And speaking of different types of technology, how about useless technology. The Japanese firm Sony has just introduced a TV set that produces a mirror image picture, i.e: on the flick of a switch it transposes the left hand side of the picture to the right, and vice-versa. Readers of ETI with nothing better to do during the next half

hour might like to figure out why anybody would want such a modification to their TVs. No prizes for the most creative solution!

Finally, there must be many young men out there who, at this point in their lives are wondering about the direction their careers should take. Our advice is don't go in for electronics, get into politics instead. We have just heard that the European parliament has decided that Europe needs a population increase. A report has called on members to examine the practical measures by which the birth rate can be increased. I'm sure that if ever the good members feel the task a little beyond them there must be readers of Dregs who will do all the examining necessary. ●



# Ladies and gentlemen, be seated. (While you tune your receiver)

The best place to tune your receiver is where you listen to it, sitting down.

And with the new Yamaha R100 you can do exactly that.

Its unique remote control gives you push button command over the R100's Computer Controlled Sound System which allows you to select from five different preset frequency response curves.

And that's in addition to all input functions like phono, video auxilliary, tuner and both tape monitors as well as remote selection of any one of ten preset AM and FM stations.

The tuner itself has Computer Servo Lock Tuning to automatically select the optimum signal, a Dynamic Noise Canceller for exceptionally quiet, noise free reproduction from tape, disc or tuner and a Stereo Spatial Expander to broaden the total stereo sound field.

The new Yamaha R100 is literally the 'state of the art' in stereo receivers, a phrase often used by others but a level of perfection only Yamaha builds to.

And as with all Yamaha audio equipment, the R100 is covered by Yamaha's unique 5 year full parts and labour warranty.

For a free brochure on the remarkable Yamaha R100, see your Yamaha dealer or clip the coupon below.

Post to: Yamaha R100 Receiver Brochure,  
Rose Music Pty. Ltd. 17-33 Market Street,  
South Melbourne, Vic 3205.

Name .....

Address .....

Postcode .....

# YAMAHA

MCR RM 5155





# If you thought you couldn't afford the famous TRIO KENWOOD quality...

## ...Think again!

For a limited period Parameters is offering TRIO oscilloscopes at special low prices. Here's your chance to own one of these leading brand oscilloscopes at a price you can afford.

**CS-1022 20MHz**      **\$649.00 Plus Tax**  
\$746.35 including tax

An economical dual trace scope packed with facilities. This scope is becoming the standard for routine work and for discerning amateurs.

**CS-1040 40MHz**      **\$1175 Plus Tax**  
\$1351.25 including tax

**CS-1060 60MHz**      **\$1495.00 Plus Tax**  
\$1719.25 including tax

3 channels, 6 traces. High bandwidth, high performance, portable scopes for communications and digital work. 1mV sensitivity — All new design.

**CS-2075 70MHz**      **\$1995.00 Plus Tax**  
\$2294.25 including tax

A truly professional scope offering a 70MHz bandwidth and a thoroughly modern design at a very attractive price.

**CS-2110 100MHz**      **\$2495.00 Plus Tax**  
\$2869.25 including tax

4 channels and 8 traces in our top of the line 100MHz scope.

Offers all the sensitivity and bandwidth for practically any job.

### Personal Buyers

Take advantage of our direct mail offer. If you are not completely satisfied with your oscilloscope return it to us, undamaged and in its original packaging, within 10 days for a complete refund.

\* These prices all include delivery anywhere in Australia.

Probes Model 88100 100MHz switchable Greenpar probes to suit all the above scopes.

**\$33 Plus Tax**  
\$39.60 including tax

Available at leading stockists  
\* Valid to 31st July, 1984



Parameters Pty. Ltd.  
Sydney: 41 Herbert St., Artarmon, N.S.W. 2064. Phone: (02) 439 3288  
Melbourne: 53 Governor Rd., Mordialloc, Vic. 3195. Phone: (03) 580 7444

PAR380



**SPECIAL OFFER**  
Free Model 601 DMM with every CS-1022 or CS-1040 purchased\*  
Free Model 7040 DMM with every CS-1060, CS-2075 or CS-2110 purchased\*

### Company Purchasers

Either attach the coupon below to your purchase order and mail (credit facilities are available to current account customers). Or should you wish to arrange a demonstration please contact us direct.

### Local Purchasers

We have set up a special demonstration area at our Sydney and Melbourne offices for your convenience. Come in any time and choose the model to suit your needs. Talk to our expert staff and get their free advice.

## ORDER FORM



Please supply the following oscilloscope(s). I understand that I will receive a FREE digital multimeter with every scope purchased.

Qty.	Model	Price	Tax*	Amount
.....	CS-1022	\$649.00	\$97.35	
.....	CS-1040	\$1175.00	\$176.25	
.....	CS-1080	\$1495.00	\$224.25	
.....	CS-2075	\$1995.00	\$299.25	
.....	CS-2110	\$2495.00	\$374.25	
.....	88100 Probes	\$33.00	\$6.80	
Total				_____

- My cheque is enclosed  
 Bill my Bankcard\*\* No. ....  
 My company order is attached (credit terms available to current account customers only.)

Name: .....

Address: .....

SIGNATURE .....

\*\* Bankcard purchasers must provide full street address (no P.O. Box numbers).  
 \* Delete if not applicable (sales tax number and office exemptions required).  
 Detach and mail to Parameters Pty. Ltd., P.O. Box 573, Artarmon, N.S.W. 2064.