

MAY 1983

\$2.35* NZ \$2.75



ELECTRONICS
TODAY
INTERNATIONAL

VIDEO
RECORDER
HEAD CLEANERS
Demons for dirt or damage?

The MICROPROFESSOR II

*New star in home computer
stakes?*



0-40V / 5A LAB SUPPLY

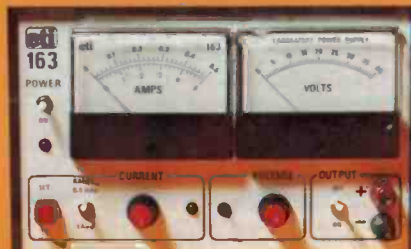

*Top specs, fully protected,
volts and amps metering
variable current limit*

**VIC-20
COLUMN**



**SCANNER ANTENNAS
PHONE PATCH FOR HAMS**

The range of Hi-Fi equipment you thought was beyond your means is now within your grasp.

RECEIVERS

SEPARATE AMPS

CASSETTE DECKS

The Yamaha separate amplifier series is designed specifically for the truly sound-conscious audiophile who will accept nothing but the ultimate in reproduction purity and precision. Yamaha separate amps also offer extensive summing facilities, permitting you to choose and adjust the sound to your taste. That is perfect for your home.

Cassette decks employ an original "low-impedance" head design. The use of specially selected coil windings are used, as compared to conventional decks. In this way, its response to transients is greatly improved.

- INTEGRATED AMPS
- TUNERS
- CASSETTE DECKS
- TURNABLES
- RECEIVERS
- SEPARATE AMPS
- SPEAKERS
- CARTRIDGES
- HEADPHONES
- SYSTEM COMPONENTS

A Hundred Years of Musical Experience



Please send me the latest Yamaha Hi-Fi catalogue.

Name _____

Address _____

Postcode _____



Yamaha Hi-Fi Division, Rose Music Pty. Ltd.,
17-33 Market St., South Melbourne, Victoria. 3205.

advertisers

Applied Technology . . .	102, 103, 109, 110
Altronics	6, 7, 30, 31, 70, 71, 79
Adaptive Electronics	98
Audio Engineers	114
Bertas	101
Bishop Systems	87
Communications Power Inc	124
Classifieds	15,
Commodore	112, 113
C & K Electronics	17
Dick Smith	106-107
Daneva Australia	104
Electronic Agencies	95
Elmeasco	81
Emona	93
Ferguson	34
George Brown	10-11
G.S. Webber	104
Goldring	117
Imark	21
Jaycar	16, 22, 23, 29, 46, 47, 52, 53, 58, 59
K-Nar	111
Magraths	12
Marantz	IBC
Maurice Chapman	127
McWilliams	128
National Panasonic	122, 123
Pre-Pak	99
Rose Music	IFC
Rod Irving	4, 45, 48, 51, 68, 73, 74, 82
Sanyo	120
Scientific Devices	15
Software Source	89
SME Electronics	86
Sony	OBC
Vendale	97

features

- 17 **Voyager Car Computer Contest Results** Five lucky winners
- 18 **Scanner Antennas** A guide to antenna types, making your own & erecting them
- 24 **The Micro-Grasp Robot Arm, Part 2** Building the interface board, setting up

projects and technical

- 24 **648: The Micro-Grasp Robot Arm, Part 2** Completing the project
- 32 **323: Headlight Delay Unit** After you park, see your way in the dark
- 39 **163: 0-40V/5A Lab. Supply** Lab-standard variable voltage & current supply
- 49 **164: Zener Tester** Handy add-on for your multimeter
- 54 **Lab Notes: How to Use DVM Modules, Part 2** Measuring temperature, frequency. . .
- 67 **Ideas For Experimenters** Blown fuse indicator, touch motor control . . .
- 75 **734: The 'Phony Patch' landline interface** Be ready for 'phone patch
- 80 **Shoparound** Where to buy kits, components, pc boards & panels for projects

computing today

- 83 **That Was the PC Show That Was . . .** '1st Australian PC show' review
- 90 **The Microprofessor II** Taking a leaf from the Apple tree
- 96 **16K to 32K Conversion for the MicroBee** Do it yourself & save
- 100 **The VIC-20 Column** More software for VIC fans
- 105 **'660 Software** 'Print' routine & example program
- 108 **MicroBee Column** Clock & Timer, Random numbers exploration

sight & sound

- 115 **Buying a CD System?** Magnat plasma loudspeaker, Marantz portables
- 118 **Video Cassette Recorder Head Cleaners** Demons for dirt or demons for damage?

news

- 8 **News Digest**
- 13 **Equipment News**
- 14 **Component News**
- 72 **Communications News**
- 84 **Printout**
- 116 **Sight & Sound**

contests and special offers

- 69 **Idea of the Month Contest**
Easy to enter — \$90 prize to win

general

- 28 **Mini-Mart**
- 35, 63 **Mail Order Books**
- 127 **Subscriptions, Back Issues — order form**
- 130 **Dregs**

Registered by Australia Post —
Publication No. NBP0407
ISSN No. 0013-5216



Our two big features this month are a review of the Microprofessor II, which features software compatibility with the Apple II, and our new lab supply project, the ETI-163.

Microprofessor II picture courtesy of Emona, power supply picture by staff photographer, John Knight.

Cover design by Ali White.

ROD IRVING ELECTRONICS

425 HIGH STREET, NORTHCOTE 3070, MELBOURNE, VICTORIA. Ph (03) 489 8131. Telex No. 38897



**ETI-268 NICAD
FLOAT CHARGER**
Keep your NiCad batteries
in tip-top condition with this
cheap, simple charger.



**ETI-1512
ELECTRIC FENCE
TESTER**

Electric fence **\$17.50**



**Check
our
prices**

SEPTEMBER EA 1982

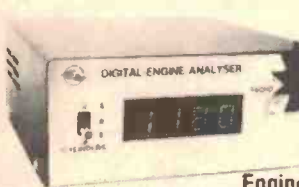

\$48.50

Engine Analyser Kit

12/240 volt Inverter



\$55

Dual Tracking Power Supply

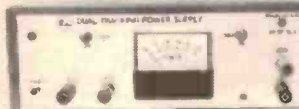

\$83.50

\$79.50

Function Generator



APRIL EA 1982

EA DIGITAL READOUT FOR
SW RECIEVERS

Short form without case **\$49.50** **\$70**



OCTOBER EA 1982

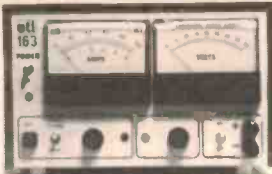

ETI-163 LAB SUPPLY

Fully variable 0-40 V current limited
0.5 A supply with both voltage and current
metering (two ranges: 0-0.5 A/0-5 A).
This employs a conventional series-pass
regulator, not a switchmode type with
its attendant problems, but dissipation
is reduced by a unique relay switching
system switching between taps on the
transformer secondary.

THIS MONTHS KITS



**ETI-323 HEADLIGHT
DELAY UNIT**

Park your car and turn off the lights.
Can't see where you're going? Press
the button and the headlights come on
to light your way, switching off auto-
matically after 50 seconds. This is a
simple, easy to build, low cost project.

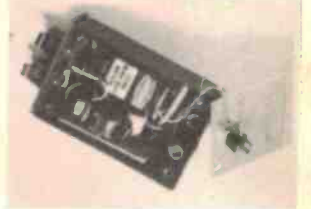

ETI-164 ZENER TESTER

A simple, low cost add-on for your
multimeter. This checks zeners and
reads out the zener voltage directly on
your multimeter. It can also check LEDs
and ordinary diodes.

**ETI-335 PUSHBUTTON-PROGRAMMABLE
WIPER CONTROLLER**



**ETI-162 30 V/1 A FULLY PROTECTED
POWER SUPPLY**



\$47.50

Tacho/dwell meter with digital display



\$69

MAY EA 1982

Eprom
Programmer



\$55.00

JANUARY EA 1982



\$55.00

SEPTEMBER EA 1982

Portable 3 1/2 Digit Heart Rate Monitor

JULY EA 1982



\$85.00



HELP HEART MONITOR

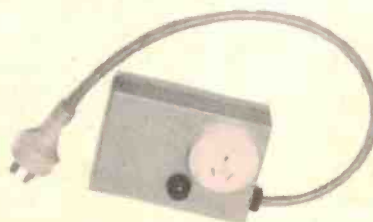

**ETI-1515 DRILL/BLENDER
SPEED CONTROLLER**

**ETI-654 APPLE II ANALOGUE/DIGITAL
INTERFACE**

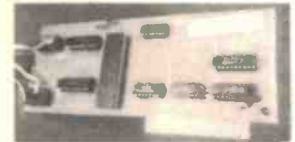

**ETI-334
AUTO TESTER**



**ETI-668
MICROBEE EPROM
PROGRAMMER**



\$47.50

Ultrasonic Rule



\$49.00

AUGUST EA 1982

**ETI-733
RADIOTELETYPE
CONVERTER
FOR THE
MICROBEE**

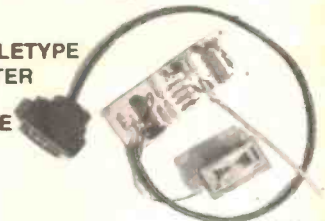

\$189.00

Analogue and Digital Storage CRO Kit

100w Sub-Woofers
Amplifier

\$85.00



JULY EA 1982

EA ELECTRONIC STARTER
FOR
FLUORESCENT
LAMPS



\$5

OCTOBER EA 1982

Minimum P & P \$3.00 for kits

eti

Editor
Roger Harrison VK2ZTB

Technical Editor
David Tilbrook VK2YMI

Assistant Editor
Jennifer Whyte B. App. Sc.

Editorial Staff
Geoff Nicholls B.Sc./B.E.
Jonathan Scott
B.Sc./B.E. (Hons) VK2YBN
Jan Vernon B.A.

Draughting
David Currie

Advertising Production
John Gerrie

Advertising Sales
Bob Taylor (Group Manager)
John Whalen (National)

Art Staff
Ali White B.A.
Bill Crump
Githa Pilbrow

Typesetting
Julie Hewlett

Reader Services
Jane Nicholls

Managing Editor
Collyn Rivers

Acoustical Consultants
Louis Challis & Associates

Editorial and Sales Office
140 Joynton Ave. Waterloo NSW 2017
Ph: (02)663-9999; Tlx FEDPUB AA74488

Melbourne: Virginia Salmon and Mel Godfrey,
150 Lonsdale St. Melbourne Vic. 3000.
Ph: 662-1222; Tlx AA34340.

Adelaide: Admedia Group, 24 Kensington Rd.
Rose Park SA 5067. Ph: 332-8144;
Tlx AA82182.

Brisbane: Geoff Horne Agencies, 16 Bellbowrie
Centre, Bellbowrie Qld 4070. Ph: 202-6813.

Perth: C. Thomas, Adrep Advertising
WA 6000. Ph: 325-6395; Tlx ADREP PERTH.

New Zealand: Steve Edgar, Circulation
Marketing Manager, c/- Collector Publications,
Box 7118, Auckland. Ph: 546-380; Tlx Archcol
NZ 21217.

United Kingdom: Australian Consolidated
Press, Ludgate House, 107 Fleet St, London
EC4A 2AL. Ph: 353-1040; Tlx: 267163.

Japan: Genzo Uchida, Bancho Media
Services, 15 Sanyocho, Shinjuku-Ku, Tokyo
160. Ph: 359-8866; Cable: Elbanchorito;
Tlx: BMSINC J25472 Tokyo.

USA: Australian Consolidated Press, 21 East
40th Street, (Floor 23), New York NY 10016.
Phone: (212)685-9570.

Electronics Today International is published
by The Federal Publishing Company Proprietary
Limited, 140 Joynton Avenue, Waterloo NSW
2017. (02)663-9999. Telex AA74488
'FEDPUB'. This issue was printed by ESN,
The Litho Centre of 140 Joynton Avenue,
Waterloo NSW 2017. (02)662-8888. Distributed
by Network Distribution Company.

Recommended retail price only

SINCE MOVING PREMISES in February, our telephone technical enquiry service has not been what it was in the past as we had no suitable telephone facilities for over two months. However, our new technical enquiry telephone has been installed and been in use for some weeks by the time you read this. If you are having difficulties with one of our projects or technical features, you can phone technical staff after 4.30 pm (eastern standard time) Mondays to Thursdays on the following number:

ETI Technical Enquiries 662-4267

If you find it engaged, keep trying until the line is free. Unfortunately, we cannot take technical enquiries prior to that time as, otherwise, the staff would have little time to develop the projects you enjoy

New artwork service

With this issue we introduce a new service for printed circuit and front panel artwork for readers wishing to make their own pc boards and panels. In the past, we have printed the artwork in the magazine, where possible, with a page in blue behind so that readers could make their own negative 'phototool' from Scotchcal 8007 film. Where this was not possible we either published the artwork with the article or made prints available to readers who sent a stamped addressed envelope.

From this issue, we can offer readers negative or positive film transparencies of pc board and panel artwork for all projects, except those where copyright is retained, for a cost between \$1 minimum and \$20 maximum. The charge is worked out on an area basis. For artwork that totals less than about 100 square centimetres (pc board and panels combined) — this covers the greater number of our projects — the charge is 4 cents/cm². For artwork that totals above this area, the charge is 2½ cents/cm². Artwork will be sent post free. At present, we can only offer this service for projects from this issue onwards. A note with each project will advise the availability of artwork and the cost. We may be able to offer this service for some past projects at a later date.

This service in no way supercedes the availability of pc boards and panels from those suppliers who choose to stock them. The service is provided for those readers who, for the satisfaction of it, wish to make their own pc boards and Scotchcal panels. The provisions of the Copyright Act, published below, still apply. Note that breach of the Copyright Act is a criminal offence.

Roger Harrison
Editor

services

Technical enquiries: We can only answer readers' technical enquiries by telephone after 4:30 pm Mondays to Thursdays. The technical enquiry number is (02)662-4267. Technical enquiries by mail must be accompanied by a stamped, self-addressed envelope. There is no charge. We can only answer queries relating to projects and articles as published. We cannot advise on modifications, other than errata or addenda. We try to answer letters as soon as possible. Difficult questions may take some time to answer.

General enquiries: For enquiries about back issues, photostats of articles, artwork or submitting articles, call (02)663-9999 or write to the address on this page.

The publisher accepts no responsibility for unsolicited manuscripts, illustrations or photographic material.

COPYRIGHT: The contents of Electronics Today International and associated publications is fully protected by the Commonwealth Copyright Act (1968).

Copyright extends to all written material, photographs, drawings, circuit diagrams and printed circuit boards. Although any form of reproduction is a breach of copyright, we are not concerned about individuals constructing projects for their own private use, nor by pop groups (for example) constructing one or more items for use in connection with their performances.

Commercial organisations should note that no project or part project described in Electronics Today International or associated publications may be offered for sale, or sold in substantially or fully assembled form, unless a licence has been specifically obtained so to do from the publishers, The Federal Publishing Company, or from the copyright holders.

LIABILITY: Comments and test results on equipment reviewed refer to the particular item submitted for review and may not necessarily pertain to other units of the same make or model number. Whilst every effort has been made to ensure that all constructional projects referred to in this edition will operate as indicated efficiently and properly and that all necessary components to manufacture the same will be available no responsibility is accepted in respect of the failure for any reason at all of the project to operate effectively or at all whether due to any fault in design or otherwise and no responsibility is accepted for the failure to obtain any components parts in respect of any such project. Further, no responsibility is accepted in respect of any injury or damage caused by any fault in the design of any such project as aforesaid. The Publisher accepts no responsibility for unsolicited manuscripts, illustrations or photographic material.

next month



THE 'SURE START' MODEL ENGINE IGNITION SYSTEM

The tiny combustion engines used in model aeroplanes, cars and boats employ a 'glow plug' to ignite the fuel. This is simply a tiny, screw-in plug with a resistive heater element that sits inside the top of the combustion chamber of the engine. When a dc source (usually a battery) is applied to it, the element glows, the heat aiding ignition of the fuel when the motor is turned over.

Problem is, they tend to burn out with regularity. Expensive, and a nuisance. This project regulates the 'juice' applied and the temperature of the element, preventing burn-outs and ensuring proper ignition.

ADD-ON TEMPERATURE SENSOR FOR MULTIMETERS

Another simple add-on project for your multimeter, particularly suited to digital multimeters. This unit is simple to build and can be arranged to read directly in degrees Celsius, degrees Kelvin, or degrees Fahrenheit.

BIPOLAR PROM PROGRAMMER

Have you ever been designing a project and wished you had a custom decoder or simple programmable logic array to reduce the chip count and circuit complexity? How about using a 7-segment LED display to show more than the usual 0-9 digit information?

All these applications and many more can be addressed by one versatile IC known as the Schottky Bipolar Programmable Read-Only Memory. They are produced by many manufacturers in pin-compatible forms and are widely available through normal suppliers. This project can be used to program types: 74S188/288, 77S188/288, 27S18/19, 6330-1 and 6331-1, 82S23 and 82S123.

USING OPTOCOUPLER DEVICES

Next month's Lab Notes covers a range of applications and gives data for commonly available optocoupler devices, including: 4N26, 4N28, MCT2, MCT6, 4N23, 6N139 and MOC3020. Such versatile, useful devices — not to be missed!

Although these articles are in an advanced state of preparation, circumstances may affect the final content. However, we will make every attempt to include all features mentioned here.

MICRON 30 WATT

This brilliant little 30 watt iron is just the "bee's knees" for the electronics hobbyist, electrician or home handyman. We searched the world for a low cost yet quality iron which met the criteria of * light-weight * screw in interchangeable tips * efficient thermal transfer from element to tip * tip temperature maintains within the limits suitable for electronic work and also small household jobs * and of course, fully S.E.C. tested and approved.



Comes fitted with T 2435 Tip

Bonus offer Free T 2436 Instrument Tip included this month.

REPLACEMENT TIPS

- T 2434 Flat Tip .95
- T 2345 Conical Tip .95
- T 2436 Instrument Tip .95

T 2430 **\$9.50**

SOLDER

200 gram reel, 1mm universal gauge. Suitable for all types of electronic soldering. Resin cored and includes bit saving additive.

T 1200 \$4.95



5 up \$4.50 ea.

SOLDERING IRON STAND UNIVERSAL TYPE

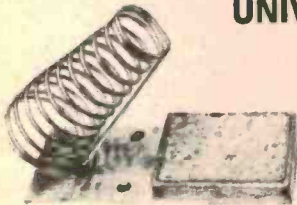

T 1302 NOW **\$5.50**

KEY OPERATED SWITCH



19.5mm mounting hole required. Supplied with two keys. Hundreds of applications for security type applications.

S 2500 **\$5.00 ea**

NEW D RANGE CONNECTORS

SUPERB AB UK QUALITY



AMAZING VALUE ea. 10 +

P 0880	DB9	Male	9 Pin	2.50	2.20
P 0881	DB9	Female	9 Pin	2.95	2.70
P 0890	DB15	Male	15 Pin	2.95	2.50
P 0891	DB15	Female	15 Pin	3.50	3.00
P 0900	DB25	Male	25 Pin	4.50	3.95
P 0901	DB25	Female	25 Pin	4.95	4.50

MASSIVE SAVINGS THIS MONTH

ALTRONICS

105 Stirling Street, Perth, W.A. 6000

For despatch P+P charges and Altronics address details please refer to our advert on page 71.

DE-SOLDER BRAID



NEAR 1/2 PRICE

T 1230 **\$1.00**

ALTRONICS

RESISTOR PACK



INCREDIBLE \$3 pack

All computer selected values, i.e. you get more of the most used values and less of the least common. All 1st quality factory fresh.

R 3501 .25W RESISTOR PACK Average contents: 300 \$12.00 Value

PROTO TYPE BREADBOARDS

- * You just plug-in vertically your components without soldering.
- * Proto Boards will accept all LSI's, semis, transistors, diodes, leds, resistors, capacitors etc.
- * 22-30 gauge solid hook up wire for Inter-connection.
- * Boards are "keyed" enabling simple "add on" facility.

MINI STRIP 100 HOLES

P 1000 **\$1.95**

640 HOLES

P 1005 **\$8.50**

640 + 100 HOLES

P 1007 **\$10.00**

640 + 200 HOLES

P 1009 **\$12.00**

400 + 1280 HOLES



P 1012 **\$26.00**

500 + 1920 HOLES

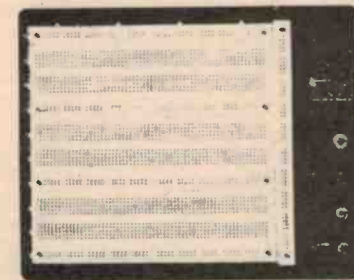

P 1015 **\$38.00**

ALTRONICS JIFFY BOXES

Incredible offer!

Black plastic body with 22 g. aluminium lid and 4 st. screws supplied. Unique horizontal PC "Snap In" mounts as well as vertical card guides. Order your PC Boards presized and dispense with costly stand offs, screws etc. These utility boxes are used in dozens of E.T.I. and E.A. projects.

Box	Dimensions	Board Width		Price this month
		Vertical	Horizontal	
H 0101	150 x 90 x 50	90	87	\$1.90
H 0102	195 x 113 x 60	106	103	\$2.90
H 0103	130 x 68 x 41	62	60	\$1.80
H 0105	83 x 54 x 28	50	47	\$1.20

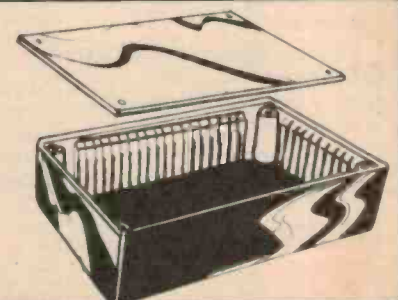

ALTRONICS ... ALTRONICS ... ALTRONICS ... ALTRONICS ...

ALTRONICS ... ALTRONICS ... ALTRONICS ... ALTRONICS ...

Innovation Centre to aid inventors

Amid a fanfare of publicity and political promotion, the Innovation Centre of NSW was opened at the University of NSW on April 8th by the NSW Premier, Neville Wran.

Considerable political push for the launching was provided by the new Federal Minister for Science and Technology, Barry Jones, who spoke on the critical role which innovative technology must play in industry if Australia is to progress in a post-industrial society. He pointed out that Australia ranks 23rd out of 24 amongst technology-producing nations. New Zealand ranks much higher.

The Kirby Report, compiled by the Committee to Review Productivity and Innovation Programs, chaired by Mr. Raymond Kirby, tabled in the Federal Parliament in April '82, recommended the establishment of innovation centres which would bring industry and inventors together.

The Victorian Chamber of Manufacturers set up a pilot innovation centre in 1979 which is reported to be operating with some success. The Innovation Council of NSW, set up in March this year, has set up the centre with the objective of facilitating the commercialisation of innovations in NSW by:

- providing private and corporate inventors with access to information, expertise, services and facilities;
- promoting greater interaction between private and corporate inventors, manufacturers, educational institution, government and financial organisations;
- seeking partners to assist in the production, marketing and financing of new ventures; and
- developing educational and promotional activities designed to encourage innovation in local industry.

The underlying objective is the promotion of Australian inventiveness and hopefully, the creation of new industries or branches of industry and the opening up of employment opportunities.

Both the Council and the Innovation Centre are supported by the State and Commonwealth

governments, the University of NSW and a number of other organisations.

The centre will service both high technology and low technology development from:

- individual inventors, • corporate inventors and companies, • educational institutions.

Basic services will cover: preliminary technical and commercial assessments using academic, industrial and supplementary resources as required; advice on patents and a patent search if necessary; referral to potential industrial partners and referral to appropriate avenues for government and other sources of financial assistance.

For selected projects the centre could negotiate a royalty or equity position and provide: laboratory space and access to some administrative support; engineering development support; assistance in market assessments; development of business plans and proposals for raising venture capital; creation of a management team; assistance in locating venture capital; assistance in relocating the business outside the centre.

An important supporting function of the Centre will be the provision of educational courses in innovation, entrepreneurship and related topics through the running of workshops, seminars and lectures; the provision of courses generally on new product development, marketing, finance, patents, government funding and services, plus legal and other aspects of managing innovation.

The Centre will promote its own services and create public awareness of the role of technology in the business community.

The Premier of NSW and the Federal Minister for Science and Technology both presented cheques (meagre, but something), representing the State and Commonwealth contributions to the Centre. These were received by Mr. Colin Bull, from the

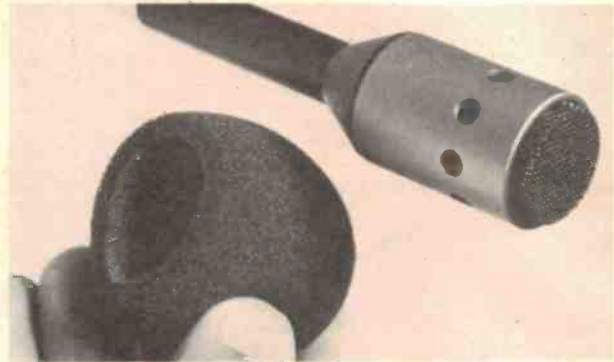

This mic stands up for itself

A new desk-top microphone from Benelec Pty Ltd, designed for PA and transceiver applications, features a 200 mm tall gooseneck for easy positioning of the mic.



Designated the Model 7-801, it comes with a heavy diecast body to ensure stability. A push-to-talk switch with lock is mounted in the base and the mic has a pop filter to minimise noise pickup when out of doors or when close-talking.

The microphone has reduced rear pickup to avoid 'howl round' in PA applications and unwanted background noise pickup in communications installations.

The sensitivity is quoted as -70 dB at 1 kHz, impedance as 10k at 1 kHz and frequency range as 200 Hz to 10 kHz.

The 7-801 stands 215 mm tall and the base is 100 mm diameter. It is supplied with a 4 mm diameter shielded three-core cable three metres long.

Further information from the distributors, Benelec Pty Ltd, P.O. Box 21, Bondi Beach NSW 2026. (02) 665-8211.

Magna 87 liquid flux

Researchers of Magna Industrial Company have produced Magna 87, a liquid flux whose acidity aids soldering.

Magna 87 gradually converts to a neutral salt, irrespective of the type of metal being soldered, eliminating the persistent problem of corrosion at soldering points.

Magna 87 liquid flux contains

no ammonium chlorides, no resins, no zinc chlorides or other strong acids or acid forming substances. While in the container the flux is mildly acidic, however this mild acid is converted into a neutral salt through heating during the soldering operation. The heat of the soldering regardless of the method, will be sufficient to cause the chemical change.

Innovation Council.

The Executive Director of the Innovation Centre is Dr. Neville Stephenson. The Centre's board of directors comprises a dozen people from industry, the University of NSW, the NSW State Department of Industrial Develop-

ment and Decentralisation and the Department of Science and Technology.

It remains to be seen whether getting this disparate group into bed together will produce lusty offspring or strangulated abortions.

National competition for electronics students to aid oceanographic studies

A low-cost reliable temperature sensor and recorder is needed for seasonal studies of the Australian Continental Shelf and, in particular, in the Great Barrier Reef Marine Park.

With the hope of an innovative solution, a competition for students has been organised jointly by the Great Barrier Reef Marine Park Authority and the Marine Studies Centre, University of Sydney.

The competition, for the electrical design and construction of a prototype of a marine temperature sensor and recorder, is open to students who are residents of Australia, including all full and part-time engineering students. Either individual students or groups can enter.

The competition is being sponsored by Neil Brown Instrument Systems of Massachusetts US, the Great Barrier Reef Marine Park Authority and the Marine Studies Centre, University of Sydney.

Neil Brown Instrument Systems has put up the substantial prize and funds for component costs.

The prize is a three month work-study program at Neil Brown Instrument Systems, including travel, accommodation and a modest salary.

To assist students the first ten suitable entries, in the opinion of the judges, received after June 1 1983, will be considered for a reimbursement of costs of components, on the basis of receipts, up to a value of \$300 per entry.

The instrument must be able to sense temperature between 5°C and 30°C and be able to operate at depths of up to 100 metres.

More information on the required specifications for the sensor and recorder may be obtained by writing to Mr. Bruce Hamon, Marine Studies Centre, University of Sydney NSW 2006.

The final data for acceptance of entries is Friday, January 13 1984.

High-efficiency, low cost film-type solar cells

National Panasonic's parent company in Japan, Matsushita Electric, has developed a film-type solar cell which will cut the cost of existing solar cell prices by more than half.

The cell, called 'Sunceram II', uses a screen printing method which results in an extremely high energy conversion efficiency as well as the lowest production cost per unit power output of all existing type of solar cells, claim Matsushita.

Matsushita is a participant in the Japanese government's 'Sunshine Project' which aims at mass producing cheap solar cells for power generation.

Hopefully our new Australian government will set up a similar project, financing and encouraging research in solar cells. In this 'land of sunshine' using solar cells for the generation of power would seem to be quite logical. But perhaps this form of power is not profitable for the government. So once again we'll have to rely on the Japanese.

The newly developed solar cell

can be either 4.6 cm x 0.17 cm or a 30 cm-square large cell. The small cell energy conversion rate is 12.8% compared with a conventional efficiency of 10.5% in existing cells. The large cell conversion efficiency is 8.5%.

Due to the simple screen printing method for all the film forming processes, the production cost of the Sunceram II is relatively low. When mass production begins the production cost per watt (power output) for the cell will be less than \$4.35, cheaper than any solar cell ever developed, claim Matsushita. A single crystal type silicon solar cell, which is most commonly used at present, costs approximately \$10.90 per watt.

More information can be obtained from National Panasonic, 95-99 Epping Rd, Nth Ryde NSW 2113. (02)887-5333.

A snappy new pushbutton switch catalogue

The latest catalogue from Dialight, a North American Philips company, consists of twenty pages of specification details about snap-action pushbutton switches.

The catalogue covers models that are panel mounted (581 Series), snap-in mounted (582 Series), pc mounted with support brackets (587 Series) and pc right angle mounted (583 Series). It also includes a wide range of round and square pushbutton caps (586 Series).

The catalogue provides complete mechanical, electrical and materials specifications for each switch series. It also includes a handy guide cross-referencing Dialight part numbers with those of other manufacturers.

The new snap-action pushbutton switch catalogue is available by contacting Philips Electronic Components &

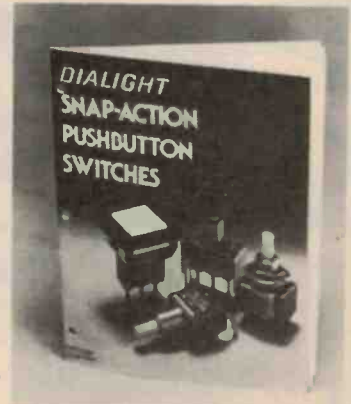

Materials, P.O. Box 50, Lane Cove NSW 2066. (02)427-0888.

Switching off Halley

Radio astronomers at Britain's Jodrell Bank radio telescope in Cheshire are planning to 'switch off' the radio waves emitted by Halley's comet when it approaches the sun in 1986.

Radio waves beamed at the comet from the large telescope may turn off the comet's natural maser.

The maser action results from the evaporation of parts of the core of the comet containing frozen water, ammonia and methane by the radiation from the sun. Some water molecules will lose a hydrogen atom to form a hydroxyl unit and the hydroxyls can radiate coherently (in unison) to form a natural maser. The maser emits radio waves of 180 mm wavelength and it has been estimated that the total

power is only about 30 W.

The Jodrell Bank group feel that they can probably switch off the maser action by beaming a 10 kW pulse of 180 mm waves at the comet from their telescope. If successful, they expect to learn more about the comet and its maser by the time taken for the natural maser action to be resumed.

Although lasers and masers were both invented on earth, they have since been found elsewhere. A natural laser occurs on Mars.

B. Dance

NOTES & ERRATA

Project 268 NiCad Float Charger, March '83, page 31. The curve for 'Typical charging characteristics of NiCad cells' is for one particular type and may not be indicative of most currently on the market. While the shape is generally similar, the maximum terminal voltage reached is generally between 1.4 V and 1.5 V, not 1.7 V as shown.

Project 1515 Motor Speed Controller, April '83. If you find your speed potentiometer has a considerable 'dead band' at the 'top' (towards full speed) end, this indicates your drill has lower back-emf than that designed for. The cure is to increase R3. If all the speed control is crowded over about 60° of rotation, increase R3 to 330k. If you get 90° or 100° of rotation for zero to full speed, change R3 to 220k or 180k, etc. You may need to increase R4 from 27k to 56k or 68k, also. DISCONNECT THE UNIT FROM THE MAINS BEFORE MAKING ANY MODIFICATIONS.

The George Brown

PROTRONICS
SOUTH AUSTRALIA

Ph. (08) 212 3111 Telex AA88261

George Brown & Co.
VICTORIA

Ph. (03) 419 3355 Telex AA35886

George Brown & Co.
SYDNEY

Ph. (02) 519 5855 Telex AA21732



DIODES



1N4004 (glass pack)
1N4007 (glass pack)

V _R V	I _F A	
Min		
400	1.0	\$0.05
1000	1.0	\$0.09

1N4148
BAW76
BAW76TR

t _{rr} ns	BV V	Min	
MAS			
4.0	100		\$0.03
4.0	75		\$0.05
4.0	75		\$0.05

FAST

74F00	QUAD 2 INPUT NAND GATE	\$.53
74F02	QUAD 2 INPUT NOR GATE	\$.53
74F04	HEX INVERTER	\$.61
74F08	QUAD 2 INPUT AND GATE	\$.53
74F10	TRIPLE 3 INPUT NAND GATE	\$.53
74F11	TRIPLE 3 INPUT AND GATE	\$.53
74F20	DUAL 4 INPUT NAND GATE	\$.53
74F32	QUAD 2 INPUT NOR GATE	\$.53
74F54	AND/OR - INVERT GATE	\$.53
74F74	DUAL D TYPE FLIP FLOP	\$.59
74F86	QUAD EXCLUSIVE OR GATE	
74F109	DUAL JK FLIP FLOP	\$ 1.10
74F138	1 OF 8 DECODER/DEMPLEX	\$ 1.18
74F139	DUAL 1 OF 4 DECODER	\$ 1.18
74F151	8 INPUT MULTIPLEXER	\$ 1.18
74F153	DUAL 4 INPUT MULTIPLEXER	\$ 1.18
74F157	QUAD 2 INPUT MULTIPLEXER	\$ 1.18
74F158	QUAD 2 INPUT MULTIPLEXER	\$ 1.18
74F75	QUAD D TYPE FLIP FLOP WITH CLEAR	\$ 3.22
74F181	ARITHMETIC LOGIC UNIT	\$ 3.97
74F182	CARRY LOOK AHEAD	\$ 1.82
74F189	64 BIT RAM 3.5	\$ 4.94
74F190	UP/DOWN DECADE COUNTER	\$ 3.23
74F191	UP/DOWN BINARY COUNTER	\$ 3.23
74F194	4 BIT SHIFT REGISTER	\$ 1.60
74F240	OCTAL BUS DRIVER	\$ 3.09
74F241	OCTAL BUS LINE DRIVER	\$ 3.81
74F243	QUAD BUS TRANSCIEVER	\$ 2.89
74F244	OCTAL BUS LINE DRIVER	\$ 2.47
74F251	8 INPUT MULTIPLEXER	\$ 1.29
74F253	DUAL 4 INPUT MULTIPLEXER	\$ 1.29
74F257	QUAD 2 INPUT MULTIPLEXER	\$ 1.29
74F258	QUAD 2 INPUT MULTIPLEXER	\$ 1.29
74F350	4 BIT SHIFTER 35 D/P	\$ 2.89
74F352	DUAL 4 INPUT MULTIPLEXER	\$ 1.29
74F353	DUAL 4 I/P MULTIPLEXER 35	\$ 1.29
74F373	OCTAL D LATCH	\$ 3.22
74F374	OCTAL D FLIP FLOP	\$ 3.22
74F399	QUAD 2 I/P MULTIPLEXER + STORAGE	\$ 1.85
74F521	8 BIT INDEXT COMPARATOR	\$ 2.80
74F533	INVERTING OCTAL D LATCH	\$ 3.22
74F534	INVERTING OCTAL D FLIP/FLOP	\$ 3.87

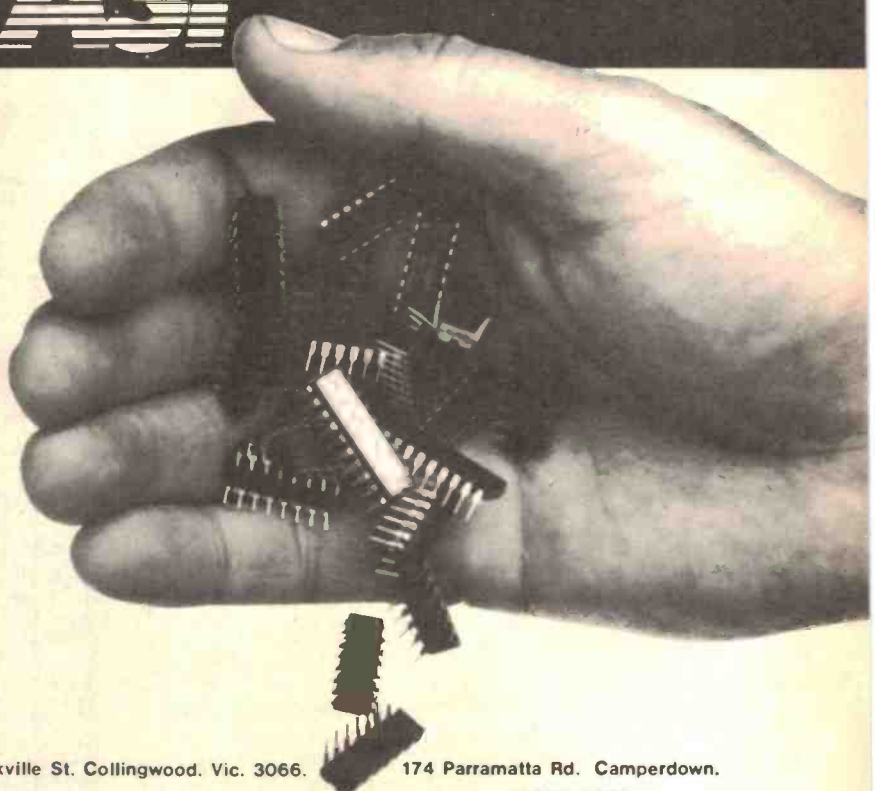

174-180 Wright St. Adelaide. S.A. 5000

93 Sackville St. Collingwood. Vic. 3066.

174 Parramatta Rd. Camperdown.
N.S.W. 2050.

Electronics Group.

PROTRONICS
WESTERN AUSTRALIA

Ph. (09) 362 1044 Telex AA93883

George Brown & Co.
NEWCASTLE.

Ph. (049) 69 6399 Telex AA28461

George Brown & Co.
A.C.T.

Ph. (062) 80 4355 Telex AA62128



PROUDLY AUSTRALIAN

Opto

FND500	7 SEG. RED C. CATHODE .5"	\$ 1.22
FND530	7 SEG. GREEN C. CATHODE	\$ 3.00
FND501	7 SEG. RED C. CATHODE .5"	\$ 1.22
FND507	7 SEG. RED C. ANODE .5"	\$ 1.22
FND800	7 SEG. RED C. CATHODE .8"	\$ 2.95
FND807	7 SEG. RED C. ANODE .8"	\$ 2.95
LTR1341HWX	5" LCD DISPLAY	\$64.98

**QUANTITY
PRICING
AVAILABLE.**

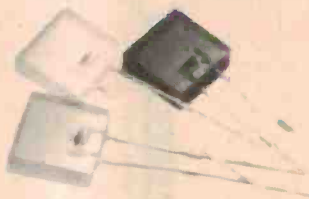

HYBRID

78H05SC	5V 5 AMP VOLTAGE REG. T03	\$ 6.59
78H12SC	12V 5 AMP VOLTAGE REG. T03	\$ 7.83
78HGSC	5 AMP VOLT. REG. 5-24 VOLT. T03	\$ 8.27
78P05SC	10A 5V REG. T03	\$11.95
UA494PC	SWITCHING REG. DIL	\$ 2.80
78S40PC	SWITCHING REG. DIL 1.3-40 VOLT.	\$ 1.85
79HGSC	5 AMP VOLT. REG. 5-24 VOLT. T03	\$13.51
SH1605SC	5 AMP SWITCH REG. T03 20V, 2.5 V.	\$12.58
SH323SC	3 AMP 5 VOLT. VOLTAGE REG. T03	\$ 6.50

PRICES WHILE STOCKS LAST.

PRICES SUBJECT TO CHANGE WITHOUT NOTICE
PRICES + SALES TAX IF APPLICABLE. S/TAX 20%

24 Teddington St. Victoria Park. W.A. 6100

3 Elizabeth St. Tighes Hill. Newcastle.
N.S.W. 2300

23 Whyalla St. Fyshwick. A.C.T. 2609



BANKCARD ORDER FORM
PLEASE DEBIT MY BANK CARD NO. _____
EXPIRY DATE _____
NAME _____
SIGNATURE _____



Value!

MITSUBISHI DISC DRIVES
M2896-63

- SLIM-LINE 8"
- DOUBLE SIDED
- DOUBLE DENSITY
- 1.6M BYTES UNFORMATTED
- 77 TRACKS PER SIDE

\$498.50 + 20% Tax



Value!

M4853

- SLIM-LINE 5.25"
- DOUBLE SIDED
- DOUBLE DENSITY
- 1.0M BYTES UNFORMATTED
- 80 TRACKS PER SIDE

\$375.00 + 20% Tax



Value!

M4854

- SLIM-LINE 5.25"
- 1.6M BYTES UNFORMATTED
- DOUBLE SIDED
- DOUBLE DENSITY
- 77 TRACKS PER SIDE

\$395.00 + 20% Tax

DISC DRIVES WITH A DIFFERENCE



AUSTRALIA'S BEST QUALITY, VALUE FOR MONEY

GREENSCREEN VIDEO MONITOR
18MHZ Video Bandwidth
BM-12E

~~Was \$227~~
\$199
+ 20% Tax

- Input Signals: Composite Video Signal Negative SYNC 1.0 P-P 75 ohm
- CRT size: 31 cm diagonal
- Green Phosphor — P31 non glare
- Power input 230V 50Hz
- Display format: 1920 characters max. (80 characters X 24 lines)

CALCULATORS

T1-55-II Advanced Professional	\$53.09
T1-35 Student - Maths Kit	\$22.92
T1-BA Business Analyst	\$43.33
T1 LCD Programmer	\$65.00
T1 54 Advanced Scientific	\$39.17
T1 59 Professional Programmer	\$249.17

All prices add 20% tax.

Prices subject to alteration due to devaluation.



PAN TILT BASE

- IDEAL FOR MOST 12" VIDEO MONITORS
- 180° TILT PAN 50°
- HIGH DENSITY FOAM — NON SLIP SURFACE

\$30 + 20% TAX

MONEY SAVERS!

FERGUSON TRANSFORMERS

PL15/5VA	\$5.85	PL18/40VA	\$12.15
PL24/5VA	\$5.85	PL24/40VA	\$12.15
PL30/20VA	\$10.80	PL24/60 A	\$15.75
PL12/20VA	\$10.80		

+ 20% Tax

LIMITED STOCK

S2600/S2601 ENCODER/DECODER REMOTECONTROL 2-CHIP SET

- Small Parts Count — No Crystals Required
- Easily Used in LED, Ultrasonic, RF, or Hardwire Transmission Schemes
- Very Low Reception Error
- Low Power Drain CMOS Transmitter for Portable and Battery Operation
- 31 Commands — 5-bit Output Bus with Data Valid
- 3 Analog (LP Filterable PWM) Outputs
- Muting (Analog Output Kill/Restore)
- Indexing Output — 2 1/2 Hz Pulse Train
- Toggle Output (On/Off)
- Mask-Programmable Codes

CHIP SET \$13.83 + 20% TAX

SOFTWARE SPECIALISTS FOR THE 68XX SERIES

OS-9 Level 1 Operating System Basic 09 Programming Language Macro Text Editor Assembler Debugger	XForth Basic Programmer Tool Kit Password Protection Pack Dynasoft Pascal Flex Spell Test Super Sleuth Stylograph 2.0 Flex, OS-9 Dynastar Full Screen Editor OS-9, Flex CRASMB Cross Assembler, Flex, 6809, 6800, Z80, 8080, 6502 Tabula Rasa Job Control Program TRS80C Colour Flex
General Purpose Flex 6809 SWTPC Flex 6809 Extended Basic Utilities Pascal for Flex 68000 Cross Assembler for Flex Soft Merge Package Text Editor Assembler Debug Package Diagnostics Text Processor	6809RMS DBM for Flex
6809 C Compiler ver 2:0	tForth tForth+
EDIT Word Processing Editor Flex	DYNAMITE Disassembler DYNACALC

Check Our Super Special Prices This Month!

80 SERIES CHIPS

8085	\$ 4.00	8243	\$ 2.01
8086	\$17.51	8251	\$ 3.32
8155	\$ 3.77	8255	\$ 2.20
8156	\$ 3.69	8253	\$ 3.69
8212	\$ 1.21	8257	\$ 3.43
8216	\$ 1.21		
8224	\$ 1.35		

EX STOCK

8226	\$ 1.21	8259	\$ 3.43
8228	\$ 2.39	8279	\$ 2.77

+ 20% Tax

T.D.K. SUPER AVILYN VHS E180

3 Hr. video tapes

\$17.10 tax inc.

T.I. PERSONAL HOME COMPUTER

TI-99/4A

\$499.00 INCLUDES SALES TAX



You can buy just a video game — or you can get a full colour Home Computer

- Typewriter Keyboard
- 16K bytes RAM
- Expandable to 52K bytes RAM
- Easy to follow instructions
- Extensive range of programmes
- Educational
- Add-on expandability

MAGRATHS ELECTRONICS
55 A'BECKETT STREET, MELBOURNE, 3000
Tele (03) 347 1122, Telex AA31001

—Mail or phone orders add \$2.00 up to 1 kg pack/post
Special rates for heavy items on request.

SUPER BARGAINS AT MAGRATHS

Phone or Mail.



WORLD OF ELECTRONICS



bankcard welcome here

MC/MG/440

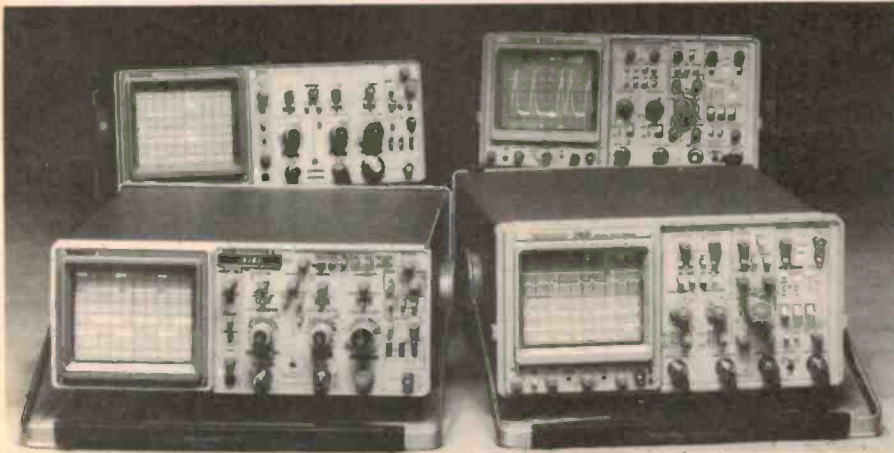

Tektronix keep a step ahead with new oscilloscopes

Tektronix has released two new top-of-the-range oscilloscopes, the 2445 and 2465, and two new general purpose scopes, the 2235 and 2236.

The 2445 and 2465, priced at \$4700 and \$6900 respectively, are analogue scopes with significant benefits for digital applications. They replace the 465B and 475 and have broader bandwidths, four channels, extensive CRT readouts, faster sweep speeds and increased timing accuracy.

The 2465 has a 300 MHz bandwidth, 500 ps per division sweep speed and auto-level trigger feature with trigger bandwidth greater than 500 MHz. The 2445 has a 150 MHz bandwidth, 1 ns per division sweep speed and the same triggering features with trigger bandwidth to 250 MHz. Another feature is the channel 1 and 2 propagation delay matching adjustment.

New developments have produced a meshless scan expansion lens to provide a shorter, more rugged CRT. The CRT readout

generates cursors which the user can superimpose on the waveform to measure delta voltage, sweep delay and delta delay time, and vertical and horizontal scale factors. The readout also indicates variable vertical sensitivity, bandwidth limit, add mode and variable hold-off.

In both the 2445 and 2465 channels 1 and 2 feature full-range step attenuators from 2 mV to 5 V per division, variable attenuators, a choice of 1M or 50 ohms input impedance, ac and dc coupling and provision to invert channel 2.

Channels 3 and 4 are optimised for logic signals with 1M, dc coupled inputs and scale factors of 0.1 V and 0.5 V per division, and 1 V and 5 V per division with 10X probes.

The 2235 and 2236, priced at \$2800 and \$4400 respectively, have all the features of the earlier 2215 scope plus higher band-

width, greater accuracy, trigger view, maximum sweep speed of 5 ns per division, 20 MHz bandwidth limit switch for reducing high frequency noise, single sweep mode for transient photography and separate A and B intensity controls.

A digital counter/timer/multi-meter (CTM) is fully integrated into the vertical, horizontal and triggering systems of the 2236, allowing measurements that previously haven't been possible with only one portable instrument, claim Tektronix. In the auto-ranging ohmmeter features an unusually wide range, from 10 milliohms to 2000M, and automatically senses and evaluates diode junctions.

More information on the 2000 series of oscilloscopes can be obtained from Tektronix Australia Pty Ltd, 80 Waterloo Rd, Nth Ryde NSW 2113. (02) 888-7066.

Australian made switch mode power supplies

Australian power supply designer and manufacturer, Scientific Electronics, has released details of switch mode power supplies which are aimed at micro users and system designers.

In the single rail series are the SM50A1/5 5 V 8 A, SM50A1/12 12 V 3.3 A, SM50A1/15 15 V 2.7 A, SM50A1/24 24 V 2 A and SM50A1/48 48 V 1 A. The output is short circuit protected and has overvoltage protection. Output rails to customer specifications are also available.

The SM65AC1 has three output rails from which a total of 65 watts can be drawn.

Standard output voltages are +5.2 V at 8 A, +12 V at 1 A and -12 V at 1 A. Outputs to customer specifications are also available.

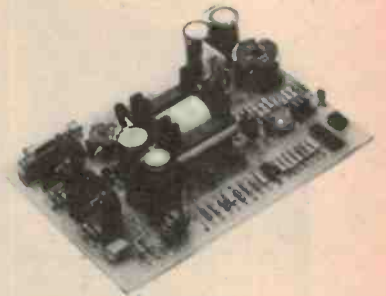

The features of the SM65AC1 are the same as those of the SM50A1 series.

All these power supplies are fully supported with a five year guarantee and complete technical back up.

For further information contact Scientific Electronics, 6 Holloway Drive, Bayswater Vic. 3153. (03)762-5777.

BWD's go-anywhere oscilloscope

The BWD 835 is a new, dual trace oscilloscope for digital or analogue applications.

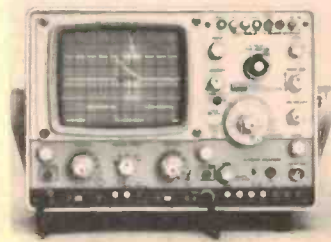

It is lightweight, compact and rugged and with a power supply that operates from 95 to 264 volts at 48 to 440 Hz without external switching, you can take it anywhere.

The vertical amplifiers provide a full 60 MHz bandwidth from 5 mV to 20 V per div and 50 MHz at 2 mV per div. For noisy waveforms or operation in noisy environments a 20 MHz band-

width limit button is provided.

Sweep speeds range from one second per div to 50 nano seconds per div and a 10X magnification increases the maximum speed to five nano seconds per div for both A and B time bases.

A high sensitivity trigger system for both time bases operates to beyond 100 MHz and in the alternate mode triggers to unrelated signals. Other features include TV line and frame lock, low or high frequency reject,

power line trigger and external trigger from both A and B time bases.

The dual time base permits either delayed sweep or delayed trigger operation and the alt A-B presentation simultaneously displays both the intensified A trace and the delayed B trace with variable offset.

For more information contact BWD Instruments Pty Ltd, Miles St, Mulgrave Vic. 3170. (03)561-2888.

80 watt voltage regulator IC

Motorola now has on the market a single-chip five volt voltage regulator, the MPC100, which combines the decision making capabilities of integrated circuits with the output capability of an 80 watt power transistor.

The new voltage regulator, capable of delivering up to 10 A, is expected to find wide spread usage in MPU related applications.

The MPC100 regulator can withstand an input voltage up to 25 V. The typical output resistance is in the order of two milliohms which results in good load regulation. The output is capable of handling large capacitive loads.

The low saturation voltages of the output transistors allows the regulator to operate with differential voltages as low as 1.5 V (typical), with a load current of 10 A. Motorola claim that this results in improved efficiency and makes the MPC100 regulator

ideal as post-regulators in conjunction with a switching regulator for remote applications.

Other features of the MPC100 include internal thermal protection, internal short circuit protection and overcurrent limiting.

The MPC100 regulator is fabricated on a 150 x 250 mm chip and uses a standard TO-204AA package. The chip requires only a die attached to the header and three wire bonds for complete assembly.

More information about Motorola products can be obtained from **Motorola Semiconductor Products, 250 Pacific Hwy, Crows Nest NSW 2065. (02) 438-1955.**

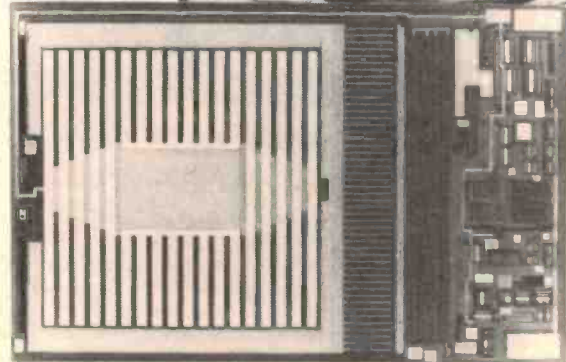
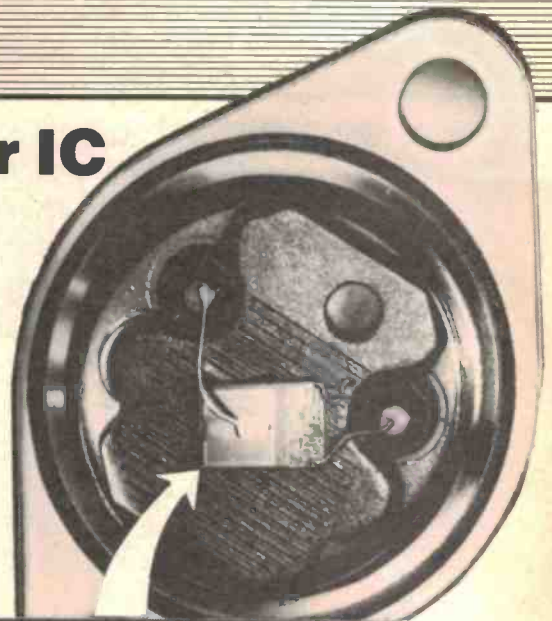

Adjustable shell-type cases

Mayer Krieg have released a new series of shell-type cases which, by combining various panels, can produce cases of different sizes in one of three heights.

A tongue and groove arrangement on all sides makes the combinations very stable and properly seals the two case sections. The cover and base are screwed together by four screws.

Optional panels, front and rear, are held in grooves and can be easily removed for punching and lettering. Guide rails are provided for vertical mounting of partitions and pc boards. Fastening studs are provided for

horizontal assembly.

Cases can also be supplied with a battery compartment suitable for nine volt batteries, or four penlight batteries, and which is accessible from the outside.

More information can be obtained about these cases, manufactured in high-impact polystyrene or noryl, by contacting Mayer Krieg and Co, 248 Angas St, Adelaide SA 5001. (08)223-6766.

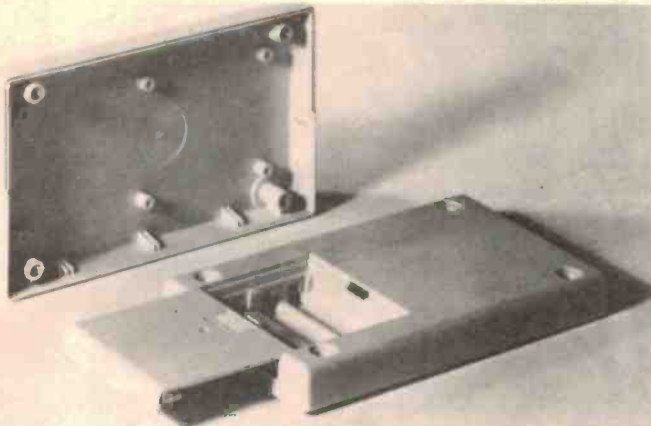

PWM switching regulator

Fairchild's uA494 voltage regulator contains all of the building blocks for designing a pulse width modulated (PWM) switching power supply, including push-pull, bridge and series configurations.

PWM operation results in a constant switching frequency which simplifies output filtering and system stabilising.

Two on-chip uncommitted output transistors, capable of sourcing or sinking 200 mA current, are provided for push-pull operation. Dead time control assures that the two transistors are never on simultaneously.

Single ended or push-pull operation is selected via the output control pin. The UA494 operates at switching frequencies between 1 and 300 kHz with output voltages up to 40 V.

Other features include an internal adjustable oscillator, an internal 5 V reference, an internal error amplifier and a current-limit amplifier designed for high-power switching systems.

The UA494 is used in applications requiring slaving or high-frequency operation. Available in both industrial and military temperature range versions, the PWM switching regulator is packaged in a 16-pin DIP.

More information from Fairchild Australia Pty Ltd, 366 Whitehorse Rd, Nunawading Vic. 3131. (03)877-5444.

Digital noise source IC

National Semiconductor has a new monolithic metal-gate NMOS integrated circuit that can be used as a digital noise source or an internal pseudorandom number generator.

The MM5437 has been designed to produce a broadband white noise signal with uniform noise quality and output amplitude. It features an internal self-contained oscillator, a single-supply voltage range of 4.5 V to 11 V, one-minute cycle time and automatic reset for an all-zeros state.

National claims that the MM5437 is ideal for use in rhythm

instrument sound generators, white and pink noise generators and room acoustics testing/equalisation.

The device is available now, in an eight-pin plastic dual-in-line package, from National Semiconductor, cnr Stud Rd and Mountain Hwy, Bayswater Vic. 3153. (03)729-6333.



National

A NEW WAVE IS ON THE HORIZON

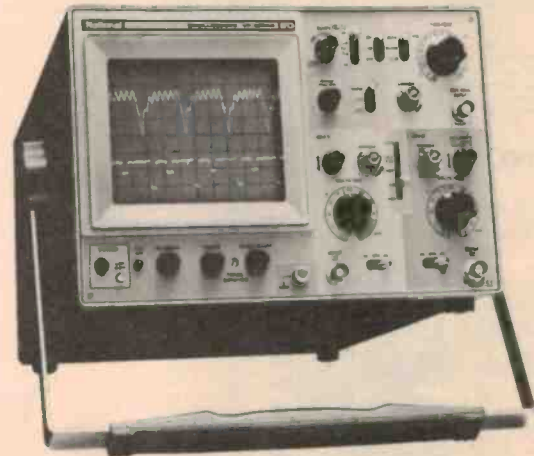

Available in four models these low cost oscilloscopes feature:

- 15-20-30 MHz.
- 1mV/Div sensitivity
- Stable automatic trigger 'AUTO FIX'
- Full range of triggering mode
- Bright and sharp CRT with Auto Fix
- TV(V) and TV(H) sync separator circuit
- Rectangular tube, illuminated internal graticule (VP-5220A and VP-5231A)
- Built-in delay line for observation of pulse transient (VP-5231A only)
- High reliability—MTBF 15,000 hours

National have a wide range of scopes—to 300 MHz. Please call or write for further information

Probes supplied as standard accessory



SCIENTIFIC DEVICES AUSTRALIA PTY. LTD.
 2 JACKS ROAD, SOUTH OAKLEIGH, VICTORIA, 3167.
 TELEPHONE: 579 3622
 P.O. BOX 63, SOUTH OAKLEIGH, VICTORIA, 3167. TELEX: AA32742
 CABLES: DEVICES MELBOURNE
 31 HALSEY ROAD, ELIZABETH EAST, S.A., 5112.
 TELEPHONE: (08) 255 6575
 35-37 HUME STREET, CROWS NEST, N.S.W., 2065.
 TELEPHONE: (02) 43 5015

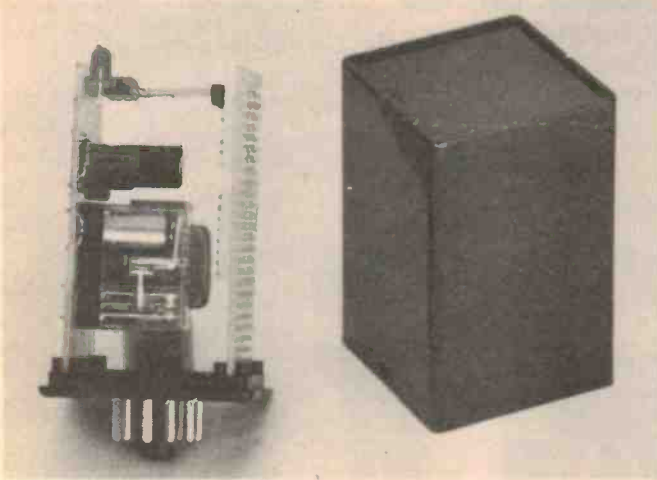

Plug-in case

A handy little case for plug-in module applications is available from Minitool Australia Pty Ltd.

Known as the '4A Series Enclosure', it measures 50 mm square by 80 mm high and can be supplied with either an 8-pin or 11-pin plug base.

To suit the enclosure, Minitool have available a number of

general purpose pc boards, including a standard power supply and relay output layout.

They can also supply a 240 V to 24 V ac output transformer and a changeover relay with 6 A contacts, plus various hardware bits, connectors, etc.

Further details from Minitool Australia Pty Ltd, 134A Ayr St, Doncaster Vic. 3108. (03) 850-9887.

Classifieds

CLASSIFIED RATES

15¢ per character

Minimum of 32 characters

CHARGES: Cash with order only

REPAIRS to all home, hobby and small business microcomputer systems and peripherals, also all EA & ETI projects. CAE Electronics, 1/27 Forge St, Blacktown 2148. (02)621 4242.

DIRECT CONNECT MODEM — A new high performance micro-processor controlled modem has received Telecom authorisation #C83/37/1021 capable of 300, 600 and 1200 baud with a RS-232-C interface. For more information about the 'MICRO-MODEM' write to the manufacturer: Woomera Electronics P/L, P.O. Box 32, Camberwell Vic. 3124.

COMPUTER Clinic repairs and services Sorcerer, Pet, Apple, System 80, Super 80, Tandy and others. (07) 269 8573, P.O. Box 68, Aspley, Qld.

COMMODORE 64/VIC-20: CASSETTE INTERFACE to SAVE/LOAD programs (including Commodore tapes) using your audio cassette recorder. \$45.00 plus \$3.00 p&p. Canberra Computers & Consultancy, PO Box 382, Dickson, Canberra ACT 2062. Tel: (062) 41 3746.

16 BIT COLOUR! Texas colour computer TI 99/4A! Fantastic colour graphics and sound. Expandable! Heaps of software! Only \$499 (p&p \$9). Orders: Software Connection, Box 375, Pymble NSW 2073 or B'card Hotline (02) 30 1839.

COMPUTERS: call us for the best price on full range of Commodore & Osborne computers. Inc. software and component parts. See our add this issue. Data Parts, Shepparton. Phone (058) 21 7155, 21 0240.

GREAT NEW BOOKS

FROM JAYCAR THE ELECTRONIC BOOK SPECIALIST.

REGULATED POWER SUPPLIES

(3rd Edition)
The newest, most comprehensive discussion of internal architecture and operation of the latest solid state regulators. Thoroughly explains when regulated supplies are needed and how to incorporate them into your design projects. Discusses modern, practical circuitry including linear and switching circuits and late ICs. A valuable asset for any technician or engineer involved in servicing or design.
424 pages, 5 1/2 x 8 1/2, soft
Cat. BS0526 \$27.95



COMPUTERS

CP/M PRIMER

If you are a first-time microcomputer user wanting to increase your technical knowledge or a veteran who wants to explore switching to the CP/M operating system, this book can help you find the answers. It's the only complete one-stop source available on CP/M - the very popular operating system for 8080, 8085 and Z80 based microcomputers. Includes a complete list of CP/M compatible software, too! 96 pages, 2 1/2 x 11, soft.
Cat. BS0564 \$24.95

ONLY \$24.95

THE S-100 AND OTHER MICRO BUSES

2nd EDITION
The key to successful computer system expansion is a complete understanding of the bus system through which the computer communicates with peripherals. This book provides you that key, a general discussion of bus systems and an examination of each of the 21 most popular buses. Additional information is given which will help you interface one type of bus to another. 208 pages, 5 1/2 x 8 1/2, soft.
Cat. BS0566 \$15.95



GREAT VALUE \$15.95

APPLE INTERFACING

Apple interfacing helps you to understand the important task of successfully interfacing your Apple computer to a variety of electronic devices. Using this book, you will be able to perform useful experiments which will provide a much clearer understanding of the fundamentals of computer interfacing and computer electronics. You will be better able to understand interactions between computer hardware and software to that you can effectively communicate with your Apple computer. 208 pages, 5 1/2 x 8 1/2, soft.
Cat. BS0568 \$15.95

A BARGAIN AT \$15.95

EXPERIMENTS IN ARTIFICIAL INTELLIGENCE FOR SMALL COMPUTERS

Conducts interesting and exciting experiments in artificial intelligence with this book, a small computer with extended BASIC, and some knowledge of the BASIC language. The author first introduces you to artificial intelligence - the capability of a device to perform functions normally associated with human intelligence, such as game playing, problem solving, reasoning, creativity, and verbal communications. Then game-playing programs, with a checkers playing game as the main topic are explained. 112 pages, 5 1/2 x 8 1/2, soft.
Cat. BS0512 \$12.95

ONLY \$12.95

TRS-80 INTERFACING BOOK 1

Written for users who have a fairly good understanding of Level II BASIC. Author John Titus introduces you to the various I/O signals used by the TRS-80 and explains how these signals can be used in a number of interesting and practical circuits. Numerous hands-on experiments are included. 192 pages, 5 1/2 x 8 1/2, soft.
Cat. BS0572 \$15.95

BOOK 1 \$15.95

TRS-80 INTERFACING BOOK 2

Provides you with a number of practical and useful ways to utilize your knowledge from Book 1. Applications include how to generate voltage and current signals used in a variety of control applications, how to measure unknown voltages how to drive high current and high voltage loads, and many more. Complete software programs are included. 256 pages, 5 1/2 x 8 1/2, soft.
Cat. BS0574 \$16.95

BOOK 2 \$16.95

COMPUTERS

PET INTERFACING

Demonstrates how you can build numerous interfacing devices for your PET hardware. BASIC language programs are used throughout the book, so you should be familiar with this powerful programming language. The Commodore PET microcomputer has several special purpose interface connectors that ease the job of interfacing the computer to "real-world" hardware. Also includes a discussion of the microprocessor's internal architecture and general software/hardware interfacing. 264 pages, 5 1/2 x 8 1/2, soft.
Cat. BS0576 \$25.95

INTERFACE FOR \$25.95 PROGRAMMING AND INTERFACING THE 6502 WITH EXPERIMENTS

Excellent starting point for 6502 based microcomputer novices and veterans alike who may not have much assembly language and programming or chip level interfacing experience. Includes experiments and examples of simple I/O techniques, instructions, and chip level interfacing that can be reinforced with a low cost KIM, SYM, or AIM system. Helps you understand all 6502 based computer systems. 416 pages, 5 1/2 x 8 1/2, soft.
Cat. BS0580 \$25.95
Also available: 6502 SOFTWARE DESIGN
Cat. BS0578 \$17.95

We have dozens of other books - Call in and browse

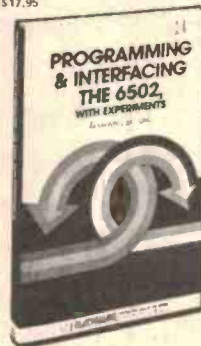

16-BIT MICROPROCESSORS

Carefully steps you through the complex processes of programming and designing with the new and powerful 16-bit microprocessors. The major advantages and disadvantages of these state-of-the-art devices are discussed and numerous benchmarks are provided to help you in your comparison of the chips. The book begins with a simple, straightforward review of the basics of microprocessor design and construction, and then takes an in-depth look at each of the most popular 16-bit microprocessors on the market today, including the 68000, 8086, Z8001/2, 9900 and NS16020. 352 pages, 5 1/2 x 8 1/2, soft.
Cat. BS0588 \$24.95

16-BITS FOR \$24.95

USING THE 6800 MICROPROCESSOR

No special background in digital electronics is needed to use this book, which steps you through the conception, configuration, writing, and running of a variety of programs that demonstrate the practical application of the powerful 6800 microprocessor. The unit's straightforward internal architecture, efficient instruction set, and sophisticated support circuits are covered. 176 pages, 5 1/2 x 8 1/2, soft.
Cat. BS0584 \$14.95



GREAT VALUE \$14.95

COMPUTERS

8085A COOKBOOK



A design-it-yourself guide to developing a number of completely operational, low cost microcomputers around the 8085A microprocessor. Includes a discussion of all support hardware and 8085A family compatible chips. A tremendous amount of software is already available for use on these systems. Almost anyone can learn to design an 8085A based microcomputer with the 8085A Cookbook. 352 pages, 5 1/2 x 8 1/2, soft.
Cat. BS0592 \$24.95

ONLY \$24.95

Z-80 MICROCOMPUTER HANDBOOK

Designed to acquaint you with the hardware of the Z-80 and to discuss the impressive software aspects of this "computer on a chip". A number of chapters are devoted to the use of machine and assembly language. Also included is a discussion of many different microcomputers built around the Z-80, including the popular TRS-80. 304 pages, 5 1/2 x 8 1/2, soft.
Cat. BS0594 \$16.95
Also available: Z-80 MICROCOMPUTER DESIGN PROJECTS. 208 pages.
Cat. BS0596 \$23.95

GENERAL

SON OF CHEAP VIDEO

This sequel to The Cheap Video Cookbook provides a complete video display system which you can build for as little as \$7. Likewise, transparency display can be created for under \$1 by using a video circuit called "The Snuffer" which is completely described in chapter 2. This book makes cheap video even cheaper. 224 pages, 5 1/2 x 8 1/2, soft.
Cat. BS0604 \$15.95

Son Of Cheap Video

By Don Lancaster



CHEAP AT ONLY \$15.95

THE CHEAP VIDEO COOKBOOK

Complete discussion of a new, low cost way to get words, pictures, and opcode out of your computer and onto any ordinary TV set. Don Lancaster outlines an easy-to-build seven IC circuit which you can build for less than \$20. This circuit can be software-controlled to provide any alphanumeric or graphics format including high resolution (256 x 256) and a four colour mode. 256 pages, 5 1/2 x 8 1/2, soft.
Cat. BS0510 \$11.95

ACTIVE-FILTER COOKBOOK

A practical, easy-to-read discussion of the many types and uses of active filters. Learn how to construct filters of all types including high-pass, low-pass, and band-pass having Bessel, Chebyshev or Butterworth response characteristics. Easy to understand - no advanced math or obscure theory is used. Active Filter Cookbook can be used as an introduction to active filter circuits or as a reference book for analysis and synthesis techniques for active filter specialists. 240 pages, 5 1/2 x 8 1/2, soft.
Cat. BS0519 \$21.00

GREAT VALUE \$27.95

RF CIRCUIT DESIGN

A user-oriented text with a practical approach to the design of RF amplifiers, impedance matching networks, and filters. Can be used in cookbook fashion as a catalogue of useful circuits with component values. Utilizes a minimum of complex math. A valuable bridge between the classroom and "real world" application, and an excellent reference manual. 252 pages, 5 1/2 x 8 1/2, soft.
Cat. BS0530 \$27.95

DESIGN OF PHASE-LOCKED LOOP CIRCUITS WITH EXPERIMENTS

An excellent introduction to the theory, design and implementation of phase-locked loop circuits using various TTL and CMOS devices. Useful self-study course for the experimenter and for inclusion in college courses on control systems or linear ICs. Includes manufacturers data sheets and describes the use of breadboarding aids in the wide range of laboratory type experiments. 256 pages, 5 1/2 x 8 1/2, soft.
Cat. BS0534 \$15.95

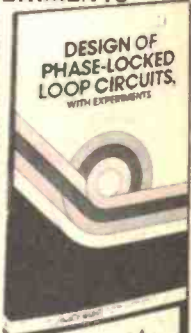

VALUE AT \$15.95

ELECTRONIC MUSIC CIRCUITS

Written for computer and electronics hobbyists with an interest in music, as well as musicians and studio engineers. The author describes how to build a custom electronic music synthesizer, outlines numerous other circuit designs and then shows you how to modify them to achieve particular responses. Many of the circuits can be used as special effects boxes for guitars and other musical instruments. Approximately 288 pages, 5 1/2 x 8 1/2, soft.
Cat. BS0528 \$25.95

OTHER BOOKS

Cat. No	Description/Title	Pages	Price
BS0516	Solar cells & photo cells	96	\$8.95
BS0518	CMOS cookbook	416	\$18.95
BS0520	IC OP amp cookbook	480	\$22.95
BS0522	555 timer cookbook	160	\$10.95
BS0524	Design of OP amp ccts/exp.	224	\$15.95
BS0532	Design of active filters/w. exp.	240	\$15.95
BS0538	How to read electronic cat. dia.	192	\$10.95
BS0540	Modern dictionary of electronics	832	\$29.95
BS0542	TV ant & signal dist. systems	256	\$13.95
BS0546	Modern recording techniques	368	\$18.95
BS0548	73 dipole & longwire antennas	160	\$10.95
BS0550	Handbook elect. tables/formulas	288	\$17.95
BS0556	IC timer cookbook	288	\$15.95
BS0558	Digital counter handbook	264	\$15.95
BS0560	Cable TV	392	\$21.00
BS0562	Sound system engineering	296	\$29.95
BS0578	6502 software design	272	\$17.95
BS0582	How to prog./interface 6800	416	\$24.95
BS0586	8080/8085 principles & programming	240	\$24.95
BS0590	8080/8085 software design	336	\$17.95
BS0596	Z-80 micro. design projects	208	\$23.95
BS0598	Microcomputer-analogous com. software/hardware interfacing	200	\$15.95
BS0600	Mostly basic exp. for Apple II	160	\$17.95
BS0602	Micros for business applications	256	\$15.95
BS0606	Audio IC OP amp applications	208	\$14.95
BS0608	Interfacing & scientific data communication experiments	160	\$11.95
BS0614	Electronic telephone projects	168	\$10.95

Jaycar

SEE OUR OTHER ADS IN THIS MAGAZINE FOR STORE ADDRESSES AND PHONE NUMBERS. . . .



CAR COMPUTER CONTEST WINNERS

Five lucky contestants each receive a Sparkrite Voyager car computer.

The contest, featured in last November's issue, certainly set many readers hunting through their history books! There were five questions on which answers were sought and a sixth asking contestants' how they would use one of the car computer's alarm functions. Here are the answers to the five curly questions:

Q1) What is this circuit?

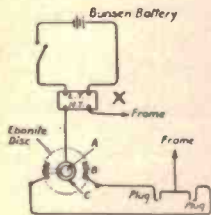

A) It is the very first coil-ignition system.

Q2) Who designed the circuit in question 1?

A) Although commonly known as the 'Kettering' system, it was in fact developed by the Frenchman Lenoir way back in 1860 — decades before Kettering was even born!

Q3) Which mechanic designed the coil marked X in the circuit?

A) The coil used in the circuit of question 1 was designed by the mechanic Ruhmkorff.

Q4) How does this quotation end?

"A traveller without knowledge is . . .

A) a bird without wings".

Q5) Who said the above?

A) The quotation is from the Persian poet Masha'if-uddin, written in 1258! Masha'if-uddin used the pen-name Sa'di.

As for question six, most contestants liked the speed alarm facility on the Voyager, with the aim of not getting caught speeding! The next most popular alarm facility was the 'lights left on' reminder. Flat batteries can be awfully inconvenient.

Well, the first five questions sorted out the best researchers, and four contestants managed to get them all correct. Choosing a fifth winner proved difficult! However, with some careful

sifting of answers to question six, we managed to choose one.

We apologise for the delay in publishing the results, but our move in February disrupted many things — the contest judging being one among many.

No doubt the five following readers will get much enjoyment out of their Sparkrite Voyagers. The winners, in alphabetical order:

THE WINNERS

B.W. Anderson, Keiraville NSW
W.K. Irish, Castle Hill NSW
Michael Reich, East Kew Vic.
Andrew Taylor, Glen Forrest W.A.
Ruth Taylor, Lawson NSW

LORLIN supa-switches from C&K

MAINS SWITCHES

Type MS — Rotary action DPST, suitable for inductive circuits.

Type PBMS — Pushbutton (push on/push off). Ideal for TV industry. Both types 4A at 250V, 80A. surge.

PRINTED TRACK SWITCH

Type PT — Offering outstanding, cost saving design — multibank.

ROTARY WAFER SWITCHES

Type CK — Inexpensive totally enclosed, single bank 12 position, 1, 2, 3 & 4 pole.

MINIATURE ROTARY SWITCH

Type RA — 1" diameter. Up to 12 position — multibank.

SECURITY KEY SWITCHES

Types KMS and KRA — Random or common keys, key trapping facility. Mains switch at 4A, 250V, 80A. surge or RA rotary wafer, multi position.

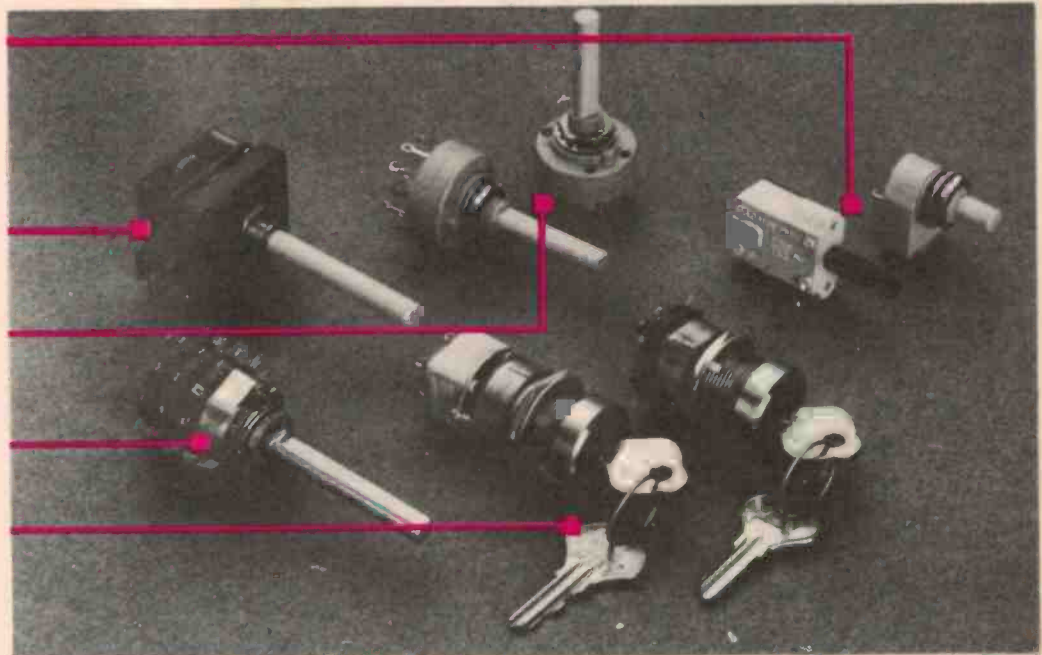

C&K
COMPONENTS

C&K Electronics (Aust.) Pty Limited

Office: 15 Cowper St, Parramatta NSW 2150.
PO Box 229, Parramatta 2150. Telephone 635 0799. Telex AA23404
Agents: Melb. 598 2333. Adel. 277 3288. Bris. 36 1277. Perth 458 7111.
Hobart 34 2233. Launceston 31 6533

Obligation free and comprehensive data is yours for the asking.

Scanner antennas

There's an old maxim about antennas that says "... the bigger it is and the higher you put it, the better it'll be ...". And it's correct. But there are a few other considerations when it comes to such a specialised application as scanning. Here's a practical guide on buying, building and erecting an antenna system for your scanner, no matter what your budget.

Roger Harrison

MOST SCANNERS are supplied with some form of plug-in whip when you purchase them. These, in general, are just a simple telescopic whip with a connector on the end for desk top/mobile scanners, or a 'rubber ducky' type short flexible whip for pocket or handheld scanners. While, in the main, they do work they are inefficient at gathering in the signals you may want to hear. You can be deceived by the apparent strength and clarity of the signals you can hear on your scanner using one of these whips, but there are likely to be myriads more you're missing out on. The one major saving grace of such antennas is *convenience*. You can just plug in your scanner, plug in the whip and be on the air.

You often hear that VHF and UHF signals travel only by 'line of sight' — from the antenna to the horizon; if you can't see the antenna of the station transmitting you can't hear it. To a certain extent this is true, but not strictly so. The 'radio horizon' is actually a little further than the visual horizon — as if the earth were 4/3 the size it is, as a rough rule. However, large landforms — hills, mountains — can get in the way, but also, bending or scattering over the top of these can extend the 'horizon' somewhat. Buildings large and small will reflect VHF and UHF signals, scattering them into places you would not expect to hear them.

As mentioned in my previous article on scanning, the lower atmosphere will occasionally 'duct' VHF and UHF signals way beyond the normal horizon, some hundreds to thousands of miles. Also, the ionosphere — the electrified layers lying from 100 km to 800 km or so above the Earth — will bounce VHF signals beyond the horizon under the right conditions, sometimes half-way round the Earth.

The 'Sporadic E' layer, which forms at about 100 km above the ground at unpredictable times (hence the name) will reflect signals for distances from 500 km out to 2000 km in a single 'hop', very occasionally 3000-4000 km on multiple hops. Sporadic E propagation is most prevalent during the summer months, with a smaller seasonal activity 'peak' during mid-winter.

Around the equinoxes (21 March, 21 September), 'transequatorial propagation' conducts VHF signals across the equator for distances of 3000 km to 10 000 km or more, bouncing the signals via two dense regions in the F layer (200 — 800 km high) lying either side of the equator.

If you're interested in the unusual, or fascinated by the vagaries of propagation, then a scanner is a useful 'tool'. More information on Sporadic E may be found in ETI, May 1978, p.82, and on transequatorial propagation (TEP) in ETI, July 1978, p.112.

Polarisation

Most services using the VHF and UHF spectrum for communications want coverage in all directions over a particular area, between a base station and a number of mobiles. The simplest antenna type for this application, for both the base and the mobile stations, is a vertical whip. Such an antenna will radiate and receive in all directions in the horizontal plane.

As the current-carrying portion of the antenna is in the vertical plane, by convention the antenna will be vertically polarised because the electric field of the antenna will be vertical. Hence, the majority of signals you hear will be vertically polarised. (Well, not after they have travelled some distance, as atmospheric effects and the effects of multiple reflections confuses the polarisation of the signal so that it will be a combination of vertical and horizontal polarisation — or elliptical.)

Antenna types

For scanning applications, the first major requirements for an antenna are that it be able to receive vertically polarised signals and that it can receive more or less equally from all directions. i.e. have omnidirectional coverage. Now, because scanners cover such a wide frequency range, typically from about 40 MHz to 500 MHz or so, the antenna needs to cover a wide frequency range with more or less equal results anywhere in the range of interest. i.e. it should have a broad bandwidth.

Now that's a pretty tall order for an antenna!

Probably the most well-known, and certainly one of the best suited, types is the *discone*, the general arrangement of which is shown in Figure 1. Quite simply, it consists of a horizontal disc sitting atop a vertical cone. The connection to the elements is via a coaxial cable, the braid (or 'outer') of the cable being connected to the apex of the cone and the inner conductor to the disc, which is insulated from the cone.

The disc and cone elements can be made of

solid metal, or in 'skeletal' form from metal rods or tubing. Figure 2 shows one of the popular commercially available types, the GDX-1.

The dimensions of the cone and disc are arranged in a particular way, the length of the cone side being around half a wavelength at the lowest frequency and the diameter of the disc being 70% of that length. The included angle of the cone is generally 60°.

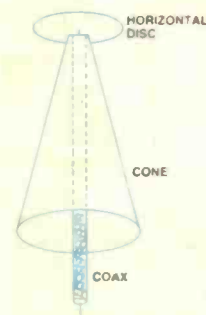

Figure 1. General arrangement of the discone antenna.

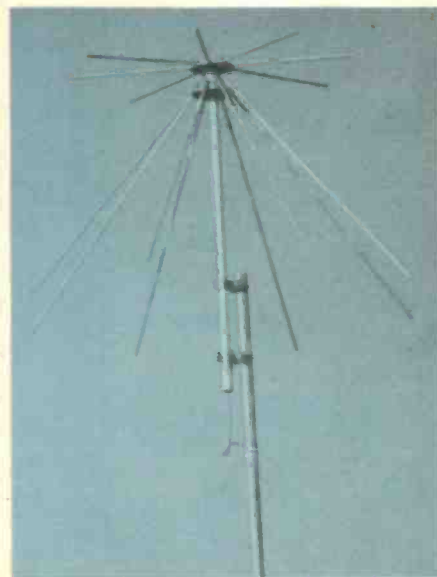

Figure 2. A popular, commercially-made 'discone', the Hoxin GDX-1. (Picture courtesy of G.F.S. Electronic Imports, Melbourne.)

Some types of discone are really stripped down to the bare essentials, the cone and disc simply consisting of three rods each, spaced 60° apart. This results in less expensive construction and a lower cost antenna. The 'Scan-X' is a widely available model featuring this form of construction (see Figure 3).

A popular form of omnidirectional, vertically polarised antenna is the *groundplane*. This consists of a single vertical element, about a quarterwavelength high, situated at the hub of four horizontal, orthogonally arranged elements, as shown in Figure 4. The four horizontal elements form a 'virtual ground', or groundplane, for the vertical element. A coaxial feedline is used, the outer (braid) connecting to the hub of the groundplane, the inner conductor to the vertical element.

The groundplane however, has a limited bandwidth, generally only +/- 5% of the designed centre frequency. However, with the addition of several shorter vertical elements alongside the original, higher frequency ranges can be covered. Tandy, for example, market such an antenna (cat. no. 20-014, 'VHF Hi/Lo, UHF Hi/Lo Ground Plane Base Antenna'). I'll show you how to build a multi-band groundplane later in the article.

The groundplane may come with a minimum of three horizontal elements, but four is more usual. Sometimes you'll see them with multiple groundplane radials, as the groundplane portion is simply a skeleton version of a solid groundplane just over half a wavelength in diameter.

If you're interested in signals from a particular area or getting improved performance over long distances, a beam antenna is required. This concentrates the area of reception of the antenna over a restricted 'window' in a particular direction, reducing the strength of signals coming from other directions. Because a beam concentrates the energy from a particular direction, it will have 'gain' compared to an omnidirectional antenna. The biggest application of beam antennas is in TV reception.

The requirement of broad bandwidth still applies and there are several types of antenna which can be used. Probably the best known, though, is the *log-periodic* antenna. The derivation of the name is quite involved, so I won't attempt to explain it here. However, a log-periodic antenna looks something like that in Figure 5.

A beam antenna will have a 'radiation pattern' or 'reception pattern' looking typically like that shown in Figure 6. If you think of it in terms of reception sensitivity, the greatest sensitivity is in the direction of the arrow, which points in the direction of the 'main lobe'.

Stations at directions off to the side of the main lobe will be received at lower strength than those toward the front. The directions either side of the main lobe peak where the signal strength falls to a half defines the 'beamwidth'. A very large beam, with many elements, may have a beamwidth of 20°, a smaller model, perhaps 80°.

Well to the side of the antenna there may be some minor 'side lobes', with very deep 'nulls' between them and the main lobe. Signals in the direction of the nulls will be

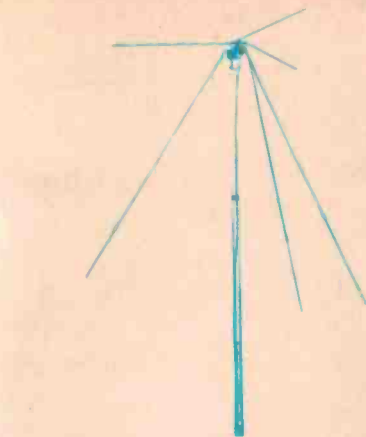

Figure 3. The Hoxin 'Scan X', a truly 'skeletal' form of the discone antenna. This one is sold by many scanner equipment suppliers.

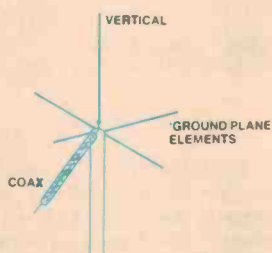

Figure 4. General arrangement of the 'groundplane' antenna.



Figure 5. A typical log-periodic beam antenna (horizontally polarised here). All the elements are split in the centre and 'cross-connected' to the next in line.



Figure 6. The 'radiation pattern' of a typical beam antenna, showing how the sensitivity varies to signals from different directions. To pick up a signal from a particular direction, the antenna is rotated so that the main lobe points in the desired direction (where the signal will be strongest).

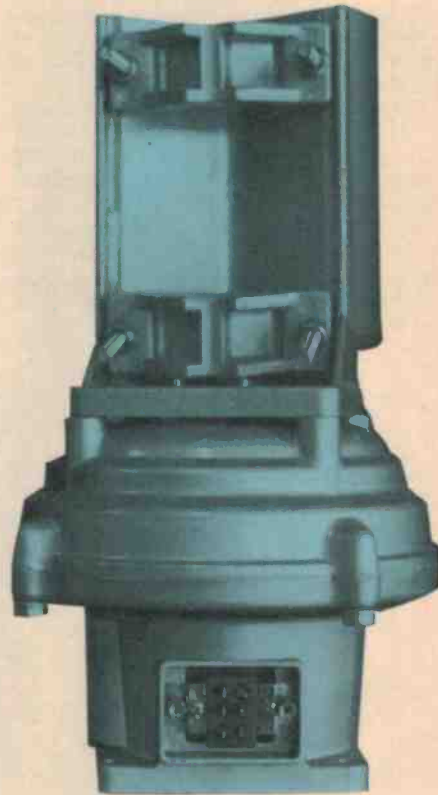

Beam rotator. A typical beam rotator comprises a motor housed in a weatherproof enclosure (to which the beam is attached) — on the right — and a remote control and Indicator unit — on the left — sited at your operating position. This is the Emotor 103SAX, available from G.F.S. Electronic Imports, Melbourne.

severely attenuated.

A further lobe will be found to the rear of the antenna, but sensitivity will be well down compared to the main lobe, as it will be with the side lobes.

Naturally, if the antenna is directional, you'll need to be able to point it in any desired direction, unless you're interested in signals from one general direction only. That's what an antenna rotator is for.

In general, omnidirectional antennas for

scanning cost \$50 to \$100, whereas a beam antenna will cost upwards of \$100.

There are many makes and models of antenna rotators on the market, for TV antenna systems and for ham or commercial antenna applications. They cost from around \$150 upwards. In general, an antenna rotator will consist of a motor assembly which mounts on a mast and a remote control unit which contains the control switches and a direction indicator. (See Figure 11, later.) ▶

Build your own scanner antenna

For a simple, quick, cheap and effective antenna that will cover a single band of interest, it's hard to beat the 'coax dipole' shown in Figure 7. There is an antenna type known as the *coaxial dipole*, and this is a version constructed on the end of a piece of coaxial cable.

To make it, cut the end of a length of coax square then measure back along the sheath the distance 'A' indicated in the accompanying table. Using a penknife or modellers' scalpel, carefully cut around the cable through the outer sheath, to the braid. Take care not to nick the braid. Slit the sheath from the cut to the end of the cable and remove it, exposing the braid. Starting at the end of the cable, gently push the braid back toward the end of the sheath, bunching it up, then work the braid loose along its length toward the end of the sheath. Carefully undo a little of the braid at the end and roll it back on itself, then roll back the braid, pulling it down over the sheath to form the antenna as illustrated in Figure 7.

If you're going to mount the antenna outdoors, seal the cable at the turnover of the braid using a silicone compound such as Silastic.

The antenna may be taped high on a wall or taped to a pole mounted outside and as high as you can conveniently get it. Use electrical insulation tape. It doesn't matter too much if the inner droops a bit at the top.

If you're taping it to a wall inside, position the antenna as high as possible; keep it vertical and away from large masses of metal. You could suspend it using nylon fishing line, if you wish.

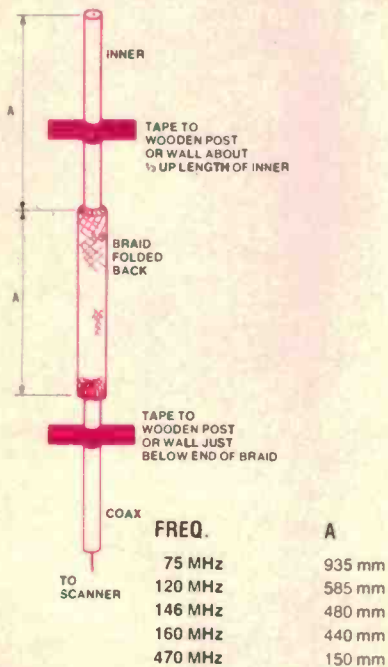

Figure 7. The 'quickie' coaxial dipole. It's simple, but only covers one band (and three times that frequency band, but not as well).

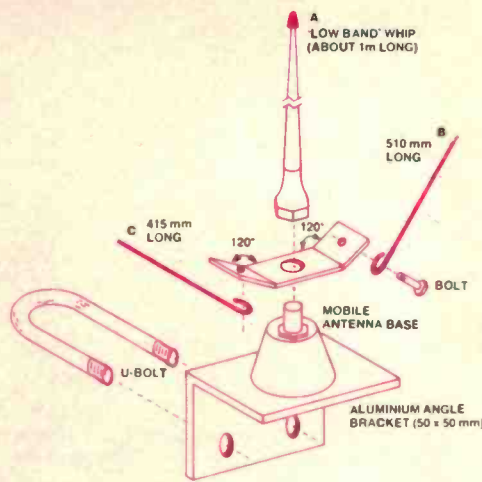

Figure 8(a). Exploded view of the whip radiator assembly for the three-band groundplane.

This 'quickie' antenna will work well over a range of 5% or so either side of the frequencies quoted in the table with Figure 7, and also at three times those frequencies.

Figure 8 shows the construction details for a multi-band groundplane for base station or mobile use. The principal element is a commercially available 'low band' VHF mobile whip about one metre long. This mounts to a standard VHF antenna base mounted on a piece of aluminium angle bracket. A small piece of aluminium plate about 20 mm wide by 40 mm long is drilled and bent as shown in Figure 8a. This holds the two side antennas, B and C, at an acute angle to the main whip (about 30°). These can be fashioned out of heavy gauge (e.g. 16g or 18g) bare copper or steel wire. Each has a small loop at the end so that it can be bolted to the bracket secured under the low band whip.

A dual groundplane system is used for base station applications. These are fashioned out of 9 mm (3/8 inch) aluminium tube bolted to a 50 mm (or larger) diameter aluminium mast which can be as long as you please. Figures 8b and 8c show the dimensions and general construction, 8d shows the completed antenna.

The angle bracket holding the vertical element is secured to the mast just above the groundplane elements using a U-bolt.

Attach a length of coax to the antenna base, seal it with a silicone compound such as Silastic and you're ready to go on the air!

For mobile operation, dispense with the groundplane elements and mount the angle bracket to a roof-rack bar using two small U-bolts positioned vertically, side by side. Alternatively, if you have a VHF mobile antenna base already mounted on your vehicle, the three elements could be mounted to it in the same fashion as shown in Figure 8a.

This antenna will cover channels within quite a few MHz of 70 MHz, 140 MHz and 170 MHz — which covers some of the more popular bands. It will also work on the UHF band, but perhaps not as well as a good UHF antenna.

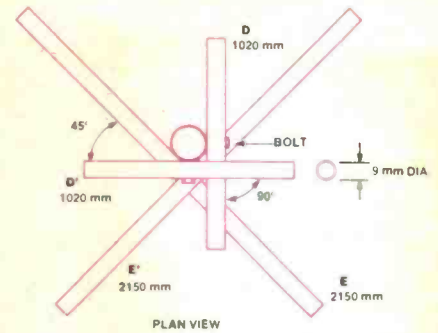

Figure 8(b). Plan view of the two sets of groundplane elements.

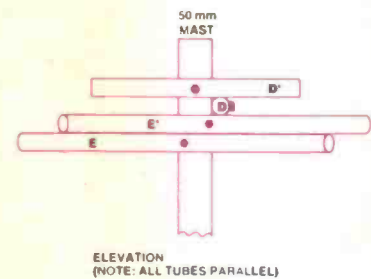

Figure 8(c). Elevation view of the two sets of groundplane elements.

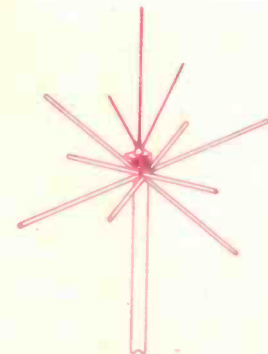

Figure 8(d). Overall view of the finished three-band groundplane.

Erections

"The higher you put it, the better it'll be . . .", says the old maxim, but there's no need to go to extremes. Really good results can be obtained simply mounting the antenna on the roof of your house. A 30 metre high tower is hardly in keeping with the cost of your scanner!

No matter what sort of antenna you're using, mount it in a conveniently high position and as clear of nearby objects or structures as you can. If you're mounting it somewhere on your house, then simple, low cost TV antenna type fittings can be used, as illustrated in Figures 9 and 10.

When contemplating where to mount the antenna, you'll need to keep in mind that the shorter the run of coax feedline you can get, the better off you'll be. Any sort of feedline has losses — that is, it will attenuate the incoming signals to some extent, and the loss increases with increasing frequency. Thus, the shorter the length of feedline, the less the loss incurred.

The sort of feedline commonly used is known as 'RG58' or 'RG58C/U'. Buy a good quality make — it will have less loss than that made for CB applications. RG58 is about 6.5 mm

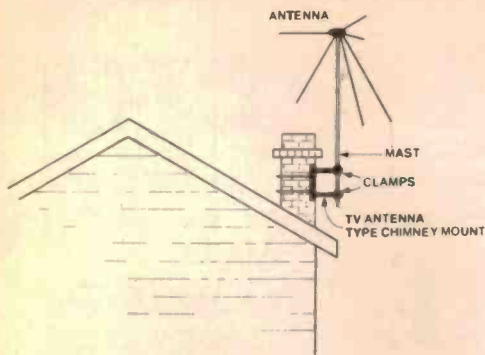

Figure 9. Mounting a scanner antenna on your chimney, using TV antenna type fittings. The mast should be no taller than two or three metres.

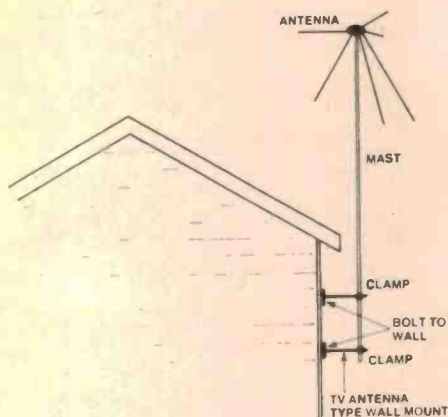

Figure 10. Mounting a scanner antenna from a wall, again using TV antenna type fittings. The mast could be up to 4m tall but, if so, keep the wall mounts about a metre apart.

in diameter and has a loss of around 16 dB per 100 metres at 100 MHz, 24 dB/100 m at 200 MHz.

However, the larger diameter coax cables have lower loss figures. These are generally 10 mm in diameter and two common types are RG8 and RG213 (sometimes with the /U or C/U suffix). These have losses of around 6 dB/100 m at 100 MHz, 9 dB/100 m at 200 MHz. As you can appreciate, despite the



Another rotator. This beam rotator is a 'medium duty' type, by Alinco, model EMR-400. It is available from Imark Pty Ltd, Melbourne.

extra cost, the larger diameter coax is a better proposition when long feedline runs are involved.

If you intend using a beam antenna, the mounting configuration shown in Figure 11 is recommended. The mast can be mounted using the techniques shown in Figures 9 and 10, but make sure the total mast length is no longer than about three metres, otherwise it may not take the wind loading that the beam antenna will exert on it.

When mounting a beam antenna, ensure that it can rotate freely and that the beam is mounted to the mast at the point of balance. The short section of mast between the beam and the rotator must not be metal, otherwise it will interfere with the operation of the beam. It should be at least as long as the longest element, or slightly longer. You can use ABS pipe, as suggested, or a wooden mast here (suitably treated against the effects of the weather, i.e. paint it with an exterior epoxy lacquer, such as Estapol).

The feedline should have enough slack in it so that it is not strained by the operation of the rotator, yet not too much that it flaps violently in the wind, which will prematurely wear it. Tape it securely to the mast sections above and below the rotator.

Well, that concludes this short guide to scanner antennas; good listening!

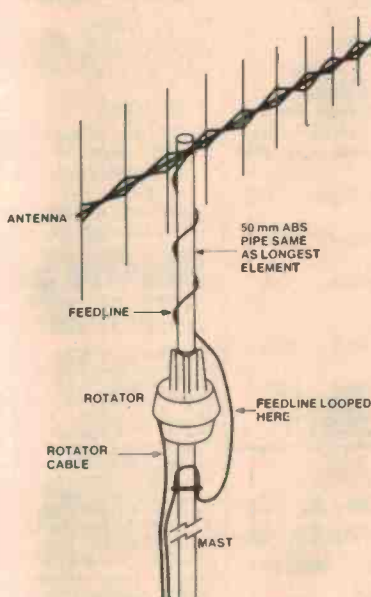

Figure 11. General arrangement for mounting a beam antenna and rotator. The mast should be supported no further than 1½m below the rotator.

Some references

Here are a few books which contain useful further reading on the general subject of antennas. They are not listed in any preference order.

The ARRL Antenna Book, *The American Radio Relay League, 1982.*

Vertical Antenna Handbook, Capt. Paul H. Lee, USNR, K6TS, *Cowan Publishing Corporation, 1974.*

The Radio Amateur's VHF Manual, *The American Radio Relay League, 1982.*

VHF-UHF Manual, Fourth Edition, G.R. Jessop, G6JP, *RSGB Publications, 1983.* ●

I M A R K

for JAPANESE ICs & TRANSISTORS

OEM Quantity prices available

NEC

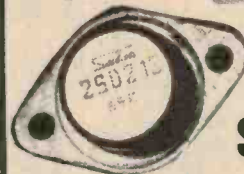
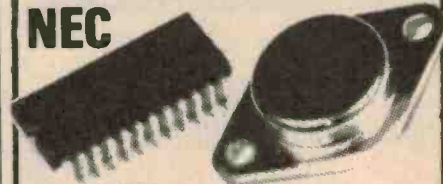

SANKEN



OKI



TOSHIBA



HITACHI



SANYO



MITSUBISHI



MATSUSHITA

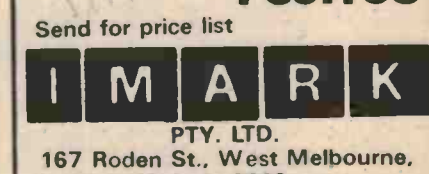

FUJITSU

Send for price list

I M A R K

PTY. LTD.

167 Roden St., West Melbourne, Victoria 3003

Phone: (03) 329 5433 Telex AA37753

zero inflation-zero

BUY EARLY TO AVOID

ALL SPECIALS SHOWN ON THESE PAGES ARE EITHER THE SAME

Smoke Detector

CONSUMER FLOP - CONSUMER FLOP
CLUB, HOTEL, HOSTEL & MOTEL MANAGERS
PLEASE NOTE

Cat. LA5006

- Contains Americium 241 Ionization Chamber
- Contains very loud solid state buzzer
- 12 month factory warranty.



10 up \$12.50ea

One of the greatest consumer flops of the last decade was the Ionization Chamber Smoke Detector. Even though it is a brilliant product (reliable compact, easy installation, fail-safe etc) it just did not sell. Human nature being what it is finds safety-oriented product just not worth the investment. We all know that accidents and fire never happen to US!! As smoke is the greatest killer in a fire, the market research gurus thought that such a product would have a wide appeal. When they were \$49.50 no-one wanted them. The price fell to a very reasonable \$29.50 and still they stayed on the shelf. We have now been instructed to clear them for less than 1/2 of \$29.50.

1-\$14.50: 2-5 \$13.50ea: 6-10 \$13.00ea:

**A BARGAIN - ONLY \$14.50
INCREDIBLE WIRE & CABLE SALE!!**

We have made an amazing scoop purchase of quality cables. Because we do not have the room in our warehouse we must move it FAST! Sorry, you must buy in 100 metre quantities (as the cable is on 100 metre hanks) - but CHECK THE SAVINGS!!

Cat. No	Description	Sale Price	Normal Price	SAVE
WB1701	Fig. 8 light duty Grey Spkr. cable	\$7.50	\$15 (100m)	50%
WB1702	Fig. 8 med. duty Grey Spkr. cable	\$8.50	\$18 (100m)	54%
WB4504	Twin screened (round sheath) audio cable	\$20	\$42 (100m)	52%
WB2000	75 ohm TV light duty coax	\$18	\$28 (100m)	35%

UP TO 54% OFF NORMAL 100m COST!!

JUMBO SPEAKER CABLE

Now you can have super-quality cable without breaking the bank! Each conductor contains a MASSIVE 259 strands of 0.12mm wire!! It could carry 30 amps! Great for HI Fi or high power amps.



Only \$2.50/m
100m \$2.00/rr
Cat. WB1732

LIQUID CRYSTAL DISPLAY

ONLY \$2.95 each
\$2.50 each 10+



AMAZING LOW PRICE!

We have done it again! Once again Jaycar has secured a quantity of valuable LCD displays. Once again we are passing them on to you at prices that will make our competition green with envy! Basically we have a 5 digit x 18mm high (that's BIG) LCD display. But there is a snag, and here is where you save. Normally this display would sell for around \$20 - If it had the connecting pins bonded to the glass substrate. But this display just has the metallization on the glass substrate. Too hard to connect you say? No, not at all!! We have discovered that a humble Molex pin is JUST PERFECT as a connector! You slip the Molex pin onto the edge and superglue it in place. You then have a permanent connection, a great LCD display and have saved a fortune to boot! (Instructions for fitting the Molex pins as well as FULL DATA and connection diagrams on the LCD are supplied.

And what do you pay for this LCD display? Only \$2.95 each or \$2.50 each 10 up. Staggering value. Cat. ZM9015
Pack of 50 Molex pins (only 42 required) Cat. P16540 Only \$1.00

COMPLETELY BUILT AND TESTED NOT A KIT!!



CAR COMPUTER

A BARGAIN

SAVE \$20
MAY ONLY

HURRY LIMITED STOCKS!!!

The Sparkrite Car Computer has been acclaimed as easily the best unit in the under \$200 market in Australia. We believe that it has features that make the \$700 units look silly! But despite the devaluation of the dollar and despite inflation for the month of MAY ONLY we are slashing \$20 OFF the normal price. That's right! You save but you must be quick!! We have strictly limited stocks and when new shipments arrive the price could well go over \$200!

We don't have a great deal of space to list the dozens of features here but hurry if you want to join the hundreds of Australians who are SAVING MONEY DAILY with the Voyager Car Computer. (Note professional drivers could recoup the cost of the unit within a year after adopting more economical driving habits as shown by the computer).

THIS OFFER IS STRICTLY LIMITED TO THIS MONTH ONLY! REMEMBER! THE VOYAGER GIVES INSTANT FUEL CONSUMPTION AS YOU DRIVE ALONG - IN L/100 Km OR MPG!
Cat. XC2010 \$179 SAVE \$20

FEATURES

- INSTANT FUEL CONSUMPTION IN LITRES/100KM AND MPG!! (MOST OTHERS HAVE ONLY ONE OF THE ABOVE) JUST SWITCH FROM ONE TO THE OTHER AS YOU DRIVE ALONG.
- INSTANT SPEED, TIME AND OTHER FUEL DATA.
- VISUAL AND AUDIBLE EXCESS SPEED ALARM.



BELOW \$200 ONLY \$179

JABBER GRABBER FLOP

We thought that you would agree with us that a good quality FM home antenna would be a good idea. You didn't, and we got caught with stock.

What to do? Well they are STILL a great FM antenna for home use, but at this new price you would be silly if you did not grab one for better FM reception. (For more info see our ads around NOV-DEC 1982). The Jabber Grabber sold for \$29.50, well, sort of sold anyway. It was probably too expensive. But at \$19.50 - another story. We aren't making anymore after this and it does work well. If you need ground plane whips they are only \$7.95 each.

JABBER GRABBER - Cat. AA2002 \$19.95
FM WHIPS for ground plane or car FM reception
Cat. AA2003 \$7.95 each
Special car base for whips - Cat. AA2004 \$2.95 each

BELOW COST EA & ETI

But only at our Carlingsford store. That's right, to encourage you to visit our Carlingsford store you can buy the LATEST ISSUE of EA or ETI for ONE DOLLAR! That is definitely BELOW our cost price. But ONLY at the Carlingsford store.

(The post and packing charges make mail ordering EA & ETI uneconomical)
PLEASE DO NOT ASK FOR THIS OFFER AT OUR YORK STREET STORE

only \$1 ☆ ☆ ☆ ☆ ☆
BELOW COST

LOW COST WALKIE TALKIES

ONLY **12.50** ea



SUPER VALUE!

Last year we sold hundreds. This year despite sales tax increases and inflation we have held the old prices!!

FEATURES: Crystal controlled transmitter
Morse code send
Voice send
Inbuilt antenna

Of all the low cost walkie-talkies that we have seen, these work the best.

devaluation sale!

PRICE AS 12 MONTHS AGO, LOWER OR HAVE NOT BEEN REVALUED!

DISAPPOINTMENT!

BARGAIN OF THE CENTURY

low cost hi fi

3 - WAY SPEAKER SYSTEM
\$29.95 a set
2 SETS (6 SPKR) FOR STEREO
ONLY \$49.96



FREE!
HI FI
CABINET
DESIGN
WITH
EACH
SET

Woofer not to same scale as other components

That's right a 3-WAY Hi Fi speaker kit from only \$24.98!! Each kit contains a massive 10" (250mm) woofer, cone midrange and DOME tweeter!! You also get, at no extra charge, the special crossover capacitors!! The system is rated at approximately 20 watts RMS so it is ideal as an economical but reasonably powerful main Hi Fi unit or as a second system for another room or outdoors. Each 3 way kit comes with a recommended enclosure design which you can build yourself easily! You would normally pay well over \$60.00 for the equivalent from major kit speaker suppliers so this represents an outstanding bargain!

BUT HURRY ONLY 250 PAIRS

Sensitivity of system 93dB/1m/1 watt
Cat. AK-3700
P.S. Bonus. These speakers are made in JAPAN, not a South Asian country.

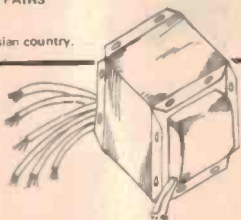

COMPUTER
TRANSFORMER
BARGAIN
ONLY \$29.50

We have secured a quantity of a power transformer at a never-to-be repeated price. This transformer is ideal as the basis of an S-100 power supply, but can be used for many other computer or general power supplies.

SPECS: Primary 240V AC - Secondary 1: 15VAC 2 amp - Secondary 2: 15V AC 2 amp - Secondary 3: 8VAC 8 amp.

A typical DC supply could be $\pm 15VDC @ 1.5A$ & $5VDC @ 8A$ or $\pm 12VDC @ 2A$ & $5VDC @ 8A$.

This transformer would normally sell for around \$50 only \$29.50. Brand new stock.

MORE EDGE CONNECTOR BARGAINS

Over the past 6 months we have sold thousands of quality PCB edge connectors. And STILL we have more bargains!!

Edge Connector No. 1
This component has a 0.1" pitch 72 way (2 x 36) configuration. Each contact is heavily gold plated and bifurcated for lower contact resistance. The 0.025 square terminations will PC mount or take one level of wire-wrap. The body is moulded in high quality Dialyl Phthalate with integrally moulded mounting feet on the ends. Outstanding quality for the price.

1 - 9 \$2.95
10+ \$2.45

Cat. HE-8655

Edge Connector No. 2
This component has a 0.156" pitch 86 way (2 x 43) configuration. Once again each contact is heavily gold plated and bifurcated. The termination is of the solder-lug type. The body is identical in fashion to the HE-8655

1 - 9 \$3.45
10+ \$2.95

Cat. HE-8656



Fully Guaranteed \$12.50

\$36.50

INTRIGUING

For years and years 240V mains powered strobes have been selling for between \$30 and \$40. Even kits are around \$36. So why is it that Jaycar can sell a 240V strobe - guaranteed - for \$12.50?

We can tell you for a start that we're not selling them below cost. Even at \$12.50 we're doing OK.

Why so cheap?

Well they were made for a well known electronics chain. Their Q.C. (Quality Control) Department rejected them on the grounds that around 5% of them were faulty. That was an unacceptable figure considering the very good name that the chain has in this country. All goods were rejected (even the 95% good ones) and sent back to the importer.

The importer came to us with his problem. We said that we would sell them PROVIDED we could offer a 90 day guarantee on the item.

Whilst all stock has been checked and the duds weeded out we STILL feel that even at \$12.50 you deserve a comeback if we sell you faulty goods.

So that's it. You get a 240V strobe that is perfectly OK for \$12.50.

Compare THAT with the \$36.50 that you will pay elsewhere.

It's almost too good to be true except for one thing. It's true.

FULL 90 DAY WARRANTY - Cat. XM7005

Jaycar NUMBER 1 FOR KITS

SYDNEY SHOWROOM
125 YORK STREET PHONE: (02) 264 6688
TELEX: 72293

CARLINGFORD SHOWROOM
Cnr. CARLINGFORD & PENNANT HILLS ROAD
PHONE: (02) 872 4444

MAIL ORDERS & CORRESPONDENCE
BOX K 39 HAYMARKET, SYDNEY 2000
POST AND PACKING CHARGES
\$5 \$9.99 (\$1.50) \$10 \$24.99 (\$3.20)
\$25 \$49.99 (\$4.50) \$50 \$99.99 (\$6.50)
\$100 or more (\$8.00)

SHOP HOURS CARLINGFORD
Mon - Fri 9am - 5:30pm; Sat - 9am - 12pm; Thurs night 8:30pm
SHOP HOURS SYDNEY
Mon - Fri 8:30am - 5:30pm; Sat - 8:30am - 12pm; Thurs night 8:30pm

Mail Order By
BANKCARD
Via Your Phone



The Micro-Grasp robot arm

Part 2

This part covers construction of the interface electronics board, which completes the project.

Richard Becker

Powertran, Andover, Hants U.K.

ALL THAT REMAINS to complete the Micro-Grasp project is the assembly of the interface board, wiring it to the mechanical assembly and arranging the interface connections.

ELECTRONIC ASSEMBLY

Many of the components on the interface board are closely spaced and you'll find assembly easiest if you follow the order detailed here.

Sockets are used for all the dual-in-line (DIL) ICs. These should be soldered in place first. Identify which is required for each IC position and solder them in place one by one taking care to orientate them correctly.

The single-in-line resistor pack, R3-R10, should be soldered in place next, making sure you place the end marked with a spot towards the outer edge of the board, as indicated on the component overlay.

All the resistors should be soldered in place next. Note that four are stood vertically from the board: R26, R27, R29 and R30. Solder the disc ceramic capacitors in place next, then the polyester capacitors (the colour-coded ones). The four 47n capacitors are located

between the row of trim pots and the row of IC6s (A, B, C, D). The 100n capacitors are all located between the row of trim pots and the line of LM2877s (ICs 8A-D and 10). Finish off this stage of the construction by soldering the electrolytic and tantalum capacitors in place. Take care they are each orientated correctly.

Now you can mount the eight trim pots. Follow by assembling the 7805 regulator, IC1, and its heatsink to the board, carefully bending the leads to fit into the holes provided. Solder the leads *after* tightening the securing bolt.

The five LM2877 dual power amp ICs can be soldered in place now. These are in single-in-line packages (SIP) and have a soft copper heatsink 'flag' on the top. The flag has one corner chamfered, indicating the pin 1 end of the package (see the accompanying pinout). Make sure these ICs are facing the right way before soldering them in place. The spot and arrow on each IC on the overlay diagram indicate the *direction of the pin 1 end* of each package.

The 10-way DIP switch may be soldered in next. The 'open' side faces *away* from IC2, note. ▶

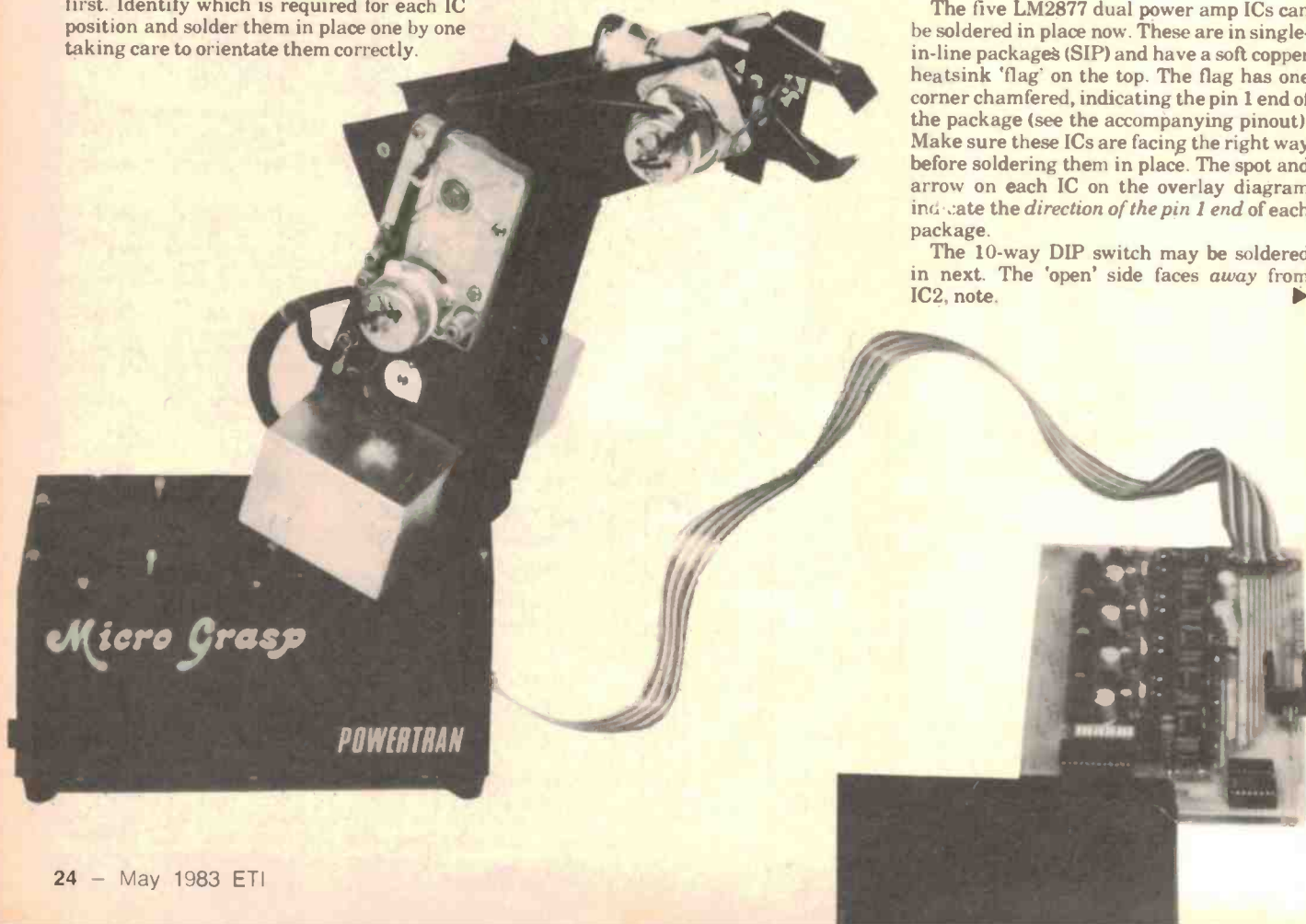

INTERFACE BOARD

Resistors	
R1, 2, 15A-D, 16A-D, 31, 33	all 1/2W, 5%
R3-10	4k7 (12 off)
R11	4k7 8-up SIP network
R12	82R
R13A-D, 18A-D, 19A-D, 21A-D, 27, 30	1k (18 off)
R14A-D	3k9 (4 off)
R17A-D	470R (4 off)
R20A-D, 22A-D, 25, 28, 32, 34	100k (12 off)
R23A-D, 24A-D, 35, 36	3R3 (10 off)
R26, R29	10k (2 off)
RV1A-D, RV2A-D	22k trim pots (8 off)

Capacitors	
C1, C2	220u/16 V RB electro. (2 off)
C3, C4	1u/16 V tant. (2 off)
C5A-D	47n ceramic (4 off)
C6A-D	100u/10 V RB electro. (4 off)
C7A-D	100p ceramic (4 off)
C8A-D	47u/10 V RB electro. (4 off)
C9A-D	47n polyester (4 off)
C10A-D, 11A-D, 12A-D, 13A-D, 16, 19	100n polyester (20 off)
C14, C15	47u/6V3 tant. (2 off)

Semiconductors	
IC1	7805
IC2	DM8130
IC3	74LS138
IC4	74LS04
IC5A-D	74LS373 (4 off)
IC6A-D	DAC0808 (4 off)
IC7A-D	1458 (4 off)
IC8A-D, IC10	LM2877 (5 off)
IC9	74LS123

Miscellaneous
 S1-S10 SPST 10-band DIL switch
 Printed circuit board; flapack heatsink; 4 x 8-pin IC sockets; 1 x 14-pin IC socket; 6 x 16-pin IC sockets; 4x20-pin IC sockets; 1x24-pin IC sockets.

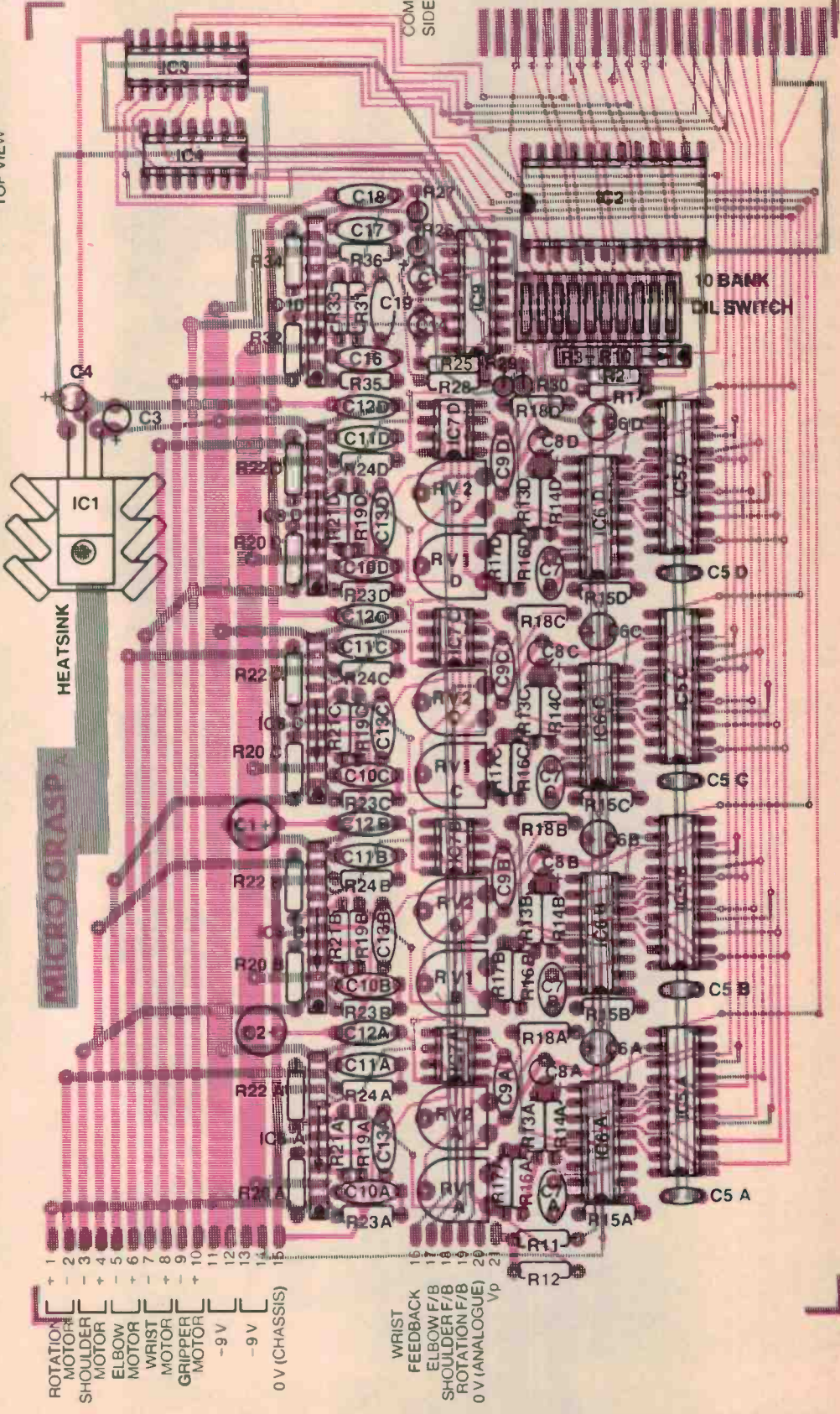
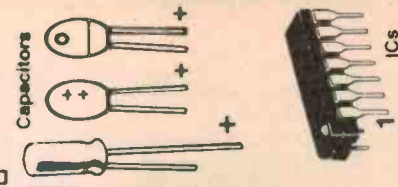
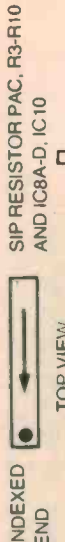
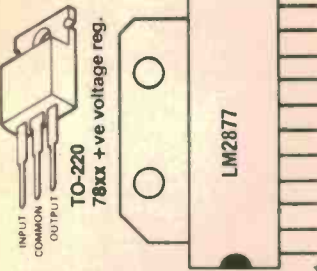
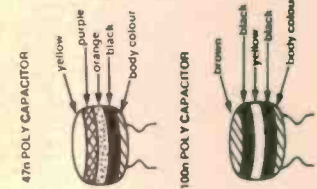

ROTATION MOTOR
 SHOULDER MOTOR
 ELBOW MOTOR
 WRIST MOTOR
 GRIPPER MOTOR
 -9V
 -9V
 0 V (CHASSIS)

TABLE 2.

PC BOARD CONNECTION POINT	TERMINAL BLOCK	DESTINATION
1	1	rotation motor +ve
2	2	rotation motor -ve
3	3	shoulder motor -ve
4	4	shoulder motor +ve
5	5	elbow motor -ve
6	6	elbow motor +ve
7	7	wrist motor -ve
8	8	wrist motor +ve
9	9	gripper motor -ve
10	10	gripper motor +ve
11, 12	11	+9 V
13, 14	12	-9 V
15	tag	0 V (solder tag on chassis)
16	13	wrist feedback (RV101D, tag B)
17	14	elbow feedback (RV101C, tag B)
18	15	shoulder feedback (RV101B, tag B)
19	16	rotation feedback (RV101A, tag B)
20	17	0 V, analogue
21	18	Vp

That completes the component assembly. A careful check at this stage may obviate problems later on.

The 21-wire flat ribbon cable can now be prepared for connecting between the interface board and the arm assembly. Separate the wires at one end and strip and tin the wires. A group of six on one side is pared back from the rest to go to connection points 16-21 (see the overlay and photograph).

The other end of the ribbon cable connects to the terminal blocks on the end plate of the arm assembly according to Table 2 (which is related to Table 1). Temporarily leave off the wires to terminals 2, 4, 6, 8 and 10.

Check everything, once again.

Don't plug in the remaining ICs yet.

All that remains now is to arrange the interface connections according to your computer's expansion socket pinout.

The edge connector at the right hand end of the board plugs into a 44-way keyed socket. This is British-made, UECL part CS 1692F 1585 8237, and suits the Sinclair ZX81 expansion connector. To interface the board to your computer, you'll need one of these sockets, a short length of 28-way ribbon cable and a plug or socket to suit your computer's expansion connector.

Testing and calibration

Power up the robot and interface board without the computer connected and with all the ICs unplugged and check the power rails for ± 9 V approximately and ± 5 V from the regulator. Assuming all is well, switch off and plug in the ICs. Check again and switch off.

Connect the computer, switch on the robot followed by the computer and check the computer's operation is unaffected by the interface board. If it is, then there is probably

a short across the address or data lines on the board.

Set all the DIL switches to open, rotate RV1 A-B-C-D fully anticlockwise and enter POKE 65472,0. Each output of IC5a will now be low and IC7a pin 1 will be close to 0 V. Enter POKE 65472,255 and each output will change to high and IC7a pin 1 will change to close to +1 V. Enter POKE 65472,128 and IC7a pin 1 will change to 0.5 V.

Similar results will be obtained on servo circuits B, C, D using addresses 65473, 65474, 65475 respectively.

Address the monostables with POKE 65477,0 and POKE 65478,0 and IC9 pins 13 and 5 respectively will go high for about two seconds and then return to low.

Connect the rotation motor (terminal block 2) whilst the robot is switched off, turn each preset to its midway position and switch on. The arm will move to some extent and come to rest peaceably i.e. without being held back by its cables.

Turning RV1A will result in the arm changing its position.

Return RV1A to its midway position, successively enter data of 0 and 255 (i.e. minimum) and maximum codes and adjust RV1A-RV2A for 180° of movement symmetrical about the forward facing position.

Repeat this procedure one axis at a time for the other three servo-controlled axes, adjusting for the shoulder to move between almost touching the end stop and about 10° below horizontal and for the elbow and wrist joints to have 180° movement.

Finally, connect and check the gripper motor circuit and after fitting the end panels the robot is ready for use.

We hope to follow up this project description with some general software details plus interfacing to some popular micros and a few programs.

ELECTRONIC HOBBYIST!

DO YOU LIVE IN ...

Ringwood Lilydale
 Boronia Wantirna
 Bayswater Croydon
 Mooroolbark etc....

We carry a comprehensive range of electronic components at very keen prices.

Ian J. TRUSCOTT
ELECTRONICS

CNR EASTFIELD
 & BAYSWATER ROADS,
 SOUTH CROYDON, VIC.
 TELEPHONE (03) 723 3860

CIRCUITS No 4

circuits and ideas culled from the 'Ideas for Experimenters' pages of ETI's Australian and British editions.

ETI CIRCUITS No. 4

contains a wide range of circuits, ideas and data for the electronics enthusiast, arranged in 15 categories, including Alarms, Audio, Computers, Games, Triggering & Switching, Techniques, RF and Test & Measurement.

\$2.95

Available at newsagents and selected specialist suppliers, or by mail order direct from:

ETI Book Sales,
 140 Joynton Ave,
 Waterloo NSW 2017.

Please add 65 cents post and handling.

MINI-MART

Where readers can advertise —
For Sale/Wanted/Swap/Join

● We'll publish up to 24 words (maximum) totally free of charge for you, your club or your association. Copy must be with us by the 1st of the month preceding the month of issue. Please — please — print or type adverts clearly, otherwise it may not turn out as you intended! Every effort will be made to publish all adverts received; however, no responsibility for so doing is accepted or implied. Private adverts only will be accepted. We reserve the right to refuse adverts considered unsuitable.

● Conditions: Name and address plus phone number (if required) must be included within the 24 words. Reasonable abbreviations, such as 25 WRMS or 240 Vac, count as one word. Adverts must relate to electronics, audio, communications, computing etc — general adverts cannot be accepted. Send your advert to:

ETI Mini-Mart,
140 Joynton Ave, Waterloo NSW 2017.

AUDIO

FOR SALE: DBX 3BX II music dynamic range expander, \$900. Audio Technica ATH8 best electret headphones, \$300. Both never used. ono. K. Tan (02)398-1189.

AUDIO SPECTRUM ANALYSER: Merguro, Mat 140. Stereo 20 Hz to 20 kHz. New price \$3600, sell for \$1410 ono. Mint condition. (02)896-2975.

SPEAKERS (TWO): GOODMAN'S Audiom 15P. 15 inch bass woofers, large cabinets, 100 WRMS. Mint condition. \$390 ono. (02)896-2975.

VALVE AMPLIFIER: Harmon Kardon integrated amplifier. Recently overhauled, 30 WRMS per channel. Superb sounding amplifier. \$390 ono. (02)46-5451.

COMMUNICATIONS

FOR SALE: KENWOOD 520S transceiver \$450. Yaesu FC 707 antenna tuner \$100. Trapped dipole 80, 40, 20 \$75. Ken George (03)878-7574.

FOR SALE: SIDEBAND 10M SSB transceiver base station, 15 W PEP, as new. A bargain at \$110. Glen (02)449-9130 ah.

MISCELLANEOUS

BRAND NEW B&W plx tubes: 1x 27ZP4, 18x 25RTP4, 5x A65-12W, 1x A65-11W, 1x 21DJP4, 2x 17BJP4, 1x AW43-80, 1x A31-120W, 1x 21CBP4. What offer for the lot. Ex Hobart. E. Searle, GPO Box 578F, Hobart Tas. 7001.

CRO 15 MHz DUAL TRACE BWD Model 539, including two Telequipment X10 probes. Excellent condition, hardly used \$375 ono. Newcastle (049)48-7638 after 9 pm.

WANTED: 6299, 7554, 6442, 6884, 7077 and 6205 valves. K901 110 Vac delay relays (similar in size to 6V6 GT). (03)583-1638.

COMPUTERS

FOR SALE: DISK DRIVES, 8" 30M Micropolis Winchester and intelligent controller, 8" Shugart floppy \$3000 ono. Alan Millett (066)52-4077 bh.

FOR SALE: LOGIC DICE, a game of strategy played against the MicroBee. Listing \$5, with cassette \$8. W.J. Bock, 14 Tudor St, Belmore NSW 2192.

WANTED TO BUY: SYM-1 single board computer. Geoff (02)638-0177 ext 341 bh.

VIC 20 COMPUTER, cassette recorder, Super Expander, 16K RAM, \$400 of software, joystick. Worth over \$1000, sell for \$500. Adrian (03)850-3113.

SELL: ONE HHP-16K ROM emulator, for use with HP-41C/CVs. Use EPROMs. As featured in ETI March '83 page 78. \$250. Stephen (03)366-6502.

SELL: Z80 S100 microcomputer. Includes DGZ80 CPU, MW640 VDU, motherboard, keyboard, cassette interface, power supply and manuals. All working, \$320 ono. Con (02)709-6393.

TRS-80 MODEL I program exchange. Send four on cassette and receive four new ones. \$2 P&P. G. Egel, 18 Sturt St, Loxton SA 5333.

NOT 20 PROJECTS
NOT 25 PROJECTS
NOT EVEN 35 PROJECTS ... BUT ...
50 PROJECTS! ... WOW!



The great, grand, gl-normous HOBBY ELECTRONICS PROJECT BOOK

is here at last! This book *must have* just about something for everyone. Something for the dabbler or dab hand, for newcomer or old timer. Contemplate it — 50 projects in six categories: Radio & Communications, Music & Audio, Games and Hobbies, Test Gear, Measurement, Miscellaneous, PLUS: Construction Techniques and a Reference section! Amazing — 50 projects and 15 articles, a veritable hobbyist's 'bible'. The articles cover project construction, the art of soldering, making printed circuits, capacitors, how to read capacitor codes, diodes, transistors, inductors, transformers, reading circuit diagrams, component numbering and where to buy components. Printed circuit board patterns are given and all the component pinouts you need to know about.

THAT'S RIGHT! \$4.95

This must be the best value ever in an electronics book. Rush out now and get your copy before they all go — which they're bound to! On sale at newsagents and selected electronic suppliers. Or, you can obtain a copy by mail order from ETI Book Sales, Federal Publishing, 140 Joynton Ave, Waterloo NSW 2017. by sending \$4.95 plus \$1.10 post and handling.

WE'RE STUCK!

FOR ROOM TO MAKE MORE KITS, OUT THESE GO AT NEVER-TO-BE-REPEATED PRICES

MICROSYNTH

COMPACT MUSIC SYNTHESIZER Kit

For details on this fantastic Synthesiser see our ads last month in EA and ETI.

We have slashed \$50 off this unit for the month of MAY ONLY. When stocks sell out it will be a LONG TIME before more arrive!

If you want one HURRY!!

Cat. KJ6002

NORMALLY \$399
THIS MONTH ONLY \$349



BAND-BOX Kit

Again for more info see our ads last month. This has to be seen and heard to be believed! It is basically a 3 "MAN" backing trio! Bass, Chords and Percussion! By far the most sophisticated muso-kit we have ever seen.

And we are SACRIFICING them this month ONLY. Strictly limited.

Cat. KJ6604

NORMALLY \$699 including Master Rhythm
THIS MONTH \$100 OFF
THAT'S RIGHT ONLY \$599

JAYCAR 2010 EQUALISER

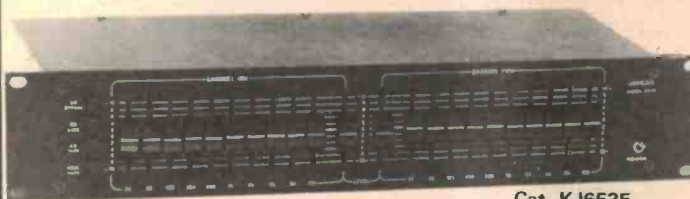

Cat. KJ6535

Fantastic value for the month of May on the Jaycar 2010 Mk IIA Octave (10 band) Equaliser — this superb unit will be cut by 5% making it superb value — add one to your system today — Stereo unit with one slider per octave — 3½" high cabinet.
NORMALLY \$139 — NOW LESS 5% MAY ONLY

MODEL 2801 Mk IIA
1/3rd OCTAVE EQUALISER

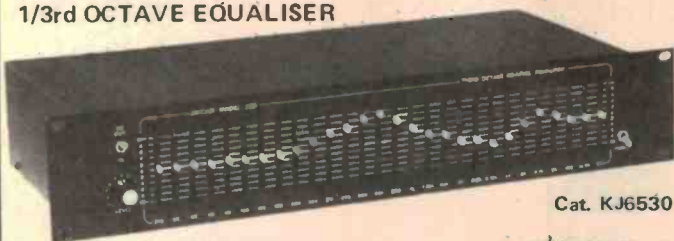

Cat. KJ6530

240 VOLT AC POWERED

CANNON XL
IN/OUT

A full road quality 1/3rd Octave Equaliser — the Jaycar 2801 Mk IIA — don't pay up to \$1000 when the Jaycar unit can do the job for you — two units are required for stereo use
NORMALLY \$225 IN KIT FORM
LESS 5% FOR THE MONTH OF MAY ONLY

WOT! PIANOS AS WELL



That's right. We are slashing the price of our piano kits because we are overstocked. Unfortunately at this price we cannot afford to add such goodies as a soldering iron and IC sockets — BUT everything else is there, including the stand!!

73 NOTE 6 OCTAVE PIANO (COMPLETE KIT)

NORMALLY \$475 - THIS MONTH \$425 — SAVE \$50!!

88 NOTE 7½ OCTAVE PIANO (COMPLETE KIT)

NORMALLY \$589 — THIS MONTH \$489 — SAVE \$100!!

BE EARLY TO AVOID DISAPPOINTMENT!!

6 Octave Cat. KA1350 : 7½ Octave Cat. KA1360

Jaycar NUMBER 1 FOR KITS

SYDNEY SHOWROOM

125 YORK STREET PHONE: (02) 264 6688
TELEX: 72293

CARLINGFORD SHOWROOM

Cnr. CARLINGFORD & PENNANT HILLS ROAD
PHONE: (02) 872 4444

MAIL ORDERS & CORRESPONDENCE

BOX K 39 HAYMARKET, SYDNEY 2000

POST AND PACKING CHARGES

\$5 — \$9.99 (\$1.50) \$10 — \$24.99 (\$3.20)

\$25 — \$49.99 (\$4.50) \$50 — \$99.99 (\$6.50)

\$100 or more (\$8.00)

SHOP HOURS CARLINGFORD

Mon — Fri 9am — 5.30pm; Sat — 9am — 12pm; Thurs night 8.30pm

SHOP HOURS SYDNEY

Mon — Fri 8.30am — 5.30pm; Sat — 8.30am — 12pm; Thurs night 8.30pm



Mail Order By
BANKCARD

Via Your Phone

TRANSISTOR ASSISTED IGNITION WITH DWELL EXTENSION

127 SOLD LAST MONTH

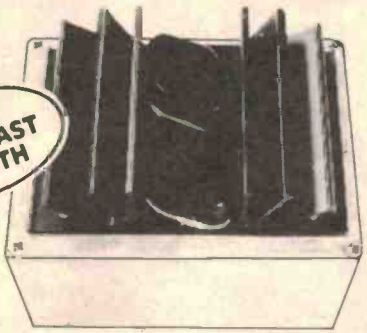

The Altronics Kit includes all components for the modifications, detailed by Electronics Australia Feb. 1983.

Yes, it's bad enough paying \$2.00 a gallon for petrol without wasting a fortune on an out of tune engine. Fit this transistor assisted ignition kit in minutes and start saving money from the very next petrol stop. Easy to build!

K 4010 \$35.00

THE EVER POPULAR MUSICOLOUR IV EA PROJECT



Combination Colour Organ and Light Chaser. Four channel colour organ. Internal microphone or connect to speakers for colour organ operation. (The lights connected to each channel pulse in beat to the music proportional to portion of frequency spectrum concerned.) Four chaser modes forward and reverse. Output lamp load capacity a massive 2400 watts — that's 100 party globes. Full instructions and every last nut and bolt included. Great for parties, shop signs, display windows etc.

K5800 \$89.50

ELECTRONIC FLURO STARTER

(SEE EA OCT. 1982)



Save a fortune on Fluoro Tubes.

- * Extends the life of your fluoro tubes by 1,000's of hours.
- * Instant "ON" — no more flickering at switch on.

K6300 \$4.95

HIGH FIDELITY AM

Sounds every bit as good as FM With this absolutely brilliant EA Project

Project 82 AR12 — See December EA



Frankly, we felt AM was dead and buried for the serious audio buff — when EA told us their new wide band AM tuner had 16KHz bandwidth and made AM sound like as never before — we were still not convinced. But on hearing the New EA AM Tuner, I for one was astonished — AM Broadcasts now sound incredible, there is no other word for it. And the 9KHz whistle filter really works! The result is clear smooth sound reproduction that will be a joy to every constructor of this fantastic tuner project. The ALTRONICS Kit includes rack box and every last nut and bolt — even solder. Full instructions included.

K 5200 \$249.00

THE INCREDIBLE SERIES 5000 FROM ETI SERIES 5000 1/3 OCTAVE GRAPHIC EQUALIZER

Another brilliant DAVID TILBROOK no compromise design



SPECIFICATIONS:

Noise — at zero gain and 20 KHZ Bandwidth — 102 db. Distortion 1 KHZ — typically .007%. Bandwidth — 12HZ — 105 KHZ + 0 — 1 db. Boost/Cut + and — 14 db.

ALTRONICS EXCLUSIVES:

* All 1C sockets provided * Quality series Racking Case supplied * Genuine Philips Sygnetics Low Noise 5534 1C op amps supplied * Specially imported high accuracy linear slide potentiometers employed for precision control adjustment. (NOTE: Not compromise "Null Centre" types that some suppliers offer.)

K 5025 See ETI Magazine November 1982 \$199.50

STUDIO FORMAT ETI 5000 STEREO CONTROL PREAMPLIFIER

There have been countless accolades exclaiming this brilliant design by Australia's top audio design engineer David Tilbrook — and with good reason!



As a demonstration of our faith in this classic designed preamplifier we proudly release the STUDIO FORMAT 5000 PREAMP which includes some very worthwhile refinements as detailed here:—

- * Gold plated RCA Jacks on all phono inputs * 1 x pair gold plated RCA Line Plugs, supplied * Military spec. National Semiconductor LM 394's employed
- * Low capacitance screened cable, supplied; 1C sockets provided throughout; Multicoloured led display * Metal film 1% resistors used throughout all audio circuitry * Pretinned PCB's * Satin Black brush finished, aluminium control knobs

DELUXE STUDIO FORMAT 5000 PREAMP KIT

Complete kit includes all ETI specified parts plus the Studio Format Package. Full instruction booklet included. SEE ETI MAG. JULY '81—OCT. '81 FOR FULL DETAILS.

K 5001 \$275.00

ETI 5000 STEREO MOSFET AMPLIFIER

See ETI magazine Jan. '81—April '81. New generation mosfet power semis facilitate David Tilbrook's classic power amplifier. Listening tests prove it surpasses even the best in conventional amplifiers in low fatigue, high definition audio. Completely uncoloured crisp sound purity.



EVEN BETTER: This beautifully engineered amp design is based principally on two identical printed circuit boards with a minimum of other wiring, thus enabling even a relative "beginner" to accomplish building this project as long as the step by step instructions are followed.

- The ALTRONICS Kit includes the DELUXE FINISH FRONT PANEL HEATSINK
- * Original specified chassis bar design case * All metal work finished satin black
 - * Flux shorting strap transformers used to minimise hum * Low leakage power supply electrolytics

SPECIFICATIONS: Power Output: 100 watts into 8 ohms x 2. Frequency Response: 8 HZ - 20 KHZ + 0 db — 4 db. Noise: 116 db below full output. Input sensitivity: 1V RMS for 100 w output. Distortion: Less than .001% at 1 KHZ and full output. Stability: Unconditional stable.

COMPLETE MOSFET AMP KIT K 5005 \$299.00

LOUDSPEAKER PROTECTION KIT

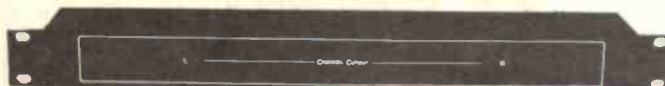

Protect your valuable loudspeaker system with this easy to build, professional appearance kit. This easy to construct kit, based on the latest ETI design (Oct. '82), provides both DC and overpower protection for your valuable Hi-Fi speakers. Self-powered unit disconnects the speakers within 1/10th of a second of a fault occurring yet in no way affects the sound quality.

The ALTRONICS Kit comes in a superb 1 unit rack box including quality silk screened front panel.

- EXCLUSIVES:** * LED Monitoring of channel cutout * Fujitsu 10 amp relays * ALTRONICS Kit, stereo unit complete to last nut bolt and washer * Input/Output speaker cable terminals supplied.

Install it in minutes — no AC or DC connections required — simply connects into the left and right channel speaker lines.

K 5050 Stereo Rack Version \$79.50

ALTRONICS ... ALTRONICS ... ALTRONICS ... ALTRONICS ... ALTRONICS ... ALTRONICS ... ALTRONICS ... ALTRONICS ... ALTRONICS ... ALTRONICS ...

ALTRONICS ... ALTRONICS ... ALTRONICS ... ALTRONICS ... ALTRONICS ... ALTRONICS ... ALTRONICS ... ALTRONICS ... ALTRONICS ... ALTRONICS ...

ALTRONICS ... ALTRONICS ... ALTRONICS ... ALTRONICS ... ALTRONICS ... ALTRONICS ... ALTRONICS ... ALTRONICS ... ALTRONICS ... ALTRONICS ...

ALTRONICS ... ALTRONICS ... ALTRONICS ... ALTRONICS ... ALTRONICS ... ALTRONICS ... ALTRONICS ... ALTRONICS ... ALTRONICS ... ALTRONICS ...

KIT OF THE MONTH

EA's BRILLIANT LABORATORY POWER SUPPLY
See EA May and June 1983



2-50V DC at a massive 175W

Over the last 2 or 3 years we have had literally dozens of requests for a universal 5 amp Bench Power Supply Kit. Naturally we passed this on to the design team at Electronics Australia and at last it is now a reality. Just look at the design concept! A fully mains transformer isolated supply with a very clever "Switch Mode" low voltage circuit.

Most importantly it's dead easy to build (ours worked first time!).
Specifications
Input 240V 50Hz
Output Variable 2-50V at up to 5 amps
Cat K3300..... \$139.50

Why pay over \$250 for an inferior commercial unit?

NEW



TOUCH LAMP DIMMER

HALF THE COST OF COMMERCIAL UNITS

Great new kit from EA. (April '83). Based on new Siemens IC S576A Light Dimmer IC. Instantly turn lamps on and off with just a light touch on a wall panel, or provide mood lighting by touching the panel for a few seconds. The Altronics Kit is complete in every way, including satin silver touch plates for that prestigious look.

K6320..... \$19.50

REMOTE CONTROL FOR K6320

This kit enables extra dimmer/switches to be installed in conjunction with the Dimmer Kit. Includes satin silver touch plate.

K6321..... ONLY \$9.00

NEW



RADIOTELETYPE-COMPUTER DECODER DESIGNED FOR THE MICROBEE
(SEE ETI APRIL '83)

Display RTTY encoded messages on your VIDEO Monitor. Simple circuit uses PLL TECHNIQUES, most components mount on a single PCB simplifying construction. Complete Kit includes D15 Plug for connection to Microbee IN/OUT PORT.

K9733..... \$19.50

'MICROBEE' EPROM PROGRAMMER

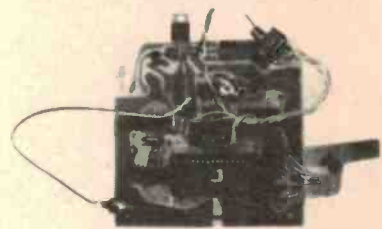

VERSATILE, LOW COST & EASY TO BUILD
Great new project from ETI (Jan 1983). All components mount on a single printed circuit board. Unit simply plugs into the Microbee 10 port Suitable for 2716, 2732, 2532, 2732A and 2764's. Burn your games programmes and eliminate cassette loading times
★ Zero insertion force IC socket for eproms
★ Sockets for all other IC ★ 1 x 2716 supplied — get started straight away ★ Kit supplied in deluxe jiffy box, all mounting hardware included
K9668..... \$48.50

VIDEO RF MODULATOR
(SEE ETI OCT. 1981)



If you cannot afford a Video Monitor for your computer this is the kit for you. Super stable oscillator design and very low modulation distortion ★ Works with both B & W and Colour TV sets ★ Suitable for computers, TV games, TV pattern generators or what have you. Deluxe kit featuring heavy duty diecast box for RF shielding ★ Input and output sockets
K9760..... \$17.50

POWER UP

See EA November, 1982

A MUST FOR YOUR COMPUTER SYSTEM

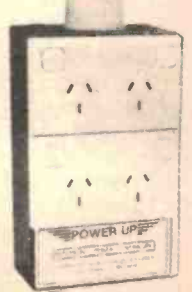

This great new Project from EA is the answer to a Maiden's Prayer.
What Does it Do?
A single 240v mains plug and lead feeds one unswitched master 240v outlet plus 4 switched 240v outlets. With say a hi-fi system, plug your main equipment item (e.g. Amp) into the master outlet and whenever you "switch on" your amp — presto — mains power is applied to the other 4 outlets i.e. simply "turning on" your amp turns on your tape cassette, tuner, turntable, graphic equaliser without mains spikes, plops etc.
Just the shot for your Computer System. The Altronics Kit includes case and all outlets.
Cat K6000..... \$39.50

GO ANYWHERE 240V PWR. KITS

See EA May and June 82. These great new Inverter kits enable you to power 240V appliances for your car, caravan or boat. (From Standard 12V car battery.)

40 WATT

Suits small appliances, i.e. turntable, tape deck, shaver etc. Variable frequency adjustment enables accurate speed control of turntable motors.

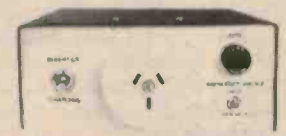

K6700..... \$55.00

300 WATT

Fully regulated and overload protected XTAL locked frequency.

NOW USING HIGH EFFICIENCY TRANSFORMER

Use to power hi-fi, TV sets and for emergency lighting.



- Gold plating on both PCB edge and edge connector.
- Low age rate parallel resonant XTAL used.
- Sockets for all IC's.

K6750..... \$199.50

\$10 DELIVERY ANYWHERE IN AUSTRALIA!

For despatch P+P charges and Altronics address details please refer to our advert on page 71.

Headlight delay unit

With this simple project you can use your car headlights to illuminate your pathway for about 50 seconds; safe on a dark night from the horrors of stumbling into bushes or slipping on those nasty smelly things lying on the footpath. The unit is easy to build and install and switches off automatically.

Jennie Whyte

THIS IS a simple circuit which lets you use your car headlights to light your way. It saves you from falling over rubbish bins or walking into fences on a dark night.

After you have parked your car and turned the delay unit on, the headlights will come on for a pre-set period of about 50 seconds. At the end of this period the unit turns the headlights off automatically. So if you haven't manoeuvred the obstacle course by this stage then you're out of luck.

THE 555 AND HOW IT WORKS

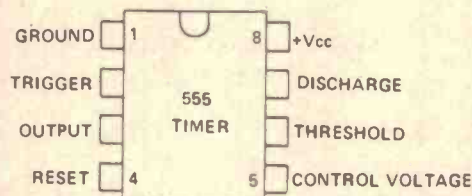

Figure 1.

The 555 timer is a very versatile IC designed specifically for precision timing applications.

It can operate from 4.5 V to 16 V and its output can source (supply) or sink (absorb) any load current up to a maximum of 200 mA. It can directly drive loads such as relays, LEDs, low-power lamps and high impedance speakers.

When used in the 'timing' mode, the IC can produce accurate timing periods variable from a few microseconds to several hundred seconds, via a single resistor-capacitor (RC) network. Timing periods are virtually independent of supply rail voltage, can be started via a 'trigger' command signal and can be stopped by a 'reset' command signal.

The device is available in a number of packaging styles, including 8 and 14-pin

dual-in-line (DIL) and 8-pin TO-99 types.

Figure 1 shows the outline and pin notations of the standard 8-pin DIL version of the 555. Figure 2 shows the functional block diagram of the same device (within the double lines), together with the connections for using it as a basic monostable generator or timer.

The 555 houses two diodes, 15 resistors and 23 transistors. These components are arranged to form one voltage-reference potential divider, two voltage comparator op-amps, one 'reset-set' (RS) flip-flop, a low-power complementary output stage and a slave transistor.

The period timer, as it is used in the headlight delay unit, gives a direct voltage output at pin 3 which is normally low, but goes high

for the duration of the timing period.

The timing action is initiated by momentarily shorting pin 2 to ground via the PB1 START switch. As this voltage is below the reference value of the built-in potential divider the output of the lower voltage comparator op-amp changes state and causes the RS flip-flop to switch over.

As the RS flip-flop switches over it cuts off Q1 and drives the pin 3 output of the 555 to the high state. As Q1 cuts off it removes the short from the timing capacitor connected to pin 7 and the capacitor starts to charge up. Then the RS flip-flop switches back to its original condition, Q1 turns on, the capacitor discharges and simultaneously the pin 3 output of the IC reverts to its low state.

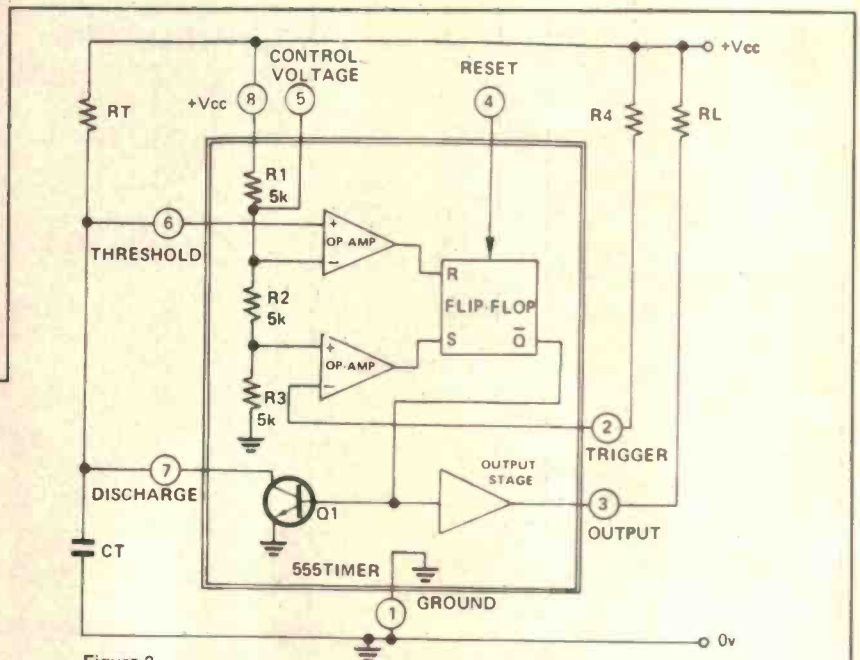

Figure 2.

PARTS LIST — ETI-323

Resistors all ½W, 5%
 R1 22k
 R2 470k
 R3 1k

Capacitors
 C1 100n greencap
 C2 100u/25 V RB electro.

Semiconductors
 D1, D2 1N4001, 1N4002,
 EM401, EM402, etc.
 IC1 uA555, NE555, LM555,
 DS555, etc.

Miscellaneous
 RLY1 DPST or DPDT relay,
 5A-rated contacts with
 12 V coil (120 ohms or
 greater).
 PB1 momentary action
 pushbutton (e.g. D.S.E.
 S-1102, S-1199 types,
 or similar).

ETI-323 pc board; five-way plastic terminal block;
 box (if necessary); wire etc.

Price estimate
\$14 — \$16

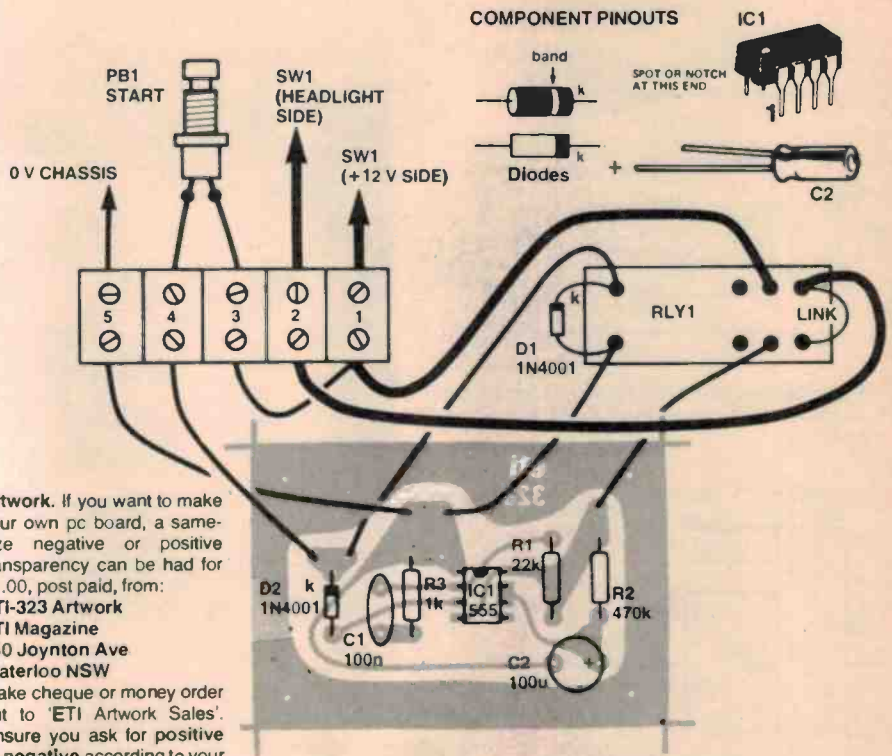

Artwork. If you want to make your own pc board, a same-size negative or positive transparency can be had for \$1.00, post paid, from:
ETI-323 Artwork
 ETI Magazine
 140 Joynton Ave
 Waterloo NSW
 Make cheque or money order out to 'ETI Artwork Sales'. Ensure you ask for positive or negative according to your requirements.

Component overlay and external wiring. How the parts are assembled onto the printed circuit board — watch which way around you assemble D2, IC1 and C2. Wiring to the external components is also shown. The pc board and relay may be housed in any suitable box, if you wish.

Construction

The unit is easy to build and install and works off the car's 12 V battery. The circuit does not interfere with normal headlight operation under actual driving conditions.

Construction is simple because there are only a few components and the layout on the pc board is clearly shown. Before you assemble the components on the board, check that the board has no track breaks or shorts between the tracks, particularly between the IC pins. Make sure you solder the diodes the correct

way round.

The relay can be any 12 V DPDT (double-pole, double-throw) type with a coil resistance of 120 ohms or greater. The contacts should be rated to switch 5 A or greater at 12 Vdc. Note that the IC, a 555, is shown on the circuit diagram with all its connections in the standard manner. Look for the notch and make sure that it's positioned on the pc board correctly, soldering it in after the other components.

Kits and components. See 'Shoparound' in this issue to find suppliers stocking kits or components for this project.

HOW IT WORKS — ETI-323

This circuit has been designed around the 555 IC timer which has already been described.

The pin 3 output is connected to a relay which has two sets of normally open contacts. D2 is wired in series with the relay coil to counteract the slight residual voltage that appears at pin 3 of the IC under the OFF condition and this makes sure that the relay turns fully off. The START switch, PB1, is also normally open so there's no power going to the timer circuit and the lights are off. Capacitor C1 is discharged under this condition.

When PB1 is momentarily closed power is fed directly to the relay coil and the relay turns on. As the relay turns on, contacts RLY1/2 close and apply power to the vehicle lights and contacts RLY1/1 close and apply power to the timer circuit. At this moment pin 2 of the IC is briefly tied to ground via C1 and R3 so a negative trigger pulse is immediately fed to pin 2 and a timing cycle is initiated.

Consequently, pin 3 of the 555 switches high at the moment that the relay contacts close, and thus locks the relay into the ON condition irrespective of the subsequent state of the PB1 START switch so the lights remain on for the duration of the timing cycle.

The period of the timing cycle depends on the values of R2 and C2. With the component values shown, this period is roughly 50 seconds.

At the end of the timing cycle pin 3 of the IC switches to the low state, so the relay turns OFF and contacts RLY1/2 and RLY1/1 open, disconnecting power from the timing circuit and the lights. The operating sequence is then complete.

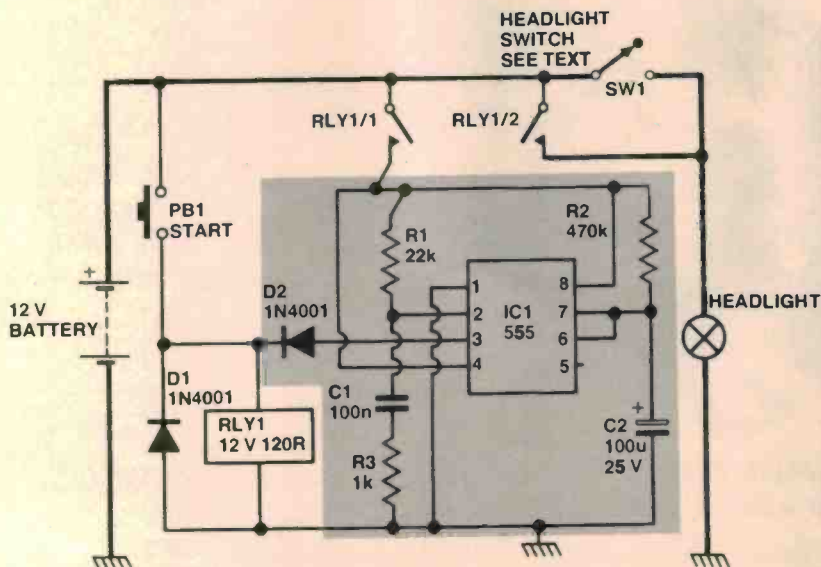

Circuit diagram. The parts in the shaded area are located on the pc board.

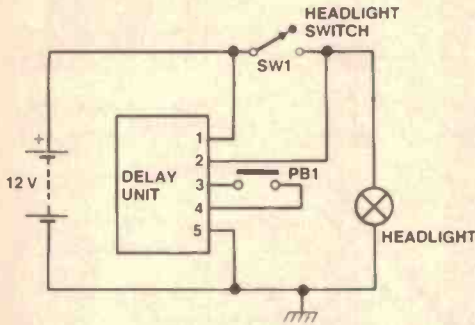

Figure 3. Connection of the delay unit to a car system where the headlights are independent of the ignition switch.

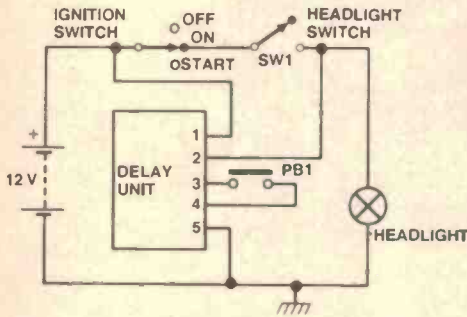
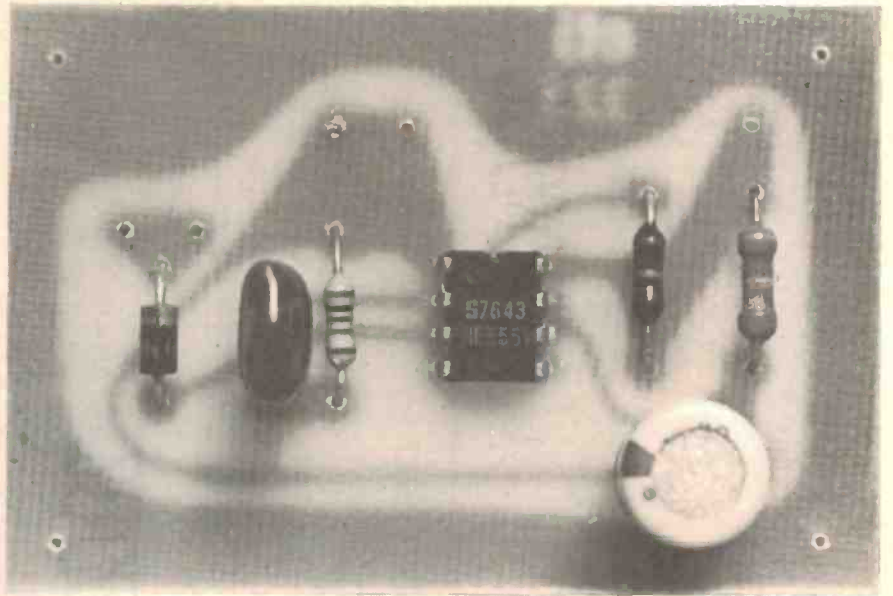

Figure 4. Connection to all other systems.



Closeup. View of the assembled printed circuit board, about four times life size!

When it comes to installing the unit, note that two methods of connection to the vehicle are possible. On some vehicles the headlight switch is connected directly to the battery so that the headlights operate even when the ignition is turned off (see Figure 3).

adopting the practice of feeding the headlight switch via the ignition switch, so that the headlights operate only when the ignition is turned on. If your car uses this type of connection then you'll have to install the unit as shown in Figure 4.

Many vehicle manufacturers are now

AS NEAR AS YOU'LL GET TO A SMALL VARIABLE TRANSFORMER

The Ferguson PL1.5-18/20VA Multi-tap Low Profile Transformer

Ideal for development situations or where the secondary voltage needs to be easily adjustable. Takes you from 1.5V to 18V in 1.5V steps. Simply plug and unplug the pinlok connectors till you get the voltage you want. Twin secondaries provide up to 2.2A. Numerous centre-tap configurations.

- **SERIES CONNECTION (1.11A)**
1.5V, 3V, 4.5V, 6V, 7.5V, 9V, 10.5V, 12V, 13.5V, 15V, 16.5V, 18V
Additional Series Configurations (1.11A)
9V-6V-1.5V-0-1.5V-6V-9V or
9V-7.5V-3V-0-3V-7.5V-9V
Centre Tap Configurations (1.11A)
1.5V-0-1.5V, 3V-0-3V, 4.5V-0-4.5V,
6V-0-6V, 7.5V-0-7.5V, 9V-0-9V
- **PARALLEL CONNECTION (2.22A)**
1.5V, 3V, 4.5V, 6V, 7.5V, 9V

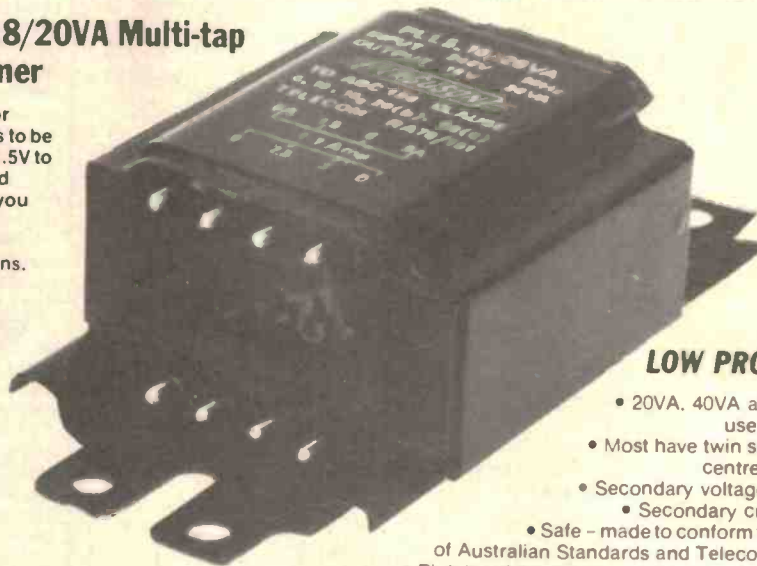

CHECK THE WHOLE FERGUSON LOW PROFILE RANGE

- 20VA, 40VA and 60VA ratings - use two to get 120VA
- Most have twin secondaries to give centre-taps if necessary
- Secondary voltages from 6V to 40V
 - Secondary currents up to 6.6A
- Safe - made to conform to relevant clauses of Australian Standards and Telecom Australia-specs.
- Pinlok quick connect connections • Made in Australia

TALK TO FERGUSON - THE AUSTRALIAN COMPANY WITH NEARLY 50 YEARS EXPERIENCE OF MANUFACTURING IN AUSTRALIA FOR AUSTRALIAN CONDITIONS



FERGUSON TRANSFORMERS PTY LTD

331 High Street, Chatswood N.S.W 2067 Tel: (02) 407 0261. Telex AA25728
Branch Office: 181-183 Hawke Street, West Melbourne Vic 3003
Tel (03) 328 2843 Telex AA33510

ETI BOOK SALES

Save time and trouble with mail order. Just fill out the coupon on page 66

APOLOGY

Electronics Today International moved to new premises during January and February. This caused some disruption to our book sales department. If your order was late arriving please accept our apologies.

electronics textbooks

ELECTRONICS — IT'S EASY VOL. 1 \$5.95
Meters, resistance, capacitance and inductance, emitter followers, op amps, power supplies and electronic filters.

ELECTRONICS — IT'S EASY VOL. 1 \$12.95
Same content in a hard-cover form.

ELECTRONICS — IT'S EASY VOL. 2 \$5.95
Digital sub-systems counters and shift registers, A-D and D-A conversion, digital instruments and test equipment, computers, transmission links and oscilloscopes.

ELECTRONICS — IT'S EASY VOL. 2 \$12.95
Same content in a hard-cover form.

ELEMENTS OF ELECTRONICS

This series is an introduction to modern electronics. All the maths is taught as the reader progresses. The course concentrates on the understanding of concepts central to electronics, rather than digressing over the whole field. The author anticipates where difficulties lie and guides the reader through them.

BOOK 1
BP62 \$7.52
All fundamental theory necessary to full understanding of simple electronic circuits and components.

BOOK 2
BP63 \$7.52
Alternating current theory.

BOOK 3
BP64 \$7.52
Semiconductors technology leading to transistors and ICs.

BOOK 4
BP77 \$9.76
Microprocessing systems and circuits.

BOOK 5
BP89 \$9.76
Communications.

ESSENTIAL THEORY FOR THE ELECTRONICS HOBBYIST
228B \$4.32

This book supplies the electronics hobbyist with the background knowledge which will exactly suit their specific requirements. Minimum maths.

BEGINNER'S GUIDE TO DIGITAL ELECTRONICS
BP61 \$3.36
Covers all essential areas including number systems, codes, constructional and sequential logic, analogue/digital/analogue conversion.

A MICROPROCESSOR PRIMER
BP72 \$5.92
Learning about microprocessors is easy with this book, written in a style that is easy to follow. The shortcomings of this basic machine are discussed and the reader is shown how these are overcome by changes to the instruction set. Relative addressing, index registers follow as logical progressions.

reference and data handbooks

AUDIO CYCLOPEDIA
20675P \$66.00

A complete, in-depth look at the art of audio — from the basic principles of sound to solid-state and integrated circuits. Over 3000 entries and hundreds of illustrations and circuit diagrams cover acoustics, amplifiers, recording, reproduction, test equipment, audio measurements, and much more.

REFERENCE DATA FOR RADIO ENGINEERS
21218P \$54.50

The largest and most comprehensive collection of equations, graphs, tables, and other reference data needed in general radio engineering and design. Contains hundreds of charts, monographs, diagrams, curves, tables and illustrations.

TUBE SUBSTITUTION HANDBOOK
21746P \$8.75

Complete, accurate, up-to-date guide to direct substitutes for receiving and picture tubes. Contains over 6000 receiving tube substitutes, over 4000 monochrome and colour picture tube substitutes, and 600 communications substitutes. Also includes pinouts for quick operational checks.

CONTEMPORARY MATHEMATICS FOR ELECTRONICS
70274P \$29.75

This book is split into three sections. Direct current maths introduces the student to the calculator, fractions and dimensional analysis. Alternating current maths covers phasors, quadratics and RMS in both sine and digital waveforms. Active device maths introduces number systems and boolean.

AUSTRALIAN MICROCOMPUTER HANDBOOK
72505 NOW \$15.00

Normally \$25.00. A detailed buyer's guide to micro-computer systems and application packages in commercial, industrial, scientific, educational and home/hobby areas.

TRANSISTOR SUBSTITUTION HANDBOOK
21515P \$8.75

17th edition — Accurate transistor substitution in a matter of seconds with this replacement listing of over 19 000 American and foreign bipolar transistors.

THE CP/M HANDBOOK WITH MP/M
88048A \$19.95

Shows you how to use CP/M (control program for microprocessors) and its resources. No prior knowledge of computers is assumed. CP/M is available on nearly all computers using the 8080, 8085 or Z80 microprocessors.

HANDBOOK OF ICs EQUIVALENTS AND SUBSTITUTES
202B \$5.76

Contains full interchangeability data on more than 9500 ICs with possible alternatives and equivalents shown. Covers many types of digital and linear ICs.

HANDBOOK OF RADIO, TV, INDUSTRIAL & TRANSMITTING TUBE & VALVE EQUIVALENTS
BP2 \$2.25

Equivalents book for amateurs and servicemen. More than 18 000 old and new valves from UK, USA, Europe, Japan et al. CV (military) listings with commercial equivalents included.

RADIO AND ELECTRONIC COLOUR CODES AND DATA CHART
BP7 \$1.60

This large wall chart covers all colour codes in use throughout the world. For all radio and electronic components made in UK, USA, Europe and Japan.

FIRST BOOK OF TRANSISTOR EQUIVALENTS AND SUBSTITUTES

BP1 \$3.36

This guide covers many thousands of transistors showing possible alternatives and equivalents. Covers transistors made in UK, Japan, USA, Germany, France, Europe, Hong Kong and includes types produced by more than 120 different manufacturers.

SECOND BOOK OF TRANSISTOR EQUIVALENTS AND SUBSTITUTES

BP14 \$5.92

Interchangeability data covers semiconductors manufactured all over the world. Immediate equivalents are shown and possible substitutes are included.

GIANT CHART — RADIO, ELECTRONICS, SEMI-CONDUCTORS & LOGIC SYMBOLS

BP27 \$1.92

Identify those symbols at a glance. A must for beginners and advanced enthusiasts alike. Professionals can always hide it in their desks!

RESISTOR SELECTION HANDBOOK

BP28 \$2.24

Shows how to combine two preferred values of resistor to obtain virtually any required value of resistance. Includes information about fixed resistors, standard ranges, colour codes and markings, power ratings and resistor calculations.

ELECTRONIC CALCULATOR USERS' HANDBOOK

BP33 \$5.12

Presents formulae, data, methods of calculation, conversion factors, etc, for use with the simplest or most sophisticated calculators. Includes the way to calculate using only a simple four-function calculator: trigonometric functions, hyperbolic functions, logarithms, square roots and powers.

LINEAR EQUIVALENTS AND PIN CONNECTIONS

BP41 \$9.12

Shows equivalents and pin connections of a selection of popular linear ICs, with details of families, functions, country of origin and manufacture. Includes devices from Analog Devices, Advance Micro Devices, Fairchild, Harris, IIT, Motorola, Philips, RCA, Raytheon, Signetics, Sescocrem, SGS-ATES, Siemens, AEG-Telefunken, Teledyne, Texas Instruments.

PRACTICAL ELECTRONIC CALCULATIONS & FORMULAE

BP53 \$9.76

For the practical person's workbench. Bridges gap between technical theory and cut-and-dried methods which work but leave the experimenter unfulfilled. There's a strong practical bias. Tedious and higher maths avoided where possible.

INTERNATIONAL TRANSISTOR EQUIVALENTS GUIDE

BP85 \$9.76

Companion to BP1 and BP14 equivalents books, but contains a huge amount of information on modern transistors produced by over 100 manufacturers. Wherever possible, equivalents are subdivided into European, American and Japanese types. Also shown are the material type, polarity, manufacturer and indication of use or application.

HOW TO IDENTIFY UNMARKED ICs

BP101 \$2.46

This chart shows the reader how, with just a test-meter, to go about recording the particular 'signature' of an unmarked IC which should enable the IC to be identified with reference to manufacturers or other data.

electronics for beginners

BEGINNERS HANDBOOK OF IC PROJECTS

74286P \$19.25
The novice is guided in mastering the fundamentals of building, troubleshooting and testing electronic projects. In addition to many elementary projects, more advanced ones are included concerning bipolar integrated circuits and medium and large-scale integrated circuits.

HI-FI LOUDSPEAKER ENCLOSURES

205B \$3.36
Data for building corner reflex, bass reflex, exponential horn, folded horn, tuned port, Klipschorn labyrinth, tuned column, loaded port and multi speaker panoramics. Clear dimensioned diagrams included.

SOLID STATE NOVELTY PROJECTS

219B \$3.04
A number of novelty projects using modern ICs and transistors. Includes 'Oplomin' — a musical instrument played by reflecting a light beam with your hand, water warbler for pot plants, music tone generator, LEDs and ladders game, touch switch, electronic roulette wheel, etc.

SOLID STATE SHORTWAVE RECEIVERS FOR BEGINNERS

222B \$4.32
Design and construction of several solid-state shortwave receivers giving high level of performance yet utilising relatively few inexpensive components.

BEGINNERS' GUIDE TO BUILDING ELECTRONIC PROJECTS

227B \$5.12
Enables total beginners to tackle electronic projects. Includes component identification, tools, soldering, building methods, cases, legends, etc. Practical basic projects are included.

ESSENTIAL THEORY FOR THE ELECTRONICS HOBBYIST

228B \$4.32
This book supplies the electronics hobbyist with the background knowledge which will exactly suit their specific requirements. Minimum maths.

RADIO AND ELECTRONIC COLOUR CODES AND DATA CHART

BP7 \$1.60
This large wall chart covers all colour codes in use throughout the world. For all radio and electronic components made in UK, USA, Europe and Japan.

FIRST BOOK OF PRACTICAL ELECTRONIC PROJECTS

BP23 \$2.72
Full constructional data, circuits, components lists for many practical projects including audio distortion meter, superFET receiver, guitar amp, metronome, etc.

RESISTOR SELECTION HANDBOOK

BP28 \$2.24
Shows how to combine two preferred values of resistor to obtain virtually any required value of resistance. Includes information about fixed resistors, standard ranges, colour codes and markings, power ratings and resistor calculations.

HOW TO BUILD YOUR OWN METAL AND TREASURE LOCATORS

BP32 \$5.92
Electronic and practical details on the simple and inexpensive construction of heterodyne metal locators.

ELECTRONIC PROJECTS FOR BEGINNERS

BP48 \$4.64
This book gives the newcomer to electronics a wide range of easily built projects. Actual components and wiring layouts aid the beginner. Some of the projects may be built without using soldering techniques.

POPULAR ELECTRONIC PROJECTS

BP49 \$4.96
A collection of the most popular types of circuits and projects to interest most electronics constructors. The projects cover a wide range and are divided into four basic types: radio, audio, household and test equipment.

BEGINNERS GUIDE TO DIGITAL ELECTRONICS

BP61 \$3.36
Covers all essential areas including number systems, codes, constructional and sequential logic, analogue/digital/analogue conversion.

ELECTRONIC GAMES

BP69 \$5.92
How to build many interesting electronic games using modern ICs. Covers both simple and complex circuits for beginner and advanced builder alike.

RADIO CONTROL FOR BEGINNERS

BP79 \$5.92
How complete systems work with constructional details of solid state transmitters and receivers. Also included — antennas, field strength meter, crystal controlled superhet, electro-mechanical controls. Section dealing with licensing etc. not applicable to Australia.

EASY ELECTRONICS-CRYSTAL SET CONSTRUCTION

BP92 \$6.56
For those who wish to participate in the intricacies of electronics more through practical construction than by theoretical study. The circuits are based on those from earlier publications but have been modified to use modern inexpensive components and home wound coils.

IC PROJECTS FOR BEGINNERS

BP97 \$6.56
Especially written for the less experienced hobbyist, and offers a range of fairly simple projects based around a number of popular and inexpensive linear and digital ICs. Complete layout and point-to-point wiring diagrams included.

ELECTRONICS — IT'S EASY VOL. 1

\$5.95
Meters, resistance, capacitance and inductance, emitter followers, op amps, power supplies and electronic filters.

ELECTRONICS — IT'S EASY VOL. 1

\$12.95
Same content in a hard-cover form.

ELECTRONICS — IT'S EASY VOL. 2

\$5.95
Digital sub-systems counters and shift registers, A-D and D-A conversion, digital instruments and test equipment, computers, transmission links and oscilloscopes.

ELECTRONICS — IT'S EASY VOL. 2

\$12.95
Same content in a hard-cover form.

HOBBY ELECTRONICS PROJECT BOOK

\$4.95
Fifty projects ranging from very simple ones for complete beginners to more elaborate ones for those with more experience. There's a complete guide to soldering and instructions on how to make your own pc boards.

HOW TO BUILD ELECTRONIC GAMES

\$3.95
Alien Invaders, electronic die, sound effects, two slot car controllers, electronic poker machine, the family ferry and lots more.

HOW TO BUILD GOLD AND TREASURE DETECTORS

\$3.95
Tells you how metal detectors work and how to construct the different types of detectors: discriminating, BFO, induction balance and a professional deep-seeking unit. How to build a geiger counter.

constructional projects general

DESIGN OF TRANSISTOR CIRCUITS, WITH EXPERIMENTS

21626P \$20.75
A self-teaching course in transistor circuits — seven chapters explore the fundamentals of active semiconductors and their operating principles and procedures. Experiments in design and semiconductor testing provide hands-on experience.

UNIQUE ELECTRONIC WEATHER PROJECTS

21484P \$13.25
Fun and easy-to-build projects include an IC barometer to serve as a tornado warning and a 'thermostat with a brain' to help conserve energy.

BUILD YOUR OWN HI-FI & AUDIO ACCESSORIES

220B \$3.04
Essential for keen hi-fi and audio enthusiasts. Projects include stereo decoder, three-channel mixer, FET preamp for ceramic pick-ups, mic preamp with adj. bass, stereo dynamic noise limiter, loudspeaker protector, voice-operated relay, etc.

28 TESTED TRANSISTOR PROJECTS

221B \$4.32
Some circuits are new, others are familiar designs. Projects can be split and/or combined for specialised needs.

50 CMOS PROJECTS

224B \$4.64
Many interesting and useful projects — multivibrators, amplifiers and oscillators; trigger devices; special devices.

MAJOR SOLID STATE AUDIO HI-FI PROJECTS

BP29 \$3.04
Three projects for the more experienced constructor: 12.5 W/ch stereo amplifier, eight input stereo/mono mixer and 4x14 W quadrasonic amplifier. Full constructional details provided.

HOW TO BUILD YOUR OWN METAL AND TREASURE LOCATORS

BP32 \$5.92
Electronic and practical details on the simple and inexpensive construction of heterodyne metal locators.

HOW TO MAKE WALKIE-TALKIES

BP43 \$5.12
This treatise on low power transmitter-receivers (walkie-talkies) covers many aspects from licensing requirements and bands, through practical circuitry and construction to the various types of aerials that may be used.

PROJECTS IN OPTO-ELECTRONICS

BP45 \$5.92
Included are simple circuits using ordinary LEDs as well as more sophisticated designs such as infra red transmitters and detectors, modulated light transmission and also photographic projects etc.

POPULAR ELECTRONIC PROJECTS

BP49 \$4.96
Includes a collection of the most popular types of circuits and projects which cover radio, audio, household projects and test equipment.

SINGLE IC PROJECTS

BP65 \$5.12
Simple to build projects based on a single IC. A few projects use one or two transistors as well. A strip board layout is given for each project plus special constructional and setting up info. Contents include low level audio circuits, audio power amps, timers, op-amps and miscellaneous circuits.

ELECTRONIC GAMES

BP69 \$5.92
A number of interesting electronic games projects using ICs for both the beginner and advanced enthusiast.

ELECTRONIC HOUSEHOLD PROJECTS

BP71 \$5.92
Most useful and popular projects for use around the home. Includes two-tone buzzer, intercom, smoke and gas detectors, baby alarm, freezer alarm etc. etc.

REMOTE CONTROL PROJECTS

BP73 \$6.56
Covers radio, infra-red, visible light, ultrasonic controls. Full explanations are provided so that the reader can adapt the projects for domestic and industrial as well as model use.

POWER SUPPLY PROJECTS

BP76 \$5.92
This book gives a number of power supply designs, including simple unregulated types, fixed voltage regulated types and variable voltage stabilised designs. The designs are all low voltage types for semiconductor circuits.

POPULAR ELECTRONIC CIRCUITS — BOOK 1

BP80 \$6.56
Yet more circuits from Mr. Penfold includes audio, radio, test gear, music projects, household projects and many more. An extremely useful book for all hobbyists, offering remarkable value for the designs it contains.

ELECTRONIC PROJECTS USING SOLAR CELLS

BP82 \$6.56
Includes a number of projects that benefit from solar power and obviate the problems encountered with batteries, such as weight and bulk, frequency of replacement, and failure when batteries are exhausted.

DIGITAL IC PROJECTS

BP84 \$6.56
Companion to No. 225 Practical Introduction to Digital ICs and BP61 Beginner's Guide to Digital Electronics. The projects included in this book range from simple to more advanced projects — some board layouts and wiring diagrams are included.

AUDIO PROJECTS

BP90 \$6.56
Covers a wide range of audio projects including pre-amplifiers and mixers, power amplifiers, tone controls and matching etc. A number of board layouts and wiring diagrams are included.

LOOK! More books!

mail order coupon on page 66

ELECTRONIC TIMER PROJECTS

BP93 \$6.56
These may have a high degree of accuracy with quartz control or they may be quite simple designs, using only a few components. A number of specialist timer projects are car windscreen wiper delay unit, darkroom timer, metronome etc.

ELECTRONIC PROJECTS FOR CARS AND BOATS

BP94 \$6.56
Fifteen fairly simple projects designed for use with 12 V electrical systems but in some cases can also be employed with 6 V and/or positive earth systems as well.

MODEL RAILWAY PROJECTS

BP95 \$6.56
Projects include such things as controllers, signals and sound effects units. Construction stripboard layouts are provided for each project.

CB PROJECTS

BP96 \$6.56
A number of useful designs include a speech processor, interference filters and a simple CB radio receiver. Stripboard layouts, wiring diagrams and notes on construction are provided.

POPULAR ELECTRONICS CIRCUITS — BOOK 2

BP98 \$7.52
A companion for BP80, this book provides a wide range of designs for electronics enthusiasts who are capable of producing working projects from just a circuit diagram without the aid of detailed constructional information.

MINI-MATRIX BOARD PROJECTS

BP99 \$6.56
This book provides a selection of 20 useful circuits which can all be built on a mini-matrix board which is just 24 holes by 10 copper strips in size. Simple and easy for those with not much experience in electronics.

MULTI-CIRCUIT BOARD PROJECTS

BP103 \$6.56
All circuits are based on one specially designed pc board. Recommended to the less experienced hobbyist.

ELECTRONIC SCIENCE PROJECTS

BP104 \$7.52
These projects range in complexity from a simple colour temperature meter to an infra-red laser. There is an electronic clock regulated by a resonating spring and an oscilloscope with a solid-state display. How to build them and use them is fully explained.

AERIAL PROJECTS

BP105 \$6.56
Practical aerial designs including active, loop and ferrite which are relatively simple and inexpensive to build. The complex theory and mathematics of aerial design have been avoided.

MODERN OP-AMP CIRCUITS

BP106 \$6.56
A collection of widely varying circuits and projects based on the op-amp ICs.

HOW TO GET YOUR ELECTRONIC PROJECTS WORKING

BP110 \$6.56
Helps you to overcome the problems of a circuit that doesn't work by indicating how and where to start looking for many of the common faults that can occur when building up a project.

circuit techniques and design

TTL COOKBOOK

21035P \$17.50
A complete look at TTL logic circuits — what TTL is, how it works, and how to use it. Many kinds of practical TTL are included, such as digital counters, electronic stopwatches, digital voltmeters, etc.

ACTIVE-FILTER COOKBOOK

21168P \$21.95
Learn how to construct filters of all kinds — highpass, lowpass, bandpass. The book is easy to understand — no advanced maths or obscure theory is used.

ELECTRONIC CIRCUITBOOK 1: PROJECT CONSTRUCTION

21241P \$7.50
Your basic guide to project construction, covering component identification, power supplies, proper tool selection, troubleshooting techniques, oscilloscope use, custom-made enclosures, and more.

CMOS COOKBOOK

21398P \$19.25
This book explains CMOS technology and its application to 'real world' circuitry. A mini-catalogue is included, which lists over 100 devices, giving their pinouts and application notes.

IC TIMER COOKBOOK

21416P \$15.95
Gives you a look at the hundreds of ways IC timers are used in electronic instrumentation.

IC CONVERTER COOKBOOK

21527P \$20.75
Written for the practising engineer, technician, hobbyist or student, this book will be an invaluable working guide to the understanding and use of IC analogue/digital and digital/analogue converters.

DESIGN OF OP-AMP CIRCUITS, WITH EXPERIMENTS

21537P \$16.50
The design of the fundamental circuits that are the basic building blocks of more sophisticated systems. A series of 35 experiments illustrates the design and operation of linear amps, differentiators and integrators, voltage and current converters, active filters, and lots more.

555 TIMER APPLICATIONS SOURCE BOOK, WITH EXPERIMENTS

21538P \$11.25
This book describes the construction of the 555 timer and gives numerous practical examples of its applications in all areas of electrical and computer engineering, including 17 simple experiments.

DESIGN OF ACTIVE FILTERS WITH EXPERIMENTS

21539P \$15.95
Introduction to the theory, implementation and design of active filters using the 741 op-amp.

DESIGN OF PHASE-LOCKED LOOP CIRCUITS, WITH EXPERIMENTS

21545P \$15.95
An excellent introduction to the theory, design and implementation of phase-locked loop circuits using various TTL and CMOS devices. Includes manufacturers' data sheets and describes the use of breadboarding aids in the wide range of laboratory-type experiments.

AUDIO IC OP-AMP APPLICATIONS

21558P \$13.25
This book discusses IC op-amps and their application in audio systems, and describes the numerous advantages of using op-amps, including small spatial needs, low power consumption, reliable performance and low cost. Assumes a basic understanding of op-amp theory.

UNDERSTANDING CMOS INTEGRATED CIRCUITS

21598P \$9.95
This book tells you what CMOS ICs are, how they work, and how they can be used in electronic circuit designs. Many practical circuits, complete with parts values, are included.

DESIGN OF TRANSISTOR CIRCUITS WITH EXPERIMENTS

21626P \$20.75
A self-teaching course to provide the background and explanations necessary to teach the reader the art of designing transistor circuits.

GUIDE TO CMOS BASICS, CIRCUITS, AND EXPERIMENTS

21654P \$14.95
If you are already familiar with TTL devices and are ready to examine the benefits of CMOS, this book is your complete source. It tells you what CMOS devices are, their characteristics and design rules. 22 experiments demonstrate the concepts discussed.

PRACTICAL TRANSFORMER DESIGN HANDBOOK

21657P \$35.50
An easy to understand, illustration-filled guide to designing and constructing transformers. Reviews the fundamentals of electricity, magnetism and algebra needed to understand transformer theory, and covers general design considerations, transformer types, power losses and transformer use in converters and inverters.

Z80 MICROCOMPUTER DESIGN PROJECTS

21682P \$20.75
This book provides a complete look at the internal architecture of the Z80, the heart of many microcomputers, and even shows how to build a microcomputer, the EX80, using this powerful chip.

DESIGN OF VMOS CIRCUITS, WITH EXPERIMENTS

21686P \$17.50
The authors look at the technology which makes dramatic advancements possible with VMOS, and show how these components can easily and effectively be integrated into common circuit designs to enhance their responses.

IC OP-AMP COOKBOOK

21695P \$23.75
Basic op-amp theory in detail, with 200 practical, illustrated circuit applications: JFET and MOSFET units are featured, plus manufacturers' data sheets and company addresses.

EXPERIMENTS IN ARTIFICIAL INTELLIGENCE FOR SMALL COMPUTERS

21785P \$13.25
Artificial intelligence is the capability of a device to perform functions normally associated with human intelligence. With this book, a small computer with extended BASIC and some knowledge of BASIC language, you can conduct interesting and exciting experiments in artificial intelligence.

PRACTICAL SOLID-STATE CIRCUIT DESIGN

21787P \$14.95
An introductory course in practical solid-state circuit design for the experimenter, designer or technician who is interested in constructing tailor-made circuits.

SCRS AND RELATED THYRISTOR DEVICES

21806P \$19.25
Written for experimenters, technicians and engineers, this book is a practical and comprehensive guide to theory, operation, specifications and applications of silicon-controlled rectifiers (SCRs) and related thyristor devices.

REGULATED POWER SUPPLIES

21808P \$29.75
Comprehensive discussion of the internal architecture and operation of the latest solid-state regulators. Explains when regulated supplies are needed and how to incorporate them in your projects, and discusses modern circuitry including linear and switching circuits and late ICs.

ANALOG INSTRUMENTATION FUNDAMENTALS

21835P \$29.75
Numerous practical, hands-on lab experiments and solved problems are included, plus discussions of movements, dc ammeters, voltmeters, ohmmeters, bridges, filters and attenuators. No calculus is required.

RF CIRCUIT DESIGN

21868P \$33.95
A practical approach to the design of RF amplifiers, impedance-matching networks and filters. Uses a minimum of complex maths.

SOLAR CELLS

22270P \$37.95
In-depth description of the basic operating principles and design of solar cells. It also covers the techniques currently used to produce solar cells and reviews system applications.

ELECTRONIC DESIGN WITH OFF-THE-SHELF ICs

50274P \$14.70
It contains virtually all the information you need to design and build electronic circuits, systems and subsystems with readily available ICs. Shows how to interface them into highly complex systems.

MODERN FILTER DESIGN

94663P \$49.95
This book details the advances in active RC filters, both from a practical standpoint and from a state-of-the-art point of view. It is the first book that gives detailed analysis and design procedures for switched capacitor filters.

50 PROJECTS USING CA3130 ICs

2238 \$4.32
The CA3130 is an advanced operational amplifier capable of higher performance than many others: circuits often need fewer ancillary components. Audio projects, RF projects. Test equipment. Household projects. Misc. projects.

PRACTICAL INTRO TO DIGITAL ICs

2258 \$4.32
Introduction to digital ICs (mainly TTL 7400). Besides simple projects, includes logic test set to identify and test digital ICs. Also includes digital counter-timer.

50 CIRCUITS USING GERMANIUM, SILICON AND ZENER DIODES

BP36 \$3.36
50 interesting and useful circuits and applications using the germanium and silicon signal diodes, silicon rectifier diodes and zener diodes etc.

50 PROJECTS USING RELAYS, SCRS AND TRIACS
BP37 \$5.92
 Practical working circuits using silicon controlled rectifiers, relays and bi-directional triodes. With a minimum of difficulty you can use them in motor control, dimming and heating control, timing and light sensitive circuits, warning devices and many others.

50 FET PROJECTS
BP39 \$5.92
 Projects include amplifiers and converters, test equipment, tuners, receivers and receiver aids, mixers and tone controls etc etc. The FET used is not critical. This book is of interest and value to SW listeners, radio amateurs, hi-fi enthusiasts and general experimenters.

50 SIMPLE LED CIRCUITS
BP42 \$3.36
 50 interesting and useful circuits and applications using the LED. Also includes circuits for the 707 Common Anode Display for the beginner and advanced enthusiast.

IC555 PROJECTS
BP44 \$6.56
 One wonders how life went on before the 555! Included are basic and general circuits, motor car and model railway circuits, alarms and noise makers plus section on subsequent 556, 558 and 559s.

PROJECTS IN OPTO-ELECTRONICS
BP45 \$5.92
 Included are simple circuits using ordinary LEDs as well as more sophisticated designs such as Infra-red transmitters and detectors, modulated light transmission and also photographic projects etc.

LM 3900 IC PROJECTS
BP50 \$4.64
 Unlike conventional op-amps, the LM 3900 can be used for all the usual applications as well as many new ones. It's one of the most versatile, freely obtainable and inexpensive devices around. This book provides the groundwork for simple and advanced uses — it's much more than a collection of projects. Very thoroughly recommended.

50 CIRCUITS USING 7400 SERIES ICs
BP58 \$5.12
 50 interesting and useful circuits and applications using these inexpensive and versatile devices.

50 CMOS IC PROJECTS
2248 \$4.64
 Projects include multivibrators, amplifiers and oscillators, trigger devices and other special devices.

SECOND BOOK OF CMOS IC PROJECTS
BP59 \$5.12
 Leading on from book number 224 '50 CMOS IC PROJECTS', this second book provides a further selection of useful circuits mainly of a fairly simple nature. Contents have been selected to ensure minimum overlap between the two books.

COUNTER DRIVER AND NUMERAL DISPLAY PROJECTS
BP67 \$5.92
 Well-known author F.G. Rayer features applications and projects using various types of numeral displays, popular counter and driver ICs, etc.

VMOS PROJECTS
BP83 \$6.56
 Though primarily concerned with VMOS power FETs and their applications, power MOSFETs are dealt with too, in a chapter on audio circuits. Projects include audio circuits, sound generator circuits, dc control circuits and signal circuits.

DIGITAL IC PROJECTS
BP84 \$6.56
 Helps the reader to develop a knowledge of the workings of digital circuits. Board layouts and wiring diagrams are included.

HOW TO USE OP-AMPS
BP88 \$7.52
 Design notes and applications on many topics including basic theory, amplifiers, power supplies, audio circuits, oscillators, filters, computers and control engineering. It's written around the 741 IC but includes design notes for most of the common op-amps.

ELECTRONIC TIMER PROJECTS
BP93 \$6.56
 These may have a high degree of accuracy with quartz control or they may be quite simple designs, using only a few components. A number of specialist timer projects are car windscreen wiper delay unit, darkroom timer, metronome etc.

ETI CIRCUITS BOOKS 1/2/3 \$2.95 ea
 Many of these circuits have been published in the 'Ideas for Experimenters' section in ETI.

ETI CIRCUIT TECHNIQUES VOLS 1/2 \$4.75 ea
 The how, what, which, where, why and how much anthology of electronic components, circuits and techniques.

test equipment and fault finding

AUTOMOTIVE TUNE-UP AND EMISSION CONTROL SERVICE
21712P \$20.75

Car owners who wish to save money and maintain their cars at peak performance will learn from this book how to adjust, repair and maintain the systems that ensure best operation.

TROUBLESHOOTING WITH THE OSCILLOSCOPE
21738P \$15.95
 Excellent for the professional service technician or the serious hobbyist, as it combines step-by-step procedures for using the scope with the specific nuts and bolts of TV receiver troubleshooting.

EFFECTIVELY USING THE OSCILLOSCOPE
21794P \$14.95
 Excellent for the professional service technician or the serious do-it-yourself, as it combines the correct step-by-step procedures for using a scope with the specific nuts and bolts of TV receiver troubleshooting.

MICROCOMPUTER DESIGN AND TROUBLESHOOTING
21819P \$26.75
 Tells you how to design microcomputer systems and make them work without an expensive commercial development system or the need for costly test instrumentation. The author also provides a complete description of two popular microprocessors — the 8085 and the 6502.

USE OF THE DUAL-TRACE OSCILLOSCOPE
40023P \$23.75
 This programmed text breaks down the process of operating a scope into a series of logical steps starting with the deflection of the electron beam and continuing through proper use of the triggering controls to measure the phase difference between two waveforms.

ELECTRONIC TROUBLESHOOTING HANDBOOK
52585P \$10.50
 This workbench guide shows you how to pinpoint transistor troubles in minutes, how to test almost everything electronic and how to get the most out of low cost test equipment.

PRACTICAL REPAIR AND RENOVATION OF COLOUR TVS
BP34 \$4.32
 This book shows how to obtain a working colour TV for very little outlay by repairing and renovating a set that has been 'written off' by a dealer. Includes practical details of how to construct your own CRT tester/rejuvenator and cross hatch generator.

TRANSISTOR RADIO FAULT-FINDING CHART
BP70 \$1.92
 Used properly, this chart should enable the reader to trace most common faults quickly. Across the top of the chart are four rectangles containing brief descriptions of the faults. Selecting the appropriate fault, the reader simply follows the arrows and carries out the suggested checks in sequence until the fault is cleared.

ELECTRONIC TEST EQUIPMENT CONSTRUCTION
BP75 \$5.92
 Describes construction of wide range of test gear including FET amplified voltmeter, resistance bridge, field strength indicator, heterodyne frequency meter etc.

POWER SUPPLY PROJECTS
BP76 \$5.92
 Includes simple unregulated types, fixed voltage regulator types and variable voltage stabilised designs. The designs are all low voltage types for semiconductor circuits.

HOW TO GET YOUR ELECTRONIC PROJECTS WORKING
BP110 \$6.56
 Helps you to overcome the problems of a circuit that doesn't work by indicating how and where to start looking for many of the common faults that can occur when building up a project.

TEST GEAR — METERING AND POWER SUPPLY PROJECTS \$3.00
 Includes many types of meters, audio noise and signal generators, simple CMOS tester, oscilloscope calibrator etc.

TEST GEAR — VOL. 2 \$3.95
 Projects include audio oscillator, transistor tester, true RMS voltmeter, RF signal generator, versatile logic test probe, microwave oven leak detector etc.

ELECTRONIC PROJECTS FOR YOUNG SCIENTISTS \$3.95
 PH meter, geiger counter, helium-neon laser, sound level meter, solar cells, negative ion generator and much more.

electronic music/audio/video

AUDIO CYCLOPEAIA
20675P \$66.00
 A complete in-depth look at the art of audio — from the basic principles of sound to solid-state and integrated circuits. Over 3000 entries and hundreds of illustrations and circuit diagrams cover acoustics, amplifiers, recording, reproduction, test equipment, audio measurements, and much more.

ELECTRONIC MUSIC CIRCUITS
21833P \$24.95
 How to build a custom electronic music synthesiser, outlines numerous other circuit designs and then shows you how to modify them to achieve particular responses. Many of the circuits can be used as special-effects boxes for guitars and other musical instruments.

INTRODUCTION TO ELECTRO-ACOUSTIC MUSIC
81515P \$15.95
 This book assumes no previous technical knowledge. It discusses the relationship between the technology and the composition of electro-acoustic music.

MODERN RECORDING TECHNIQUES
21037P \$19.25
 Explains the equipment controls and techniques found in a modern recording studio and how to use them creatively and correctly to produce a desired result. Numerous photographs, diagrams and charts.

SOUND SYSTEM ENGINEERING
21156P \$32.50
 Dealing with audio systems as a whole, it includes installing and equalising the sound system and interfacng the electrical and acoustic systems. Instrumentation, the acoustic environment and designing for acoustic gain are covered.

TUBE SUBSTITUTION HANDBOOK
21746P \$8.75
 Complete, accurate, up-to-date guide to direct substitutes for receiving and picture tubes. Contains over 6000 receiving tube substitutes, over 4000 monochrome and colour picture tube substitutes, and 600 communications substitutes. Also includes pinouts for quick operational checks.

HOW TO BUILD SPEAKER ENCLOSURES
20520P \$8.75
 A practical guide to the 'whys' and 'hows' of constructing high-quality top-performance loudspeaker enclosures.

ACTIVE-FILTER COOKBOOK
21168P \$21.95
 Learn how to construct filters of all kinds — highpass, lowpass, bandpass. The book is easy to understand — no advanced maths or obscure theory is used.

DESIGN OF ACTIVE FILTERS WITH EXPERIMENTS
21539P \$15.95
 Introduction to the theory, implementation and design of active filters using the 741 op-amp.

AUDIO IC OP-AMP APPLICATIONS
21558P \$13.25
 This book discusses IC op-amps and their application in audio systems, and describes the numerous advantages of using op-amps, including small spatial needs, low power consumption, reliable performance and low cost. Assumes a basic understanding of op-amp theory.

VIDEO TAPE RECORDER
21521P \$17.50
 In this completely revised second edition, the author tells in simple language how helical VTRs work and how to operate and service them. Includes numerous examples of circuits and mechanical systems.

continued on page 63

0-40 V/5 A laboratory power supply

Part 1.

Here's a laboratory standard power supply featuring truly regulated output from zero to 40 volts capable of delivering a massive 5 A across the whole voltage range, plus current limiting variable from zero to 5 A. Two meters monitor voltage and current and regulator dissipation is reduced by employing an automatic transformer switching circuit.

David Tilbrook

IN APRIL 1976 we published the ETI-131 General Purpose Power Supply. This project could be built in two versions — 0-20 V/2.5 A or 0-40 V/1.25 A. It featured variable current limiting and had pretty close to lab-standard specs. A great many have been built since then and are to be found in development laboratories, service workshops, technical college and university labs and hobbyist's workshops.

Since that time, electronic technology has made considerable strides and the sort of things now being investigated by hobbyists and in electronics labs of all descriptions range much wider than they did when the ETI-131 was in vogue. It came to our notice that a lab-standard supply having 'expanded' specifications was in demand so we set out to investigate what sort of project would best meet that demand.

Following considerable discussion with both users and project suppliers, it was apparent that the most generally useful output voltage range would be about 0-40 V or 0-50 V and the required maximum current capability would be in the vicinity of 3-4 A or so. The next thing to do was to define 'lab-standard'.

Defining 'lab-standard'

An 'ideal' power source should provide the following: • a regulated voltage variable from zero to some chosen limit • no extraneous hum or noise on the output and none radiated from the supply • current-limit operation from zero to some chosen limit • simultaneous metering of current and voltage output • protection from short circuits on the output at any output setting.

In addition, handy 'operator features', such as indicators to show voltage and current mode operation, output and current-set switches, are desirable.

What sort of specifications would approach the 'ideal'? With sensitive high gain, dc control, audio or RF circuitry attached to the supply during circuit development or fault locating, you want to be sure that any problem experienced is not caused by some characteristic of the power supply. Hence, hum and noise are an important consideration. ▶

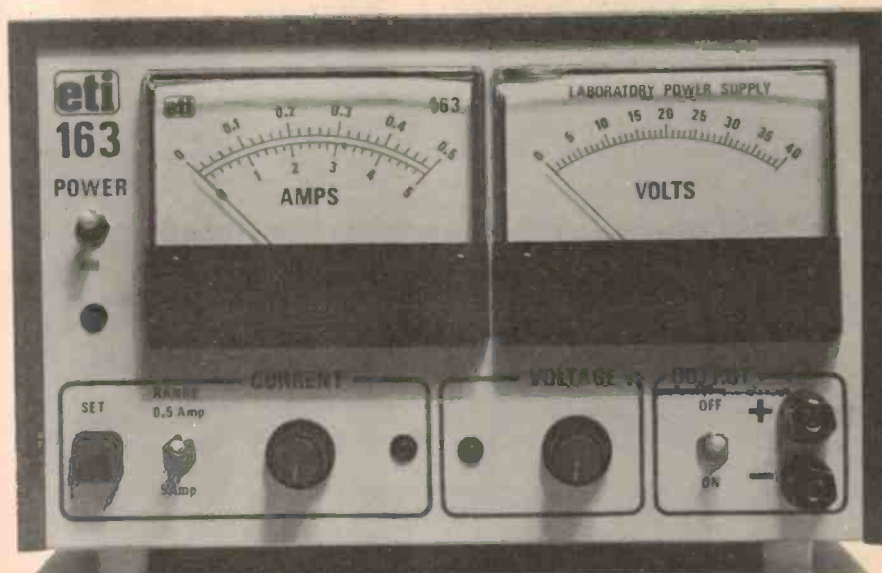

Power and performance. The completed supply looks smart, performs well and is economical to build — at around \$150-\$160.

SPECIFICATIONS — ETI-163 LAB. SUPPLY

TABLE 1

Output voltage	0-40 V, variable
Output current	0-0.5 A, variable limiting 0-5 A, variable limiting
Output regulation	<50 mV at up to 2.5 A <100 mV up to 5 A
Ripple and noise	
voltage mode	<3 mV RMS
current mode	<10 mV RMS
Maximum output power	200 watts
Metering	
Voltage	0-40 V in 1 V divisions
Current	0-0.5 A in 20 mA divisions 0-5 A in 200 mA divisions

- LED to indicate voltage mode operation
- LED to indicate current mode (limiting) operation
- Current-set switch provided for setting current limit value
- Output switch provided to isolate supply output
- Output terminals isolated from chassis
- Full output current available right up to 40 V

A figure under 10 mV is a desirable goal, preferably less than 5 mV. Performance in the current-limit mode should be similar, but is not as critical a parameter.

As supply voltage variations can adversely affect some circuits, regulation of the output voltage over the whole variation range is paramount. It should remain virtually constant despite relatively large mains input voltage excursions and despite large variations in current drawn (up to the maximum). Regulation can be expressed as a percentage (with respect to full output) or as a voltage variation. The latter is preferred as it shows performance over the whole output variation range.

A regulation figure of 0.1% (100 mV in 100 V) is common for low current output supplies (up to 1 A), but 0.5% is more usual for high current supplies. That would be 250 mV for a 50 V supply.

Regulator techniques

There are a number of basic techniques used to provide a regulated supply voltage. Choice depends on the application. The respective methods and their characteristics may be summarised as follows:

- **The shunt regulator.** This design is suitable mainly for low-power supplies — 15 to 20 watts. It has good regulation and is inherently short circuit proof. However, it dissipates the full amount of power it is capable of handling under no-load conditions.

Current-limit operation is not so easy to incorporate, but cost is low.

- **The series regulator.** Probably the most widely used technique. It is suitable for power supplies capable of delivering up to 200 watts.

Regulation, hum and noise performance is good, it's easy to arrange current-limit operation and cost is relatively low.

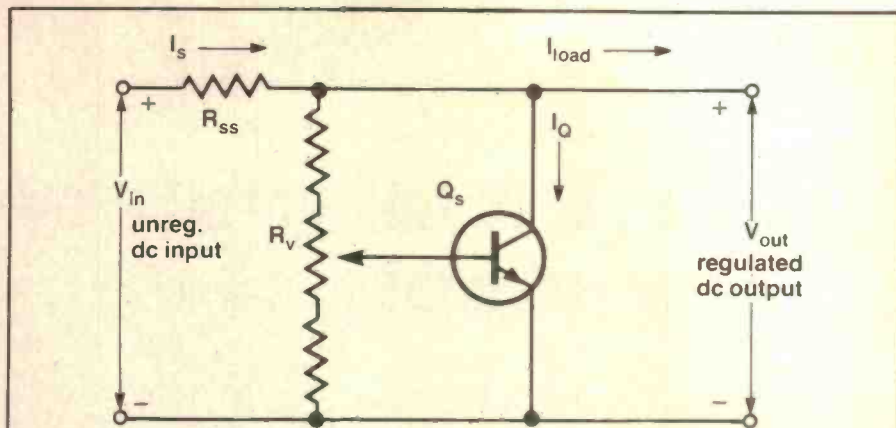

SHUNT

The shunt regulator. Fundamental circuit of a shunt regulator. As the load current (I_{load}) increases, the output voltage (V_{out}) tends to fall, reducing base current to Q_s . This, in turn, reduces the collector current (I_Q) of the shunt regulator, Q_s . The voltage drop across R_{ss} then decreases, maintaining the output voltage. As load current decreases, the opposite happens.

If the input voltage (V_{in}) increases, V_{out} tends to rise, increasing the base current to Q_s . This increases I_Q and the voltage drop across R_{ss} increases, maintaining the output voltage. If V_{in} decreases, the opposite happens.

Varying the wiper of R_v varies the collector current of Q_s , thus varying the voltage dropped across R_{ss} , setting the output voltage. Resistor, R_{ss} dissipates considerable power and Q_s dissipates the maximum output power under no load.

- **SCR regulator.** This technique is mainly suited for medium to very high power applications. The regulator has low dissipation and good regulation, but output noise and ripple are worse than for the series regulator and radiated switching 'hash' requires extensive shielding.

- **SCR pre-regulator and series regulator.** This combines the best features of the previous two and is best suited to medium to high power applications (say to several hundred watts).

An SCR pre-regulator provides a roughly regulated supply about five volts above the required output voltage, followed by a conventional series regulator. This keeps dissipation in the series regulator low. Cost is relatively high.

- **Switchmode regulator.** This technique is also used in medium to very high power applications. A series switching element stores energy in an inductor or capacitor, the on-time of the switching element being controlled to provide the required regulated output.

This technique keeps regulator dissipation low and regulation performance is good. With modern ICs purpose-built for the application, cost is about the same as a series regulator. However, noise and ripple on the output can be difficult to suppress and considerable wideband RF energy is radiated by the circuitry, necessitating careful and extensive shielding.

Design features of this supply

I settled on an output voltage range of 0-40 V as this seemed to cover the great majority of supply requirements for circuit testing, development and fault locating. A maximum output current of 5 A was settled on for similar reasons. This results in an output rating of 200 watts, hence choice of an appropriate regulator technique was of paramount importance.

Two techniques were obvious contenders — series regulator and switchmode regulator. Previous experience with switchmode regulators made me wary that I could use one in a 'lab-standard' supply. The ETI-142 0-30 V/15 A supply (Feb. '79) employed a switchmode pre-regulator and a series regulator. Despite elaborate precautions, noise from the switchmode pre-regulator made it impossible to use this supply in the vicinity of, let alone connected to, sensitive circuitry. Pity, but a fact of life.

The inherent attractiveness of high efficiency — low dissipation is generally outweighed in this application. The necessity of elaborate screening and filtering brings problems of its own for constructors and increases costs.

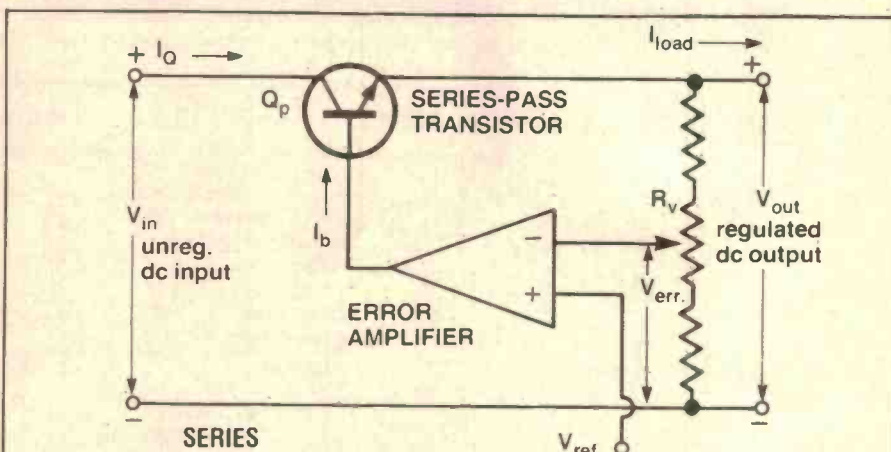

SERIES

The series regulator. Fundamental circuit of a series regulator. As the load current (I_{load}) increases, the output voltage (V_{out}) tends to fall. This causes V_{err} to fall (the 'error voltage'). The error amplifier is operated as an inverting amplifier and thus, as V_{err} falls, the base current (I_b) to the series-pass transistor (Q_p) will rise. This causes the collector current (I_C) of Q_p to rise, maintaining the output voltage. If I_{load} decreases, the opposite occurs.

If the input voltage (V_{in}) rises, the output will tend to rise, as will V_{err} . This will produce a decrease in base current to Q_p , reducing I_C , thus maintaining the output voltage. If V_{in} falls, the opposite will occur.

Varying the wiper of R_v varies V_{err} , setting the output voltage.

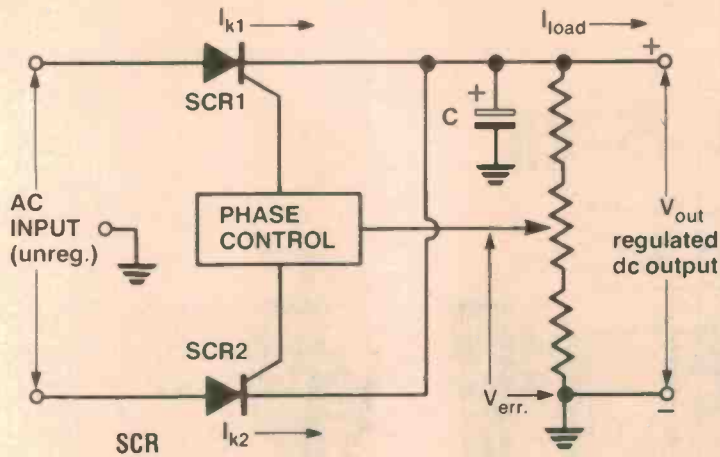

The SCR regulator. Fundamental circuit of an SCR regulator. As the load current (I_{load}) increases, the output voltage (V_{out}) tends to decrease causing the 'error voltage' ($V_{err.}$) to drop. The phase control circuit then advances the triggering of the SCRs so that I_{k1} and I_{k2} and the average rectified voltage increases, maintaining the output voltage. If load current decreases, the opposite occurs.

If the ac input voltage rises, V_{out} tends to rise, causing $V_{err.}$ to rise also. The phase control circuit then retards the triggering of the SCRs, reducing the average rectified voltage, and maintaining V_{out} . The opposite happens if the ac input falls.

Varying the potentiometer varies $V_{err.}$, setting the output voltage.

I looked at the series regulator — and how to reduce the dissipation. For a 40 V output, dc input to the regulator would have to be around 50 V. At 5 A output into a short circuit, worst case dissipation would be around 250 watts! That requires *big* transistors and *lots* of heatsink.

As pre-regulators increased the cost and the noise problems, I had to find another way to reduce regulator dissipation and I hit on the idea of switching the transformer secondary.

Using several cheap ICs as comparators and a couple of relays, I could switch the rectifier across different transformer taps as the regulator output voltage was varied.

However, this technique had the drawback that a 'special' transformer would be required. If I could choose the output taps so that they were at generally 'useful' voltages, the transformer stood a good chance of becoming a 'stock' item. With this in mind, I chose the secondary taps to be 12 V, 24 V and 36 V.

The prototype transformer was wound up for us by Permatran of Melbourne. It is rated at 250 VA.

Astute readers will notice that basically, only two output taps are really required as the 12 V output could be selected by switching between the 24 and 36 volt terminations. However, using relay switching, it is possible under some circumstances to short part of the secondary with consequent disastrous results. The 'switching' tree employed avoids this possibility.

A separate low voltage and current dc supply is necessary to power the op-amps in the regulator and to provide a 5 V reference. In the prototype, I used a small 12 V/150 mA transformer — a stock item from most electronics suppliers — but a 15 V/200 mA winding may be available on the transformers obtained by suppliers of this project.

Worst case regulator dissipation for this supply is around 120 watts, a much more manageable figure than 250 watts. It occurs when the output current is 5 A at a voltage setting near 25 volts. At maximum dissipation, the heatsinks stabilise at a temperature of around 65°C.

The regulator circuit is similar to the ETI-131 and employs two CA3130s for the voltage-mode and current-mode error amplifiers. A pair of MJ15003 high power NPN transistors connected in parallel are used for the series-pass element.

Another pair of CA3130s are used as comparators for the transformer secondary relay switching circuitry. These were chosen because their output can go right down to 0 V, ensuring the relay driver transistors turn off. The transformer taps are switched as the output voltage passes through about 12 V and about 25 V (these are adjustable over a few volts range). About a volt of hysteresis is added to the switching points so that the relays won't chatter when the output control is set on the switching point.

Separate meters are provided for indicating output voltage and current. There are two current-limit ranges — zero to 0.5 A and zero to 5 A. The point at which the supply switches from constant-voltage to current-limited (constant-current) output is fully variable across the two ranges.

A current-set pushbutton, which shorts the output terminals, is provided on the front panel and two LEDs indicate in which mode the supply is operating. A switch in series with the output allows you to isolate the supply from the load, without having to disconnect the supply or turn it off if you want the supply removed.

Performance turns out to be generally better than what was discussed as desirable for a lab-standard supply. See Table 1 for a complete run-down.

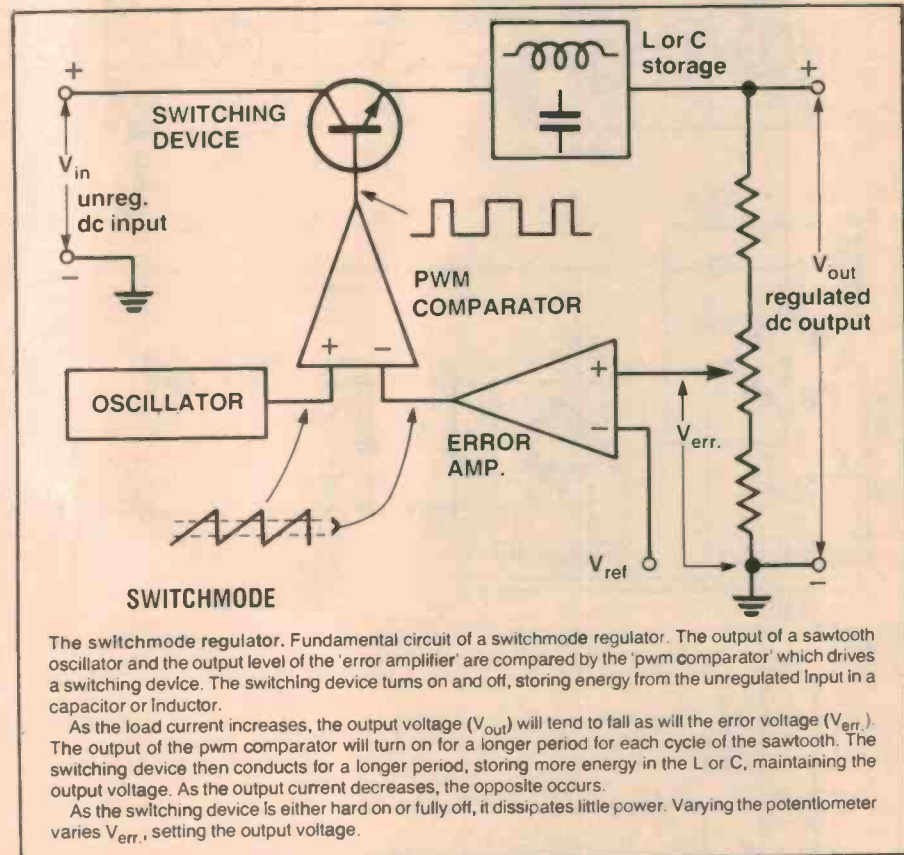

The switchmode regulator. Fundamental circuit of a switchmode regulator. The output of a sawtooth oscillator and the output level of the 'error amplifier' are compared by the 'pwm comparator' which drives a switching device. The switching device turns on and off, storing energy from the unregulated input in a capacitor or inductor.

As the load current increases, the output voltage (V_{out}) will tend to fall as will the error voltage ($V_{err.}$). The output of the pwm comparator will turn on for a longer period for each cycle of the sawtooth. The switching device then conducts for a longer period, storing more energy in the L or C, maintaining the output voltage. As the output current decreases, the opposite occurs.

As the switching device is either hard on or fully off, it dissipates little power. Varying the potentiometer varies $V_{err.}$, setting the output voltage.

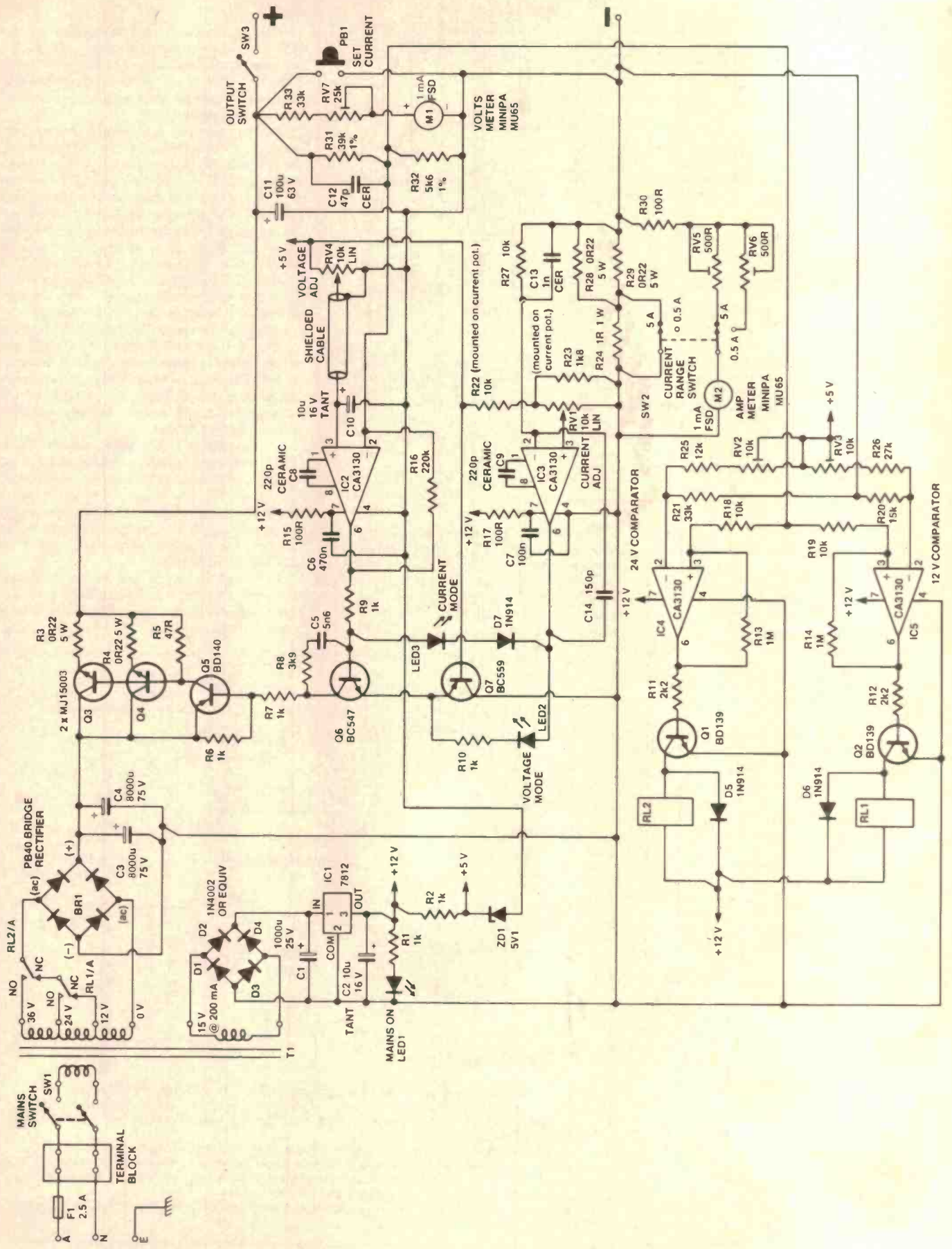

The power supply employs a series regulator circuit with current limiting operation added. The 36 V secondary of the power transformer has taps which are switched in automatically by relays as the output voltage is adjusted so that power dissipation in the series-pass transistors is minimised.

An auxiliary 15 V secondary (or an auxiliary transformer) provides a supply for the reference voltage, the relays, relay drive circuitry and voltage and current feedback op-amps (IC2 and IC3).

The main power transformer (T1) secondary of 36 volts is rated to deliver 5 A and is tapped at 12 and 24 volts. The appropriate tapping is selected by the contacts of relays RL1 and RL2.

These relays are controlled by Q1 and Q2, which are driven by a pair of comparators formed by IC4 and IC5 and associated resistors — R13, 14, 18 and 19. These resistors give the comparators some hysteresis which ensures that the relays do not chatter when the output voltage is set exactly equal to one of the trip voltages.

Resistors R21, 25, 20 and 26 and the two preset pots RV2 and RV3 form adjustable potential dividers, driven from the +5 V reference line. These potential dividers set the trip voltages for the two comparators. The presets allow the actual trip voltage to be adjusted over a small range.

Relay RL1 will trip when the voltage is around 12 V, while RL2 will trip when it is around 25 V. In this way the series-pass transistors, Q3 and Q4, are supplied with enough voltage to ensure good regulation but not excess voltage which would cause unnecessary power dissipation.

The main voltage regulator error amplifier is formed by IC2, a CA3130 FET-input op-amp. This compares the voltage on its non-inverting input (pin 3) with that on its inverting input (pin 2) which measures the output voltage via the potential divider formed by R31 and R32. The non-inverting input is connected to the wiper of RV4 which allows the reference voltage at this point to be varied from 0 to 5 V.

The output of IC2 is connected via resistor R9 to the base of Q6 which, in conjunction with Q5, provides the necessary current to drive the bases of the parallelised series-pass transistors, Q3 and Q4.

The RC network R8-C5 serves to provide negative feedback around Q6 and helps to

ensure stability by reducing the gain of the circuit at high frequencies.

The tantalum capacitor C10 serves to filter the reference voltage. This is important since the error amplifier uses this voltage to establish the output voltage. Any ripple at the non-inverting input of IC2 will be amplified and appear at the output of the power supply. Capacitor C12 serves a similar purpose as C5 and controls the high frequency phase shift in the negative feedback loop to prevent oscillation. C8 provides compensation for IC2.

The current-limit error amplifier is formed by IC3 and associated components — C14, C9, R17 and C7. Resistor R17 and capacitor C7 simply form a low pass filter to ensure a reasonably clean supply to the op-amp. C9 compensates the op-amp and C14 provides feedback to decrease overall gain of the feedback loop at high frequencies, thereby ensuring stability when the supply is operating in the current-limit mode.

The non-inverting input to IC3 is connected to an adjustable voltage reference formed by RV1, R22 and R23. The inverting input is connected via R27 to the negative output terminal of the supply.

This op-amp is, in effect, measuring the voltage drop across the series resistance of R24, R28 and R29. This voltage is proportional to the current drawn from the supply. The amount of series resistance is switchable by the current range switch, SW2.

In the 5 A range, R24 is shorted by the switch providing a series resistance of 0.11 ohms. If, for example, a 5 A current limit was desired, the current adjust pot (RV1) would be adjusted, after depressing the current-set pushbutton (PB1) to give 5 A, and this would result in a 0.55 V reference voltage appearing at pin 3 of IC3. This op-amp then compares the reference voltage to the voltage developed across the series resistance.

IC3 will provide the appropriate output to bring its two inputs to the same voltage and, since 5 A will cause a 0.55 V drop across the series resistance, the load current will be limited to 5 A.

This assumes that the output voltage has been set high enough to force more than the desired current through the load. If this is not the case, it is impossible for the current error amp. to correct what it sees as a gross error in the current. The reference voltage at pin 3 of

IC3 will be greater than the voltage at pin 2 so that the output of the op-amp is forced hard against its positive supply rail, i.e. around 12 V. This forward biases LED2, which indicates that the supply is in voltage mode, i.e. the output is controlled by the voltage pot.

If, however, the reference voltage has been set high enough so that the current flowing in the load approaches that set by the current limit potentiometer, then the current error amp takes over control of the feedback loop and maintains the output so that only the required current flows in the load.

The voltage error amp (IC2) is then incapable of correcting the output voltage and its output swings hard against its positive supply rail (12 V) in an attempt to do so. This forward biases LED3 which indicates that the supply is in current mode, i.e. the output is controlled by the current adjust pot., RV1.

The voltage meter, M1, is a straightforward milliammeter arranged to measure voltage via series dropping resistors R33 and the preset RV7 — the latter being for the purpose of calibration.

The current meter, M2, is effectively a voltmeter, measuring the voltage developed across the series resistance in the negative output line of the supply. Independent presets RV5 and RV6 are provided to allow calibration of the two output current ranges.

A bridge rectifier (BR1) and two 8000µ/75 V capacitors (C3, C4) provide the main supply for the regulator.

The voltage and current error amplifiers must be supplied with a 12 V rail obtained independently of the main tapped secondary winding of the transformer. This can be supplied from an auxiliary winding on the main transformer or from a second small transformer. It should be rated, at a minimum, to deliver 12 V at 150 mA, but a rating of 15 V at 200 mA provides a greater margin.





Diodes D1 to D4 rectify this supply, C1 providing smoothing. This is then regulated by IC1 to 12 V. A 5V1 zener diode connected across this supply provides the 5 V reference used by the reference inputs of the voltage and current error op-amps, IC2 and IC3.

The 'mains on' LED indicator, LED1, is powered from the +12 V rail by the series dropping resistor, R1. The output switch, SW1 permits 'turning off' the supply output without turning off the mains. ●

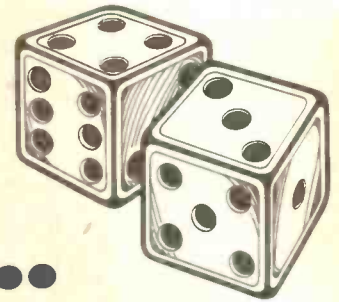
Next month The interesting bits come next month — putting it together, setting it up and using it. Don't miss the next exciting episode! . . .

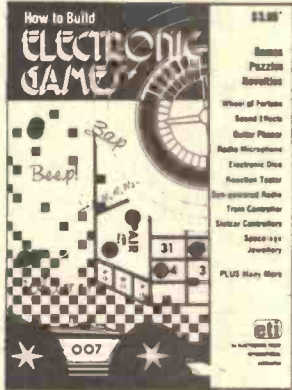
AFTER YOU PLAY THE GAME...



<p>GO</p> 	<p>Decided to build your own electronic games rather than waste your money on the video game at the local milkbar. Clever thinking!</p> <p>Advance 2 Paces.</p>	<p>You've lost the dice from your Ludo set.</p> <p>Go to Jail!</p>	<p>You are interested in electronics!</p> <p>Advance 2 Paces.</p>
<p>You're a Winner!</p> <p>If you rush out and buy your copy of "How to Build ELECTRONIC GAMES"</p>	<p>How to Build ELECTRONIC GAMES</p> <p>Contains 35 projects including an Electronic Poker Machine, Alien Invaders, Radio Microphone, Sound Bender, Reaction Tester, Racetrack Game, Electronic Grenade and lots more. This book is full of the sort of projects you like to build when your not building a project! Check your favourite newsagent or electronics supplier.</p>		<p>So, you've just built the "Electronic Dice" — one of the many projects to be found in "How to Build ELECTRONIC GAMES"</p> <p>Advance 4 Paces.</p>
<p>Got drunk trying to work out the "Puzzle of the Drunken Sailor"</p>  <p>Go to Jail!</p>	<p>Congratulations! You've just won at the races playing our "Race-track Game" Project.</p>  <p>Advance to Finish</p>	<p>The batteries in your radio are dead. If you had bought a copy of "How to Build ELECTRONIC GAMES", you could have built your own Sun-powered radio.</p> <p>Lose a Turn.</p>	<p>The plants are thriving, thanks to the "Soil Moisture Indicator" Project.</p>  <p>Advance 5 Paces.</p>
<p>Lost all your money on the Poker Machines?</p> <p>Lose a Turn.</p> <p>(You wouldn't have lost any with our "Electronic Poker Machine" Project)</p>	<p>JAIL</p> 		

...read the book!



RITRONICS WHOLESALE PTY. LTD. DISCOUNT CITY STORE

48-50 A'Beckett Street, Melbourne 3000, Ph.: (03) 347 9251
Mail orders to P.O. Box 235, Northcote 3070

**You Will Never
Have to Pay
Full Price
for Components
Again!**

The Mitsubishi range of disc drives

M2896-63

Slimline 8" Disk Drive, Double Sided, Double Density, No AC power required, 3ms track to track, 1.6 mbytes unformatted, 77 track/side, 10⁹ bit soft error rate.

\$575 + tax Box & Power supply to suit \$95 + tax

M2894

Standard size 8" drive, Double sides, double density, 3ms track to track access, 77 track/side, 10⁹ bit soft error rate.

\$575 + tax Box & power supply \$95 + tax

M4854

Slimline 5 1/4" disk drive, Double sides, double density, 96 track/inch, 9621 bits/inch, 1.6 mbytes unformatted, 3ms track to track access, 77 track/side.

\$435 + tax Box & power supply \$65 + tax

M4853

Slimline 5 1/4" disk drive, Double sides, double density, 1 mybyte unformatted, 3ms track to track, 80 track/side, 5922 bits/inch, steel band drive system.

\$435 + tax Box & power supply \$65 + tax

**Vic 20
is coming**

CPM SYSTEMS

Twin 8"
4 MHz Double Density
Big Board (2) \$2950.00 + tax
Twin 5" Drives
4 MHz Double Density
Big Board \$2250.00 + tax

Ring for Details

HARD DISC DRIVES ARE HERE!

5 megabyte \$900 + tax
10 megabyte \$1250 + tax
Controller to suit \$495 + tax
Box and Power Supply \$225 + tax

CENTRONICS CONNECTORS

Solder type

Male \$9.50 + tax
Female \$9.50 + tax

BIG BOARD (1) NEWS

Double density add on
\$195 + tax (incl. software and hardware)
Hard disc interface \$195 + tax

MPI DISC DRIVES

to suit Tandy and System 80 Computers) with box and power supplies)

	1 DRIVE	2 DRIVES
B51	\$295 + tax	\$550 + tax
B52	\$375 + tax	\$750 + tax
B91	\$460 + tax	P.O.A.
B92	\$550 + tax	P.O.A.



HI TECHNOLOGY PRODUCTS AND EXPERIENCE

LINEAR REGULATORS					
UA309KC	1.00	MJ802	2.40	Z80 CPU	\$3.40
UA317KC	1.65	2N3055	.55	Z80A CPU	\$3.60
UA317UC	.95	BU326	1.20	Z80 CTC	\$3.20
UA494PC	2.60	BU326	1.20	Z80A CTC	\$3.75
UA723PC	.38	BUX80	2.10	Z80 P10	\$2.90
UA780KC	.99	2N3771	2.50	Z80A P10	\$3.40
UA780JC	.45	2N3772	2.50	Z80 S10	\$8.00
UA7808UC	.45	2N3773	2.50	Z80A S10	\$10.00
UA7812KC	1.00	FND 500	.99	6800	\$2.70
UA7812UC	.45	FND 507	.99	6802	\$3.70
UA7815KC	1.00	MAN74A	.65	6809	\$8.60
UA7815UC	.45	MAN72A	.65	6821	\$1.00
UA7818KC	1.00	4N28	.60	6840	\$3.20
UA7818UC	.50	4N33	.70	6845	\$8.40
UA7824KC	1.00	BDU64B	2.90	6850	\$1.40
UA7824UC	.50	BDU65B	2.90	8212	\$1.10
UA78L05AWC	.27	AD149	1.50	8216	\$1.04
UA78L12AWC	.27	25K134	3.80	8224	\$1.30
UA78L15AWC	.27	2S149	3.80	8255	\$2.15
UA78S40DC	1.70	W02	.20	8155	\$3.70
UA7905KC	1.05	W04	.25	4011	.14
UA7905UC	.45	IN5401	.10	4016	.24
UA7908KC	1.05	IN5404	.12	4017	.44
UA7908UC	.50	BC547	.05	4023	.16
UA7912KC	1.05	BC548	.05	4028	.45
UA7912UC	.50	BC549	.05	4040	.52
UA7915KC	1.00	C1220	.65	4051	.49
UA7915UC	.50	SC141D	.65	4066	.28
UA78L15AWC	.27			4081	.16
				4511	.49
				4520	.55
				74LS00	.13
HYBRID REGULATORS		MEMORY SPECIALS		74LS04	.14
SH1605	9.50	27C16 CMOS Prom		74LS14	.19
SH323C	4.50		\$9.50	74LS30	.16
UA78HO5SC	4.50	27C32 CMOS Prom		74LS32	.13
UA78H12SC	6.00		\$12.50	74LS47	.34
UA78HGSC	6.20	58725 2Kx8 RAM		74LS90	.26
UA78HGSC	10.00		\$4.50	74LS161	.33
UA78PO5SC	8.50	2716 50ONS	\$2.75	74LS240	.45
		2732 45ONS	\$4.50	74LS244	.42
TRANSISTORS		2764 25ONS	\$9.00	74LS245	.55
BD139	.23	4164 15ONS	\$5.00	74LS366	.25
BD140	.23	per 100 @ \$4.00		74LS367	.25

SCOTCHCAL RANGE OF PHOTSENSITIVE PRODUCTS.

			Per Sheet	Per Box
8001	Red on Aluminium	250mm x 300mm	\$5.50	\$40.00 (10sh)
8001	Red on Aluminium	300mm x 600mm	\$10.00	\$43.00 (10sh)
8005	Black on Aluminium	250mm x 300mm	\$ 5.50	\$40.00 (10sh)
8005	Black on Aluminium	300mm x 600mm	\$10.00	\$43.00 (10sh)
8009	Blue on Aluminium	250mm x 300mm	\$ 5.50	\$40.00 (10sh)
8009	Blue on Aluminium	300mm x 600mm	\$10.00	\$43.00 (10sh)
8007	Reversing Film	250mm x 300mm	\$ 4.00	\$22.50 (10sh)
8007	Reversing Film	300mm x 600mm	\$ 8.50	\$30.00 (10sh)
8011	Red on White Plastic	250mm x 300mm		\$43.00 (10sh)
8013	Black on Yellow Plastic	250mm x 300mm		\$43.00 (10sh)
8015	Black on White Plastic	250mm x 300mm		\$43.00 (10sh)
8016	Blue on White Plastic	250mm x 300mm		\$43.00 (10sh)
8018	Green on White Plastic	250mm x 300mm		\$43.00 (10sh)
8500	1 Litre Developer			\$9.00 per bottle
8500	250ml Developer			\$2.50 per bottle
3900	Scotch Clear Finish	368gm Aerosol		\$10.00 per can

All prices plus Sales Tax. Dealer and Trade inquiries welcome.
Please note full range of products are available on order.
Please contact Tim Bray on (03) 489-7099 for further information.

RITRONICS WHOLESALE FOR FAIRCHILD DISTRIBUTION

All prices plus 20% tax
Transistors plus 32.5% tax
Post \$2 Heavy items extra



Bankcard mail orders welcome
ORDER FORM
Please Debit my Bankcard

No. _____
Expiry Date _____
Name _____
Signature _____

RITRONICS WHOLESALE PTY. LTD.

48-50 A'Beckett St., Melb. 3001. Telephone: (03) 347 9251

Errors and omissions excepted.

KITS-- KITS-- KITS--

500MHz Digital Frequency Period Meter

Ref: EA Dec '81 - Feb '82
Jaycar has by far the best kit version of this project in Australia. We now supply 2 x GOLD plated BNC input connectors at no extra cost!
Cat. KA1390 \$119 (50MHz Version)
Cat. KA1392 \$26 (500MHz option)
(Beware of kits that don't conform to the original design).



ONLY \$119

HEART RATE MONITOR

Ref: EA July '82
Brilliant kit which enables you to measure your heartbeat instantly. One of our most popular kits ever. The Jaycar kit comes in a beautiful ABS splashproof case with professional silkscreened panel.
Cat. KA1466 \$79



DIGITAL CAPACITANCE METER

\$74.50



Ref: EA March '82
Accurately measure capacitance from 1pF - 19.99uF. A must for the serious enthusiast.
Cat. KA1420 \$74.50

Digital Thermometer

Ref: EA Feb '82
0 - 100 degrees C with 0.1 degree resolution. Bright, easy to read display. Kit includes two temperature sensors.
Cat. KA1404 \$74.50

magnificent!
\$74.50

TRANSISTOR ASSISTED IGNITION

Ref: EA Jan '83
Latest version of this fantastically popular kit! The Jaycar kit comes with genuine DIE CAST box - as us' in the EA prototype. Beware of others that use flimsy sheet metal.
Cat. KA1506 \$35

MAGIDICE

The best electronic dice ever made! Firstly, this is not a kit. It is completely built and tested.
Basically the MAGIDICE is a glistening black cube measuring 75mm on all sides. It has 6 LED's set into the top of the cube under a red filter (the filter LOOKS black as well!).
When the switch in the base is turned on, a wave of the hand over the top of the cube causes the circuit to operate. The cube beeps and gives you a guaranteed random dice "throw" in the form of illuminated LED's. There are no buttons to press and you don't even have to touch the cube!
The last number will remain until you note or wave your hand over the unit to "throw" another number. This (patented) product makes an absolutely unique gift and comes attractively presented.
Cat. XC-2006

Please note that a 9V battery snap (supplied) must be fitted to use on local 9V standard cell.

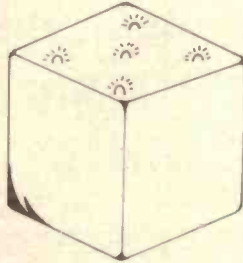

GREAT GIFT

\$19.95
BRILLIANT FUN

0-30V 1amp power supply

Ref: ETI December 1982

- Fully protected
- Output variable from 0-30V DC
- Selectable current limit
- Both voltage and current metering
- After a multimeter & soldering iron an absolute must for the enthusiast.

You will never own a more useful piece of gear.



KE4570 \$49.50

Function Generator

Ref: EA April 1982

\$99

"Pigeon Pair" companion to the new 500MHz DFM. Low distortion generator of sine, square and triangular waveforms. From below 20Hz to over 160kHz. Inbuilt 4 digit frequency counter in de-luxe Pac-Tec case. Only \$85

JAYCAR EXCLUSIVE - 1% 50ppm metal film resistors used for stability

5000 SERIES GRAPHIC EQUALISERS



SPECIFICATIONS:
Signal to Noise: -102dB with respect to 1 Volt
Frequency Response: 19Hz - 105kHz to -10dB
Slew Rate: 14dB/120dB/oct
Distortion: 100Hz @ 0.07%, 1kHz @ 0.03%, 10kHz @ 0.005% (measured at 100mA @ 2.15V)
Current Consumption (DC) Approx 100mA @ 2.15V
(Requires 30V AC CT)
Output short-circuit proof.

\$199

BUY 2 AND SAVE \$10 - ONLY \$389

AUSTRALIAN (NOT HONG KONG) MADE - SPECIAL BUILT RACK CABINET - QUALITY!!! ALL IC SOCKETS PROVIDED
Cat. KE4204

STEREO STEREO STEREO STEREO Synthesiser

Creates a very realistic stereo sound from mono sources i.e. AM tuners, TV or video units Very easy to build and comes complete.

Ref: EA September 1982

Cat. KA1478



Short Form Version Only Cat. KA1476 \$39.50

EA dual tracking P/S



Extremely versatile power supply: Will give plus & minus 1.3V to 22V at up to 2 amps PLUS A FIXED +5V@0.9A. The supply is completely protected against short circuits, overloads and thermal runaway. A large meter with voltage calibration is supplied as well as IC sockets. A quality kit.

\$89.50



FREE! TILTING BAIL WORTH \$4.95 included

NEW MAGNUM 200

NEW! - LOW COST 5000 SERIES AMP

ONLY \$299

Black Monolith \$319

"BLUEPRINT"

ONLY \$299



REF: ETI JAN/MARCH 1981

Cat. KE4200



Cat. KE4202

- FUNCTIONS**
- MOVING COIL INPUT
 - MOVING MAGNET (DYNAMIC CART)
 - INPUTS (2 OFF)
 - TUNER INPUT
 - AUX INPUTS (2 OFF)
 - TAPE INPUTS (2 OFF)
 - INPUT LEVEL CONTROL
 - TAPE OUTPUTS (2 OFF)
 - 500Hz CALIBRATION OSCILLATOR
 - LED AVERAGE (VU) & PEAK
 - LEVEL METERS -48dB TO +9dB

- MODE SWITCH, STEREO BALANCE CONTROL
- LINE OUT, MONITOR OUT, MONITOR VOLUME CONTROL

- FEATURES**
- EXTREMELY CLOSE TRACKING TO RIAA PHONO EQ.
 - GOLD PLATED CONNECTORS ON ALL INPUTS
 - ENGLISH 'LORLIN' LOW NOISE SELECTOR SWITCHES

- LOW NOISE 1% 50ppm METAL FILM RESISTORS USED
- TINNED FIBREGLASS PCB'S
- LOW CAPACITANCE SCREENED CABLE USED THROUGHOUT
- QUALITY IC SOCKETS
- SPECIAL REAR PANEL
- MULTICOLOURED RECTANGULAR LED'S USED

KITS-- KITS-- KITS--

LOW COST DIGITAL MULTIMETER KIT

BY POPULAR DEMAND
 Ref: EA March 1983 (This month)
 Almost everyday we are asked for a multimeter kit. Up until now we thought that it was just not worth it considering the fine low-cost built-up units available. The DP2010 changed all that.
 This kit, fully imported from the UK, uses the famous DP1005 custom LCD/Voltmeter to achieve phenomenal accuracy at very modest cost!
 All parts are included to complete the meter, including an attractive and colourful front panel. (A 9V battery is required)
 Set of test probes to suit \$2.95
 Probe to suit Cat. WTS312 ONLY \$2.50
 Eveready 216 (red) 9V Battery Cat. SB2370 ONLY \$1.40



ONLY \$45

SPECIFICATIONS

Function (d.c.)	f.s.d.	Resolution	Accuracy	Protection
Voltage (d.c.)	2V	1mV	1%±1 digit	500V for 1 minute
	20V	10mV	1%±1 digit	one minute
	200V	100mV	1%±1 digit	
Current (d.c.)	500V	1V	1%±1 digit	
	2mA	100A	1%±1 digit	1A/250V
	20mA	10A	1%±1 digit	
Voltage (a.c.)	200mA	1000A	3%±1 digit	
	2000mA	1mA	5%±1 digit	
	2V	1mV	2%±5 digit	500V for 20V 10mV 100mV 500V
Current (a.c.)	20V	10mV	2%±5 digit	one minute
	200V	100mV	2%±5 digit	
	500V	1V	2%±5 digit	

AC VOLTAGE AND CURRENT RANGES
 When S3a selects a.c. functions the output from either the voltage attenuator or current shunt is fed through C1 to remove any d.c. component.

DP2010 kit Cat. KJ7010 ONLY \$45

Sparkrite

The Brandleaders in Auto Electronics

the ultimate in electronic ignition

Each kit is complete down to the last nut & bolt. All fittings included!
SX-2000. UK's largest selling electronic ignition! "Reactive Discharge" system - NOT CDI - with great reliability.
 Cat. KJ-6650

Sparkrite SX2000

- A Reactive Discharge System combines all features of the SX500 plus:
- Reactive Discharge electronics combining all the advantages of both Inductive and Capacitive Discharge for maximum spark performance.
 - Gives the most thorough combustion of air/fuel ratios especially current lean mixture emission controlled engines.
 - Voted 'Accessory of the Year' and the best as tested by Popular Motoring Magazine.
 - Patented clip-to-coil fitting
 - Systems Function Light as well as Static Timing Light.
 - The ultimate brand leading contact-breaker triggered system.

NEW
 Value
\$59



TX-2002. Breakerless Ignition! Full fitting kit to convert 90% of all cars! All contactless hardware supplied. No drilling or tapping. You can easily convert - and even use your points to work the TX-2002!
 Cat. KJ-6652

Sparkrite TX2002

- A Reactive Discharge System - with unique auxiliary circuit. Combines all features of the TX1002 plus:
- Reactive Discharge electronics combining all the advantages of Inductive and Capacitive Discharge for maximum spark performance.
 - Gives the most thorough combustion of air/fuel ratios especially current lean mixture emission controlled engines.
 - Unique 3-way change over switch incorporating an auxiliary back up circuit. ELECTRONIC/OFF/AUXILIARY.
 - Robust die-cast case, fully resistant to moisture and heat.
 - The ultimate system - REACTIVE DISCHARGE - CONTACTLESS OR CONTACT TRIGGERED - AUXILIARY BACK UP CIRCUIT - CLIP-TO-COIL FITTING - FOUR CONNECTIONS ONLY - ALL PARTS IN ONE BOX TO FIT OVER 500 APPLICATIONS.

\$115

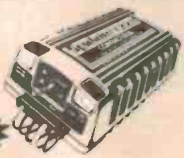

THE BRAND LEADER

TX APPLICATIONS
 No separate fixing kit required, all parts in one box, to fit more than 500 vehicles.

Sparkrite TX1002

- Brightest Computer Programmed Car Security System. This kit, the famous British Sparkrite AT-80 is absolutely unique. It uses a self-adhesive sensor-pad that attaches to the inside of your glass windscreen. You have a special key (2 x 1/2 inch) supplied and you program YOUR SPECIAL CODE in from the DU/55101 OF THE CAR to get back in. The windscreen pad is a REAL deterrent sticker! Cat. KJ-6660
- An Inductive Discharge System
- Can be operated utilising 'Mail Effect' triggerhead, or existing contact-breakers
 - Extended dwell Inductive Discharge for maximum spark efficiency.
 - Three position switch
 - Static Timing Light
 - Systems Function Light
 - Patented clip-to-coil fitting
 - Robust die-cast case.
 - Fully waterproof.
 - Protected from the hostile environment of the engine compartment



\$79



ONLY \$99

ROBOTICS

JAYCAR - FIRST IN AUSTRALIA WITH THE VERY LATEST IN THE FIELD OF ROBOTICS

Jaycar is the first major electronics company in Australia to stock useful robots in kit and built-up form.

MICRO GRASP



ONLY \$499

The Micro Grasp is the first low-cost true robot. Basically the unit has an articulated arm jointed at the shoulder, elbow and wrist positions. The entire arm rotates on its base and has a motor driven gripper on the end of the arm. Each of the arm movements is SERVO CONTROLLED. In addition, error is automatically and continuously corrected. This servo action is independent of the computer, smartly grasping the software to drive the robot. All programming is carried out with a small number of common BASIC commands. The interface board is memory mapped using only 64 bytes of any of the 1024 switch-selectable locations. Control of the Micro Grasp as a computer peripheral is accomplished thru the parallel expansion port of most small computers. To keep the cost to an absolute minimum and to increase the learning factor the Micro Grasp is supplied as a self-contained kit. All components down to the last nut and bolt are included, as is the power supply.

MICRO GRASP KIT INCLUDING POWER SUPPLY Cat. #R1000 - SPECIAL INTRODUCTORY PRICE \$499.00
 UNIVERSAL COMPUTER INTERFACE BOARD (in kit form) Cat. #R1010 ONLY \$179.00 (not required for Spectra ZX81 computer)
 23 - 23 way edge connector at \$8.95. ZX 81 peripheral/RAM pack splitter board \$10.95
 CALL IN TO OUR YORK STREET SHOWROOM AND SEE WORKING!

AS DESCRIBED ETI MAG. APRIL 1983

EPROM programmer for the MicroBee

Ref: ETI Feb '83

Fantastic little accessory for the popular "MicroBee" computer. The Jaycar kit contains all components including the following SPECIAL features:

- 28 pin IC socket included!
- 3 x 16 pin "PERSONALITY PLUG" HEADERS
- 15 pin PARALLEL CONNECTOR
- IC sockets for all logic devices including personality socket.

ALL THIS FOR ONLY \$39.95!
 Cat. KE4650

24 pin ZIF socket to suit only \$12.95 Cat. P16522



Jaycar NUMBER 1 FOR KITS

SYDNEY SHOWROOM
 125 YORK STREET PHONE: (02) 264 6688
 TELEX: 72293

CARLINGFORD SHOWROOM
 Cnr. CARLINGFORD & PENNANT HILLS ROAD
 PHONE: (02) 872 4444

MAIL ORDERS & CORRESPONDENCE
 BOX K 39 HAYMARKET, SYDNEY 2000
 POST AND PACKING CHARGES
 \$5 - \$9.99 (\$1.50) \$10 - \$24.99 (\$3.20)
 \$25 - \$49.99 (\$4.50) \$50 - \$99.99 (\$6.50)
 \$100 or more (\$8.00)

SHOP HOURS CARLINGFORD
 Mon - Fri 9am - 5.30pm; Sat - 9am - 12pm; Thurs night 8.30pm
SHOP HOURS SYDNEY
 Mon - Fri 8.30am - 5.30pm; Sat - 8.30am - 12pm; Thurs night 8.30pm

Mail Order By **BANKCARD**
 Via Your Phone



WE are a No.1 Kit Supplier



SERIES 5000

PRICES SLASHED

As designed by ETI

PREAMPLIFIER

PRICES SLASHED
this month only

~~\$259~~
\$239

SPECIFICATIONS

Frequency response: High-level input: 15Hz-130 kHz, +0, -1 dB Low-level input — conforms to RIAA equalisation, ±0.2 dB
Distortion: 1kHz <0.003% on all inputs (limit of resolution on measuring equipment due to noise limitation).
S/N noise: High-level input, master full, with respect to 300 mV input signal at full output (1.2V): > 92 dB flat > 100 dB A-weighted.
MM input, master full, with respect to full output (1.2V) at 5 mV input, 50 ohm source resistance connected: > 86 dB flat > 92 dB A-weighted.
MC input, master full, with respect to full output (1.2V) and 200 µV input signal: > 71 dB flat > 75 dB A-weighted.



POWER AMPLIFIER

Please note that the "Superb Quality" Heatsink for the power amp was designed and developed by Rod Irving Electronics and is being supplied to other kit suppliers. This product cost \$1,200 to develop so that your amplifier kit would have a professional finish as well as sound. We also have a new range of rack mounting boxes which will be released soon.

SPECIFICATIONS

Power output: 100W RMS into 8 ohms (± 55 V supply).
Frequency response: 8 Hz to 20 kHz, +0—0.4 dB 2.8-Hz to 65 kHz, +0—3 dB. NOTE: These figures are determined solely by passive filters.
Input sensitivity: 1V RMS for 100W output.
Hum: —100dB below full output (flat).
Noise: —116 dB below full output (flat, 20 kHz bandwidth).
2nd harmonic distortion: <0.001% at 1 kHz (0.0007% on prototypes) at 100 W output using a ± 56 V supply rated at 4 A continuous. <0.003% at 10 kHz and 100 W.
3rd harmonic distortion: <0.0003% for all frequencies less than 10 kHz and all powers below clipping.
Total harmonic distortion: Determined by 2nd harmonic distortion (see above).
Intermodulation distortion: <0.003% at 100 W. (50 Hz and 7 kHz mixed 4:1).
Stability: Unconditional



Price Slashed ~~\$299~~ **\$279**

THIRD OCTAVE GRAPHIC EQUALIZER



SPECIFICATIONS E.T.I. Dec. 1982
Bands: 28 Bands from 31.5 Hz to 16 kHz
Noise: <0.008 mV, sliders at 0, gain at 0 (—102 dB),
20 kHz bandwidth
Distortion: 0.007% at 300 mV signal, sliders at 0, gain at 0;
max. 0.01%, sliders at minimum.
Frequency Response: 12 Hz-105 kHz, +0, —1 dB, all controls flat
Boost & Cut: 14 dB

MX-1200 MICROPHONE/AUDIO MIXER

MX 1200 \$499 this month only



This unit features: 12 microphone line inputs with pan, bass, treble, effect and fold back controls for each channel • LED peak indicators for each channel • 2 turntable inputs with cross-fade and individual output controls • master equaliser for bass, midrange and treble • variable headphone output etc. etc. • complete with carrying case.

~~\$599~~

SPECIFICATIONS
INPUTS
Level/Impedance Mic: 48 dB/1K
Line: 22 dB/16K ± 12
Phono: 32 dB/50K STEREO ± 2 (2mV) at 1kHz
Effect Return (Aux): 20 dB/50K ± 1
OUTPUTS
Level/Impedance L & R: 0 dB/2K
Effect Send: 0 dB/2K F/B Cut: 0 dB/2K
Headphone Stereo: +10 dB/500 (100-1K)
EQUALISATION
Channel
Bass: ±15db
Treble: ±15db
Master
Bass: ±12db
Treble: ±10db
Mids: ±12db
FADER & CONTROLLERS
12 channel fader: Slide, 60mm, LOG 25%
2 Master fader, Slide, 60mm, LOG 15%
12 F/B Volume, 300, LIN
1 F/B Master level, 300, LIN
12 Effect Send, 300, LIN
1 Effect Return, 300, LOG 15%
2 Phono, 300, LOG 15%
1 Head Phone, 300, LOG 15%
S/N: 58dB
FREQUENCY RESPONSE: 20-20 KHz
TOTAL HARMONIC DISTORTION: Less than 0.1%
METER: 2 illuminated VU Meters 0db = 0.775V
PEAK INDICATOR: 12 LED Peak indicators
VOLTAGE: 240 VAC 50Hz
POWER CONSUMPTION: 7.2 watts
DIMENSIONS: 620 (W) x 356 (D) x 108 (H) mm (supplied complete with carrying case)

EXTRA FEATURES OF OUR KITS POWER AMPLIFIER

- KIT PRICE \$299 P&P \$8.00**
- 1% Metal Film Resistors are used where possible
 - Prewound Coils are supplied
 - Aluminium case as per the original article
 - All components are top quality
 - Over 200 Kits now sold
 - We have built this unit and so know what needs to go into every kit
 - SUPER FINISH Front panel supplied with every kit at no extra cost to you
 - We are so confident of this kit that we can now offer it assembled and tested so that people who do not have the time can appreciate the sound that this amplifier puts out. This is done on a per order basis delivery approx. two weeks after placement, only \$425
- *All parts available separately for both kits.

PREAMPLIFIER

- KIT PRICE \$259 P&P \$8.00**
- 1% Metal Film Resistors are supplied
 - 14 metres of Low Capacitance Shielded are supplied (a bit extra in case of mistakes)
 - English "Lorlin" Switches are supplied no substitutes as others supply
 - We have built and tested this unit and so know what needs to go into every kit
 - Specially imported black anodised aluminium knobs
 - Again as with the power amp we are offering this kit A & T at a price which we do not believe there is a commercial unit available that sounds as good. Same delivery as the PA, only \$425

ROD IRVING ELECTRONICS

2 BRANCHES: 425 High St. Northcote, Ph.: (03) 489 8131
48-50 A'Beckett St. Melb. Ph.: (03) 347 9251
Mail orders: P.O. Box 235 Northcote, Vic. 3070



Bankcard mail orders welcome
ORDER FORM
Please Debit my Bankcard

No. _____
Expiry Date _____
Name _____
Signature _____

Errors and omissions excepted.

Zener diode tester plugs into your multimeter

Geoff Nicholls

This handy little adjunct for your multimeter allows you to read out the actual zener voltage of any zener diode up to 60 volts and will also test LEDs!

EVER DUG INTO a tray of components looking for a zener diode only to find that the markings have worn off? Even a brand new zener is usually marked with a code number giving little indication of the thing you want to know — the actual zener voltage rating. This simple tester will save you thumbing through the data books looking for a 1N4XXX, and allows easy identification of those unmarked diodes.

Most multimeters have a diode check position, but few can test LEDs, let alone zeners. This handy little adjunct for your multimeter allows you to test zeners up to about 60 volts, and can drive enough current through a LED to light it (and give you a reading of its forward voltage drop).

The tester simply plugs into your multimeter (a digital meter is ideal) and gives a direct reading of zener voltage. The circuit uses an inverter to provide a current-limited output of up to 70 volts dc from a nine volt battery. Table 1 shows the output characteristics of the prototype.

The leads on diodes are designated *anode* and *cathode*, the latter being marked by a band. When connected to the tester with the cathode to the black or negative terminal, the multimeter will indicate the diode forward voltage. For a silicon diode this will be about 650 mV while a germanium diode will read around 300 mV. Zener diodes are

normally operated in reverse bias and are therefore tested with the cathode (banded end) connected to the red or positive terminal so that the zener voltage is displayed on the meter.

Zener characteristics

The zener voltage rating of a diode is only a nominal figure and should be considered with other parameters when designing circuitry. The first thing to realise is that the zener voltage is rounded to the *nearest preferred value*. Secondly, the voltage rating is dependent on the current passing through the diode. The diode manufacturers usually quote zener voltages at a current of 5 mA for voltages up to 30 volts and at 2 mA above this.

Low voltage zeners will not develop their nominal voltage until the current reaches a few milliamperes. As the diode current is increased the voltage drop will also increase, representing a dynamic resistance which varies from tens of ohms for zeners between six and ten volts, to hundreds of ohms outside these limits.

Lastly, the zener exhibits a temperature sensitivity that varies with zener voltage as shown in Figure 2. A detailed explanation of the temperature characteristic may be found in any solid state physics textbook, the essential features being a negative temperature coefficient associated with true zener

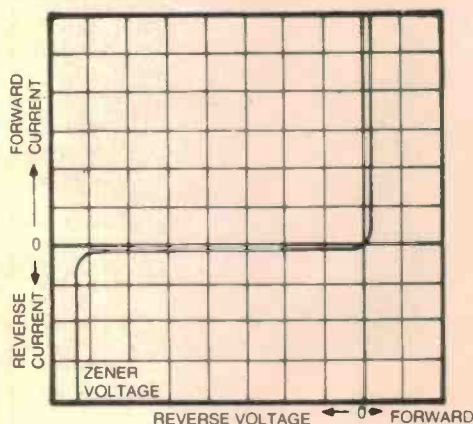

Figure 1. The fundamental characteristics of a zener diode. Little reverse current flows until a certain voltage — the zener voltage — is reached. This voltage is almost constant.

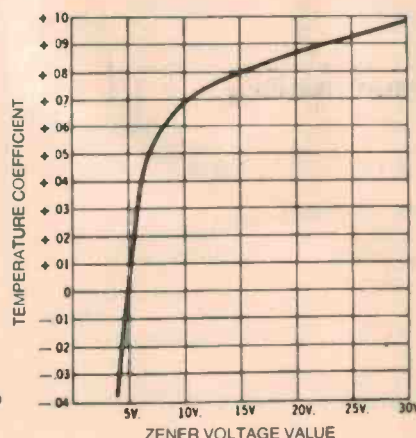

Figure 2. Temperature characteristics of zener diodes — depends on the zener voltage value.



Push-to-read. The tester is housed in a 'zippy' box with banana plugs protruding from the rear spaced to suit the multimeter input sockets spacing.

breakdown below six volts and a positive temperature coefficient associated with avalanche breakdown above six volts.

It is possible to combine zener diodes with opposing temperature coefficients in order to obtain a near temperature-independent reference, or to use a normal diode (with a negative coefficient) and a zener with the same result.

For further information on practical zener usage, refer to *ETI Circuit Techniques, Vol. 1*, pages 136 to 141.

Construction

I built the zener tester into a plastic zippy box with metal lid measuring about 30 x 50 x 80 mm. This is the smallest common low cost box that will accommodate the electronics and battery.

The pushbutton switch is mounted centrally in the lid about 10 mm from one end with the two banana plugs in the box underneath the switch. The spring terminals mount on the other end of the box, as shown in the photographs. You may wish to vary construction to suit the components on hand, but check ▶

TRANSFORMER NOTES

The transformer used in this zener tester is a 'transistor audio transformer'. Two separate types were tested, with virtually equivalent results.

The Dick Smith M-0216, described in the catalogue as being 'primary 1k ohm CT/secondary 8 ohm' was the one used in designing the circuit (CT means 'centre tapped'). Although described as having a ferrite core, the several we purchased had iron cores.

Many component suppliers stock this transformer, or an equivalent type. For example, Altronics call it an 'output transformer', catalogue number M 0216; Electronic Agencies have a '1k CT/8 ohm' mini transformer listed as cat. no. ME4012.

Just for safety's sake, in case the 1k CT/8 ohm transformers may not be available at some time or another, we tried a 500 ohm CT/8 ohm type from Altronics, cat. no. M 0226. Many other suppliers stock a transformer like this, too. As results were virtually equivalent, we can safely say transformers of this type may be used for T1 also. Connections were found to be the same as the M-0216.

Note that it may be physically larger, necessitating mounting R1 on the copper side of the board.

that the bits all fit together before chopping up your box.

The banana plugs are mounted at a spacing of 0.75", or about 19 mm, which allows the tester to plug straight into a standard multimeter with 'GR' inputs.

To mount the plugs, first remove the plastic handles and cut them down to 20 mm so they can be fitted inside the box. Solder about 100 mm of insulated wire to each plug and feed the end through the holes in the box. Grab each plug with pliers and push them through the holes from the bottom. Now slip the handles over the wires and tighten up the plugs.

If all that seems too much, you may want to simply bring a couple of wires out to the multimeter with the banana plugs soldered to the ends.

The spring terminals I used had mounting holes about 45 mm apart which allowed screws to tap into the plastic pillars in the corners of the box. You may also mount the terminals on the long side of the box. In any case, a couple of holes will be necessary under the spring terminals to allow the solder lugs to pass through.

The pc board is straightforward to assemble, watch the orientation of the electrolytic capacitors, the two diodes (note: D1 is the smaller) and the transistor. There are several types of transformer available and some may require R1 to be mounted on the copper side of the board in order to fit properly. The pc board may slot into a groove inside the box, or simply lay alongside the battery as in our prototype.

TABLE 1 Performance of prototype.

OUTPUT VOLTAGE volts	OUTPUT CURRENT mA	BATTERY DRAIN mA
0	5	140
5	8	160
15	9	190
24	9	190
48	5	160
60	1.5	130
72	0	120

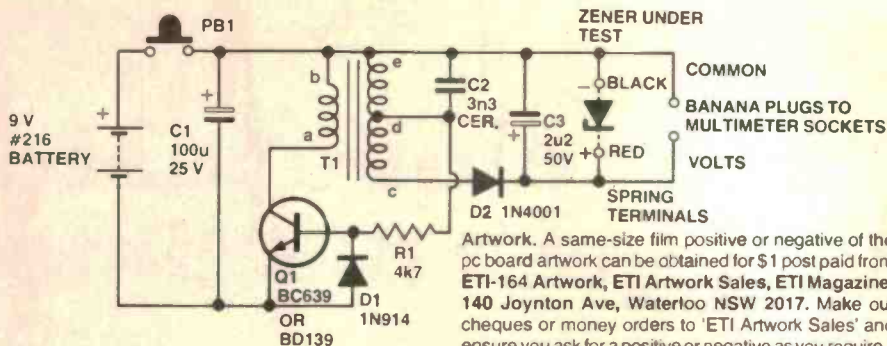

Artwork. A same-size film positive or negative of the pc board artwork can be obtained for \$1 post paid from ETI-164 Artwork, ETI Artwork Sales, ETI Magazine, 140 Joynton Ave, Waterloo NSW 2017. Make out cheques or money orders to 'ETI Artwork Sales' and ensure you ask for a positive or negative as you require.

HOW IT WORKS — ETI-164

The operation of apparently simple inverter circuits is usually exceedingly complex, so the following is a simplified explanation!

After PB1 is closed, current flows through terminals 'e' and 'd' of the transformer (and C2) to the base of Q1 via R1. Q1 starts to conduct and causes current flow through transformer terminals 'b' and 'a' (the primary winding) which causes the magnetic field to build up in the transformer. This field increases the base current to Q1 because of the phasing of the windings.

The magnetic field increases until the transformer core saturates, when the transformer base current reverses, turning the transistor off.

Diode D1 protects the base-emitter junction against excessive reverse bias voltage.

The energy in the transformer's magnetic field is dissipated via several mechanisms, one being to charge C3 via D2.

The whole cycle repeats at a rate of a few kilohertz.

Capacitor C1 provides a low impedance source to ac signals and improves operation with a battery supply.

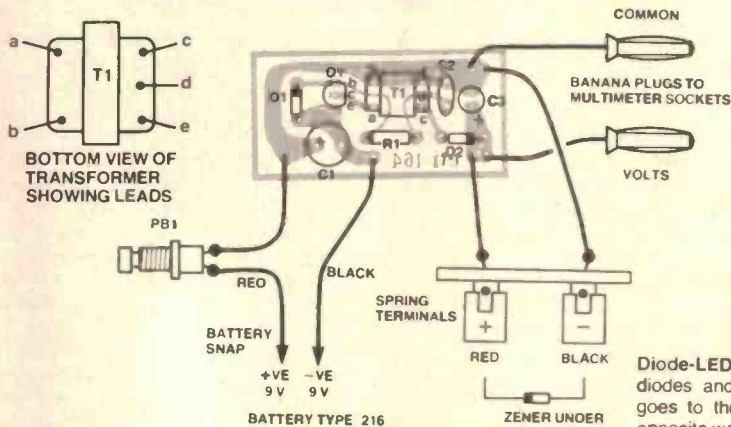

Diode-LED test. When testing diodes and LEDs, the anode goes to the red terminal, the opposite way to zeners.

PARTS LIST — ETI-164

- Resistor 1/4W, 5%
R1 4k7
- Capacitors
C1 100u/25 V (or 16 V)
RB electro.
C2 3n3 ceramic
C3 2u2/50 V RB electro.
(see text).
- Semiconductors
D1 1N914
D2 EM401, 1N4001, EM402,
1N4002, etc.
Q1 BC639 or BD139
- Miscellaneous
PB1 momentary action
pushbutton
T1 transistor audio
transformer, '1k CT
to 8 ohm', D.S.E. M-0216
or similar (see text).

ETI-164 pc board; UB5 zippy box (28 x 54 x 83 mm); spring terminals; wire etc.

Price estimate \$8 — \$9



Inside story. Internal view of the zener tester. Note the cut-down banana plug handles at the top of the box.



No. 1 for Video accessories

Built and tested

Video Switching box



\$47.50

Low loss R.F. switching—allows inputs for:- VCR, video disc, antenna, cable TV, home computer and video games.

WE HAVE A GREAT RANGE OF VIDEO CONNECTORS AND CABLES FOR VIDEO TO VIDEO DUBBING.

Cables

- PA-25**
5 pin 180 degree dubbing adaptor—Reverse pins for video use **\$6.95**
- VC-14**
8 pin square plug to 8 pin square plug. Cable length 2 metres **\$29.95**
- VC-15**
6 pin DIN plug to 6 pin DIN plug. Cable length 1.5m **\$4.95**
- VC-1**
BNC plug to BNC plug. Impedance-75Ohm. Cable length 1.5m **\$6.50**
- VC-2**
BNC plug to PL259 plug. Impedance-75Ohm. Cable length 1.5m **\$6.75**
- VC-3**
PL 259 plug to PL 259 plug. Impedance-75Ohm. Cable length 1.5 **\$4.95**
- VC-4**
PL 259 plug to RCA plug. Impedance-75Ohm. Cable length 1.5m **\$4.95**
- VC-5**
RCA plug to RCA plug. Impedance-75Ohm. Cable length 1.5m **\$5.95**
- VC-8**
BNC plug to RCA plug. Impedance-75Ohm. Cable length 1.5m **\$5.95**

Video Connectors

- VP-8**
8 pin square video connector plug **\$7.50**
- VS-8**
8 pin square video connector inline socket **\$7.50**
- VP-10**
10 pin male video plug. Used in J.V.C., Panasonic, Sharp and other VHS machines **\$11.50**
- VS-10**
10 pin female inline socket. Used in J.V.C., Panasonic, Sharp and other VHS machines **\$11.50**
- VP-14**
14 pin male video plug. Used in Sony, Sanyo, Toshiba and other Beta machines **\$16.50**
- VS-14**
14 pin female inline socket. Used in Sony, Sanyo, Toshiba and other Beta machines. **\$16.50**



Built and tested

Video Enhancer



Detail Enhancer VP5030 is another important contribution to the world of video accessories. The lightweight Detail Enhancer has been particularly designed to rectify loss in detail derived from VCR tapes and picture impairments. With simple adjustments for more or moderate detailing, the detail enhancer can also overcome such picture impairments as loss of detail and disappearance of verticle lines.

Specifications:

1. Power requirement: 12V DC 110mA
2. Input: 1 Video (RCA connector)
3. Outputs: 3 Videos (RCA connectors)
4. Output lever: Video outputs: 1.0Vp-p, 75 Ohm unbalanced below 1Vp-p out.
5. Enhance: Enhance 9dB (Referenced/1.0Vp-p)
6. Signal-to-noise ratio: Greater than 50dB below 1Vp-p out.

Bargain Price
\$87.50

TDK E180
VHS VIDEOTAPES
10 for \$148.00
Unbelievable Value!!

T.V. and F.M. Splitters

Model	F Range (MHz)	Impedance (Ohms)		Output	Band	Splitting loss	Isolation	V S W R
		IN	OUT					
DDF-332 U/V	50-890	300	300	2	VHF UHF	3.5	25	1.5
DDF-772 U/V	50-890	75	75	2	VHF UHF	3.5	25	1.5
DDF-774 U/V	50-890	75	75	4	VHF UHF	6.7	30	1.4
					UHV	7.6	22	1.8

DDF-332 \$3.95, DDF-772 \$4.95, DDF-774 \$6.95

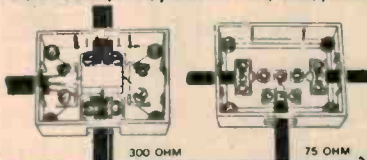

VIDEO HEAD CLEANERS

- HC-1 V.H.S. Video head cleaner
- HC-2 Beta Video head cleaner

A professional head cleaner—employs new "double sided" cleaning action—no need to "operate" on your machine. Just insert the cassette, play for 30 seconds and the job's done. Effective for 100 operations.



HC-1 \$17.50 HC-2 \$17.50

ROD IRVING ELECTRONICS

2 BRANCHES:

425 High St. Northcote, Ph.: (03) 489 8131
48-50 A'Beckett St. Melb. Ph.: (03) 347 9251

Mail orders: P.O. Box 235 Northcote, Vic. 3070

min p&p \$3.00



Bankcard mail orders welcome
ORDER FORM
Please Debit my Bankcard

No.
Expiry Date
Name
Signature

Errors and omissions excepted.



GREAT NEW PROD

JAYCAR'S DIRECT IMPORT PRICES

BALANCED MIC TRANSFORMER **\$18.95**



A true Mu-metal shielded unit for balanced applications.
 Primary - 200 - 600 ohm CT (Balanced)
 Secondary - 10 - 50K Unbalanced
 (Can be operated either way round)
 9mm bushing mount with flexible wire leads
 Frequency response 30 - 15KHz at mic level
STAGGERING VALUE ONLY \$18.95

Cat. MT4710

We also have a 10K:10K line isolating transformer (Identical in appearance to above) at **ONLY \$17.95**

Cat. MT4720

SENNHEISER MUFFS

\$5.95



PAIR

Genuine factory made spare foam earpads for the famous HD-414. We now have plenty of stock.

Cat. AA2011

\$5.95 pair

HIGH SPEED LOGIC PROBE



QT2210

- DTL/TTL/HTL/CMOS/MOS compatible
- Pulse memory
- 10MHz Input frequency (tested to 12MHz)
- ± 50V Input overload
- Complete with leads.

ONLY \$29.95

IEC 320 240V APPLIANCE CONNECTOR

Some day all mains equipment will be fitted with these!

- CHASSIS PLUG
- Front or rear mount
 - Accepts RH, LH, or straight IEC 320 standard line skt.
 - Simplifies 240V wiring
 - Quick connect/solder terminals

Cat. PP2302

ONLY \$2.95

LINE CORD/SOCKET

- 3 wire cord (A,N,E)
- Moulded line socket
- Strain relief grommet
- other end unterminated

Cat. PS4302

\$4.95

\$4.95

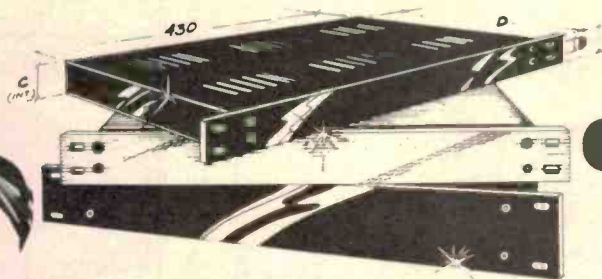
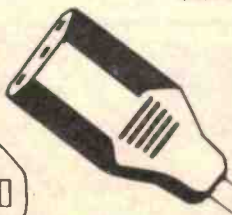

19" rack cabinets



We have a great range of these cabinets. Beware of imitations that do not conform to IEC International dimensions!

(All units are 19" (or 481mm wide))

Cat. No	Height	Colour	Price
HB5410	44mm (1 3/4")	Black	\$39.95
HB5411	44mm (1 3/4")	Silver	\$39.95
HB5412	88mm (3 1/2")	Black	\$49.50
HB5413	88mm (3 1/2")	Silver	\$49.50
HB5414	132mm (5 1/4")	Black	\$54.95
HB5145	132mm (5 1/4")	Silver	\$54.95

We also have genuine RACK FRONT PANELS. These can either be used as blank fill-ins or small projects can be mounted on the panel itself. Each panel is 2.5mm thick with a light scratch finish and well anodised.

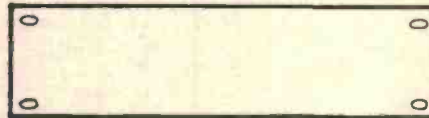

Cat. No	Height	Colour	Price
HB5410	44mm (1 3/4")	Black	\$8.95
HB5411	44mm (1 3/4")	Silver	\$8.95
HB5412	88mm (3 1/2")	Black	\$11.95
HB5413	88mm (3 1/2")	Silver	\$11.95
HB5414	132mm (5 1/4")	Black	\$14.95
HB5415	132mm (5 1/4")	Silver	\$14.95

NEW 28 PIN ZIF SOCKET



It's hard to keep up with demand for the popular 24 pin zero insertion force socket however, we have had many requests for a 28 pin version.

24 PIN ZIF SOCKET

Cat. PI6522

\$12.95

28 PIN ZIF SOCKET

Cat. PI6523

\$17.95



FUEL FLOW SENSOR NEW LOW PRICE



As used in the EA Fuel Consumption Meter. (Ref: EA March 1983)

The original, accurate fuel flow meter. Delivers a TTL compatible pulse in linear proportion to fuel flow. Will measure flow of many low-viscosity liquids apart from fuel.

Cat. XC2020

NORMALLY \$59.50 SAVE \$14.50

SPEEDO CABLE SENSOR BACK IN STOCK



Amazing \$29.50

Great for precision electric speedos, car computers etc. Provides TTL compatible pulse directly proportional to speed of vehicle. Simple fitting with instructions provided.

Cat. XC2025

\$29.50

INSULATION DISPLACEMENT CONNECTORS & RIBBON CABLE

I.D. Insulation displacement. The quick and reliable way of making multiple connections to computer peripheral connectors. Great for Disk Drives, Printers etc. Crimp them yourself and save a fortune.

PI6550	16 pin DIP header	\$1.99
PI6555	24 pin DIP header	\$2.50
PI6560	PC edge connector 34 way (Suits 5 1/4" Disk Drives)	\$8.50
PI6575	25 pin Cannon 'D' male	\$8.95
PI6576	25 pin Cannon 'D' female	\$8.95
WM4502	16 way cable	\$1.50/metre
WM4504	25 way (for DB25's) & 24 way DIP	\$2.50/metre
WM4506	34 way for Disk Drives	\$3.45/m

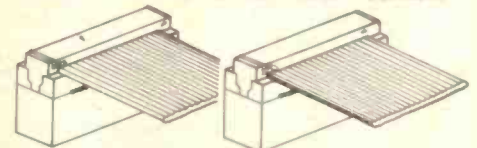

EXPERIMENTER BREADBOARDS



from \$3.45

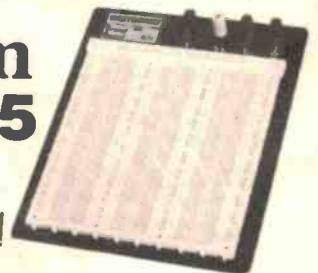

VALUE!

Cat. PB8810	WBDN 100 holes	\$3.45
Cat. PB8812	WBTN 640 holes	\$10.95
Cat. PB8814	WB2N 840 holes	\$16.95
Cat. PB8816	WB4N 1680 holes	\$29.50
Cat. PB8818	WB6N 2420 holes	\$45.00

UCTS - LOW PRICES

MEAN YOU SAVE A BUNDLE!!

\$42.95

totally new

NEW

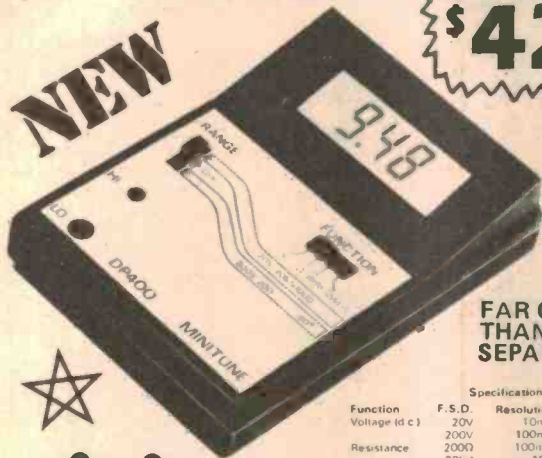

FAR CHEAPER THAN DPM SEPARATELY

Function	F.S.D.	Resolution	Accuracy
Voltage (d.c.)	20V	10mV	0.5% + 1 digit
	200V	100mV	0.5% + 1 digit
Resistance	200k	100mΩ	0.5% + 1 digit
	20kΩ	100	0.5% + 1 digit
R.P.M.	20,000	10 μm	1% - 3 digits
Dwell	90°	0.1°	2% + 3 digits

minitune

Following the spectacular success of the DP2010 Digital Multimeter kit, we now have an **ENGINE ANALYSER KIT!** But the spectacular thing is the price! It is **ACTUALLY CHEAPER** than the DPM-05 Display and Case!! The Minitune will measure voltage, resistance (down to a very low range), RPM and Dwell Angle.
Cat. KJ7012

MINITUNE KIT \$42.95
TEST LEADS TO SUIT ONLY \$2.95

AT LAST! Jaycar now stocks 0.1" pitch P.C.B. Launchers. You have seen these great little components on most imported computer equipment. They enable fast and reliable connection/disconnection to a P.C.B. Give your projects the professional finish that they deserve!

We stock these in 8 way (only). For smaller sizes simply cut down. The launchers will stack side-by-side without affecting the 0.1" pitch.

Cat. No.	Description	Price
HM3210	0.1" pitch x 8 way vertical pins	\$2.50
HM3215	0.1" pitch x 8 way right angle pins	\$2.95
HM3220	0.1" pitch x 8 way connector socket	\$2.95

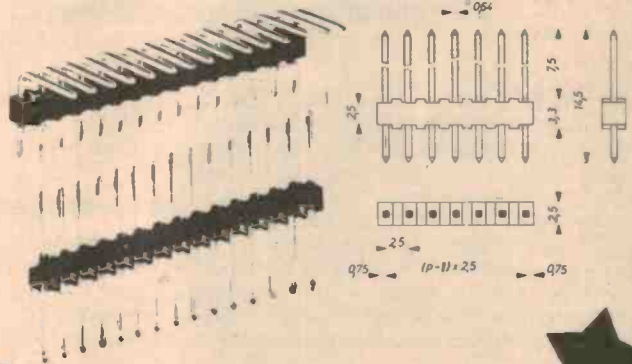

Digital Delay Line KIT

ONLY \$399 COMPLETE

WE DARE YOU TO COMPARE WITH DEARER UNITS!!

The Digital Delay Line is designed to produce a huge variety of electronic effects. It works very well but the amazing thing is the low, low price!

The effects depend on the time delay selected and some of those included are: Phasing, Flanging, Chorus, ADT (Automatic Double Tracking), Echo, and Vibrato. The delay time can be varied from 0.32ms to 1.6 seconds! Because the signal is stored in digital form there is, unlike analog systems, no degeneration of the signal with time and unlimited repetition is provided by use of the Freeze control.

All the controls mount directly upon PCB's to eliminate wiring and to further simplify construction the main board is 'plated-through' i.e. there are no wire links or link-through pins. The whole of the memory whether for the basic 400ms machine or the fully expanded 1.6 second model all fits on the main board with all ICs in sockets for easy serviceability. The cabinet, which is free standing but also suitable for 19" rack mounting, is fully finished to a very high standard. The panel is deep blue whilst the cover is sprayed with a durable black enamel.

The (1.6 second) kit is available right now from Jaycar at only \$399 - compare that with inferior units that can cost over \$2,000!!
Cat. KJ6621

\$399

Jaycar NUMBER 1 FOR KITS

SYDNEY SHOWROOM
125 YORK STREET PHONE: (02) 264 6688
TELEX: 72293

CARLINGFORD SHOWROOM
Cnr CARLINGFORD & PENNANT HILLS ROAD
PHONE: (02) 872 4444

MAIL ORDERS & CORRESPONDENCE
BOX K 39 HAYMARKET, SYDNEY 2000
POST AND PACKING CHARGES
\$5 - \$9.99 (\$1.50) \$10 - \$24.99 (\$3.20)
\$25 - \$49.99 (\$4.50) \$50 - \$99.99 (\$6.50)
\$100 or more (\$8.00)

SHOP HOURS CARLINGFORD
Mon - Fri 9am - 5.30pm; Sat - 9am - 12pm; Thurs night 8.30pm
SHOP HOURS SYDNEY
Mon - Fri 8.30am - 5.30pm; Sat - 8.30am - 12pm; Thurs night 8.30pm



Mail Order By
BANKCARD
Via Your Phone

How to use digital voltmeter modules

Part 2

In this concluding part of the series, Ray Marston shows how to use 3½-digit LCD DVM modules to build a multimeter and measure temperature, capacitance, frequency and a whole lot more.

Ray Marston

IN PART 1 I explained the basic characteristics and usage rules of 3½-digit LCD digital voltmeter modules and showed how these units can be used to measure voltage, current and resistance.

This part kicks off with the complete circuit of a five-function, 25-range digital multimeter and continues by showing how these modules can be used to give accurate measurement of temperature, capacitance, frequency and various other parameters. It

finishes up with some vital hints on actually constructing projects that are designed around the modules.

A 25-range multimeter

Figure 21 shows how the circuits of Figures 15 to 20, in Part 1, can be joined together to make a complete five-function 25-range multimeter. Table 3 details the ranges/functions of the meter.

The reader should have little difficulty in following the Figure 21 circuit. Functions are selected by SW1, ranges by SW2. SW1a connects the inputs to the voltage, current or resistance measuring networks, and SW1d activates the ac/dc converter or energises the 'ohms' circuitry when necessary.

Voltage ranges are selected by SW2a, current ranges by SW2b, and resistance ranges by SW2c.

SW2d and SW2e control the decimal point

Figure 21. Complete five-function 25-range multimeter.

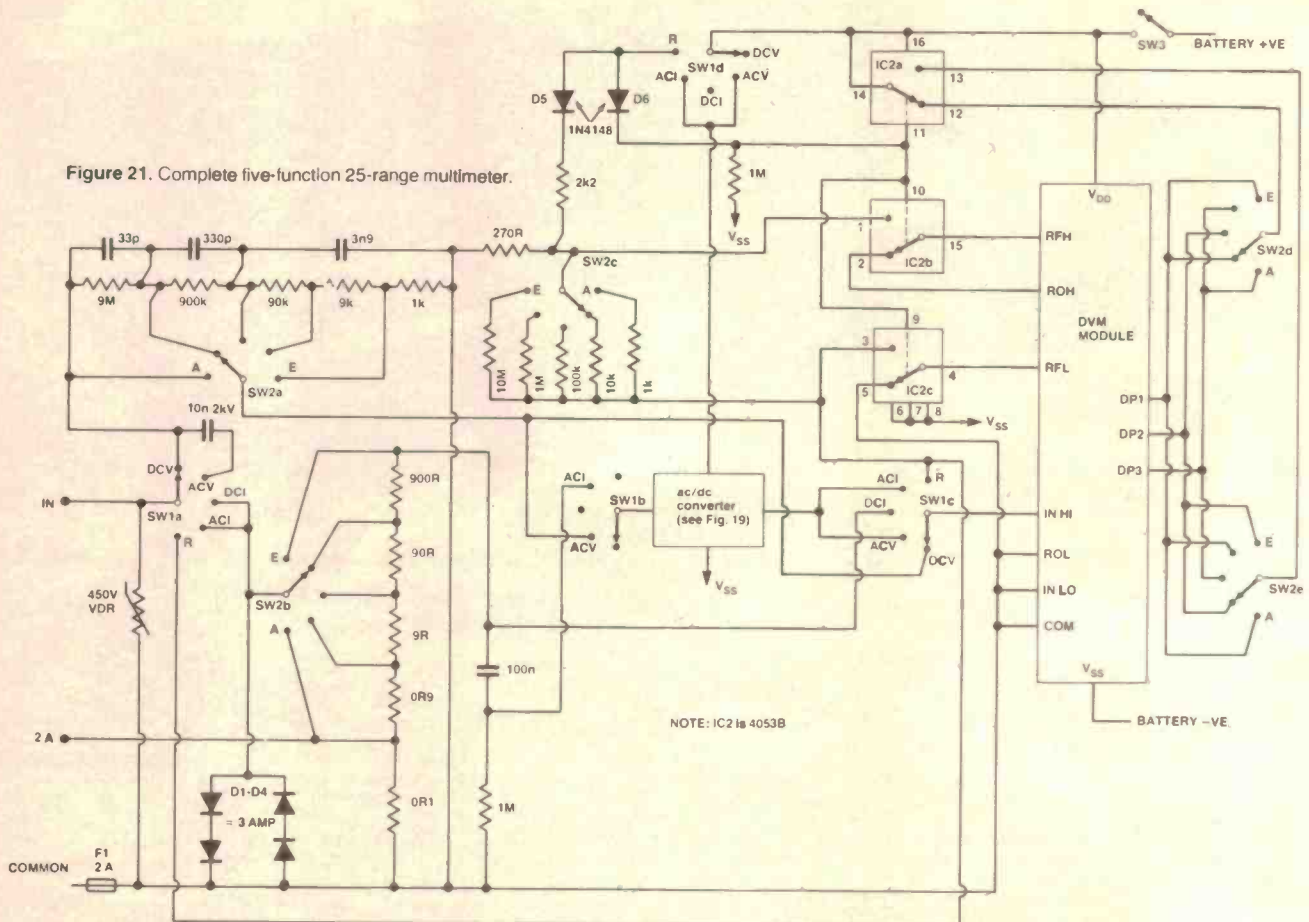

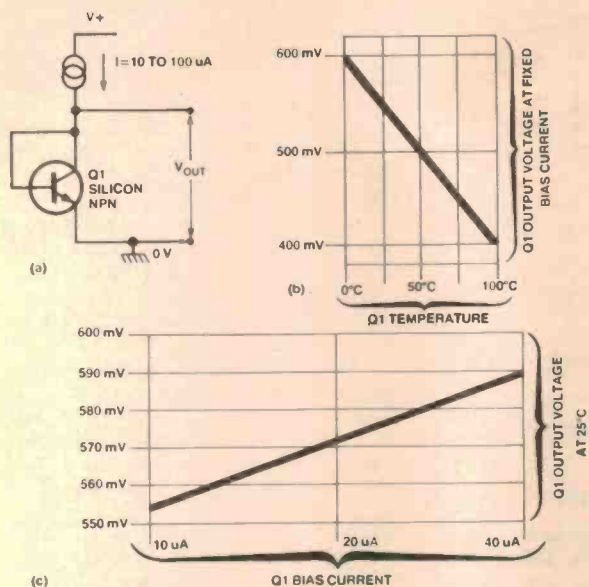

Figure 22. When a transistor is connected as in (a), its output voltage varies at a rate of about $-2 \text{ mV}/^\circ\text{C}$ as shown in (b). The output voltage also varies with drive current as shown in (c).

positions on each range, the appropriate switch being selected automatically by IC2a. IC2b and IC2c control the basic configurations of the DVM module. IC2 (a triple two-way analogue switch) is activated via SW1d.

Digital thermometers

A DVM module can be made to act as a wide-range (-50°C to $+150^\circ\text{C}$) digital thermometer by feeding the output of a linear voltage-generating temperature sensor to its inputs. Two suitable types of sensor are readily available; the first of these is the ordinary bipolar silicon transistor and the second is a dedicated IC. In either case, the resulting digital thermometer has a temperature discrimination of 0.1°C . Linear accuracy varies from 0.5°C to 1.5°C , depending on the sensor and circuitry used.

Because of the low mass of a transistor sensor, the device has a thermal response time some 10 to 100 times faster than a normal mercury thermometer. When used to measure a sharp change in the temperature of free air, a transistor-sensor circuit typically settles to within 0.1°C of the new temperature in less than one minute; a mercury thermometer takes some 20 minutes to attain the same accuracy.

Transistor-sensor circuits

When an ordinary NPN silicon transistor is connected as shown in Figure 22a and driven from a constant-current source, it generates an output voltage that varies in direct proportion to the transistor temperature. This voltage has a negative temperature coefficient of about $-2 \text{ mV}/^\circ\text{C}$ and typically varies from about 600 mV at 0°C to 400 mV at 100°C , as shown in the idealised graph of Figure 22b.

In practice, the 'straight line' of the Figure 22b graph is linear within 1 mV or so over the 200 mV 0°C to 100°C temperature variation range, but the precise voltage generated at any given temperature depends on the individual transistor and its operating current. If operating currents are kept below 100 μA , errors due to self-heating are negligible. Figure 22c shows the measured variation in voltage at 25°C of a small sample of transistors at currents ranging from 10 to 40 μA .

MODE (SW1)	RANGE (SW2)				
	A	B	C	D	E
DCV	199.9 mV	1.999 V	19.99 V	199.9 V	1.999 kV (700V max)
ACV	199.9 mV	1.999 V	19.99 V	199.9 V	1.999 kV (450 V max)
DCI	199.9 μA	1.999 mA	19.99 mA	199.9 mA	1.999 A
ACI	199.9 μA	1.999 mA	19.99 mA	199.9 mA	1.999 A
R	1.999 k Ω	19.99 k Ω	199.9 k Ω	1.999 M Ω	19.99 M Ω

Table 3. Ranges and functions of the Figure 21 multimeter circuit.

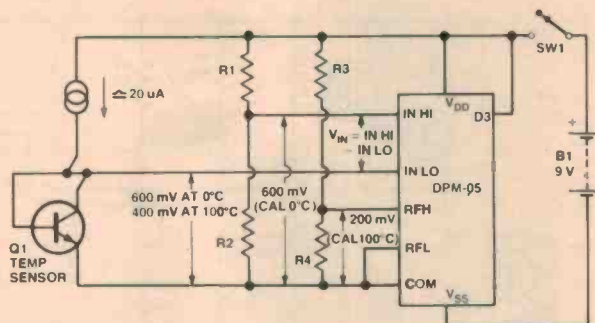

Figure 23. Basic digital thermometer circuit using an idealised (Figure 22b) transistor sensor.

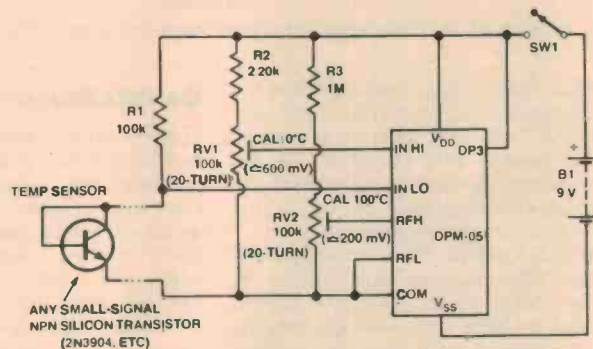

Figure 24. Simple digital thermometer using a transistor sensor. Linear accuracy is about 1.5°C .

Figure 23 shows the basic method of connecting the idealised transistor sensor of Figure 22b to a DVM module so that the meter gives a direct readout of temperature in $^\circ\text{C}$. The output of the sensor is fed directly to the module's IN LO terminal and a 600 mV offset voltage (equal to the sensor voltage at 0°C) is fed to IN HI. The module actually responds to the differential value (IN HI minus IN LO) of the input, so under this condition it sees an input of $600 \text{ mV} - 600 \text{ mV} = 0 \text{ mV}$, and gives a reading of '00.0'.

At 100°C the module sees an input of $600 \text{ mV} - 400 \text{ mV} = 200 \text{ mV}$. Since a reference voltage of 200 mV (equal to the difference in voltage between 0°C and 100°C) is fed to RFH, the meter gives a reading of '100.0' under this condition.

Figures 24 and 25 show two practical examples of digital thermometers. The Figure 24 circuit is virtually the 'standard' one published in many magazine articles and application sheets and has a typical linear accuracy of 1.5°C over the 0°C to 100°C temperature range. A stable 2V8 is generated between V_{DD} and COM of the DVM module, so R1 drives the sensor with a current of about 22 μA at 0°C , rising to about 24 μA at 100°C . This current variation, combined with the basic linear error of the transistor, causes the 1.5°C linear error of the circuit.

The 'CAL 0°C ' voltage feeding IN HI is variable from zero to 875 mV via RV1, and the 'CAL 100°C ' voltage feeding RFH is variable from zero to 255 mV via RV2. These two controls are for the calibration of the meter, using the technique to be described shortly.

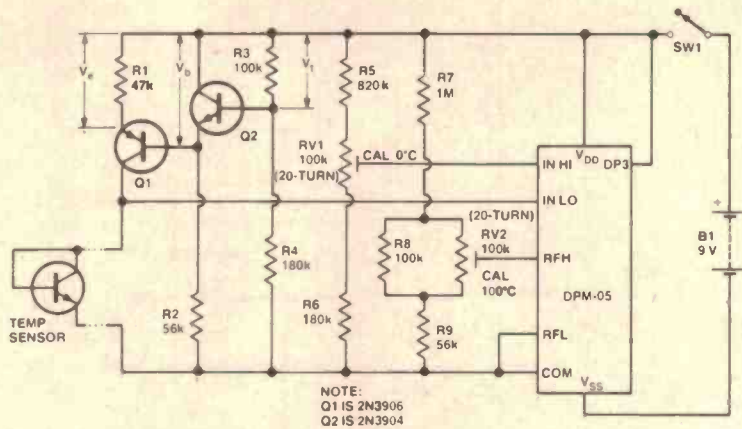

Figure 25. Precision digital thermometer using a transistor sensor. Linear accuracy is 0.5°C.

Figure 25 shows a precision version of the digital thermometer, giving a linear accuracy of about 0.5°C. In this case the transistor sensor is energized at about 20 μ A via constant-current generator Q1 which is temperature compensated by Q2. This section of the circuit works as follows.

Potential divider R3-R4 is wired between V_{DD} and COM and generates voltage V_t (about one volt) across R3. This voltage is 'followed' by NPN transistor Q2, causing $V_t + V_{be2}$ to appear on Q1 base; let's call this voltage V_b . The voltage V_e appearing on the emitter of PNP transistor Q1 is equal to $V_e - V_{be1}$ and it is the product of V_e and R1 that determines the magnitude of the constant-current output of Q1. Note, however, that V_e is, in fact, equal to $V_t + V_{be2} - V_{be1}$ and that since Q1 and Q2 operate at virtually identical temperatures and at similar current levels, the V_{be1} and V_{be2} values automatically cancel out at all temperatures and V_e thus equals V_t . The output current of Q1 is thus independent of ambient temperature.

Other points to note about the precision circuit of Figure 25 are that the 'CAL 0°C' control, RV1, is adjustable over the limited range of 460 mV to 710 mV. Also, the 'CAL 100°C' control, RV2, is adjustable over the limited range 140 mV to 260 mV, thus giving very fine adjustment of each calibration point.

Calibration procedure

The procedure for calibrating the Figures 24 and 25 circuits is as follows. First, solder the base and collector leads of the sensor transistor together. Then solder the sensor to a pair of flexible leads and connect it to the meter circuit. Paint all visible transistor leads and solder joints with insulating varnish (Humbrol clear varnish No 35 is excellent). Next, set RV1 and RV2 at mid value, mix a quantity of crushed ice and cold water in a tumbler (to act as a '0°C' standard) and immerse the sensor in the tumbler. Now adjust RV1 to give a reading of '00.0' on the meter. Finally, remove the sensor from the tumbler and immerse it in gently boiling water (to act as a '100°C' standard), then adjust RV2 to give a meter reading of '100.0'. Basic calibration is then complete.

If the meter is to be used mainly around some mid-scale value, such as 25°C etc, RV1 can (after initial calibration) be used to set the meter 'spot on' at that value by immersing the probe and a standard thermometer in a liquid that is raised to the desired temperature.

An IC-sensor circuit

Intersil make a special two-terminal IC for use as a temperature sensor in digital

thermometers. The device is the AD590 and gives an output current of 1 μ A/°K which, when fed through a 1k resistor, gives a voltage of 1 mV/°K. Uncalibrated accuracy of the device varies from 0.5°C to 10°C. Linearity error varies from 0.3°C to 1.5°C, depending on the grade of the device (indicated by a suffix number). Figure 26 shows how an AD590 can be used with a DVM module.

The AD590 needs a supply voltage of at least four volts and this is obtained by wiring the IC between V_{DD} and TEST (which is internally biased at about five volts below V_{DD}) via D1. The COM terminal is biased about 600 mV above TEST via D1. R1 is wired in series with the AD590 and generates approximately 1 mV/°K (= 273.2 mV at 0°C, 373.2 mV at 100°C). This voltage is fed to the IN HI terminal. Bandgap reference IC2 generates a temperature-stable 1.2 V via R2 and this voltage is divided down by R3-RV1-R4 to give a 'SET 0°C' offset voltage of 273.2 mV nominal at IN LO. The bandgap reference voltage is also divided down by R5-RV2-R6 to provide a 'SET 100°C' scaling voltage of 100 mV nominal at RFH. The circuit must be calibrated in the way already described for the Figures 24 and 25 circuits.

Digital capacitance meter basics

A DVM module can be made to read capacitance values by connecting the unknown capacitance to the module via a linear capacitance-to-voltage converter. The easiest way to make such a converter is to use the technique shown in Figure 27. Here, the unknown capacitor and a standard resistor are used as the timing elements in a precision monostable which produces an output pulse with a width, W, that is directly proportional to the C-R product. The monostable is triggered at a fixed frequency via a clock generator and the output of the monostable is converted to a mean dc value by a simple C-R integrator.

The mean dc value of the monostable output equals the peak pulse amplitude multiplied by W/P, where W and P are the width and the period of the pulse respectively. Thus, since R_x and P are fixed, the mean dc voltage out-

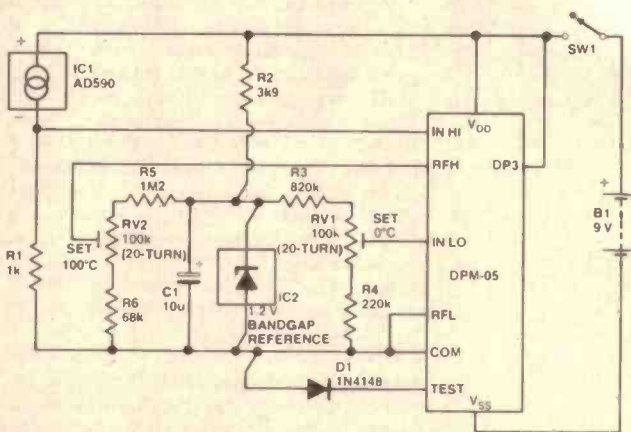

Figure 26. Digital thermometer based on the AD590 temperature-sensor IC.

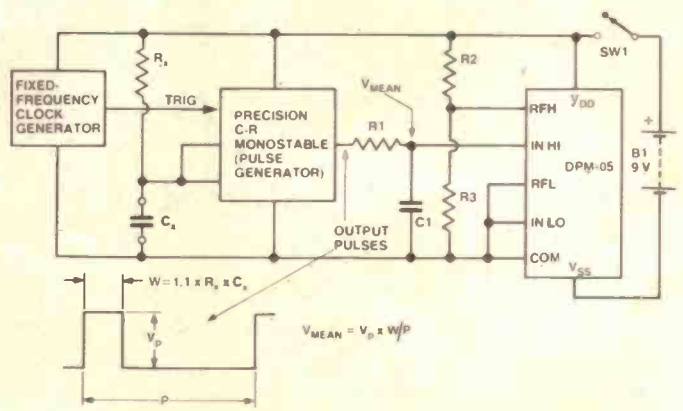

Figure 27. Basic operating principle and circuit of a digital capacitance meter.

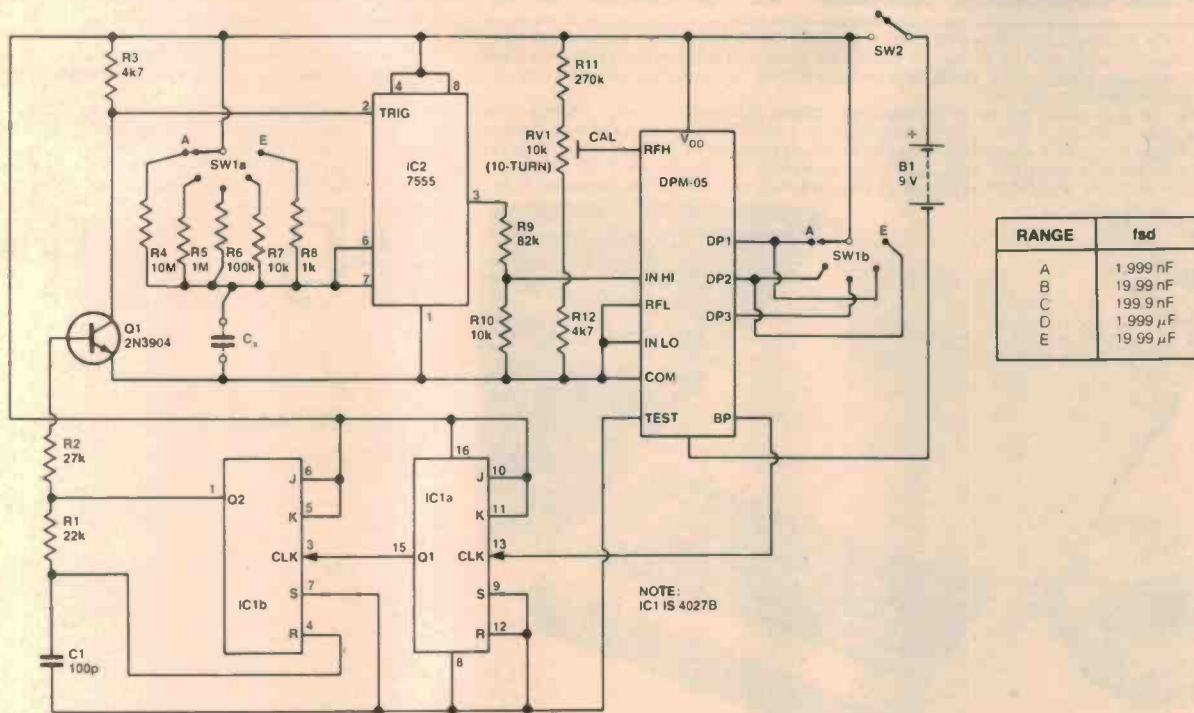

Figure 28. Digital capacitance meter.

put is directly proportional to C_x and when this voltage is fed to the DVM module, the module acts as a digital capacitance meter.

In Figure 27, the reference (RFH) voltage of the module is derived from the mono's supply rail via potential divider R2-R3. Since the meter reads the ratio of the input and reference voltages, the calibration of the unit is independent of variations in supply rail voltage, but can be varied by altering the R2-R3 ratio. The circuit can be made to read different capacitance ranges by switching R_x in decade multiples.

Practical capacitance meters

The basic Figure 27 circuit is quite easy to implement and gives very accurate results. Figures 28 and 29 show two practical versions of the circuit. Both of these designs use a 7555 timer IC (a CMOS version of the 555 timer) as the precision monostable element, and use decade values (1k to 10M) of R_x for range selection.

The 7555 monostable generates a pulse with a width of $1.1 \times C \times R$, giving a full-scale pulse width (at '1999' on the DVM module) of 22 ms with C and R values of 1999 pF and 10M, or 19.99 μ F and 1k etc. To give the 7555 adequate recovery time between pulses, the clock period must be at least 50% longer than the maximum pulse width and must have a period of at least 33 ms.

The 7555 mono is triggered by pulling pin 2 of the IC low. If the pin is not returned high again by the time the output pulse ends

naturally, the trigger pulse extends the output pulse artificially. The trigger pulse must thus be shorter than the minimum output pulse. In our application, the shortest pulse width that can be indicated by the DVM module is 22 ms/1000 = 11 μ s. So in the circuits of Figures 28 and 29 it is a design requirement that the 7555 must be triggered by negative-going pulses with widths less than 11 μ s and periods greater than 33 ms. In Figure 28 these requirements are met as follows.

In the DVM module, the TEST terminal is internally biased at about 5 V below V_{DD} and the BP (backplane) terminal switches between TEST and V_{DD} at about 50 Hz (= clock frequency divided by 800), giving a period of 20 ms. In Figure 28 IC1 is powered via the TEST terminal and the BP signal is divided-by-2 by flip-flop IC1a. The resulting 25 Hz (40 ms) signal is used to clock IC1b, which is configured as a monostable and generates positive-going output pulses with widths of 2 μ s via R1 and C1. These pulses are level-shifted and inverted via R2-Q1-R3 to produce negative-going 2 μ s trigger pulses with periods of 40 ms on the pin-2 TRIG terminal of IC2, the 7555 monostable generator.

The pulse width of the 7555 is controlled by C_x and precision range resistors R4 to R8. The 7555's output is attenuated by R9-R10 to give a mean value of about 100 mV at the midscale ('1000') setting of the DVM module. The resulting signal is fed to the module's IN HI terminal where it is integrated by

the internal 10M — 10 nF filter. Divider R11-RV1-R12 feeds 100 mV nominal to the RFH terminal of the module and RV1 is used to adjust the precise calibration of the capacitance meter.

Accuracy of the Figure 28 meter is determined mainly by the precision of the R4 to R8 range resistors, which should be 1% or better hi-stab types. To calibrate the meter, simply connect a precision capacitor (say 100 nF) in place of C_x , switch to the appropriate range and adjust RV1 to give the appropriate meter reading. Calibration is then valid on all ranges.

The Figure 28 circuit has two minor defects. First, the clock signals of the 7555 are derived (via BP) from the clock signals of the DVM module. These signals are not highly frequency-stable and the calibration of the circuit may thus shift by up to 0.5% or so over the normal range of operating temperatures and supply voltages. If precise accuracy is needed, calibration should be checked before use.

The second snag is that the circuit reads all capacitance, including residuals, appearing between the C_x terminals. These residuals include stray capacitance and the internal capacitance of IC2 between pins 6/7 and 1, and typically total 32 pF. With no external capacitance connected, the meter thus gives a typical reading of '.032' on range A and '.003' on range B. These residuals are too small to give readings on the remaining ranges of the meter, but must be subtracted from all readings obtained on ranges A and B.

RANGE	fsd
A	1.999 nF
B	19.99 nF
C	199.9 nF
D	1.999 μ F
E	19.99 μ F

GREAT NEW PRODUCT

You may have wondered why Jaycar did not (until now) sell home computers. We had many reasons but our main one was that we were not entirely "happy" with any of the units currently on the market. The closest we came to what we thought was a pretty good computer was the Apple. We thought that it was, quite frankly expensive. However it was sold and serviced throughout Australia by a reputable sales network — so there was no need for Jaycar!

That's why we got so excited when we saw the "Micro Professor MkII". It is the closest thing that we have seen to be software compatible with the Apple. Yes, we know what you're thinking. It's NOT one of those cheap Taiwanese "Apple" copies which infringe Apples' copyright. The Micro Professor MkII is a completely new and unique design in its own right. It just so happens that most of the widely distributed Apple software will run on this machine. O.K. But why so excited? LOOK AT THE PRICE! Check out the STANDARD FEATURES of this unit. Sit down. Think about it and COMPARE what you get with the Micro Professor MkII as STANDARD that are options on other machines!

6 Colours



COMPUTER SENSATION! Only \$658

MICRO-PROFESSOR II OUTSTANDING!
Low cost colour computer with APPLE compatibility*



SPECIFICATIONS

CPU	8080Z
ROM	128 Bytes
RAM	8K Bytes
BASIC	Interpret
Video	Type: Monochrome
Display	Monochrome
Screen Format	40 x 25
Character Set	Upper case ASCII, 84 characters
Character Type	1800 blocks (low resolution) in 40 x 48 array, 53750 dots (high resolution) in 280 x 192 array
Graphics Capacity	1800 blocks (low resolution) in 40 x 48 array, 53750 dots (high resolution) in 280 x 192 array
Number of Colors	6 colors
Keyboard	28 alphanumeric and function keys
Cartridge	Uses various cartridge tapes and cartridges as data storage units
Software	Cartridge interface
Printer	Interface
Display	Interface
Speaker	Central Facility
Power	8 ohm, 50mm, 0.25W
Dimensions	A switching power supply is provided to convert AC power to required power supply. 243 x 175 x 30mm

*Most Apple Soft II BASIC programs will run on the MPF II.

PRO-GRADE SOLDER SUCKER

SEE REVIEW EA DECEMBER 1982
Our claim. The best solder sucker for its price in Australia!

- Unique double diaphragm design
- O-ring seal
- Spare O-rings supplied
- Teflon tip
- Self-cleaning plunger
- One hand operation
- Non slip body
- Pro-grade for heavy usage.
- 225(l) x 28(d)mm
- Spare Teflon tip \$1.95



COOLING FANS 240VAC



Quality ball race construction, now you get no more fan wobble, much longer lasting and more efficient ball-bearing fans from Jaycar!

TWO POPULAR SIZES:
12 WATTS — 80x80x42(d)
\$24.95 Cat. YK2510
13.5 WATTS — 110x110x25(d)
\$27.50 Cat. YK2514

MORE GREAT KITS

Cat. No.	DESCRIPTION OF KIT	Ref.	PRICE
KA1300	FUZZ BOX COMPLETE	EA 1/81	\$ 19.50
KA1320	LE GONG	EA 3/81	\$ 13.95
KA1346	PC BIRDSIES SHORT FORM	EA 5/81	\$ 14.95
KA1370	PHOTON TORPEDO	EA 9/81	\$ 29.50
KA1400	METRONOME	EA 1/82	\$ 16.95
KA1402	EPROM PROGRAMMER	EA 1/82	\$ 59.00
KA1406	CUDLIPP CRICKET SHORT FORM	EA 2/82	\$ 12.50
KA1408	DIGITAL STORAGE CRD ADAPTOR	EA 2/82	\$110.00
KA1430	VOCAL CANCELLER	EA 4/82	\$ 19.50
KA1432	VDX RELAY SHORT FORM	EA 4/82	\$ 14.50
KA1434	QUIETER BOOSTER	EA 6/82	\$ 14.50
KA1452	SUBWOOFER MOSFET AMP	EA 7/82	\$ 79.00
KA1454	SUBWOOFER ENCLOSURE	EA 8/82	\$ 79.00
KA1476	STEREO SYNTHESISER SHORT FORM	EA 9/82	\$ 39.50
KA1478	STEREO SYNTHESISER COMPLETE	EA 9/82	\$ 49.50
KA1482	POWER UP KIT COMPLETE	EA 11/82	\$ 39.50
KA1484	SUPER SIREN SHORT FORM	EA 11/82	\$ 5.00
KA1490	BOGGLE GOGGLES	EA 12/82	\$ 9.50
KA1492	PH METER LCD	EA 12/82	\$ 69.00
KA1494	PROBE FOR PH METER WITH BUFFER	EA 12/82	\$ 69.00
KA1498	AM WIDEBAND TUNER	EA 12/82	\$249.00
KA1500	LED HEAD SHORT FORM	EA 1/83	\$ 9.95
KA1510	STEREO SYNTHESISER SHORT FORM	EA 4/83	\$ 11.95
KA1515	ALIGNMENT KIT AM TUNER	EA 3/83	\$ 7.95
KE4050	50 WATT AMP MODULE	ETI 480	\$ 23.00
KE4052	100 WATT AMP MODULE	ETI 480	\$ 27.00
KE4064	PREAMPLIFIER MODULE	ETI 480	\$ 30.00
KE4090	GENERAL PURPOSE PREAMPLIFIER	ETI 445	\$ 7.99
KE4092	AUDIO LIMITER	ETI 446	\$ 12.00
KE4094	BALANCED MICROPHONE PREAMPLIFIER	ETI 449	\$ 5.50
KE4105	CAR ALARM	ETI 330	\$ 29.50
KE4205	LED LEVEL METER	ETI 458	\$ 59.00
KE4206	MC MOVING COIL PREAMPLIFIER	ETI 478	\$ 26.50
KE4207	MM MOVING MAGNET PREAMPLIFIER	ETI 478	\$ 19.50
KE4210	MOSFET AMPLIFIER	ETI 477	\$ 59.00
KE4220	150 WATT MOSFET AMPLIFIER	ETI 459	\$ 79.50
KE4222	150 WATT MOSFET PREAMPLIFIER	ETI 458	\$ 39.50
KE4225	BRIDGING ADAPTOR	ETI 479	\$ 9.95
KE4405	+/- 15 VOLT POWER SUPPLY	ETI 581	\$ 17.50
KE4410	POWER SUPPLY 13.8 VOLT/10 AMP	ETI 160	\$ 79.50
KE4505	SOUNDBENDER SHORT FORM	ETI 492	\$ 24.50
KE4552	UHF CONVERTOR	ETI 735	\$ 32.50
KE4554	VIDEO MODULATOR	ETI 760	\$ 12.99
KE4560	LOW OHMS METER	ETI 158	\$ 29.50
KE4570	POWER SUPPLY 0-30 VOLTS 1 AMP	ETI 162	\$ 49.50
KE4600	MODEM SHORT FORM	ETI 644	\$169.00
KE4602	MODEM COMPLETE	ETI 644	\$189.00
KJ6502	SYNTOM DRUM SYNTHESISER KIT		\$ 36.50
KJ6508	CHORUS GENERATOR KIT		\$ 69.95
KJ6510	SHORT FORM IONISER KIT		\$ 14.50
KJ6511	FULL IONISER KIT		\$ 29.50

MICRO CHARTS



Instant Data on the Most Popular Computer and Microprocessor Parts

- Fully decided data — no need to unscramble numbers
- Instant Access
- Compact 8 1/2" x 11" size
- Durable credit card plastic — lasts a lifetime
- Perfect for programmers and engineers — two sided and totally comprehensive
- Clear and concise tables for full instruction set, dis assembly, ASCII, base conversion, effect of flags, com pare vs. jump, interrupt structure, pinout, cycle times, diagrams, bug notes, and much more.

Cat. BM8500 Z80 CPU \$12.95
Cat. BM8501 8080A/8085A \$12.95
Cat. BM8502 6502(65XX) \$12.95

MAGAZINE BINDER

Keep your precious (and expensive) magazines in order for easy reference. Smart blue colour with gold lettering. Heavy gauge and richly chromed metal fittings.

LOW IMPORT PRICE ONLY \$4.95
4 up \$4.50 each



'T-REX' top buy



Our wirestripper, nicknamed 'Tyranosaurus-Rex' is far from extinct! It's a great way to strip all sorts of cable without damaging the conductors. It's also a price breakthrough!!

- Automatically adjusts to insulation diameter.
- One hand operation.
- New low price for an automatic wirestripper

ONLY 9.95

CIT'S-FROM JAYCAR

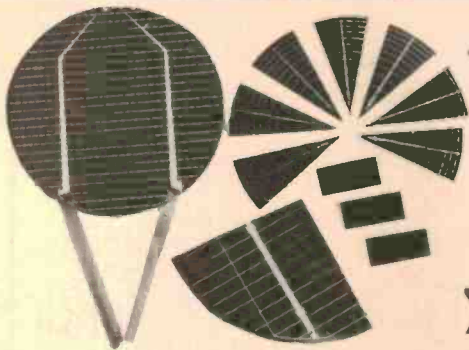

LOW
COST
SILICON
PHOTO
CELLS



We now stock a COMPLETE range of high efficiency Silicon Solar Cells. All cells will give 0.45V under rated load and they can be stacked in series or in parallel for higher current.

Cat. No	Description	Price	1-9	10+
ZM9002	Rect. 10x20mm 45mA		\$2.95	\$2.45
ZM9003	3" diameter 1 amp		\$29.50	\$26.50
ZM9004	3" diameter x 30° segment 78mA		\$3.50	\$3.25
ZM9005	4" diameter x ¼ segment 450mA		\$12.95	\$12.45

8 CHANNEL MIXER KIT

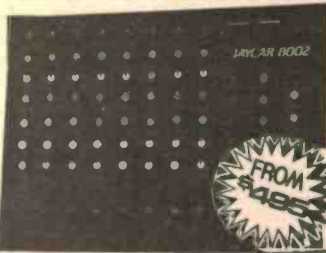

- Balanced (600 Ohm) Min. Inputs/Line Inputs.
- Cannon Connectors included in the price.
- Lim, Mid & Treble Equalisation on each input.
- "Effects" (i.e. Echo etc.) capability.
- Feedback and Stereo Pan on ALL 8 inputs.
- 60mm Slip Faders used throughout.
- 19" Rack Mount capability (or Console Mount).
- Professional Black Front Panel with Format borders & multi-coloured knobs to assist function identification.
- VU Metering.

FEATURE PROJECT IN EA

★ THE BEST ★

We are proud to announce a great new range of DIRECT IMPORT all - ABS plastic cases for the discerning electronics enthusiast. Quite frankly we are sick and tired of those black flimsy styrene boxes with their Aluminium lids. They split, they shatter and they look plain ORDINARY. Shown below is a range of boxes that is going to revolutionise your small projects. Each box has a precision fitting MOULDED lid (in the same colour as the box) with moulded-in brushes to take metal-thread countersunk screws. True quality. Naturally each box has slots formed in the sides to take PCB's etc. Most are available in 4 Beautiful colours - Black is one of them!! Shown also are 2 new sizes of die cast box. Note the sizes.

CONSOLE BOXES

EACH UNIT HAS AN ALUMINIUM FRONT PANEL

SIZE - 161(W) x 96(D) x 39(HF) x 57(HR)mm	Cat. HB6200 - ORANGE	Cat. HB6201 - GREY	Cat. HB6202 - BLUE	Cat. HB6203 - BLACK
PRICE 1 - 9 UNITS ONLY \$6.95 EACH; 10 OR MORE \$6.45 EACH				
SIZE - 215(W) x 130(D) x 47(HF) x 73(HR)mm	Cat. HB6210 - ORANGE	Cat. HB6211 - GREY	Cat. HB6212 - BLUE	Cat. HB6213 - BLACK
PRICE 1 - 9 UNITS ONLY \$12.95 EACH; 10 OR MORE \$11.95 EACH				
SIZE - 105(W) x 143(D) x 32(HF) x 56(HR)mm	Cat. HB6220 - GREY	Cat. HB6221 - BLUE	Cat. HB6222 - BLACK	
PRICE 1 - 9 UNITS ONLY \$7.95 EACH; 10 OR MORE \$7.45 EACH				
SIZE - 170(W) x 143(D) x 32(HF) x 56(HR)mm	Cat. HB6230 - GREY	Cat. HB6231 - BLUE	Cat. HB6232 - BLACK	
PRICE 1 - 9 UNITS ONLY \$9.95 EACH; 10 OR MORE \$9.45 EACH				
SIZE - 170(W) x 214(D) x 32(HF) x 82(HR)mm	Cat. HB6240 - GREY	Cat. HB6241 - BLUE	Cat. HB6242 - BLACK	
PRICE 1 - 9 UNITS ONLY \$12.95 EACH; 10 OR MORE \$11.95 EACH				

RECTANGULAR BOXES

SIZE - 100(L) x 50(W) x 25(D)mm	Cat. HB6120 - ORANGE	Cat. HB6121 - GREY	Cat. HB6122 - BLUE	Cat. HB6123 - BLACK
PRICE 1 - 9 UNITS ONLY \$3.95 EACH; 10 OR MORE \$3.45 EACH				
SIZE - 112(L) x 62(W) x 31(D)mm	Cat. HB6130 - ORANGE	Cat. HB6131 - GREY	Cat. HB6132 - BLUE	Cat. HB6133 - BLACK
PRICE 1 - 9 UNITS ONLY \$4.75 EACH; 10 OR MORE \$4.25 EACH				
SIZE - 120(L) x 65(W) x 40(D)mm	Cat. HB6140 - ORANGE	Cat. HB6141 - GREY	Cat. HB6142 - BLUE	Cat. HB6143 - BLACK
PRICE 1 - 9 UNITS ONLY \$4.95 EACH; 10 OR MORE \$4.45 EACH				
SIZE - 150(L) x 80(W) x 50(D)mm	Cat. HB6150 - ORANGE	Cat. HB6151 - GREY	Cat. HB6152 - BLUE	Cat. HB6153 - BLACK
PRICE 1 - 9 UNITS ONLY \$5.45 EACH; 10 OR MORE \$4.95 EACH				
SIZE - 190(L) x 110(W) x 60(D)mm	Cat. HB6160 - ORANGE	Cat. HB6161 - GREY	Cat. HB6162 - BLUE	Cat. HB6163 - BLACK
PRICE 1 - 9 UNITS ONLY \$9.95 EACH; 10 OR MORE \$9.25 EACH				

DIE CAST BOXES

NATURAL GREY FINISH
 SIZE: 50 x 50 x 31mm Cat. HB5010 1-9 \$3.95 each; 10 or more \$3.45 each
 SIZE: 190 x 110 x 60mm Cat. HB5016 1-9 \$12.95 each; 10 or more \$11.95 each.

Video Enhancer

NOT A KIT
BUILT AND
TESTED...

Cat. AV6500

\$89



Unbelievable but true. This unit enables you to actually IMPROVE a copy of a recorded video tape. How? By amplifying the top end of the video signal by a small amount. This sharpens up the detail of the picture. Dubs can actually look better than the original. Works as a video distribution amplifier as well. Will drive up to 4 VCR's from one VCR input.

VIDEO STABILISER Cat. AV6502

As many of you know, many video tapes, - especially from the USA have the sync pulses suppressed to prevent unauthorised copying of the original dub. This process is fine because it hinders unauthorised re-recording (dubbing) of material. It is annoying though when you hire the original and find that the "Copyguard" is causing problems with your TV. The AV6502 re-inserts the sync pulses automatically and restores stability.

WARNING! The AV6502 is intended solely for the use above. Whilst the AV6502 will virtually remove copyguard on a tape copy (and hence restore the picture) it is against the law to unlawfully copy copyright material.

The AV6502 looks almost identical to the AV6500 **ONLY \$79.95**

NEW Touch Sensitive Light Dimmer

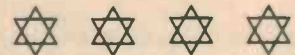

Ref: EA April 1983

Complete kit including quality HPM wall plate with attractive brushed metal insert. The Jaycar kit is absolutely complete including a small dial spring which can be used to connect the PCB to the wall plate. (Beware of other kits that do not include this).

In addition to the above, we supply the High Voltage Resistors ALREADY SOLDERED in as a foolproof safety feature!

Buy the complete kit for this exciting project for only Cat. KA-1508



only
\$19⁹⁵

NEW! 3-50V @ 5A SWITCHMODE POWER SUPPLY!

Spectacular new design by EA features extremely simple construction with enormous power capability.

Get the COMPLETE KIT (with special meter scales included) from JAYCAR for only:

\$149 - STAGGERING VALUE

Cat. KE1520 SEE EA MAY 1983

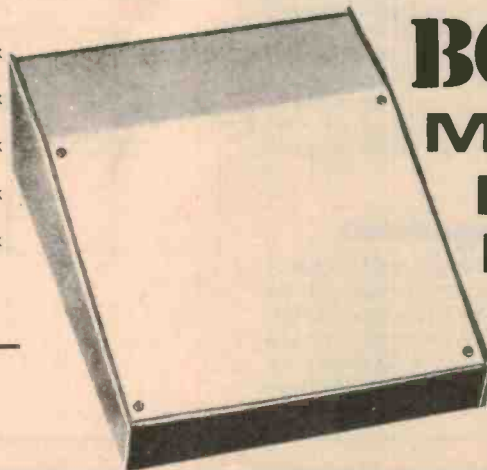

BOXES MULTI PUR- POSE



JAYCAR

SEE THE OTHER JAYCAR ADS IN THIS MAGAZINE FOR OUR STORE ADDRESSES AND PHONE NUMBERS...

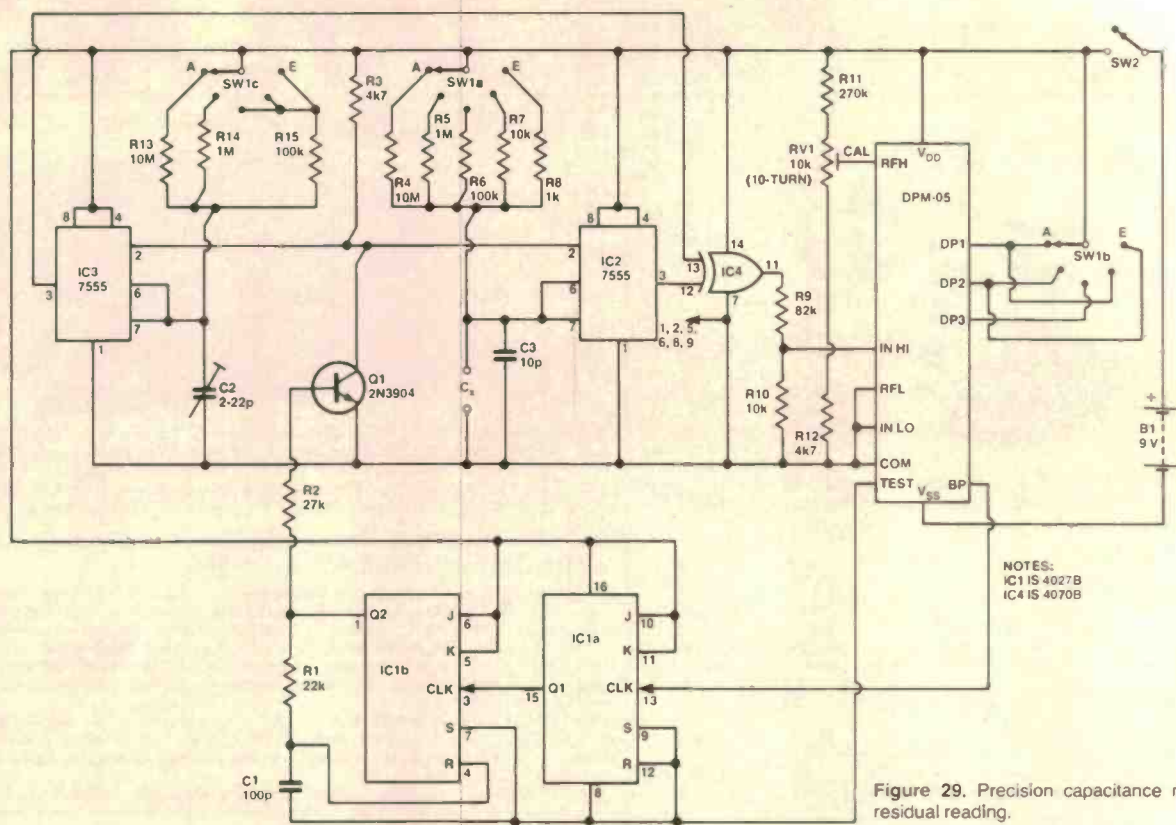

Figure 29. Precision capacitance meter with zero residual reading.

Figure 29 shows how the circuit can be modified so that residual capacitance is effectively cancelled and the meter gives a zero reading on all ranges when no external capacitance is connected to the C_x terminals. In this case the BP-derived signal is used to synchronously trigger two 7555 monostables. Their outputs are EX-ORed via IC4 to give a pulse with a width equal to the difference between the pulse widths (and thus the residual capacitances) of the two monostables. This pulse is fed to the IN HI terminal of the DVM module via R9-R10. Thus, if the monostables have identical residuals, the EX-OR pulse width is zero and the meter gives a zero reading with zero external C_x applied.

In Figure 29 monostable IC2 is connected to the C_x terminals and functions in the same way as in Figure 28, except that an additional 10 pF is permanently wired across the terminals. The IC3 monostable, however, has C2 wired across its input terminals and the value of C2 can be adjusted to equal (and thus cancel) the residual of the input of IC2. IC3 is range-switched in parallel with IC2 via SW1c. Precise ganging is provided on ranges A, B and C only and on all other ranges the residuals are too small to influence the meter readings.

Frequency measurement

A DVM module can be made to read frequency by connecting the unknown frequency to the module's input via a f-to-V converter. A suitable converter can easily be made by using a 7555 monostable; Figure 30 illustrates the principle. The input signal is first fed to an

input conditioner and trigger-pulse generator which triggers a fixed-period 7555 monostable on the arrival of each new input cycle. The output pulses of the mono are converted to mean dc values by integrator R2-C2 and fed to the input of the DVM module which is scaled via R3-R4.

The mean dc value of the 7555 output pulses equals V_p (the peak amplitude of the pulses) multiplied by W/P , where W and P are the width and period of the pulses respectively. V_p and W are, however, fixed. Only the pulse period is variable and this is inversely proportional to the input frequency, f , so the mean output voltage is equal to $V_p \times W \times f$ and is thus directly proportional to f . Therefore, when the DVM module is suitably scaled via R3-R4 it gives a direct reading of input frequency.

In practice, the lowest convenient full scale frequency range of a DVM-based $3\frac{1}{2}$ -digit

frequency meter is 1.999 kHz. In this case, the 7555 pulse has a period of 500 us at full scale. For maximum accuracy the pulse width must be as large as possible but must not be greater than two thirds of P . A pulse width of about 300 us is necessary and this can be obtained from the 7555 by choosing values for R1 and C1 of 27k and 10 nF respectively.

Figure 31 shows how the basic Figure 30 circuit can be modified to act as a multi-range frequency meter. In this case the input signal is fed to an input conditioner and Schmitt trigger and the Schmitt output is used to ripple-clock four decade dividers. The 7555 300 us monostable is provided with a trigger generator than can be fed from the output of the Schmitt or from any of the dividers. Thus, when the 7555 is triggered directly from the Schmitt the meter reads 1.999 kHz full scale and when fed from the

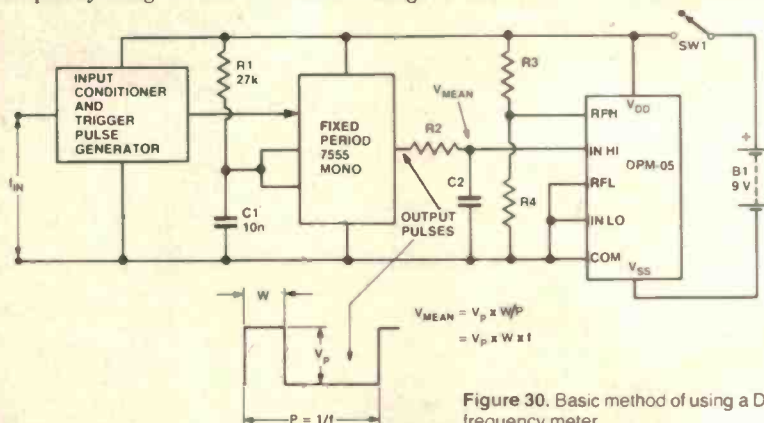

Figure 30. Basic method of using a DVM module as a frequency meter.

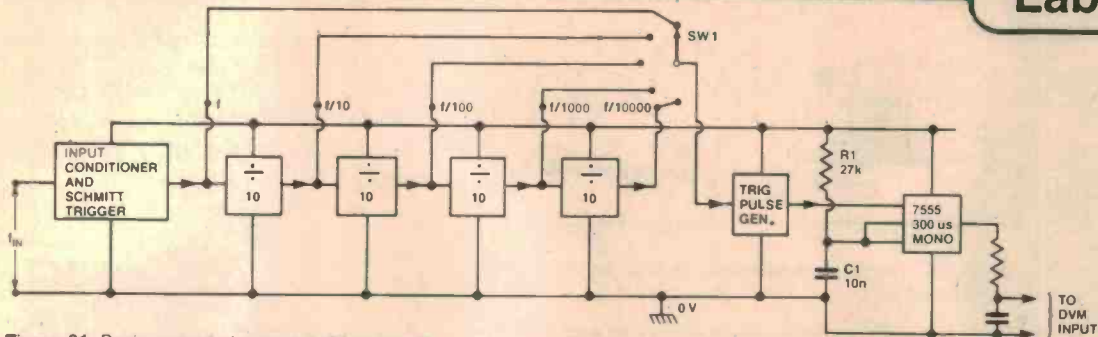

Figure 31. Basic method of using a DVM as a multi-range frequency meter.

output of the last divider stage reads 19.99 MHz full scale.

Practical frequency meters

The 7555 IC can operate from supplies as low as 2 V. Standard CMOS counter ICs, however, need supplies of at least 3 V. Consequently, if a DVM module is to be used as a frequency meter sharing supplies that are common with those of the CMOS divider stages, the DVM module must be used in the 'split-supply' mode with its COM terminal pulled below the normal 'V_{DD} - 2V8' value by external circuitry.

In other words, COM must operate at '0 volts' and V_{DD} and V_{SS} at nominal values of +4V5 and -4V5 respectively. Figure 12 in Part 1 showed how these supplies can be obtained if the module is built into existing equipment that has split supplies. Alternatively, Figure 32a shows how the supplies can be obtained from a stack of six 1V5 cells. Figure 32b shows how the supplies can be obtained from a single 9 V battery via an op-amp supply-splitter. The supply-splitter of Figure 32b adds a quiescent current consumption of about 2 mA to the DVM circuit, but can supply additional supply currents of tens of milliamps to circuitry connected between +4V5 and 0 V.

Figure 33 shows the practical circuit of a DVM-based digital frequency meter that reads up to 19.99 MHz full scale in five

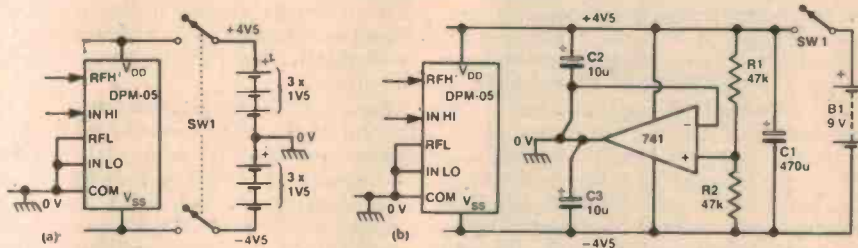

Figure 32. A DVM frequency meter needs split supplies. These can be obtained from either a stack of 1V5 cells (a), or from a single 9 V battery and an op-amp supply-splitter (b).

decade ranges. When used with the Figure 32b power supply, the circuit consumes about 3 mA quiescent from the 9 V battery, rising to 4 mA at 1 MHz, and (when calibrated) has a reading accuracy of +/- one digit. The circuit accepts input signals in the range 200 mV to 5 V RMS and operates as follows.

Input signals are fed, via C1-R1, directly to the input of IC1a, a very fast Schmitt trigger, which is biased as half-supply volts via R2-R3. The Schmitt output is used to ripple-clock four decade-divider stages. Ordinary CMOS dividers typically operate at maximum speeds of only 800 kHz or so when powered from 4V5 supplies. To give the required fast operating speeds the very latest 'HC' types of silicon-gate CMOS counters are used in the first two (IC2 and IC3) counter positions. On the prototype unit they clock at frequencies up to about 18 MHz.

The output of the IC1a Schmitt and of the four divider stages are fed to range-selector switch SW1a. The output of SW1a is fed to 4 us trigger-pulse generator C4-R4-IC1b-IC1c which triggers the 7555 monostable via Q1. The output of the 7555 is fed to IN HI of the module via R8-R9, and a calibration 'reference' voltage is fed to RFH via RV1. The circuit is calibrated by feeding in a signal of known frequency, switching to the appropriate range and trimming RV1 for the appropriate reading on the DVM module.

Once RV1 has been initially calibrated, calibration is influenced only by variations in the pulse width of the 7555 and these may be caused by thermal variations in the values of R7 and C5. For optimum calibration stability R7 should be a metal-glaze resistor and C5 should be a polycarbonate capacitor.

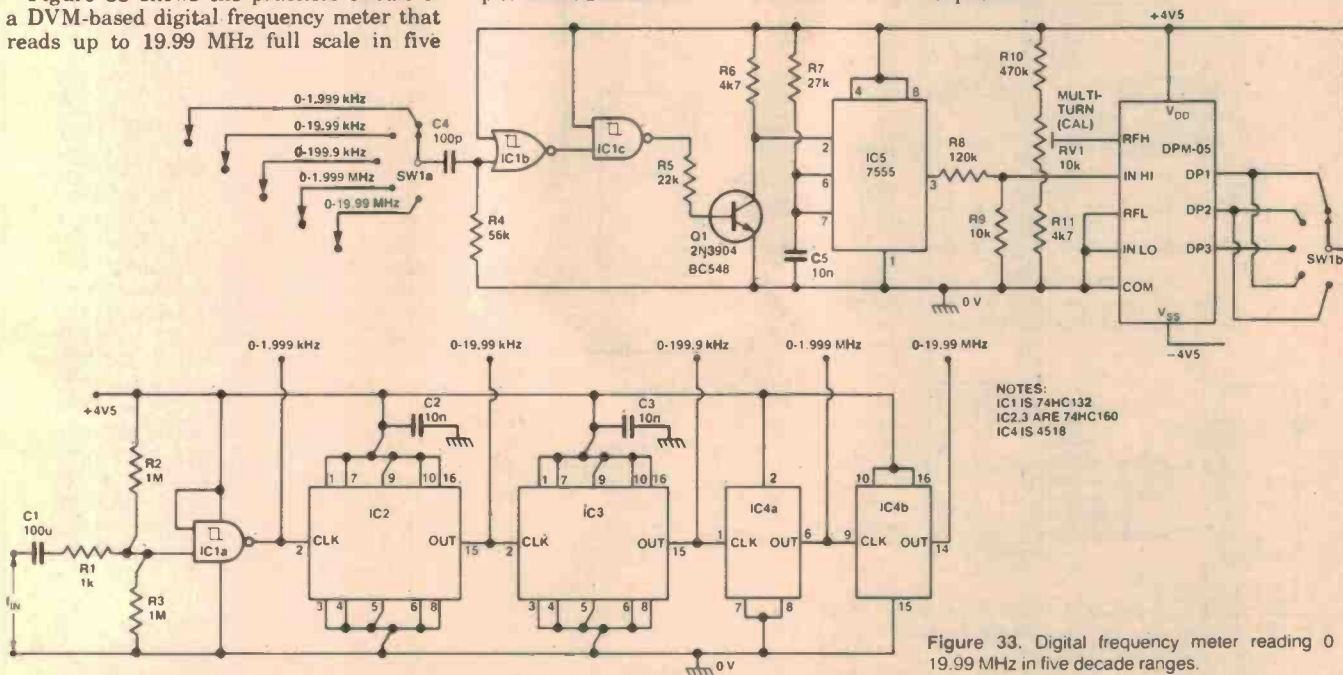

NOTES:
IC1 IS 74HC132
IC2,3 ARE 74HC160
IC4 IS 4518

Figure 33. Digital frequency meter reading 0 to 19.99 MHz in five decade ranges.

Lab Notes

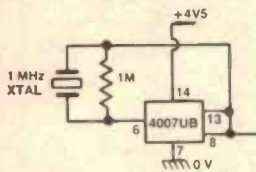

Figure 34. This 1 MHz crystal calibration oscillator can easily be added to Figure 33 circuit.

The Figure 33 circuit can be modified in a variety of ways to satisfy individual requirements. Figure 34 shows a 1 MHz crystal calibration oscillator, designed around one section of a 4007UB CMOS IC, which can be easily added to the frequency meter and consumes a mere 300 μ A when active. Figure 35 shows two simple preamplifiers which can be used to improve the basic sensitivity of the meter. The Figure 35a design, based on one section of a 4007UB, has an input impedance of about 1M and improves sensitivity by about 20 dB (to 20 mV RMS) at audio frequencies, but is useful to only a few hundred kHz. The simple

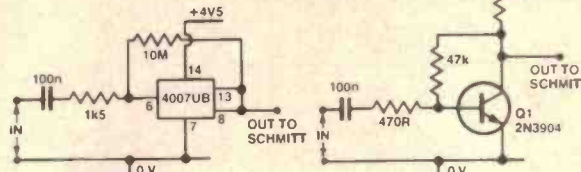

Figure 35. Two simple preamplifiers that can be used with the frequency meter.

Figure 35b design also gives a gain of about 20 dB at low frequencies, but has a low input impedance (about 2k Ω) and is useful to several MHz. Both circuits consume a couple of milliamps.

Figure 36 shows, in basic form, how the DVM module can be used to read both frequency and ac volts (or any other desired parameter). With SW1 switched to 'f', the input is switched to the input of the f-meter circuit and IN HI and RFH of the module are switched to the outputs of the circuit. When SW1 is switched to 'Vac', the input is switched to the input of the frequency-compensated attenuator, which has its output fed to IN HI

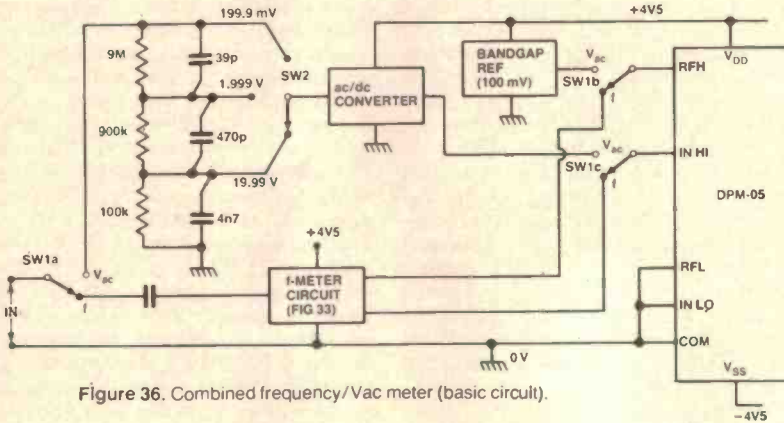

Figure 36. Combined frequency/Vac meter (basic circuit).

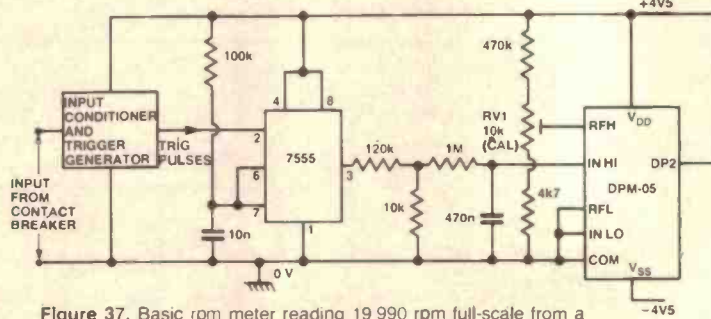
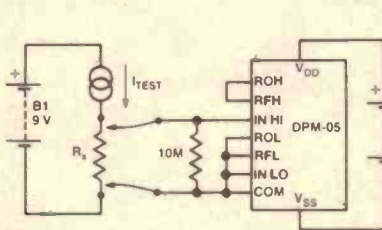

Figure 37. Basic rpm meter reading 19990 rpm full-scale from a four-cylinder four-stroke petrol engine.



I_{test}	$R_x f_{sd}$
1 mA	199.9 Ω
10 mA	19.99 Ω
100 mA	1.999 Ω

Figure 38. Basic milli-ohmmeter using four-terminal measurement technique.

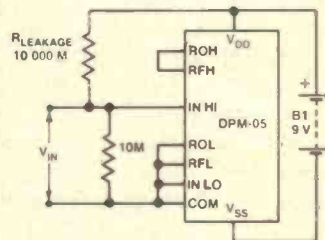

Figure 39. In this 199.9 mV dc voltmeter circuit, pc board or module leakage resistance causes the meter to indicate 28.0 mV with no external input applied.

via SW2 and a precision ac/dc converter (see Figure 19 in Part 1). RFH is switched to a 100 mV standard voltage derived from a bandgap reference.

Miscellaneous applications

DVM modules can be used to indicate the value of any parameter than can be converted into a predictable (linear or log) voltage, current or resistance. Linear transducers are readily available for measuring values of pH, light intensity, and radiation etc.

Cyclic parameters such as rpm and heart-beat rate etc, can be measured by adapting the frequency meter technique already described. The rpm of a petrol engine, for example, is directly proportional to contact-breaker (CB) frequency, f . On a four-stroke engine, $f = N \times \text{rpm}/120$, where N is the number of cylinders. Thus, on a single-cylinder engine 10 000 rpm gives a CB frequency of 83.3 Hz, and on a four-cylinder engine a frequency of 333.3 Hz. Figure 37 shows the basic circuit of a digital rpm meter designed to read 19 990 rpm full scale (10 000 rpm at mid scale) on a four-cylinder four-stroke engine. The 7555 monostable gives an output pulse width of about 1 ms.

When measuring low values of resistance care must be taken in circuit design to ensure that the resistive effects of range switches, fuses and terminals etc, are excluded from the measurement results. The only way of achieving this is to use the four-terminal measurement technique shown in Figure 38, in which two independent circuits are used. Here, the unknown resistor is connected between the R terminals and fed with a constant current from B1. The volt drop directly across R_x is measured via a 199.9 mV full scale dc voltmeter powered from B2. Thus, when 10 mA is passed through R_x , the voltmeter indicates 19.99 ohms at full scale.

Constructional notes

When using DVM modules two vital usage points must be noted. The first of these arises from the high sensitivity of the module and is illustrated in Figure 39, where the module is wired as a 199.9 mV full scale dc voltmeter with a 10M input resistance. Thus, if a leakage resistance of 10 000 megohms appears between V_{DD} and IN HI, the meter will read 28.0 mV with no external input applied. Leakage resistances of this magnitude (and lower) can be caused by minute amounts of moisture or dirt appearing between the terminals of the module or the tracks of a pc board to which it is connected. To eliminate the possibility of this effect, the entire module and pc board must be cleaned and dried after project construction is complete. Then both must be thoroughly coated with insulation varnish. Humbrol clear varnish No 35 (available from model and art shops) is excellent for this purpose.

The final usage point concerns external components. General-purpose resistors and capacitors have very poor thermal stability. Consequently, in all practical DVM-based designs great care must be taken to ensure that all critical resistors are metal-glaze or similar hi-stab types, and all critical capacitors are polycarbonate types.

OOPS! More books!

mail order coupon on page 66

CHEAP VIDEO COOKBOOK

21524P \$11.75
Complete discussion of a new, low-cost way to get words, pictures and opcode out of your computer and onto any ordinary TV screen, using a seven-IC easy-to-build circuit which you can build for less than \$20.

AN INTRODUCTION TO VIDEO

BP100 \$6.56
This book is written in layman's language and is for anyone who is thinking about buying or renting or who has just bought or rented a video recorder and wants to get the best out of the machine.

MOBILE DISCO HANDBOOK

BP47 \$4.64
Most people who start mobile discos know little about equipment or what to buy. This book assumes no preliminary knowledge and gives enough info to enable you to have a reasonable understanding of disco gear.

ELECTRONIC MUSIC AND CREATIVE TAPE RECORDING

BP51 \$5.92
Shows how electronic music can be made at home with the simplest and most inexpensive of equipment. Describes how the sounds are generated and how these may be recorded to build up the final composition.

PRACTICAL CONSTRUCTION OF PREAMPS,

BP60 \$4.96
This book shows the enthusiast how to construct a variety of magnetic tape recording, microphone and disc pre-amplifiers, and also a number of tone control circuits, rumble and scratch filters, attenuators and pads.

ELECTRONIC SYNTHESIZER PROJECTS

BP81 \$5.92
For the electronic music enthusiast, an invaluable reference. This book is full of circuits and information on how to build analogue delay lines, sequencers, VCOs, envelope shapers, etc. etc. The author takes a clear and logical approach to the subject that should enable the average enthusiast to understand and build up what appears to be a quite complex instrument.

AUDIO PROJECTS

BP90 \$6.56
Covers a wide range of audio projects including preamplifiers and mixers, power amplifiers, tone controls and matching etc. A number of board layouts and wiring diagrams are included.

ELECTRONIC MUSIC PROJECTS

BP74 \$5.92
Provides constructors with practical circuits for the less complex music equipment including fuzz box, waa-waa pedal, sustain unit, reverb and phaser, tremolo generator etc. Text covers guitar effects, general effects, sound generators, accessories.

SONICS 1982 YEARBOOK

\$5.35
An interview with Kraftwerk, how to cope with rebinding, lighting, rock acoustics, guitars, equipment reviews and more.

SONICS MAGAZINE

\$2.35 ea
The Australian music magazine dedicated to the art and craft of sound. Published April, July, October, Yearbook in December. \$15 for one year subscription. Please indicate starting issue.

computers for beginners

COBOL FOR BEGINNERS

39378P \$21.95
It is a solid text for introductory programming courses in Cobol, using a format that is easy to understand, yet comprehensive enough to make supplementary readings unnecessary.

THE PET PERSONAL COMPUTER FOR BEGINNERS

61827P \$20.95
This handy guide is written for use with all varieties of PET computer, from the original 2001 to the new 8032 Super PET. It is suited to novices with no practical experience and provides advice and practical examples.

BIG THINGS FROM LITTLE COMPUTERS

77859P \$19.25
A layperson's guide to personal computing with all the basic information and lots of examples of how personal computers can be used.

BEGINNER'S GUIDE TO DIGITAL ELECTRONICS

BP61 \$3.36
Covers all essential areas including number systems, codes, constructional and sequential logic, analogue/digital/analogue conversion.

BEGINNER'S GUIDE TO MICROPROCESSORS

& COMPUTING
BP66 \$5.92
Introduction to basic theory and concepts of binary arithmetic, microprocessor operation and machine language programming. Only prior knowledge assumed is very basic arithmetic and an understanding of indices.

A MICROPROCESSOR PRIMER

BP72 \$5.92
Learning about microprocessors is easy with this book, written in a style that is easy to follow. The shortcomings of this basic machine are discussed and the reader is shown how these are overcome by changes to the instruction set. Relative addressing, Index registers follow as logical progressions.

AN INTRO TO BASIC PROGRAMMING TECHNIQUES

BP86 \$6.56
Ideal for beginners seeking to understand and program in BASIC. Book includes program library for biorhythms, graphing Y against X, standard deviations, regressions, generating musical note sequences, and a card game.

BEGINNING BASIC

39806A \$19.95
Intended for beginners with no computing experience, one should be able to intelligently program in BASIC in a short time.

BEGINNING FORTRAN

46011A \$19.95
Starts with simple elementary examples and proceeds to intermediate level programs. Also includes references, tutorials, flow charts, deck set-ups and matrix algebra.

UNDERSTANDING COMPUTERS

39815A \$17.95
This book describes how computers work. For people who use small computers, it starts with the most elementary gates and works up to the complete computer. Gives an understanding of languages and how they operate in the computer.

NAILING JELLY TO A TREE

39842A \$24.95
This guide to software teaches you about machine language, assembly language programming and BASIC. The emphasis is not on learning to write programs but on learning to use the thousands of available programs that have already been written.

PEANUT BUTTER AND JELLY GUIDE TO COMPUTERS

39813A \$14.95
A simple, easy-to-digest source of information on personal computing for the potential buyer who is less than an expert in the field.

INTRODUCTION TO WORD PROCESSING

88076A \$17.95
Written for the non-technical reader, this book tells about the concepts common to all word processing systems, then analyses all features in detail.

YOUR FIRST COMPUTER

88045A \$12.50
An easy-to-understand beginner's book to small computers. Understanding them, buying them and using them for personal and business applications.

FROM CHIPS TO SYSTEMS: AN INTRODUCTION

TO MICROPROCESSORS
88063A \$19.95
Explains exactly what a microcomputer system is and how it works. Introduces fundamental concepts and covers all aspects of microprocessors and related components: internal operation, memories, interfacing and system development etc.

COMPUTERS FOR EVERYBODY

39849A \$8.95
In this easy-to-understand book it is explained how a computer can be used at home, in the office or at school. Includes a consumer's guide to computer equipment that will help the reader decide what to buy and who to buy it from.

computers hardware & techniques

USING THE 6800 MICROPROCESSOR

21512P \$13.25
This will guide the reader through the conception, configuration, writing and running of a variety of programs that demonstrate practical use of a 6800 system.

Z80 MICROCOMPUTER DESIGN PROJECTS

21682P \$20.75
This book provides a complete look at the internal architecture of the Z80, the heart of many microcomputers, and even shows how to build a microcomputer, the EX80, using this powerful chip.

MICROPROCESSOR CIRCUITS VOL. 1

21877P \$14.75
Presents basic microprocessor concepts in simple language for beginners and teaches you to construct a useful microcontroller system. Offers 30 demo circuits which take you through assembly, operation and programming of a microcontroller.

INTERFACE PROJECTS FOR THE APPLE II

69387P \$15.95
A series of interface projects that are easily built and enable the user to realise the computer's potential through project construction. Projects are primarily hardware-orientated, with some software supporting the hardware.

PET INTERFACING

21795P \$25.25
Demonstrates how to build numerous interfacing devices for PET hardware. BASIC language programs are used throughout, and the book includes a discussion of the microprocessor's internal architecture and general hardware/software interfacing.

6809 MICROCOMPUTER PROGRAMMING AND

INTERFACING, WITH EXPERIMENTS
21798P \$21.95
Gives a solid understanding of how to program and interface the high-performance 6809 microprocessor. The author completely explores internal structure, addressing modes, data movement instructions, registers, arithmetic logic and test instructions for the 6809.

Z80 MICROCOMPUTER HANDBOOK

21500P \$17.50
This thorough handbook covers hardware, software and microcomputers built around the Z80.

THE \$100 AND OTHER MICRO BUSES

21810P \$13.25
The key to successful computer expansion is a complete understanding of the bus system, through which the computer communicates with peripherals. This book will give you that understanding.

MICROCOMPUTER DESIGN AND TROUBLESHOOTING

21819P \$26.75
Tells you how to design microcomputer systems and make them work without an expensive commercial development system or the need for costly test instrumentation. The author also provides a complete description of two popular microprocessors—the 8085 and the 6502.

DON LANCASTER'S MICRO COOKBOOK, VOLUME 1

21828P \$20.75
This 'cookbook' starts with the very fundamentals of microprocessors and microcomputers and takes you through number systems, codes, memory, etc, until you can work intelligently with micros.

DON LANCASTER'S MICRO COOKBOOK, VOLUME 2

21829P \$20.75
Carries on where Volume 1 left off.

APPLE INTERFACING

21862P \$15.95
Using this book, you will be able to perform useful experiments which will provide a much clearer understanding of the fundamentals of computer interfacing and computer electronics. A better understanding of interactions between hardware and software will enable you to communicate more effectively with your Apple.

MICROPROCESSOR CIRCUITS VOL. 1

21877P \$14.75
Presents basic microprocessor concepts in straightforward language for beginners. Teaches you to construct a useful microcontroller system through progressive demonstration circuits.

8080 MICROCOMPUTER EXPERIMENTS

39808A \$29.50
This 'hands on' book includes 105 experiments presenting programs and diagrams as required for clarification.

A STEP-BY-STEP INTRODUCTION TO

8080 MICROPROCESSOR SYSTEMS
39804A \$16.95
Doesn't require any electronics or computer background. This book describes the 8080 architecture and instruction set through simple examples. Some basic software is introduced.

DIGITAL CIRCUITS WITH MICROPROCESSOR APPLICATIONS

46032A \$39.50
An introductory text, this book provides readers with the basic ideas and tools needed to analyse and design digital circuits and computer systems. Discusses microprocessor computer organisation, machine language number systems and gate circuits.

MICROPROCESSOR INTERFACING TECHNIQUES

88029A \$24.95
Teaches you how to interconnect a complete microprocessor system and interface it to the usual peripherals. The hardware and software skills needed to effectively interface peripheral devices are covered along with various buss standards and A/D conversion.

PRACTICAL INTRO TO DIGITAL ICs

225B \$4.32
Introduction to digital ICs (mainly TTL 7400). Besides simple projects, includes logic test set to identify and test digital ICs. Also includes digital counter-timer.

BEGINNER'S GUIDE TO MICROPROCESSORS & COMPUTING

BP66 \$5.92
Introduction to basic theory and concepts of binary arithmetic, microprocessor operation and machine language programming. Only prior knowledge assumed is very basic arithmetic and an understanding of indices.

A MICROPROCESSOR PRIMER

BP72 \$5.92
Learning about microprocessors is easy with this book, written in a style that is easy to follow. The shortcomings of this basic machine are discussed and the reader is shown how these are overcome by changes to the instruction set. Relative addressing, index registers follow as logical progressions.

PRACTICAL COMPUTER EXPERIMENTS

BP78 \$5.92
How to build typical computer circuits using discrete logic. This book is a useful intro to devices such as adders and storers as well as a general source book of logic circuits.

THE 6809 COMPANION

BP102 \$6.56
It is not a beginners introduction to microprocessors in general but a discussion of the features of the 6809 and a reference work for the 6809 programmer in particular.

COMPUTERS & COMPUTING YEARBOOK 1982

\$4.95
Includes disks, CP/M and your computer, learners microcomputer, programming in CHIP-8, alphasort, fast plotter, PET talk, the System 80 etc.

computing software

CP/M PRIMER

21791P \$21.95
A complete one-stop course on CP/M, the very popular operating system for 8080, 8085 and Z80-based microcomputers. Complete terminology, hardware and software concepts, startup of a CP/M system, and a complete list of CP/M-compatible software.

THE CP/M HANDBOOK (WITH MP/M)

88048A \$19.95
Contains a step-by-step description of all the CP/M command features. Designed for the beginner, the book progresses to detailed explanations of the file transfer program, the debugging program and CP/M's text editing program.

HOW TO GET STARTED WITH CP/M

39832A \$19.95
This practical book eases the reader into the essentials of the system, giving an overview of the operating system, an idea of what it will be like to use and what it can do for the reader.

AUSTRALIAN MICROCOMPUTER HANDBOOK

72505 NOW \$15.00
Normally \$25.00. A detailed buyer's guide to microcomputer systems and application packages in commercial, industrial, scientific, educational and home/hobby areas.

THE C PROGRAMMING LANGUAGE

10163P \$21.95
C is a general purpose 'low-level' programming language. It is not specialised to any particular area of application, but its absence of restrictions make it convenient and effective for many tasks.

THE 68000: PRINCIPLES AND PROGRAMMING

21853P \$19.95
An easy-to-read, systematic approach to the 68000 advanced 16-bit microprocessor. The book guides you through the complex architecture, instruction set, pinouts and interfacing techniques. Written for design engineers, programmers and students.

PROGRAMMING IN BASIC FOR PERSONAL COMPUTERS

30739P \$14.75
Simple instructions show how to give BASIC commands and statements a wide range of applications, from programming video games to developing business or scientific programs.

PROGRAMMABLE CALCULATORS

46008A \$24.95
This book suggests which calculators to buy, their possibilities and limitations, and the how-tos of programming them.

TAKE A CHANCE WITH YOUR CALCULATOR

39807A \$14.95
An introduction to modern mathematics, this book deals with programming of programmable calculators and includes probability problems.

AN INTRO TO BASIC PROGRAMMING TECHNIQUES

BP86 \$6.56
Ideal for beginners seeking to understand and program in BASIC. Book includes program library for biorhythms, graphing Y against X, standard deviations, regressions, generating musical note sequences, and a card game.

BASIC FOR EVERYONE

61481P \$19.75
349 pages of BASIC information for all purposes.

BEGINNING BASIC

39806A \$19.95
Intended for beginners, this book discusses how a programmer and a basic computer interact with the computer, problems likely to be met by the beginner, the need for and uses of documentation etc.

FIFTY BASIC EXERCISES

88056A \$17.95
Designed to teach BASIC through actual practice, this book contains graduated exercises in math, business, operations research, games and statistics. The programs were designed to run directly on a TRS-80 and will run with minor or no changes on any system with Microsoft BASIC.

INSIDE BASIC GAMES

88055A \$19.95
The medium of games teaches readers how to design error-free, interactive BASIC programs. Rules, algorithms and coding differences for the PET, APPLE II and TRS-80 are also included.

MICROSOFT BASIC

39823A \$19.95
Includes branching and loops, arithmetic in BASIC, strings, editing, arrays and files, the disk and a description of the Radio Shack Level II BASIC.

INTRODUCTION TO FORTH

21842P \$14.95
The most complete book available on the MMS FORTH version of FORTH, but also a fundamental approach to programming in all versions of FORTH. Many programming examples are provided, with direct comparisons to the Microsoft Level II BASIC version of these programs.

STARTING FORTH

42922P \$23.75
A clear and complete guide to FORTH, this book covers fundamental principles and then a full set of high-level FORTH commands. It concludes with advanced techniques and style.

A FORTRAN PRIMER

80454P \$6.95
Assumes no previous knowledge of program writing. It covers the fundamentals of the FORTRAN language, enables extensive program writing and concentrates on programming style.

INTRODUCTION TO STRUCTURED FORTRAN

46007A \$19.95
Written for the beginner, the text incorporates the new FORTRAN 77 with a discussion of structural programming. Includes a discussion of time-sharing, pseudo language programming and WATFIV statements.

MICROSOFT FORTRAN

39846A \$24.95
An introductory text on FORTRAN in general and Microsoft FORTRAN in particular. The latter is exceptionally well suited for use on microcomputers using CP/M and others of the 8080/8075/Z-80 family.

BEGINNING FORTRAN

46011A \$19.95
Introduces readers to FORTRAN. Included are references for further study, brief tutorials on key punching, flow charting, deck set-ups and matrix algebra.

QWIKTRAN

39824A \$19.95
Quick FORTRAN for Micros, Minis and Main Frames. Starts with the basic concepts of computing and Qwiktran, a fundamental subset of FORTRAN IV. Lots of examples to increase the reader's proficiency.

THE UCSD PASCAL HANDBOOK

35536P \$23.75
Language descriptions organised in a quick and easy reference are given in this book for readers with no prior experience of Pascal programming.

INTRODUCTION TO PASCAL

91522P \$19.95
The second edition of this popular book has been updated to conform to the new international standard of Pascal. The contents illustrate the design and construction of Pascal programs, involving a wide range of basic computer algorithms in a practical context.

PASCAL

46028A \$19.95
For people with little or no programming experience, this book gives lots of examples that clearly explain proper usage of language features. Discusses top-down programming, debugging, self-documentation etc.

THE PASCAL HANDBOOK

88053A \$23.50
This book summarises the entire Pascal vocabulary, including the variations introduced by different commercial versions of Pascal. All in dictionary format.

PASCAL PROGRAMS FOR SCIENTISTS AND ENGINEERS

88058A \$23.50
Over 60 of the most frequently used scientific algorithms, along with their program implementation in Pascal, are in this book.

COBOL FOR BEGINNERS

39378P \$21.95
It is a solid text for introductory programming courses in Cobol, using a format that is easy to understand, yet comprehensive enough to make supplementary readings unnecessary.

STARSHIP SIMULATION

39810A \$11.95
This book offers both a specific simulation which can be implemented, modified and played, and a complete look at how to put together a simulation on almost any subject.

BASIC PROGRAMS FOR SCIENTISTS AND ENGINEERS

88073A \$19.95
This book contains scientific and engineering application programs written in BASIC.

COMPUTER GRAPHICS PRIMER

21650P \$21.95
Almost every page has a colour drawing, photograph, picture or a schematic to help you learn computer graphics quickly and easily. Programming concepts apply to all microcomputers, and examples are given in BASIC for the Apple II.

INTRODUCTION TO TRS-80 GRAPHICS

39818A \$17.95
It begins with the basic concepts of line drawing and leads the reader on to geometric shapes, moving figure animation and other more advanced topics.

CIRCUIT DESIGN PROGRAMS FOR THE TRS-80

21741P \$21.75
A number of programs written to aid you in using your TRS-80 and Level II BASIC for the design and analysis of many electronic circuits. The programs analyse information on ms values, periodic waveforms, integrated circuit timers and bipolar transistor circuits.

MOSTLY BASIC: APPLICATIONS FOR YOUR TRS-80

— BOOK 1
21788P \$19.25
28 ready-to-use BASIC programs which have been completely tested and debugged. Programs include a telephone dialler, digital stop-watch, spelling test, house buying guide, gas mileage calculator, and others. Complete with explanations of each program, sample runs, and complete program listing.

MOSTLY BASIC: APPLICATIONS FOR YOUR TRS-80

— BOOK 2
21865P \$19.25
32 ready-to-run BASIC programs, including two to test your ability in history and maths, a Dungeon of Danger that's strictly for fun, eleven household programs, seven on money and investment, two to test your ESP level, and more. Complete with explanations, sample run and listing for each program.

INTERMEDIATE PROGRAMMING FOR THE TRS-80 MODEL I

21809P \$14.95
Step-by-step instructions for the TRS-80 user who wants to progress from BASIC to machine and assembly language programming with the TRS-80 Model I system. A complete how-to guide with numerous examples.

...and for good measure...

computing for business

TRS-80 — MORE THAN BASIC

21813P \$15.95
Learn to program in Z80 mnemonics by using the book's error-tolerant interactive monitor program. Over 26 commands available, with total documentation that helps you change the commands to meet specific applications.

TRS-80 ASSEMBLY LANGUAGE MADE SIMPLE

21851P \$19.25
If you have an understanding of BASIC programming, this book will help you learn to plan, write and hand-assemble your own assembly language programs in memory, using the T-bug and Level II BASIC ROM subroutines.

PROGRAMMING THE TRS-80 POCKET COMPUTER

30531P \$13.25
This book explains all aspects of problem-solving in BASIC, and covers cassette machine interfacing and how to make the best use of the system's keyboard and display.

TRS-80 ASSEMBLY LANGUAGE SUBROUTINES

31188P \$19.25
A wide spectrum of applications is discussed in this book, which provides easy-to-use routines that can be used as they stand or modified.

32 BASIC PROGRAMS FOR THE TRS-80 COMPUTER

39827A \$29.50
Programs for the TRS-80 Level II or Model III BASIC (with 16K or more user memory).

APPLE BASIC

39099P \$19.25
This book gives the beginner a thorough introduction to BASIC programming on an Apple computer, and covers all areas of programming, including graphics, games, mathematical programs, and a great deal more.

CIRCUIT DESIGN PROGRAMS FOR THE APPLE II

21863P \$23.75
A series of ready-to-run Apple II programs ideal for electronics design engineers and others faced with solving problems related to plotting and verification of experimental data. The programs may be used as sub-routines in larger programs, and many can be translated to run on other microcomputer systems.

APPLESOFT LANGUAGE

21811P \$13.95
Written for Apple II micros that use the Microsoft language, this introduction covers each aspect of programming in non-technical language, from elementary concepts to advanced techniques.

APPLE MACHINE LANGUAGE

90230P \$21.95
This straightforward book teaches machine language programming through BASIC, the transition being made step-by-step. Many sketches of video displays are provided, as well as exercises with answers.

APPLE PASCAL GAMES

88074A \$19.95
Explore all the essential elements of UCSD Pascal and learn the important Apple Pascal extensions.

PASCAL PROGRAMMING FOR THE APPLE

95454P \$18.95
This book teaches UCSD Pascal on the Apple II. Many examples, programs for financial applications, graphics, file structures and sound reproduction are supplied.

32 BASIC PROGRAMS FOR THE APPLE COMPUTER

38834A \$29.50
Full of programs with practical applications, educational uses, games and graphics.

PET/CBM BASIC

61751P \$19.25
This book provides a thorough introduction to BASIC programming on a PET computer, explaining programming concepts for graphics, including three-dimensional letters, bar graphs and the use of sound effects in PET programs.

THE PET PERSONAL COMPUTER FOR BEGINNERS

61827P \$20.95
This handy guide is written for use with all varieties of PET computer, from the original 2001 to the new 8032 Super PET. It is suited to novices with no practical experience and provides advice and practical examples.

PET BASIC 1

95524P \$19.25
For users of the PET computer, this book covers such topics as creative graphics, humour and interesting small programs.

PET GAMES AND RECREATIONS

95529P \$18.85
Presenting an interesting mixture of diversions guaranteed to entertain and educate. Ideal for beginners, yet also challenging to computer veterans, the book features progressive levels of difficulty and five different types of games.

32 BASIC PROGRAMS FOR THE PET COMPUTER

39825A \$29.50
Each chapter fully documents a different bug-free program. If readers have a good working knowledge of BASIC, they can devise and implement their own program changes.

THE ATARI ASSEMBLER

90236P \$19.25
This practical book gives detailed instructions for using the Atari Assembler cartridge for novices with some knowledge of BASIC programming. Fundamental Information programming in assembly language is given.

ATARI GAMES AND RECREATIONS

90242P \$19.25
Beginners and advanced users can use the pre-programmed games in this book to improve their skill. Charts, flash cards, an error dictionary and graph paper designs are among the features.

EXPLORE COMPUTING WITH THE TRS-80 (AND COMMON SENSE)

96137P \$17.95
This introduction to microcomputers and the BASIC language is suitable for novices and users of the TRS-80. Among the topics covered are creating tables, arts and graphics, games and simulation.

32 BASIC GAMES FOR THE EXIDY SORCERER

39835A \$29.50
Full of programs with practical applications, educational uses, games and graphics. Each chapter documents a different bug-free program.

THE ART OF PROGRAMMING THE 1K ZX81

BP109 \$6.56
This book explains how to use the features of the ZX81 including its random number generator, graphics and timer. PEEK and POKE are explained and you should learn enough to develop programs of your own.

PROGRAMMING THE 6502

88046A \$18.95
Principles of assembly language programming for the 6502 microprocessor are taught in this introductory text. Includes a discussion of trade-offs between hardware and software and detailed explanations of the 6502's internal registers and buss operation.

6502 APPLICATIONS BOOK

88015A \$17.95
Use this book and a few low-cost components to build a complete home alarm system, an electric piano, a motor speed-regulator, a time-of-day clock, a simulated traffic control system and a Morse code generator, etc.

6502 GAMES

88023A \$17.95
You learn how to play ten sophisticated games and also learn assembly language programming. Also learn the techniques of algorithm design and data structures.

8080 MACHINE LANGUAGE PROGRAMMING FOR BEGINNERS

39814A \$12.95
The book will take the reader step-by-step through the most common 8080 op codes and it will do so at a level anyone can understand.

PROGRAMMING THE Z80

88047A \$19.95
This book will enable every reader to write complete application programs for Z80-based computer systems. Includes exercises to measure progress and comprehension at each level of programming.

PROGRAMMING THE Z8000

88072A \$19.95
A complete introduction to programming concepts and techniques for use with the 16-bit, Z8000 microprocessor. Presents detailed descriptions of the architecture and functions of this 'super chip'.

START WITH BASIC ON THE COMMODORE VIC 20

97070P \$14.75
Helpful exercises and step-by-step instructions show you how to program in BASIC utilising all the graphic functions on the Vic 20.

BASIC FOR ACCOUNTANTS

80098P \$9.95
Shows accountancy students and accountants how to use a computer to perform the repetitive tasks associated with record keeping, calculating and report writing. Using the BASIC language attention is concentrated on debtors, inventory and general ledger systems.

COMPUTER BASED BUSINESS SYSTEMS

80192P \$10.95
A short introduction to the sorts of systems used by a typical business to handle its typical activities. The book aims at providing a general understanding and therefore avoids technological detail.

THE COMPUTER SOLUTION

80195P \$13.50
It should be of interest to business people contemplating, implementing or already using computer data processing or to any non-technical person curious to know why and how computers are used in Australian businesses and organisations.

SMALL BUSINESS COMPUTERS: A GUIDE TO EVALUATION AND SELECTION

81134P \$14.95
Ideal for the inexperienced user, this text emphasises management considerations in determining the feasibility, economics, evaluation, selection, contracts and practicality of installing a computer.

SMALL BUSINESS COMPUTER SYSTEMS

81136P \$14.95
This book provides a bridge between the accountant and the DP professional by explaining every step of the trading and reporting process in DP terms. It is especially useful to people engaged in the specification process or in auditing DP accounting systems.

THE VISICALC BOOK — APPLE EDITION

98397P \$22.25
If you are using Visicalc on your Apple II and want to learn more about its expanded uses then this book will show you how to build a model, enter your data and solve problems about profit/loss projections, pricing/costing estimates etc.

THE CP/M HANDBOOK (WITH MP/M)

88048A \$19.95
Containing a step-by-step description of all the CP/M command features, the book progresses to detailed explanations of the file transfer program, the debugging program and CP/M's text editing program.

YOUR FIRST COMPUTER

88045A \$12.50
A beginner's guide to small computers, understanding them, buying them and using them for personal and business applications. Includes peripherals, languages and application packages.

DON'T (OR HOW TO CARE FOR YOUR COMPUTER)

88065A \$16.95
A guide to computer and peripheral preservation. Specific advice for the computer, floppy disks, hard disks, the CRT terminal, the printer, tape units, the computer room, software and documentation are included.

INTRODUCTION TO WORD PROCESSING

88076A \$17.95
Written for the non-technical reader, this book tells about concepts common to all word processing systems, then analyses all features in detail, from screens to scrolling and formatting.

SMALL COMPUTERS FOR THE SMALL BUSINESSMAN

39831A \$24.95
The book tells readers how and where to shop for a computer successfully; what to expect their computer to do for them; how to select software; whether or not to use a consultant; how to introduce the computer to the staff and how much computer is necessary.

INVENTORY MANAGEMENT FOR SMALL COMPUTERS

39848A \$24.95
Owners of retail businesses and their employees need this book. The program provides an inventory control system so that you know what stock is on hand, where it is located, what price was paid for it and the selling price.

BASIC FOR BUSINESS FOR THE TRS-80

90352P \$22.25
This book covers the application of BASIC language to business uses on the TRS-80 models II and III.

FROM THE COUNTER TO THE BOTTOM LINE

39811A \$24.95
A demystifying guide to basic accounting needs and computer use. Includes inventory and purchasing, billing, accounts receivable, accounts payable and general ledger.

IDEAS FOR EXPERIMENTERS

These pages are intended primarily as a source of ideas. As far as reasonably possible all material has been checked for feasibility, component availability etc, but the circuits have not necessarily been built and tested in our laboratory. Because of the nature of the information in this section we cannot enter into any correspondence about any of the circuits, nor can we produce constructional details.

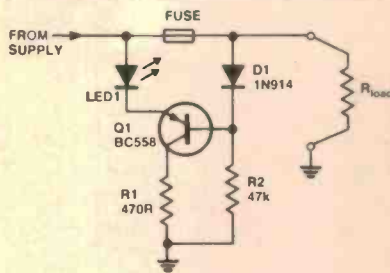

Blown fuse indicator

John Beaver, Concord NSW.

Fuses are probably the handiest tool in electronics in that for an outlay of cents they can save hundreds of dollars worth of equipment. When a fuse blows it is usually obvious as the equipment it supplies stops working, sometimes however this is not always the case. If the fuse supplies, for example, power to brake lights in a vehicle or even long delay timer circuits it may not be noticed for days. This circuit will give immediate indication of a blown fuse, whether there is a load on the circuit or not as long as there is power.

On a nominal 12 volt supply there is about a 1.7 volt drop across the LED leaving a potential of about 10.3 V on the

emitter of Q1. With the fuse intact there is a potential at the base (via fuse and D1) of about 11 V which holds Q1 off. If, however, the fuse blows, power is removed from the anode of D1 therefore allowing current to flow from the base of Q1 through R2 turning on the LED.

The advantage of this circuit is that in the standby mode it draws only 255 microamps, which makes it particularly useful in battery operated circuits. It may be adapted for different voltages by simply changing the values of R1 and R2 using the following formula: $R1 = (Vs-2)*100/2$, $R2 = (Vs-2)*10000/2$. (A flashing LED, which is more of an attention-getter, could be used for LED1.)

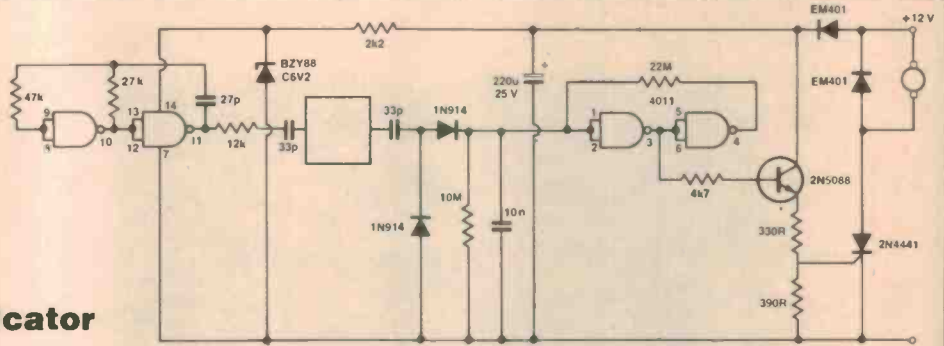

Touch motor control

L.W. Brown of Burwood Vic. designed this circuit of a touch switch suitable for operating 12 Vdc motors. He says that an excellent use for it would be to mount the touch switch on a shop window, allowing the movement of a display via a car electric fan motor.

An oscillator drives a touch plate stuck to the inside of a glass window. Anything capacitively grounding the 50 mm diameter touch plate causes the Schmitt trigger to turn on the SCR. The 10nF capacitor provides several seconds extra operation once the touch plate has been released. As

the SCR will latch on with a dc supply, an unregulated, unfiltered supply should be used. A suitable supply would be the A&R Chargette which is double insulated and very safe.

For intermittent operation no heatsink is required and because of this the entire circuit will be smaller than the touch plate. The small size allows the whole switch to be mounted in a sealed plastic box for protection from environmental humidity. The double insulated power supply could enable the system to operate in hazardous locations.

Avoid flat batteries

B.P. of Putney NSW has obviously forgotten to switch his car lights off on a dark winter's morning and come back, after a day's work, to find that the battery is flat.

This device has been on my car for several years now and I've found that it is extremely useful. Despite the many complicated circuits published, all that is needed is a solid state buzzer, a resistor and a couple of diodes.

the passive side of each switch. For a positive earth system, just reverse all the diodes and the buzzer. Make this up on a small strip of bakelite or insulating material and attach it to the glove box under the dash. It will outlast the car.

The only problem is that if you really want to park the car and leave the lights on for a short time, you have to put up with the buzzer.

When the ignition is switched on both sides of the buzzer are held at a nominal 12 V, so there is no sound. The moment the car is stopped and the ignition switched off, current can flow from the lighting circuits through the buzzer and the resistor to earth. It is a very penetrating sound, so there is no way you will leave the lights on!

The connections are made to

There are two possibilities to overcome this problem.

1. Insert a switch between the resistor and earth, but don't forget to turn it back on later.
2. Add a relay and a push button switch (on the dash board), as in Figure 2, and you can override the system. After you have switched off the lights the relay will drop out, leaving the device reset for further protection.

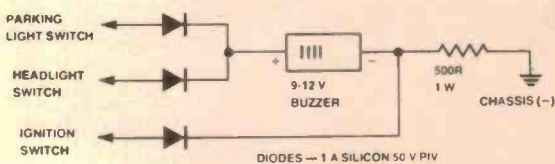

Figure 1. A buzzer warns you that you have left the lights on.

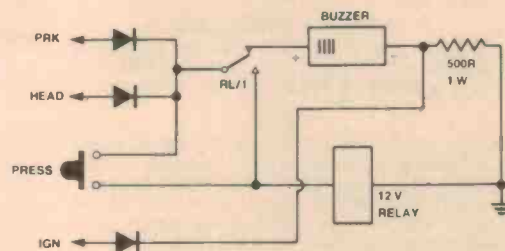
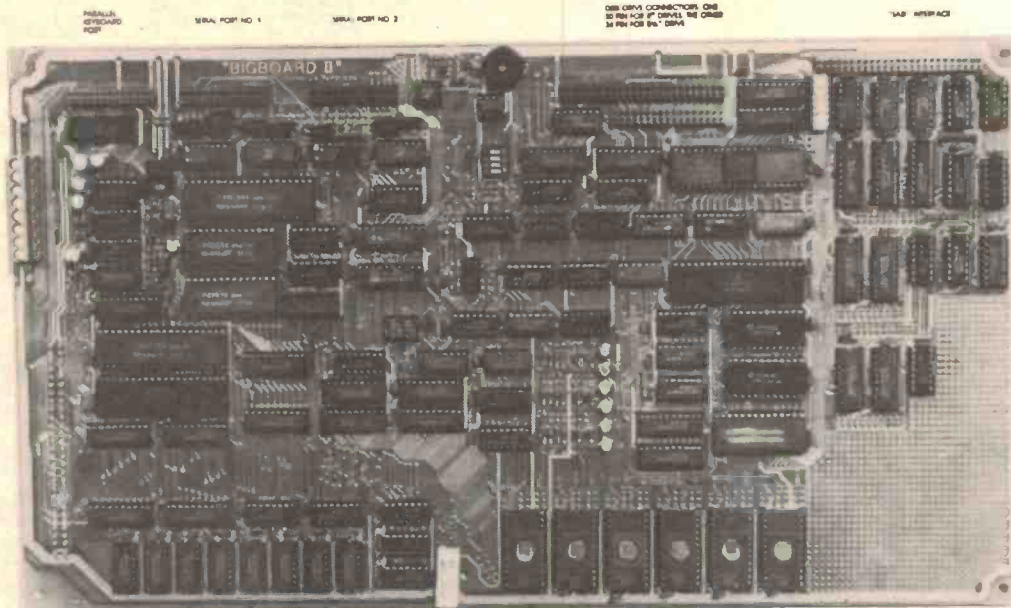

Figure 2. Over-riding the system.

RITRONICS WHOLESALE PTY LTD

425 HIGH STREET NORTHCOTE 3070 MELBOURNE (03) 489-8131
48-50 A'BECKETT STREET MELBOURNE (03) 347-9251

"BIG BOARD II"



STD
Bus
Connector

EPROMs
shown only
for clarity.

Prototyping
Area

Jim Ferguson, the designer of the "Big Board" distributed by Digital Research: Computers, has produced a stunning new computer that we will begin shipping in November called "Big Board II", it has the following features:

4 MHz Z80 — CPU AND PERIPHERAL CHIPS

The Ferguson computer runs at 4 MHz. Its monitor code is lean, uses Mode 2 Interrupts, and makes good use of the Z80-A DMA chip.

64K DYNAMIC RAM + 4K STATIC CRT RAM + 24K E(E)PROM OR STATIC RAM

"Big Board II" has the three memory banks. The first memory bank has eight 4164 RAMs that provide 60K of user space and 4K of monitor space. The second memory bank has two 2Kx8 SRAMs for the memory-mapped CRT display and space for six 2732 As, 2Kx8 static RAMs, or pin-compatible E(E)PROMs. The third memory bank is for RAM or ROM added to the board via the STD bus. Whether bought as a bare board, a full kit, or assembled and tested, it comes with a 350 nS2732 EPROM containing the monitor.

MULTIPLE-DENSITY CONTROLLER FOR SS/DS FLOPPY DISKS

The new Ferguson single-board computer has a multiple-density disk controller. It can use 1793, 1797, or 8877 controller chips since it generated the signal with TTL parts. The board has two connectors for disk signal with 34 pins for 5.25" drives, the other with 50 pins 8" drives.

VASTLY IMPROVED CRT DISPLAY

The new Ferguson SBC uses a 6845 CRT controller and 8002 Video Attributed controller to produce a display that will rival the display of quality terminals. Characters are formed by a 5x7 dot matrix on 15.75 KHz monitors and 7x9 dot matrix on 18.60 KHz monitors. The display is user programmable with the default display 24 lines of 80 characters. 8002a chip supplied for 18 to 60 khz monitors.

STD BUS CONNECTOR

The Ferguson computer brings its bus signals to a convenient place on the PC board where users can solder an DSTD, bus cards can be plugged directly into it, and it can as well be connected by bus cable to industry-standard card cages.

DMA

The new Ferguson computer has a Z80-A DMA chip that will allow byte-wise data transfers at 500K bytes per second and bit serial transfers via the Z80-A S10 at 880K bytes per second with serial processor overhead, though the monitor for the new computer uses the DMA chip mainly for transferring data to and from disk, the chip can readily be used for other things since its "wait/ready" pin can be connected under software control to some half a dozen signal lines. When a hard-disk subsystem is connected to the "Big Board II" via its "SASI" interface, the DMA chip makes breathtaking disk performance possible.

"SASI" INTERFACE FOR WINCHESTER DISKS

The "Big Board II" implements the Host portion of the "Shugart Associates Systems Interface". Adding a Winchester disk drive is no harder than attaching a floppy-disk drive. A user simply 1: Runs a 50-conductor ribbon cable from a header on the board to any of several inexpensive controller cards for Winchester drives that implement the controller portion of the SASI interface. 2: Cables the controller to an appropriate drive, and 3: Provides power for the controller-card and drive. Since our CBIOS contains code for communication with hard-disk, that's all a user has to do to add a Winchester to a system!

A Z80-A S10/0 = TWO ASYNCHRONOUS/SYNCHRONOUS SERIAL PORTS A PARALLEL KEYBOARD PORT = FOUR OTHER PARALLEL PORTS USER I/O

The new Ferguson single-board computer has one parallel port for an ASCII keyboard and four others for user-defined I/O. When the computer is powered-up or reset, the monitor looks for a carriage-return at the keyboard and serial ports. If the first carriage-return the monitor gets comes from the parallel keyboard, the monitor uses the board's video display circuitry to communicate with the user via a CRT. If the first carriage-return is typed at an ASCII terminal attached to a serial port, the monitor autabauds and makes the terminal the system console.

TWO Z80-A CTCs = EIGHT PROGRAMMABLE COUNTERS/TIMERS

The new Ferguson computer has two Z80-A CTCs. One is used to clock data into and out of the Z80-A S10/0, while the other is for systems and application use.

PROM PROGRAMMING CIRCUITRY AND SOFTWARE

The new Ferguson SBC has circuitry and drivers for programming 2716s, 2732(A)s, or pin-compatible (E)EPROMs. Software \$25 extra.

CP/M with Russell Smith's CBIOS for the new Ferguson computer is available for \$220. The CBIOS is available separately for \$65.

Actual board size: 39.6cm x 22.2cm. 5 inch BIOS being developed. Approx price \$95

Pricing and Availability:

Availability: 2 weeks delivery.

In single quantities, full kits cost \$775.00 + tax, and A&T'd computers cost \$895. There are attractive discounts that range to 35% for OEM's and dealers. For details about them please call Rod Irving on (03) 489 7099. I.e. 3 Ferguson II "Big Board" are less 20% off the one-off price, hard disks disk controllers, boxes and power supply to suit both 8" & 5 1/4" systems will be available.

Bare board with main chips now available (includes PCB, Manual, PALS, Monitor ROM, SMC chips). You have to add rest of components at \$495 + tax

Errors and omissions excepted

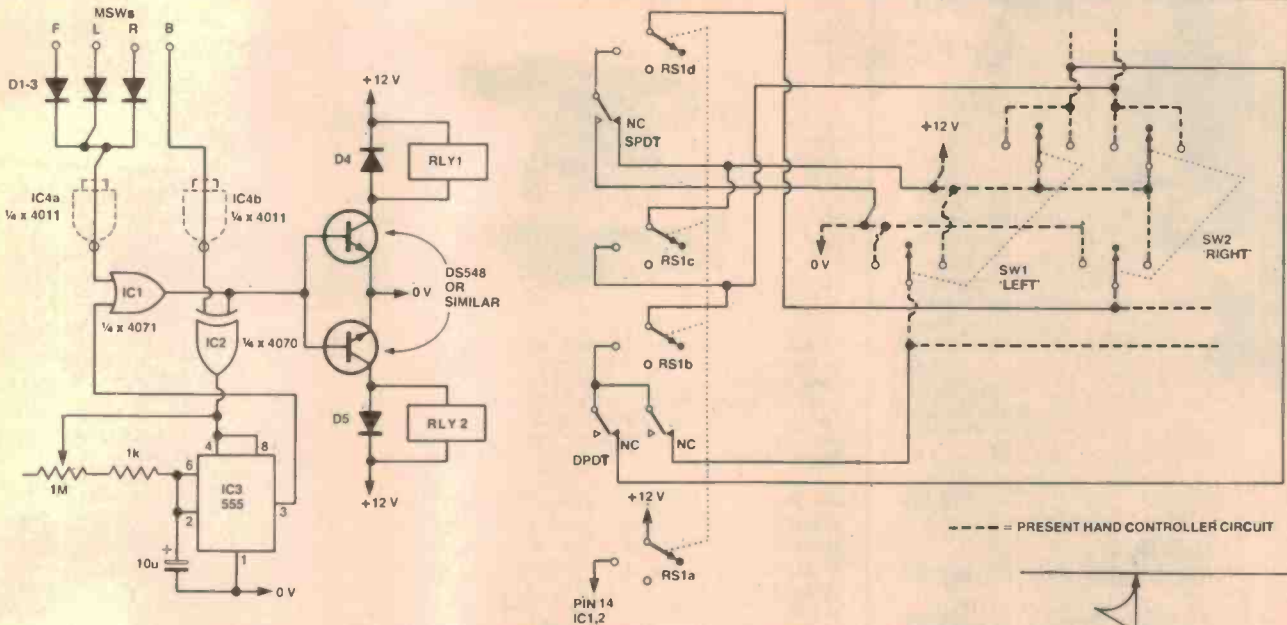

Self discipline for the Turtle robot

Mark Harwood, Dural NSW
Age: 14 years

The circuit was designed to 'fit in' with the Turtle robot hand controller. As the title suggests, when the robot runs into something it will 'discipline' itself by reversing at an angle, then going forward again.

If the Turtle backs into an object while reversing, it will immediately go forward.

The circuit is basically a timer which reverses the right stepper motor and is triggered by microswitches around the Turtle.

D1-3 are simply to stop shorting between the LEDs already on the hand controller. IC4 is optional. The circuit is designed to work on a 'high' at the 25-pin connector when a microswitch is bumped. However, if the opposite is the case, D1-3 can be reversed and IC4a and b can be included.

If no microswitches have been bumped the output of IC1 is low and both motors are in forward gear.

However, if the left, right or

front microswitch is bumped, the output of IC1 will go high, making the output of IC2 high also. This triggers the timing circuit which latches IC1 with its output. This supplies the relay driver transistors, activating both relays.

The relay contacts are merely bypassing present switches on the hand controller (see diagram). Relay 1 normally holds the right stepper motor forward. When it is activated it puts the motor into reverse. Relay 2 normally holds the left stepper motor in forward. When it is activated it stops the motor completely.

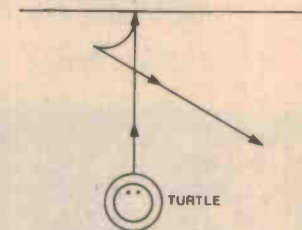

If the Turtle should back into an object the output of IC2 will go low, resetting the timer and the Turtle will go forward immediately.

RS1 is an off/on switch for the whole circuit.

The time for which the Turtle reverses is set by the 1M potentiometer in the timing circuit.

'IDEA OF THE MONTH' CONTEST

NEW PRIZE! WORTH \$90!

COUPON

Cut out and send to: Scope/ETI 'Idea of the Month' Contest, ETI Magazine, 140 Joynton Ave, Waterloo NSW 2017.

"I agree to the above terms and grant Electronics Today International all rights to publish my idea in ETI Magazine or other publications produced by them. I declare that the attached idea is my own original material, that it has not previously been published and that its publication does not violate any other copyright."
* Breach of copyright is now a criminal offence.

Title of idea

Signature

Name

Date

Address

Postcode

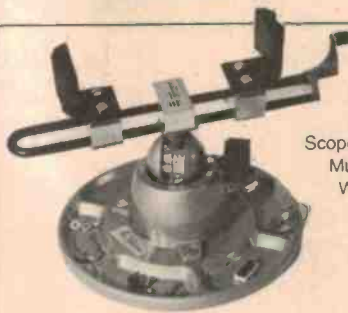

Scope Panavise Multi-purpose Work Centre.

Scope Laboratories, who manufacture and distribute soldering irons and accessory tools, have offered to sponsor a contest with a prize to be given away every month for the best item submitted for publication in the 'Ideas for Experimenters' column — one of the most consistently popular features in ETI. Each month we will be giving away a Scope Panavise Multi-purpose Work Centre, Model 376/300/312, comprising a self-centering head (376), standard base (300) and tray base mount (312), all worth about \$90! Selections will be made at the sole discretion of the editorial staff of ETI Magazine. Apart from the prize, each winner will be paid \$10 for the item published. You must submit original ideas of circuits which have not previously been published. You may send as many entries as you wish.

RULES

This contest is open to all persons normally resident in Australia with the exception of members of the staff of Scope Laboratories, Federal Publishing Company Propriety Limited, ESN, The Litho Centre and/or associated companies.

Closing date for each issue is the last day of the month. Entries received within seven days of that date will be accepted if postmarked prior to and including the date of the last day of the month.

The winning entry will be judged by the Editor of ETI, whose decision will be final. No correspondence can be entered into regarding the decision.

Winner will be advised by telegram the same day the result is declared. The name of the winner, together with the winning idea, will be published in the next possible issue of ETI.

Contestants must enter their names and address where indicated on each entry form. Photostats or clearly written copies will be accepted but if sending copies you must cut out and include with each entry the month and page number from the bottom of the page of the contest. In other words you can send in multiple entries but you will need extra copies of the magazine so that you send an original page number with each entry.

This contest is invalid in states where local laws prohibit entries.

Entrants must sign the declaration on the coupon that they have read the above rules and agree to abide by their conditions.

ALTRONICS ... ALTRONICS ... ALTRONICS ... ALTRONICS ... ALTRONICS ... ALTRONICS ... ALTRONICS ... ALTRONICS ... ALTRONICS ... ALTRONICS ...

Powerful New 6000 RPM Mini Drill for PC Work



Tons of Torque.
Just the shot for
PCB work.
12V DC
operated
from external
Power Pack
1.2mm
chuck
capacity.
Supplied c/w
1mm drill bit.

T2302 \$12.95

Drill Bits:
T2320 (0.8mm) ... \$1.25

T2325 (1.0mm) ... \$1.25

WILL
**YOUR BUDGET PROBABLY WON'T STRETCH TO AFFORD OUR
PROFESSIONAL SERIES ALL ALUMINIUM RACK CABINETS**

NOW YOUR PREAMPS, AMPS, CONTROL MODULES MONITOR PANELS ETC. CAN LOOK EVERY
BIT AS GOOD AS TECHNICS, NAKAMICHI AND OTHER TOP MANUFACTURERS

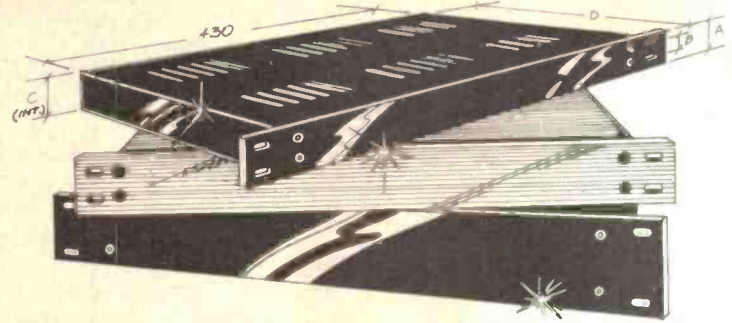

* These beautifully crafted rack cabinet boxes will give your equipment a real 1st class appearance. * All aluminium construction. * REMOVABLE TOP AND BOTTOM PANELS. * All dimensioning conforms to the International Standard. * Natural or Black finish. * Ventilated lid. * Deluxe brushed finish anodised front panel. * Individually cartoned. * Supplied in Flat Pack Form - Easily assembled in minutes.

Side Elevation:
D = 254mm C (Internal Chassis Height)
B (Mounting Bolt Centres)

Cat. No.	Finish	A	B	C	ea.	5 +
H 0401	Natural	44	34	38	\$42.50	\$39.95
H 0402	Natural	88	57	82	49.95	47.50
H 0403	Natural	132	89	126	55.00	49.95
H 0411	Black	44	34	38	42.50	39.95
H 0412	Black	88	57	82	49.95	47.50
H 0413	Black	132	89	126	55.00	49.95

Beware of other rack boxes that do not conform to International Rack Sizing.

**DIRECT IMPORT ELECTRONIC HARDWARE
FANTASTIC SAVINGS ON BULK 'TRADE' PACKS**

TO3 INSULATING KIT



Mica washers and bushes for 4 TO3 semi conductors H 158075

TO3 Trade Pack

100 mica washers + 200 bushes
H 1582 \$12.50

TO220 INSULATING KIT



Mica washers and bushes for 4 TO220 or other flat Pack Semls. H 158595

TO220 Trade Pack

100 mica washers + 100 bushes
H 1587 \$9.80

RUBBER FEET

With 3mm Mounting Hole

Standard Stickon Type



Size (diam.)	Pack Qty.	Price
H 0914 13mm	8	\$.85
H 0913 13mm	100	7.50
H 0917 16mm	8	.95
H 0916 16mm	100	8.00
H 0940 12mm Stickon	4	.80
H 0942 12mm Stickon	100	9.60
H 0950 20mm Stickon	4	.95
H 0952 20mm Stickon	100	11.50

1/8th inch WHITWORTH STEEL NUTS AND BOLTS ROUND HEAD ZINC PLATED

Length	Pack Qty.	Price
H 1000 9mm	25	\$.85
H 1002 9mm	500	4.50
H 1005 12mm	25	.85
H 1007 12mm	500	4.95
H 1009 25mm	25	.95
H 1011 25mm	500	6.95
H 1012 Hex Nut	30	.75
H 1020 Hex Nut	500	5.95
H 1030 S/Proof Washer	50	.95
H 1032 S/Proof Washer	500	6.95
H 1040 Flat Washer	50	.95
H 1042 Flat Washer	500	6.95

Huge Savings with Trade Packs (Contents: 500)

BA NUTS AND BOLTS

Bolts Cheesehead Steel, Nuts Brass

Pack	Price
H 1045 4BA x 6mm	25 \$.95
H 1047 4BA x 6mm	500 5.95
H 1050 4BA x 12mm	25 .95
H 1052 4BA x 12mm	500 6.95
H 1060 6BA x 12mm	25 .95
H 1062 6BA x 12mm	500 7.50
H 1070 Nut Hex 4BA	25 1.00
H 1072 Nut Hex 4BA	500 12.50
H 1080 Nut Hex 6BA	25 1.00
H 1082 Nut Hex 6BA	500 12.50
H 1090 4BA S/Proof Washer	50 .95
H 1092 4BA S/Proof Washer	500 5.95
H 1095 4BA Flat Washer	50 .95
H 1097 4BA Flat Washer	500 6.95

SELF TAPPING SCREWS

Nickel Plated Steel



From less than 1c each

Pack	Price
H 1100 No. 4 x 6mm	25 \$.75
H 1102 No. 4 x 6mm	500 4.50
H 1110 No. 4 x 12mm	25 .95
H 1112 No. 4 x 12mm	500 5.50
H 1120 No. 8 x 12mm	25 .95
H 1122 No. 8 x 12mm	500 6.95

From less than 1c each.

SPACERS (STANDOFFS) SUPERB NICKEL PLATED BRASS

UNTAPPED 4 BA or 1/8" CLEARANCE

Cat.	Length	Pack Qty.	Price
H 1305	6mm	8	\$.95
H 1359	6mm	100	8.50
H 1362	9mm	8	.95
H 1365	9mm	100	9.50
H 1372	12mm	6	.95
H 1373	12mm	100	11.00
H 1375	25mm	4	.95
H 1376	25mm	100	15.00



TAPPED 4 BA

Cat.	Length	Pack Qty.	Price
H 1379	9mm	8	\$1.00
H 1380	9mm	100	9.50
H 1383	12mm	8	1.20
H 1384	12mm	100	12.50
H 1387	25mm	4	1.00
H 1388	25mm	100	17.50



NEW

DELUXE ABS INSTRUMENT CASE

Case color light grey front-rear panels black.

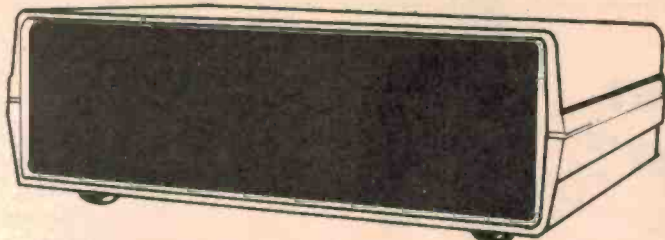

Our superb new instrument case will give your projects the professional appearance they deserve.

- * Internal mounting posts enable a wide combination of PCB's, Transformers, etc. to be accommodated (screws supplied).
- * PCB guide rails provided internally allow vertical PCB positioning to several locations.
- * Removable front and rear panels. Attractive textured finish one side and plain the reverse side. (Enables direct engraving, silk screen printing etc. to plain side.)
- * Great for test instruments and other high grade projects.

Overall Size: 200W x 160D x 70mmH

H 0480 ONLY \$13.50 10 up \$11.50

OEM'S - Manufacturers - Bulk Users: Your product will look like it's straight out of "Hewlett Packard's" factory with this brilliant low cost case. Contact our Wholesale Department for Bulk Prices.

**HIGH RESOLUTION MONITOR
NOW WITH SCREEN INVERT FUNCTION
AT NO EXTRA COST**

One of the hassles of sitting there for countless hours operating your computer is *eye strain* (anyone who has just spent 10 hours solid will agree!!) Well our fantastic new MICRON 12 High Resolution Green Phosphor Monitor has a 'reverse' or invert screen function where by simply rotating the contrast control anti-clockwise the screen information and background are reversed. This is especially valuable in poor lighting conditions.

NO MORE HEADACHES AND BLURRED VISION

MICRON 12

Green Phosphor Monitor
Features 12" screen
Front controls, on/off, contrast reverse, brightness. Power 240V 50Hz or 12V DC. Input RCA type, DC Output Jack 12V 1.1 Amp - power your Micro direct without a power pack. Bandwidth 10Hz to 20MHz the resultant definition is truly amazing for a low cost monitor

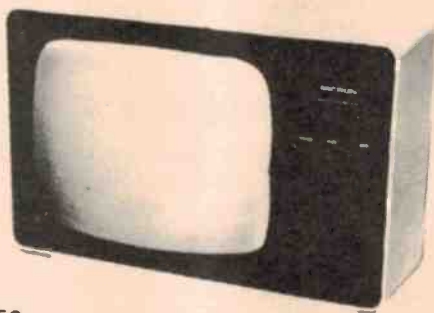

Guaranteed by **ALTRONICS!**
Incredible Value.

D 1112 \$199.50

Adjustable Azimuth DATA CASSETTE

At last a Data Cassette Recorder/Player you can afford. The Micron D 1120 is fully adjustable azimuth (absolutely essential in our opinion) and incorporates tailored audio frequency response audio stage together with low distortion.

Now you can save and load software in your Micro with confidence.

Micron D 1120 Data Cassette ONLY \$49.50

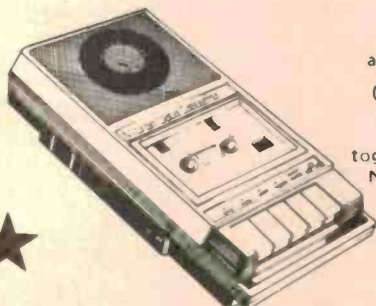

ALTRONICS RESELLERS

Please note that resellers may not have all the items advertised in stock, and as resellers have to bear the cost of freight, prices may be slightly higher than advertised. ALTRONICS reseller prices should however represent a considerable saving over our competitors' prices.

SOUTH AUSTRALIA CITY ADN Electronics 212 5505 Pntronics 212 3111	QUEENSLAND CITY Dehsound P/L 229 6155
SUBURBAN PROSPECT Janus Electronics 269 4744 ELIZABETH GROVE A.E. Cooling 255 2249 CHRISTIES BEACH Force Electronics 382 3386 KESWICK Freeway Electric Wholesalers 297 2033	SUBURBAN SALISBURY Colourvision Wholesale 275 3188 FORTITUDE VALLEY St. Lucia Electronics 52 3547 BIRKDALE Wholesale Sound Accessories 207 2502
VICTORIA CITY All Electronic Components 662 3506 Ellitronics 602 3499	COUNTRY CAIRNS Thompson Instrument Services 51 2404 TOWNSVILLE Solera 77 2015 ROCKHAMPTON Purity Electronics 2105R GLADSTONE Purity Electronics 72 4321 GYMPIE TV and Appliance Services 82 1671 IPSWICH P & P Electronics 281 8001 TOWDOOMBA Purity Electronics 32 9677 Dnwn's Radio and TV 32 1044 NAMBOUR Nambour Electronics 41 1604
COUNTRY SHEPARDTON GV Electronics 21 8866 MILDURA Electronic and Digital Services 23 3380	NT DARWIN Radio Paris Darwin 81 9508 Kens Electronics 81 4749 Vestronics 81 3491
NEW SOUTH WALES CITY Radio Dispatch 211 0191 Electronic Agencies 29 2098 Aycal 264 6688	ALICE SPRINGS Farmer Electronics 52 2967 Ascorn Electronics 52 1713
SUBURBAN LEWISHAM ProPak Electronics 569 9770 CONCORD Electronic Agencies 745 3077 DEE WHY David Ryall Electronics 982 7500 WAITARA Appliance Technology 487 2711	TASMANIA HOBART Beta Electronics 34 8232 KINGSTON Kingston Electronics 29 6802 AVOCA Frontiers TV 84 2166
MATRAVILLE Creative Electronics 606 4000	WEST AUSTRALIA ALBANY BP Electronics 49 2681
COUNTRY BROKEN HILL Crosby TV 8803 COFFS HARBOUR Coffs Harbour Electronics 52 5884 PENRITH Acorn Electronics 21 2400 NEWCASTLE D G E Systems 69 1625 WINDANG Malyrak Electronics 56 5066 GOSFORD Tomtronic Electronics 24 7246 KURRI KURRI Kurri Electronics 37 2141	GERALDTON Generation TV and Radio 21 2777 WYALKATCHEM D & J Peap 81 5132 MANOURAH Kensronics 35 3277 KALGOORLIE Toolies Electronics 215 212
	ACT Sentronics 54 8334 Electronic Components 80 4654

**RESELLERS WANTED IN ALL AREAS
(including WA)**

Phone: **STEVE WROBLEWSKI (09) 381 7233**
for details

NEW 24 HOUR 7 DAYS P/WEEK PHONE ORDER SERVICE FOR BANKCARD HOLDERS

Take advantage of "off peak" low STD phone rates and phone your order to our new recorded 24 hour order service. Give your name, address with postcode, phone number, bankcard number and expiry date then your order—and presto your order will be processed and back to you in a flash—Please nominate Jetservice if you want overnight delivery.

\$2.50 DELIVERY AUSTRALIA WIDE We process your order the day received and despatch via Australia Post. Allow approx. 7 days from day you post order to when you receive goods. Weight limited 10kgs.

\$4.50 DELIVERY AUSTRALIA WIDE We process your order day received and despatch via Jetservice for delivery next day.

BANKCARD HOLDERS CAN PHONE ORDER UP TO 8PM (EST) FOR NEXT DAY DELIVERY - SOUNDS INCREDIBLE DOESN'T IT? Alright you cynics just try us! Weight limit 3.3kgs. Jetservice cannot deliver to P.O. box numbers (Australia Post would have a fit).

\$10.00 HEAVY HEAVY SERVICE - AUSTRALIA-WIDE All orders over 10kgs must travel on the heavy service, that is - road express. Delivery time 7 days average.

ALTRONICS
105 STIRLING ST., PERTH
FOR INSTANT SERVICE
(09) 328 1599

All Mail Orders:
Box 8280 Stirling St.,
Perth WA 6000

ALTRONICS ... ALTRONICS ... ALTRONICS ... ALTRONICS ...

ALTRONICS ... ALTRONICS ... ALTRONICS ... ALTRONICS ...

Pocket transceiver is world's smallest?

The Transair TW-260 is a tiny VHF pocket or handheld FM transceiver that the makers claim is the smallest in the world.

Measuring just 120 mm high by 62 mm wide by 36 mm deep, the TW-260 weighs just 340 grams, including the rechargeable batteries!

The TW-260 can operate on up to six channels in any 3 MHz segment between 134 MHz and 174 MHz. The transmitter delivers 2 W and rated deviation is ± 5 kHz.

The double conversion receiver has a sensitivity of 0.3 μ V for 12 dB SINAD, 0.5 μ V for 20 dB of quieting. Audio output is given as 300 mW for less than 10% distortion at 1 kHz.

The unit is DOC approved. It operates from a rechargeable 7.2 V/450 mAh nickel cadmium battery which has a rated life of eight hours at 5% transmit, 5% receive, 90% standby.

An external microphone/speaker socket is provided so that the transceiver may be mounted on your belt and an optional remote handheld mic/speaker unit attached.

Two charger units are available to suit the TW-260; a plugpack unit and a desktop model. With the latter, the transceiver simply slips into a cradle and two contacts on the bottom provide connection to the battery.

Two cases are available for the transceiver; a soft vinyl one for ordinary use and a tough, heavy duty synthetic leather one. Although the TW-260 is provided with a flexible whip antenna, Benelec has several suitable

models available in their range of antennas.

We've had the opportunity to evaluate a pair of these transceivers here at ETI and found them to be a remarkable product.

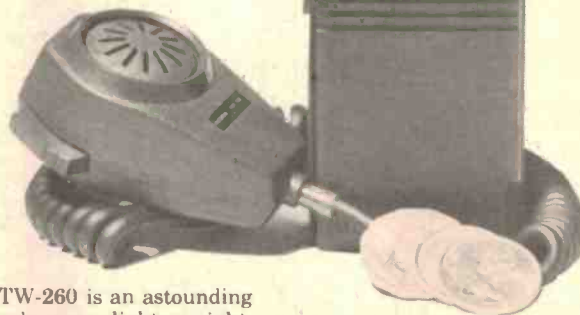

The TW-260 is an astounding size and very light weight. Nevertheless, its performance is not at all compromised in comparison to other handheld transceivers on the market. All controls work smoothly with no 'surprises' and are easy to operate, despite the tiny 'control panel'.

Squelch operation is sensitive and clean — no annoying tendency to chatter or hang on. The audio on both transmit and receive is clear and clean. No overload breakup was detectable when operating a pair in close proximity. Well worth serious consideration if you're after a handheld VHF transceiver for any application.

Full details on specifications, pricing and availability are obtainable from Benelec Pty Ltd, P.O. Box 21, Bondi Beach NSW 2026. (02)665-8211.

US 6 m beacon

A 6 m band beacon has been put on the air from Aurora Colorado running 50 watts on 50.065 MHz, according to Westlink Report.

Operating under the new US regulations pertaining to beacon operations, the beacon was established by, and runs under the callsign of, W0IJR.

The antenna is a horizontally polarised double halo located 35 metres above ground. The beacon operates from 1300 Z to 0300 Z daily. If you're interested in transpacific TEP, look for the beacon when it's midday over the path mid-point and later (say, from 0900 EAST to when the beacon cuts out at 1300 EAST).

QSA reports should be sent to either W0IJR or KA0CDN at their callbook addresses.

Next Shuttle launch 'live' broadcast

Plans are afoot to provide a live amateur band broadcast of the next Shuttle launch communications.

The Jet Propulsion Lab's Amateur Radio Club trustee, Jay Holladay, W6EJJ, has been granted permission to broadcast the launch 'live' in conjunction with W5RRR at the Johnson Space Centre.

Exactly when the next Space Shuttle launch will take place was unclear at time of going to

press. Dr. Owen Garriott may operate the first amateur station from space on this next flight.

For more information on the Shuttle Information Network, send a stamped-addressed envelope and 15 IRCs to the JPL A.R.C., California Institute of Technology, 4800 Oak Grove Dr., Pasadena CA 91109 USA.

Telescopic masts

A new series of pneumatic telescopic masts is now available in Australia designed for commercial, industrial and military purposes. The masts come in a variety of sizes up to 60 m.

Typical applications include: ENG (electronic news gathering), emergency communications services, military communications and as vertical radiators etc.

When equipped with floodlights the portable and quickly erected SKI-HI masts provide instant illumination for emergency or temporary lighting, construction work etc.

The SKI-HI masts are available to be installed inside vehicles through the roof, outside of vehicles, on trailers and trucks. Some are designed for field installations.

The pneumatic seals between telescoping sections are designed

to function from -50° C to $+80^{\circ}$ C, making them suitable for extreme environments.

All masts are tested to raise at a speed of 30 cm per second. Wind ratings to over 30 km/hr are available.

Mast options include manual or electric rotation and sequential locking of sections as they are raised or lowered.

SKI-HI masts are manufactured in the USA by the TMD division of the Will-Burt Company. Australian agent is Antenna Engineering Australia Pty Ltd, P.O. Box 191, Croydon Vic. 3136. (03)728-1777.

PHASE 3-B OSCAR TO FLY THIS MONTH?

A trouble-free launch of the Ariane L-6 booster, carrying several payloads including the Phase 3-B OSCAR, is expected by the European Space Agency and AMSAT sometime between 20 and 27 May.

Following E.S.A. investigations into the L-5 booster failure, remedies have been taken to ensure, as far as possible, that a similar failure in the L-6 launch will not occur.

The last Phase 3-B bird was lost when the L-5 'terminated' a few minutes after lift-off. If all goes well, Ariane L-6 will rise from the E.S.A. facility in Guiana to place the Phase 3-B satellite into an elliptical orbit that will provide almost hemispherical coverage for several hours per day beneath the apogee.

The main 3-B transponder uplink is around 435 MHz, downlink on two metres. Other transponders will be included. Keep your ears out for it.



C. Itoh PRINTERS

FROM ROD IRVING ELECTRONICS

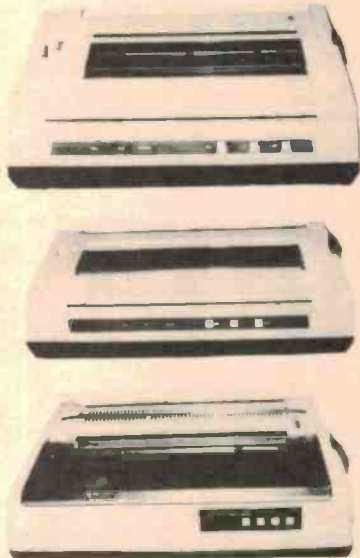

Pro/Writer Printer 8510

Print Features: Number of columns—136 col. max. Print Speed—120 CPS. Print Direction—Single-directional and Bidirectional. Switch Selectable. Throughput Speed—From 44 to 152 lpm. Character spacing (max. number of columns per line)—Pica 10 CPI (80), Double Width 8 CPI (40), Compressed Font 17 CPI (136), Double Width 8.8 CPI (68), Elite 12 CPI (96), Double Width 6 CPI (48), Proportional Double Width Proportional. Line Spacing—Variable to 1/14". Print Width—405 mm (16") max. Forms Type: Fan Fold Roll or Cut Sheet. Width—113 mm to 254 mm (4.5" to 10.0"). Total Thickness—0.05 to 0.28 mm (0.002" to 0.011"). Number of Copies—Original + 3 copies nominal.

Form Feed: Method—Tractor or Friction. Form Loading—Either rear or top. Interface—Serial: Method—EIA RS232-C and 20mA (40 & 60mA switchable option) Current Loop Serial Interface. Baud Rate (BPS)—110, 300, 600, 1200, 2400, 4800, 9600. Transmitting Method—Half Duplex. Synchronization—Asynchronous. Interface—Parallel: Method—TTL compatible, 7-bit, parallel interface. Control Signals—ACK, BUSY, SELECT, DATA STB, INPUT PRIME FAULT, INPUT BUSY, PAPER EMPT. Instruction Codes—(ASCII): CR, LF, VT, FF, CAN, SO, SI, DEL, DC1, DC2, DC3, DC4, GS, RS, US, FS, EM. GRAPHIC SYMBOLS: BIT GRAPHICS. Error Detection: (1) Parity (VRC)—Odd, Even, No-parity. Switch selectable. (2) Framing Error—Stop bit check. (3) Overrun Error—Error is detected when data are received before the previous data have been processed. Physical dimensions: 386 mm W x 120 mm H x 285 mm D (15.2" W x 4.7" H x 11.2" D). Weight: 5.8 kg (12 lbs., 12 oz.)

P* \$975 (\$845)
S** \$1095 (\$945)

Model 1550

The Model 1550 is a compact desk-top dot matrix serial impact printer used for data communication terminals, hardcopy of CRT displays, peripheral terminals for minicomputers and microcomputers, and small-sized business systems. The character format is a dot matrix of 7(H) x 9(V), or 8(H) x 8(V). Print speed is 120 characters/second. Up to 136 characters can be printed per line at 10 CPI. Its main features are: • Compact desk-top dot matrix printer • 136-column print • Lightweight • Low power-consumption • High-quality print • Bit image graphics • Graphic Symbols • Prints in six different languages • High reliability • Low cost.

P* \$1295 (\$1175)
S** \$1395 (\$1295)

F-10 Printmaster Daisy Wheel Printer

Print Speed: 40 CPS. Print Method: Static Print Impact. Number of Printable Columns: 136. 163, Variable. Character Spacing: 1/120 Inch (minimum). Line Spacing: 1/48. Return Time: 900 msec. Line Feed Time: 40 msec. Paper Width: 406 mm (maximum). Print Characters: 96. Printwheel: Industry Standard 96 Character Wheel. Interface: Industry Standard 8-bit Parallel, RS232-C Compatible, X-ON, X-OFF, 12-bit Dume and Diablo Compatible. Dimensions: 574 mm W x 405 mm D x 153.5 mm H (22.6" W x 15.9" D x 6" H). Weight: 14 kg (30.8 lbs.) with cover and power supply. Noise: Less than 65 Db (1M from Plate, A Scale).

P* \$1950 (\$1675)
S** \$2100 (\$1775)

'THE PRINTER PEOPLE' SPECIALS AND BARGAINS

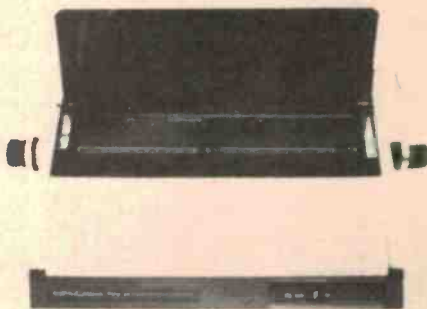

SMITH-CORONA DAISY WHEEL PRINTER

SPECIFICATIONS
Printing technique — Daisy printwheel, fully formed character
Print speed — 12 CPS
Character set — 128 ASCII, 88 printable
Character spacing (Pitch) — 10 CPI or 12 CPI
Printing — Unidirectional
Paper width — 13" (33cm) maximum
Writing line — 10.5" (26.7cm) — 105 character line in 10 pitch, 126 character line in 12 pitch
Line spacing — 6, 4.5, 3.0 lines per inch
Paper feed — Friction
Paper thickness — maximum .027" paper thickness
Impression control — Operator selectable 5 levels
Interface — Parallel — 7 bit parallel data, 3 control line (data strobe, busy, acknowledge)
Serial — RS232C Compatible, Baud Rates — 50, 75, 110, 134.5, 150, 300, 600, 1,200, 1,800, 2,000, 2,400, 3,600, 4,800, 7,200, 9,600, 19,200; BPS, Switch selectable. Parity and character bit length also switch selectable.
Physical dimensions — 6.4" (16.25cm) H; 19.5" (49.6cm) W; 13.5" (33.7cm) D. 20.7lbs (9.4kg)

\$895 inc. tax



STAR PRINTER

SPECIFICATIONS
Printing system — Impact dot matrix
Interface — Centronics standardized parallel interface (TTY level) built in printer
Matrix — Character mode 9 x 7 matrix, Graphic mode 6 x 6 matrix
Printing direction — Character mode: Bi-directional printing with logical seeking function, Graphic mode: Unidirectional printing from left to right
Number of characters per line — 80/96/131 140/48/66 for double-width characters
Printing speed — 80 characters/sec
Character set — JIS 160 codes/ASCII 96 codes + International character codes 64 graphics pattern
Character size — 2.0 (W) x 2.6 (H) in mm in case of 80 columns/line
Character space — 2.54mm (1/10 inch) in case of 80 columns/line
Line space — 1/6, 1/8, or 1/12 inch
Paper feed system — Friction type, Friction feed, Tractor type; Variable sprocket feed or friction feed
Line feed speed — 7.5 lines/sec at 1/6 inch spacing, 10 lines/sec at 1/8 inch spacing
Buffer capacity — 2K bytes
Other important functions — Form feed, Diagnostic printing, No-paper detection, Buzzer

\$495 + tax



GP-100A Graphic Printer SEIKOSHA

SPECIFICATIONS
Print method — Impact dot matrix print (SEIKOSHA's uni-hammer method)
Character matrix — 5 x 7 dot matrix
Characters — 116 upper/lower case characters, numerals and symbols
Graphics — Dot addressable, 7 vertical dots per column, max 480 columns
Character codes — 8-bit ASCII
Character size — Height 7 dots (2.82mm), Width 5 dots (2.11mm)
Print speed — 50 character/sec (left to right, unidirectional)
Max. number of columns — 80 columns
Character spacing — 10 characters/inch
Linefeed spacing — 6 lines/inch — Character mode, 9 lines/inch — Graphic mode
Linefeed speed — 5 linefeeds/sec — Character mode, 7.5 linefeeds/sec — Graphic mode
Paper feed — Pin feed
Paper width — 4.5 to 10 inches acceptatic
Multiple copies — 2 including original
Inked ribbon — Single color, linked roller built-in cassette type
External dimensions — 234.5D x 420W x 136H mm

\$395 inc. tax

RITRONICS WHOLESALE

425 HIGH STREET, NORTHCOTE 3070, MELBOURNE. (03) 489-8131
NOW OPEN AT 48-50 A'BECKETT STREET, MELBOURNE (03) 347 9251

TO ORDER: Heavy items sent Skyroad Freight on Mail Order Phone 481-1436. Wholesale Customers Phone: 489-7099. Mail Orders to RITRONICS WHOLESALE, P.O. Box 235, Northcote 3070. Minimum P&P \$2. Add extra for heavy items, registration and certified mail. Prices and specifications subject to change without notice.



Bankcard mail orders welcome
ORDER FORM
Please Debit my Bankcard

No. _____
Expiry Date _____
Name _____
Signature _____

* Parallel Interface ** Serial Interface

ERRORS AND OMISSIONS EXCEPTED



Rod Irving's

WIDE WORLD OF COMPONENTS

425 High St. Northcote, Ph.: (03) 489 8131
48-50 A'Beckett St. Melb. Ph.: (03) 347 9251
Mail orders: P.O. Box 235 Northcote, Vic. 3070



Prices subject to change without notice.

CRYSTAL SPECIALS

1 MHz	6.00
2 MHz	4.00
3.579 MHz	1.00
4 MHz	2.00
8 MHz	2.00
12 MHz	2.00
16 MHz	2.00
32 MHz	2.00

WIRE WRAP SOCKETS

	1-9	10-25	25+
8 PIN	1.20	1.00	.80
14 PIN	1.40	1.20	1.00
16 PIN	1.60	1.40	1.20
18 PIN	1.90	1.70	1.50
20 PIN	2.20	2.00	1.80
22 PIN	2.40	2.30	2.10
24 PIN	2.50	2.30	2.10
28 PIN	2.80	2.60	2.50
40 PIN	3.30	2.90	2.60

IC SOCKETS ECONOMY LOW COST

	1-9	10-25	25+
8 PIN	.30	.25	.20
14 PIN	.40	.30	.25
16 PIN	.40	.35	.30
18 PIN	.50	.45	.35
20 PIN	.55	.50	.45
22 PIN	.60	.55	.50
24 PIN	.60	.55	.50
28 PIN	.60	.55	.50
40 PIN	.70	.60	.55

PRECISION MACHINED GOLD INSERT

	1-9	10-25
8 PIN	1.20	1.00
14 PIN	1.60	1.40
16 PIN	1.90	1.70
18 PIN	2.00	1.80
20 PIN	2.20	2.00
22 PIN	2.40	2.20
24 PIN	2.60	2.40
28 PIN	2.90	2.70
40 PIN	4.40	4.00

SCOTCHCAL RANGE OF PHOTOCSENSITIVE PRODUCTS.

			Per Sheet	Per Box
8001	Red on Aluminium	250mm x 300mm	\$ 6.60	\$48.00 (10sh)
8001	Red on Aluminium	300mm x 600mm	\$12.00	\$51.60 (5sh)
8005	Black on Aluminium	250mm x 300mm	\$ 6.60	\$48.00 (10sh)
8005	Black on Aluminium	300mm x 600mm	\$12.00	\$51.60 (5sh)
8009	Blue on Aluminium	250mm x 300mm	\$ 6.60	\$48.00 (10sh)
8009	Blue on Aluminium	300mm x 600mm	\$12.00	\$51.60 (5sh)
8007	Reversing Film	250mm x 300mm	\$ 4.80	\$27.00 (10sh)
8007	Reversing Film	300mm x 600mm	\$10.20	\$36.00 (5sh)
8011	Red on White Plastic	250mm x 300mm		\$51.60 (10sh)
8013	Black on Yellow Plastic	250mm x 300mm		\$51.60 (10sh)
8015	Black on White Plastic	250mm x 300mm		\$51.60 (10sh)
8016	Blue on White Plastic	250mm x 300mm		\$51.60 (10sh)
8018	Green on White Plastic	250mm x 300mm		\$51.60 (10sh)
8500	1 Litre Developer		\$10.80	per bottle
8500	250ml Developer		\$3.00	per bottle
3900	Scotch Clear Finish	368 Aerosol	\$12.00	per can

Dealer and Trade Inquiries welcome.
Full range of products are available on order. For further information please call TIM BRAY on (03) 489 7099.

ICL7106	12.50	74S157	3.10	74H04	.90	74C150	6.50	74LS12	30	74LS155	1.20	74LS354	3.95	6522	10.00	LM301H	1.50	UA710CN	1.00
ICL7107	15.50	74S158	3.10	74H05	.90	74C151	4.20	74LS13	50	74LS156	1.20	74LS365	.60	6522A	11.00	LM302H	6.50	LM711	1.20
ICL7109	27.50	74S160	5.90	74H08	1.10	74C154	6.00	74LS14	60	74LS157	.60	74LS366	.60	6532	12.50	LM305H	1.50	LM723	.75
ICL7116	21.50	74S162	7.90	74H11	.80	74C157	3.75	74LS15	.30	74LS158	.80	74LS367	.60	6545	32.50	LM307CN	1.00	LM723CH	1.50
ICL7117	21.50	74S163	7.90	74H12	.80	74C160	1.90	74LS18	.45	74LS159	.80	74LS368	.60	6551	12.90	LM307H	1.60	LM725	4.75
ICL7660	4.90	74S168	11.50	74H15	.80	74C162	2.00	74LS20	.30	74LS160	.70	74LS373	1.50	2650	21.00	LM308	1.00	LM733	1.50
ICL7663	4.90	74S169	11.50	74H20	.80	74C163	2.00	74LS21	.30	74LS162	1.10	74LS374	1.75	2651	23.00	LM308H	1.80	UA739	2.75
ICL7664	4.90	74S174	4.50	74H21	.90	74C164	1.90	74LS22	.30	74LS163	.90	74LS375	.85	6800	8.00	LM309K	1.90	741	.50
ICM7211	12.50	74S175	4.50	74H22	.80	74C165	1.90	74LS24	.30	74LS164	1.40	74LS377	2.15	6802	10.00	LM310N	3.20	UA747	1.30
ICM7261A	47.50	74S181	8.50	74H30	.90	74C173	1.50	74LS26	.30	74LS165	.60	74LS378	1.20	6808	12.50	LM310H	3.20	UA748	.80
ICM7216B	42.50	74S182	3.40	74H40	.90	74C174	1.50	74LS27	.35	74LS166	2.55	74LS379	1.90	6809	17.00	LM311	.80	MC1310	9.50
ICM7217A	47.50	74S188AN	4.10	74H50	.90	74C175	1.50	74LS28	.35	74LS167	2.45	74LS386	.50	6810	3.50	LM311H	1.80	MC1312	6.90
ICM7218A	18.50	74S189	8.50	74H51	.90	74C192	1.90	74LS30	.30	74LS168	.90	74LS390	1.80	6820	5.50	LM317T	2.50	MC1314	6.90
ICM7224A	18.50	74S194	3.30	74H52	.90	74C193	1.90	74LS32	.30	74LS174	.80	74LS393	1.80	6821	3.50	LM317K	4.50	MC1315	7.50
ICM7226A	48.50	74S195	2.90	74H53	.90	74C195	1.90	74LS33	.35	74LS175	.80	74LS395	2.00	6840	6.50	LM318	3.50	MC1327	6.50
ICM7227A	18.50	74S196/82590	4.90	74H54	.90	74C200	14.00	74LS37	.35	74LS181	2.80	74LS396	2.50	6844	12.00	LM319	3.50	MC1350	1.30
ICM7231A	15.50	74S197/82591	4.90	74H55	.90	74C221	2.40	74LS38	.40	74LS183	4.00	74LS399	3.00	6845	12.00	LM324	1.20	MC1408L8	7.50
ICM7240	7.50	74S201	9.90	74H60	.90	74C240	2.60	74LS40	.40	74LS191	1.90	74S419	1.90	6847	7.50	LM325	4.50	MC1437	3.50
ICM7242	3.90	74S214AN	P.O.A.	74H61	.90	74C244	2.60	74LS42	.80	74LS192	.80	74S424	5.50	6850	3.50	LM326	4.50	MC1445	3.75
ICM7250	7.90	74S225	10.90	74H62	.90	74C373	3.00	74LS47	1.80	74LS193	.80	74S440	5.50	6860	10.00	LM329DZ	.90	MC1456	1.50
ICM7260	7.90	74S226	7.90	74H64	.90	74C374	3.00	74LS48	1.80	74LS194	.80	74S442	5.50	6875	13.50	LM344Z	1.70	MC1458	1.20
ICM7555	1.90	74S240	6.90	74H65	.90	74C901	1.50	74LS49	1.80	74LS195	1.25	74S443	5.50	Z80CPU	7.00	LM335Z	2.20	MC1466L	14.50
ICM7556	2.50	74S241	6.90	74H71	1.40	74C902	1.00	74LS51	.35	74LS196	1.25	74S444	5.50	Z80A	8.00	LM339	.90	MC1469R	8.90
		74S244	9.90	74H72	1.20	74C903	1.00	74LS54	.40	74LS197	1.20	74S445	5.50	Z80B	16.00	LM348	1.60	MC1488	1.20
		74S251	3.90	74H73	1.80	74C904	1.00	74LS55	.40	74LS221	1.20	74S446	5.50	Z80P10	4.50	LM349	1.60	MC1489	1.20
74S00	.80	74S253	4.90	74H74	1.80	74C905	15.00	74LS63	2.80	74LS240	1.90	74S447	5.50	Z80A	6.50	LM350K	7.50	MC1494	7.50
74S02	.80	74S257	3.30	74H76	1.90	74C906	1.00	74LS73	50	74LS241	1.20	74S448	5.50	Z80CTC	6.50	LF351-N	.80	MC1495	7.90
74S03	.80	74S258	3.30	74H78	1.90	74C907	1.00	74LS74	40	74LS242	1.20	74S449	5.50	Z80ACTC	8.50	LF356N	1.40	MC1496	2.90
74S04	.85	74S260	2.90	74H87	7.90	74C908	1.70	74LS75	50	74LS243	1.50	74S490	3.20	Z80DMA	16.00	LF357	1.40	LM1596	2.90
74S05	1.10	74S274	P.O.A.	74H101	1.80	74C910	14.00	74LS76	55	74LS244	1.50	74S540	11.95	Z80ADMA	19.00	LM358	1.00	MC1648	6.90
74S08	.80	74S275	P.O.A.	74H102	1.80	74C911	12.50	74LS77	65	74LS245	1.20	74S541	11.95	Z80AS10	19.00	LM361	3.50	LM1812	10.50
74S09	1.10	74S280	5.90	74H103	2.50	74C912	12.50	74LS78	55	74LS246	1.50	74S621	2.75	Z80S10	16.00	LM377	4.90	LM1830	3.90
74S10	.80	74S281	P.O.A.	74H106	2.50	74C914	2.50	74LS83	100	74LS247	1.20	74S622	2.75	AY-3-8910	14.50	LM378	3.95	LM2907	3.50
74S11	.80	74S283	7.90	74H108	2.50	74C915	2.00	74LS85	1.30	74LS248	1.40	74S623	2.75	AY-3-2513	14.50	LM379-S	7.95	LM2917 8 pin	3.40
74S15	1.30	74S287	3.30	74H113	1.10	74C917	12.50	74LS86	40	74LS249	1.30	74S629	2.95	MMS303	7.50	LM380 8 pin	1.40	LM2917 14 pin	3.40
74S20	1.00	74S288	3.60	74H114	1.10	74C918	1.90	74LS90	70	74LS251	1.00	74S640	2.95	S1883	8.50	LM380 14 pin	1.50	MN3001	19.50
74S22	1.20	74S299	13.90	74H118	7.90	74C920	12.50	74LS91	70	74LS252	.90	74S641	2.75	S1883	7.50	LM381	2.20	CA3028	3.00
74S30	.80	74S301	12.90			74C921	12.50	74LS92	70	74LS253	.90	74S642	2.75	MMS303	9.50	LM382	2.00	CA3046	2.90
74S32	.80	74S314	P.O.A.	74C		74C922	6.50	74LS93	.60	74LS254	2.25	74S643	2.75	LMH002	7.50	LM383	2.95	CA3056	7.50
74S37	1.70	74S330	P.O.A.	74C00	.60	74C923	6.50	74LS95	.75	74LS255	1.00	74S644	2.75	LMH004	7.50	LM384	2.95	CA3059	6.90
74S38	1.70	74S331	P.O.A.	74C02	.60	74C925	7.90	74LS96	1.00	74LS256	2.50	74S645	2.75	LMH007	7.50	LM386	1.95	CA3080	2.50
74S40	1.20	74S373	9.90	74C04	.60	74C926	7.90	74LS107	.60	74LS266	7.00	74S668	1.75	LM061	1.75	LM387	2.00	CA3086	2.50
74S51	.80	74S374	9.90	74C08	.60	74C927	7.90	74LS109	.60	74LS273	1.55	74S669	1.75	LM062	2.90	LM389	2.95	CA3089	4.90
74S64	1.20	74S381	9.90	74C10	.60	74C928	8.00	74LS112	.60	74LS275	6.80	74S670	2.75	LM064	2.90	LM391	5.00	CA3130E	2.50
74S65	1.20	74S387	3.30	74C14	1.00	74C929	9.50	74LS113	.60	74LS279	8.00	74S673	12.55	LM074	1.20	LM393	1.00	CA3130T	2.50
74S74	1.30	74S412/8212	5.90	74C20	.60	74C930	2.75	74LS114	.60	74LS280	2.60	74S674	12.55	LM077	1.60	LM394	4.95	CA3140E	2.50
74S86	1.60	74S428/8228	9.90	74C30	.60	74C932	2.50	74LS122	.90	74LS283	1.20	74S690	3.95	LM073	3.20	LM395T	4.90	CA3140T	2.50
74S109	2.50	74S470	9.90	74C32	.60	74C941	2.50	74LS123	.90	74LS290	1.10	74S691	3.95	LM075	2.90	LM396K	19.50	LM3401	1.00
74S																			

The 'Phony Patch' — a landline interface for your ham rig

Be ready for 'phone patch when it comes. In the meantime, you can practice operating your rig over the house intercom, or whatever.

The phone patch committee*



* This project was designed, developed and written up by a group of radio amateurs interested in promoting 'phone patch in Australia. They modestly wish to remain anonymous.

States have long had access to 'phone patches', which were fully legal to connect to the telephone network. In Australia there has been no method of connecting a transceiver to a telephone line.

The current situation is this: the Department of Communication permits third party 'phone patch' operation for amateurs, but to connect a phone patch device to Telecom lines would breach Telecom regulations — with the risk of having your service disconnected plus prosecution for effecting a 'non-permitted' attachment.

In fact, not only are phone patches not permitted, but there are no standards laid down to which equipment can be made. Certain safety standards for equipment in general are all that can be relied on.

The recent report of the Davidson Inquiry into telecommunications foreshadows that Telecom is, or shortly will be, taking a much more enlightened attitude to attachments to their phone lines. Witness the recent decision by Telecom to allow 'user connected' phone devices to be plugged in to Telecom lines (for the first time — until now any item, even permitted, had to be 'installed' by Telecom).

In light of the changing attitude of Telecom, we set about designing an interface which could, when allowed, connect transceivers to Telecom lines. In the meantime, there are a large number of private installations, intercoms, links etc, which could still make use of such a device.

In the absence of any technical specifications, the interface was made to meet all of Telecom's safety standards. It was also designed to meet the audio level requirements of other equipment.

The interface is equipped with its own monitor speaker so it can be used as a direct link between the transmitter and line. Obviously, normal transceiver operating practice must be followed as the transceiver will only operate in simplex mode.

However, the interface can make use of the ►

SPECIFICATIONS — ETI-734

SENSITIVITY

Rx-to-line (at 1 kHz)

level pot. mid-position 3.0 V for 0.77 V (0 dBm) in line
level pot. maximum 1.5 V for 0.77 V (0 dBm) in line

Line-to-Tx (at 1 kHz)

level pot. mid-position 0.77 V (0 dBm) in line gives 0.5 V out
level pot. maximum 0.77 V (0 dBm) in line gives 1.3 V out

CROSSTALK

Rx output to Tx input

level pots mid-position 26 dB with 0 dBm on line
(dependant on level settings;
decreases with higher settings)

* All voltages RMS; line terminated in 600 ohms

ONE OF the more positive aspects of the CB 'boom' was that it paved the way for 'third party traffic' in both the citizens bands and (later) the amateur bands.

Third party traffic means that an amateur or CB operator is allowed to relay messages, via his equipment, to another amateur or CB operator for someone else (i.e. neither of the operators).

This in itself was a 'breakthrough', but didn't

go quite far enough. For it still meant that the message had to be actually re-broadcast by the operator.

The ridiculous part was that, if the message was being relayed from Australia to, say, the USA, the American amateur could connect his transceiver directly to his phone, call the party to whom the message is directed — and sit back!

This is because amateurs in the United

Project 734

transceiver's VOX, if available, for 'hands free' operation.

It is anticipated that a large number of amateur operators, and maybe even CB operators, will build the interface, ready for the time when such devices are 'legalised'. And it appears that this is not too far away!

Design

A block diagram of the interface is shown in Figure 1. The object is to convert a 'four wire' communications path — a pair for the receiver output and a pair for the transmitter input — to a 'two wire' link.

For safety's sake, and to take into account the later likelihood of the unit requiring approval for attachment to Telecom lines, the interface is isolated from the line by a special transformer and a high voltage, high reliability capacitor. This is terminated in a resistance of a value that provides a close match to the general line impedance of about 600 ohms.

A bidirectional amplifier system is attached to this to pass audio from the line to the transmitter mic. input and from the receiver output to the line. Each of these amplifiers has a bandpass response. Figure 2 shows the two response curves.

The response from receiver output to the line shows a narrow bandwidth with steep rolloff above and below the speech midband frequency of 1 kHz. The -6 dB bandwidth is from about 500 Hz to 1.7 kHz, rolling off at about 12 dB per octave below 500 Hz and at about 15 dB per octave above 1.7 kHz. This is perfectly adequate for speech, and in fact, provides a measure of improvement with noisy signals as well as attenuating noise and heterodynes that may be passed down the line.

The response from the line to the transmitter mic. input is considerably broader, the -6 dB bandwidth running from about 200 Hz to 6 kHz. Rolloff below 200 Hz is about 12 dB per octave, about -15 dB per octave above 6 kHz. Why is it different? Well, many modern transceivers incorporate speech filtering and bandwidth shaping to improve the effectiveness and clarity of the signal. Any filter in the mic. line may adversely affect the performance of a transceiver's own speech filter. But, any extraneous noise (hum, clicks-pops, etc) that may be on the line should not be passed to the transceiver, either. Hence the line-to-Tx filter response was rolled off above and below the usual speech band limits of 3 kHz and 300 Hz, respectively.

The 'Rx output' is intended to come from the transceiver's external speaker output or a high level, low impedance auxiliary output. Most modern transceivers have an audio power output of around two to three watts. Under normal use, average output power into the speaker is perhaps 0.5 W, which is about 2 V into an eight ohm load. Hence, this amplifier was designed to deal with signals from about 1.5 V RMS (level control at maximum) to produce 0 dBm in the line (0.77 V in 600 ohms).

With the line-to-Tx amplifier, 0 dBm on the line will produce a maximum output of about 1.3 V RMS (level control at maximum),

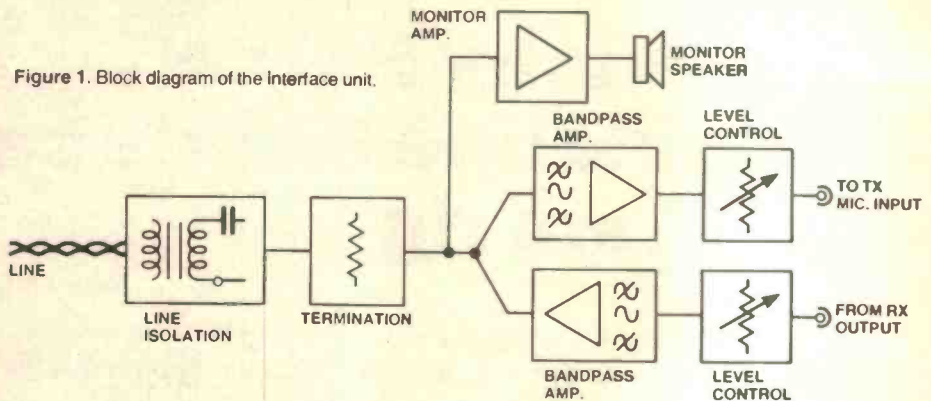

Figure 1. Block diagram of the interface unit.

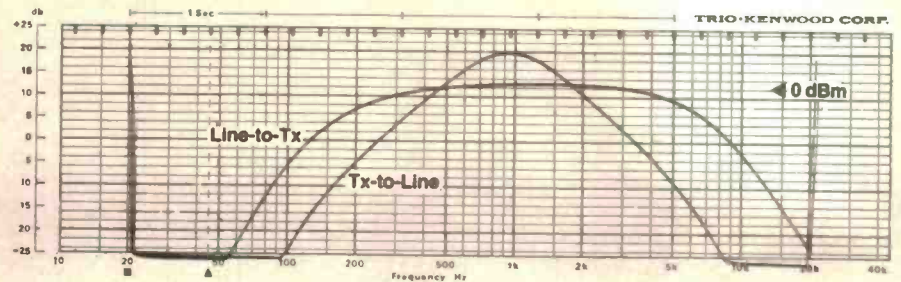

Figure 2. Response curves of the 'Rx-to-line' and 'Line-to-Tx' stages of the interface. (Measured on the prototype using ETI's Trio SE-3000 acoustic test set.)

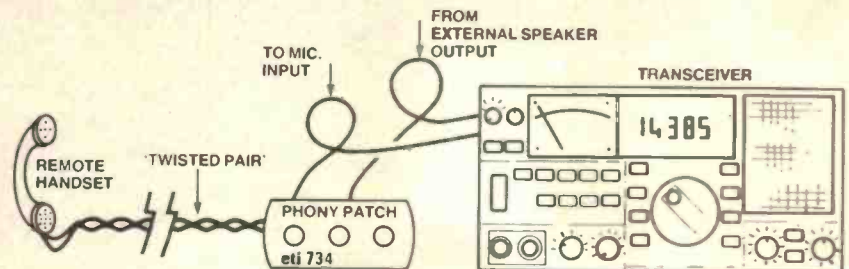
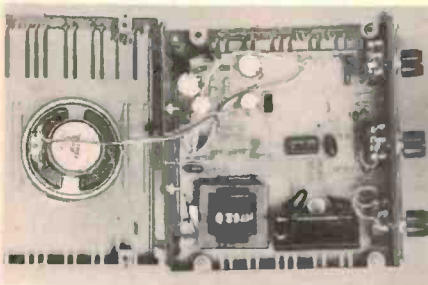

Figure 3. General arrangement of how the ETI-734 interface unit is hooked up.



Inside story. General internal view of the project.

which should be more than adequate to handle the majority of situations.

For local monitoring, a simple amplifier picks audio off at the isolation stage and drives a small loudspeaker in the interface.

Power is derived from an ac plugpack so that mains is not brought into the unit at all — again, for safety's sake.

Construction

All the electronic components, with the exception of the pots, are mounted on a single printed circuit board measuring 113 mm square. This fits nicely inside an ARLEC

PC1 plastic case which we used to house the project. This case has a plastic front panel and a metal rear panel. The pc board has four mounting holes at each corner that match the plastic pegs in the bottom half of the ARLEC case so that the board is easily secured with four small self-tapping screws.

The three pots mount on the front panel and all the external 'interfacing' connections exit via the back panel. The transceiver connections are made via two RCA sockets. The line enters via a grommet and is soldered to the appropriate pc board points. A flying lead with a suitable plug attached permits convenient connection to and removal from the line. The ac plugpack adaptor was hard wired direct to the board using figure-8 cable. Some plugpacks come with a flying lead of Figure-8 cable, some have two screw terminals on the plugpack body.

We dressed up the front panel with an aluminium Scotchcal label, the artwork for which is reproduced elsewhere in the article. The monitor speaker was mounted on the lid, simply glued in place with Silastic. Holes were drilled in the lid over the speaker position, before mounting (it's too hard afterwards!).

Probably the best way to go about con-

structuring the project is to tackle the pc board first. If you're making your own board, give it a thorough check after etching and drilling it. Even if you've purchased a ready-made board or a kit, check the board for missed holes, bridges between tracks (particularly between IC pins) and holes not drilled to the correct size. Make sure the four mounting holes line up with the pegs in the base of the box. Correct any problems and then proceed with mounting the components.

Assemble the resistors, capacitors (except C2) and semiconductors first. If you wish, a socket can be used for IC1. Watch the orientation of the electrolytic capacitors and all the diodes, especially. The orientation of the transistors and IC1 should be clear from the overlay diagram.

Leave the line isolation transformer, T1, and capacitor C2 until last as these are bulky components. We used pc stakes for all the external leads from the board. These should be mounted next. Check everything so far. All OK? Now bolt C2 in place, then mount T1. C2 has flying leads, note, while T1 has been designed for direct pc board mounting.

Now you can attach the flying leads to the pc board stakes around the perimeter of the board. Make sure the leads are long enough to reach their destination, but not too long so that they form a 'rat's nest' inside the box when it's all assembled. Don't attach the line or ac input leads yet.

Now you can tackle the box. Mark out and drill the front and rear panels. The Scotchcal label can be used as a template to mark out the front panel. Drill holes in the box top where the speaker will be positioned, then glue the speaker in place.

The Scotchcal label can now be applied to the front panel. Trim the label to size first. Cut it slightly undersize, the box pieces have an overhanging lip which covers the panel all round the edge. Peel off the backing strip and carefully position one end of the label on the panel. Smooth the Scotchcal onto the panel slowly, then give it a hard rub all over, using a soft cloth, when you've got it in place. Trim off any overhanging bits.

Now mount the potentiometers to the front panel. Position them so that their terminals face upwards; this makes it easier to solder the leads to them. Put grommets in the holes in the rear panel where the line and ac input leads will pass through. Mount the stereo RCA connector strip (or two individual RCA sockets).

Screw the pc board into place in the bottom

AC PLUGPACKS

There are a number of ac plugpacks available that will suit this project.

The prototype was powered by a Dick Smith Electronics M-9555 ac plugpack which is rated at 12 Vac/500 mA.

The ARLEC APP.V/79309/60672 is rated to deliver 12.8 Vac no load, 9.3 Vac at 1 A. The project draws about 125 mA (quiescent) and this plugpack will deliver around 12.5 Vac at that load current.

The Ferguson PPB 8/1000 is rated to deliver 8 Vac at 1 A, and delivers about 11.5 V or so at around 150 mA, so it will suit, as would their PPB 12/500 (12 V @ 500 mA).

PARTS LIST — ETI-734

Resistors	
all	1/4W, 5%
R1	82R
R2, R4	150k
R3	15k
R5, R8	1k5
R6, 7, 22, 23	220R
R9, R10	2R2
R11, 14, 17, 20	68k
R12	560R
R13	39k
R15, R18	4k7
R16	1k2
R19	1M5
R21	22k
RV1	22k/C log. pot.
RV2	500R/C log. pot.
RV3	5k/C log. pot.

C11, C12	330u/25 V RB electro.
C13, C14	1000u/16 V RB electro.

Semiconductors

D1, D2	1N4001, 1N4002, EM401, EM402, etc.
IC1	uA324, LM324, etc.
Q1	BC639
Q2	BC640
Q3	TIP31
Q4	TIP32
ZD1, 2, 5, 6	5V6/1 W zeners
ZD3, ZD4	4V7/1 W zeners

Miscellaneous

T1	Ferguson MT620 line isolation transformer
----	---

Capacitors

C1	10n/400 V or 630 V greencap
C2	2u/440 Vac film cap. (see text)
C3	10n greencap
C4, 6, 10	100n greencap
C5	33n greencap
C7	220n greencap
C8, C9	4n7 greencap

ETI-734 pc board; Arlec PC1 box or similar (plastic, 140 x 130 x 78 mm); 50 mm diameter 8 ohm speaker; Arlec ac plugpack adaptor 9.3 V @ 1 A, or similar; stereo RCA socket strip; one rubber grommet; knobs; Scotchcal front panel; wire, etc.

Price estimate

\$55 — \$65

See 'Shoparound' in this issue for a guide to firms stocking kits and components for this project.

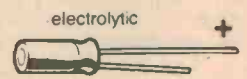
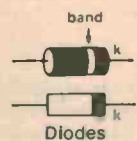
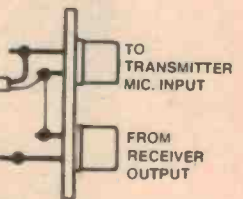
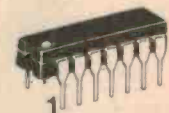
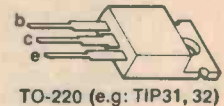
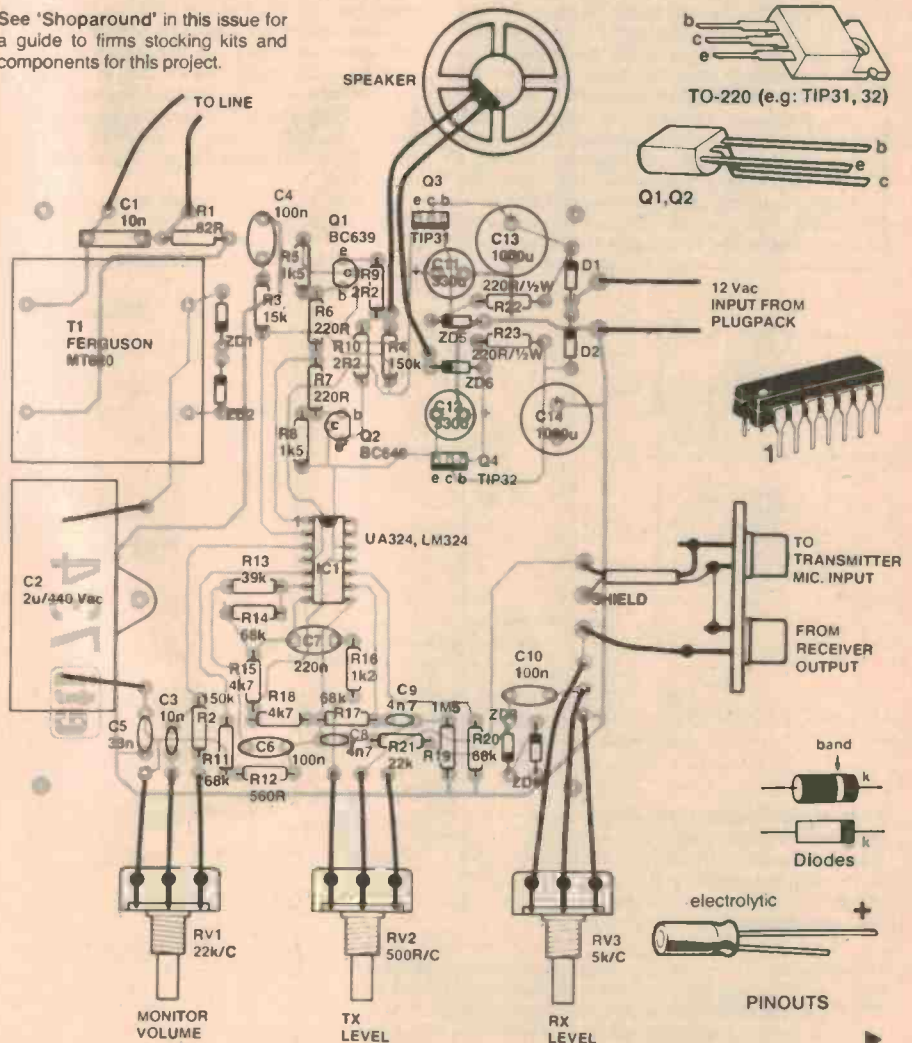

PINOUTS

HOW IT WORKS — ETI-734

The overall design of the interface is detailed under design notes in the main text.

The line and interface are coupled via T1 which provides isolation to Telecom requirements. Further isolation is provided by the coupling capacitor, C2. Capacitor C1 and resistor R1 attenuate transients on the line. Two back-to-back zener diodes, ZD1 and ZD2, clip any signals with amplitudes above about 6 V peak.

The interface side of T1 is terminated by R12, which provides a close match to the 600 ohm line impedance. The junction of R12-C6-R17-etc is a 'virtual earth' point.

Signals going in the line-to-Tx direction are coupled into IC1b via R11. The output of IC1b is coupled to the level control via C7 and R16. Capacitor C5 provides high frequency rolloff, as its impedance decreases with increasing frequency, while C6 provides low frequency rolloff as its impedance increases with decreasing frequency and the feedback ratio increases (R14 divided by the impedance of R13-C6). Frequency response is shown in Figure 2. The characteristics of T1 also affect the high frequency rolloff. IC1b has a mid-band gain of a little under two.

Signals going in the Rx-to-line direction pass via the level control RV3, then via C10, R21 and C9 to the input of IC1c. Two zener diodes, ZD3 and ZD4, clip any signals with amplitudes exceeding about 5 V peak. IC1c is a filter having loss, not gain, as the receiver output level will generally be higher than the required 0 dBm level. Capacitor C8 provides high frequency rolloff as it shunts the feedback, reducing IC1c's gain with increasing frequency. Capacitor C9 provides low frequency rolloff as its impedance increases with decreasing frequency. The frequency response of this stage is shown in Figure 2.

Now, it is obvious that the output of the Rx-to-line stage is coupled to the line-to-Tx

stage. Why then, doesn't the output of the receiver appear at the Tx mic. input? Well, R12 ties the inverting and non-inverting inputs of IC1b together, the Tx output looks like a common-mode signal and will not be amplified by IC1b. It's not a 'perfect' arrangement, but the cross-coupling between the Tx output and Tx mic. input is adequately low.

For the purpose of local monitoring, signals appearing at the common coupling point — the junction of C2 and R12 — are 'picked off' by RV1, the monitor volume control. Signals are coupled to the input of IC1a via C3/R2. The output of IC1a drives a simple class B amplifier comprised of Q1, Q2 and associated resistors, which drives a small eight ohm loudspeaker. Negative feedback is provided via R4 to the inverting input of IC1a. This stage has a midband gain of 10. Low frequency rolloff is provided by C4, the impedance of which rises with decreasing frequency, thus increasing the feedback ratio.

The interface requires positive and negative power rails. An ac plugpack, delivering 12 Vac output, provides power and isolation from the mains for safety. Two halfwave rectifiers, D1 and D2, provide positive and negative dc rails, of about 16 V or so, smoothed by capacitors C13 and C14 respectively. These are each regulated to about 5 V or 6 V using simple zener controlled series pass regulators comprised of Q3, ZD5, R22 and Q4, ZD6, R23. The two zeners are each 5V6, though 6V2 or 6V8 zeners could be used. The supply rails will each be equal to the zener voltages less the b-e drop of the series pass transistors (about 0.6 V). Thus, with 5V6 zeners, the supply rails will be about 5 V each, or with 6V2 zeners, about 5½ V. The actual supply rail voltage is not critical.

Capacitors C11 and C12 provide ac bypassing for the supply rails.



In and out. Rear view of the Interface showing the ac input line at left, the RCA sockets for connections to the transceiver and the cable to the line at right.

half of the box. Slip the front and rear panels in place and solder the appropriate flying leads to the three pots and the RCA connectors. Solder the speaker leads in place, then pass the line lead and ac input lead through their respective grommets and knot them just inside the box, to prevent strain on the board terminals, if they're pulled, then solder them to their respective pc stakes.

Put the lid on the box and you're ready to test it.

Getting it on the air

Apply power and run a multimeter over the supply rails. These should be within one volt of the specified rail voltage (see the circuit diagram). If you've used 5V6 zeners, for ZD5 and ZD6, the rails will be around 5 V, or a bit over 6 V if you've used 6V8 zeners.

Check the voltage on pin 1 of IC1. This should be less than ± 100 mV. The base of Q1 should be about 0.6 V positive, the base of Q2 about 0.6 V negative. See that pin 4 of IC1 is at the positive supply rail and pin 11 at the negative supply rail.

Temporarily hook up a 'phone handset to the line and your transceiver to the RCA connectors. Use a shielded lead to the transmitter mic. input. You won't need a shielded lead between the interface's 'receiver output' socket and the rig's external speaker output as you're dealing with high levels and low impedances. Figure-8 cable is quite OK.

Set the Rx and Tx gain controls to about half way and the monitor gain well down, or you'll get 'howl round' feedback. Set your transceiver VOX controls to where you normally have them, as well as the transmitter mic. gain (if your rig has a mic. gain control).

Turn up the rig's audio gain and listen in the handset for band noise or signals. Set the interface unit's 'Rx output level' control for a comfortable volume in the earpiece.

Talk and the VOX should operate the transceiver. Adjust the interface's 'Tx input level' control and your rig's VOX controls if necessary to get the desired operation.

With the handset located at the end of your twisted pair line, check the overall operation. Adjust the interface monitor level to suit.

Have fun with your 'Phony Patch'!

When the authorities get around to permitting 'phone patch for amateurs, you'll be ready. In the meantime, remember it's an offence to use this unit on the public telephone network.

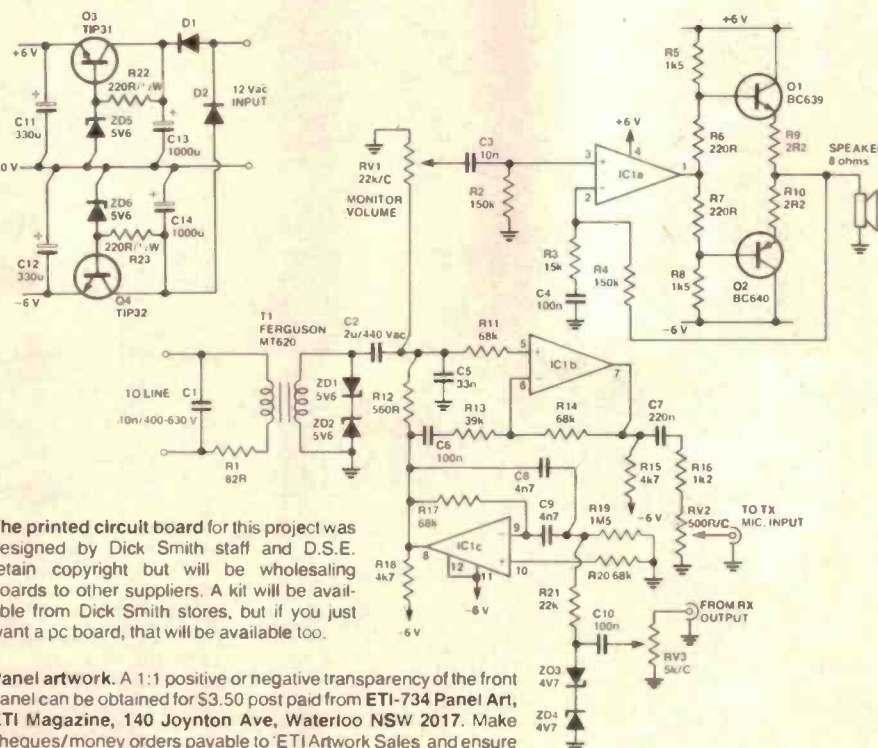

The printed circuit board for this project was designed by Dick Smith staff and D.S.E. retain copyright but will be wholesaling boards to other suppliers. A kit will be available from Dick Smith stores, but if you just want a pc board, that will be available too.

Panel artwork. A 1:1 positive or negative transparency of the front panel can be obtained for \$3.50 post paid from ETI-734 Panel Art, ETI Magazine, 140 Joynton Ave, Waterloo NSW 2017. Make cheques/money orders payable to ETI Artwork Sales and ensure you ask for a negative or positive.

DIGITAL FREQUENCY METER

7 Digit Resolution, measures period and frequencies to ± 500 MHz
Professional unit — cost a fraction of similar built-up units.



This project is "so easy to construct", virtually all components mount on one single PCB, ensuring success even for the "not so experienced" constructor.

Use of the latest LSI circuitry ensures impeccable performance from the completed unit. This is further ensured by our use of top grade components.

NOTE: (Altronics use only the specified Interall LSI — beware of inferior kits that do not conform to the original design.)

Frequency measurement to 500MHz (with optional Prescaler) in 3 ranges — 0—10MHz, 0—50MHz, 10—500MHz • 4 gating times — 0.01, 0.1, 1, 10 seconds.

Period measurement for accurate low frequency counts, 4 ranges — 1, 10, 100, 1000 input cycles • resolution 0.1us.

High Input Sensitivity — 10MV to 30MHz, 100MV at 50MHz @ 1MOHM input impedance, 200MV @ 500MHz @ 75 OHMS input impedance.

Accuracy — typically better than 0.005% uncalibrated.

Exclusive Altronics Kit Features

- IC sockets provided throughout
- low aging 10,000 MHz XTAL.
- Genuine Fairchild High Brightness FND 507 display's.
- Quality ABS plastic case — deluxe front panel.
- Complete kit as specified by EA includes instructions, all cables and every last nut, bolt and washer.

K2500. \$119.50

DECIMAL POINT FOR K2500

READ FREQUENCY DIRECTLY IN MHz and PERIOD IN US.

K2502. \$7.50

PRESCALER FOR K2500

ALLOWS FREQUENCY MEASUREMENT TO 500MHz

K2501. . . (essential option) . . . \$26.00

TRANSISTOR TESTER



Electronics Australia Project. Tests Bipolar Transistors, Diodes, Fets, SCR's and PUT's. Excellent service aid for the hobbyist and serviceman. Complete kit and instructions.
K 2525. \$19.75

FUNCTION GENERATOR

(with digital display)

Sine, triangle and squarewaves : 15Hz — 250KHz.



The most essential piece of test gear (second only to a good multimeter) on any hobbyist's bench is some kind of audio signal generator. This design utilizes the latest circuit techniques to produce stable, low distortion waveforms.

A truly versatile unit at a bargain price.

- 4 digit frequency readout (eliminates tiresome dial calibration) — typical accuracy $\pm 2\%$.
- 3 overlapping ranges x1, x10, x100.
- 600 OHM Nominal Output — continuously variable 3MV—2.5V P—P.
- Distortion — sinewave — less than 0.7% @ 1KHz.
- Linearity — triangle wave — better than 1% @ 1KHz.
- Squarewave rise time — 6V/uz maximum output.
- Amplitude stability — better than 0.1dB on all ranges.

With the exception of the display all components mount on a single PCB making this kit suitable for all constructors.

K2505. \$85.00

DIGITAL LED CAPACITANCE METER

K 2521 . ONLY \$55.00



with Deluxe Instrument Case

NEW DELUXE FINISH

We are pleased to announce the release of the Digital Capacitance Kit housed in our Deluxe H 0480 ABS Instrument Case.

This superb Test Instrument Kit now complements our top selling Digital Frequency Counter and Function Generator Project Kit. Electronics Australia Project. Measures capacitance of both polarized and non-polarized capacitors from 1 picofarad to 99.99 microfarads in 3 ranges.

Check values of unmarked capacitors, especially those little trimmers that are never coded.

Select precise values for filters and timing networks within ease.

• • • EXCLUSIVE TO ALTRONICS • • • Each kit includes precision measured capacitors for accurate calibration of each range.

STANDARD VERSION K 2520 (In metal case) Same Specifications. . \$49.50

ANALOG / DIGITAL STORAGE CRO ADAPTER

(See EA Nov 1980 and March 1981).



Unit enables indefinite storage of non-repetitive waveforms at a fraction of the cost of conventional storage CRO's. National semiconductors A—D/D—A conversion techniques allow analog signals up to 100KHz to be stored • two channels write in digital mode • positive and negative edge triggering • AC/DC/HF and LF rejection • timebase tracer for accurate frequency measurement • accurate down to 1.9Hz Analog mode — plus Digital Mode • delayed trigger 10us-1s • sensitivity — 160MV P—P @ 1 MEG (Analog) • standard TTL and CMOS levels 3-15 volt supply (Digital).

The features of this unit are to numerous to list, yet is simple to operate.

Be assured of quality with an Altronics Kit.

1. Genuine National A—D conversion chips not second sourced dropouts.
2. All IC sockets provided (27 total — you pay no more)
3. Low capacitance coax and a full metre of rainbow cable.
4. Full instructions and every last nut, bolt and washer.
5. Deluxe mini rack cabinet.

K2600. \$189.00

CURRENT TRIP CAR ALARM

Exit / entry delay
No false alarms
State of the Art Design by ETI

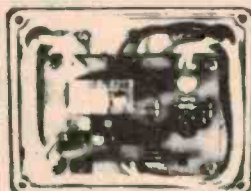

Protect Your Valuable Car and Contents

Circuit detects minutest voltage drop across vehicle's battery earth strap, tripping the alarm • uses MIIspec LM394 • Quality diecast box • genuine fujiitsu relay • automatic reset after pre set time period • installs in minutes • includes dash mounting LED-flashes to deter thieves.

K 4330. \$29.50

CAR ALARM ETI 084

A staggering number of cars are stolen each year. Install an Altronics Alarm Kit and yours won't be one of them.



Circuit operates by detection of voltage drops in the electrical system and features a flashing LED for dash mounting as a deterrent to would be vandals and thieves.

K 4084. \$12.00

EXPANDED — SCALE LED VOLTMETER — HAS MANY APPLICATIONS



ETI design suitable for lead-acid wet cells, lead acid gel electrolyte, vented nickel cadmium types and so on and so on.

Unit covers range of 10.5v to 15v

Determine battery condition instantly

Easy to Build!

K4326. \$9.50

ETI 162 BENCH SUPPLY

1.3 — 30V @ 1 Amp
With voltage and current limiting

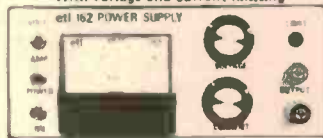

- Overload and short circuit protected.
- Voltage and current metering.
- Regulation — better than 0.2% zero to full load
- Hum and noise on output — less than 1MV at full load.
- LED indication of current limit.

Exclusive — fully S.E.C. Certified Mains Transformer supplied.

If you're considering buying this kit from your local supplier or one of our competitors — first ring and ask them if the mains transformer is S.E.C. certified to ASC126 — chances are that it won't be.

So why not give us your order? An Altronics Quality Kit speaks for itself and with our overnight JetService we guarantee to deliver to your door faster than your local supplier.

K3205. \$49.50

POWER SUPPLIES

13.8V HIGH CURRENT SUPPLY



- (See ETI JULY 1982)
- Output voltage 13.8 Vdc.
 - Output current 7.5A continuous 10A intermittent
 - Regulation — 0 to 7.5A : 50MV
- Save the expense of a mains powered rig. Kit complete in every way.

K3250. \$84.00

OUT BEST SELLING POWER SUPPLY KIT EVER

3—32 volt output at 1 amp UNDER \$40 THE ALTRONICS POWER SUPPLY

Based on EA LM 317K Project
Every workshop, school and hobbyist should get one now !!!



- Fully protected from thermal runaway and short circuits.
- Voltage and current metering.
- To—3 regulator plus power/in heatsink.
- Fully documented, every last part included.

K3200. \$39.95

DUAL TRACKING POWER SUPPLY

± 1.3 to ± 22V @ 2 AMPS : + 5V @ 0.9 AMPS



The ideal power supply for the audiophile experimenting with linear OP amp designs in which split supply operation ensures improved distortion and noise figures.

- Fully protected against short circuits, overloads and thermal runaway.
- LED indicator for regulator dropout.
- Floating ground.
- Uses 0.25% linearity 10 turn pot — tracks within 1MV.
- Voltage adjustable to within 10MV.

K3220. [EA MARCH 1982]. . . \$86.00

For despatch P+P charges and Altronics address details please refer to our advert on page 71.

SHOP AROUND

This page is to assist readers in the continual search for components, kits, printed circuit boards and other parts for ETI projects and circuits. If you are looking for a particular item or project and it is not mentioned here, check with our advertisers.

ETI-163 Lab, supply

This project is a 'must' for any electronics laboratory, whether you're an engineer, technician, serviceman or serious hobbyist. The power transformer for it was specially designed for the project and will be manufactured by Permatran of Melbourne. With 12, 24 and 36 V secondary outputs rated at 5 A, this transformer should find wide application apart from this project and will likely become a stock item from a number of electronic parts suppliers.

To date, the following suppliers have indicated they will be stocking kits for this project: **Altronics** in Perth, **Rod Irving** in Melbourne and **Dick Smith Electronics** (stores in all states). You might also try **All Electronic Components** in Melbourne.

The three relays we obtained from **Dick Smith Electronics**. They only cost \$3.50, which is remarkable value, and they are listed in the latest catalogue as "extra heavy duty" types, no. S-7140. They are made by Fujitsu and are type no. FRL-264 D012/02CK. Plenty of similar types are available.

The SPST momentary action pushbutton switch is a common type, listed by **Altronics** as cat. no. S 1080 and D.S.E. as S-1199. The contacts are rated at 6 A, 125 Vac.

The three DPDT toggle switches are of the miniature type, rated at 5 A, 240 Vac and known as 'heavy duty' models. **Electronic Agencies** list them as cat.

no. SE0120, D.S.E. as cat. no. S-1168.

The heatsinks were supplied by **Rod Irving Electronics**. They are the black-anodised, single-sided radial fin type 150 mm long, cat. no. HS5.

The case we used is Australian-made by **K&W** of Ballarat, Victoria, model no. C1066, also supplied by **Rod Irving Electronics**. It has an aluminium U-shaped chassis with turned-in lips and a steel cover with ventilation strips, painted hammer-tone blue. Overall, it measures 255 x 165 x 155 mm. Four feet are provided with it. The same case was used in the ETI-160 13.8 V/10 A power supply in the July '82 issue.

The 1 mA meter movements we used are the widely available Minipa MU-65s, kindly supplied by **Altronics** (who introduced us to Permatran, makers of the transformer). Other types of comparable size can be used, but mounting details are likely to vary slightly.

Scottical labels for the meter scales and case front panel will be obtainable from suppliers listed at the end of this column. Printed circuit boards can be obtained by consulting the same list.

ETI-164 zener tester

This handy little adjunct for your multimeter uses commonly available components, so constructors should have little difficulty getting it together. We obtained several models of the 'transistor

audio transformer' to try in our prototypes, and all worked well. Suitable '1k CT to 8 ohm' transformers are available from many suppliers, and we don't anticipate any supply problems. **Dick Smith Electronics** lists one as cat. no. M-0216; **Altronics** lists two suitable types — M 0216 and M 0226 (we tried both); **Tandy** lists one as cat. no. 273-1380.

All the other parts are standard stock items in most parts suppliers.

Printed circuit suppliers are listed at the end of this column.

If you're after a kit for this project, check out **Rod Irving Electronics** and **All Electronic Components** in Melbourne.

ETI-323 headlight delay

There's nothing so simple as a project for which all the components are stock items in almost every electronics shop. Constructors should have no difficulty with this project. Printed circuit boards will be available through the suppliers listed at the end of this column. You may find firms like **All Electronic Components** and **Rod Irving Electronics** will be stocking kits.

ETI-734 phony patch

This project was a late inclusion, but constructors should find most parts to be readily available. The line isolation transformer is locally made by Ferguson but we didn't know at press time which suppliers would have stocks, so you'll have to check around. The

2u/440 Vac block capacitor is Japanese-made, by **Shizuki**. There are similar types around, so it's worth checking with several suppliers. **Dick Smith Electronics** may have it in stock, but it's not listed in the current catalogue.

As the project is a late inclusion, kits may not be available until late in the month. **Dick Smith Electronics** will definitely be stocking it and we'll advise about other suppliers in this column next month, hopefully.

Printed circuit board and panel suppliers

Almost every pc board ever published by ETI may be obtained from the following suppliers:

All Electronic Components
118 Lonsdale St
Melbourne Vic. 3000

RCS Radio
651 Forest Rd
Bexley NSW 2207

Panels, meter scales and dial faces for almost every ETI project published may also be obtained from the above two firms.

For pc boards produced over the past three to five years, the following suppliers generally keep stocks on hand:

Electronic Agencies
115-117 Parramatta Rd
Concord NSW 2137
and

117 York St
Sydney NSW 2000

Radio Despatch Service
869 George St
Sydney NSW 2000

Rod Irving Electronics
425 High St
Northcote Vic. 3070

James Phototronics
522 Grange Rd
Fulham Gardens SA 5024

Jemal Products
P.O. Box 168
Victoria Park WA 6100

Jaetronics
58 Appian Drive
St Albans Vic. 3021

Sunbury Printed Circuits
Lot 14, Factory 3,
McDougall Rd
Sunbury Vic. 3429

Billed Electronics
Shop 2, 31 Pultney St
Dandenong Vic. 3175

Mini Tech
P.O. Box 9194
Auckland N.Z.



Jaycar, Carlingford. Located on the corner of Carlingford and Pennant Hills Roads. Jaycar's Carlingford store is conveniently placed for enthusiasts in Sydney's north shore and NW suburbs. All Jaycar items are stocked and many kits can be demonstrated (like the Series 5000 gear). Avoid the city traffic, congregate at Carlingford! The store is open 9 am to 5.30 pm weekdays, till 8.30 pm Thursdays and 9-12 am Saturdays. Phone no. is 872-4444.

LOOK AT THESE EXTRAS YOU GET WITH FLUKE MULTIMETERS

8060A OFFERS FREQUENCY, TRUE RMS & DIRECT dB

This remarkable state of the art DMM combines the accuracy and resolution of larger, more expensive instruments with the convenience of a hand-held instrument. Flukes own LSI/microcomputer design provides:

- Wideband true RMS AC measurements to 100kHz
- Frequency measurement to 200kHz
- dBm and relative dB
- 10µV sensitivity
- Direct resistance measurement to 300Meg
- Relative reference on any range or function
- Microcomputer-based self diagnostics

8062A

As 8060A above but without frequency and dB ranges. Provides true rms to 30kHz and relative reference functions.



8024B OFFERS PEAK HOLD AND DIRECT TEMPERATURE

The 8024B state of the art multimeter offers two important extra features - peak hold and temperature. Peak hold is a useful tool for capturing and retaining elusive voltage or current surges long enough to check and record the displayed reading. If your work involves measuring temperature then connect a K-type thermocouple and you can get direct temperature readings (we have a range available specially to suit the 8024B).

- 11 functions including temperature with K-type thermocouples
- Peak hold on voltage and current ranges
- Logic detection and continuity
- Audible and visible indicators
- 0.1% basic accuracy. 3½ digit



8026A OFFERS TRUE RMS AND CONTINUITY TESTING

The 8026A is the latest addition to the Fluke range and offers the advantage of true rms readings on ac functions. While most meters measure ac voltages almost all use the average-sensing, rms-scaled technique. In many applications average sensing does not give an accurate result - especially with non-sinusoidal waveforms. If you work with motors or data transmission type circuitry, true rms is critical to your measurements. For quick circuit checking the 8026A also incorporates the Fluke high speed continuity beeper.

- 8 functions
- True rms AC measurements to 10kHz
- Conductance and diode testing
- High speed continuity beeper



CHECK THE COMPLETE FLUKE 8020B SERIES

	DC Voltage	AC Voltage	DC Current	AC Current	Resistance	Diode Test	Conductance	Continuity	Logic Level	Temperature	Peak Hold	DC Accuracy
8022B	•	•	•	•	•	•	•	•	•	•	•	0.25%
8021B	•	•	•	•	•	•	•	•	•	•	•	0.25%
8020B	•	•	•	•	•	•	•	•	•	•	•	0.1%
8024B	•	•	•	•	•	•	•	•	•	•	•	0.1%

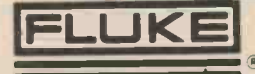

SOLD & SERVICED IN AUSTRALIA BY

ELMEASCO

Instruments Pty. Ltd.

SEND FOR YOUR FREE MULTIMETER GUIDE

Please send me details of Fluke DMMs
 8060/62 & 8050 8020B Series

NAME _____

ADDRESS _____

PCODE _____

TELEPHONE _____

	100 kHz	200 kHz	10µV	300Meg	Relative	Self-Diagnostic	Basic DC Accuracy
8060A	•	•	•	•	•	•	•
8062A	•	•	•	•	•	•	•

All prices are plus Sales Tax if applicable and subject to change without notice.

P.O. Box 30, Concord
 N.S.W. 2137
 13-15 McDonald Street,
 Mortlake, N.S.W.
 Telephone (02) 736 2888
 Telex 25887

P.O. Box 107, Mt. Waverley
 Victoria 3149
 21-23 Anthony Drive,
 Mt. Waverley, Victoria
 Telephone (03) 233 4044
 Telex 36206

Adelaide: (08) 271 1839
 Brisbane: (07) 369 8688
 Perth: (09) 398 3362



N.S.W. Ames Agency 699 4524 • George Brown 519 5855 • Davred 29 6601 • DGE Systems (049) 69 1625 • Radio Despatch 211 0191 • Vimcom (042) 28 4400 VICTORIA Radio Parts 329 7888 • Browntronic 419 3986 • G.B. Telespares 328 4301 • Elanco 428 4345 • Ellitronics 602 3282 QUEENSLAND L.E. Boughen 36 1277 • Colourview Wholesale 275 3188 • Audiotronics 44 7566 • Electronic Shop (075) 32 3632 • Nortek (077) 79 8600 • W.G. Watson (079) 27 1099 S.A. Protronics 212 3111 • Trio Electrix 51 6718 W.A. Atkins Carlyle 321 0101 • Hincoc Eng 381 4477 • Brookeades 276 8888 • Protronics 362 1044 A.C.T. Acltec (062) 80 6576 N.T. Thew & McCann (089) 84 4999 T.A.S. G.H.E. Electronics 31 6533 & 34 2233



Rod Irving's

WIDE WORLD OF COMPONENTS



Phone NOW!

425 High St. Northcote, Ph.: (03) 489 8131

SC141E	1.95	BF458	1.00	TIP122	3.45	2N5656	2.50	74109	.60	9305	2.40	8379	8.50	OPTO	OM350	16.50	4096	2.40	
SC142D	2.95	BF459	.90	TIP125	2.90	2N5770	.30	74110	.80	9307	3.80	8282	6.90	4N25	1.20	IM65X8CPE	5.00	4097	6.50
SC146D	2.85	BF469	.90	TIP127	3.40	2N5777	1.50	74111	.80	9308	2.60	8283	6.50	4N26	1.20	XR2206	6.50	4098	2.90
SC146M	2.95	BF470	.90	TIP145	3.40	2N5830	.30	74112	.80	9309	2.40	8284	8.50	4N27	1.20	XR2207	6.50	4099	3.90
SC150D	4.95	BF494	.90	TIP2955	1.90	2N5831	.30	74113	.80	9310	1.50	8286	6.50	4N28	1.20	XR2208	6.50	4104	6.90
SC151D	2.95	BF495	.90	TIP3055	1.90	2N5873	1.40	74114	.80	9311	1.50	8287	6.50	4N29	1.50	XR2209	5.90	4160	1.25
C103YY	.90	BFW10	1.50	2N301	4.00	2N5874	1.70	74120	1.65	9312	2.50	8288	25.00	4N30	1.50	XR2211	6.90	4161	1.25
C103B	.90	BFW11	1.50	2N697	1.00	2N5944	17.50	74121	.65	9313	6.00	8289	73.00	4N32	2.50	XR2216	4.90	4162	1.25
C106B	.90	BFW16	1.50	2N918	1.00	2N5945	21.00	74122	.65	9314	2.40	8291	43.00	4N33	2.50	XR2240	4.90	4163	1.25
C106D	.90	BFY50	1.20	2N1304	1.00	2N5946	22.50	74123	.60	9316	1.90	8292	34.50	4N35	2.50	XR2242	4.90	4174	1.25
C122D	2.50	BFX90	1.50	2N1613	1.20	2N5961	1.90	74125	.55	9317	4.20	8293-10	26.50	4N37	2.00	XR2243	5.90	4175	1.60
C122E	2.95	BU126	2.50	2N2102	1.90	2N6027	1.00	74126	.60	9318	4.60	8741	57.50	MCT6	6.90	XR8208	6.50	4194	1.95
SC260D	8.50	BU208	3.90	2N2219	.90	2N6049	1.90	74128	1.80	9319	2.00	8748	29.50	MCT66	1.50	IC67660	12.50	4402	1.00
SC260F	9.90	BU326	3.00	2N2222A	1.00	2N6080	8.50	74132	.80	9320	6.90	8749	58.50	MCT2	6.90	95H90	6.50	4404	1.15
2N2646	1.20	BUX80	4.90	2N2369	1.00	2N6083	17.90	74136	.55	9321	2.40	8755	33.50	1L074	5.90	11C90	16.50	4408	6.90
2N2647	2.50	MFE131	2.90	2N2484	1.00	2N6084	22.50	74138	1.80	9322	1.90	2911	26.50	1L074	6.50	LM7555	1.90	4409	13.50
2N6027	.90	MFE3001	9.90	2N2646	1.20	2N6124	1.90	74139	1.00	9324	1.40	2912	27.50	FND357	1.80	MC10116L	1.50	4410	11.50
		MFE3003	6.95	2N2647	1.20	2N6125	2.50	74141	1.10	9328	4.90	2920	239.00	FND500	1.80	LF13741	.80	4411	12.60
		MJ413	5.90	2N2894	1.00	2N6130	1.90	74142	1.45	9334	6.00	3205/8205	9.90	FND507	1.80	LF13741-H	1.50	4412	.45
AC125	1.20	MJ802	7.50	2N2904	1.10	2N6133	1.90	74143	1.45	9338	5.90	3242	17.50	FND800	3.50	DS75451	.60	4415	10.15
AC126	1.20	MJ901	4.50	2N2905	1.10	2N6256	16.50	74144	3.90	9340	9.90	3245	10.90	T1L31A	2.95	DS75452	.60	4416	.60
AC127	1.20	MJ1001	3.90	2N2906	1.10	2N6259	15.50	74145	1.45	9342	5.90	3628	18.50	T1L81C	2.95	DS75491	2.00	4419	3.45
AC128	1.20	MJ11011	9.90	2N2907	1.10	2N6274	29.50	74147	1.95	9368	2.20	8008-1	62.50	T1L306	14.50	DS75492	2.00	4422	9.50
AC187	1.50	MJ11015	14.50	2N3019	1.90	2N6378	4.90	74148	1.40	9374	3.30	8031-3	2.90	BPW50	2.25	7216A	41.50	4425	2.35
AC188	1.50	MJ11016	14.50	2N3053	.90	2N6425	5.90	74150	1.15	9386	2.40	8035	6.90	COY89	1.50	7216B	42.00	4428	1.75
AC149	3.40	MJ15003	6.50	2N3054	1.90	2N6578	4.50	74151	.60	75107	2.50	8039	7.90	MOC3011	2.95	DM2502	10.00	4433	2.25
AC161	2.90	MJ15004	6.50	2N3055	1.20	3N201	1.50	74153	.65	75110	2.50	FD1771	19.00	MOC3020	2.50	ADC0800	16.00	MC14433	13.90
AC162	2.90	MJ15024	10.00	2N3096	1.20	2SJA9	7.50	74154	1.15	75154	2.50	FD1791	39.00	MOC3021	2.95	ADC0808	17.00	4435	7.95
AF118	2.90	MJ2955	1.50	2N3109	1.90	2SK134	7.50	74155	.85	75450	1.50	FD1793	39.00	DAC0800	4.50	4441	1.50		
AF126	2.90	MJ3001	6.90	2N3251	1.90	7400	.25	74156	1.45	75451	.60	FD1795	39.00	DAC0808	3.50	4443	3.90		
AF127	1.50	MJ4032	12.50	2N3302	1.90	7401	.30	74157	.60	75452	.60	FD1797	39.00	3mm RED	.25	SAK140	9.50	4445	2.65
BC107	.50	MJ4035	11.90	2N3440	1.80	7402	.25	74158	.85	75453	.60	WD1691	16.50	3mm YELLOW	.30	ZN414	1.95	4446	3.55
BC108	.50	MJ4502	6.90	2N3441	2.90	7403	.35	74160	.85	75461	1.50	WD2143	12.50	3mm GREEN	.15	4000	.40	4449	1.00
BC109	.50	MJ5340	2.00	2N3442	3.50	7404	.30	74161	1.00	75462	1.00	WD1931	22.50	5mm RED	.15	4001	.40	4450	3.75
BC159	.50	MJE350	2.50	2N3563	.30	7405	.35	74162	1.00	75471	3.00	WD1933	34.00	5mm GREEN	.30	4002	.40	4451	3.75
BC177	.60	MJE371	2.90	2N3564	.30	7406	.40	74163	1.00	75472	3.00	WD1983	14.75	5mm YELLOW	.30	4006	1.60	4457	5.90
BC178	.60	MJE521	2.50	2N3565	.30	7407	.40	74164	.60	75491	2.00	WD1993	59.00	5mm ORANGE	.30	4007	.50	4458	14.90
BC179	.60	MJE700	3.50	2N3566	.30	7408	.35	74165	.60	75492	2.00	WD1213	26.50	RED RECT	.30	4008	1.40	4459	9.90
BC212	.30	MJE800	2.90	2N3567	.30	7409	.35	74166	1.35	75493	3.00	WD2050	16.50	GREEN RECT	.30	4009	.80	4490	5.90
BC318	.30	MJE2801	3.95	2N3568	.30	7410	.30	74167	2.20	75494	3.00	TR1602	8.50	YELLOW RECT	.30	4010	.70	4495	3.95
BC320	.40	MJE2955	4.90	2N3569	.30	7411	.35	74174	.45	8121	4.00	TR1863	8.90	RED CHROME	.30	4011	.40	4500	8.90
BC327	.30	MJE3055	3.90	2N3638	.30	7412	.35	74175	.85	8123	4.00	COM8116	24.00	BEZEL	1.20	4012	.50	4501	1.80
BC328	.30	MJE13005	5.90	2N3640	.30	7413	.30	74176	1.10	8130	3.00	BR1941	18.50	YELLOW CHROME	.30	4013	.75	4502	1.80
BC338	.30	MJE13007	7.90	2N3641	.30	7414	.70	74177	1.10	8131	3.95			BEZEL	1.20	4014	1.50	4503	.90
BC546	.40	MJE13009	12.50	2N3642	.30	7415	.35	74178	2.15	8135	4.25	74F00	.79	GREEN CHROME	.30	4015	.95	4504	2.00
BC547	.20	MPF121	2.50	2N3643	.30	7416	.60	74179	2.15	8136	5.50	74F02	.79	BEZEL	1.20	4016	.65	4506	.75
BC548	.20	MPF131	2.50	2N3644	.30	7417	.55	74180	.90	8303	6.90	74F04	.92	VOLTAGE REGS	.40	4017	1.50	4508	4.50
BC549	.20	MPSA05	1.00	2N3645	.30	7420	.25	74182	.90	8304	4.50	74F08	.79	7805UC	.90	4019	.80	4510	1.50
BC550	.40	MPSA06	1.00	2N3646	.30	7421	.40	74184	1.20	82S23	3.90	74F10	.79	7805KC	2.00	4020	.80	4511	1.50
BC556	.40	MPSA09	1.00	2N3702	1.20	7422	1.40	74190	1.00	82S123	4.87	74F11	.79	7812UC	.90	4021	1.10	4512	1.10
BC557	.20	MPSA10	1.00	2N3704	1.40	7423	4.5	74191	1.45	8311	3.83	74F20	.79	7812KC	2.00	4022	1.15	4513	2.65
BC558	.20	MPSA12	1.00	2N3739	4.50	7425	4.5	74192	1.65	8641	4.95	74F32	.79	7815UC	.90	4023	.40	4514	2.90
BC559	.20	MPSA13	1.00	2N3771	5.50	7426	3.5	74193	.80	8820	5.00	74F64	.79	7815KC	2.20	4024	1.00	4515	2.90
BC635	.80	MPSA14	1.00	2N3772	5.70	7427	.40	74194	1.10	8830	5.00	74F74	.89	7818UC	1.00	4025	.40	4516	1.45
BC636	.80	MPSA20	1.00	2N3773	5.90	7428	.40	74195	.65	8831	5.00	74F86	1.19	7818KC	2.20	4026	2.00	4517	8.75
BC637	.80	MPSA42	1.00	2N3792	6.00	7430	.35	74196	.85	8832	4.90	74F109	.99	7824UC	1.00	4027	.60	4518	1.50
BC638	.80	MPSA43	1.20	2N3819	1.20	7432	.35	74197	1.10	8833	5.90	74F138	1.79	7824KC	2.40	4028	.90	4519	.90
BC639	.50	MPSA55	1.00	2N3866	2.95	7433	.55	74198	1.10	8834	4.00	74F139	1.79	7905UC	1.40	4029	1.20	4520	1.55
BC640	.50	MPSA56	1.00	2N3904	1.00	7437	.40	74199	1.30	8835	2.00	74F151	1.79	7905KC	3.00	4030	.90	4521	3.90
BCY70	1.90	MPSA63	1.00	2N3906	1.00	7438	.45	74221	.90	8836	1.20	74F153	1.79	7912UC	1.40	4031	2.50	4522	1.90
BCY71	1.90	MPSA65	1.00	2N4032	2.20	7439	.70	74240	1.50	1488	2.50	74F157	1.79	7912KC	3.00	4032	2.25	4526	1.85
BD135	1.00	MPSA92	1.00	2N4033	2.20	7440	.45	74241	1.50	1489	2.90	74F175	1.79	7915UC	1.50	4033	2.25	4527	2.65
BD136	.90	MPSA93	1.20	2N4036	2.50	7442	.50	74242	1.50	81LS95	2.90	74F181	5.98	7918UC	1.50	4035	1.30	4529	1.80
BD137	.90	MPF102	.90	2N4121	1.50	7443	1.30	74243	1.50	81LS96	2.90	74F182	2.73	7924UC	1.50	4038	2.75	4530	1.60
BD138	.90	MPF103	.90	2N4123	1.50	7444	1.10	74244	1.75	81LS97	2.90	74F189	7.44	78L05	50	4041	1.40	4531	1.65
BD139	.60	MPF105	.90	2N4236	1.90	7445	1.												

COMPUTING TODAY

That was the PC show that was . . .

If you didn't already know, there's a new computer trade buzzword. It's 'pee see', or just PC on your user-friendly, sculptured-key, ergonomically designed qwerty keyboard. The 'first' Australian Personal Computer Show had them all.



Portable power. The Otrona 'Attache'.



Junior? National's JR.100 home computer.



Yes, Captain? Commodore's latest — the Commodore 64.

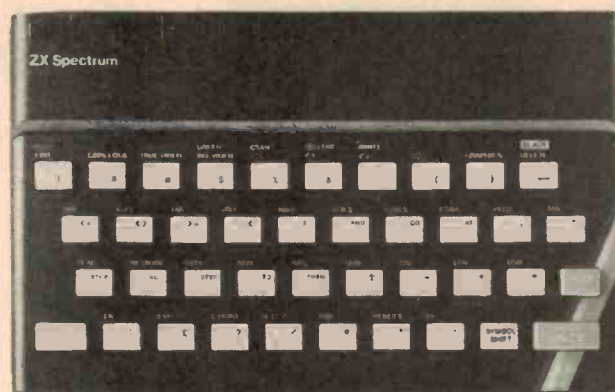

Colourful. The Sinclair Spectrum, here at last.

Crowded into three days in March, and crowded into three levels of the convention centre at Centrepoint in Sydney, the show attracted over 50 000 computer voyeurs who pushed, POKEd, RAMmed, PEEKed, BRUNned, asked questions, took brochures and generally got into it. (Thank go for press passes or I'd never have got the kids in . . .)

Every PC worth its salt was there, plus every imaginable peripheral, attachment, inputter, outputter and set of software imaginable . . . and some that weren't.

Not to be overwhelmed by myriads of imports, several Australian manufacturers were there. Applied Technology released the 64K MicroBee (with CP/M 2.2 et al) and the Colour-Bee. The latter was perpetually surrounded six-deep by school kids.

RDM Computers showed their all-singing & dancing single board computer featuring a Z80 running at 4 MHz, 256K of RAM and numerous ports plus STD buss expansion. It supports both 130 mm and 200 mm disk drives with disk formats for the Osborne 1, ICL PC and a few others. Display is standard 80 x 24, plus hi-res graphics. You can run CP/M, MP/M and Turbodos. Basic board costs just \$950!

Amongst the 'home' PCs, were Commodore with the new 64, The Computer Company with National's JR100 (16K RAM, 8K BASIC, 45-key keyboard, graphics, RF output, et al), Barson Computers with the Sinclair ZX Spectrum and the Acorn Atom. Apple trotted out the Ile (64K RAM, 80 x 24 display, etc).

Portable computers are obviously the 'coming thing' in one sector of the market. Elmeasco showed the Otrona, Sharp showed their handheld PC range, Hewlett Packard had the HP-75 on show with some really 'smick' software and Warburton Franki heavily promoted Epson's new QX-10 and HX-20 portables (featuring LCD displays . . .).

The 'big boys' threw their busses around and flexed their memories. Wouldn't you know it, the IBM PC was there, represented on about half a dozen stands apart from IBM's. DEC occupied a corner with their latest systems — or was it a corner and two walls? H-P had their new 68000-based machine on show.

NEC had ranks of their Advanced PC demonstrating themselves (leaving the salesmen free to sell). If you've never seen the Advanced PC's graphics demo, you've missed one of life's great experiences.

Mitsui, not content with showing one machine, showed three new Sords. Flagship was the 16-bit 8086-based M343, with arithmetic co-processor and Z80 'housekeeper'. Talking of 16-bit machines, they're everywhere.

A.E.D. decided some public education was in order and ran a series of seminars on their new machines (more native technology).

Attracting a lot of attention was a large-screen display video demo for the Apple Lisa. If that's the shape of things to come, 'mice' will reach plague

proportions within a few years.

If you wanted a printer, they were on show in every conceivable shape, size, configuration and cost. If you wanted something a little out of the ordinary, robots were shown by both Elmeasco and Jaycar (who had the Powertran Genesis and Micro-Grasp).

At this stage, we're running out of space . . . so we bid farewell to Balham's PC show as the nursemaid reads the brochures to her pre-school charges: . . . with one bound he was by her side. He planted a hot 1Kbyte on her buss as he ripped the . . .



Serial-parallel and parallel-serial converters

Alfatron, the Melbourne-based computer hardware company, has released a line of serial to parallel and parallel to serial converters for use on RS-232 and Centronics type communications channels.

The AL range is designed to go from a serial RS-232 input to a Centronics parallel output. They are available with 256, 1024 and 2048 character buffer built in and can handshake using XON/XOFF or hardware control.

The units are designed to power themselves completely from the Centronics side if possible (requires 5V at 400 mA). If no power is available from the Centronics port then power may be provided with an optional plug pack.

The serial channel has baud rates switch selectable from 110 to 9600.

Mounting of the units is facilitated with the use of self-adhesive 'Velcro' strips that allow removal of the unit from its mounting for service or altering switch settings. The switches have been deliberately mounted internal to the case to prevent tampering once they are set as

these units have been designed to be placed in service and forgotten.

The CS-256 converts a parallel Centronics style output to a serial RS-232 output. This is especially useful when a printer needs to be a long distance away and only a parallel port is available.

The AL series of converters will directly interface with the CS-256 (back to back) to allow a parallel printer to be driven a long way from the source over a three wire link using RS-232. The handshaking in between will be transparent to the printer and driving system.

An additional advantage is that the units can be optionally programmed to provide protocol conversion.

Details from Alfatron Pty Ltd, 1761 Ferntree Gully Rd, Ferntree Gully Vic 3156. (03) 758-9551.

GaAs and CMOS gate arrays

Toshiba has developed ultra high-speed Gallium Arsenide and CMOS gate arrays.

The GaAs gate array LSI chip has an operating speed of 80 ps, which is about five times faster than an ECL device, and a power dissipation of 0.2 mW.

To make a chip with such low power consumption the active layer coating the whole surface of the substrate had to be as thin as 0.1 micron. Toshiba developed the 'Pt bury gate electrode' technology which made it possible to form a 0.1 micron active layer.

They are now using this technology to build a gate array with about 2400 elements and 500 gates on a chip of about 16 mm.

The CMOS gate array has about 88 000 elements integrated on a chip in an area of 10 mm with 20 010 gates. The gate array is equivalent to about 2000 TTL ICs in terms of integration.

ACICS appointed as national IBM PC distributor

Australian Consolidated Industries Computer Services has been appointed national distributor for IBM's new personal computer.

Mr A. K. Klingender, ACICS General Manager, said the company would draw upon its extensive experience in data processing for major Australian and international companies to provide specialist hardware and software support and backup.

"IBM has selected us as the national distributor because of our familiarity with the computing needs of the business and professional community, and experience of our staff in servicing often very complex data processing requirements," Mr Klingender said.

He added that ACICS had augmented the basic software packages with a carefully-selected range of business packages.

Software would be drawn from a number of overseas and local suppliers, which provided cus-

tomers with a great deal of flexibility, Mr Klingender said.

"Since the new personal computer can also function as a terminal to a mainframe computer, we will be carrying data banks of business information to be assessed by IBM PC owners.

"Naturally, we will be happy to sell a PC for any purposes, but we believe our market strength lies in the business and professional area," he added.

Mr Klingender said ACICS would promote the product in non-technical terms, highlighting the utility and usefulness of the PC, and the comprehensive service and software backup available nationally.

The company would also offer training programs and user-information updates on a regular basis.

High speed letter quality printer

Datatel Pty Ltd has announced the release of a high performance 18-needle matrix printer which gives letter quality printing at 110 char. per sec., and doubles as a data output printer with a rate of 400 char. per sec.

The Swiss-made Wenger 4/1 features a high standard of letter quality printing, supported by precision engineering and powerful hardware and firmware.

The printer utilises an 18-needle staggered or in-line printhead, is bi-directional and logic seeking, and produces letter output in a single pass at 110 char. per sec.

Paper transport is both by tractor and friction feed, and a sheet feeder is optional. Up to five resident character sets may be down loaded into the printer, and 136 columns at 10 char. per inch are accommodated in a single line.

Compressed printing and proportional spacing is also available. Left and right margins and tabulation points are programmable, as are forms length, print zone and perforation skip.

Text may be printed as underlined, elongated, compressed, double intensity as well as half

line feed forward and reverse. Multi-colour printing is provided as an option, using four basic colours.

Further options include block graphics, vector graphics and bar code printing.

The standard printer is fitted with a 5K buffer, which may be expanded to 40K. Self diagnostics, confidence testing and printout of configured character sets is available during the self test function.

Interfaces include RS232, RS422, current loop and industry standard parallel. A range of switch selectable serial interface handshake protocols is also available.

The manufacturer claims exceptionally low noise performance to maintain high comfort levels in an office environment.

Further details are available from Datatel Pty Ltd, 19 Raglan Street, South Melbourne Vic. 3205. (03) 690-4000.

New Apple III disk drives

Two high-density floppy disk products, Unifile and Duofile, which provide new mass storage options for the Apple III personal computer, have been introduced by Apple Computer.

Apple claims that the drives ensure a greater integrity of data than other high-density drives by way of a unique, double-sided mechanism designed and manufactured by Apple.

Unifile is also designed to serve as the ideal backup for Profile, which allows the user to backup to one location information that would fill 35 floppy diskettes. Unifile requires only six diskettes to back up the total contents of Profile. It also takes advantage of Backup III, a new software utility that selectively backs up and restores Profile's files.

The systems are equipped

with a doorless self-ejecting mechanism that eliminates the chance of errors that occur when disk drive doors are opened while writing data to a diskette. Unifile is designed to fit between the Apple III and the Apple III monitor.

Apple claim that the 871 disk drive is the first high-density, double-sided disk drive mechanism to be built specifically for personal computer applications.

For more information contact Electronic Concepts, Apple's Australian distributor, at 55-57 Wentworth Ave, Sydney NSW 2000. (02) 212-2833.

Add bar code to RS-232C terminals

Bar code data input may now be easily added to VDU terminals operating in RS-232C systems with the Databar 401V Bar Code reader.



The bar code reader receives and retransmits all data from the terminal keyboard without change and as it is connected through a patch cable no modifications are necessary to either the computer or terminal hardware or software.

To allow its use in a wide range of operating systems and hardware configurations, a selectable inter-character delay is available in 10 ms increments to a maximum of 150 ms.

Data transmission rates from 110 baud to 9600 baud are also switch selectable.

The Australian designed and

manufactured Databar 401V Bar Code Reader is available with any of the commonly used bar codes. Depending on the code selected, the reader may perform a check digit calculation before transmission, transmit or ignore start-stop characters or test for a specified message length.

Bar code readers are commonly used in libraries, blood banks and other organisations requiring fast and accurate data entry to a computer system.

Enquiries to Harold Norrie, Nortronic Instruments, Box 995, GPO Sydney 2001. (02) 290-2844.

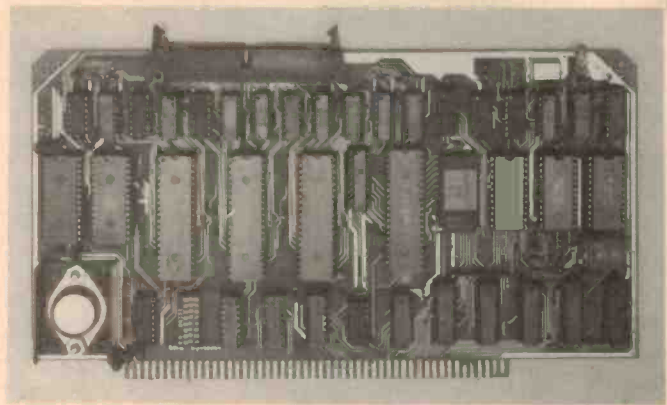

Multichannel intelligent RS232 I/O card

SME Systems has released the MPC-6 Dartbaud, a Z80 based six channel I/O card.

It is designed for use in multiterminal systems or industrial monitoring situations where fully buffered peripheral devices can be connected to the system.

It provides against loss of data due to latency in the main processor by buffering data in both directions through 6K of CMOS on-board memory (battery backed). This facility also ensures that the MPC-6 will continue from where it was interrupted once power is restored.

Each of the six channels can have independent baud rates set by the control program on power up. These can be changed by the host processor. Default parameters can be altered simply by

issuing 'OpCodes' to the control port which will be interpreted by the on-board processor as instructions to perform certain tasks. It is possible to change or reset parameters 'on-the-fly'.

Some of the directions that can be given by the host CPU are to redirect data from one channel to another, alter baud rates of individual channels and alter buffer size allocations to each channel in 128 byte increments.

The boards are S100 bus compatible, supplied assembled and tested and are backed by an unconditional 90-day guarantee.

SME Systems are at 22 Queen St, Mitcham Vic. 3132 (03) 874-3666.

A gay holiday with a camp computer

The proprietors of Morton Park Farm, a stud property near Moss Vale in NSW, are now offering 'Compucamps', a variation on their usual camping holidays for young people.

Their new project is a camping adventure in the world of microcomputers and is intended primarily for high school students. It is a camping holiday but at the same time the students will gain 'hands on' experience in the use of micros from basics to advanced applications.

Six computer stations will be available for individual practice and instruction. There will also be films, lectures and demonstrations and, of course, recreational activities.

The microcomputers are from the OKI range and are fully supported with an OKI/Microsoft enhanced BASIC language and the CP/M operating system. Disk

and cassette storage media will be operated.

Most of the equipment was purchased from Sigma Data Corporation which is assisting with the installation of the hardware and training.

Future plans involve using the wider range of software and hardware available to business users as a basis for an agricultural orientated course for local farmers.

Weekday courses for school groups or weekend courses for individuals can be booked by contacting John Molloy at Morton Park Farm, Foxgrove Rd, Canyonleigh NSW 2577. (048) 78-9132.

Colour graphics terminal

The 2405 colour graphics terminal from Anderson Digital Equipment features an 80-column, 24-line alphanumeric and graphics display on a 13 inch CRT.

It is a new single-board terminal using the 8085 microprocessor. It has a 6 x 12 dot character matrix, 36 programmable functions, 4K screen refresh RAM and 8K EPROM for the operating system.

To find out more about the new 2405 colour graphics terminal contact your nearest ADE branch in Australia or New Zealand or 14 Whiteside Rd, Clayton Vic. (03) 544-3444.

4M bubble memory pin compatible with 1M

Intel's new 7114 is a VLSI magnetic, non-volatile, bubble memory chip which has a storage capacity of four million bits.

The 4M 7114 is 14.6 mm x 13.5 mm which is smaller in size than the 1M 7110.

The 7114 and support circuits are pin-compatible and directly upgraded from the 1M architecture. Motorola has agreed to alternate-source the Intel 7110.

Initially the 7114 will have an average access time of 80 ms and a data transfer rate of 200K per second. A high performance version, the 7114A, will have a

40 ms average access time and a 400K per second data transfer rate. This performance equals four 7110 1M devices operating in parallel.

Production and distributor stocking of the 7114 will take place in the second half of 1983. More information can be obtained from **Total Electronics, 9 Harker St, Burwood Vic. 3125. (03) 288-4044.**

Text editor/word processor for Commodore VIC

The Microcomputer House developed VIC-TEXT because there was no text editor/word processor available for the Commodore VIC.

The VIC-TEXT cartridge, incorporating 8K of RAM, is a professionally written package, programmed in machine code for maximum speed and efficiency.

It costs \$149 and can be used as a second word processing system at home. The prepared disk can then be taken to the office where a compatible system can edit it, format and print it.

VIC-TEXT features full cursor control by character, word or line, deletion, restore deleted text, duplicate text, tabulations, right justification when printing, programming the text editor, searching for a word, etc.

Microcomputer House can be contacted at 116 Abercrombie St, Chippendale NSW 2006. (02) 698-7076.

Downturn in sales of video games

ROM suppliers are concerned with the apparent dip in the once booming sales of video games.

Warner Communications put Wall Street in a spin by announcing that its sales of video game cartridges were 'disappointing'. Then Mattel announced that it

was expecting to make a loss.

After these announcements stocks of all videogame manufacturers, home computer manufacturers and semiconductor companies that supply parts to both went into a sharp decline.

Semiconductor companies maintain, however, that their orders for ROMs from video game makers have not declined.

HARD STORAGE

with the

HDU-1001

10Mb HARD DRIVE/FLOPPY SUBSYSTEM.

SME presents the HDU-1001 a hard working hard drive unit with 10 Megabytes of Winchester based disk storage backed up by a 1 Megabyte 8" double sided floppy.

Built around Tandem's sturdy TM603S mini-Winchester drive coupled to an 8" QUME floppy the HDU-1001 gives you the storage capacity you need to handle large data base applications; the ability to transfer data to and from the hard disk; and back up facilities all in one compact package.

Employing the latest bit slice technology the HDU-1001's Winchester drive controller offers rapid reliable data collection, micro diagnostics for fault finding and error detection, plus the option to add another 10Mb of storage with the addition of another Winchester drive.

Housed in a rugged steel based, aluminium bodied enclosure the HDU1001 is rack-mount compatible and is supplied fully tested and ready to go to work for you ... hard.

SME SYSTEMS

22 Queen Street,
Mitcham,
Victoria, 3132.
Telex:
SMELEC AA37213

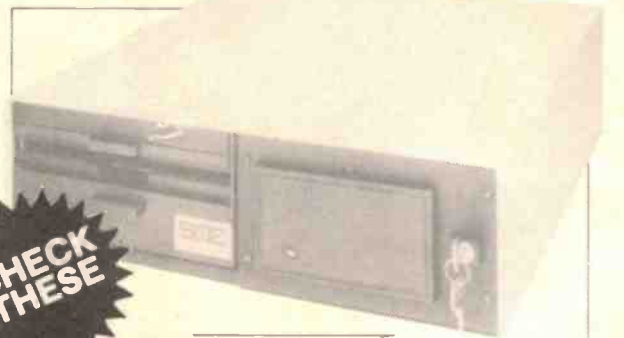

CHECK THESE

FEATURES

- 10Mbyte Winchester Storage.
- 1Mbyte 8" double sided floppy disk.
- Internal Winchester controller.
- High speed data throughput.
- Very quiet operation.
- Separate 50 way connector interface.
- CP/M 2.2 and MP/M 2.2 available.
- Designed and manufactured in Australia.

SME 448

16-word by 4-bit port RAM

Fairchild's 29F705 is a 16-word by 4-bit port RAM with tri-state output.

This RAM features two separate output ports such that any two 4-bit words can be read simultaneously. Each output port has a 4-bit latch with a common latch enable (LE).

The device has two write enable inputs (WE) and is designed such that the write enable (WE1) and latch enable (LE) inputs can be wired together to make the operation of the RAM appear edge triggered. Also the A latch can be forced to zero using the A-LO input.

The device has a fully decoded

4-bit A-address to select any of the 16-memory words through the A-output port.

Likewise a 4-bit B-address input is used to simultaneously select any of the 16-memory words through the B-output port. New incoming data is written into the RAM location selected by the B-address.

More information about this device is available from **Fairchild Australia Pty Ltd, 366 Whitehorse Rd, Nunawading Vic. 3131. (03)877-5444.**

New software source for Commodore computers

A new software company, Acme Software, specialises in programs for the Commodore range of microcomputers.

They have four programs available now for the VIC-20 computer and they plan to have more titles soon.

Locomotion is a game based on a railway network where you have to keep the trains on the tracks, avoiding collisions and derailments.

Up to nine players can play Vic-Derby which simulates real horse racing.

Sentinels is a game which uses 3-D sentinels to block your path and keep your score down.

Vic-Voice is a machine language program which shows how pseudo voice synthesis can be achieved by using the standard VIC electronics.

Acme Software requires at least an additional 8K of memory, in addition to the VIC's standard memory, to operate.

The programs, with instruction manual, cost \$20 each and can be obtained from most VIC dealers or **Acme Software, P.O. Box 1053, Richmond North Vic 3121. (03) 41-5708.**

Club Call

The Sydney Forth Group has recently been established to promote the use and understanding of the Forth computer language. The group will meet on the second Friday of each month at 7pm in room LG16, Morven Brown Building (opposite the library), University of New South Wales.

The next meeting of this group will be held on Friday April 15 which, if you checked your calendar like I did, isn't the second Friday of the month. To find out about this or for any information contact Peter Tregeagle, 10 Binda Rd, Yowie Bay NSW 2228. (02)524-7490.

The Commodore User's Group in Queensland has changed its postal address to P.O. Box 274, Springwood Qld. 4127. The President

of the group is Greg Perry and meetings are held on the first Tuesday of the month at 130 Petrie Terrace, Brisbane. There's easy wheelchair access to the room, for those who require it.

The group is for the owners of Pet/CBM and VIC-20 machines and is endeavouring to meet the needs of the new CBM-64 owners. If you have any questions contact the secretary/treasurer, John Egan, on (07)287-2705.

A Super-80 User's Group has started up in Perth, Western Australia. To contact the group get in touch with either Garry Black, 19 Bendigo Way, City Beach WA 6015. (09)385-8813 or Geoff Dixon, 13 Adross Way, Noranda WA 6062. (09)176-7662.

GEMINI VIDEO BOARD

2 Video Boards in One!

8 Colours of 640 x 200
AND
80 x 25 Alpha Numerics

GRAPHICS:

- 640 x 200 Resolution (or programmable)
- 8 Colours (or three independent planes)
- TTL outputs; red, green, blue, hsync, vsync, composite sync
- Alternative format: 2 banks used to give 640 x 400 monochrome in memory (not all 400 lines are displayed together).
- Some of the onboard graphics commands:
 - Set Drawn Mode (set, clear, toggle, move)
 - Draw point (x, y)
 - Draw Line (x₁, y₁, x₂, y₂)
 - Draw relative (Δx, Δy)
 - Fill page with colour pattern (in 20mst)
- Single high quality S-100 Board
- 4MHz Z80 — A on board
- 64K Video memory (48K graphics, 16K text)
- 2K RAM for the CPU (will fit 8K)

\$680 + 20% sales tax

Assembled and Tested 90 day warranty.
Manual only \$10 refundable with board purchase. Enquiries to:
BISSHOP SYSTEMS
P.O. Box 483 Leichhardt 2040
or phone: 569 3389

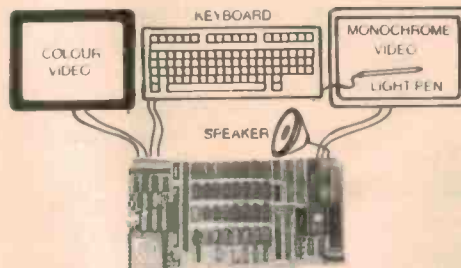

Surely the most versatile S-100 video board available
Add a keyboard, a lightpen, and video monitor to make a complete graphic terminal.

ALPHANUMERICS:

- Up to 16K EPROM (2716, 2732, 2764, 27128)
- 8-BIT keyboard port with type-ahead buffer
- Command buffer of 256 characters
- Programmable refresh rate — 50Hz at power-on
- Provision made for external synchronisation
- Hardware pan & scroll on graphics and text
- Software control of most video parameters: Horizontal & vertical synch position and width, number of lines & columns, cursor position & type, start address of page
- 3-octave tone generator: play (note, duration)
- Text & graphics can be overlaid and separately erased
- Flicker-free screen updating
- Not memory mapped — simple 2-port interface with any address selectable means no host memory space is used
- Conforms with the proposed IEEE 696 standard
- Bank any number of boards together for more colours

- 80 x 25 format, or programmable
- 256 characters in software-programmable character generator
- Power-up character set same as ITOH 8510 printer (including line drawing)
- Light pen interface — power and strobe
- Composite video or TTL video and hsync, vsync and composite sync
- 16K of text memory makes over 8 pages of 80 x 25
- Cursor and start (top L.H. corner) can be anywhere in the 16K
- Includes emulation of hazeltine® Esprit
- Future emulations: Tektronix 4010, DEC VT125
- In future a small add-on board will provide 8 bits of text attributes for every character — flashing, half-intensity, underline, inverse, etc, using one of the three graphic banks.
- Dot clock can be changed by replacing a cheap (C.B. radio) crystal
- You can write your own Z-80 software to install onboard

Intel releases high performance Multibus extension for fast access to local memory

Intel Corporation has announced a new iLBX buss extension to the company's well-known Multibus that allows a microprocessor to access up to 16M of local system memory at very high speeds.

The new iLBX (for Local Buss Extension) definition is compatible with and uses the P2 connectors of the existing Multibus connector layout on board-level products.

The new iLBX buss is optimized for high-speed, high-bandwidth system memory transfer such that it can be used with existing and planned 8- and 16-bit microprocessor-based single board computers and with current and future high-density memory products.

For example, the new iLBX buss allows data transfer at the rate of 9.5 megabytes per second for 8-bit data, and 19 megabytes per second for 16-bit data.

The new iLBX buss is the fourth part of Intel's buss architecture for single and multiple board-level systems.

Earlier buss specifications include the Multibus (now IEEE standard P796) system interface buss, the iSBX (now IEEE standard P959) single board expansion buss and related multimodules, and the multi-channel high-speed, general purpose data path between a microcomputer system and up to 15 direct memory access (DMA) devices.

"The new iLBX buss exten-

sion rounds out our approach to buss architecture", said William W. Lattin, vice president and assistant general manager of Intel's systems group.

"Moreover, it continues the trend toward specialization of buss architectures that will be required to handle rapidly advancing Very Large Scale Integration (VLSI) technology. The iLBX buss extension will carry the basic Multibus approach through at least the next three generations of random access memory".

The development of new, high-performance microprocessors has been responsible for expanding buss architectures, such as that reflected in the new iLBX buss extension.

Earlier microprocessors, such as the Intel 8080 8-bit device, could directly access only 64K of system memory. The second generation Intel 8086, however, can directly access 1M, and the recently introduced third generation iAPX 286 can access 16M of physical system memory.

As a result, systems are being designed that use large amounts of local memory. Applications include graphics display, robotics, office and business systems, and CAD/CAM.

While advancements in memory technology have resulted in high-density memory devices such as the 64K dynamic RAM, microprocessor addressability has advanced at a faster rate.

Using 64K dynamic RAMs, for example, only approximately one-fourth of a megabyte of local memory can be placed on a typical single board computer. Configurations using large amounts of system memory require the use of separate memory boards.

The iLBX buss architecture provides a direct specialized link between up to five iLBX compatible processor and memory boards.

Because it is optimised for system memory applications, the iLBX buss provides a designer with the equivalent of up to 16M of virtual memory addressability and no-wait-state performance for new, high-performance microprocessors.

In 1982 the market for single board computers was estimated by Intel at about \$375 million in sales revenue, approximately one-half of which was Multibus compatible. By 1985, according to Intel, the value of revenues is expected to grow to almost \$800 million, with Multibus compatible products expected to maintain an approximate 50% share of market.

Currently, approximately 150 different firms supply over 1000 different Multibus-based products.

Details from Total Electronics, 9 Harker St, Burwood Vic 3125. (03) 288-4044.

New address for MicroPro design

The new address for MicroPro Design is 1st Floor, 192 Pacific Hwy, Greenwich NSW 2065. (02) 438-1055.

The entrance is in Bellevue Avenue.

The postal address remains the same, P.O. Box 153, North Sydney NSW 2060.

AED Universe Computers for Tonga

AED Microcomputer Products has been awarded a large contract to supply a number of multi-user Universe Supercomputer II microcomputer systems to Tongan government departments.

Multi/OS is the operating system which will be used mostly. The Universe computer provides both 8- and 16-bit facilities in the one computer.

AED will install the systems on site and provide extensive technical and non-technical operator training. Several on-site maintenance personal will also be trained.

For further information about these systems contact AED Microcomputer Products, 130 Military Rd, Guildford NSW 2161. (02) 681-4966.

Micronix to distribute ADA subset compiler JANUS

Queensland-based Micronix has been appointed Australian distributor for RR Software's ADA subset compiler called JANUS which provides programming features like walk-back, re-entrant initialised variables, true modular programming and full error messages in English.

The compiler package comes with a large set of tools for program development. In addition to the compiler, the package includes an assembler for the target machine, the JANUS linker, a disassembler, a cross reference generator, a syntax checker, example programs and the source code for the runtime libraries.

What's more, the package also includes full documentation and you can get a full screen editor, ADA textbooks and other tools.

The JANUS compiler and assembler produce relocatable code files. The linker combines the relocatable files into target machine code files. All code generated by the JANUS compiler can be stored in ROM and is re-entrant.

Code generators are currently available for 8080, Z80 and 8086/8088 microprocessors.

Further details from Micronix, 11 Blackmore St, Windsor, Qld. 4030. (07) 57-6999.

Apple Signal Conditioners ISAAC 41A

Bell & Howell have available the low cost ISAAC 41A system which interfaces directly into an Apple microcomputer.

The basic ISAAC 41A includes the Apple interface, distribution panel, test kit, Labsoft programming language and instruction and reference manuals, turning the Apple into a powerful laboratory or process micro.

A system can be configured using any four combinations of 16 channels A/D, four channels D/A, 16 bit in and 16 bit out.

A further enhancement is to use the Remote Input system to

configure for low level signals such as transducers, thermocouples, etc.

Together with the Apple, the system can be used in chemical, engineering, psychology, physiology and process applications.

For further information contact Bell & Howell Australia Pty Ltd, Electronics & Instrumentation Div, GPO Box 4788, Sydney NSW 2001. (02) 660-5366.

Five books for TRS-80 users

The Richcraft Engineering Co of New York has produced a series of five volumes for users of the Tandy Mod I and Mod III.

The material is also applicable to the Dick Smith System 80.

Volumes 6 and 7, which are in preparation, feature the ultimate radio teletype program and packet radio.

The books cover little known functions of the Microsoft ROM, Morse, RTTY, ASCII, Bulletin Board, analogue and digital conversions, satellite locator and a host of other interesting and useful programs.

They were originally intended to be tutorials for student machine language programmers. They contain information for programmers, amateur radio operators or users of these computers who are not interested in these fields.

The programs are mostly in machine language and, for those who do not wish to enter the programs themselves, single sided disks are available covering each volume. Mod III disks are available for vol 5 only. All disks are compatible with TRSDOS and NEWDOS 80.

For the amateur radio operator these books represent the least expensive way of getting into computer operated morse, RTTY and ASCII.

Simple interface circuits for the Mod I are available. Minor hardware and program alterations for the Mod III are fully covered in the text.

Northern Digital, P.O. Box 33, Charlestown NSW 2290, is the Australia and New Zealand distributor of these products.

Intelec address

Intelec Data Systems has moved to 217 Blackburn Rd, Mount Waverley, Vic. 3149. (03) 233-1844.

The new larger premises cater for demonstration, training and support facilities of the Charles River Universe 68 computer system together with the Charles River DEC based systems, Servogor Plotters and Data-media Video Display Terminals.

Expansion chassis for VIC20

An expansion chassis unit for the Commodore VIC20 is available from Seahorse Computers.

It fits into the VIC20 expansion slot and provides sockets for up to four memory expansion

modules or ROM cartridges.

This well-made unit from DATA20 is available for \$59.95 plus \$1.50 post and packing from Seahorse Computers, 10 Mitchell St, Camden NSW 2570. (046) 666-406.

UniFLEX on Pennywise systems

Pennywise Peripherals, Australian manufacturers of 6809 microcomputer systems, has just completed a licensing agreement with TSC to run UniFLEX, the UNIX-like multiuser, multitasking disk operating system.

Each intelligent peripheral controller has an on-board 6809 with a DMA channel to main memory. The intelligent disk controller controls both floppies and hard disks, together with a serial and parallel printer. The intelligent VDU controller can handle up to five VDUs. Any number of controllers can be installed.

Pennywise Peripherals offers systems with dual double-sided, double-density eight inch floppies

and an optional five inch Winchester disk up to 20M. At present an interface is being developed for eight inch Winchester which are available with over 100M.

UniFLEX languages include Pascal, BASIC, Fortran, Cobol, C and Assembler.

For more information contact Pennywise Peripherals, 96 Camberwell Rd, Hawthorn East Vic. 3123. (03) 82-2389.

How can I write better software, faster? Write it in BASIC/Z!

BASIC/Z. A new standard in compilers for the CP/M system. BASIC/Z is the most powerful implementation of the BASIC language available. BASIC/Z generates executable machine code compatible with 8080, 8085, Z-80 under CP/M 80 and 8086/8088 processors under CP/M 86 and MS-DOS.

Syntax testing as you type. BASIC/Z has a powerful program editor with built in syntax testing as you type. Time saving features include global search and replace, fifteen local edit commands and extensive debugging facilities. Line trace, error line retention, and the unique ability to 'single step' a program with a continuous display of selected variables are just a few of the features which will save you time.

Multitiered error handling allows your program to trap logical errors, including previously fatal BDOS errors. Only BASIC/Z can trap that 'BDOS ERROR ON A: READ ONLY' before it happens.

Printer/terminal customizing is built in. The runtime library of BASIC/Z (included in the package) includes installation routines for the majority of CP/M machines on the market. Your software will have near universal application without further modification. Just one set of programs will run on practically any hardware.

Unsurpassed accuracy. Floating point numerics with a range of 1E-61 to 1E+61, with a choice of precision from six to eighteen digits. All floating point maths are performed in decimal (BCD), avoiding rounding off errors.

Powerful executive functions aid programming. Using SORT, it can sort 2,000 elements in two seconds. User defined functions are fully recursive, support multiple arguments and may contain an unlimited number of statements.

No Royalties. BASIC/Z has no royalties nor runtime charges. The license agreement confers the right to distribute support software such as the BASIC/Z runtime module and the installation hardware configuration utility, subject only to specified copyright acknowledgements.

What does it all cost? BASIC/Z documentation & Software: \$495* inc. tax. Available from your computer supplier or from Software Source direct. Available on 21 days approval (if software seal not broken). Or clip out the coupon and send in for further details.

CONVENTIONAL COMPILER

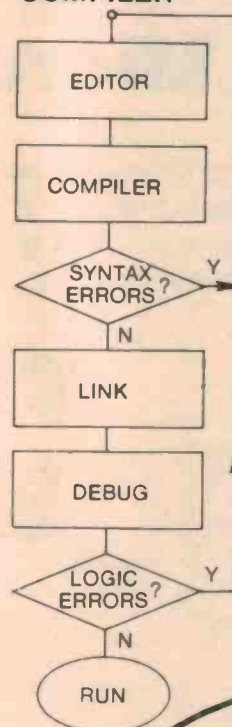

BASIC/Z

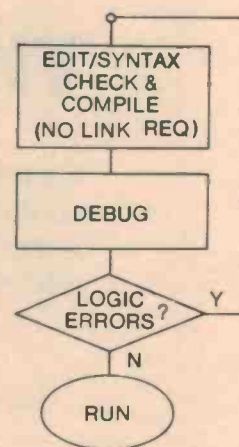

BASIC/Z produces direct machine object code, NOT P-CODE. It is better and faster than CBASIC or Microsoft BASIC.

Software Source Pty Ltd
 PO Box 364 Edgecliff NSW 2027 Phone (02) 389 6388
 Please send me further information on BASIC/Z
 Name _____ Address _____



Taking a leaf from the Apple tree —

The Microprofessor II

Clearly marketed as a strong contender in the home/educational computer market, Multitech Industrial Corporation's latest offering is a colour computer featuring Apple BASIC software compatibility, 64K of RAM on-board and plug-in ROM-based software.

**Roger Harrison
Jonathan Scott**

THERE HAS BEEN much controversy over the past year about 'clones' or copies of the highly successful Apple II appearing on the market. The US-based Apple company has been vigorously pursuing the protection of their rights in Taiwan, Hong Kong and Japan in an effort to stamp out the manufacture and distribution of machines which are both hardware and software copies of the Apple II.

The Microprofessor II is *not* one such beast. Its link to the Apple II is via the BASIC compatibility that Multitech claim for it and some hardware similarities.

Compared to the Apple II, the MPF II

is positively leprechaun-ish, measuring a mere 175 mm wide by 241 mm deep by 30 mm high! At the front is a scaled-down, calculator-type keyboard with 49 keys in the familiar QWERTY layout. This keyboard has a 'standard' overlay showing all the 'shifted' functions available which includes one-key BASIC commands (after the fashion of Sinclair's ZX81 and Spectrum). An overlay for special graphics symbols is also supplied.

Located down the left hand side of the machine are a number of connectors: at the rear is a 50-pin socket that is similar to an Apple II 'slot'. Just in front of that is a

Centronics-type parallel interface socket for a printer and forward again of that is another, similar socket, for either a remote keyboard or a joystick controller.

On the rear panel is the power supply connector, cassette recorder connectors, TV output (from an RF modulator) and a direct video output (monitor).

The MPF II comes with 64K of RAM, 16K ROM with operating system (OS), monitor and BASIC. The video display is memory-mapped into system RAM and, like the Apple II, you get text, low-res and high-res graphics. The screen format on text is the same as the Apple's — 40 columns by

24 lines, as is the character set — standard ASCII, 64 characters 5 x 7 dot matrix. In low-res graphics mode you get a 40 x 48 array (1920 blocks); in high-res you get a 280 x 192 array (53 760 dots). Six colours can be called on the video display: black, white, green, purple, orange and blue (although black and white are not colours as such).

In low-res graphics mode, you can colour your blocks using any of those colours, anywhere on the screen. In high-res graphics mode dots in the even-numbered screen columns can only be coloured black, blue or purple while dots in the odd-numbered screen columns can only be coloured black, green or orange.

A speaker is housed in the top of the MPF II case, at the right rear. You can address the speaker from software to create sounds.

A remote full-size keyboard is available as an option and one was supplied as part of the review equipment. This has switches beneath rubber keys and, frankly, we found it terrible to use. It is a 55-key unit in the general QWERTY layout with two FIRE keys at either end of the base row.

The cursor control keys are not only non-standard but difficult to use with left and right keys duplicated on different ranks. All the 'shifted' functions are printed either on the keyboard face or the keys themselves, including the special graphics characters. That's a saving grace, but the key operation is where it falls down.

All is not lost, though. It seems a 'proper' keyboard is on its way and should be released around mid-year.

Software in ROMs is available and come in a plastic pack that simply plugs into the 50-way connector. We received a number of ROM software packages with the review equipment: Space Invaders, Rain (rather like 'Galaxians') and a demo pack. A word processing package is to be released shortly, we understand.

A disk drive, or dual disk drive, can be obtained for the MPF II. Either plugs into the MPF II via an interface unit that slips into the 50-way connector. We received a single disk drive unit with the review equipment with which we were able to assess the disk-based compatibility between the MPF II and the Apple II.

You get an MDOS II disk and a blank disk with the disk drive and, for converting Apple II DOS 3.3 software to MPF II DOS, you can obtain an 'ATOM' disk as an optional extra.

We also received a joystick with the MPF II. This comes in a rectangular plastic case with a switch-type joystick handle at one end and 'fire' button at the other. Size-wise it seems to be more suited to the average 10 year-old's hand, rather than an adult's, which makes sense. Pity it's not an analogue type. With Apple II software calling for an analogue joystick, you're in trouble (and probably in more ways than one — see under 'Apple Compatibility'). The joystick is, however, adequate for the ROM-based software which was supplied with the review equipment.

The machine itself comes with an Installation Manual, a User's Manual and an Introduction to BASIC Programming. Each peripheral comes with an instruction booklet. ROM-based software throws up instructions on-screen.

Operator-wise

For the first-time computer user, the MPF II is straightforward to set up and easy to use, particularly for those under 16. The on-board keyboard is for two-finger hunt-and-peck typists (otherwise known as biblical system typists — seek and thou shalt find) under 16 years of age (small fingers).

The full-size add-on keyboard we were given with the review equipment is an abomination. The space bar is ineffective unless you hit it in the right place, your fingers are often deflected by the rubber keys without operating the key switch and some keys are unconventionally placed.

Presumably the next model of outboard keyboard will be better. Here's an opening for a do-it-yourselfer to attach his own keyboard. It should be pretty simple as only a scanned row-and-column arrangement is involved.

The machine design at the hardware level is very good — compact, powerful and capable, within the usually necessary constraints. There is one drawback with the ports — you can only plug one thing in at a time to the erstwhile-Centronics port (the keyboard/joystick connector is not a port), unless you have some sort of port expansion plugged into the 50-way slot. Which brings us to the next one — you can virtually only have one thing at a time plugged into the 50-way slot. But that's a price you pay for simplification on a lower-priced machine. It seems an acceptable compromise under the circumstances.

The games ROM packs are great. They can be plugged in upside down but the label identifies which way is up. The software we got with the review equipment was well thought out and well executed; Rain being the favourite!

The graphics is quite good, but not a lot is said about it in the documentation. It is apparent that you need to have much Apple documentation to exploit this aspect of the MPF II to the fullest.

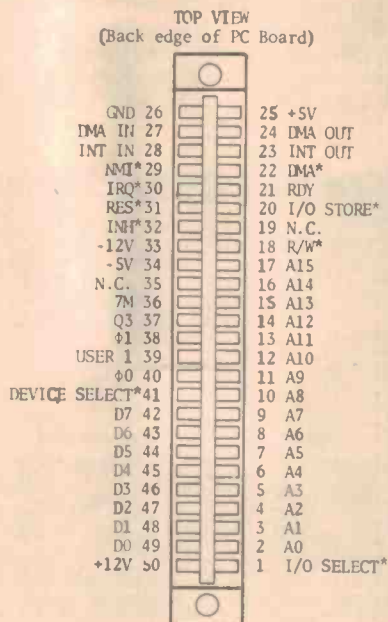

Apple slot versus the MPF II's. On the left is the standard Apple II slot pinout. On the right is the MPF II's single 'slot' pinout. Major differences on the MPF II connector are at pins 19, 20, 32, 33, 35, 36, 37, 40 and 41 but you'd have to directly compare them to see how it matters in particular circumstances.

The text on-screen is just as ugly as the Apple's. It's a pity this couldn't be fixed, but then the MPF II wouldn't emulate the Apple as closely as it does and confusion might arise. It seems that Multitech intend the MPF II to be purchased and used, by the educational sector of the market, as an adjunct to an existing Apple-based teaching setup.

Having both RF modulated and direct video outputs is a big plus for the MPF II. The RF output would primarily be used in the home, the direct video where a monitor is available.

There's a powerful argument for purchasing the MPF II for a student, for use at home, where Apples are used at school. But beware the compatibility question, to which we shall now address ourselves.

Apple compatible?

The MPF II is described as 'Apple compatible', and a strong case is made in the billing for its ability to draw on the vast reserve of support for the Apple II machine. Just how compatible is compatible?

Well, basically it is designed very much the same as the Apple II. It is a 6502 based system with identical graphics capability and identical monitor layout and BASIC operation.

It comes with a 16K page of RAM which can be switched in over the ROMs, built-in printer interface capability and graphics colour ability; which three things must be added in three of the expansion slots of all but the very latest model Apples, where these are standard in the MPF II.

It has only one slot with the format of the Apple expansion slots, so clearly it will be unable to replace a system which uses more than one expansion slot beyond the three functions mentioned above. (The disk drive, if used, requires a slot.)

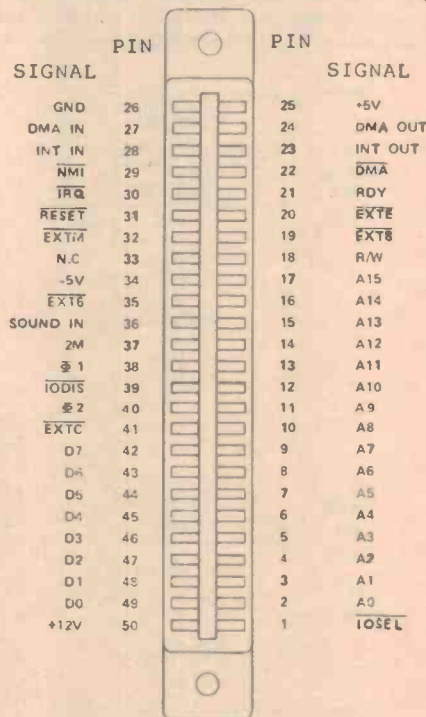

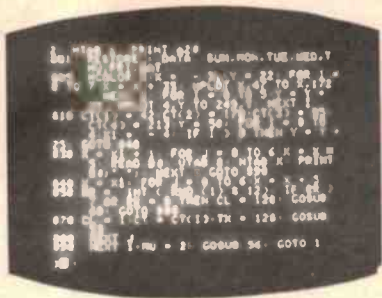

Text. Example of the text screen format—40 columns by 24 lines.

However, this is OK for most systems not dedicated to some peculiar task. There are machine differences in the MPF II, but these are hidden from the user by the operating system (OS) and disk operating system (DOS). It will read Apple disks directly once the DOS is booted from a MPF disk; it is also provided with a utility for updating Apple disks to MPF II DOS or MDOS. This is where the compatibility ends, however.

While memory (RAM) usage is kept identical in format, certain machine locations are different. Any program which PEEKs or POKEs, or is direct rather than going through the interpreter and DOS, is liable to malfunction because it does not have the totally identical machine layout to the Apple.

A good deal of existent software will bypass the interpreter occasionally, and fail; but such programs can be modified to work on the MPF II. The adjustment to these programs which PEEK and POKE past the BASIC system should be trivial. For instance, the PEEKing at the keyboard can be moved to the correct location. The holdup is the acutely rudimentary documentation provided.

Programs which use machine routines for I/O are no good at all on the MPF II. The more sophisticated games or well protected disks that tamper with the straight DOS are flat useless. It would represent a lot of work,

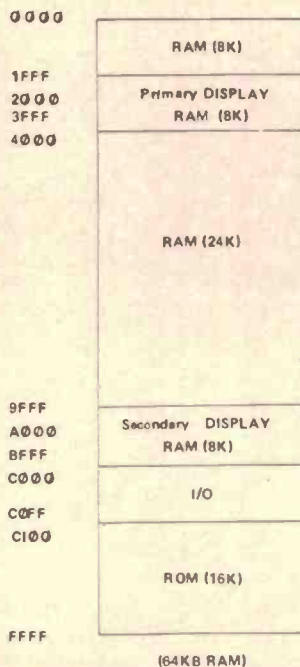

Take a left at 9FFF. Memory map of the Micro-professor II.

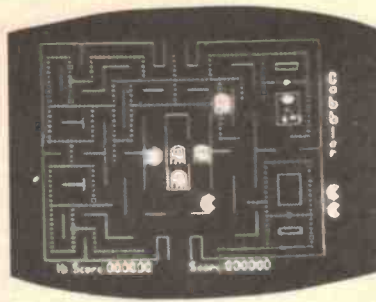

Mixed screen: Much of the games software has mixed text and hi-res graphics.

but some program-inspecting program utility might be concocted for the upgrade of packages with simple hardware PEEK/POKEs, but the job would be hard for anyone who had to sift the documentation for clues as to what was what. It would also not help the cases of machine level programs — BRUNning an Apple file is doomed on the MPF II. (It should be noted that most fast action or heavy thinking Apple games are of this sort.)

The above notwithstanding, programs and routines can be readily transferred from the MPF II to the Apple II because of the disk compatibility. Any software written with compatibility in mind would be OK, because the changes, *once you know what they are*, are not too major it would seem. So you could work hand in hand with Apples, but a good deal of the Apple support stuff is not instantly useable.

Peripherals

We received a single disk drive (with interface) and a dot matrix thermal printer with the review equipment.

The disk drive is a 'slimline' 5¼" unit that comes with an interface that plugs into the 50-way slot. It works just like an Apple II disk drive — which means the disk format is unique — quite unlike any other disk system on the market. This unit operated perfectly and we had no serious hitches in using it.

The printer is a thermal type and will print the standard 96 ASCII character set, 40 columns to the page. Each character is a 5 x 7 dot matrix in a 7 x 10 dot raster. On



Ogle-boggle. Focus your eyes on that! Example of the hi-res graphics (and it was in colour).

graphics it can print 280 dots per horizontal line and you can access 50 internal-generator graphics symbols.

Printing is bidirectional at around 150 to 180 lines per minute. The paper is 112 mm wide. Printing pitch is 0.36 mm character-to-character, line pitch 0.42 mm. The print head has two sets of 20 needles and is replaceable. Quoted life is one million lines. The interface is a Centronics-style 8-bit parallel type. Seeing as this is a relatively inexpensive printer, it will no doubt find a market for itself aside from the MPF II.

The print quality is adequate, considering the cheapness of the unit, and the graphics reproduction remarkable for a printer of this type.

Documentation

While it is apparent that Multitech is aware of the necessity of good documentation, and have appeared to have gone to some length to prepare comprehensive, illustrated manuals for Chinese or Japanese consumption, as English translations they're abysmal. With some effort, you'll make sense of them. But, they're poorly organised — even though everything is there — and the peculiar 'Chinglish' makes it hard going. Also, it demands Apple documentation to be really useful in depth.

If you're using, or intend to use, the MPF II in conjunction with an Apple, well and good, otherwise arm yourself with as much literature on the 6502 and the Apple II as you can muster. ▶



You can be boss of the DOS. On the left is the MPF II DOS boot disk which comes with a utility for converting Apple DOS programs on disk to MPF II DOS. For programs running under Apple II DOS 3.3, you use the ATOM disk, at right. The disk interface manual assumes you are already familiar with the Apple II DOS manual.

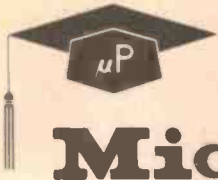

Micro-Professor MPF-II



**Only
\$549**
plus sales tax

A VERSATILE PERSONAL COMPUTER FOR PEOPLE FROM THE AGE OF 5 TO 95

HOME

For finding either an exciting new electronic hobby or ways to just take it easy, there's no place like home. And no computer quite like the Micro-Professor. Since MPF-II runs most of the existing Apple II software for home management and entertainment, you'll never be at a loss for interesting and work saving ways to apply its capabilities. For keeping tabs on family budgets and investments, managing personal finances, balancing a chequebook and spotting stock trends, exploring the emerging worlds of computer music, art, design and animation — the MPF-II is invaluable.

GAMES

The games people play today with personal computers like the Micro-Professor are simply amazing. There's a lot more to games than meets the eye. There are mind games — like bridge and chess — where planning counts for more than luck, and games of chance like poker and blackjack, where remembering the computers last card can help you win. Then there are fantasy games and games for the sports minded too. In all of these, there's still the basic challenge of the game: to win over a worthy opponent. In the case of MPF-II a very worthy one.

If you can get the Micro-Professor away from your kids, it can be a valuable tool at work too. Because of its compact size it can be carried comfortably if you're on the road a lot. If you operate your own business and have to keep a close tab on expenses, the modestly priced MPF-II can actually pay for itself almost immediately. With it, you can use many of the pre-written programs for accounting, payroll, job costing and inventory control. If you have a special problem unique to your business, you can write your own programs using one of MPF-II's several high-level language options. Then too, if you're a member of a large organization who can't get access to mainframe computing power, you'll appreciate the convenience of having an MPF-II right on your own desk.

If education is "what's left after you've forgotten all the facts" then with a powerful learning tool like the Micro-Professor, you should begin to notice more of "what's left". With educational packages that run on MPF-II students are constantly challenged in new ways, and individually prompted to respond — something that doesn't usually happen in a large classroom. With self-paced, interactive learning sequences, students can work through exercises in reading, math, science — any academic subject, or practice skills in more practical areas, such as typing. They can even begin to prepare for the computer age by becoming familiar with basic concepts in machine logic, programming and data structures.

BUSINESS

EDUCATION

The Micro-Professor MPF-II is the perfect computer for modern homes. All the features that a home/personal computer can have are packaged in the compact, portable MPF-II.



EMONA COMPUTERS

A DIVISION OF EMONA ENTERPRISES PTY. LTD.
Sales and Showroom

CBC Bank Building, Suite 204/661 George St, Haymarket Sydney 2000.
Telephone: (02) 212 4815, 212 3463. Telex: AA74500. Cable Emona Sydney.

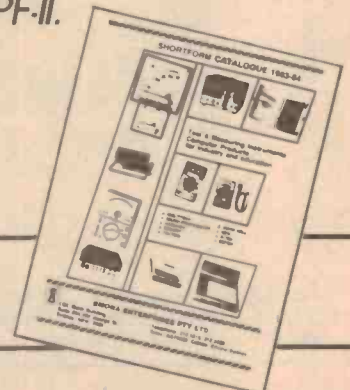

**Send for EMONA's 1983-84 Shortform
Catalogue of Test Instruments and Computer Products.**

**Postage
65c**

BILL EDGE'S

ELECTRONIC AGENCIES

115-117 Parramatta Rd, Concord 2137
(Corner Parramatta Rd & Lloyd George Ave)
Telephone (02) 745 3077 (two lines)
117 York St. Sydney Phone 29 2098

Mail Orders:
PO Box 185
Concord
2137

NSW & ACT ONLY	VIC. SA. QLD. TAS. WA. NT
\$10 — \$ 9.99 \$15.00	\$10 — \$ 9.99 \$25.00
\$25 — \$24.99 \$25.00	\$10 — \$24.99 \$40.00
\$25 — \$49.99 \$35.00	\$25 — \$49.99 \$50.00
\$50 — \$99.99 \$45.00	\$50 — \$99.99 \$60.00
\$100 or more \$55.00	\$100 or more \$75.00



TRADING HOURS
BOTH STORES
Mon-Fri 9 am-5:30 pm
Thursday 9 am-8 pm
Saturday 9 am-12 pm

What else do we carry? HI-FI ★ KITS ★ TEST EQUIPMENT ★ SEMICONDUCTORS ★ COMPONENTS ★
All prices correct and goods in stock at time of going to press. Please phone to check current availability

NEW HOUSE ALARM KIT. ETI582

This great kit was released by ETI back in 1977. To make it easier for the constructor we have joined the two PCB's together and added a power supply, on the one board.

SPECIFICATION

Types of inputs

Silent entry

Perimeter circuits

Internal circuits

Emergency circuits

Current drain and battery life (type 732)

Emergency only
Alarm active
Alarm sounding

Alarm time

Silent entry. Perimeter circuits, Internal circuits, Emergency circuits.

Single circuit, 30 s exit delay, 30 s entry delay.

7 circuits, N/C contacts, can be expanded in units of 4.

4 circuits, N/C contacts, can be expanded in units of 4. Any number of N/O circuits.

Any number of N/O circuits. These circuits are active even if perimeter and internal circuits are switched off.

2.5 mA (4000 hours)
9 mA (2000 hours)
500 mA (10 hours)
12 minutes

\$59.90
KE7009

WE ARE THE KIT SPECIALISTS
6-HOUR TURNAROUND ON MAIL ORDER



All components are supplied, including mains transformer, lead, terminal strip, nuts and bolts. but no case. See ETI July/August, 1977.

UPGRADED TRANSISTOR ASSISTED IGNITION KIT

See EA Jan. 1983

This new addition gives longer spark duration and more reliable operation. Our kit includes a die cast box for less interference and to keep out the substance and to keep out grease and oil.

STILL ONLY

\$35.00 KE1825

Why not add a Breakerless ignition kit as well for a full system

\$19.50 KE1850

MONITORS FOR MICROBEE

- XE1186 12" MICRON GREEN MONITOR **\$199.50**
- XE1188 12" KAGA DENSHI ORANGE MONITOR **\$325.00**
- XE1190 12" KAGA DENSHI GREEN MONITOR **\$325.00**
- XE1192 12" BLACK & WHITE **\$149.50**

- XE6253 MONKEY MATHS \$14.95
- XE6255 GRAPH PLOT \$14.95
- XE6181 FINANCIAL DIARY \$14.95
- XE6270 BUSY CALC \$14.95
- XE6272 DATA BASE \$14.95
- XE6216 SUPER DISSASSEMBLER \$19.95
- XE6230 VOL 1B MUNCH/TNT LEARNING \$ 9.95
- XE6225 VOL 1A GRILLA/FRACE LEARNING \$ 9.95
- XE6235 VOL 1C ADSTAR/SQUARE LEARNING \$ 9.95
- XE6220 BOGGLER \$ 9.95
- XE6249 ESCAPE FROM COLDITZ \$14.95
- XE6247 MATHS ADVENTURE \$14.95
- XE6210 TURTLE GRAPHICS \$14.95
- XE6275 MATCAL \$14.95
- XE6278 CHPLUS GRAPHICS/GAMES \$ 9.95
- XE6205 WORK A BEE AUTHORIZING SYS \$19.95
- XE6280 BUSY BEE CAI SYSTEM \$14.95
- XE6251 BASIC TUTORIAL 1/KEYBOARD \$ 9.95
- XE6245 CHASE PLUS \$ 9.95
- XE6257 LISTING FORMATTER \$14.95
- XE6240 LEARNING CAN BE FUN VOL 2A \$ 9.95
- XE6745 TYPING EDITOR \$16.95
- XE6750 FINANCIAL MANAGER \$14.95
- XE6755 CARD INDEX SYSTEM \$ 9.95
- XE6285 CORVILLE CASTLE ADVENTURE 16 + 32K \$16.95
- XE6290 TOUCH TYPING TUTOR LESSONS Vol 1 \$ 9.95
- XE6291 TOUCH TYPING TUTOR LESSONS Vol 2 \$ 9.95
- XE6292 TOUCH TYPING TUTOR LESSONS Vol 3 \$ 9.95
- XE6293 TOUCH TYPING TUTOR LESSONS Vol 4 \$ 9.95
- XE6294 TOUCH TYPING TUTOR LESSONS Vol 5 \$ 9.95
- XE6297 ASTORIDS PLUS (GREAT FUN) \$22.50
- XE6298 BEEZ 80 SECRET CODE DISASSEMBLER \$20.00



Free with all kits over \$20. Bill Edges Kit Constructors Reference Manual.

All PCBs from EA and ETI since 1975 are available from both our stores — ex stock.

TEMPERATURE PROBE KIT FOR DIGITAL MULTIMETERS - ETI153

A handy temperature probe for any digital multimeter. It can be read directly in °C, °F or Kelvin (for the scientists).

NEW See ETI June '83 **\$19.50** KE7010

5A POWER SUPPLY KIT

NEW 3-50V See EA May, '83. **\$149.00** KE7011



STEREO SIMULATOR KIT

See EA Apr 83
All parts supplied including box, front panel, etc. but excluding plug pack. Plug Pack \$9.95. Cai ME7121. KE7008 **\$19.95**

MOTOR SPEED CONTROLLER KIT

See ETI Apr. 83. KE7006 **\$19.95**

TOUCH LIGHT DIMMER KIT

See EA Apr. 83
Complete kit including all hardware. KE7007 **\$19.95**

SPEAKER SPECIALS

PHILIPS ADO1610/T8 TWEETER
As used in ETI4000. 100w RMS system handling
This month only **\$12.95**
Save \$4
CE:2013 Normally \$16.95

MOTOROLA KSN1025 PIEZO HORN

No Crossover needed. Over 100w RMS
This month only **\$19.50**
Save \$7.00
CE:2028 Normally \$27.00

PHILIPS ADO2160/Sq 8 MIDRANGE

As used in ETI4000
This month only **\$35.00**
Usually \$45.00
Save \$10
CE:2085

THE RED FLASHER

Car theft has risen dramatically recently. Is your car safe? Thieves stay away from cars which have those expensive flashing light alarms. The ones with the red square pushbutton switch that flashes.
Now you can make your car look like it has one of those alarms, whether you have one or not.
We supply a quality Swiss pushbutton illuminated square switch and the electronics to make it flash. We even put in two deterrent stickers.

ALL THIS PEACE OF MIND FOR ONLY **\$19.50**
KE7004

Pushbutton switch separate \$13.95
Deterrent stickers 85¢ each

SEQ580
LEB500

“EXCLUSIVE”
ALL ELECTRONIC AGENCIES KITS OVER \$20 INCLUDE OUR KIT CONSTRUCTORS REFERENCE MANUAL. WHY SETTLE FOR ANYTHING LESS.

WE SELL THE BEST KITS

ETI668 MICROBEE EPROM PROGRAMMER KIT

Complete kit includes 24-pin ZIF socket, box, transformer and all the quality components you would expect in a kit from Electronic Agencies.

See ETI Feb 82 **\$46.50** KE7003

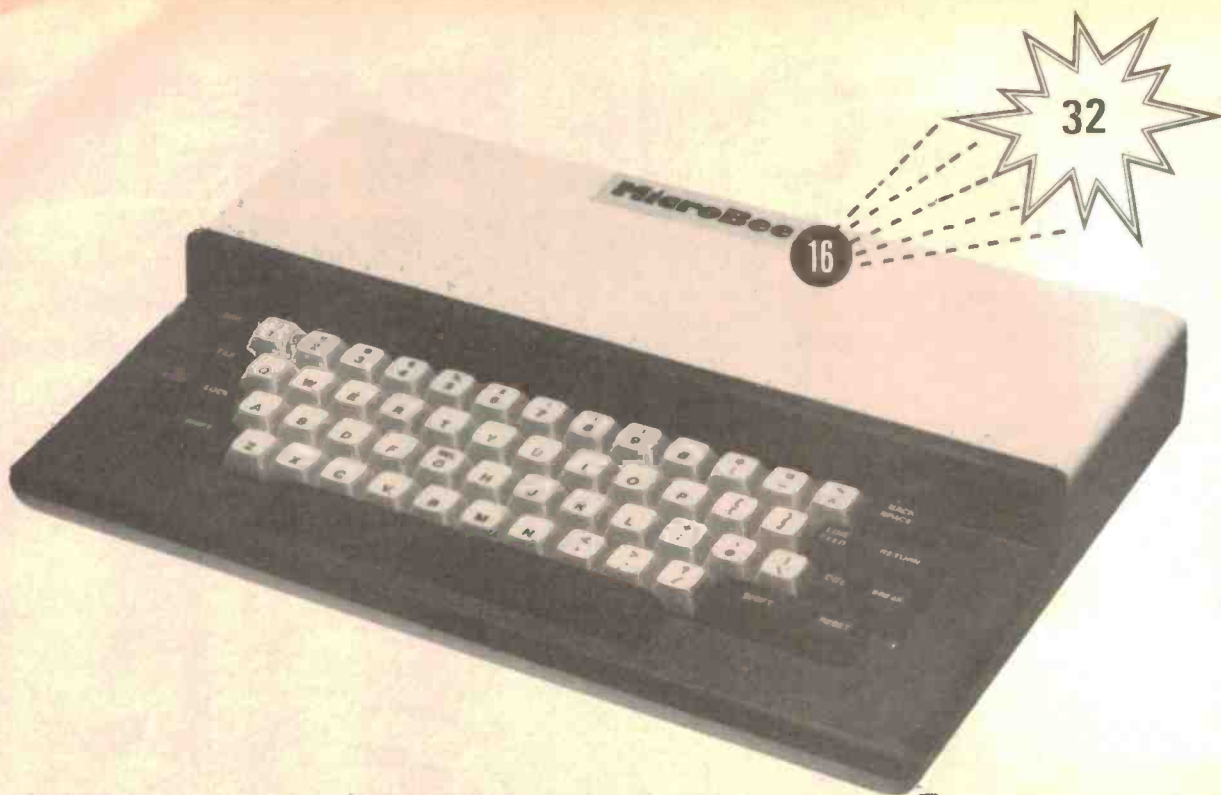

16K to 32K expansion for your MicroBee

Considering going on to bigger and better things with your MicroBee? Not afraid of a little soldering and want to save money? Here's how!

Tom Moffat

PAGE TWO of my MicroBee construction manual says: "Should you wish to upgrade your 16K MICROBEE you will need to purchase a 32K changeover CORE BOARD. WARNING do not attempt to upgrade your 16K board as this will invalidate your warranty and will require an updated BASIC anyhow."

But don't believe everything you read. It is entirely feasible to upgrade your own MicroBee memory, if you take care. Yes, you will blow your warranty, but the warranty only runs for 90 days. That much time has probably passed already now that you've learned to use your MicroBee, and want to move on to bigger and better things.

As for the "updated BASIC" all I can say is the BASIC in my MicroBee handles expanded memory nicely without any updating. It took a bit of digging to discover this. The MicroBee Users Manual gives the 'top of memory' pointer location as 00A0 (hex). The 'Search' feature of the MicroBee Monitor was used to find a load instruction to that address. Sure enough, there it was in the BASIC ROMs at 857D. It was then necessary to work backwards from that address, disassembling the code by hand, to find how the data for the top of the memory pointer was developed.

It seems that the MicroBee finds out where the memory ends automatically by testing each byte and declaring "end of memory" when the test fails or when the start of the BASIC ROMs is reached. So it can cope with any amount of memory up to 32K, in any sized blocks. The relevant part of BASIC is reproduced in Listing 1, for those interested.

Pros and cons

Now to the pros and cons of doing it yourself. The prime advantage is financial... it cost exactly \$75.40 to turn my MicroBee 16 into a MicroBee 32. Applied Technology charges \$125 to change a 16 into a 32 PLUS. The 'PLUS' part involves supplying the parallel port plug and the battery backup arrangement, another seven dollars or so worth of goodies.

This is not to suggest that Applied Technology is ripping anybody off. If you took your 'Bee to your local electronics shop they'd probably charge more than \$125 for the job. After all, there's a lot of labour in it. If you do it yourself, you supply the labour and you save the shipping which, from Tasmania at least, is dreadfully expensive.

Now before you get stuck into it, it's time to do a bit of soul-searching. Are you

technically competent to do it? Is your soldering up to truly *professional* standard? Is your soldering *iron* up to professional standard? Something like a Weller or Adcola temperature-controlled soldering station is needed with the finest possible tip.

Do you have one, or can you borrow one? Look at the pictures, you'll notice that just about all IC pins have other tracks running between them on the board. It will be a very delicate job, and a mistake could ruin your MicroBee forever. If you don't feel you're up to it there's certainly no shame in handing it over to Applied Technology.

Ready?

If, after all that scary stuff, you still want to press on, here's what to do. First, get your ICs and eight 10n 'blue chip' ceramic bypass capacitors, or similar. My ICs were bought from a normal supplier in Hobart, and the capacitors were rattled from a defunct computer board (these are usually very good quality).

Because of the MicroBee's memory testing feature it is possible to upgrade your computer in 2K stages. You only install the chips you need, or can afford. Table 1 sets out what chips are required for each level of 'K', and it should be understood that each level's

LISTING 1

```

ADDR  CODE  LINE  LABEL  MNEM  OPERAND
      00100 ;END OF MEMORY DETERMINATION, FROM BASIC. 16/1/83
      00110
0400   00120   DEFR  16
0567   00130   ORG   0567
E000   00140   DEBUG EQU   0E000
0567 210009 00150   LD    HL,0900 ;START OF BASIC
056A 3E00   00160   JUMP1 LD    A,00
056C BC     00170   CP    H
056D 200E   00180   JR    Z,JUMP2 ;GET OUT IF HL=0000
056F 7E     00190   LD    A,(HL) ;LOAD BYTE INTO ACCUMULATOR,
0570 2F     00200   CPL                   ;TURN IT UPSIDE DOWN,
0571 77     00210   LD    <HL>,A ;AND PUT IT BACK.
0572 2B     00220   DEC   HL
0573 70     00230   LD    <HL>,B ;PREVIOUS BYTE INTO B
0574 23     00240   INC   HL
0575 0E     00250   CP    <HL> ;COMPARE A WITH <HL>
0576 2005 00260   JR    NZ,JUMP2;NO GOOD? GET OUT.
0578 2F     00270   CPL                   ;TURN BYTE OVER AGAIN
0579 47     00280   LD    B,A ;AND PUT IT INTO B.
057A 23     00290   INC   HL ;NOW DO NEXT BYTE.
057B 1B0D 00300   JR    JUMP1
057D 22A000 00310  JUMP2 LD    <0A0>,HL;TOP OF MEMORY POINTER
0000   00320   END
00000 Total errors

JUMP2  057D   JUMP1  056A   DEBUG  E000
    
```

requirements are in addition to previous levels. Even if you're going for the full 32K it's a good idea to upgrade 2K at a time, testing as you go.

To begin the job, open up the MicroBee, disconnect the memory battery (if installed), and carefully unplug the core board. If you don't know what the core board is STOP right now and don't attempt the upgrade.

Put the computer aside and lay the core board on the workbench. Study the silk screened labelling on the top (component side) and work out what ICs go where, and which way around. In other words think the job through in advance.

Now, install the eight bypass capacitors in their positions next to the empty memory chip locations. You might as well put them all in even if you're not installing all the memory now.

Next come the ICs. Start with the small ones first to get a bit of practise for the big ones. When soldering them in, remember that they are CMOS devices and you should

take the usual precautions against static damage. Don't handle the pins, pick up the packages with your thumb and forefinger holding the ends only. Use a soldering iron with an earthed tip and solder the supply and earth pins first. ▶

TOTAL K	74LS138	4053	6116P	PEEK(161)
18	IC14	IC16	IC13	72
20			IC15	80
22			IC17	88
24		IC19	IC18	96
26			IC20	104
28			IC21	112
30		IC23	IC22	120
32			IC24	128

Soldering the pins. Apply the iron to the pin and the pad from the 'inside' of the IC, heat the joint, then apply the solder. Use only enough to do the job — and no more.

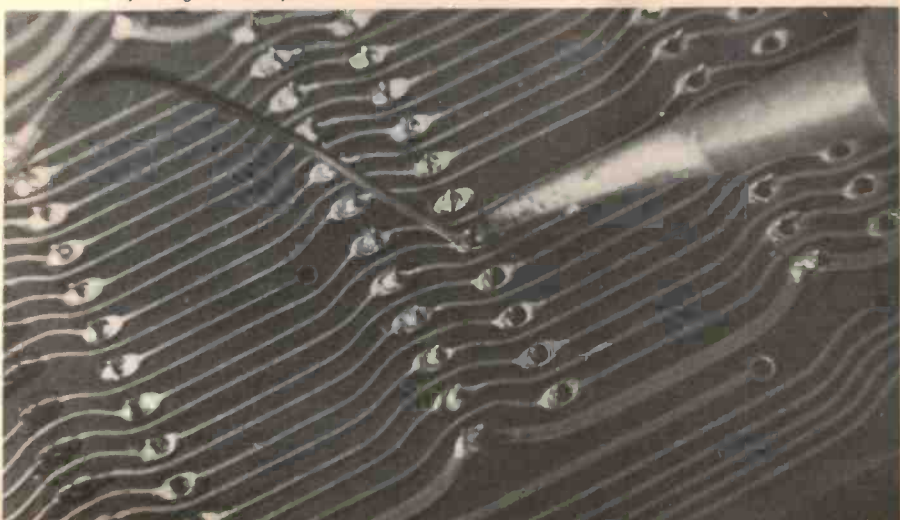

THE ZX SPECIALISTS

The Professionals who care!

COMPUTERS

SINCLAIR ZX 81. . . . \$149.95 (add \$7. for p&p)
SPECTRUM 16K Version. \$315.00 (add \$7. for p&p)



HARDWARE

16K SPECIAL RAM PACK, (cased) \$69.50 (incl p&p)
Suitable for ZX 80/81.



32K D RAM PACK (cased). . . . \$125.00 (incl p&p)
Suitable for ZX 81. No extra PSU required. Plugs into expansion port behind printer.

X ROM CARD. \$69.95 (incl p&p)
Fits inside our 16K Ram Pack. Has built-in printer interface to use a printer other than ZX Printer and contains EPROM Burner for Basic and Machine code programs.

PROGRAMMABLE CHARACTER GENERATOR. . . .
. \$95.00 (incl p&p)
(Fully assembled) Suitable for ZX 81/80 fitted with 8K ROM. Create own character sets, high resolution graphics etc. FREE supporting software of Demmo, 2 Games and instructions.

VIDEO UPGRADE UNIT for ZX 80. . \$38.50 (incl p&p)
(Fully assembled) Upgrade to fully animated graphics of ZX 81. Will now run in SLOW MODE. Requires 8K ROM—not included.

ZON X-81 SOUND UNIT. . . . \$69.50 (add \$4. p&p)
Self contained unit, plugs in, no extra power required, works with 16K RAM and printer. Uses 3 channel sound chips. Huge range of sounds for games and music.



SINCLAIR PRINTER. . . . \$175.00 (add \$7. for p&p)
ZX Printer Paper. \$5.50 per roll (add \$1.50 for p&p)
8K ROM for ZX 80.
. . . \$75.00 (for ROM, Manual and Keyboard overlay)

COMING SOON. KITS FOR ZX 80/81.



Payment by cheque, money order or Bankcard.
For further information send a large S.A.E. to:

VENDALE

VENDALE PTY. LTD.,
Dept. T7, Box 456, Glen Waverley,
Vic. 3150, Australia. Ph: (03) 232 0444.

VEN 8901

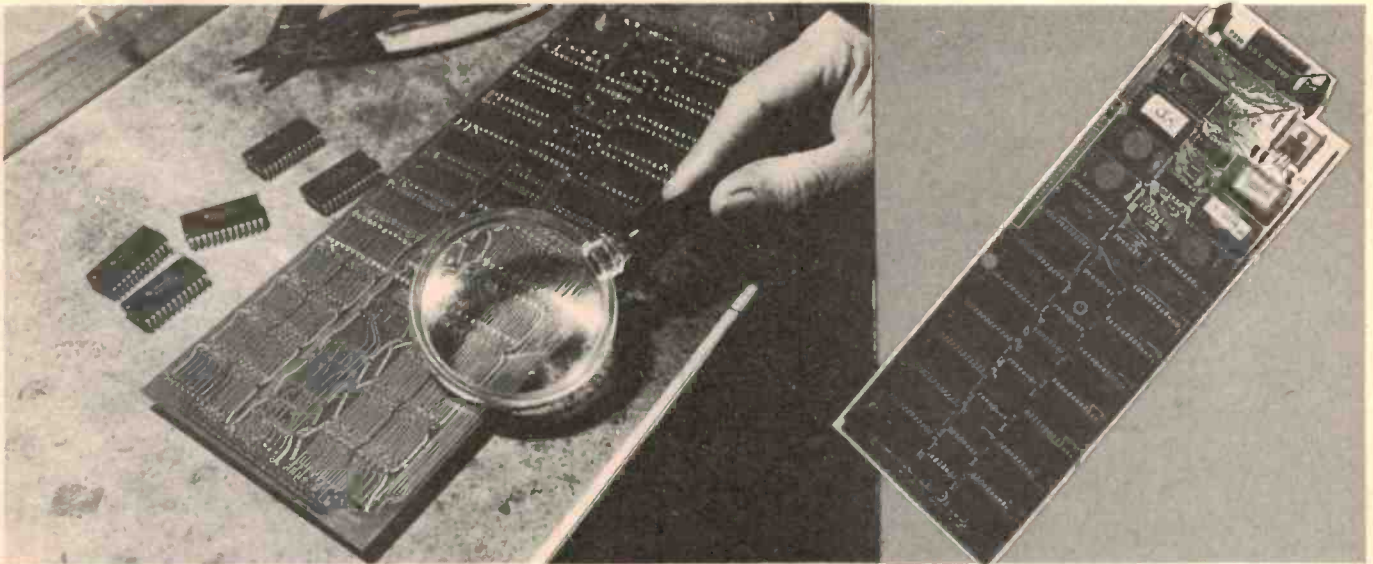

Inspect It! Inspect each soldered joint carefully. Look for solder 'bridges' across tracks, pins not soldered, etc.

Finito! The completed coreboard — now the 'full bottle' 32K.

Look at the close-up photograph. Notice that the soldering iron tip is applied to the pins from the 'inside the IC' direction. You press down on the pad and the pin at the same time and then apply the solder from the 'outer' side of the pin. Each pin will take about two seconds to do, keeping the total heat input to a reasonable level.

The results should look like the photo-

graph . . . just enough solder to do the job and no more.

Test as you go

Testing your work is simple. After each 2K, reinstall the core board and fire up the computer. It should 'beep' into a cold start. If you inspect location 161 (decimal) with a

PEEK instruction, you will find where the MicroBee thinks the end of memory is. If it agrees with where you think the end of memory is, congratulations.

If you've gone for the full 32K, try out the 'self-test' routine by holding down 'S' and operating RESET at the same time. The computer should now pass the '32K RAM' part of the test that it had always failed in the past. ●

MEET THE LOW COST DRIVING FORCE.

TANDON TM500 Series Disk Drives Disk Drives up to 19.1 megabytes

Today Tandon 5¼" rigid disk drives are used in many proprietary systems on sale in Australia. And now you can get the same performance and reliability as the professionals get, direct from the distributor, at huge savings.

Specifications:

MODEL:	TM501	TM502	TM503
Capacity (unformatted)	6.4Mb	12.8Mb	19.1Mb

Case, power supplies and controllers also available.

For further information contact:-

**AE ADAPTIVE
ELECTRONICS P/L**

418 St. Kilda Road, Melbourne. 3004. (03) 267 6800.

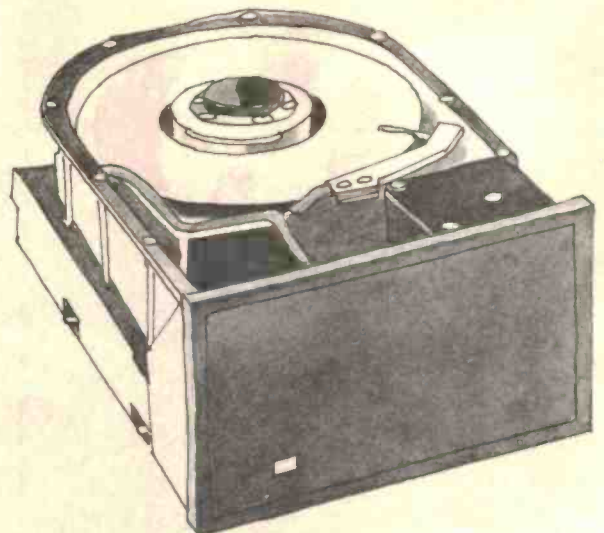

JHA/4731/HP

WE ARE THE.....

PAK SPECIALISTS

PAKS OF ASSORTED POTS

20 MIXED VALUES
Linear, log, our choice!
100 MIXED VALUES
Dual, switched, all new
250 MIXED VALUES
(Bonus bulk package)

\$3
\$10
\$20

SEMIS

NPN UNMARKED TO-5 TRANSISTORS
40V 500mA SILICON
20 for \$1.100 for \$4.1K/\$30

BC547 10 for 90¢
BC558 10 for \$1
BC559 10 for \$1
BC528 10 for 90¢
BC204 (BC557) 10 for 50¢
BD237 80V 2A 25 WATT 2 for \$1
TT800 2 for \$1
T1801 2 for \$1
2SC1307 2 for \$1

RECTIFIERS, DIODES ETC.

0A91 5 for 70¢
1N914/1N4148 10 for 60¢
1N4002 10 for 60¢
100P IV 3AMP 6 for \$2
400P IV 6AMP 4 for \$3
1N5626 600PIV 3AMP 5 for \$2

BRIDGE RECTIFIERS
W02 200V 1.5A 5 for \$2.65
400VOLT 6AMP 2 for \$3.95
1000VOLT 25AMPS 2 for \$8.95

ELECTROS

220uF 25v pcb 10 for \$2
220uF 25v ax 12 for \$2
330uF 63v ax 5 for \$2
400uF 40v ax 6 for \$2
470uF 25v pcb 8 for \$2
470uF 25v ax 10 for \$2
470uF 63v ax 4 for \$2
640uF 16v pcb 9 for \$2
1000uF 16v ax 6 for \$2
1000uF 25v pcb 5 for \$2
2200uF 16v pcb 4 for \$2
2500uF 25v ax 2 for \$2
3300uF 6.3v ax 4 for \$2
2000uF 64v can 2 for \$4
5500uF 25v can 2 for \$8
15000uF 75v can 1EA \$12

CAPACITORS

100pF ceramic 15 for \$1.00
0.001uF ceramic 15 for \$1.00
0.01uF 50v cer 15 for \$1.00
0.01uF 500v cer 8 for \$1.00
0.047uF ceramic 12 for \$1.00
0.1uF ceramic 12 for \$1.00
0.001uF 630v poly 8 for \$1.00
0.001uF 1kv styro 5 for \$1.00
0.0068uF 600v styro 6 for \$1.00
0.01uF 200v poly 10 for \$1.00
0.015uF 200v poly 12 for \$1.00
0.022uF 250v poly 9 for \$1.00
0.047uF 200v poly 8 for \$1.00
0.056uF 1kv poly 2 for \$1.00
0.068uF 100v poly 7 for \$1.00
0.068uF 400v poly 5 for \$1.00
0.1uF 100v poly 5 for \$1.00
0.1uF 630v GC poly 3 for \$1.00
0.15uF 100v poly 6 for \$1.00
0.15uF 250v poly 5 for \$1.00
0.22uF 100v poly 5 for \$1.00
0.22uF 250v poly 5 for \$1.00
0.27uF 250v GC poly 5 for \$1.00
0.33uF 100v poly 4 for \$1.00
0.33uF 250v poly 4 for \$1.00

GREENCAPS 100V POLYESTER
0.001uF, 0.0022uF, 0.0033uF, 0.0047uF, 0.0068uF, 0.025uF \$2.00
0.01uF, 0.022uF 20 for \$2.00
0.033uF, 0.047uF 14 for \$2.00
0.056uF, 0.068uF 13 for \$2.00
0.082uF 15 for \$2.00
0.1uF 10 for \$2.00
0.22uF 9 for \$2.00
0.39uF 8 for \$2.00
0.47uF 6 for \$2.00

LEDs

3mm Round
RED 10¢
GREEN 15¢
YELLOW 15¢
5mm Round
RED 10¢
GREEN 15¢
YELLOW 15¢
5x2mm Rect
RED 20¢
GREEN 25¢

FANS

MUFFIN, ROTRON, ETC.



MOTOROLA MRF-603 SIMILAR TO 2N5590
2 for \$8

FLASHER

5mm RED ONLY 35¢
SUPER-BRIGHT LEDS
5mm GREEN 59¢
5mm YELLOW 59¢
DUAL-COLORED LEDS
5mm RED/GREEN 90¢

Ex-computer
5 inch
115v \$8
220v \$10

MINI RELAYS

240V AC coil HEAVY DUTY
10A CONTACT CHANGEOVER

SPDT 8 to 15V DPDT 24V, 700 OHMS, 5A CONTACT
PCB MOUNTING

Great value, worth over \$5
huge purchase enables us to sell for less than HALF!
Buy 10+ \$2.25

RESISTORS

1/2 WATT
5% TOLERANCE
ALL E12 VALUES,
10HM TO 10MEG,
PAKS OF 10 EACH VALUE 25¢
PAKS OF 100 EACH VALUE \$1.25
PAKS OF 1000 EA. VALUE \$10

\$2 OFF ELECTRO-LUBE SPRAY-PAKS

ANTI-STATIC FOAM CLEANSER \$5.50 now \$3.50
FOR PLASTICS, GLASS, METALS, SYNTHETICS
PERMAGUARD SILICON SPRAY \$5.95 now \$3.95
WATER AND MOISTURE-REPELLING COMPOUND
ELECT. CLEANING SOLVENT \$6.50 now \$4.50
FOR TAPE HEADS, VIDEO, COMPUTERS, FAST-DRYING
CLEAR PROTECTIVE LACQUER \$6.95 now \$4.95
FLEXIBLE COATING FOR PCB'S, FRONT PANELS, ETC
CONTACT ARC SNORKEL \$6.95 now \$4.05
PREVENTS ARCING ON RELAYS AND OTHER CONTACTS
CONTACT CLEANING STRIPS \$3.50 now \$1.50
CLEANSER AND LUBRICATOR FOR RELAYS, EDGE CONNECTORS
LUBRICATING SNORKEL PEN \$3.50 now \$1.50
NON-DRYING ELECTRO-MECHANICAL LUBRICANT

TV PCB'S

From USA, these new circuit boards have over 80 parts incl. 8 trans. (25C1014, 25C711, 25A675, 25A628, 25C670), 10 diodes, caps, resistors, tripoats, etc. GREAT VALUE HERE!

Push-Button TUNER BOARDS
Comprises 2 boards, one has 8xDPDT push-button switches, similar to Isostat - the other has 8x100K multi-turn tripoats with 3 position band-change switches. LTD. QTY!

LAST FEW!
\$3 EACH
10 for \$25

SCOOP PURCHASE

NO MAIL ORDERS!
VDU WITH KEYBOARD \$60.00
NOT OPERABLE AS IS, BUT IDEAL CABINET, KEYBOARD, DISPLAY FOR HOME BUILDER. LOTS OF USEFUL PARTS ARE YOURS FOR A FRACTION OF THE NORMAL PRICE!

POWER SUPPLY UNIT \$45.00
PROBABLE WORKING ORDER, IN LARGE, ATTRACTIVE DESK-TOP CABINET WITH OVER 100 74 SERIES IC'S AND PLENTY OF EXTRA SPACE. 240V IN. +5v 5A, +24v 2A, -24v 2A OUT

SOCKETS

HIGH QUALITY LOW PROFILE

8 or 14p 5 for \$1
18 PIN 4 for \$1
24, 28p 3 for \$1
40PIN 2 for \$1
1 for \$1

8 Kgm SURPRISE KIT

LOTS OF HANDY HOBBY-PARTS!
Transformers
Resistors
Capacitors
Semiconductors
Samples, etc etc.

9.95

INTER-STATE POST- ADD \$3.00

TRIMPOTS

Save Buy 100 for \$8 or 10 for \$1

CHOICE OF - 100, 470, 1K, 10K, 25K, 50K, 750K, 500K, 20K

240 VOLT VIDEO MONITORS

Ex-Computer Fully Tested and Working!

8" SCREEN **\$69**

A LARGE RANGE OF KITS, PARTS, METALWORK

QT SILENCE+MOTHERBOARDS

The SILENCE has become one of the most tried and proven motherboards on the market. Using a unique ground stratig, each line is completely surrounded with ground shielding which eliminates necessity for termination and gives the unit a very high cross-talk rejection. Has been used as high as 16MHz w/o term.

PRICES: no Tax incl Tax

6 slot bare board \$ 31.00 \$ 37.20
6 slot AAT \$ 81.00 \$ 87.20
8 slot bare board \$ 33.00 \$ 39.60
8 slot AAT \$104.00 \$110.60
12 slot bare board \$ 39.00 \$ 46.80
12 slot AAT \$138.00 \$145.80
18 slot bare board \$ 61.00 \$ 73.20
18 slot AAT \$178.00 \$190.20

MAINFRAMES

DUAL 5 1/2" DRIVES
432mmL x 178mmH x 508mmD

DUAL 8" DRIVES
432mmL x 244mmH x 532mmD

Power and Reset switches on front
Fully professional

The QT Mainframes are, we believe, the most versatile models on the market. They will accommodate 6, 8 or 12 slot card cages using the Silence Motherboards. Any 5 1/2 inch, 8 inch standard or slimline disk drives can be fitted. Adequate space is available for a fan and power supply (these are included in assembled and tested versions). Just add a CPU, memoryboard, disk controller and terminal and you have an inexpensive, high quality computer system. The finish is beige with brown cover.

Prices are for 5 1/2" or 8" sizes. No Tax Incl Tax

Bare cabinet \$198.00 \$237.60
incl 6 slot M/board (AAT) \$552.00 \$662.40
incl 8 slot M/board (AAT) \$581.00 \$697.20
incl 12 slot M/board (AAT) \$612.00 \$734.40

All parts available separately, let us quote!

QT CARD CAGES

QT card cages are strong, cadmium-plated steel frames, punched ready-to-accept card-guides and motherboard. Perfectly suited for industrial control applications with the addition of CPU and memory card with the Silence Motherboard.

no Tax incl Tax

6 slot Card Cage \$ 30.00 \$ 36.00
incl motherboard, etc \$117.00 \$140.40
8 slot Card Cage \$ 33.00 \$ 39.60
incl motherboard, etc \$145.00 \$174.00
12 slot Card Cage \$ 39.00 \$ 46.80
incl motherboard, etc \$189.00 \$226.80

DISK DRIVE CABINETS

1 1/2" QT cabinets are professionally designed and finished and are ready to accept power supplies and disk drives.

PRICES: no Tax incl. Tax

5 1/2" Mini Single cabinet \$ 35.00 \$ 42.00
incl. power supply (AAT) \$129.00 \$154.80
5 1/2" Dual Mini Cabinet \$ 39.00 \$ 46.80
incl. power supply (AAT) \$159.00 \$190.80
8" Single Cabinet \$ 89.00 \$106.80
8" Single standard drive or dual slim-line cabinet incl. power supply \$295.00 \$354.00
(Assembled and Tested)

\$100 CONNECTORS

100 pin standard connector for \$100 plus.
Specially plated contacts for maximum efficiency.
Made in USA.
\$7.45
TAX FREE \$6.20 EA. INCL. TAX

64K \$100 STATIC RAM BOARD

BARE BOARD \$95
KIT (NO RAM) \$149
ASSEMBLED 64K \$390
Plus Sales Tax 20% if applc.

150ns RAMs standard fitting.
Board access time under 200nanosec.
Uses popular 2716 pinout type static rams.
All data, status and address lines fully buffered.
Top 8K may be switch disabled and/or interchangeable with 2716 type Eprams.
Extremely low power dissipation (500mA typical).

256K \$100 DYNAMIC MEMORY BOARD

BARE BOARD \$195
ASSEMBLED \$995
PLUS SALES TAX 20% EXTRA

16K to 256K bytes; uses 4116 or 4516 or 4164 memory devices.
Guaranteed to operate at 4MHz with no wait states (6MHz: 1 wait).
Adjustable timing allows operation with Z80, 8080, 8085 micros.
Can be divided into max. 16 banks, each variable in 4K address.
Each 4K segment can be individually enabled or disabled easily.
Each bank can be located on any 4K boundary.

Z80 SINGLE BOARD \$100 COMPUTER SBC 2/4

SALE! LAST DAYS!

\$239
\$199 NO S/TAX
KIT PRICE.
BUILT \$299.00
& TESTED. \$249 no Tax
BARE BOARD \$79.20
PLUS MANUAL. \$66 no Tax
ADD FREIGHT: \$4.00 ONLY

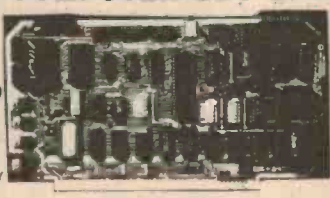

The QT Computer SBC 2/4 Processor Board may be used as a stand-alone computer or as the host CPU of a large system. It works reliably with dynamic RAM boards and more importantly with soft-sectored disk controllers, and hence standard versions of CP/M. This gives access to the largest software base for microcomputers. 2 or 4 MHz switch selectable. 1K RAM (can be located at any 1K boundary) One each serial and parallel I/O ports power on jump to on board EPROM (2708 or 2716) addressable on any 1K or 2K boundary Full 64K use of RAM in shadow mode 2 programmable timers avail. for use by programs DMA capability allows MMT signal generation on CPU board elsewhere in system under DMA or front panel control programmable baud rate 110-9600

PRE-PAK electronics p/l

1a WEST ST, LEWISHAM, NSW

569-9797
24 HR PHONE ORDER SERVICE

SEE THE HUGE RANGE IN-STORE!
IF YOU THINK WE PACK A LOT INTO OUR ADS, YOU SHOULD SEE WHAT'S IN OUR SHOP!

THE VIC-20 COLUMN



'LOTTO 8' SELECTOR

H.J. Smith, Tempe NSW

If you're into the 'numbers game' — Lotto — you'll know how tedious it is choosing the field of numbers each week. Here's a program to automate the task, especially written for syndicate pickers.

Seven mates and I go into an 8x8 ticket each week. I have a VIC-20 with printer attached and press it into service to provide a string of printouts. I run the program and cut up the printout so we can all have the fun of following the numbers.

The program listing reproduced here is pretty well self explanatory for those with a modicum of experience with VIC BASIC. Note that the listing has been printed out in lower case. All the calculations are performed between lines 10 and 70, the rest is basically output formatting.

A sample of the printout is shown below.

```

Lotto: 14
01- 4 17 32 15 33 34 25 7
02- 21 1 12 20 30 24 22 11
03- 22 20 16 3 8 24 38 7
04- 32 26 18 38 35 12 31 24
05- 14 3 24 7 4 8 10 17
06- 17 1 16 34 31 27 30 25
07- 25 10 24 16 37 30 5 17
08- 7 9 15 27 22 3 4 39
    
```

```

2 Print"#"
3 Print:Print:Print:PrintsPc(6)"systems 8":Print:
  PrintsPc(8)"lotto"
4 fort=1to3000:nextt
5 Printchr$(9)+chr$(14):gosub1010:Print"#"
6 Print:Print:input"Lotto Week Number:";v
7 input"No. of Games:";z:Print:input"Printout Y or N:";
  w$:Print"#"
8 ifw$="y"thencmd3,4,7:ifw$="y"thencmd3
9 rem"lotto"
10 dima(63):dimx(7)
11 s=int(1+40*rnd(0))
12 s(x)=s:onxgoto107,106,105,104,103,102,101,100
13 ifx=7thengosub50
14 x=x+1:ifx=9thenx=0
15 ify=zthen70
16 goto30
17 Print:Print
18 Prints(0);s(1);s(2);s(3);s(4);s(5);s(6);s(7)
19 y=y+1
20 onygoto300,400,500,600,700,800,900,1000
21 return
22 r=r+1
23 Print:Print:PrintsPc(6)"Lotto:";v
24 Print"01-";a(0);a(1);a(2);a(3);a(4);a(5);a(6);a(7)
25 Print"02-";a(8);a(9);a(10);a(11);a(12);a(13);a(14);a(15)
26 Print"03-";a(16);a(17);a(18);a(19);a(20);a(21);a(22);a(23)
27 Print"04-";a(24);a(25);a(26);a(27);a(28);a(29);a(30);a(31)
28 Print"05-";a(32);a(33);a(34);a(35);a(36);a(37);a(38);a(39)
29 Print"06-";a(40);a(41);a(42);a(43);a(44);a(45);a(46);a(47)
30 Print"07-";a(48);a(49);a(50);a(51);a(52);a(53);a(54);a(55)
31 Print"08-";a(56);a(57);a(58);a(59);a(60);a(61);a(62);a(63)
32 ifr=8then90
33 goto69
34 rem
35 ifw$="y"thenclose3
36 end
37 ifs(x)=s(7)then30
38 ifs(x)=s(6)then30
39 ifs(x)=s(5)then30
40 ifs(x)=s(4)then30
41 ifs(x)=s(3)then30
42 ifs(x)=s(2)then30
43 ifs(x)=s(1)then30
44 ifs(x)=s(0)then30
45 goto33
46 a(0)=s(0):a(1)=s(1):a(2)=s(2):a(3)=s(3):a(4)=s(4)
47 a(5)=s(5):a(6)=s(6):a(7)=s(7)
48 goto55
49 a(8)=s(0):a(9)=s(1):a(10)=s(2):a(11)=s(3):a(12)=s(4)
50 a(13)=s(5):a(14)=s(6):a(15)=s(7)
51 goto55
52 a(16)=s(0):a(17)=s(1):a(18)=s(2):a(19)=s(3):a(20)=s(4)
53 a(21)=s(5):a(22)=s(6):a(23)=s(7)
54 goto55
55 a(24)=s(0):a(25)=s(1):a(26)=s(2):a(27)=s(3):a(28)=s(4)
56 a(29)=s(5):a(30)=s(6):a(31)=s(7)
57 goto55
58 a(32)=s(0):a(33)=s(1):a(34)=s(2):a(35)=s(3):a(36)=s(4)
59 a(37)=s(5):a(38)=s(6):a(39)=s(7)
60 goto55
61 a(40)=s(0):a(41)=s(1):a(42)=s(2):a(43)=s(3):a(44)=s(4)
62 a(45)=s(5):a(46)=s(6):a(47)=s(7)
63 goto55
64 a(48)=s(0):a(49)=s(1):a(50)=s(2):a(51)=s(3):a(52)=s(4)
65 a(53)=s(5):a(54)=s(6):a(55)=s(7)
66 goto55
67 a(56)=s(0):a(57)=s(1):a(58)=s(2):a(59)=s(3):a(60)=s(4)
68 a(61)=s(5):a(62)=s(6):a(63)=s(7)
69 goto70
70 Print:Print"The program will request :-"
71 Print:Print"1..Week Number"
72 Print:Print"2..Number of Games"
73 Print:PrintsPc(3)"(1 to 8)":fort=1to3000:nextt
74 Print"#" :Print:Print:Print
75 Print"The program will then":Print
76 Print"random select numbers":Print
77 Print"and then printout a":Print
78 Print"copy for each synd-":Print
79 Print"icate member.":
80 fort=1to3000:nextt
81 return
    
```

ready.

COLOUR GENIE

The Versatile Computer

Enter the exciting world of computer with the EG2000 Colour Genie

- * Low Priced — Compare the Features.
- * Clear & Defined Colourfull Graphics.
- * Fully Expandable — Compare the Prices.
- Children & Adults love Video Games.
- Home Accounting.
- Small Business Computing.
- Educational Purposes.

CALL OR WRITE FOR
LOCATION OF YOUR
NEAREST COLOUR GENIE
DEALER.

\$499⁰⁰

INCLUDES CASSETTE RECORDER



WE DARE TO COMPARE

FEATURES	COLOUR GENIE	VIC 20	TRS 80 COLOUR	ATARI 400
ROM	16K	8K	8K	10K
RAM on Board	16K	5K	4K	16K
Max. RAM on Board	32K	5K	32K	48K
Professional Typewriter Keyboard	YES	YES	NO	NO
R.F. with sound modulators built-in	YES	NO	YES	YES
Built in Power Supply	YES	NO	YES	YES
RS-232C Built-in	YES	NO	YES	NO
Sound	YES	YES	YES	YES
Screen Display	24 x 40	22 x 23	16 x 32	24 x 40
Programmable Characters	YES	NO	NO	NO
Upper/Lower Case Characters	YES	YES	YES	NO
Dedicated Graphics	YES	YES	NO	YES
User-Programmable Function keys	8	YES	NO	NO
CPU	Z80	6502	6809E	6502
Clock Speed	2.2MHz	1 MHz	0.89MHz	1.8MHz
Baud rate	1200	300	1200	1200
Price including Cassette Recorder (approx RRP)	\$499	\$394	\$784	\$758

FOR FURTHER INFORMATION CONTACT BERTAS INTERNATIONAL PTY LTD
P.O. BOX 294 BOX HILL, VIC. 288 7708

ROBOT MAN — You must move about the maze eating up the power food. Watch out for the Robot Men as they are programmed to destroy you before you complete your mission!
\$14.95

MICROBEE CHASE PLUS — A menu driven collection of 6 BASIC programs featuring excellent use of PCG graphics.
BANNER — Allows large character displays on the screen.

LEARNING CAN BE FUN — This set of 3 cassettes combines graphics with text to produce highly motivated teaching games. Uses variations of well known arcade games to enhance the learning process. **Volume 1A: GRILLA** — Answer questions to avoid the barrels Kong is rolling.

Love my
MicroBee
Don't you

CHESSE — Match your skills against the MicroBee chess master. You can select from 1 to 6 ply and also analyse any position. A built-in 'Help' feature enables the computer to play your current move for you.
\$9.95

LEARNING CAN BE FUN — Volume 2A
A — C This is a maths revision program, based around a well known little Alien Creature. All questions, including the opening selection, are answered by moving the hand of the alien to point to the required answer. Correct answers score points and also cause a plant to grow on the screen.

Incredible software support.

The MicroBee is supported by a wide range of software running in colour and black and white. High resolution, low resolution graphics and text freely mixed.

MICROSPACE INVADERS — Yes the arcade favourite! This fast moving version was written especially for MicroBee by Tim Morris-Yates and has become one of the most popular programs yet released. \$14.95

MATHS ADVENTURE — Wander into the fascinating world of the Wizard of Aus. Test your mathematic skills and have fun at the same time. A highly recommended graphics adventure game. Fun for high school maths students and teachers. \$14.95

TURTLE GRAPHICS — A very clever program allows the student to use the MicroBee to draw using high resolution turtle graphics. A booklet of procedures is available from the N.S.W. Department of Education. This is a very powerful graphics program which uses the PCG facility of the MicroBee to its full extent. \$14.95

WORK-A-BEE — A new release. Work-A-Bee is a program which can actually write educational programs almost automatically! Any teacher with little or almost no knowledge of BASIC can insert details as to question and answer, number of tries, marks per question and other controls. Any CAI program can be saved and reused and subroutines have been included to enable the student to go back over his work, printing answers, avoid error traps etc. \$14.95

CONCENTRATION — A real family favourite for 1 to 4 players to test your memory skills. If you call one player Merlin, the computer will play that turn so watch out! \$9.95

BUSY-CALC — Yes, an electronic spreadsheet running under microworld BASIC. Accepts text and numbers with easy cursor

control. Commands include:— Average; Sum; Compute; Format; Recalculate; Load and Save. Ideal for cash flow projections, bill of materials and even classroom data. \$14.99

PRINTER PACK — Biorhythm Calendar Maker, Banner Print Maze Maker. Ideal for parties or carnivals. Requires a serial printer. You can print biorhythms for anyone. Also prints calendars for any year A.D. and B.C. \$9.95

Z TREK — Captain! The warp drives are disabled, the Klingons are closing in on us, what will we do? In Z Trek you are the captain of the starship Enterprise, your five year mission to search out the Klingons and destroy them. There are ten levels of difficulty (0 - 9). Beware of this game — it is strangely addictive. \$9.95



SEARCH AND DESTROY WUMPUS — Have you ever played the game Wumpus? If you liked it then you'll like this! The object is the same as the earlier version except that it's a lot harder. To say any more would spoil the fun. Good Hunting! **\$14.95**

ESC KEY — This is a program for all of the two fingered typists in the world. The program allows you to enter BASIC key words in an abbreviated form. For instance, instead of typing 'list' the user would press the "ESC" key and then "1". The computer then types out the rest of the word for you. Suitable for 16K and 32K machines. Only. **\$14.95**

GRAPHIC GAMES PACK — This cassette contains five programs, 'Poker', 'Slots', 'Dodgem', 'Picture', 'Richochet'. 'Poker' is the main program on the cassette. In this game the computer is the bank and you have to beat it at Draw Poker. Warning — the computer plays a cunning game and is quite prepared to bluff! 'Slots' is a one armed bandit and for 20c a go you can try your luck. In 'Dodgem' the player must guide his car through a forest to the bottom of the screen — this game allows you to drive a car without the random breath tester getting you!! 'Picture' is an excellent game for the children. The final program on the cassette is 'Richochet', where the player has to decide where to fire a bullet through a hole in the wall. If you hit the wall you're dead. **\$14.95**

PCG TUTORIAL — The PCG Sampler cassette has eight programs on it. These programs show you how the graphics work and demonstrates their capabilities by way of games etc. The cassette is excellent for both beginners and experts. It allows you to design your characters on the screen, so you can see exactly what you are creating. Suitable for all MicroBees. **\$9.95**

STARSHOOT/HANGMAN — Starshoot is perhaps one of the most deceptive games available on computer. It appears to be very easy: it isn't. Hangman is based on the popular school game that everybody knows. **\$9.95**

ELIZA — Want someone to talk to? Eliza is possibly the person for you. (If you can get her to shut-up). Eliza is a program that demonstrates artificial intelligence. Eliza is prepared to talk about life, the universe and everything. **\$9.95**

BUSY BEE CAI SYSTEM — Easy to use computer aided instructions similar to the very popular Work-A-Bee, a two sided program with students and teachers versions. **\$14.95**

TYPING DRILL/SOLITAIRE — Want to become a touch typist? Typing Drill enables you to learn touch typing without paying an exorbitant fee to learn. Solitaire is a game in which the object is to remove all of the "pegs" from the board, leaving one peg in the centre of the board. Sounds simple, but, it requires skill to master it. **\$9.95**

TARGET — Target is a game of hit and miss. Your task is to aim the cannon at the bottom of the screen and shoot down the U.F.O.'s (ET watch out). There are nine levels of play to this entertaining game thus making it suitable for any player. Suitable for all Microbees. **\$9.95**

LEARNING CAN BE FUN — This set of 3 cassettes combines graphics with text to produce highly motivated teaching games. Uses variations of well known arcade games to enhance the learning process.
Volume 1A: GRILLA — Answer questions to avoid the barrels Kong is rolling.
FRACE — A game to teach fractions.
Volume 1B: MUNCH — Tests your knowledge by eating the right answer.
TNT — Answer before the dynamite fuse burns down.
Volume 1C: ADSTAR — Avoid the invaders. Shoot the space ship with the right answer.
SQUARE — The Enterprise can save the Galaxy. You arm the laser cannons. **\$9.95 each or \$24.95 for the set of three.**

PILOT — Pilot is a very easy programming language to learn, and ideal for preparing CAI (computer-aided-instruction). Microbee Pilot supports several enhancements including full integer arithmetic. **\$14.95**

BOGGLER — The popular family word game. **\$14.95**

ESCAPE FROM COLDITZ — An exciting adventure game. Beat the Hun and escape to freedom. **\$14.95**

SEADOG GRAPHICS GAME — A Swashbuckling adventure at sea in days of old. Engage the enemy, fire cannons and launch boarding parties. Call in at port for supplies — but watch out for the natives! **\$9.95**

MATCAL — An educational program for calculating with matrices. **\$14.95**

MICROBEE BASIC TUTORIAL — Teaches familiarity with Keyboard Self Pace Learning of Microworld Basic. Ideal for real beginners. **\$9.95**

INVENTORY SYSTEM — Personal business software. **\$14.95**

MICROBEE USERS GROUP SOFTWARE: Vol 1 — Assorted programs. **\$14.95**

GRAPH PLOTTER — An excellent learning tool — Specify the function and your Microbee plots the graph. **\$14.95**

PERSONAL FINANCIAL DIARY — Keeps track of your own personal debit/credit situation. Reconciles bank statements etc. **\$14.95**

DATBAS — Database demonstration illustrates the concepts of database management. **\$14.95**

SUPER DISSASSEMBLER — Utility software for technical boffins. **\$19.95**

MONKEY MATHS — A fun learning game. Answer the questions before the monkey climbs the palm tree. **\$14.95**

UNDERWORLD OF KIN — A 32K adventure game with graphics. You are transported to the massive twisted underworld and must escape by destroying the evil wizard.

LEARNING CAN BE FUN — Volume 2A: A - C — This is a maths revision program, based around a well known little Alien Creature. All questions, including the opening selection, are answered by moving the hand of the alien to point to the required answer. Correct answers score points and also cause a plant to grow on the screen.
M-RACER — Similar to A - C but without the graphics. The main variation is that a pre set time limit is placed on answering each question. **\$9.95**

MICROBEE CHASE PLUS — CHPLUS — A menu driven collection of 6 BASIC programs featuring excellent use of PCG graphics. The first 3 items on the menu are pattern drawing programs. The **TIMEHOLES** program can produce a superb display. **BANNER** allows large character displays on the screen. **KNOCKOUT** is a variation of single player Ping Pong. **CHASED** is a game where you attempt to avoid robots which are chasing you around an enclosure with electrified fence. **\$14.95**

microbee



AUSTRALIA'S OWN EDUCATIONAL AND PERSONAL COMPUTER

Designed and manufactured in Australia by
APPLIED TECHNOLOGY PTY LTD

Head Office/Showroom: 1 Pattison Avenue, Waltara 2077 N.S.W.
 Telephone: (02) 487 2711

Factory: 1 Debenham Road, West Gosford 2256 N.S.W.
 Telephone: (043) 24 2711 Telex: AA72767

For direct enquiries or the name of your nearest dealer, Phone: (02) 487 2711.



SHARP

5 KV. OPTOs



RIGHT 1st TIME!

WHATEVER THE APPLICATION

SHARP's massive range of opto couplers has a product to suit . . .
High Gain, High Current, High Voltage, Hybrid Mounting, OPTO FET,
ULTRA HIGH SPEED, Single, Double, Triples and Quads, End Stackable or solo

SHARP . . . right, FIRST time



Distributed in Australia by:

daneva australia pty ltd
66 Bay Rd, Sandringham, Vic., 3191.
P.O. Box 114, Sandringham, Vic., 3191.
Telephone: 598-5622. Telex: AA34439.

Sydney: (02) E&M Electronics 51-5880
Adelaide: (08) DC Electronics 223-6946

Perth: (09) Micro Controls 445-2544
Brisbane: (07) Baltec 369-5900

Win a
FREE

ZX81 64K RAMPACK

NO PURCHASE NECESSARY

PLUS **FREE**

BONUS CERTIFICATE
REDEEMABLE ON ANY PROGRAMME

- BUSINESS • IMPORTS
 - GAMES • EDUCATIONAL
 - HARDWARE
 - PROGRAMMING AIDS
- (incl: Keyboards, Memories)

FOR FULL DETAILS SEND FOR
YOUR COMPREHENSIVE
CATALOGUE AND BONUS
CERTIFICATE TO:

**G. S. WEBBER
& ASSOCIATES**

P.O. BOX 238
GYMEA 2227



100% GUARANTEE

PRINT ROUTINE

Tim Parish, Myrtle Bank S.A.

This subroutine provides an easy way of coding a number of multi-line messages for printing on the screen during execution of a CHIP 8 program on the '660. It features: • 13 characters per line • long messages flow onto new lines as required • equal spacing between characters of different width (making more natural-looking words).

The memory requirement in any program calling the subroutine is just seven bytes per message plus one byte per character — that's pretty economical.

The routine occupies the last 1/3K of a 3K machine, equivalent in memory requirement to about 58 characters, and is most useful in message oriented games (such as 'Guessing Game', reproduced here).

The subroutine leaves all registers unchanged, except V0 and V1. Here's an example of how to use the subroutine:

Call: (prints HELLO)

```
0720 A831 points to start of message
0722 A720 points to above instruction
0724 2EA8 call PRINT
```

```
Data:
0830 0506 length of message/'H'
0832 0408 'E'/L'
0834 0809 'L'/O'
```

There are two approaches to using PRINT with various programs: (1) record it separately and load it into RAM before or after the main program is loaded — saves space on tape; (2) treat the program and subroutines as one program — convenient.

GUESSING GAME

This is a simple game demonstrating use of the PRINT subroutine. The program itself explains the game, which is left with hexadecimal output for variation.

If your '660 is not called 'Little Zen' (which becomes clear when you run the program), you might like to change the first message! Don't forget to load the PRINT subroutine.

● PRINT ROUTINE

```
0e90 -----
0ea0 ----- f165 ae9e f955 aeca
0eb0 f155 aeba 6401 8145 f155 a--- f065 8800
0ec0 00e0 6600 6200 6700 6900 a--- f21e 7901
0ed0 7201 390e 1edc 6700 7607 6901 f065 8300
0ee0 8034 8034 8034 8034 af10 f01e d765 601f
0ef0 8035 3f00 1f02 6024 8035 3f00 1f00 7701
0f00 7701 7704 9280 1f0a 1eca ae9e f965 00ee
0f10 e0a0 e0a0 a0e0 a0c0 a0e0 e080 8080 e0c0
0f20 a0a0 a0c0 e080 c080 e0e0 80c0 8080 a0a0
0f30 e0a0 a040 4040 4040 8080 8080 e0e0 a0a0
0f40 a0e0 e0a0 e080 80e0 80e0 20e0 e040 4040
0f50 40a0 a0a0 a0e0 e020 e000 8080 8080 0080
0f60 0000 8000 8000 0000 0000 2040 4040 2040
0f70 2020 2040 4040 0000 00a0 a000 0000 0000
0f80 0000 80e0 20e0 80e0 e020 e020 e0a0 a0e0
0f90 2020 e080 e020 e0e0 80e0 a0e0 e020 2020
0fa0 20e0 a0e0 a0e0 e0a0 e020 20e0 2040 80e0
0fb0 f080 8090 f070 2020 a0e0 90a0 c0a0 9090
0fc0 d0b0 9090 f090 f0a0 9050 a8a8 a888 f090
0fd0 90b0 f888 8888 5020 8888 a8a8 5088 5020
0fe0 5088 8850 2020 2050 f850 f850 a870 f870
0ff0 a800 00e0 0000
```

Note : memory used by subroutine is denoted by ' ---- '

CODE FOR CHARACTERS :

A - 00	L - 08	w - 28	9 - 1e	* - 2c
B - 01	M - 25	X - 29	? - 0e	- - 2d
C - 02	N - 23	Y - 2a	! - 0f	
D - 03	O - 09	Z - 1f	:	- 10
E - 04	P - 0a	2 - 17	blank	- 11
F - 05	Q - 26	3 - 18	(- 12	
G - 20	R - 24	4 - 19) - 13	
H - 06	S - 0b	5 - 1a	' - 14	
I - 07	T - 0c	6 - 1b	" - 15	
J - 21	U - 0d	7 - 1c	. - 16	
K - 22	V - 27	8 - 1d	# - 2b	

● GUESSING GAME

```
0600 a6c4 a600 2ea8 26a6 6200 c6ff a6ee a60c
0610 2ea8 26a6 a724 a614 2ea8 26a6 a754 a61c
0620 2ea8 26b2 8430 8444 8444 8444 8444 6a1f
0630 6b07 f329 dab5 6d0f fd15 fd07 3d00 163a
0640 26b2 f329 7a04 dab5 26a6 8030 8044 7201
0650 9060 165e 8760 8705 4f00 1696 169e a79c
0660 a65e 2ea8 641f 680e f229 d485 26a6 a7bf
0670 a66e 2ea8 600f f00a 400f 1676 4001 160a
0680 3000 168e a809 a684 2ea8 26a6 0000 a7ff
0690 a68e 2ea8 1674 a76a a696 2ea8 161a a783
06a0 a69e 2ea8 161a 6d60 fd15 fd07 3d00 16aa
06b0 00ee 6c0f 63ff 7301 83c2 e39e 16b6 00ee
06c0 00ff 0028 0604 0808 0911 1011 1111 1111
06d0 1108 070c 0c08 0411 1f04 2311 1111 0b0a
06e0 0400 2207 2320 1611 1111 1111 0034 0711
06f0 0600 2704 110a 0702 2204 0300 1124 0023
0700 0309 2511 0604 2911 230d 2501 0424 1105
0710 0924 1111 112a 090d 110c 0911 200d 040b
0720 0b16 002e 0607 230c 1110 110c 0604 1111
0730 1123 0d25 0104 2411 070b 1101 042d 0c28
0740 0404 2311 1f04 2409 1111 1100 2303 1105
0750 0516 0014 0423 0c04 2411 2a09 0d24 1111
0760 1120 0d04 0b0b 1110 0017 0c09 0911 0607
0770 2006 112d 1111 110c 242a 1100 2000 0723
0780 16ff 170c 0909 1108 0928 112d 1111 1111
0790 0c24 2a11 0020 0007 2316 0021 0c06 000c
07a0 140b 1107 0c11 0f11 1123 0d25 0104 2411
07b0 0905 1111 1111 0c24 0704 0b11 10ff 3f03
07c0 0911 2a09 0d11 2800 230c 1111 0c09 110c
07d0 242a 1100 2303 1111 1120 0d04 0b0b 1100
07e0 2309 0c06 0424 230d 2501 0424 110e 1111
07f0 1111 112a 040b 1007 1111 2309 1009 0907
0800 1109 2411 0911 0f0f 0920 0909 0301 2a04
0810 110f -----
```



Colour TV Game

All the excitement of the big, expensive TV games - without the big expense! This colour TV game console lets you decide which games you want to play - at a surprisingly low cost. The console comes complete with two individual joystick controllers, readily accepts any of the plug-in microprocessor games modules. All you have to do is connect the console to your TV antenna input, plug in the game and you're away! The game is absolutely safe: it's battery operated so it cannot harm you or your TV in any way if used according to instructions.

- GAMES MODULES** Cat. Y-1160
- Car Race Cat. Y-1165 \$25.00
 - Motor Cycle Cat. Y-1163 \$29.00
 - Submarine Cat. Y-1167 \$27.50
 - Super wipe out Cat. Y-1168 \$25.00
 - Shooting Gallery Cat. Y-1169 \$29.50 ~~WAS \$35.50~~

~~WAS \$59.90~~ **ONLY \$49.90**

1,000 SOLD!
SAVE \$10
BUY THE TV GAME & GET THE SUPERSPORT CARTRIDGE FREE!

Superb Project Case



Cat. H-2505

For all 'Instrument' type projects. Split apart design. Size 200 x 160 x 65mm.

~~WAS \$19.95~~
NOW ONLY \$12.50

The Dick Smith Printer/Calculator

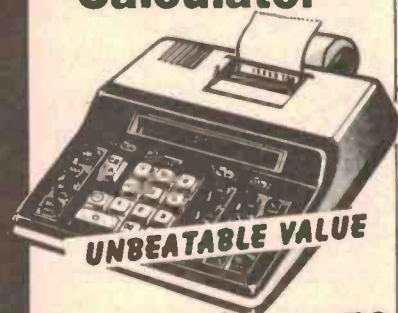

UNBEATABLE VALUE

ONLY \$99.50

A compact desk-top calculator with print or no-print function. This mains operated model is designed to afford the most efficient, simplest method of performing the broadest range of calculations. Cat. Q-3018

- One memory function
- Automatic motor shut-off system
- Large easy to operate key-board
- Easy to read green display
- Non-print function uses less paper
- Automatic constant
- Floating and fixed decimal point
- 240 Volt power supply



SAVE UP TO \$355

MICROPOLIS™ DISK DRIVES

You can have from one to four drives, giving up to 1260K bytes - that's more than a megabyte! Two models available, the 1043 is a quad density unit with controller that packs 77 tracks each of 16 sectors on one 134mm disk. The result is an incredible 315,000 bytes of storage per disk. The 1023 is an add-on unit.

YOU CAN HAVE MORE THAN A MEGABYTE OF STORAGE!

- Cat. X-3205 includes Controller Board
~~WAS \$1350~~ **NOW \$795**
- Cat. X-3208 Add-on Drive
~~WAS \$750~~ **NOW \$620**

1043 - Cat. X-3205
1023 - Cat. X-3208

Needs S-100

LAST CHANCE TO BUY! HUGE SAVINGS!

ONLY \$599

Hitachi 15MHz Dual Trace CRO

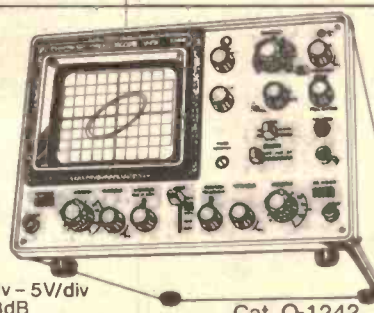

Cat. Q-1242

Vertical Sensitivity: 5mV/div - 5V/div
Bandwidth: DC - 15MHz, -3dB
Rise Time: 24ns
Input R and C: Direct 1 Mohm, approx. 30pF
Power Requirements: 120-240V, 40W

For the service bench, the development laboratory, the technical college, university or school - or even the serious hobbyist or amateur who simply wants a top-of-the-line CRO with out breaking the bank, we now have the outstanding Hitachi V-152B 15MHz Dual Trace Oscilloscope. And it costs no more than the previous CRO's we've sold which didn't have anywhere the number of features of the Hitachi V-152B.

- Z-axis input: use as CRT display
- One-touch 10X sweep magnifier
- One-touch wave-form shifting
- Very convenient X-Y operation

TAX-FREE PRICES AVAILABLE FOR APPROVED TAX-FREE PURCHASERS

Quality Disks

SAVE HEAPS



Buy soft sector floppy disks in bulk. You get 10 floppy disks plus the disk library. Cat. X-3512

ONLY \$54.50

Superb quality 5 1/4 in. minifloppy diskettes at a very low price! Both types, hard & soft sector, at the same low, low price!

Hard Sector

Suit Micropolis - type drives for Sorcerer etc. Cat. X-3505

Soft Sector

Suit most computer systems in use today. Cat. X-3510

AMAZING \$4.95 VALUE

Head Cleaner Disk Kit

Another area often overlooked is your disk drives. For longer life and absolute reliability, they should be cleaned at least once a week. These handy items make head cleaning easy. Cat. X-3517

Replacement disk insert
Cat. X-3518 **\$1.495**

16K Expansion Pack

Just bought a computer? Why not upgrade with these quality RAM IC's. Don't be misled into paying extra for no better quality: ours are the premium quality 200ns type 4116 dynamic RAMS used by most microcomputers. Upgrades an 8K to 16K or 16K to 32K or 32K to 48K. Cat. X-1186

Pack of 8 x 4116 RAMS
~~WAS \$100~~ **NOW \$22.50 ONLY**

Direct Coupled & 1/2 Price Data Phone Modem



ONLY \$199

A truly high performance direct coupled modem. Authorised by Telecom - and costs less than half the comparable acoustic modem! Simple plug-in connections, full duplex operation for speed & convenience. Cat. X-3272

Business Analyst Calculator

You'll wonder how you got along without it. Solves today's complex business calculations in seconds: tax, mortgages, leases, bond rates, interest... complete with detailed owners manual and wallet. Cat. Q-3785



\$49.95

Amazing 28 Memory

Digital Dialler

The very latest in microprocessor technology! This amazing new Computer Telephone Digital Dialler can store 28 seventeen digit numbers - so you can ring any of 28 people at the touch of a button, or you can call other numbers by using the push button dial. Each number is displayed as you dial. Ideal for PABX too! Cat. Y-1180 Telecom Permitted C82/4/7.

~~WAS \$99~~
Great Value \$79



SAVE \$20

Quality Stainless Steel Tools Dick Smith Prices!

Resists rust, spring load return, insulated, easy grasp hand grips.

Transistor Nipper

Ideal for PCB work, long life, cutting edge. Cat. T-3205

Mini Flat Nose Plier

Great for those small nuts. Cat. T-3325

Mini Needle Nose Plier

Ideal for small components, and confined spaces. Cat. T-3570

Mini Long Nose Plier

Long reach in a small plier. Cat. T-3565

**DIRECT IMPORT YOU ALL ONE
REAP THE BENEFIT! PRICE**

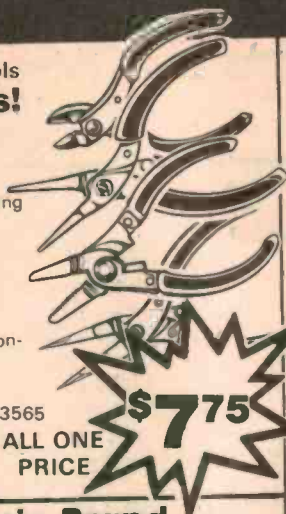

\$7.75

Famous Casio Brand Programmables

Casio Cassette Interface

ONLY \$52.50

Punching in programmes can be a bore - so why not save them on cassettes so they're always ready! Interfaces FX-602 to any standard cassette recorder. Cat. Q-3125

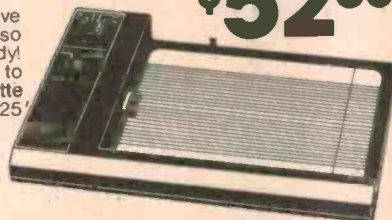

Casio FX-3600P Scientific/Programmable

Wow! Check out the Casio FX-3600P, programmable up to 38 steps - it's an ideal calculator for engineers, uni, tech and advanced high school students, technicians etc. Ask about our tax free price for students. Cat. Q-3105

WAS \$54.50 ONLY \$49.50



Casio FX-602P Advanced Programmable

Advanced programmable: 88 memories... 512 steps... full memory retention. An amazing 33 parenthetical levels, up to 9 sub-routines and nestings... Sounds more like a computer than a calculator? You're right!

WAS \$499.95 ONLY \$179.95

Cat. Q-3110



What a beauty!

Mini Matrix Printer

We sold 100's of the previous model - and it was only for 204mm paper! This model is the same price - but it takes standard 240mm paper! If you don't need word processor quality - you can save a fortune. Cat. X-3250

WAS \$495 ONLY \$395

Ribbon to suit Cat. X-3251 \$12.50

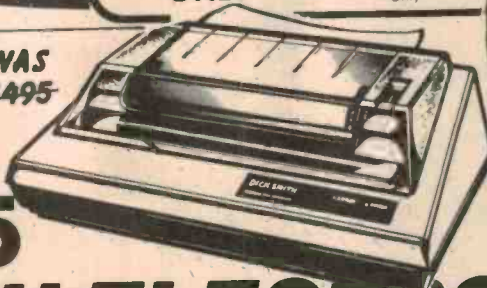

Metric Conversion \$19.95



Like most people? Still can't convert your metrics? Your troubles are over! This dandy calculator will do it all for you - as well as work out everything you want to work out. PLUS it has non-volatile memory: it remembers even when it's turned off!! Cat. Q-3025

* Tax Free price to bona fide students Enquire at your nearest Store.

Plessey Foster Speakers

Famous brand Plessey Foster speaker at a ridiculous bargain price! Huge scoop purchase of distressed stock - you reap the benefit... 8 ohms impedance, handles 6 watts. Fantastic replacement, ideal for new projects too. Cat. C-2050



ONLY \$4.95 NEW NEW

The Dick Smith Solder Station

It's the one for all your servicing or hobby needs and it's still at the pre-budget, pre-devaluation price! Look at these features:

- Variable temperature control from around 200 to over 500 degrees C.
- Large temperature meter
- Fully permitted by the Energy Authority
- Complete with lightweight iron, holder, cleaning sponge and users manual!!

ONLY \$65

HUGE SAVINGS!



The Dick Smith FM 2 Station Intercom

These handsome units will perform as well or better than units costing much more. Simply plugs into the AC mains... No wiring required for your home, office or factory! What could be easier? Cat. F-1012

- New featherlight touch keys
- No batteries or wiring
- Has call tone
- On/Off volume control
- Two channel Master/Slave operation
- Lock key for hands-free operation
- LED power On/Off Indicator
- Complete with mains plug

ONLY \$69.95
Pair

NO WIRING REQUIRED -
NEW FEATHERLIGHT TOUCH KEYS
No buttons to push!



BARGAIN SPEAKER DRIVER KIT

Build your own enclosures - here are the speakers ready to drop in! Includes two x 200mm woofers, midrange and two tweeters, plus crossovers and wiring harness PLUS full instructions. Cat. C-2046

ONLY \$89.50
Speakers Only

NOTE:
DOES NOT
INCLUDE
BOXES

**POT
PACKS
75 POTS \$9.95**
for
75 POTS

Selection includes mixed values:
Dual Gang, Single Gang & Switch Pots!
**UNBELIEVABLE VALUE
AT TODAY'S PRICES!**

DICK SMITH ELECTRONICS



7 Day Satisfaction Guarantee

If you're not completely happy, you can return your purchase within 7 days in original condition & packing for a full refund! You owe nothing - not even an explanation.

NSW Auburn 648 0558 • Bankstown Sq. 707 4888 • Blakehurst 546 7744 • Bondi Jct. 387 1444 • Broadway 211 3777 • Brookvale 93 0441 • Chullora 642 8922 • Gore Hill 439 5311 Gosford 25 0235 • Liverpool 600 9888 • North Ryde 88 3855 • Parramatta 689 2188 • Sydney (Bridge St) 27 5051 • Sydney (York St) 290 3377 • Tamworth 66 1961 • Tighes Hill 61 1896 • Wollongong 28 3800 ACT Fyshwick 80 4944 VIC Coburg 383 4455 • Frankston 783 9144 • Geelong 78 6766 • Melbourne 67 9834 • Richmond 428 1614 QLD Brisbane 229 9377 • Buranda 391 6233 • Chermide 59 6255 Townsville 72 5722 Toowoomba 38 4300 SA Adelaide 212 1962 • Darlington 298 8977 • Enfield 260 6088 WA Perth (William St) 328 6944 • Perth (Hay Street) 321 4357 Cannington 451 8666 TAS Hobart 31 0800

MAIL ORDER CENTRE: PO Box 321, North Ryde NSW 2113. Phone: (02) 888 2105

MICROBEE COLUMN

WE TRUST you enjoyed last month's April Fools funny. If you're still attempting to work it out or de-crash your 'Bee, the answer's on page 137 of the April Issue (ho, ho, ho... hee, hee... har, har).

Enough levity, back to the serious business. Every programmer gets into random numbers at some time or another. If you haven't, then Tom Moffat has an interesting demonstration program for you. Nonetheless, if you're an old hand with random numbers, Tom's contribution this month will hold you fascinated... for minutes at a time.

If you'd like to perform a real task with your MicroBee, M.J. Hennessy has something useful for you by way of a clock-&-timer program.

CLOCK AND TIMER

M.J. Hennessy, Lae, PNG

The easy access to the MicroBee data ports and the ease with which they can be controlled in software holds great promise for use in controlling a host of external peripherals or receiving data from external sources.

As an applications microcomputer, the MicroBee could be readily programmed to act as an alarm clock, turn on the coffee percolator... etc, by sending data on the RS232 output or by using the parallel PIO port.

For a timed sequence of events one usually needs a clock and this program uses the MicroBee as a digital clock and timer where any number of conditional statements can be set up in the program for the MicroBee to act upon them at the time required.

The program is straightforward and illustrates use of some of the graphics commands in generating the display, plus use of the sound facility for the alarm.

The clock is set up in the 24 hour mode. However, this may be changed to 12 hours by changing the reference to the variable Z at lines 180, 240 and 500.

In operation, the program asks for the input of the time in hours, minutes and seconds to set the clock and the alarm. Invalid time entry, i.e: 25 hrs 67 mins, is checked for each input and if an invalid entry occurs there is a branch to line 630 where you are politely taken back to the start again.

To finally start the clock, use is made of the return key for verification and curiously, with the MicroBee, the ASCII value for the return key is decimal 128 and this is used at lines 290 and 660 where a verified entry is required.

In setting up the display the CURS statement positions the cursor where you want it using X — Y addressing.

CURS 8,3 : PRINT "Digital Timer ..."
prints out at column 8, VDU line 3.

Similarly, at line 370 the display is printed out at column 18, VDU line 8.

Use of CURS 18,8 at line 380 is a simple trick to turn off the flashing cursor while the program is running and it leaves the cursor where we want it for our next print out.

One feature of MicroBee BASIC that has to be admired is the use of logical AND and OR conditional statements. I have used AND to show how it can be combined with IF-THEN at line 390 so that when hrs. min. sec of the clock and alarm are identical the statement is true and our alarm goes off.

It is at this point that conditional statements of your own choosing could be inserted to activate external devices using the OUT instruction.

The alarm is a loop that runs for one minute starting at line 570 and randomly plays each of the MicroBee's 25 notes, including the rest... enough to wake up the deepest sleeper!

When the alarm finishes the time is advanced by

```

00100 CLS
00110 REM ...Clock and Timer... for MICROBEE QS 5.10
00120 REM M.J.HENNESSY.....
00130 REM
00140 CURS 20,3:PRINT "Clock and Timer."
00150 PRINT
00160 PRINT"Enter time to start clock....."
00170 PRINT
00180 INPUT" Hours = ",Z;:IF Z => 24 THEN 630
00190 INPUT" Minutes = ",Y;:IF Y => 60 THEN 630
00200 INPUT" Seconds = ",X1;:IF X1 => 60 THEN 630
00210 PRINT
00220 PRINT"Enter time for alarm or function to occur."
00230 PRINT
00240 INPUT" Hours = ",W;:IF W => 24 THEN 630
00250 INPUT" Minutes = ",V;:IF V => 60 THEN 630
00260 INPUT" Seconds = ",U1;:IF U1 => 60 THEN 630
00270 PRINT
00280 INPUT" Press RETURN to start clock.";A1$
00290 IF ASC(A1$) <> 128 THEN 280
00300 CLS
00310 CURS 8,3 : PRINT"Digital Timer....."
00320 LORES
00330 PLOT 28,30 TO 100,30
00340 PLOT 100,30 TO 100,18
00350 PLOT 100,18 TO 28,18
00360 PLOT 28,18 TO 28,30
00370 CURS 18,8 :PRINT "hrs ";Z;" : min ";Y;" : sec ";X1
00380 CURS 18,8
00390 IF X1 = U1 AND Y = V AND Z = W THEN 580
00400 GOSUB 540
00410 X1=X1+1
00420 IF X1=60 THEN 440
00430 GOTO 370
00440 X1 = 0
00450 Y = Y + 1
00460 IF Y = 60 THEN 480
00470 GOTO 370
00480 Y = 0
00490 Z=Z + 1
00500 IF Z = 24 THEN LET Z = 0
00510 PLAY 16
00520 GOTO 300
00530 REM ...SECOND COUNT LOOP...
00540 FOR B = 1 TO 383
00550 NEXT B
00560 RETURN
00570 REM...ALARM OR FUNCTION...
00580 FOR N = 1 TO 370
00590 PLAY INT(RND*25)
00600 NEXT N
00610 Y=Y + 1
00620 GOTO 370
00630 REM ...INVALID ENTRY STATEMENT...
00640 PRINT:PRINT"The last time entered was invalid.":PRINT
00650 INPUT"Press RETURN to start again...";B1$
00660 IF ASC(B1$) <> 128 THEN 640 ELSE 100
00670 END

```

one minute and the clock continues. I should mention that, for any event that you ask the MicroBee to do, after it occurs the time must be adjusted. As clever as it is, the MicroBee can only do one thing at a time.

While on the point of adjusting the time, the speed of the clock is controlled in the subroutine from line 530. This is a one second loop.

Finally, to brighten up the display, I opted for a border around the hrs. min. sec.

I drew a border using the low resolution graphics initiated by LORES at line 320 followed by a series of PLOT statements.

What else does the program do?... it gives a BEEp every hour on the hour!

Learning is Fun



Green Screen Monitor pictured is an optional extra.

16K PLUS

The 16K PLUS has built in features such as music generation, PCG high and low resolution graphics, with a screen display of 16 lines each containing 64 upper and lower case characters. When you also consider all of the standard extras like continuous memory, built in printer and input/output interfaces and parallel port, 4.5 volt battery back-up and self testing BASIC in ROM, the Microbee 16K PLUS is unbeatable in its class.

\$449

32K PLUS

All of the standard features of the 16K Plus with twice as much usable RAM. When you add the new Wordbee ROM Pack, you have a powerful word processing capability which does a lot more than play the many games available for the Microbee. Add a printer and just see what you and your family can now do with your home computer.

\$549

microbee 

AUSTRALIA'S OWN EDUCATIONAL AND PERSONAL COMPUTER

Designed and manufactured in Australia by

APPLIED TECHNOLOGY PTY LTD

Head Office/Showroom: 1 Pattison Avenue, Waitara 2077 N.S.W.
Telephone: (02) 487 2711

Factory: 1 Debenham Road, West Gosford 2256 N.S.W.
Telephone: (043) 24 2711 Telex: AA72767

For direct enquiries or the
name of your nearest dealer,
Phone: (02) 487 2711.



CEAT2933

The Microbee

IC

has arrived

Z80 Expansion Port

RAM: 16K or 32K
CMOS Non-Volatile

Programmable RS232
Serial Port

Programmable 8 Bit I/O Port

2K Screen RAM

Z80A PIO

6545 Programmable VDU
Driver

Full Size 60 Key Positive
Travel Keyboard

Integrated Software in ROM

Battery Backup

Cassette Interface (300 and
1200 Baud)

Character Generator ROM

PCG Graphics RAM

Z80A Microprocessor

3.375 Mhz Clock Generator

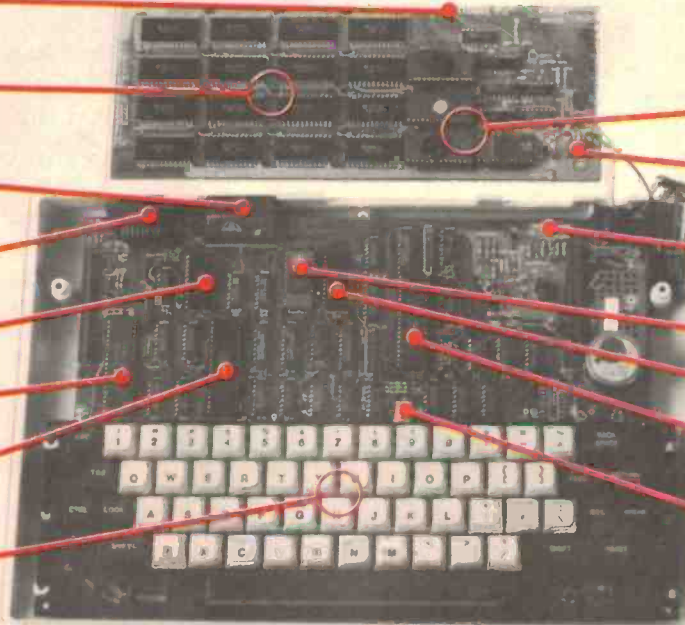

New from Microbee, a world first totally new concept. Now with totally integrated software such as BASIC, WORDBEE, MACHINE MONITOR, TERMINAL COMMUNICATION, the new MICROBEE 16K IC and MICROBEE 32K IC represents a major breakthrough in microcomputer technology.

The MICROBEE IC computers now all run at a FAST 3.375 Mhz, all fitted with the new 6.0 ENHANCED MICROWORLD BASIC, all are capable of 64 by 16 or 80 by 24 screen formatting.

The MICROBEE IC series are software compatible with the earlier MICROBEES and owners of earlier BEES can easily upgrade their machines. You get all the features that have made the MICROBEE what 'YOUR COMPUTER' calls "one of the success stories of the Australian computer industry", with bonus features like word processing, communications, integrated BASIC and Z80 machine code operation, the MICROBEE IC series is the ideal educational/personal computer that you take home with you.

With almost 10,000 MICROBEES sold to date, a large base of highly original and effective software for games, business and educational uses, CAN YOU AFFORD NOT TO CONSIDER this Australian designed computer for your next purchase?

MICROBEE 16K IC \$499
MICROBEE 32K IC \$599



microbee 

AUSTRALIA'S OWN EDUCATIONAL AND PERSONAL COMPUTER

CEAT2932

RANDOM NUMBERS

Tom Moffat, Fern Tree, Tas.

One of any computer's more interesting features is its random number generator. Without it, games would be very dull and many statistical operations would be impossible. The random numbers so generated aren't really random, they're pseudo-random... they follow a pattern, but it's so complicated the results look like pure chance.

The best practical way to get true random numbers out of a computer is to use a noise diode or some other noise source and store the highs and lows so generated as ones and zeroes in the computer. The technique would be worth some experimentation. The MicroBee's random number generator develops real numbers between 0 and 1 which are then multiplied by some factor to provide the range of numbers required.

How random are the numbers? Does the MicroBee

play with loaded dice, or stack the deck against you? This program lets you see the random number generator working, then displays a statistical distribution of the numbers generated.

A total of 4096 numbers are generated, ranging from 0 to 127. These are displayed in 128 stacks of pixels across the bottom of the screen. Zeroes are stacked on the left, 127s on the right, and everything else in between.

If the random number generator were perfectly random there would be an equal quantity of each number generated. For 4096 numbers that would be 32 of each. Each stack shown on the screen would be of equal height.

But things don't work that way, as you'll soon see... watching the program is like watching the grass

grow! When the 4096 numbers are complete, the computer beeps, clears the screen and then shows a graph of how many stacks got 32 numbers, how many got 33, 34, 31, 30, and so on. The big vertical line represents the 32 mark.

If one particular stack gets to 47 before the total of numbers reaches 4096 a graphics error will cause the statistical result to be displayed early. In this case there will be no beep.

You may sometimes notice that one number is heavily favoured. At other times some number may badly miss out. But this is all part of the game of randomness. If you would watch the program for an infinite length of time you would possibly see them all even out.

You'd certainly develop a nasty case of eyestrain! ●

```

00100 REM Random number distribution study,
00110 REM Tom Moffat
00120 CLEAR: CLS: LORES
00130 ON ERROR GOTO 210
00140 DIM X(127), Z(127)
00150 FOR A=1 TO 4096
00160 Y=INT(RND*128)
00170 SET Y,X(Y)
00180 X(Y)=X(Y)+1
00190 NEXT A

00200 PLAY 1
00210 CLS
00220 FOR A=0 TO 127
00230 P=X(A)
00240 SET P,Z(P)
00250 Z(P)=Z(P)+1
00260 NEXT A
00270 PLOTI 32,16 TO 32,47
00280 GOTO 280
    
```

END OF MODEL SELL OUT.

Huge savings for bargain hunters.

We have acquired limited stocks of superceded S100 cards from a number of suppliers which we are able to sell at component cost or less.*

FDC-I

Single-density floppy disk controller. Suits single or double-sided 5 1/4 or 8" drives. Handles up to four drives. Our Price \$185.

SD SYSTEMS MPB-100 Z80 CPU Card.

4MHz, 2KEprom on board, front panel interface. Bargain Price \$150.

2708 16KEPROM Cards.

Switch selectable for 8K or 16K, full address decodable. Our Unbeatable Price \$50.

SHUGART SA 400 FLOPPY DRIVES*

We have 60 of these 5 1/4" drive in excellent condition for a magic price. \$250 each.

DRC-II*

The state-of-the-art S-100 memory card, with bank select, supports 64K to 256K bytes of Dynamic memory. Operates up to 4MHz. We have 30. Save \$\$\$\$\$. New price \$600. OUR PRICE \$297.

All boards are supplied with full manuals and circuit diagrams, and are backed with a 90 day guarantee.

K-NAR also stock a full range of the latest S-100 boards. Write to us today for a full list of product data sheets.



K-NAR
COMPUTER CARDS

PO Box 412, Dandenong, 3175 Phone (03) 795 5858

Prices subject to change without notice. All prices excluding tax. For retail prices add 20%. All boards fully assembled and tested and backed by 90 day guarantee.

To K-NAR Computer Cards

Please send me product data sheets.

(I enclose 4 stamps).

I wish to order _____

My cheque/order form is enclosed _____

Please debit my _____

Bankcard No. _____

Name _____

Address _____

Signature _____

Please include me on your new product mailing list. I am mainly interested in systems for Hobby, Industrial use, Education, Business, Process control, Other.

KNAR 448

THIS IS THE COMMODORE 64 ONLY \$699.

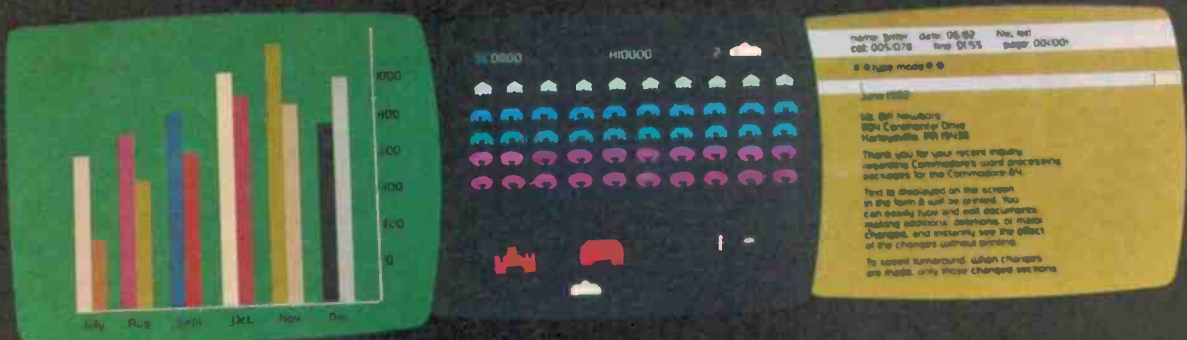

"THE COMMODORE 64 COULD BE THE MICROCOMPUTER INDUSTRY'S OUTSTANDING NEW PRODUCT INTRODUCTION SINCE THE BIRTH OF THIS INDUSTRY."

-SHEARSON/AMERICAN EXPRESS

They're speaking to a group as interested as anyone else in the future of computers: the people who buy stock in the companies that make computers.

If, on the other hand, you're a person whose livelihood depends on a personal computer - or whose leisure time revolves around one - what follows should impress you even more than it impresses investors.

MIGHT MAKES RIGHT.

The value of a computer is determined by what it can do. What it can do is largely determined by its memory.

The Commodore 64's basic RAM is 64K. This amount of power is unusual enough in a micro at any price.

At \$699, it is astonishing.

Compared, with the Apple II+® for instance, the Commodore 64™ offers 33% more power at considerably less than 50% of the cost.

Compared with anything less, it's even more impressive.

And it can effectively double your computer-equipped work force.

PILE ON THE PERIPHERALS

Because the basic cost of the 64 is so low, you can afford more peripherals for it. Like disk drives, printers or even printer-plotters.

This means you can own the 64, disk drive and printer for a little more than an Apple II+ computer alone.

HARD FACTS ABOUT SOFTWARE

The Commodore 64 will have a broad range of custom software packages including an electronic spreadsheet; business graphics (including printout); a user-definable diary/calendar; word processor; mailing lists, and more.

With BASIC as its primary language, it is also PET BASIC compatible.

The Commodore 64 will also be programmable in USCD PASCAL, PILOT and LOGO.

And, with the added CP/M® option, you will have access to hundreds of exciting software packages.

THE FUN SIDE OF POWER

The Commodore 64 can become very playful at a moment's notice.

You can use Commodore's plug-in game cartridges or invent your own diversions. All will be enhanced by brilliant video quality and high resolution graphics (320 x 200 pixels, 16 available colors, 3D Sprite graphics), plus outstanding sound.

The 64's built-in music synthesizer has a programmable ADSR (attack, decay, sustain, release) envelope, 3 voices (each with a 9-octave range) and 4 waveforms. All of which you can hear through your audio system and see in full color as you compose or play back.

NOW'S YOUR CHANCE

If you've been waiting for the "computer revolution," consider it as having arrived.

Through its 25 years of existence, Commodore has been committed to delivering better products at lower prices.

Today, the company's vertical integration has resulted in the Commodore 64's price performance breakthrough heralded by Shearson/American Express.

Visit a Commodore Computer dealer and discover the 64 soon.

It will expand your mind without deflating your wallet.

CP/M® is a registered trademark of Digital Research, Inc.

Commodore Business Machines Pty. Ltd.
5 Orion Road, Lane Cove NSW. 2066. (02) 427 4888.

Please send me more information on the Commodore 64.™

Name _____

Address _____

Postcode _____ Phone _____

BF

COMMODORE BUSINESS MACHINES PTY. LTD.
5 Orion Road, Lane Cove NSW. 2066. (02) 427 4888.

 **commodore**
COMPUTER

Here are four good reasons to dbx your sound system

No matter how good your sound system is, you are limited by one major thing: the record. Every normal record is severely limited in musical range. Compression during cutting results in half the dynamic range being eliminated. The excitement of the music is lost. This applies to digitally mastered and direct to disc recordings. The other problem is something you hear every time the stylus enters the groove: surface noise. We went to the source of the problem, the cutting of the record. We encode the record by



compressing it 2:1. The decoder expands back in a mirror fashion. In this way, the vinyl record can achieve a staggering 90dB dynamic range, compared to 50dB achieved on normal high quality recordings. Only through dbx can you truly appreciate digital recordings. The range of dbx discs is growing. There are now over 150 titles available, including a wide variety of Classical, Popular and Jazz discs. Hear "The Empire Strikes Back" by John Williams, Vivaldi's "Four Seasons" and artists such as Oscar Peterson, Dave Brubeck and Almeida.



MODELS 222 AND 224. The benefits of dbx for both disc playing and home recording. Your cassette deck's dynamic range increased from 50dB to a staggering 80dB.

The 224 further provides simultaneous encode/decode for three head recorder off tape monitoring. Both models provide decoding for dbx discs.



MODEL 228. This new model provides the noise reduction and disc decoding capabilities of the 222/224 with dynamic range expansion for your non encoded discs and tapes. Restore the dynamic range of records, tapes and radio broadcasts.



The most advanced dynamic range expander ever developed is now more affordable. Three band expansion brings new life to your entire record collection.

Audio Engineers

342, Kent St., Sydney, Phone (02)29 6731.
Victoria: (03)44 32 95. Queensland (07) 369 9670
Western Australia 335 8273 S.A. (08) 293 4896

Please Send full details of Full range of dbx discs The range of dbx equipment.

Name

Address

So you're thinking of buying a CD system?

The Compact Disc player and software on laser-scanned 12 cm discs should appear on the Australian market this month.

Heralding its arrival are some amazing claims — the greatest technological development in audio since stereo, you can make mud pies on the disc, you can play frisbee with them, the sound quality is perfect, and so on.

Many of the claims are true; the CD system is approaching perfection and has many advantages over the traditional stylus-in-groove system. But some of the claims are outrageous and before you rush off and buy the first system you listen to you should have a few facts to back you up.

There are not expected to be many digital discs available early in the piece, probably 200 titles or less, because there are still only three pressing plants in the world that can produce them: a PolyGram plant in West Germany and one each for Sony and Denon in Japan.

Sony and CBS announced that CBS would be setting up a US pressing plant to be operating in 1984 but the outlook still looks bleak.

One reason for the dearth of discs is that the pressing plants disc yield (the percentage of usable discs from each press run) is still low. Figures vary between 50-80 per cent but they are not yet up to the 90% average yield typical of vinyl record pressings.

The discs are difficult to manufacture. A disc has an incredibly high 'information density' which stems from the 'pit track' engraved on the embedded 'signal surface' (the aluminised reflective layer which the laser in a CD player actually scans).

The thickness of the disc must be 1.2 ± 0.1 mm; flatness must be within 0.6 degrees; the edges of the engraved pits must be within 50 nanometres of their ideal positions; pit depths must be 12 ± 10 nanometres.

With such tight tolerances and minuscule dimensions lots of things can go wrong, and not only with the discs. The CD player is subject to defocusing of the laser-optical system, 'mistracking' when the laser servos 'lose track' of the pits, noise in the electrical circuitry and variations in the rotation rate of the disc.

It is possible that if any of these problems occur the results will be errors in the data as interpreted by the digital circuitry. But the quality of the players is so high that the Compact Disc system's error correction circuitry effectively conceals the errors so you won't hear any defects; unless, of course, you deliberately damage the discs.

Warp, fingerprint and scratch tests have shown that, with reasonable care, a compact disc is much more durable than an analogue record. The damage may look bad but you won't be able to notice any audible defects.

According to overseas reports, when non-standard, uncalibrated, greasy thumbprints were applied to the scanning side of the disc the number of digital error indications increased.

However, there were no error concealment indications which meant that the rise in errors due to the fingerprints was still within the system's ability to make a complete correction.

Making a scratch which follows the embedded track for several millimetres is the easiest way to make a CD pressing unplayable or at least audibly defective, according to reports.

Concentric scratches can obscure so much interrelated data beneath them that the otherwise well-informed error-concealment circuits are at a loss for reasonable interpolations.

To minimise the possibility of concentric scratches, PolyGram recommends that CDs be cleaned from centre to rim.

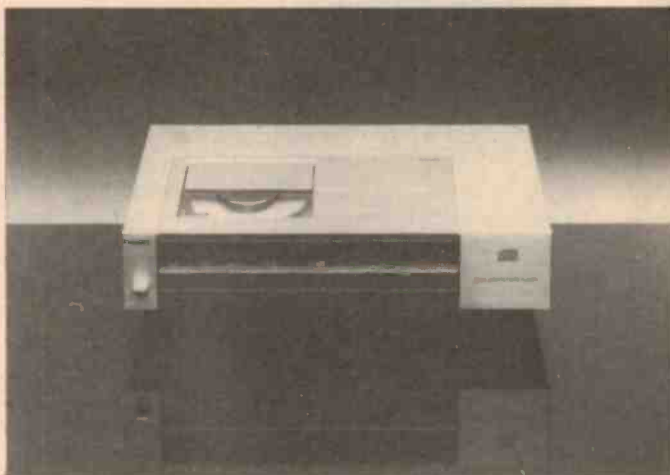

The Compact Disc Player. Approaching perfection in the reproduction of recorded music.



Compact disc software. Few discs, as yet, are 'direct to digital'.

Extensive radial and tangential scratches seem to have no effect on the tracking or sound of a disc unless they are very wide or very deep.

So if you handle digital discs in the same way as you would treat analogue records, taking care to minimise dust, fingerprints and scratches, your Compact Disc should provide exactly the same performance decades from now, regardless of how many times it is played.

It may be that you are not overwhelmed by the sound quality of the first CDs you hear, but don't immediately blame the CD system. There have been so few digitally mastered recordings of popular music that most of the early non-classical CD releases are derived from analogue

master tapes of extremely variable quality.

Of course, the CD will have much less background noise but even this advantage may be obscured by high hiss levels if (conventional) master tapes were made without noise reduction.

No matter how good CD technology is, and it is spectacular, it cannot significantly change the sound of what is on analogue, or conventional, master tapes.

For performances directly digitally encoded and then transferred to CD, the dynamics of the reproduced sound are truly breathtaking.

While many recent recordings have been made 'direct to digital', CDs of these number less than a third of titles to be released. But this will grow.

Magnat's omnidirectional plasma loudspeaker

In 1981 Magnat won the German Hi-Fi prize for developing the world's first electronic omnidirectional plasma loudspeaker.

The plasma loudspeaker consists of a needle electrode surrounded by an earthed electrode in the form of a sphere made from very fine wire mesh. A 27 MHz signal is delivered to the needle electrode. The electrical field developed between the electrodes induces a corona discharge which produces an intense ionisation of the air molecules around the point of the needle.

The plasma loudspeaker is an almost massless, inertialess sphere. As there is no traditional cone there is no resonance of the cone material to colour the sound.

The Plasma MP-02 tweeter, at

a cost of around \$899 each, has a built-in amplifier with volume control and can be matched into any high quality loudspeaker unit. A full range speaker with the MP-02 plasma tweeter is in the final stages of production and the price is estimated to be at \$4500 a pair.

At a more affordable price are the Magnat 2A speakers at \$499 a pair and the Magnat 3A speakers at \$599 a pair. Both these speakers use flat ribbon technology.

In the budget price range are Magnat's Sonobull 10 speakers at \$299 a pair and the Sonobull 20 at \$399 a pair. These three-way systems have ferro fluid cooled tweeters and specially treated cones.

Duratone Imports, the Australian distributors of Magnat loudspeaker systems, can be contacted at 3A Botany St, Phillip ACT 2606. (062)82-1388.



Lightweight professional audio equipment

Hill Audio's range of audio equipment, for musicians and users of high power PA systems, is claimed to be ideal for the professional as it tends to be smaller and lighter than comparable products with the same output power.

The range, including mixing consoles, amplifiers, electronic crossovers, powered stage boxes and speakers, is manufactured in England by Hill Audio and distributed in Australia by Q Sound.

Now available is a range of FOH mixing consoles from 16 into 2 up to 32 into 8, monitor mixers from 12 into 4 up to 32 into 10, stereo amplifiers and tri-amplifiers with a total power output of 1000 W.

The Hill DX 901 amplifier, an entirely new model, has a power output of 900 W per channel into

two ohms. The Hill DX 701 has a power output of 625 W into two ohms per channel. They have a 12% larger heatsink than previous Hill amplifiers and a thermostatically controlled fan. Other features include a 12-way LED display with separate error indicators and parallel input and output XLRs.

For further information on the full range of Hill Audio equipment contact Q Sound Pty Ltd, 150 Lawrence St, Alexandria NSW 2015. (02)516-1671.



Marantz portable units

Two micro component systems, the Marantz PH32 priced at \$499 and the PH52 priced at \$549, can be mounted on a shelf or assembled into portable units.

The tuner in the PH52 features digital frequency display and press button memory recall. The amplifier in both systems has a built-in five-band graphic equaliser and the cassette deck

has metal tape facility and a track search function.

Another portable radio cassette recorder, Marantz PMS5 priced at \$209, has a quick music select system and a choice of mono, stereo or 'stereo wide' which gives an illusion of spaciousness of the sound heard from the built-in speakers.

The mic mixing facility requires an optional external microphone. The cassette recorder can use metal tapes.

Marantz (Australia) Pty Ltd can be contacted at 19 Chard Rd, Brookvale NSW 2100. (02) 939-1900.

Sanyo's car sound system

Sanyo has released a new combination car radio/stereo tape player.

The FT 420M features 20 watts per channel output, AM/FM stereo radio and an auto reverse tape player. Other features include tone and balance controls, mono/stereo switch, tape play/direction indicators, fast forward control and separate left/right LED power output indicators.

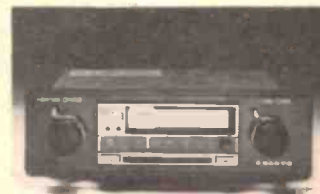

Its recommended retail price is \$163. More information can be obtained from Sanyo Australia Pty Ltd, 225 Miller St, Nth Sydney NSW 2066. (02)436-1122.

close enough is just not good enough

We live in an age where compromise is so often the norm.

Manufacturers compromise performance to gain a price advantage and people accept it, so it continues.

This philosophy is evident in the manufacture of some sound equipment, particularly in the choice of the cartridge supplied as original equipment.

Regardless of the quality of the rest of your system, it is the cartridge that has the complex task of translating the intricate combination of signals in the record grooves to the sound that is music to your ears.

Fortunately, a number of dedicated cartridge manufacturers have developed cartridges incorporating the latest technical know-how that will allow you to upgrade your system quite inexpensively.

We at Goldring Audio Industries believe that there are still a few of us left who are simply not prepared to accept compromise when it comes to sound reproduction so we have searched out those dedicated manufacturers and offer their products nationally.

Our huge range of cartridges will suit just about every hi-fi system on the market today.

Contact your Goldring Stockist or Goldring Audio Industries for a copy of our twelve page cartridge catalogue that further outlines the range and advantages of the various cartridges available.

Shown here are just some of the state of the art cartridges available from Goldring.

Distributed nationally by

GOLDRING
AUDIO INDUSTRIES



SALES OFFICES:

N.S.W. - Suite 1, 89 Chandos St.,
St. Leonards, 2065. (02) 439 3100
QLD. - 40D Milsom St., Coorparoo, 4151.
(07) 398 8044
VIC. - 1st Floor, 42 Berkeley St., Carlton, 3053.
(03) 347 5177
S.A. - Shop 7, 28 Sampson Road, Semaphore
Park, 5019. (08) 49 2064

DISTRIBUTORS:

Jensen Distributors, 35 Downie St.,
Wickham 2293. (049) 69 1333
S.J. Pontague & Associates, 440 Murray St.,
Perth, W.A. 6000. (09) 321 4567
Tasmanian Record Company, 10 Cameron St.,
Launceston, 7250. (003) 31 5588

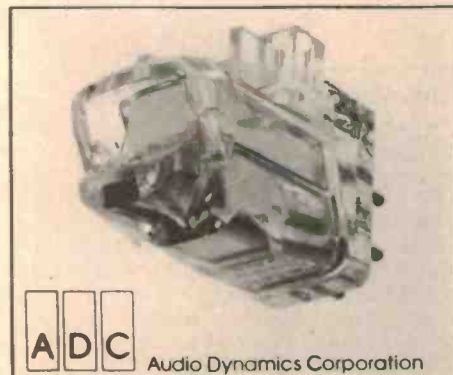

Video cassette recorder head cleaners

Beta format: ALLSOP 3 FOR BETA
AUDIO TECHNICA AT5002 • RALMAR BCL-200
SONY L-25CL • TDK LCL-30
VHS format: ALLSOP 3 FOR VHS
PANASONIC VFK-0185 • RALMAR VCL-300

A head cleaner should be used regularly on any VCR. But there are a number of different types and numerous brands on the market. Which is effective, and under what circumstances? This multiple review sheds some light on the matter.

Louis Challis

A VIDEO CASSETTE RECORDER can make TV viewing more flexible as you can arrange a much better choice of programmes and you can choose the time to watch them. It's hard to imagine or even appreciate the performance of VCRs until you actually get 'hands on' experience in your own home. But as we all know, nothing is perfect. Like all the other equipment with which you or I will come into contact, the video cassette recorder has limitations which can degrade the quality of performance.

The most common problem is usually caused by magnetic debris being deposited on the recording heads of the machine. The amount of debris deposited increases with usage of the VCR. Obviously the better the tape you use, the better the results. But even if you use the finest quality, most expensive tapes you can't guarantee that you will not have this problem.

For those of you who do not own a video cassette recorder and are unfamiliar with the effect of 'dirty' tape or 'dirty' heads, the problem usually shows up as bursts of white light on the TV screen. The effect is like watching TV in a 'fringe area' with a lot of external electrical interference affecting your picture. As the heads get dirtier with use the effective video signal that the heads can pick up from the tape is reduced, and the quality of the picture gets worse. In time the signal may even disappear completely if sufficient magnetic material is deposited to bridge over the tiny gap in the heads. If the heads are already worn, then the impact of magnetic particles is usually more serious and this generally results in a greater likelihood of drop-outs and overall picture degradation.

I don't want to spend too much time on the physical characteristics of the two video

cassette recorder systems currently dominating the Australian market (VHS and Beta). However, it is important to realise that the magnetic tape passing over the heads of the recorder during replay, and even more importantly during the original recording cycle, is subject to the same vicissitudes as your reel-to-reel and your audio compact cassette recorder.

You may already be aware of the problems which tape head drop-out creates in the audio frequency domain. It is well known that the problems of using extremely thin magnetic tape, coupled with the dynamic tape transfer problems in the recording path, are compounded by instability of the magnetic tape surface. This causes periodic drop-outs of the tape signal which may become almost continuous if the tape is of poor quality. This is worsened by the slow deposition of magnetic material on the heads, resulting in significant attenuation of high frequency, and to a lesser extent mid-frequency, content. In many early cassette recorders, this problem was accentuated by the excessive wear of some magnetic heads which utilised 'soft' materials. Extensive use led to the premature demise of these heads.

If you've ever suffered the embarrassment of having to replace the heads on your VCR, you'll appreciate that this can be a relatively expensive repair which may seem unwarranted and unfair. This is why most manufacturers of video cassette recorders now warn the purchasers of what they should and should not do in order to extend the life of their machines. Most also advise on the merits and disadvantages of the various head cleaning systems which are offered to the user through advertisements and retail outlets.

Types of VCR head cleaners

There are currently two basic types of consumer video head cleaners being produced.

- Wet or solvent-impregnated cleaners
- Abrasive cleaners

A third, minor or sub-classification is a semi-abrasive cleaner which is really only a rough, plastic tape with very light abrasive characteristics.

The characteristics of the abrasive cleaners range between moderately abrasive to lightly abrasive.

Some VCR manufacturers specifically advise against the use of abrasive cleaners, others recommend not to use any form of head cleaner and some recommend only specific brands and/or types. Some manufacturers don't give any recommendations or advice and it seems this may be because they have little knowledge of either their machines' characteristics or those of the many head cleaners available.

Developing a test method

To assess the available head cleaning tapes we wanted to evaluate the advantages, problems and characteristics of each of the samples to determine what they do and, more importantly, what they don't do. We decided that this review would not be purely subjective. We hoped to back up our statements with objective testing so that we would not be in any doubt as to the accuracy and objectivity of our results.

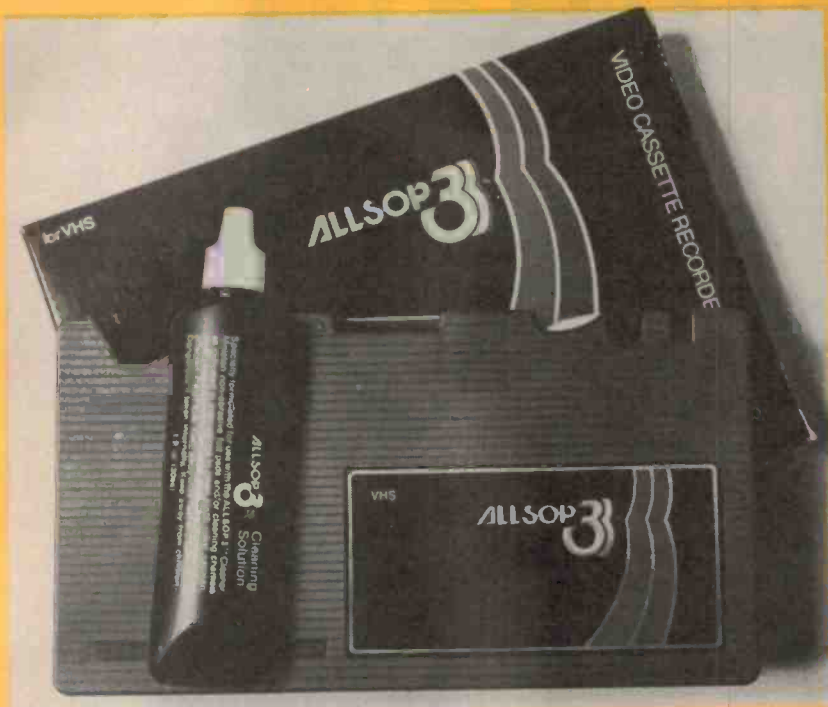

Allsop 3 (VHS & Beta models). The Allsop 3 cleaners are of the wet (non-abrasive) type. The VHS and Beta models differ in construction, apart from being housed in necessarily-different cassettes. Both, however, are constructed so that they clean the audio, video and erase heads, plus the capstan and pinch roller.

The VHS model has a soft chamois-like absorbent tape which is in contact with the VCR head mechanism for about five seconds — the length of the cleaning cycle. An adjacent felt pad cleans the capstan and pinch roller. A 'specially formulated' bottle of cleaning solution comes with it and this is applied to the tape and pad. This is an isopropyl-alcohol-based solution that is totally evaporative, leaving no residue after use. The VHS Allsop 3 can be used with any VHS machine.

The Beta model just has a chamois-like tape which is in contact with the heads, capstan and pinch roller. The cleaning solution is applied through five 'windows' in the cassette. This model has a ten second cleaning cycle. The Beta Allsop 3 can be used with any Beta machine on the Australian market, but a simple adjustment needs to be made to use it on the various makes.

Both Allsop cleaners have replaceable cartridges containing the cleaning gear — the only make on the market to have this feature. Each comes with a plasticised card giving complete, detailed instructions for use.

The picture below shows a closeup of the VHS model after use on which some magnetic tape material can be clearly seen on the chamolis toward the centre-top edge.



My first plans for the objective testing had been to pre-record an audio test signal on two test tapes which we would make for each of the formats. We borrowed two excellent video recorders, the AKAI model VS-2EA VHS recorder and the Sanyo model VTC 5400P Beta recorder. These recorders were used to test the measurement procedure. We then decided to produce a series of test tapes with which we would directly measure drop-out characteristics and head cleaning efficiency.

The troubles that we experienced were not with the concept, but with the implementation of a test method which is fast enough to respond correctly to the various types of drop-out likely to be experienced. This problem ▶

Beta format

ALLSOP 3 FOR BETA

Manufactured: by Allsop Inc, USA
Distributor: Allsop Fidelity Accessories,
P.O. Box 246, Double Bay NSW 2028.
(02)357-2022.
Price: Rrp \$39.95 for complete cassette and
cleaning solution; \$12 for replacement kit.

AUDIO TECHNICA AT5002

Manufactured: by Audio Technica Corp,
Tokyo, Japan
Distributor: Rose Music, 17-33 Market St,
South Melbourne Vic. 3205. (03)699-2388.
Price: Rrp \$29.95

RALMAR BCL-200

Manufactured: in Hong Kong
Distributor: Ralmar Agencies Pty Ltd, 4 Carlotta St,
Artarmon NSW 2064. (02)439-6566.
Price: Rrp \$27.50

SONY L-25CL

Manufactured: by Sony Corporation in Japan
Distributor: Sony, 453 Kent St, Sydney
NSW 2000. (02)266-0655.
Price: Rrp \$15

TDK LCL-30

Manufactured: by TDK in Tokyo, Japan
Distributor: TDK (Australia) Pty Ltd, Unit 5,
100 Harris St, Pymont NSW 2009. (02)660-4955.
Price: Rrp \$17.95

VHS format

ALLSOP 3 FOR VHS

Manufactured: by Allsop Inc, USA
Distributor: Allsop Fidelity Accessories,
P.O. Box 246, Double Bay NSW 2028.
(02)357-2022.
Price: Rrp \$39.95 for complete cassette and
cleaning solution, \$12 for replacement kit.

PANASONIC VFK-0185

Manufactured: by National Panasonic, USA
Distributor: GEC Australia Ltd, 2 Giffnock Ave,
North Ryde NSW 2113. (02)887-6222.
Price: Rrp approx. \$50

RALMAR VCL-300

Manufactured: in Hong Kong
Distributor: Ralmar Agencies Pty Ltd, 4 Carlotta St,
Artarmon NSW 2064. (02)439-6566.
Price: Rrp \$32.10

trim, taut and terrific

Mini
&
Slim

Here, at last, are the portable radio cassette recorders with the really big performance. Tough enough to handle, with sound reproduction you'd expect from a full size stereo.

See and hear one now at your nearest retailer...you may even take one home. But-that's life.



SANYO

That's Life!



M7880K



M7770K



M-W25F



M7000



M1600

was further compounded when we discovered that not only do the drop-outs occur in both the audio and the video signal paths, but there are also many types of drop-outs, ranging between microseconds to milliseconds in duration.

I discovered, to my chagrin, that the simple theory and practice did not quite agree and that there is "many a slip twixt the cup and the lip". Suitably impressed by my initial lack of knowledge of the problem, I continued to look for a practical and objective solution.

As luck would have it I found two possible avenues by which a solution could be obtained. The first related to the advice I received from a very knowledgeable Melbourne recording firm, AAV, whose laboratory manager provided me with background data on a machine which they had built to evaluate the problem. The second advice and assistance I received was from Star Video, one of Australia's largest software producers, which had purchased a commercial tape drop-out analyser, the DOM4, which was specifically designed to provide objective data in what was rapidly proving to be a very complex task.

With the help of Star Video I set out to analyse the characteristics of VCR head cleaners. As it turned out I also produced other useful data which may help you to keep your VCR running safe and sound.

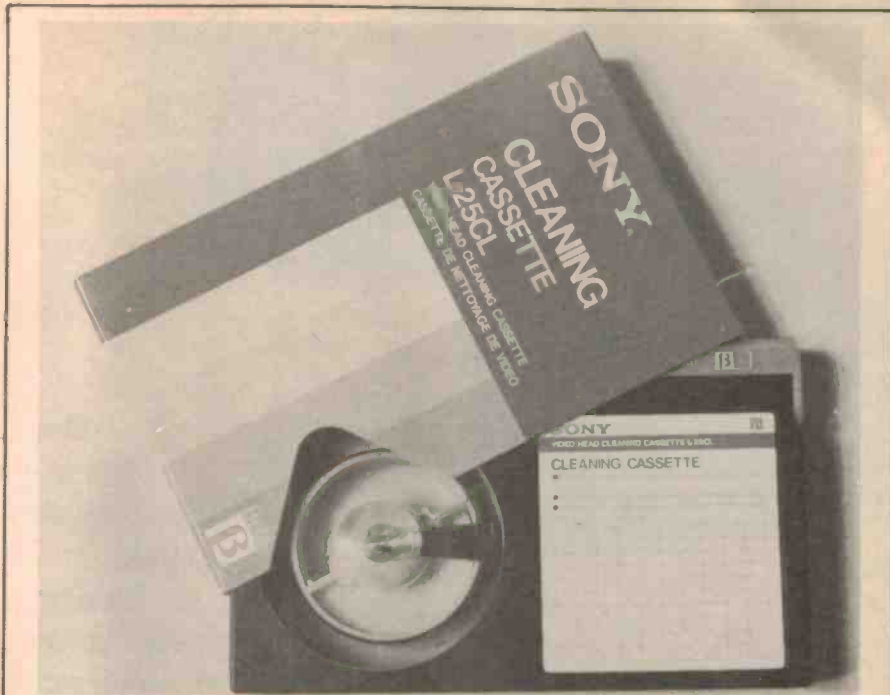

Figure 1. Drop out test signal.

Objective testing

With Star Video's assistance I recorded a special test signal as shown in Figure 1. This test pattern, with black background and superimposed white circle, provides an excellent format for both instrumental and visual checking of tape drop-out incidence. The evaluation procedure that we used was to pre-record a series of special signals on a group of test tapes provided in both formats by TDK, Sony, 3M and BASF.

The first phase was an instrumental assessment using the DOM4 video drop-out recorder to assess the drop-out performance of a series of the consumer head cleaners. The DOM4 has to have a 'dedicated' electrical connection to one or more video cassette recorders in order to collect the drop-out data which it records and then prints out on its internal printer. The concept is simple as each video recorder already incorporates a video drop-out detector as part of the video circuitry. This drop-out detector is usually followed by a compensation circuit. By connecting the DOM4 video drop-out recorder before the compensation circuit, the data



Sony L-25CL (Beta). This is an abrasive-type cleaner, similar in construction to the Audio Cleanica, but employing a different type of cleaning tape. This looks not unlike video tape, being a matte brown material on a plastic tape backing.

Instructions are supplied in four languages! Recommended cleaning time is 30 seconds and the instructions say not to repeat the cleaning process more than four times in a session, to prevent excessive head wear.

The L-25CL can be used for about 200 'cleans', or 100 for 'B1' mode, Sony say.

on the drop-out phenomena can be directly recorded. Testing with the DOM4 was reasonably fast. The results were also displayed on a video monitor and a CRO screen.

The data recorded by the DOM4 may be either extremely short transients which are detected individually or the more important 'bursts' of drop-out phenomena which your eyes can 'see'. The DOM4 prints out the time history of the drop-outs and the number

of significant bursts which result in total transient loss of vision on your television screen.

With a good clean tape and clean heads these drop-outs are virtually invisible. With bad tapes or dirty heads the results are, as I soon discovered, visually *devastating*. One problem that we observed was that poor tapes can create more drop-outs than the limited digital memory in the DOM4 can cope with. ▶

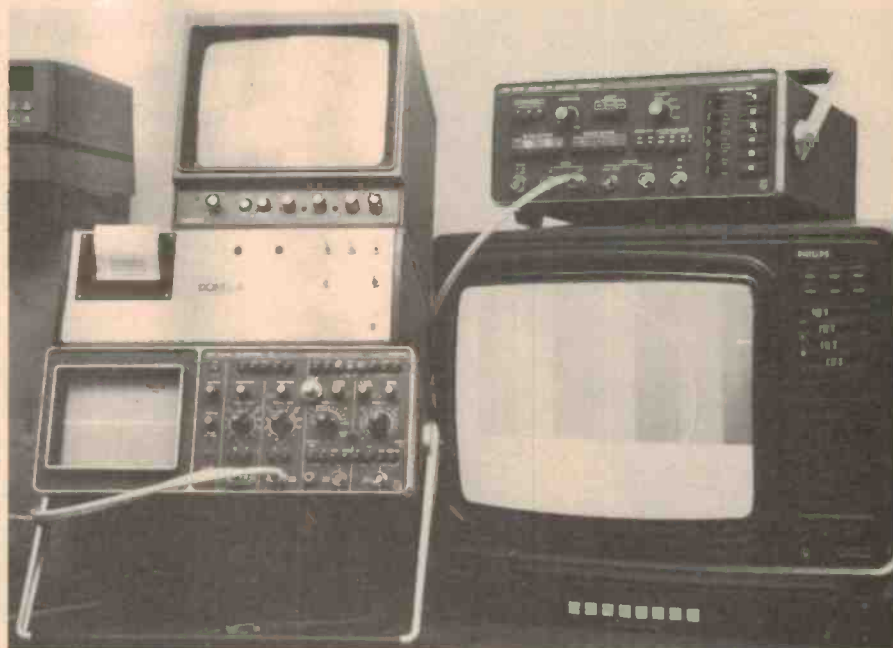

Recording drop out performance. The DOM4 recorder is at upper left.

Why Direct

Don't tangle with Technics.

The majority of audio systems – even the most beautifully designed – have something ugly to hide.

It's that mass of jumbled-up connecting leads that you find, all too easily, at the rear of the equipment. Not only are they ugly, they're inconvenient, too.

And as audio components become smaller, the problem becomes bigger and more unsightly.

To solve this problem, Technics developed their Direct Connector systems, which eliminate all audio connecting leads between the tuner, amplifier, graphic equalizer and cassette deck.

Each of these components features a special flip-up connector to allow them to be literally plugged in to each other!

It's an elegant piece of Technics technology that results in a stylish, neat installation that can be put together or taken down for re-location in a matter of seconds.

The 315 Series.

But Direct Connector capability is not the only innovative feature in this new and compact series from Technics.

The SL-5 direct-drive, linear-tracking turntable employs its own plug-in connector system for the pickup cartridge.

This unique Technics development has been adopted as a World Standard.

It means you can compare and evaluate cartridges from leading manufacturers like Audio Technica, Ortofon, Shure, Stanton, Empire, Pickering, ADC and, of course, Technics without conventional setting up procedures.

Technics developed Connector systems.

No adjustment of tracking weight or bias correction is needed.

The innovations continue in the rest of the components: the SU-5 amplifier includes a Super Bass switch to enhance the bass response of a speaker system without inducing bass boom; the ST-5 quartz synthesizer digital tuner provides random access memory for 16 pre-set stations; the SH-E5 graphic equalizer – offers adjustment of 12 audio bands from 16Hz to 32Hz on each channel; whilst the RS-5 cassette deck – has soft touch controls, auto selection of metal, CrO₂ and normal tape settings plus convenient Cue and Review functions.

Finally, a pair of SB-F5 speakers with horn-type tweeters and bass reflex porting turn the high quality electrical signals of the rest of the system into the high quality sound you expect.

Compact components, full-size warranty.

All components in this series are perfectly matched in styling and performance.

And all are covered by a full 2-year warranty backed by Technics' reputation. Visit your Technics stockist soon and experience the superb styling and brilliant sound of Technics' compact Series 315 for yourself.



Technics

National Panasonic (Australia) Pty Ltd

Expanding the music experience.



Allsop does it best with award winning VCR cleaners!

In *Video Review* magazine's "Best Gear of the Year" roundup for '81, the **ALLSOP 3** non-abrasive video cassette cleaning system for **VHS** and **BETA** was the *only* cleaner named. The Allsop 3 VHS cleaner is recommended by Akai America Ltd. The new Gen II/for **BETA** is compatible with all Beta VCRs. **ALLSOP 3** is the safe way to help maintain video and sound quality and to avoid costly repairs.

It cleans the critical VCR parts with exclusive, non-abrasive cleaning material and **ALLSOP 3** cleaning solution. Both systems give extra-long service and are designed with easy-to-install replacement cartridges. VCR cleaners are part of **ALLSOP 3** high fidelity care products respected throughout the audio, record and video industries.



World Leaders In Fidelity Cleaning.

Dealer inquiries invited.

ALLSOP FIDELITY ACCESSORIES,
 PO Box 246 Double Bay, NSW 2028. (02) 357 2022. Telex 23381 "COMPOW"



Following my investigations of this phenomena, it became particularly clear that assessments of tape cleaners' efficiency can only be reliably performed with a test tape which already has the best possible drop-out performance.

The objective measurements that followed confirmed that all blank video tapes exhibit some degree of drop-outs and that the best tapes have a much lower incidence of drop-outs than the average 'commercial grade' tapes. Some of the worst tapes which I examined exhibited continual drop-outs, to such an extent that there was not much picture left between the drop-outs.

The DOM4 test results showed that the Ralmar VCL-300 head cleaner reduced major drop-outs from 450 in 100 seconds to 430, the Panasonic VFK-0185 tape reduced drop-outs from 430 to 380 and the Allsop wet cleaner made no significant impact on the residual cleaning response of a tape recorder after the easily removed debris had been cleaned off by an abrasive cleaner.

These tests were then supplemented by a series of tests on a selection of machines which had been drawn from the Star Video production line after operating for approximately 1500 hours without cleaning. All exhibited dirty heads and either unstable performance or reduced video output. An inspection of both the machines and the heads revealed that while the use of video head cleaners may reduce the extent of recorder head contamination, they *do not* remove the contamination from tape guides or lift heavy drop-outs of oxide from the video head drum.

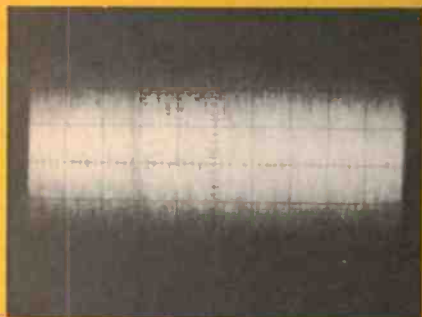

Clean. RF level from machine with clean heads.



Dirty. RF level from machine with dirty heads.

Only the abrasive cleaners lift substantial quantities of oxide from the drum and heads and then only at the risk of causing further wear on the heads and tape guides.

From this I concluded that if a head cleaner is to be used at all, it should be used before the contamination reaches serious proportions and preferably on a regular basis at intervals of between 50 and 100 hours of playing time.

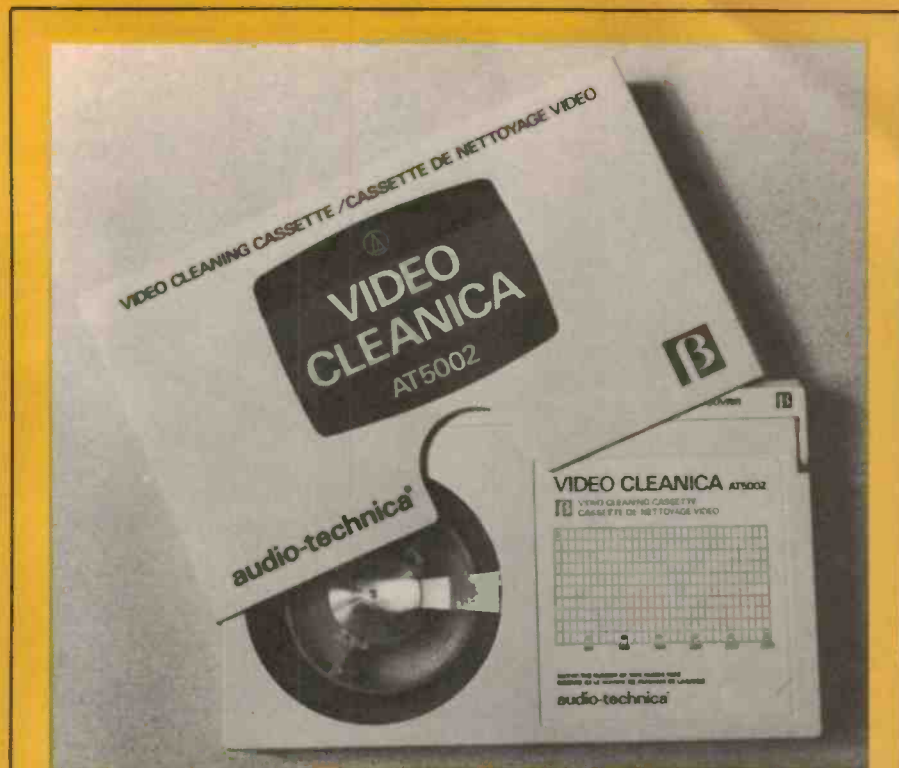

Audio-technica Video Cleanica AT5002 (Beta). This is an abrasive type cleaner employing a non-magnetic metallic silvery cleaning tape that contacts both the heads and tape transport mechanisms in the VCR.

The instructions, printed on the plastic packet, indicate that 'normal' cleaning time should be 30-40 seconds, 60-90 seconds in severe cases.

The cassette contains a panel on which you can record the number of times you've used the cleaner against hours of VCR usage. No indication is given of how many 'cleanings' can be obtained.

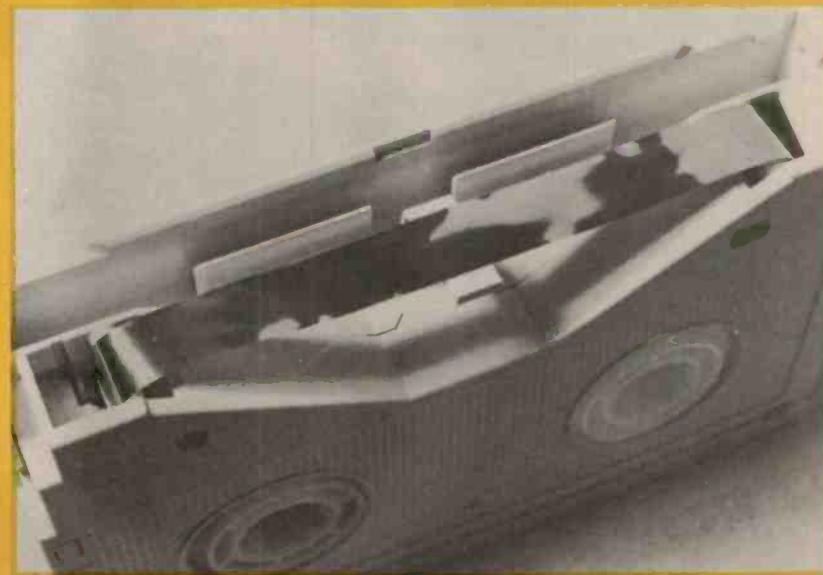

I also discovered that the recording heads of the Beta system are somewhat more susceptible to premature damage than the VHS heads, if reasonable care and precautions are not taken in normal usage. This comment is not meant as a condemnation of Beta recorders, but rather as a caution to avoid unnecessary and unwarranted manoeuvres such as heavy use of the slow motion or 'still

frame' (stationery picture) facilities. This can cause premature head damage.

To provide objective data to support my suppositions, I proceeded to disturb all of my friends and neighbours who already own video recorders, particularly those who had not cleaned the heads of their machines for a while.

The procedure was first tested on the ►



Ralmar BCL-200 (Beta) and VCL-300 (VHS). These employ what seems to be a lightly abrasive, white cloth-type tape with a coarse fibrous surface. Instructions are brief, printed on the cassette label. Cleaning time is about five seconds and the tape is rewound for successive uses. No information is given on how often the cleaner can be used.

This self-same cleaner seems to be available under other 'brand name' labels. The photograph below shows the Beta cassette opened up, displaying the cloth-type tape.

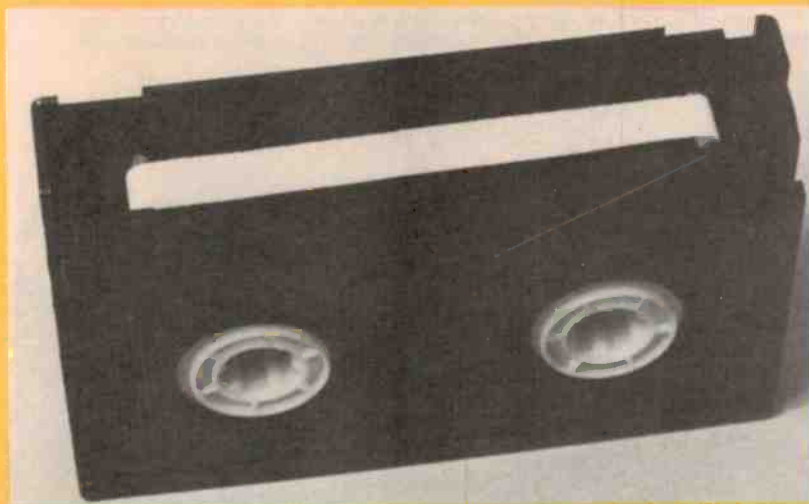

Sanyo VTC 5400P recorder which had, by this time, sufficient magnetic debris on the heads to reveal the classical early signs of video tape drop-outs. By turning the colour balance to black with maximum contrast, it became very easy to detect the drop-outs, which then show up as bright white individual flashes or lines of intermittent white streaks on the video screen.

The pre-recorded test tapes produced by Star Video then made it relatively easy to assess the readily observable drop-outs and count them over a fixed period of 10 minutes.



Filth! The Ralmar VCL-300 cleaner after use, showing tape oxide material taken from a dirty VCR head.

Test results

The results of these measurements are not, however, accurate or even directly comparable, as no two machines are identical, either in terms of age or degree of contamination. We found that some poor tapes deposit debris easily which lifts off almost as easily during the cleaning cycle. Other tapes do not necessarily deposit the magnetic material quite as easily, but once down it takes either an abrasive tape cleaner or a scrape with a finger nail to remove it. These variable conditions are not conducive to accurate measurements and so all of the tabulated results must be treated with caution. ▶



Video Recorder Tape Head Cleaners

The Results of the testing

E109/2885/106

A. VHS CLEANING TAPES

B. BETA CLEANING TAPES

Brand	Dropouts before use in 10 minutes	Dropouts after use in 10 minutes	Indicative % Reduction	Brand	Dropouts before use in 10 minutes	Dropouts after use in 10 minutes	Indicative % Reduction
Alsop 3	157	103	34	Alsop 3	402	128	68
Panasonic VFK0185	201	88	56	Audio Technica AT5002	279	89	68
Ralmar VCL-300	106 *	94	11	Ralmar BCL200	186	129	30
				Sony L-25CL	378	79	79
				TDK Super 30	245	72	70

* Machine cleaned 2 weeks before test.



For over a thousand years the people of Alsace have been making Traminer Riesling remarkably like ours.

Now we're not suggesting that the good people of Alsace have in any way stolen our idea.

We do, however, suggest that Oliver de Serres' idea that "the essence of wine lies in the grape" is correct.

And that our Traminer and Riesling grapes produce wine every bit as delicate and heady as those of Alsace. **McWILLIAM'S**

What is clear is that the 'wet cleaners' (Allsop 3) and the very mild abrasive cleaners (Ralmar VCL-300) are most effective on light deposits of magnetic debris or on heads that are cleaned fairly regularly. They are, in my opinion, the safest cleaners to use on a regular basis.

By contrast the abrasive cleaners — Audio Technica, Panasonic, Sony and TDK are the only cleaners that you can effectively use with really dirty or caked heads.

I recommend that you consider using the wet Allsop 3 cleaners or the soft Ralmar cleaners every 30 — 50 hours. The abrasive cleaners should only be used either when the drop-out becomes severe or on the occasion the other cleaners are ineffective.

In the long term, the best solution to drop-out problems is to use the best possible tape. But remember, even the best tapes aren't perfect, so you're going to need that video head cleaner.

Absolute copyright in this review and accompanying measurements is owned by Electronics Today International. Under no circumstances may any review or part thereof be reprinted or incorporated in any reprint or used in any advertising or promotion without the express written agreement of the Managing Editor.



Panasonic VFK-0185 (VHS). Another abrasive-type cleaner, this unit employs a fine-grained matte black coating on an opaque black plastic tape. Abbreviated instructions are printed on a label on the cassette and a slip of paper in the plastic case gives more detailed instructions.

The 'normal' cleaning time recommended is 15 seconds and the instructions advise that cleaning time should not be longer than 45 seconds.

The cassette contains enough tape to clean 20 heads without rewinding. The cleaner may be used up to 100 times by rewinding, according to the instructions.



TDK LCL-30 (Beta). This abrasive-type cleaner employs a tape having a fine-grained matte deep-brown material on a plastic substrate. The recommended cleaning time is 30 seconds, which the makers say should not be repeated more than four times in a single cleaning session. They also recommend the cleaner not be used for more than 90 seconds at a time — which is a total of three cleans. Confusing.

The LCL-30 can be used for about 200 'cleans', TDK say, and 80 little boxes are provided on the cassette label so you can mark off how many times you've used it.

From the 'Super 30' on the label, one assumes there's 30 inches of tape inside the cassette (about 760 mm).

A sheet of illustrated instructions, in English and German, is included.

WHAT DISTRIBUTORS SAY

In order to find out something of what VCR distributors in Australia advise with regard to head cleaning and head cleaners, we rang around seven major companies and spoke to either the video products manager or the service manager at each; in some cases, both. We asked what their company policy or recommendation was regarding head cleaning and head cleaning products. Summarised below is what we found.

Akai (VHS). Akai Australia recommend that, if trouble occurs, their equipment should be professionally serviced and definitely do not advise the use of a head cleaner.

Curiously, Akai America endorses the Allsop 3 head cleaner.

National Panasonic (VHS). National take much the same position as Akai — they do not recommend the use of any head cleaner and advise that their equipment should be returned for service. They have a service technician pull the machine down and clean the heads with a fluid.

Curiously, G.E.C. Australia, who market certain National video machines to the 'non-consumer' market here, themselves use and sell the Panasonic VFK-0185 head cleaner reviewed here.

Phillips (VHS). Phillips' position is simple. They sell and recommend the Allsop 3 video head cleaner.

Sanyo (Beta). Regular professional servicing is one recommendation Sanyo make, but they also sell the 'Fuji' and 'Soundtrack' brands of VCR head cleaners. The gentleman we spoke to said they found the Fuji cleaner easiest to use. Both are made in Japan.

Sharp (VHS). Simple; they take the same line as Akai and National.

Sony (Beta). They sell and recommend their L-25CL.

Toshiba (Beta). Firstly, Toshiba don't recommend the use of a VCR head cleaner and do recommend that their equipment undergo regular servicing and maintenance. They advise that, if a head cleaner is used, then the manufacturer's directions as to time of use should be followed carefully.

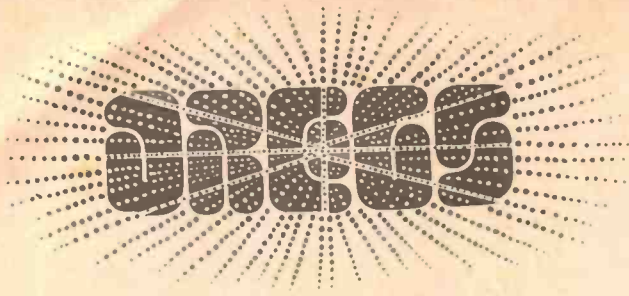

NO DOUBT you're all acquainted with the various 'dial-a-(whatever)' services you can find in the 'phone book. Dial-a-Prayer was famous when such things started up. Now you can 'phone such diverse services as Dial-a-Bubbly, Dial-a-Car or Dial-a-Date (which is quite distinct from Dial-a-Girl, nudge-wink and say no more!). You can even Dial-a-Flower or Dial-a-Fruit Basket. There's Dial-a-Minstrel (serenading services perhaps?), Dial-an-Angel (home help) and even Dial-a-Jewish Story!

There was once even a Dial-a-Joke service! But the one to eclipse them all must be one we spotted on the latest Altronics catalogue. It's called "JESTSERVICE".

Jack O'Donnell, the peripatetic proprietor of Altronics, is known to be fond of a joke. He's also known for walking on water (see ETI, April '81, page 11). Page 2 of his catalogue lists his 'overnight jestservice'. Not wishing to spoil a bit of fun by deducing what it obviously means,



the dilatory dilettantes of the Dregs Department dallied awhile with this dicky little dictum.

They asked 'What would happen if you ordered the Altronics jestservice?' Would Jack O'Donnell arrive on your

doorstep the next morning in full court jester's outfit with an Irish joke for the day?

Guarding your rear

It has been said that Alexander the Great firmly believed in guarding his rear, keeping a small force in reserve to make sure none of the enemy snuck round the back of the main force to distract them with a little sabotage.

It seems that latter day master of battle tactics, ex-Prime Minister Malcolm Fraser (retired), had been reading the thoughts of Commander Alexander, according to a story we heard from our sister magazine, Sonics.

It seems that a Sydney firm called the Fat Road Company was contracted to provide the sound for one of Mal's pre-election speeches in Martin Place, Sydney.

Apparently, the contract called for the power outlet to be guarded!

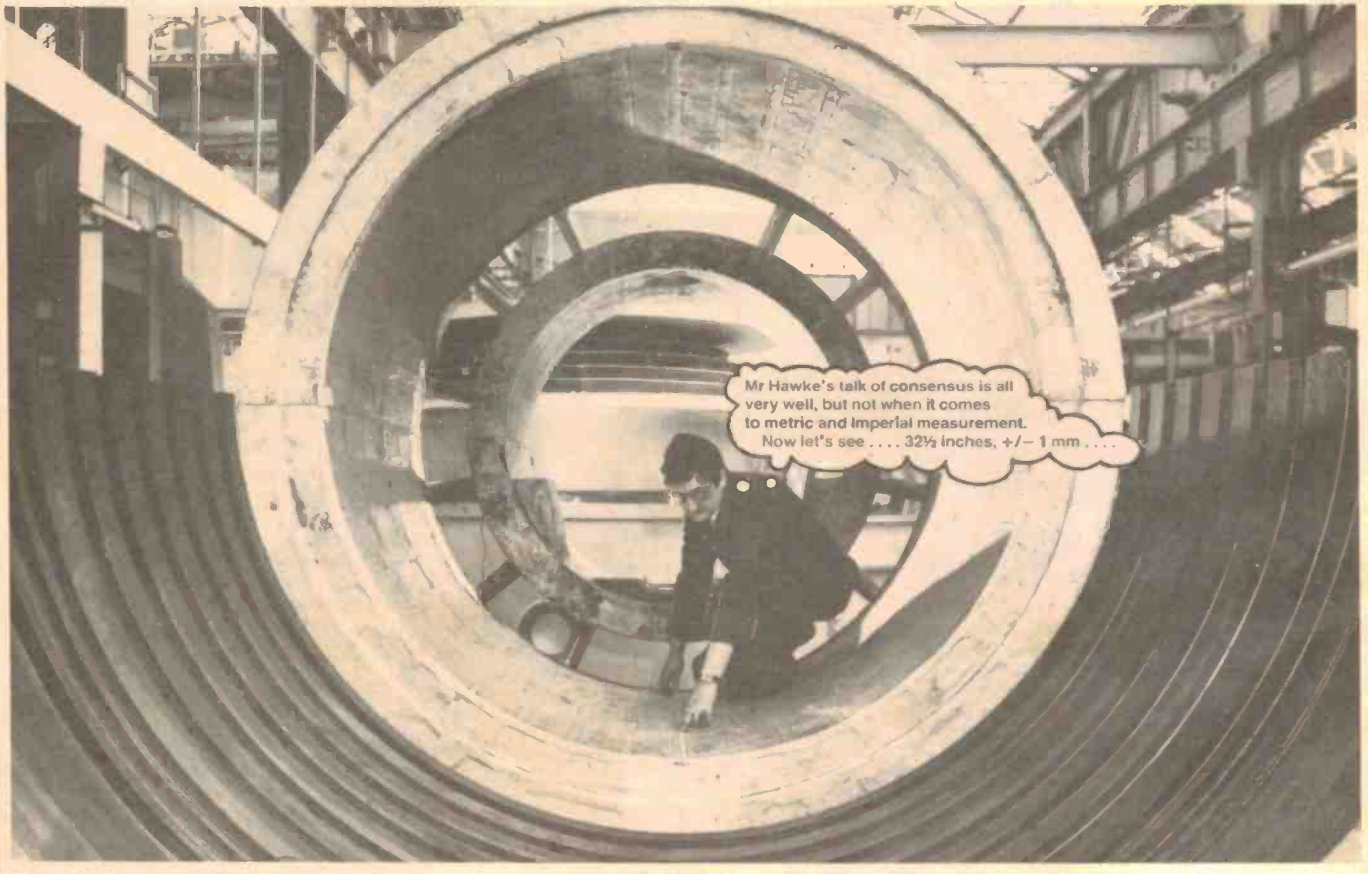

Mr Hawke's talk of consensus is all very well, but not when it comes to metric and Imperial measurement. Now let's see . . . 32½ inches, +/- 1 mm . . .

PURIFY YOUR HI-FI

INTRODUCING THE REVOLUTIONARY NEW MARANTZ COMPACT AUDIO DISC PLAYER.



DIGITAL AUDIO, the greatest improvement in music reproduction since the birth of stereo is now available to give you sound more pure than any you have previously heard.

THE MARANTZ CD EXPERIENCE. It's dramatic. And instant.

Plug the Marantz Compact Disc Player directly into your existing system and it immediately upgrades the sound—limited only by the performance of your current equipment. You can expect astonishing channel separation. Very precise spatial imaging. Sensational dynamic range. Rich bass notes. Pure true treble. And, because the encoded music is read by non-contact laser—absolutely no background noise and no disc wear.

MARANTZ FEATURES. The Marantz CD73 is gold toned. Elegant. Simple. The control panel is clean and neat, with LED signals to indicate function and track selection. The highly sophisticated technology is push-button operated. The disc drawer glides with the smooth precision of electronic control.

Marantz is control convenience.

And technologically, Marantz uses a special integrated circuit with three functions (oversampling, a transversal filter and noise-shaping) which processes the original signal through various stages to give a dynamic range of 97dB. This amounts to a 1dB improvement over most other systems. You may never hear the difference. But Marantz cared enough to make their Compact Disc Player demonstrably closer to perfection.

IS THE MARANTZ CD73 REALLY ANY DIFFERENT? David Praker for Hi Fi Answers magazine (UK) who did hear the difference said: "I have been surprised by the quite audible difference between different CD players and have already stated a preference for the sound of the Marantz machine in terms of its handling of 'ambience' and its sheer unflagging listenability. Other players I've heard in direct comparison have shown a bright veiling effect with more up-front presentation and a fatiguing quality."

Hear the CD73 for yourself. Call our local office for your nearest Marantz Dealer or write for further information.



marantz®



HEAR NO EVIL

MARANTZ (Australia) Pty. Limited Inc. in NSW, 19 Chard Rd., Brookvale, NSW 2100. Sydney (02) 9391900, Melbourne (03) 544 2011, Brisbane (07) 44 6477, Adelaide (08) 223 2699, Perth (09) 276 3706, Townsville (077) 72 2011.

The Sony CDP101

The magic of digital audio becomes a magnificent reality.

Digital Audio is a revolution. The greatest advance in home music reproduction since the gramophone record. As you'd expect, Sony is the leader of this revolution with its magnificent CDP-101 player that offers you original studio master quality at home.



For the technically minded, the specifications read more convincingly than any superlatives

- flat frequency

- response over the entire audible range
- dynamic range and signal to noise ratio over 90dB
- perfect channel separation
- immeasurable wow and flutter
- negligible distortion.

Sony's CDP-101 uses an optical laser pick-up (incorporating three micro processors), it is easier to use than a conventional turntable and connects easily to your existing system.

Other features include

- fully automatic linear skate front disc loading

- automatic music sensor
- dual function digital readout of playtime
- audible fast forward and reverse
- 10 function wireless remote control.

Compact Discs Last Forever

Just 12 cms in diameter, the Compact Disc plays up to 60 minutes of music. It's protected from scratches, dust and finger prints by a plastic coating; and because the pick-up is a laser beam, deterioration is non-existent. Reproduction remains perfect virtually forever.

Hundreds of titles will be available with many more to follow from major companies such as CBS.

CDP-101 Specifications

Frequency Range	5Hz-20kHz \pm 0.5dB
Dynamic Range	more than 90dB
S/N	more than 90dB
Channel Separation	more than 90dB (at 1kHz)
Harmonic Distortion	less than 0.004% (at 1kHz)
Wow and Flutter	immeasurable



The CDP-101 will be generally available May 1 throughout Australia but for a demonstration now, contact Sony for the name of your nearest dealer.

Sydney (02) 266 0655, Adelaide and N.T. (08) 212 2877, Brisbane (07) 44 6554, Perth (09) 323 8686,
Melbourne (03) 419 3133, Launceston (003) 44 3078, Wollongong (042) 71 5777.