

DEC 1982

\$2.15 NZ 2.50

**EXCLUSIVE**  
12 page 'zip out' mini-catalogue from  
Rod Irving Electronics

**eti**

**ELECTRONICS  
TODAY  
INTERNATIONAL**

**TRAIN CONTROLLER**

**GET THE FEEL  
OF A 'REAL' TRAIN**

**30 V/1 A BENCH SUPPLY**

**FULLY PROTECTED**

**WHAT BATTERY TO USE?**

**MODEM FOLLOW-UP**

**MICROBEE REVIEWED - twice!**

**BALANCED INPUT PREAMP**

**HI-FI: Cassette deck and noise reduction unit reviewed**



# The average hi-fi designer versus the human ear.

The human ear forms part of a sound receiving system that outperforms the best audio equipment known to science.

Capable of interpreting a dynamic range of 120db or 10 octaves, it has double the capability of any man made electronic equipment.

The ear can discern direction, coloration and musical within a complex detail rendition of a 50 piece orchestra in a manner no electronic equipment is able to do.

It is, in short, a sophisticated piece of equipment that should represent the most stimulating challenge to any designer of audio equipment.

Unfortunately it's a challenge that's largely ignored. Which is why in most stereo

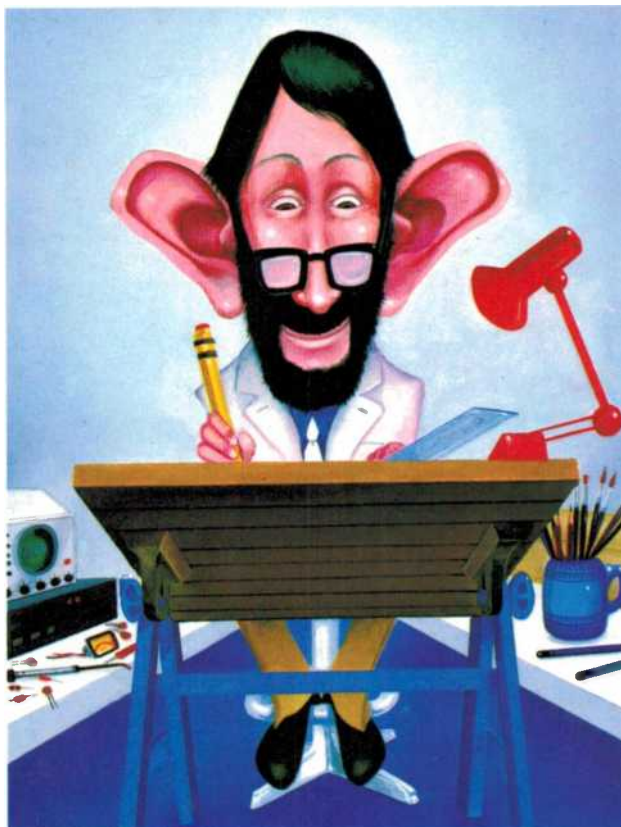

were tired of compromise, Vector Research represents a new standard in high fidelity excellence.

Discussing the Vector VRX 9000, *Stereo Review* states "The receiver surpassed virtually every one of its performance specific ations... it sounds as good as it looks, which is saying a lot..."

*High Fidelity* states "a receiver with such sophisticated performance and functions demands attention." *Popular Electronics* on the Vector VCX 600 cassette deck, "Lower Flutter readings than those of the VCX 600 are hard to find . . .

while not cheap, it affords excellent value." *Hi-Fi Buyer's Review* sums up.

"Vector Research is a newcomer to the audio scene, but if the VCX 600 is any guide, this company should be very successful."

If then you are an audiophile whose interest goes beyond famous names and shiny knobs then you owe it to yourself to learn more about Vector Research.



systems handling power and volume are substituted for subtlety and frequency response. Vector Research however is one of the few exceptions. Developed by a team of highly experienced audio engineers who

Dear V. R., In my book, beauty is in the ear of the beholder. Send me the test reports and the name of my nearest stockist.

Name \_\_\_\_\_

Address \_\_\_\_\_

Postcode \_\_\_\_\_

Keio International Pty. Ltd.  
198 Normanby Road, South Melbourne 3205.  
Telephone: (03) 64 3546.

KO 304 ETI

## Vector Research. A fraction better than excellent.

Australia Government	106
Altronics	26,27
Audio 2000	125
All Electronic Components	71
AED	98
Audio Engineers	112
Blilco	68
Bright Star Crystals	77
Butterworths	11
Comdec	88
Commodore	84,102
Computer City	91
Classifieds	12
Data Parts	100
Dick Smith	16-17
Delsound	46
Danish Hi-Fi	123
ECQ Technics	13
Electronic Agencies	67
Electronic Lifestyle	IBC
Elmeasco	103
Electrocraft	109
Emtronics	76
G.F.S.	74
Inca Data	91
Imark	74
Jasco	8
Jaycar	4,6,7,22,23,32,33,38,39,69
John Cawsey	109
Kalex	74
Kiwi	122
Magraths	15
Microtrix	101
Mini Tools	46
Magnetic Media	93
Marantz	116
McWilliams	114
Paton	13
Pioneer	129
Pre-Pak	72
Q.T. Computers	86
Rod Irving	Zip out Pgs 51-62
Rose Music	115
Scientific Devices	79
Software Source	91
Sheridan	18
SME Electronics	98
Sony	OBC
Technitron	91
Vanfi	IFC
Vendale	89
Warburton Frankl	92

- 19 Which Battery to Use? The choice isn't simple
- 51 Rod Irving's Zip-out Mini Catalogue A first!

## projects and technical

- 35 1508: Model Train Controller Simulates 'real' train controls
- 47 461: Balanced Input Preamp Balance out that hum and noise
- 63 162: 30 V/1 A Fully Adjustable Power Supply Protected, too.
- 24 Circuit File: Using the 4007UB A versatile 'FETset' IC
- 70 Ideas for Experimenters Voltage dividers, slave flash, VDU mod.
- 77 Shoparound Where to buy kits and components for projects

## computing today

- 85 'Move master' Micro Robots Unicorn S100 system released
- 94 Two views of the MicroBee Two builder-users get a buzz
- 100 Modem Follow-up No. 1 Programming the diode matrices
- 104 ZX80-81 Programs Fourier synthesis, label printer, two games
- 110 Hints For Chip 8 Programmers, Part 1 Dialect translation, etc

## electronic lifestyle

- 113 Major New Beta Format VTR Compact disc system is getting around
- 117 Review of Vector Research VCX500 Cassette Deck More humdrum
- 126 Nakamichi NR-200 Dolby B-C Noise Reduction Unit Hiss off!

## news

- 9 News Digest
- 78 Communications News
- 87 Printout
- 117 Lifestyle News

## contests and special offers

- 75 Idea of The Month Contest  
Win a Scope pc board stand

## general

- 42,80 Mail Order Books From ETI
- 119 Subscriptions
- 107 Printed Circuit Board Artwork
- 108 Mini-Mart
- 130 Dregs

Registered by Australia Post —  
Publication No. NBP0407  
ISSN No. 0013-5216

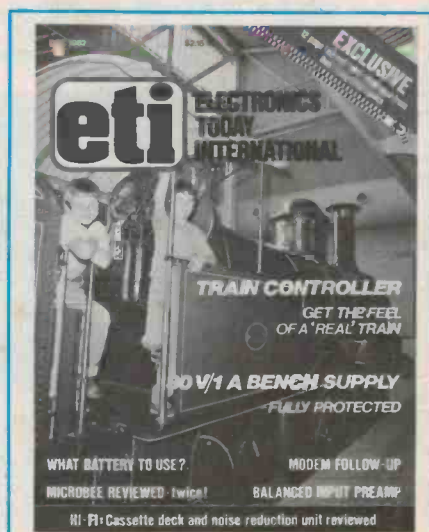

It's a 'real' train! Engine No. 1, now residing in Sydney's Power House Museum was almost Australia's first passenger train loco (it got pipped at the post by a Melbourne outfit). Jamey and Corey Harrison are still deciding whether they prefer the real thing to playing with models. We are indebted to the staff of the Power House Museum for permission to photograph Engine No. 1. Photography by John Knight.

Cover design: Githa Pilbrow



# GREAT NEW BOOKS

FROM JAYCAR THE ELECTRONIC BOOK SPECIALIST.....



## THE CHEAP VIDEO BOOK

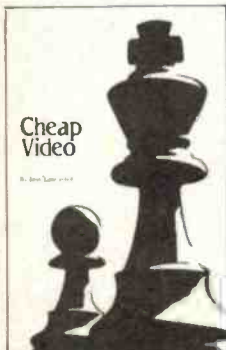

ONLY \$10.95

Complete discussion of a new, low-cost way to get words, pictures, and operate out of your computer and onto any ordinary TV set. Don Lancaster outlines an easy to build, seven-IC circuit which you can build for less than \$20. This circuit can be software controlled to provide any alphanumeric or graphics format including high resolution (256x256) and four colour mode. By Don Lancaster. 256 pages, 5 1/2 x 8 1/2, soft. Ask for No. 21524

## EXPERIMENTS IN ARTIFICIAL INTELLIGENCE FOR SMALL COMPUTERS

Conduct interesting and exciting experiments in artificial intelligence with this book, a small computer with extended BASIC, and some knowledge of the BASIC language. The author first introduces you to artificial intelligence — the capability of a device to perform functions normally associated with human intelligence, such as playing problem solving, reasoning, creativity, and verbal communications. Then game-playing programs, with a checkers-playing game as the main topic, are explained. By John Krutch. 112 pages, 5 1/2 x 8 1/2, soft. Ask for No. 21785

## THE BEST FOR \$11.95

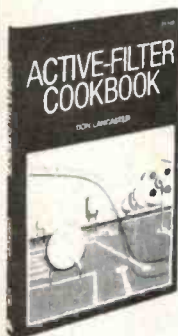

## ACTIVE FILTER COOKBOOK



GREAT READING — \$19.95

A practical, easy to read discussion of the many types and uses of active filters by popular author Don Lancaster. Learn how to construct filters of all types, including high pass, low pass, and band pass having Bessel, Chebyshev, or Butterworth response characteristics. Easy to understand — no advanced math or obscure theory is used. Active Filter Cookbook can be used as an introduction to active filter circuits or as a reference book for analysis and synthesis techniques for active filter specialists. By Don Lancaster. 240 pages, 5 1/2 x 8 1/2, soft. Ask for No. 21168

## DESIGN OF ACTIVE FILTERS WITH EXPERIMENTS



An introduction to the implementation and design of active filter circuits that use the popular 741 op amp chip. The emphasis is on the use of active filters and their design, without complex maths. Twenty six detailed experiments and many practical examples. By Howard M. Berlin. 240 pages, 5 1/2 x 8 1/2, soft. Ask for No. 21539

FOR THE SHELF — \$14.95

## CMOS COOKBOOK

One of the best selling technical books on the market, this cookbook gives you a solid understanding of CMOS technology and its application to real world circuitry. The author explains how CMOS differs from other MOS designs, how it is powered and what its advantages are over other constructions. A mini-catalogue is included which lists over 100 devices, giving their pinouts and application notes. The final chapter shows you how to put all the previous information together to construct a number of large scale, working instruments. By Don Lancaster. 416 pages, 5 1/2 x 8 1/2, soft. Ask for No. 21398

## GET COOKING FOR \$17.95

## IC OP-AMP COOKBOOK

An informal, easy to read guide covering basic op-amp theory in detail, with 200 practical, illustrated circuit applications to reflect the latest technology. JFET and MOSFET units in both single and multiple formats are featured. Includes manufacturers' data sheets and lists addresses of the companies whose products are featured. By Walter G' Jung. 480 pages, 5 1/2 x 8 1/2, soft. Ask for No. 21695

## GREAT BOOK ONLY \$21.95

## 555 TIMER APPLICATIONS SOURCEBOOK WITH EXPERIMENTS

Describes the construction and use of the 555 timer and gives you numerous, practical examples of its applications in all areas of electrical and computer engineering. Seventeen simple experiments are provided to give you working knowledge. By Howard M. Berlin. 160 pages, 5 1/2 x 8 1/2, soft. Ask for No. 21538

## LATE NIGHT READING \$9.95

## DESIGN OF OP-AMP CIRCUITS WITH EXPERIMENTS



A series of 35 experiments illustrates the design and operation of linear amplifiers, differentiators and integrators, voltage and current converters, active filters and lots more. By Howard M. Berlin. 224 pages, 5 1/2 x 8 1/2, soft. Ask for No. 21537

## EXPERIMENT FOR \$14.95



## REGULATED POWER SUPPLIES (3rd Edition)

## 'THE' BOOK ONLY \$25.95



The newest, most comprehensive discussion of internal architecture and operation of the latest solid state regulators. Thoroughly explains when regulated supplies are needed and how to incorporate them into your design projects. Discusses modern practical circuitry including linear and switching circuits and late ICs. By Irving M. Gottlieb. 424 pages, 5 1/2 x 8 1/2, soft. Ask for No. 21808

## ELECTRONIC MUSIC CIRCUITS

Written for the computer and electronics hobbyist with an interest in music, as well as musicians and studio engineers. The author describes how to build a custom electronic music synthesizer, outlines numerous other circuit designs, and then shows you how to modify them to achieve particular responses. Many of the circuits can be used as special effects boxes for guitars and other musical instruments. Approx. 288 pages, 5 1/2 x 8 1/2, soft. Ask for No. 21833

FOR 'MUSO's' — \$23.95

## RF CIRCUIT DESIGN

A user-oriented text with a practical approach to the design of RF amplifiers, impedance matching networks, and filters. Can be used in cookbook fashion as a catalogue of useful circuits with component values. Utilizes a minimum of complex math. A valuable bridge between the classroom and "real world" application, and an excellent reference manual. Approx. 352 pages, 5 1/2 x 8 1/2, soft. Ask for No. 21868

## FOR DESIGNERS — \$25.95



## 'THE' PLL BOOK — \$14.95



## DESIGN OF PHASE-LOCKED LOOP Cts WITH EXPERIMENTS

An excellent introduction to the theory, design, and implementation of Phase-Locked Loop circuits using various TTL and CMOS devices. Useful self study course for the experimenter and for inclusion in college courses on control systems or linear ICs. Includes manufacturers' data sheets and describes the use of breadboarding aids in the wide range of laboratory type experiments. 256 pages, 5 1/2 x 8 1/2, soft. Ask for No. 21545

## DESIGN OF VMOS Cts WITH EXPERIMENTS

VMOS technology easily surpasses the BJT, FET, and CMOS circuitry in its mimicry of the ideal active circuit element. The authors provide an in-depth look at the technology which makes dramatic advancements possible, and show how these components can easily and effectively be integrated into common circuit designs to enhance their responses. 176 pages, 5 1/2 x 8 1/2, soft. Ask for No. 21886

## THE LATEST — \$16.95

## HOW TO READ SCHEMATIC DIAGRAMS (3rd Edition)

Learn to successfully read schematics — the roadmaps of electronic circuits. Defines many of the newer symbols including logic gates and provides up-to-date definitions of many electronic symbols. Author Herrington shows you how various components are combined to form circuits, and takes you step by step through a schematic for a radio receiver. 192 pages, 5 1/2 x 8 1/2, soft. Ask for No. 21127

## GREAT VALUE — \$9.95

## MODERN DICTIONARY OF ELECTRONICS

Join the millions who use this superb reference to the world of electronics. Contains over 20,000 terms, including the latest language used in the fields of communications, reliability, semiconductors, medical electronics, microelectronics, fibre-optics, and computers. For quick and easy reference, separate coverage of schematic symbols, the International System of Units (metric) and a table of the Greek alphabet are provided. By Rudolf F. Graf. 832 pages, 5 1/2 x 8 1/2, hard. Ask for No. 21314

## THE GREATEST — \$29.95



## TV ANTENNAS AND SIGNAL DISTRIBUTION SYSTEMS

As reviewed in Sept. EA page 107

WAS \$14.75 NOW \$12.50

An aid in selection and installation of TV antennas and signal distribution systems, and how to implement these systems for high quality TV reception. Includes valuable performance data based on actual measurements made by the author. 256 pages, 5 1/2 x 8 1/2, soft.

## LASER TECHNOLOGY (2nd Edition)

Update laser technology from a practical standpoint. Discover applied laser principles, laser photography, and beam capabilities and energies. Other chapters explain laser communications systems, laser systems for the military, and instrumentation in medical surgery and dentistry. 288 pages, 5 1/2 x 8 1/2, hard. Ask for No. 21588

## BE A LASER MAN — \$21.95



## MODERN RECORDING TECHNIQUES

FOR THE HI FI MAN \$17.95



Explains the equipment, controls and techniques found in the modern recording studio and how to use them creatively as well as properly to produce desired results. Numerous photographs, diagrams, and charts. 368 pages, 5 1/2 x 8 1/2, soft. Ask for No. 21037

## 73 DIPOLE AND LONG-WIRE ANTENNAS

Experiment with one or more of 73 different wire antennas — from dipole to rhombic. By Edward M. Rull. W3FQJ. 160 pages, 5 1/2 x 8 1/2, soft. Ask for No. 24006

## GOOD READING — \$9.95 NATIONAL LINEAR DATA '82

Our thickest book — 170w x 230h x 65d. The book for linear data from the world leaders. Titles include: voltage regulators, op amps/buffers, instrumentation amps, comparators, analogue switches A/O, D/A, TV circuits, transistor and diode arrays. Digitaltalker speech synthesiser and physical details of devices.

VALUE AT ONLY \$17.95

## Jaycar NUMBER 1 FOR KITS

125 York Street, Sydney 2000  
Phone: 264 6688 Telex: 72293

"Nevilles Corner"  
Cnr. Carlingford & Pennant Hills Road,  
Carlingford  
Phone: 872 4422

Mail Orders To: Box K-39 Haymarket  
Sydney 2000

POST AND PACKING CHARGES  
\$8-\$49 (\$1.20) \$10-\$24.99 (\$2.40)  
\$25-\$49.99 (\$3.50) \$50-\$99.99 (\$4.60)  
\$100 up (\$6.20)

NEW SHOP HOURS  
Mon-Fri 8.30 to 5.30pm  
Sat 8.30 to 12.00pm  
Thurs night to 8.30pm



MAIL ORDER BY  
BANKCARD VIA  
YOUR PHONE



# eti

## Editor

Roger Harrison VK2ZTB

## Technical Editor

David Tilbrook VK2YM1

## Assistant Editor

Jennifer Whyte B.App.Sc.

## Advertising Production

John Gerrie

## Advertising Sales

Bob Taylor (Group Manager)

John Whalen (National)

## Editorial Staff

J.B. Scott B.Sc./B.E.(Hons)

VK2YBN

Jan Vernon B.A.

David Currie

Geoff Nicholls B.Sc./B.E.

## Art Staff

Ali White B.A.

Bill Crump

Githa Pitbrow

## Typesetting

Julie Hewlett

## Reader Services

Paula Maloney

## Managing Editor

Collyn Rivers

## Acoustical Consultants

Louis Challis & Associates

## Editorial and Sales Office:

4th Floor, 15 Boundary St,  
Rushcutters Bay NSW 2011.  
Ph: (02)268-9811; Tlx: 27243

Melbourne: Virginia Salmon and Mel Godfrey,  
150 Lonsdale St, Melbourne Vic. 3000.  
Ph: 662-1222; Tlx AA34340.

Adelaide: Admedia Group, 24 Kensington Rd,  
Rose Park SA 5067. Ph: 332-8144;  
Tlx AA82182.

Brisbane: Geoff Home Agencies, 16 Bellbowrie  
Centre, Bellbowrie Qld 4070. Ph: 202-6813.

Perth: C. Thomas, Adrep Advertising  
Representatives, 62 Wickham St, East Perth  
WA 6000.

New Zealand: Frank Hargreaves, Circulation  
Marketing Manager, c/- ACP, 4th Floor, Sun  
Alliance House, 42-44 Shortland St, Auckland.  
Ph: (9)30311.

United Kingdom: Australian Consolidated  
Press, Ludgate House, 107 Fleet St, London  
EC4A 2AL. Ph: 353-1040; Tlx: 267163.

Japan: Genzo Uchida, Bancho Media  
Services, 15 Sanyei-cho, Shinjuku-Ku, Tokyo  
160. Ph: 359-8866; Cable: Elbanchorito;  
Tlx: BMSINC J25472 Tokyo.

USA: Australian Consolidated Press, 21 East  
40th Street, (Floor 23), New York NY 10016.  
Phone: (212)685-9570.

Electronics Today International is published  
by Murray Publishers Pty Ltd, 15 Boundary St,  
Rushcutters Bay NSW 2011. In 1982, it is  
printed by Offset Alpine, cnr Wetherill and  
Derby Sts, Silverwater NSW, and distributed  
by Australian Consolidated Press.

\* Recommended retail price only

# comment

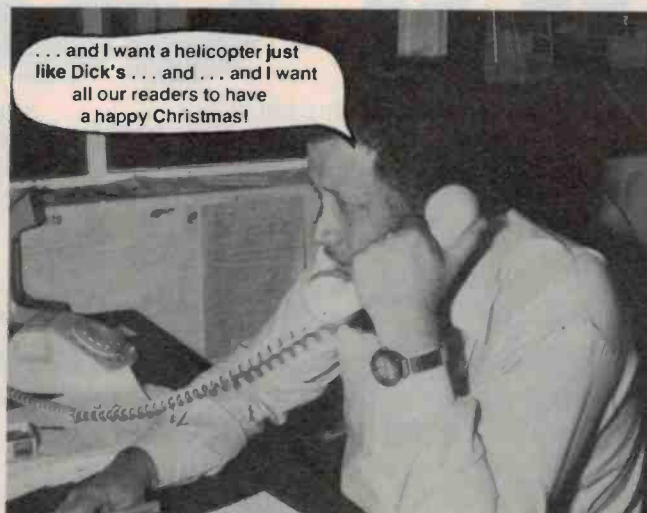

*Roger Harrison*

Roger Harrison  
Editor

## services

**Mail enquiries:** There is no charge for replies, but a foolscap-sized, stamped addressed envelope must be enclosed. Queries relating to projects can only be answered if related to the item as published. We cannot advise on modifications to projects, other than errata or addenda, nor if a project has been modified or if components are other than specified. We try to answer letters as soon as possible. Difficult questions may take time to answer.

**Phone enquiries:** We can only answer readers' technical enquiries by telephone after 4.30 pm. The number to ring is: (02)33-5669. In enquiring by telephone about back issues or photostats, please ring (02)268-9015.

**The publisher accepts no responsibility for unsolicited manuscripts, illustrations or photographic material.**

**COPYRIGHT:** The contents of Electronics Today International and associated publications is fully protected by the Commonwealth Copyright Act (1968).

Copyright extends to all written material, photographs, drawings, circuit diagrams and printed circuit boards. Although any form of reproduction is a breach of copyright, we are not concerned about individuals constructing projects for their own private use, nor by pop groups (for example) constructing one or more items for use in connection with their performances.

Commercial organisations should note that no project or part project described in Electronics Today International or associated publications may be offered for sale, or sold in substantially or fully assembled form, unless a licence has been specifically obtained so to do from the publishers, Murray Publishers Pty Ltd, or from the copyright holders.

**LIABILITY:** Comments and test results on equipment reviewed refer to the particular item submitted for review and may not necessarily pertain to other units of the same make or model number. Whilst every effort has been made to ensure that all constructional projects referred to in this edition will operate as indicated efficiently and properly and that all necessary components to manufacture the same will be available no responsibility is accepted in respect of the failure for any reason at all of the project to operate effectively or at all whether due to any fault in design or otherwise and no responsibility is accepted for the failure to obtain any components parts in respect of any such project. Further, no responsibility is accepted in respect of any injury or damage caused by any fault in the design of any such project as aforesaid. The Publisher accepts no responsibility for unsolicited manuscripts, illustrations or photographic material.

## next month

### POLYPHONIC TOUCH ORGAN PROJECT

Held over from December, awaiting parts supply. This project features a 'touch' sensor keyboard on the pc board, full polyphonic capability (you can play chords) and 25-note range. It has loudspeaker output and can be operated from a battery or plugpack. Circuitry has been designed to eliminate moisture on keyboard problems.

### 60 W AMP MODULE WITH TWO N.D.F.Ls

This project is the practical culmination of Professor Cherry's recent two-part series in ETI on Audio Amplifiers Using Nested Differentiating Feedback Loops. This amp has 60 W output and extremely low distortion. Components are inexpensive and readily available.

### 'AUTO TESTER'

Bamboozled by automotive electrics? This project was developed to make fault-finding in vehicle electrics just that much easier. Simple LED Indicators give 'ballpark' readings of voltage and resistance. Simple to build and inexpensive.

### MODEL RAILWAY POINTS CONTROLLER

Following up December's train controller, this project operates model railway points solenoids and provides an indication of which way the points are set. Power is only applied to the points solenoid for as long as it takes to close them, using a capacitor discharge system. Solenoid burn-outs are thus avoided.

### MICROBEE COLUMN

Starting a regular column for the MicroBee. A not-to-be-missed feature for MicroBee owners. Don't wait, contributions are welcome!

### CIRCUIT FILE: ANALOGUE DELAY LINES

Ray Marston goes into the subject of analogue delay lines in depth and follows up with some practical circuits using the TDA-1022 and SAD512. Start hunting up suppliers now.

### MORE CHIP 8 PROGRAMMING HINTS AND SOFTWARE

Hints for CHIP 8 Programmers continues in January with some more interesting utility routines plus some you-beat software.

Although these articles are in an advanced state of preparation, circumstances may affect the final content. However, we will make every attempt to include all features mentioned here.



# GLUB! GLUB!

## JUMBO SPEAKER CABLE

Now you can have super-quality cable without breaking the bank! Each conductor contains a MASSIVE 259 strands of 0.12mm wire!! It could carry 30 amps! Great for Hi Fi or high power amps.

Only \$2.50/m  
100m \$2.00/m



## THIS ONE MISSED THE BOOK PAGE - CMOS DATA '82 FROM NATIONAL SEMICONDUCTORS

Complete data on National 4000 and 74C series CMOS as well as the CMOS LSI devices produced by N.S. Size: 170w x 230h x 60d.

ONLY \$8.95

## final runout of GE Consumer Products

WE HAVE SOLD OVER 1000 OF EACH OF THESE ITEMS. ONLY A FEW ARE LEFT NOW.

WHY NOT BUY ONE FOR YOUR MUM?

## Smoke Detector Burglar Alarm



FROM \$12.50

- Contains Americium 241 Ionization Chamber
- 9V Mallory Duracell included
- Contains very loud solid state buzzer
- 12 month factory warranty.

One of the greatest consumer flops of the last decade was the Ionization Chamber Smoke Detector. Even though it is a brilliant product (reliable compact, easy installation, fail-safe etc) it just did not sell. Human nature being what it is finds safety-oriented products just not worth the investment. We all know that accidents and fires never happen to US!! As smoke is the greatest killer in a fire, the market research gurus thought that such a product would have a wide appeal. When they were \$49.50 no-one wanted them. The price fell to a very reasonable \$29.50 and still they stayed on the shelf. We have now been instructed to clear them for less than 1/2 of \$29.50.

## GENERAL ELECTRIC

BURGLAR ALARM SLASHED!!!  
HUGE SCOOP PURCHASE -  
ONCE SOLD FOR OVER \$100

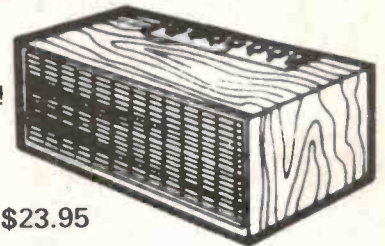

FROM \$23.95

Amazingly low price for a full feature ultrasonic proximity/burglar alarm. + Completely self contained + 12 month manufacturer guarantee + Instant or delayed alarm + Handsome imitation woodgrain + Cabinet measures 180(w)x85(h)x100(d)mm + Programmable multi-code disable switch + Single 9V Alkaline battery\* lasts one year + unit beeps when battery gets low + Contains receiver element designed for greater sensitivity without false triggering + Uses state-of-the-art LSI circuitry + Worth the money in parts alone + Comprehensive 24 page manual included + Comes complete with 4 window deterrent stickers + Absolutely no installation needed \* Battery extra.

### QUANTITY PRICES

1-\$14.50: 2-5 \$13.50ea: 6-10 \$13.00ea: 10 up \$12.50ea

1-\$29.50: 2-5 \$25ea: 6-10 \$24.50ea: 10up \$23.95ea

Buy one for Mum for Christmas...

### 4116 RAMs 150ns - GOING CHEAP

We have secured a quantity of 4116 (150ns) RAMs at a price which means great savings to you. Why are they cheap? Well they don't actually have '4116' branded on them. They have '9016 FPC' on their little backs. They are used in a well known TV game computer and this is the 'House Number' for their 4116. If you have ever had to buy a non-standard replacement part you will know that the 'House Number' part can be VERY expensive. We don't want to sell them as 9016 FPC's we want to sell them as 4116's - and at a great price. The normal (i.e. lower than most) price for our 250ns 4116 is \$2.50 You can grab a 9016 FPC (150ns) 1 off for only \$1.95!!! For larger quantities see below:

1-9 pcs \$1.95  
10-24 pcs \$1.85  
25-99 pcs \$1.75  
100+ \$1.65

This price includes sales tax!!

### HEAVY DUTY UMBILICAL CONNECTOR

This magnificent connector has to be seen to be believed. It consists of two halves which screw together in similar fashion to the US style Military connectors. The body of each half is machined out of SOLID BRASS and is then heavily Nickel plated. Both halves have heavy duty strain relief mechanisms. The male half has three heavy duty silver plated pins set into a quality thermosetting plastic dielectric. The pins are recessed inside the body of the connector for protection. A polarising key is brazed into the solid body. The female half contains 3 equally heavy silver plated socket pins with a polarising keyway in the dielectric. We estimate that each contact could carry at least 10 amps. The applications for such a high quality device are endless, but a few: 12V linear amps, Power supplies, Marine connectors or anywhere where you want to disconnect high current, high voltage or both. Even if you have no need for one right at this moment someday you will. Never before has such a high quality connector been offered at this price. We estimate that this connector could easily fetch \$20 if specified by the military. So you will gasp when you hear the price - \$2.95 that's right!! We dare any manufacturer to make this connector in 1000 lots for TWICE THE PRICE!! Each connector measures 92mm (l) x 28mm (d) assembled and weighs 150 grams. Limit of 2 per customer.

\$2.95



### THE ULTIMATE 6.5mm SOCKET??

You don't think sometimes. We saw these in an obscure part of our warehouse some time ago but did not think much about them. After idly playing with one on his bench one day our technician realised how fantastic they actually were. He'd dreamed of such a component in the past but never really thought that they were made. Basically this all metal device is a stereo 6.5mm (1/4") jack. When a plug is inserted, however TWO SEPARATE single pole single throw switch contacts are opened. The switched contacts are isolated from the signal. Just imagine you can actually turn the appliance on and off simply by plugging in! No need for a separate switch! (Note that the contacts are normally closed and go open when a plug is inserted). Such a component would normally sell for about \$2.95. But, December only \$1.00!! (Limit 5 per customer).

DECEMBER ONLY  
JUST \$1.00 EACH



### JUMBO SPAGHETTI PACK

Genuine P.V.C. Spaghetti tubing. Always handy. From 1/8mm I.D. through to 13mm. Over 20 metres in all! Many colours.

ONLY \$3.50

### JUMBO HEATSHRINK TUBING PACK

Amazing value. A huge bag of lengths of Heatshrink sleeving. At least 5 different colours in sleeving ranging from 3mm Ø to 32mm Ø. You will probably never need to buy heatshrink again.

ONLY \$3.50

### X'TAL FILTERS

Narrow band-pass type - ideal for communications equipment. High quality multi-stage unit suitable for precision I.F. work. Incredible value. Manufacturers distress stock - YOU SAVE.

SAVE \$1.05 -  
Now ONLY \$3.95  
Worth 4 times this amount.  
Oscillator crystals to suit:  
10.240MHz or  
10.695MHz  
SAVE \$1.50  
now ONLY \$1.00 Less 25% on each price for 10 or more



JAYCAR'S BUYER  
LOOKING FOR MORE  
BARGAINS





# We're drowning in more BOTTOM-OF-THE-HARBOR BARGAINS!!

COULD IT BE THE  
CHRISTMAS TIDE???

## S 100 Socket Sensation

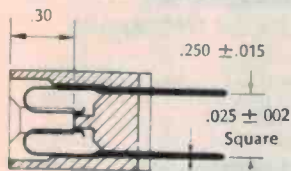

ONLY \$4.95 each  
10+ \$4.45 each

A socket of this quality is normally around \$12. Not this bottom of the harbor special! We dredged these from the mighty Yarra!!

We have secured a bulk-buy of HIGH QUALITY S-100 card edge connectors. Remember! the S-100 Standard is a "queer" 0.125" pitch. Each connector features gold plated bifurcated contacts with wire wrap pins in a Diallyl Phthalate moulded body. If you want to solder into a PCB this is O.K., simply cut the pins down to suit.



Quantities strictly limited.

### rotary mains switch 99¢



— A 20 year throwback. These days all we do is flick our toggles. In the past a quick twist of the knob turned things on. You can relive this experience with our DPST mains switch. Convenient bushing mount with ¼" shaft. Ideal replacements. Genuine 240VAC 3 amp rated.

### micro headphones

AS REVIEWED  
SEPT EA Page 45  
FEATURES:  
MODEL MT310  
Samarium Cobalt magnets  
102dB/mW  
Weight 15 grams  
Response: 50Hz-20kHz  
Impedance: 32 ohms  
Unit fits into the cusp of your ear. Can be worn under motorcycle helmets. Unbelievably clean sound.



ONLY \$19.50

### fibreglass matrix board

Not flimsy Bakelite junk. You will be able to use this board over and over again without deterioration. Measuring a massive 115x164mm and contains 2816x1.0mm dia. holes. Worth over \$8 but our special for December only \$2.95 ea. Source: Brisbane river.

\$ 2.95

### Motorola Piezo Horns



Model KSN 1005A 50 WATT P.A. ONLY \$17.00 EACH  
Model KSN 1025A 100 WATT P.A. ONLY \$26.00 EACH  
Model KSN 1038A 50 WATT HI-FI/P.A. ONLY \$17.00 EACH  
Model KSN 1039A 50 WATT HI-FI ONLY \$13.00 EACH

### Factory Seconds

YOU COME FIRST...

We have secured a smallish quantity of 5 pin DIN to 4 RCA audio leads that are the wrong side of the Q. C. inspection. Shame though. Because the DIN plug is ALL METAL and GOLD plated. So are the RCA plugs. Problem is that the gold plating is bubbling on the gold DIN plug. (As far as we can see the 4 gold RCA's are PERFECT.) An ordinary NICKEL PLATED lead set like this costs around \$4.75. The gold versions normally are around \$9.95 You can have one of these for \$2.95 and that's better than Nickel any day! Worth it for the 4 RCA's alone!

ONLY \$2.95 SAVE \$1.00!!!

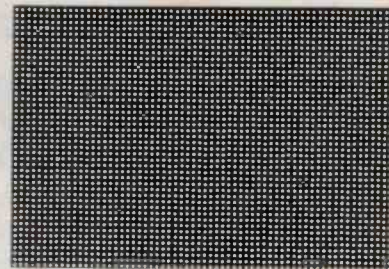

### Electric Eels?? ★ ★

No. One metre long 7.5A appliance cords. Each (black) cord has a moulded 3 pin approved mains plug on the end. Why so cheap? Well they ARE only a metre long. But consider this:

— Any benchtop piece of equipment only needs a short mains cord. A long mains cord gets in the way and is positively dangerous!!  
— Ideal for power supplies or any bench or rack mounted audio or test equipment.

We have HEAPS. But we have said that before. Buy in bulk and save. We doubt whether you will ever see mains cords this cheap again.



1-9pcs 69 cents each  
10-24pcs 50 cents each  
25-99pcs 45 cents each  
100 up 39 cents each

GENUINE APPROVED cords from the Parramatta River

### Jaycar NUMBER 1 FOR KITS

125 York Street, Sydney 2000  
Phone: 264 6688 Telex: 72293

"Nevilles Corner"  
Cnr. Carlingford & Pennant Hills Road,  
Carlingford  
Phone: 872 4422

Mail Orders To: Box K-39 Haymarket  
Sydney 2000

POST AND PACKING CHARGES  
\$5-\$9.99 (\$1.20) \$10-\$24.99 (\$2.40)  
\$25-\$49.99 (\$3.50) \$50-\$99.99 (\$4.60)  
\$100 up (\$6.20)

NEW SHOP HOURS  
Mon-Fri 8.30 to 5.30pm  
Sat 8.30 to 12.00pm  
Thurs night to 8.30pm

MAIL ORDER BY  
BANKCARD VIA  
YOUR PHONE





**SUPER LOW PRICES**

**AMPHENOL  
17 SERIES  
DB25 PLUGS  
& SOCKETS**

Plugs \$2.45 Sockets \$1.85



**SPEAK & SPELL  
IS HERE**

as featured in **E.T.™**

**\$110.00**  
INCLUDES SALES TAX

**E.T. PACK INCLUDES**

- One Speak & Spell learning aid
- The new E.T. Fantasy Module
- New photo-filled activity book
- Colorful movie poster
- T-shirt decal with E.T. and Elliot

**MEMORY BARGAINS**

- HM6116P-3 (HITACHI) 2KX8 CMOSRAM \$7.50
- MB2716 (FUJITSU) 2KX8 EPROM \$3.00
- MB2764 (FUJITSU) 64K EPROM \$12.00
- MB8118 (FUJITSU) 16K DYNAMIC RAM (Intel 2118) 120ns \$4.00

**INDUSTRY STANDARD**

**BOURNS  
MODEL 3006P  
CERMET  
TRIMPOTS**

15 TURN 1.25 WATT  
ALL POPULAR VALUES

Standard Range ~~Was \$1.60~~  
100 OHM-1 MEG **\$1.10 ea.**

**MAGRATH'S —  
THE ONLY CITY SOURCE**  
Now you can make professional  
quality PC artwork and boards

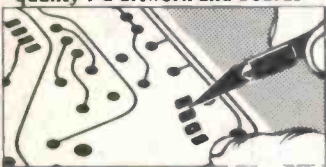

**E-Z CIRCUIT™**  
BY BISHOP GRAPHICS INC.  
**PRESSURE SENSITIVE  
DRAFTING AIDS**

Ideal for small volume OEM users, Consultants, Breadboarders, Experimenters, Designers, Hobbyists Bishop quality in small, economical packages.

**CHRISTMAS SPECIAL**

**Professional  
Video  
Monitor**

~~Was \$227~~  
**\$199**

**18MHZ Video Bandwidth  
BM-12E**

- Input Signals: Composite Video Signal Negative SYNC 1.0 P-P 75 ohm
- CRT size: 31 cm diagonal
- Green Phosphor — P31 non glare
- Power input 230V 50Hz
- Display format: 1920 characters max. (80 characters X 24 lines)

**TI PERSONAL HOME  
COMPUTER**

TI-99/4A  
**\$499.00** INCLUDES SALES TAX

**You can buy just a video game — or you can get a full colour Home Computer**

- Typewriter Keyboard
- 16K bytes RAM
- Expandable to 52K bytes RAM
- Easy to follow instructions
- Extensive range of programmes
- Educational
- Add-on expandability

**AUDAX**

The Compact 200 as featured in EA, Sept 82

**HIGH QUALITY,  
LOW COST,  
DO-IT-YOURSELF  
BOOKSHELF  
SPEAKER SYSTEM**

Speakers, Electronics Kit \$199  
Cabinets (per pair) \$99.50

**MAGRATHS DECEMBER MONEY SAVERS  
SEMICONDUCTORS**

See 6 pack Specials for super prices. on asterisked products.

4011B 19c	*74LS04 20c	*LM340T 5 51c
*4016B 30c	*74LS14 40c	LM340T.15 60c
4023B 19c	74LS47 72c	LM386M 60c
4028B 55c	*74LS90 42c	LM555 25c
*4066B 44c	74LS16T 53c	LM741N DIP 23c
*4511B 69c	81LS95 87c	LM741 DIP 36c
4520B 74c	81LS98 88c	*74C02 20c
7406 20c	LM301A DIP 35c	74C89 \$1.50
7414 33c	LM308 DIP 49c	*74C107 30c
74164 48c	*LM324 42c	*UA317UC REG. \$1.20
74365 37c	LM339 DIP 42c	*KBPC602 6A 200V BR. \$1.00
*74LS00 20c	*LM340KC.12 \$1.20	*S6006L 6A 600V SCR 80c

**TI CALCULATORS  
FROM MAGRATH'S**

- FINANCIAL
- SCIENTIFIC
- STUDENT

TI-35 Student math kit \$27.00  
TI-54 Engineers & Science \$45.00  
TI Business Analyst II \$50.00

PRICES INCLUDE SALES TAX

**Add Sales Tax if applicable**  
Prices valid until stock sold.  
Prices subject to alteration

Visit us at our new address  
**55 A'BECKETT STREET  
MELBOURNE, 3000.**  
Tel (03) 347 1122

**SUPER XMAS BARGAINS AT MAGRATHS**



## Take yourself in hand

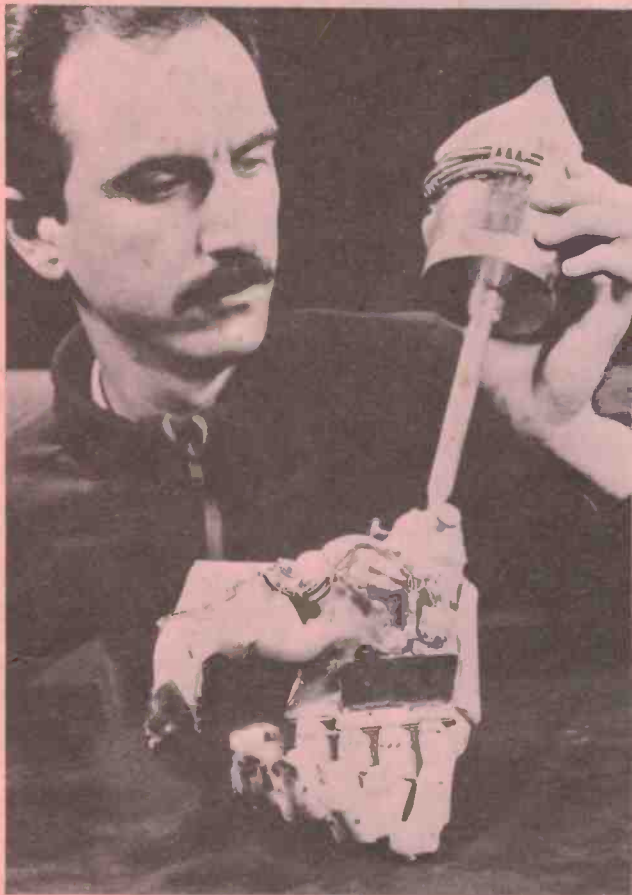

With the possibility of using your friendly robot as a surrogate human (see 'Dregs' in this issue) it's obvious that its bedside manner could be made more stimulating with the help of some artificial manipulation. Rather handy, don't you think?

But I'm sure the team at Southampton University in southern England who developed this artificial manipulating hand envisaged it being used in a more orthodox manner. Microelectronics is now within easy reach for people who have had one or both hands amputated. The hand can differentiate between a ball of wool and a steel block and is so sensitive that it can even pick up a cigarette.

Controlled by a small computer worn on a belt and powered by a rechargeable battery, the moulded plastic fingers and thumb can all be moved individually and the hand can be formed into 14 different shapes from first grips to precision grips. For the first time, amputees will be able to handle assembly work, such as screwing a nut onto a bolt.

Inside the palm are four tiny motors, complete with tiny gearboxes and brakes, that drive the fingers and thumb. Sensors on the hand send signals to the electronic control box, which in turn makes the decision as to what shape to form the hand and what force to apply.

Weighing only 540 gm, the hand operates very naturally. The sequence in which the fingers curl is correct, as is the way certain fingers stay out of the way when not in use — for example, when picking up a teacup with forefinger and thumb.

The result of 12 years work at the University's electrical engineering department, the hand will shortly be passed to a limb manufacturer in the grounds of Queen Mary Hospital, Roehampton, one of the major limb-fitting centres in Britain, where it will be put into production. This handy device is not yet in commercial production.

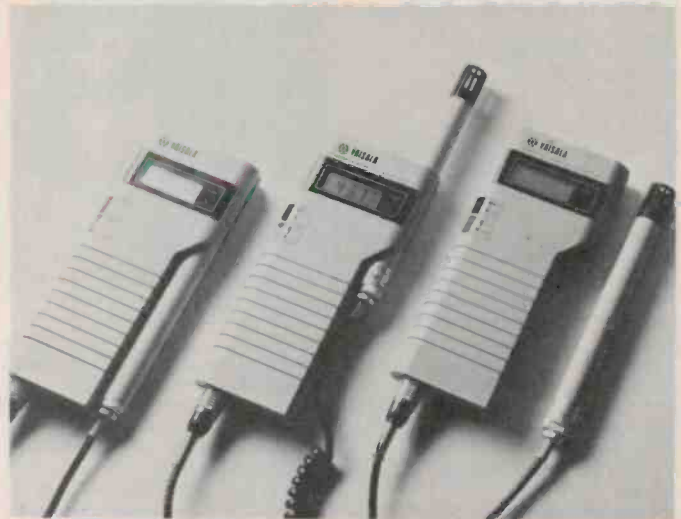

## Digital humidity meter

A new hand-held meter from Vaisala provides fast measurement and display of humidity from 0 to 100% RH and of temperature from  $-40$  to  $+115^{\circ}\text{C}$ .

The indicator, designated HM1 31, has a  $3\frac{1}{2}$  digit LCD display to show the parameter selected with a push button on the side of the meter.

Humidity is measured by a HUMICAP sensor which is based on capacitance change in a polymer thin film capacitor. Temperature is measured by a Pt 100 element.

Both sensors are mounted in the tip of the HMP 31 UT probe producing a millivolt output which is linear from 0 to 100 mV corresponding to 0 to 100% RH.

The indicator is powered from a standard 9 V dry cell battery.

Vaisala is represented in Australia by Paton Electrical Pty Ltd, 90 Victoria Street, Ashfield NSW 2131.

## Professional series of audio input transformers

Designed and manufactured in Australia by Selectronics, the TAI range of audio input transformers is suitable for input levels of  $-30$ ,  $-10$  or  $+18$  dBm.

Series TAI 261, 262 and 263 ( $-10$  or  $-30$  dBm) have an output impedance of 600R, 15k and 30k respectively and an input impedance of 600R CT. Frequency response is  $\pm 1$  dB from 20 Hz to 20 kHz and THD is less than 0.4% at 30 Hz and  $-10$  dBm. They are packaged in a Mumetal can with single bush mounting, flying leads and electrostatic shield.

TAI 541 and 542 ( $+18$  dBm) have an output impedance of 600R and 15k respectively and an input impedance of 600R. Frequency response is  $\pm 0.5$  dB from 20 Hz to 20 kHz. THD is



less than 0.35% at 30 Hz and 18 dBm. This series has an electrostatic shield, open clamp mounting and flying leads.

For further information contact Selectronic Components Pty Ltd, 25 Holloway Drive, Bayswater Vic. 3153. (03) 762-4822.



## New Faces at ETI

**Geoff Nicholls,  
Project Engineer**



Geoff is an Orangeman (i.e. born in Orange, NSW). He commenced a distinguished academic career in Orange then moved on to other learned institutions in Tibooburra, Darwin and Adelaide. An early interest in chemistry (uh, oh... another one) led to many explosions, finally culminating in third degree burns to his hand! Exit chemistry. A wise occupational therapist pressed a soldering iron into his hand, scattered a few brightly coloured capacitors and resistors on the floor in front of him and said, "Play with those!" On completion of his first superheterodyne passive-state wideband tuner and mixmaster he decided an engineering degree would be the thing to do.

Settling eventually in Sydney, Geoff entered Sydney University. They tried to stop him but he burst through by putting money in their hand. Or maybe it was just that he enrolled in chemistry and they put him in electrical engineering for their own good.

Following a string of good grades in his early university years (continuing that distinguished academic career), Geoff managed to convince a few mates (delete 'vince' and you'll be closer to the truth, his mates say) to do the extra year's work and obtain a science degree as well. Caught up in the rush, they all breezed through the science year, majoring in Physics, Mechanics of Collisions of Elastic Objects (i.e. pool) and Fluid Mechanics (using beer as the main test medium).

Back in engineering, Geoff and cohorts found those lectures following fluid mechanics prac. sessions were much more easily digested, following the student trend since Shakespeare was a lad (i.e. four out of five took an extra year).

About this time Geoff shifted to living in the fast lane and indulged a voyeuristic interest in the mechanics of objects accelerating through a fluid, known to the cognoscenti as 'drag boat racing'.

As a budding engineer (he's having hormone treatment for this problem) he couldn't resist measuring things so built up a set of timing equipment using modulated lasers to shoot across rivers to measure and display terminal velocities of the boats. The system was used in the recent World Water Ski Speed Record run by Grant Torrens on the Hawkesbury River at Windsor, NSW. That effort made it into the Guinness Book of Records, but Geoff didn't.

Geoff completed his B.Sc./B.E. in 1981 and intended to further his interests in fluid mechanics for six months or so. But, fate took a hand when a friend pointed out a job advertisement from ETI in the paper. Being quite unable to resist the opportunity to practise his hobby and be paid for it, Geoff presented his credentials. Despite that, he got the job and the fruits of his labours can be seen in ETI.

Star sign: Virgo (the water carrier, hence the consuming interest in fluid mechanics).

Beliefs: Hard science (things you can measure).

Likes: Tooheys Old, Sydney Draught, Guinness, Coopers ales and stouts, ... etc, hot beef curries (from Sydney's famous Sri Lanka Room), cooking Chinese, digital electronics and hot Toranas.

Dislikes: Audio fanatics who argue ad nauseum about capacitors in the signal path, most Japanese cars (they get in the way of Toranas) and 'para' science. Quote: "Whose shout is it?"

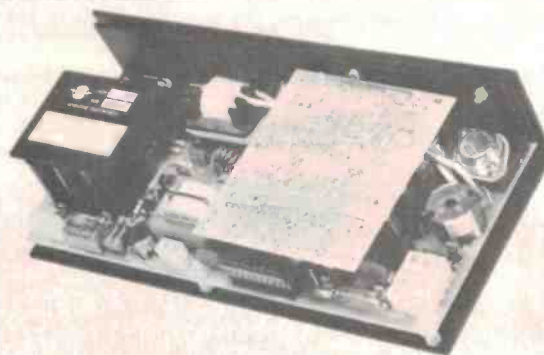

## Four rail switch mode supply

**Australian power supply designer and manufacturer, Scientific Electronics, have released the latest model in their switch mode series of high efficiency power supplies.**

Designated SM130AD2, this new, low cost power supply has four output rails from which a total of 115 watts can be drawn. There are two standard models and a 'custom' model which allows the OEM or microprocessor designer to specify his own output rails.

The standard output rails are +5.2 V at 10 A, +12 V at 1 A, -12 V at 1 A and 24 V at 2 A floating rail. The second standard model has a 20 V at 2 A floating rail.

All outputs are short circuit protected and the +5 V and +12 V outputs have overvoltage protection. A DCLO signal is available to warn logic of an impending supply rail failure making this supply ideally suited to microprocessor based systems.

The SM130AD2 carries a five year guarantee. For further information contact Mr. Peter Lloyd, Scientific Electronics, 6 Holloway Drive, Bayswater Vic. 3153. (03)762-5777.



## Setting up a graphic equaliser?

**Technics late this year released a graphic equaliser test generator/meter which they dubbed an 'Audio Frequency Analyzer', model SH-8000.**

The unit incorporates a special 31 channel 'warble' (narrow sweep) tone generator covering the 20 Hz to 20 kHz range and a calibrated microphone and meter.

The generator covers one-third octave channels in one-third octave steps, sweeping across each channel to provide a signal that can be integrated across the whole channel. A switch is provided to protect tweeters when using the generator above 10 kHz.

In use, the generator is

coupled to the system input and the microphone set at a suitable position in the listening room. The generator is then switched through each channel and the graphic equaliser controls adjusted to produce the same reading on each channel.

A fast/slow meter response switch is provided and the meter level range can be set to 50, 60, 70, 80 and 90 dB.

The instrument is battery operated. Further details from Technics, 95-99 Epping Rd, North Ryde NSW 2113.

## Rifa distribute Spectrum Control products

**Component distributor Rifa recently announced the availability of the Spectrum Control range of EMI/RFI filters and shielding materials.**

Products in the Spectrum Control range include hermetic seal filters and capacitors, resin seal filters and capacitors, connector contact filters, multi circuit filters, knitted wire shielding gaskets, EMI-proof ventilator panels, variable capacitors and many other products designed to solve electro-magnetic interference problems.

Applications for the Spectrum Control product range include communications, data processing, medical and scientific instrumentation and military.

For further information contact Mr. W. Scott, Rifa Pty Ltd, 202 Bell Street, Preston Vic. 3072. (03)480-1300.







# Classifieds : Classifieds

## CLASSIFIED RATES

15¢ per character

Minimum of 32 characters

CHARGES: Cash with order only

**COMPUTER CLINIC** repairs & services Sorcerer, Pet, Apple, System 80, Super 80, Tandy & others. (07)269 8573, P.O. Box 68, Aspley, Qld.

**PCB's and SCREEN PRINTING** at the best prices. Short runs, long runs from your own artwork. Contact Peninsula Circuits, 7 Portrush Gr., Mornington 3931. (059) 75 5568.

**REPAIRS** to all home, hobby and small business microcomputer systems and peripherals, also all EA & ETI projects. CAE Electronics, 1/27 Forge St, Blacktown 2148. (02)621 4242.

**COMPUTERS:** call us for the best price on full range of Commodore & Osborne computers. Inc. software and component parts. See our add this issue. Data Parts, Shepparton. Phone (058) 21 7155, 21 0240.

**SORCERER** Disk Upgrade Kit with manual. Many Pro features. MICRO-POLIS \$44.95. EXIDY FDS \$39.95. A must! Also free Soft. catalogues. PJB Box 252, Forestville 2087.

**COMPUTER** Clinic repairs and services Sorcerer, Pet, Apple, System 80, Super 80, Tandy and others. (07) 269 8573, P.O. Box 68, Aspley, Qld.

# NEWS digest

## Sun sets on position of Government Astronomer

It's the end of an era for those on Observatory Hill. William Robertson, who has held the post of Government Astronomer for the last eight years, retired in October. He was the last Government Astronomer as the work has now been taken over by the Museum of Applied Arts and Sciences.



"While they take over our work, their records will really only be of museum value," Robertson says.

William Robertson first went to Observatory Hill as Assistant Government Astronomer in 1942. "My biggest regret is that work at the Observatory will be scaled down," he said, "Our job here is to provide information on the rising and setting of the sun, the moon and other planets. This information is published in newspapers and put in our records. Sometimes we have to supply solicitors and insurance companies with details on the time of sunset — they use this information to build up a more accurate picture of what really happened in a particular traffic accident."

In 1975, Robertson, a science graduate from the University of Sydney, ended his 33-year apprenticeship when the then Government Astronomer, Dr. Harley Wood, retired. During his term in office, Mr. Robertson and his staff gave lectures on

astronomy at the Observatory to high school and tertiary students. Lectures were also open to the general public.

Observatory Hill has been a busy point of observation since it opened in 1858. Since 1890, night-time photographs of the sky above Sydney have recorded the position and movement of planets and stars. "We send the results to other observatories around the world. It helps us build up a better picture of outer space," Robertson said.

Long before the Harbour Bridge was built, Observatory Hill was used as an aid to maritime navigation. "In the old days ships were usually at sea for up to four months, and when they reached Port Jackson they had to check their chronometers," Robertson explained. "As soon as they rounded Bradley's Head they could see our time ball and correct their longitudinal readings. Of course, they don't do this any more, but we still operate the time ball for historical reasons."

CHANNEL  
0/28



VIDEOTAPE  
MAINTENANCE

*Applications are invited from suitably qualified persons for the following position at our Milsons Point studios*

## TECHNICAL OFFICER

(\$17,117-\$20,791)

Applicants should have experience with broadcast or industrial/domestic videotape or videocassette recorders and should possess an appropriate certificate awarded by the NSW Department of Technical and Further Education or an equivalent.

Conditions of employment will be similar to those offered by other Commonwealth authorities.

Applications, including details of qualifications and experience and copies of appropriate certificates and references should be forwarded to

The Personnel Officer

Special Broadcasting Service  
GPO Box 21 Sydney NSW 2001

by 31 December 1982.

Please quote reference number T222 on your application. Enquiries may be directed to Mr Basil Byrne on (02) 923 4811.





Season's Greetings to all our Customers  
For all your electronic components come and see us for  
the largest range in Brisbane.



**SPECIAL — INTERSIL ICL 7106 DVM KIT — ONLY \$28**

**MEMOREX 5¼" FLOPPY DISKS**  
SINGLE SIDED  
SINGLE DENSITY  
BOX OF TEN \$54.00  
ONE FOR \$6.40  
DOUBLE SIDED  
DOUBLE DENSITY  
BOX OF TEN \$76.50  
ONE FOR \$8.65



Paddington Drive-In Shopping Centre,  
95 Latrobe Terrace,  
Paddington. 4064.  
Telephone: (07) 369 1474

**CHRISTMAS SPECIALS**

25 PIN  
"D" TYPE  
SOCKET \$3.80

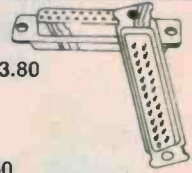

25 PIN  
"D" TYPE  
PLUG \$4.50

**HIT PRECISION HAND TOOLS**  
Cutters, pliers, etc.



All priced at  
\$7.50 each  
or 2 for \$14.00  
or 4 for \$24.00

**KAISE Model SK50 50kohm / V**

**HIGH PRECISION, VERSATILE, MULTIMETER**

This meter offers precision performance in an economical package. 22 ranges including 3 capacitance scales (using external AC source); diode and fuse protection and jewelled meter movement are just a few of the features of this instrument.

**Battery:** 1 x 1.5V 'AA' cell, 1 x 15V  
**Dimensions:** 150 x 100 x 40mm  
**Weight:** 450g  
**Accuracy:** DC ± 3% (full scale)  
AC ± 4% (full scale)  
Resistance ± 4% (full scale)  
**Input Resistance:** 50,000 ohms per volt DC  
10,000 ohms per volt AC

**DC Voltage:**  
0.6, 3, 12, 60, 300, 600, 1200, 3000V  
**AC Voltage:** 6, 30, 120, 300, 1200V  
**DC Current:** 30uA, 6mA, 60mA, 600mA, 12A  
**Resistance:** 5k, 500k, 5M, 50M ohm  
**Decibels:** -20 to +17.31, 43.51, 63dB  
**Capacitance:** 6V range: 0.001uF-0.2uF  
30V range: 200pF-0.04uF  
120V range: 50pF-0.01uF



**STUDENTS DISCOUNTS**

Send SAE for catalogue  
and inclusion on future  
mailing list.

**MAIL ORDERS:**  
P.O. Box 287,  
Paddington 4046.

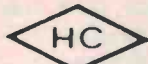

**HUNG CHANG**

**LOW COST 3½ DIGIT  
LCD DIGITAL MULTIMETER**

- ★ Push Button Operation
- ★ 0.1% DC-Volt Accuracy
- ★ Fully Overload Protected
- ★ Hi-low Resistance Diode Check

**\$62\***

PLUS TAX

**HC703**

(Includes test leads)

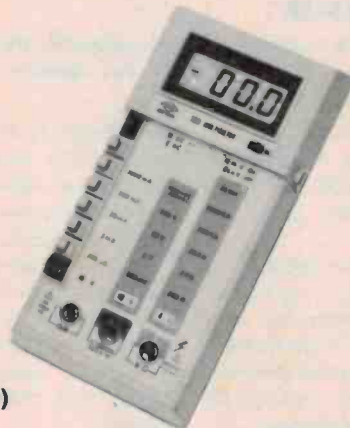

\*FROM STOCK (subject to prior sales)

BANKCARD WELCOME

**PATON ELECTRICAL PTY. LTD.**

90 VICTORIA ST, ASHFIELD NSW 2131. TEL: (02) 797 9222  
136 UNION RD, ASCOT VALE VIC. 3032. TEL: (03) 370 5994

**AGENTS:**

NSW: Newcastle (049) 61 5628 Wollongong (042) 71 3844 ACT: (062) 80 4654 PNG: Lae  
43 2277 NZ: (04) 68 3589 QLD (S): (07) 52 5231 QLD (N): (070) 51 2404 WA: (09) 381 4477  
SA: (08) 268 2300 TAS: (002) 34 5978 (003) 31 9868.

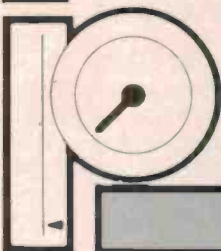





## Silicon-diffused transistors

The BUX46, 47, 48 and 98 high-voltage, high-speed transistors, now available from Philips, can be used as converters, inverters, switching regulators and motor control systems.

These transistors have a peak collector current rating of 5 to 60 A, and a maximum power dissipation of 85 to 250 W. The maximum collector-emitter voltage is 850 V. 'A' versions of the transistors (with maximum collector-emitter voltages of 1000 V) are also available. The transistors are glass passivated, and are supplied in a TO-3 envelope. For further information contact Elcoma, 67 Mars Road, Lane Cove NSW 2066. (02)427-0888.

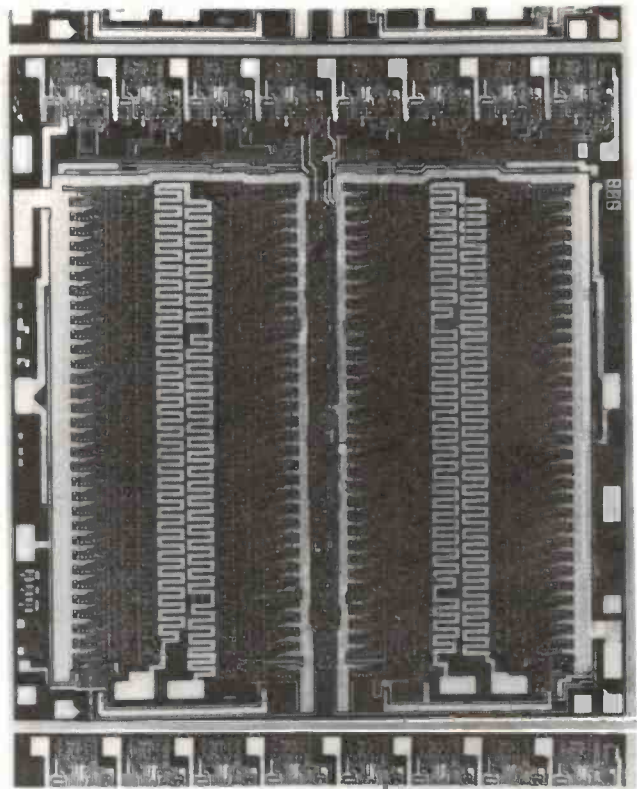

## Japanese semiconductor data manuals

Data manuals for Japanese semiconductor devices are now available from Imark Pty Ltd, 167 Roden Street, West Melbourne. 3003. (03) 329-5433.

The 1982 manuals are:

'The Transistor Manual' lists all 2SA, 2SB, 2SC and 2SD devices and their characteristics.

'The Transistor Substitution Manual' lists equivalent Japanese transistors for 2SA, 2SB, 2SC and 2SD transistors.

'The Diode Manual' provides specifications and package details for Japanese diodes.

'The FET Manual' details specifications and package details for Japanese FETs (2SK, 3SK and others).

'The Op Amp Manual' (Parts 1 and 2) provides detailed specifications and package information.

'The Linear IC Manual' provides technical specifications, and package details.

'The TTL IC Manual' provides technical specifications, package details and lists worldwide

manufacturers of the particular device. The manual includes details for 7400 series/74SL series/74S series.

'The CMOS IC Manual' provides technical specifications, package details and world-wide manufacturers for 4000B series, 4500 series, TC5000BP series, TC5000P series, MSM500 series, and TC40H000P series devices.

'The Memory IC Manual' provides technical and package details and has tables of similar devices. Devices covered include Static RAMs, Clocked RAMs, Dynamic RAMs, PROMs, UV-EPROMs, and EAROMs.

Each manual is priced at \$9.95 (plus \$1.50 post/pack) and the complete set of ten manuals is \$89.50 (plus \$5.00 post/pack).

## Flash converter

Motorola has introduced a monolithic high speed 7-bit parallel flash A/D converter designed to serve the needs of the video, radar, communications and high speed instrumentation markets.

The flash converter, part numbers MC10315L and MC10317L, is claimed to be capable of encoding video speed signals without a sample and hold at conversion rates to 15 MHz. MECL 10K compatibility, along with an over-range bit, enables simple interconnection of two devices for expansion to an A/D function with 8-bits of resolution and accuracy.

The MC10315L and MC10317L perform identically in all aspects except for data output coding during over-range.

When an MC10315L is driven into over-range, all data bits remain high, but when the same condition occurs on an MC10317L, the data bits go low. This feature permits direct wire ORing of additional A/D converters to the MC10317L for expansion to greater than 7-bits.

Versatility of the input comparator structure and reference resistor ladder allows analogue input options of unipolar positive, unipolar negative (below ground), or bipolar with accuracy maintained at full-scale analogue signals as low as 1.0 volt peak-to-peak.

Low capacitance loading of only 70 pF at the analogue input reduces the demand on the driving amplifier at high frequencies. In addition, differential phase and gain are low.

Power supplies required are +5 Vdc and -5.2 Vdc with a total power consumption of one watt.

The MC10315L and MC10317L are specified over a 0°C to +70°C temperature range and can be obtained from Motorola Semi Conductor Products, 250 Pacific Hwy, Crows Nest NSW 2065. (02)438-1955.





electronic layout  
made easy

**LINEX** shows you how

Is electronics your hobby? You will soon find out that you cannot use the prints shown in foreign magazines; in particular because you cannot find components of the design imagined by the maker of the print.

This means that you will have to re-do the drawing and this is highly facilitated by using a P.C.B. Design Template.

First, draw in pencil a sketch layout, showing the positions of the components, the terminals, and the conducting paths — using the 1241S. Then redraw your layout, using ink, on a tracing foil.

The P.C.B. Design Template is provided with ink bosses, which prevent the ink from blurring the lines below the template during the tracing.

The drawing, thus completed, can be used directly for copying on a photo-print-plate. Place the side with the inked lines against the emulsion-side of the print, and use UV-lamp for copying.

This procedure prevents the inked lines from "burning out" during the exposure.

For development, etc., use the specified developers, etc.

Electronic templates are available from Jaycar

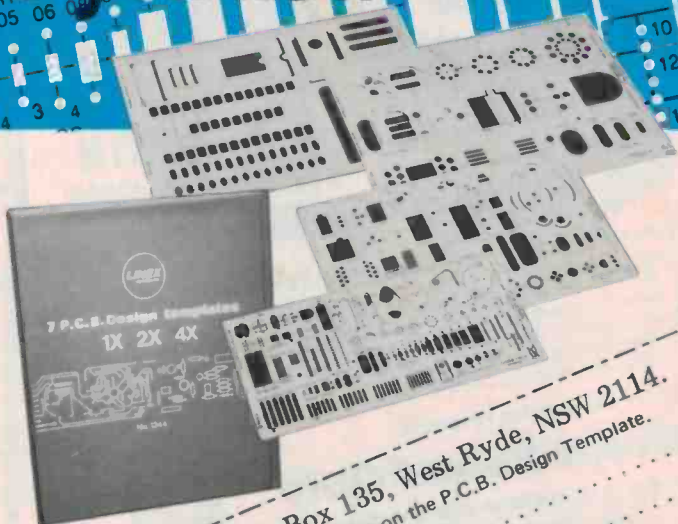

**JASCO PTY. LTD., P.O. Box 135, West Ryde, NSW 2114.**  
Please send me further information on the P.C.B. Design Template.

Name . . . . . Address . . . . . Post Code . . . . .



**3 WEEKS TO GO!**

Not suitable for diesel engines

**The EA CAR COMPUTER — YOU CAN SAVE A FORTUNE!!!**



only **\$93.50** (Plus Sensors)

Cat. K-3400

YES! The kit you've been waiting for is now a reality! EA's new Car Computer is the ideal way to find out how your car is performing. All those questions you ask yourself as you're driving can be answered. How much fuel is left? Can I make it to the next town? What is my exact speed (more accurate than the speedo)? and many more!

**SPECIAL OFFER** Buy both sensors and get the speed sensor for \$3.00! YES: the exclusive Moray Fuel Flow Sensor plus the Driveline Sensor at the bargain price of just \$72.50! This makes the complete Dick Smith Car Computer only \$166!

**7 Day Trial Offer**

if you're not completely happy, you can return the CAR COMPUTER within 7 days in original condition and packaging for a full refund! You owe nothing — not even an explanation. So why not try the CAR COMPUTER today!

**HOME QUALITY SOUND IN YOUR CAR!**

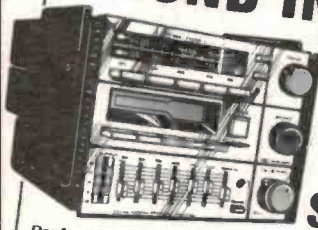

with this amazing **DICK SMITH THREE-IN-ONE STEREO SYSTEM!**

Professional quality Hi-Fi stereo sound for your car! Take your favourite sound with you!  
 • Separate AM/FM stereo push button tuner • Separate Auto Reverse stereo cassette • Separate 30W/Ch stereo amplifier with 7 band graphic equalizer, LED level meters and front/rear fader • Plus mounting brackets with quick release system for security. Great for trucks and vans, etc. Cat. A-6500

\$6.94 per week for 12 months

**Great Value! Only \$299**

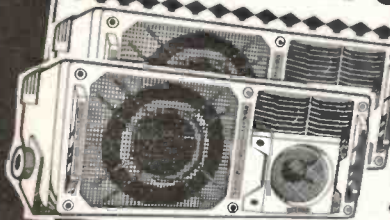

team with these brilliant **50W 3 way stereo**

Look a million dollars — and will make your car Hi-Fi sound just as good. 3-way system, great for rear shelf or in trucks and 4W0's. Supplied with brackets.

Cat. A-7083

**\$99.50**

**Xmas day and no batteries — wouldn't you be popular!!!**  
**BIG BATTERY BARGAINS!**

SAVE WITH HI WATT		1-9	10 up
Cat. S-3001	D size metal jacket	40¢	35¢
Cat. S-3002	C size metal jacket	35¢	30¢
Cat. S-3003	AA penlight	25¢	25¢
Cat. S-3004	AAA size	30¢	30¢
Cat. S-3005	UM 5 (R 11)	20¢	20¢
Cat. S-3006	216 9V Transistor	50¢	50¢

**NI-CADS IN POPULAR SIZES**

Cat. S-3300	1.2V Ni-Cad Pencil	\$2.45	\$2.20
Cat. S-3306	7.2V (size 216)	\$11.00	\$10.25
Cat. S-3302	'C' size cells	\$6.20	\$5.60
Cat. S-3304	'D' size cells	\$6.60	\$5.95

**NI-CAD CHARGING CARTRIDGE** Cat. M-9519

Charges virtually any size rechargeable battery. Includes test meter and 5 separate LED indicators to show the strength of batteries being charged.

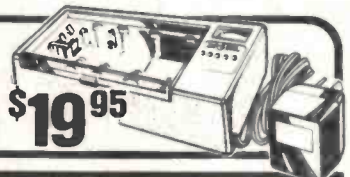

**\$19.95**

**AMAZING GIFT IDEA!**

**MINI-POCKET FM STEREO**



Unbelievable quality — you've really got to hear this amazing FM radio to believe it! Tiny design — fits into a shirt pocket and comes complete with superb padded stereo headphones. Cat. A-4000

**Great sound, Great price!**

**\$49.95**

**RESISTOR VALUEPACK** Cat. R-7015

Yes — a specially selected pack of 1/4 watt resistors (normally 6¢ each) almost half price! No rubbish — this pack includes the values most used in service and project construction. Metal films are more stable, have an amazing 1% tolerance and better temperature coefficient. Now there's no excuse not to use them! (over 300)

**\$9.95**

**RELAY BARGAIN**

Heavy Duty PC mounting relay, with DPDT contacts rated at a HUGE 10A (@ 120VAC). Relay coil 160 ohms — quite happy to operate on 12V so it's great for a huge range of transistor operated projects. Cat. S-7140

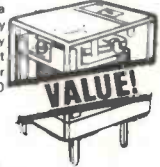

**\$3.50**

**THE DICK SMITH SYSTEM 80 GROWS WITH YOU!**

Cat. X-4005



**WAS \$758.00 NOW \$699!!!**

The System 80 comprises a Z80 based processor, keyboard, cassette recorder, whopping 16K of user memory and Microsoft Level II BASIC which means the System 80 can use an enormous range of software available for the Tandy TRS-80 and System 80 computers. The System 80 is an excellent choice as a first computer. It's easy to understand so it won't frustrate the beginner. How about a System 80 as a Christmas present to yourself! Come in and 'test drive' one today!

Only \$16.24 per week for 12 months to approved applicants



# YOU'D BE CRAZY TO BUY JUST A T.V. GAME!

before you see the amazing DICK SMITH

## WIZZARD

The one with the inbuilt personal computer

### Compare the quality

Amazing picture quality with over 49,000 dots - over twice as good as the largest selling TV game. You'll be amazed at the clarity, the detail - just like the screens NASA used in the space shuttle.

### Space Age Controllers

Not just simple sticks: full space-age guiding devices with 48 keys as well. You get incredible control capability - far more than possible with other games.

### Fantastic games Cartridges

21st century games - like you've never played before. And every cartridge has many games - up to 32 in each! You'll never be satisfied with anything less after playing the WIZZARD.



Cat Y-1600



THE DICK SMITH WIZZARD ONLY

**\$295**

GREAT RANGE OF GAMES CARTRIDGES ALL AT

**\$39<sup>95</sup>**

BASIC CARTRIDGE NOW IN STOCK **\$69<sup>50</sup>**  
Cat Y-1605

## Measure it - time it - tabulate it!

It really is the 'Exception to the Rule! Amazing technology breakthrough has put both an LCD clock AND a calculator INSIDE the rule! Ultra-Long battery life (batteries replaceable) and rule has both metric & imperial graduations.

IDEAL STUDENTS HOUSEWIVES, IN FACT EVERYONE!

**\$19<sup>95</sup>**



Robust clock shows hours, minutes, seconds, month & date. 300mm metric and 12" imperial ruler.

5-function calculator with memory and %

Handy Imperial/Metric conversion table.

HALF PRICE CABLE



### SPEAKER CABLE

Ideal cable to use with HI-FI Systems For speaker connections or for Intercoms. Marked with a trace

was 18c/m NOW @ 9c/m

### RG 58 COAX CABLE

75 ohm coax for all TV installations. Minimum ghosting

was 40c/m NOW @ 20c/m

LAST CHANCE TO SAVE!

ON FAMOUS AMPEX TAPES!



C-3088 C-90EDR \$2.59  
C-3078 C-90ELN \$1.60  
C-3090 C-45EDR \$1.99  
C-3082 C-60EDR \$2.49

"DON'T BE CONNED"

all our prices include Sales Tax

## DICK SMITH Electronics

NSW Auburn 648 0558 - Bankstown Sq. 70, 4888 - Blakehurst 546 7744 - Bondi Jct. 387 1444 - Broadway 211 3777 - Brookvale 93 0441 - Chullora 642 8922 - Gore Hill 439 5311 - Liverpool 600 9888 - North Ryde 888 3200 - Parramatta 689 2188 - Sydney (Bridge St) 27 5051 - Sydney (York St) 290 3377 - Tamworth 66 1961 - Tighes Hill 61 1896 - Wollongong 28 3800 ACT Fyshwick 80 4944 VIC Coburg 383 4455 - Frankston 783 9144 - Geelong 78 6766 - Melbourne 67 9834 - Richmond 428 1614 QLD Brisbane 229 9377 - Buranda 391 6233 - Chermside 59 6255 SA Adelaide 212 1962 - Darlington 298 8977 - Enfield 260 6088 WA Perth (William St) 328 6944 - Perth (Hay Street) - Cannington 451 8666 TAS Hobart 31 0800  
MAIL ORDER CENTRE: PO Box 321, North Ryde, NSW 2133. Phone: (02) 888 3200. COMPUTER HOT LINE: (02) 888 2002

A391 CT/LM

## YAESU BARGAINS



I MUST CLEAR THIS STOCK BEFORE XMAS - NEW PRODUCTS COMING - YOU REAP THE BENEFIT!

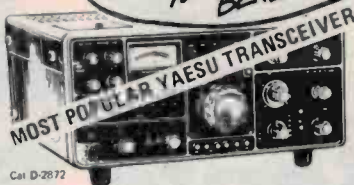

Cat D-2872

FT 101Z FM

~~\$885~~ **\$825**



Cat D-2853

FT 902D

~~\$1195~~ **\$950**

Price savings also on: antenna couplers, memory units & D/C inverters.

## AUSTRALIAN AMATEUR RADIO CALLBOOK



Brand new 1982/83 edition just published by the WIA. Greatly increased in size (now 176pp) with huge amount of data, etc - plus all VK & P29 amateurs and registered SWL's. A must for the amateur.

**\$4<sup>20</sup>**

Cat B-2322

YOU'LL FIND HAMSHACK STORES AT:  
SYDNEY: York St, Bridge St, Gore Hill.  
MELBOURNE: Lonsdale St, Springvale, Richmond.  
BRISBANE: Buranda, Chermside.  
PERTH & ADELAIDE



MERRY CHRISTMAS

FROM DICK SMITH AND STAFF



Terms available to approved applicants through...



Prices correct and stock available at press time



# See Santa Sheridan's for super Christmas specials

## MONSTER PACKS ARE BACK!!!

Due to unprecedented demand, we are again making our famous monster packs available!! If you are a real enthusiast or technician, this is the only way to build up your component stocks at reasonable cost. Our Monster Bargain packs are assembled from a host of scoop purchases, which we continually search out. You reap the benefit!!!

### MONSTER RESISTOR PACK - INCREDIBLE!!!

At least 400 per bag in 1/4, 1/2, 1 and 2 watt types. 10%, 5% 2% and 1% types. Carbon and wirewound types!! What a knockout!!!

**A must at only \$4.00!!**



### MONSTER CAPACITOR PACK

Half a kilogram of brand new unused capacitors (electros, polyesters, ceramic and styro types. Well over 100 per bag Crazy!!

**GRAB EM only \$5.00!!**



### MONSTER POT PACK

Huge selection of pots including single, dual, switch, slider etc. 30 in all. Wow!!!!

**VALUE!! only \$5.00**



### MONSTER RELAY PACK

20 brand new unused relays. Huge selection. 12, 24 and 48 volt types. Worth at least \$50.00 But look at the monster saving!!!!

**only \$5.00!!**



### RADIO CONTROLLED CARS FOR THE KIDS!

These beaut radio controlled cars are perfect for the kids, especially dad!! You may have seen models like these for over \$100.00. Look at the features!!

- Digital proportional control
- 11 functions including forward and reverse, (variable speed), left and right turn, left and right indicators, headlights, and backup horn

**\$69.00**

Batteries not included

Two models:  
Mercedes Benz  
Ford Mustang



## LATEST IN PHONE TECHNOLOGY

The fantastic Fairphone telephone/dialler has all the features of more expensive diallers at a price you can afford. The Fairphone includes the following features:

- Dialling LED indicator
- Ring ON/OFF switch
- Pushbutton keyboard
- Redial at the touch of a key
- Mute button for telephone conversation
- Telephone line powered.

So don't pay \$50.00. Our price is **only \$27.95**

Also available is a model which plays a tune while the other party is waiting. Again at fantastic saving

**only \$29.95**

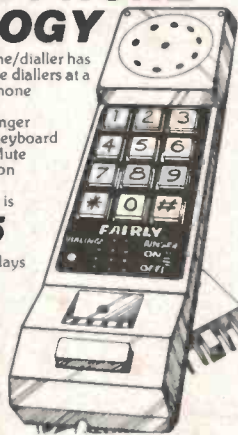

Not Telecom Approved

**IT'S A STEAL!!**

## SCOOP ON CITIZEN CALCULATORS!!

We have just made a scoop purchase of brilliant **Solar Powered** calculators. These are famous Citizen brand. They require no batteries. These normally sell for \$24.95 each so make a big saving now!!

### MODEL SOLAR 81

- 8 digit LCD display
- Basic calculation
- constant, power reciprocal, percentage, add on/discount, square root
- Memory
- complete with instruction book and wallet.

### SOLAR CARD

Has all the functions of the Solar 81.

**SAVE \$7.00!!**

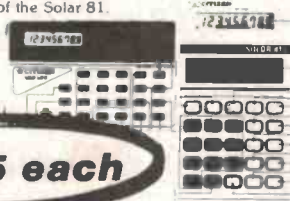

**\$17.95 each**

## BRILLIANT NEW GAME/CLOCKS

These superb new game clocks are the best we have seen. A real challenge to play (harder than Game and Watch) they include and clock with alarm function.

### Fighting Climber

Find a way to the top roof by avoiding many falling obstacles and get out by helicopter. But beware of King Kong!! look at our fantastic price!! **\$19.95**

### Cupid's Arrow

Shoot a heart. The devils prevent the heart going up. Quality construction at a reasonable price!

**\$19.95**

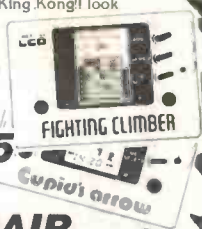

## SUPER SANTA OFFER:- THE PAIR FOR ONLY \$36.00!!

Both games have 2 levels and a clock/alarm function. Others are charging over \$30.00 so save with Santa Sheridan!!

### NEON DISPLAY

Once in a lifetime offer. 6 digit orange displays are used in pinball machines etc. Made by Cherry of Waukegan USA. Normally cost over \$30.00 but we are selling them for just \$10.00 each. 18mm high characters. 160V DC operation. Sorry no spec.

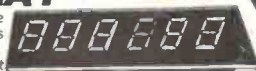

**\$10 each**  
~~10up \$8.00~~

## A PUSHBUTTON PHONE COMPLETE!

Complete pushbutton phone with 10 memories. Includes plug and manual. We have sold hundreds of these phones from PYE/TMC. Its your chance to grab one of the last few. Reduced just for Christmas!!

**WAS \$59.00**

**\$49.00**

**Battery Backup Available**

Nicad battery backup. Keeps memories available when you move phone. **\$20.00**



Not Telecom Approved

# SHERIDAN ELECTRONICS

164-166 Redfern St., Redfern NSW 2016. Phone (02)699 6912, (02)699 5922  
Mail Orders to Dept EA, PO Box 229 Redfern NSW 2016

**Trading Hours:-**  
Mon-Fri..... 9am-5.30pm  
Thursday..... 9am-7pm  
Saturday..... 9am-12noon

**Mail Charges:**  
\$5.00-\$9.99 ..... \$3.50  
\$10.00-\$24.99 ..... \$4.00  
\$25.00-\$49.99 ..... \$6.00  
\$50.00-\$99.99 ..... \$7.00  
\$100.00 or over ..... \$8.00

**bankcard**  
welcome here





# Which battery to use?

The advent of microcircuits leading to miniaturisation of equipment and to decreased power demands has resulted in a resurgence of battery operated devices. Advances in technology have led to some remarkable developments in batteries today. But there you have a problem. Which battery to use?

**Philip Clark**

MANY PEOPLE have a tendency to replace conventional 'dry' cells with the rechargeable nickel-cadmium type simply to avoid replacement costs, but this practice may not be cost effective and can even lead to reduced equipment performance and greater cost. In order to make some form of meaningful comparison between types, it was necessary to select one common size of cell and look at the performance under similar load conditions. Also, because the performance of carbon-zinc cells is more dependent on usage than alkaline or NiCad cells, a definite statement as to which is best cannot readily be made.

The purpose of this article is to try to present a guide to the selection of cell type best suited for an application, bearing in mind equipment performance, duty cycle, current demand, weight and cost. The information presented here has been obtained from the data sheets

of many manufacturers and should not be regarded as typical of any particular make. Because of the variation in performance of carbon-zinc cells with differing loads, the presentation has been optimised to give a reasonable overall guide to performance without being too optimistic.

## Cells tested

The basic cells compared are the nickel-cadmium rechargeable type, the ordinary carbon-zinc dry cell, both normal and heavy duty (leclanche type) and the manganese dioxide-alkaline type. The size of the cells selected for comparison are the 'AA' or UM-3, SAA designation R6. In the case of the NiCad this is a 450 mA hour capacity cell. The load characteristic selected was a current drain of 30 mA for four hours per day. This is typical of much portable

equipment such as walkie-talkies, portable radios, calculators, etc. This was also the load which was easiest to compare on a range of data for various cells.

## Result of comparisons

Generally, the comparison here shows alkaline cells to have a performance about twice that of ordinary carbon-zinc cells, however they can be many times better, depending on usage. Alkaline cells have higher efficiency when used for continuous or heavy load (high current) applications where the conventional carbon-zinc cell is less effective. The rechargeable NiCad is good for heavy current applications, provided the correct supply voltage can be achieved. Unfortunately, carbon-zinc and alkaline cells are not directly interchangeable with NiCad cells due to ▶



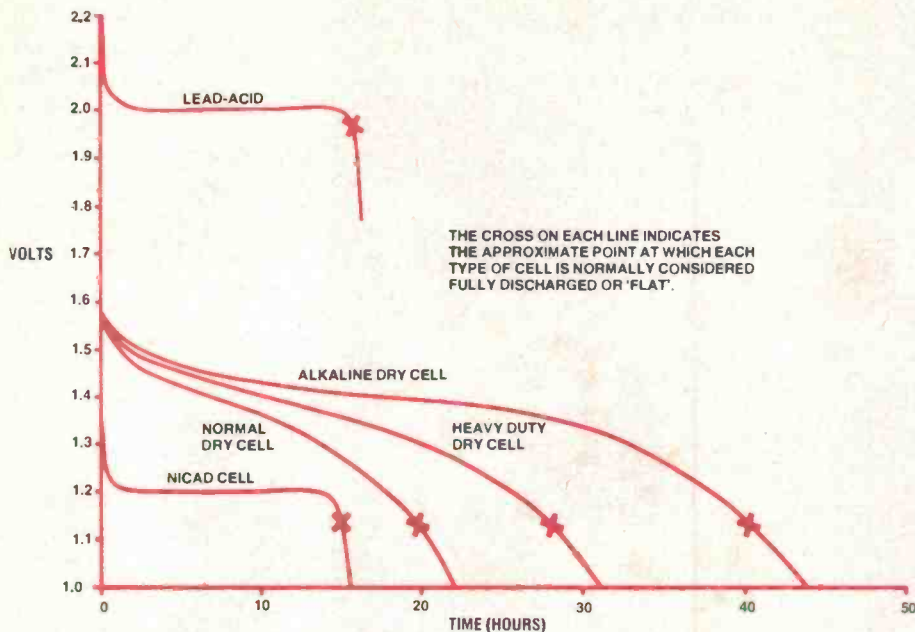

Figure 1. The discharge performance of various cells. The discharge characteristics of a lead-acid cell are shown for comparison. Note that terminal voltage cannot be used to indicate the state of charge of NiCad cells.

differing terminal voltages. This is caused by the different types of materials and construction used for these cells. The result is that while carbon-zinc and alkaline cells have a terminal voltage of 1.5 V, the NiCad cell has a voltage of only 1.2 V.

Figure 1 shows the performance of the various cells and that of a similar capacity lead-acid cell for comparison. It is important to note that the terminal voltage cannot be used to indicate the state of charge of the NiCad cell but can be used as an approximate indicator for 'dry' cells. NiCad cells are about 25% to 30% heavier than 'dry' cells and because more of them may be required for the same voltage, this could mean a substantial weight penalty in portable equipment.

## Batteries at work

The place where these various cells must work is in the equipment, and this is where many factors become important. The points to be considered are: *duty cycle* — is the load to be continuous or intermittent high current, or is it to be low current, continuous or intermittent? *Operating environment* — will the power be required at extremes of temperature? What is the design voltage of the equipment and can sufficient cells be accommodated to provide this? *Replacement or recharging* — in a particular situation one option may be preferable to the other, and which option is cost effective? *Operational life* — how long will the selected cell operate before recharge or replacement is necessary? *Shelf or storage life* — how good is a particular cell after a period of no use?

## Duty cycle

This will have a major effect on the performance of a cell in any situation. Conventional carbon-zinc cells perform best at a relatively light load when operated intermittently. This allows a degree of recovery between periods of use. The service life of alkaline cells is relatively constant regardless of whether use is continuous or intermittent. This type of cell then shows its advantage mainly when continuous use is required. It can have a service life of three to ten times that of carbon-zinc cells in ideal circumstances.

Another advantage of the alkaline cell is its ability to supply considerably higher currents than the carbon-zinc type. In fact, the current available from alkaline cells can approach that from NiCad rechargeable cells in some circumstances. For high current loads, intermittent or continuous, the NiCad cell may be preferred, either because other cell types cannot supply the required current or because discharge is so rapid that continual replacement would be necessary. Substitution of carbon-zinc or alkaline cells with NiCads should only be undertaken after consideration of all the factors involved, including operating environment, equipment voltage requirements and storage life.

## Operating environment

Carbon-zinc cells deteriorate quickly at temperatures above about 50°C and become rapidly unable to deliver useful current below -18°C. Alkaline cells

show better operating characteristics at extremes of temperature. Although it is difficult to determine the upper temperature limit of these cells, it is considerably better than carbon-zinc cells. Alkaline cells perform reasonably well down to temperatures of -40°C.

NiCad rechargeable cells have an operating temperature range of about -20°C to +45°C but should not be exposed to temperatures below 0°C while charging. Generally, their operating temperatures are about the same as for carbon-zinc cells. There may be some temperature rise in NiCad cells during charging or heavy discharge, and this factor should be considered if these cells are used as a replacement for 'dry' cells in sensitive or critical equipment.

## Design voltage of equipment

This is an important factor when consideration is being given to replacing carbon-zinc or alkaline cells with rechargeable NiCad types or replacing NiCads with 'dry' cells. In equipment such as portable transceivers, satisfactory operation depends greatly on the available supply voltage. Some of this equipment is designed to operate from NiCad cells while other is intended to use 'dry' cells. Most such equipment has a specified operating range of voltages and attempted use outside of this range will result in severely degraded performance, no operation at all, or possible damage to the equipment. Typical ranges for nominal 12 V equipment are 11 V to 14 V or 10 V to 15 V. There is a temptation to replace carbon-zinc or alkaline cells with an equal number of rechargeable NiCad cells but because of the difference in terminal voltage (1.5 V as compared to 1.2 V), a fully charged NiCad battery may not meet the minimum voltage requirements of equipment.

Figure 2 shows the performance of various battery types in a piece of 12 V rated equipment such as a portable transceiver. Note that if provision is only made for eight cells, then replacement with lower voltage types can result in insufficient supply for the correct operation of the equipment. Often, the mere fact that the equipment operates at all under these conditions is more a tribute to the designer than the performance of the power source! On the other hand, replacement of NiCad cells with 'dry' cells could allow the equipment voltage specification to be exceeded.

## Replacement or recharging

Which is best here will depend very much on the user requirement. For example, a transceiver used by emergency



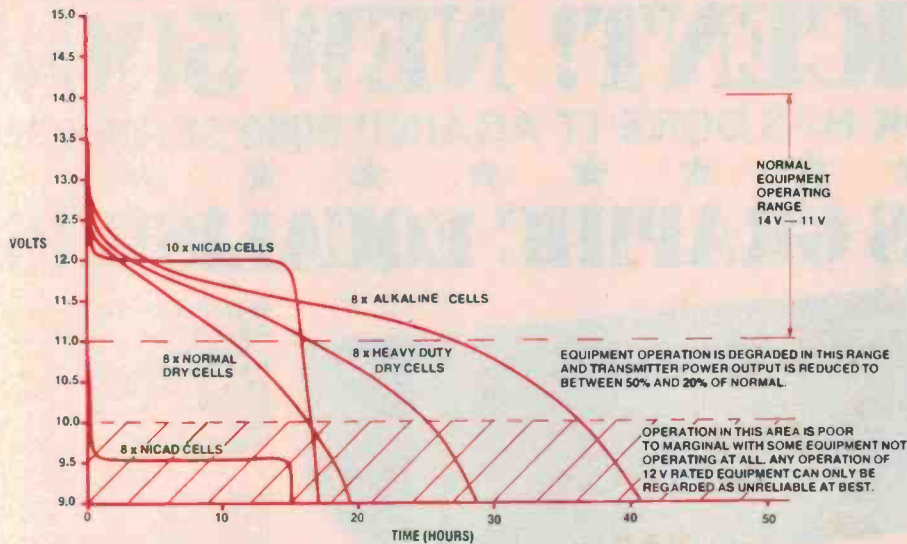

Figure 2. The performance of various battery types in a 12 V operated handheld transceiver. Note that you cannot expect to replace eight dry cells with eight NiCads.

services might be more quickly restored to service by replacement of batteries than by recharging. For personal use, where failure due to battery discharge is not so critical, recharging may be acceptable. If the equipment is in heavy or continuous use then recharging may be a viable alternative to replacement.

The cost of any option will depend on how often replacement is required, the higher initial cost of rechargeable cells, (and you may need more of them), the cost of a charger and the cost of an additional battery pack if operation is needed while recharging is in progress. Another important factor, especially in an emergency environment, is the availability of power for recharging. If such a source is not readily accessible, a user may be ill-advised to use rechargeable batteries at all.

### Operational life

The effective operational life of a battery may become very important if access to replacement or recharged cells is difficult. As can be seen from Figure 2, the NiCad cells under this load will supply power for about 15 hours of operation. This is conditional on the battery being fully charged and in good condition. Ordinary carbon-zinc cells will provide about the same service life and heavy duty ones about twice this. Alkaline cells can be expected to have a greater operating life, about three times or better, than either NiCads or carbon-zinc as compared here.

There is a further factor which should be considered where the use of NiCad cells is contemplated. It has become recognised that NiCad cells tend to develop a 'memory' of their usage pattern. What appears to happen is that if a cell is used to say only 50% of capacity and then recharged, after a few cycles of

this pattern the cell then becomes only capable of delivering 50% of rated capacity before going 'flat'. This condition can be reversed by correctly cycling the cell through several discharge and charge cycles, but unless this condition is recognised as developing, it may seriously degrade the operational life of the equipment in which it is used.

### Shelf life or self discharge

All cells will discharge by themselves when not in use, to a greater or lesser degree. This self discharge will determine the length of time for which a cell can be left unused and still be able to deliver a reasonable proportion of its original charge. The major factors which influence the rate of self discharge are storage temperature, amount of charge at storage, and the condition of the cell.

The definition of shelf life is somewhat variable, but for carbon-zinc and alkaline cells appears to be the time taken to decrease to 90% of initial capacity. Accepting this definition then gives the following approximate storage lifetimes for cells in good condition.

- Carbon-zinc cell — 8 to 9 months
- Alkaline cell — Over 2 years.
- NiCad cell — 3 days to 4 weeks.

These storage times are based on a constant temperature of about 20°C to 25°C. Storage life may be improved by storing the cells at 5-10°C. Generally, higher temperatures cause more rapid degradation. Storage life is also shown in graphical form in Figure 3. An approximation for a lead-acid car battery type cell is shown for comparison. NiCad cells appear to show up poorly in this regard and some manufacturers now claim to have substantially improved this characteristic. The self discharge of NiCad cells depends on the type of cell, whether it is intended for high or normal current discharge. The condition of the cell is also important, whether it has been cycled correctly, the age (number of cycles), the environment in which it has been used and the state of charge at storage.

Consideration of the information provided here may be able to assist you to make a better informed decision as to the best power source for your battery operated equipment. It is not practical to cover all the eventualities and applications in a short article, but at least this should provide some guide to the cost effectiveness and practicability of the battery that you select. Most manufacturers will provide design and engineering data on request should you need to make a more detailed analysis of your particular needs.

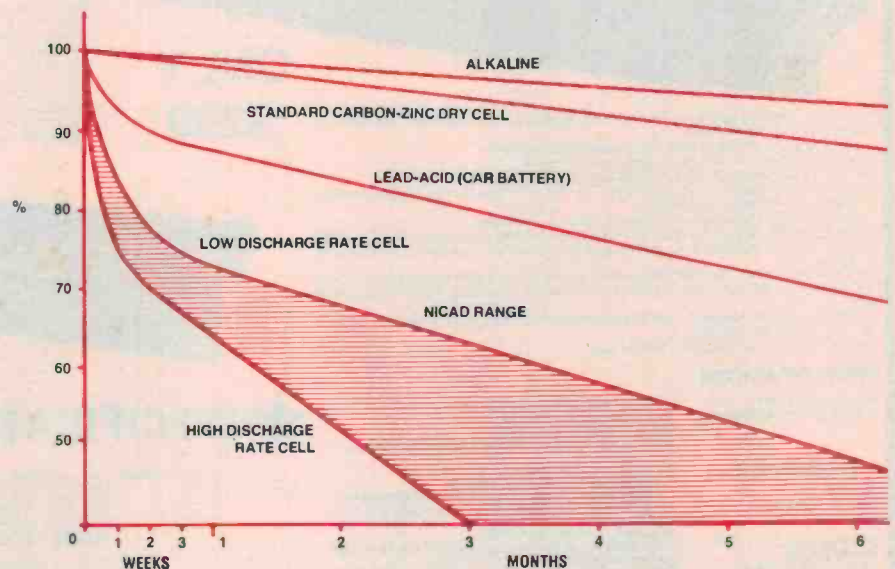

Figure 3. All secondary cells self-discharge, which gives them a certain 'shelf life'. Here, the self-discharge characteristics of the various cells are shown. A lead-acid cell is included for comparison.



# MAGNIFICENT! NEW 5000

DAVID TILLBROOK HAS DONE IT AGAIN!! 5000 SERIES 1/3

★ ★ ★ ★ ★ ★ ★ ★ ★ ★

## 5000 SERIES GRAPHIC EQUALISERS



ALL IC  
SOCKETS  
PROVIDED



AUSTRALIAN (NOT HONG KONG)  
MADE — SPECIAL BUILT RACK  
CABINET — QUALITY!!!



**SPECIFICATIONS:**  
Signal-to-Noise: -102dB  
with respect to 1 Volt  
Frequency Response:  
12Hz - 105kHz to -1dB  
Boost/Cut: 14dB (28dB  
total)  
Distortion: 100Hz-0.007%  
1kHz-0.007%  
10kHz-0.008%  
(essentially Irrepective of  
cut or boost)  
Current consumption (DC)  
Approx 100mA @ ±15V  
(Requires 30V AC CT)  
Output short-circuit proof.

Latest addition to the thoroughbred 5000 Series stable! David Tillbrook has once again produced a 'No Compromise' design. This new component, a 1/3 octave equaliser, gives you ABSOLUTE CONTROL over the acoustics of your particular listening environment. You get 3 SEPARATE CONTROLS for every octave of audio bandwidth to virtually eliminate the subtle nuances that are particular to your listening area.

1/3 octave equalisers have been used by professional engineers in Recording Studios and live concerts for over a decade now. It is no accident that the advent of the 1/3 octave equaliser and studio quality live sound have gone hand-in-hand. BUT THERE'S A CATCH. One of these equalisers is not enough. You will have to buy 2 (for stereo). Quite a lot of money — but worth it if you want the best.

For those whose budget does not extend to \$389, may we suggest the 2010MkIIA octave (10 band) equaliser. This unit is rack mounted and in the same format as the 5000 series equaliser. It is stereo (In one 3 1/2" cabinet) with one slider per octave. Basically an upgrade of the ETI 485 graphic, it represents outstanding value for money at only \$139.00.

The Jaycar kit includes a fully prepunched plated chassis, prepunched heavy gauge front panel with silkscreened front panel to match the other 5000 components. It is absolutely original. You can purchase the kits one at a time for \$199 ea. or, for two, \$389 — a \$10 saving. If you are one of the hundreds of happy 5000 users we are convinced that you will be just as delighted with this unit.

BUY 2 AND SAVE \$10 — ONLY \$389

★ only ★  
**\$199**

## "BLACK MONOLITH"



ONLY  
**\$299**

Once again, imitation is the sincerest form of flattery. The Black Monolith 5000 Mosfet Power Amp has the following EXCLUSIVE features:

- Beryllium Oxide (Space Age ceramic) TD-3 washers. (Not flimsy mica)
- Jig drilled and extruded heavy gauge, anodised heatsink bracket.
- SUPERFINISH front panel. STILL THE BEST now with blind tapped holes.
- New heavy duty heatsinks for the driver transistors. 100% extra heatsink area and black anodised for greater efficiency. (Not in original design).
- Ventilation holes in metalwork at critical points. (Not in original design).
- Extra 3 pin DIN socket on rear panel (total 2) to power new 5000 components (1/3rd Octave 5000 series Equaliser coming soon!). Not in original design but now a must with the new additions in the family.

IF YOU THINK THAT YOU CAN SAVE MONEY ON THESE KITS ASK YOUR SUPPLIER IF HE WILL GIVE YOU ALL OF THESE FEATURES AT THE PRICE. MAKE SURE THAT YOU GET IT IN WRITING!

A PRICE RISE ON BOTH KITS (i.e. SALES TAX AND METALWORK ETC.) IS EXPECTED SOON! BUY THE BEST FOR NO MORE.

Write In (SAE) for a new glossy leaflet on both amps.

### SPECIFICATIONS

POWER OUTPUT  
FREQUENCY RESPONSE

Around 100W RMS into 8 ohms  
8Hz to 20kHz, +0 - 0.4dB  
2.8Hz to 65kHz, +0 - 3dB  
Note: these figures are determined solely by passive filters

INPUT SENSITIVITY

HUM

NOISE

2nd HARMONIC

DISTORTION

3rd HARMONIC

DISTORTION

TOTAL HARMONIC

DISTORTION

INTERMODULATION

DISTORTION

STABILITY

1V RMS for 100W output  
- 100dB below full output (flat)  
- 116dB below full output (flat, 20kHz bandwidth)  
<0.001% at 1kHz (0.0007% on prototypes) at 100W output using a ±56V supply rated at 4A continuous  
<0.003% at 10kHz and 100W  
<0.0033% for all frequencies less than 10kHz and all powers below clipping  
Determined by 2nd harmonic distortion (see above)  
<0.003% at 100W (50Hz and 7kHz mixed 4:1)  
Unconditional

## "BLUEPRINT"

5000 PREAMPLIFIER

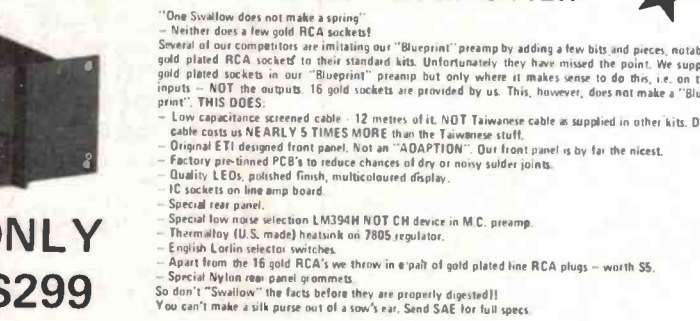

**BLUEPRINT \$275**

## ★ SPECIFICATIONS

Frequency Response High level input: 15Hz-100kHz, +0, -1dB  
Low level input: conforms to RIAA equalisation  
+0.2dB (see detail on Phono sock)  
1kHz: 0.003% on all inputs (limits of resolution on measuring equipment due to noise limitation)  
High level input, master full, with respect to 100mV input signal at full output (1.2V)  
92dB flat, 100dB A-weighted  
MM input, master full, with respect to full output (1.2V) at 5mV input, 500 ohm source resistance connected: 86dB flat  
92dB A-weighted  
MC input, master full, with respect to full output (1.2V) at 200V input signal: 74dB flat, 75dB A-weighted

ETI-478MM Moving Magnet input stage Gain  
Frequency Response 1, 1kHz  
Conforms to RIAA Equalisation +0.2dB  
Total Harmonic Distortion 0.001%, 1kHz, 10mV RMS input  
Headroom 28dB with respect to 5mV RMS input signal, i.e. 135mV RMS  
Noise Total equivalent input noise, 122mV A, input shorted, 216mV flat, input shorted  
S/N ratio 1mV 5mV 10mV  
Flat 72dB 87dB 92dB  
A-weighted 78dB 92dB 95dB  
ETI-478MC Moving coil input stage Gain  
Frequency Response 24Hz - 135Hz Q = 1dB  
Total Harmonic Distortion 0.003%, 1kHz, 30mV input  
Noise Total equivalent input noise 83mV flat, input shorted  
42mV A, input shorted  
56mV flat, after RIAA Eq. input shorted  
14mV A, after RIAA Eq. input shorted



# SERIES COMPONENT

OCTAVE GRAPHIC EQUALISER — BRILLIANT!!



FROM \$495



## 8 CHANNEL MIXER KIT

The Jaycar 8002 Mixer was originally conceived to be the successor to the very popular ET1414 Master Mixer. The 414 was basically configured as a 'stage' mixer and suffered from a number of severe technical limitations — notably poor signal-to-noise figures. Enormous advances in Audio IC's have occurred since the 414 was designed. Jaycar engineers have taken advantage of this. The incredibly low noise and distortion figures of the 8002 are a testimony to the sound basic design of the mixer coupled with the performance capability of these IC's. Whilst the 8002 is the ideal 8 channel compact stage mixer, other applications have been kept in mind. AS A "STUDIO" MIXER. The prime requirement of a studio mixer is that it must be quiet — i.e. have good S/N. Due to the fact that the "miracle" 5534 IC's are used in the 8002 studio applications are entirely feasible. In addition to this, metal film resistors are used in critical signal areas. AS A DISCO MIXER. The balanced input feature of the 8002 is not really necessary for disco use. This section can easily be bypassed with either a moving magnet (Dynamic Cartridge) preamp, or a moving coil preamp. The sensitive format of the 8002 and tremendous equalization facilities should make this mixer popular for disco use.

- Balanced (600 Ohm) Mic. Inputs/Line Inputs.
- Cannon Connectors included in the price.
- Bass, Mid & Treble Equalization on each Input.
- "Effects" (i.e. Echo etc.) capability.
- Foldback and Stereo Pan on ALL 8 Inputs.
- 60mm Slide Faders used throughout.
- 19" Rack Mount capability (or Console Mount).
- Professional Black Front Panel with Format borders & multi-coloured knobs to assist function identification.
- VU Metering.

Send SAE for full details + details on use as stage mixer

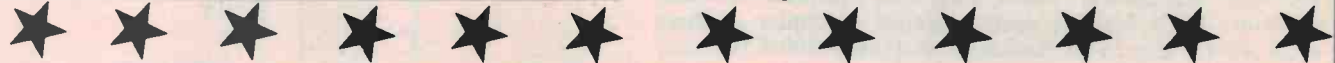

# MASSIVE BREAKTHROUGH! CAR COMPUTER BELOW \$200

COMPLETELY BUILT AND TESTED — NOT A KIT!!

MADE IN ENGLAND! — QUALITY!!



CONTAINS EQUIVALENT OF THOUSANDS OF TRANSISTORS — USES MASSIVE CUSTOM LSI CHIP TO ACHIEVE LOW PRICE

Never before has such a comprehensive car performance computer been offered at such a low price!! Once again miracle microprocessor technology has enabled us to pass enormous savings on to you!! But don't let the low cost fool you. The "Voyager" car computer IS THE MOST COMPREHENSIVE PRODUCT THAT WE HAVE SEEN. No other car computer matches this one AT EVEN TWICE THE PRICE! You could buy a \$20,000 Holden and not get a better car computer!! Just check the features. We are sure that you will calculate that the "Voyager" represents outstanding value!

IDEAL RALLY COMPUTER!

only \$199 complete

### FEATURES

- INSTANT FUEL CONSUMPTION IN LITRES/100KM AND MPG!! (MOST OTHERS HAVE ONLY ONE OF THE ABOVE) JUST SWITCH FROM ONE TO THE OTHER AS YOU DRIVE ALONG.
- INSTANT SPEED, TIME AND OTHER FUEL DATA.
- VISUAL AND AUDIBLE EXCESS SPEED ALARM.

### INSTALLATION

The "Voyager" comes complete with an unbelievable array of mounting configurations, on dash, under dash or stalk mount. ALL installation hardware is supplied (even a roll of insulation tape!) as well, of course, as the speed and fuel sensors. A lavishly illustrated installation manual is provided as well as a comprehensive operators manual.

A typically competent EA/ETI reader would be able to install this unit in 3-4 hours.

## 'super siren'

Incredible CMOS circuit drives a Motorola piezo horn (KSN 1038A) to achieve extremely high sound pressure levels. Makes a great alarm and only draws — would you believe — 5mA average? Runs for ages on a 9V battery. You can get the electronics including the PCB for only \$5.00. KSN1038A only \$17 extra.



Ref: EA 11/82 FROM \$5.00

## Jaycar NUMBER 1 FOR KITS

125 York Street, Sydney 2000  
Phone: 264 6688 Telex: 72293  
"Nevilles Corner"  
Cnr. Carlingford & Pennant Hills Road,  
Carlingford  
Phone: 872 4422  
Mail Orders To: Box K-39 Haymarket  
Sydney 2000

MAIL ORDER BY BANKCARD VIA YOUR PHONE



POST AND PACKING CHARGES  
\$5-\$9.99 (\$1.20) \$10-\$24.99 (\$2.40)  
\$25-\$49.99 (\$3.50) \$50-\$99.99 (\$4.80)  
\$100 up (\$6.20)

NEW SHOP HOURS  
Mon-Fri 8.30 to 5.30pm  
Sat 8.30 to 12.30pm  
Thurs night to 8.30pm



## Using the 4007UB 'FETset' IC

The 4007UB comprises two pairs of complementary MOSFETs and a simple MOSFET inverter stage, all independently accessible, which makes this simple IC a very versatile chip indeed.

Ray Marston

THE 4007UB is the simplest chip in the entire CMOS range. It contains little more than two pairs of complementary MOSFETs, plus a simple CMOS inverter stage. All of these elements are, however, independently accessible, enabling them to be configured in a wide variety of ways, thereby making the IC the most versatile in the entire CMOS range.

The 4007UB is an ideal device for demonstrating CMOS principles to students, technicians and engineers. It is sometimes known as the 'design-it-yourself' CMOS chip, and can readily be configured to act as a multiple digital inverter, NAND or NOR gate, transmission gate, or as a uniquely versatile 'micropower' linear amplifier, oscillator or multivibrator. We'll look at some practical examples of these applications later. In the meantime, let's look at 4007UB basics.

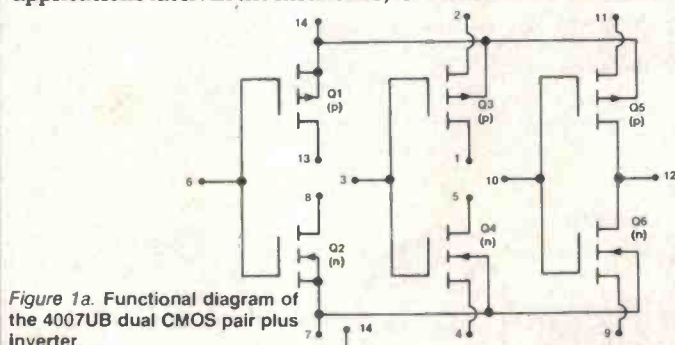

Figure 1a. Functional diagram of the 4007UB dual CMOS pair plus inverter.

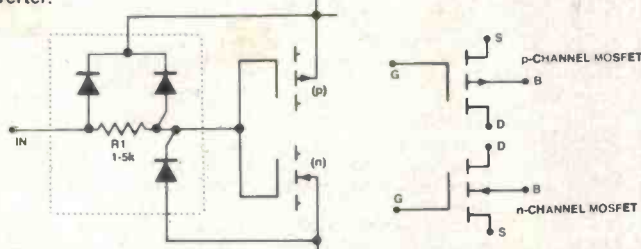

Figure 1b. Internal input protection network (within dotted lines) on each input of the 4007UB.

Figure 1c. MOSFET terminal notations. G = Gate. D = Drain. S = Source. B = Bulk substrate.

### Basics: digital operation

Figure 1a shows the functional diagram and pin numbering of the 4007UB. Each of the three independent input terminals of the IC is internally connected to the standard CMOS protection network shown in Figure 1b. All MOSFETs in the 4007UB are enhancement-mode devices; Q1, Q3 and Q5 are p-channel MOSFETs, and Q2, Q4 and Q6 are n-channel MOSFETs. Figure 1c shows the terminal notations of the two MOSFET types; note that the B terminal represents the bulk substrate.

The term 'CMOS' actually stands for 'Complementary Metal Oxide Silicon field-effect transistors' and it is fair to say that all CMOS ICs are designed around the basic elements shown in Figure 1. It is thus worth getting a good basic understanding of these elements. Let's look first at the digital characteristics of the basic MOSFETs.

The input (gate) terminal of a MOSFET presents a near-infinite impedance, and the magnitude of an external voltage applied to the gate controls the magnitude of source-to-drain current flow. Basic characteristics of the enhancement-mode n-channel MOSFET are that the source-to-drain path is open circuit when the gate is at the same potential as the source, but becomes a near short-circuit (a low resistance) when the gate is heavily biased positive with respect to the source. Thus the

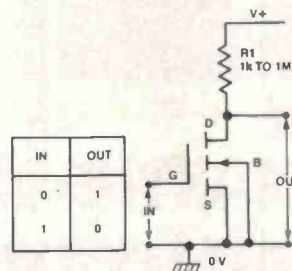

Figure 2. Digital inverter made from n-channel MOSFET.

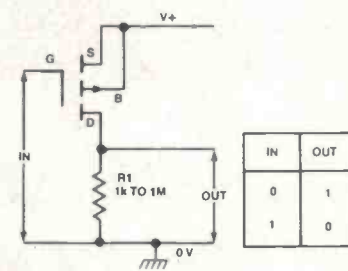

Figure 3. Digital inverter made from p-channel MOSFET.

n-channel MOSFET can be used as a digital inverter by wiring it as shown in Figure 2. With a logic 0 (zero volts) input the MOSFET is cut off and the output is at logic 1 (positive rail voltage), but with a logic 1 input the output is at logic 0.

Basic characteristics of the p-channel enhancement-mode MOSFET are that the source-to-drain path is open when the gate is at the same potential as the source, but becomes a near-short when the gate is heavily biased *negative* to the source. The p-channel MOSFET can thus be used as a digital inverter by wiring it as shown in Figure 3.

Note in the Figures 2 and 3 inverter circuits that the on currents of the MOSFETs are determined by the value of R1 and that these circuits draw a finite quiescent current when they are in one of their logic states. This snag can be overcome by connecting a complementary pair of MOSFETs in the standard CMOS inverter configuration shown in Figure 4a.

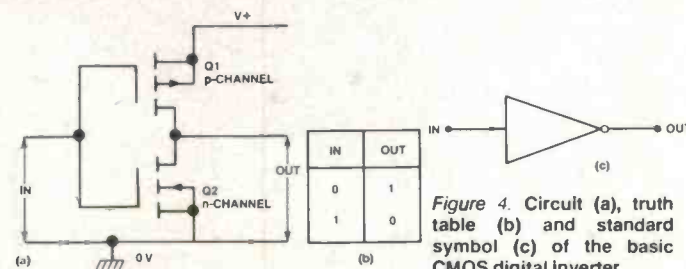

Figure 4. Circuit (a), truth table (b) and standard symbol (c) of the basic CMOS digital inverter.

Here, with a logic 0 input applied, Q1 is shorted, so the output is firmly tied to the logic 1 (positive rail) state, but Q2 is open and the inverter thus passes zero quiescent current via this transistor. With a logic 1 input applied, Q2 is shorted and the output is firmly tied to the logic 0 (zero volt) state, but Q1 is open and the circuit again passes zero quiescent current. This



'zero quiescent current' characteristic of the complementary MOSFET inverter is one of the most important features of the CMOS range of digital ICs, and the Figure 4a circuit forms the basis of almost the entire CMOS family. Figure 4c shows the standard symbol used to represent a CMOS inverter stage. Q5 and Q6 of the 4007UB are fixed-wired in this inverter configuration.

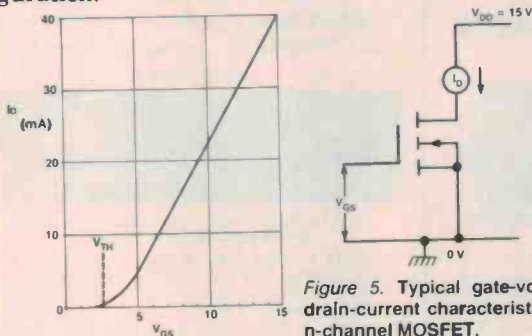

Figure 5. Typical gate-voltage to drain-current characteristics of an n-channel MOSFET.

### Basics: linear operation

To truly understand the operation and vagaries of CMOS circuitry, it is essential to understand the linear characteristics of basic MOSFETs. Figure 5 shows the typical gate-voltage to drain-current graph of an n-channel enhancement mode MOSFET. Note that negligible drain current flows until the gate voltage rises to a 'threshold' value of about 1.5 to 2.5 volts, but that the drain current then increases almost linearly with further increases in the gate voltage.

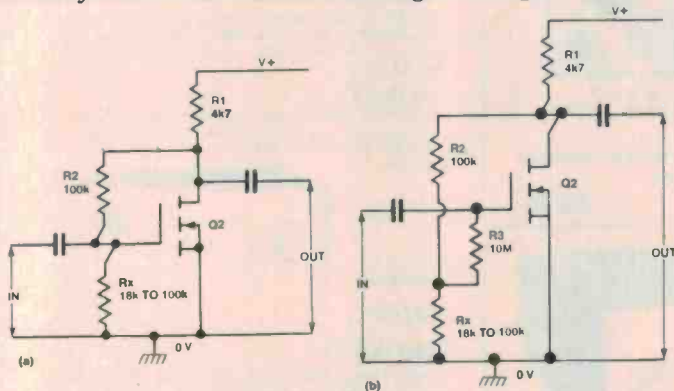

Figure 6. Methods of biasing an n-channel 4007UB MOSFET for use as a linear inverting amplifier.

Figure 6 shows how to connect an n-channel 4007UB MOSFET as a linear inverting amplifier. R1 serves as the drain load of Q2 and R2-Rx bias the gate so that the device operates in the linear mode. The Rx value must be selected to give the desired quiescent drain voltage; the Rx value is normally in the range 18k to 100k. If you want the amplifier to give a very high input impedance, wire a 10M isolating resistor between the R2-Rx junction and the gate of Q2, as shown in Figure 6b.

Figure 7 shows the typical  $I_D$  to  $V_{DS}$  characteristics of an n-channel MOSFET at various fixed values of gate-to-source voltage. Imagine here that, for each set of curves,  $V_{GS}$  is fixed at the  $V_{DD}$  voltage, but that the  $V_{DS}$  output voltage can be varied by altering the value of drain load  $R_L$ . The graph can be divided into two characteristic regions, as indicated by the dotted line, these being the triode region and the saturated region.

When the MOSFET is in the saturated region (with  $V_{DS}$  at some value in the nominal range 50% to 100% of  $V_{GS}$ ) the drain acts like a constant current source, with its current value controlled by  $V_{GS}$ . A low  $V_{GS}$  value gives a low constant-

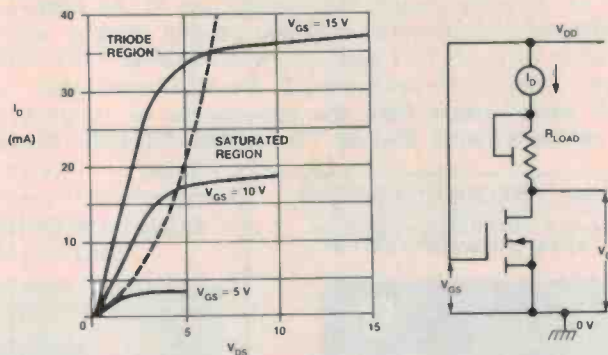

Figure 7. Typical  $I_D$  to  $V_{DS}$  characteristics of the n-channel MOSFET at various fixed values of  $V_{GS}$ .

current value, and a high  $V_{GS}$  value gives a high constant-current value. These saturated 'constant-current' characteristics provide CMOS with its short-circuit proof feature and also determine its operating speed limits at different supply voltage values.

When the MOSFET is in the triode region (with  $V_{DS}$  at some value in the nominal range 1% to 50% of  $V_{GS}$ ) the drain acts like a voltage-controlled resistance, with the resistance value increasing approximately as the square of the  $V_{GS}$  value.

The p-channel MOSFET has an  $I_D$  to  $V_{DS}$  characteristics graph that is complementary to that of Figure 7. Consequently, the action of the standard CMOS inverter of Figure 4 (which uses a complementary pair of MOSFETs) is such that its current-drive capability into an external load, and also its operating speed limits, increases in proportion to the supply rail voltage.

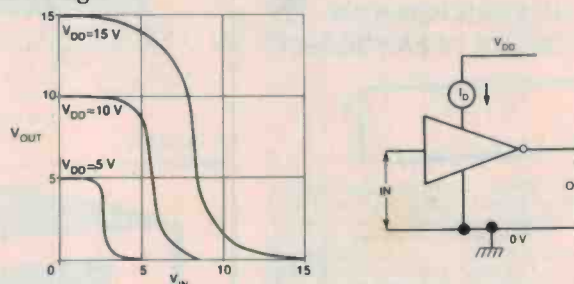

Figure 8. Typical voltage transfer characteristics of the 4007UB simple CMOS inverter.

Figure 8 shows the typical voltage-transfer characteristics of the standard CMOS inverter at different supply voltage values. Note (on the 15 V  $V_{DD}$  line, for example) that the output voltage changes by only a small amount when the input voltage is shifted around the  $V_{DD}$  and 0 V levels, but that when  $V_{in}$  is biased at roughly half-supply volts a small change of input voltage causes a large change of output voltage.

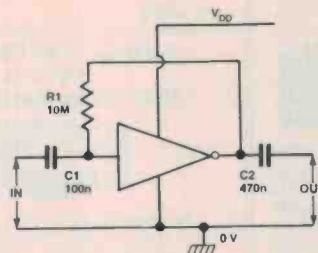

Figure 9. Method of biasing the simple CMOS inverter for linear operation. Typical gain and bandwidth performance figures are 30 dB and 2.5 MHz at 15 V supply, 40 dB and 710 kHz at 5 V.

Typically, the inverter gives a voltage gain of about 30 dB when used with a 15 V supply, or 40 dB at 5 V. Figure 9 shows how to connect the CMOS inverter for use as a linear amplifier; the circuit has a typical bandwidth of 700 kHz at 5 V supply, or 2.5 MHz at 15 V.



# I'M BUILDING *have built* THE FIRST TWO

— what am I raving about? Well, having one of the World's finest home stereo systems (the brilliant ETI 5000 series amp and preamp together with my beloved B & W DM II loudspeakers of course!), I couldn't resist building ETI's 5000 series 1/3 octave Graphic Equalizers. I have been pestering ETI for well over a year — and at last the many 1000's of 5000 series owners have the opportunity to complete their system with another classic, no compromise DAVID TILBROOK DESIGN. Details are on the other page of this ad. Cheers *Jack O'Donnell*

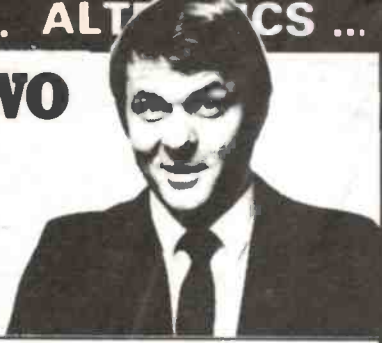

## DIGITAL FREQUENCY METER

See Electronics Aust. Mag. Dec. 81-Feb. '82  
500 MHZ, 7 DIGIT RESOLUTION PLUS PERIOD MEASUREMENT FEATURE



**IMPORTANT NOTES:**  
(1) This project is well within the scope of the "not so experienced" as virtually all components are contained on a single PCB.  
(2) ALTRONICS USE ONLY THE SPECIFIED INTERSCIL LSI — BEWARE OF INFERIOR KITS THAT DO NOT CONFORM TO THE ORIGINAL DESIGN.

- Screened front panel • Bright high efficiency 7 segment display • Frequency ranges 0-10MHz, 0-50MHz, 10-50MHz (with optional pre-scaler) • 4 gating times — 0.1, 1, 10, 100 seconds • 4 period measuring ranges 1, 10, 100 and 1000 input cycles give 0.1µS resolution.
  - High Input sensitivity — 10mV to 30MHz, 100mV at 50MHz @ 1M input impedance, 200mV at 500MHz @ 75 ohms input impedance.
  - High accuracy — typically better than .005% count uncalibrated.
  - Costs a fraction of commercial counters.
  - EXCLUSIVE ALTRONICS KIT FEATURES:**
    - IC sockets provided throughout.
    - Low aging 10,000 MHZ XTAL.
    - Thermalloy heatsink for 5V regulator.
    - Quality Pactec Instrument Case
- K 2500 (50 MHZ version) . . . . \$119.50  
K 2501 Pre-scaler . . . . \$ 26.00  
(add for 500 MHZ version)

## FUNCTION GENERATOR WITH DIGITAL DISPLAY



EA's new Function Generator covers the frequency range from 15Hz to 170kHz in three ranges with coarse and fine frequency controls. An economical 4-digit display has been incorporated to eliminate dial calibration. Sine wave distortion can be trimmed to around 0.5%.  
See EA April, 1982

K 2505 . . . . . \$85.00

## ALTRONICS POWER SUPPLY

BASED ON EA LM 317K PROJECT  
Every workshop, school and hobbyist should get one now!



- Overload and short circuit protected.
- Full voltage and current metering.
- 3-32 volt output at 1 AMP.
- Uses LM 317K variable regulator.
- Full instructions and every last part included.

VALUE PLUS!

K 3200 . . . . . \$39.95



**DIGITAL CAPACITANCE METER**  
Electronics Australia Project. Measures 1PF — 99.99 UF. 240V Mains Powered. Bright LED Display. Easy to build. Complete kit of parts and full instructions.

... EXCLUSIVE TO ALTRONICS ...  
Each kit now includes precision measured capacitors for accurate calibration of each range.

K 2520 . . . . . \$45.00

## NEW ETI 162 POWER SUPPLY

0-30V at 1 amp  
With Voltage and Current Limiting



- Overload and Short Circuit Protected.
- Full Voltage and Current Metering.
- Fully variable voltage and adjustable current limiting.

Exclusive — Fully S.E.C. Certified Mains Transformer supplied.  
If you're considering buying this kit from your local supplier or one of our competitors — first ring and ask them if the mains transformer is S.E.C. certified to ASC126 — chances are that it won't be.  
So why not give us your order? An Altronics Quality Kit speaks for itself and with our overnight jetservice we guarantee to deliver to your door faster than your local supplier.

K3205 . . . . . \$49.50

## GREAT NEW MOSFET PA AMPLIFIER KIT FROM ETI

150 watts power output.  
See June '82



UNCONDITIONALLY STABLE - SOUND STUDIO SPECIFICATIONS

- OUTPUT IMPEDANCE Selectable to low Z voice coil or 100V or 70V line out.  
INPUTS 2 mic Inputs HI or low Z with speech filter.  
1 Aux. input.
- Low noise 5534 op amps used.
  - Noble W/wound power resistors used in output stage for guaranteed stability.

\*\*\* ALTRONICS EXCLUSIVE \*\*\*  
All due respects to ETI, but we felt the original case was lousey — So we've brought out ours utilising our snazzy H 0400 Black Rack Cabinet.  
It looks terrific!! And for this month only, it's the same price as the original version.  
K 5035 . . . . . ONLY \$239.00

## GO ANYWHERE 240V PWR. KITS

See EA May and June 82. These great new inverter kits enable you to power 240V appliances for your car, caravan or boat. (From Standard 12V car battery.)

**40 WATT**  
Suits small appliances, i.e. turntable, tape deck, shaver etc. Variable frequency adjustment enables accurate speed control of turntable motors.



IC Sockets Provided  
K 6700 . . . . . \$55.00

**300 WATT**  
Fully regulated and overload protected XTAL locked frequency.

Use to power hi-fi, TV sets and for emergency lighting.



- Gold plating on both PCB edge and edge connector.
  - Low age rate parallel resonant XTAL used.
  - Sockets for all IC's.
- K 6750 . . . . . \$199.50

## ELECTRONIC FLOURO STARTER

See EA October 1982



Save a fortune on Fluoro Tubes

- Extends the life of your fluoro tubes by 1,000's of hours.
  - Instant "ON" — no more flickering at switch on.
- K3210 . . . . . \$4.95

## \* THE EVER POPULAR \* MUSICOLOUR IV EA PROJECT



Combination Colour Organ and Light Chaser. Four channel colour organ. Internal microphone or connect to speakers for colour organ operation. (The lights connected to each channel pulse in beat to the music proportional to portion of frequency spectrum concerned.) Four chaser modes forward and reverse. Output lamp load capacity a massive 2400 watts — that's 100 party globes. Full instructions and every last nut and bolt included. Great for parties, shop signs, display windows etc.  
K 1004 . . . . . \$79.50

## HIGH FIDELITY AM

Sounds every bit as good as FM  
With this absolutely brilliant EA Project

Project 82 AR12 — See December EA



Frankly, we felt AM was dead and buried for the serious audio buff — when EA told us their new wide band AM tuner had 16KHz bandwidth and made AM sound like as never before — we were still not convinced. But on hearing the New EA AM Tuner, I for one was astonished — AM Broadcasts now sound incredible, there is no other word for it. And the 9KHz whistle filter really works! The result is clear smooth sound reproduction that will be a joy to every constructor on this fantastic tuner project.  
The Altronics Kit includes rack box and every last nut and bolt — even solder. Full instructions included.  
K5200 . . . . . \$249.00







# circuit file

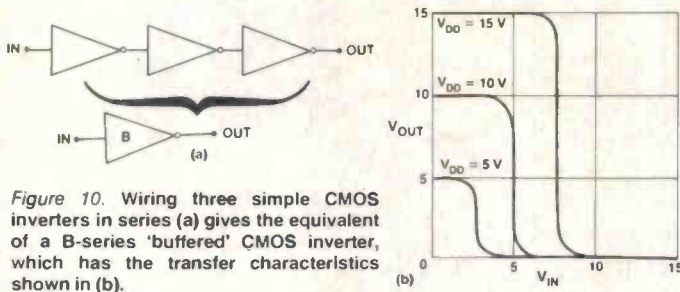

Figure 10. Wiring three simple CMOS inverters in series (a) gives the equivalent of a B-series 'buffered' CMOS inverter, which has the transfer characteristics shown in (b).

Wiring three simple CMOS inverter stages in series (Figure 10a) gives the direct equivalent of a modern B-series 'buffered' inverter stage, which has the overall voltage transfer graph shown in Figure 10b. The B-series inverter, typically gives about 70 dB of linear voltage gain, but tends to be grossly unstable when used in the linear mode.

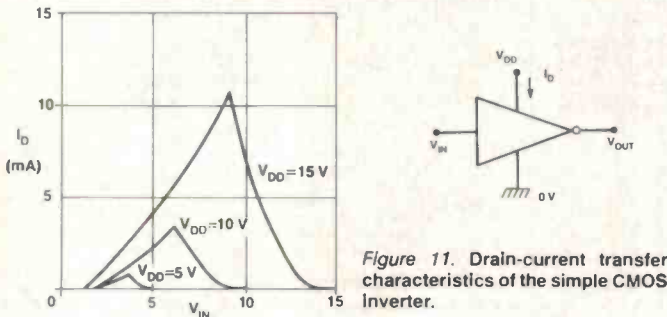

Figure 11. Drain-current transfer characteristics of the simple CMOS inverter.

Finally, Figure 11 shows the drain-current transfer characteristics of the simple CMOS inverter. Note that the drain current is zero when the input is at zero or full supply volts, but rises to a maximum value (typically 0.5 mA at 5 V supply, or 10.5 mA at 15 V supply) when the input is at approximately half-supply volts, under which condition both MOSFETs of the inverter are biased on. In the 4007UB, these *on* currents can be reduced by wiring extra resistance in series with the source of each MOSFET of the CMOS inverter; we use this technique in the 'micropower' circuits shown later in this article.

## Using the 4007UB

The usage rules of the 4007UB are quite simple. In any specific application, all unused elements of the device must be disabled. Complementary pairs of MOSFETs can be disabled by connecting them as standard CMOS inverters and tying their inputs to ground, as shown in Figure 12. Individual MOSFETs can be disabled by tying their source to their substrate (B) and leaving the drain open circuit.

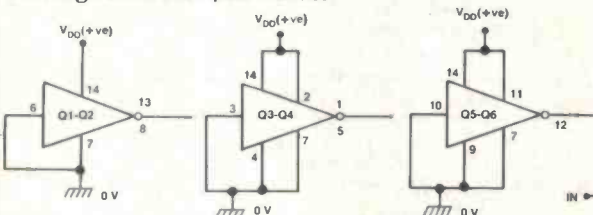

Figure 12. Individual 4007UB complementary MOSFET pairs can be disabled by connecting them as CMOS inverters and grounding their inputs.

In use, the input terminals must not be allowed to rise above  $V_{DD}$  (the supply voltage) or below  $V_{SS}$  (zero volts). To use an n-channel MOSFET, the source must be tied to  $V_{SS}$ , either directly or via a current-limiting resistor. To use a p-channel MOSFET, the source must be tied to  $V_{DD}$ , either directly or via a current-limiting resistor.

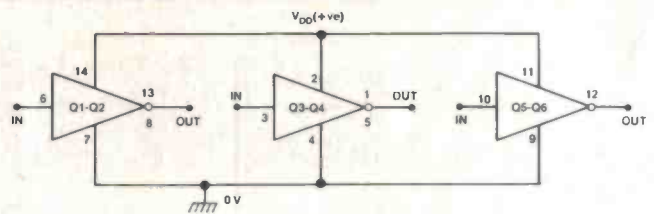

Figure 13. 4007UB triple inverter.

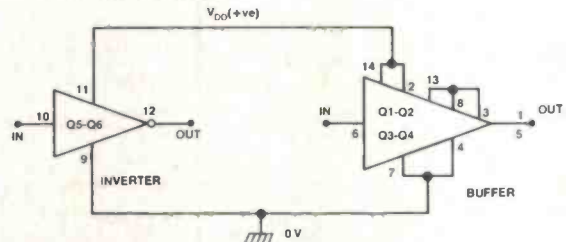

Figure 14. 4007UB inverter plus non-inverting buffer.

## Practical 4007UB circuits: digital

The 4007UB elements can be configured to act as any of a variety of standard digital circuits. Figure 13 shows how to wire it as a triple inverter, using all three sets of complementary MOSFET pairs. Figure 14 shows the connections for making an inverter plus non-inverting buffer; here, the Q1-Q2 and Q3-Q4 inverter stages are simply wired directly in series, to give an overall non-inverting action.

The maximum source (load-driving) and sink (load-absorbing) output currents of a simple CMOS inverter stage self-limit at 10-20 mA as one or other of the output MOSFETs turns fully on. Higher sink currents can be obtained by simply wiring n-channel MOSFETs in parallel in the output stage.

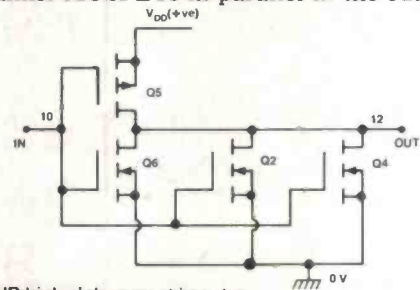

Figure 15. 4007UB high sink-current inverter.

Figure 15 shows how to wire the 4007UB so that it acts as a high sink-current inverter that will absorb triple the current of a normal inverter. Similarly, Figure 16 shows how to wire the IC to act as a high source-current inverter, and Figure 17 shows the connections for making a single inverter that will sink or source three times more current than a standard inverter stage.

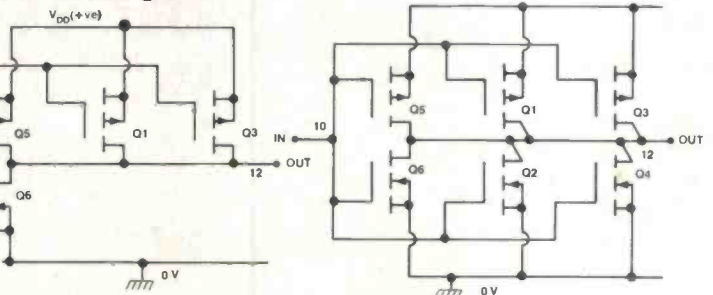

Figure 16. 4007UB high source-current inverter.

Figure 17. 4007UB high-power inverter, with triple the sink- and source-current capability of a standard inverter.



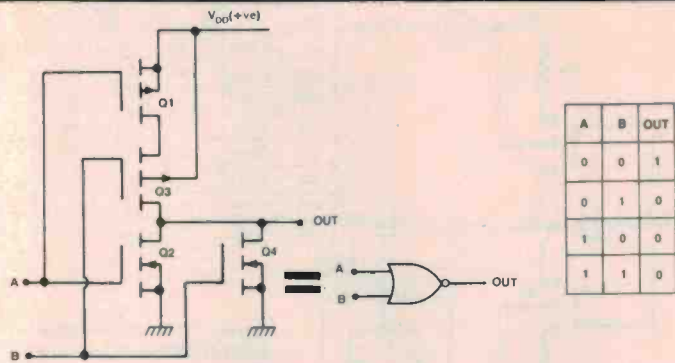

Figure 18. 4007UB two-input NOR gate.

The 4007UB is a perfect device for demonstrating the basic principles of CMOS logic gates. Figure 18 shows the basic connections for making a two-input NOR gate. Note that the two n-channel MOSFETs are wired in parallel so that either can pull the output to ground from a logic 1 input, and the two p-channel MOSFETs are wired in series so that both must turn on to pull the output high from a logic 0 input. The truth table shows the logic of the circuit. A three-input NOR gate can be made by simply wiring three p-channel MOSFETs in series and three n-channel MOSFETs in parallel, as shown in Figure 19.

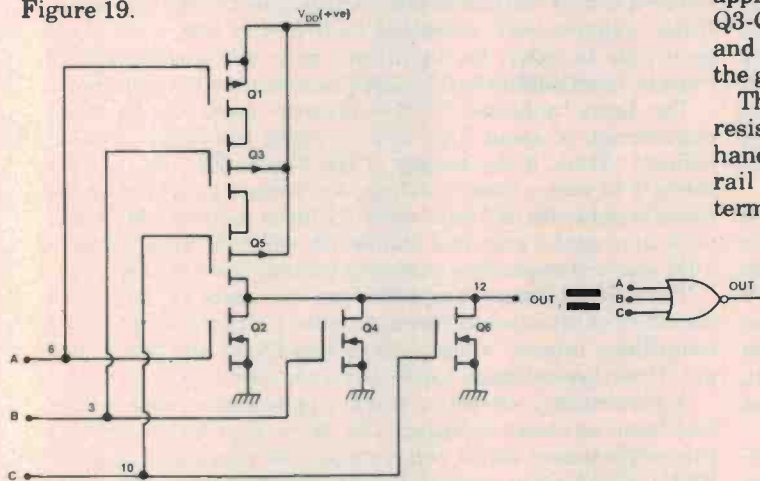

Figure 19. 4007UB three-input NOR gate.

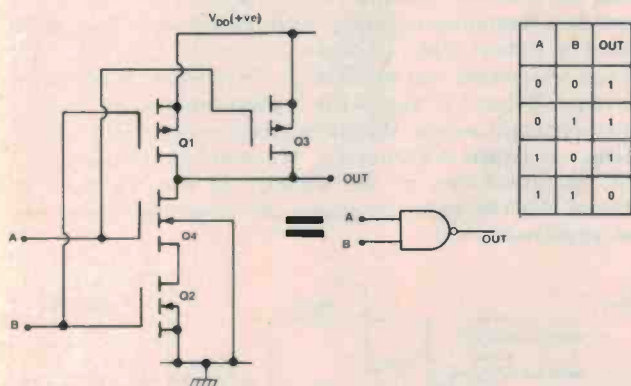

Figure 20. 4007UB two-input NAND gate.

Figure 20 shows how to wire the 4007UB as a two-input NAND gate. In this case the two p-channel MOSFETs are wired in series and the two n-channel MOSFETs are wired in parallel. A three-input NAND gate can be made by similarly wiring three p-channel MOSFETs in parallel and three n-channel MOSFETs in series.

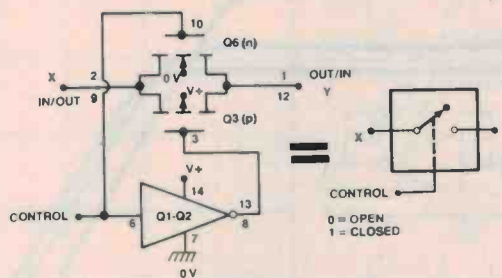

Figure 21. 4007UB transmission gate or bilateral switch.

Figure 21 shows the basic circuit for using the 4007UB to make another important CMOS element, the so-called transmission gate or bilateral switch. This device acts like a near-perfect switch that can conduct signals in either direction and can be turned on (closed) by applying a logic 1 to the control terminal or turned off (open) via a logic 0 control signal. Here, an n-channel and a p-channel MOSFET are wired in parallel (source-to-source, drain-to-drain), but their gate signals are applied in anti-phase via the Q1-Q2 inverter. To turn the Q3-Q6 transmission gate on (closed), Q6 gate is taken to logic 1 and Q3 gate to logic 0 via the inverter. To turn the switch off, the gate polarities are simply reversed.

The 4007UB transmission gate has a near-infinite OFF resistance and an ON resistance of about 600 ohms. It can handle all signals between zero volts and the positive supply rail value. Note that, since the gate is bilateral, either of its terminals can function as input or output.

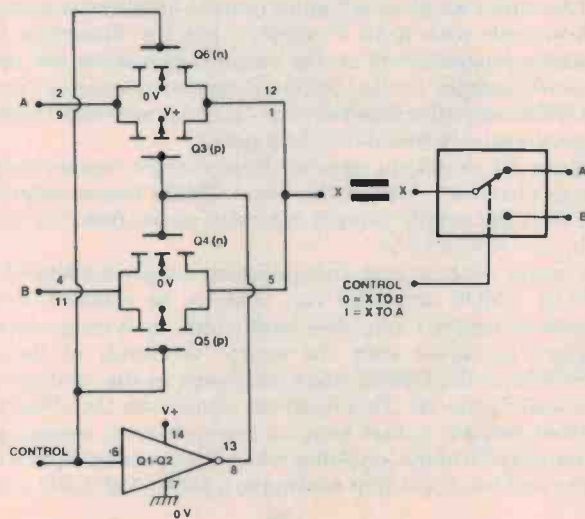

Figure 22. 4007UB two-way transmission gate.

Finally, Figure 22 shows how the 4007UB can be wired as a dual transmission gate that functions like a single-pole double-throw (SPDT) switch. In this case the circuit uses two transmission elements, but their control voltages are applied in antiphase, so that one switch opens when the other closes, and vice versa; the 'X' sides of the two gates are shorted together, to give the desired SPDT action.



# circuit file

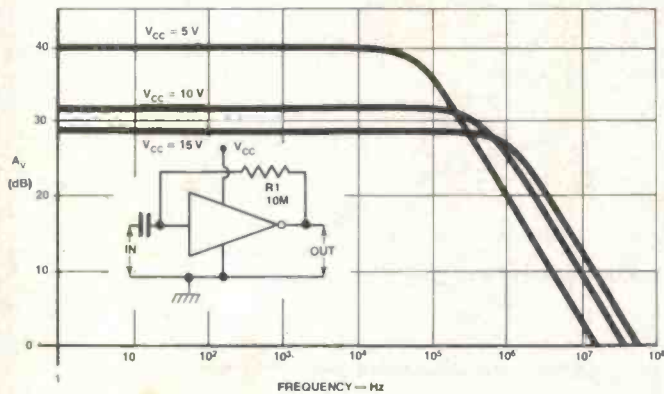

Figure 23. Typical  $A_v$  and frequency characteristics of the linear-mode basic CMOS amplifier.

## Practical 4007UB circuits: linear

We've already seen in Figures 6 and 9 that the basic 4007UB MOSFETs and the CMOS inverter can be used as linear amplifiers. Figure 23 shows the typical voltage gain and frequency characteristics of the linear CMOS inverter when operated from three alternative supply rail values. This graph assumes that the amplifier output is feeding into the high impedance of a 10M/15 pF 'scope probe'. The output impedance of the open-loop amplifier typically varies from 3k at 15 V, to 5k at 10 V, to 22k at 5 V, and it is the product of the output impedance and output load capacitance that determines the bandwidth of the circuit, increasing the load capacitance or output impedance reduces the bandwidth.

As you would expect from the voltage transfer graph of Figure 8, the distortion characteristics of the CMOS linear amplifier are not particularly wonderful. Linearity is quite good for small-amplitude signals (output amplitudes up to 3 V peak-to-peak with a 15 V supply), but the distortion then increases progressively as the output approaches the upper and lower supply limits. Unlike a bipolar transistor circuit, the CMOS amplifier does not 'clip' excessive sine wave signals, but progressively rounds off their peaks.

Figure 24 shows the typical drain-current versus supply-voltage characteristics of the basic CMOS linear amplifier. Note that the supply current typically varies from 0.5 mA at 5 V to 12.5 mA at 15 V.

In many applications, the quiescent supply current of the 4007UB CMOS amplifier can usefully be reduced, at the expense of reduced amplifier bandwidth, by wiring external resistors in series with the source terminals of the two MOSFETs of the CMOS stage, as shown in the 'micropower' circuit of Figure 25. This diagram also shows the effect that different resistor values have on drain current, voltage gain and bandwidth of the amplifier when it is operated from a 15 V supply and has its output feeding to a 10M/15 pF CRO probe.

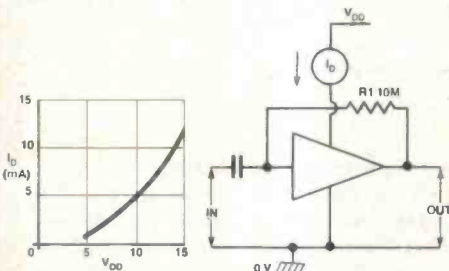

Figure 24. Typical  $I_D/V_{DD}$  characteristics of the linear-mode CMOS amplifier.

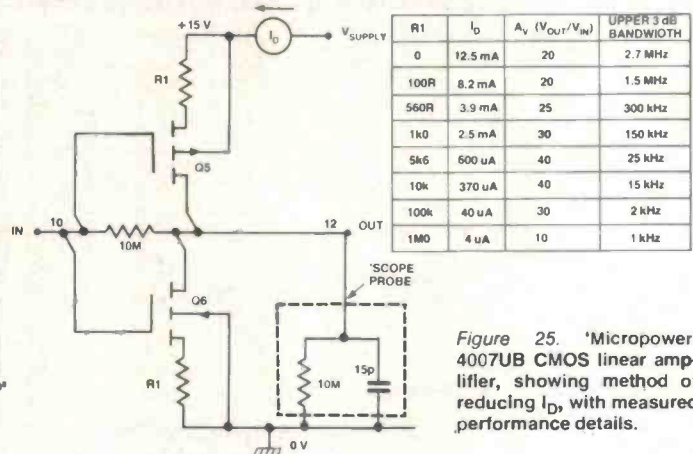

Figure 25. 'Micropower' 4007UB CMOS linear amplifier, showing method of reducing  $I_D$ , with measured performance details.

It is very important to appreciate in the Figure 25 circuit that these additional resistors add to the output impedance of the amplifier (the output impedance is roughly equal to the  $R1 \cdot A_v$  product) and this impedance and the external load resistance/capacitance has a great effect on the overall gain and bandwidth of the circuit. When using 10k values for  $R1$ , for example, if the load capacitance is increased to 50 pF the bandwidth falls to about 4 kHz, but if the capacitance is reduced to 5 pF the bandwidth increases to 45 kHz. Similarly, if the resistive load is reduced from 10M to 10k, the voltage gain falls to unity; for significant gain, the load resistance must be large relative to the output impedance of the amplifier.

The basic (unbiased) CMOS inverter stage has an input capacitance of about 5 pF and an input resistance of near-infinity. Thus, if the output of the Figure 25 circuit is fed directly to such a load, it will show a voltage gain of about 30 and a bandwidth of 3 kHz when  $R1$  has a value of 1M; it will even give useful gain and bandwidth when  $R1$  has a value of 10M and will consume a quiescent current of only 0.4  $\mu$ A!

The CMOS linear amplifier can be used, in either its standard or micropower forms, to make a variety of fixed-gain amplifiers, mixers, integrators, active filters and oscillators, etc. Three typical basic applications are shown in Figure 26.

A particularly attractive linear application is as a crystal oscillator, as shown in Figure 27a. Here, the CMOS amplifier is linearly biased via  $R1$  and provides 180° phase shift, and the Rx-C1-XTAL-C2 pi-type crystal network provides an additional 180° of phase shift at the crystal resonant frequency, thereby causing the circuit to oscillate. If you simply want the crystal to provide a frequency accuracy within 0.1% or so, Rx can be replaced by a short and C1-C2 can be omitted. For ultra-high accuracy, the correct values of Rx-C1-C2 must be individually determined (Figure 27 shows the typical range of values). In micropower applications, Rx can be incorporated in the CMOS amplifier, as shown in Figure 27b. If desired, the output of the crystal oscillator can be fed directly to the input of an additional CMOS inverter stage, for improved waveform shape/amplitude.

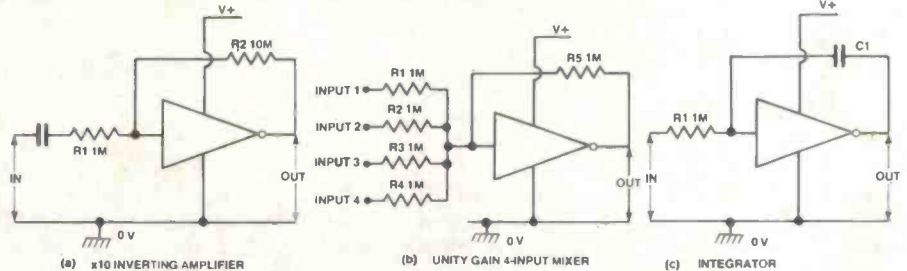

Figure 26. The CMOS amplifier can be used in a variety of linear inverting amplifier applications. Three typical examples are shown here.



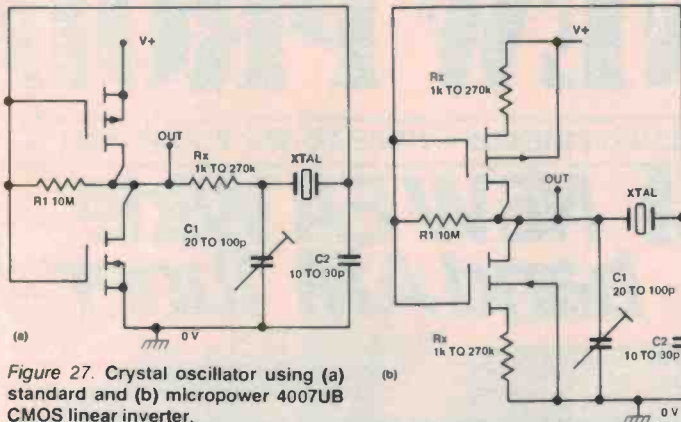

Figure 27. Crystal oscillator using (a) standard and (b) micropower 4007UB CMOS linear inverter.

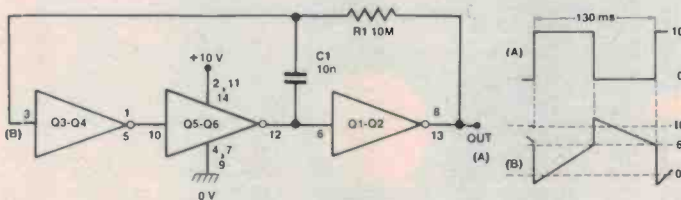

Figure 28. This 4007UB ring-of-three astable consumes 280  $\mu$ A at 6 V, 1.6 mA at 10 V.

### Practical 4007UB circuits: astables

One of the most useful applications of the 4007UB is as a ring-of-three astable multivibrator. Figure 28 shows the basic configuration of the circuit. Waveform timing is controlled by the values of R1 and C1, and the output waveform (A) is approximately symmetrical. Note that for most of the waveform period the front-end (waveform B) part of the circuit operates in the linear mode, so the circuit consumes a significant running current.

In practice, the running current of the Figure 28 astable circuit is far higher than that of an identically configured B-series 'buffered' CMOS chip such as the 4001B, the comparative figures being 280  $\mu$ A at 6 V and 1.6 mA at 10 V for the 4007UB against 12  $\mu$ A at 6 V and 75  $\mu$ A at 10 V for the 4001B. The 4007UB circuit, however, has far lower propagation delays than the 4001B and typically has a maximum astable operating speed that is three times higher than that of the 4001B.

The running current of the 4007UB astable can be greatly reduced by operating its first two stages in the 'micropower' mode, as shown in Figure 29. This technique is of particular value in low frequency operation, and the Figure 29 circuit in fact consumes a mere 1.5  $\mu$ A at 6 V or 8  $\mu$ A at 10 V, these figures being far lower than those obtainable from any other IC in the CMOS range. The frequency stability of the

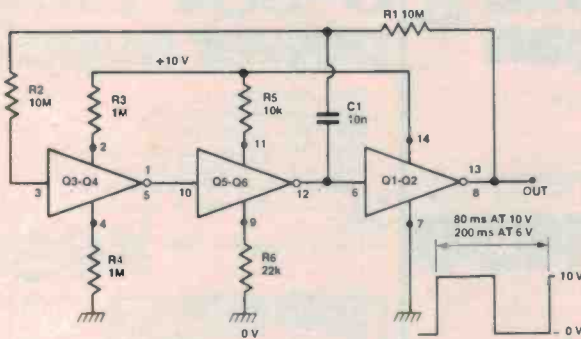

Figure 29. This micropower ring-of-three symmetrical 4007UB astable consumes 1.5  $\mu$ A at 6 V, or 8  $\mu$ A at 10 V.

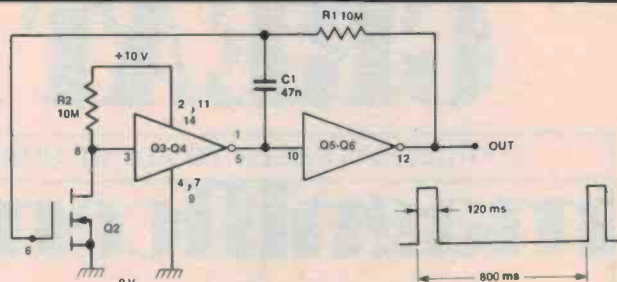

Figure 30. This 4007UB asymmetrical ring-of-three astable consumes 2  $\mu$ A at 6 V, 5  $\mu$ A at 10 V.

Figure 29 circuit is not, however, very good, the period varying from 200 ms at 6 V to 80 ms at 10 V.

Figure 30 shows how the 4007UB can be configured as an asymmetrical ring-of-three astable. In this case the 'input' of the circuit is applied to n-channel MOSFET, Q2. The circuit consumes 2  $\mu$ A at 6 V or 5  $\mu$ A at 10 V.

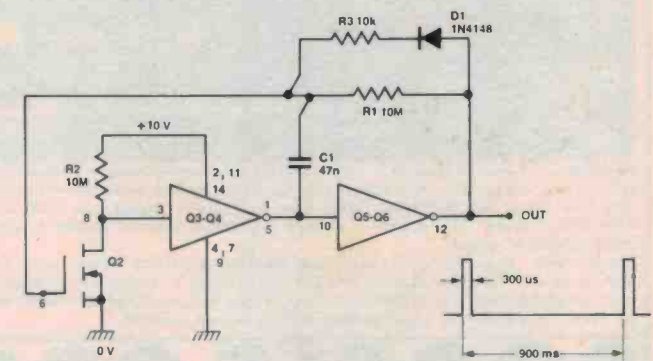
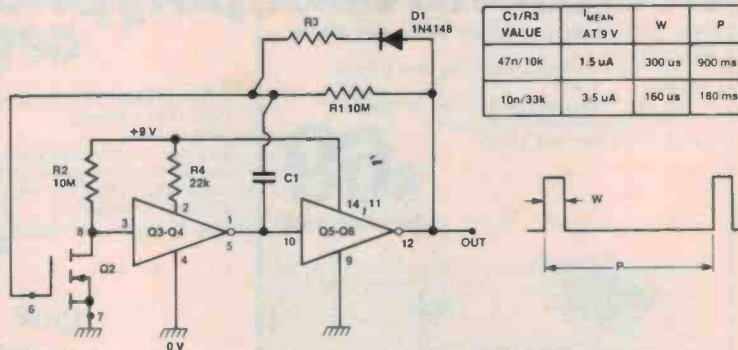

Figure 31. This dual time constant version of the 4007UB astable generates a very narrow output pulse.

Figure 31 shows how the symmetry of the above circuit can be varied by shunting R1 with the D1-R3 network, so that the charge and discharge times of C1 are independently controlled. With the component values shown, the circuit produces a 300  $\mu$ s pulse once every 900 ms and consumes a mere 2  $\mu$ A at 6 V or 4.5  $\mu$ A at 10 V. Note that these characteristics are similar to those of the ideal 'sample-pulse generator' circuit that was mentioned at the end of the last Circuit File, on Voltage and Window Comparators (ETI, November '82, pp 48-51).

Finally, to round off this edition of Circuit File, Figure 32 shows how the current consumption of the above circuit can be even further reduced, by operating the Q3-Q4 CMOS inverter in the micropower mode. The table gives details of circuit performance with alternative C1 and R3 values. This circuit will give years of continuous operation from a single battery supply.



C1/R3 VALUE	$I_{MEAN}$ AT 9 V	W	P
47n/10k	1.5 $\mu$ A	300 $\mu$ s	900 ms
10n/33k	3.5 $\mu$ A	160 $\mu$ s	180 ms

Figure 32. This micropower version of the 4007UB dual time constant astable consumes absolutely minimal currents.



# GREAT NEW PRODU

A CHRISTMAS CHEER TO ALL OF OUR VALUED FRIENDS — HOPE TO SEE YOU IN 1983

## magnificent! NEW EA Wide-band AM Tuner ☆

Ref: EA Dec-Jan 82-83

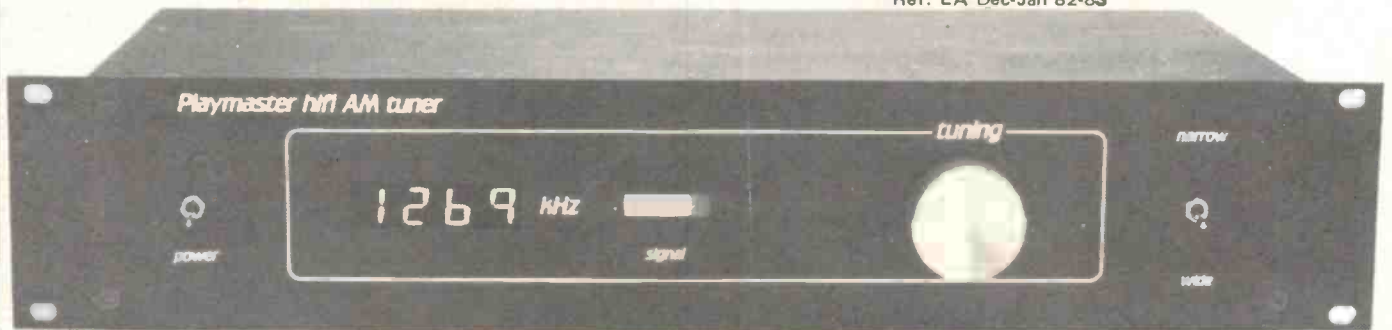

Australia is one of the few countries in the world where wideband AM is transmitted. In fact a good quality AM signal can be much better than its FM counterpart! Anyone who has suffered from FM multipath distortion will know what we mean. The Playmaster AM tuner is a true broad-bandwidth superhet design. See the frequency response graph.

Once again, the Jaycar kit is a high quality approach. The cover illustration shows the high quality front panel supplied EXCLUSIVELY in our kit. (Note that the standard EA front panel artwork is different). The Jaycar kit provides all components to complete the project INCLUDING a completely pre-punched cabinet.

FANTASTIC VALUE  
AT ONLY

**\$249**

See Page  
for Digital Ph  
Meter

## BOGGLE GOGGLES! crazy \$9.50

You've wired your head for sound, now you can wire your head for light!! Great for parties or discos. Simply connect to your spectacles or sunglasses. CRAZY!!!

Ref: December 1982



## Electronic X-Mas Decoration

Ref: EA December 1981

A zany project that will amuse you over the festive season. Basically a circuit which flashes sets of LEDs in succession. When assembled on a picture of a X-mas tree the effect is startling! (You must have a copy of EA Dec '81).

Only \$14.95 for the kit which includes 18 multi-coloured LEDs, PCB and other circuit board components (a 9V plugpack is required)

**\$14.95**

GREAT NEW KITS FROM DECEMBER ETI GREAT NEW KITS FROM DECEMBER ETI GREAT NEW KITS FROM ETI  
GREAT NEW KITS FROM DECEMBER ETI GREAT NEW KITS FROM DECEMBER ETI GREAT NEW KITS FROM ETI

## train controller

New project that features simulated inertia and loading.

- Throttle and brake controls like a 'real' train
- Will run Micro-gauge to twin 'O' gauge
- Complete with control panel

Ref: ETI December 1982

**\$69**  
for single track



## polyphonic organ ☆

- "Touch Sensitive" PCB board
- Fully Polyphonic
- Two voices
- 25 note, 2 octave keyboard
- Can run from battery or plugpack

Unbelievable performance for the price. (Case not included)

Ref: ETI December 1982

**\$49.50**

Due  
January  
83

## 0-30V 1amp power supply ☆

- Fully protected
  - Output variable from 0-30V DC
  - Selectable current limit
  - Both voltage and current metering
  - After a multimeter & soldering iron an absolute must for the enthusiast.
- You will never own a more useful piece of gear.

Ref: ETI December 1982

**\$49.50**  
complete





# CTS & KITS FOR '83!

A CHRISTMAS CHEER TO ALL OF OUR VALUED FRIENDS — HOPE TO SEE YOU IN 1983

## Video Enhancer

Unbelievable but true. This unit enables you to actually IMPROVE a copy of a recorded video tape. How? By amplifying the top end of the video signal by a small amount. This sharpens up the detail of the picture. Dubs can actually look better than the original. Works as a video distribution amplifier as well. Will drive up to 4 VCR's from one VCR input.

value for money

\$89

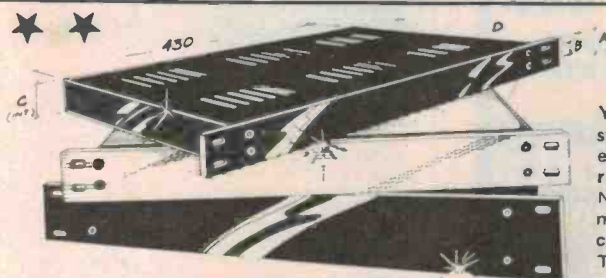
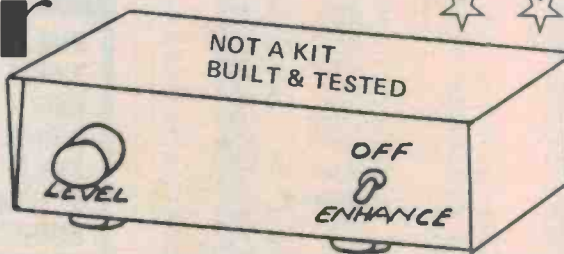

### GREAT RACK CABINETS IN STOCK!!

Your Budget probably will stretch to afford our professional series all aluminium rack cabinets.

Now your Pre-amps, control modules, monitor panels etc can look every bit as good as Technics, Nakamichi etc.

Finish	A	B	C	Price	5 or more	Finish	A	B	C	Price	5 or more
Natural	44	34	38	\$39.50	\$38.00	Natural	88	57	82	\$45.00	\$42.50
Natural	132	89	126	\$49.50	\$45.00	Black	44	34	38	\$39.50	\$38.00
Black	88	57	82	\$45.00	\$42.50	Black	132	89	126	\$49.50	\$45.00

### PRO-GRADE SOLDER SUCKER

SEE REVIEW EA DECEMBER 1982  
Our claim. The best solder sucker for its price In Australia!

- Unique double diaphragm design
- O-ring seal
- Spare O-rings supplied
- Teflon tip
- Self-cleaning plunger
- One hand operation
- Non slip body
- Pro-grade for heavy usage.
- 225(l) x 28(d)mm
- Spare Teflon tip \$1.95



ONLY \$11.95

### QUALITY FM ANTENNA "JABBER GRABBER"

\$29<sup>50</sup>

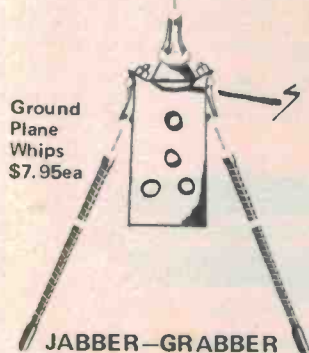

Ground Plane Whips \$7.95ea

#### JABBER-GRABBER

OK. So you have spent a fortune on your HI Fi system. The FM is great. Almost. You are in a area where the FM fades badly or is affected by multipath distortion. Not all stations but only the ones that you want to listen to!! We may have the answer to your problem!! Jaycar has had a helical FM antenna SPECIALLY MADE for vertically polarised transmissions (i.e most FM stations). The unit is supplied with a vertical whip, heavy duty stainless steel bracket, pre-terminated coax lead (environmentally sealed), U-clamp. It will mount on top of your TV mast and give about 3dB of gain over isotropic. The bracket is designed to fit any flat surface & will even lock into a window sill! If you cannot mast mount you will need the two ground plane radials as shown in the illustration. The "Jabber-Grabber" may be the FM antenna to solve your problems!!

### low cost IC inserters extractors

Up until now these have cost a fortune!!

Features:

- CMOS SAFE conductive plastic
- Exclusive bent pin alignment guides in handle . 8 to 40 pins.
- Ground strap can be connected.
- One hand operation.

#### INSERTERS

CIT820	8-20 pin	ONLY \$5.95
CIT2428	24-28 pin	ONLY \$6.95
CIT3640	36-40 pin	ONLY \$8.95
CIT22	22 pin	\$6.50

from \$2.95



#### EXTRACTOR

Deceptively simple looking device. One piece metal construction. 8-40 pins. ET-840 ONLY \$2.95  
**IMPORTANT!!**  
Don't be conned into buying a non conductive inserter/extractor. The possible static damage to your MOS I.C.'s could cost you a fortune!!

### 'T-REX'

Our wirestripper, nicknamed 'Tyranosaurus-Rex' is far from extinct! It's a great way to strip all sorts of cable without damaging the conductors. It's also a price breakthrough!!

- Automatically adjusts to insulation diameter.
- One hand operation.
- New low price for an automatic wirestripper



top ONLY buy \$9<sup>95</sup>

### HIGH SPEED LOGIC PROBE



- DTL/TTL/HTL/CMOS/MOS compatible!!
  - Pulse memory
  - 10MHz input frequency (tested to 12MHz)
  - ± 50V input overload
  - Complete with leads.
- ONLY \$29<sup>95</sup>

## Jaycar NUMBER 1 FOR KITS

125 York Street, Sydney 2000  
Phone: 264 6688 Telex: 72293

"Nevilles Corner"  
Cnr. Carlingford & Pennant Hills Road,  
Carlingford  
Phone: 872 4422

Mail Orders To: Box K-39 Haymarket  
Sydney 2000

POST AND PACKING CHARGES  
\$5-\$9.99 (\$1.20) \$10-\$24.99 (\$2.40)  
\$25-\$49.99 (\$3.50) \$50-\$99.99 (\$4.60)  
\$100 up (\$6.20)

NEW SHOP HOURS  
Mon-Fri 8.30 to 5.30pm  
Sat 8.30 to 12.00pm  
Thurs night to 8.30pm

MAIL ORDER BY  
BANKCARD VIA  
YOUR PHONE





# SPECIAL PRICE REDUCTION FOR XMAS

TTL7400	194	.35	7905	.80	2N3906	10
7401	20 195	.40	7905K	1.50	2N4030	.50
7403	20 196	.60	7906	.80	2N4032	.40
7405	25 197	.50	7908	.80	2N4033	.50
7406	25 221	.50	7912K	1.50	2N4036	.60
7407	25 247	.80	7915	.80	2N4037	.70
7408	20 251	.40	7918	.80	2N4124	.15
7409	20 253	.40	7924	.80	2N4126	.20
7410	20 257	.30	79HG	6.00	2N4231	.60
7413	25 259	1.50	79L series		2N4234	1.00
7414	35 279	.30	03.05.12.		2N4235	.85
7416	25 290	.50	15.18.24.		2N4401	.12
7420	20 385	.25	all	40	2N4870	.60
7421	20 366	.35	79MGT2C	.90	2N5086	.12
7426	20 367	.45			2N5088	.15
7427	20 368	.45	TRANSISTORS		2N5401	.60
7430	20 373	1.00	AD149	1.30	2N5459	.30
7432	20		AD161	1.00	2N5462	.45
7437	20		AD182	1.00	2N5550	.45
7438	25		BC107	1.15	2N5673	.95
7440	25 4002	.25	BC108	.25	2N6027	.80
7442	25 4008	.50	BC108C	.20	2N6124	.60
7447	50 4009	.40	BC109	.15	2N6126	.65
7448	50 4012	.25	BC109C	.20	2N6129	.70
7451	25 4014	.80	BC177	.15	2N6130	.65
7453	20 4015	.45	BC177B	.30	2N6132	.80
7454	30 4018	.75	BC178	.15		
7470	25 4020	.60	BC182B	.10	C106E	.30
7472	30 4021	.50	BC212L	.15	(500V/4A)	
7473	30 4022	.50	BC286	.08		
7474	30 4023	.20	BC287	.08	303	.60
7475	30 4027	.30	BC217	1.10	310can.	1.20
7476	30 4028	.45	BC318	1.10	311	.35
7480	30 4029	.60	BC319	1.10	318	1.50
7483	40 4042	.35	BC320	1.10	319	1.80
7485	40 4043	.35	BC327	.15	321	2.50
7486	30 4044	.35	BC337	.15	324	2.50
7489	1.00 4046	1.40	BC338	.15	339	.40
7491	25 4052	.60	BC546	.15	377	1.40
7492	30 4053	.60	BC550	.15	378	2.00
7494	45 4060	1.00	BC639	2.00	381	1.20
7495	35 4066	.60	BC640	2.00	381AN	2.00
7496	.45 4067	8.00	BCY72	4.00	382	1.50
74100	1.00 4068	.20	BD262	.60	386M1	.50
74107	40 4070	.40	BD648	1.00	386N2	.60
74123	30 4071	.25	BD649	1.00	387	.90
74132	40 4076	.90	BDV648	2.00	388	.70
74145	40 4078	.30	BDV658	2.00	391N80	3.00
74150	60 4441	.60	BF173	.65	391N80	3.00
74151	30 4502	.70	BF338	.60	556	.60
74153	35 4506	.35	BF884	.80	566	1.50
74154	60 4510	.60	BFW10	.70	709	.40
74157	30 4511	.95	BFX64	.60	710	.40
74160	35 4518	.75	BFY50	.60	711	.40
74165	30 4520	.80	BFY90	.80	725	2.00
74172	70 4528	.70	BU126	1.95	733	1.80
74173	60 4543	1.40	FPT100	.60	739	1.40
74175	45 4555	.50	MEJ2955	.80	747	.50
74176	60 4581	1.80	MPS3655	.09	748	.80
74180	50 4582	.70	MPS3638	.09	1558	1.00
74192	80 4585	1.50	MPSA05	.15	2917N6	1.60
74193	40 40014	.50	MPSA12	.25	3089	2.00
74367	50 40098	.50	MPSA14	.25	3360P	.70
			MPSA55	.15	3403	.90
			MPSA56	.20	3909	.60
			MPSA93	.30	LM393	.80
			PN2222A	.15	3916	2.50
			PN2907A	.20	5837	1.20
			PN3564	.12	7392	1.50
			PN3567	.09	13600	1.50
			PN3568	.09	33465	.80
			PN3569	.10	3080	.90
			PN3638A	.09	3086	.35
			PN3641	.10	3140	.60
			PN3642	.10	3302	.35
			PN3644	.10	3401	.40
			PN3645	.10	671	4.50
			PN3646	.10	4136	.70
			PN3693	.15	4151	.95
			PN3694	.15	TCA220	1.50
			PN4121	.18	TL080	.60
			PN4248	.10	UAF772	.50
			PN4250	.15	UAF774	.90
			PN4355	.15	XR082	.65
			TP2955	.80	XR084	1.20
			TT800	.60	XR8038	3.00
			2N2222A	.18		
			2N2368	.12		
			2N2369A	.35	VM48	.80
			2N2484	.30	(IA, DIL)	
			2N2646	.50		
			2N2905	.25	INTERFACE IC	
			2N2906A	.25	1488	.50
			2N3001	2.00	9368	1.20
			2N3053	4.00	9528	2.20
			2N3300	4.50	8724	1.20
			2N3302	3.00	8726	1.20
			2N3642	1.50	8728	1.20
			2N3702	1.00	81LS97	1.20
			2N3703	.15		
			2N3704	.15	IC SOCKETS	
			2N3740	.80	16pin LP	.10
			2N3819	.30		

**TASMAN ELECTRONICS**  
**P.O. BOX 110, PRESTON VIC. 3072.**  
**TEL.: (03) 478 8191**  
 (Minimum P&P \$2.00)

# SPEAKER SPECIALS

- PHILIPS HIGH QUALITY TWEETER \$ 7.95
- MINI TWEETER \$ 1.50
- PIONEER 12" WOOFER \$11.95
- PHILIPS HIGH QUALITY 8" WOOFER \$11.50
- BUDGET PRICED 8" WOOFER \$ 5.95

And a comprehensive range of electronic components at very keen prices.

**Ian J. Truscott's ELECTRONIC WORLD**  
**CNR EASTFIELD & BAYSWATER ROADS, SOUTH CROYDON, VIC.**  
**TELEPHONE (03) 723 3860**

## SYNERTEK SLASH LS1 PRICES

Check these for real value.

- 1791-02 Floppy Disc Controller ..... \$28.19
- 2661-1 Sync/Asyn ComsIF ..... \$12.53
- 6502 CPU on chip clock ..... \$5.17
- 6522 Two 8 bit parts, two 16 bit timer counters, 8 bit shift register ..... \$4.54
- 6532 128 Bytes RAM, two 8 bit Ports interval timer ..... \$6.26
- 6545-1 CRT controller for Raster Scan Displays ..... \$10.41
- 6551 ACIA with SW prog. baud rate ..... \$6.42

### NEW PRODUCTS

- EPSON MX 80 TYPE 111 ..... \$740
- SYM-1 Users group floppy disc controller kit with DOS source & drive cable ..... \$259
- KTM 2/KTM 2-80 case ..... \$39
- PSI Four output power supply for AIM 65 5V @ 5A adjustable; Ferguson C126 Transformer. +12V @ 1.5A; -12V @ 1.5A; 24V @ 0.5A. Open frame ..... \$109

### SPECIAL PACKAGE DEAL

A65-450 AIM65 4K with FORTH. Normally \$106.83 **NOW \$540.54**



P.O. BOX 8502,  
 GOODNA, 4300.  
 AUSTRALIA.  
 PH: (07) 288 2757

Prices for prepaid orders plus tax if applicable.

## Beeforth On Oscilloscopes



If you have anything to do with electronics then I bet you can't think of many jobs where an oscilloscope isn't useful. I guess it all comes about from the old adage 'a picture is worth a thousand words'. Now, in less than a thousand words, I'll put you in the picture regarding TRIO's CS-1560All oscilloscope.

The 1560All is a dual trace, 15MHz, honest-to-goodness value for dollar instrument. It is well suited to industrial applications, TV servicing, production line testing, educational or hobby work. It is rugged, reliable, easy to use and very portable. Vertical sensitivity is good without sacrificing large signal input capability. Sweep rates are from a high 0.5µs to 0.5S per division and a high persistence P7 Phosphor is now available as an option to make full use of the slowest ranges.

Triggering can be normal or via a video sync separator and has to be the best in any low-cost oscilloscope ever made. How often have you used a big name, high performance oscilloscope for routine work and been driven mad by the constant fiddling needed to maintain a stable triggered display particularly when the input is variable. With one wave of a CS-1560All the problem vanishes. Up to its rated 3db point of 15MHz it will produce a locked display with only 0.2 of a division deflection amplitude. At 20MHz it requires only 0.3 of a division to lock and at 25MHz, 0.7 of a division. That is real triggering!

Along with the rest of TRIO's range, this instrument is slanted toward useability, the kind of convenience and practicability that makes you reach past the 'Gee wizz technoscope' to grab the little TRIO with the sharp, stable, bright blue trace that shows the whole picture quicker than I can tell it.

The best way to see why I'm so keen on the CS-1560All is to check it out for yourself at any Parameters location or stockist right throughout Australia.



Trade Enquiries: Sydney (02) 439 3288  
 Melbourne (03) 580 7444

Adelaide:	PROTRONICS	(08) 212 3111
	TRIO ELECTRIX	(08) 51 6718
Brisbane:	K. D. FISHER & CO.	(08) 277 3288
	ST. LUCIA ELECTRONICS	(07) 52 3547
Canberra:	GEORGE BROWN & CO.	(062) 80 4355
	ORTEX	(062) 82 4995
Hobart:	IMBROS	(002) 34 9899
	GEORGE HARVEY ELECTRIC	(002) 34 2233
Launceston:	GEORGE HARVEY ELECTRIC	(003) 31 6533
Melbourne:	RADIO PARTS GROUP	(03) 329 7888
	GEORGE BROWN & CO.	(03) 419 3355
	ELLISTRONICS	(03) 602 3282
Newcastle:	D. G. E. SYSTEMS	(049) 69 1625
	GEORGE BROWN (NEWCASTLE)	(049) 69 6399
Perth:	W. J. MONCREIFF CO.	(09) 325 5277
	PROTRONICS	(09) 362 1044
Rockhampton:	PURELY ELECTRONICS	(079) 2 1058
Sydney:	GEORGE BROWN & CO.	(02) 519 5855
	DAVID REID ELECTRONICS	(02) 29 6601
	RADIO DESPATCH SERVICE	(02) 211 0191
Townsville:	NORTEK	(077) 79 8600
Wollongong:	MACLEEC	(042) 29 1455



# Model train controller simulates 'real' train controls

This model train, or better, railway, controller has controls that operate like 'real' train controls. In addition, it signals open circuit or short circuit conditions on the track and you can make emergency stops.

Jonathan Scott



MODEL RAILWAY controllers are one of those perennial projects which recur every year or so in some magazine or other, because they are almost ideal as a project: lots of people have model electric train sets (what other sort is there? Yeh, yeh — steam, but this isn't Steam Train International Today magazine! — Ed.), lots of commercial controllers are either crude or relatively expensive and there are plenty of 'angles' to explore, both electronic and philosophical.

Some controller designs are *cheap*. And that's as it should be, a hobbyist has to start somewhere. Some are designed to employ recently-released innovations. Some use microprocessors and digital tone-encoding techniques to be really comprehensive. Others are designed to make driving the train 'easy' by compensating for loads of hill-climbing or many carriages, etc. It is our belief that these are rather artificial aims, so let's see what *we* think is *really* necessary.

The model railway enthusiast does not just like to see it go, he likes to *drive* the train. So, a controller should pass on to the user as many of the 'inputs' as a real train would encounter, but hide from him unreal inputs which only a model exhibits. In other words, he wants to feel the effect of inertia, but not of bad contacts, feel the engine and brake work separately and to feel the effort of climbing or carrying extra load, but not feel some loss of power when junior gets his train going too, or the butler turns on the mixmaster. In addition, a controller should be able to run everything from a micro-gauge small locomotive to twin O-gauge engines. Finally, it wants to be as inexpensive to build as is possible without sacrificing anything. (After all,

if you've got a butler, there's not going to be too much spare cash left to spend on luxuries like model railways!) This is precisely the philosophy adopted for this project. Our new controller has been built in rack panel form with two separate control systems running from one mains step-down transformer. Needless to say, if you want to build 1-to-21 such units in wooden consoles all run from two car batteries, then you can please yourself — our design can be used as a guide for those who want to follow that course. From our experience, hobbyists like to customise their housings.

The front panel of our controller is rather unconventional for a *model* train controller, but somewhat closer to the controls of a real train. One switch selects the thrust applied ("accelerate"), no thrust, or in the momentary (spring-loaded return) position, normal brake. This is the main control, and indeed the only one required for commuter trains such as London's Tube or Le Metro in Paris. Once the throttle knob has been set to define maximum torque, throwing the main lever to ACCELERATE causes a small jerk in the wheels, corresponding to the take-up of slack etc, followed by normal acceleration toward the top speed. Moving the main level to the centre or 'idle' position causes the train to start coasting to a final halt. Pressing it to BRAKE hastens the stop. In metropolitan trains the driver aligns the train correctly in the station by judicious pressing and releasing of the main lever, finally stopping with precision, in spite of the train's great inertia, of a few inches. This you will discover, requires *some skill*.

The throttle knob we have already mentioned. On brief runs, you never reach full speed, so the setting of this control is not critical. It sets final engine torque, and hence speed, after the acceleration is over. This is important on long runs. This control can be internally preset to match the size of model train you have; on the prototype the MAX. SET is a screwdriver preset accessible from the front, but provision has been made for it to be a preset on the pc board if you so desire.

The STOP button is the front panel control corresponding most closely to the 'communications cord' on a real train. It is the one concession to necessity over realism. When pressed it quickly shuts down the controller output, halting the train as rapidly as possible. There are two possible ways of wiring it — one which restarts the train when the button is released and another which requires the mains to be removed before it can be restored. This latter option discourages frivolous use of the STOP button (people don't *believe* it when you put a notice on it saying "Fine — \$40 for unwarranted use") and provides some failsafe against accident. It is the option we recommend. This will be further discussed in the construction section.

The forward-reverse switch is the fourth and final driving control. In many normal controllers we have seen, even some with inertia, immediate reverse is possible. This is not the case in real life and not the case on our controller. The switch is 'momentary' in its action. It will only have effect when the train is stationary. This further limits the model train driver to abide by the rules of 'realism'. You cannot spoil the ▶







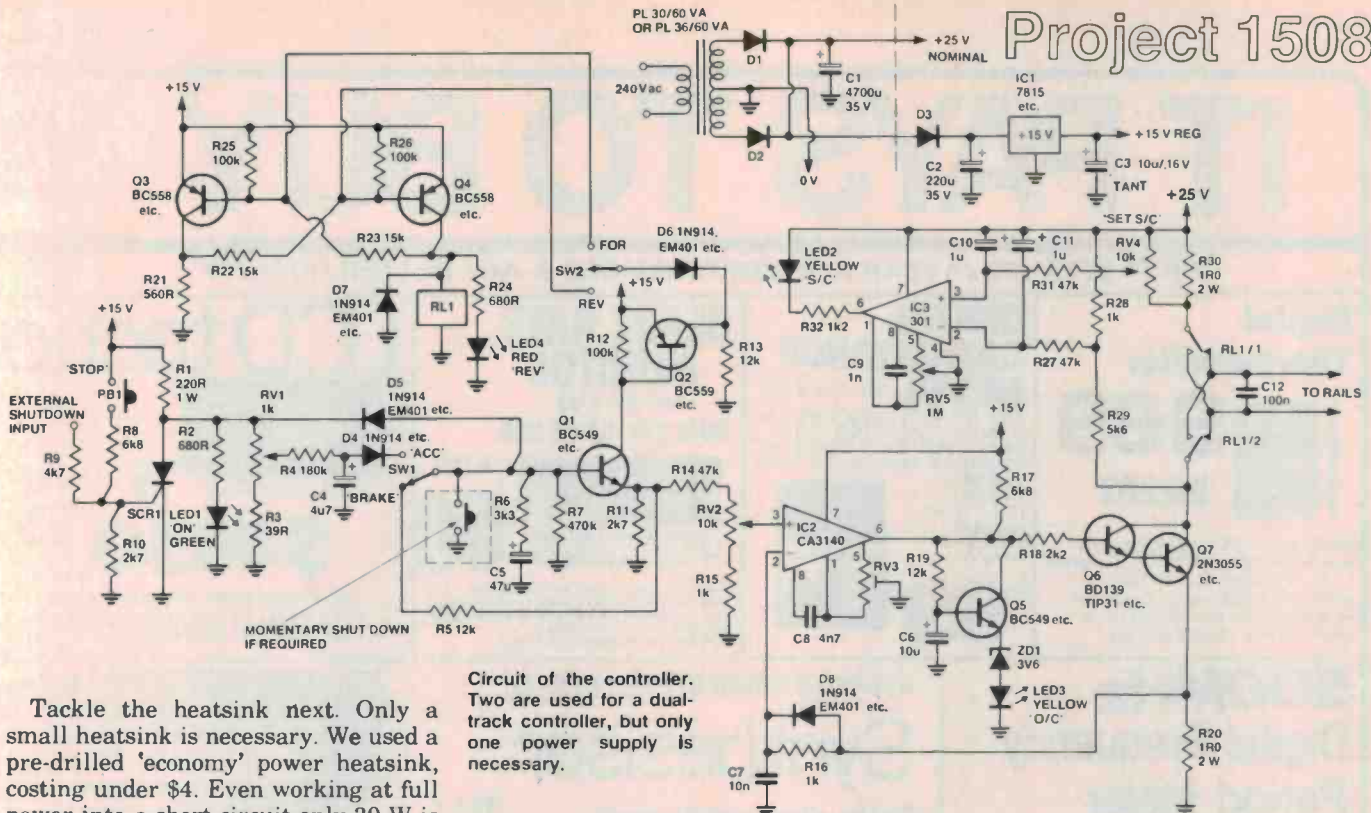

Tackle the heatsink next. Only a small heatsink is necessary. We used a pre-drilled 'economy' power heatsink, costing under \$4. Even working at full power into a short circuit only 30 W is dissipated. Mount the 2N3055s and BD139s to the heatsink taking care to insulate the 2N3055 with a mica washer.

Circuit of the controller. Two are used for a dual-track controller, but only one power supply is necessary.

Ensure that no burrs on any of the holes can puncture the insulator. Smear the insulator both sides with thermal com-

ound before mounting it. Check with an ohmmeter that none of the transistor leads is shorted to the heatsink. ▶

## HOW IT WORKS — ETI-1508

The circuit of the train controller can be considered as five separate functional blocks: power supply, current control, current regulator, reversing control and short circuit detector.

The current control serves to interpret the driver's instructions and, taking inertia and energy into account, outputs a voltage proportional to the requisite engine torque. The current regulator forces the train to conduct this current and indicates the high resistance, or open circuit, condition, should it occur. The reversing control consists of a flip-flop driving a relay. This circuit will only toggle when the train is not being driven, preventing reversal during operation. Finally, the short circuit detector continuously searches for a low resistance condition in the load.

The power supply requirements are: a 15 V regulated rail for the electronics and an unregulated rail of between 18 and 35 volts. The circuit can tolerate severe ripple on the unregulated supply. Its only constraints are that the average voltage should lie between 18 and 30 volts with peak excursions no more than 35 volts and minimum excursions no lower than 10 volts. The supply must be able to deliver at least 1.5 amps per controller. We recommend a transformer such as the Ferguson PL36/60 VA or PL30/60 VA, which should be more than sufficient for two controllers. The +15 V rail is separately regulated for each controller, the regulator IC being mounted on the pc board (IC1). Diode D3 isolates C2 and IC1 from severe ripple on C1. IC1 may be a low power type (78L15) but provision for a 7815 was made on the pc board as these are more readily obtainable. Capacitor C3 bypasses the +15 V rail and prevents IC1 oscillating.

The current control comprises SCR1, SW1, RV1, Q1 and surrounding components (i.e.: about the middle of the circuit!). If about 4 — 15 V appear on the 'EXTERNAL SHUTDOWN'

input, or the 'STOP' button is pressed, SCR1 is triggered, removing drive from RV1 and discharging C5 via D5-R6. This condition is indicated by LED1 going out.

Normally, when SCR1 is not triggered, control is vested in SW1 ('ACCELERATE — BRAKE') and RV1 ('THROTTLE'). With SW1 in the mid (open) position, C5 remains discharged while C4 charges to the level set by RV1. When SW1 is moved to the ACCELERATE position, C4 discharges into C5 via R6. This causes C5 to charge to about 20% of the final voltage set by RV1. Also, a small voltage pulse appears on the base of Q1. Capacitor C5 then charges exponentially via R4 to the final level. If RV1 is reduced, D4 prevents C5 discharging through R4. Capacitor C5 discharges via R7, allowing a different rate of reduction of speed, as is the case in reality. (A train accelerates faster than it slows down if no braking is applied).

If SW1 is placed in the 'BRAKE' position, a constant current is drawn out of C5 via R6 and R5, because Q1 maintains its emitter voltage at about 0.65 V below its base. This action causes a linear reduction (rather than an exponential fall-off) of the voltage on C5. (A vehicle dissipates energy proportional to the square of speed. This linear braking effect causes the model to reflect this sharp-halt situation more realistically). Transistor Q1, acting as an emitter follower, copies this voltage on C5 out to RV2 via R14. Thus, the initial peak and the continuously varying voltage on C5 are output for the current regulator.

The current regulator consists of IC2 (a CA3140) and surrounding components. This is simply an op-amp wired to ensure that the emitter current of Q7 in amps equals the voltage on pin 3 (the non-inverting input). Trimptop RV3 is included so that a small offset voltage may be established to fix the emitter

current of Q7 at a value of about 15 mA when the voltage on pin 3 of IC2 is at 0 V. This minimum current value allows the short circuit and open circuit detectors to work all the time, even when the train is stationary. This current is not sufficient to cause train movement. Resistor R16 and capacitor C7 remove hash caused by commutation and dirt on the tracks. Diode D8 is required to protect the circuit from overload when going from an open circuit condition to a short circuit condition. Transistor Q5 and surrounding components detect the open circuit condition. If the collectors of Q6-Q7 go open (i.e.: no current supplied via the rails), they saturate, the voltage on R20 falls and the output of IC2 rises toward the +15 V rail. If this condition persists for more than quarter of a second or so, C6 charges up and Q5 turns on LED3 via ZD1. The delay prevents flickering due to momentary effects such as crossing isolators on the track or dirty engine pickup wheels.

Reversing is achieved by operating the relay, RL1. Transistors Q3 and Q4 form a flip-flop which drives RL1 on in one state and off in the other. When Q1 draws no current (i.e.: there is no drive signals to IC2) Q2 is off, allowing SW2 to toggle the flip-flop by pulling the base of either Q3 or Q4 to ground via D6-R13. When running the train, Q2 remains turned on and SW2 has no effect because of D6. The 'REVERSE' indicator, LED4, lights when Q4 is on and the relay activated.

The short circuit detector is built around IC3. This acts as a comparator. Its output lights LED2 if the voltage across the relay contacts drops below a preset ratio of that voltage dropped across R30, the current sense resistor. Capacitors C10 and C11 prevent IC3 responding to hash. Trimptop RV5 is for nulling the op-amp offset. Capacitor C12 also helps reduce interference from getting into the high gain circuits on the pc board.



# IT PAYS TO BUY YO

WHY? BECAUSE JAYCAR KITS COST NO MORE & ARE BETTER QUALITY

**Digital Thermometer**  
  
**\$69**  
 EA282

Read the temperature in your room (or outside) from 0 degrees C to 100 degrees C in fact to within 0.1 degree C. Fantastic resolution on a bright easy-to-read display. Includes case.

**DIGITAL CAPACITANCE METER** Ref: EA 3/82

This kit once again uses the amazing DPM 200 LCD /driver module. Capable of measuring capacitance from 1pF to 19.99uF. It is a must in every workshop or lab.

**\$69** 

**HEART RATE MONITOR**

Ref: EA 7/82  
 WAS \$79 SAVE \$10

**NOW \$69** 

This unit enables you to measure your own pulse instantly and accurately. It is light enough even for joggers to carry. A must for people who may have heart problems. Complete kit including LCD Display.

**LCD tacho**

  
 ref: EA May 1982  
**\$49.50**

- USES NEW DPM-05 DISPLAY
- FITS INTO YOUR DASHBOARD
- RPM, DWELL DISPLAY

**500MHz Digital Frequency Period Meter**

REF: EA Dec '81 - Feb '82



**ONLY \$119**

Other people may appear to be selling this kit for less. But you GET less!!! Exclusive Jaycar features:

- \* Heavy gauge front panel. Pre-punched and silkscreened. (NOT Scotchcal).
- \* Low aging rate 10.000MHz crystal
- \* Quality IC sockets provided (A MUST)
- \* All metal film resistors used (1% 50ppm)
- \* Thermalloy heatsink for +5V reg.

Beware of advertised units that do not conform to the original design. They may have inferior performance.

**EXCLUSIVE**

- Gold plated BNC Input Connectors
- 500MHz option only \$26 extra
- 50MHz version \$119
- Tilting bail to suit **ONLY \$4.95**

**Function Generator**

FREE! TILTING BAIL WORTH \$4.95 included



**\$99**

Ref: EA April 1982

"Pigeon Pair" companion to the new 500MHz DFM. Low distortion generator of sine, square and triangular waveforms. From below 20Hz to over 160kHz. Inbuilt 4 digit frequency counter in de-luxe Pac-Tec case. Only \$85. **JAYCAR EXCLUSIVE** - 1% 50ppm metal film resistors used for stability

**STEREO STEREO STEREO STEREO**

**Synthesiser**

Creates a very realistic stereo sound from mono sources i.e. AM tuners, TV or video units Very easy to build and comes complete. **ONLY \$49.50**



**COMPLETE**

Ref: EA September 1982

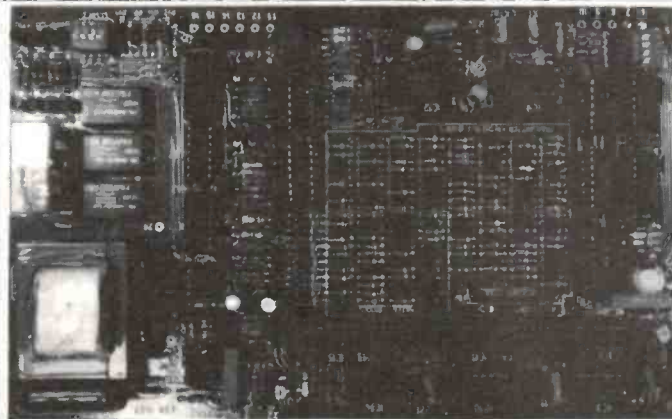

**ETI 644 direct connect modem**

Ref: ETI October 1982  
**SHORTFORM KIT**

**\$169**

**FULL KIT**

**\$189 NEW**

Two models (i) Short form which contains ALL PCB components as specified by ETI (BEWARE!!). The genuine ETI PCB with plated-thru holes, solder mask and component overlay is supplied. We also supply at NO EXTRA CHARGE a full set of quality I.C. sockets. A must with plated-thru PCB's Remember this when making comparisons. (ii) Full kit. Includes: all of above plus 12V plugpack, case, front panel, switch and LED bezel and Cannon DB-25 RS-232 connector. Makes a complete stand alone modem.

- \* Capable of a range of Answer/Originate operating modes
- \* Selectable Baud rate
- \* Software controlled
- \* Uses new patented technique
- \* More reliable and faster than most acoustic modems.

**Lyrebird Piano Kit NEW LOW PRICE... ★**

**GREAT NEW FEATURES!!**

- FREE! A stand (like the one illustrated but not exactly the same). Worth around \$50 but yours at no extra charge with each 73 or 88 note kit.
- FREE! A soldering iron (worth around \$19). Yours to keep to give years of faithful service after you have completed your Lyrebird. (88 note only)
- FREE! A 200g roll of solder. You will need some to build the Lyrebird but there will be plenty left over for other projects. (73 & 88 note versions).
- FREE! Quality IC sockets provided in both kits.

REF: EA 11/81-1/82

**7 1/2 OCTAVE (88 NOTE) VERSION \$589**



# OUR KITS FROM US

WHY? BECAUSE JAYCAR KITS COST NO MORE & ARE BETTER QUALITY

**NEW**

## EA FUZZ BOX KIT

Ref: EA January 1981  
Economical way to get great guitar sounds! The Jaycar kit contains a heavy duty foot-switch and diecast box. All components only

**\$19.50**

Staggering value



## 'Power UP' ONLY \$39.50

Ref: EA 11/82

What will they think of next???! Sensational project that detects the current drawn by one appliance to switch on up to 4 others - AUTOMATICALLY!  
Great for computers, component Hi Fi etc. when you have to normally switch on several items in a system. Will switch total load of 240V 10A.

Complete kit including outlets, box, mains relay etc. ONLY \$39.50

# EA CAR COMPUTER KIT new low price!

BUY THE WHOLE KIT Ref: August EA 1982

(INC. FUEL & SPEED SENSORS!)

FOR ONLY

**\$165!! NOW \$159.00!!**

WE TOO have the genuine

Moray fuel sensor. We buy it from the same factory as Dick Smith!!

We also have an EA APPROVED Speedo Cable sensor. The speedo cable sensor gives better results at very low speed.

### TAILSHAFT SPEED SENSOR

This unit also has the EA stamp of approval. The sensor kit includes two powerful magnets, two long Nylon locking straps to secure the magnets to the tailshaft. We recommend that you Araldite the magnets as well and a plated mounting stud with nut and shakeproof washer.

ONLY \$14.50

### 'T' PIECE JAYCAR EXCLUSIVE

Only necessary if your car has a fuel by-pass system. (Many European and Japanese cars). Enables by-pass system to operate without affecting the accuracy of the flow sensor. Has special restriction in T-section.

ONLY \$3.95



### SPEEDO CABLE SENSOR

This device has been tested and endorsed by EA. It works on cars that don't have tailshafts!! We won't treat you like an imbecile and say not to buy it in case your speedo cable breaks - how often does THAT happen? At \$29.50 you may as well leave it in the car when you sell it, as it is cheaper than most speedo cables anyway.

ONLY \$29.50



### FUEL FLOW SENSOR - NEW MODEL

This is the LATEST VERSION of the Moray fuel sensor. The early models had a turbine/impeller moulded in ordinary Nylon. Apparently this component absorbed moisture & expanded. The expanded impeller then gave slightly inaccurate results. The Jaycar/Moray LATEST MODEL impeller is now moulded in DELRYN. This does not absorb moisture & the flow sensor remains accurate over the life of the car. If you do not buy a Jaycar Car Computer kit make sure that you are getting the LATEST MODEL fuel flow sensor.

ONLY \$59.50

### PRICING INFORMATION

ALL ELECTRONICS including both PCB's plated through, programmed EPROM, 1% metal film resistors, and other high spec. components. You also get a CHOICE of either tailshaft or speedo cable type speed sensor (PLEASE SPECIFY) ONLY \$99.50

Pre-punched genuine AMERICAN PAC-TEC case (as used by EA) and NOT a Hong Kong copy, with special silk-screened front panel and multi-way connector ONLY \$39.50

Genuine MORAY high resolution fuel sensor - LATEST VERSION ONLY \$59.50

**NEW**



## DIGITAL pH METER KIT

At last a true scientific instrument for a fraction of the cost of commercial units. Great for checking swimming pools, fish tanks and countless other uses.

The Jaycar kit comes complete with DPM-05 display, ABS case and all components as specified by EA.

'lonode' probe to suit only \$69

Ref: EA December 1982

ONLY \$69.00

# syntom

As used by Warren Cann of 'Ultravox'

Original design from the UK magazine 'Electronics and Music Maker' April 1981. Self-contained unit produces a variety of fixed and falling pitch effects. Trigger by tapping the unit itself or by striking a drum to which the unit is attached. The Jaycar 'SYNTOM' comes complete with high quality pre-drilled moulded all ABS box 152 x 80 x 47mm with professional silk-screened front panel. FEATURES: Decay from less than 0.1 second to several seconds, pitch control, sweep control and volume on/off.

ONLY \$36.50

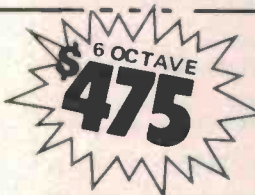

**NEW LOW PRICE!!** Because we are shipping keyboards and other expensive components in bulk due to high demand, we can pass savings on to YOU.

You can now have a magnificent "Lyrebird" 6 octave touch sensitive piano now for only \$475!! That's a staggering \$50 off the old price. REMEMBER!! THE LYREBIRD OUTPERFORMS READY BUILT PIANOS COSTING UP TO THOUSANDS OF DOLLARS MORE. WHY PAY MORE WHEN YOUR CONSTRUCTION KNOWLEDGE CAN SAVE YOU A FORTUNE?

## Jaycar NUMBER 1 FOR KITS

125 York Street, Sydney 2000  
Phone: 264 6688 Telex: 72293

"Nevilles Corner"  
Cnr. Carlingford & Pennant Hills Road,  
Carlingford  
Phone: 872 4422

Mail Orders To: Box K-39 Haymarket  
Sydney 2000

POST AND PACKING CHARGES  
\$5-\$9.99 (\$1.20) \$10-\$24.99 (\$2.40)  
\$25-\$49.99 (\$3.50) \$50-\$99.99 (\$4.60)  
\$100 up (\$6.20)

NEW SHOP HOURS  
Mon-Fri 8.30 to 5.30pm  
Sat 8.30 to 12.00pm  
Thurs night to 8.30pm

MAIL ORDER BY  
BANKCARD VIA  
YOUR PHONE





# Project 1508

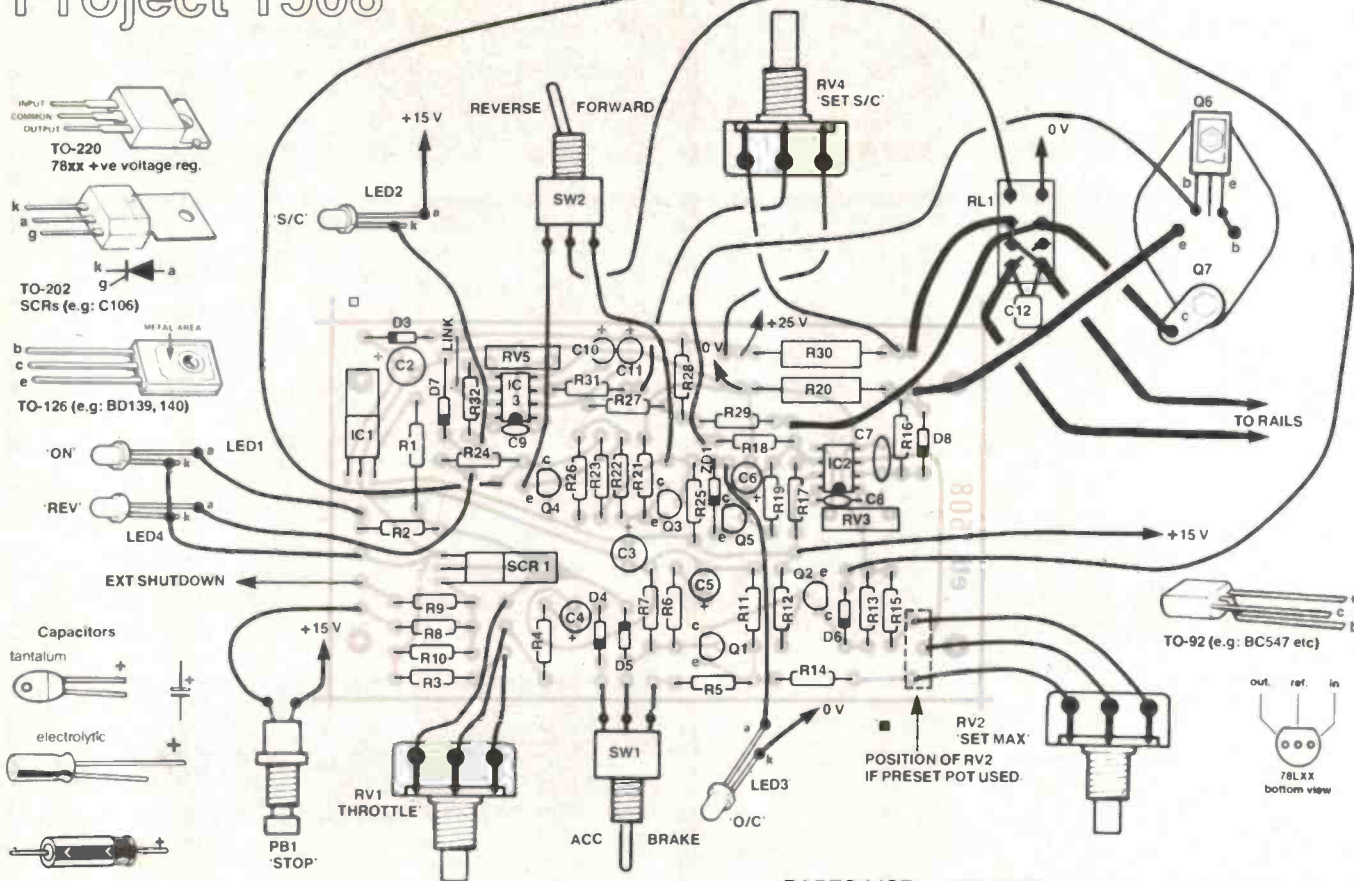

## PARTS LIST — ETI-1508

You can wire up the transistors and attach flying leads, referring to the wiring diagram, but don't connect the leads from the pc board yet.

Now you can return to the mechanical assembly. Mount the pc boards and wire up all the flying leads. Note that the +15 V and 0 V leads go to several locations each: for example, LEDs 1, 3 and 4 all have their cathodes (k) going to 0 V. Double check to see that no connections to off-board components are left unused. We used double-pole switches for SW1, SW2 and PB1. This was mainly because single-pole versions were not available at the time we constructed the prototype. The spare poles were unused.

Note that heavier gauge hookup wire should be used to connect the collector and emitter of Q7 to the rest of the circuit. Use 24 x 0.2 mm plastic insulated hookup wire at least.

Now check *everything*.

Finally, wire up the rectifier and filter capacitor as per the wiring diagram, unless you're using some other supply, and connect up the power transformer. Take care with the mains wiring. If you are using an existing transformer/rectifier, then only a filter capacitor is needed. Its value depends on the voltage: we recommend at least 3300 uF for a supply of 21 volts peak, which is the minimum unsmoothed supply recommended. Now you're ready for 'the big switch on!'.

Resistors	
R1	220R, 1 W
R2, R24	680R
R3	39R
R4	180k
R5, 13, 19	12k
R6	3k3
R7	470k
R8, 17	6k8
R9	4k7
R10, 11	2k7
R12, 25, 26	100k
R14, 27, 31	47k
R15, 16, 28	1k
R18	2k2
R20, 30	1R, 2 W
R21	560R
R22, 23	15k
R29	5k6
R32	1k2
RV1	1k lin. pot.
RV2	10k trimpot or lin. pot.
RV3	10k trimpot
RV4	10k pot.
RV5	1M trimpot

Capacitors	
C1	4700u/35 V or 50 V axial electro.
C2	220u/35 V RB electro.
C3, 6	10u/16 V tant.
C4	4u7/16 V RB electro.
C5	47u/16 V RB electro.
C7	10n greencap
C8	4n7 greencap
C9	1n greencap
C10, 11	1u/16 V tant.
C12	100n greencap

Semiconductors	
D1-D3	1N4001, EM401, 1N4002 etc.
D4-D8	1N914, 1N4148, 1N4001 etc.
IC1	7815, 78L15
IC2	CA3140
IC3	LM301, uA301
Q1, Q5	BC549
Q2	BC559
Q3, Q4	BC558
Q6	BD139, TIP31
Q7	2N3055
LED1	TIL220G green LED
LED2, 3	TIL220Y yellow LED
LED4	TIL220R red LED
SCR1	C106

Miscellaneous	
RL1	12 V double-pole change-over relay with contacts rated at 2 A or more, coil 240 ohms or more.
SW1	SPDT toggle switch with spring return.
SW2	single-pole, three-position switch, centre-off, spring-loaded return one side.

ETI-1508 pc board; PL30/60VA transformer or PL36/60VA, if needed; knobs to suit; panel metalwork, channels etc as per drawings; spacers; nuts, bolts etc; hookup wire.

Note: For a twin-track controller, two of everything except the mechanical hardware will be necessary.

Price estimate \$105 — \$115 (dual track unit)

## Adjustments

Once the wiring up is complete some adjustment of preset pots must be made. As well, some adjustment of component

values may be desirable in order to tailor the controller action, or 'feel', to your particular requirements. You may also wish to modify the action of the 'STOP' button.



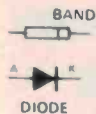

Wiring diagram of the power supply. Use a 50 V capacitor if T1 is 2 x 18 V (PL36/60 VA).

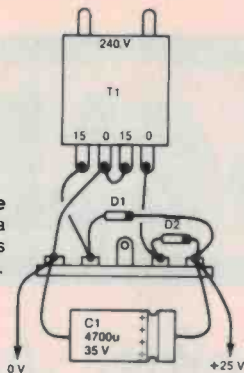

**TABLE 1**

Possible component variations.

FUNCTION	COMPONENT TO CHANGE	RANGE OF VALUES
Acceleration	R	50k to 330k
Starting pulse magnitude	R6	100R to 10k
Slowing	R7	390k to 10M
Braking	R5	1k to 27k
(Note: R4 affects this too!)		
% charge jump	C4	0 to 20 uF

\*Do not forget to adjust R14 if necessary to limit maximum current to 1.5 A.

There are two preset potentiometers, the offset null pots for the two op-amps, which must be adjusted. These will probably never need readjustment once initially set. The 3140 (IC2) offset pot should be adjusted to give the required 15 mA minimum current in the output. Place a current meter across the track, and adjust this pot until 12 to 18 mA flows. Removing the meter, leaving an open circuit, should illuminate the O/C LED. Shorting the output will turn it off.

The 301 (IC3) offset pot should be adjusted with pins 2 and 3 shorted to pin 7. When you have temporarily made these connections, move the wiper to

and fro, observing that one direction turns the S/C LED off, the other turns it on. Leave the wiper at the point of switching just so that the slightest movement in the appropriate direction will toggle the LED. Remove the temporary connection. Verify the correct connection and operation of the short circuit detector by following this procedure: place a locomotive on the track; adjust the 'SET S/C' pot, slowly, until the LED just goes out. If the track is now shorted, the LED should come on. This takes half a second or so. The SET pot can be adjusted to recognise any resistance from almost zero to 5 ohms at least, as the minimum acceptable value, before a short condition is indicated. This range will be adequate for all normal wiring up resistances, etc. The 'SET MAX' pot is adjusted simply to set the level which is the most current a locomotive or pair of locomotives will ever need. It can be adjusted either with a current meter if you know the value, or simply to give convenient feel to the throttle knob. If you find you are always at the beginning of the throttle range, adjust this pot down to reduce the maximum. If you always need full throttle to run a train, adjust it up.

Once you have familiarised yourself with the operation, you may wish to change certain time constants. The accompanying table shows what components affect what characteristics. Recommended values fit recent design HO scale models. If you wished to increase all the time constants because your layout is very large, you could increase C5, or vice versa. This will also affect the initial current jump, reducing it. If you need to restore this or even

make it larger, increase C4 as well. If you change any of the resistors, you may need to change R14. This resistor does not directly affect the 'feel' of the controller, but limits the maximum current which may be requested, to the controller limit of 1.5 A so that prolonged short circuits at full current cannot harm the unit. It is likely that R4, C4 and C5 only will need changing, to tailor the controller for another scale, such as N-gauge, etc.

Finally, you may wish to change the STOP button action. We suggest wiring it as shown in the diagrams. It triggers the SCR when pressed. This locks out the controller until the SCR is isolated by turning off the supply. Two modifications may be implemented. Firstly, you may wish to have it stop the train but allow it to start as soon as the button is released. This is achieved by wiring it from the top of R6 to ground. Alternately you may wire it across the SCR, anode to cathode. This has the advantage that it may be used to restore power by isolating the SCR if it is triggered by an external signal. The other option is to include a separate (possibly concealed) button across the SCR for restoring power. Whichever option you wish is open to you. We feel that the need to use the button should incur some inconvenience, so we opted for the turn-off-to-restore-power method.

The external SCR trigger input is provided for those who wish to include some logic in their layout. Position sensors, point and signal control systems, etc, may be wired to stop the train by means of applying a TTL-high (4 V or more) to this input, which has the effect of pressing the STOP button.

## Some Notes on TRAIN DRIVING and Problems you may encounter

This controller, as we have said before, delivers constant current rather than constant voltage. Constant current produces constant motor torque. Thus, just as is the case in a car, the train will slow for hills, speed up for descents, etc. This will mean that you have to pay fairly constant attention or the train will end up derailing or throwing carriages due to speed or 'stalling' due to insufficient 'gas'. The author can barely manage to control two trains at once, so be warned that train driving is not as easy as it used to be! Braking is also not exponential, as is acceleration. This corresponds to an effect you may have noticed if you drive a car — hard braking at 25 kph causes fairly severe loss of speed, but hard braking at 125 kph causes an alarmingly mild reduction of speed; you dissipate energy proportional to speed, but the energy needed to be dissipated rises with the square of speed.

A problem which demands some discussion is that of 'starting torque'. Many model engines, particularly old ones (the author has several engines over twenty years of age) have a tendency to require an amount of current to start moving which is greatly in excess of that to keep moving. Thus they sit still until the 'starting torque' is achieved then take off at some speed. This is not due to bad contacts. To some degree this

controller scheme can overcome the problem. Firstly, actual bad contact problems will be automatically resisted, and Indication is given as soon as the fault becomes serious. Thus, these will be separated from other problems and can be remedied by cleaning, and so forth. Secondly, the controller gives a small 'jerk' at startup, corresponding to the take-up of coupling slack in a real train. If controls are adjusted suitably, the train will not quite stop after this jerk (which should easily exceed starting torque) and will pull away smoothly. Recall that the controller output jumps to some preset fraction of the initial throttle setting immediately after switching to the 'accelerate' position of the main control switch. Judicious adjustment of the throttle before startup can ensure a sizeable jerk and a large initial step level. If necessary, increasing the startup capacitor C4 will increase the initial step torque so that the engine does not come to rest even for a moment after startup. Reducing R6 will reduce the duration of the jerk, increased by increasing C4. Newer engines respond smoothly and may benefit purely from reduction of R6 to minimise the startup jerk. Our older engines used 15 uF for C4 successfully.

One further point arising is that the jerk may be reduced or eliminated where you wish by reducing the throttle to zero before going to accelerate

mode, and bringing it up as soon as you start up, though this eliminates the initial torque step. Our prototype units delivered a typical jerk of about 30 degrees of wheel rotation on a model steam locomotive — most pleasing.

Another problem which is regrettably unique to current type controllers such as this one is that they do not like the non-linear load of incandescent lamps in parallel with the engines. Two effects will be evident: when the train is stationary, the lamps are cold and look like a short circuit and so the S/C detector will respond. It will reset as soon as power is delivered however, and should be sensitive enough to be settable at the level where only a genuine short is registered. The second problem is that the cold lamps draw a lot of the current delivered in total until they heat up and begin to glow, whereupon they allow a much larger voltage across themselves while drawing the same current. This makes the train sluggish at first and likely to run away once the lamps are on. This effect is similar to and worsens the starting torque problem. In general, lamps should be avoided or at least have a few tens of ohms inserted in series to minimise the problem. Using lower voltage units and series resistances is less power economical but better. The author uses LEDs on locomotives, which are sufficient and do not affect performance.



# ETI BOOK SALES

Save time and trouble with mail order. Just fill out the coupon on page 83.

## electronics textbooks

**ELECTRONICS — IT'S EASY VOL. 1** \$5.95  
Meters, resistance, capacitance and inductance, emitter followers, op amps, power supplies and electronic filters.

**ELECTRONICS — IT'S EASY VOL. 1** \$12.95  
Same content in a hard-cover form.

**ELECTRONICS — IT'S EASY VOL. 2** \$5.95  
Digital sub-systems counters and shift registers, A-D and D-A conversion, digital instruments and test equipment, computers, transmission links and oscilloscopes.

**ELECTRONICS — IT'S EASY VOL. 2** \$12.95  
Same content in a hard-cover form.

### ELEMENTS OF ELECTRONICS

This series is an introduction to modern electronics. All the maths is taught as the reader progresses. The course concentrates on the understanding of concepts central to electronics, rather than digressing over the whole field. The author anticipates where difficulties lie and guides the reader through them.

**BOOK 1**  
**BP62** \$7.52  
All fundamental theory necessary to full understanding of simple electronic circuits and components.

**BOOK 2**  
**BP63** \$7.52  
Alternating current theory.

**BOOK 3**  
**BP64** \$7.52  
Semiconductors technology leading to transistors and ICs.

**BOOK 4**  
**BP77** \$9.76  
Microprocessing systems and circuits.

**BOOK 5**  
**BP89** \$9.76  
Communications.

**ESSENTIAL THEORY FOR THE ELECTRONICS HOBBYIST**  
**228B** \$4.32

This book supplies the electronics hobbyist with the background knowledge which will exactly suit their specific requirements. Minimum maths.

**BEGINNER'S GUIDE TO DIGITAL ELECTRONICS**  
**BP61** \$3.36

Covers all essential areas including number systems, codes, constructional and sequential logic, analogue/digital/analogue conversion.

### A MICROPROCESSOR PRIMER

**BP72** \$5.92  
Learning about microprocessors is easy with this book, written in a style that is easy to follow. The shortcomings of this basic machine are discussed and the reader is shown how these are overcome by changes to the instruction set. Relative addressing, index registers follow as logical progressions.

## reference and data handbooks

**AUDIO CYCLOPEAIA**  
**20675P** \$66.00

A complete, in-depth look at the art of audio — from the basic principles of sound to solid-state and integrated circuits. Over 3000 entries and hundreds of illustrations and circuit diagrams cover acoustics, amplifiers, recording, reproduction, test equipment, audio measurements, and much more.

**REFERENCE DATA FOR RADIO ENGINEERS**  
**21218P** \$21.95

The largest and most comprehensive collection of equations, graphs, tables, and other reference data needed in general radio engineering and design. Contains hundreds of charts, monographs, diagrams, curves, tables and illustrations.

**TUBE SUBSTITUTION HANDBOOK**  
**21746P** \$8.75

Complete, accurate, up-to-date guide to direct substitutes for receiving and picture tubes. Contains over 6000 receiving tube substitutes, over 4000 monochrome and colour picture tube substitutes, and 600 communications substitutes. Also includes pinouts for quick operational checks.

**CONTEMPORARY MATHEMATICS FOR ELECTRONICS**  
**70274P** \$29.75

This book is split into three sections. Direct current maths introduces the student to the calculator, fractions and dimensional analysis. Alternating current maths covers phasors, quadratics and RMS in both sine and digital waveforms. Active device maths introduces number systems and boolean.

**AUSTRALIAN MICROCOMPUTER HANDBOOK**  
**72505** NOW \$15.00

Normally \$25.00. A detailed buyer's guide to micro-computer systems and application packages in commercial, industrial, scientific, educational and home/hobby areas.

**TRANSISTOR SUBSTITUTION HANDBOOK**  
**21515P** \$8.75

17th edition — Accurate transistor substitution in a matter of seconds with this replacement listing of over 19 000 American and foreign bipolar transistors.

**THE CP/M HANDBOOK WITH MP/M**  
**88048A** \$19.95

Shows you how to use CP/M (control program for microprocessors) and its resources. No prior knowledge of computers is assumed. CP/M is available on nearly all computers using the 8080, 8085 or Z80 microprocessors.

**HANDBOOK OF ICs EQUIVALENTS AND SUBSTITUTES**  
**202B** \$5.76

Contains full interchangeability data on more than 9500 ICs with possible alternatives and equivalents shown. Covers many types of digital and linear ICs.

**HANDBOOK OF RADIO, TV, INDUSTRIAL & TRANSMITTING TUBE & VALVE EQUIVALENTS**  
**BP2** \$2.25

Equivalents book for amateurs and servicemen. More than 18 000 old and new valves from UK, USA, Europe, Japan et al. CV (military) listings with commercial equivalents included.

**RADIO AND ELECTRONIC COLOUR CODES AND OATA CHART**  
**BP7** \$1.60

This large wall chart covers all colour codes in use throughout the world. For all radio and electronic components made in UK, USA, Europe and Japan.

### FIRST BOOK OF TRANSISTOR EQUIVALENTS AND SUBSTITUTES

**BP1** \$3.36

This guide covers many thousands of transistors showing possible alternatives and equivalents. Covers transistors made in UK, Japan, USA, Germany, France, Europe, Hong Kong and includes types produced by more than 120 different manufacturers.

### SECOND BOOK OF TRANSISTOR EQUIVALENTS AND SUBSTITUTES

**BP14** \$5.92

Interchangeability data covers semiconductors manufactured all over the world. Immediate equivalents are shown and possible substitutes are included.

### GIANT CHART — RADIO, ELECTRONICS, SEMI-CONDUCTORS & LOGIC SYMBOLS

**BP27** \$1.92

Identify those symbols at a glance. A must for beginners and advanced enthusiasts alike. Professionals can always hide it in their desks!

### RESISTOR SELECTION HANDBOOK

**BP28** \$2.24

Shows how to combine two preferred values of resistor to obtain virtually any required value of resistance. Includes information about fixed resistors, standard ranges, colour codes and markings, power ratings and resistor calculations.

### ELECTRONIC CALCULATOR USERS' HANDBOOK

**BP33** \$5.12

Presents formulae, data, methods of calculation, conversion factors, etc, for use with the simplest or most sophisticated calculators. Includes the way to calculate using only a simple four-function calculator: trigonometric functions, hyperbolic functions, logarithms, square roots and powers.

### DIGITAL IC EQUIVALENTS AND PIN CONNECTIONS

**BP40** \$12.32

Revised edition showing Japanese, American and European equivalents. Also shows pin connections of a popular user-orientated selection of digital ICs.

### LINEAR EQUIVALENTS AND PIN CONNECTIONS

**BP41** \$9.12

Shows equivalents and pin connections of a selection of popular linear ICs, with details of families, functions, country of origin and manufacture. Includes devices from Analog Devices, Advance Micro Devices, Fairchild, Harris, IIT, Motorola, Philips, RCA, Raytheon, Signetics, Sescocrem, SGS-ATES, Siemens, AEG-Telefunken, Teledyne, Texas Instruments.

### PRACTICAL ELECTRONIC CALCULATIONS & FORMULAE

**BP53** \$9.76

For the practical person's workbench. Bridges gap between technical theory and cut-and-dried methods which work but leave the experimenter unfulfilled. There's a strong practical bias. Tedious and higher maths avoided where possible.

### INTERNATIONAL TRANSISTOR EQUIVALENTS GUIDE

**BP85** \$9.76

Companion to BP1 and BP14 equivalents books, but contains a huge amount of information on modern transistors produced by over 100 manufacturers. Wherever possible, equivalents are subdivided into European, American and Japanese types. Also shown are the material type, polarity, manufacturer and indication of use or application.

### HOW TO IDENTIFY UNMARKED ICs

**BP101** \$2.46

This chart shows the reader how, with just a test-meter, to go about recording the particular 'signature' of an unmarked IC which should enable the IC to be identified with reference to manufacturers or other data.



## electronics for beginners

### BEGINNERS HANDBOOK OF IC PROJECTS

74286P \$19.25

The novice is guided in mastering the fundamentals of building, troubleshooting and testing electronic projects. In addition to many elementary projects, more advanced ones are included concerning bipolar integrated circuits and medium and large-scale integrated circuits.

### HI-FI LOUDSPEAKER ENCLOSURES

205B \$3.36

Data for building corner reflex, bass reflex, exponential horn, folded horn, tuned port, Klipschorn labyrinth, tuned column, loaded port and multi speaker panoramics. Clear dimensioned diagrams included.

### SOLID STATE NOVELTY PROJECTS

219B \$3.04

A number of novelty projects using modern ICs and transistors. Includes 'Optomin' — a musical instrument played by reflecting a light beam with your hand, water warbler for pot plants, music tone generator, LEDs and ladders game, touch switch, electronic roulette wheel, etc.

### SOLID STATE SHORTWAVE RECEIVERS FOR BEGINNERS

222B \$4.32

Design and construction of several solid-state shortwave receivers giving high level of performance yet utilising relatively few inexpensive components.

### BEGINNERS' GUIDE TO BUILDING ELECTRONIC PROJECTS

227B \$5.12

Enables total beginners to tackle electronic projects. Includes component identification, tools, soldering, building methods, cases, legends, etc. Practical basic projects are included.

### ESSENTIAL THEORY FOR THE ELECTRONICS HOBBYIST

228B \$4.32

This book supplies the electronics hobbyist with the background knowledge which will exactly suit their specific requirements. Minimum maths.

### RADIO AND ELECTRONIC COLOUR CODES AND DATA CHART

BP7 \$1.60

This large wall chart covers all colour codes in use throughout the world. For all radio and electronic components made in UK, USA, Europe and Japan.

### FIRST BOOK OF PRACTICAL ELECTRONIC PROJECTS

BP23 \$2.72

Full constructional data, circuits, components lists for many practical projects including audio distortion meter, superFET receiver, guitar amp, metronome, etc.

### RESISTOR SELECTION HANDBOOK

BP26 \$2.24

Shows how to combine two preferred values of resistor to obtain virtually any required value of resistance. Includes information about fixed resistors, standard ranges, colour codes and markings, power ratings and resistor calculations.

### HOW TO BUILD YOUR OWN METAL AND TREASURE LOCATORS

BP32 \$5.92

Electronic and practical details on the simple and inexpensive construction of heterodyne metal locators.

### ELECTRONIC PROJECTS FOR BEGINNERS

BP48 \$4.64

This book gives the newcomer to electronics a wide range of easily built projects. Actual components and wiring layouts aid the beginner. Some of the projects may be built without using soldering techniques.

### POPULAR ELECTRONIC PROJECTS

BP49 \$4.96

A collection of the most popular types of circuits and projects to interest most electronics constructors. The projects cover a wide range and are divided into four basic types: radio, audio, household and test equipment.

### BEGINNERS GUIDE TO DIGITAL ELECTRONICS

BP61 \$3.36

Covers all essential areas including number systems, codes, constructional and sequential logic, analogue/digital/analogue conversion.

### ELECTRONIC GAMES

BP69 \$5.92

How to build many interesting electronic games using modern ICs. Covers both simple and complex circuits for beginner and advanced builder alike.

### RADIO CONTROL FOR BEGINNERS

BP79 \$5.92

How complete systems work with constructional details of solid state transmitters and receivers. Also included — antennas, field strength meter, crystal controlled supermet, electro-mechanical controls. Section dealing with licensing etc. not applicable to Australia.

### EASY ELECTRONICS-CRYSTAL SET CONSTRUCTION

BP92 \$6.56

For those who wish to participate in the intricacies of electronics more through practical construction than by theoretical study. The circuits are based on those from earlier publications but have been modified to use modern inexpensive components and home wound coils.

### IC PROJECTS FOR BEGINNERS

BP97 \$6.56

Especially written for the less experienced hobbyist, and offers a range of fairly simple projects based around a number of popular and inexpensive linear and digital ICs. Complete layout and point-to-point wiring diagrams included.

### ELECTRONICS — IT'S EASY VOL. 1

Meters, resistance, capacitance and inductance, emitter followers, op amps, power supplies and electronic filters. \$5.95

### ELECTRONICS — IT'S EASY VOL. 1

Same content in a hard-cover form. \$12.95

### ELECTRONICS — IT'S EASY VOL. 2

Digital sub-systems counters and shift registers, A-D and D-A conversion, digital instruments and test equipment, computers, transmission links and oscilloscopes. \$5.95

### ELECTRONICS — IT'S EASY VOL. 2

Same content in a hard-cover form. \$12.95

### SIMPLE PROJECTS FROM ETI

Two volumes containing easy projects plus chapters on construction techniques and useful information on components. \$2.95

### HOBBY ELECTRONICS PROJECT BOOK

Fifty projects ranging from very simple ones for complete beginners to more elaborate ones for those with more experience. There's a complete guide to soldering and instructions on how to make your own pc boards. \$4.95

### HOW TO BUILD ELECTRONIC GAMES

Alien invaders, electronic die, sound effects, two slot car controllers, electronic poker machine, the family ferry and lots more. \$3.95

### HOW TO BUILD GOLD AND TREASURE DETECTORS

Tells you how metal detectors work and how to construct the different types of detectors: discriminating, BFO, induction balance and a professional deep-seeking unit. How to build a geiger counter. \$3.95

### DESIGN OF TRANSISTOR CIRCUITS, WITH EXPERIMENTS

21626P \$20.75

A self-teaching course in transistor circuits — seven chapters explore the fundamentals of active semiconductor and their operating principles and procedures. Experiments in design and semiconductor testing provide hands-on experience.

### UNIQUE ELECTRONIC WEATHER PROJECTS

21484P \$13.25

Fun and easy-to-build projects include an IC barometer to serve as a tornado warning and a thermostat with a brain to help conserve energy.

### BUILD YOUR OWN HI-FI & AUDIO ACCESSORIES

220B \$3.04

Essential for keen hi-fi and audio enthusiasts. Projects include stereo decoder, three-channel mixer, FET preamp for ceramic pick-ups, mic preamp with adj. bass, stereo dynamic noise limiter, loudspeaker protector, voice-operated relay, etc.

### 28 TESTED TRANSISTOR PROJECTS

221B \$4.32

Some circuits are new, others are familiar designs. Projects can be split and/or combined for specialised needs.

### 50 CMOS PROJECTS

224B \$4.64

Many interesting and useful projects — multivibrators, amplifiers and oscillators; trigger devices; special devices.

### MAJOR SOLID STATE AUDIO HI-FI PROJECTS

BP29 \$3.04

Three projects for the more experienced constructor: 12.5 W/ch stereo amplifier, eight input stereo/mono mixer and 4x14 W quadrasonic amplifier. Full constructional details provided.

### HOW TO BUILD YOUR OWN METAL AND TREASURE LOCATORS

BP32 \$5.92

Electronic and practical details on the simple and inexpensive construction of heterodyne metal locators.

### HOW TO MAKE WALKIE-TALKIES

BP43 \$5.12

This treatise on low power transmitter-receivers (walkie-talkies) covers many aspects from licensing requirements and bands, through practical circuitry and construction to the various types of aerials that may be used.

### PROJECTS IN OPTO-ELECTRONICS

BP45 \$5.92

Included are simple circuits using ordinary LEDs as well as more sophisticated designs such as infra red transmitters and detectors, modulated light transmission and also photographic projects etc.

### RADIO CIRCUITS USING ICs

BP46 \$4.64

This book describes ICs and how they can be employed in receivers for the reception of either amplitude or frequency modulated signals. Also discussed are stereo decoder circuits, quadrasonic circuits and voltage regulator devices.

### POPULAR ELECTRONIC PROJECTS

BP49 \$4.96

Includes a collection of the most popular types of circuits and projects which cover radio, audio, household projects and test equipment.

### HOW TO BUILD YOUR OWN SOLID-STATE OSCILLOSCOPE

BP57 \$5.12

Project divided into sections for builder individually to construct and test — then assemble into complete instrument. Includes short section on scope usage.

### SINGLE IC PROJECTS

BP65 \$5.12

Simple to build projects based on a single IC. A few projects use one or two transistors as well. A strip board layout is given for each project plus special constructional and setting up info. Contents include low level audio circuits, audio power amps, timers, op-amps and miscellaneous circuits.

### ELECTRONIC GAMES

BP69 \$5.92

A number of interesting electronic games projects using ICs for both the beginner and advanced enthusiast.

### ELECTRONIC HOUSEHOLD PROJECTS

BP71 \$5.92

Most useful and popular projects for use around the home. Includes two-tone buzzer, intercom, smoke and gas detectors, baby alarm, freezer alarm etc. etc.

### REMOTE CONTROL PROJECTS

BP73 \$6.56

Covers radio, infra-red, visible light, ultrasonic controls. Full explanations are provided so that the reader can adapt the projects for domestic and industrial as well as model use.

### POWER SUPPLY PROJECTS

BP76 \$5.92

This book gives a number of power supply designs, including simple unregulated types, fixed voltage regulated types and variable voltage stabilised designs. The designs are all low voltage types for semiconductor circuits.

### POPULAR ELECTRONIC CIRCUITS — BOOK 1

BP80 \$6.56

Yet more circuits from Mr. Penfold! Includes audio, radio, test gear, music projects, household projects and many more. An extremely useful book for all hobbyists, offering remarkable value for the designs it contains.

### ELECTRONIC PROJECTS USING SOLAR CELLS

BP82 \$6.56

Includes a number of projects that benefit from solar power and obviate the problems encountered with batteries, such as weight and bulk, frequency of replacement, and failure when batteries are exhausted.

### DIGITAL IC PROJECTS

BP84 \$6.56

Companion to No. 225 Practical Introduction to Digital ICs and BP61 Beginner's Guide to Digital Electronics. The projects included in this book range from simple to more advanced projects — some board layouts and wiring diagrams are included.

### AUDIO PROJECTS

BP90 \$6.56

Covers a wide range of audio projects including pre-amplifiers and mixers, power amplifiers, tone controls and matching etc. A number of board layouts and wiring diagrams are included.

## constructional projects general



# LOOK! More books!

Mail order coupon on page 83.

## ELECTRONIC TIMER PROJECTS

**BP93** \$6.56  
These may have a high degree of accuracy with quartz control or they may be quite simple designs, using only a few components. A number of specialist timer projects are car windscreen wiper delay unit, darkroom timer, metronome etc.

## ELECTRONIC PROJECTS FOR CARS AND BOATS

**BP94** \$6.56  
Fifteen fairly simple projects designed for use with 12 V electrical systems but in some cases can also be employed with 6 V and/or positive earth systems as well.

## MODEL RAILWAY PROJECTS

**BP95** \$6.56  
Projects include such things as controllers, signals and sound effects units. Construction stripboard layouts are provided for each project.

## CB PROJECTS

**BP96** \$6.56  
A number of useful designs include a speech processor, interference filters and a simple CB radio receiver. Stripboard layouts, wiring diagrams and notes on construction are provided.

## POPULAR ELECTRONICS CIRCUITS — BOOK 2

**BP98** \$7.52  
A companion for BP80, this book provides a wide range of designs for electronics enthusiasts who are capable of producing working projects from just a circuit diagram without the aid of detailed constructional information.

## MINI-MATRIX BOARD PROJECTS

**BP99** \$6.56  
This book provides a selection of 20 useful circuits which can all be built on a mini-matrix board which is just 24 holes by 10 copper strips in size. Simple and easy for those with not much experience in electronics.

## MULTI-CIRCUIT BOARD PROJECTS

**BP103** \$6.56  
All circuits are based on one specially designed pc board. Recommended to the less experienced hobbyist.

## ELECTRONIC SCIENCE PROJECTS

**BP104** \$7.52  
These projects range in complexity from a simple colour temperature meter to an infra-red laser. There is an electronic clock regulated by a resonating spring and an oscilloscope with a solid-state display. How to build them and use them is fully explained.

## AERIAL PROJECTS

**BP105** \$6.56  
Practical aerial designs including active, loop and ferrite which are relatively simple and inexpensive to build. The complex theory and mathematics of aerial design have been avoided.

## MODERN OP-AMP CIRCUITS

**BP106** \$6.56  
A collection of widely varying circuits and projects based on the op-amp ICs.

## HOW TO GET YOUR ELECTRONIC PROJECTS WORKING

**BP110** \$6.56  
Helps you to overcome the problems of a circuit that doesn't work by indicating how and where to start looking for many of the common faults that can occur when building up a project.

## circuit techniques and design

## TTL COOKBOOK

**21035P** \$17.50  
A complete look at TTL logic circuits — what TTL is, how it works, and how to use it. Many kinds of practical TTL are included, such as digital counters, electronic stopwatches, digital voltmeters, etc.

## ACTIVE-FILTER COOKBOOK

**21168P** \$21.95  
Learn how to construct filters of all kinds — highpass, lowpass, bandpass. The book is easy to understand — no advanced maths or obscure theory is used.

## ELECTRONIC CIRCUITBOOK 1: PROJECT CONSTRUCTION

**21241P** \$7.50  
Your basic guide to project construction, covering component identification, power supplies, proper tool selection, troubleshooting techniques, oscilloscope use, custom-made enclosures, and more.

## CMOS COOKBOOK

**21398P** \$19.25  
This book explains CMOS technology and its application to 'real world' circuitry. A mini-catalogue is included, which lists over 100 devices, giving their pinouts and application notes.

## IC TIMER COOKBOOK

**21416P** \$15.95  
Gives you a look at the hundreds of ways IC timers are used in electronic instrumentation.

## IC CONVERTER COOKBOOK

**21527P** \$20.75  
Written for the practising engineer, technician, hobbyist or student, this book will be an invaluable working guide to the understanding and use of IC analogue/digital and digital/analogue converters.

## DESIGN OF OP-AMP CIRCUITS, WITH EXPERIMENTS

**21537P** \$16.50  
The design of the fundamental circuits that are the basic building blocks of more sophisticated systems. A series of 35 experiments illustrates the design and operation of linear amps, differentiators and integrators, voltage and current converters, active filters, and lots more.

## 555 TIMER APPLICATIONS SOURCE BOOK, WITH EXPERIMENTS

**21538P** \$11.25  
This book describes the construction of the 555 timer and gives numerous practical examples of its applications in all areas of electrical and computer engineering, including 17 simple experiments.

## DESIGN OF ACTIVE FILTERS WITH EXPERIMENTS

**21539P** \$15.95  
Introduction to the theory, implementation and design of active filters using the 741 op-amp.

## DESIGN OF PHASE-LOCKED LOOP CIRCUITS, WITH EXPERIMENTS

**21545P** \$15.95  
An excellent introduction to the theory, design and implementation of phase-locked loop circuits using various TTL and CMOS devices. Includes manufacturers' data sheets and describes the use of breadboarding aids in the wide range of laboratory-type experiments.

## AUDIO IC OP-AMP APPLICATIONS

**21558P** \$13.25  
This book discusses IC op-amps and their application in audio systems, and describes the numerous advantages of using op-amps, including small spatial needs, low power consumption, reliable performance and low cost. Assumes a basic understanding of op-amp theory.

## UNDERSTANDING CMOS INTEGRATED CIRCUITS

**21598P** \$9.95  
This book tells you what CMOS ICs are, how they work, and how they can be used in electronic circuit designs. Many practical circuits, complete with parts values, are included.

## DESIGN OF TRANSISTOR CIRCUITS WITH EXPERIMENTS

**21626P** \$20.75  
A self-teaching course to provide the background and explanations necessary to teach the reader the art of designing transistor circuits.

## GUIDE TO CMOS BASICS, CIRCUITS, AND EXPERIMENTS

**21654P** \$14.95  
If you are already familiar with TTL devices and are ready to examine the benefits of CMOS, this book is your complete source. It tells you what CMOS devices are, their characteristics and design rules. 22 experiments demonstrate the concepts discussed.

## PRACTICAL TRANSFORMER DESIGN HANDBOOK

**21657P** \$35.50  
An easy to understand, illustration-filled guide to designing and constructing transformers. Reviews the fundamentals of electricity, magnetism and algebra needed to understand transformer theory, and covers general design considerations, transformer types, power losses and transformer use in converters and inverters.

## Z80 MICROCOMPUTER DESIGN PROJECTS

**21682P** \$20.75  
This book provides a complete look at the internal architecture of the Z80, the heart of many microcomputers, and even shows how to build a microcomputer, the EX80, using this powerful chip.

## DESIGN OF VMOS CIRCUITS, WITH EXPERIMENTS

**21686P** \$17.50  
The authors look at the technology which makes dramatic advancements possible with VMOS, and show how these components can easily and effectively be integrated into common circuit designs to enhance their responses.

## IC OP-AMP COOKBOOK

**21695P** \$23.75  
Basic op-amp theory in detail, with 200 practical, illustrated circuit applications: JFET and MOSFET units are featured, plus manufacturers' data sheets and company addresses.

## EXPERIMENTS IN ARTIFICIAL INTELLIGENCE FOR SMALL COMPUTERS

**21785P** \$13.25  
Artificial Intelligence is the capability of a device to perform functions normally associated with human intelligence. With this book, a small computer with extended BASIC and some knowledge of BASIC language, you can conduct interesting and exciting experiments in artificial intelligence.

## PRACTICAL SOLID-STATE CIRCUIT DESIGN

**21787P** \$14.95  
An introductory course in practical solid-state circuit design for the experimenter, designer or technician who is interested in constructing tailor-made circuits.

## SCRs AND RELATED THYRISTOR DEVICES

**21806P** \$19.25  
Written for experimenters, technicians and engineers, this book is a practical and comprehensive guide to theory, operation, specifications and applications of silicon-controlled rectifiers (SCRs) and related thyristor devices.

## REGULATED POWER SUPPLIES

**21808P** \$29.75  
Comprehensive discussion of the internal architecture and operation of the latest solid-state regulators. Explains when regulated supplies are needed and how to incorporate them in your projects, and discusses modern circuitry including linear and switching circuits and late ICs.

## ANALOG INSTRUMENTATION FUNDAMENTALS

**21835P** \$29.75  
Numerous practical, hands-on lab experiments and solved problems are included, plus discussions of movements, dc ammeters, voltmeters, ohmmeters, bridges, filters and attenuators. No calculus is required.

## RF CIRCUIT DESIGN

**21868P** \$33.95  
A practical approach to the design of RF amplifiers, impedance-matching networks and filters. Uses a minimum of complex maths.

## SOLAR CELLS

**22270P** \$37.95  
In-depth description of the basic operating principles and design of solar cells. It also covers the techniques currently used to produce solar cells and reviews system applications.

## ELECTRONIC DESIGN WITH OFF-THE-SHELF ICs

**50274P** \$14.70  
It contains virtually all the information you need to design and build electronic circuits, systems and subsystems with readily available ICs. Shows how to interface them into highly complex systems.

## MODERN FILTER DESIGN

**94663P** \$49.95  
This book details the advances in active RC filters, both from a practical standpoint and from a state-of-the-art point of view. It is the first book that gives detailed analysis and design procedures for switched capacitor filters.

## COIL DESIGN AND CONSTRUCTION MANUAL

**160B** \$6.56  
How to make RF, IF, audio and power coils, chokes and transformers. Maths is simplified.

## 50 PROJECTS USING CA3130 ICs

**223B** \$4.32  
The CA3130 is an advanced operational amplifier capable of higher performance than many others: circuits often need fewer ancillary components. Audio projects. RF projects. Test equipment. Household projects. Misc. projects.

## PRACTICAL INTRO TO DIGITAL ICs

**225B** \$4.32  
Introduction to digital ICs (mainly TTL 7400). Besides simple projects, includes logic test set to identify and test digital ICs. Also includes digital counter-timer.

## 50 CIRCUITS USING GERMANIUM, SILICON AND ZENER DIODES

**BP36** \$3.36  
50 interesting and useful circuits and applications using the germanium and silicon signal diodes, silicon rectifier diodes and zener diodes etc.



**50 PROJECTS USING RELAYS, SCRS AND TRIACS**  
**BP37** \$5.92  
 Practical working circuits using silicon controlled rectifiers, relays and bi-directional triodes. With a minimum of difficulty you can use them in motor control, dimming and heating control, timing and light sensitive circuits, warning devices and many others.

**50 FET PROJECTS**  
**BP39** \$5.92  
 Projects include amplifiers and converters, test equipment, tuners, receivers and receiver aids, mixers and tone controls etc etc. The FET used is not critical. This book is of interest and value to SW listeners, radio amateurs, hi-fi enthusiasts and general experimenters.

**50 SIMPLE LED CIRCUITS**  
**BP42** \$3.36  
 50 interesting and useful circuits and applications using the LED. Also includes circuits for the 707 Common Anode Display for the beginner and advanced enthusiast.

**IC555 PROJECTS**  
**BP44** \$6.56  
 One wonders how life went on before the 555! Included are basic and general circuits, motor car and model railway circuits, alarms and noise makers plus section on subsequent 556, 558 and 559s.

**PROJECTS IN OPTO-ELECTRONICS**  
**BP45** \$5.92  
 Included are simple circuits using ordinary LEDs as well as more sophisticated designs such as infra-red transmitters and detectors, modulated light transmission and also photographic projects etc.

**RADIO CIRCUITS USING ICs**  
**BP46** \$4.64  
 This book describes ICs and how they can be employed in receivers for the reception of either amplitude or frequency modulated signals. Also discussed are stereo decoder circuits, quadrophonic circuits and voltage regulator devices.

**LM 3900 IC PROJECTS**  
**BP50** \$4.64  
 Unlike conventional op-amps, the LM 3900 can be used for all the usual applications as well as many new ones. It's one of the most versatile, freely obtainable and inexpensive devices around. This book provides the groundwork for simple and advanced uses — it's much more than a collection of projects. Very thoroughly recommended.

**50 CIRCUITS USING 7400 SERIES ICs**  
**BP58** \$5.12  
 50 interesting and useful circuits and applications using these inexpensive and versatile devices.

**50 CMOS IC PROJECTS**  
**2248** \$4.64  
 Projects include multivibrators, amplifiers and oscillators, trigger devices and other special devices.

**SECOND BOOK OF CMOS IC PROJECTS**  
**BP59** \$5.12  
 Leading on from book number 224 '50 CMOS IC PROJECTS', this second book provides a further selection of useful circuits mainly of a fairly simple nature. Contents have been selected to ensure minimum overlap between the two books.

**COUNTER DRIVER AND NUMERAL DISPLAY PROJECTS**  
**BP67** \$5.92  
 Well-known author F.G. Rayer features applications and projects using various types of numerical displays, popular counter and driver ICs, etc.

**VMOS PROJECTS**  
**BP83** \$6.56  
 Though primarily concerned with VMOS power FETs and their applications, power MOSFETs are dealt with too, in a chapter on audio circuits. Projects include audio circuits, sound generator circuits, dc control circuits and signal circuits.

**DIGITAL IC PROJECTS**  
**BP84** \$6.56  
 Helps the reader to develop a knowledge of the workings of digital circuits. Board layouts and wiring diagrams are included.

**HOW TO USE OP-AMPS**  
**BP88** \$7.52  
 Design notes and applications on many topics including basic theory, amplifiers, power supplies, audio circuits, oscillators, filters, computers and control engineering. It's written around the 741 IC but includes design notes for most of the common op-amps.

**ELECTRONIC TIMER PROJECTS**  
**BP93** \$6.56  
 These may have a high degree of accuracy with quartz control or they may be quite simple designs, using only a few components. A number of specialist timer projects are car windscreen wiper delay unit, darkroom timer, metronome etc.

**ETI CIRCUITS BOOKS 1/2/3** \$2.95 ea  
 Many of these circuits have been published in the 'Ideas for Experimenters' section in ETI.

**ETI CIRCUIT TECHNIQUES VOLS 1/2** \$4.75 ea  
 The how, what, which, where, why and how much anthology of electronic components, circuits and techniques.

## test equipment and fault finding

**AUTOMOTIVE TUNE-UP AND EMISSION CONTROL SERVICE**

**21712P** \$20.75  
 Car owners who wish to save money and maintain their cars at peak performance will learn from this book how to adjust, repair and maintain the systems that ensure best operation.

**TROUBLESHOOTING WITH THE OSCILLOSCOPE**

**21738P** \$15.95  
 Excellent for the professional service technician or the serious hobbyist, as it combines step-by-step procedures for using the scope with the specific nuts and bolts of TV receiver troubleshooting.

**EFFECTIVELY USING THE OSCILLOSCOPE**

**21794P** \$14.95  
 Excellent for the professional service technician or the serious do-it-yourself, as it combines the correct step-by-step procedures for using a scope with the specific nuts and bolts of TV receiver troubleshooting.

**MICROCOMPUTER DESIGN AND TROUBLESHOOTING**

**21819P** \$26.75  
 Tells you how to design microcomputer systems and make them work without an expensive commercial development system or the need for costly test instrumentation. The author also provides a complete description of two popular microprocessors — the 8085 and the 6502.

**USE OF THE DUAL-TRACE OSCILLOSCOPE**

**40023P** \$23.75  
 This programmed text breaks down the process of operating a scope into a series of logical steps starting with the deflection of the electron beam and continuing through proper use of the triggering controls to measure the phase difference between two waveforms.

**ELECTRONIC TROUBLESHOOTING HANDBOOK**

**52585P** \$10.50  
 This workbook guide shows you how to pinpoint transistor troubles in minutes, how to test almost everything electronic and how to get the most out of low cost test equipment.

**PRACTICAL REPAIR AND RENOVATION OF COLOUR TVs**

**BP34** \$4.32  
 This book shows how to obtain a working colour TV for very little outlay by repairing and renovating a set that has been 'written off' by a dealer. Includes practical details of how to construct your own CRT tester/rejuvenator and cross hatch generator.

**HOW TO BUILD YOUR OWN SOLID STATE OSCILLOSCOPE**

**BP57** \$5.12  
 The oscilloscope is divided into various sections which can be individually constructed and tested and then assembled together to complete the whole instrument. Also tells you how to use the instrument.

**TRANSISTOR RADIO FAULT-FINDING CHART**

**BP70** \$1.92  
 Used properly, this chart should enable the reader to trace most common faults quickly. Across the top of the chart are four rectangles containing brief descriptions of the faults. Selecting the appropriate fault, the reader simply follows the arrows and carries out the suggested checks in sequence until the fault is cleared.

**ELECTRONIC TEST EQUIPMENT CONSTRUCTION**

**BP75** \$5.92  
 Describes construction of wide range of test gear including FET amplified voltmeter, resistance bridge, field strength indicator, heterodyne frequency meter etc.

**POWER SUPPLY PROJECTS**

**BP76** \$5.92  
 Includes simple unregulated types, fixed voltage regulator types and variable voltage stabilised designs. The designs are all low voltage types for semiconductor circuits.

**HOW TO GET YOUR ELECTRONIC PROJECTS WORKING**

**BP110** \$6.56  
 Helps you to overcome the problems of a circuit that doesn't work by indicating how and where to start looking for many of the common faults that can occur when building up a project.

**TEST GEAR — METERING AND POWER SUPPLY PROJECTS** \$3.00  
 Includes many types of meters, audio noise and signal generators, simple CMOS tester, oscilloscope calibrator etc.

**TEST GEAR — VOL. 2** \$3.95  
 Projects include audio oscillator, transistor tester, true RMS voltmeter, RF signal generator, versatile logic test probe, microwave oven leak detector etc.

**ELECTRONIC PROJECTS FOR YOUNG SCIENTISTS** \$3.95  
 PH meter, geiger counter, helium-neon laser, sound level meter, solar cells, negative ion generator and much more.

## electronic music/audio/video

**AUDIO CYCLOPEDIA**

**20675P** \$66.00  
 A complete in-depth look at the art of audio — from the basic principles of sound to solid-state and integrated circuits. Over 3000 entries and hundreds of illustrations and circuit diagrams cover acoustics, amplifiers, recording, reproduction, test equipment, audio measurements, and much more.

**ELECTRONIC MUSIC CIRCUITS**

**21833P** \$24.95  
 How to build a custom electronic music synthesiser, outlines numerous other circuit designs and then shows you how to modify them to achieve particular responses. Many of the circuits can be used as special-effects boxes for guitars and other musical instruments.

**INTRODUCTION TO ELECTRO-ACOUSTIC MUSIC**

**81515P** \$15.95  
 This book assumes no previous technical knowledge. It discusses the relationship between the technology and the composition of electro-acoustic music.

**MODERN RECORDING TECHNIQUES**

**21037P** \$19.25  
 Explains the equipment controls and techniques found in a modern recording studio and how to use them creatively and correctly to produce a desired result. Numerous photographs, diagrams and charts.

**SOUND SYSTEM ENGINEERING**

**21156P** \$32.50  
 Dealing with audio systems as a whole, it includes installing and equalising the sound system and interfacing the electrical and acoustic systems. Instrumentation, the acoustic environment and designing for acoustic gain are covered.

**TUBE SUBSTITUTION HANDBOOK**

**21746P** \$8.75  
 Complete, accurate, up-to-date guide to direct substitutes for receiving and picture tubes. Contains over 6000 receiving tube substitutes, over 4000 monochrome and colour picture tube substitutes, and 600 communications substitutes. Also includes pinouts for quick operational checks.

**HOW TO BUILD SPEAKER ENCLOSURES**

**20520P** \$8.75  
 A practical guide to the 'whys' and 'hows' of constructing high-quality top-performance loudspeaker enclosures.

**ACTIVE-FILTER COOKBOOK**

**21168P** \$21.95  
 Learn how to construct filters of all kinds — highpass, lowpass, bandpass. The book is easy to understand — no advanced maths or obscure theory is used.

**DESIGN OF ACTIVE FILTERS WITH EXPERIMENTS**

**21539P** \$15.95  
 Introduction to the theory, implementation and design of active filters using the 741 op-amp.

**AUDIO IC OP-AMP APPLICATIONS**

**21558P** \$13.25  
 This book discusses IC op-amps and their application in audio systems, and describes the numerous advantages of using op-amps, including small spatial needs, low power consumption, reliable performance and low cost. Assumes a basic understanding of op-amp theory.

**VIDEO TAPE RECORDERs**

**21521P** \$17.50  
 In this completely revised second edition, the author tells in simple language how helical VTRs work and how to operate and service them. Includes numerous examples of circuits and mechanical systems.

continued on page 80.



# WE'RE YOUR RELIABLE SOURCE FOR COMPONENTS

And our prices are most competitive!

Whenever you're looking for quality components — capacitors, switches, connectors, ICs, resistors, speakers, volume controls, and displays — we offer you your best selection, your best quality, and your lowest prices. And we keep large stocks on hand to ensure prompt delivery.

**Delsound** PRICE — QUALITY SERVICE

1 WICKHAM TERRACE, BRISBANE 4000 — PH (07) 229 6155 TELEX AA44442  
 QLD. DISTRIBUTORS OF  
 ● SWANN (MCMURDO) PRODUCTS ● SWITCHES & ELECTRONIC HARDWARE  
 ● AUDITEC AUDIO MODULES ● CLIFF KNOBS, PLUGS & SOCKETS ● R.C.A. SEMICONDUCTORS ● NATIONAL SEMICONDUCTORS.

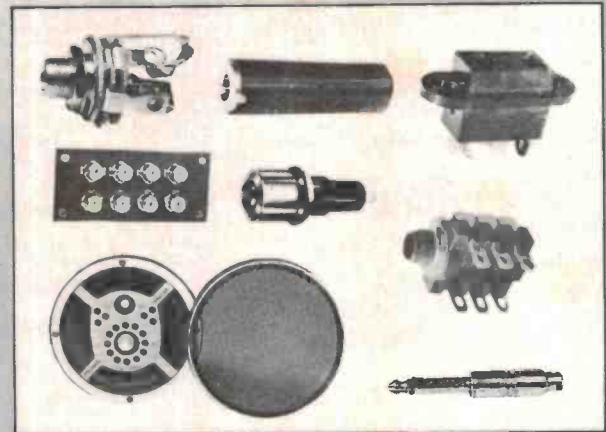

# minitool

# FOR ACCURACY & PRECISION

## WORKSHOP KIT

000.62.90X — Carry case, Power supply, Pistol drill, Drill stand, Orbital sander, Jigsaw, flexible Shaft unit, spare Blades, Table clamp, Platform table. R.R.P.

**\$187.50**

## WORKSHOP KIT

000.62.90Y — Same as above but not including flexible Shaft unit. R.R.P.

**\$149.50**

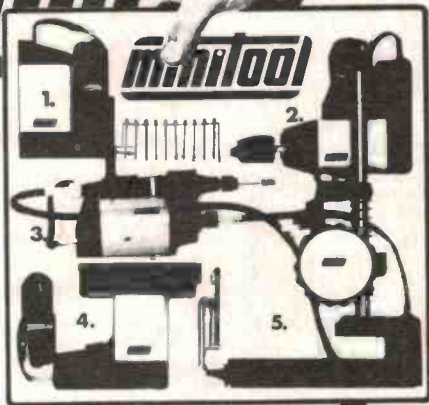

**1. JIG SAW** 10mm CUT 5,000 S/MIN.  
 000.62.108 Platform Table inc. in Kit, Extra as Individual Item. **\$37.00**

**3. FLEXIBLE SHAFT & GRIND STICK**  
 000.62.804 7,000 R.P.M. **\$45.00**

**5. DRILL STAND**  
 000.62.493 Accepts Pistol Drill & Angle Grinder.

**2. PISTOL DRILL**  
 000.62.402 7,000 R.P.M. 6mm Diameter **\$37.00**

**4. ORBITAL SANDER**  
 000.62.206 9000 S/MIN. **\$37.00**

**POWER SUPPLY**  
 240V **\$15.00 + TAX \$2.62**  
 Plug-Pak 12V output 1A

**ANGLE GRINDER\***  
 40mm Diameter 000.63.605 7,000 R.P.M. **\$45.00**



Circ. Sawblades for Wood & Metal available.

CIGAR LIGHTER ADAPTOR AVAILABLE: 000-62-073  
 Send Self Addressed Envelope for full price and accessory list. (Accessories include points, cutters, blades, burs, brushes, stones, etc.)

**minitool**  
 AUSTRALIA PTY. LTD.

134A AYR STREET,  
 DONCASTER, VIC. 3108  
 Tel. 850 9887

NAME .....

ADDRESS .....

BANKCARD NO. OR CHEQUE .....

EXPIRY DATE ..... VALUE ..... SIGNED .....



**TOYO MINI-LATHE** **\$436.00**  
 \* Sales Tax if applicable

ACCURACY EQUAL TO LARGER MACHINE TOOLS.

### FEATURES:

- TOYO MINI-LATHE made of high quality materials used in the construction of standard large machine tools.
- TOYO MINI-LATHE will give you unparalleled precision and solidity.

- Although TOYO MINI-LATHE is not multi-purpose lathe, it has all the functions of sophisticated large type lathe.
- Its machining capacity is the largest in the table top class. With maximum working diameter 100mm length 250mm.
- Numerous and well designed accessories are available.

## minitool Gravilo

Self contained hand engraver  
 18000 R.P.M 12V DC



**\$29**

## TOYO MINI DRILL

The ultimate for P.C.B. drilling.  
**\$165.00**  
 \* Sales Tax if applicable

MD-1 — 6 SPEED  
 850 — 3100 R.P.M.

MD-1H — 2 SPEED  
 8000 — 12000 R.P.M.





# Balanced input differential preamp

David Tilbrook

This versatile little preamp has a host of applications in the audio-and-beyond range, not the least of which would be as a balanced mic preamp.

MANY transducers require a balanced or differential preamplifier rather than the simpler single input unbalanced type. Balanced microphones, for example, require a balanced preamplifier to ensure minimal susceptibility to extraneous noise sources. The concept in the balanced approach is fairly simple. The microphone, for example, is connected to the balanced preamp using three wires instead of two. Two of these wires carry signal and the other is a ground connection. The balanced source, in this case a microphone, generates a signal voltage on the two signal wires such that one of the signals is 180 degrees out of phase with the other. The two active lines are twisted together, with the earth line, or a two-wire shielded cable is used to connect the mic to the preamplifier. In this way any external noise or hum source will affect both inputs equally, producing a signal that is in phase on both of the

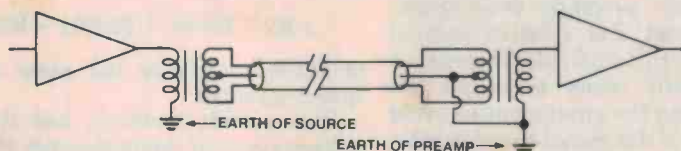
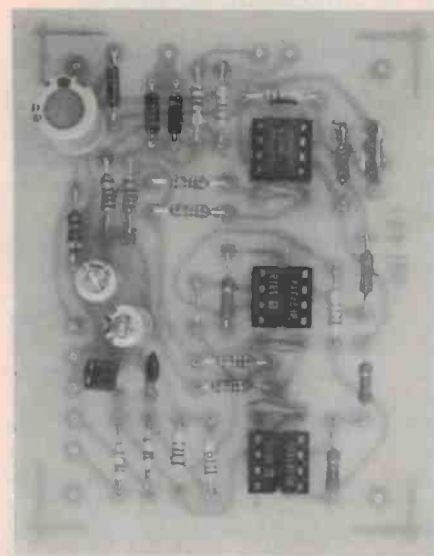

Figure 2. Balanced line with transformer coupling.

signal wires. Such a signal is called a *common mode* signal. The balanced preamplifier however, is configured in such a way as to amplify only a differential signal. The preamp produces an output signal that is proportional to the difference between its two inputs. Since the signal is generated out of phase, it is amplified. The noise source however is a common signal and is the same in both input wires. The difference between the noise signals on each of the input wires is therefore zero, and is not amplified (see Figure 1). With this technique small signals can be sent over long lines, an otherwise impossible task

due to the susceptibility of these lines to mains hum in particular.

In audio the most common method employed to implement a balanced line is with transformers. The basic approach is shown in Figure 2. The source may be a microphone or a small preamplifier inside the microphone, or simply the output from a mixer or other electronic device. This is connected to the input of a balancing transformer that is wound to represent the correct load to the driving stage. The output of this transformer consists usually of a bifilar wound secondary connected as shown in Figure 2. A similar transformer is used at the other end of the line to convert the differential signal back into one that can be amplified by the single input preamp. This technique has the advantage that the signal earth of the source need not be connected to that of the preamplifier. This can be a *very* useful feature at times, particularly when large numbers of cables are connected together at a common point such as at a mixing console. The ability to isolate the input earths of the various inputs enables complete freedom from hum loops which otherwise can become almost impossible to remove.

Transformers have disadvantages however. Firstly, good ones are expensive as they must be carefully wound and shielded from external hum fields. Since the transformer is a coil of wire, wound specifically for good response over the complete audio

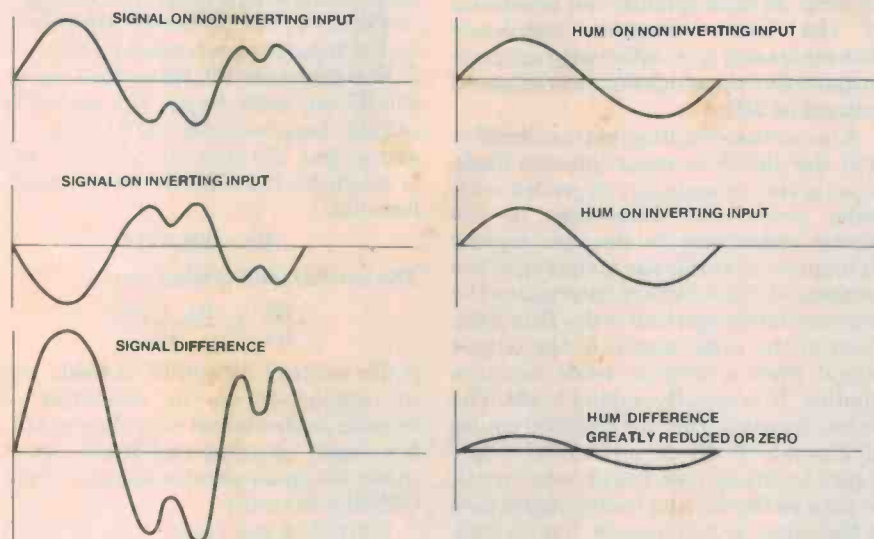

Figure 1. Differential signals on a balanced line are amplified while common-mode signals are reduced.



# Project 461

spectrum, they are particularly susceptible to magnetic fields produced by power transformers etc. The problems associated with isolating the transformers from power supply hum fields can be very real, if not impossible in some instances.

It is often said that a transformer's ability to reject a common mode signal is inferior to that of a balanced pre-amplifier such as the one to be described in this project. Although this is true it is largely irrelevant since the limit to common mode rejection is usually set by the shielded cable used to connect the input devices. Even the best quality cables seldom allow common mode rejections greatly in excess of 60 dB, a figure which is easily surpassed by most input transformers. The main advantage of differential preamps over transformers is cost and relative lack of susceptibility to hum fields. This makes it substantially easier to mount the preamp within the equipment to avoid degradation of the signal-to-noise ratio by hum pickup. Another advantage of the preamp over transformers is that even the best transformers generate significant amounts of harmonic distortion in comparison to distortion figures easily obtained with an op-amp based balanced design.

The differential input needed is easy to implement with the help of operational amplifiers, since these have inverting and non-inverting inputs already. The simplest circuit that could be used and one that is adequate with microphones is shown in Figure 3. This circuit is the standard differential op-amp circuit and offers good performance with most balanced sources. The resistor from the

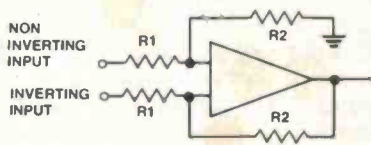

Figure 3. Preamp stage with a simply-balanced input.

non-inverting input to ground is made the same value as the feedback resistor. In this way the gain of the stage is identical for the two inputs. With the non-inverting input grounded, the gain of the stage is determined by the ratio of the resistors  $R2/R1$ . With the inverting input grounded, the gain of the op-amp is given by the standard formula

$$(R2 + R1)/R1.$$

In this case however, the input resistor in series with the non-inverting input and the resistor from this input to

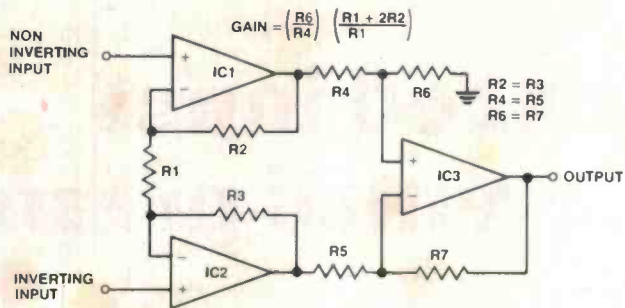

Figure 4. The solution to the problem.

ground form a potential divider and attenuate the signal by an amount given by:

$$V_i = V (R2/(R1 + R2))$$

So the total gain of the stage at the non-inverting input is

$$((R2 + R1)/R1) (R2/(R1 + R2))$$

or  $R2/R1$ , which is the same as the inverting input.

This circuit however, has the disadvantage that the impedance to earth from each of the two inputs is very different. The impedance at the non-inverting input can usually be regarded as approximated by the series combination of the two resistors, i.e:  $R1 + R2$ . The impedance at the inverting input is simply that of the input resistor, since the inverting input is a virtual earth once feedback is applied in this way. This does not bother most balanced sources, since a true balanced source works independently of the ground connection.

The impedance seen by the balanced source is a result of that due to both input resistors and the internal impedance from base to base of the input differential pair within the op-amp. In most circuits the resistance of the input resistors completely dominates and it is sufficiently accurate to quote the input impedance to balanced sources as  $2R1$ .

A major disadvantage of this circuit is that the ability to reject common mode signals can be seriously degraded with some sources by differences in the source impedance to the two inputs. Remember that it is the matching of the two sets of resistors that determines the common mode rejection ratio. This is the ratio of the input signal to the output signal when a common mode signal is applied. It is usually quoted in dB. The value quoted earlier for shielded cables of around 60 dB is a relatively easy figure to obtain with the op-amp circuit so long as the driving source impedance is the same for both inputs. A mismatch of only one per cent will degrade the

common mode rejection ratio (CMRR) of an otherwise well designed preamp by around 20 dB, and result in a figure that could easily be unsatisfactory.

Another disadvantage of this circuit is that it is not capable of delivering the full gain needed of the preamplifier and still give satisfactory distortion figures. If we take a nominal output signal level from a balanced microphone to be around 0.2 mV and the required output from the preamp to be around 100 mV, then a gain of 500 is required, or around 54 dB. The distortion figure obtained using the best op-amps available would be unsatisfactory. For example, an NE5534N at a gain of 500 would have a distortion figure around 0.15%, a poor figure by modern standards and well outside the capabilities of a good transformer. The solution is simply to decrease the gain of the stage and add a second stage to make up the difference. This however, does not solve the problem of degradation of the CMRR on some sources. The real solution is to add a *third* op-amp to the design and implement a full instrumentation amplifier.

The basic circuit for an instrumentation amplifier is shown in Figure 4. The second stage, formed by IC3, is the same as the simple differential amplifier in Figure 3, but its inputs are buffered by the input stages formed by ICs 1 and 2. Resistor pairs  $R2, R3$  and  $R4, R5$  and  $R6, R7$  are made equal. The gain of the second stage is simply  $R6/R4$  as derived above, but the gain of the first stage is given by the slightly more complex formula:

$$(R1 + 2R2)/R1$$

The overall gain is therefore

$$\frac{R6}{R4} \times \frac{R1 + 2R2}{R1}$$

If the value of  $R4$  and  $R5$  is made large in comparison to the estimated difference in the output impedances of the two input op-amps and if the gain of these two op-amps is the same then good CMRR will result.

A problem can occur on many instrumentation amplifiers in ensuring that



# differential preamp

the gains of the input op-amps are as close as possible to being the same. One feature of this circuit is that the CMRR is affected to a lesser extent by the matching of the resistors around the first stage. Furthermore, this will not be degraded by mismatch of the source impedance to the two inputs. The overall gain of the preamplifier is divided into two stages ensuring sufficient amounts of negative feedback to provide low distortion.

Close tolerance resistors (1% or 2%) are specified for R6, 7, 8 and 9 so that any dc imbalance between the input stages, IC1 and IC2, can be balanced out by RV1.

It is a good idea to use low noise metal oxide resistors for the input resistors, R3 and R4, to get good noise performance. They cost little more than standard carbon deposition types. Indeed, metal oxide resistors could well be used throughout, without a significant cost penalty. Most metal oxide resistors are available in 1% or 2% tolerance classes in any case.

## Construction

Construction of the unit is straightforward if the ETI pc board is used, since all components are mounted on the board. The usual precautions should be taken. The circuit employs several electrolytic capacitors so be certain these and the transistors, diodes and ICs are inserted with the correct orientation. The circuit is shown to run from a nominal  $\pm 20$  V supply. This ensures a clean  $\pm 15$  V supply to the op-amps giving the circuit good headroom. If this voltage is not available however, the circuit will run perfectly well on a lower supply voltage. If the supply is clean

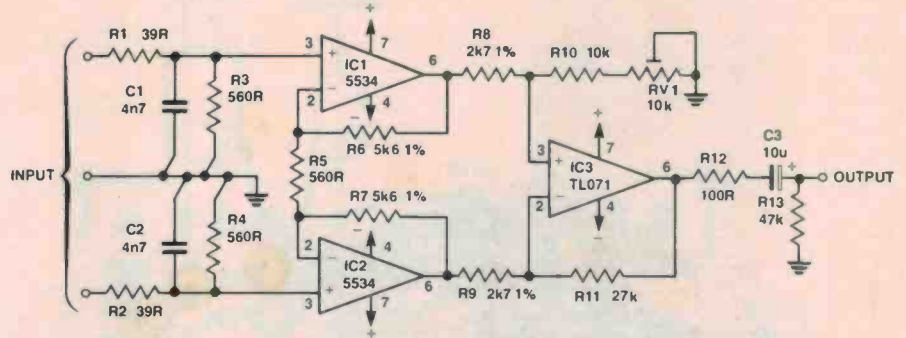

NOTE: EXTERNAL CONNECTION MUST BE PROVIDED BETWEEN POWER SUPPLY 0 V POINT AND THE SIGNAL GROUND. SEE TEXT.

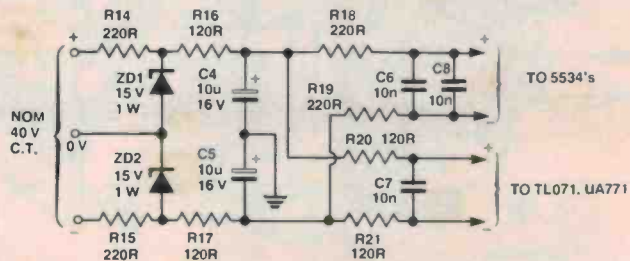

## HOW IT WORKS — ETI-461

The circuit is a relatively straightforward Instrumentation amplifier. The main differential stage is formed by IC3, the TL071. This is a BiFET op-amp with good common mode rejection ratio (CMRR) figures. This stage is buffered from the inputs by a pair of NE5534AN op-amps that also provide additional gain and determine the overall noise performance of the preamp. As mentioned in the main article, the overall gain of the preamp is determined by the gain of the first and second stages. The gain of the second stage is determined by the ratio of R11 to R9, and is around 10. The gain of the first stage is approximately 20, giving an overall gain of about 200, or 46 dB. If you require a different gain to this, try to keep the ratios of gain in the first and second stages the same. The amount of gain provided here should be suitable for most microphones, pro-

viding around 100 mV output from a 0.5 mV input signal level.

The circuit is dc coupled at the input. This assumes that the driving source will be transformer or capacitively coupled at the output, which should be a safe assumption. The input impedance of the stage is set by the two input resistors R3 and R4. To increase the input impedance, simply increase the value of these resistors.

The RC networks consisting of R1-C1 and R2-C2 are high frequency filters to reduce the circuit's susceptibility to RF interference.

The split power supply is provided either from two zener regulators or from a well-regulated and filtered dc source. The supply pins to each IC are decoupled by 1k resistors and 10n capacitors to prevent IC-to-IC interaction and possible feedback via the supply rails.

## SPECIFICATIONS — ETI-461 DIFFERENTIAL PREAMPLIFIER

Frequency response (10k load) 12Hz - 60 kHz,  $\pm 0.1$  dB

T.H.D. (at 5 V RMS output)  
 100 Hz <0.007%  
 1 kHz <0.006%  
 10 kHz <0.012%

Distortion figures can be expected to decrease further at more realistic signal levels but becomes difficult to measure.

Total equivalent input noise (20 kHz bandwidth) -124 dB (approx)

Input impedance nominally 560 ohms to ground from each input.

Output impedance nominally 260 ohms

Common mode rejection ratio depends on calibration but easily adjusted to 80 dB.

regulated dc, the on-board zeners can be eliminated. If not, replace them with a lower voltage type to suit the supply voltage available. The NE5534ANs are rated for supply voltages in excess of 20 V but some second-source alternatives to the Signetics devices seem to be incapable of running on this supply voltage. If the devices you obtain do not have the NE prefix it might be wise to ensure that the supply voltage to the op-amps does not exceed 15 V. If in doubt, leave the zener diodes in circuit as shown on the pc board layout and the circuit diagram.

The pc board has been designed so that an external connection must be provided between the 0 V point on the pc board and the signal earth. The correct place for this connection is at the input to the preamplifier, i.e. on the input



# Project 461

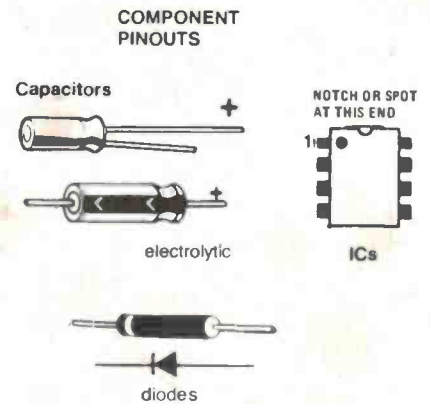
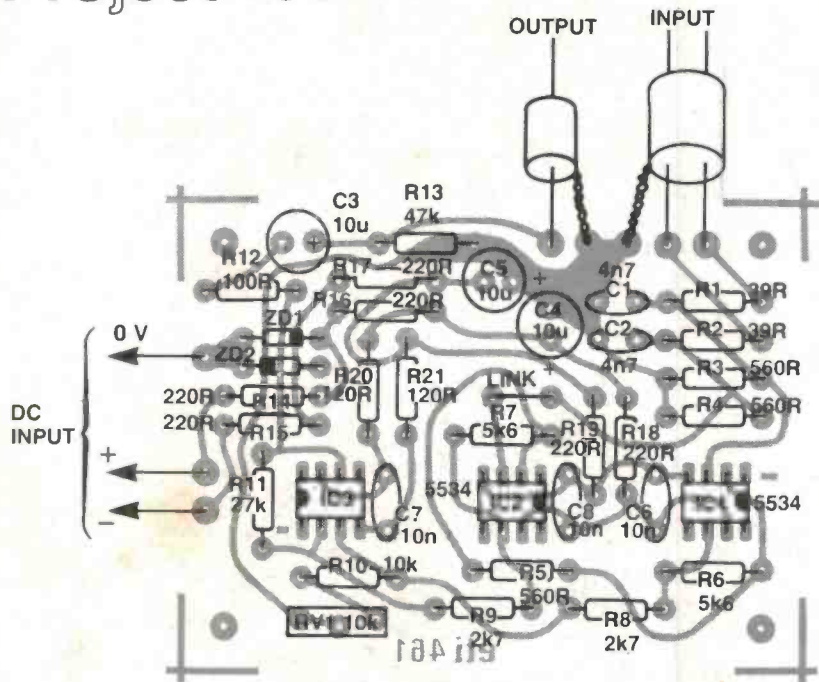

## PARTS LIST — ETI-461

<b>Resistors</b>	..... all 1/2 W, 5% unless noted
R1, R2	..... 39R
R3, 4, 5	..... 560R
R6, R7	..... 5k6, 1%
R8, R9	..... 2k7, 1%
R10	..... 10k
R11	..... 27k
R12	..... 100R
R13	..... 47k
R14, R15, 18, 19	..... 220R
R16, R17, 20, 21	..... 120R

<b>Capacitors</b>	
C1, C2	..... 4n7 greencaps
C3	..... 10u/35 V RB electro.
C4, C5	..... 10u/16 V RB electro.
C6, 7, 8	..... 10n greencap

<b>Semiconductors</b>	
IC1, IC2	..... NE5534N (see text)
IC3	..... TL071
ZD1, ZD2	..... 15 V, 1 W zener

**Miscellaneous**  
ETI-461 pc board

**Price estimate**  
**\$18 — \$20**

socket. A separate wire is run from the 0 V point to the signal earth point of the input socket. The signal leads from the input socket to the pc board should be shielded cable with the earth braid connected at both ends. The signal earth should not be connected to the chassis directly. RF shielding can be accomplished by connecting a 100nF capacitor between the signal earth at the input socket and the chassis. This will eliminate any problems with hum loops that might otherwise be formed around the mains earth line. If in doubt about this, consult the article on the Series 5000 power amplifier published in March 1981. This article describes in detail the earthing arrangement and the principles employed in power amp design are similar to those needed for good earthing of a preamplifier.

## Performance

This preamplifier is capable of excellent performance. The noise figures obtained are, to a large extent, determined by the choice of op-amp used. With the NE5534AN the noise figures and distortion performance quoted in the specifications table can be expected. An equally important parameter is of course the slew rate and slew-induced distortion (SID) characteristics of the design. The open loop frequency response of the op-amps used ensures an extended frequency response and all tests for slew-induced distortion gave good results.

The subjective testing of the preamp showed no sign of harshness due to slew limiting or other distortion mechanisms until very high input signal levels caused clipping of the output. The unit was tested with a number of high quality balanced microphones and several unbalanced types as well. If an unbalanced low impedance mic is to be used, the unused input is simply connected to ground at the input socket.

In all tests, the unit performed well and should prove to be a good balanced mic amplifier suitable for incorporation in a large number of high quality audio projects.

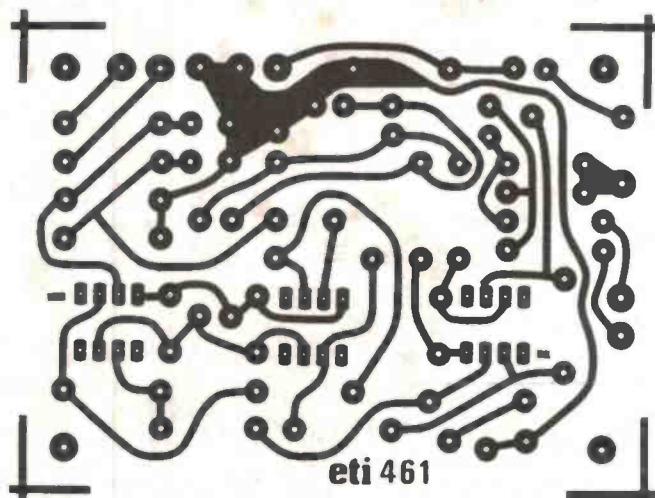



## Project 162

# 30 V/1 A fully adjustable, protected power supply

This low cost, easy to build power supply features full protection, variable voltage output from 1.3 to 30 volts, variable current limit from zero to one amp plus metering of both voltage and current output.

David Tilbrook  
Roger Harrison

THE FIRST piece of test gear an electronics enthusiast or technician wants after a good multimeter is a power supply. But, exactly *what* does that hypothetical person want, we asked ourselves? After much discussion, examining past projects etc, we came up with a specification like . . . A, B, C. As he happened to be a captive in the advertising sales office, which is next door to ETI's lab, we put it to a famous Irish West Australian electronics dealer who walks on water for a hobby (see ETI, April '81, p.11), to 'test the water', so to speak. He said, "No, no, no! What they want is a power supply with D, E, F for XY.Z dollars". Conceding he might be right but that there was an element of pecuniary interest to be deducted, we counter-proposed a power supply with G, H, I but the Irishman said that would cost ZY.X dollars and no electronics person in their right mind would pay that. At this stage we thought compromise would result in a power supply with a camel-hitching rail on the front panel and thought retreat/rethink the wiser move.

Suspecting XY.Z dollars was something like \$49.50 (\$10 above a current kit supply and \$10 below our last low-cost supply project) it was apparent some awful constraints were looming up. Rather than taking a 'better' supply and pruning it to meet a price, we started from the ground and looked at what was necessary and asked could it be done?

Obviously, a 'laboratory standard' power supply with dual digital metering, programmable voltage and current and nuclear blast proofing was not necessary. Most solid-state circuitry requires voltages between 3 V and 30 V and may require currents up to half an amp or so. Any circuitry run from the supply would need to be protected from damage by excess current should there be a fault in it, so current limiting was necessary. Current limiting also has the

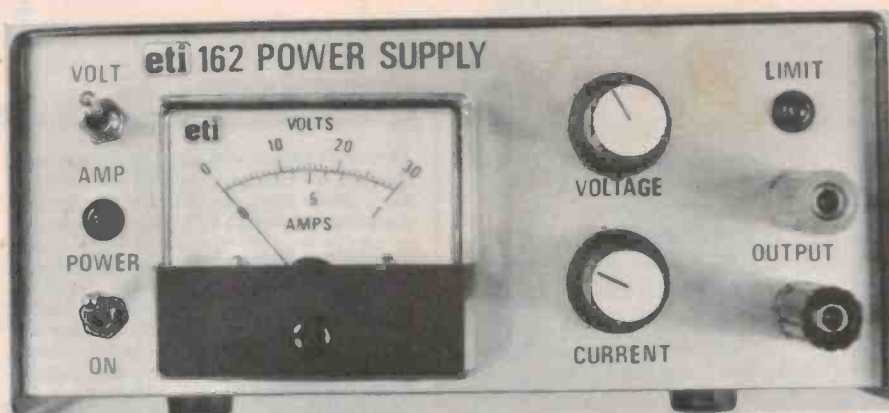

Our power supply presents a neat, functional appearance. It uses low cost, readily available components and is housed in a standard 184 x 70 x 160 mm metal case. Scotchcals were made up and applied to the front panel and meter scale.

advantage of providing protection for the power supply if the output should be short-circuited. So, variable output up to 30 V and variable current limit were two prime goals. A pot costs less than a toggle switch so continuously variable current limiting could be included, perhaps.

Meters are a relatively expensive item. Assuming the user has a multimeter (you bought that first, remember) then the meter on the power supply only needs to read either voltage or current at any one time. Voltage metering for the supply is an obvious requirement, leaving current to the user's multimeter. But, from experience, you often need an extra meter. Thus, switched metering was desirable. Dual meters are nice, but relatively *expensive*.

Three-terminal IC regulators are cheap, readily available and provide good results. They can also provide thermal overload protection. Internal circuitry turns them off if the case temperature of the device rises above a specified maximum. Getting a variable output from a three-terminal regulator is easy, but providing variable current limit is another matter. Use a specialised regulator? "You'd be in all sort of compost if, and it's inevitable, it was hard to get", said the Irishman-who-walks-on-water. Point there. We looked at some op-amp and transistor regulator circuits, tried one or two, but thermal overload protection was unavailable and the circuits got a little complex — and expensive. Back to the three-terminal regulator and scouring of ▶

### SPECIFICATIONS — ETI-162 PROTECTED POWER SUPPLY

Output voltage	1.3—30 V, variable
Output current	0—1 A, variable limiting
Output regulation	better than 0.2% zero to full load
Hum and noise on output	less than 1 mV at full load
● LED indicates current limiting mode	
● Output terminals isolated from chassis	







# bench supply

under the rear mounting nut nearest the mains terminal block by punching a hole in the appropriate place in the bent-up piece — see the internal photograph.

Assemble the 317 regulator and TIP32 transistor to the heatsink next. Insulate each with a mica or plastic thermal washer and bolt insulators. Using a multimeter, check that the metal tag of each device is not shorted to the heatsink. Bend the leads of each device up from the heatsink.

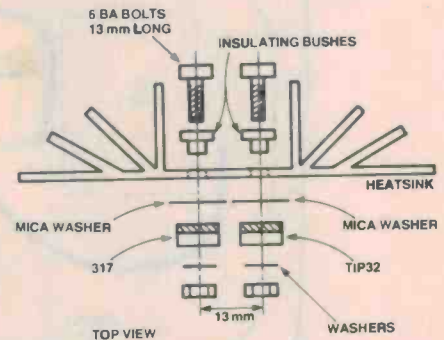

Mounting the 317 regulator and TIP32 transistor to the heatsink.

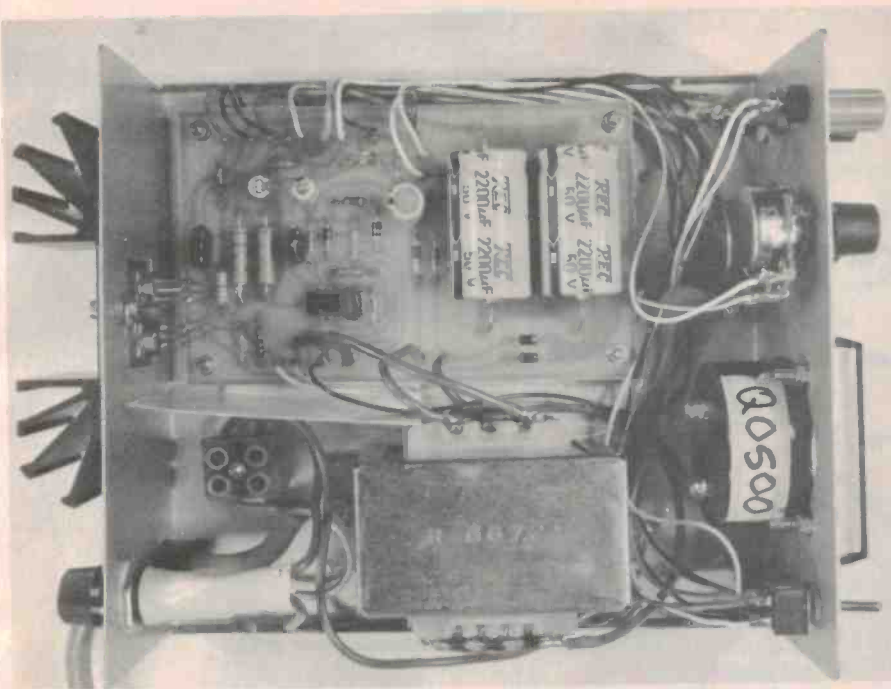

Overall internal view of the power supply. Note the cardboard 'shield' separating the mains terminal block and leads from the pc board.

## Construction

For most electronic enthusiasts the mechanical work involved in a project is usually the tedious bit. We would expect most constructors to purchase a pre-punched and drilled chassis, but if you want to do it yourself or plan to use a different chassis, then start by carefully laying out and marking up the metalwork. Component placement is not critical, but we would suggest you keep a strict division between the mains components and wiring and the rest of the circuitry and components. If you're using the same chassis, or something similar, then our Scotchcal front panel artwork can be used as a template for the front panel. General placement of components can be determined from the photographs. The 184 x 70 x 160 mm chassis we used could have done with some bracing of the front and rear panels. Some small brackets could be made up from scrap aluminium pieces to do this job, if you wish. If you do this, tackle it first, but make sure the brackets won't foul any components attached to the panels.

If you're using the same chassis we used and all holes are prepared, first thing to do is apply the Scotchcal front panel. We made up a metal Scotchcal, rather than plastic, as it's more durable. Carefully lift the backing from one edge and align the edge on the chassis panel. Peel off the backing and carefully smooth the Scotchcal into place across the panel making sure it's correctly aligned as you go. When it's in place,

smooth out any bubbles by carefully rubbing them toward an edge. You can cut out the holes with a sharp penknife or modelling scalpel.

We also made up a metal Scotchcal label for the meter scale. Disassemble the meter and carefully apply the Scotchcal to the original scale, trim the edges if necessary and then re-assemble the meter.

If you want to make your own Scotchcals for this project, the artwork is reproduced on page 107 with a page of blue behind so that you can expose through the page.

Mount the meter to the front panel first, otherwise you will have great difficulty reaching the nuts that secure it as they will be obscured by other components. Then mount the LEDs, switches, pots (and their knobs) and output terminals. On the rear panel, mount the mains fuse and install the mains cable with its clamp grommet, leaving enough of the cable protruding inside the case so that it reaches the terminal block. Mount the terminal block on the chassis bottom next, then terminate the mains cable. Make sure the green and yellow earth lead is the longest so that it's the last to break in the event of a catastrophic accident.

Insert the four pc board mounting bolts next. We used 13 mm long 6 BA bolts. Put two nuts on them to space the pc board up from the chassis. Cut a 'shield' for the mains wiring from a 70 x 70 mm piece of heavy cardboard, bend up one edge about 8 mm in and secure it

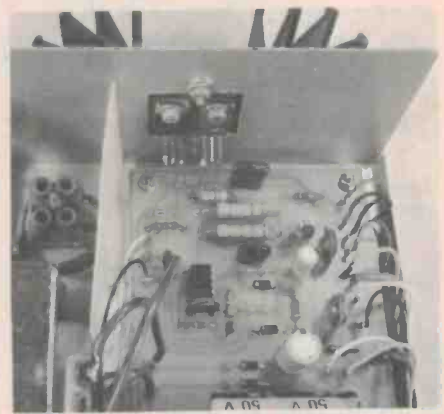

Internal view of the power supply showing mounting and terminating details for the regulator and transistor. These are assembled to the heatsink as shown above and the heatsink mounted to the rear panel using bolts above and below the cutout visible here.

Now you can attach flying leads to all the components mounted on the front panel and between the mains terminal block and fuse to the mains switch. Put heatshrink tubing over the mains fuse and mains switch, ensuring they are well covered. Make sure all leads are long enough to reach their destination. Solder C7 to the terminals of RV1 and D9 to the output terminals, as shown in the overlay and wiring diagram.

Mount the power transformer next, oriented such that its 240 Vac input terminals are away from the pc board. Terminate the leads from the mains switch to the transformer primary connections, using heatshrink tubing again to shroud the terminals.



# Project 162

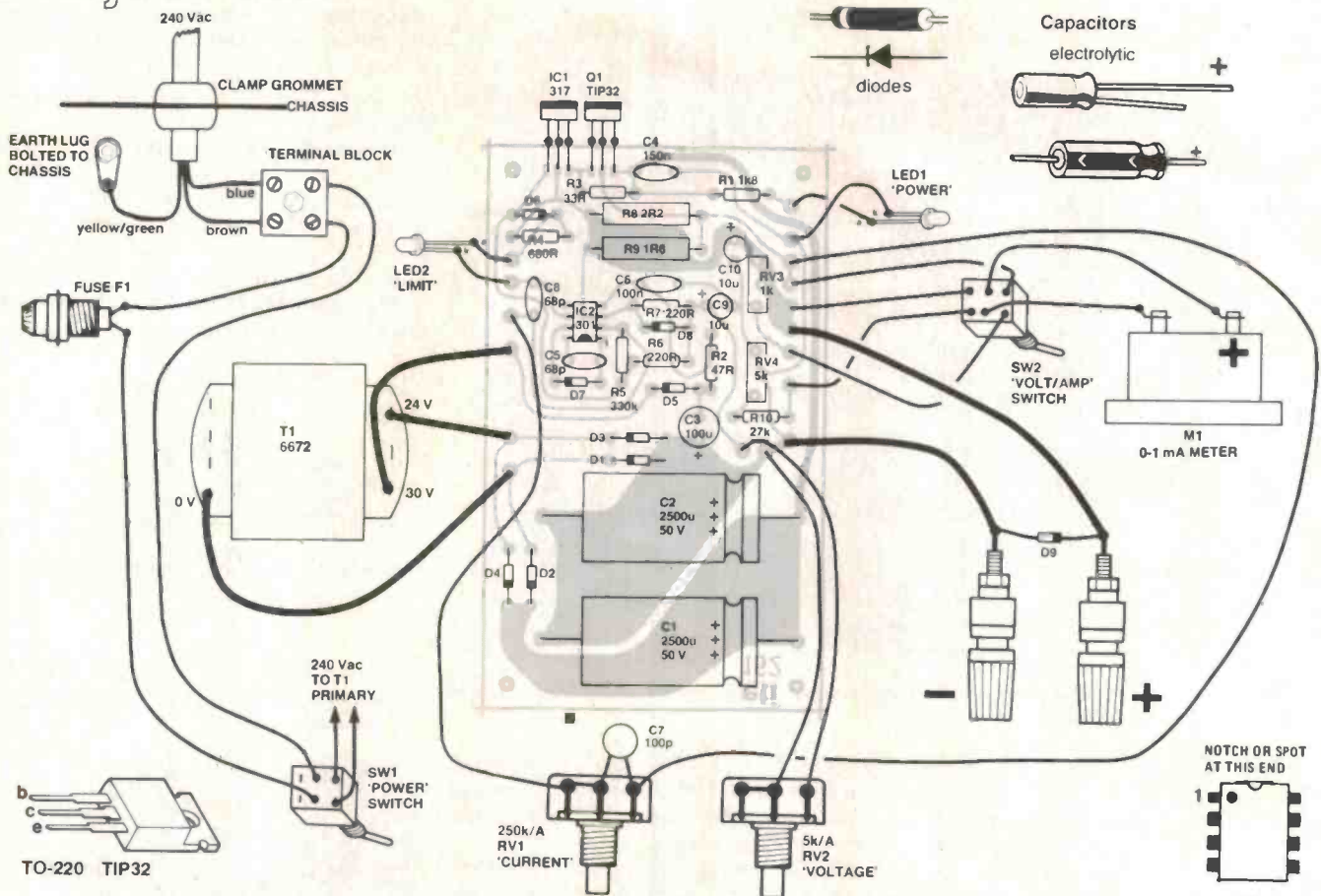

## PARTS LIST — ETI-162

### Resistors

all 1/2W, 5% unless noted
R1 ..... 1k8
R2 ..... 47R
R3 ..... 33R
R4 ..... 680R
R5 ..... 330k
R6, R7 ..... 220R
R8 ..... 1R8, 1W
R9 ..... 2R2, 1W
R10 ..... 27k
RV1 ..... 250k lin. pot.
RV2 ..... 5k lin. pot.
RV3 ..... 1k min. vertical mount trimpot
RV4 ..... 5k min. vertical mount trimpot

### Capacitors

C1, C2 ..... 2500u/50 V axial electro.
C3 ..... 100u/25 V RB electro.
C5, C8 ..... 68p ceramic
C6 ..... 100n greencap
C7 ..... 100p ceramic
C9, C10 ..... 10u/35 V RB electro.

### Semiconductors

D1-5, 8, 9 ..... 1N4001, 1N4002, 1N4004, EM401 ... etc.
D6-D7 ..... 1N914, 1N4148
IC1 ..... LM317T, uA317UC
IC2 ..... LM301, uA301
Q1 ..... TIP32A, B or C

### Miscellaneous

F1 ..... 0.5 A, 3AG fuse
M1 ..... 1 mA MU-45 meter, or similar
SW1, SW2 ..... DPDT miniature toggle switches, 250 Vac/1 A rated.
T1 ..... 6672 transformer, 240 V primary, 30 V/1 A multi-tapped secondary.

ETI-162 pc board; two binding posts — one red, one black; case — metal, U-chassis & lid type; 184 x 70 x 160 mm (e.g. D.S.E. H2744, Aitronics H0444, Electronic Agencies HE1742); two small knobs; mains cable, clamp grommet and terminal strip; fuseholder; Scotchcal panel and meter scale; heatshrink tubing; heatsink — flat sided radial fin type, 30 mm long (e.g. Rod Irving HS1); nuts, bolts, hookup wire etc.

### Price estimate

**\$45 — \$50**

Note that this is an estimate only and not a recommended price. A variety of factors may affect the price of a project, such as — quality of components purchased, type of pc board (fibreglass or phenolic base), type of front panel supplied (if used), etc — whether bought as separate components or made up as a kit.

Now you can tackle the pc board. Start with all the resistors. Then mount the two trim pots. Next, solder all the semiconductors in place. It is *most important* you get all of these the right way round, especially the rectifier diodes. The capacitors can be mounted next. There are five electrolytics and all have to be mounted with the correct orientation. Note that the two filter capacitors are given as 2500 uF in the parts list but the photograph shows 2200 uF types. Either can be used without affecting circuit operation at all. Remember, electrolytic capacitors have a very wide tolerance (like +80%, -20%). We used pc stakes to terminate the leads from the off-board components. You could use short lengths of 22 gauge tinned copper wire with a loop bent at the top, if you wish. Six 30 mm lengths of tinned copper wire are needed to connect the 317 and TIP32.

Carefully check the pc board to see that all components are mounted and the semiconductors and electrolytics are correctly polarised. Mount the pc

board and terminate the flying leads from all the off-board components. Use heavy duty hookup wire from the transformer secondary to the board and from

the output terminals to the board.

All OK? *Check it!*

Now you're ready to switch it on and try it out. ▶



BILL EDGE'S

# ELECTRONIC AGENCIES

115-117 Parramatta Rd. Concord 2137  
(Corner Parramatta Rd & Lloyd George Ave)  
Telephone (02) 745 3077 (two lines)  
117 York St. Sydney Phone 29 2098

Mail Orders: NSW & ACT ONLY VIC. SA. QLD. TAS. WA. NT

PO Box 185	\$1	— \$ 9.99	\$1.50	\$1	— \$ 9.99	\$2.50
Concord	\$25	— \$49.99	\$3.50	\$25	— \$49.99	\$5.00
2137	\$50	— \$99.99	\$4.50	\$50	— \$99.99	\$6.00
	\$100	or more	\$5.50	\$100	or more	\$7.50

**bankcard**  
welcome here

TRADING HOURS  
BOTH STORES  
Mon-Fri ..... 9 am-5.30 pm  
Thursday ..... 9 am-8 pm  
Saturday ..... 9 am-12 pm

What else do we carry? **HI-FI ★ KITS ★ TEST EQUIPMENT ★ SEMICONDUCTORS ★ COMPONENTS ★**  
All prices correct and goods in stock at time of going to press. Please phone to check current availability.

## "Merry Christmas!!!"

**ET15000 1/3 OCTAVE GRAPHIC EQUALIZER KIT,**  
Absolutely complete kit which includes pre punched chassis, all IC sockets, metal film resistors, and all the quality components you would expect from an Electronic Agencies kit.  
See ETI Nov 82  
KE5060 **\$199.00**  
or two for **\$389.00**



**NEW ARLEC SECURITY BEAM**  
Protect the doorways in shops, medical surgeries, reception areas and the home etc. The unit projects an infra red beam across a doorway to a reflector.  
LE8655 **\$59.90**



**FREEZER ALARM KIT**  
See EA Oct 82  
KE1627 **\$21.50**  
This beaut little kit will buzz you when your freezer fails. Complete with box and all parts

**NEW BOGGLE GOGGLES KIT**



See EA Dec. 82.  
KE0196 **\$9.50**

**NEW O-30V POWER SUPPLY**  
See ETI Dec. 82.



KE1940 **\$48.50**

**SPEAKER PROTECTOR KIT**  
See ETI Oct 82  
The ultimate in speaker protectors. Needs no power supply. unit runs from amplifier output signal.  
Suits amplifiers from 20-1000 watts  
Parts list only kit KE2077 **\$18.50 mono.**

**1/2 PRICE DOME MIDRANGE. PHILIPS ADO210/S08**  
BUY TWO FOR THE PRICE OF ONE.  
CE2082 WAS \$32.00

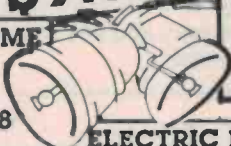

**DC-DC INVERTER KIT**  
See ETI Sept 82  
Suitable for running ETI power modules ETI470, ETI477, ETI480, ETI499 from 12 volts. Full kit.  
KE1700 **\$35.00**

**SUPER SIREN.**  
Ultra loud (over 100db) alarm beeper device built around a Motorola Piezo tweeter.  
Complete kit including piezo tweeter KE1055  
See EA Nov 82. **\$22.00.**

**SUPER TWEETER**  
Available again for a limited period. Plessey HO16N17 Horn Power 50 watts RMS  
Freq resp 5K-40 KHZ  
SPL 96db 1w/1mt  
CE2016 STILL ONLY **\$18.00 ea**

**ELECTRIC FENCE KIT**  
See EA Sept 82  
KE1635 **\$15.00**  
Coil not included.

**PLESSEY 12" WOOFER.**



This price can never be repeated.  
90 watt handling, about 50w RMS  
Foam rubber surround  
beautiful white cone  
Freq response to 3500 hz  
SPL 92db 1w/1mt  
CE2140 Res. freq 25 hz  
ONLY **\$25.00 each**

**POWER UP.**  
Switch all your HiFi equipment on with the flick of one switch. Just unplug your power leads from your Tuner, Amplifier, Equalizer, Cassette Deck, etc and plug them into the Power Up and Whammo, by switching off your Amplifier, you switch the power off on everything else.  
KE1940 Complet Kit  
See EA Nov 82. **\$39.50.**

**NEW DRIVEWAY SENTRY KIT**

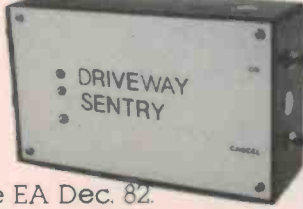

See EA Dec. 82.  
KE1088 **\$32.00**

**300 WATT INVERTER KIT**  
See June 82 EA  
Run your 12 volt appliances in your car. Great for power strikes. Kit includes everything even handles  
KE4085 **\$195.00**

**STEREO SYNTHESIZER KIT**  
Refer E/A Sept '82  
KE3020 **\$55.00**  
This kit gives you stereo sound from a mono source, like your video







Internal view from the rear of the front panel.

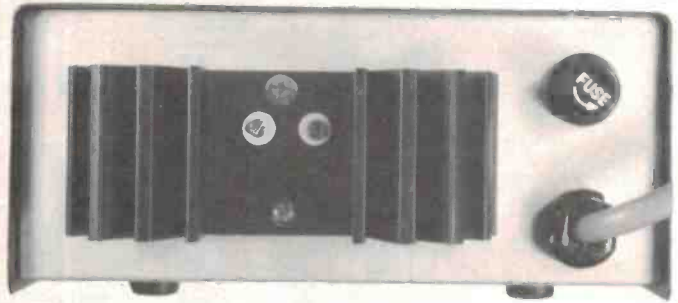

View of the rear panel showing heatsink and mains fuse placement.

### Switch on

Set the CURRENT and VOLTAGE control to about half rotation and the VOLT/AMP switch to read volts on the meter. Hook your multimeter to the output, switched to the 30 V range or a higher one, plug in and switch the power supply on. If all is well, the POWER LED should light and the multimeter will read some voltage. The power supply meter will probably read something quite different. If you don't get these indications, switch off and look for a wiring error or components misplaced or incorrectly oriented.

If all is well, set the VOLTAGE control so that you get a reading of 20 V on your multimeter. Then, adjust RV4 (the trimpot nearest the front panel) until the power supply meter reads the same. Vary the VOLTAGE control and check that the supply's meter corresponds closely with the multimeter. See that you get around 1.3 V at minimum and 30 V (within 0.5 V) at maximum.

Turn the power supply off. Wind the VOLTAGE control fully anticlockwise and set the CURRENT control half way. Set the VOLT/AMP switch to read current on the supply's meter. Switch your multimeter to the 1 A range, or higher. Turn the power supply on. The LIMIT LED should light and the multimeter should indicate about half an amp of current flowing. The supply's meter will likely read something quite different. Wind up the CURRENT control so that your multimeter reads one amp. Adjust RV3 (nearest the back panel) so that the supply's meter reads the same. Vary the CURRENT control and see that the supply's meter corresponds closely to your multimeter. The LIMIT indicator should go out when the CURRENT control is at minimum.

If at any time you don't get the correct indications, or worse still — burning smells!, switch off and hunt for a fault.

If all is well, you can put the lid on your supply and put it proudly on your workbench.

### Using it

In use, you set the output voltage to what is required by the circuit you are working on then apply a short to the output terminals and set the current limit to something a little above what you judge the circuit will draw. With most CMOS circuitry, even that containing many ICs, 100 mA is a good safe limit. Allow for relay and indicator (LEDs, lamps etc) currents. A little experimentation will teach you what to expect under a wide range of circumstances.

We trust you get many useful years of use from your ETI-162 power supply. ●

**NOTE:** this supply is not meant to be used as a battery charger so don't connect lead-acid batteries to it. Accidental reverse connection of a lead-acid car battery will likely destroy D9 and maybe other components. Nickel-cadmium batteries could be charged from the supply operated in the constant-current mode and D9 will prevent damage to the supply if you accidentally reverse-connect them. However, take the usual precautions regarding the charging period and charging current.

## BILCO ELECTRONICS

SHOP 2, 31 PULTNEY STREET, DANDENONG, VICTORIA, 3175. TELEPHONE (03) 791 8655

## INDUSTRIAL RADIO REMOTE CONTROL

*"Billco Electronics would like to wish  
all E.T.I. readers a  
very Merry Christmas."*



# NEW! NEW! JAYCAR★

## Walkie Talkies Sensational price for X'tal controlled units



Sensational price for CRYSTAL CONTROLLED UNITS!! Not your super-regen rubbish!! Don't be fooled! These units actually do work - well in fact. Will transmit voice or morse over fairly respectable distance (over a mile in ideal conditions). Fitted with proper transmit/receive crystal controlled superhet circuitry. DO NOT COMPARE with far inferior units that may only be a dollar or so cheaper anyway and almost always are a disappointment. At only \$12.50 each, how could you go wrong?

only \$12.50

## AT LAST!! INTERNATIONAL STANDARD (IEC 320) 240V APPLIANCE CONNECTOR

You asked for it and here it is. Fully approved 240V mains Inlet to International Standard IEC 320.

- Front or rear panel mount
  - 240V AC 6A rating
  - Accepts IEC 320 international power cords
  - Simplifies 240V wiring.
  - Quick-connect/solder on terminals.
- We also have the IEC 320 line plug assembly for ONLY \$4.95.

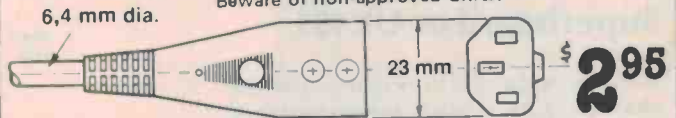

Beware of non-approved units!

## low cost balanced mic transformer

Sensational price for a completely MU-metal shielded unit!!

Until now you had to pay a fortune for a shielded balanced tranny!

- 2-600 ohm (CT) input/output
  - 50k output/input
  - Can be used either way round
  - Standard 9mm bushing mount
  - Colour coded leads.
- Don't pay over \$30!!!

\$17.50

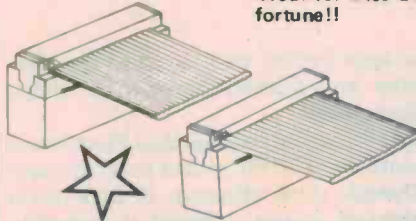

## NEW! INSULATION DISPLACEMENT CONNECTORS & RIBBON CABLE!!

I.D. Insulation displacement. The quick and reliable way of making multiple connections to computer peripheral connectors. Great for Disc Drives, Printers etc. Crimp them yourself and save a fortune!!

WE NOW CARRY

- CONNECTORS:
- 16 pin DIP HEADER \$1.99
  - 24 pin DIP HEADER \$2.50
  - P.C. Edge Connector 34 way (Suits 5 1/4" Disc Drives) \$8.50
  - 25 Pin Cannon 'D' Male \$8.95
  - 25 Pin Cannon 'D' Female \$8.95
- CABLE:
- 16 way \$1.50/metre
  - 25 way (suit DB25's & 24 way DIP) \$2.50/metre
  - 34 way for Disc Drives \$3.45/metre

## MAGAZINE BINDER

Keep your precious (and expensive) magazines in order for easy reference. Smart blue colour with gold lettering. Heavy gauge and richly chromed metal fittings. LOW IMPORT PRICE ONLY \$4.95 4 up \$4.50 each



## LOW-COST COLLET-TYPE KNOBS

"Made in England" Quality. Economical slide-on fit to any 1/4" shaft pot with flat (i.e. Soaner or Jaycar pot.) Dull black finish on body with choice of SEVEN bright coloured snap-in tops.

- Knob body ONLY \$0.50 ea 1-9 \$0.45 ea 10+
  - Caps ONLY \$0.10 ea any quantity
- Cap Colours: Red, Green, White, Yellow, Grey, Blue and Black

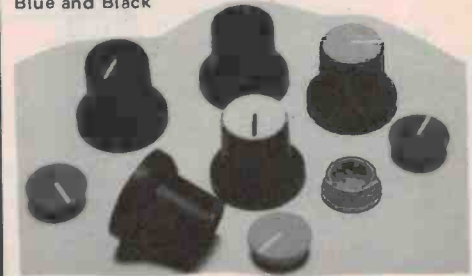

## Cannon XL connectors - great new range

5 pin and right angle types now in stock.

DESCRIPTION	PRICE
3 pin male line	\$3.50
3 pin female line	\$3.95
3 pin male chassis	\$3.25
3 pin female chassis	\$3.95
5 pin male line	\$6.95
5 pin female line	\$7.95
5 pin male chassis	\$3.95
5 pin female chassis	\$6.95
240V Mains line	\$6.50
240V mains chassis	\$5.25
3 pin male right angle line (Neutrik)	\$4.95
3 pin female right angle line	\$5.95
3 pin female line (Neutrik)	\$4.95
3 pin male line (Neutrik)	\$3.95

## SCR AND TRIAC SELLOUT!!!!

We only have VERY SMALL quantities of some.

Part No.	Description	Rating	VARMAX	PRICE
BT137/500	TRIAC	8 amp	500	\$1.50
BT139/600	TRIAC	16 amp	600	\$4.00
BT151/500R	SCR	12 amp	500	\$1.95
BT151/650R	SCR	12 amp	650	\$1.95
BTW24/600R	SCR	35 amp	600	\$2.95
BTW33/1000R	SCR (fast)	110 amp	1000	\$29.50
BTW38/1000R	SCR	16 amp	1000	\$4.95
BTW38/600R	SCR	16 amp	600	\$4.50
BTW41/500	TRIAC	40 amp	500	\$4.95
BTW43/800	TRIAC	15 amp	800	\$3.95
BTW92/1200R	SCR	31 amp	1200	\$9.95
BTY79/400R	SCR	16 amp	400	\$1.95



## superbright LED

The average 15 cent LED has a light output of 0.8mCd (milli Candelas) at 20mA. Can you imagine a 200mCd LED? (at 20mA)? Well if you can't - buy one and find out. They are ideal for panel illumination or very low current work. (They will still give useful light at 1mA!).

Red with clear lens - 69c each  
10 up only  
62c each. . . .

## Jaycar NUMBER 1 FOR KITS

125 York Street, Sydney 2000  
Phone: 264 6688 Telex: 72293

"Nevilles Corner"  
Cnr. Carlingford & Pennant Hills Road,  
Carlingford  
Phone: 872 4422

Mail Orders To: Box K-39 Haymarket  
Sydney 2000

POST AND PACKING CHARGES  
\$5-\$9.99 (\$1.20) \$10-\$24.99 (\$2.40)  
\$25-\$49.99 (\$3.50) \$50-\$99.99 (\$4.60)  
\$100 up (\$6.20)

NEW SHOP HOURS  
Mon-Fri 8.30 to 5.30pm  
Sat 8.30 to 12.00pm  
Thurs night to 8.30pm

MAIL ORDER BY  
BANKCARD VIA  
YOUR  
PHONE





# Ideas for Experimenters

These pages are intended primarily as a source of ideas. As far as reasonably possible all material has been checked for feasibility, component availability etc, but the circuits have not necessarily been built and tested in our laboratory. Because of the nature of the information in this section we cannot enter into any correspondence about any of the circuits, nor can we produce constructional details.

## Software selectable reverse video for the Superboard or UK101

Imagine being able to switch from white characters on a black screen to black characters on a white screen under program control, just when those alien invaders are about to demolish your last laser turret. Neil Westgarth of Modbury Heights SA could and came up with this modification.

All you need is a spare half hour, a 1k resistor, a 74LS00 and a means to POKE a '1' or '0' to switch the video. In my case I use one bit of a PIA port, however if you have a bare board with no other modifications you can use pin 5 of U14 (ACIA) which is set high by POKE 61440,81 and low by POKE 61440,17. These POKEs have no effect on other operations.

As the video information to be displayed is stored in binary form, i.e: '1' = white dot and '0' = black dot, it is a simple matter to switch an inverter in

the appropriate port of the video circuitry and thereby reverse the video information.

All the modifications that I have seen to date use a DPST switch to do this and although it is effective it is a little awkward in use. I found it desirable to have it software switchable. The relevant circuit information can be found on OSI supplied circuits sheet 10 of 13.

As shown U42 is a 74LS165 shift register whose Q output is used to shift

the video information to pin 2 of U70. The modification involves cutting this connection and then selecting either pin 9 (Q op) or pin 7 (Q op, previously unused) through to pin 2 of U70 as before. The same modification is done to the UK101 except that U42 and U70 become IC42 and IC70 respectively.

The 74LS00 and resistor can be mounted on the prototyping area of the superboard. Remember to take care when cutting or soldering to the pc board traces.

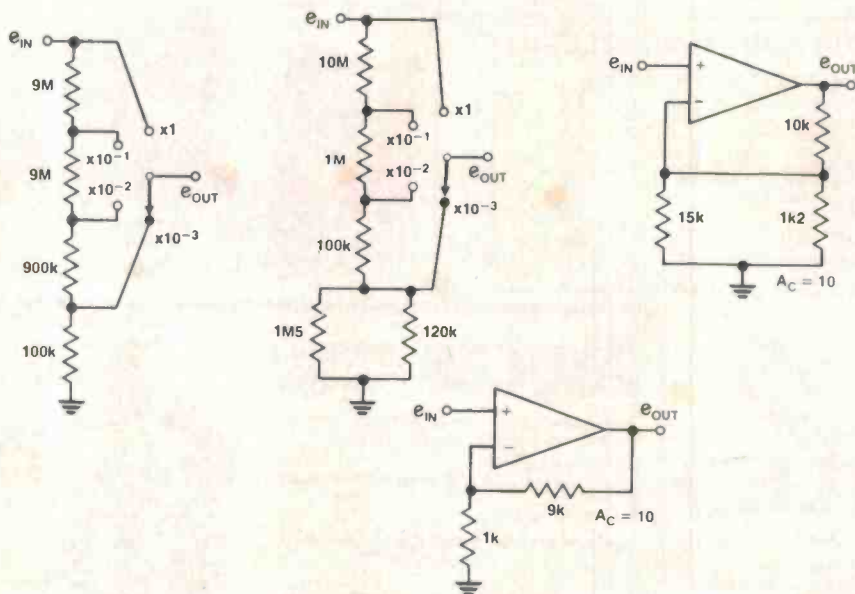
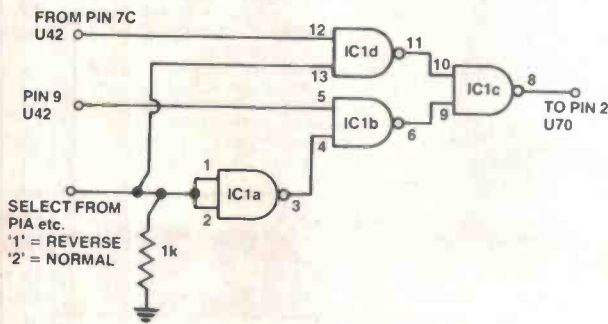

## Voltage divider

Graham Taylor of Caulfield South, Victoria wanted to divide a voltage by a multiple of 10 and found the following circuit in application notes. This was all very well but then he couldn't buy a 900k resistor.

So then I started thinking about using different valued resistors. If you parallel 1.2 and 15 you get 1.1. Aha! So now I use dividers as shown. Now it's possible to go to your average hobby shop and buy 1% resistors off the shelf and not mess around with trying to make up 900k.



# ALL ELECTRONIC COMPONENTS

118 LONSDALE STREET, MELBOURNE, VIC. 3000. TEL: 662-3506.

**WE STOCK THE LARGEST RANGE OF KITS AND PRINTED CIRCUIT BOARDS IN AUSTRALIA AS WELL AS OUR HUGE RANGE OF COMPONENT PARTS AND VALVES.**

## STEREO UNITS

- S1 ETI 484 Compressor Expander
- S2 ETI 482 50 watt per channel Amplifier
- S3 ETI 482A Preamp Board
- S4 ETI 482B Tone Control Board
- S5 ETI 485 Graphic Equalizer
- S6 ETI 480 50 watt Amplifier less H/S & bracket
- S7 ETI 480 100 watt Amplifier less H/S & bracket
- S9 ETI 443 Expander Compressor
- S10 ETI 444 Five watt stereo
- S12 ETI 438 Audio Level Meter
- S13 ETI 440 25 watt Stereo Amplifier including metalwork
- S18 ETI 426 Rumble Filter
- S19 ETI 429 Simple Stereo Amplifier
- S21 ETI 417 Over led Distortion Monitor
- S33 E.A. Musicolour III 1000 w/ch
- S35 ETI 470 60 watt audio amplifier module
- S36 ETI 4000 Series 60 watt stereo amplifier
- S37 ETI 451 Hum Filter for Hi-Fi systems
- S38 E.A. Stereo Infrared Remote Switch
- S39 ETI 455 Stereo Loudspeaker Protector
- S40 E.A. Super-Bass Filter Less Power Pack
- S42 E.A. Stylus Timer
- S43 ETI 3000 Series Amplifier 25 w/ch
- S44 ETI 477 Mosfet power amp module inc. brackets
- S45 ETI 457 Scratch/Rumble Filter
- S46 ETI 458 VU Level Meter
- S47 ETI 479 Bridging Adaptor
- S48 ETI 5000 Series Power Amplifier

## STAGE

- ST1 ETI 592 Light Show Controller (3 ch.) (1000 w/ch)
- ST2 ETI 593 Colour Sequencer (for use with ETI 592)
- ST3 ETI 551 Light Chaser 3 ch. 1000 w/ch
- ST4 E.A. Light Chaser 3 channel
- ST5 E.A. Twin Tremolo for Organs/Stage Amps
- ST6 E.A. Light Chaser
- ST7 ETI 499 150 w Mosfet P.A. Module
- ST8 ETI 498/499 150 w Public Address Amplifier
- ST9 E.A. Musicolour IV  
all prices are inclusive of sales tax

## PRE-AMPLIFIER AND MIXERS

- P1 ETI 445 Stereo Pre-amplifier
- P2 ETI 449 Balance Mic Pre-amplifier
- P6 ETI 419 Mixer Pre-amplifier-4 ch. Mixer Pre-amplifier-2 ch.
- P7 ETI 401 F.E.T. 4 Input Mixer
- P10 E.A. Playmaster 145 Mixer
- P11 ETI 446 Audio Limiter
- P12 ETI 471 High Performance Stereo Pre-amplifier-less F/P & Backing Plate
- P13 ETI 477 Moving Coil Cartridge Pre-Amp
- P14 ETI 474 High to low Impedance Interface
- P15 ETI 467 4 Input Guitar/Mic. Pre-amp suits ETI 466-includes power supply
- P16 E.A. Moving Coil Pre-Amplifier (Battery)
- P17 E.A. Moving Coil Pre-Amplifier (Plug pack)
- P18 ETI 478 MM Moving Magnet Pre-amp (Series 5000)
- P19 ETI 478MC Moving Coil Pre-amp (Series 5000)
- P20 ETI 478 Series 5000 Pre-Amplifier
- P21 E.A. Vocal Cancellor

## GUITAR UNITS

- G1 ETI 447 Audio Phaser
- G2 ETI 413 2-100 watt Bridge Amplifier
- G5 ETI 413 100 watt Guitar Amplifier
- G6 ETI 410 A.D.U. for your Guitar
- G14 ETI 452 Guitar Practice Amplifier
- G15 ETI 466 300 watt Amp module-less H/s & Transformer
- G16 ETI 454 Fuzz Sustain less foot switch
- G17 HE 102 Guitar Phaser
- G18 ETI 450A Bucket Brigade
- G19 ETI 450B Mixer for above
- G20 E.A. guitar Pre-amplifier
- G21 Sonics ME2 Sonics ME2 Wah Wah Pedal-less pedal

## AUDIO TEST UNITS

- AT1 ETI 441 Audio Noise Generator
- AT2 ETI 128 Audio Millivolt Meter
- AT4 ETI 102 Audio Signal Generator
- AT5 E.A. A.F. Tone Burst Generator
- AT7 ETI 137 Audio Oscillator
- AT9 HE 105 Bench Amplifier (less case)
- AT10 E.A. Audio Test Unit
- AT11 E.A. Function Generator

## TIMERS

- T1 ETI 650 STAC Timer
- T2 ETI 564 Digital Wall Clock
- T3 E.A. Universal Timer and Stopwatch
- T4 ETI 540 Universal Timer

## COMMUNICATION EQUIPMENT

- CE1 ETI 711 Remote Control Transmitter Switch
- CE2 ETI 711R Remote Control Receiver
- CE3 ETI 711D Remote Control Decoder
- CE4 ETI 711B Single Control
- CE5 Double Control
- CE6 ETI 711P Power Supply
- CE7 ETI 707A 144 Mhz Converter
- CE8 ETI 707B 52 Mhz Converter
- CE9 ETI 708 Active Antenna
- CE11 ETI 780 Novice Transmitter
- CE12 ETI 703 Antenna Matching Unit
- CE18 E.A. All Wave I/C 2
- CE21 E.A. Fremodyne 4 RF Section
- CE29 E.A. Short Wave Converter for 27 Mhz
- CE31 E.A. 27 Mhz Pre-amp
- CE32 E.A. 10-30 Mhz Pre-amp
- CE33 ETI 718 Shortwave Radio
- CE34 ETI 490 Audio Compressor
- CE35 ETI 721 Aircraft Band Converter (less XTALS)
- CE36 ETI 726 6 or 10 metre Power Amp
- CE37 ETI 475 Wide Band A.M. Tuner
- CE38 E.A. Masthead Pre-amplifier
- CE39 ETI 731 R.T.Y. Modulator
- CE40 ETI 729 UHF TV Masthead Preamp. (less external box)
- CE41 ETI 735 UHF to VHF TV Converter
- CE42 HE 104 AM Tuner (less case)
- CE43 HE 106 Radio Microphone (less case)
- CE44 E.A. R.T.Y. Demodulator
- CE45 E.A. Voice Operator Relay

## METAL DETECTORS

- MD1 ETI 549 Induction Balance Metal Detector includes wire for search head
- MD2 ETI 561 Metal Locator less dowel and tubing, potplant stand
- MD3 ETI 1500 Discriminating Metal Locator (undrilled case)
- MD4 ETI 1500 Discriminating Metal Locator (predrilled case)
- MD5 ETI 562 Geiger Counter with ZP 1310 Tube
- MD6 ETI 566 Pipe and Cable Locator
- MD7 E.A. Prospector Metal Locator including headphone

## TEST EQUIPMENT

- TE2 ETI 133 Phase Meter
- TE4 ETI 129 R.F. Signal Generator
- TE6 ETI 706 Marker Generator
- TE8 ETI 122 Logic Tester
- TE9 ETI 124 Tone Burst Generator
- TE11 ETI 116 Impedance Meter
- TE15 ETI 704 Cross Hatch Dot Generator
- TE16 ETI 120 Logic Probe
- TE17 ETI 121 Logic Pulser
- TE34 ETI 487 Read Time Audio Analyser
- TE35 ETI 483 Sound Level Meter
- TE36 ETI 489 Read Time Audio Analyser
- TE37 ETI 717 Cross Hatch Generators
- TE38 E.A. 3 Mhz Frequency Counter
- TE42 E.A. Transistor Tester incl. BiPolar & F.E.T.S.
- TE43 ETI 591 Up Down Pre-settable Counter
- TE44 ETI 550 Digital dial (less case) includes ETI 591
- TE45 ETI 144 Expanded Scale R.M.S. Voltmeter
- TE46 ETI 148 Versatile Logic Probe
- TE47 ETI 724 Microwave Oven Leak Detector
- TE48 ETI 150 Simple Analog Frequency Meter
- TE49 ETI 151 Linear Scale Ohm Meter
- TE50 ETI 152 Linear Scale Capacitance Meter
- TE51 E.A. Digital Capacitance Meter
- TE52 ETI 589 Digital Temp. Meter
- TE53 E.A. T.V. C.R.O. Adaptor less Power Pack
- TE54 E.A. XTAL Locked Pattern Generator
- TE55 E.A. Decade Resistance Sub Box
- TE56 E.A. Capacitance Sub Box
- TE57 E.A. Decade Capacitance Sub Box
- TE58 E.A. Tantalum Capacitance Sub Box
- TE59 ETI 140 1 Ghz Frequency Meter/Timer
- TE60 ETI 572 PH Meter

**WE HAVE NOW BEEN APPOINTED OFFICIAL INTERSIL DISTRIBUTORS AND ARE CURRENTLY STOCKING SUPPLIES OF THESE FABULOUS PRODUCTS IN CONJUNCTION WITH ALL OUR OTHER COMPONENTS.**

- TE61 ETI 135 Panel Meter
- TE62 E.A. Modulated Signal Injector
- TE63 HE 103 Transistor Tester
- TE64 HE 111 Ohm meter
- TE65 ETI 157 Crystal Marker
- TE66 ETI 161 Digital Panel Meter
- TE12 ETI 533 Digital Display

## MODEL TRAIN UNITS (see also "SOUND EFFECTS")

- MT1 ETI 541 Model Train Control
- MT2 E.A. 1974 Model Train Control
- MT6 E.A. 1978 Train Control less Front Panel
- 1978 Train Control with Front Panel

## SOUND EFFECTS

- SE1 E.A. Sound Effects Generator\*
- SE2 E.A. Musical Tone Generator
- SE3 E.A. Cylon Voice
- SE4 E.A. Steam Whistle
- SE5 ETI 607 Sound Effects
- SE6 E.A. 492 Audio Sound Bender
- SE7 E.A. Electronic Sea Shell Sound Effects \*set as for Steam Train and Prop Plane noise

## VOLTAGE/CURRENT CONTROLS

- V1 ETI 481 12 volt to  $\pm 40$  v D.C. 100 watt Inverter
- V2 ETI 525 Drill Speed Controller
- V6 E.A. 1976 Speed Control
- V8 E.A. Inverter 12v D.C. input 230v 50hz 300 VA output
- V10 E.A. Zero-voltage switching heat controller
- V11 E.A. Inverter 12v D.C. input 230v 50hz 300VA output not incl. switch 35 amp.

## WARNING SYSTEMS

- WS1 ETI 583 Gas Alarm
- WS3 ETI 528 Home Burglar Alarm
- WS4 ETI 702 Radar Intruder Alarm
- WS7 ETI 313 Car Alarm
- WS12 ETI 582 House Alarm
- WS14 E.A. 1976 Car Alarm
- WS15 E.A. 10 Ghz Radar Alarm
- WS16 E.A. Light Beam Relay
- WS17 ETI 247 Soil Moisture Indicator
- WS18 ETI 250 Simple House Alarm
- WS19 ETI 570 Infrared 'Trip' Relay (including plug pack)
- WS20 ETI 585 T&R Ultrasonic Switch
- WS21 ETI 330 Car Alarm
- WS22 ETI 322 Dver Rev Car Alarm incl. case
- WS23 ETI 1505 Fluorescent Light Inverter
- WS24 ETI 1506 Xenon Bike Flasher

## PHOTOGRAPHIC

- PH1 ETI 586 Shutter Speed Timer
- PH3 ETI 514B Sound Light Flash Trigger
- PH4 ETI 532 Photo Timer
- PH7 ETI 513 Tape Slide Synchronizer
- PH12 ETI Sync-a-Slide
- PH14 ETI 558 Mast Head Strobe
- PH15 ETI 553 Tape Slide Synchronizer
- PH16 E.A. Digital Photo Timer
- PH17 ETI 594 Development Timer
- PH18 ETI 568 Sound or light operated Flash Trigger including optional parts
- PH19 E.A. Sound Triggered Photoflash
- PH20 HE 109 Extra Flash Trigger
- PH21 E.A. Photographic Timer

## POWER SUPPLIES

- PS1 ETI 132 Experimenters Power Supply
- PS2 ETI 581 Dual Power Supply (High Powered Version)
- PS3 ETI 712 CB Power Supply
- PS4 ETI 131 Power Supply
- PS6 ETI 105 Laboratory Power Supply
- PS7 ETI 111 I/C Power Supply
- PS9 E.A. 1976 Regulated Power Supply
- PS11 E.A. C.B. Power Supply
- PS12 ETI 142 Power Supply 0-30 V 0-15 A (fully protected)
- PS13 ETI 472 Power Supply
- PS14 E.A. Power Supply for Dream 6800
- PS15 ETI 577 Dual 12V supply
- PS16 E.A. Power Saver

- PS17 ETI 480 PS Power Supply for ETI 480 (100 watt Amp.)
- PS18 E.A. Bench Mate Utility Amplifier/Power Supply
- PS19 HE 108 Power Supply

## COMPUTER AND DIGITAL UNITS

- C1 ETI 633 Video Synchronizer
- C2 ETI 632M Part 1 Memory Board V.D.U.\*
- C3 ETI 632P Part 1 Power Supply V.D.U.\*
- C4 ETI 632A Part 2 Control Logic V.D.U.\*
- C5 ETI 632B Part 2 Control Logic V.D.U.\*
- C6 ETI 632C Part 2 Character Generator V.D.U.\*
- C8 ETI 632 U.A.R.T. Board\*
- C9 ETI 631-2 Keyboard Encoder\*
- C10 ETI 631 A/Sch. Keyboard Encoder (less keyboard\*)
- C14 ETI 638 Eprom Programmer
- C15 ETI 637 Cuts Cassette Interface
- C16 ETI 651 Binary to Hex Number Converter
- C17 ETI 730 Getting Going on Radio Tele Type
- C18 E.A. Dream 6800 Computer for Beginners less keyboard and cover
- C22 ETI 660 Basic Computer
- C23 ETI 660 Basic Computer incl. colour option on board expandable memory, RF modulator, case and power supply
- C24 ETI 760 Video RF Modulator
- C25 E.A. Eprom Programmer \*all V.D.U. projects priced less connectors

## BIO FEEDBACK

- BF1 ETI 546 G.S.R. Monitor (less probes)
- BF2 ETI 544 Heart Rate Monitor
- BF3 ETI 576 Electromyogram

## AUTOMOTIVE UNITS

- A1 ETI 317 Rev. Monitor
- A2 ETI 081 Tachometer
- A3 ETI 316 Transistor Assisted Ignition
- A4 ETI 240 High Power Emergency Flasher
- A6 ETI 312 Electronic Ignition System
- A7 ETI 301 Vari-Wiper
- A14 E.A. Dwell Meter
- A15 E.A. Variwiper
- A16 E.A. Tacho for Tune-ups
- A17 E.A. Ignition Analyser and Tachometer
- A18 E.A. Strobe Adaptor for Ignition Analyser
- A19 E.A. 1975 C.D.I. Capacitor discharge Ignition
- A22 ETI 318 Digital Car Tachometer (less metalwork)
- A23 ETI 319A Variwiper Mk. 2 (no dynamic braking)
- A24 ETI 319B Variwiper Mk. 2 (for dynamic braking)
- A25 ETI 555 Light Activated Tacho
- A26 ETI 320 Battery Condition Indicator
- A27 E.A. Transistor Assisted Ignition
- A28 ETI 324 Twin Range Tacho less case
- A29 ETI 328 Led Oil Temp Meter less V.D.D. probe
- A30 ETI 321 Auto Fuel Level Alarm
- A31 ETI 332 Stethoscope
- A32 ETI 325 Auto Probe Tests Vehicle Electricals
- A33 ETI 333 Reversing Alarm
- A34 E.A. Low fuel Indicator
- A35 ETI 326 Led Expanded Voltmeter
- A36 ETI 329 Ammeter (expanded scale)
- A37 ETI 327 Turn and Hazard Indicator
- A38 ETI 159 Expanded Scale Voltmeter

## ELECTRONIC GAMES

- EG1 ETI 043 Heads and Tails
  - EG2 ETI 068 L.E.D. Dice Circuit
  - EG3 E.A. Electronic Roulette Wheel
  - EG4 ETI 557 Reaction Timer
  - EG5 ETI 814 Dinky Die
  - EG6 E.A. Selector
  - EG7 HE 107 Electronic Dice
  - EG8 E.A. Photon Torpedo
  - EG9 HE 123 Alien Invaders
- ## MISCELLANEOUS KITS
- M1 ETI 604 Accentuated Beat Metronome
  - M4 ETI 547 Telephone Bell Extender
  - M5 ETI 602 Mini Organ (less case)
  - M7 ETI 044 Two Tone Doorbell
  - M10 ETI 539 Touch Switch
  - M25 E.A. Digital Metronome
  - M37 ETI 245 Combination lock (less lock)
  - M39 E.A. Electronic Combination lock (including lock)
  - M46 E.A. Power Saver for induction motors
  - M48 E.A. Lissajous Pattern Generator
  - M53 ETI 247 Soil Moisture Alarm
  - M54 E.A. Electrochune Keyless Organ
  - M55 E.A. Pools/Lotto Selector
  - M56 ETI 256 Humidity Meter
  - M57 ETI 257 Universal Relay Driver Board
  - M58 E.A. Simple Metronome

Note: We do not stock sub-standard poor quality components  
**TRADE AND RESELLER ENQUIRIES WELCOME.**

**ALL AT NEW DISCOUNT PRICES**



# PRICEBREAKERS Our Savings Are Tops!

## 6V BATTERIES

DRY-CHARGED  
LEAD-ACID  
ACCUMULATORS

**\$8.99**



IDEAL FOR BURGLAR ALARMS,  
PORTABLE VIDEO/STEREO  
EQUIPMENT, TOYS, BIKES,  
ETC. SIZE 120x130x60MM.

## BATTERY CHARGER

or POWER SUPPLY  
**6 VOLT DC 1A**



**\$5**

IDEAL CHARGER FOR THE  
6V BATTERIES ABOVE!  
AUST. MADE BY FERGUSON  
AND FITTED WITH 3 CORE  
MAINS LEAD, FUSEHOLDER  
AND INDICATOR LIGHT.  
METAL CASE 100x70x58MM

## TV PCB'S

From AMA, these new circuit boards  
have over 80 parts incl. 8 trans,  
(25C1014, 25C711, 25A673, 25A628,  
25C620), 10 diodes, caps, resistors,  
triodes, etc. GREAT VALUE HERE!



**\$1 EACH**  
10 FOR  
**\$8.00**



Push-Button  
**TUNER  
BOARDS**

**\$3 EACH**  
10 For  
**\$25.**

Complies 7 boards, one has 8xDPDT  
push-button switches, similar to  
Isostat - the other has 8x300K  
multi-turn potentiometers with 3 position  
band-change switches. LTD. QTY.

## 12 VOLT SIEMENS CRADLE RELAYS

**\$2**



Double  
pole  
on-off  
contacts  
normally open

Regular price is over \$4.00 for this quality!

## Telescopic AERIALS

for  
TV's

170 to 875mm  
POPULAR TYPE

Pack of 10  
\***\$16**

and swivels  
**\$1.95**

## COMPUTER VDU & KEYBOARD



•240V AC MAINS  
•GREEN SCREEN MONITOR  
•KEYBOARD EASILY ENCODED  
•SELF-CONTAINED CABINET WITH MODERN "SWEEP-BACK" STYLE

**\$169**

10 only ex-computer (from a famous manufacturer) terminals avail.  
for desk-top mounting. Late model, untested but assumed working.  
Standard video input to monitor, keyboard output easily inter-  
faced to hobbyist computer. MAIL ORDERS - FREIGHT ON BY COMET!

## AM/FM STEREO RADIO CASSETTE WITH SPEAKERS



AUTO-STOP, FAST  
FORWARD,  
WARRANTY.

**\$79**



## 4 NEW PA AMPS



•ALL WITH SIREN,  
FOG HORN SOUND.  
•LATEST, MODERN,  
COMPACT STYLING.  
•DETAILS, SPECS,  
AVAIL WITH S.A.E.

12V MARINE MODEL WITH REMOTE MIKE CONTROL  
Features- power level meter, siren/fog horn switch with  
manual or auto select, 4 switched speaker outputs, all  
with intercom facility, 20 WATTS rms output power.

**\$185**

12V MARINE MODEL WITHOUT REMOTE MIKE  
Features as above but only 3 speaker outputs.

**\$152**

240VAC/12VDC MODEL WITH 20WRMS OUTPUT  
Features- siren/fog horn switch, mike and aux. volume  
controls, 4/8/16 ohms output imped. inputs for radio  
cassette recorder, tuner, tape deck, mike 200-50k ohm.

**\$159**

240VAC/12VDC MODEL WITH 50WRMS OUTPUT  
This model illustrated above.  
Features- 2 mike inputs, siren/fog horn and 4 tone chime  
switch, 4/8/16 ohms plus 25/70/100 volt outputs, other  
features as above.

**\$249**

## AUDIO MIXERS



**\$99**

NEW IMPROVED MODEL!  
•2 Mic channels, 2 Phono channels, 1  
channel for tape or Tuner •Magnetic  
or Ceramic inputs •Tape outputs •2  
VU Meters to monitor output or CUE  
for each channel •Stereo or Mono  
•9V battery operation with ext. DC input socket  
•Size 265x195x70mm •Headphone monitor socket

## 4 CHANNEL PLUS MASTER GAIN MIKE MIXER

Same as above except has 4 side inputs,  
all high or low, and no cue controls

**\$68**

## 5 BAND STEREO GRAPHIC EQUALIZER

240vac MIXER

## THE PRO MODEL

•Facilities for 4 stereo program input and 2 mic. input  
•Impedance microphones  
•Professional stereo slide controls  
•Headphone outputs to monitor each input and output  
•Tape switch to attenuate music volume -14dB to mic) can be used  
without readjusting music level  
•5 channel stereo graphic equalizer section using separate slider controls  
•Meters monitor the output of left and right channels independently.

BONUS: WITH ANY MIXER  
PURCHASE THIS MONTH  
WE WILL SUPPLY  
FREE HEADPHONES

## MIKE MIXER

A new basic model mixer with 4 inputs, all  
compensated for low to high impedance mics.  
Mono or stereo output, battery operated.

**\$34**

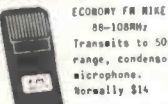

ECOBONY FM MIKE  
88-108MHz  
Transmits to 50a  
range, condenser  
microphone.  
Normally \$14

**\$10**

## FANS



Ex-computer  
5 inch  
**115v \$8**  
**220v \$10**

## LIGHT DIMMER KITS OR MOTOR SPEED CONTROL

700 watt  
capability  
WITH  
RFI  
SUPPRESSION

**\$4.95**  
OR  
**2 FOR \$9.00**

## TRIMPOTS

Save!  
Buy  
100  
for \$8  
or  
10  
for \$1

CHOICE OF -  
100, 470, JK,  
10K, 25K, 50K,  
220K, 500K, 2K

## YOKES FOR COLOUR TV'S

MANUFACTURERS EXCESS STOCK!  
Brand new picture tube deflec-  
tion yokes for AMA 63cm H  
chassis and 53 cm K chassis  
TV sets.

sale price  
at **\$8** EA

## TAKE OFF 25%

## ex-computer ELECTROS

FULLY GUARANTEED, TESTED!

21,000uF .75V	\$2.50
20,000uF .10V	\$3.50
90,000uF .10V	\$6.00
4,600uF .15V	\$2.00
15,000uF .15V	\$4.00
120,000uF .15V	\$9.00
7,200uF .20V	\$4.00
10,000uF .20V	\$5.00
46,000uF .20V	\$7.50
58,000uF .20V	\$8.00
8,200uF .25V	\$4.00
12,000uF .25V	\$4.50
19,000uF .25V	\$6.00
22,000uF .25V	\$6.50
50,000uF .25V	\$8.00
71,000uF .25V	\$9.00
2,000uF .30V	\$1.50
16,000uF .30V	\$5.00
35,000uF .30V	\$6.50
37,000uF .30V	\$7.50
40,000uF .30V	\$8.00
8,200uF .40V	\$4.00
6,500uF .45V	\$9.00
8,000uF .45V	\$7.00
15,000uF .63V	\$9.00
6,300uF .75V	\$4.00
22,000uF .75V	\$11.00
14,500uF .100V	\$12.00
1,700uF .150V	\$4.00
3,100uF .150V	\$6.00

This is a sample of our huge  
range, please ask for others

## NUMERIC KEYPADS

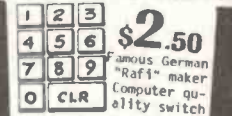

**\$2.50**

Famous German  
"Rafit" maker  
Computer qual-  
ity switch  
11 keys 18x18mm, long  
life, for PCB mtg.

**PACK  
& POST**  
\$2.00 PLUS 5%  
OF ORDER VALUE

## \* LOWER PRICES \*

- Transistor Substitute, Jap 1981 .....\$3.00
- 12v to 6.9, 12vDC 800mA car converter .....\$6.00
- 240v electronic lamp flasher 300K .....\$2.95
- Lesson power mike with compression .....\$14.95
- 30kHz CB low pass filter stops TVI .....\$2.50
- Quality Ralmar C-60 cassettes .....2 for \$1.00
- 100yd rolls multi-strand hook-up wire .....\$3.00
- GE C37D 400v 35amp SCR's, stud mtg .....\$2.00
- 560uF + 47uF 160v can electrolytics .....\$2.00
- NE-2 neons, 20c ea or 10 for \$1 or 100 @ \$8.00
- Philips NT3100, NT3101 or NT3122 EHT  
transformers \$4.00 ea or 5 for \$15.00
- 3AG in-line fuseholders, now only 5 for \$1.00
- 8 ohm magnetic earpieces, 1m cord, 5 for \$1.00
- DPDT slider switches, PCB mtg, 7 for \$1.00
- 6.5mm stereo headphone sockets, 2 for \$1.00
- 3PDT rocker action switch, buy 3 for \$1.00
- uA741 TO-5 case op-amp IC's, 4 for \$1.00
- 25C-515A only \$1.00 ea or 25D-198 only \$2.00
- EM-410 1000v lamp rectifiers, 8 for \$2.00
- 0.47uF Greencaps 100v, 10 for \$2.50, 50 for \$3.00
- 10uF 16v, 47uF 16v, 100uF 10v caps ea. 3c
- 4.7uF 100v, 22uF 100v, 47uF 25v caps ea. 10c
- 50uF 100v, 220uF 16v, 1uF 350v caps ea. 15c
- 2.2uF 350v, 330uF 35v, 10uF 315v ea. 20c
- 220uF 50v, 400uF 40v, 640uF 16v caps ea. 25c
- 220uF 63v, 330uF 50v electro caps ea. 30c
- 15uF 500v, 470uF 50v electro caps ea. 40c
- 470uF 63v, 15uF 500v electro caps ea. 50c

## Dynamic stereo headphones

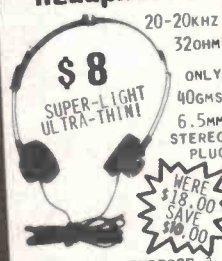

**\$8**

20-20KHZ  
32OHM  
ONLY  
40GMS  
6.5MM  
STEREO  
PLUG  
BONUS: DUAL-PURPOSE 3.5  
TO 6.5mm ADAPTOR FREE!

## VIDEO GEAR

- 14 pin female plug.....\$10.55
- 14 pin male plug.....\$10.30
- 10 pin female plug.....\$8.90
- 10 pin male plug.....\$8.90
- RF-Video switcher.....\$39.50
- Video enhancer.....\$84.95
- Image stabilizer.....\$74.95

**PRE-PAK**  
electronics p/1

1a WEST ST,  
LEWISHAM, NSW

**569-9797**  
24 HR PHONE ORDER SERVICE

SEE THE HUGE RANGE IN-STORE!  
IF YOU THINK WE PACK A LOT INTO OUR ADS,  
YOU SHOULD SEE WHAT'S IN OUR SHOPS!







## JIL SX-200, A BETTER SCANNING MONITOR RECEIVER.

Covers 26-88 MHz & 108-180 MHz  
& 380-514 MHz



Monitors over 33,000 frequencies from 26 to 88 MHz, 108 to 180 MHz and 380 to 514 MHz. Bands included within this range are HF and UHF CB, 27 and 155 MHz MARINE, Australian LOW BAND, AIRCRAFT band, VHF SATELLITE band, 10 Mx, 6 Mx, 2 Mx and 70CMx AMATEUR BANDS, VHF High BAND as well as UHF two-way band.

Mechanically rugged the SX-200 uses high quality double-side Epoxy-Glass printed circuit boards throughout. Some of its other outstanding features include 3 MODE SQUELCH circuitry which allows the lockout of spurious and carrier only signals, extremely low spurious count, AM and FM detection on all bands, FINE TUNING control for off channel stations, 240 VAC on 12 Volt DC operation, Accurate QUARTZ CLOCK, Squelch operated OUTPUT for switching a tape recorder etc, 16 Memory channels, MEMORY BACKUP which lasts up to two years, high SENSITIVITY and SIGNAL-TO-NOISE ratio on all bands, CRYSTAL FILTER for excellent SELECTIVITY and easy serviceability due to component layout as well as a 90 day warranty.

Its high quality and performance is testified by the fact that it is in use by a large number of State government and Federal bodies including most state and federal police departments.

Contact GFS, the Australian Distributors, or our interstate outlets for full technical specifications.

We also market a range of pocket scanning receivers and transceivers. Contact us for full details.

PRICE \$525 INCL S.T. + \$8 P&P  
SERVICE MANUAL \$10 + \$1 P&P  
SCAN-X BASE ANTENNA \$54 + \$8 P&P

Interstate Dealers:  
WA: (09) 387 4966  
NSW: (02) 211 0531  
QLD: (07) 397 0808  
SA: (08) 269 4744

### GFS Electronic Imports

15 McKeon Road  
Mitcham, 3132 Vic  
TLX 38053 GFS  
(03) 873 3939

## TALKMATE

### "HANDS-FREE" VHF FM POCKET TRANSCEIVER

The TALKMATE is a compact transceiver with VOX operation to allow complete "HANDS-FREE" two-way radio communications over short ranges. Ideal for use by surveyors, film crews, plumbers, electricians, firemen, road engineers, crane operators, sports shooters, farmers, etc. etc. In T.V. studios, search and rescue operations, car parks, theatres, hospitals, factories, tour parties, etc. etc.

COMPACT TRANSCEIVER  
(fits in your shirt pocket)

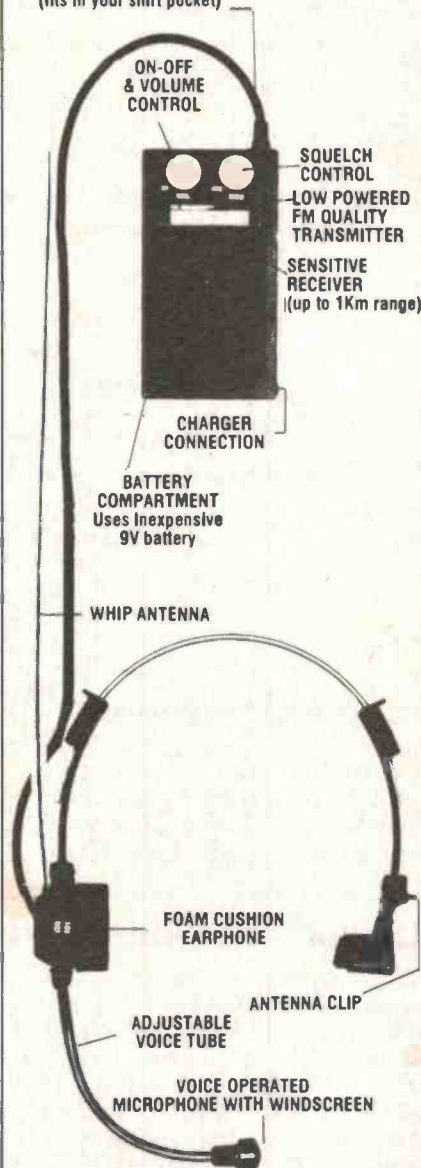

## I M A R K

PROPRIETARY LIMITED

167 RODEN ST.,  
WEST MELBOURNE, 3003  
Phone (03) 329 5433 Telex: AA37753

## 3M BRAND

Photosensitive  
● Products ●

### SELF ADHESIVE ALUMINIUM OR PLASTIC FILM

- \* BLACK, BLUE OR RED  
"ON ALUMINIUM"
- † BLUE, BLACK, GREEN, RED  
"ON WHITE FILM"
- "ON CLEAR FILM"

### 3M BRAND "I.N.T."

"Image 'n Transfer"

### BLACK OR WHITE Graphic TRANSFER Material for

\*Architects, Draftsmen,  
Map Makers, Illustrators,  
Key Liners

†A.V. Producers,  
Layout Artists

**WE STOCK IN DEPTH**  
MAJOR SUPPLIERS  
INDUSTRY, SCHOOLS.

### INTRODUCTORY KIT SPECIAL \$56.80 + S.T.

Telex, Phone Toll Free  
or Write

### PROMPT DELIVERY Maximum Charge \$3.00

**KALEX** 101 Burgundy St,  
Heidelberg 3084  
(03)458 2976  
Melton  
Telex AA37678 (03)743 1011

**ELECTRONIC COMPONENTS &  
ACCESSORIES SPECIALIST  
SCHOOL SUPPLIERS**



# Ideas for Experimenters

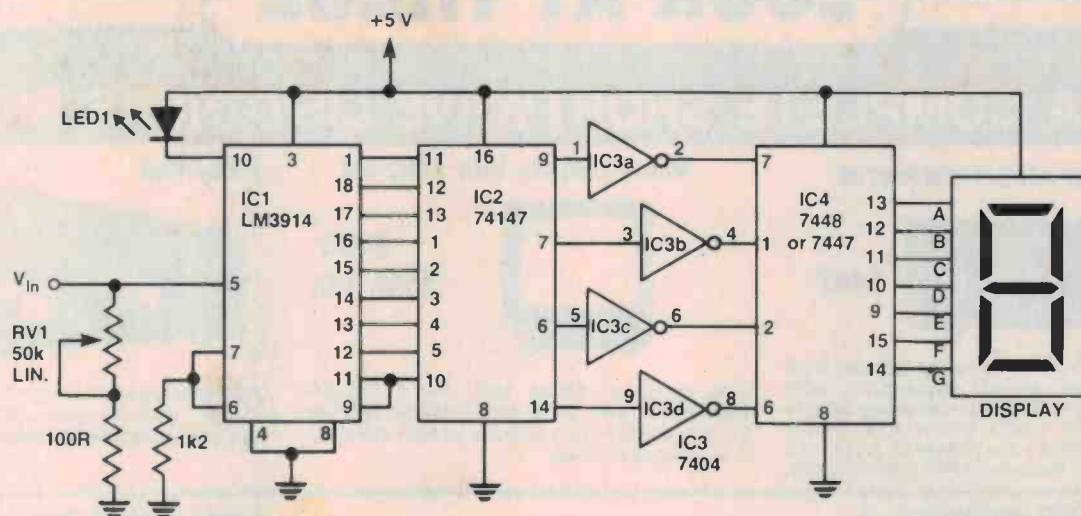

## Simple 'flash' type A/D converter

The LM3914 dot/bar LED driver is put to use in this circuit to form the basis of a so called 'flash' type analogue-to-digital converter. This device (IC1) will send one of its ten comparator outputs low in response to a voltage applied to its input. Which output will go low is determined by that voltage. The outputs of the LM3914 are fed to the inputs of a 9-line to 4-line BCD priority encoder (IC2), the outputs of which are inverted by IC3 and taken to the inputs of a BCD to 7-segment decoder (IC4). If a voltage is applied to the input of IC1, one of its outputs will go low (as stated before-

hand) which, in turn, sends one of IC2's inputs low and its 4-bit BCD equivalent will be set on IC2's output. This is then decoded to 7-segment format, by IC4.

Full scale deflection can be adjusted by RV1. As there are ten outputs from IC1 and only nine inputs to IC2, a LED is connected to the tenth output of IC1 and this effectively functions as an over-range indicator.

The LM3914's outputs change linearly, but if logarithmic changes are needed the LM3915 could be used. It must also be noted that for a full scale deflection of say 12 volts, each output will only

change state when the voltage on its comparator input rises at least 1.2 V above the previous comparator's threshold. (See Lab Notes, ETI March 1980 for more data.)

Despite this limitation the circuit could be used for joystick controls (two circuits per stick, leaving out IC4) for computer games, photo print meters, thermometers (where only a scale and not the exact temperature is required); in fact, anything requiring a non-critical one-digit readout from an analogue input.

## ★ IDEA OF THE MONTH

Brian King, Elizabeth Park S.A.

## 'IDEA OF THE MONTH' CONTEST

Scope Laboratories, who manufacture and distribute soldering irons and accessory tools, have offered to sponsor a contest with a prize to be given away every month for the best item submitted for publication in the 'Ideas for Experimenters' column — one of the most consistently popular features in ETI. Each month we will be giving away a Scope Panavise pc board holder, model 333 — as described in News Digest, p.8, October '81 issue. Selections will be made at the sole discretion of the editorial staff of ETI Magazine. Apart from the prize, worth about \$70, each winner will be paid \$10 for the item published. You must submit original ideas of circuits which have not previously been published. You may send as many entries as you wish.

### RULES

This contest is open to all persons normally resident in Australia with the exception of members of the staff of Scope Laboratories, Murray Publishing, Offset Alpine, Australian Consolidated Press and/or associated companies.

Closing date for each issue is the last day of the month. Entries received within seven days of that date will be accepted if postmarked prior to and including the date of the last day of the month.

The winning entry will be judged by the Editor of ETI, whose decision will be final. No correspondence can be entered into regarding the decision.



Winner will be advised by telegram the same day the result is declared. The name of the winner, together with the winning idea, will be published in the next possible issue of ETI.

Contestants must enter their names and address where indicated on each entry form. Photostats or clearly written copies will be accepted but if sending copies you must cut out and include with each entry the month and page number from the bottom of the page of the contest. In other words you can send in multiple entries but you will need extra copies of the magazine so that you send an original page number with each entry.

This contest is invalid in states where local laws prohibit entries.

Entrants must sign the declaration on the coupon that they have read the above rules and agree to abide by their conditions.

### COUPON

"I agree to the above terms and grant Electronics Today International all rights to publish my idea in ETI Magazine or other publications produced by them. I declare that the attached idea is my own original material, that it has not previously been published and that its publication does not violate any other copyright."

\* Breach of copyright is now a criminal offence.

Title of idea .....  
 Signature .....  
 Name .....  
 Date .....  
 Address .....  
 Postcode .....

Cut out and send to: Scope/ETI 'Idea of the Month' Contest, ETI Magazine, 15 Boundary St, Rushcutters Bay NSW 2011.



# LOOK AT THESE

## A COMPLETE SHORTWAVE LISTENERS RIG

### Telereader Model CWR-670E



**\$447**

This receiving converter takes audio output from your receiver and converts morse (CW), radio teletype (RTTY) and ASCII (computer) signals into text for display on a VDU. Converts almost any speed morse and all the standard RTTY and ASCII speeds and frequency shifts. Simple to use.

### Video Display Unit TMC-9M



**\$185  
incl. tax**

This compact display unit has a 210 mm diameter screen, an all-metal cabinet and two 75 ohm SO239 input sockets to take standard 1 V composite video.

### FRG-7700

**\$499**



The shortwave listeners dream; High Quality, medium price, general coverage communications receiver.

### THE INTELLIGENT RECEIVER IS YOURS, FOR DX IN THE 1980's



**NRD-515  
\$1595**

This new receiver is full of performance advantages including general coverage, all modes of operation, PLL digital VFO for digital tuning, 96-channel frequency memory (option), direct mixer, passband tuning, etc.

### MARC NR82F1 12 BAND COMMUNICATIONS RECEIVER



**\$310**

#### Features:

- ★ 12 bands LW/MW/4-SW/5-VHF/VHF with digital frequency
- ★ 3 way power AC/Battery/Car Battery
- ★ Frequency coverage 145 KHz to 479 MHz
- ★ 8 Microvolt sensitivity on VHF bands
- ★ Controls for squelch, RF gain, BFO antenna adjustment narrow/wide sensitivity, bass, treble, and direct taping facilities.

### THE DRAKE R7A

**\$2145**



Offers performance and versatility for those who demand the ultimate.

- ★ Continuous no compromise 0 to 30MHz frequency coverage
- ★ Full passband tuning (PBT) NEW! Noise Blanker Supplied as standard
- ★ State-of-the-Art features.

### 8510/8510P DOT MATRIX PRINTER



**8510  
8510P**

This compact desk top dot matrix serial impact printer is ideal for hard copying CRT displays, and for data communications and peripheral minicomputer terminals. Features include variable fonts, dot graphics, 4-copy capability, print speed of 100 characters per second, 136 characters per line.

### Dot Matrix Printer DP-8480

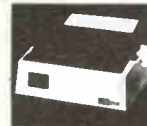

- ★ Low cost
- ★ Excellent printing quality
- ★ Logical Seeking carriage control for faster throughput
- ★ Graphics printing capability
- ★ Self-Diagnostic capability
- ★ 96 ASCII character set plus block graphics characters
- ★ Long life print head.

### KGN-12N DISPLAY MONITOR



Designed to fit Telereader equipment and computers with composite video output, the 12"

(31 cm) CRT displays up to 2000 characters, using an implosion proof green phosphor. Dependable 14 transistor circuitry with DC restoration for raster prevention.

### ALL NEW EMTRON 470



**\$299**

Introducing the latest in UHF CB ★ 6CH ★ hand held ★ smallest on the market ★ 1W output ★ repeater offset. Complete with CH 20 XTL, rechargeable nicad batteries and car adapter. XTL's for other channels and carry case available.

### Compact Sized Terminal Printer DP-8240



**\$349  
incl. tax**

- ★ Low cost
- ★ Compact and easy to use
- ★ Excellent printing quality
- ★ Graphics printing capability
- ★ Self diagnostic capability
- ★ 96 ASCII character set plus block graphics characters.

**EMTRONICS Sydney's Radio Communications Centre**

649 George Street, Sydney, NSW 2000. Ph: (02) 211 0531  
P.O. Box K21, Haymarket, NSW 2000



# Shoparound

THIS PAGE is to assist readers in the continual search for components, kits and printed circuit boards for ETI projects. If you are looking for a particular component or project — check with our advertisers if it is not mentioned here.

## ETI-162 Power supply

Every hobbyist needs a bench supply. If you've already got one, two you'll find three times as useful! All parts used in this project are available pretty well everywhere and kits will be widely stocked. In Perth, Altronics will have kits; in Melbourne, Rod Irving and All Electronic Components; in Sydney, Electronic Agencies and Jaycar; all over the country, Dick Smith Electronics.

## ETI-1508 Model train controller

This project will be available in various 'kit' forms from a number of suppliers. Some will have 'short form' kits only, others complete kits. In Sydney, Electronic Agencies and Jaycar will be stocking some form of this project. In Melbourne, Rod Irving Electronics will stock a kit and you might try All Electronic Components.

If you're customising your setup using the controller as a basis, then components should be widely available, nothing 'specialised' has been used, apart from the switches. However,

standard C&K types were used in the prototype and many suppliers stock them. In Sydney, Electronic Agencies and Jaycar stock a wide range; in Melbourne, Rod Irving Electronics and Radio Parts are good places to start.

Printed circuit boards can be obtained from the aforementioned suppliers and additionally, from suppliers listed on page 70 of the August issue.

## ETI-461 Preamp

Nothing out of the ordinary here, all parts are widely stocked. So far as we know, only Rod Irving will actually be stocking a kit. Printed circuit boards will be available from Jaycar and Electronic Agencies in Sydney as well as the suppliers listed on page 70 of the August issue.

## ETI-653 16 channel computer output driver

Altronics in Perth are now stocking this kit (November issue). Existing stockists are Electronic Agencies in Sydney and Rod Irving Electronics in Melbourne. Dick Smith Electronics has decided not to stock it after all.

## ETI-644 Modem

The list of suppliers stocking kits for this project has grown some since the October issue was published. Here is the total list of current suppliers, in

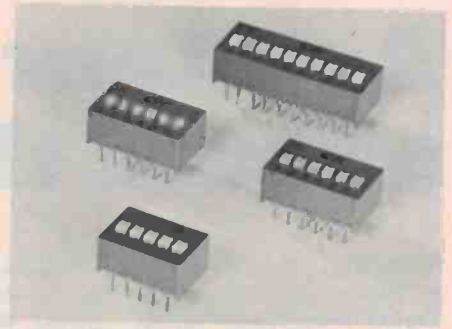

## NEW C&K DIP SWITCHES

These DIP switches are part of the new C&K range and would be suitable for any of our past projects specifying DIP switches. They are available in two-pole through 10-pole configurations with a positive detent slide mechanism that is said to all but eliminate accidental switching. Wiping contacts are gold over nickel with solder-clad or gold-plated terminals. Further information from C&K Electronics, now at their new address: 15 Cowper St, Parramatta NSW 2150. (02)635-0799.

alphabetical order: Altronics, Perth; Billco, Melbourne; Jaycar, Sydney; Microtrix, Melbourne and Rod Irving Electronics, Melbourne.

For those who can gather their own bits, printed circuit boards are still available at a cost of \$50 each, post free, from:

ETI-644 pc board

ETI Magazine

15 Boundary St

Rushcutters Bay NSW 2011.

For a list of parts suppliers who stock the specialist parts for this project, see the October issue, page 51.

## Bright Star Crystals Pty Ltd

PO Box 42, Springvale.  
Ph (03) 546-5076 Telex AA36004

Manufacturers of

**PIEZO ELECTRIC CRYSTALS**

Contractors to Federal and State Government Departments.

REPRESENTATIVES:

NSW: Master Communications,  
27 Woodville Rd., Granville N.S.W.  
(02) 682 5044.

SA: R.W. Electronics, 51 Woodville Ave.,  
Riddleton S.A. (08) 464 571.

# 36 years in the business

## AND STILL ON TOP

QLD: Fred Hoe & Sons P/L, 246 Evans Rd., Salisbury North, Brisbane.  
(07) 277 4311.

WA: Westest Electronics, 71 Jean St., Hamilton Hill 6161 (Mail Only)  
(09) 337 6393.

TAS: Dilmond Industries, PO Box 219, Bellerive, Hobart. (002) 47 9077.

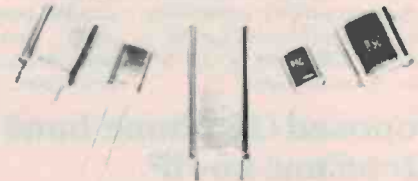

## CRYSTAL UNITS

- Decade Counting Units to 1 Hz.
- Wide Band Amplifier for your counter, 1MV sensitivity, band width 1-250 MHz.

Send SAE for new catalogue or quote for your requirements.





## Amateur radio to fly aboard the Space Shuttle?

Astronaut Dr. Owen Garriott, W5LFL has been granted tentative permission from NASA to use 2m FM from the Shuttle Columbia orbiter during the STS-9 mission scheduled to fly in October next year.

**Present plans call for Garriott to use a low power rig such as a handy talky or a 'black box' constructed in the ARRL Lab. The radio will be required to meet the rigid specifications of the shuttle as determined by NASA.**

ARRL president Vic Clark, W4KFC is personally overseeing the project for the League and it is expected that all coordination for the amateur portion of the STS-9 mission will be handled through Bernard Glassmeyer, W9KDR, the ARRL's satellite coordinator. AMSAT is also expected to play a significant role.

Garriott's amateur operation from Columbia will be limited to the lower 2 MHz of the band in the interest of making this a world-wide goodwill mission, and to avoid 20m-type pile-ups on US and Canadian

repeater systems.

The exact frequencies that will be used, as well as the proper procedure to work the spacecraft will be announced later.

To avoid confusion and pile-ups, several ideas are being considered, including the designation of specific repeaters around the world to act as 'gateway' stations through which all QSOs will be coordinated.

The approvals for this first manned space amateur experiment have been okayed by NASA in Houston and only await a final 'green light' from Washington.

Credit for this first belongs to the ARRL, along with Garriott and NBC Network News Correspondent Roy Neal, K6DUE according to Westlink Report.

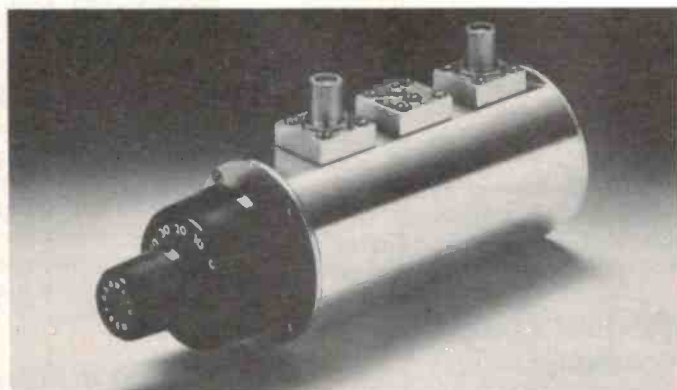

### Up or down a notch

**Two new dual-concentric rotary attenuators for operation up to 1 GHz and covering 0 to 50 dB in 1 dB steps have been released by Vicom recently.**

Made by the US-based JFW Industries, one model is for 75 ohm systems, the other for 50 ohm systems, each is designated 75DR-003 and 50DR-003 respectively.

Attenuation accuracy is claimed to be better than 0.5 dB up to 500 MHz and the attenuators can

handle an input power of 1 watt average or 1000 watt peak, according to JFW. Connectors available are BNC, TNC, N, SMA or F types.

Further details, pricing and availability are available from Vicom Melbourne, Sydney or Wellington (New Zealand).

### Amateur satellite TV?

**World-wide fast-scan amateur TV by satellite has been proposed by ATV pioneer Henry Rue, KB9FO in a recent letter to A5 Magazine, the journal of amateur TV experimenters.**

Rue suggests that amateur fast-scan TV experimenters build and orbit a satellite of their own with the intention of enhancing ATV operation.

He proposes a satellite carrying a 2 MHz-wide transponder capable of relaying 'fair quality' monochrome or reduced bandwidth heterodyned colour pictures. It would operate in either the 1240 MHz or 3.5 GHz C-band downlink region.

A5 Magazine has endorsed the proposal and pledged an initial US\$500 to a fund to get the project off the ground. Mike Stone, Editor of A5, has written to Cablesat General Corporation President Ray Kassiss WA40HK to ask that ATV be included in the Cablesat Amateur transponder proposal (see November issue Communications News), according to a recent issue of Westlink Report.

### Proposed US phone-band extensions on HF

**The ARRL has recommended to the US Federal Communications Commission (FCC) that all HF phone bands be extended, except on 40m (7 MHz), partially segmented by licence class. A chart of the proposed extensions appears below. (From Westlink Report.)**

Band	Extra & Above	Advanced & Above	General & Above
80/75	3.750 - 3.775	3.775 - 3.850	3.850 - 4.000
40	No change prop.	No change prop.	No change prop.
20	14.150 - 14.175	14.175 - 14.225	14.225 - 14.350
15	21.200 - 21.225	21.225 - 21.300	21.300 - 21.450
10	28.300 - 29.70*	28.300 - 29.70*	28.300 - 29.70*

\* No Novice or Technician privileges between 28.300 - 28.500 MHz.

### New directional HF antenna

**Model 4131 HF Sloping Triangle antenna from Antenna Engineering Aust. is a simple low cost broadband directional antenna designed for medium to long range transmission or reception.**

The antenna comprises two sloping wires resistively terminated at the centre point of the vee near ground level. The apex of the vee is supported by a suitable 15m mast. The antenna is fed via a balun transformer at the mast head. Installation is simple and can be readily undertaken by trained personnel.

This broadband antenna covers 5-30 MHz without adjustment. Power rating is optional to 1kW average. Power gain varies from 0 to 10 dBi depending on frequency.

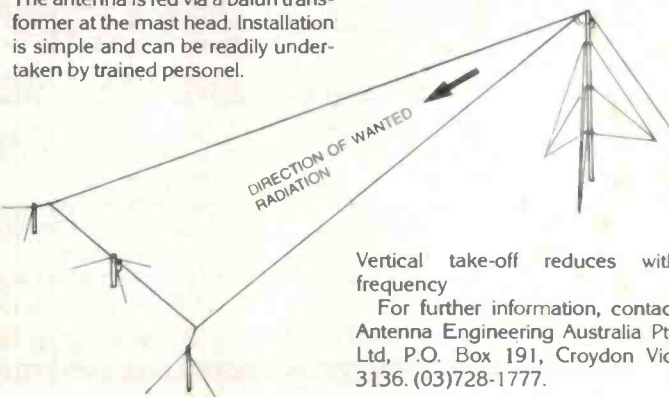

Vertical take-off reduces with frequency

For further information, contact Antenna Engineering Australia Pty Ltd, P.O. Box 191, Croydon Vic. 3136. (03)728-1777.



## Private launchings for amateur satellites?

The Amateur Satellite Corporation (AMSAT) had observers present at the first launch of the privately-owned 'Conestoga 1' American spacecraft.

Built and launched by Space Services International at a cost of US\$6 million, the Conestoga 1 carried a dummy payload of 400 lbs of water on its first flight late in September.

The craft was launched from Madagorda Island off the Gulf Coast of Texas and reached an altitude of 320 km (200 miles) before falling

into the Gulf about 480 km (300 miles) downrange.

S.S.I. officials said the launch was an overwhelming success and say that private enterprise is now firmly established in the space business. AMSAT have not commented at this stage. Fifty investors put money into the venture.

## Cut out the noise!

GFS Electronic Imports of Mitcham, Victoria, recently announced the availability of a new HF noise reducing antenna system called the 'Wandra'.

The antenna is designed to allow successful HF Communication directly from electrically noisy sites such as city and industrial locations in which ordinary antennas normally operate poorly.

The Wandra is a complete antenna system tuned specifically to the users' frequencies and is claimed to offer up to 30 dB of noise reduction on one, two or three frequencies using automatic switching and having a presel low VSWR. Noise reducing characteristics are maximum on the two frequency

version. All preset frequencies can be changed at a later date if necessary and feed impedance is 50 ohms.

An attractive feature, particularly for a city situation, is that only one mast is required to mount the Wandra. Designed to stand up to the elements, it is constructed using stainless steel, fibreglass and aluminium. (Wandra is an abbreviation for West Australian Noise Decreasing Radio Antenna.)

Contact GFS Electronic Imports, 15 McKeon Road, Mitcham Vic. 3132. (03)873-3939.

## UOSAT back to normal

Amateurs at the Stanford Research Institute in Palo Alto, California, were successful in using their 60' dish antenna to function off OSCAR 9's 2 m and 70 cm transmitters, thereby normalising the satellite.

UOSAT, built by AMSAT-UK in conjunction with the University of Surrey, was launched into orbit in October 1981 from Vandenberg AFB in California. Late in April this year, what was termed an "anomaly in its control system" caused both transmitters to be activated simultaneously, thereby desensitising both command receivers.

When it became apparent that no normal amateur station could punch through the 'RF curtain' created by the satellite's receiver desensitisation, a last-ditch attempt to save the bird and its experimental

package using the Stanford Antenna was decided upon.

That attempt was successful, and it is expected that AMSAT-UK will announce a new schedule for resuming experimentation with OSCAR 9.

UOSAT differs from previous OSCAR missions as it does not carry any relay transponders. Instead, its purpose is experimental, with collection of data and telemetry as its main function. When turned on, its main beacon can be heard at 145.825 MHz. (Westlink Report.)

## New UHF power/SWR meter

The Maldol HS450 power and SWR meter is now available from Imark Pty Ltd. The frequency range is quoted as 130 — 500 MHz and it has three power measuring ranges.

The unit is fitted with 'N' Type RF connectors. Insertion loss is quoted as less than 0.5 dB. The meter is designed for use with 50 ohm equipment. Dimensions are only 220 mm (w) x 66 mm (h) x 86 mm

(d). Power ranges covered are 5 W, 20 W and 150 W.

For further details, contact Imark Pty Ltd, 167 Roden Street, West Melbourne 3003. (03)329-5433.



# National

## A NEW WAVE IS ON THE HORIZON

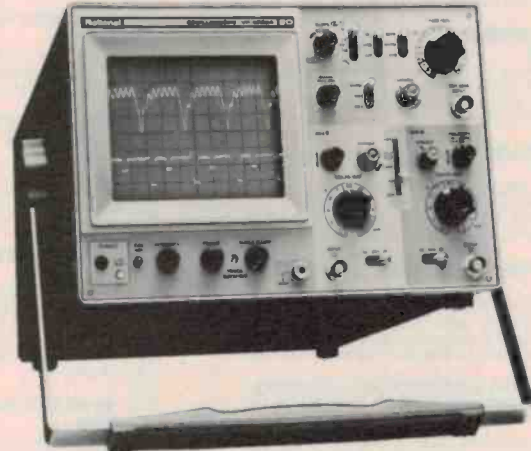

Available in four models these low cost oscilloscopes feature:

- 15-20-30 MHz.
- 1mV/Div sensitivity
- Stable automatic trigger 'AUTO FIX'
- Full range of triggering mode
- Bright and sharp CRT with Auto Fix
- TV(V) and TV(H) sync separator circuit
- Rectangular tube, illuminated internal graticule (VP-5220A and VP-5231A)
- Built-in delay line for observation of pulse transient (VP-5231A only)
- High reliability—MTBF 15,000 hours

National have a wide range of scopes—to 300 MHz. Please call or write for further information

...FROM \$399.00 (NOT INC. S.T.)

Probes supplied as standard accessory



SCIENTIFIC DEVICES AUSTRALIA PTY. LTD.

2 JACKS ROAD, SOUTH OAKLEIGH, VICTORIA, 3167.

TELEPHONE: 579 3622

P.O. BOX 63, SOUTH OAKLEIGH, VICTORIA, 3167. TELEX: AA32742

CABLES: DEVICES MELBOURNE

31 HALSEY ROAD, ELIZABETH EAST, S.A., 5112.

TELEPHONE: (08) 255 6575

35-37 HUME STREET, CROWS NEST, N.S.W., 2065.

TELEPHONE: (02) 43 5015



# OOPS! More books!

Mail order coupon on page 83.

**CHEAP VIDEO COOKBOOK**  
21524P \$11.75  
Complete discussion of a new, low-cost way to get words, pictures and opcode out of your computer and onto any ordinary TV screen, using a seven-IC easy-to-build circuit which you can build for less than \$20.

**AN INTRODUCTION TO VIDEO**  
BP100 \$6.56  
This book is written in layman's language and is for anyone who is thinking about buying or renting or who has just bought or rented a video recorder and wants to get the best out of the machine.

**MOBILE DISCO HANDBOOK**  
BP47 \$4.64  
Most people who start mobile discos know little about equipment or what to buy. This book assumes no preliminary knowledge and gives enough info to enable you to have a reasonable understanding of disco gear.

**ELECTRONIC MUSIC AND CREATIVE TAPE RECORDING**  
BP51 \$5.92  
Shows how electronic music can be made at home with the simplest and most inexpensive of equipment. Describes how the sounds are generated and how these may be recorded to build up the final composition.

**PRACTICAL CONSTRUCTION OR PREAMPS, TONE CONTROLS, FILTERS, ATTENUATORS**  
BP60 \$4.96  
This book shows the enthusiast how to construct a variety of magnetic tape recording, microphone and disc pre-amplifiers, and also a number of tone control circuits, rumble and scratch filters, attenuators and pads.

**ELECTRONIC SYNTHESIZER PROJECTS**  
BP81 \$5.92  
For the electronic music enthusiast, an invaluable reference. This book is full of circuits and information on how to build analogue delay lines, sequencers, VCOs, envelope shapers, etc. etc. The author takes a clear and logical approach to the subject that should enable the average enthusiast to understand and build up what appears to be a quite complex instrument.

**AUDIO PROJECTS**  
BP90 \$6.56  
Covers a wide range of audio projects including preamplifiers and mixers, power amplifiers, tone controls and matching etc. A number of board layouts and wiring diagrams are included.

**ELECTRONIC MUSIC PROJECTS**  
BP74 \$5.92  
Provides constructors with practical circuits for the less complex music equipment including fuzz box, waa-waa pedal, sustain unit, reverb and phaser, tremolo generator etc. Text covers guitar effects, general effects, sound generators, accessories.

**SONICS 1982 YEARBOOK**  
\$5.35  
An interview with Krathwerk, how to cope with recording, lighting, rock acoustics, guitars, equipment reviews and more.

**SONICS MAGAZINE**  
\$2.35 ea  
The Australian music magazine dedicated to the art and craft of sound. Published April, July, October, Yearbook in December. \$15 for one year subscription. Please indicate starting issue.

## computers for beginners

**COBOL FOR BEGINNERS**  
39378P \$21.95  
It is a solid text for introductory programming courses in Cobol, using a format that is easy to understand, yet comprehensive enough to make supplementary readings unnecessary.

**THE PET PERSONAL COMPUTER FOR BEGINNERS**  
61827P \$20.95  
This handy guide is written for use with all varieties of PET computer, from the original 2001 to the new 8032 Super PET. It is suited to novices with no practical experience and provides advice and practical examples.

**BIG THINGS FROM LITTLE COMPUTERS**  
77859P \$19.25  
A layperson's guide to personal computing with all the basic information and lots of examples of how personal computers can be used.

**BEGINNER'S GUIDE TO DIGITAL ELECTRONICS**  
BP61 \$3.36  
Covers all essential areas including number systems, codes, constructional and sequential logic, analogue/digital/analogue conversion.

**BEGINNER'S GUIDE TO MICROPROCESSORS & COMPUTING**  
BP66 \$5.92  
Introduction to basic theory and concepts of binary arithmetic, microprocessor operation and machine language programming. Only prior knowledge assumed is very basic arithmetic and an understanding of indices.

**A MICROPROCESSOR PRIMER**  
BP72 \$5.92  
Learning about microprocessors is easy with this book, written in a style that is easy to follow. The shortcomings of this basic machine are discussed and the reader is shown how these are overcome by changes to the instruction set. Relative addressing, index registers follow as logical progressions.

**AN INTRO TO BASIC PROGRAMMING TECHNIQUES**  
BP86 \$6.56  
Ideal for beginners seeking to understand and program in BASIC. Book includes program library for biorhythms, graphing Y against X, standard deviations, regressions, generating musical note sequences, and a card game.

**BEGINNING BASIC**  
39806A \$19.95  
Intended for beginners with no computing experience, one should be able to intelligently program in BASIC in a short time.

**BEGINNING FORTRAN**  
46011A \$19.95  
Starts with simple elementary examples and proceeds to intermediate level programs. Also includes references, tutorials, flow charts, deck set-ups and matrix algebra.

**UNDERSTANDING COMPUTERS**  
39815A \$17.95  
This book describes how computers work. For people who use small computers, it starts with the most elementary gates and works up to the complete computer. Gives an understanding of languages and how they operate in the computer.

**NAILING JELLY TO A TREE**  
39842A \$24.95  
This guide to software teaches you about machine language, assembly language programming and BASIC. The emphasis is not on learning to write programs but on learning to use the thousands of available programs that have already been written.

**PEANUT BUTTER AND JELLY GUIDE TO COMPUTERS**  
39813A \$14.95  
A simple, easy-to-digest source of information on personal computing for the potential buyer who is less than an expert in the field.

**INTRODUCTION TO WORD PROCESSING**  
88076A \$17.95  
Written for the non-technical reader, this book tells about the concepts common to all word processing systems, then analyses all features in detail.

**YOUR FIRST COMPUTER**  
88045A \$12.50  
An easy-to-understand beginner's book to small computers. Understanding them, buying them and using them for personal and business applications.

**FROM CHIPS TO SYSTEMS: AN INTRODUCTION TO MICROPROCESSORS**  
88063A \$19.95  
Explains exactly what a microcomputer system is and how it works. Introduces fundamental concepts and covers all aspects of microprocessors and related components: internal operation, memories, interfacing and system development etc.

**COMPUTERS FOR EVERYBODY**  
39849A \$8.95  
In this easy-to-understand book it is explained how a computer can be used at home, in the office or at school. Includes a consumer's guide to computer equipment that will help the reader decide what to buy and who to buy it from.

## computers hardware & techniques

**USING THE 6800 MICROPROCESSOR**  
21512P \$13.25  
This will guide the reader through the conception, configuration, writing and running of a variety of programs that demonstrate practical use of a 6800 system.

**Z80 MICROCOMPUTER DESIGN PROJECTS**  
21682P \$20.75  
This book provides a complete look at the internal architecture of the Z80, the heart of many microcomputers, and even shows how to build a microcomputer, the EX80, using this powerful chip.

**MICROPROCESSOR CIRCUITS VOL. 1**  
21877P \$14.75  
Presents basic microprocessor concepts in simple language for beginners and teaches you to construct a useful microcontroller system. Offers 30 demo circuits which take you through assembly, operation and programming of a microcontroller.

**INTERFACE PROJECTS FOR THE APPLE II**  
69387P \$15.95  
A series of interface projects that are easily built and enable the user to realise the computer's potential through project construction. Projects are primarily hardware-orientated, with some software supporting the hardware.

**PET INTERFACING**  
21795P \$25.25  
Demonstrates how to build numerous interfacing devices for PET hardware. BASIC language programs are used throughout, and the book includes a discussion of the microprocessor's internal architecture and general hardware/software interfacing.

**6809 MICROCOMPUTER PROGRAMMING AND INTERFACING, WITH EXPERIMENTS**  
21798P \$21.95  
Gives a solid understanding of how to program and interface the high-performance 6809 microprocessor. The author completely explores internal structure, addressing modes, data movement instructions, registers, arithmetic logic and test instructions for the 6809.

**Z80 MICROCOMPUTER HANDBOOK**  
21500P \$17.50  
This thorough handbook covers hardware, software and microcomputers built around the Z80.

**THE S100 AND OTHER MICRO BUSES**  
21810P \$13.25  
The key to successful computer expansion is a complete understanding of the bus system, through which the computer communicates with peripherals. This book will give you that understanding.

**MICROCOMPUTER DESIGN AND TROUBLESHOOTING**  
21819P \$26.75  
Tells you how to design microcomputer systems and make them work without an expensive commercial development system or the need for costly test instrumentation. The author also provides a complete description of two popular microprocessors—the 8085 and the 6502.

**DON LANCASTER'S MICRO COOKBOOK, VOLUME 1**  
21828P \$20.75  
This 'cookbook' starts with the very fundamentals of microprocessors and microcomputers and takes you through number systems, codes, memory, etc., until you can work intelligently with micros.

**ODN LANCASTER'S MICRO COOKBOOK, VOLUME 2**  
21829P \$20.75  
Carries on where Volume 1 left off.

**APPLE INTERFACING**  
21862P \$15.95  
Using this book, you will be able to perform useful experiments which will provide a much clearer understanding of the fundamentals of computer interfacing and computer electronics. A better understanding of interactions between hardware and software will enable you to communicate more effectively with your Apple.

**MICROPROCESSOR CIRCUITS VOL. 1**  
21877P \$14.75  
Presents basic microprocessor concepts in straightforward language for beginners. Teaches you to construct a useful microcontroller system through progressive demonstration circuits.

**8080 MICROCOMPUTER EXPERIMENTS**  
39808A \$29.50  
This 'hands on' book includes 105 experiments presenting programs and diagrams as required for clarification.

**A STEP-BY-STEP INTRODUCTION TO 8080 MICROPROCESSOR SYSTEMS**  
39804A \$16.95  
Doesn't require any electronics or computer background. This book describes the 8080 architecture and instruction set through simple examples. Some basic software is introduced.



**DIGITAL CIRCUITS WITH MICROPROCESSOR APPLICATIONS**

**46032A** \$39.50  
An introductory text, this book provides readers with the basic ideas and tools needed to analyse and design digital circuits and computer systems. Discusses microprocessor computer organisation, machine language number systems and gate circuits.

**MICROPROCESSOR INTERFACING TECHNIQUES**

**88029A** \$24.95  
Teaches you how to interconnect a complete microprocessor system and interface it to the usual peripherals. The hardware and software skills needed to effectively interface peripheral devices are covered along with various buss standards and A/D conversion.

**PRACTICAL INTRO TO DIGITAL ICs**

**225B** \$4.32  
Introduction to digital ICs (mainly TTL 7400). Besides simple projects, includes logic test set to identify and test digital ICs. Also includes digital counter-timer.

**BEGINNER'S GUIDE TO MICROPROCESSORS & COMPUTING**

**BP66** \$5.92  
Introduction to basic theory and concepts of binary arithmetic, microprocessor operation and machine language programming. Only prior knowledge assumed is very basic arithmetic and an understanding of indices.

**A MICROPROCESSOR PRIMER**

**BP72** \$5.92  
Learning about microprocessors is easy with this book, written in a style that is easy to follow. The shortcomings of this basic machine are discussed and the reader is shown how these are overcome by changes to the instruction set. Relative addressing, index registers follow as logical progressions.

**PRACTICAL COMPUTER EXPERIMENTS**

**BP78** \$5.92  
How to build typical computer circuits using discrete logic. This book is a useful intro to devices such as adders and stores as well as a general source book of logic circuits.

**THE 6809 COMPANION**

**BP102** \$6.56  
It is not a beginners introduction to microprocessors in general but a discussion of the features of the 6809 and a reference work for the 6809 programmer in particular.

**COMPUTERS & COMPUTING YEARBOOK 1980**

\$4.95  
Includes beginners buying guide, the Apple, Tandy's TRS-80, the Vector MZ, introducing BASIC, S100 VDU, EPROM programmer, microcomputer power supply and lots more.

**COMPUTERS & COMPUTING YEARBOOK 1982**

\$4.95  
Includes disks, CP/M and your computer, learners microcomputer, programming in CHIP-8, alphasort, fast plotter, PET talk, the System 80 etc.

## computing software

**CP/M PRIMER**

**21791P** \$21.95  
A complete one-stop course on CP/M, the very popular operating system for 8080, 8085 and Z80-based microcomputers. Complete terminology, hardware and software concepts, startup of a CP/M system, and a complete list of CP/M-compatible software.

**THE CP/M HANDBOOK (WITH MP/M)**

**88048A** \$19.95  
Contains a step-by-step description of all the CP/M command features. Designed for the beginner, the book progresses to detailed explanations of the file transfer program, the debugging program and CP/M's text editing program.

**HOW TO GET STARTED WITH CP/M**

**39832A** \$19.95  
This practical book eases the reader into the essentials of the system, giving an overview of the operating system, an idea of what it will be like to use and what it can do for the reader.

**AUSTRALIAN MICROCOMPUTER HANDBOOK**

**72505** NOW \$15.00  
Normally \$25.00. A detailed buyer's guide to microcomputer systems and application packages in commercial, industrial, scientific, educational and home/hobby areas.

**THE C PROGRAMMING LANGUAGE**

**10163P** \$21.95  
C is a general purpose 'low-level' programming language. It is not specialised to any particular area of application, but its absence of restrictions make it convenient and effective for many tasks.

**THE 68000: PRINCIPLES AND PROGRAMMING**

**21853P** \$19.95  
An easy-to-read, systematic approach to the 68000 advanced 16-bit microprocessor. The book guides you through the complex architecture, instruction set, pinouts and interfacing techniques. Written for design engineers, programmers and students.

**PROGRAMMING IN BASIC FOR PERSONAL COMPUTERS**

**30739P** \$14.75  
Simple instructions show how to give BASIC commands and statements a wide range of applications, from programming video games to developing business or scientific programs.

**PROGRAMMABLE CALCULATORS**

**46008A** \$24.95  
This book suggests which calculators to buy, their possibilities and limitations, and the how-tos of programming them.

**TAKE A CHANCE WITH YOUR CALCULATOR**

**39807A** \$14.95  
An introduction to modern mathematics, this book deals with programming of programmable calculators and includes probability problems.

**AN INTRO TO BASIC PROGRAMMING TECHNIQUES**

**BP86** \$6.56  
Ideal for beginners seeking to understand and program in BASIC. Book includes program library for biorhythms, graphing Y against X, standard deviations, regressions, generating musical note sequences, and a card game.

**BASIC FOR EVERYONE**

**61481P** \$19.75  
349 pages of BASIC information for all purposes.

**BEGINNING BASIC**

**39806A** \$19.95  
Intended for beginners, this book discusses how a programmer and a basic computer interact with the computer, problems likely to be met by the beginner, the need for and uses of documentation etc.

**FIFTY BASIC EXERCISES**

**88056A** \$17.95  
Designed to teach BASIC through actual practice, this book contains graduated exercises in math, business, operations research, games and statistics. The programs were designed to run directly on a TRS-80 and will run with minor or no changes on any system with Microsoft BASIC.

**INSIDE BASIC GAMES**

**88055A** \$19.95  
The medium of games teaches readers how to design error-free, interactive BASIC programs. Rules, algorithms and coding differences for the PET, APPLE II and TRS-80 are also included.

**MICROSOFT BASIC**

**39823A** \$19.95  
Includes branching and loops, arithmetic in BASIC, strings, editing, arrays and files, the disk and a description of the Radio Shack Level II BASIC.

**INTRODUCTION TO FORTH**

**21842P** \$14.95  
The most complete book available on the MMS FORTH version of FORTH, but also a fundamental approach to programming in all versions of FORTH. Many programming examples are provided, with direct comparisons to the Microsoft Level II BASIC version of these programs.

**STARTING FORTH**

**42922P** \$23.75  
A clear and complete guide to FORTH, this book covers fundamental principles and then a full set of high-level FORTH commands. It concludes with advanced techniques and style.

**A FORTRAN PRIMER**

**80454P** \$6.95  
Assumes no previous knowledge of program writing. It covers the fundamentals of the FORTRAN language, enables extensive program writing and concentrates on programming style.

**INTRODUCTION TO STRUCTURED FORTRAN**

**46007A** \$19.95  
Written for the beginner, the text incorporates the new FORTRAN 77 with a discussion of structural programming. Includes a discussion of time-sharing, pseudo language programming and WATFIV statements.

**MICROSOFT FORTRAN**

**39846A** \$24.95  
An introductory text on FORTRAN in general and Microsoft FORTRAN in particular. The latter is exceptionally well suited for use on microcomputers using CP/M and others of the 8080/8075/Z-80 family.

**BEGINNING FORTRAN**

**46011A** \$19.95  
Introduces readers to FORTRAN. Included are references for further study, brief tutorials on key punching, flow charting, deck set-ups and matrix algebra.

**QWIKTRAN**

**39824A** \$19.95  
Quick FORTRAN for Micros, Minis and Main Frames. Starts with the basic concepts of computing and Qwiktran, a fundamental subset of FORTRAN IV. Lots of examples to increase the reader's proficiency.

**THE UCSD PASCAL HANDBOOK**

**35536P** \$23.75  
Language descriptions organised in a quick and easy reference are given in this book for readers with no prior experience of Pascal programming.

**INTRODUCTION TO PASCAL**

**91522P** \$19.95  
The second edition of this popular book has been updated to conform to the new international standard of Pascal. The contents illustrate the design and construction of Pascal programs, involving a wide range of basic computer algorithms in a practical context.

**PASCAL**

**46028A** \$19.95  
For people with little or no programming experience, this book gives lots of examples that clearly explain proper usage of language features. Discusses top-down programming, debugging, self-documentation etc.

**THE PASCAL HANDBOOK**

**88053A** \$23.50  
This book summarises the entire Pascal vocabulary, including the variations introduced by different commercial versions of Pascal. All in dictionary format.

**PASCAL PROGRAMS FOR SCIENTISTS AND ENGINEERS**

**88058A** \$23.50  
Over 60 of the most frequently used scientific algorithms, along with their program implementation in Pascal, are in this book.

**COBOL FOR BEGINNERS**

**39378P** \$21.95  
It is a solid text for introductory programming courses in Cobol, using a format that is easy to understand, yet comprehensive enough to make supplementary readings unnecessary.

**STARSHIP SIMULATION**

**39810A** \$11.95  
This book offers both a specific simulation which can be implemented, modified and played, and a complete look at how to put together a simulation on almost any subject.

**BASIC PROGRAMS FOR SCIENTISTS AND ENGINEERS**

**88073A** \$19.95  
This book contains scientific and engineering application programs written in BASIC.

**COMPUTER GRAPHICS PRIMER**

**21650P** \$21.95  
Almost every page has a colour drawing, photograph, picture or a schematic to help you learn computer graphics quickly and easily. Programming concepts apply to all microcomputers, and examples are given in BASIC for the Apple II.

**INTRODUCTION TO TRS-80 GRAPHICS**

**39818A** \$17.95  
It begins with the basic concepts of line drawing and leads the reader on to geometric shapes, moving figure animation and other more advanced topics.

**CIRCUIT DESIGN PROGRAMS FOR THE TRS-80**

**21741P** \$21.75  
A number of programs written to aid you in using your TRS-80 and Level II BASIC for the design and analysis of many electronic circuits. The programs analyse information on ms values, periodic waveforms, integrated circuit timers and bipolar transistor circuits.

**MOSTLY BASIC: APPLICATIONS FOR YOUR TRS-80 — BOOK 1**

**21788P** \$19.25  
28 ready-to-use BASIC programs which have been completely tested and debugged. Programs include a telephone dialler, digital stop-watch, spelling test, house buying guide, gas mileage calculator, and others. Complete with explanations of each program, sample runs, and complete program listing.

**MOSTLY BASIC: APPLICATIONS FOR YOUR TRS-80 — BOOK 2**

**21865P** \$19.25  
32 ready-to-run BASIC programs, including two to test your ability in history and maths, a Dungeon of Danger that's strictly for fun, eleven household programs, seven on money and investment, two to test your ESP level, and more. Complete with explanations, sample run and listing for each program.

**INTERMEDIATE PROGRAMMING FOR THE TRS-80 MODEL I**

**21809P** \$14.95  
Step-by-step instructions for the TRS-80 user who wants to progress from BASIC to machine and assembly language programming with the TRS-80 Model I system. A complete how-to guide with numerous examples.



# ...and for good measure...

## TRS-80 — MORE THAN BASIC

**21813P** \$15.95  
Learn to program in Z80 mnemonics by using the book's error-tolerant interactive monitor program. Over 26 commands available, with total documentation that helps you change the commands to meet specific applications.

## TRS-80 ASSEMBLY LANGUAGE MADE SIMPLE

**21851P** \$19.25  
If you have an understanding of BASIC programming, this book will help you learn to plan, write and hand-assemble your own assembly language programs in memory, using the T-bug and Level II BASIC ROM subroutines.

## PROGRAMMING THE TRS-80 POCKET COMPUTER

**30531P** \$13.25  
This book explains all aspects of problem-solving in BASIC, and covers cassette machine interfacing and how to make the best use of the system's keyboard and display.

## TRS-80 ASSEMBLY LANGUAGE SUBROUTINES

**31188P** \$19.25  
A wide spectrum of applications is discussed in this book, which provides easy-to-use routines that can be used as they stand or modified.

## 32 BASIC PROGRAMS FOR THE TRS-80 COMPUTER

**39827A** \$29.50  
Programs for the TRS-80 Level II or Model III BASIC (with 16K or more user memory).

## APPLE BASIC

**39099P** \$19.25  
This book gives the beginner a thorough introduction to BASIC programming on an Apple computer, and covers all areas of programming, including graphics, games, mathematical programs, and a great deal more.

## CIRCUIT DESIGN PROGRAMS FOR THE APPLE II

**21863P** \$23.75  
A series of ready-to-run Apple II programs ideal for electronics design engineers and others faced with solving problems related to plotting and verification of experimental data. The programs may be used as sub-routines in larger programs, and many can be translated to run on other microcomputer systems.

## APPLESOFT LANGUAGE

**21811P** \$13.95  
Written for Apple II micros that use the Microsoft language, this introduction covers each aspect of programming in non-technical language, from elementary concepts to advanced techniques.

## APPLE MACHINE LANGUAGE

**90230P** \$21.95  
This straightforward book teaches machine language programming through BASIC, the transition being made step-by-step. Many sketches of video displays are provided, as well as exercises with answers.

## APPLE PASCAL GAMES

**88074A** \$19.95  
Explore all the essential elements of UCSD Pascal and learn the important Apple Pascal extensions.

## PASCAL PROGRAMMING FOR THE APPLE

**95454P** \$18.95  
This book teaches UCSD Pascal on the Apple II. Many examples, programs for financial applications, graphics, file structures and sound reproduction are supplied.

## 32 BASIC PROGRAMS FOR THE APPLE COMPUTER

**38834A** \$29.50  
Full of programs with practical applications, educational uses, games and graphics.

## PET/CBM BASIC

**61751P** \$19.25  
This book provides a thorough introduction to BASIC programming on a PET computer, explaining programming concepts for graphics, including three-dimensional letters, bar graphs and the use of sound effects in PET programs.

## THE PET PERSONAL COMPUTER FOR BEGINNERS

**61827P** \$20.95  
This handy guide is written for use with all varieties of PET computer, from the original 2001 to the new 8032 Super PET. It is suited to novices with no practical experience and provides advice and practical examples.

## PET BASIC 1

**95524P** \$19.25  
For users of the PET computer, this book covers such topics as creative graphics, humour and interesting small programs.

## PET GAMES AND RECREATIONS

**95529P** \$18.85  
Presenting an interesting mixture of diversions guaranteed to entertain and educate. Ideal for beginners, yet also challenging to computer veterans, the book features progressive levels of difficulty and five different types of games.

## 32 BASIC PROGRAMS FOR THE PET COMPUTER

**39825A** \$29.50  
Each chapter fully documents a different bug-free program. If readers have a good working knowledge of BASIC, they can devise and implement their own program changes.

## THE ATARI ASSEMBLER

**90236P** \$19.25  
This practical book gives detailed instructions for using the Atari Assembler cartridge for novices with some knowledge of BASIC programming. Fundamental information programming in assembly language is given.

## ATARI GAMES AND RECREATIONS

**90242P** \$19.25  
Beginners and advanced users can use the pre-programmed games in this book to improve their skill. Charts, flash cards, an error dictionary and graph paper designs are among the features.

## EXPLORE COMPUTING WITH THE TRS-80 (AND COMMON SENSE)

**96137P** \$17.95  
This introduction to microcomputers and the BASIC language is suitable for novices and users of the TRS-80. Among the topics covered are creating tables, arts and graphics, games and simulation.

## 32 BASIC GAMES FOR THE EXIDY SORCERER

**39835A** \$29.50  
Full of programs with practical applications, educational uses, games and graphics. Each chapter documents a different bug-free program.

## THE ART OF PROGRAMMING THE 1K ZX81

**8P109** \$6.56  
This book explains how to use the features of the ZX81 including its random number generator, graphics and timer. PEEK and POKE are explained and you should learn enough to develop programs of your own.

## PROGRAMMING THE 6502

**88046A** \$18.95  
Principles of assembly language programming for the 6502 microprocessor are taught in this introductory text. Includes a discussion of trade-offs between hardware and software and detailed explanations of the 6502's internal registers and buss operation.

## 6502 APPLICATIONS BOOK

**88015A** \$17.95  
Use this book and a few low-cost components to build a complete home alarm system, an electric piano, a motor speed-regulator, a time-of-day clock, a simulated traffic control system and a Morse code generator, etc.

## 6502 GAMES

**88023A** \$17.95  
You learn how to play ten sophisticated games and also learn assembly language programming. Also learn the techniques of algorithm design and data structures.

## 8080 MACHINE LANGUAGE PROGRAMMING FOR BEGINNERS

**39814A** \$12.95  
The book will take the reader step-by-step through the most common 8080 op codes and it will do so at a level anyone can understand.

## PROGRAMMING THE Z80

**88047A** \$19.95  
This book will enable every reader to write complete application programs for Z80-based computer systems. Includes exercises to measure progress and comprehension at each level of programming.

## PROGRAMMING THE Z8000

**88072A** \$19.95  
A complete introduction to programming concepts and techniques for use with the 16-bit, Z8000 microprocessor. Presents detailed descriptions of the architecture and functions of this 'super chip'.

## START WITH BASIC ON THE COMMODORE VIC 20

**97070P** \$14.75  
Helpful exercises and step-by-step instructions show you how to program in BASIC utilising all the graphic functions on the Vic 20.

## computing for business

### BASIC FOR ACCOUNTANTS

**80098P** \$9.95  
Shows accountancy students and accountants how to use a computer to perform the repetitive tasks associated with record keeping, calculating and report writing. Using the BASIC language attention is concentrated on debtors, inventory and general ledger systems.

### COMPUTER BASED BUSINESS SYSTEMS

**80192P** \$10.95  
A short introduction to the sorts of systems used by a typical business to handle its typical activities. The book aims at providing a general understanding and therefore avoids technological detail.

### THE COMPUTER SOLUTION

**80195P** \$13.50  
It should be of interest to business people contemplating, implementing or already using computer data processing or to any non-technical person curious to know why and how computers are used in Australian businesses and organisations.

### SMALL BUSINESS COMPUTERS: A GUIDE TO EVALUATION AND SELECTION

**81134P** \$14.95  
Ideal for the inexperienced user, this text emphasises management considerations in determining the feasibility, economics, evaluation, selection, contracts and practicality of installing a computer.

### SMALL BUSINESS COMPUTER SYSTEMS

**81136P** \$14.95  
This book provides a bridge between the accountant and the DP professional by explaining every step of the trading and reporting process in DP terms. It is especially useful to people engaged in the specification process or in auditing DP accounting systems.

### THE VISICALC BOOK — APPLE EDITION

**98397P** \$22.25  
If you are using Visicalc on your Apple II and want to learn more about its expanded uses then this book will show you how to build a model, enter your data and solve problems about profit/loss projections, pricing/costing estimates etc.

### THE CP/M HANDBOOK (WITH MP/M)

**88048A** \$19.95  
Containing a step-by-step description of all the CP/M command features, the book progresses to detailed explanations of the file transfer program, the debugging program and CP/M's text editing program.

### YOUR FIRST COMPUTER

**88045A** \$12.50  
A beginner's guide to small computers, understanding them, buying them and using them for personal and business applications. Includes peripherals, languages and application packages.

### DON'T (OR HOW TO CARE FOR YOUR COMPUTER)

**88065A** \$16.95  
A guide to computer and peripheral preservation. Specific advice for the computer, floppy disks, hard disks, the CRT terminal, the printer, tape units, the computer room, software and documentation are included.

### INTRODUCTION TO WORD PROCESSING

**88076A** \$17.95  
Written for the non-technical reader, this book tells about concepts common to all word processing systems, then analyses all features in detail, from screens to scrolling and formatting.

### SMALL COMPUTERS FOR THE SMALL BUSINESSMAN

**39831A** \$24.95  
The book tells readers how and where to shop for a computer successfully; what to expect their computer to do for them; how to select software; whether or not to use a consultant; how to introduce the computer to the staff and how much computer is necessary.

### INVENTORY MANAGEMENT FOR SMALL COMPUTERS

**39848A** \$24.95  
Owners of retail businesses and their employees need this book. The program provides an inventory control system so that you know what stock is on hand, where it is located, what price was paid for it and the selling price.

### BASIC FOR BUSINESS FOR THE TRS-80

**90352P** \$22.25  
This book covers the application of BASIC language to business uses on the TRS-80 models II and III.

### FROM THE COUNTER TO THE BOTTOM LINE

**39811A** \$24.95  
A demystifying guide to basic accounting needs and computer use. Includes inventory and purchasing, billing, accounts receivable, accounts payable and general ledger.







# “Why buy just a video game when you can get a full colour computer for the same price.”

A computer like this would have been science fiction a few years ago. Now it's a reality. It's the Commodore VIC-20, a full-fledged, expandable colour computer that costs the same as a video game.

Everybody loves video games and the VIC-20 has some of the best. But the Commodore VIC-20 can also help the kids with their homework and mum with her budgeting. Dad can even take the light, portable VIC-20 to the office for financial and business applications.

And Commodore has many more applications on the way.

## With Full Capability For:

- Education programs
- Recreational programs
- Personal computing
- Includes Microsoft, PET BASIC
- Full-size typewriter-style keyboard
- Easy to follow instruction manual
- Memory expansion to 32K RAM
- Connects to any TV set
- 66 graphic characters
- 25K total memory
- 4 sound generators
- 16 colours



# VIC-20

## The computer for everyone.

The VIC-20 is the friendliest way we know to learn computing. It has a full computer keyboard even a small child can operate.

It plays music, has exciting graphics and lets you create pictures. It even tells you when you've made a mistake and how to correct it. The VIC-20 can take your children from pre-school through post-graduate studies.

Why get just another game that could end up in the closet? Get an honest-to-goodness home computer for just \$299. Get the Commodore VIC-20.

Learn more about Commodore, the home-computer you can depend on. Call or write for the name and location of your Commodore dealer nearest you.

**The Commodore Information Centre,**  
3 Campbell St., Artarmon NSW 2064. Phone: 437 6296.

 **commodore**  
COMPUTER



# COMPUTING TODAY

## Mitsubishi Electric's 'Move Master' micro-robot

Mitsubishi Electric Corporation has recently developed the 'Move Master', Japan's first micro-robot designed for use in training operators, as a teaching aid, or as a point of purchase (POP) display, as well as for hobbyists. The Move Master was first released in Japan in April 1982 and is now available in Australia.

The 245 mm high Move Master is a six-axis articulated robot with five degrees of freedom of motion. The manipulator weighs only about 10 kg for easy portability and can lift objects weighing up to 500 gm. Move Master can be used in combination with either a robot controller or a personal computer.

The Move Master has a built-in power supply for control and drive motors. Each axis is driven by a pulse motor. It has a repeatability of  $\pm 0.3$  mm which is as good as most industrial robots.

Since the Move Master is equipped with a microcomputer, instructions

to the Move Master can be externally given in simple robot language. In addition, programming can be done with BASIC. The Move Master is equipped with a semi-Centronics interface for connection to personal computers made by Mitsubishi Electric and by other major computer builders. It is provided with a software package and a manual for these computers, offering a wide range of applications. A high-performance microprocessor adopted as a robot controller can be used as a CP/M base for various purposes, in addition to controlling the manipulator.

Despite its low price, the Move



Master is provided with functions equal to those of industrial robots, and can be used for a wide range of purposes such as training operators in robot language and operating techniques, and by hobbyists in

conjunction with a personal computer.

For more information contact Mitsubishi Electric, 73-75 Epping Rd, Nth Ryde NSW 2113. (02) 888-5777.

## Low profile S100 microprocessor released by SME systems

SME Systems of Mitcham Victoria has released the latest of its Unicorn microcomputer series, the low profile MPU-100, a Z80 S100 bus microprocessor.

This entirely Australian designed and manufactured unit is a single user and multi-user system, accommodating up to 15 terminals. The low profile cabinet is achieved by using a vertical motherboard with five S100 slots per side. This allows rack mounting and minimises the likelihood of transmission line defects.

The basic system is configured with an SBC 800 CPU, an FDC II floppy disk controller capable of running four drives and the DRC II dynamic RAM card. Other cards can be added in the remaining seven slots to allow up to fifteen extra terminals or modems to be connected and at least 50M of hard drive. Colour graphics, video and 128K CMOS RAM cards are also available from SME to expand the system further for specific applications. All the cards are manufactured by SME in Melbourne, who



are S100, Z80 specialists.

On the rear panel of the MPU-100 provision has been made for twelve, 25-way 'D' connectors, two 50-way Centronics connectors and two 36-way Centronics connectors. Two switched 240 V outlets are provided for connection to other peripherals such as disk drives, terminals and printers.

Full information is available from SME Systems, 22 Queen St, Mitcham Vic. 3132. (03)874-3666.

## New Ferguson 'Big Board II'

Jim Ferguson, the designer of the 'Big Board' distributed by Digital Research Computers, has produced a new computer called the 'Big Board II'. It runs at 4 MHz, its monitor code is lean, uses Mode 2 interrupts and makes good use of the Z80-A DMA chip.

Big Board II has three memory banks. The first memory bank has eight 4164 RAMs that provide 60K of user space and 4K of monitor space. The second memory bank has two 2K x 8 static RAMs, or pin compatible E(E)PROMs. The third memory bank is for RAM or ROM added to the board via the STD buss.

The Ferguson single board computer has a multiple density

disk controller and brings its buss signals to a convenient place on the pc board where an STD buss connector can be attached so you can plug in an STD cable or other cards.

In single quantities full kits cost \$750 plus tax, and assembled and tested they cost \$895. There are discounts that range to 35% for OEMs and dealers. For more details contact Rod Irving on (03)489-7099.

## Computerland enters joint venture in Australia

Computerland Corporation has entered a joint venture with Computerland Australia Pty Ltd to open Computerland franchises in Australia. The new joint venture will be known as Computerland Australia Limited.

The purpose of this joint venture is to provide additional support from the US corporation and to provide a permanent structure for the Computerland stores in Australia.

Computerland Australia Ltd will be capitalised and staffed by

both parent companies and headquartered in Sydney. Previously, Computerland Australia Pty Ltd, the company formed by Mr. and Mrs. Hoess in 1977, was a sub-franchise of the US Corporation.





# SYSTEMS THAT GROW WITHOUT GROWING PAINS

Head Office:  
41 Sydney St,  
Marrickville 2204  
Phone: (02) 519 2680

## One Q.T. System 2000 Supports 16 CP/M User Stations

AND NOW AVAILABLE  
as a standard feature with all systems  
**MEMORY DRIVE SOFTWARE**  
for lightning performance  
**SOON TO BE RELEASED**  
16 bit micro based  
on the 8086 processor

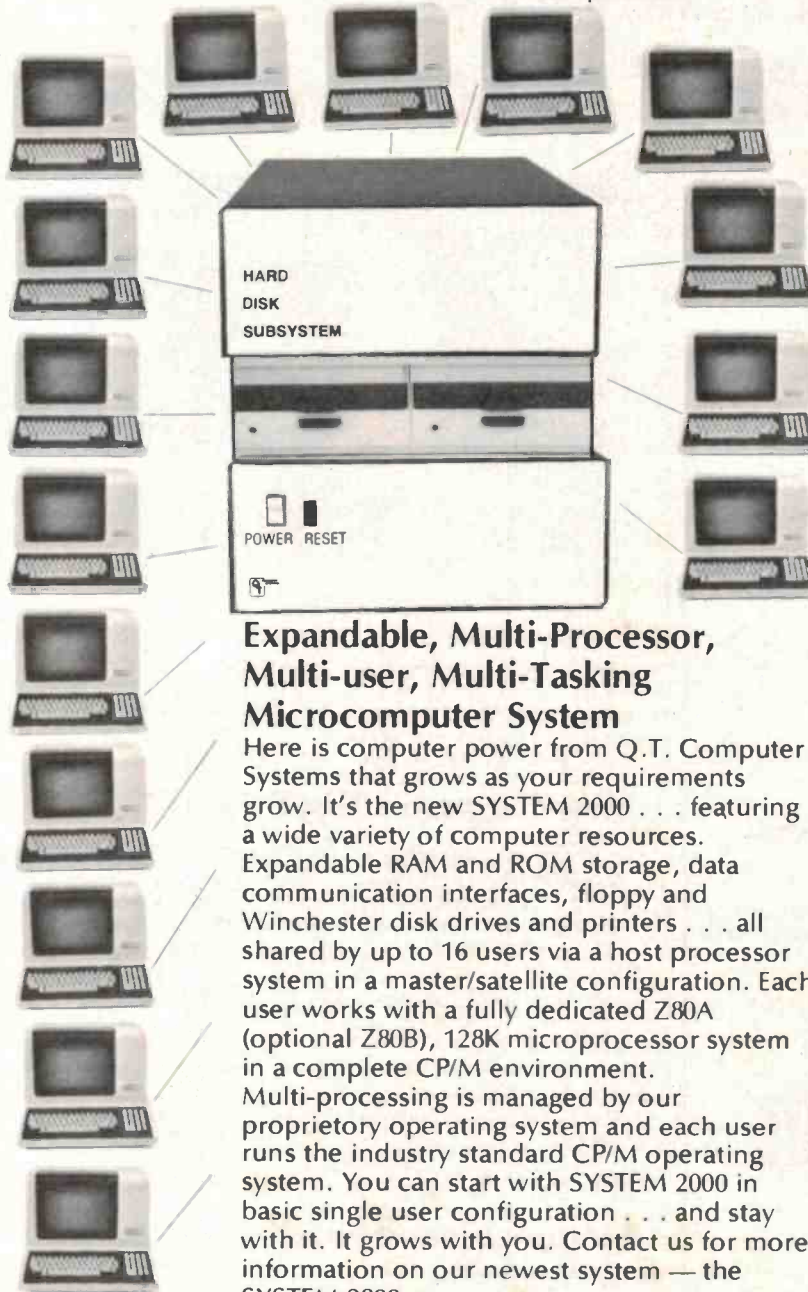

### Expandable, Multi-Processor, Multi-user, Multi-Tasking Microcomputer System

Here is computer power from Q.T. Computer Systems that grows as your requirements grow. It's the new SYSTEM 2000 . . . featuring a wide variety of computer resources. Expandable RAM and ROM storage, data communication interfaces, floppy and Winchester disk drives and printers . . . all shared by up to 16 users via a host processor system in a master/satellite configuration. Each user works with a fully dedicated Z80A (optional Z80B), 128K microprocessor system in a complete CP/M environment. Multi-processing is managed by our proprietary operating system and each user runs the industry standard CP/M operating system. You can start with SYSTEM 2000 in basic single user configuration . . . and stay with it. It grows with you. Contact us for more information on our newest system — the SYSTEM 2000.

Typical Applications include — A multi-station word processing network, educational systems, business systems, real time data acquisition etc.

*We are actively seeking local and interstate distributors for our new system. OEMs can purchase the system in knocked down form as bare boards, bare metal work, kits etc. Complete systems available from as little as \$2800 + S.T. Bare boards from \$195 + S.T.*

Prices and specifications subject to change without notice.

# HOW? WHAT? WHICH? WHERE? WHY? HOW MUCH?



## CIRCUIT TECHNIQUES VOL. 1.

Is an anthology of electronic components, circuits and techniques, gathering together a host of useful articles published in the pages of ETI over the past few years.

Within its 148 pages, the book covers how to use op-amps, 555 timer applications, a practical guide to CMOS, VFET techniques, Power MOSFETs and circuit techniques, using the 4093 Schmitt trigger, voltage regulator applications, designing with diodes, LED circuits, practical guide to zeners, crystal oscillator techniques and more.

All in one handy volume, 16 timeless articles of inestimable value to the electronics enthusiast, experimenter, technician or engineer.

For just

**\$4.75** it's a steal!

Available from newsagents, selected electronic suppliers or direct from

ETI Magazine

15 Boundary St Rushcutters Bay  
NSW 2011 Please add 65 cents for  
post and handling if buying by mail  
order





## Two new personal computers and new software from Hewlett-Packard

The lowest priced personal computer ever offered by Hewlett-Packard Company, the HP-86, has been introduced along with an increased-memory version of the recently introduced HP-87 personal computer.

The new HP-86 is priced at \$2450 tax free, the first HP personal computer for less than \$2500. A complete HP-86 system carries a recommended list price of around \$5500.

The new modularly designed HP-86, together with new software for accounting, data-base management and word processing, adds broad new solutions to HP's personal computers for professionals. The new software complements HP's existing graphics, electronics worksheets and data-communication programs.

All of HP's Series 80 BASIC software will run on the new HP-86, as will CP/M operating-system software, with the addition of HP's plug-in CP/M system. The new machine is also compatible with a variety of HP's printers and graphics plotters, as well as several mass storage devices.

The HP-86 system features a choice of 9" or 12" display monitors, a 270K capacity flexible disk drive and an HP 82905B dot matrix impact printer. Memory in the HP-86 itself consists of 128K, of which 64K is user RAM, 48K is operating system ROM and 16K is RAM devoted to the display. User RAM can be increased to more than 500K with the addition of plug-in memory modules.

Accounting software from Peachtree Software Inc. General-ledger, accounts-receivable and accounts-payable software packages are being introduced by HP and make up a complete solution for many professionals who need small business accounting. Peachtree's inventory-control and PeachPay Payroll System packages for the HP-86 will be available late 1982. These accounting programs carry a suggested list price of about \$1020 excluding tax.

A second new offering, the HP-87XM premier personal computer, features user memory expandable to 640K and built-in HP-IB interface (IEEE-488) for professionals who need larger memory and a variety of peripherals. The HP-87XM (for 'extra money') is an increased-memory version of the HP-87A.

New software for the HP-86 and existing Series 80 software will run on the HP-87XM. HP also introduced the HP-86/87 BASIC Training Pac, designed to let new owners teach themselves the HP BASIC programming language. The HP-87XM sells for \$4075 recommended tax free.

More information can be obtained from Hewlett-Packard, 31-41 Joseph St, Blackburn Vic. 3130. (03)89-6351.

## New name, old face

Linx Computer Systems Pty Ltd was formerly known as Halifax Facilities Pty Ltd, a member of the Halifax computer group.

Managing Director of Linx, Peter Flett, said the name change was necessitated because of a new market direction taken by the company and a broader range of services being offered. "We are still principally a software house which tailors packages for a broad range of industry applications, but we also have some excellent ready-made packages that have a proven track record. And, of course, one of our major products is still Computerplan, a complete software package

tailored for applications in wholesale, distribution and stock control oriented type businesses," he added.

Module packages available from Linx include: Financial Reporting, Purchasing, Order Entry, Stock Control, Asset Register, Job Cost, Payroll, Word Processing, Invoicing, Bills of Materials and others.

For further information contact Mr. P. Flett, Managing Director, Linx Computer Systems Pty Ltd, 160 Johnston St, Fitzroy Vic. 3065. (03)419-6311.

## Talk to your computer

Intel Corporation has announced a set of new products aimed at the evaluation, simulation and implementation of speech-transaction system applications. The products are intended to permit designers to proceed in an orderly fashion as they investigate the viability of speech recognition and synthesis for their systems.

Intel's new products are oriented toward discrete word/speaker-dependent applications and include system, board and component levels to support designers from concept to all levels of production. The board- and system-level products are designed to save time and cost in implementing production-ready systems. The three levels of integration, all using identical firmware, provide the engineer with a cost-effective solution vehicle that matches his requirements.

Intel's iSBC 570 consists of the speech-transaction board, a flexible diskette with an application example and the speech-transaction generator software on it, plus a microphone and a new front panel for the Intellec system. The board plugs into the Intellec system's chassis and the user loads the software via the Intellec system's built-in disk drive.

The iSBC 576 is a Multibus-compatible speech-transaction board (which is included with the iSBC 570) that can be used in

conjunction with other Multibus products to implement a prototype or volume production system. The board contains two Intel 2920/21 single-chip analogue signal processors, an 8048 single-chip microcontroller, four 27128 (16K x 8) EPROMs, and an 8086 16-bit microprocessor. These chips make up the speech-transaction recognition subsystem on the board. Their functions, combined with the resident firmware, enable them to recognise speech input.

These same chips make up the iSBC 577 Speech Transaction Recognition Chip Set; the user receives them with recognition firmware and the Speech Transaction Manager already in place. With them, designers can tailor the speech-transaction subsystem to their own particular applications need.

For further information please contact Total Electronics, 9 Harker St, Burwood Vic. 3125. (03) 288-4044.

## Club Call

If anyone is interested in joining the Sorcerer Users Group of South Australia they should contact the secretary, Brian Richards, P.O. Box 647, Salisbury SA 5108. He'll tell you everything you need to know about the club.

The Western Australian ZX Users Group commenced operations in September. For further information ring Phil Taylor (09)328-4111 bh or (09)328-8111 ah.

The Blue Mountains Computer Club committee would like the dates of their meetings clarified. They meet on the Friday of the second and fourth weeks of each month at the Springwood Civic Centre at 7.30 pm.



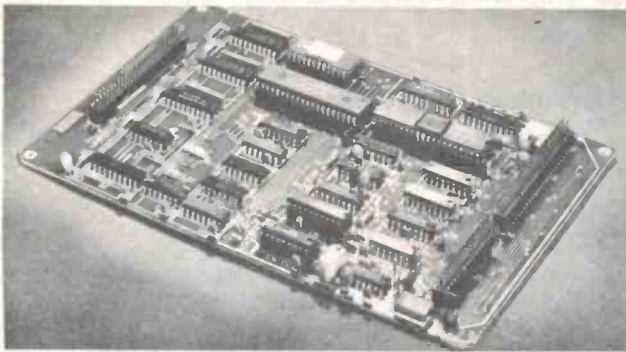

## ◀ Sorcerer disk controller

Digitrio has announced the availability of their floppy disk controller for the Sorcerer microcomputer. The Digitrio product is Australian designed and built and connects directly to the expansion slot on the back panel of the Sorcerer. An S100 unit is therefore not required. High speed operation is achieved through the use of DMA. The board will fit beside a 5" drive so it can be conveniently packaged in the same unit as the disk drives.

Digitrio claim that their product is the most versatile controller for the Sorcerer. Up to four soft sector drives of virtually any type can be connected at one time. Eight inch and five inch drives can be intermixed. The selection of single or double density operation is transparent to the user as is the selection of single or double sided operation. A full featured single drive capability is implemented to allow single drive installations the use of all multi drive facilities. The flexibility of the Digitrio BIOS is achieved without sacrificing user memory space. The CP/M fits within 8K.

CP/M 2.2 is supplied with the controller board. An extensive col-

lection of Digitrio utilities, in addition to the standard Digital Research products, accompany the controller. Comprehensive documentation thoroughly outlines how to use the controller and describes all software in detail. The controller should be of interest to OEMs who wish to package the board with disk drives as well as end users who are willing to build their own case and power supply.

The retail price of the controller is \$500. Complete disk systems are also available. Further information may be obtained from Digitrio, P.O. Box 4553, Melbourne Vic. 3001. (03)578-4064 bh or (03) 419-3026 ah.

## 6502/6809 microcomputer workshop

The Department of Electrical Engineering at the Queensland Institute of Technology is planning an advanced microcomputer workshop during April 1983. The successful basic workshop in April 1982 was attended by over 100 participants.

Papers are invited for the 1983 workshop and these should be related preferably to the following topics: techniques for good program structuring practice; development of operating systems; comparison of high level languages for real-time operation; use of microprocessor development systems; practical techniques for hardware debugging, using logic state analysers etc; practical techniques for software debugging; DMA techniques and

multiprocessor systems. They should be examples, with demonstrations, of practical applications of 6502 and 6809 microcomputing systems.

Please direct enquiries and correspondence to Dr. C.J. Chesmond, Senior Lecturer — Control Engineering, Department of Electrical Engineering, Queensland Institute of Technology, GPO Box 2434, Brisbane Qld 4001. (07)223-2484.

## COMDEC

**FREE  
OFFER**

# BUSINESS TECHNOLOGY

**A wonderful opportunity to receive a one year's subscription to Australia's leading BUSINESS TECHNOLOGY magazine.**

**Exclusively for business people who have the power to purchase or influence the purchase of office technology equipment or services.**

This offer applies in Australia only

Yes! I will take advantage of this opportunity to receive a free subscription to Comdec Business Technology

Name .....

Title .....

Company .....

Address .....

Postcode .....

My company's main activity is .....

and it employs ..... people. \*

Please attach your business card or letterhead, fill in the above form and return to:-

**Comdec Business Technology**  
4th Floor, 15 Boundary Street, Rushcutters Bay NSW 2011.

\* This information will be kept strictly confidential

## CASE provides access to Austpac

CASE Communication Systems has announced the release of an X.25 interface and multiplexor product specifically for use with the Austpac packet switching system.

The DCX 816 enables terminals and computers operating with simple asynchronous RS232 interfaces to be connected to the Austpac network without hardware or software changes.

The DCX 816 enables up to eight terminals, printers, modems or computer ports to be multiplexed onto a single Austpac X.25 access line. The multiplexed devices can be attached at any of ten speeds up to 9600 bps and devices of differing speeds may be freely intermixed.

Providing full X.25 Packet Assembler and Disassembler (PAD) functions, the DCX 816 features automatic or manual call request,

CR and LF padding, port selection and speed conversion. Calls may be set-up and cleared down from the terminal keyboards. A printer slaving facility and the ability to transfer calls are additional features also available from the keyboard.

The DCX has been proven in the UK, USA and Europe working into such packet switching networks as PSS (UK), Teleneff and Tymnet (USA) and Transpac (France).

For further information contact Barry Foster, CASE Communication Systems Ltd, 1-3 Atchison St, St Leonards NSW 2065. (02) 438-2400.

## Apple signs publishing agreements

Apple Computer Inc has signed separate agreements with Milton Bradley Company and Hayden Software Company for the development of educational software to be used by Apple Personal Computers.

The non-exclusive contracts call for technical and marketing cooperation between Apple and the publishers in the areas of software development, product demonstration and training.

Apple Computer will support the publishers' efforts by providing technical information, computer training, access to Apple Computers and marketing support. The publishers have signed agreements that outline general areas of co-

operation for the development of courseware.

The Milton Bradley Company is the world's largest game manufacturer. The publisher is developing language arts and math programs for middle grade levels.

Hayden Software Company, a new subsidiary of Hayden Publishing Company, is developing language arts, science and math programs for both the institutional and home markets.



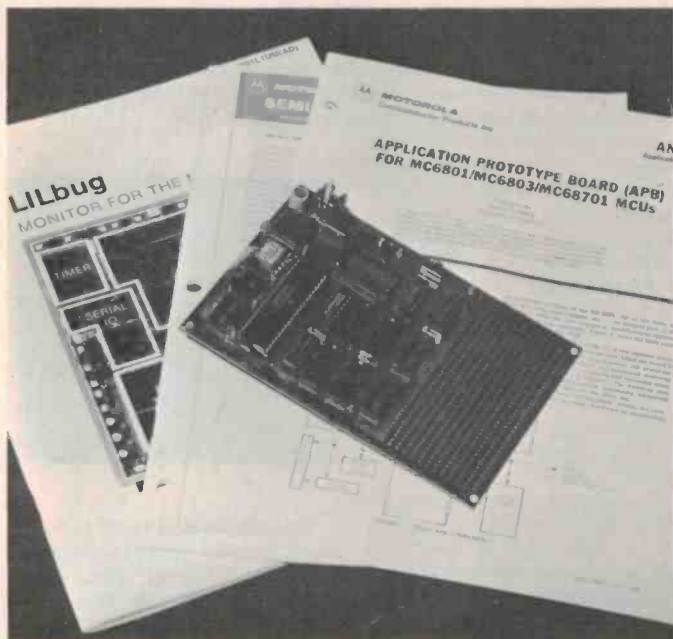

## Microprocessor applications prototype board

A MC6801 microprocessor applications prototype board is available from Paris Radio Electronics in NSW. This small board from Innovative Technology US, supports the MC6801 family of microcomputers.

A typical 6801 contains an enhanced 6800 processor, 2K of ROM, 128 bytes of RAM, a 16-bit programmable timer, parallel I/O, and a serial communications interface. In addition to the resources of the 6801, the board provides an additional 2K EPROM (TMS2716), 2K of RAM (TMS2114), and a full Duplex RS232 interface.

The board comes with full documentation and is only 4" x 6" and includes a 4" x 2" prototyping area. Priced at only \$129.95 + sales tax. The bare board is also available for only \$32 + sales tax from Pains Radio Electronics, 161 Bunnerong Rd, Kingsford NSW 2032. (02) 344-9111.

## Help for personal computer users

ARPAGE Business Software was set up with the aim of providing information, advice, custom software and consumables for the Tandy TRS-80 model I and model III and the Dick Smith System-80 microcomputers.

They claim to have the best and fastest accounts receivable system that is available for this range of computers, designed for use with the absolute minimum of operator training. They also have a small taxi fleet management system that provides detailed information on as many as 20 separate repair cost/failure items. There's also a system for security companies to log all

alarm events, verify voice identity codes and provide detailed printouts of all events for the client at the end of the month. Accounts payable and general ledger systems should be ready for installation soon.

For more information on ARPAGE Business Software contact them at P.O. Box 386, Gladsville NSW 2111. (02)816-2471.

## National announces 24-pin PAL devices

National Semiconductor Corporation has introduced the Series-24 family of programmable array logic (PAL) medium-size devices in 24-pin packages. The new Series-24 family complements National's PAL Series-20 family by providing two additional inputs and two additional outputs, allowing more complex functions in a single package.

In addition to providing more logic functions per chip, 24-pins allow for many natural functions which were previously unavailable in 20-pin packages such as: 8-bit parallel-in, parallel-out counters; 8-bit parallel-in, parallel-out shift registers; 16-line-to-one-line multiplexers; dual 8-line-to-one-line multiplexers.

The family lets the systems engineer design his own chip by blowing fusible links to configure AND and OR gates to perform his desired logic function. Complex interconnections which previously required time-consuming layout are

thus 'lifted' from pc board etch and placed on silicon where they can be easily modified during prototype check-out or production.

The entire PAL family is programmed on inexpensive conventional PROM programmers with appropriate personality cards and socket adaptors. Any one of these medium PAL devices can replace five to 15 packages of standard SSI/MSI logic. These devices are available now in plastic and ceramic packages and can be obtained from National Semiconductor, cnr Stud Rd and Mountain Hwy, Bayswater Vic. 3153. (03)729-6333.

# 32K BYTES FOR THE ZX81

## SPECIAL RAM PACK FOR THE ZX81

This board uses dynamic RAM chips for lower cost and lower power consumption. Simply plugs into the ZX 81 expansion port offering 32K BYTES for basic programmes and data handling. No extra PSU required. Extra memory to help you build your ZX81 into a powerful microprocessor system at an affordable price. Compare the price with other RAM PACKS available on the market!

# VENDALE

**JUST RELEASED!**

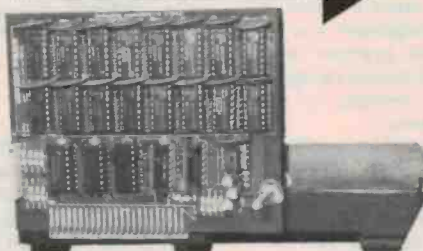

**Price for 32K Ram Pack (RP32) only: \$165.00 incl. P&P (Aust)**

Free cases available soon.

Please send order or SAE for further information to:  
**VENDALE PTY. LTD.**, Dept T7, Box 456,  
 Glen Waverley, Victoria 3150.  
 36 Plymouth St., Glen Waverley,  
 (03) 232 0444.

## ZX80/81 PROGRAMMABLE CHARACTER GENERATOR

Using simple BASIC programs you can create your own unique character sets and graphic symbols for games, High Res graphs and charts and interesting patterns. Program symbols normally available only on more expensive microprocessors and you are not limited to preprogrammed graphic sets.

Fully assembled price \$95.00 incl. P & P (Australia)  
 Uses the 8K ROM from Sinclair (not incl.).

## UPGRADE YOUR ZX80 GRAPHICS

Now you can upgrade your ZX80 to the full animated graphics of the ZX81. Your ZX80 will now run in SLOW mode.

Fully assembled price only \$38.50 incl. P & P (Australia)

Works only in conjunction with 8K ROM from Sinclair (not incl.)

VEN 0261



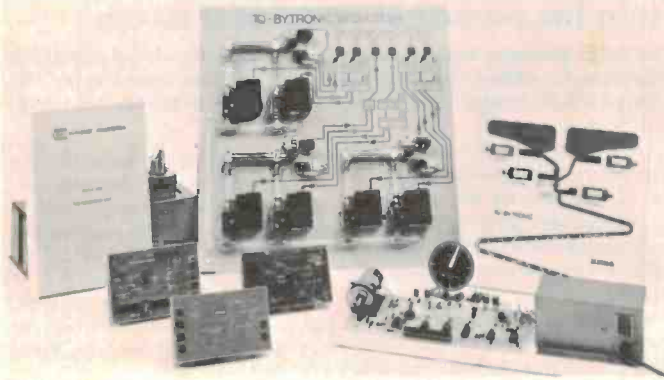

## Microprocessor application equipment for the student

These teaching aids, designed to illustrate the principles concerned with the industrial application of microprocessors, have been introduced by a British company.

Developed in conjunction with microprocessor specialists, all items in the TQ Bytronic range, from TecEquipment International Ltd, are based on standard industrial circuitry and equipment.

The teaching aids are designed for student experimental work and are said to be usable at most course levels from schools to universities.

They are compatible with all major microcomputers currently available.

The range consists of a stepper motor with software and notes, an A-D converter, a D-A converter, a sorter, a sequencing unit, a traffic flow controller and a motor.

Enquiries to the British Consulate-General, Gold Fields House, Sydney.

## Apple's plea to enjoin Franklin denied

A US District Court judge has denied Apple's request for a preliminary injunction to prevent Franklin Computer Corp. from marketing an Apple compatible computer, citing lack of merit in Apple's case.

Apple claims that Franklin's Ace 100 personal computer violates Apple patents and copyrights. Franklin, in a countersuit, claims that several Apple patents and copyrights are invalid.

Apple's suit now advances to the discovery stage, and officials with both Apple and Franklin say it could take as long as a year before the suit comes to trial.

The judge considered Apple's request on the basis of a reasonable probability for success on the merits of the claim, and on the risk of irreparable harm being caused Franklin by an injunction. The judge said that although Apple's arguments were strong he did not believe that it had shown a reasonable probability of success.

In his ruling the judge also cited one of Franklin's counter-arguments as decisive. "Franklin's argument is that it has created not an Apple-compatible system, but rather a system compatible with Apple-compatible software, which must, of necessity, share a great deal of the essential structure of Apple," he noted.

Apple's response was short. "We will take this to the next step, the trial stage," a spokesman said. "That could be over a year from now," he added.

Since the suit was filed, Franklin has replaced the Ace 100 with an upgraded version, the Ace 1000, a move Franklin chairman Barry Borden said was not related to the Apple suit. Compared with the 100, the 1000 is a faster machine with greater ROM expansion and color capabilities, but operates on the same basic 6502-based design that Apple alleges infringes its copyrights and patents.

Franklin plan making 1000 Ace 1000 units per month, Mr. Borden noted. The firm distributes the Ace through High Technology, Inc, St. Louis, and markets directly to retailers.

Franklin's countersuit has not been heard in court yet. In addition to claiming that Apple patents and copyrights are invalid, Franklin also alleges Apple violated antitrust law, and seeks treble damages exceeding \$150 million.

## Intel's 16-bit microcontroller

Intel has announced a new 16-bit microcontroller, designed for high-speed maths and control operations. The part will be available for general sampling in the first quarter of next year.

Intel's first 16-bit microcontroller diverges from the dual in-line package of the company's eight-bit microcontroller offerings and is being sampled in a 68 lead flat-pack. A less complex 48-pin DIP version of the 8096 will be available, the company said.

The single-chip microcontroller uses over 120 000 transistors and carries 232 bytes of RAM, including 16 bytes of power-down RAM, 40 I/O lines and a 10-bit A-D converter. A version with 8K of ROM, the 8396, is also available.

According to the company, the 8096's I/O is designed to interface with a wide range of transducers and sensors, and to offload real-time I/O operations from the CPU. The I/O includes an eight-level priority interrupt structure, analogue input, PWM output, high resolution pulse measurement and pulse output, full-duplex serial I/O and a watchdog timer, along with the 40 parallel I/O ports.

New human interface enhancements for its Inteltec Series II and Series III microprocessor development systems have also been announced by Intel.

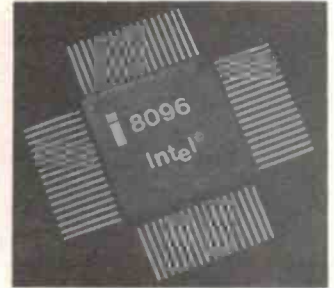

The new features result in fewer keystrokes and higher productivity, claim Intel, helping shorten the development cycle time. They make file viewing on the system screen more versatile, speed up command-line editing and guide the user in choosing the correct commands.

The upgrade kit consists of four 2716 EPROMs, a single 8741 microcontroller and two flexible diskettes. The EPROMs and microcontroller replace those currently in the system, and the diskettes are loaded on top of the ISIS operating system.

## Case data communication adaptors

CASE Communication Systems has announced the availability of a comprehensive range of data communication adaptors designed to solve a wide range of terminal, computer and peripheral interfacing problems.

Comprising some 30 different devices the 'Blue Box' range enables computer users to configure large or small terminal systems in the most efficient manner and implement them at a minimum cost.

The product range includes limited distance modems, modem eliminators, asynchronous to

synchronous converters, IBM loop adaptors, modem sharing devices, code converters, interface adaptors and fallback switching equipment.

For further information contact Case Communication Systems, 1-3 Atchison St, St. Leonards NSW 2065. (02)438-2400.

## Apple clone causes problems

A restraining order has been issued by the Supreme Court of Victoria prohibiting the sale of alleged bogus Apple II computers by Micro Pro Computers of Melbourne.

The Supreme Court order not only restrains Micro Pro from selling bogus Apples, but also requires the company to provide the names of all suppliers.

In the USA, the US Customs Service has begun detaining, seizing and destroying imitations of the Apple II being imported into the USA. Most of the imitations were coming from Taiwan and Hong Kong, the company said.

Apple Computer Inc. has filed a number of lawsuits in Taiwan, Hong Kong and New Zealand to prevent the manufacture and export of fake Apples. Sunrise Computer of Taiwan, maker of the Apollo II computer, has agreed to cease production and in New Zealand, Orbit Electronics, which was selling 'Orange' computers from an unknown Taiwanese manufacturer, has ceased trading.



**LETTER QUALITY PRINTER**  
and  
**K.S.R. TERMINAL**  
and  
**ELECTRONIC TYPEWRITER**  
from \$995.00



Call now —  
Special ETI  
reader offer  
on ribbons!

Our printer/terminals use the range of Olivetti daisy wheel electronic typewriters — including the new PRAXIS 41/45 — with twice the life of the PRAXIS 30/35.

Print speeds range from 12 to 25 characters per second. 10, 12 and 15 pitch are standard — proportional spacing models available.

Gain more computer time with printer interface buffers which store as much as 16,000 characters.

RS232c standard, parallel (receive only) option.

All these printer/terminals are maintained throughout Australia. INCA developed the STOL interface for Olivetti's ET221 — we have the experience to understand interfacing problems. Call or write:—



**data systems**  
pty. Ltd.

33 Ryde Road, Pymble,  
2073. Phone (02) 498 6933  
P.O. Box 200 Pymble 2073

# PROVIDA

## PROFESSIONAL COLOUR VIDEO DISPLAY BOARD

Memory mapped colour video display board has 2K RAM page buffer, 2K RAM function block and separate 2K RAM for 128 programmable characters. The dual character set is generated by an 8K PROM.

- 7 colour RGB output
- 80 x 24 and 16 x 64 page format
- 128 programmable characters or 128 x 256 Hires graphic
- Light pen facility
- S100 standard bus
- Flashing, inverse, ½ intensity, underlining & mirror reverse
- Jitter free video display
- Programmable TV synch. suitable overseas use

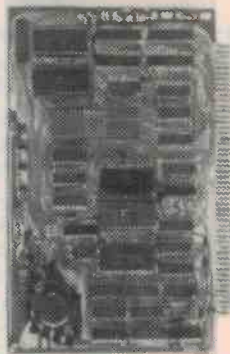

**QUALITY THRU HOLE PLATED  
BOARD ASSEMBLED & TESTED**

\$220 + 20% Sales Tax

90 day warranty

enquiries to:

**TECHNITRON**

84 TARGO ST., BUNDABERG  
4670 PH (071) 72 5606

*Software  
Source Pty Ltd.*

89 OXFORD ST.,  
BONDI JUNCTION  
PH: (02) 389 6388 P.O. BOX 364,  
EDGECLIFF 2027

## SOFTWARE AND PERIPHERALS FOR THE SORCERER

**WRITE FOR  
FREE  
CATALOGUE**

**COME TO  
COMPUTER  
CITY'S**  
Newer and larger  
Showroom at  
**193 Cavendish  
Road, Coorparoo.  
QLD. 4151**  
Telephone:  
**(07) 398 6759**

Same friendly service at competitive prices our range includes Apple II & III, Peach, Xerox, Sirius, BBC micro, NEC Spinwriter, EPSON anadex, C-ITOH & Brother. Huge selection of Software, Books, magazines

Remember our new address

**193 Cavendish Road,  
Coorparoo. QLD. 4151**



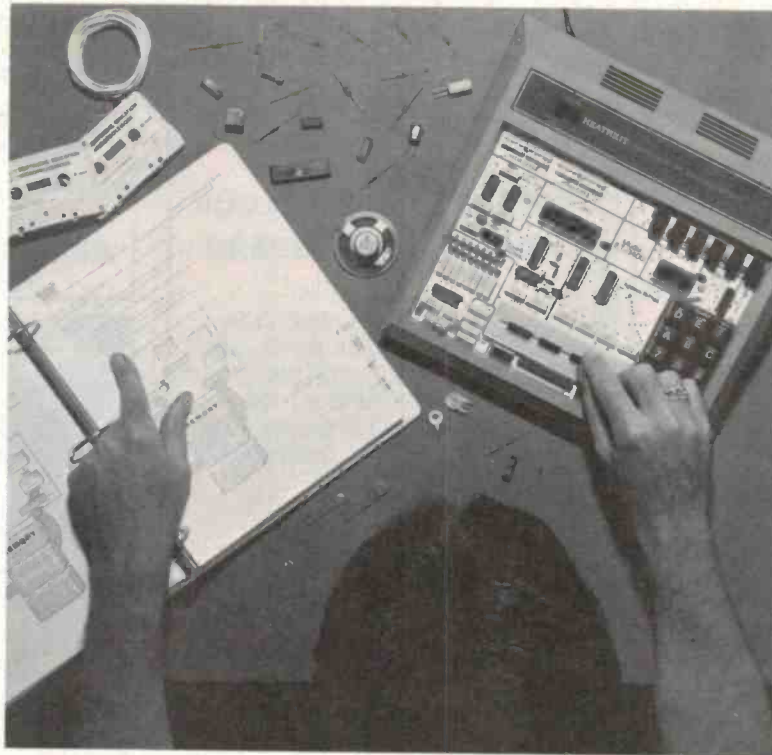

# We can put your future at your fingertips.

The Heathkit Continuing Education Courses are the low-cost, time-saving way to learn . . . in your own time . . . at your own speed.

### Programmed Learning

Comprehensive programs that lead you naturally, logically, from one subject to the next. You read about one aspect of a subject . . . listen to a recording that expands on it . . . measure your understanding with the self-evaluation quizzes . . . then reinforce that learning with actual "hands on" experiments which demonstrate what you've just mastered.

### A "state of the art" learning system!

Heathkit Learning Programs are furnished in vinyl-covered looseleaf binders that lay open for easy use, and allow you to add additional material for your own reference.

Along with your program, you'll receive related audio recordings that provide a personal touch as you're introduced to the program . . . given an overview of the theories involved and their applications . . . and

then a preview of what you'll be learning in the next. These handy records can be played on any standard record player, serving as a refreshing "change of pace" as you learn this pleasant, modern way.

**Courses available in the Heathkit Continuing Education Program include:** ● Weather Course ● Electronics for Hobbyists ● D.C. Electronics Course ● A.C. Electronics Course ● Semi-conductor Electronics Course ● Electronics Course ● Analogue & Digital Meters Course ● Oscilloscopes Course ● Frequency & General Measurement ● Special Measuring Instruments ● Digital Techniques ● Microprocessors Course ● Introduction to Microprocessors ● Operational Amplifiers Course ● Active Filters Course ● I.C. Timers Course ● Phase-locked Loops Course ● Optoelectronics Course ● Basic Electricity Course ● Basic Course ● Pascal Course ● Cobol Course.

**Send for your free Heathkit Catalog today and find out how you can acquire valuable new knowledge in a logical, enjoyable way.**

## Heathkit<sup>®</sup> Continuing Education Courses

Please send the free Heathkit Continuing Education Catalog

Name .....

Address .....

.....P/Code.....

Send to W.F. Heathkit Centre, 220 Park Street, South Melbourne, 3205.  
Phone: (03) 699 4999.



# Print-out

## Monstera Ridiculosa

If we collected all the Apple Computer copies together we'd have a good fruit salad. Apple Computer Inc has filed suit against Formula International Inc of Los Angeles for copyright, patent and trademark infringement. The lawsuit, filed in the US district court in Los Angeles, charges Formula with selling copies of the Apple II computer in kit form under the brand name 'Pineapple'. (Now that's the best name yet.)

The kits are being imported from the Far East and include all components necessary for an Apple copy, including ROM containing Apple's copyrighted programs. Formula is also selling diskette-form copies of Apple's copyrighted programs.

Apple seeks injunctions against the importation and sale of the kits in addition to the profits, if any, from Formula's sales. The suit has been brought by Apple to supplement the actions of US Customs which has been confiscating Apple copies being imported into the US.

## Vendale ZX80/81 programmable character generator and video upgrade

The ZX80/81 programmable character generator removes the limitations of the ZX character set by allowing users to define their own characters. This feature is normally only available on more expensive machines and allows you to create your own graphics for games, charts and interesting patterns.

The programmable characters can be any shape defined on an 8 x 8 matrix of black and/on white dots and are created by using simple BASIC commands. Because the Vendale ZX80/81 programmable character generator has onboard RAM it does not interfere with memory expansions etc. The pc board plugs into the ROM socket inside the ZX80/81 (the Sinclair 8K ROM plugs into the add-on board) leaving the edge connector free for other add-ons and requires one simple internal connection. The fully assembled price is \$95 incl p&P (Australia).

The video upgrade add-on will allow the ZX80 to run at two speeds, slow and fast. Like the ZX81, this add-on will cause the ZX80 to compute and display information on the screen at the same time. Now the ZX80 can run animated displays

completely free of annoying screen flicker and also overcomes the problem of the top lines of the display slanting to one side.

The Vendale video upgrade is fully assembled and will fit easily inside the case of the ZX80. If you are handy with a soldering iron, you could install this add-on quite simply or Vendale could do it for you at a minimal charge. The fully assembled price is \$38.50 incl p&P Australia. If you would like Vendale to install the video upgrade for you, the charge will be \$15 for an unmodified ZX80 and Vendale ask that the ZX80 owner pays his own postage and insurance. The video upgrade will only work in conjunction with the Sinclair 8K ROM.

Both units are available from Vendale Pty Ltd, P.O. box 456, Glen Waverley Vic. 3150.

## Software for TRS-80 and System 80

Aiming to capture the swelling demands from TRS-80 and System 80 users for quality software, Molymerx has established a mailorder network with outlets in Gosford and Auckland.

Managing Director, Alistair Campion, says that the last 12 months have been spent compiling together an extensive catalogue encompassing some of the best software currently available in Europe and North America. The catalogue is being marketed as a reference tool, with extensive descriptions and screen photos accompanying many of their products. Regular updates of the catalogue will be mailed to subscribers as new software is released.

Readers will be able to choose between a wide range of program-

ming utilities, arcade and adventure games, data management systems, disk operating systems, education and communications software. For business users, there will be a number of small accounts packages, stock control, time recording, word-processing and mailing systems.

The Molymerx software catalogue is available through mailorder for \$2 (NZ\$3). For further information contact Molymerx at P.O. Box 900, Gosford NSW 2250. (043)694-888. New Zealand readers should write to P.O. Box 60152, Auckland. (817)4372.

magmedia magmedia magmedia

# Here's to longer life with Datalife from Verbatim.

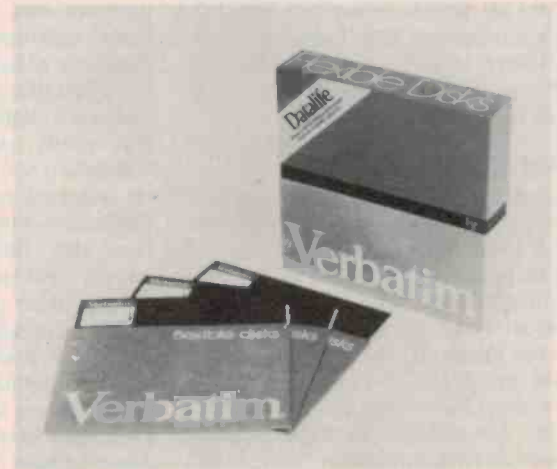

Verbatim is committed to offering customers the very best removable magnetic storage media. Our line of highest quality magnetic storage products extends to virtually all removable media forms and includes Datalife TM flexible disks and minidisks, data cartridges, data cassettes and Datalife TM head cleaning diskettes. Verbatim is intent on keeping their products at the forefront of technology, going above industry standards, setting a new standard for excellence.



## magmedia

MAGMEDIA SERVICE PUTS THE CUSTOMER FIRST

SYDNEY  
(02) 428 1100  
CANBERRA  
(062) 48 6751

BRISBANE  
(07) 229 1600  
HOBART  
(002) 34 4522  
ADELAIDE  
(08) 223 6261

MELBOURNE  
(03) 699 9688  
PERTH  
(09) 328 3311

magmedia magmedia magmedia



# Two views of the MicroBee

There is no point repeating here the boasts of this locally designed and manufactured personal computer — read the advertisements! But, just what do you get? Two builder-users relate their experiences and give their views.

**Eric Lindsay  
Tom Moffat**

THIS ARTICLE is the combined contributions of two authors, Eric Lindsay and Tom Moffat. Both purchased MicroBee kits and relate their experiences with the kit and their impressions of the working machine. Eric Lindsay bought his kit early in 1981 when the MicroBee was first released, whereas Tom Moffat bought his some six months later.

## To bee or not to bee . . .

**Eric Lindsay, Faulconbridge, NSW**

AFTER some two hours of playing with a prototype MicroBee, I phoned Applied Technology to order one. They would not accept an order until the components were to hand. This attitude rather pleased me, although I admit that I did try to bribe them to put me at the top of the list for orders, because when I ordered my first computer, from a very well known organisation, I had to wait nine months for delivery.

I bought one of the earliest kits delivered and I did have problems. There were some etch cuts and jumpers on the board. The manuals were photocopied and loose-leaf, the connection diagrams were wrong, testing procedures incomplete, and the circuit diagram was both incomplete and incorrect in areas. Even worse, not one step of construction went to completion without extensive debugging. After finding plated-through holes on the boards that were not plated through, I sought expert help and we then spent about 36 hours, without achieving much more than considerable admiration for the ingenuity of the designer. Eventually we gave up, and sent the kit back to Applied Technology. They spent about four days on it before also giving up. The offending board was returned to the supplier as an example of problems, and with a new board my MicroBee started running and has been trouble-free since.

Construction is reasonably straightforward. The memory board is completely assembled and contains most of the expensive components. The bottom board is nicely marked with components, double-sided and solder-masked, and although closely packed, should provide no problems for the experienced hobbyist. A number of MicroBees have been

constructed by inexperienced builders of my acquaintance, and only one other had a plated-through hole problem, and that was also from the earliest production run. There have been some board changes. The jumpers and etch cuts are absent from boards after the first 500, the mounting of the 7805 has changed, with the TO3 case mounted on the metal baseplate replaced by two flatpack 7805s with heatsinks. This is an advantage as poor construction on the earlier method could drive the leads into the 7805 case, causing power supply problems. The plugpack power supply that provides 12 V dc to the board is adequate, as a fully expanded MicroBee draws less than 900 mA, but hardly inspires confidence. Several owners have built up replacement supplies, just in case. If you need low power consumption, you can replace some ICs with 74C series. However, Applied Technology do not give advice on this. I can tell you that 74C151s and 157s do not give good results, and most of the video components also need LS chips.

The manuals with the MicroBee now include a corrected construction guide, in which I could not find any errors (after my initial experience, I can assure you I looked long and hard). The BASIC tutorial manual gives a guide to some of the commands, and explains some of the differences between the MicroWorld BASIC used, and the more standard Microsoft BASIC as found in Apples TRS-80s, and PETs. The 27-page tutorial manual also contains the only mention of the "On Error" command, which is not mentioned in the 110-page BASIC manual. The documentation is adequate for a person who has a little program experience, however the complete beginner would find it hard going, despite the tutorial. The manuals are bound in the same format as those with the Apple, but as could be expected with a new computer, are not as extensive. As most textbooks tend to cover Micro-soft BASIC, if they mention home computers, I would advise newcomers to BASIC to join a user group or seek out others with a MicroBee before they get too involved. Since the MicroBee is designed to meet school needs, I anticipate that better guides will be

available in the future.

Running the MicroBee was a *delight*. I have never owned a cheap home computer that was so easy to interface to other equipment. I needed a listing of a program the first day I had the Bee. Plugged an RS232 cable into the Bee, typed "Out#4 on", and listed it. No problems for my ancient 300 baud Terminet. There are some printers with serial connections that give problems, but if the printer can take 300 or 1200 baud, 8-bit ASCII with two stop bits and no parity, it will run. Centronics printers are another matter. There is no official way to run them, at least in the MicroBee advertisements. However the Bee contains the required software, and the only changes required are to fit a 15-pin right angle D socket to the Bee in the position marked on the circuit board, and then add a 74123 to widen the strobe. "Out#1 on" then transmits to a Centronics printer, such as the Tandy Model VII with proper handshake. Connecting modems is a matter of plugging them into the RS232 socket.

Communication with other computers is equally easy. I dumped a lengthy BASIC program from a System 80 to the MicroBee by typing "in#4" on the MicroBee, and then "LLIST" on the System 80. This transmitted straight through the RS232 connection. I did have to add a short program to the System 80 to put nulls out after each line of BASIC, however you can just LLIST line number and transmit a line at a time if the program is short.

Another beauty of the design is memory designed to be 'continuous', that is, to remember its contents without mains power, using a battery. Adding the backup battery is easy. Two soldered connections and a 4.5 volt photo battery. Unfortunately, you can sometimes have a cold start, usually when you have been relying on the battery backup to retain the program you have been working on for the past month. I found I was getting into the habit of just unplugging the MicroBee, confident that programs would be there when I returned . . . but when I started doing that with other computers, I decided it was time to start backing up



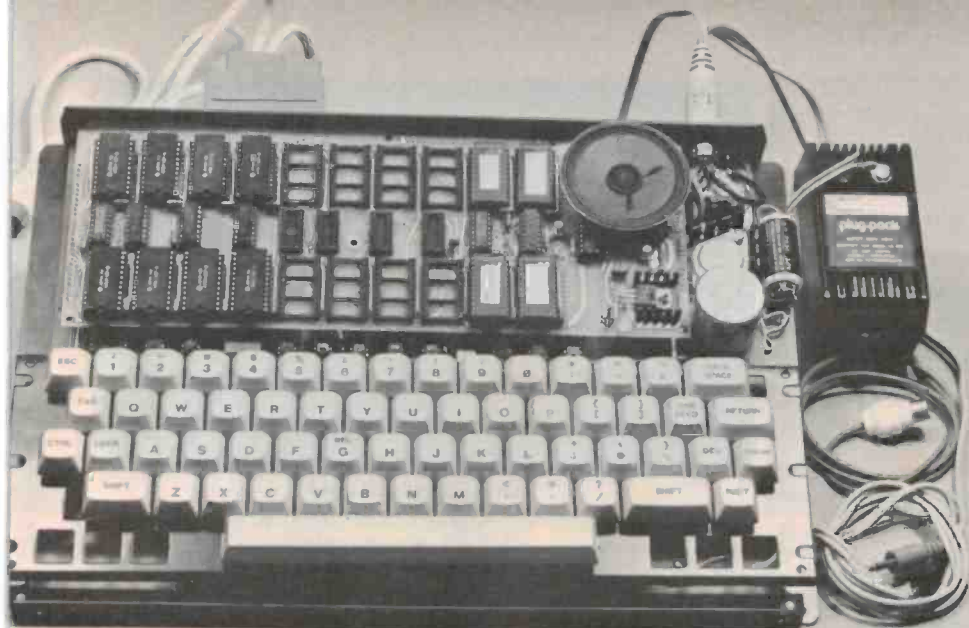

The MicroBee exposed! The 'core' board is prominent above the keyboard. This can be changed to provide different configurations for the machine — PROM-based software, more RAM etc.

programs to cassette! I started at 300 baud, since I don't trust cassette. Those of you with early TRS-80s, Apples or System 80s will know what I mean. After a bit I tried 1200 baud. Then for portability, I started using my micro-cassette recorder, at 1200 baud. I can dump a 350-line program in a few minutes, and can only provoke a bad load by having totally flat batteries. The cassette interface is *very impressive*. It does however lack remote control of the cassette motor.

Video output is not so impressive. It lacks power. I tried the amendments suggested in a MicroWorld newsletter, but they did not help much. I must admit that output is not low enough to cause viewing problems; merely that you have to adjust your monitor brightness and contrast, and if you run several computers, this gets to be a problem. Synchronisation is excellent. No wavering or swimming of the image, unlike every other home computer I've owned. To my considerable delight, the MicroBee also produced an excellent picture on an unmodified US monitor, so I will carry the Bee with me overseas to use as a word processor.

## Software

The MicroWorld BASIC is somewhat slow, about half the speed of the Apple. Since most real time games are written in machine code, this probably won't be a problem. It is also fragile: you find errors where you don't expect them, if you have used Microsoft BASIC. Most come from having integer and real variables being incompatible and unable to be mixed within a line, a method common in early BASICs, and familiar to those who program in Fortran IV. String manipulation is also different, being to the ANSI Standard, or like the

early HP BASICs. For example, to pick characters 1 to 3 from a string, you would use A1\$(1,3). You can do everything that LEFT\$, RIGHT\$ and MID\$ will do. In the fancier commands, the GX, global search and replace, and PLOT commands are very nice, as is the SD — set decimal precision. The loud-speaker tends to be standard now, but having the PLAY command run exact musical notes was a good idea.

However, the major problem with any home computer is to justify the purchase. At \$399 the MicroBee is less expensive than most, and needs less justifying. If you are using it for business it is more difficult. There are relatively few programs available as yet, and unless the capabilities of the MicroBee fit your particular need, writing a program is hardly cost effective. Apart from the educational market, where MicroBees could form an effective network machine with a single master running multiple slave MicroBees, there are a few very small business uses, where the cost of a MicroBee plus cheap printer could be justified.

Take a milk vendor. A MicroBee and monitor could run off the milk float battery and list all customers and their orders. Changes could be indicated at once, and the MicroBee removed after the run for accounting. No other machine has the combination of small size, low power, battery backup, printer outputs and low cost needed to suit a one-person business with limited resources. There are probably a whole range of small businesses for which a MicroBee is the ideal size computer.

## Expansion

Future expansion is always problematical. Most manufacturers take far longer than anticipated to produce

expansion units. However it appears that a four-slot S100 expansion, with in-built power supply and disk drive will be available for the MicroBee. This will have room for two drives, and be fitted with a single MPI B51 running double density to obtain 180K capacity. A new core board to provide 64K of memory would be required, and a disk boot EPROM. There would probably be minor changes to the main MicroBee board to obtain an 80 column display to match the standard expected in CP/M2.2 equipped micros. A light pen and perhaps some form of external ROM pack for programs might appear by next year.

## Graphics

The MicroBee's graphics are achieved in a similar fashion to the Sorcerer — that is, a programmable character generator (PCG) is used. This is memory economical but it is possible to overflow the PCG by just blindly plotting on the screen, with little consciousness of PCG usage. Not quite as flexible as the Apple's bit-mapped approach, but if you think about it carefully, it can do as complex a pattern as you are likely to need and it costs you less than the brute force techniques.

Another memory economy is the storage of BASIC words as tokens, rather than as the strings of characters which make them up. A program to find what tokens mean what, just as a matter of interest, is appended (over the page).

## Summary

In summary, an excellent machine for learning computing, and for the ultra small business, with considerable expansion potential. A little time will show just how much potential is realised. It is excellent value for money.

## The MicroBee revealed

Tom Moffat, Fern Tree, Tasmania

THIS isn't a review, as such, but an account of experiences... the frustrations, and sometimes the joys, of buying and building Australia's latest homegrown computer. MicroBee... where'd they get a name like that in the first place? Is it a \$400 wonder, or a \$400 headache?

Getting the MicroBee from Applied Technology was a hassle from the start. You don't just go out and buy one, you get put on a waiting list, and you wait and you wait and you wait. As quoted delivery times kept slipping back and back, two of us, myself and a friend named 'J.J.', decided to take the bull by the horns and order two MicroBees, with a notice on the order saying if they didn't appear within 30 days the order ▶



```

list
00100 REM Care, include the space between line no and rem
00130 FOR T =129 TO 240:POKE 2308,T
00140 PRINT "token ";T;" ";LIST100
00150 A1$=KEY$:IFA1$=""THEN150
00160 NEXT T
00170 POKE2308,161
>run

token 129
00100 LET Care, include the space between line no and rem
token 130
00100 LPRINT Care, include the space between line no and rem
token 131
00100 PRINT Care, include the space between line no and rem
token 132
00100 IF Care, include the space between line no and rem

Stop at 00150
>

```

Example program from Eric Lindsay to show what tokens stand for which BASIC commands. e.g: token 129 is LET, token 130 LPRINT, etc.

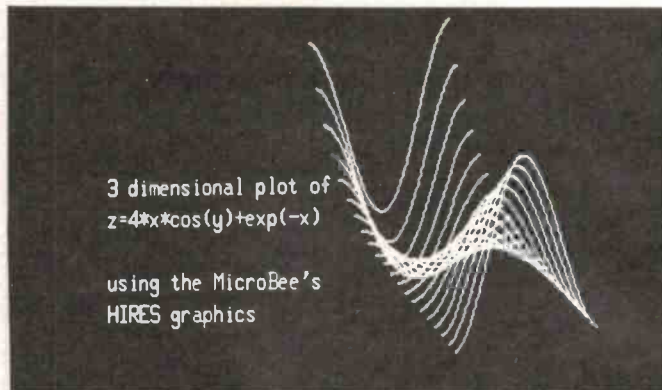

This one speaks for itself!

would be considered cancelled. On the 30th day they arrived, along with a stinging bill for \$46 for double-speed, door-to-door, air express delivery. Oh well, we would now consider the investment \$422 each — \$399 for each computer, plus the freight.

Our MicroBees arrived as kits... a large circuit board which was to be filled with ICs and a few other bits, a ready-built keyboard, and a ready-built core board (the plug-in section with most of the memory chips). Construction was uneventful. It took each of us about eight hours, following a generally well-written manual, pausing to carry out tests at the recommended stages. Both computers survived the final smoke test working the first time.

Within an hour of completion, the first problem surfaced: heat, and lots of it. Two 5 V regulators attached to the keyboard frame as a heatsink, and a third on the core board simply flapping in space were all hot as a firecracker. And the 12 V/1 A plugpack supplied with the kit — same thing. There is an old rule of thumb in the electronics business, ... if a part is too hot to touch, it's too hot! Just about every active part of the power supply produced painful burns. Inquiries to Applied Technology brought the response that 'all the parts were running within their ratings'. J.J. and I, being of a more conservative nature, found a source of Sinclair ZX81 plugpacks rated at 9.5 V/1.2 A. One of these for each computer got the heat down to a more reasonable level, at a cost of \$15 each. Total system cost now \$437 each. Another Hobart MicroBee user didn't get there in time — his 12 V plugpack 'blew its guts'.

Another loud grizzle concerns the case supplied with the MicroBee kit. The blank moulded plastic case probably started out all right, but then someone cut the hole for the keyboard, from the looks of it *either with a nail file or an axe*. The holes were marked with blue ball point pen, and then the cuts were made inside the lines, leaving the blue marks

behind. In other words, a real mess. Applied Technology promised some replacement cases, but at the time of writing, there's been no sign of them. Same goes for the software cassette tapes promised as a reward for returning the user registration card. When I tell people I built the MicroBee from a kit, in the next breath I must save face and deny responsibility for cutting the hole in the case.\*

### The BASIC interpreter

MicroWorld BASIC is a real enigma. It's a bit on the slow side, it's choosy about how you assign variable types, and it can produce some strange crash conditions. But within its 16K it has some features usually found only on multi-thousand dollar systems, such as a 'global search and replace' facility, full editing, and the ability for the programmer to define some of his own functions.

Variables come as three types: integer, real (floating point), and string. There's absolutely no mixing of different variable types allowed, and if you try to take the square root of A, for instance, you'll bomb out to an error message: mixed mode. 'A' is an integer variable. If you want the square root of a number represented by A, you'll have to call it 'A1' or 'A2', a letter and a number. String variables need a letter, a number and '\$' — A1\$. Actually, for the right applications, integer mathematics are very handy — division results in the fractional part being dropped, and all variables can be expressed as 16-bit binary values. The upshot of all this variable mode stuff is that it's easy enough to write original programs, but a bit messy to translate material from other dialects of BASIC.

### BASIC funny business

There are a few strange things that occur under BASIC which haven't been successfully explained. When working on a large program, inserting and moving lines around, program material

far removed from the area being worked on is sometimes corrupted. This happens before an attempt is even made to run the program. If you fix the corrupted line using the edit commands and then go back and look at it again, it will once again be faulty. An educated guess is that there are two versions of the line, the faulty one and the one fixed under edit.

When Applied Technology were told of this, they said it was the first case of its kind they'd heard of. They offered to look into it if I sent the core board back, but before I could do this my friend J.J. advised that his MicroBee was sometimes developing bodgy lines that 'he couldn't get rid of'. Aha! It's not just my computer after all. Further investigations are to follow.

The current theory is that the 'funny business' gets worse as the computer is used more and more. Now the MicroBee has what's called 'continuous memory', a small battery keeps its RAM contents intact, even when the power is switched off. The suspicion is that some 'little crashes' poke bad values into areas of RAM, with resulting weird effects, and as time goes on these 'bad bytes' keep building up since nothing is ever actually erased. When you hit 'NEW', 'RESET', or even a full blown cold start, RAM contents remain. Only the 'end of file' marker gets moved to the start, making the computer think it's empty.

Enter upon the scene a small program called 'purge'. Its purpose is to clear, in a violent manner, all memory between zero and the end of a 32K system! As it resides in an area of RAM above the VDU, it's out of range of the 'wipe' and won't be affected. Both a machine language and a BASIC version are given. When the computer is playing up with much 'funny business' under BASIC, run this program and you will notice a considerable improvement.

### Editor/Assembler/Monitor

Not many MicroBee owners will have this \$50 software package in two 4K

\* Applied Technology supplied new cases just as we went to press. MicroBees now have 'proper' moulded cases.



EPROMs. Pity. It is one *beauty-bonzer-rip-snorter-crash-hot option*. I am an incurable machine code freak, and this software package helps write machine code. Helps? It damn well does it for me! I've hand assembled thousands of lines in Motorola 6800 code. Now I'm into Z-80 and I just type in what I want the instruction to do. The assembler does all the looking up of operation codes, notifies any syntax errors, works out the machine code, puts it in the desired area of memory and prints out the result of the whole works. *Magic*. The machine code version of 'purge' was made on this system; all that nice labelling and formatting is automatic.

The original plan for a program is worked out on the Editor. Before attempting an assembly you can type in lines, change them, add them, drop them, compose whole blocks of material and then dump them in the middle of the main file, pushing existing lines apart to fit it all in. And the Editor isn't restricted to machine code program lines, it works on text as well. This entire article was composed on the Editor, saved on cassette tape and when completed (after much chopping and changing), the whole file was played out to an old 50 baud teletype machine. Typewriters, my friends, are old stuff now.

The Monitor allows the programmer to look at memory contents, change or enter material into memory, search

memory for specified contents, or move blocks of memory. You can also record and load machine language tapes, and run machine language programs.

An interesting fact about the Editor/Assembler is that it does not indulge in 'funny business'. This is the private domain of BASIC. The Editor/Assembler appears to be perfectly behaved, once one learns how to drive it. Commands are in the form of one- or two-letter codes that must be looked up, or memorised. It's got its own instruction manual. My copy has a few mistakes but one would assume these will be corrected in later editions.

A final word from J.J. came the week before this article was written. "My MicroBee blew up last night," he said, "just as my wife was typing programs in for me" ... (Eh?) ... "The keyboard froze, she lost complete control of it, and then it went pffff ... dead, snuffed it, expired."

We had one worried fellow there for a couple of days as all normal troubleshooting procedures failed. Nothing made sense, all ICs were changed until all that remained were the big 40-pin chips. And the culprit? — the Z80 itself. Why? Who knows ... could it be the original heat problem somehow weakened it?

How reliable the MicroBee turns out to be will be interesting to observe. At the price they're selling for, Australia will likely be flooded with them, in

schools, in homes and even offices as their uses as 'el cheapo' word processors and accounts machines become evident. If they're good they're going to be glorious. But if the problems persist ... ?

The heat trouble is the first priority — this must be sorted out in future machines. The BASIC bugs will not be quite as obvious, as they don't appear during program run time, only when it's being written. So users of pre-written software, such as students running maths drills, will never see the bugs. But programmers will scream in frustration until it's fixed. If Applied Technology would care to supply a sorted out version of MicroWorld BASIC, I'll be happy to test it out and eat my words if necessary.

In the meantime, have a program to play with. Yes, you've seen it before, in another version, published in ETI with a review of the Sharp/Tandy pocket computer. Now it's been translated again, and souped up a bit to provide some printer-style graphics. Since it's been printed out on the old teletype machine, built before ASCII characters were ever heard of, a few substitutions have been made. 'X' means multiply. '(' means less than. ')' means greater than. Of course, in the proper context, '(' are brackets as well. If you go back and compare this version of the program with the one published earlier, you'll see how variable types have to be shuffled around. Happy landings!

```

THE FOLLOWING TWO LISTINGS ARE OF THE SAME
PROGRAM., 'PURGE'. IN THE ASSEMBLER VERSION THE
ACTUAL PROGRAM IS THE HEXADEXIMAL NUMBERS LISTED
UNDER 'CODE', STORED AT THE LOCATIONS UNDER 'ADDR'.
THE BYTES CAN BE ENTERED INTO THE COMPUTER MANUALLY,
OR BY USING THE BASIC PROGRAM BELOW. IN THIS CASE
THE NUMBERS IN THE DATA STATEMENTS ARE THE SAME
PROGRAM CODE, ONLY IN DECIMAL FORM. THE PROGRAM,
ONCE ENTERED, IS RUN BY TYPING 'PRINT USR(62464) AND
HIT RETURN. AFTER A BRIEF PAUSE THE COMPUTER WILL
CONDUCT A BASIC COLD START, WITH A CLEAR MEMORY.

ADDR CODE LINE LABEL MNEM OPERAND
0400 00210 DEFR 16 ,ALL VALUES ARE HEX
F400 00220 ORG OF400 ,PUT PCM AT F400
F400 210000 00230 LD HL,0 ,START OF CLEAR AREA
F403 010080 00240 LD BC,8000 ,HOW MANY BYTES
F406 3600 00250 CLEAR LD (HL),0
F408 23 00260 INC HL
F409 08 00270 DEC BC
F40A 78 00280 LD A,B
F40B B1 00290 OR C
F40C 20F8 00300 JR NZ,CLEAR
F40E C30080 00310 JP 8000 ,JUMP TO BASIC.
0000 00320 END
00000 TOTAL ERRORS

CLEAR F406

00100 REM PURGE... A MICROBEE LAXATIVE.
00110 FOR A=0 TO 16
00120 READ B
00130 POKE (62464+A),B
00140 NEXT A
00150 END
00160 DATA 33,0,0,1,0,128,54,0,35,11
00170 DATA 120,177,52,248,195,0,128

00100 REM SPACECRAFT LANDING SIMULATION, TOM MOFFAT, 12/9/82
00110 CLS: PRINT 'SPACESHIP LANDER'
00120 PRINT 'ENTER DESTINATION...'
00130 INPUT 'EARTH, MOON, MARS, VESTA:',S1$
00140 IF S1$='EARTH' THEN LET K1=980.7: E1=6371: GOTO 200
00150 IF S1$='MOON' THEN LET K1=162: E1=1738: GOTO 200
00160 IF S1$='MARS' THEN LET K1=374: E1=3380: GOTO 200
00170 IF S1$='VESTA' THEN LET K1=17.5: E1=195: GOTO .00

```

```

00180 PRINT 'X NAVIGATION ERROR. TRY AGAIN.'
00190 PLAY 5,2,5,2: PRINT': GOTO 120
00200 CLS: PRINT S1$, ' GRAVITY=' , K1
00210 UNDERLINE: PRINT ' BURN MGT VEL FUEL': NORMAL
00220 L1=K1/36: M=INT (SQR (L1)*100)
00230 IF M<175 THEN LET M=175
00240 N=55XM
00250 IF N<10000 THEN LET N=10000
00260 O1=FLT(N)*X(2.30258)*XLOG(X1)/20+10000
00270 A1=-6400: B1=5000: C1=15000: D1=10
00280 M1=FLT(M): N1=FLT(N)
00290 H1=D1: F1=B1: P1=M1: Q1=N1
00300 IF P1<7 THEN LET Y1=PIX5 ELSE LET Y1=P1/10
00310 Z=62-INT(Y1)
00320 PRINT (F6.1 J1),(F7.2 P1),(F7.1 F1),(F7.0 Q1),
00330 PRINT TAB(Z),'X', TAB (63),'/'
00340 PLAY 1: OUTO OFF: INPUT J1: OUTO
00350 IF J1=0 THEN 380
00360 IF (J1<0) OR (J1>100) THEN 450
00370 T1=Q1/J1: IF T1<10 THEN LET M1=T1
00380 Q1=Q1-J1*XH1: W1=G1
00390 I1=L1+L1*XP1/(-2XE1)-(J1XO1)/(C1+Q1)
00400 G1=F1+I1*XH1: R1=P1
00410 P1=P1+(G1+F1)/A1*XH1: F1=G1
00420 IF P1<0 THEN 480
00430 IF C1<0 THEN 460
00440 GOTO 300
00450 PRINT 'ILLEGAL BURN, USE 0-100.': GOTO 340
00460 X1=SQR(F1*F1+5650*P1*X1)
00470 PRINT 'OUT OF FUEL.': GOTO 510
00480 X1=SQR (ABS (R1/26X11))X11+W1
00490 IF X1<20 THEN PLAY 4,11,8 ELSE PLAY 22,14,22,14
00500 CLS: PLAY 10,0,10,0
00510 SPEED 180: PRINT 'YOU HAVE...'
00520 IF X1<20 THEN PRINT 'LANDED OK.': GOTO 580
00530 IF X1<100 THEN PRINT 'CRASHED.': GOTO 600
00540 IF X1<250 THEN PRINT 'BEEN BLOWN UP.': GOTO 640
00550 IF X1<5000 THEN PRINT 'MADE A NEW CRATER.': GOTO 640
00560 IF X1<4999 THEN PRINT 'BEEN VAPORIZED.'
00570 PRINT 'XXX BOOM. XXX'
00580 IF X1<1 THEN PRINT 'NICE TOUCH - VERY GOOD.': GOTO 640
00590 IF X1<5 THEN PRINT 'A BIT ROUGH.': GOTO 640
00600 IF X1<30 THEN PRINT 'UNABLE TO TAKE OFF.': GOTO 640
00610 IF X1<45 THEN PRINT 'LANDER ON FIRE.': GOTO 640
00620 PRINT 'THERE ARE NO SURVIVORS.'
00630 PRINT 'CONDOLENCES TO YOUR FAMILY.'
00640 PRINT 'IMPACT VELOCITY=' , X1, ' METERS PER SECOND.'
00650 SPEED 0: FOR X=1 TO 2000: NEXT X: PLAY 9: GOTO 110

```



# THE LITTLE BIG BOARD

COMPLETE DISK-BASED COMPUTER  
SYSTEM ON A SINGLE CARD  
WITH S.T.D. BUSS EXPANSION,  
JUST ADD DRIVES, POWER  
SUPPLY AND TERMINAL.  
CP/M, MP/M AND  
MULTI/OS  
AVAILABLE.

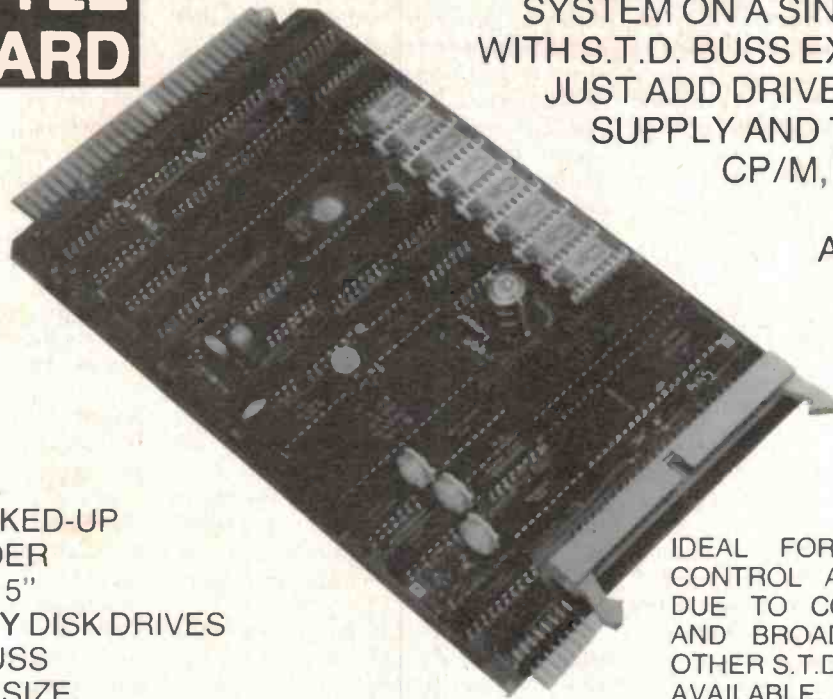

- \* 4 MHZ  
280
- \* 64K RAM
- \* 2 x RS232  
SERIAL PORTS
- \* BATTERY BACKED-UP  
CLOCK CALENDER
- \* UP TO 4 x 8" or 5"  
SINGLE DENSITY DISK DRIVES
- \* FULL S.T.D. BUSS
- \* ONLY 4.5" x 8" SIZE.

IDEAL FOR INDUSTRIAL  
CONTROL APPLICATIONS,  
DUE TO COMPACT SIZE  
AND BROAD RANGE OF  
OTHER S.T.D. BUSS CARDS  
AVAILABLE.



**MICROCOMPUTER PRODUCTS**

WRITE FOR A COMPLETE S100 & S.T.D.  
BUSS CATALOGUE.

## END OF MODEL SELL OUT. Huge savings for bargain hunters.

We have acquired limited stocks of superceded S100 cards from a number of suppliers which we are able to sell at component cost or less.\*

### FDC-I

Single-density floppy disk controller. Suits single or double-sided 5 1/4 or 8" drives. Handles up to four drives. Our Price \$185.

### SD SYSTEMS MPB-100 Z80 CPU Card.

4MHz, 2K Eprom on board, front panel interface. Bargain Price \$150.

### 2708 16K EPROM Cards.

Switch selectable for 8K or 16K, full address decodable. Our Unbeatable Price \$50.

### COMPUTIME

#### Clock Calendar Card.

Time of day, date, can have battery fitted. Runs with Basic or Assembly language programs. Software supplied. Our Price \$60.

### ITHICA AUDIO 2708/2716 EPROM Cards.

16K/32K Eprom card, fully address selectable. Only \$80.

### ITHICA AUDIO CPU Card.

Z80, 4MHz, 1K Eprom on board, front panel interface. Unbeatable value for \$100.

All boards are supplied with full manuals and circuit diagrams, and are backed with a 90 day guarantee.

K-NAR also stock a full range of the latest S-100 boards. Write to us today for a full list of product data sheets.

**K-NAR**  
**COMPUTER CARDS**

PO Box 412, Dandenong, 3175 Phone (03) 795 5658

\*Prices subject to change without notice. All prices excluding tax. For retail prices add 17.5%. All boards fully assembled and tested and backed by 90 day guarantee.

#### To K-NAR Computer Cards

Please send me product data sheets.  
(I enclose 4 stamps).

I wish to order \_\_\_\_\_

My cheque/order form is enclosed \_\_\_\_\_

Please debit my Bankcard No. \_\_\_\_\_

Name \_\_\_\_\_

Address \_\_\_\_\_

Signature \_\_\_\_\_

Please include me on your new product mailing list. I am mainly interested in systems for  Hobby,  Industrial use,  Education,  Business,  Process control,  Other.

SME364







# COMPUTER COMPONENT SPECIALS

COMMODORE Vic-20  
Computer, 8k Ram, 8k Rom.  
COMPLETE WITH AUDIO  
CASSETTE INTERFACE



SAVE \$\$\$

**\$398.00**

the lot

CALL REVERSE CHARGES AND  
CHECK OUR PRICES ON ALL  
COMPUTER HARDWARE

Also SPECIAL Vic-20 Software,  
e.g. Footy Game \$14.00.  
Vic. Payroll System \$89.00

\*ALL OF ABOVE INC. SALES TAX

## POWER SUPPLIES

Ex.—T.A.B. ±5 volt,  
12v @ 6A. **\$18.95**

Keyboards **\$6.90**  
Card Printers **\$7.90**

Freight \$5.00 each



## COMPONENT PARTS MEMORY

2114 RAM **\$1.25 ea.**  
4116 RAM **\$1.25 ea.**  
6116 RAM **\$6.85 ea.**  
2532 EPROM **\$4.95 ea.**  
264 EPROM **\$9.95 ea.**

Plus 20% sales tax if applicable. \$1.50 freight  
etc. on any qty anywhere in Australia.

## OHIO COMPATIBLE BOARDS

EXPANSION BOARD, 32K C'MOS RAM  
FLOPPY DISK CONTROLLER, SOUND  
GEN.

• Bare board & manual **\$85.00**  
• Kit (inc. above) complete **\$299.00**  
• Fully tested & assemble unit **\$430.00**  
ALL THESE INC. TAX

- Epson printers
- M.P.I. drives

CALL FOR YOUR SPECIAL PRICE

CALL NOW:

# DATA PARTS

11 Edward Street,  
Shepparton, 3630.  
Ph. (058) 21 7155  
21 0240

# Modem follow-up No. 1

Geoff Nicholls

In response to many requests from keen computerists who have constructed the ETI-644 modem we present here details on how the diode matrices are programmed to produce the desired transmit, receive and filter frequencies.

THE THREE diode matrices on the modem provide considerable scope in re-arranging the operating parameters of the modem. This article gives general details on how it's done and illustrates the techniques with reference to the setup as detailed in the original article.

## Transmit frequency matrix

There are diode positions for up to eight transmit frequencies. These are arranged as four frequency-pairs. The Baud Rate Control Inputs, S1 and S0, select which frequency-pair is being used and the data coming in (data to be transmitted) is then switched between the two frequencies of the frequency-pair. The following table shows which diode matrix column number, as on the pc board, is selected for different combinations of S1, S0 and the data input.

TABLE 1

S1	S0	DATA	Column No.
0	0	0	0
0	0	1	1
0	1	0	2
0	1	1	3
1	0	0	4
1	0	1	5
1	1	0	6
1	1	1	7

The diodes are placed within the column according to the following procedure:-

First calculate the required division from the crystal frequency using this formula:

$$\text{Division Number} = \frac{\text{crystal frequency}}{16 \times \text{desired transmit frequency}}$$

$$\text{or} = \frac{316\ 200}{\text{desired transmit frequency}}$$

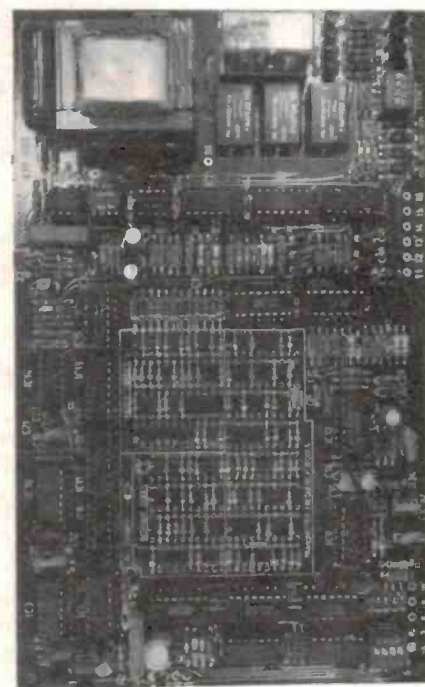

This gives a close enough approximation to the desired result, regardless of whether you use a 5.06 or 5.07 MHz ceralock resonator or a 5.0688 MHz crystal.

Round-off the result to an integer. Convert that number into binary. Diodes are then placed in matrix positions corresponding to 'ones' in the binary number, where the rows (IC6 outputs) intersect the appropriate frequency column.

For example: if the required transmit frequency is 390 Hz

$$\text{Division Number} = \frac{316\ 200}{390} = 811$$

or in binary presentation, see Chart 1.



CHART 1

IC6 OUTPUTS	Q9	Q8	Q7	Q6	Q5	Q4	Q3	Q2	Q1	Q0
DECIMAL VALUE	512	256	128	64	32	16	8	4	2	1
BINARY NO.	1	1	0	0	1	0	1	0	1	1
ROWS	K	J	H	G	F	E	D	C	B	A

So diodes are placed down the 390 Hz column at row positions K, J, F, D, B and A.

**Receiver diode matrix**

The baud rate control inputs, S1 and S0, select which receiver reference frequency is used. The reference frequency should be equal to *twice the average of the two incoming frequencies*, which is simply the sum of them. Table 2 shows which column is selected for the S1-S0 combinations.

TABLE 2

S1	S0	Column No.
0	0	0
0	1	1
1	0	2
1	1	3

The filter diode columns are selected as for the receiver diodes.

To program the receiver diode matrix for frequencies  $f_L$  and  $f_H$ , use the following formula to calculate the division number:

$$\text{Division Number} = \frac{5.0688 \times 10^6}{f_L + f_H}$$

Just take the integral part of the result, convert it to binary and put diodes where there are 'ones'. Ignore the lowest three bits (there are no matrix positions for them anyway!).

For example: to program the receiver for the transmit frequency pair 390/450 Hz, the division number is:-

$$\frac{5.0688 \times 10^6}{390 + 450}$$

= 6034

In binary form, see Chart 2.

CHART 2

IC5 OUTPUTS	Q12	Q11	Q10	Q9	Q8	Q7	Q6	Q5	Q4	Q3	Q2	Q1	Q0
DECIMAL VALUE	4096	2048	1024	512	256	128	64	32	16	8	4	2	1
BINARY NO.	1	0	1	1	1	1	0	0	1	0			
ROWS	K	J	H	G	F	E	D	C	B	A			

In practice, you can use 5.06 or 5.07 x 10<sup>6</sup> as the crystal frequency, but the lowest few binary digits make little practical difference.

Diodes should therefore be placed in the appropriate matrix column at the row intersections K, H, G, F, E and B.

**Filter diode matrix**

For the high and low pass filter component values given in the original article, the following -10 dB filter cutoffs are obtained by placing diodes as indicated by an X in Table 3. Rows ABCD determines the high pass control, rows EFGH the low pass control.

TABLE 3

HIGH PASS -10 dB	H	G	F	E	LOW PASS -10 dB
	D	C	B	A	
1600 (Hz)	-	-	-	-	4800 (Hz)
1500	-	-	-	X	4400
1400	-	-	X	-	4150
1300	-	-	X	X	3850
1200	-	X	-	-	3500
1100	-	X	-	X	3200
1000	-	X	X	-	2850
875	-	X	X	X	2600
750	X	-	-	-	2250
675	X	-	-	X	1900
540	X	-	X	-	1650
430	X	-	X	X	1280
325	X	X	-	-	960
225	X	X	-	X	675
110	X	X	X	-	330

Filter combinations are selected by S1-S0 logic which selects which Y row of IC8 is 'active'. From experience better filter performance is obtained by placing diodes according to Table 4 (note that rows JKLM remain as per the original).

TABLE 4

S1	S0	Y	A	B	C	D	E	F	G	H
0	0	0	-	-	-	X	X	-	X	-
0	1	1	X	-	X	X	X	-	X	X
1	0	2	X	-	-	X	-	X	-	X
1	1	3	X	-	X	-	X	X	X	-

Table 5 shows the frequency pairs and transmit/receive baud rates against the S1-S0 data.

TABLE 5

S1	S0	FREQ. PAIR	BAUD RATE
0	0	1300/2100	1200
0	1	390/450	75
1	0	980/1180	300
1	1	1650/1850	300/600

**S100 BOARDS  
THE BEST THERE ARE**

**SIERRA DATA SCIENCES**



- SBC100M Master Processor true single board computer \$895
- SBC100S Slave Processor \$795
- CP/M 2.2 \$150
- TurboDOS Multi-user Op. System \$750

**MORROW DESIGNS**

- DJDMA DMA Disk Controller \$520
- HDDMA DMA Hard Disk Controller for ST506/SA 1000 \$540
- MPZ-80 CPU with memory management \$435
- MULT I/O 3 serial, 1 parallel \$395

**GODBOUT**

- CPU 8085/8088 Dual Processor \$495
- CPU Z Z-80B CPU \$345
- CPU 8086 \$795
- DISK DMA Floppy \$575
- SS1 System Support 1 Interfacar 4 \$460
- 3 serial, 1 parallel, 1 Centronics \$410
- M-DRIVE with 128K \$1390
- MP/M 8-16 \$1162

**16-BIT SYSTEMS**

We have systems running CP/M-86 and MSDOS. Please call us for details.

**NEW!**

The best 64K CMOS Static RAM for the S100 bus is available now—IEEE 606 extended addressing, bank select, battery back-up, 6 MHz with Z-80B, 8/10 MHz with 16-bit processors. Call us for details and unbelievable pricing.

**microtrix**

75 Grand Boulevard,  
Montmorency, 3094  
Vic. Phone (03)  
439 5257.  
Postal: PO Box 158  
Hurstbridge, Vic.  
3099.





# How to make the best home computer in the world even better.

## Peripherals to turn a powerful computer into a super-computer for the professional.

With the Commodore VIC 20 Computer, you have the finest home computer money can buy. And the more you use it, the more you will ask it to do.

Pretty soon, you'll want to extend VIC's vast potential to the full; and there is a wide range of VIC peripherals to help you do it.

Disk drives, disk-based software, a printer, cassette unit, joysticks, paddles — with these, VIC computing becomes total computing: giving you true professional power and capability.



### VIC PRINTER

The VIC Printer, like all VIC peripherals, offers a very high specification at a very competitive price.

It will print programs, letters, business data, graphic displays and so on.

Its main features include: 80 characters per line • Tractor feed dot matrix • 30 characters per second print speed • Full alphanumeric and graphic printing • Double-size character capability.

### VIC FLOPPY DISK UNIT

The VIC single-drive Disk Unit provides a fast, accurate and efficient means of storing and retrieving data and programs.

Together with the Printer, it transforms the VIC 20 into the ideal system for the small businessman or serious computer programmer.

Features include:

- 174,848 bytes capacity
- Uses soft-sectored standard 5¼" single density floppy disks
- Direct interface to VIC
- Direct compatibility with Printer
- Intelligent system independent of VIC.



### EXPANSION MEMORY CARTRIDGES

Special plug-in cartridges are available to expand VIC's memory. 3K, 8K and 16K RAM packs plug directly into the computer.

A Memory Expansion Board is also available to develop VIC's capabilities to the maximum.

#### 1. Introduction to Basic

This package contains materials that will enable you to learn the fundamentals of programming in the BASIC computer language on your VIC 20 computer. It assumes no prior knowledge of computer programming and includes two cassettes containing 17 programs specially designed to accompany a comprehensive 152 page manual.

#### 2. Programming Aids

To aid programmers to write their own programs, Super Expander, Machine Code Monitor and Programmers Aid cartridges are available.

#### 3. Games

The VIC 20 has the largest selection of cartridge and cassette-based games available on any personal computer. VIC 20 games offer a real challenge and take a great deal of skill, time and mental agility to win.

#### 4. Joysticks and Paddles

These accessories make playing games on the VIC even more enjoyable. The joystick has even more practical uses and can be used with high resolution graphics to draw pictures or help with graph plotting.



For full details of VIC 20, its peripherals and software, and a list of your local dealers, contact: The Commodore Information Centre, P.O. Box 336, Artarmon, N.S.W. 2064 Tel: 437 6296



**commodore**  
**VIC 20**

So much brain for so little.

MLVL 1613



## 'DODGE' game for the ZX81, 1K (or 16K)

Benjamin Smith, Mt Nelson Tas.

'DODGE' is a fast, real-time moving graphics game in which the player must try to guide his spacecraft (represented by 'V') across an enemy space zone without being hit by one of the missiles which constantly emerge from the lower part of the screen. The keys '5' and '8' are used to move the craft left and right respectively. If the ship is hit, a score appears, along with the highest score so far. In his next game (which begins as soon as a key is pressed), the player must attempt to beat this record. The program may be terminated by BREAK.

This particular version is designed for the 1K ZX81, hence the use of expressions instead of numbers in lines 20 and 30 (numeric literals on the Sinclair chew up an additional six bytes). If 16K is available, however, the following modifications should be made:

```
20 LET B = 0
30 LET S = -1
60 PRINT AT 0, 31
70 IF PEEK (16928+P)<>0 THEN GOTO 130
85 PRINT AT 9, P+RND-RND-1;
90 IF RND<.3 THEN PRINT "M";
95 PRINT TAB 31
```

Beware of making any other alterations as the address reference in line 70 will be invalidated.

```
10 POKE 16418, 14
20 LET B = PI-PI
30 LET S = -PI/PI
40 LET P = INT (RND*12+2)
50 LET S = S + 1
60 PRINT AT 0, 14

70 IF PEEK (16897+P)<>0 THEN GOTO 130
80 PRINT AT 0, P; "V"
90 IF RND<.3 THEN PRINT AT 9, P+RND-RND-1; "M"
100 LET P = P+(INKEY$ = "8")*(P<13)-(INKEY$ = "5")*(P>1)
110 SCROLL
120 GOTO 50
130 CLS
140 IF S>B THEN LET B = S
150 PRINT "YOU SCORE "; S; ", BEST SO FAR "; B
160 PAUSE 550
170 CLS
180 GOTO 30
```



## "RAPID DESCENT" for the 1K ZX80

R.A. Chalmers, Inala Qld.

THE PROGRAM starts by giving the height and acceleration, in this case 1000 feet and acceleration of 32 ft/sec/sec\*, the pull of gravity. After inputting both the period of time one wishes to check, and the initial velocity at the 1000 ft mark, the program will give adjusted height and new velocity. The catch now is to bring the vehicle to zero height and velocity. Input F is the accelerator, and -F will allow the vehicle to move

towards the surface, while F will increase height by applying sufficient retard acceleration to reverse the vehicle.

The program is based on the calculations of acceleration and velocities and, as it stands, is stretching the memory to its limits. However, as the calculations remain the same, the program is eminently suitable for expansion and use on larger computers.

Notes U = initial velocity  
F = given acceleration  
V = velocity at end of time T, in feet/second.

\* The program is run in feet as the equivalent in metric to 1 ft/s/s is 981 cm/second/second. The ZX80 has limited maths ability. The reason for the programs name will be immediately obvious to anyone attempting to land safely!

```
5 LET H=1000
10 PRINT " INITIAL HEIGHT = ";H;"FEET AND ACC.OF 32 FT/S/S"
12 PRINT " INPUT T(FLIGHT TIME IN SECONDS)"
13 PRINT "AND U(INITIAL VELOCITY)"
15 INPUT T
16 INPUT U
18 CLS
40 LET T=T
55 LET F=32
56 LET V=U+F*T
65 IF U>0 THEN LET S=((U+V)*T)/2
70 LET H=H-S
80 PRINT " HEIGHT NOW ";H;" FEET"
85 PRINT
90 PRINT "VELOCITY = ";V;" FEET/SECOND"
95 PRINT
100 PRINT "DISTANCE TRAVELLED ";S;" FEET"
102 PRINT "INPUT F +/- ACC, TO RETARD FLIGHT"
105 INPUT F
106 CLS
120 PRINT H; "= LAST KNOWN HEIGHT"
130 PRINT
200 LET S= U*T+(-F)*T**2
300 PRINT
400 PRINT S;" FEET = DISTANCE TRAVELLED TOWARDS EARTH"
500 LET V= U+(-F)*T
501 PRINT
555 PRINT V; " FT/SECOND = VELOCITY AFTER ";T;" SECONDS WHEN
ACC, IS RETARDED BY ";F;" FT/S/S"
556 PRINT
560 LET H=H-S
567 IF S AND V<0 THEN PRINT" VEHICLE IN REVERSE "
568 PRINT
570 PRINT H; "= NEW HEIGHT "
580 GO TO 102
```



# IF YOU'RE SWITCHED ON, THIS IS PARADISE.

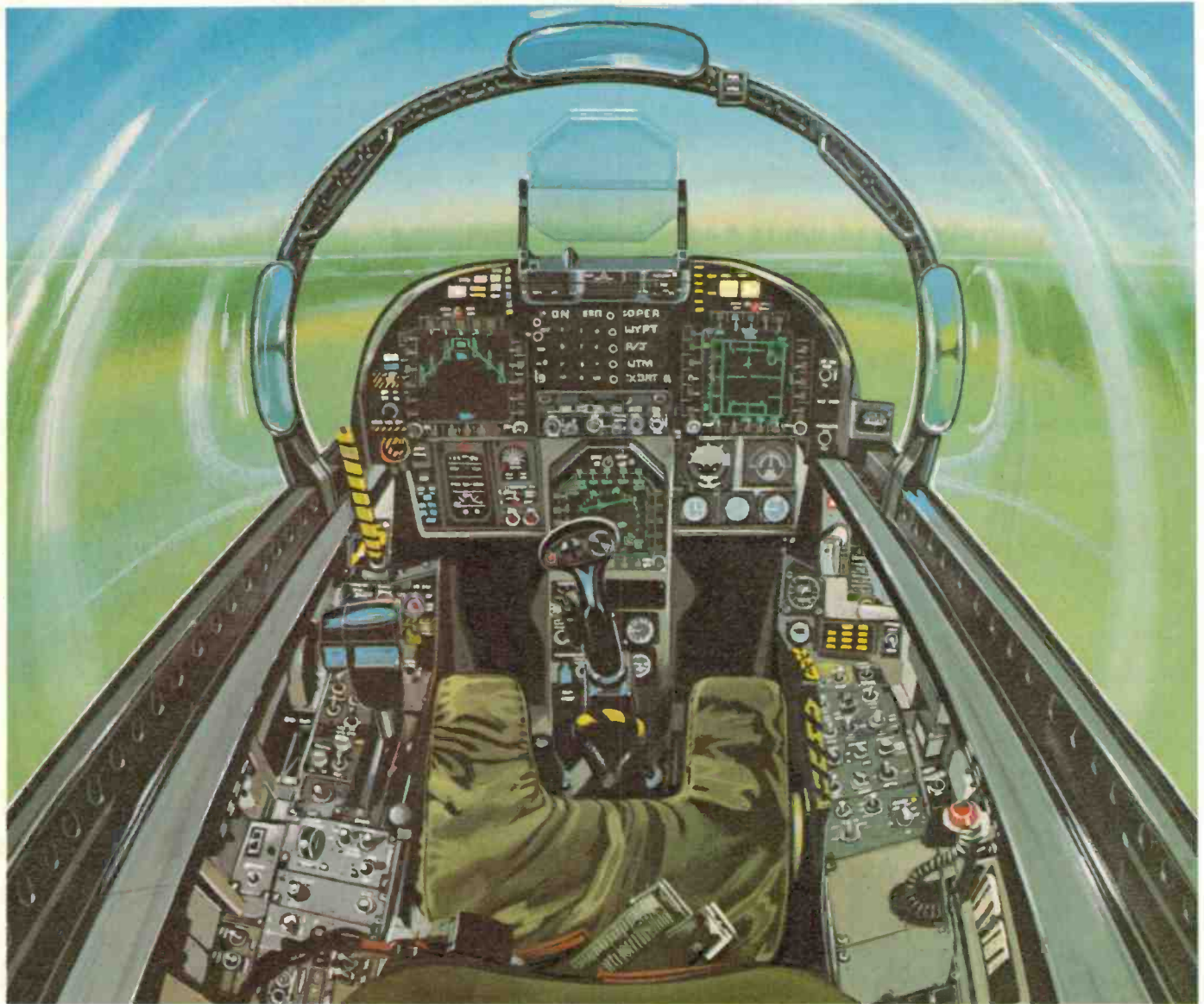

Australia's Hornet. The cockpit contains the latest in the world. Enough electronics to keep any switched on enthusiast happy for years. The Hornet will form the backbone of Australia's Air Force. You can form the backbone of the people who will keep it in the air. Simply phone your Air Force Careers Adviser on Sydney 212 1011, Newcastle 25476, Wollongong 286492, Parramatta 635 1511, Canberra 822333, Melbourne 613731, Geelong 21 1588, Brisbane 2262626, Townsville 724566, Adelaide 212 1455, Perth 3256222, Hobart 347077, Launceston 31 1005.



**JOIN AUSTRALIA'S AIR FORCE.**

Authorised by Director General Recruiting Dept. Defence.





# PCBs

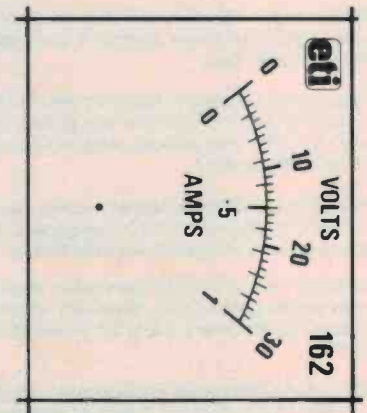
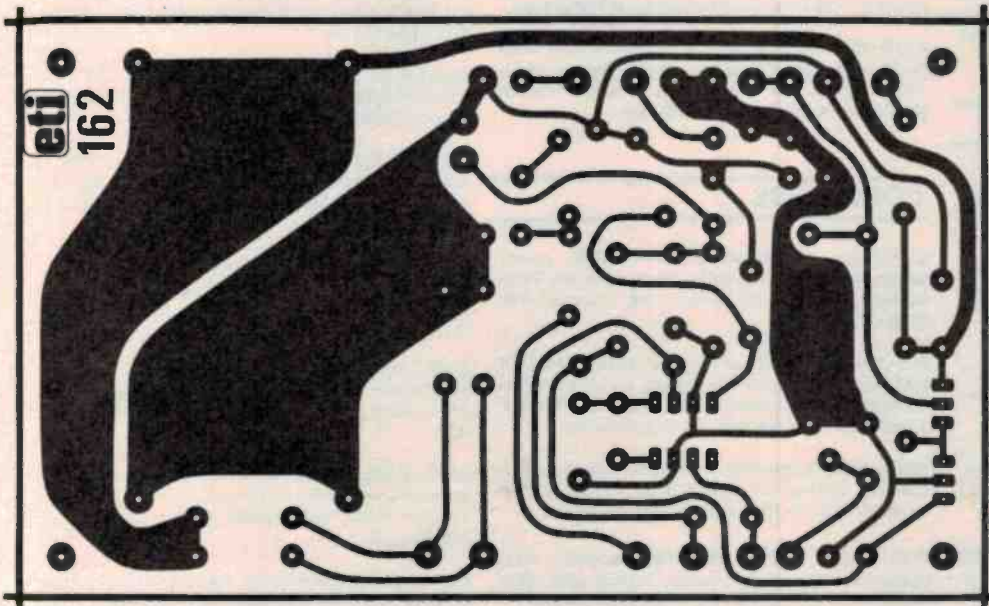
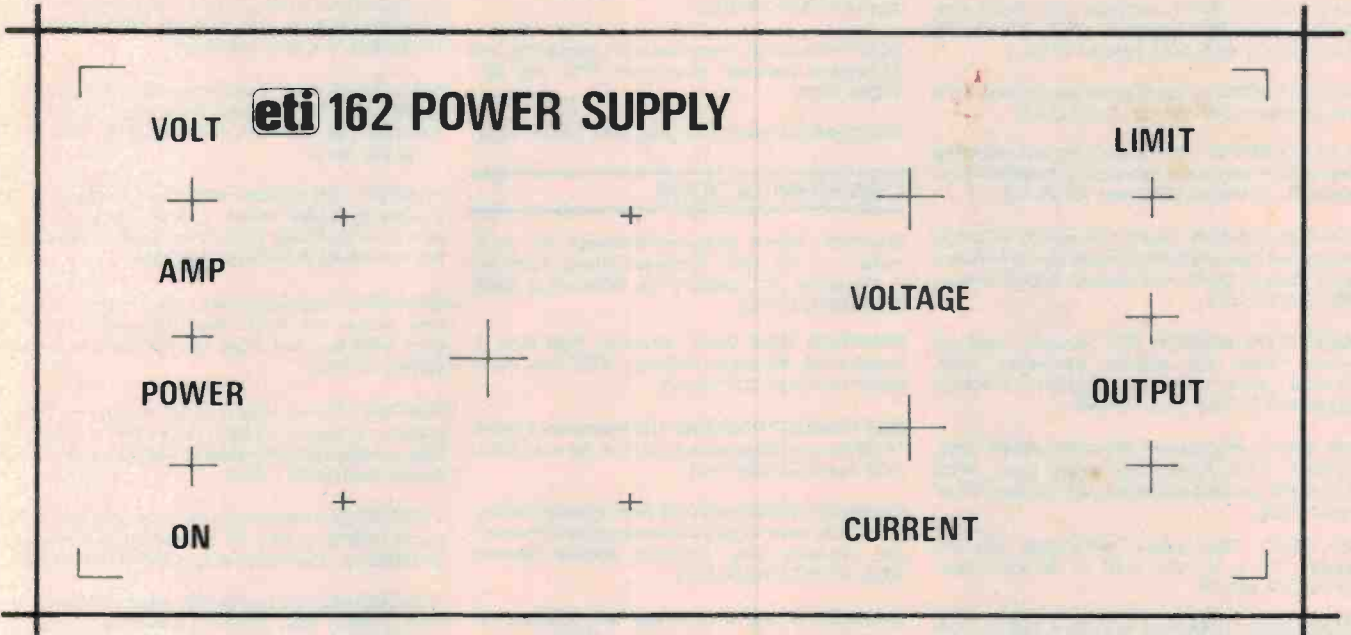
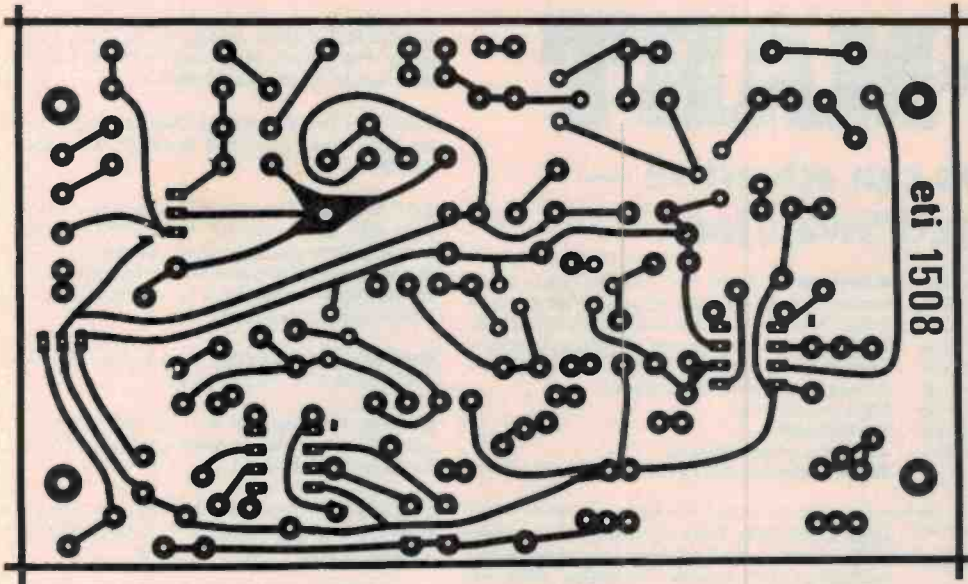



# MINI-MART

Where readers can advertise —  
For Sale/Wanted/Swap/Join.

● We'll publish up to 24 words (maximum) totally free of charge for you, your club or your association. Copy must be with us by the 1st of the month preceding the month of issue. Please — please — print or type adverts clearly, otherwise it may not turn out as you intended! Every effort will be made to publish all adverts received; however, no responsibility for so doing is accepted or implied. Private adverts only will be accepted. We reserve the right to refuse adverts considered unsuitable.

● Conditions: Name and address plus phone number (if required) must be included within the 24 words. Reasonable abbreviations, such as 25 W RMS or 240 Vac, count as one word. Adverts must relate to electronics, audio, communications, computing etc — general adverts cannot be accepted.

Send your advert to:

ETI Mini-Mart,  
4th Floor, 15 Boundary St,  
Rushcutters Bay NSW 2011.

## AUDIO

SELL: SHURE V15-3 cartridge plus spare new stylus, \$50. W. Selwood, 113 Stuart St, Mullumbimby NSW 2482. (066)84-2110.

EA PLAYMASTER graphic equaliser, as new, \$100 firm. Perth (09) 367-6519 ah. C.K. Leung.

LEAK STEREO 60 valve power amp and matching preamplifier. New valves throughout, original mint condition. 60 WRMS, \$380 ono. (02)46-5451.

HARMON KARDON award 500 series all triode integrated tube amplifier. Completely overhauled using state-of-the-art techniques. Superb sound, \$390. (02)46-5451.

MUSIC SYNTHESISER: ETI portable, built by Jaycar. Three high stability oscillators, filter, envelope, wave generator, equaliser, 4 octave keyboard E.C., \$600. (03)578-9644.

FOR SALE: Playmaster MOSFET stereo amp, 50 W/ch, \$135. Playmaster stereo tuner, \$120. Playmaster graphic equaliser, \$85. All ono. David (02)48-3679.

FOR SALE: Video tapes, reel-to-reel, 106 low density, 7" x 1/2" (70 min) at \$6 each ono. (02)44-1234 ext. 12.

ETI DELUXE synthesiser, 8 VCO, 4 VCF, 5 VCA, 6 ENV, 2 trans, noise, mixer (6), numeric k/b for presets, 20 x 40 patchboard. Exclusive basspedal system. Extra (61) k/b, 2 VCO, 10 VCA, \$3900. (03)531-3207.

## MISCELLANEOUS

SELL: CRO Telequipment Serviscope S32-A, \$155. CRO dual beam Hartley 5 inch, \$80. (02) 869-7247 after 5pm.

TRIO OSCILLOSCOPE latest 20 MHz dual trace model CS 1566, 5 mV/div with two probes. As new, had very little use, manual, original carton, \$660. VK2BZT (02)84-2312.

WANTED: TEKTRONIX plug in module type 1/a/1 or similar for type 545/b CRO. Pay good \$\$. Please phone reverse charges Gavin (09)397-5369.

WANTED: COLOUR BAR generator. Must be in good working condition. Woomera Electronics, 3 Gilgill St, Woomera SA 5720. Phone Woomera 73-7103.

SELL: 1974 BWD 509B oscilloscope, s/beam, DC — 7 MHz, \$130. D. Ward, 7 Park St, Maryborough Qld 4650.

OSCILLOSCOPE, TRIO CS-1559, DC — 10 MHz, single trace, horizontal input, ext/int triggering, calibration O/P, excellent condition, \$450 ono. Box Hill (03)88-6125 ah.

SONY WALKMAN, new/unwanted quiz prize. Still in original package. New price \$185, sell \$95. (02)93-3630.

KEYBOARD, Clare C70 in case, \$140. (02)888-7624.

## COMMUNICATIONS

WANTED: Circuit diagram/handbook for Hallcrafters S 36 UHF communications receiver. F. Reynolds, 221 Eastern Rd, Wahroonga NSW 2076. (02)487-3912.

KENWOOD R600 comm. receiver, 0-30 MHz. 7 months old, still under warranty. \$270 firm. Perth (09)367-6519 ah. C.K. Leung.

355F HEWLETT PACKARD VHF attenuator 12 step 10 dB/step programmable, 50 ohm, as new, \$280. John Harris (03)786-1424.

KENWOOD TS520S with CW filter, speaker SP520, VFO 520S, tuner AT200, microphone. All unmarked, exc. working order, manuals, original cartons, \$820. VK2BZT (02)84-2312.

WANTED: RF signal generator with AM and FM internal and external modulation. Minimum freq. range 0 — 50 MHz, good condition. (07)265-1259.

ICOM 225 with scanner and digital display, \$250. 50 W amp, \$40. 100 W amp, \$120. Power supply 13.8 Vdc at 30 amps, \$90. Phone Graham (03)419-1630 ah or (03)697-5027 bh.

## COMPUTERS

SUPER-80: 32K RAM, EPROM BASIC, power supply, manuals and cables, some software, \$290. Rowan McKenzie, 35 Moore Ave, Croydon Vic. 3136. (03)723-3937.

APF IM-1: With colour monitor, disk drive, 24K RAM, cassette, hand controllers, much software. All excellent condition, \$1100 ono. Paul Whiteley, 2 Heffernan St, Laverton Vic. (03)369-2598.

IBM golfball typewriter with computer interface, use as printer or stand-alone, \$350. Phone Graham (03)419-1630 ah or (03)697-5027 bh.

FOR SALE: Sinclair 16K RAM module, \$100. Microace with adaptor, leads, manual, \$50. Sold together or separately. Phone (02)639-3115 ah.

COMPUTER GAME, similar to Dig-Dug arcade game. For details send SAE to Mr. E. Hughes, 52 Lowry St, Cardiff NSW 2285.

WANTED: Two SCL brand 4046 PLL chips (must be SCL). Les White, 503 Churchill Rd, Kilburn SA 5084.

DISC DRIVE system. Micropolis 1043/23 with S100 controller, 315K per drive, MDOS CPM 2.2, Wordstar and other quality software and games plus all service manuals and 40 diskettes included. Set up for DG680/640/6545 as is or will modify to suit. \$1500 ono. (02)888-7624.

S100 BOARDS assembled and tested. TCT Prom \$80. DG640 \$100. (02)888-7624.

MODEM, Prentice Star V21 acoustic, RS232, as new in carton. With modem programs on disk, \$160 ono. (02)888-7624.

ZX-81 PROGRAMS, wide range of uses. Send \$10 postal order or cheque to Poseldon Software, 72 May St, West Preston Vic. 3072.

MICROACE 4K ROM, 2K RAM, with adaptor, works perfectly, \$70 ono. R. Connell, 18 Eustace St, Mt Gambier SA 5290. (087)25457.

SELL ZX-81, M/C Pedestrian, 1K frogger type game \$10 + \$1 postage. Also other programs. Send SAE for details. G. Armitage, 8 Menzies Pde, Lalor Vic. 3075.

PRINTER: IBM golfball with serial interface and control by SCMP micro. Can be used as typewriter. All inclusive \$150. Brian Laird, 8 Kilkenny Rd, Penrith NSW 2750. (047)36-3698.

SYSTEM 80 expansion unit, latest model, brand new, extra 16K RAM fitted (total 32K). Worth over \$450 but sell \$395. Ian (02)44-5027 ah or (02)407-2722 bh.

WANTED: Circuit diagrams for expanding RAM memory in System 80 from 16K to 48K 'internally'. Also wanted TRS80/System 80 software programs. Phone Tom (02)217-2303.

VIDEO DISPLAY terminal with detached keyboard, serial interface, 24 x 80 display and full cursor addressing. Upper case only, \$250. (07)376-3323.

S100 BOARDS, 3 x Logos I, 8K static RAM boards, fully tested, \$45. 11-slot motherboard, active termination by VECTOR ELEC, \$75. 24 A 8 V plus 15 V x 2 each 1.5 A power supply, \$35. Phone (03)543-5451 ah.

SUPER 80: 48K, S100, case, graphics, manuals, EPROM BASIC, software, cassette recorder, \$475. Phone (08)49-3705.

FOR SALE: 2 off Shuggart SA800/801 'monolithic' chip version 8 inch disk drives DD, \$400 ea. 1 off 64K dynamic RAM BRD 32K populated, \$250 ono. Martin (03)726-6134.

ZX-80: 4K/8K ROM. Includes leads, power supply, 26 programs plus Super Invasion tape. Requires second power supply for UHF or VHF Modulator. \$195. (03)728-1519.

SYM-1 for sale. Full memory, extra I/O, cassette switch and one transistor buffer out. Reasonable offer. John (03)690-5088 ext 32 bh or (03)44-6479 ah.

SELL: ZX80, 8K BASIC ROM. Includes leads, two manuals, programs and tapes. Plus '30 programs for the ZX80' book. \$200. Phone (052)50-1948 Geelong Vic.

SELL: ATARI 400 with 32K RAM, BASIC cartridge, manuals and software, \$695. (03)787-6004.



# REWARDS



## \$3000

Are you a member of the public who has spent approximately \$3000 minimum on your

**HI-FI — TELEVISION — VIDEO RECORDER**

and are you trying to operate all this valuable equipment on an inside aerial or an old system 10-20 years old. If so you should have spent \$150 less on your equipment and \$150 or more on a new antenna or antenna system. The end result would be:—

**GOOD VIEWING —**

**GOOD SOUND —**

**GOOD RECORDING.**

Regardless of what you have spent on your equipment, it can only perform as well as your aerial system will allow it.

The E.F.C.3/03S by "Hills" is their top of the range antenna for Sydney, Melbourne and Brisbane fringe areas, very good gain and good for ghosting situations.

We have the largest stocks of antenna equipment available from 5 manufacturers, ANTENNA'S — BOOSTERS AND MAST HEAD AMPLIFIERS — BRACKETS — CABLES — PLUGS — FILTERS — ATTENUATORS, anything you may require.

Treat yourself to an Xmas present and have a happy Xmas from

**ELECTROCRAFT  
MANUFACTURING PTY LTD  
TRADE SUPPLIED**

Free verbal advice given  
Phone or call 438 4308 or 438 3266  
68 Whiting St ARTARMON 2066  
Hours 8am to 5pm Mon: to Friday  
Off Street Parking at rear

# THE EVENING'S JUST BEGUN...



## COME HOME TONIGHT TO A BLACK & WHITE





# Hints for CHIP 8 programmers

## Part 1

For owners of the ETI-660 Learner's Microcomputer, the COSMAC VIP, or any other machine running CHIP 8, this short series will help you with programming and to understand a little more how the computer works.

THIS SHORT SERIES of articles has been compiled from the contributions of several authors and will cover such aspects of CHIP 8 as the various dialects and how to translate between them, displaying data and characters on-screen, sorting, using the sound generator etc. Let's go to it, then!

### Dialects & Translation

Frank Rees, Boort, Vic.

At present, there are three main CHIP 8 dialects. The earlier two, which we will call CHIP 8 dialect 1 (CHIP 8.D1) and CHIP 8 dialect 2 (CHIP 8.D2), have programs listed from address location 0200 onwards. The dialect used in the ETI-660, which we shall refer to as CHIP 8.D3, has programs listed from address location 0600 onwards. As a result, any programs written for CHIP 8.D1 and D2 must be relocated to 0600 onwards to run on the ETI-660 under CHIP 8.D3. Thus, all instructions containing addresses must have 400H added to them. These instructions are:

0MMM  
1MMM  
AMMM  
BMMM

Two of these are special cases — 0MMM and AMMM. The first, 0MMM, refers to a machine code subroutine and this part of any program may require rewriting, preferably with a CHIP 8 subroutine, where possible. The other special case, AMMM, is the 'pointer'. If it points to a location in or at the end of a program, OK. But A100 to A1FF in CHIP 8.D1 and D2 refers to the screen memory which starts at location 0100H whereas in CHIP 8.D3 it starts at 0480H. Any other AMMM pointers must be studied with knowledge of more memory allocation differences (i.e. refer to the machine's memory map. For convenience, the ETI-660's memory map is shown in Figure 1).

Now follows some useful routines you can incorporate in your own programs.

### Captions-to-Screen Movers

Frank Rees, Boort, Vic.

In the CHIP 8 Column on page 108 of the August '82 issue of ETI I showed how we can, with the aid of the FX55 instruction, 'stack' the contents of variables in reserved memory locations beginning at a location indicated by the 'pointer' AMMM and later recover them with the same pointer and the FX65 instruction. The same combination of instructions was used also to shift 16 consecutive bytes into view on screen.

Now, to move more than 16 bytes there are many options, but before getting right into it, switch on the computer and try the routine listed in Table 1 for moving data to the screen. Table 1 shows two methods. Method 1 takes data from consecutive memory locations and stores it in consecutive memory locations. The differences between Method 1 and Method 2 are threefold: (i) Method 2 is confined to use in screen memory; (ii) It moves bytes of data from consecutive memory locations and stores them at locations that are eight bytes apart. 'Move' is used in the computer sense, but actually means 'copy'. Because each line of screen is made up of eight bytes, this results in each byte moved being stored under each other and, in this case, forming a block that is one byte (or eight bits) wide by 16 bytes deep, which gives us an 8-bit x 16-bytes matrix of 128 dots. With this you can construct graphics and alpha-numeric characters; (iii) When the DXYN display instruction is used to move data to screen, it only 'selectively erases' any previous display. Erasure only occurs at points where the previous display and the new one coincide. Example: if you displayed 0 and later displayed 0 in the same spot, it would be erased, but if you displayed 8 on top of the original 0 then only the centre bar of the 8 (one dot) would be displayed. This can be used to great advantage in graphics.

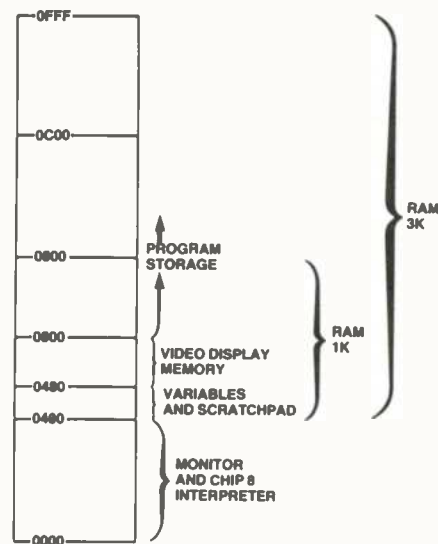

Figure 1. Memory map of the ETI-660. The memory map of the VIP VP-111 (CHIP 8.D2) can be found on page 78 of the April '81 ETI.

The DXYN instruction can be read as "display at horizontal coordinate X and vertical coordinate Y, N number of bytes". The X,Y coordinates are numbered from the top left hand corner of the screen, remember. Note that X is a left-to-right count of bits in eight bytes of each line, 0 to 3F (hex), a total of 40H (64) bits across the screen. Also, Y is a top-to-bottom count of lines in screen display of 0 to 1F for the VIP etc, and 0 to 2F in the ETI-660. Figure 2 shows the two screen configurations. This totals 20H (32) lines in the VIP etc, and 30H (48) lines in the ETI-660. Note that N is numbered one to zero which equals 10H (16 decimal). Two variables, often A and B, are assigned to hold the current value of coordinates for the 'pointer' to be computed by the DXYN instruction.

The objective is to display captions. If we use the five dots high by three dots wide format of characters, as used in the 'memory window' display in the bar at the bottom of the screen, then either Method 1 or Method 2, suitably modified to move, would do.

While CHIP 8 is fast for game visuals, it's lost for words without some help. At present, we shall not discuss how data was raised but only how to move and display it.

While studying a CHIP 8 program to find out how it let you know game results it was found that a machine code routine had been used for this section of program and, as it limited a good program to one machine design, the following Method 1 CHIP 8 version of the routine was written. What the routine does is to display across the top of the machine one of three messages indicating your performance at the end of a game.

Table 2 shows Method 1 expanded to move a lot more than 16 bytes and has been commented to show how it operates.



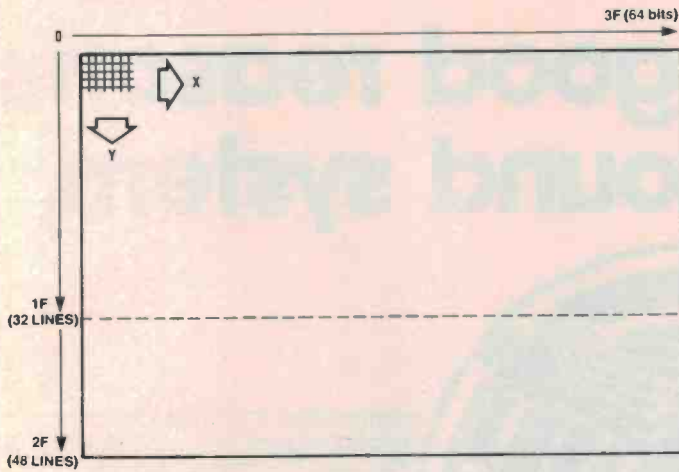

To find out what the game results captions have to say, enter the program and run it. Pressing any key will throw up a display. As you press keys nearer 0, the display gets more complimentary.

Table 3 shows Method 2 also expanded to move a single message which again, you'll have to enter and run to read what it says.

Note: In the program listings, some instructions have another instruction in brackets following. e.g: A480 (A100). The first refers to ETI-660 instructions (CHIP 8.D3), those in brackets refer to the equivalent in other CHIP 8 dialects. ●

Figure 2. The two different screen areas used by CHIP 8 dialects. The smaller screen (down to 32 lines) is used by CHIP 8.D1 and D2, the larger is used by CHIP 8.D3 (as in the '660).

— to be continued.

TABLE 1

Location	Instruction	Comments
0600 0200	1650 (1250)	Go to method 1 & 2 routine
	RESET	Method 1
0650 0250	A662 (A262)	Set pointer to data start
	FF65	Load V0-VF there
	A480 (A100)	Set pointer to -screen start at top left hand corner.
	FF55	Store V0-VF starting there
		Method 2
0658 0258	A662 (A262)	Set pointer to data start
	6A00	VA=0, use as screen X coord. at left hand edge.
	6B04	VB=4, use as screen Y coord. fourth line down.
	DAB0	Display data starting at X,Y 16 bytes, 8 bytes apart.
0660 0260	1660 (1260)	GOTO self to 'stop'
		Data
0662 0262	FFFF FFFF FFFF FFFF FFFF FFFF FFFF	16 FF bytes

TABLE 2

Location	Instruction	Comments
0600 0200	1602 (1202)	Go to "Games Video Captions"
0602 0202	F70A	V7=KEY IN. Key wait. (Loop 1 start).
	6800	V8=0, use to change pointer
	3700	Skip if V7=0. If score = 0.
	4701	Skip if V7#1. If score # 1.
	6850	V8=50, use to change pointer
	3702	Skip if V7=2. If score = 2.
	4703	Skip if V7#3. If score # 3.
	6828	V8=28, use to change pointer
	6900	V9=0, counter of bytes moved
(loop 2)	A700 (A300)	I=0MM. Set pointer to data start.
	F81E	I=I+V8. Change pointer (start).
	F765	V0:V7=MI. Load V0-V7 starting there.
	A480 (A100)	I=0MM. Set pointer to screen start.
	F91E	I=I+V9. Change pointer as required.
	F755	MI=V0:V7. Store V0-V7 starting there.
	7808	V8=V8+8. To alter pointer to next eight bytes.
	7908	V9=V9+8. To count bytes moved.
	3928	Skip if V9=28. If all bytes moved.
	1614 (1214)	Go to loop 2 if more bytes to go.
	1602 (1202)	Go to start of Loop 1 to demo further.

Games captions data

0700 (0300)	0EFB BBAB 8100 0000 0AAA 922A 8100 0000
0710 (0310)	0EAB 93AB 8100 0000 0AAA 922B 0000 0000
0720 (0320)	0AAA 93BA 8100 0000 0AEE A0EE EC04 0000
0730 (0330)	0A8A A08A AA04 0000 0AEE E0AA AA04 0000
0740 (0340)	0A8C 40AA AA00 0000 04EA 40EE EC04 0000
0750 (0350)	0EAE FB8B B810 0000 08AA AA92 A810 0000
0760 (0360)	08EE AB92 A810 0000 08AA AA12 A800 0000
0770 (0370)	0EAA AA3B A810 0000

TABLE 3

Location	Instruction	Comments
0600 0200	1680 (1280)	Go to "Win caption"
0680 0280	1682 (1282)	Go to next, no operation. (Loop 1).
	6A00	VA=0, use as screen X coord. starting at top left.
	6B00	VB=0, use as screen Y coord. top line.
	6C00	VC=0. Use to change pointer.
(Loop 2)	A780 (A380)	I=0MM. Set pointer to data start.
	269A (229A)	Do CHIP 8 subroutine at 0MM
	FC1E	I=I+VC. Change pointer.
	DAB5	Show at coord. VA,VB five bytes.
	7A04	VA=4. Add 4 to X coord.
	7C05	VC=5. Add 5 to pointer.
	3A40	Skip if VA=40. If end of line.
	1688 (1288)	Go to Loop 2 to move more.
	1680 (1280)	Go to Loop 1, start and repeat.
069A 029A	68FF	VB=FF. Delay counter = -1.
	80C0	V0=VC. Copy, so unchanged by 'greater than' routine.
	6134	V1=34. Use to check 'cursor' pos.
	8015	V0=V0-V1. To compare VC to V1.
	3F00	Skip if VF=0, if VC greater than 34H then VF = 1.
	6800	V8=0. Change delay count to 0.
(Loop 3)	7801	V8=V8+1. Add 1 to delay count.
	3800	Skip if V8=0. 01 to 00 = 100H count.
	16A6 (12A6)	Go to Loop 3 delay routine.
	6602	V6=2, use for bleep duration.
	F618	Tone = V6. 'bleep'.
	00EE	Return to location after caller.
		Data
0780 (0380)	0000 0000 00E0 4040 4040 A0A0 E0A0 A0E0 80C0 80E0 0000 0000 00A0 A0A0 A0F0 A0A0 A0A0 A0E0 A0A0 A0A0 E0A0 A0A0 A0E0 80C0 80E0 E0A0 E0C0 A000 0000 0000 E080 C080 E0E0 4040 4040 E040 4040 E000 0000 0000	



# Here are four good reasons to dbx your sound system

No matter how good your sound system is, you are limited by one major thing: the record. Every normal record is severely limited in musical range. Compression during cutting results in half the dynamic range being eliminated. The excitement of the music is lost. This applies to digitally mastered and direct to disc recordings. The other problem is something you hear every time the stylus enters the groove: surface noise. We went to the source of the problem, the cutting of the record. We encode the record by



compressing it 2:1. The decoder expands back in a mirror fashion. In this way, the vinyl record can achieve a staggering 90dB dynamic range, compared to 50dB achieved on normal high quality recordings. Only through dbx can you truly appreciate digital recordings. The range of dbx discs is growing. There are now over 150 titles available, including a wide variety of Classical, Popular and Jazz discs. Hear "The Empire Strikes Back" by John Williams, Vivaldi's "Four Seasons" and artists such as Oscar Peterson, Dave Brubeck and Almela.



MODELS 222 AND 224. The benefits of dbx for both disc playing and home recording. Your cassette deck's dynamic range increased from 50dB to a staggering 80dB.

The 224 further provides simultaneous encode/decode for three head recorder off tape monitoring. Both models provide decoding for dbx discs.



MODEL 228. This new model provides the noise reduction and disc decoding capabilities of the 222/224 with dynamic range expansion for your non encoded discs and tapes. Restore the dynamic range of records, tapes and radio broadcasts.



The most advanced dynamic range expander ever developed is now more affordable. Three band expansion brings new life to your entire record collection.

## Audio Engineers

342, Kent St., Sydney, Phone (02)29 6731.  
Victoria: (03)44 32 95. Queensland (07) 369 9670  
Western Australia 335 8273 S.A. (08) 293 4896

Please Send full details of  Full range of dbx discs.  The range of dbx equipment.

Name .....  
Address .....

Glover & Assoc AE/9



# ELECTRONIC LIFESTYLE

## New Beta-format portable video tape recorder

Seven Beta-group companies recently announced that they have jointly developed the smallest and lightest portable VTR, using the existing half-inch Beta cassette tape. The new VTR can record and play back for five hours continuously.

The seven companies which will work on their respective prototypes are AIWA, General, New Nippon Electric, Pioneer, Sanyo, Sony and Toshiba. They plan to introduce their new VTRs on to the market in Japan sometime around May in 1983.

The Beta group companies have been developing the portable VTRs with the objectives of higher portability with more compact and light-weight units, longer recording time

to accommodate long TV programs and complete compatibility for all Beta videocassette tapes.

They say that this new portable VTR has a full, versatile range of functions and it can be easily combined with a video camera for active and speedy outdoor recording. It can also operate as an integral part of a component video system, when combined with a tuner-timer unit and a PCM adaptor.



### TDK change their audio cassette range

The complete range of TDK tapes has been upgraded and re-packaged so that the product can be clearly seen. The cassette mechanism has been improved by employing 'Laboratory Standard Cassette Mechanism' for AD, SA as well as the SA-X, MA and AD-X series. The AD-X series is a newcomer to the range, replacing the OD series.

The AD, SA and MA series are for the ordinary man in the street who wants a tape that offers a good sound at a reasonable price, say TDK. AD (Acoustic Dynamic) employs a re-developed magnetic formulation of linear ferric oxide particles. TDK claims that it has the lowest noise level of all Type I (normal bias) tapes on the market.

The AD-X and SA-X series cater for the specialist market and hi-fi 'buffs'. The AD-X is the first tape to employ TDK's Avilyn formulation for use on the normal bias setting. And to satisfy all needs, TDK has the MA-R (metal position) series in the 'Reference Standard Cassette Mechanism' diecast cassette.



### Compact disc system is getting around

The Compact Disc Digital Audio System, announced in June 1980, is the result of a cooperative venture between Sony and Philips. In this joint research program Philips investigated the basic operating principles and designed the hardware. Sony's contribution centered mainly on the development of software, including the signal processing method. Now over 40 leading hardware and software companies in the world have taken out licenses to manufacture Compact Disc players or records.

Sony has recently been demonstrating their new Compact Disc Digital Audio player, the CDP-101, in Australia. It is not known exactly when it will be available in Australia but it is now on the market in Japan and will be in Europe in March 1983.

At the Japan Audio Fair in Tokyo at the end of October, more than 30 brands of players using the Philips system were on display, including Sony's CDP-101. Philips Industries have recently announced that they will launch their compact disc system early in 1983.

Interchangeability with video disc systems was not included in the design goals of the CD system. Instead, the system offers a number of advantages that far outweigh this video interchangeability. The small disc has a diameter of 120 mm with about 60 minutes playing time on one side.

Dramatically improved audio characteristics offered by the CD system include a flat frequency over the entire audible range, dynamic range and signal-to-noise ratio over 90 dB, perfect channel separation,

undetected wow and flutter and negligible distortion. These merits have been achieved by adopting PCM direct digital recordings with 16-bit linear digital to analogue conversion, as well as entirely new modulation and error correction systems.

An optical laser pickup system is situated underneath the disc to read the encoded signals on the disc, so there is no physical contact and therefore no wear on the disc or deterioration of sound quality from playing, as with conventional records. The encoded signal is below the disc surface, protected by a transparent plastic coating. Thus the disc is also protected from scratches and dirt. Sony's CDP-101 features fully automatic linear skate front disc loading, three micro-processors, automatic music sensor, repeat function in three modes, dual function digital display and wireless remote control.

Future product applications may well include portable audio products and car audio systems.





For over a thousand years the people of Alsace have been making Traminer Riesling remarkably like ours.

Now we're not suggesting that the good people of Alsace have in any way stolen our idea.

We do, however, suggest that Oliver de Serres' idea that "the essence of wine lies in the grape" is correct.

And that our Traminer and Riesling grapes produce wine every bit as delicate and heady as those of Alsace. **McWILLIAM'S**



# This remarkable amplifier was developed over 95 years from a primitive reed organ.

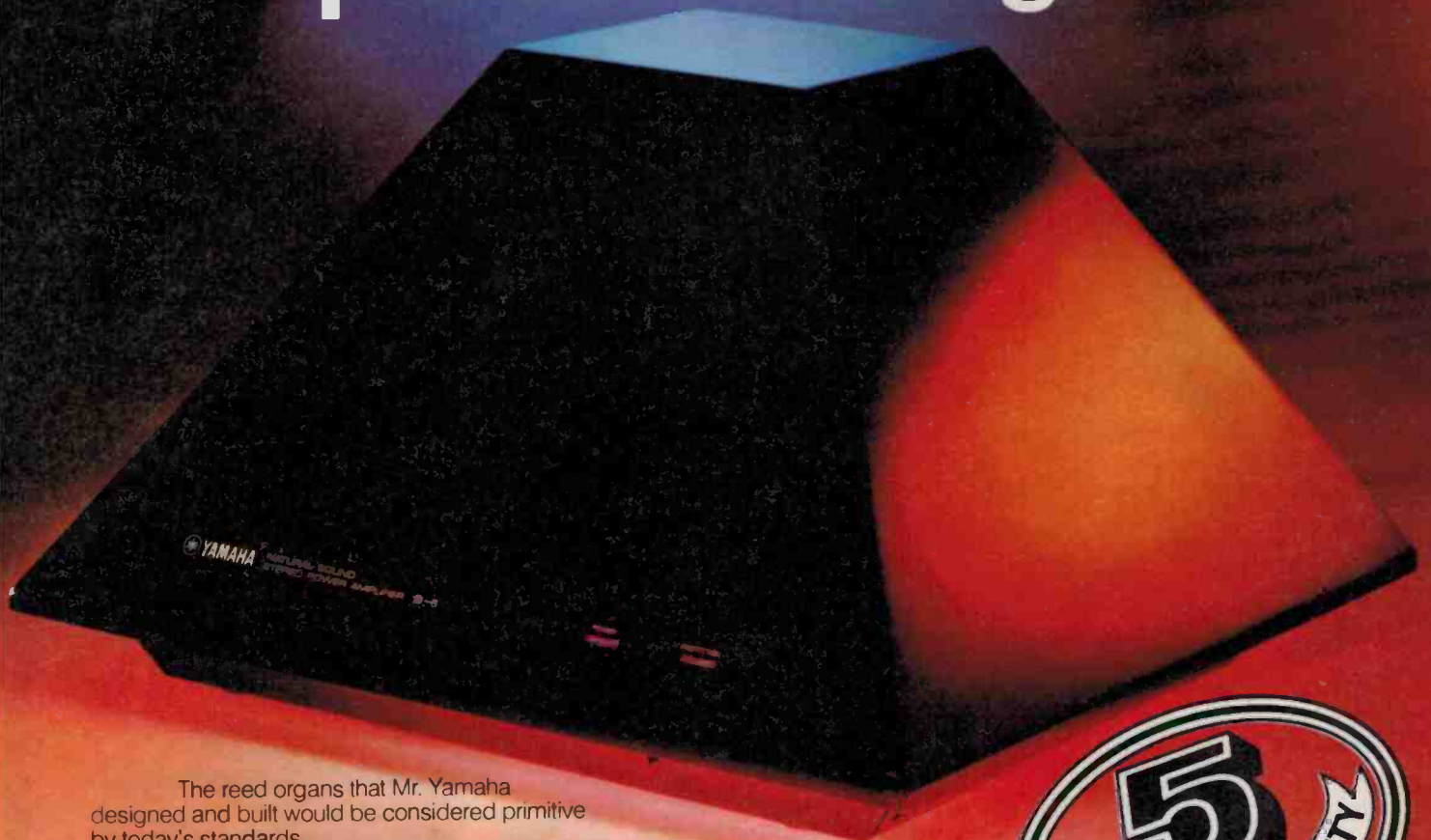

The reed organs that Mr. Yamaha designed and built would be considered primitive by today's standards.

But in 1887 they were hailed as the world's finest.

Since then, Yamaha has become the world's largest maker of high quality musical instruments; from flutes to flügel horns, from clarinets to concert grands.

But our audio equipment is perhaps our proudest achievement.

The pyramid-shaped B-6 amplifier illustrated above for instance, is just as much 'state-of-the-art' now as Mr. Yamaha's reed organs were 95 years ago. And though technology has changed, the Yamaha principle hasn't.

All of our audio equipment, just like our fine musical instruments, is designed, crafted and ruthlessly tested by musicians. Just like our reed organs almost a century ago.

Indeed, the trained ear rather than a computer will always be the final arbiter of perfection.

And naturally the perfection that our musicians require and that our heritage demands, cannot be achieved by cutting corners or trimming costs.

Which may explain Yamaha's premium pricing and the full five year warranty we give all our audio equipment.

Simply, Yamaha precision audio equipment will reward those whose passion for perfection matches their means with a lifetime of the finest, most natural sound reproduction.



Please send me the latest Yamaha Hi-Fi Catalogue

Name

Address

Send to: Yamaha Hi-Fi Catalogue,  
Rose Music Pty. Ltd., 17-33 Market Street,  
South Melbourne Vic. 3205





Exclusive to Marantz.  
 Very sophisticated. Very superior. Very expensive.



Very high fi indeed.

These Marantz Gold components represent the world's most advanced, most inspired, most stringently tested and sophisticatedly engineered audio equipment.

For the wealthy—exclusive toys.

For the connoisseur—the finest hi-fi money can buy.

The Marantz TT1000 (around \$2500), with its precision-made high density glass and golden aluminium sandwich structure, is justifiably described as one of the most beautiful turntables ever.

'Playing a series of direct-recorded discs, warped discs, discs with nasty low frequency content and discs requiring unusual trackability performance, showed clearly that this system borders on the superlative in areas where even most good turntables only provide good to above average performance.'

'...the resonance characteristics of the TT1000 are the lowest we have yet seen from any turntable irrespective of its selling price.'

'This is top-of-the-line equipment for people who rate hi-fi as their greatest pleasure in life.'

— Louis Challis, *Electronics Today International*, April 1981.

Similarly, the Marantz SM1000 Stereo Amplifier (around \$5000) is designed to be the ultimate in luxury and performance.

When it was benchmarked by ETI Magazine in an exhaustive lab study, Louis Challis stated 'The Marantz SM1000 Amplifier has the capability to provide superlative performance at home, in a laboratory, in a studio, or in a rock band with the ease and panache of a professional.'

'The power output claims are modest for the unit is readily capable of producing 625 watts into an 8 ohm load with both channels driven...'

And when the Marantz ST8 FM/AM Tuner (around \$700) was

put through its paces so technically surprising was its performance that a second series of tests was devised to check the first results.

'As a result... the Marantz ST8... far ahead of any tuner we have ever measured and better than any tuner we have ever seen reviewed in any other



The TT1000's adjustable, high-absorption air suspension audio insulator feet.

magazine, either local or overseas.' — Paul de Noskowski, *Electronics Australia*, April 1981.

### Marantz Gold. The New Audio Standard.



Detailed specifications of these exclusive Marantz Gold components are available on request by writing to:

Marantz (Australia) Pty. Limited,  
 19 Chard Road, Brookvale, NSW 2100  
 Phone (02) 939 1900 Telex AA24121

Melbourne (03) 544 2011

Brisbane (07) 44 6477

Adelaide (08) 223 2699

Perth (09) 276 3706

Townsville (077) 72 2011

**marantz®**







## New Eminent power amplifier

Eminent Amplifiers, well known for their professional range of equipment, has just released the all new Eminent E-300 rack mounted stereo power amplifier, retailing at about \$549.

This unit is designed for such applications as medium power two and three-way passive composite bins, mid, upper mid, and top end on three and four-way electronic systems, fold-back wedges, rack mounted instrument amplifiers and studio play-back systems.

It is solidly constructed of heavy gauge aluminium and steel. The electronic componentry is arranged in a completely modular form, allowing easy removal and replacement in a matter of minutes, an

important feature for the professional user.

The power output, with both channels driven, is 140 W/ch into eight ohms and 180 W/ch into a four ohms load. With one channel driven the power output is 160 W/ch into eight ohms and 225 W/ch into a four ohms load.

These amps can be obtained from Eminent Amplifiers, 14 Chamfield Court, Thomastown Vic. 3074. (03)465-7144.



## Nakamichi ZX-9 cassette deck

Nakamichi say that the most significant differences between their ZX-7 and the new ZX-9 are a dramatic improvement in transport precision and performance due to the incorporation of a Nakamichi-designed super linear torque direct drive motor. Nakamichi also claim that the signal transmission accuracy is enhanced in the internal electronics due to direct coupling of the playback head to the playback amplifier.

Up until now Nakamichi have stayed with the traditional belt-drive system but the direct-drive motor that they have developed achieves better flutter performance than the belt-drive system, they claim.

Precise manual calibration of record head azimuth, record/playback level and bias current can be accomplished using a built-in 400/15 000 Hz calibration oscillator and accurate LED level meter. This permits the deck's record/playback characteristics to be precisely matched to those of any particular type of tape for optimum reproduction performance, according to Nakamichi.

The ZX-9 also features a four-bit N-MOS microprocessor, a discrete three head system and Dolby B-C noise reduction.

Nakamichi's BX-1 and BX-2 cassette decks are aimed at a broader cross-section of audio enthusiasts and offer simplified features, functions and operation. A newly-designed two-head reproduction system and precision mechanism result in superior overall sound quality, extended reliability and outstanding cost/performance, claim Nakamichi. Both models are available in either matt black or silver finish.

## Infinity loudspeakers

The eight Infinity loudspeaker systems, manufactured in America, share many state-of-the-art technologies. They differ from each other primarily in their power handling capacity, depth of bass response and the size of the musical image they are capable of recreating.

Top of the range is the Reference Standard II which has a five way crossover which blends the seven drivers into an apparent point source. The solid oak wings are curved in a configuration calculated to minimise distortion due to diffraction.

There's a Reference Standard III and then the Reference Studio Monitor which stays cool and smooth regardless of whether it is

handling 35 watts or 250 watts, claim Infinity.

Infinity has created speakers for bookshelf use and for low powered receivers or amplifiers.

The top of the range speakers are not what you'd call cheap but they claim that they have a speaker system to suit everyone. Infinity loudspeakers can be obtained from Audio Excellence, 29 Yarrabung Rd, St. Ives NSW 2075. (02)449-7812.



Hand made. Constructing the chassis of the amplifiers in the Perreux Sound factory

## Perreux Sound, New Zealand

Perreux Sound is a family company, based in Napier NZ. The company has been operating for about eight and a half years, since Peter first began designing and building amps and speaker cabinets for the NZ market.

Top of the range of power amps is the PMF 8000B. Output is rated at 500 WRMS/ch minimum into eight ohms, from 20 Hz to 20 kHz, with no more than 0.15% THD from 0.25 W to rated output. Into four ohms the RMS output at the onset of clipping at 1 kHz is 900 W.

The 5000B is also physically very strong and has a rated output of 280 WRMS into eight ohms. There is a budget-priced 2000B model too, designed for the 'up-and-coming' market.

Perreux Sound is also making a quality hi-fi amp using many of the design features of the professional power amps, including the power

MOSFETs. The PMF 2150B Class A amplifier has a rated power of 200 WRMS per channel with both channels driven into eight ohms from 20 Hz to 20 kHz with no greater than 0.009% THD from 0.25 W to rated power. The dynamic headroom is greater than three dB, input sensitivity is 1.5 VRMS for rated output at 1 kHz, whilst input impedance is 10k.

In Australia, Perreux Sound amps are handled by Eurovox United who can be found at 6 University Pl, Nth Clayton Vic. 3168. (03)561-5244 and 133 Alexander St, Crows Nest NSW 2065. (02)439-5488.





## Little lightweight headphones that sound like the big ones

AWA have released the AKG K1 and K4 lightweight headphones. The 'top' ones, the K4s, weigh 57 gm, have ear cushions with a diameter of 50 mm and incorporate the patented AKG two-way transducers.

The dynamic transducer radiates the bass and middle ranges while the electrostatic transducer responds to the higher frequencies, providing a frequency range from 16 Hz to 25 kHz. AKG claim that the advantages of this system can be heard in the quality of the sound. The recommended retail price is around \$112.

The K1 headphones, retailing at \$30, consist of a headband that is really a collapsible design which will fit every head perfectly and folds into a box the size of a pack of cigarettes. And there's just no way that it can pull your hair, they say.

For more information contact AWA at 554 Parramatta Rd, Ashfield NSW 2131. (02)797-5757.

## dbx 610 autographic computerised room equaliser

Klarion and dbx have announced the release of the dbx model 610. This is a microprocessor controlled room equalisation system suited for professional applications such as recording or broadcast studio monitor equalisation and fixed or portable sound reinforcement system equalisation.

Using its own calibrated microphone, pink noise generator, real-time analyser (RTA), and specially designed, digitally controlled filters, the model 610 can automatically equalise a listening field for a flat or user determined frequency response in less than 15 seconds.

The stereo equaliser section of the model 610 incorporates two tracking sets of ten digitally controlled one-octave filters on ISO centres. The filters are combined in a series/parallel arrangement to

optimise the signal-to-noise ratio and avoid excessive control interaction.

The display panel, consisting of more than 300 LEDs, can be switched to display either the selected equalisation curve or the output of the 610's real-time analyser.

For more information contact Klarion Enterprises, 63 Kingsway, South Melbourne Vic. 3205. (03) 61-3541.

## US Congress considers home-taping copyright exemption

When the US Court of Appeals for the 9th Circuit ruled, in what is known as the Betamax Case, that off-the-air taping of copyrighted TV programs constituted a copyright infringement, it really caused a stir. It prompted a rush to legislation that has since included proposals to require royalty payments to be allocated to copyright owners as a means of safeguarding their property rights and encouraging creativity.

Manufacturers and retailers of audio and video software have outlined to Congress their support for the pending legislation that would exempt home audio and video taping for private non-commercial viewing from copyright infringement. Senate and House committees are considering the issue

which pits those groups against the copyright-conscious, royalty-seeking motion picture entertainment industry.

Contesting sides in the dispute are expending a lot of energy and money in a huge lobbying effort for and against the pending legislation.



## New Denon range of cassette decks, amplifiers, tuners and speakers

The new range of Denon products which has just been released includes 40 W per channel and 80 W per channel class-A integrated amplifiers, a digital display synthesised tuning FM/AM tuner, the TU-750, compact two-way 80 W speaker enclosures and two Dolby equipped cassette decks.

One of the decks, the DR-F7, has a three head configuration, using a new M & X combination head and Dolby B and C noise reduction. It also features a flat-twin direct drive motor which drives the capstan while a dc motor powers the take-up reel. This operates in conjunction with a tape tension servo sensor type II transport. A microprocessor based Flat Tuning System automatically tunes the proper amount of bias to match the characteristics of each individual tape to optimise sensitivity and frequency response.

The PMA-750 amplifier has a rated output power of 80 W (both channels driven) with a THD of 0.008% from 20 Hz to 20 kHz. Denon claim that it is a non-negative feedback amplifier with zero dynamic distortion.

Denon is manufactured in Japan and has been marketed by AWA for nearly ten years. More information about these products can be obtained from AWA at 554 Parramatta Rd, Ashfield NSW 2131. (02)797-5757.



# LIFESTYLE NEWS

## Acoustic Research introduces three new loudspeaker systems

The top of the line floor standing AR9LS (Lambda System) replaces the AR9 as Acoustic Research's reference loudspeaker. The 9LS is a four way acoustic suspension system utilising AR's newly developed Dual-Dome mid-highrange driver. And in addition to an eight inch lower midrange, the 9LS design includes a twin twelve and ten inch woofer bass section with a Bass Contour Chamber to eliminate room imposed aberrations in the bass response down to 28 Hz. The suggested retail price is \$2695.

The AR98LS is also a four way system utilising the Dual-Dome mid-highrange driver, an eight inch lower midrange and a front mounted twelve inch woofer in a shallow bookshelf cabinet. A new switching system allows for floor or shelf placement and it has a suggested retail price of \$1595.

In the AR Lambda Dual-Dome driver a single massive magnet structure is used to provide the necessary magnetic flux for both an upper midrange dome and a tweeter dome, enabling the domes to be positioned only two inches apart from centre to centre. This results in an almost ideal point

source with uniform radiation due to the elimination of crossover region interferences. The system's crossover divides up the frequency range between the 1½ inch upper midrange dome and the ¾ inch tweeter dome at 5.5 kHz.

AR has also entered the mini-speaker market with the AR 1ms which is a two way aluminium system in a deep drawn cabinet. It employs a ¾ inch dome tweeter and a four inch long throw woofer rated at 75 watts of continuous power. It has an optional mounting bracket for automotive applications and retails at about \$369.



# SUBSCRIPTIONS BACK ISSUES BINDERS PHOTOCOPIES BINDERS

### ORDER FORM

I enclose \$..... for (tick appropriate box/es). All prices include postage.

Send orders to: ETI, 4th Floor, 15 Boundary St, Rushcutters Bay NSW 2011. Phone: (02)33-4282.

<input type="checkbox"/>	<b>Subscriptions</b>	\$25.75 per year within Australia \$39.00 overseas (surface mail) Airmail rates on application	\$..... \$.....	<b>NAME (Please print)</b> ..... .....
<input type="checkbox"/>	<b>Back Issues</b>	\$2.50, available from November 1978.		<b>ADDRESS</b> .....
<input type="checkbox"/>	<b>or photocopies</b>	\$2.50 per article per issue		.....
	Project No. ....	Month .....	Year .....	\$.....
	Project No. ....	Month .....	Year .....	\$.....
	Project No. ....	Month .....	Year .....	\$.....
	Project No. ....	Month .....	Year .....	\$.....
	Please attach a list if more than four required.			Please debit my <input type="checkbox"/> Bankcard <input type="checkbox"/> American Express card
<input type="checkbox"/>	<b>Binders</b>	No. .... @ \$6.10 in NSW No. .... @ \$7.50 in other states	\$..... \$.....	Number: .....
				Signature .....



# Vector Research VCX-500 stereo cassette deck

An otherwise excellent performance in terms of frequency response, distortion characteristics and signal-to-noise ratio is downgraded by an unacceptably high hum level. This relatively simple problem puts this machine well below par, says Louis.

**Louis Challis**

VECTOR RESEARCH is a relatively new name on the Australian market and apparently almost as new on the American market. The VCX-500 cassette deck has all the makings of a first class, top line machine with an outstanding appearance, well made electronics and a solid cabinet structure. According to the claims made regarding the performance of this unit, it should be placed amongst the best of the cassette recorders currently available in this country.

## Design and appearance

The frontal appearance is neat, business like and with a generally sensible layout. The basic design incorporates a feature which many manufacturers are tending to use now. Components like the cassette deck well, display module and various switching functions are mounted on a series of raised escutcheon sections. This is done to 'improve the appearance' and possibly to facilitate component or switch location (even in the dark).

The front panel appears to be an aluminium extrusion finished in matt black with clear white lettering for the control designations. At the left hand of the deck is the power 'on/off' switch and 'eject' button. Recessed beside them, on the raised section of the escutcheon, is the cassette well featuring a clear acrylic screw-on front cover. This feature helps make servicing easier and gives it a more professional appearance. The eject mechanism utilises a spring loaded mechanically damped flywheel system to slow down the opening of the cover which works effectively with a two second operation time. Below this is a headphone socket which provides an eight ohm output via a small transformer with buffer amplifier which does not provide level adjustment.

On the uppermost raised section of the escutcheon a three digit counter is located together with a Dolby noise reduction LED below. Adjacent to this is a 'reset' button with a 'music search' button below it. And next to these is a memory 'in/out' button and a switch to activate music search. When this switch

is activated in conjunction with the 'rewind/review' control, the cassette recorder searches for the nearest five second gap between sections of pre-recorded music or programme content. The recorder then automatically stops and switches into the 'play' mode to replay that section of programme. Its major attribute comes when you wish to replay the section of programme that you have just heard. Without having to note the tape counter number, all you do is activate the two controls in order to cue back to the correct place.

The peak level indicator system features a series of eight green LEDs and four red LEDs. These cover the range from -30 VU to 0 VU and 0 VU to +8 VU respectively. Whilst the indicator system presents gradations and calibration numbers in increments of half a decibel at one end and five decibels at the bottom end, these calibrations are only really indicative as the small number of LEDs provided are incapable of providing that sort of resolution. Notwithstanding, the peak level indicator works very well and

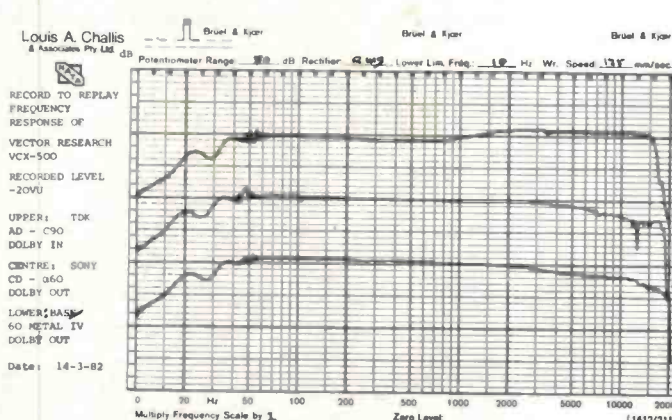
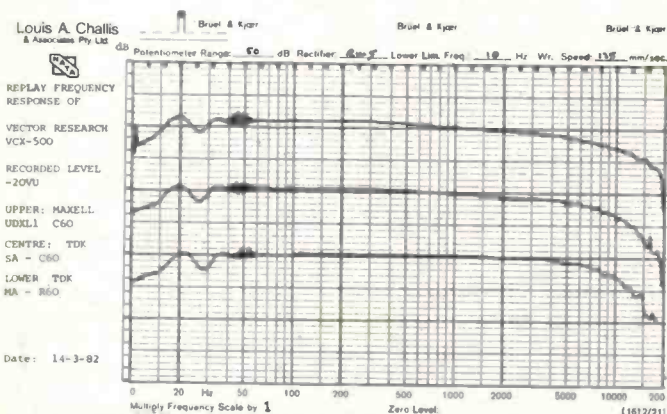





performs its function adequately, as the designers intended.

The central section of the right hand side of the front panel contains an elongated raised section with seven long narrow electronic push buttons. Each of these, with the exception of the 'stop' button, is supplemented by its own indicating light. The functions provided are 'record', 'rewind/review', 'play', 'fast forward' and 'cue' on the top, whilst on the bottom row are a 'record mute' button, the 'pause' button and a double length 'stop' button. The 'record mute' control is the only unusual control and when it is activated at the end of a section of recorded programme and released before the next section of programme, it provides a minimum of four seconds of blank space (or more). This blank section of tape ensures the proper operation of the 'music search' function. Whilst the switch is being activated the programme being recorded may still be monitored through the headphones or the external amplifier and loudspeakers.

On the bottom of the front panel are a series of switches and rotary controls which are noted in order, from left to right. The 'Dolby noise reduction' switch has positions for Dolby B encoding. This switch also provides a 'multiplex' filter switch with the normal 19 kHz notch filter capability required for recording FM transmissions. A particularly useful function is the incorporation of a fine bias adjustment with a  $\pm 10\%$  range but for which the handbook provides no usable data. The designers have also provided two separate switches for bias and equalisation providing bias settings for type 1, type 2 and type 4 tapes, and separately, equalisation settings of 120  $\mu$ s and 70  $\mu$ s. This facility does allow

alternative settings of equalisation and bias to those normally provided by a single switch control. But such a facility is of little use without guidance from the manufacturer as to the most appropriate settings for currently available tapes. Two rotary controls are provided for line output level and microphone or line input level with coaxial controls for input. The last two facilities are two tip and sleeve sockets which provide for either high impedance (50k) or low impedance microphones (600 ohm).

The rear of the deck is relatively sparse with only two pairs of line-in and line-output coaxial sockets and a remote control socket. This utilises a conventional valve-type octal socket into which can be plugged the remote control which activates the solenoid operated electronic controls of the tape transport mechanism.

The cabinet is extremely strong, fabricated from heavy-gauge plated steel. The additional bracketry inside the cabinet makes this one of the strongest units we have yet seen from any manufacturer. The top cover of the cabinet is unusual as it is silk screened with a block schematic circuit diagram to assist the technical user in interpreting the control functions contained within the unit.

### Inside the VCX-500

The inside of the unit appears to be reasonably well constructed, with a number of separate pc boards rather than using the more typical 'mother board' concept. These boards take up virtually all the available space on the base of the unit (excluding the space required for the main power transformer and cassette drive mechanism).

Additional boards take up one side of the chassis for the electronic control of the cassette drive mechanism together with a separate digital control board for the LED peak level indicator circuitry. The circuit boards are clearly marked with circuit designations to assist in maintenance. The drive mechanism features two separate drive motors and a large high inertia flywheel to minimise wow and flutter.

The circuit fuses are mounted off the side of the chassis and are not directly accessible from the rear panel. The main power transformer and power supply feature a separate sub-chassis without provision of any fine adjustment for minimising mains flux leakage. This is a feature we have come to expect from most manufacturers, the majority of whom have learnt the art of finely adjusting the transformer position to minimise mains induction pick-up. The wiring within the unit is more extensive than usual. Although it is neatly harnessed it presents a picture of complexity which may not have been intended by the designers. Circuit access for maintenance could prove to be a little tricky in this unit compared with other units we have recently reviewed.

### On test

The objective testing of this unit proved to have a few more problems associated with it than we would have expected at first sight. The record/replay response of the unit is particularly good featuring a basic 13 Hz to 10 kHz replay response with the Maxell UDXL1 reference tape and a similar performance with the TDK SA C60 and TDK MA-R reference replay tapes. These responses are particularly smooth with the metal tape and are

*continued on page 123*



# A revolutionary way to grow younger.

Let's face it, every car interior gets old. But it needn't show. The Kitten System has created Revive All, the facelift that comes in a bottle.

Revive All will dramatically improve the appearance and feel of vinyl or leather upholstery, the dashboard, inside doors, roof linings, tyres, rubber bumper strips and vinyl tops.

Now this isn't just an extravagant claim. Revive All penetrates surfaces with a special silicone film to restore original beauty.

And if you use it regularly, Revive All will preserve against cracking and decay caused by natural elements.

If you have an interior that needs cleaning, we recommend Kitten Interior Cleaner or Kitten Upholstery Cleaner before using Revive All.

Otherwise, for your car's good health, use Revive All regularly and help your car grow young.



KIW 311/2

**THE KITTEN SYSTEM.**

**THE CREAM OF CAR CARE.**



# Best bass yet from a kit!

As featured in Electronics Australia Projects June and July 1981.

Now Peerless introduces another major advance to kit-set loudspeaker technology. A bass speaker with a rigid polypropylene cone that clearly outperforms traditional paper composite cone speakers to provide:

- Cleaner, tighter bass sound reproduction
- Low colouration and distortion
- High efficiency, suiting 25W to 100W amplifiers
- Consistent rigid panel, low mass speaker cones.

Other outstanding features of Danish-built Peerless speaker kit-sets are:

- Sealed back mid-range with excellent linearity and low distortion
- Latest Peerless 1" soft-dome tweeter
- State-of-the-art crossover networks
- Exceptionally flat response extending to 25,000 Hz.



**Choose from these EA/Peerless speaker projects:**

- PAS 100 12" 3-way 100W (100L)
- PAS 60 10" 3-way 90W (60L)
- PAS 25 8 1/4" 2-way 60W (25L)

includes drivers, crossover, wiring and instructions.

**Sole Australian Importer, G.R.D. GROUP PTY. LTD.**  
698 Burke Road, Camberwell, Vic. 3124. Trade enquiries welcome.

N.S.W.	VIC.	S.A.	W.A.
<b>Bondi Junction</b> Danish Hi-Fi Aust. Pty. Ltd. Ph: (02) 387 5878	<b>Ballarat</b> Turner Audio Ph: (053) 32 2042	<b>Adelaide</b> Hi-Fi Acoustic Ph: (08) 223 6774	<b>Nedlands</b> Danish Hi-Fi Aust. Pty. Ltd. Ph: (09) 386 8564
<b>Concord</b> Electronic Agencies Ph: (02) 745 3077	<b>Camberwell</b> Danish Hi-Fi (Aust) Pty. Ltd. Ph: (03) 82 7348	<b>Adelaide</b> Danish Hi-Fi Aust. Pty. Ltd. Ph: (08) 51 2124	<b>QLD.</b>
<b>Crows Nest</b> Deeva Hi-Fi Ph: (02) 439 3999	<b>Cheltenham</b> Beland Electronics Ph: (03) 550 2279	<b>Goodwood</b> The Acoustic Foundry Ph: (08) 271 0276	<b>Brisbane</b> Brisbane Agencies Audio Centre Ph: (07) 221 9944
<b>Dee Why</b> David Ryall Electronics Ph: (02) 982 7500	<b>Geelong</b> Steve Bennett Audio Ph: (052) 21 6011	<b>Hawthorn</b> Sound Craftsmen Ph: (08) 272 0341	<b>Barunda</b> G. Mills Stereo Ph: (07) 391 5606
<b>Sydney</b> Electronic Agencies Ph: (02) 29 2098	<b>Hawthorn</b> Tivoli Hi-Fi Ph: (03) 818 8637	<b>St. Peters</b> Miltronix Ph: (08) 42 3781	<b>Redcliff</b> Hi-Fi Sales Ph: (07) 284 2495
<b>Wagga Wagga</b> Car Radio & Hi-Fi Centre Ph: (069) 21 4618	<b>Warrnambool</b> Bruce Henderson Audio World Ph: (055) 62 5147		

CONCORD/6480

from page 121

equally good with the other two tapes. The only factor impeding a superlative replay response performance is the time honoured problem resulting from slight differences between our reference tapes and the alignment tapes used by the manufacturer in azimuth alignment in the factory.

We chose to produce the record/replay frequency response with the bias adjustments set to the nominal 100% position rather than attempting fine bias adjustment for optimisation of the performance. Under these conditions, the performance with TDK AD C90, Sony CD60 and BASF60 metal-IV tapes proved to be excellent. These provided frequency responses which were typically 30 Hz to 17 kHz with the type 1 tape, 28 Hz to 19 kHz with the type 2 tape and 28 Hz to 16 kHz with the type 4 tape. The type 2 and type 4 tapes could

be extended in frequency response to beyond the specified limits by fine adjustment of the bias control but the frequency responses achieved are nonetheless, excellent. The record/replay frequency response achieved with the BASF LH1 tape is indicative of how smooth a frequency response this machine can produce, which is, as you will see, essentially flat from 30 Hz to beyond 10 kHz (within one decibel) and comparable with the performance achieved by the best professional recorders only a few years ago.

A close look at the results of the one third octave band analysis of background noise, after erasure by the machine, is disconcerting. Whilst the machine achieves, and in fact even exceeds the performance figures quoted by the manufacturer in terms of A-weighted signal-to-noise ratio, with both the Dolby-in and Dolby-out modes,

this does not take into account the unusually high hum levels at 50 Hz, 100 Hz and 150 Hz which are produced by this machine.

We actually tested two machines, the first of which produced a 50 Hz component that was only -37 dB relative to 0 VU. The second machine which we requested for evaluation produced a component that was somewhat better at -44 dB but unfortunately had higher levels of second and third harmonic (100 and 150 Hz) than the first machine. These figures fall below our minimum level of acceptability and downgrade what is otherwise a really excellent performance to an unacceptable level.

The channel separation at mid-band is typically in the range -45 to -49 dB rising to -25 dB channel separation at 20 kHz. This is slightly better than claimed by the manufacturer but not outstanding. The 'wow' is 0.2% peak to





RECORD TO REPLAY FREQUENCY RESPONSE AT -20VU

Tape	Dolby	Point	Lower -3dB	Max. Point and Frequency	Upper -3dB
TDK AD-C90	In	32Hz		+1dB @ 3kHz	16kHz
Sony CD - 60	Out	23Hz		-	17kHz
BASF 60 Metal IV	Out	23Hz		+1dB @ 100 Hz	16kHz
BASF LHI	Out	24Hz		-	15kHz

HARMONIC DISTORTION:

Tape	Level	Order	100Hz	1kHz	6.3kHz
TDK AD - C90	OVU:	2nd	-51.0	-56.2	-49.4 dB
		3rd	-42.5	-40.9	-34.9 dB
		4th	-	-	-56.9 dB
		5th	-53.0	056.7	- dB
		T.H.D.	0.83	0.92	1.8 %
-6VU		2nd	-52.4	-	-46.8 dB
		3rd	-58.1	-50.4	-38.9 dB
		4th	-	-	-56.9 dB
		5th	-68.4	-62.7	- dB
		T.H.D.	0.27	0.3	1.2 %

SPEED ACCURACY: +0.125%

WOW AND FLUTTER:

WOW:	Average	0.2 % P-P
FLUTTER:	Unweighted	0.1 % RMS
	Weighted	0.06% RMS

MAXIMUM INPUT LEVEL:

(for 3% third harmonic distortion at 1kHz)

Tape	TDK AD - C90	+4.0 VU
------	--------------	---------

DYNAMIC RANGE:

Tape	TDK AD - C90		
	Dolby Out	40 dB(Lin)	60 dB(A)
	Dolby In	39.5 dB(Lin)	65 dB(A)

(High hum level in system)

ERASURE RATION:

(for 1kHz signal recorded at OVU)

Tape	TDK AD - C90	> 80 dB
Tape	BASF 60 Metal IV	75 dB

peak which is reasonable. The 'flutter' A-weighted is 0.06% which is close to the manufacturers's claims and quite acceptable. The distortion characteristics of the machine at low frequencies and at 0 VU are excellent, being 0.83% at 100 Hz, 0.92% at 1 kHz and 1.8% at 6.3 kHz. These figures improve substantially with reduced input level so that at -6 VU the distortions are 0.27%, 0.3% and 1.2% which are first class. The maximum input level for 3% third harmonic distortion with a type 1 tape is +4 VU. The dynamic range in the unweighted mode thus tends to be relatively poor at -45 dB in the second of the machines reviewed by us (Serial No. 5004485). The erasure ratio is excellent, being greater than 80 dB with a type 1 tape and 75 dB with a type 4 tape.

Subjectively

The subjective assessment of this machine had its good points and its bad points. When playing the VCX-500 with an amplifier and loudspeakers offering first class output down to below 50 Hz, the level of hum produced at moderate

to high listening levels tended to be disturbing. When played through a loudspeaker system which has a frequency roll-off below 100 Hz, this is less pronounced and tends to be less disturbing.

The other characteristics of the machine are in the main, exemplary, and it offers a performance which is comparable with the majority of other top line machines. I played a wide range of prerecorded tapes and made some recordings of material which I replayed through the machine to determine its own basic record/replay characteristics. The VCX-500 performs exceptionally well excluding its hum problem. The control function switches work well, although the size of the switches used to control the tape transport mechanism appear to be slightly thinner and thus a little less ergonomically suitable than comparable switches currently being utilised by other cassette recorder manufacturers. The electronic controls function smoothly, and the purchase of the remote control for this particular unit could be a worthwhile addition.

It seems a shame to criticise so

strongly a machine that has so many other excellent features, but unless the designers are prepared to seriously tackle the question of hum then they are left with a machine that is way below par instead of having a first grade machine. This is one machine that we cannot recommend to the intending purchaser until the manufacturer solves what is obviously a relatively simple problem.

VECTOR RESEARCH VCX-500 STEREO CASSETTE DECK

Dimensions:	440 mm wide x 142 mm high x 375 mm deep
Weight:	22 kg
Price	Rrp \$499
Manufactured:	In Japan by Vector Research Inc. of California
Distributor:	Keio International Pty Ltd, 198 Normanby Rd, South Melbourne Vic. 3205. (03)64-3546.

Absolute copyright in this review and accompanying measurements is owned by Electronics Today International. Under no circumstances may any review or part thereof be reprinted or incorporated in any reprint or used in any advertising or promotion without the express written agreement of the Managing Editor.

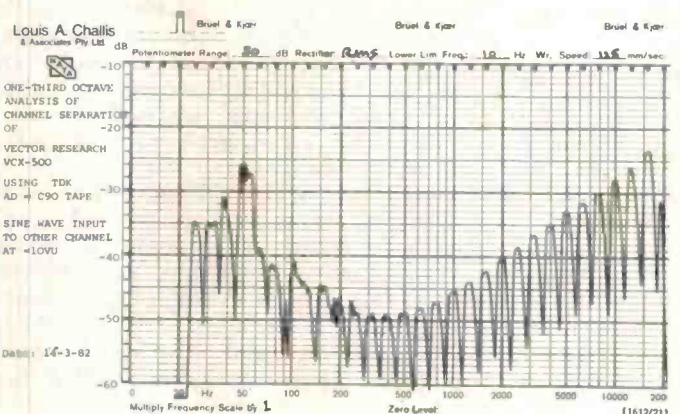
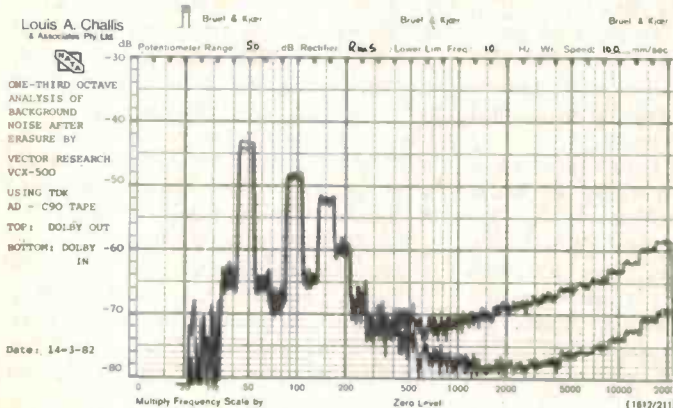



# Simply more than better!



- When you've decided you need that new turntable (meaning now unless you already have your Walker!) and you've checked out the fancy prices against engineering quality and performance of others - look at Walkerdeck CJ55.
- Simple, logical, economical design. Innovative use of materials. Fully sprung sub-chassis system. Precision belt drive. Universal arm mounting arrangements. And, all levelling and suspension adjustments can be made from above!
- Listen to it - and you'll know how much difference a truly good turntable can make.
- Buy it, and you'll know the satisfaction of owning a superior, reliable, consistently excellent product.
- Walkerdeck CJ55.
- When you're ready for something that's simply more than better!

Illustrated:

WALKERDECK CJ55 WITH HADCOCK GH220S TONE ARM AND GRADO GF1+ CARTRIDGE

DISTRIBUTED BY:

**AUDIO 2000**

P.O. Box 107, Brookvale NSW 2100. Tel: (02) 939-2159.

# AUDIO 2000

Please send me further information on the Walkerdeck CJ55

NAME: \_\_\_\_\_

ADDRESS: \_\_\_\_\_

Postcode: \_\_\_\_\_

Ref. CW1



# Nakamichi NR-200 noise reduction system

When coupled to a high quality recorder the NR-200 can achieve quite outstanding results. It has an advantage over the High-Com II noise reduction system as it provides compatibility between prerecorded tapes and cassettes recorded on other machines.

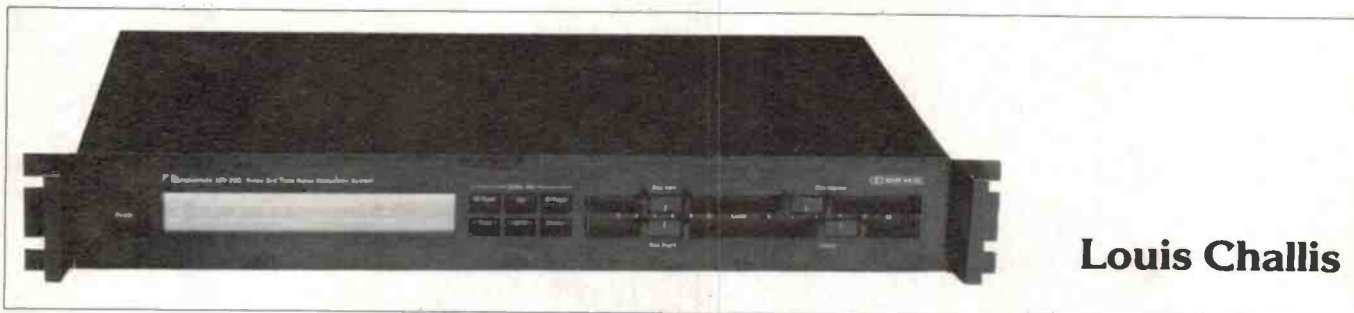

**Louis Challis**

**NAKAMICHI NR-200  
NOISE REDUCTION SYSTEM**

*Dimensions:* 482 mm wide x 71.5 mm high  
x 268 mm deep  
*Weight:* 5.5 kg  
*Manufactured:* by Nakamichi Corporation,  
Tokyo, Japan  
*Price:* Recommended retail \$299  
*Distributor:* Convoy International,  
400 Botany Rd, Alexandria  
NSW 2015. (02)698-7300.

WITH ALL THE recent talk in technical magazines, newspapers and even on television concerning the introduction of the compact laser discs, one could be forgiven for asking "why all this talk and involvement in alternative noise reduction systems?"

Obviously with a little thought you start to realise that while a 90 dB dynamic range is a basic design feature of those wondrous new laser discs, it is most certainly not a feature of the ubiquitous tape recorder. Those of you who own one, irrespective of its type, age or attributes, know only too well the problems of background noise level and restricted dynamic range which constitute one of the most serious limitations of tape recorders.

The past ten years have seen a remarkable number of attempts by various researchers and manufacturers to develop a solution to this problem,

with each one producing his own solution, the majority of which are completely incompatible. The only serious and generally accepted solutions, in order of importance, have been the Dolby B system, the dbx system, the DNL system and most recently the Dolby C system. The only two systems which are in any way compatible with one another are the Dolby B and the Dolby C systems. The only reason for compatibility is their development by Ray Dolby and his staff who realised that unless there was a degree of compatibility, both the new and the old systems would suffer severe penalties in the marketplace.

We have already spoken at length concerning at least three cassette recorders incorporating Dolby C processors, the Nakamichi 480Z, the Sony TC-FX 6C and the NAD 6150C. All three of these machines provided us with the opportunity to describe the technical attributes of the Dolby C processor, which when well executed converts a good cassette recorder into a better one, or better still an excellent machine into an exceptional one. That's all very good, but you may already own a good machine, and a small number of you may already own machines which you believe (even if your are wrong) to be excellent.

The NR-200 is designed to provide

you with that extra little boost in technical performance. It provides you with the Dolby B and C signal processor performance in the form of an add-on unit designed for mating with any brand or type of tape format. Even as I write these lines it occurs to me that the NR-200 could even be used with a wire recorder or any other museum piece which you may happen to own.

## Design and appearance

The NR-200 is a sleek and if I might use the word slick, rack-mounting module in the typical neat Nakamichi style, which is a satin black aluminium fascia. This features, in the format in which it is delivered, a pair of screw-on brackets with miniature handles to facilitate the mounting of the unit into a normal 19" rack (Editor NB: I'm getting more perplexed every time I have to describe this as to its correct metricated description).

The controls provided are modest being respectively a power switch at the extreme left-hand end and a peak signal meter next to this utilising LEDs covering the range -40 VU to +10 VU, together with four indicator lights inset to show the selection of Dolby B, Dolby C, tape or source. In the centre of the fascia are two rows of switches with three switches in each. The top row features the Dolby B and Dolby C selector switches and a central 'off'



switch which cancels and resets the other two. The bottom row features a monitor switch which provides the ability to select and monitor the signal either before or after it has been encoded by the unit, a multiplex switch which notches out any residual 19 kHz pilot tone signals from FM stereo broadcast transmissions and a test tone switch. The test tone switch produces a standard 400 Hz Dolby reference signal for correctly aligning the recording signal range within the upper and lower limits specified by both Dolby Laboratories and the Nakamichi Laboratories.

The only remaining controls on the front panel are the left and right channel record level controls mounted one above the other. I am pleased to see this as I have previously criticised other Nakamichi units for failing to follow this logical sequence. Adjacent to these is the master level control which provides the same function as the two previous controls and a separate output level control which is used to set the listening level during playback or when monitoring the output.

The rear of the unit features four sets of normal RCA type coaxial sockets which are colour coded and two sets of miniature record and playback potentiometers for adjusting the separate encoding (record) signal level, and the decoding (playback) signal level from the tape recorder's output. The unit is constructed with a strong steel cabinet without normal ventilation facilities (which appear to be unnecessary in this situation) finished in the now famous 'black is beautiful' look.

### Inside the NR-200

Inside the unit the circuitry is constructed on one large mother board, with a reasonable amount of coaxial wire interconnections above the board, a number of which have obviously been carefully routed to minimise the screen-

ing problems. The circuitry has a separate display logic board, screened linear potentiometer boards and a power transformer. This has necessitated a change in the bottom panel of the unit to facilitate its incorporation in the obviously limited space allocated at the design phase. All the components are clearly designated on the top of the board. The sixteen pin dual in-line Dolby chips are all mounted in plug-in sockets, whilst the remaining components are all directly soldered in the normal manner. The internal circuit fuses are only accessible by removal of the cover. The bottom plate of the chassis features a protective insulation cover to remove the possibility of short circuiting the circuitry to the bare metal plate which is spaced only 4 mm away.

### On test

In evaluating the performance we once again elected to deviate from what other reviewers may consider normal practice by measuring the performance on our reel-to-reel recorder, which features neither Dolby B nor Dolby C. This unit, whilst very convenient because of its wide frequency response, excellent spooling characteristics and faultless electronic controls, nonetheless suffers markedly in terms of its basic limitation of 'conventional tape recorder signal-to-noise capabilities'. This is most probably the major area and most significant market for the NR-200 unit. Obviously if one had previously purchased a \$200 or \$300 tape recorder a few years ago you could be forgiven for being reluctant to spend \$299 on this unit. However, if you had spent \$600 to \$1000 three or four years ago on a two-channel (or four-channel) reel-to-reel recorder you would most probably think very seriously about upgrading it to circa '82 performance with the simple addition of the NR-200 unit.

This was the philosophy underlying our evaluation of the unit with our AKAI GX-650D reel-to-reel recorder. This machine is typical of the best reel-to-reel recorders developed in the mid-seventies for amateur use. It is designed for both 250 mm (10 inch) as well as 175 mm (7 inch) spools and has a frequency response that extends from 20 Hz to beyond 35 kHz at 37.5 mm/s (15 inches/sec). More significantly the A-weighted signal-to-noise ratio is 55 dB relative to 0 VU. Such a performance is just not good enough in the current scene where 'run-of-the-mill' cassette recorders with an internal noise reduction capability produce signal-to-noise ratios 10-20 dB better.

Our first step was to evaluate the record to replay frequency response of the tape recorder with BASF SP54R tape without the Dolby unit and then with Dolby B and Dolby C. The results in practical terms showed no significant difference between Dolby out and Dolby B but showed a significant increase in the high frequency response at frequencies about 10 kHz with Dolby C activated. What surprised me was the extent of the high frequency rise which was typically +10 dB at 20 kHz at -20 VU. This unwanted rise could obviously be removed by adjusting the bias level and although we didn't actually do it, a better overall performance would have been achieved with a small reduction in distortion as well.

There were no other visible effects on either the mid-band or low frequency response, which are a function of the tape recorder rather than the NR-200 unit. The more significant results related to the improvement in signal-to-noise ratio which were far more dramatic and of unquestionably greater interest. In the Dolby B mode there was a 9.5 dB improvement in the A-weighted signal-to-noise ratio, but only a 6 dB improvement in the unweighted signal-

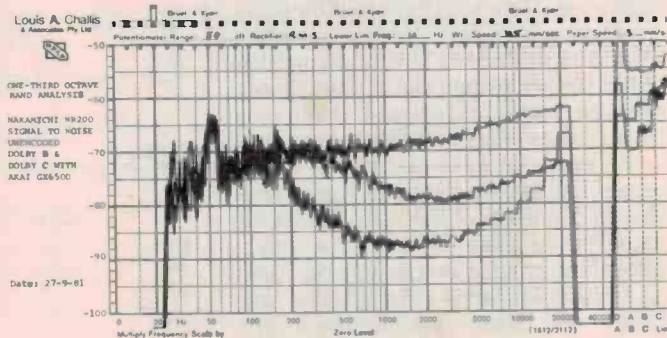
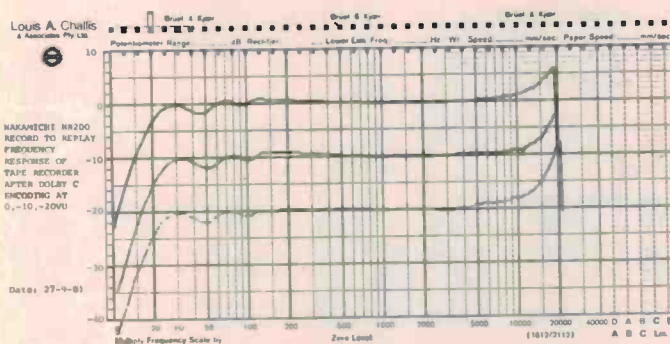



to-noise ratio. In the Dolby C mode there was a 15 dB improvement in the A-weighted signal-to-noise ratio but only a 7 dB improvement in the un-weighted signal-to-noise ratio. A 15 dB improvement in signal-to-noise is dramatic for this provides a 70.5 dB signal-to-noise ratio relative to 0 VU and a 76.5 dB ratio relative to 3%, third harmonic distortion, the normal reference point for relating total dynamic range. The improvement in the signal-to-noise ratio in the Dolby C mode is maximised in the region 500 Hz to 5 kHz providing approximately 15-18 dB of weighted improvement over that particular range.

This is, in fact, the frequency range of maximum subjective sensitivity so that the perceived signal-to-noise enhancement is greater than the A-weighted figure indicates by approximately 0-3 dB, depending on your own 'real ear' transfer characteristics. A recorder achieving this performance is only one order below the performance achieved by the next generation of digital recorders. But they cost approximately three times the price of a conventional reel-to-reel recorder supplemented by the NR-200 noise reduction unit.

## Subjectively

To evaluate the performance of the NR-200 noise reduction unit I took it home and utilised it with an excellent cassette recorder, an AIWA AD6900, which incorporates Dolby B but not Dolby C. The process of alignment was very simple and straightforward and once set-up can be almost forgotten. By playing a series of prerecorded Dolby C encoded tapes, produced by the Nakamichi Corporation, I was able to achieve a quality of replay which was in all respects indistinguishable from the best Dolby C machines currently being marketed. This was important for there are large numbers of expensive cassette recorders in various homes around the world whose owners could understandably be loathe to discard them only because they lack the Dolby C capability.

My major 'piece de resistance' was to record and replay some live music with the combination of the AKAI GX650G recorder coupled to the Nakamichi NR-200 unit with two Bruel and Kjaer 12 mm laboratory microphones and Bruel and Kjaer preamplifiers providing the input signal. This set up

provided signals with a dynamic range exceeding 100 dB which was more than suitable for this application. The quality of reproduction was positively outstanding. By utilising the replay facilities that we have in our monitoring room we produced a sound which was unquestionably superior to the best records or tapes that I have ever had the pleasure of listening to.

The Nakamichi Dolby B-C noise reduction unit is not a panacea. When coupled to a high quality recorder it can achieve outstanding results. It has to be correctly adjusted to track properly between the encoded and decoded states, otherwise the results may be disconcerting. If the recorder has a poor frequency response so too does the resulting signal. If the recorder has poor

wow and flutter or drop-out problems because of poor tape spooling dynamics or dirty heads so too does the resulting signal.

The ability of the NR-200 to provide compatibility between prerecorded tapes and cassettes recorded on other machines is a tremendous advantage. Although the unit will obviously never be sold in large numbers, it is unquestionably just as attractive as the Nakamichi Hi-Com II offering a different set of advantages and in my mind a smaller set of constraints in its usage. As for the difference between this system and the Hi-Com II. Well, the Hi-Com II is slightly superior, but it is not compatible with other peoples' prerecorded tapes the way the NR-200's results are, right now.

MEASURED PERFORMANCE OF NAKAMICHI NR-200					INTERMODULATION DISTORTION (Dolby B)					
Serial No. F103.01211					$f_1 = 330\text{Hz}$ and $f_2 = 8.0\text{kHz}$ mixed 4:1 Distortion components measured near 8kHz					
- 20kHz					Combined level as indicated on V.U. meter					
FREQUENCY RESPONSE: 0Hz Left Right					Level	$f_2-2f_1$	$f_2-f_1$	$f_2+f_1$	$f_2+2f_1$	
INPUT IMPEDANCE: 50Kohms 50Kohms					+5	-	-49.6	-32.4	-	
Line Playback					0	-	-60.5	-61.7	-	
OUTPUT IMPEDANCE: 2.2Kohms 2.2Kohms					-5	-	-	-	-	
Line Record					-10	-	-	-	-	
HARMONIC DISTORTION:					INTERMODULATION DISTORTION (Dolby C)					
PLAYBACK MODE					Level	$f_2-2f_1$	$f_2-f_1$	$f_2+f_1$	$f_2+2f_1$	
Dolby B (with output control at maximum)					+5	-	-50.0	-51.2	-	
Indicated level 0dB					0	-	-58.5	-59.0	-	
	63Hz	1kHz	6.3kHz	10kHz	-5	-	-	-	-	
2nd	-82.3	-67.4	-76.3dB	-70.5	-10	-	-	-	-	
3rd	-69.1	-	-	-						
4th	-	-	-	-						
5th	-	-	-	-						
THD	.035%	.043%	.019%	.03%						
Indicated level +6dB					Signal to Noise Improvement (see curves)					
	63Hz	1kHz	6.3kHz	10kHz	Dolby B	6dB(Lin) 9.5dB(A)				
2nd	-84.8	-72.2	-70.1dB	-67.2	Dolby C	7dB(Lin) 15dB(A)				
3rd	-70.9	-86.6	-	-						
4th	-	-94.6	-	-						
5th	-	-	-	-						
THD	0.036%	0.023%	0.031%	0.044%						
Dolby C (with output control at maximum)										
	63Hz	1kHz	6.3kHz	10kHz	63Hz	1kHz	6.3kHz	10kHz		
2nd	-55.2	-72.9	-72.6	-59.9dB	2nd	-56.6	-73.3	-65.6	-58.3dB	
3rd	-73.4	-81.8	-	-dB	3rd	-54.6	-86.5	-	-dB	
4th	-79.8	-87.7	-	-dB	4th	-77.1	-	-	-dB	
5th	-	-	-	-dB	5th	-76.0	-91.6	-	-dB	
THD	0.17%	0.024%	0.023%	0.1%	THD	0.24%	0.012%	0.05%	0.12%	





# BLACK POWER



Pioneer Black Avante Systems give you the very latest in sound technology. Featured here is the G9 system – SA 930 amplifier with power output of 70 watts RMS and auto input selector, plus a TX 930 tuner with 8 FM/AM pre-set station selectors, auto band search and LED frequency indicator.

A PL 930 direct drive turntable features an exclusive quartz lock indicator to give you perfect sound reproduction at all times.

The CT 930 cassette deck has 3 motors that are computer co-ordinated for superb musical accuracy. It also features auto reverse, music search and Dolby\* B&C noise reduction circuitry. A pair of Pioneer 3-way speakers with maximum output of 70 watts RMS completes the system. It all adds up to maximum sound performance – that's Pioneer Black Avante power.

**PIONEER®**  
Leads the world in sound.

Pioneer Electronics Australia P/L (Incorp. in Victoria), 178-184 Boundary Road, Braeside 3195. Telephone (03) 580 9911. Branches in all states.

Systems and product specifications subject to change without notice.  
\*Dolby is the registered trademark of Dolby Laboratories.



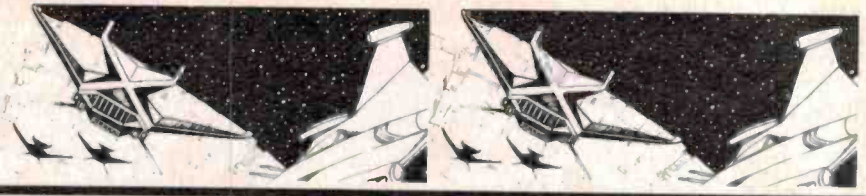

**PRESS RELEASE:** November 31, Hollywood. Following the phenomenal overseas success of David Spielberg's latest and greatest sci-fi movie spectacular, "E.T.", Flurry Publishers announced today that they would launch a magazine here aimed at sci-fi enthusiasts and fans of the film E.T. To be titled 'Extra Terrestrial Inhabitant', or ETI for short, the magazine will include features on building and flying your own CRO (a type of flying saucer that is rectangular rather than circular), dealing with life on earth (the strangest planet of them all) and popular competitions. The first issue's cover is reproduced herewith.

Flurry Publishers is located in Hollywood on the Outer Barcoo (where men of religion are scanty). The magazine will be printed by The Outer South Western Riverina and Barcoo Nut Gatherers and Paper Recyclers Cooperative Press at Gulargambone.\*\*

## Love thy robot

Robots behaving as surrogate humans may well exist within two decades, claims Arthur Harkins, director of the graduate programme in futures research at the University of Minnesota.

Most human relationships are basically ritualistic, according to Harkins; even relationships between lovers involve expected behaviour and expected response.

Harkins believes it is entirely feasible for computer-based 'primitives', as he calls them, to act as companions for the elderly, the extremely lonely, people in prison, or those suffering from massively disfiguring injuries.

Furthermore says Harkins, "It seems imminently possible to program software accordingly. When you add voice recognition and synthesis and at least limited mobility, you don't even need artificial intelligence to reach a plateau of performance acceptable for a lot of human beings."

\*\*The Marginal Finking Department and ETI's other editorial staff would like readers to know that this is one of Roger Harrison's stranger twists of humour. i.e: a joke. Laugh now and have a happy Christmas.

NOVEMBER 1982



**EXTRA  
TERRESTRIAL  
INHABITANTS** monthly



**CRO FLYING**  
- the latest craze

**LIFE ON EARTH**  
- Attenborough explains

**WIN —**  
a Roger Harrison mask!

In reply to the obvious question, Harkins says, "The Japanese have already developed all kind of mechanical substitutes for human sexual organs, which are implanted in robots and embellished with heat and other types of human-like characteristics."

When queried about the possibility of 'marriage' between robot and human, Harkins was guarded. He sees 'legal bonding' perhaps for limited periods but, in what must be the understatement of the year, Harkins says, "The theologians are basically... unwilling to deal with any of this."

Ultimately Harkins sees the human race dying out and being replaced by non-biological cyborgs "... in which

the best artificial intelligence and artificial organs will be implanted and buttressed by genetic engineering."

"We gradually move in thousands upon thousands of directions as a modified species," says Harkins, "But what will give us our enhanced longevity and our greater protection against environmental glitching — including radiation, water contamination or the absence of food and water — will be the movement from a biological species into an ecology of non-biological species."

Harkins sees a non-biological species as 'living' if it reproduces itself. The mind boggles as to how it proposes to do it!



# ELECTRONIC LIFESTYLE



Hi-fi, video, home computers and the latest in electronic home entertainment — the information you need to get the best from today's lifestyle.

Find out what's new and what's just around the corner, in non-technical, easy-to-understand language — from the walkabout telephone and the latest in the video world to the complete electronic house.

Out in December — all newsagents.



# Power you can taste.



Sony's new TA-AX5 amplifier with memory is a high fidelity feast.

Its multiple memory lets you create your own acoustic "flavours." Bass and treble tone settings, turnover frequencies, high and low filter are all programmable.

At a touch you can instantly recall the recipe for bittersweet country, hot 'n' spicy rock, or a well-seasoned Stravinsky. And electronic displays graphically show you everything the amp is cooking up.

Sony's Audio Signal Processor means that every function is touch controlled. This knifes through the usual maze of audio circuitry for a streamlined design of the future. Pure and simple, it sounds delicious.

The ideal companion for this tasty new amplifier is Sony's ST-JX4 synthesizer tuner. Why not make a reservation for two?



**SONY**  
THE ONE AND ONLY  
SON 0118