

NOVEMBER, 1974  
75c

# electronics

**TODAY**  
INTERNATIONAL

**HI-FI**

**COLOUR ORGAN  
TO BUILD**

**UNDERSTANDING  
COLOUR TV**

**- NEW SERIES STARTS NOW**

**555 TIMER - SPECIAL OFFER!**

**SCOOP TEST - MOTIONAL FEEDBACK SPEAKERS**

# The A-4300. The deck you asked us to build.

The remarkable A-4300 is the direct result of a study we made of tape deck owners' procedures and preferences. That's why all of the controls are placed where they are. To make the A-4300 the easiest to operate professional-quality open reel deck.

But that was just the beginning. The A-4300 incorporates a host of goodies to delight the heart of a serious audiophile.

Consider these features.

Automatic Reverse and Index Counter Repeat Playback function give you continuous playback as long as you like.

Then there are Bias Level and Equalization switches. They allow you to use the new, improved tapes currently available. And the A-4300's expanded dual scale VU meters let you record up to +6VU without noticeable saturation distortion.

TEAC's thoughtfully provided the A-4300 with its unique Memory Marker Level Guides on all three level controls.

They let you accurately locate your previous level position.

Add to these the three motors, our own High Density Permaflux heads, the Pause Control button, and the complete Remote Control capability, and you have one outstanding tape deck.

Investigate the A-4300 soon. After all, it's the deck you asked us to build.



## TEAC

AUSTRALIAN DISTRIBUTORS: Australian Musical Industries P/L., 155 Gladstone St., South Melbourne, Vic., 3205. Phone: 69-5888 — 619 Pacific H'way., St. Leonards, N.S.W., 2065. Phone: 439-6966 — Arena Distributors, 273 Hay St., East Perth, Phone: 25-9993 — Sth. Aust. Truscott Electronics Pty. Ltd., Hindmarsh Square, Adelaide. Phone: 23-3024. Miltons Department Stores Ltd., P.O. Box 146, Norfolk Island. OCEANIC DISTRIBUTORS: New Zealand: Direct Imports (N.Z.) Ltd. Box 72, Hastings, N.Z. Phone: 89-184 — Fiji: D. Jeevan & Sons, 87 Cumming Street, (G.P.O. Box 148), Suva. Phone: 22-710 — New Guinea: Paul Mow & Co., Box 449, Lae. Phone: 2953.

# electronics TODAY INTERNATIONAL

NOVEMBER, 1974

Vol. 4. No. 8.

## main features

UNDERSTANDING COLOUR TV .....	24
<i>Upgrade your knowledge of colour TV with ETI's great new series.</i>	
COUNTING PHOTONS .....	32
<i>How to extract ultra-low-level signals from high noise environments</i>	
THE 555 TIMER .....	50
<i>How and where to use this versatile device.</i>	
VARIABLE SPEED SPEECH .....	86
<i>Played-back recordings can be varied in speed without changing pitch.</i>	
CABLE TV — THE WIRED CITY .....	90
<i>A new era in home communication and entertainment services.</i>	
CAMTEC .....	94
<i>Holiday camps provide training in technology for many young people.</i>	
ELECTRONICS IT'S EASY. PT 12 .....	100
<i>Operational amplifiers — how they work and how to use them.</i>	
SENSORS ON .....	118
<i>Medical electronics — 1800 style!</i>	
IDEAS FOR EXPERIMENTERS .....	127
<i>Our new regular feature — a potpourri of circuits, ideas, hints and tips.</i>	

## projects

CAR-ALARM .....	56
<i>Protect your car with this simple yet effective circuit.</i>	
METER-BEATER .....	60
<i>Build this simple 555-based timer and avoid expensive parking fines.</i>	
TOUCH CONTROL LIGHT DIMMER .....	72
COLOUR ORGAN .....	76

## reviews

PIONEER PL 51 DIRECT DRIVE TURNTABLE .....	42
<i>'One step nearer perfection'</i>	
PHILIPS MOTIONAL FEEDBACK LOUDSPEAKERS ...	64
<i>Remarkable performance from truly bookshelf speakers.</i>	

## news & information

NEWS DIGEST 5; EQUIPMENT NEWS 110; COMPONENT NEWS 122; ADVERTISING INDEX 134.

COVER: This dramatically effective picture of ETI's great new colour organ was arranged by Kim Ryrle.

# NEXT MONTH

## TWO SPECIAL OFFERS

Exclusive to ETI readers

- Less than \$60  
Full scientific calculator!!
- Cheapest ever LM 380 OP AMPS!

## INERTIAL NAVIGATION

How space craft are guided

## HIGH TEMPERATURE BATTERIES

New generation batteries operate at 300°C plus!

T.T.O. W.B. PALMER  
SERVICE SECTION

17A GEORGE STREET,  
SOME BUSH 2140.

## PROJECTS

- METAL DETECTOR
- CAPACITOR DISCHARGE  
IGNITION SYSTEM
- TV MAST-HEAD  
AMPLIFIER
- LM 380 PROJECTS

Published by Modern Magazines (Holdings) Ltd, 15 Boundary St., Rushcutter's Bay, 2011. Telephone 33-4282. Cables Modmags Sydney. General Manager: Max Press; Editorial Director: Collyn Rivers; Technical Editor: Brian Chapman; Engineering Manager: Barry Wilkinson; Advertising Manager: Terry Marsden; Advertising Rep (Sydney): Grant Evans; Advertising Manager (Melbourne) Clarrie Levy.

INTERSTATE advertising — Melbourne: Clarrie Levy, Suite 23, 553 St. Kilda Rd., (51-9836). Adelaide: Ad Media Group of South Australia, 12-20 O'Connell Street, North Adelaide, S.A. 5006. (67-1129). Brisbane: David Wood, Anday Agency, 11-14 Buchanan St., West End (44-3485). OVERSEAS — United Kingdom: Modern Magazines (Holdings) Ltd, Ludgate House, 107 Fleet Street, London EC4, U.S.A.: A.C.P. Room 2102, 444 Madison Avenue, New York 10022. Printed in 1974 by Compress Printing Ltd., 65 O'Riordan St., Alexandria N.S.W. Distributors: Australian Consolidated Press. (\*Recommended and maximum price only). COPYRIGHT.

# apan

## MUSIC MAKER

### APAN BFU-121

*Apan BFU 121*\* fully automatic belt-drive turntable features

- \* 4-pole synchronous motor
- \* Wow and flutter less than 0.16% wrms
- \* Signal to noise ratio better than -52dB
- \* 12" diecast aluminium platter weight 1.3 kg
- \* Integrated oil damped lifter
- \* Static balance "S" type tone arm with anti-skate device
- \* Removeable headshell and revolving counterweight with graduated scale from 1-3 grams
- \* Complete with magnetic cartridge
- Frequency response 20-20,000Hz
- Output 4.5 MV

\* Comes complete with "high tension" four-channel leads and is 4-channel ready.



### APAN BFU-121 Four-Channel

*Apan BFU 121*\* fully automatic belt-drive turntable features:

- \* 4-pole synchronous motor
- \* Wow and flutter less than 0.16% wrms
- \* Signal to noise ratio better than -52dB
- \* 12" diecast aluminium platter weight 1.3 kg
- \* Integrated oil damped lifter
- \* Static balance "S" type tone arm with anti-skate device
- \* Removeable headshell and revolving counterweight with graduated scale from 1-3 grams
- \* Complete with magnetic cartridge
- Frequency response 20-20,000Hz
- Output 4.5 MV

\* Complete with Jelco 4C1X CD4 cartridge

Frequency response 10-50,000 Hz. Output 2.5 mV using revolutionary Ichikawa styles.



# RALMAR

agencies pty. ltd.

71 Chandos St., St. Leonards 2065 Tel.: 439 4352

#### AGENTS:

QLD: Tallerman & Co. Pty. Ltd., Robberson St., Valley, Brisbane

VIC: K. J. Kaires & Co. Pty. Ltd., 4 Hill Court, Mordialoo

S.A.: K. D. Fisher & Co., 72-74 McLaren St., Adelaide

ACT: George Brown & Co. Pty. Ltd., 23 Whiyalla St., Fishwick

N.Z.: Avalon Radio Corp. Ltd., 131-139 Hobson St., Auckland

#### STATE DISTRIBUTORS:

W.A.: G. K. Cameron & Co. Pty. Ltd., 245 Churchill Ave., Subiaco

TAS: W. & G. Genders Pty. Ltd., Launceston, Burnie, Hobart

N.T.: N.T. Musical & Electrical Wholesale Pty. Ltd., 54 Cavenagh St., Darwin

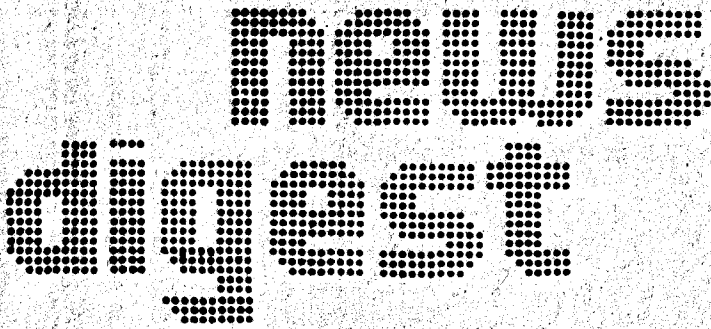

## CABLE TV IN AUSTRALIA NOW

Our article on Cable TV (pages 90 — 93 this issue) mostly concerns development overseas — where most of the development and design originated.

Nevertheless some installations have been made in Australia. In Queensland for example, Community Broadcasting Services have completed a number of CATV projects.

The first, which is an ongoing project, is a Community Antenna Television (CATV) system feeding over 120 homes in a privately-owned housing development. It is located at Buderim on the "Sunshine coast" and presently provides high quality reception to every home in the estate of the four channels from Brisbane, 90 km to the south. On completion of the present system upgrade, the number of channels will be increased to five, while removing co-channel interference presently encountered in the summer months on channel 2 from Brisbane.

Thus upgrade has been made possible by the availability of signals from a translator 28 km to the north, so there will be two reception sources. Ultimately, 300 homes will be connected to the system, providing first-class reception of colour TV and

FM stereo without the need for individual large antenna installations. In addition to the off-air channels, the system will have provision for local origination in colour on a spare channel, allowing programming such as movies news etc, directly on the system, should the residents desire.

The company has also designed a CATV system for the Brisbane City Council, which serves their employees at the Somerset Dam, 50 km NW of Brisbane. While this system serves only 14 homes, it is possibly the most technically advanced CATV system in Australia.

The area served is in a valley immediately behind a solid granite mountain, which is in turn behind an even higher mountain range. This combination of obstacles effectively blocked all television signals from Brisbane.

Stack 13 element cut-to-channel yagi arrays 2000 metres up the mountain-side at the rear of the village receives 3 Brisbane channels. These signals are pre-amplified by underground CATV aluminium cable down the mountain. Before being distributed to the village, two more channels from Toowoomba are fed in from a second

set of quad stacked yagis located in a separate antenna area. The five channels are then amplified and distributed throughout the village.

Features of the system include single-channel MOSFET preamps of our own design, these are remotely powered from a duplexer by the same cable that carries the signals back down the mountain. This system, which is installed and working, provides this little town with five high-quality television channels, where before there was none.

## NEW MULLARD RADAR UNIT COULD ACT AS GUIDE DOG

A cheap, tough Doppler radar circuit, which could be used to guide blind people, has been produced by Mullard Research Laboratories (UK) — one of Philips' research centres.

The radar shows the direction and speed of objects, and because of its small size, it could be used in a number of applications including traffic light control and conveyor belt monitoring, as well as in an electronic guide dog system for the blind.

In a Doppler radar, use is made of the fact that the observed frequency of signals originating in an object increases as the object approaches the observer and decreases as it moves further away from him.

In the new device all microwave circuit functions, with the exception of the Gunn source, are carried on a single slice of alumina substrate, 18 x 16 x 0.5 mm.

This radar can be operated, without need for adjustment or modification, within the frequency band 9.3 to 10.6 GHz. The tangential signal sensitivity for an i.f. bandwidth of 4.5 MHz is -70 dBm.

The unit was designed primarily to be used with a slot line aerial on the alumina substrate but it can also be used with a waveguide horn.

The information given above relates to a laboratory model; development and production will be undertaken by Mullard Ltd.

## BUBBLE MEMORIES

Bubble memories will replace tape recorders and computer disc and drum memories in aircraft and spacecraft within a few years, predicts the US Air Force Avionics Laboratory.

Such memories utilize the magnetic domains of very thin magnetic garnet material that contract into stubby cylinders a few microns in size under the influence of an external magnetic field. The laboratory currently is testing and evaluating a 10 000-bit module.

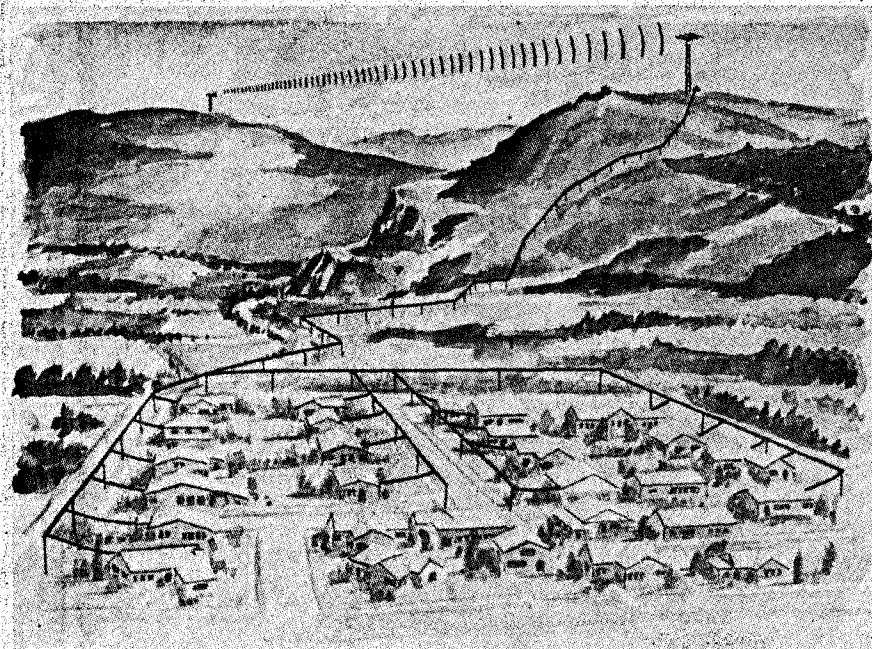

## CHIPS ARE DOWN

Companies manufacturing basic calculator chips have grossly over-estimated the potential market — according to the US weekly 'Electronic News'.

Priced at US \$6 to \$8 last year, basic four-function eight-digit chips can now be bought for as little as US\$3 each (in lots of 100 000).

Mostek confirmed that US\$3 'was about right' for their devices, and Western Digital said that chips with a memory function were going for as little as US\$3.50.

Several companies suggested that these prices could go lower still —

US\$2 each was mentioned several times.

The situation is being exacerbated by a tendency for many Japanese calculator manufacturers to upgrade their products and/or buy from their own MOS sources.

## 200 MILLION DEGREES!

An important advance in work on nuclear fusion is reported by scientists at the University of Texas, Austin. Dr. William E. Drummond, director of the university's fusion research center, says that a temperature of more than 200 million degrees Centigrade has been attained for some 50 micro-seconds in the center's Tokamak-type unit by turbulent heating of the plasma, a new technique developed at Texas and in the U.K.

## CEEFAX NOW A REALITY

The first commercially-viable public data broadcasting service is now available to TV viewers in Britain.

At an exhibition staged as part of the Fifth International Broadcasting Convention held in London during September, the general public had their first chance to see the service in operation. Days earlier the British Government had given approval for the introduction of an experimental service by the BBC and the Independent Broadcasting Authority (IBA) which administers Britain's commercial network.

Originally developed separately by the BBC and the IBA, the new service will operate within parameters agreed upon by both these organisations and BREMA, the body representing the receiver manufacturing industry. The receiver industry has developed add-on adapters for old TV sets and is currently working on circuitry to incorporate in new TV sets later this decade.

Presently being produced in custom built quantities only, the cost of the add-on adapter is approximately £800. Researchers and marketers alike believe that this cost could be brought down to as low as £70 within two years.

The IBA has launched *their* campaign to win users (and viewers) in an elaborate colour booklet. Their name for the system is ORACLE (optional reception of announcements by coded line electronics). The BBC's broadcasts are under the title CEEFAX (from 'seeing facts').

Since late 1972, when both organisations began work on their respective systems, there has been increasing interest among broadcasters in the possibility of employing domestic television receivers for the display of data or graphical information in addition to normal programme material.

Now, at the press of selector buttons, TV users in the UK can receive the latest information on more than 100 topics, ranging from weather reports and motoring information, to world currency exchange rates and news headlines, in fact anything that can be represented in the written word. Such information may be viewed in place of the normal programme or be superimposed on the programme image. It is viewable in either monochrome or colour.

Deaf people, and those who are literate only in languages other than English, may now be able to fully enjoy television in the UK by selecting relevant sub-titles for each regular TV programme.

Eventually it is thought that it may be possible to transmit private letters

## AWA AIRCRAFT NAVIGATION AIDS FOR THE HIMALAYAS

A \$650,000 contract has been awarded to AWA by the Government of Nepal for the supply and installation of air navigational aid equipment at Kathmandu, the capital city, and at Pokhara, about 200 km from Kathmandu. These units, Doppler VHF Omirange (DVOR) and Distance Measuring

Equipment (DME) will form part of a modern air traffic control system for Nepal.

Federal Minister for Science, Mr. W.L. Morrison (left) is pictured with AWA Commercial Manager (Engineering Products), Mr. J.D. Gilchrist, alongside a Doppler VOR unit at AWA's North Ryde works.

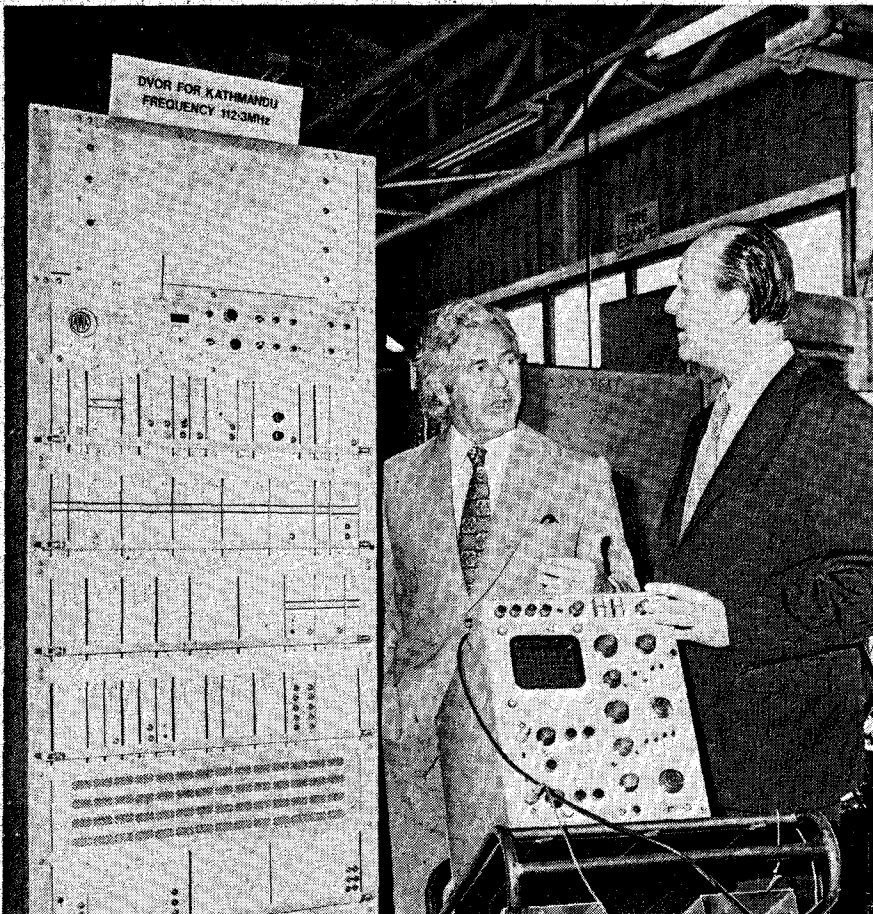

using the system whilst normal channels are off-air in the early hours of morning. Such a scheme would require the addition of hard copy printout devices to domestic receivers and the connection of the system into individual homes via telephone lines.

The system will also be geared to providing absolutely local news (as community radio is capable of handling), as well as general wider-interest data. These refinements are thought to be at least three years away.

In a paper presented to the 1000 delegates to the convention, Mr P. Rainger (BBC) and Mr W.N. Anderson (IBA), said, "the most important feature characterising both systems, and one which differentiates them from most, if not all, other proposals, is that they cater for a relatively large amount of information, covering many topics, from which the viewer may choose. At the origination point of the data signal, the information to be offered to the viewer is assembled in pages with a standard format and one or more pages are allocated to each topic.

"The coded signals describing each page are initially generated using a keyboard device such as a tele-type-writer or a computer video-display terminal. The complete set of coded signals, constituting a 'magazine', can then be assembled in a purpose-built electronic core or in the magnetic disc store of a specially programmed computer system.

"The contents of the store are then transferred, in packets, to the allocated lines in the broadcast signal," they said.

Several other papers, dealing with more technical aspects of the service, were presented to the conference.

Data broadcasting systems utilise unused spectrum-space or time in the existing television and sound wave-forms, such as unused lines in the television field blanking period, to transmit additional data signals.

These signals are decoded by either an additional 'add-on' adaptor or optimally by new circuits within the television receiver.

This summary, although it does not mention, however briefly, all aspects in the specification for the unified system, indicates clearly that a system has been evolved which could provide a very attractive service to the user. The system is flexible and efficient, offers opportunities for receiver design advancements and has the potential for future development.

At this stage the specification of the system allows for eight magazines with up to 100 pages in each magazine.

Good reception of either of these systems will be possible wherever good UHF 625-line television pictures can

be received in Britain, but difference between receiving this type of data and ordinary television is that where interference and ghosting have a serious effect on the appearance of an ordinary television picture, with this new system, these effects may cause errors in the display of information.

Despite this slight limitation, the applications of advancements of this British unified system seem endless. Many of the international delegates to the convention in London expressed their interest in the system for their home-markets and indicated that they had been and would continue to watch the developments of the system in commercial use.

### SINCLAIR CALCULATORS

A special offer of Sinclair scientific calculators at the

extremely low price of fifteen pounds sterling was made recently by the UK edition of this magazine.

The offer was more successful than either we or Sinclair ever imagined.

At the time this issue goes to press, ETI UK had sold over 7000 calculators and confidently expect the total to exceed 10 000. Sinclair's entire production line is now devoted to producing scientific calculators to fulfill the orders!

### US COMPONENTS SALES SLUMP

New orders for electronic components slumped 7½% during the first half of 1974, compared with the same period last year, according to the US Electronic Industries Association.

Despite the fall, sales were still nearly 50% higher than comparable periods in 1966, 1967 and 1968.

### SOLAR POWERED SPACE SHIPS

A desk-top model demonstrates an advanced lightweight 30 watts/pound solar array for space power. This system is designed to use the sun's energy to produce 25 kilowatts of electricity to supply very-low-thrust ion engines for Solar Electric Propulsion Stage (SEPS) propulsion.

The SEPS and arrays would be launched from the Space Shuttle into Earth orbit. Designed and built for NASA's Marshall Space Flight Center in Huntsville, Ala., by Lockheed Missiles & Space Co., Sunnyvale, Calif., the model

demonstrates the mechanisms for multiple extensions and retractions of the solar panels during flight.

While solar arrays have been flown on many space missions, none has to date been extended and retracted on command. Partial or full retraction is desirable for Earth orbital operating during rendezvous and docking and planetary missions should the SEPS encounter meteorites or solar flares that could damage the solar cells.

Another reason for retraction will be to permit return of the SEPS and arrays to Earth via the Space Shuttle for refurbishment and reuse.

*Continued on page 10*

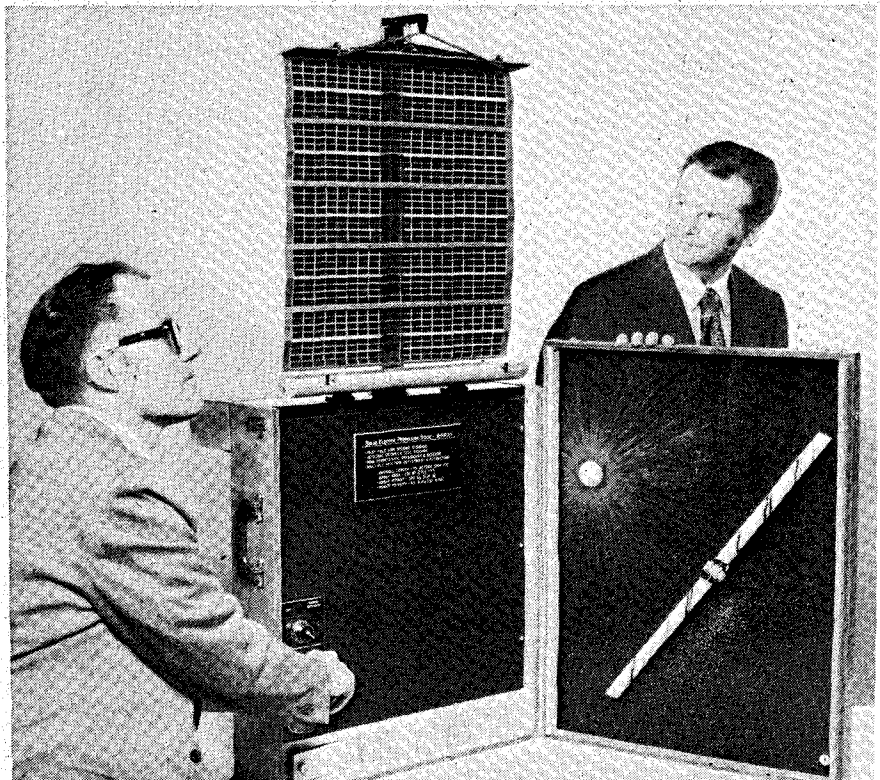

# AUTEL SYSTEMS PTY LTD

## NORTH SHORE SUPER SOUND CENTRE

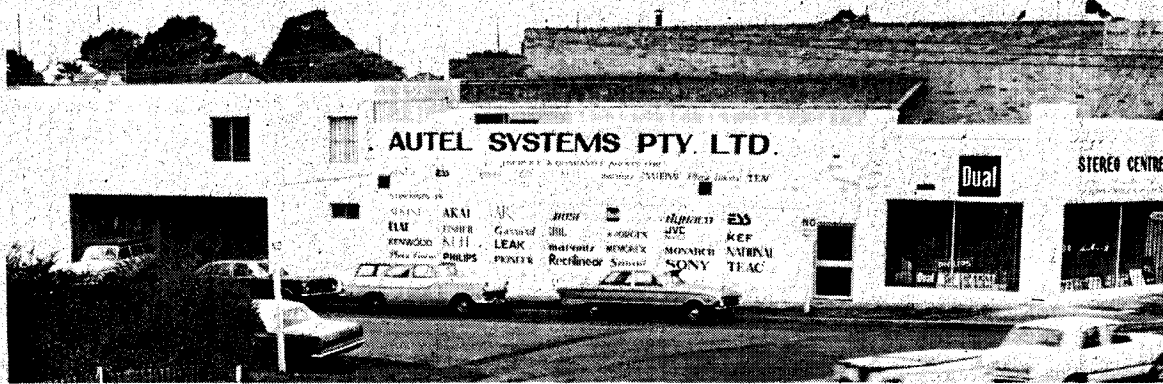

### AUSTRALIA'S LARGEST MAIL ORDER SECTION

Ask for our quotation to send equipment anywhere in Australia at our competitive prices. All new equipment with full manufacturers guarantees that we can back up ourselves.

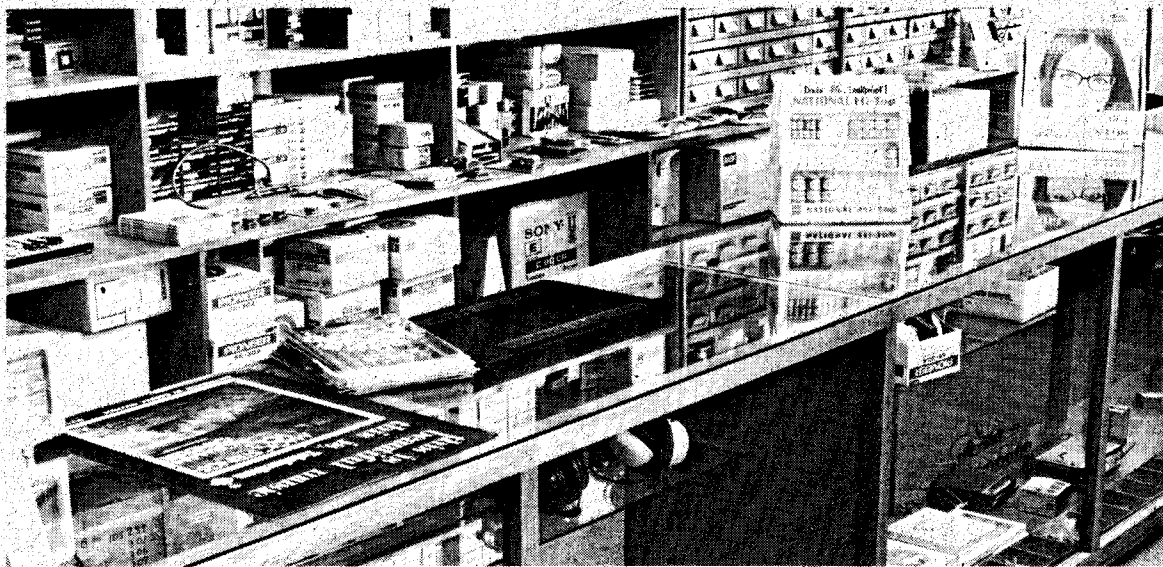

Want a lead to suit your set to match that accessory? Want any type of plug? Also, complete stocks of spare parts for National, Nivico, Teac, Jorgen, ESS, Marantz, and many others. Largest range of equivalent parts to suit those hard-to-get spare parts for rare models.

# AUTEL SYSTEMS PTY LTD

639 Pacific Highway, Chatswood Phone 412 4377

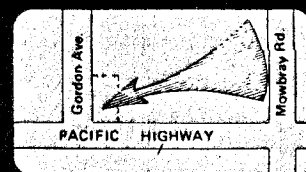



# AUTEL SYSTEMS PTY LTD



No where in Australia have you the choice to buy everything you want without being forced to buy the particular brand the shop specializes in and at the best prices. Come and Compare all the brands to chose what really is the best.



## REASONS FOR BUYING FROM AUTEL

- top quality equipment at competitive prices
- free delivery and connections in Sydney metropolitan area
- Full installation for complete systems — ask for our quotation
- under guarantee service and full workshop facilities
- credit sale and terms arranged
- We are audio experts, so trust us
- We have expanded to give better service, to give you a better purchase

Continued from page 7

## CD4-ICS

TDK Fairchild will introduce a demodulator IC for the CD-4 discrete four-channel stereo system early next year.

## STATIC 4k MEMORY

For some time now, efforts have been made to increase the integration density of static memories. In the Siemens Research Laboratories a static MOS memory has been produced accommodating 4000 bits on 14.7 mm<sup>2</sup>.

The memory is an integrated circuit in aluminium gate ESFI technology. This step forward was made possible by integrating the switching elements on an insulating substrate and employing a non-crossing conductor layout between the transistors and resistors in a memory cell.

An initial breakthrough on the way towards static ESFI MOS memory cells (ESFI = epitaxial silicon film on insulators) of high packing density was the development of a complementary MOS cell with five transistors and an area of 4000 μm<sup>2</sup>. The second measure was to combine two

The device, to be priced at from US\$1.50 to US\$3.33 per chip, is the first product developed by the TDK Electronics and Fairchild Camera & Instrument joint venture. Actual production of the CD-4 chip will be handled by FC&I, Mountain View, California.

The device will be made in a 16-pin plastic or ceramic DIP and features automatic loop gain control circuit, muting circuit, and sub-carrier display lamp drive circuit.

complementary transistors and two load resistors in one cell in a non-crossing layout to obtain a flip-flop. In this way, the cell area was reduced to 2000 μm<sup>2</sup>. The final step was to replace the select transistor by a diode and to use the power supply lines. It was thus possible to reduce the memory cell area again to 1500 μm<sup>2</sup>. This is even less than the area required by MOS memories and bipolar memory cells.

Such memory cells have already been integrated in a configuration with 4096 bits. The chip area is then 14.7 mm<sup>2</sup>: the actual memory matrix, the word and bit line decoders and the read-out circuit are accommodated in an area measuring 4.2 mm x 3.5 mm. The results of tests allow us to predict an access time of around 120 ns and a cycle time of about 170 ns for the production module. The power dissipation is 100 mW.

## FERRANTI — POSSIBLE SALE

Both Plessey and English General Electric are reported to be interested in buying the semi-conductor division of Britain's financially-ailing Ferranti empire. Ferranti has over 17 000 workers at plants throughout the UK and is heavily involved in manufacturing electronic defense equipment for a number of European countries.

The company's financial problems came to light recently when it was revealed that the firm was overdrawn by more than £20 million.

The British government has provided monetary assistance — and because of this nationalisation of the company has by no means been ruled out.

## NASA HOLOGRAPHY SURVEY

The NASA Technology Utilization Office has published a comprehensive survey on the subject of holography. The volume covers the state of development of holography and holographic techniques.

Entitled "Holography: A Survey", the 140-page volume was written by David D. Dudley of Computer Sciences Corporation, Falls Church, Va.

Unlike the human eye and camera film which record only the intensity of an object, holograms record true depth perception in three dimensions. Contemporary holographic techniques for recording and viewing objects are having an important impact in engineering, production and display applications.

In addition to optical holography, the volume covers recent developments involving microwave, acoustic, ultrasonic and seismic holography. Also discussed are such subjects as data processing, storage, pattern recognition and computer-generated holography. Finally, a comprehensive glossary of terms is included.

The paperbound volume sells for US\$1.70 and can be obtained from the Superintendent of Documents, U.S. Government Printing Office, Washington, D.C. 20402. USA.

## SOLAR POWERED WATCH

Production is now said to have begun on the light-powered Ragen Synchron watch.

A feature of the LED digital watch is its 100-year calendar, which is pre-programmed to allow for monthly aberrations and leap years to the year 2100.

An average exposure to sunlight of 10 to 15 minutes per day claimed to be adequate to charge the watch.

Continued on page 15

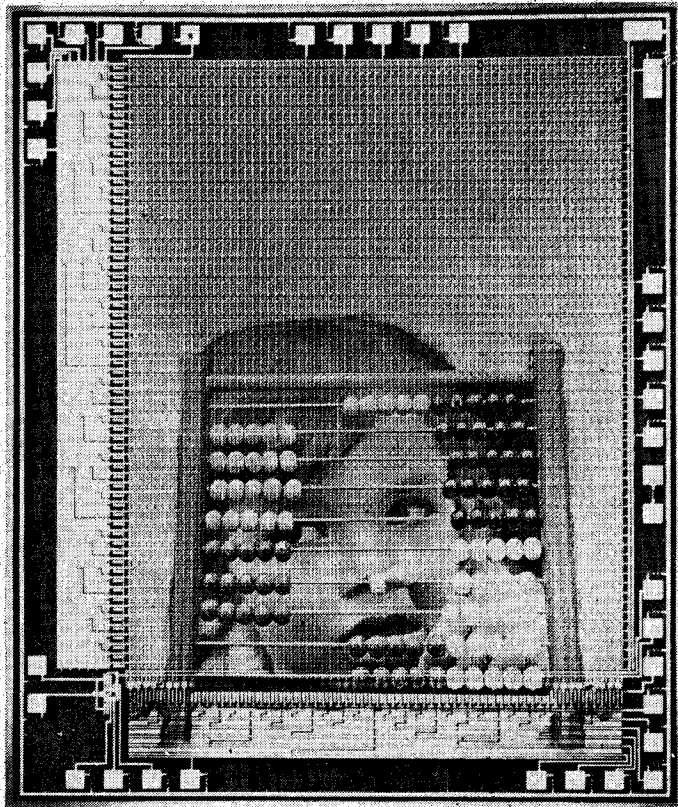

# The complete range of Optoelectronic devices

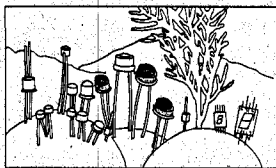
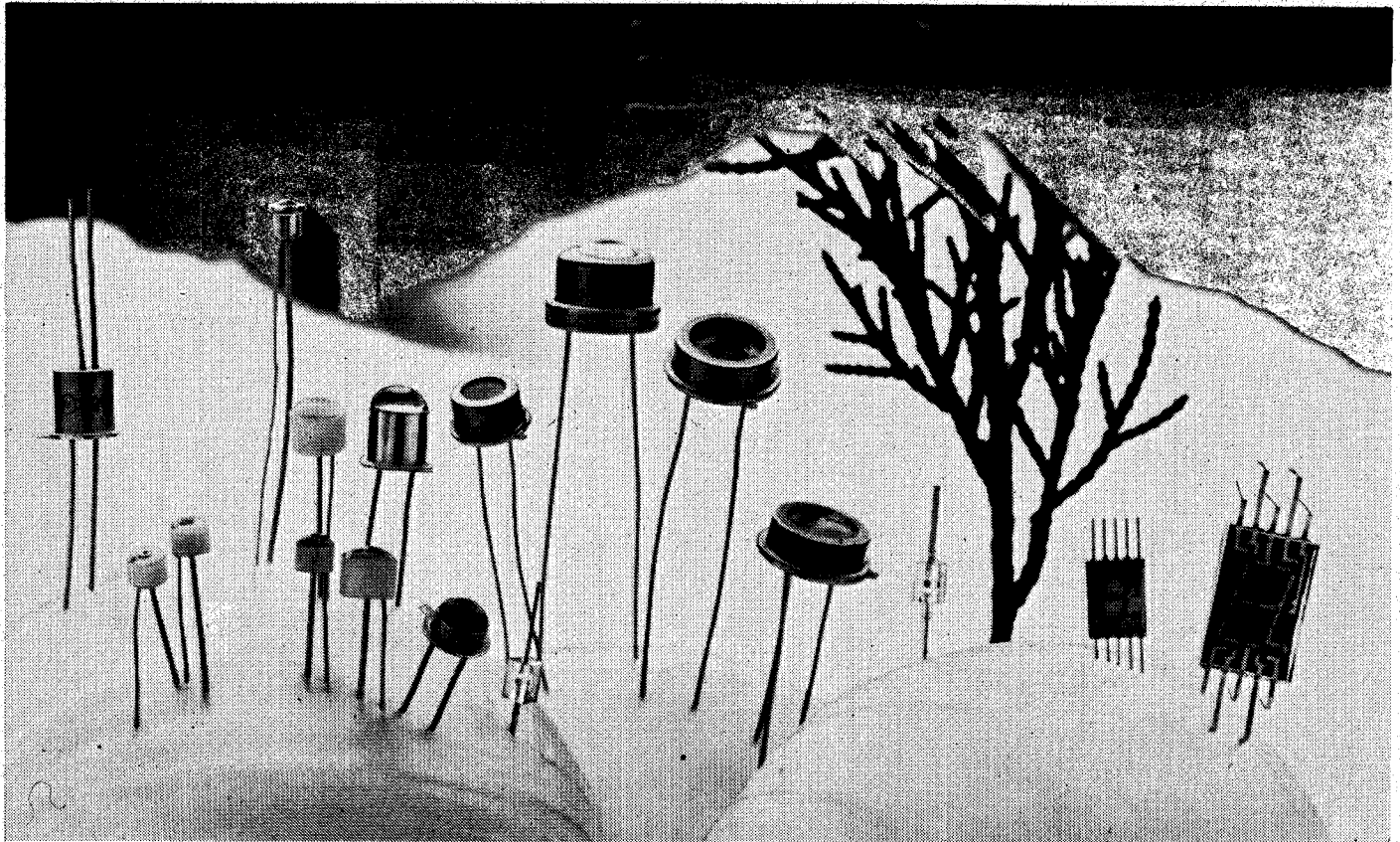

## Photodiodes

OKI photodiodes are of diffused planar silicon construction, feature high performance and reliability and are suitable for application in computer peripheral equipment, process control, industrial control, photo-meters or any other design requiring light sensitivity.

A 9-bit silicon photodiode array is available which finds application in punched paper tape readers of input machines for computer and NC equipment.

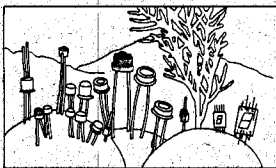

## Phototransistors

OKI phototransistors are of planar silicon construction and are highly sensitive devices. They are particularly suitable for use in optical measuring equipment, control devices and other electronic applications.

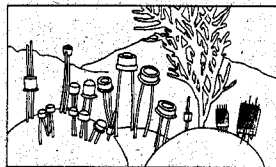

## Solid-state Numeric and Alphanumeric Displays

OKI numeric displays are of GaAsP monolithic or hybrid, 7-segment composition. They are suitable for application in a wide variety of display apparatus. Features include high brightness with small current, numerals 0-9 and decimal point and rugged, vibration-resistant construction.

Typical applications include computer terminals, electronic desk and portable calculators, cameras, electronic wrist watches and various digital measuring instruments.

The alphanumeric display (not illustrated) is a 5 x 7 dot matrix of 36 GaAsP red L.E.D.s.



## Light Emitting Diodes

OKI L.E.D.s are available in INFRARED, RED or GREEN versions. A wide range of body styles is available to suit a multitude of applications including solid-state indicators and displays, photochoppers, photocouplers, photo-switches . . . e.g. punch tape readers, conveyor control, rotation counters, automatic weighing machines, position control and opto-isolators.

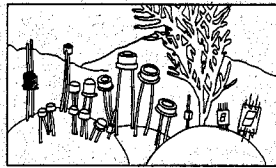

## Photocouplers

The OKI photocoupler employs GaAs L.E.D.s and Si phototransistors. Its light source and sensor are optically coupled with no electrical connection. Typical applications include pulse transformers, photoswitches, photorlays, power separation circuits (for analog and digital) and level converting circuits (for potential and impedance).

## \*Optical Mark Sensor

(\*not illustrated) OKI manufacture an optical mark sensor which senses by the reflection method, 12-unit signal marks and a timing mark recorded on the paper for OCR use and converts the data into electrical signals.

It is composed of GaAsP L.E.D.s as the light source, planar silicon photodiodes as the sensor and IC preamplifier.

# PLESSEY

**Plessey Australia Pty. Limited**  
**Components Division**  
**Box 2, P.O. Villawood, N.S.W. 2163**  
**Telephone: 72 0133 Telex: 20384**  
**Melb: Zephyr Products Pty. Ltd. 56 7231**  
**Adel: K. D. Fisher & Co. 223 6294**  
**Perth: H. J. McQuillan Pty. Ltd. 68 7111**  
**N.Z.: Henderson (N.Z.) 64 189**

AC79/R2

# AUSTRALIA'S ORGANISATION NOW SYDNEY AND

All the great

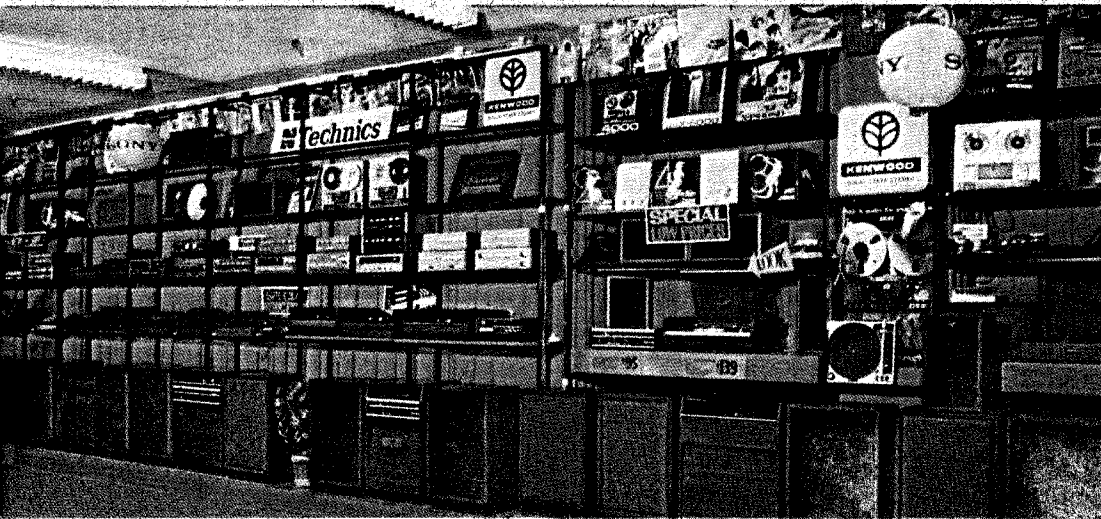

## DOUGLAS HI-FI Melbourne

185-191 Bourke St., City,  
Melbourne, 3000. Phone 69 9321.  
Drive-In Service Centre,  
202 Felham St., Carlton.  
Phone 347 8412.

Call in now and see the gear and prices that make us Australia's Hi-Fi sales leaders. Douglas Hi-Fi is the only showroom in Melbourne where you can see more than 30 of the world's leading brands together. And compare any combination of turntable, tape deck, amplifier and speaker instantaneously - in Australia's most sophisticated demonstration rooms. If you want expert advice, you can trust our consultants, they are all Hi-Fi enthusiasts - not just salesmen. Huge nation wide bulk buying power enables Douglas to bring you all these top brands at **SPECIAL LOW PRICES!** Douglas sells sound for less!

# Douglas-hifi

LINEAR  
DESIGN 279 Hi-Fi  
System. Douglas Price \$279 complete.

# LARGEST HI-FI IN MELBOURNE, PERTH **Douglas-hifi** brands together

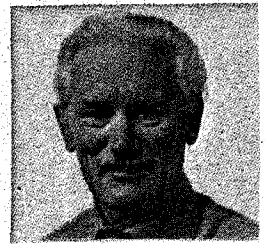

Ben Douglas, Chairman of Douglas Trading Pty. Ltd.

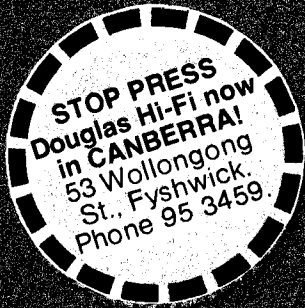

## DOUGLAS HI-FI SYDNEY

65 Parramatta Rd., Five Dock,  
2046. Phone 798 4177, 798 4533,  
798 4355, 798 4711.  
Trade Enquiries: BJD Electronics  
P/L., Phone 799 3156.

Great news for N.S.W. Douglas Hi-Fi have opened exciting new showrooms in Sydney. Here you can see all the world's leading gear - at Special low prices.

We're the biggest Hi-Fi organisation in Australia, so we buy at better prices than anyone else. We do our own importing - in bulk. Often by the container load. And we pass the savings on to you.

See, hear and compare all the great brands together, in a single showroom. More than 30 top brands, from 4 continents. Hundreds of different models, the most comprehensive range in Australia.

All fully guaranteed, and backed by Australia's fastest, best equipped drive-in service centre. Douglas sells sound for less!

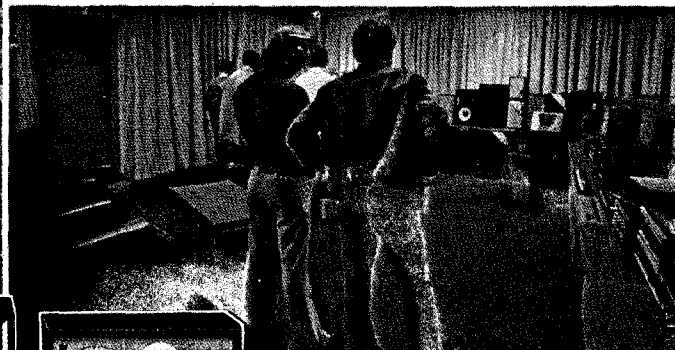
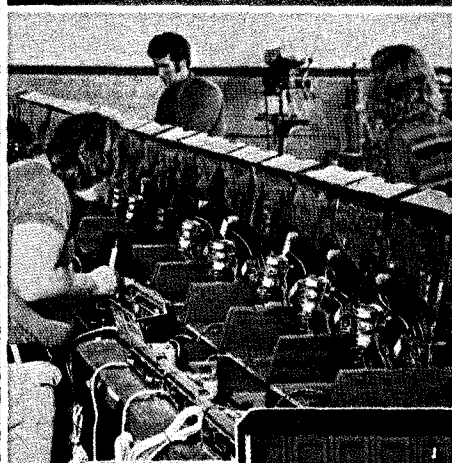

**MELBOURNE:** 185-191 Bourke St., City.  
Ph. 63 9321.

**SYDNEY:** 65 Parramatta Rd., Five Dock.  
Ph. 798 4177.

Trade Enquiries: BJD ELECTRONICS P/L.,  
Phone 799 3156.

**PERTH:** 883 Wellington St. Phone 22 5177.

**CANBERRA:** 53 Wollongong St., Fyshwick.  
Phone 95 3459.

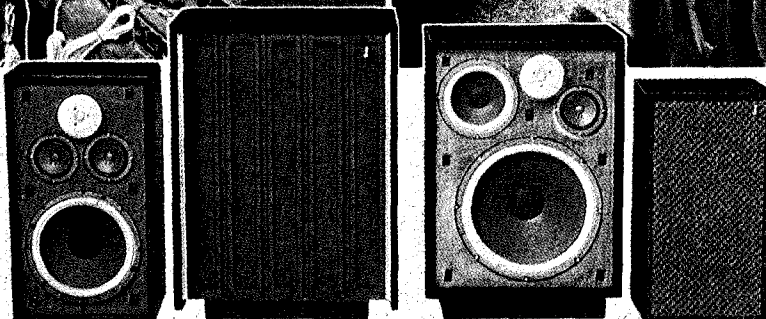

Douglas Hi-Fi have the complete range of the fabulous JENSEN Speakers from \$99 pair to \$1099 pair.

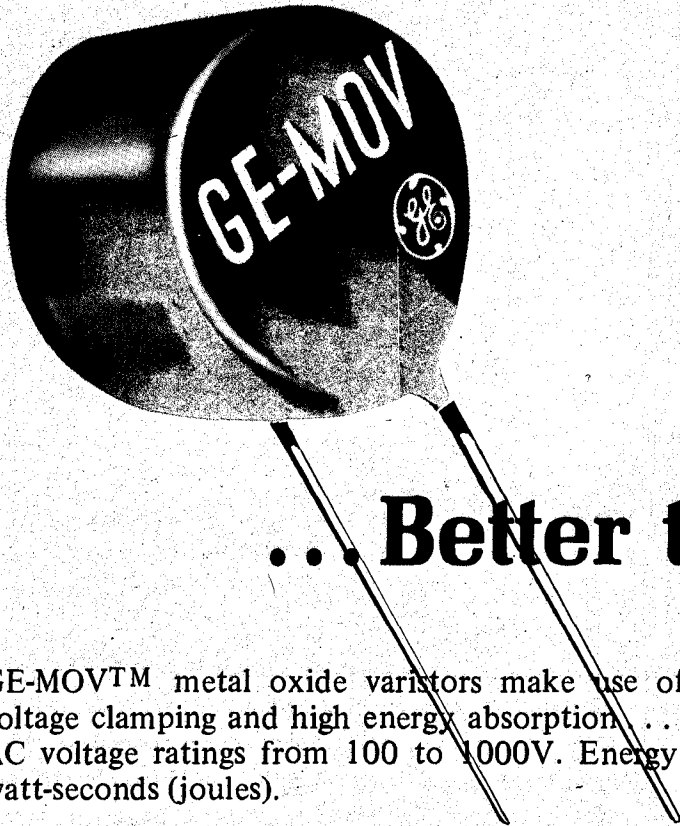

# Better system protection against transient voltages

## ... Better than selenium

GE-MOV™ metal oxide varistors make use of a new technology. They provide tight voltage clamping and high energy absorption... better than selenium. Present models offer AC voltage ratings from 100 to 1000V. Energy absorption ratings range from 10 to 160 watt-seconds (joules).

### GE-MOV SUPERIOR FEATURES:

- Clamping Ratio
- Size
- Peak Current
- Energy Density

### COMPETING SELENIUM SUPPRESSORS

Mfrs.	Commercial or Trade Names	Device Nomenclature			
		Selenium Suppressors			
		1 inch Square	2 inches Square	4 inches Square	5" x 6"
IR (W)	Klip-Sel Volt-Trap	KSA ----	KSL ----	KSP ----	KSF ----
		SO1.2AA --	SO3AA ----	SO6AA ----	SO9AA ----
			SO4AA ----		
Syntron Sarkes Tarzian	Surge Stop Klip Volt	SD1544 --	SD2650 --	SD2411 --	SD2452 --
		2KV26 ---	5KV26 ---	7KV26 ----	10KV26

## AUSTRALIAN GENERAL ELECTRIC LIMITED

86-90 BAY STREET, ULTIMO, N.S.W. PHONE 212-3711

### DISTRIBUTORS:

Fairchild Australia Pty. Ltd., Sydney 439-4355,  
Melbourne 723-4131.  
PB Components, Melbourne 53-2766.  
GEC-Elliott Automation Pty. Ltd., Adelaide

71-7971, Melbourne 387-2811, Sydney 439-1922,  
Brisbane 32-0441.  
Watkin Wynne Pty. Ltd., 32 Falcon St., Crows  
Nest. 43-2107.  
H. Rowe & Co. Pty. Ltd., Perth 28-5444.  
The National Electrical & Engineering Co. Ltd.,  
Wellington 553-709, Auckland 599-089.

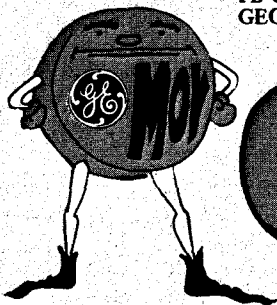

# GE-MOV™ VARISTORS

## ASSURE YOUR EQUIPMENT WILL ENDURE

Continued from page 10

### UK COMPANIES CEASE MONO TV TUBE PRODUCTION

In Britain, Philips Industries and also Thorn Electrical Industries are ceasing manufacture of black-and-white TV picture tubes.

Philips in fact are getting out of black-and-white TV receiver production altogether. The company is currently planning to close down its present plant at Squiresgate (Lancs) and to switch workers at its Croydon (Surrey) plant from TV assembly to video cassette recorder production.

The joint move means that no mono TV tubes will in future be quantity-produced in the UK. All will be imported.

Sales of black-and-white TV receivers have fallen in the UK from 1.5 million in 1972 to 990 000 last year and a projected 700 000 this year.

### LINEAR TEMPERATURE SENSITIVE RESISTOR

A temperature-sensitive resistor, whose resistance varies linearly with temperature, has been developed by the Electronic Products Division of Corning Glass Works (Bradford, P.A., USA).

The resistance of the device is claimed to remain substantially linear over the range -20°C to +150°C. Nominal resistance at 25°C is 1000 ohms.

### FOUR-CHANNEL TEST TRANSMISSION

Discrete FM 4-channel signals were transmitted by subscriber-type cable systems in San Jose and Santa Clara (California) during July.

Co-operating parties were Santa Clara University, Gill Cable, Inc., Teleprompter, CATEL (cable-FM equipment maker), and Matsushita Electric Industrial Co., Ltd. Signals were originated at the university's cable FM studio using a CD-4 discrete 4-channel record system and a prototype discrete FM 4-channel generator.

A survey of audience participants indicated that 98 percent found the sound "more exciting" than stereo. Of those in the market for new equipment, 86 percent indicated interest in purchasing quad provided prices were in the \$500 to \$1000 range. Although no serious equipment problems were encountered during the test, it is thought that a small amount of hiss noticed on soft passages may be suppressed by running the carrier level 2-3 dB above that of stereo, to compensate for 4-channel transmission's poorer signal-to-noise ratio.

### 250 WATTS - CLASS D AMPLIFIER

A 250 watt per channel power amplifier weighing a mere 10 kg is shortly to be released by Infinity.

The unit utilises Class D operation - a technique in which audio signals are digitized before amplification. In operation the output transistors are switched at a rate exceeding 500 kHz.

Efficiency is claimed to be 96%, compared with 40% or so typical of the more commonly used Class B units.

### GRAVITY WAVE DATA TRANSMISSIONS?

Future communications systems could well utilize modulated gravity waves propagating directly through the centre of the earth - according to a report given recently to the British Association by Dr. Drever of the Dept of Natural Philosophy, Glasgow University.

The notion is very much on the border-line between physics and science fiction as great controversy still continues as to whether gravity waves exist or not, however modern theory increasingly supports the idea of energy waves flowing across the universe in the way that light energy flows from the gigantic energetic disturbances in stars and galaxies.

### NS INTO DIGITAL WATCHES

National Semiconductor has now officially entered the electronic digital watch market with six Novus timepieces priced from US\$125 to US\$220 and three digital alarm clocks priced from US\$35 to US\$60.

The complete line will be sold through jewellery and department stores.

## SPECIAL OFFER

## IC 555 TIMER

SEE PAGE 53 THIS ISSUE.

# THE FIGHT OF THE DECADE by JBL

L16 The Welterweight at 22½lbs.

L36 The heavyweight at 38lbs.

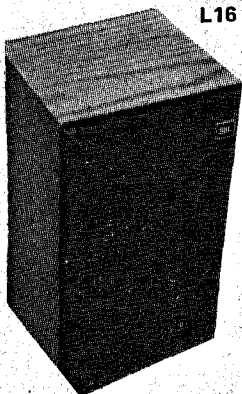

... little guy with a really  
BIG one-two punch  
- Kid Novack

The Middleweight belt retained by the  
L26 at 34½lbs.

"... a ring record you wouldn't believe.  
Knocked me out"  
- Cyclone Billy McGee

## GLEN-DOR

43 THE CORSO, MANLY

Ph. 977 2709 - 977 2415

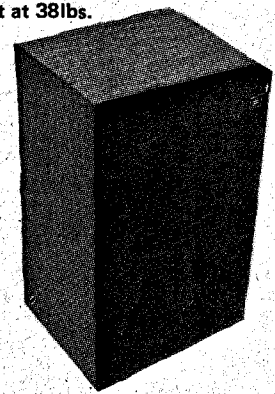

"... No stopping this guy in any round  
throws everything at you."  
- Battling Jack Bixbee

# INCOMPARABLE JANSZEN

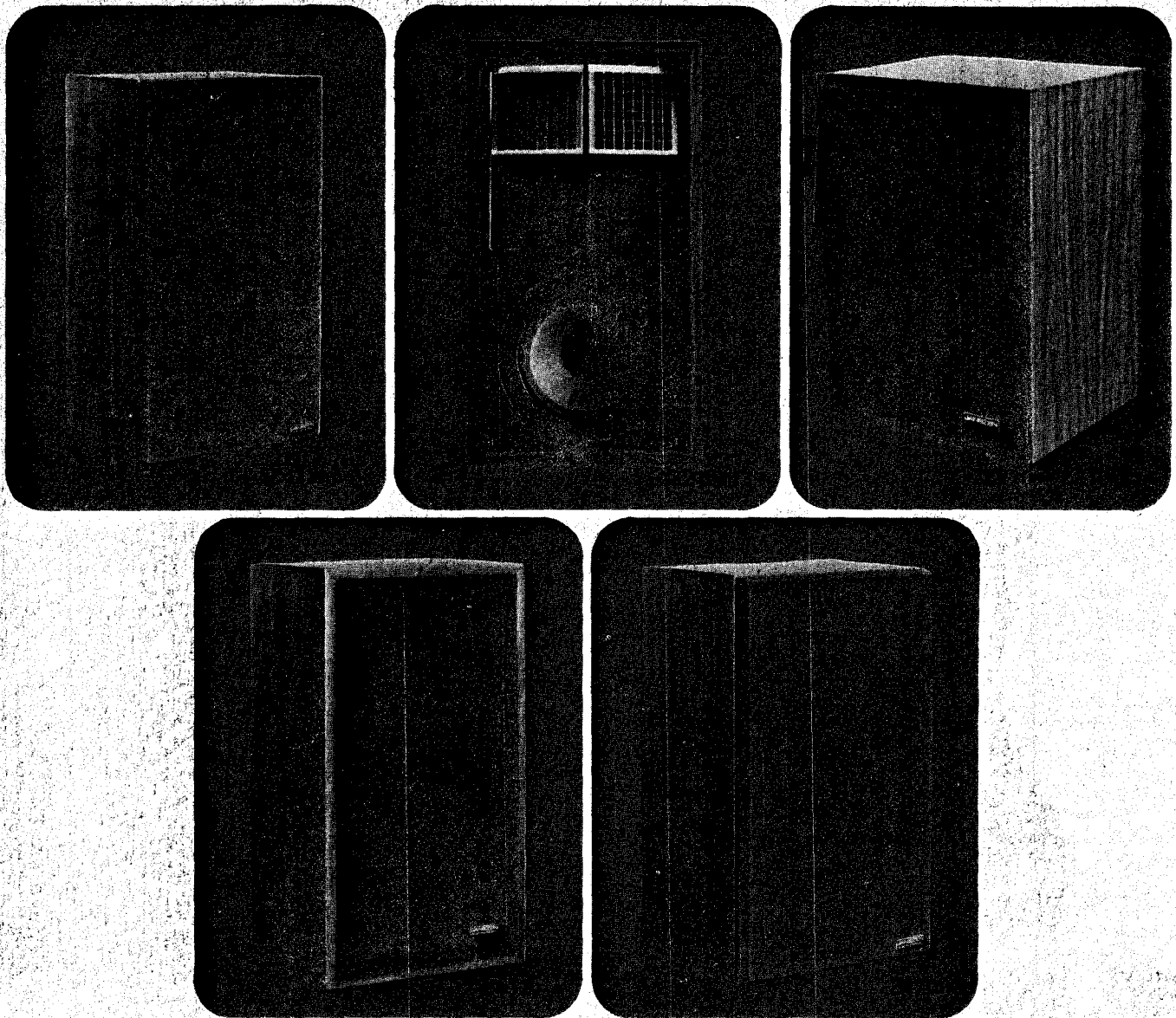

ADELAIDE  
BRISBANE  
HOBART  
MELBOURNE  
PERTH  
SYDNEY

**HIROWE  
& CO PTY LTD**

A Member of the Hecla Rowe Group Sole Australian Agents

When we say Janszen is incomparable we mean it . . . but not without qualification. Janszen was the original electrostatic manufacturer in the United States, and has developed electrostatic speakers for more than 20 years. Janszen offers the dedicated high fidelity enthusiast the highest level of technical excellence and performance that is unmatched. Want to know more about Janszen? See your high fidelity retailer now.



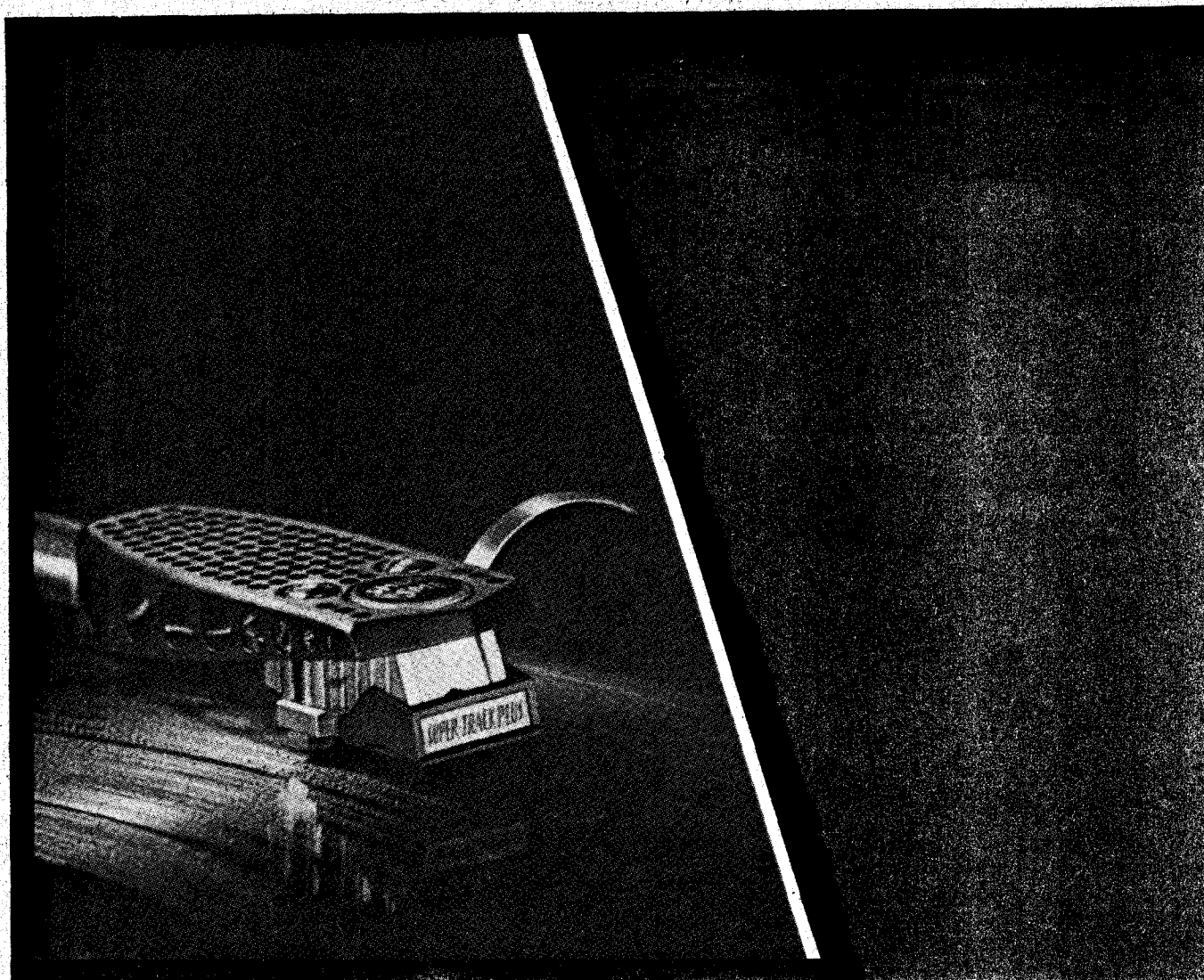

## anything II could do III can do better!

Several years ago, we decided that our next challenge would be to go beyond the best there was. Our computers told us we had taken the existing cartridge structure and stylus assembly of the V-15 Type II Improved as far as we could, and that hereafter, any improvement in one performance parameter would be at the expense of performance in some other parameter.

Therefore, over the past several years, a wholly new *laminated* cartridge structure has been developed, as was an entirely new stylus assembly with a 25% reduction in effective

stylus mass! These developments have resulted in optimum trackability at light tracking forces ( $\frac{3}{4}$ - $1\frac{1}{4}$  grams), a truly flat, unaccented frequency response, and more extended dynamic range than was possible even with the Type II Improved, without sacrificing output level!

If you like its sound today, you will like it even more as time goes on. In fact, to go back to any other cartridge after living with the Type III for a short while is simply unthinkable, so notable is its neutral, uncolored sound. You must hear it.

**SHURE** V-15 TYPE III  
 Super-Track "Plus" Phono Cartridge

<b>AUDIO ENGINEERS P/L</b> 342 Kent Street SYDNEY 2000 N.S.W.	<b>AUDIO ENGINEERS (Vic.)</b> 2A Hill Street THORNBURY 3071 Vic.	<b>RON JONES PTY. LTD.</b> 57 Castlemaine Street MILTON 4064 Qld.	<b>ATHOL M. HILL P/L</b> 1000 Hay Street PERTH 6000 W.A.
---	--	---	--

AE089/FP

# Lloyd's Doesn't Mind Being Called a Bargain\*

\*In fact, every Lloyd's calculator is a bargain in the truest sense of the word—a great value for the money.

**PRICES**  
SALES TAX PAID

MODEL A	\$ 48.61
B	\$ 85.90
C	\$120.33
D	\$ 67.88
E	\$ 31.01
F	\$ 47.59
G	\$ 44.85

DISCOUNT for 5 or more units.  
POST and PACK \$2.00 per order

**OPTIONAL EXTRAS**  
Recharger and rechargeable batteries for A, C, D, E and F.  
\$10.23

See for yourself, Lloyd's always means more features at the same price or equal features at a lower price.

**PRICES**  
SALES TAX EXEMPT

MODEL A	\$ 43.50
B	\$ 78.00
C	\$108.50
D	\$ 61.50
E	\$ 28.00
F	\$ 43.00
G	\$ 40.50

DISCOUNT for 5 or more units.  
Students ask for our Sales Tax Exemption Form.

POST and PACK \$2.00 per order

**OPTIONAL EXTRAS**  
Recharger and rechargeable batteries for A, C, D, E and F.  
\$9.50

- (A) Model ACC 200**
- High-powered pocket model
  - Bright 8-digit display
  - Fully addressable memory bank
  - Percentage key
  - Floating or fixed (to 2 places) decimal
  - Negative (credit balance) and overflow indicators
  - Automatic constant
- (B) Model ACC 300**
- Desk-top office model
  - 12-digit liquid crystal display
  - Fully addressable memory bank
  - Percentage key
  - Floating or fixed (to 2, 4 or 6 places) decimal
  - Round-off switch
  - Negative and overflow indicators
  - Change sign key
  - Automatic constant
  - AC operation
- (C) Model ACC 999**
- Advanced scientific pocket model
  - 8-digit high-intensity display
  - Performs trigonometry functions; logarithms and antilogs; square roots; powers of numbers; reciprocals and more, as well as basic arithmetic
  - Fully addressable memory plus  $m + x^2$  key
  - $\pi$  (pi) key
  - Angle readouts in degrees or radians
  - Automatic constant

- (D) Model ACC 500**
- Scientific pocket model
  - High-intensity 8-digit display
  - Performs: square roots, powers of numbers, reciprocals, and more.
  - Fully addressable memory bank
  - Percentage key
  - Floating or fixed (to 2 places) decimal
  - Negative and overflow indicators
  - Automatic constant

- (E) Model ACC 30**
- Economical pocket model
  - Bright 8-digit display
  - Percentage key
  - Floating decimal
  - Direct reciprocals and squaring of numbers
  - Negative number and overflow indicators
  - Automatic constant plus chain and mixed calculations

- (F) Model ACC 50**
- Efficient pocket model
  - Large 8-digit display
  - Square root key; Percentage key
  - Fully addressable memory bank
  - Negative and overflow indicators
  - Floating decimal
  - Direct reciprocals and squaring of numbers
  - Automatic constant

- (G) Model ACC 40**
- Prism-aided 8-digit liquid crystal display
  - Compact design and light weight
  - Fully addressable memory
  - Percentage key
  - Negative number and overflow indicators
  - Floating decimal
  - Automatic constant
  - 40 hour DC operation from 2 standard 9-volt batteries

W.H.K. handles the greatest range of the world's most advanced Calculators including the ROCKWELL METRIC CONVERTER with 112 direct conversions involving U.S., METRIC, IMPERIAL constants, plus two fully addressable memories; the ROCKWELL FINANCIER, a business calculator with logic selection switch, business or algebraic; plus four memories; various SCIENTIFIC CALCULATORS including one with two deep nesting parentheses. Most of our Pocket Calculators have oversize "GREEN DISPLAYS" which are superior to small red displays found in many other units. We stock the world famous ADLER and LLOYDS PRINTING CALCULATOR. In Electric Typewriters, we offer the new SMITH-CORONA "CORONAMATIC 7000" with a three second cartridge ribbon change, at \$100.00 below the suggested retail price. No other Company in Australia offers you QUALITY at such LOW PRICES. Send \$0.50 in Stamps or Money Order for our 50 page CALCULATOR/TYPEWRITER Catalogue, which describes the operation of all units. Compare QUALITY, WARRANTY, PRICES and you will buy from us.

MODELS A, C, D, E and F are supplied with a De-Luxe Carrying Case  
4 Penlight Batteries and a Manual — FREE OF CHARGE

AUSTRALIAN SOLE DISTRIBUTOR



**W.H.K. ELECTRONIC & SCIENTIFIC INSTRUMENTATION**  
MANUFACTURER, IMPORTER & WHOLESALE MERCHANT

2 GUM ROAD, ST. ALBANS, VICTORIA, AUSTRALIA. 3021. PHONE 03-396 3742  
POSTAL ADDRESS: P.D. BOX 147, ST. ALBANS, VICTORIA, AUSTRALIA. 3021.

PLEASE SEND COUPON TO W.H.K.

Name .....

Address .....

Post Code .....

Sole Australian distributors:  
**INTERNATIONAL DYNAMICS  
(AGENCIES) PTY. LTD.,**  
P.O. Box 205, Cheltenham, Vic. 3192.

# INTERDYN

## Big name! Small price! Top quality!

# ROTEL RA-211

**... and it outperforms many units almost double the price!**

It keeps astounding new audio people every day ... because it has lower distortion than all other amplifiers in its price range, and because of sheer performance and value.

Check the facts: Frequency response 20-75,000Hz. 12 watts RMS per channel, 50 watts total music power (IHF). All

solid state electronics, all silicon output transistors. Pushbutton controls for power, speaker systems 1 and 2, volume, tape monitor. Headphone jack, facilities for ceramic and magnetic cartridges, tuner, tape recorder, auxiliary equipment. In handsome timber cabinet.

**... and it still sells under \$100.**  
**As will the matching RT 222 AM-FM tuner.**



**Hear the Rotel range (and the fabulous new range of tuner-amps) at**

**Available from:**

**N.S.W.** M & G Hoskins Pty Ltd, 37 Castle St, Blakehurst 2221  
Telephone: 546 1464  
**Q'LD.** Stereo Supplies, 95 Turbot St, Brisbane 4000  
Telephone: 21 3623  
**S.A.** Challenge Hi-Fi Stereo, 96 Pirie St, Adelaide 5000  
Telephone: 223 3599

**TAS.** Audio Services, 44 Wilson St, Burnie 7320  
Telephone: 31 2390  
**VIC.** Encel Electronics Pty Ltd, 431 Bridge Rd, Richmond 3121  
Telephone: 42 3762  
**W.A.** Albert TV & Hi-Fi, 282 Hay St, Perth 6000  
Telephone: 21 5004  
**A.C.T.** Duratone Hi-Fi, Cnr Botany St & Altree Crt, Phillip 2606  
Telephone: 82 1388

KSV64B

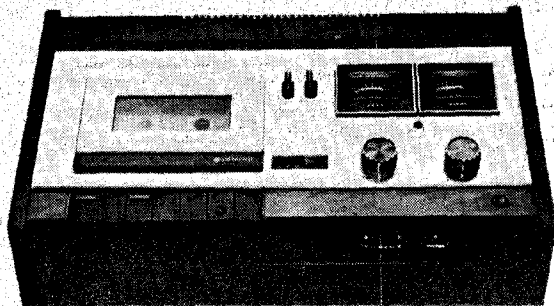

## TRQ-2020D

Stereo Cassette Deck. 2 VU meters, noise filter, chrome tape switch, auto stop, ferrite heads.

**\$139.00**

## TRQ-2030D

Stereo Cassette Deck. 2 VU meters, noise filter, chrome tape switch, auto stop, ferrite heads, memory rewind counter, separate record and play volume controls.

**\$159.00**

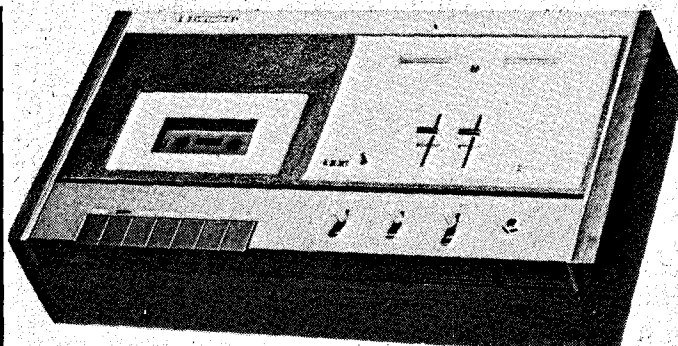
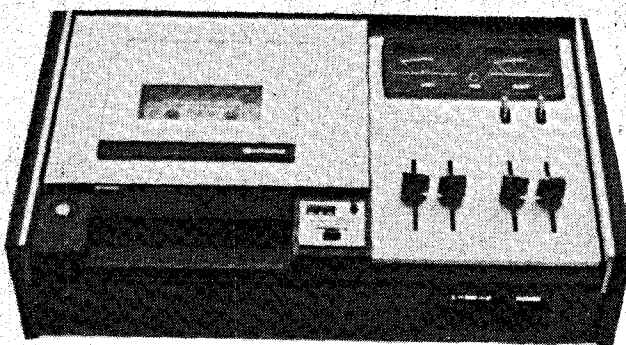

## TRQ-2000D

Stereo Cassette Deck. 2 VU meters, chrome tape switch, auto stop, separate recording controls, Dolby noise reduction system, Din and RCA connectors.

**\$189.00**

# ★ SPECIALS FOR NOVEMBER ★

HITACHI		1 of	12 of	23 of
C60		\$1.60	\$1.47	\$1.33
C90		2.20	2.00	1.80
C120		2.85	2.50	2.25
UDC46		2.05	1.95	1.85
UDC60		2.35	2.14	1.93
UDC90		3.15	2.84	2.56
UDC120		4.35	3.92	3.53

Philips AD1265/W8 12"	\$24.00	Philips 5" Squakers	\$16.00
Philips 8" Woofers	\$12.00	3TC Tweeters	\$ 3.50
Philips 1" Tweeters	\$ 8.00		

Magnavox 8-30's \$12.95 PLENTY OF STOCKS

		1 of	10 of	20 of
Sony C90 LN		\$2.20	\$2.00	\$1.80
Sony C120 LN		\$2.85	\$2.65	\$2.50
Maxel C90 LN		\$2.10	\$1.90	\$1.70
Basf C90 SM		\$2.20	\$2.00	\$1.80
Audio Cassette C60 Hi-Fi		\$1.20	\$1.00	\$0.80
Audio Cassette C90 Hi-Fi		\$1.50	\$1.30	\$1.15
Audio Headcleaner		\$1.00	\$0.95	\$0.85

		1 of	3 of	6 of
Basf LN DP26 2400' 7" tape		\$10.00	\$9.50	\$9.00
Basf LP 35 1800' 7" tape		\$ 6.50	\$6.00	\$5.50
Basf LN DP26 1200' 5" tape		\$ 6.50	\$6.00	\$5.50

**EDGE ELECTRIX 34A Burwood Rd.,**

# CORAL

## 8" SPEAKER SYSTEM KIT 8SA-1

35W, 3-way, 3-speaker system in kit form includes all speakers, crossovers, terminals, wire, screws, coral emblem for front of box.

The features as assembled in a designed cabinet are as follows:

Features (8SA-1)	
Type of cabinet	Closed type
Type of speaker	3-way 3-speaker
Input impedance	8 Ohms
Crossover frequency	4,000 : 9,000 Hz
Frequency response	70 ~ 20,000 Hz
Sensitivity	93 dB
Capacity	.35 W

Price \$30.00 pair

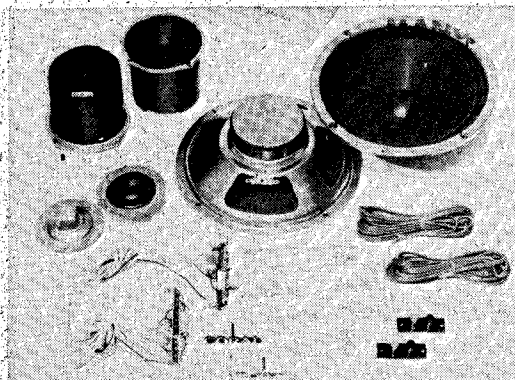
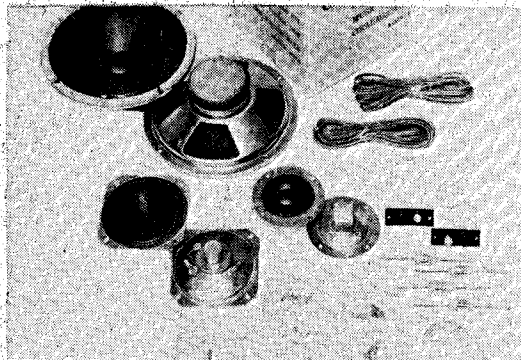

## 10" SPEAKER SYSTEM KIT 10SA-1

50W, 3-way, 3-speaker system in kit form includes all speakers, crossovers, terminals, wire, screws, coral emblem for front of box.

The features as assembled in a designated cabinet are as follows:

Features (10SA-1)	
Type of cabinet	Closed type
Type of speaker	3-way 3-speaker
Input impedance	8 Ohms
Crossover frequency	2,000 : 6,000 Hz
Frequency response	40 ~ 20,000 Hz
Sensitivity	93 dB
Capacity	.50 W

Price \$50.00 pair

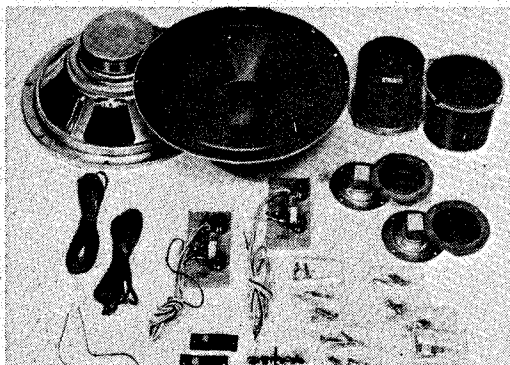

## 12" SPEAKER SYSTEM KIT 12SA-1

60W, 3-way, 4-speaker system in kit form includes all speakers, crossovers, terminals, wire, screws, coral emblem for front of box.

The features as assembled in a designated cabinet are as follows:

Features (12SA-1)	
Type of cabinet	Closed type
Type of speaker	3-way 4-speaker
Input impedance	8 Ohms
Crossover frequency	1,000 : 10,000 Hz
Frequency response	30 ~ 20,000 Hz
Sensitivity	95 dB
Capacity	.60 W

Price \$70.00 pair

The kits are on display at our showroom, working in boxes. We stock the boxes already pre cut, drilled etc for all 3 kits at reasonable prices. Must be heard to be believed. All kits come with box sizes, wiring, diagrams, etc.

# CORAL



**University**  
meters

MUA5/73  
(20K-VOHDC)  
\$13.50 each

CTN500MP  
(20K-VOHDC)  
\$20.00 each



Plessey	12U50	8Ω	15Ω	\$36.00	C100X	8Ω	15Ω	\$14.68
	C12P	8Ω	15Ω	\$19.79	C8MX	8Ω	15Ω	\$ 8.95
	C12PX	8Ω	15Ω	\$21.15	C6MR	8Ω	15Ω	\$ 7.90
	C100	8Ω	15Ω	\$13.26	C60	8Ω	15Ω	\$11.09

HITACHI DISC O  
TAPE RADIO —  
SDT-3420  
Stereo cassette, Stereo  
record player, 2 VU meters,  
5 W RMS per channel  
output, 2 matching  
speakers. \$295.00

HITACHI STEREO —  
CST215—CASSETTE RADIO  
with 2 matching speakers. Big  
7W output. \$129.00

KINGSONIC 8 TRACK  
STEREO  
Car player with 2 speakers.  
Special at \$55.00

### COMPLETE MAIL ORDER SERVICE

All goods available at competitive prices. Please write or ring for a quote ... allow a sufficient amount to cover Freight when ordering.

**Burwood. N.S.W. 2134 - Phone 747 2931**

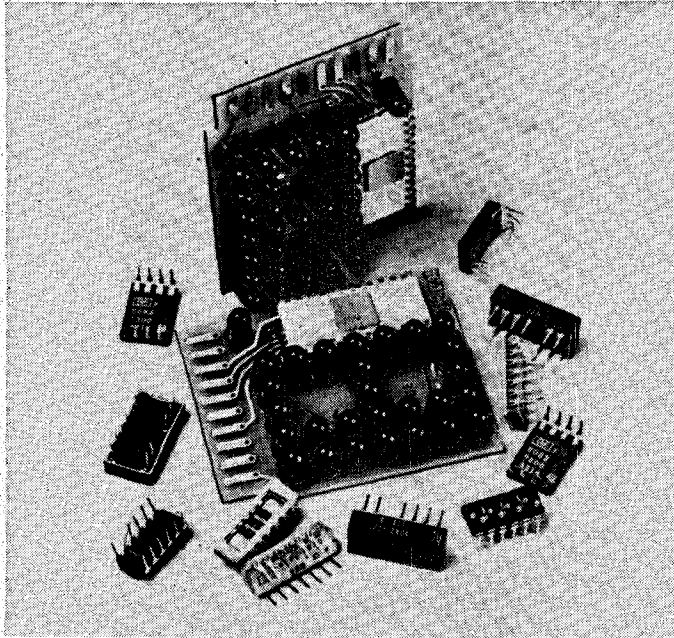

# the numbers game

LET OUR DISTRIBUTORS SHOW YOU THEIR COMPLETE RANGE OF HP SOLID STATE DISPLAYS.

Hewlett-Packard is happy to announce the appointment of a new distributor:

## C. W. TYREE SEMI-CONDUCTOR PTY. LTD.

1100 Toorak Rd.,  
Hartwell, Vic. 3125  
Phone 29 2338

10 Charles St.,  
Redfern, N.S.W. 2016  
Phone 69 5264

Tyree can supply Solid State Displays from stock in quantity.  
They join the distributors with whom you already deal:

	<b>N.S.W.</b>	<b>N.S.W.</b>	<b>S.A.</b>
	<b>DIGITRONICS AUSTRALIA PTY LTD</b>	<b>RADIO DESPATCH SERVICE</b>	<b>GERARD &amp; GOODMAN PTY LTD</b>
<b>HP DISTRIBUTORS</b>	12 William Street Maryville, N.S.W. 2293 Phone 69 2040	869 George Street Sydney, 2000 Phone 211 0816	192 Rundle Street Adelaide, 5000 Phone 23 2222
<b>VIC.</b>	<b>W.A.</b>	<b>QLD.</b>	<b>A.C.T.</b>
<b>RADIO PARTS GROUP</b>	<b>EVERETT AGENCY PTY LTD</b>	<b>ELECTRONIC COMPONENTS</b>	<b>ELECTRONIC COMPONENTS PTY. LTD.</b>
562 Spencer Street West Melbourne, 3003 Phone 329 7888, 30 1251	17 Northwood Street West Leederville Western Australia, 6007 Phone 81 5500	P.O. Box 162, Indooroopilly, 4068 Phone 78 7979	3 Pirie Street, Fyshwick, 2600 Phone 95 6811



Sales and service from 172 offices in 65 countries.  
Australia, 31-41 Joseph Street, Blackburn, 3130, Victoria. Telephone  
89 6351. Other Offices: Adelaide, Brisbane, Canberra, Perth and  
Sydney. Also Auckland and Wellington, New Zealand.

90417B

# Goodmans

## High Fidelity Equipment



### Dimension 8

- 8 speaker system

L.F. radiator, 4 bass speakers, 2 midrange, 2 dome tweeters.  
**Nominal Power Input:**  
 60 Watts  
**Impedance:** 4 Ohms  
**Sensitivity:** 4.4 Watts  
**Frequency Range:** 30-22,000 Hz  
**Size:** 30-3/8 x 14 x 12 1/2  
 77 x 35.5 x 31.5 cms  
**Finishes:** Teak, Walnut or White

### Goodwood

- 3 way system

1 x 12" bass speaker, 1 x 4" midrange, 1 dome tweeter.  
**Nominal Power Input:**  
 40 Watts  
**Impedance:** 4-8 Ohms  
**Sensitivity:** 9 Watts  
**Frequency Range:** 35-22,000Hz  
**Size:** 30 x 14 1/4 x 10-5/8"  
**Finishes:** Teak or Walnut.



### Model One-Ten Am/Fm Tuner Amplifier

**Power Output:**  
 50 Watts per Channel into 4 Ohms  
**Variable Tuning Ranges:**  
 VHF FM: 87.5-108 MHz  
**Length:** 584mm  
**Depth:** 305mm  
**Height:** 115mm  
**Finishes:** White with discreetly coloured control tabs. Teak or Walnut finish case with brushed aluminium fascia.

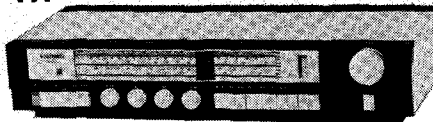

### Amplifiers



### Model Forty Forty Amplifier

**Power Output:**  
 35 Watts RMS per channel into 4 ohms  
**Total harmonic distortion:**  
 Less than 0.1% at 30 Watts per channel  
**Frequency Response:**  
 30 - 20,000 Hz  $\pm$  1.5 dB  
**Finishes:** Teak, Walnut or White  
**Size:** 22 x 11 1/4 x 3 3/4 ins.

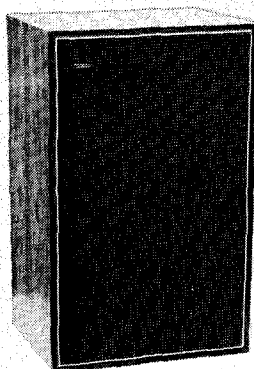

### Magnum S.L.

- 3 way system

1 x 12" bass speaker, 1 x 4" midrange, 1 dome tweeter.  
**Nominal Power Input:**  
 40 Watts  
**Impedance:** 4-8 Ohms  
**Sensitivity:** 2 Watts  
**Frequency Range:**  
 30-22,000 Hz  
**Size:** 24 x 15 x 11-3/8  
 62 x 38.1 x 29 cms  
**Finishes:** Teak or Walnut

### Havant S.L.

- 3 way system

1 x 8" bass speaker, 1 x 3-3/8" midrange, 1 dome tweeter.  
**Nominal Power Input:**  
 20 Watts  
**Impedance:** 4 Ohms  
**Sensitivity:** 4.4 Watts  
**Frequency Range:**  
 45 - 22,000 Hz  
**Size:** 18 1/4 x 10 1/2 x 10 1/2  
 48 x 26.5 x 26.5 cms  
**Finishes:** Teak, Walnut or White



Available At  
 Leading Hi-Fi Dealers.



## Thorn Sales

A DIVISION OF AWA-THORN CONSUMER PRODUCTS PTY. LTD.

**BRANCHES:**  
**Victoria**  
 123-131 Bamfield Road,  
 West Heidelberg, Vic. 3081  
 Tel.: 459 1688  
**Queensland**  
 73-75 Jane Street,  
 West End, Queensland, 4101  
 Tel.: 44 7211

**New South Wales**  
 348 Victoria Road,  
 Rydalmere, N.S.W. 2116  
 Tel.: 638 0411

**South Australia**  
 101 Main North Road,  
 Nailsworth, Adelaide, 5083  
 Tel.: 269 1966

**Western Australia**  
 321 Bulwer Street,  
 Perth, W.A. 6000  
 Tel.: 28 6400

**AGENTS**  
**Tasmania**  
 Barrett & Maher Pty. Ltd.  
 4 Lefroy Street,  
 North Hobart, Tasmania, 7000  
 Tel.: 34 3509

ABSTRACT  
'SUPER'  
GREEN SOURCE

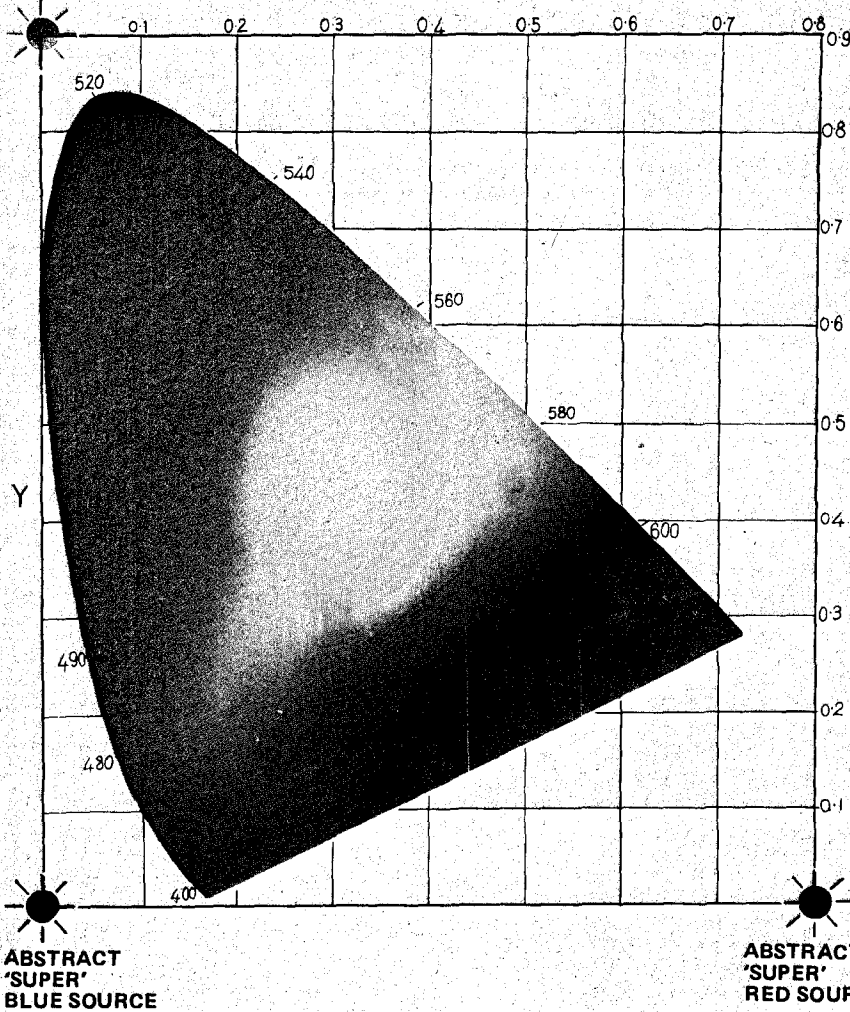

The aim of this series is to explain the basically simple principles which, when combined, make the near-miracle of colour television possible.

The intention is to avoid intensive explanations of any step in the process (as a specialist may require) since this would cause a general reader to feel adrift. Instead we shall describe the fundamentals which are essential matter for anybody seeking a broad understanding of colour television.

Fig. B. The C.I.E. chromaticity diagram which shows how all colours, including spectral colours which lie along the heavy line can be achieved by combining three 'super' fictitious primary sources.

# UNDERSTANDING COLOUR TV

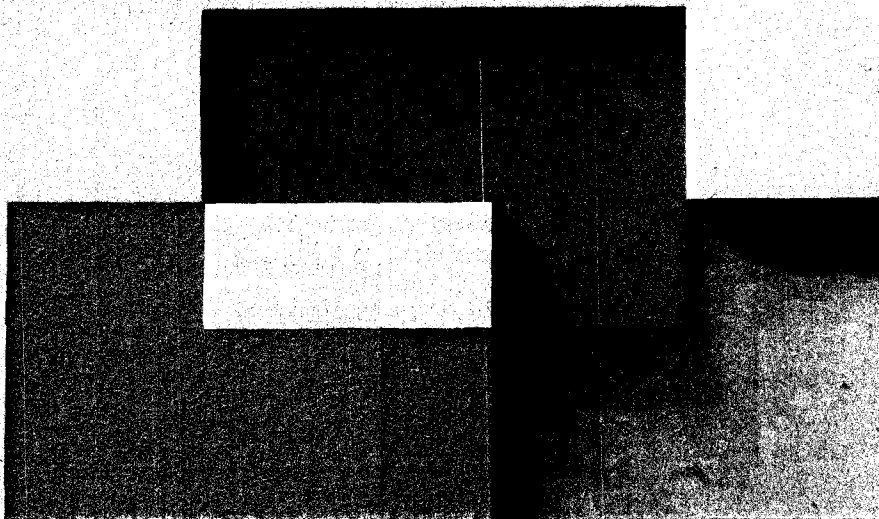

Fig. A. This illustration shows the effect of mixing varying proportions of light coloured red, green and blue. These are the additive primaries used in colour television displays.

THE PHYSICAL NATURE of colour was a complete mystery until 1666. Then, Sir Isaac Newton discovered that a single beam of sunlight passing through a wedge-shaped piece (prism) of glass becomes *dispersed* into a fan-shaped beam or *spectrum* of many brilliant colours.

We recognise the spectral colours as different wavelengths of light energy which were all present in the sunlight but have become separated by varying degrees of bending in the glass wedge. For example, spectral green is a monochromatic (single wavelength) radiation of about 550 nanometres wavelength. Its frequency is nearly 1000 000 000 Megahertz!

The eye is sensitive to only a very narrow band of this spectrum. This band extends from 380 to 780 nanometres ( $1 \text{ nm} = 10^{-9} \text{ m} = 10 \text{ \AA}$  wavelength (Fig. 1).



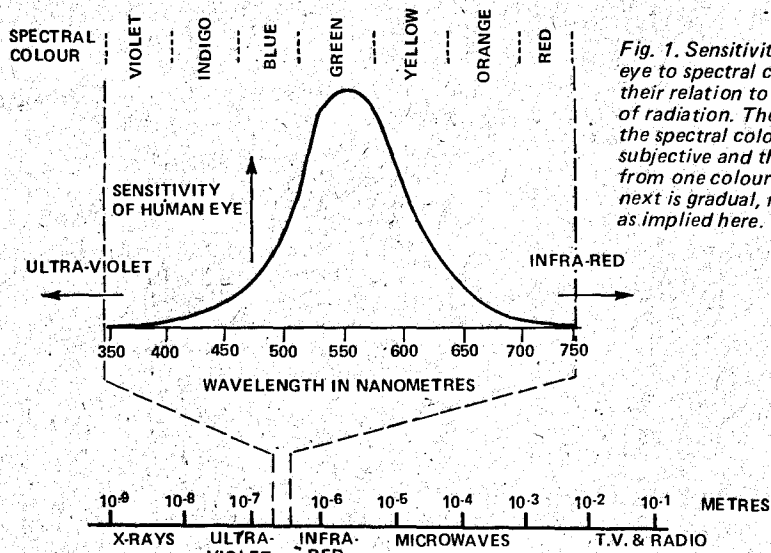

Fig. 1. Sensitivity of human eye to spectral colours and their relation to other forms of radiation. The names of the spectral colours are subjective and the transition from one colour to the next is gradual, not sharp as implied here.

Red is the colour sensation produced by wavelengths in the region of 700 nm and violet is the colour sensation produced by wavelengths in the region of 380 nm.

The colours at the ends of the spectrum (violet and deep red) appear comparatively dim, this is because the eye has less sensitivity to these wavelengths.

Although there is surprisingly great variation between people, an average response curve for the eye has been measured and is shown in Fig. 2. Those in electronics will notice that this curve resembles the response shape of a tuned circuit and it is a remarkable result of evolution that the peak is 'tuned' to near the wavelength of maximum emission from the sun. The eye does not judge colours by measuring wavelengths.

Instead the eye *seems* to contain three sets of nerves with different wavelength responses, and the sensation of colour seems to be a sensation of the relative proportions in which this triad of nerves is stimulated — see Fig. A. It must be stressed that this description is merely conjecture. It describes the way the eye reacts to known mixtures of wavelengths but has not yet been medically proven. Certainly though it is a reasonable conjecture, for if we combine three light sources (particular shades of red, green and blue light called *primaries*) and stimulate each nerve individually, any possible colour impression can be simulated by varying the relative strengths of the sources.

Figure A is a way of showing this. It is a colour triangle where each primary coloured light is shown alone at a corner and becomes mixed with one of the other two primaries as one moves towards one of the other two corners, or becomes mixed with both of the other two primaries as one moves towards the centre of the opposite

side. At the centre is the colour 'white'. This is produced by near equal strengths of each primary. The precise position of white on the triangle is a matter of choice since, like any other colour, its separation from bordering colours is indistinct.

The colour triangle shows only the colours produced by different proportions of the three lights. It does not show the effect of brightening or darkening all three lights by the same factor. Doing this does not change the *colour* of any position on the triangle, it merely varies the *luminosity* (brightness) of the colour. Since luminosity information is absent from the triangle, the 'white' area could equally rightly be called light grey, medium grey, dark grey or black since this is the variation caused by varying luminosity. The reason brown was not found in the spectrum is now apparent: brown is merely the colour yellow with low luminosity. (Therefore a brown object brightly lit against an otherwise dark background, so the eye over-estimates its luminosity, appears yellow!) Also the

nature of purple, a mixture of red and green which has no single place on the spectrum, becomes clear in Fig. A.

Artists may be questioning our choice of red, green and blue primaries since they have found red, blue and yellow to be the most flexible choice of paints to be mixed to give other colours. However our simulation of colours by *additive* mixing of lights is quite different from the process of paint mixing which is a *subtractive* process i.e.: the more coloured pigment is added to the mix, the darker the result because fewer wavelengths of light are reflected. An artist concocts his colours by removing some of the wavelengths present in white light (the colour of his canvas or of the base of his paints) until the right mixture is left. He can therefore start with more than one set of subtractive primaries, using more than three for best results (as is done in printing the colour pages of this magazine).

Although the combination of primary coloured lights to create new colours is fairly successful, some colours, including the spectral colours, cannot be simulated completely by any mixture. For example, spectral blue-green cannot be copied by mixing any other colours, spectral or otherwise. (Of course if we choose spectral blue-green as one of our primaries this particular problem is solved, but all the other spectral colours remain.) However, it has been found that any of these inimitable colours, if first modified by adding an amount of one of the primary colours, becomes a colour which *can* be simulated by combining the remaining two primaries. It is as though each primary to the spectral colour counteracts the negative quantity to produce a colour which lies within Fig. 2.

Since we cannot have negative light sources, spectral colours will lie

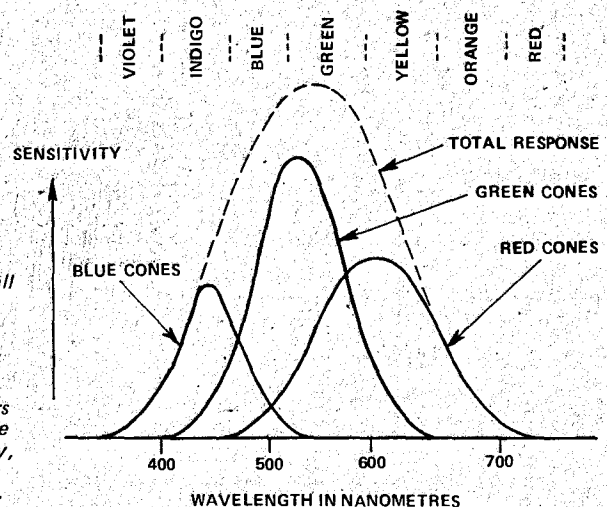

Fig. 2. The three hypothetical responses which combine to give the overall eye response in Fig. 1, (based on experimental data). From left to right the peaks are at blue, green and red which suggests that these colours could be used to influence each response individually, and in combination cause the eye to see any colour.

# UNDERSTANDING COLOUR TV

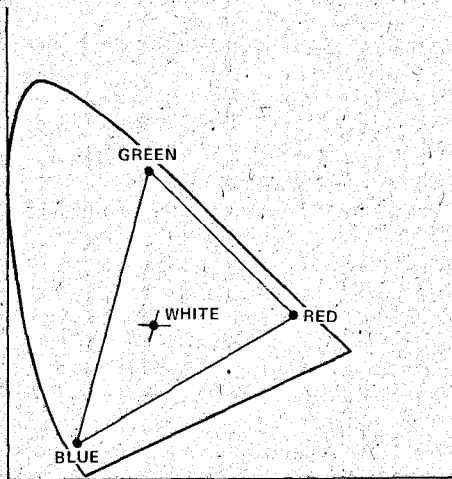

Fig. 3. A feature of the chromaticity diagram is that the colours achievable by combining any three primaries can be found by connecting them on the chart. The three dots above represent to scale the best television screen phosphors available for colour television. Therefore colour television can only reproduce colours lying inside the triangle.

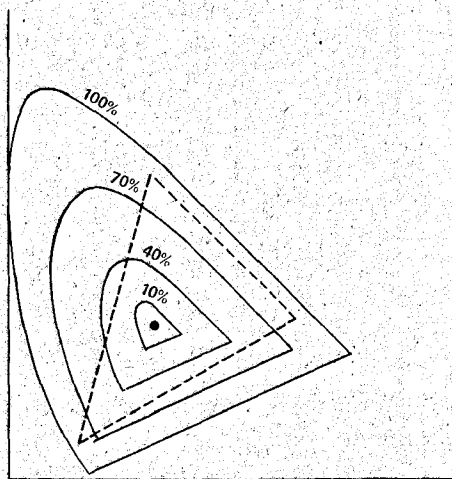

Fig. 4. Contours of four levels of saturation. Dot at centre is white, 'zero saturation'.

outside any colour triangle drawn with real light sources at the corners. However the C.I.E. (Commission Internationale de L'Eclairage — the International Commission on Illumination) defined in 1931 three *abstract* primary colours which, if they existed, could be combined in suitable ratios to stimulate any known colour impression, including all the spectral colours. The usual presentation of the

colour triangle using these sources is the 'chromaticity diagram' shown in Fig. A. Here the quantities of the primaries are given in 'tristimulus units'  $x$ ,  $y$  and  $z$ , which have the property that units of different primaries can be assumed to give an accurate measure of the visual brightness of the resulting colour. Since brightness (luminosity) variation does not affect the triangle, luminosity can be given unity value and the triangle drawn like a conventional graph with only two variables,  $x$  and  $y$ ,

since the third  $z$  can be found for any colour position from  $z = 1 - (x + y)$ .

Much can be deduced from this diagram. For example it shows that any real colour triangle must have as its corner primaries three colours on the diagram — Fig. 3. Since no such triangle can be drawn to encompass the entire horseshoe, spectral colours can never be simulated.

## SATURATION

Colours near the horseshoe boundary have a strong undiluted quality, the strongest being the spectral colours. Colours nearer to the white at the approximate centre of the horseshoe are paler or 'pastel'. The distance from white of a colour on the diagram is called its 'saturation' which ranges from 0% (white itself) to 100%

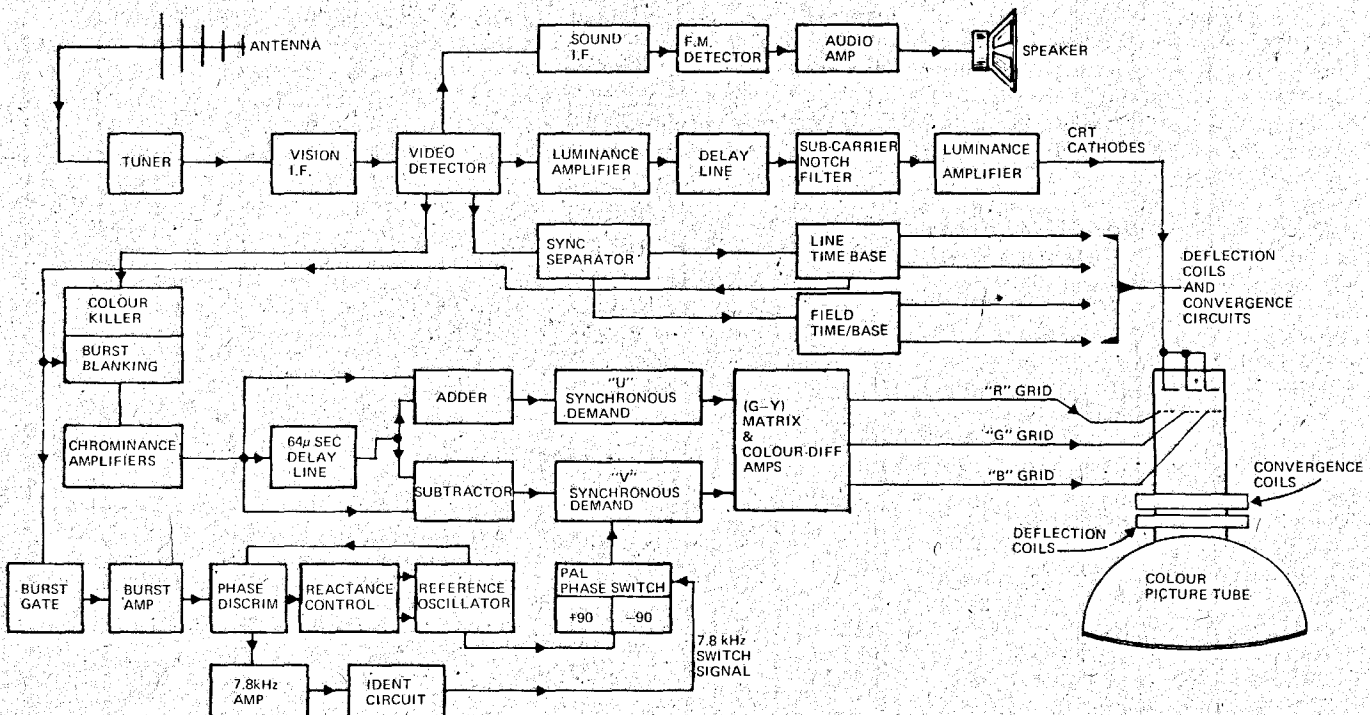

Block diagram of PAL colour receiver, it looks complex here, but in actuality it is a basically simple, logical device.

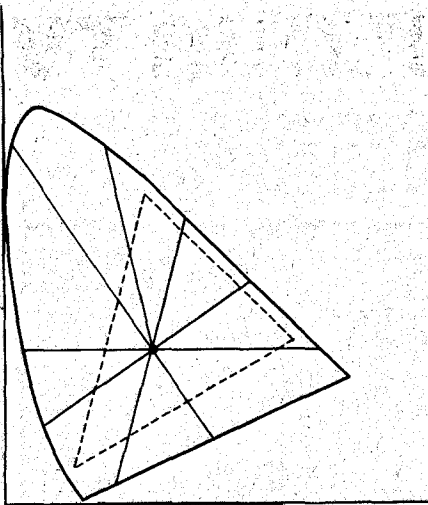

Fig. 5. Each radiating line joins colours of a particular 'hue'. White at the centre has no hue.

saturation on the border of the horseshoe — Fig. 4.

### HUE

If we start at any 100% saturated colour and progressively desaturate it by adding white light, we travel from the boundary of the horseshoe along a straight line towards white. All colours along such a line are said to have the same *hue* and vary only in saturation. There is an infinity of possible hues — see Fig. 5. Note that a triangle of real primaries, as used in a colour television display, can simulate any *hue* but not at full saturation. Since 100% saturated colours are rare in nature the restriction is acceptable. Thus the question of how colour television can reproduce a rainbow spectrum is answered — the hues are reproduced correctly but some colours may lack true saturation.

### CHOICE OF COLOUR VARIABLES FOR TV

We shall see in Part 2 of the series that because of the need for the colour television signal to be suitable also for monochrome receivers, luminosity information is transmitted in the form of a monochrome television signal and two extra streams of information are cunningly added to the signal for recognition by colour receivers only. These two extra signals are two variables which define positions of colours on the chromaticity diagram. There could be many choices of pairs of variables. Hue and saturation are a possible pair since they uniquely define any colour. However it is undesirable to use variables capable of specifying colours which cannot be reproduced.

## HOBIPAK

P.O. Box 224, South Carlton, Vic. 3053.

### RESISTORS

1/8 W carbon film 10% ..... 4c ea.  
 Special — 100 for \$3.40 — 25 for 92c  
 1 ohm 1% 1/2W Wire Wound ..... 45c ea.  
 10 ohm 1% 1/2W Wire Wound ..... 38c ea.  
 1/8 W carbon film E12 5% ..... 5c ea.  
 1/2 W carbon film E25 5% ..... 5c ea.  
 Special — 100 for ..... \$4.50  
 1 W carbon film E12 5% ..... 6c ea.  
 Special — 100 for ..... \$5.40  
 MR30 metal film E24 2% ..... 11c ea.  
 Special — 100 for ..... \$9.50

### SOLID STATE DEVICES

MEL12 Light Detectors ..... \$2 ea.  
 IS44 Diodes (40 V PIV) ..... 18c ea.  
 ZN414 (Chip radio) ..... \$3.95 ea.  
 MC1455 P/Timers ..... \$3 ea.  
 7490 (Decade Counters) ..... \$1.65

### TRANSISTORS

2N2926 \$.100 BF598 \$.160 ZTX382 \$1.40  
 2N3693 .41 ME8003 .85 ZTX500 \$1.05  
 2N4121 .40 ME8003 \$1.00 ZTX501 \$1.18  
 2N5133 .85 ZTX107 \$1.00 ZTX502 \$1.25  
 2N5134 .86 ZTX108 .99 ZTX503 \$1.38  
 2N5137 .86 ZTX109 \$1.15 ZTX531 \$1.95  
 2N5138 .86 ZTX114 \$2.00 SC45D \$9.50  
 2N5139 .80 ZTX300 \$1.15 SC50D \$11.20  
 BC214L \$.104 ZTX301 \$1.12  
 BFS61 \$.169 ZTX304 \$1.90

### SLIDE POTENTIOMETERS

Linear 5K to 100K ..... 70c ea.  
 Logarithmic 5K to 50K ..... 70c ea.  
 Knobs — chrome 23c — black 18c

### CAPACITORS

Tantalum 0.1-10µF ..... 28c ea.  
 Polyester Film — .0047, .01µF — 10c;  
 .022µF — 12c; .047 — 14c; .1µF — 16c;  
 .15µF, .22µF — 24c; .33µF — 30c.

### Electrolytic P.C.B. Type

100/16V ..... 34c 25/25V ..... 16c  
 470/50V ..... 70c 100/25V ..... 26c  
 470/25V ..... 59c 220/25V ..... 38c

### Pligtall type

470/50V ..... 75c 100/25V ..... 30c  
 470/25V ..... 49c 250/50V ..... 49c  
 2000/25V ..... 60c 2200/16V ..... 75c

DENCO Coils (Plug In type) —

Valve or Transistor types ... \$2.25 ea.  
**POSTING & PACKING 30c per order.**

## SIMPLA-LUX

### MODULAR WALL UNITS

Ph. Sydney 57-1841

### SAVE BY ASSEMBLING YOURSELF

Natural Teak Hi-Fi furniture

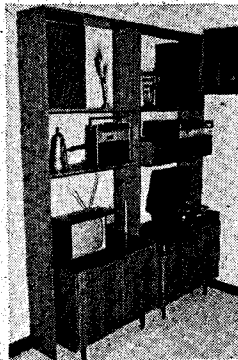

MODULES — multiples of 30%  
 ILLUSTR. 5'2" x 6'9" high — \$180.00

Full range displayed at:—

504 KING GEORGES RD.,

BEVERLY HILLS, NSW 2209

(opp. Hotel Bennelong)

CLOSED MONDAYS otherwise  
 normal trading hours. PH: GWEN  
 TINNEY 57-1841 for brochure and  
 prices or post coupon to above  
 address:—

NAME .....

ADDRESS .....

..... Post Code .....

[Advertisement]

# BECOME A COLOR TV TECHNICIAN

AND EARN MONEY THAT  
WILL MAKE YOUR FRIENDS  
GREEN WITH ENVY

Within months colour TV will be coming to Australia. It's a chance for you to get in on the ground floor, because there will be a huge demand for new sets and technicians specially trained in the field of colour TV servicing. Through ICS you'll get the necessary training to break into the industry. However, if you're already in the TV servicing field, you'll receive all the instruction necessary to prepare you for this coming revolution in home entertainment. As an engineer, technician or serviceman, there's a whole profitable new future about to open for you.

### If you start learning now

With an ICS course you'll get expert tuition at home, in your own time. Mail the coupon and we'll send you a FREE ICS career program kit on this or any of the courses below. Mail the coupon TODAY.

Hotel Motel Management  
 TV Servicing — Colour  
 Accountancy  
 Bookkeeping, Costing  
 Computer Programming  
 Electronics  
 Building & Architecture  
 Quantity Surveyors,  
 Carpentry  
 Engineering  
 Mechanical & Civil  
 Chemical & Industrial  
 Electrical  
 Automotive  
 Mechanical Engineering  
 Panel Beating I.A.M.E.  
 Business Management  
 Small Business  
 Industrial/Personnel  
 Air Conditioning  
 Refrigeration & Heating  
 Sales & Marketing  
 Creative & Professional  
 Writing  
 Secretarial  
 Art

## ICS Career Programs

International Correspondence Schools,  
 400 Pacific Hwy, Crows Nest,  
 N.S.W. 2065. Tel: 43-2121

I am genuinely interested in starting  
 my new career as soon as possible.  
 Please express Career Program Guide  
 ticked.

TV Servicing  Air Conditioning &  
 Refrigeration  Automotive  Engi-  
 neering  Drafting  Electronics   
 Building & Architecture  Writing   
 Art

Mr./Mrs./Miss .....

Address .....

.....

..... Postcode .....

Occupation .....

Age .....

CONFIDENTIAL

## Have you had the **LUX** experience?

### Ultimate fidelity.

The world's longest-established manufacturer of amplifiers (1921), Lux first make the unit to their own standards of quality, then put the price on it. Lux amplifiers make apparent the mystery and softness of every instrument—

this is ultimate fidelity. The logical layout of the controls gives you an immediate affinity with the unit, and there's a Lux model with just the power handling and performance to suit you.



#### LUX SQ 505X (Shown)

Electronics Australia: A listening test, using familiar speakers and source material, proved what a superb unit this is. Power output 30 watts per channel RMS, with both channels driven, for 0.04% distortion. Power bandwidth (0.04%—3dB) is 5Hz to 50kHz.

#### LUX SQ 507X

"Hi Fi For Pleasure" March '73 said: "Unhesitatingly met and frequently exceeded its exhaustive specifications in all parameters. Suitable for installations of the highest quality, it can provide ample power for all domestic applications, including the larger, low efficiency transmission line speakers. At 8 ohms, both channels, 61 + 61 watts are available. Singly driven, power rose to 80 watts. At rated output (50 + 50 watts) total harmonic distortion was 0.02% at 1kHz. Power bandwidth is 5Hz to 50kHz."

#### Available from:

**N.S.W.** M & G Hoskins Pty Ltd, 37 Castle St, Blakehurst 2221  
Telephone: 546 1464  
**Q'LD.** Stereo Supplies, 95 Turbot St, Brisbane 4000  
Telephone: 21 3623  
**S.A.** Challenge Hi-Fi Stereo, 96 Pirie St, Adelaide 5000  
Telephone: 223 3599

**TAS.** Audio Services, 44 Wilson St, Burnie 7320  
Telephone: 31 2390  
**VIC.** Encel Electronics Pty Ltd, 431 Bridge Rd, Richmond 3121  
Telephone: 42 3762  
**W.A.** Albert TV & Hi-Fi, 282 Hay St, Perth 6000  
Telephone: 21 5004  
**A.C.T.** Duratone Hi-Fi, Cnr Botany St & Altree Crt, Phillip 2606  
Telephone: 82 1388

# HUSQVARNA MICROWAVE OVENS

for home and commercial use

Industrial  
microwave  
for drying,  
cooking and  
heating  
processes.

Holiday microwave  
measuring  
equipment  
for  
workshop  
and laboratory.

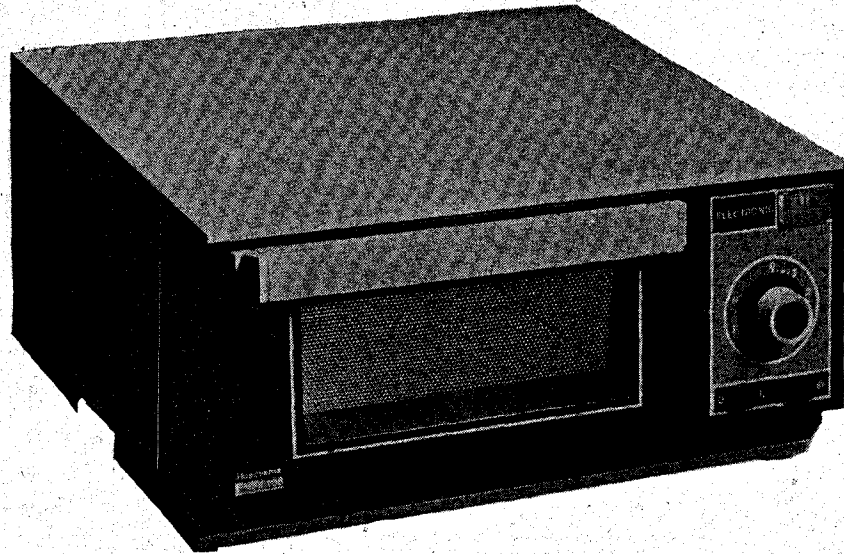

Distributed in Australia by:

**Supaspede Microwave oven Mfg. Co. Pty. Ltd.**

47 GLENVALE CRESCENT, MULGRAVE 3170 Phone: 560-1468

# KOENIG HI-FIDELITY AUDIO SYSTEMS



*For information  
about our range  
of speakers  
contact:*

**KOENIG**  
**AUDIO INDUSTRIES**

15 Rochester Street,  
Botany 2019.  
Telephone: 666 5201  
or your local retailer

We also specialize in building to order all  
type of horn enclosures for stage or domestic use.

# The Acid Test.

"Hey!  
Watch out!  
The needle's right  
over into the red!"

"Relax...  
I'm using a  
**MEMOREX**  
Cassette"

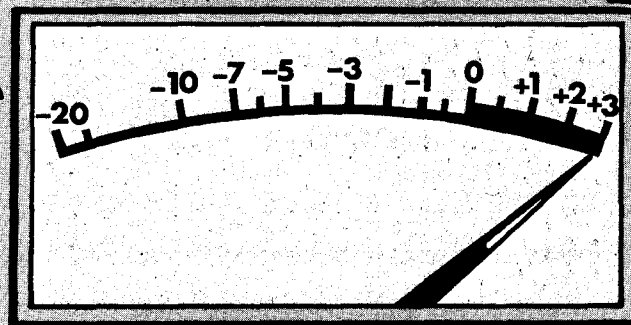

## MEMOREX THE UNDISTORTER!

For the very first time you can forget about overload distortion when you record. Just use 'Memorex' the Undistorter. No hiss, no distortion, no hassle, just beautiful clean clear sound. And Memorex costs only cents more than the cheapies.

You'll never know how good your recorder is until you try 'Memorex' tape.



**Leroya Industries PTY. LTD.**

266 Hay Street, Subiaco, Western Australia 6008.

QLD. BRISBANE AGENCIES  
Audio Centre,  
72 Wickham Street,  
Fortitude Valley, QLD. 4006.

N.S.W. LINEAR SOUND P/L  
639 Pacific Highway,  
Chatswood, N.S.W. 2067.

A.C.T. HOMECRAFTS  
Petrie Street,  
Canberra, A.C.T. 2600.

S.A. HILLS ELECTRONICS P/L  
7 Ackland Street,  
Edwardstown, S.A. 5039.

VIC. B.J.D. ELECTRONICS  
202 Pelham Street,  
Carlton, Vic. 3053.

# **Career Opportunities for COLOUR TECHNICIANS**

Large international marketing organisation with offices in all states invites applications from experienced Television Technicians with some knowledge of colour.

Company specialises in colour television only and is building a large comprehensive national sales and service network.

Opportunities will exist in each capital city but immediate requirement is for cities of Sydney, Melbourne and Brisbane.

For Sydney, workshop technicians will be required to work at area service centres located at Pagewood, Rydalmere and Greenwich.

For Brisbane area location will be Albion, and Melbourne location, Richmond.

Field Technicians will be required to operate from area service centres and will be provided with suitable vehicles.

- Training will be provided.
- Colour work only
- Best salaries in industry.
- Immediate life cover and superannuation after qualifying period.
- Successful applicants will be brought to Sydney for training.
- Within reason candidates may choose location.

For interesting career opportunity apply:

Mr. "Berry" Beresford,  
TRIDENT TELEVISION PTY. LTD.  
152 Bunnerong Road,  
Pagewood 2035. (Phone: 349-8888)

***trident colour  
television*** 

# COUNTING PHOTONS

How to extract ultra-low level signals from a high noise environment.

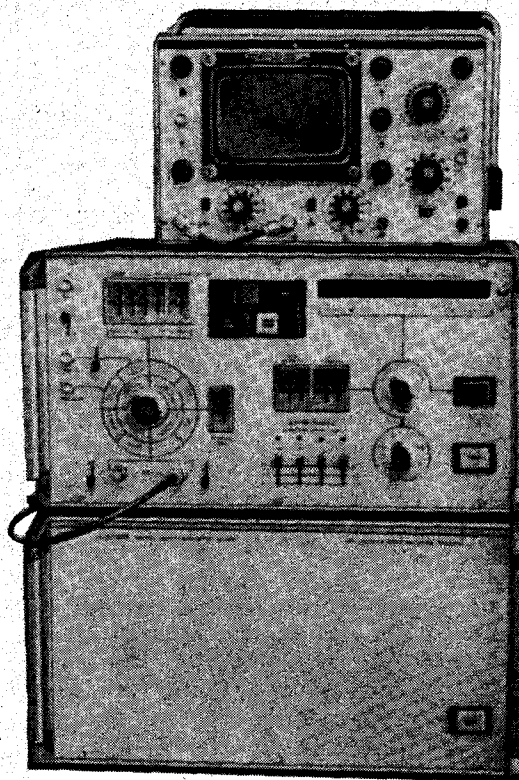
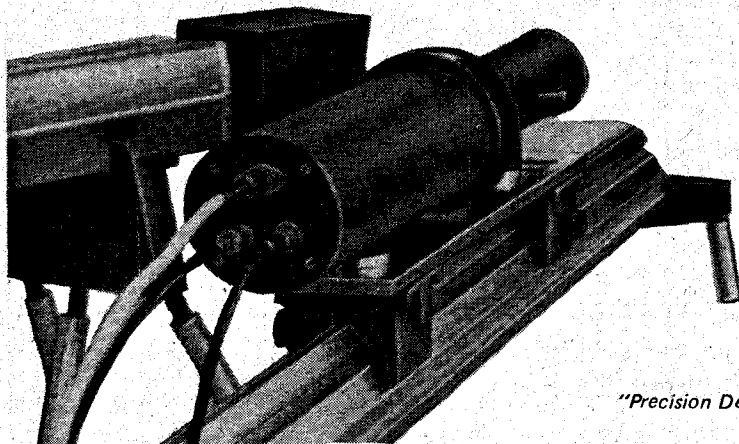

*"Precision Devices" Laser Photon Correlation Anemometer.*

OUR ABILITY to detect signals from any area of interest is largely limited by the extent to which noise signals (those that *look* like the desired signal but which come from unwanted sources) are present in the total output energy from the system being studied.

All practical signals contain noise: signal/noise ratio expresses the relative proportion of each.

When the ratio is much larger than unity little difficulty in detecting the signal is experienced. It is when it falls close to, or below, unity that special techniques must be brought to bear if the signal is to be extracted.

The uninitiated might feel that a signal containing as much noise as signal is close to useless. But it is possible, provided the noise is different in character to the signal in some way, to separate the two. By the use of certain very powerful methods it is possible to recover signals that are only 1/100,000th of the noise level.

An incredible amount of knowledge gained from research studies has been obtained under conditions where the signal/noise (S/N) ratio is extremely poor. Many experiments can be designed to work with large S/N ratios: this is fine if it can be achieved. However, many effects are not under the control of the experimenter, so when natural background swamps the

signal there is no option but to employ advanced detection techniques. Examples include studies of atomic absorption, various forms of spectroscopy, audiometry, bio-medical stimuli response measurement, cochlea microphonics, doppler measurements, electro-luminescence, electron spin resonance, nuclear magnetic resonance, Zeeman effect, laser frequency controllers, Hall-effect probes, photometry, strain gauges, micro-wave studies and many more where signal enhancement is needed if anything useful is to be learned.

A large proportion of these examples are concerned with the measurement of optical radiation levels... those in the radiation band from infrared to ultraviolet. The usually applied methods for detecting the minute radiation signal energies involve looking at analogue properties of the light — the detector produces a continuous form of signal that has an amplitude proportional to the signal.

The most used method is the lock-in technique (also known under numerous other names, such as, phase-sensitive-detection, synchronous detection, coherent detection). In this method the photons collected in the detector (photomultipliers are the most usual form employed in high

sensitivity work) are used to produce a voltage or current that is amplified and processed as an analogue signal entity. A good lock-in amplifier can detect signals as small as 100 pV or, in terms of current, 0.01 pA ( $10^{-14}$  A) which is certainly good but it is not the maximum attainable.

Our dual concepts of light tell us that it can be of a continuous nature or that it comes in discrete pulses of energy, called photons. Photons are fundamental quanta of electromagnetic energy occurring in the visible region of the electromagnetic spectrum. In the shorter wavelength region we have the nuclear particles that are handled as pulses for this range, pulse counting methods are used instead of analogue procedures.

It is not so surprising, therefore, to see the same approach to the problem has also been applied to light, considering it as photons. It is a relatively new concept in practice having its commercial origins about seven years ago when the methods were developed for chemical analyses.

Today several manufacturers offer equipment for detecting extremely low-light-levels that are buried in noise by the use of the digital photon counting method.



## DIGITAL BETTER THAN ANALOGUE

The analogue lock-in methods of signal recovery, although good, are not as powerful as a well designed photon counter arrangement. Firstly, practical lock-ins cannot achieve the same degree of improvement in S/N ratio at very low light levels with a subsequent reduction in overall sensitivity. Secondly, analogue systems are prone to gain changes as the components drift in value with time. Digital counting is far less affected by gain changes, for signal amplitudes are not critical in digital circuitry. Thirdly, detector characteristics are time-dependent because of such things as leakage current variation, applied voltage variations, dimensional and chemical changes which, being analogue in nature, produce drift. If the detector can be used to detect signals that are digital at their source, these drift effects are greatly reduced.

Another important factor is that sophisticated signal processing systems nearly always incorporate digital computing machines, so signals already in a digital form are to be preferred as the need for an analogue to digital converter is avoided.

## PRACTICAL CONSIDERATIONS OF DIGITAL LIGHT INTENSITY DETECTION

The energy of a photon is given by  $hc/\lambda$  where  $h$  (Planck's constant) and  $c$  (the velocity of light) are constant. This means that the pulse height of photons formed by visible radiation (and near to it) will have energy levels that are much the same. This fact is used to effect in noise reduction as we will soon see.

Each quantum of light landing on the detector should ideally produce a well-shaped pulse ready for counting. Furthermore the ideal detector should not generate pulses of its own, for these would appear as signal resulting in misleading answers. Photomultipliers are usually used; they come closest to the ideal, and have internal gain of around 1 000 000 with very little addition of noise.

In practice, as the system is made more sensitive, the signal will be found to contain stray noise generated in the signal background. It has been established that only some 6.15% of photons are detected in the photomultiplier and that it too generates noise pulses internally. These pulses arise from secondary emission on the dynodes, electron emission from the photo-cathode, and from emissions caused by external radiations fluxing through the photomultiplier. On top of these noise problems there is an unpredictable

surface leakage current. A photomultiplier typically generates a background noise count of 10-100 per second from these sources.

## SEPARATING NOISE PULSES FROM SIGNAL PULSES

The analogue lock-in method derives its signal extraction capability by limiting the bandwidth of the signal to very narrow limits, thus reducing the noise energy which is usually wide-band white noise. As the signal energy is all contained in the same narrow bandwidth the signal power remains unaltered but the noise power is reduced. The net result is a dramatic improvement in the S/N ratio. As the improvement is proportional to bandwidth, the longer the response time allowed, the better the signal enhancement.

In pulse counting a somewhat similar procedure is used by distinguishing between pulses of different height. It has been established that the signal pulses have amplitudes lying within well defined limits (the energy equation tells us this) and that the noise pulses (discussed above) have heights ranging from small to large with a uniform distribution of amplitude.

The principle used, therefore, to reduce the noise level of a pulse count is to accept only those pulses that lie within two defined levels of amplitude. Those that lie above the level are not counted and neither are those that lie below the lower level. The amplitude range wherein pulses are accepted is called the window; see Fig.1. By this means some, but not all, noise pulses are ignored, thus raising the signal to noise ratio. Noise pulses in the window are, of course, accepted as signal.

Another advantage of the window scheme is that the system is more tolerant of detector gain changes — for the following reason. A gain change effectively raises or lowers the position of the discrimination window but does not alter its width by much. Signals now accepted in the new area at the top of a raised window are balanced out by roughly equal losses in the area lost below. Provided the window

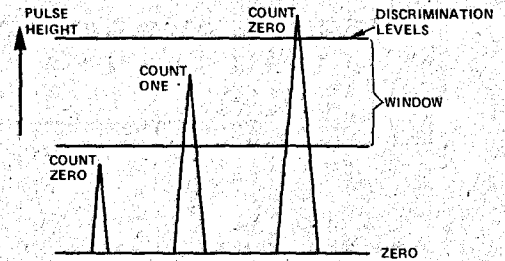

Fig.1. Pulses with height lying inside the two discrimination levels are accepted for counting. The central area is known as the window.

width and mean height is chosen intelligently to suit the energy of the signals to be detected, this method is not affected much by gain changes. A similar argument applies for drift in the dc level of the detector output. In sharp contrast, the equivalent analogue method suffers directly from gain changes and drift.

## THE BASIC PHOTON COUNTER SYSTEM

The block diagram of the basic photon counting arrangement is shown in Fig.2.

The detector is coupled to the experiment with the known stray influencing effects screened out as well as possible. As the pulses from the photomultiplier are still very small in amplitude (maybe only microvolts), a low noise, very fast (1 ns rise time is used) preamplifier is needed to raise the signal to a reasonable level ready for acceptance by the discriminator. This stage has adjustable discriminator levels that form the window needed for the particular experiment concerned. After discrimination the remaining pulses are fed to the counter unit. The output of the counter can be displayed, fed to data storage, used to control a process or sent for further processing to provide information such as photon rate.

Typical count rates provided in commercial equipments, such as that shown in Fig.3, range from less than 1 per second to  $10^8$  per second using interval times from 1  $\mu$  to 1000 s.

As the signals are digital rather than analogue, the dc drift of the detector

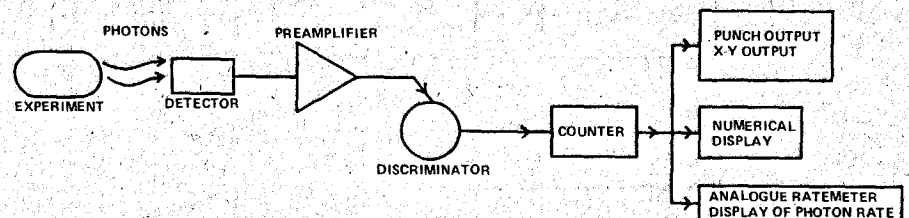

Fig.2. Basic block diagram of a photon counting system.

# COUNTING PHOTONS

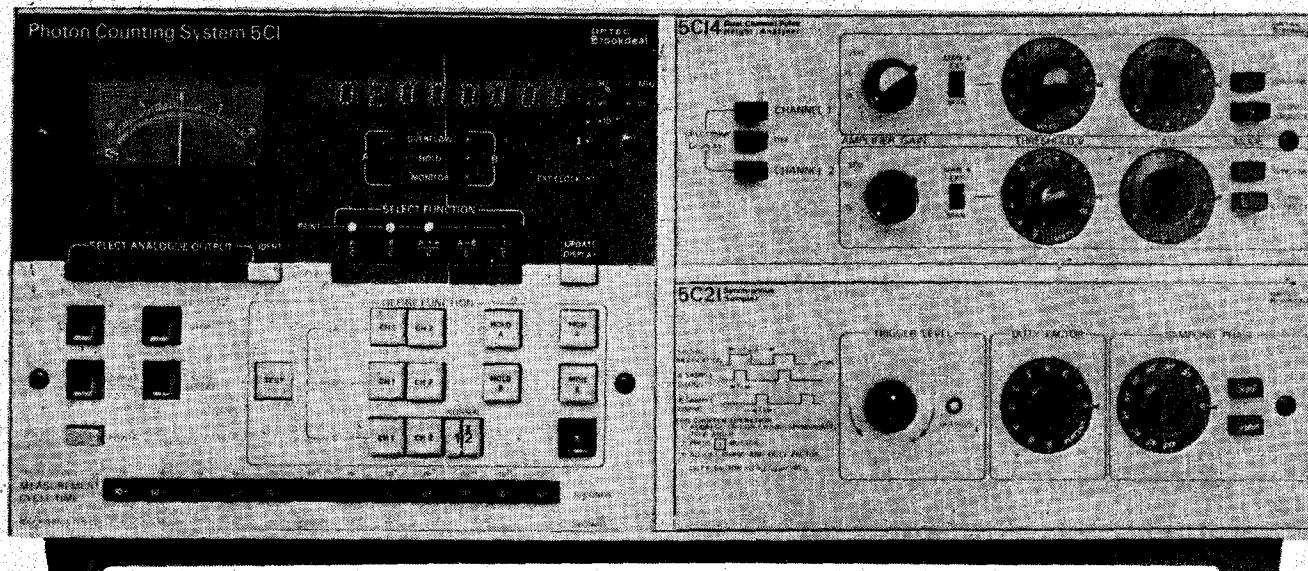

Fig.3. Front Panel of Brookdeal Photon Counting System 5C1.

with time does not impose a duration limit on the counting period. Very large intervals of counting can be used to improve the accuracy of the data by taking more counts.

## IMPROVEMENTS TO THE BASIC SYSTEM

Several interesting improvements can be incorporated to improve the signal detection sensitivity. Let us look at these.

**Compensating for light source variations** — The number of photon pulses produced at the detector output is proportional to the intensity of the source illuminating the experimental area. Fluctuations in intensity will, therefore, alter the output, introducing error. As this source of error is systematic (we know where it is produced and how) it is feasible to monitor it and make corrections.

Figure 4 shows how this is achieved in the photon counter of Brookdeal. A second photodetector is set up to see the same source as is used to illuminate the experiment. This

monitoring detector needs to have the same type of cathode but its gain does not have to be matched with that of the main detector. The Brookdeal system uses a second monitoring counter that is arranged as a preset count-level indicator. Both counters are cleared together, and counting begins. When the monitor count reaches its preset level it is used to inhibit counting in the main store. As the monitor counter fills each time for a given number of photon pulses, the value in the other counter must be the signal counts compensated for variation in the illuminating intensity.

**Digital lock-in** — The window concept can eliminate noise pulses that are unlike signal pulses on the criteria of amplitude, but it is unable to discriminate against those that look like signal.

If the light signal is chopped just before it enters the detector (a rotating blade is used) the detector firstly sees signal-plus-noise photons and then only noise photons, for the signal is screened from it. The signal

still contains some noise . . . that from the strays in the experiment background . . . but the method does reduce the noise contributed by the detector and strays entering its target.

Two counters are used to store the pulses produced, firstly with the chopper obscuring the beam, and then with the chopper open, the two being synchronised. The difference between the two count totals at any time is the signal count. Care has to be exercised with the starting and stopping times as these affect the accuracy of the procedure.

As the noise is random in nature it can be shown statistically that the effect of noise is reduced as the square-root of the number of counts taken. Hence, the longer the integration time the better the result and with photon counting this is not restricted by drift in the detector.

## APPLICATIONS OF PHOTON COUNTING TO ANEMOMETRY

The flow of fluids can be studied at the microscopic level with laser

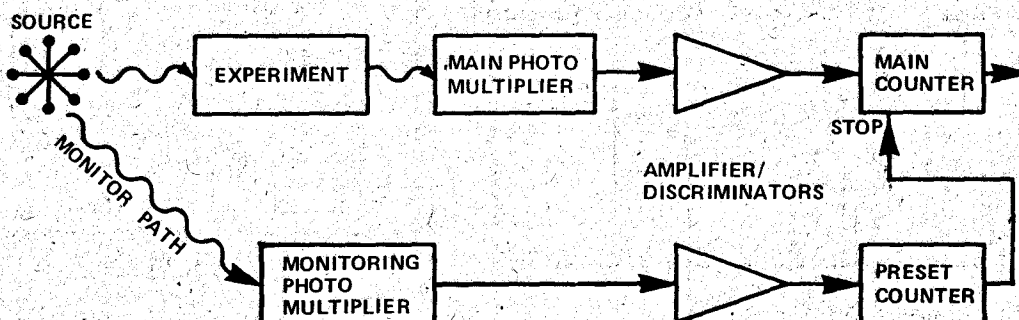

Fig.4. A second photo-multiplier is used to monitor the intensity.

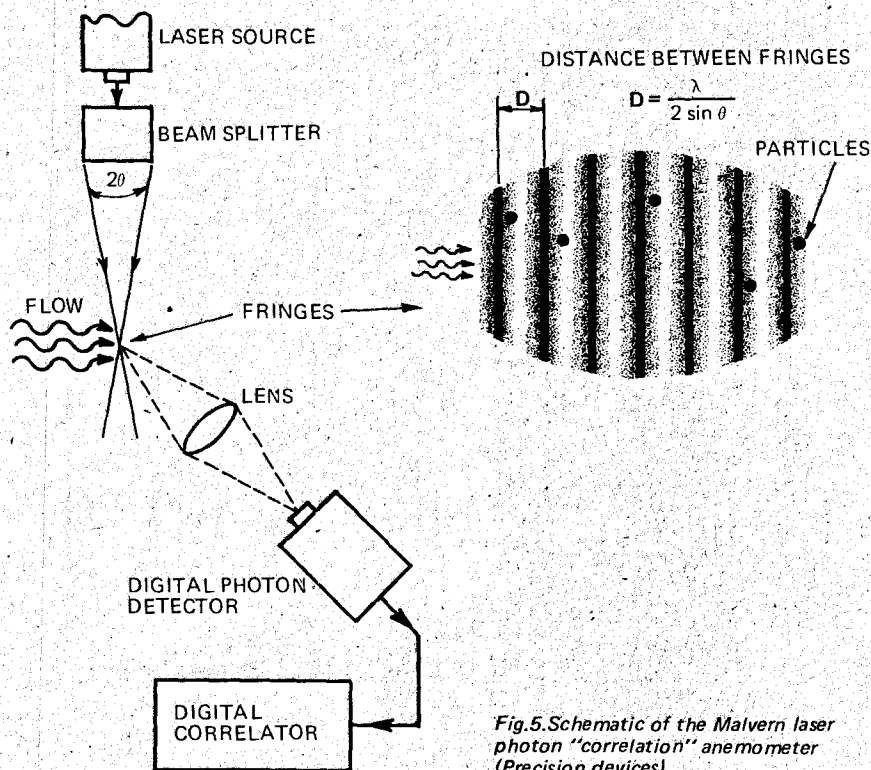

Fig.5. Schematic of the Malvern laser photon "correlation" anemometer (Precision devices).

doppler velocimeters (see E.T.I. Aug. 1972). These use a laser source to produce brief bursts of signal of only a few cycles long from the scattering particles moving with the fluid flow. The frequency of these bursts is related to the flow rate by virtue of the doppler effect.

A limitation to this method is that there is often need to add artificial scattering particles in order to gain a reasonable signal level for processing. Seeding is done with aluminium oxide, smoke particles or diesel fuel, but in many instances this is not feasible.

Since the E.T.I. article was published there have been many improvements and a number of alternative equipments operating on this principle are now marketed. The need to seed still exists however.

One method now available can measure velocity without seeding. It uses laser radiation but processes the signals by correlation rather than with the period measurements adopted in the earlier types.

Referring to Fig.5, the two laser beams converge to produce a fringe

pattern in the flow under study. This pattern is viewed by a photon detector like those described above. Particles passing through the fringe-field scatter light to the detector with a signal strength that is greatest when the particles are passing the bright part of the fringe and lowest when in the dark part. In effect it appears as though the particles are bunched into the bright parts of the fringes.

The signal coming from the detector contains these scattered signals, but it is swamped by the general background level, so the whole must be processed in some way to extract the wanted information. This system does not need seeded particles for it can obtain a sufficient return from the microscopic structure of the fluid by virtue of the greatly enhanced sensitivity of the photon detector stage.

The key to enhancement is to use correlation methods to extract the time taken for a particle to traverse a cycle of the fringe. Flashes of light caused by the scattering particles in the flow result in pulse train bursts

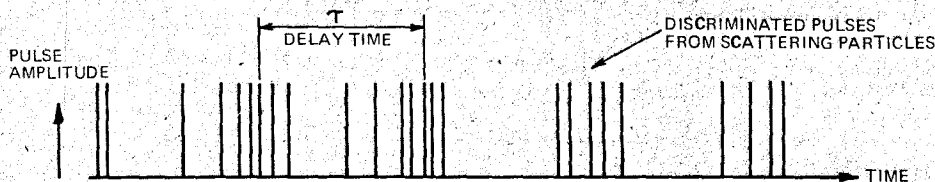

Fig.6. Pulse-time graph of light flashes in the noise could be removed.

that have a periodicity related to flow rate. Figure 6 shows what these pulses would look like if the noise could be removed. With the noise added, the plot becomes a mass of pulses. If a section of this plot is recorded and multiplied with many different time-delayed versions of the same train, the plot of this correlated output looks like that shown in Fig.7. The period of the cosine wave produced by the correlator is the time taken for a particle to pass across a fringe pitch. Knowing the geometry of the fringe it is then possible to produce an output that is the velocity of the fluid.

In condition of turbulence, the correlogram takes the form shown in Fig. 8, looking like a damped oscillation. The envelope of the decay is a measure of the intensity of turbulence as is shown by the equation given in Fig.8. The complete system is shown in Fig.3.

This system is, however, unable to yield information about the direction of flow as the correlation procedure takes no account of which way the particles are going. If bi-directional flow exists the answer produced will be in error. This disadvantage can be overcome by addition of some more elements into the design.

The fringes, that are normally stationary, are modulated with electro-optic crystals, as shown in Fig. 9. This causes the fringe pattern to move from side to side with a small amplitude about the mean position. If the fringes are moving in the same direction as the flow the correlogram period is lengthened as shown in Fig.1; the opposite effect occurs if the fringe is made to move against the flow.

This information can be used to give

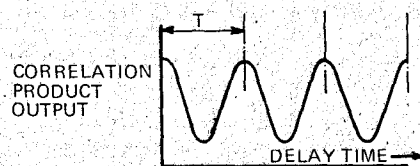

Fig.7. Correlator output for laminar uni-directional flow.

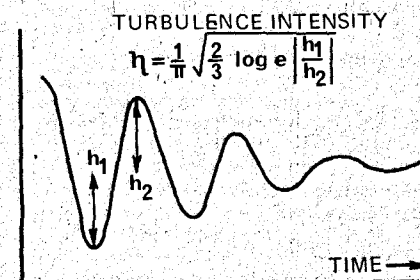

Fig.8. Turbulence produces correlator signals that enable the degree of turbulence to be estimated from the damping.

# The AKAI Professionals

No compromises accepted



The better a tape recorder works, the nearer it gets to giving you back on tape what you fed in.

Some tape recorders give you back sounds that only resemble what you fed in. There are things missing, like brilliance, depth and presence. There are things added, like wow and flutter, distortion, tape hiss and amplifier hum.

And that's not what you put in. Certainly not what you wanted back. This kind of tape recorder is plain dishonest.

AKAI make honest tape recorders. They give you back on tape what you fed in. Nothing more. Nothing less.

How does AKAI guarantee such honest sound? Through state of the art innovations like:

#### The GX head system.

Single crystal ferrite cores made in a high temperature furnace and set in glass. Glass cut so smooth by a jeweller that no composite particle can ever separate and cause head gap damage. Perfect head to tape contact and AKAI's exclusive focused field provide: improved sensitivity, no sound dropout and performance that always stays new.

#### Professional three motor drive.

A unique inner rotor AC servo capstan motor enables voltage input to be stabilised. Resulting in constant

perfectly controlled tape speed. External hum is also eliminated.

Two 6 pole eddy-current inner rotor reel drive motors prevents vibration. Tape travel becomes smooth. Constant tape tension is maintained so that tape stretch becomes a thing of the past.

Result: AKAI tape transport is second to none.

#### The complete protection plan.

There is also an honest 12 months parts and labour warranty on all AKAI equipment. And an honest 12 months free insurance. And a very real lifetime guarantee on every AKAI GX Head. It's all put there by AKAI to give you back on tape what you put in.

Nothing more — nothing less.

For optimum performance from your recorder we recommend BASF tape.

Available from the AKAI Hi-Fi Professionals. Distributed by AKAI Australia Pty. Ltd., Sydney 61 9881, Melbourne 81 0574, Brisbane 44 0171, Adelaide, 74 1162, Perth 25 5177, Darwin 81 3801, Launceston 31 5815.

# AKAI

The very real sound experience

#### GX-600 SERIES

Available in 4 track 2 channel, with or without Dolby and in 2 track 2 channel.

Reel Capacity: Up to 10½" reel

Tape Speed: 15 and 7½ ips (±0.8%) (Pro model)

Wow & Flutter: Less than 0.05% RMS at 15 ips

Less than 0.07% RMS at 7½ ips

Frequency Response: 30 Hz to 25,000 Hz (±3 dB) at

15 ips

30 Hz to 23,000 Hz (±3 dB) at

7½ ips

Distortion: Less than 0.7% (1,000 Hz "0" VU)

Signal to Noise Ratio: Better than 59 dB

Erase Ratio: Better than 70 dB

Cross-Talk: Better than 60 dB (monaural)

Better than 40 dB (stereo)

Bias Frequency: 150 kHz

Heads (3): One GX 2 track recording head,

One GX 2 track playback head,

One 2 track erase head.

#### GX-400 SERIES

Available in 4 track 4 channel, 4 track 2 channel and

2 track 2 channel.

Reel Capacity: Up to 10½" reel

Tape Speed: 15, 7½ and 3¾ ips (±0.5%)

Wow & Flutter: Less than 0.35% RMS at 15 ips

Less than 0.05% RMS at 7½ ips

Less than 0.08% RMS at 3¾ ips

Equalization: NAB curve

Frequency Response: Using low noise tape

30 Hz to 27,000 Hz (±2 dB) zero

VU/15 ips

Distortion: Less than 1% (total harmonic distortion

1,000 Hz zero VU)

Signal-To-Noise Ratio: Better than 58 dB

Erase Ratio: Better than 70 dB

Cross-Talk: Better than 45 dB

Recording Bias Frequency: 160 kHz (±10 kHz)

Heads (4): 2-track recording GX head, 2-track playback

GX head, 4-track playback GX head, full

track erase head.

PKB70506

# The AKAI Hi-Fi Professionals have the deal for you.

To be an AKAI Hi Fi Professional, you must first become an expert on hi fi. Then you must become an expert on AKAI. So that the full potential of AKAI equipment can be passed on to its owner. Expertly. Or as we say, professionally. The AKAI Hi-Fi Professionals are:

## NEW SOUTH WALES

**Allied Hi-Fi & Records**, 330 Pacific Highway, Crows Nest. Tel 439 1072; 331 Princes Highway, St. Peters. Tel 51 7071; Cnr. Townshend & Botany Sts., Phillip. A.C.T. Tel 82 1862; 122 Bunda St., Civic, Canberra City. A.C.T. Tel 48 8785. **Apollo Hi-Fi**, 283 Victoria Road, Marrickville. Tel 560 9019. **Autel Systems Pty. Ltd.**, 639 Pacific Highway, Chatswood. Tel 412 4377. **Ron Chapman & Associates**, 880 Hunter Street, Newcastle. Tel 69 2796. **Fidela Sound Centre**, 93B Liverpool Road, Summer Hill. Tel 799 2618. **Gosford Hi-Fi**, 163 Mann Street, Gosford. Tel 25 2222. **Douglas Hi-Fi**, 65 Parramatta Road, Fivedock. Tel 798 4533. 55 Wollongong Street, Fyshwick, A.C.T. Tel 95 3459. **Hi-Fi House**, 118 Keira Street, Wollongong Tel 28 6661; 127 Forest Road, Hurstville. Tel 579 4673. **Magnetic Sound Industries**, 20 Macquarie Street, Parramatta: Tel 635 0830; 32 York Street, Sydney. Tel 29 3371. **Miranda Stereo & Hi-Fi Centre Pty. Ltd.**, Shop 67, Top Level, Miranda Fair. Tel 525 7800. **Masterstone Electronics**, 824 Pittwater Road, Dee Why. Tel 982 5749. **Norman Ross Discounts**, 69-73 Magellan Street, Lismore. Tel 21 2245. **Photo Art & Sound**, 287 Military Road, Cremorne. Tel 909 1729. **Pee Jay Sound Centre**, 364 Argent Street, Broken Hill. Tel 7303. **Roselands Hi-Fi**, Gallery Level, Roselands. Tel 750 6593. **Selsound Hi-Fi Pty Ltd.**, 619 Princes Highway, Blakehurst. Tel 546 7462; 27 Darcy Street Parramatta. Tel 635 9491. **Sonarta Music Services**, 24 Cabarita Ave., Cabarita. Tel 736 2066. **Jack Stein Audio Pty. Ltd.**, 275 Clarence Street, Sydney. Tel 29 6315. **Strand Electronics**, 519 Hunter Street, Newcastle. Tel 2 5623. **Sutherland Hi-Fi**, 5 Boyle Street, Sutherland. Tel 521 6926. **Warringah Hi-Fi**, Shop 5, Mona Vale Crt. Bungen St., Mona Vale. Tel 997 5313. **Duty Free Travellers Suppliers Ltd.**, 400 Kent Street Sydney. Tel 290 1644.

## VICTORIA

**Douglas Hi-Fi**, 191 Bourke St., Melbourne. Tel 63 9321.

## QUEENSLAND

**Chandlers Pty. Ltd.**, 120 Edward Street, Brisbane. Tel 29 1954, and all other Chandlers Stores from Tweed Heads to Cairns. **Trevor Stokes**, Scarborough Street, Southport. Tel 32 2886. **The Sound Centre**, West Street, Mt. Isa. Tel 43 3096. **Tel Air Electronics**, George Street, Brisbane. Tel 21 7272. **Mandrix Pty. Ltd.**, 107 Breakfast Creek Road, Newstead. Tel 52 4355. **Packard - Bell Pty. Ltd.**, 302 Wickham Street, Fortitude Valley. Tel 52 3131. **Woolworths (Qld) Ltd.**, Brisbane Station Road, Booval. Tel 81 5611; 345 Flinders Street, Townsville. Tel 71 3171. **Catchpoles Cassette Centre**, T & G Arcade, Ruthven Street, Toowoomba. Tel 32 8382. **Mumphrey's Hi-Fi Centre**, Ruthven Street, Toowoomba. Tel 32 8288. **David Jones Pty. Ltd.**, Sydney Street, Mackay. Tel 57 2501.

## SOUTH AUSTRALIA

**Flinders Trading Co. Pty. Ltd.**, 55 Flinders Street, Adelaide. Tel 223 5655. **Metrovision T.V. Rentals Pty. Ltd.**, 9-11 Beulah Road, Norwood. Tel 42 2283. **Sunstrom's Radio**, 157 Port Road, Brompton. Tel 46 4076. **Ernamith's**, 52 King William Street, Adelaide. Tel 51 6351.

## WESTERN AUSTRALIA

**Douglas Hi-Fi**, 883 Wellington St., Perth. Tel 22 5177.

## TASMANIA

**Wills & Co. (1954) Pty. Ltd.**, 7-11 Quadrant, Launceston. Tel 31 5688. **James Loughran & Sons Pty. Ltd.**, 29-31 Wilmut St., Burnie. Tel 211 533. **Gillards Music Centre**, 57A Reiby St., Ulverstone. Tel 25 2777. **Quantum Electronics Pty. Ltd.**, 181 Collins Street, Hobart. Tel 28 1893. **Tasman Acoustics Pty. Ltd.**, 62 Tamar St., Launceston. Tel 31 2526.

## NORTHERN TERRITORY

**Pfitzners Music House**, Smith St., Darwin. Tel 81 3801

\*Recommended selling price

PKB 70521

# COUNTING PHOTONS

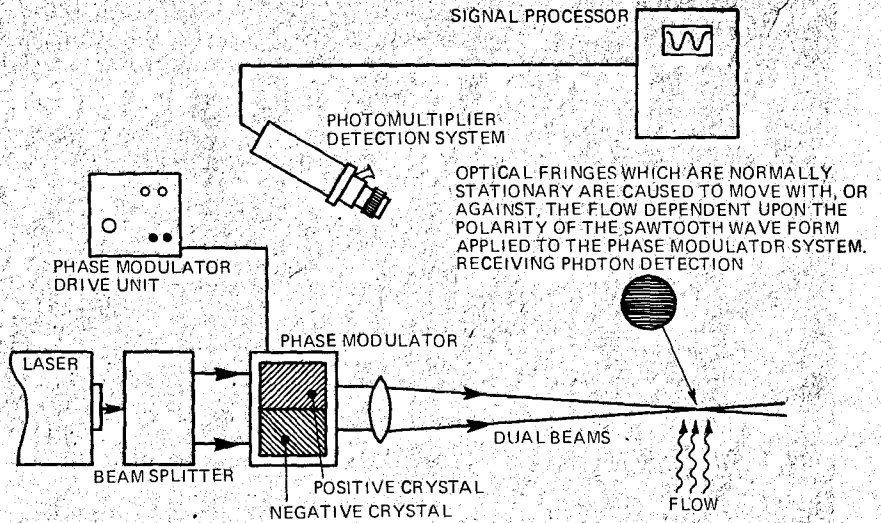

Fig.9. Addition of fringe modulation enables the direction of flow to be ascertained.

a measure of flow direction and being continuous in nature can be used to close the loop in a servo that controls the fluid flow rate, as is illustrated in the scheme proposed by Precision Devices — shown in Fig. 11.

It is interesting to see how correlator units have become accepted instruments that are added to systems

as dedicated units. It was not so long ago that they were regarded as highly sophisticated research tools that took many a long day to build. No doubt we will soon see correlators produced on large-scale integrated chips that are wired into circuits in the same casual way that we use integrated amplifiers today.

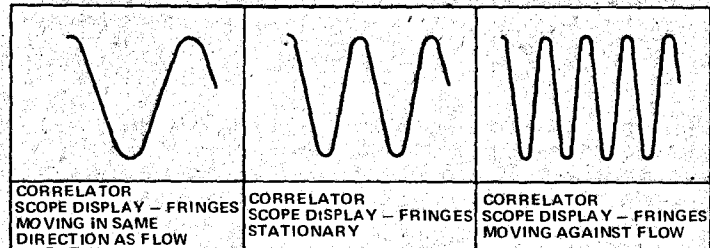

Fig.10. Effect of fringe movement on the correllogram.

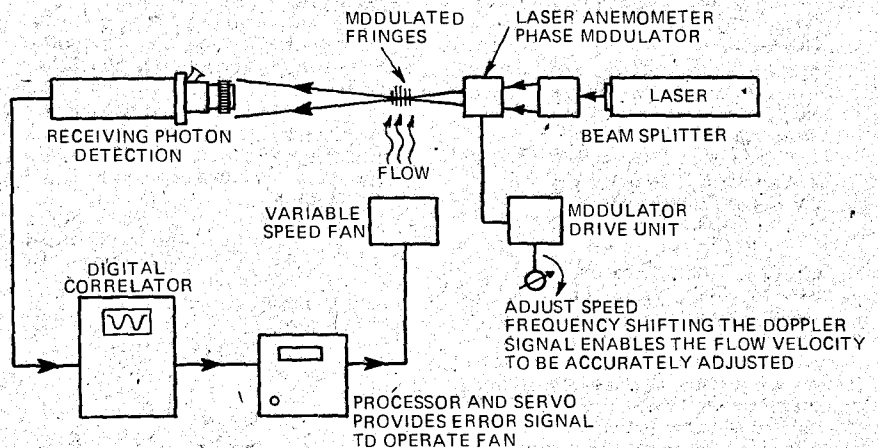
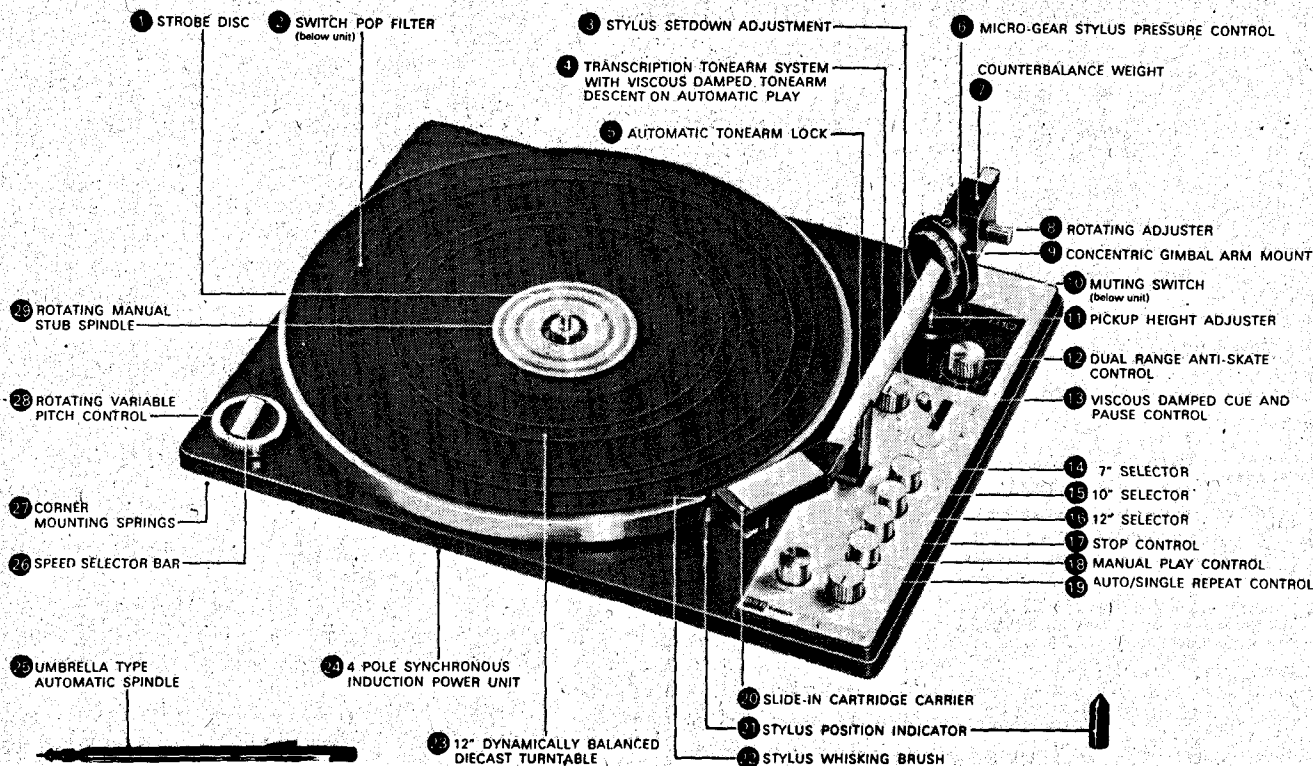

Fig.11. Use of the correlation anemometer to gain control of fluid flow rate.

“Taking it all together — performance, features, styling — the BSR 810 moves into ranking place among the best automatics we know of. And at its price, the others may well be in for a real contest.” Hi-Fidelity Magazine, May 1972.



# The brilliant BSR/810 transcription turntable is hardly cheap. But your ears will tell you it's a bargain.

BSR, manufacturers of most of the world's turntables, have now turned the tables on expensive units.

And here are the features that make the 810 such an attractive proposition: the unit weighs 17 lbs — the diecast turntable alone is a solid, dynamically balanced 7½ lbs. A 4-pole beautifully balanced synchronous motor automatically compensates for any fluctuation in voltage input, or for any record load. A pitch control gives absolute accuracy of speed, utilising a stroboscopic centre plate.

The low mass pick-up arm gyroscopically pivots in a concentric gimbal mount producing virtually friction free movement in both horizontal and vertical planes. It also has a slide-in cartridge carrier, decoupled one piece counterbalance for a minimum tracking pressure of ½ gramme with suitable cartridge. And the arm length is over 8½ inches to reduce tracking

error to less than 0.5" per inch.

Viscous cueing is also standard on automatic as well as manual operation, and a unique anti-skate device is also featured for elliptical and standard styli. Speeds are 33½ rpm and 45 rpm. (Which are all you need today.)

Single to automatic play conversion is achieved with the interchangeable umbrella centre spindle.

Start-stop, record size control and auto repeat and manual conversion are actuated by push button controls set in a handsome brushed aluminium panel.

Of course there is much more you'll want to know about the BSR 810. Write to BSR and we'll send you a colour brochure.

BSR (A/asia) Pty. Limited.  
Anne St., St. Marys. 2760  
TELEGRAMS "BSR" St. Marys. 2760  
TELEX 23159 PHONE 623 0375

**BSR McDONALD**  
**810**

BSR:117F3

# DON'T DELAY...TIME LINE IS NOW!

The time has come when digital delay for both the recording studio and sound contractor is no longer a luxury but a necessity. Pandora Systems has developed a unit which fulfills the needs of both, and has flexibility and technical excellence that surpasses any comparable device available on the market today.

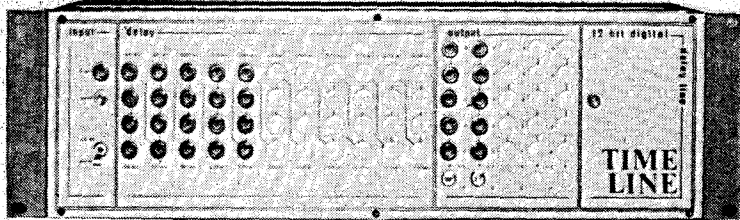

High resolution 12 bit digital encoding produces a full 72 dB dynamic range naturally, making the use of signal altering noise reduction unnecessary. Coupled with less than .1% distortion (measured at full output 400 Hz) the Time Line literally is a black box that generates time delays without any alteration to the signal.

By using modular construction the unit can be expanded at any time. The main frame holds 449 ms. of delay and 5 outputs. Inter-connecting frames are available for longer delays.

Delay times are variable in 1 ms. steps by simple front panel patching or internal strapping for permanent installations.

Tie this all together with the lowest basic price in the industry, the Time Line becomes the ultimate time machine. Pricing starts at \$2,500.

Manufactured by **PANDORA** NASHVILLE TENN.

## LM-401 UNIVERSAL LIMITER

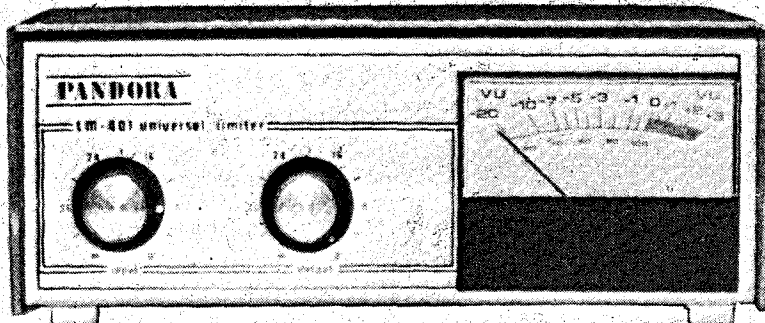

The LM 401 UNIVERSAL LIMITER is a state of the art F.E.T. type compressor designed and packaged to interface with any recording equipment. Specifically the High-Z, low level machines and consoles so prevalent today.

Operation is simple and virtually "goof-proof", in that all time constants and ratios are internally pre-set to those values generally accepted in the industry to be the most musical and desirable. Only the input and output level controls

are available to the user, preventing improper operation by untrained personnel. Internal line operated power supply and rugged attractive housing allow the LM 401 UNIVERSAL LIMITER to be placed anywhere and used with virtually any system.

# NEW!

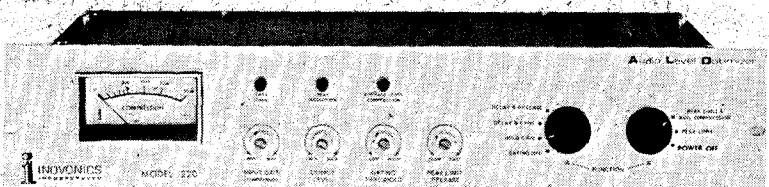

## AUDIO LEVEL OPTIMISER FOR AM, FM, TV gives you —

PROTECTION FROM PEAKS  
HIGHER AVERAGE PROGRAM LEVEL  
GATED TO ELIMINATE AUDIBLE EFFECTS

- Selectable peak limiting and average compression functions
- Fast peak limiting — no clipping
- Gated operation with Gain Hold, Hold and Release, Hold and Fade functions
- Adjustable limiting symmetry for full carrier modulation
- Built-in Frequency Selective Limiter for FM and TV optional for \$25.

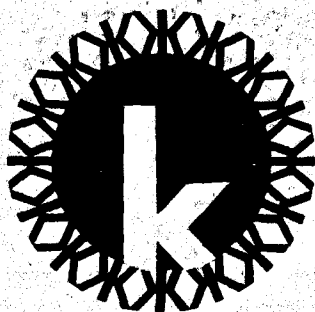

*Klarion Enterprises Proprietary Limited*

REGENT HOUSE, 63 KINGSWAY, SOUTH MELBOURNE, 3205. AUSTRALIA.  
PHONE 61-3801 CABLES KLARIONMELB

# BURGLAR ALARMS

## DO-IT-YOURSELF AND SAVE!

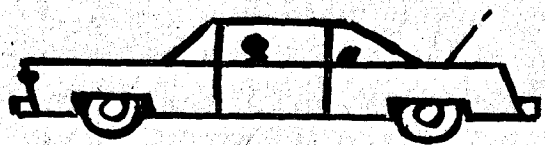
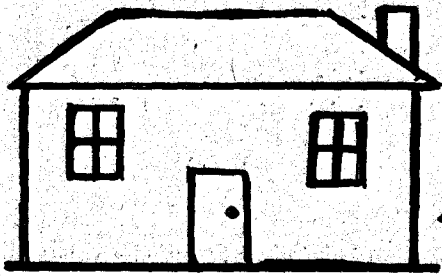

### XL250 BURGLAR/INTRUDER/FIRE ALARM

- Complete kit ready to install
- Additional sensors, alarm accessories may be added any time to meet future needs
- Fully automatic operation, simple to operate
- Protects the family against burglars, intruders and fires (with optional sensors)
- Do-it-Yourself Installers Handbook included

The XL250 SECURITY SYSTEM offers the kind of professional protection you have been looking for at realistic prices. The "heart" of the system is the XL250 control module which uses custom designed CMOS technology to achieve the high reliability and low current drain essential for security systems. The XL250 can accept any sensor (open or closed circuit) and triggers instantly. A special feature is the programmable delay unit which can be added to the designated exit door to provide automatic exit/entry so the alarm can be set from within the house. The output of the alarm is an ear piercing electronic siren which automatically resets after about 10 minutes.

THE XL250 SYSTEM INCLUDES control console disguised as a loudspeaker box fitted with a key operated master switch with 2 keys, 5W horn loudspeaker (indoor/outdoor type), magnetic door/window switches, emergency push button, 100' hookup wire and security handbook. Operates on a standard 12 volt lantern battery.

12 months manufacturer's warranty: \$66.00 incl. post and packaging.

### ALARM ACCESSORIES

- |         |   |         |
|---------|---|---------|
| • SD-10 | Magnetic switch (for doors/windows)                                   | \$ 1.80 |
| • SD-20 | Emergency tamper push button  | \$ 1.50 |
| • SD-40 | Ultra Thin Pressure mat 55 cm x 85 cm (for under carpets, rugs, etc). | \$11.25 |
| • SD-50 | Foil Tape/Terminal kit (for protecting plate glass)                   | \$ 4.25 |
| • HU-30 | Fire Detector (ceiling mounted)                                       | \$ 8.75 |
| • AS-60 | 5 Watt reflex horn loudspeaker (for external siren etc.)              | \$11.25 |
| • CA-20 | Flashing Red Light Module (very effective with car alarm system)      | \$ 8.75 |
| • XL250 | Home alarm module only (complete with instructions)                   | \$18.75 |

PHONE ENQUIRIES: (02) 412-1328

OFFICE HOURS: 9-5 Mon-Fri, 9-12 Sat.

### RB200 CAR BURGLAR ALARM

- Complete kit ready to install
- Operates on patented "current sensor" principle (not the unreliable vibrator type)
- Only 3 wires to connect, no special switches required.

The CARGARD RB200 is the latest development of the popular 100HR system. The RB200 module includes the same patented current sensing circuit which senses any disturbance in the vehicle's electrical system and eliminates the need to fit special switches to doors etc. An automatic exit/entry delay is built in which eliminates the need for fitting an external key switch in the car's bodywork. The output of the alarm is a pulsating horn blast (1 second on/1 second off) which automatically resets after 3 minutes. An optional RED LIGHT module (CA-20) is available and when mounted on the vehicle's dashboard becomes a powerful burglar deterrent.

The RB200 SYSTEM INCLUDES RB200 alarm module, highly efficient electrical horn, on/off switch, wiring connectors, mounting hardware, 2 CARGARD warning decals and full step-by-step installation instructions.

12 months manufacturer's warranty: \$37.50 incl. post and packaging.



1ST FLOOR,  
25 SPRING STREET,  
CHATSWOOD,  
N.S.W. 2067  
Phone: 412-1328

PLEASE PRINT CLEARLY

NAME .....

ADDRESS .....

Post Code .....

PLEASE SEND ME: XL250 HOME ALARM FOR \$66.00   
RB200 CAR ALARM FOR \$37.50

ACCESSORIES: .....

Enclosed is my cheque, postal note, money order for \$..... I understand that the goods are covered by a 12 months warranty and a money back guarantee applies if I am not completely satisfied within 14 days of purchase.



MODEL  
SR870

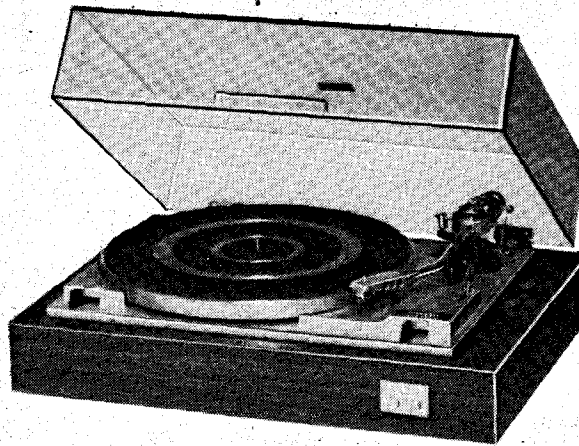

MODEL  
SR300C

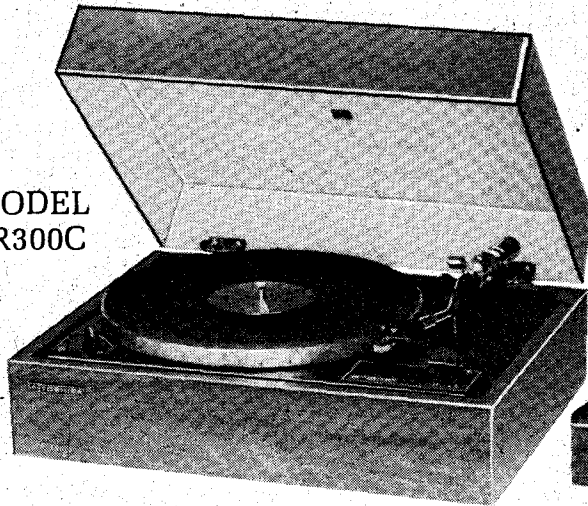

MODEL  
SR510

# For the record

You will do better at your local Toshiba dealer.

 **TOSHIBA**  
In Touch with Tomorrow

Distributed throughout Australia by  E.M.I. (AUSTRALIA) LIMITED.

T 103 4M



'One step nearer perfection'

# PIONEER PL51 Direct Drive Turntable

**MEASURED PERFORMANCE  
PIONEER PL51 TURNTABLE WITH PIONEER PC50 CARTRIDGE  
SERIAL NO: TD13043**

Frequency Response:	20 Hz to 20 kHz $\begin{matrix} +1 \text{ dB} \\ -3 \end{matrix}$
Channel Separation at 1 kHz:	33 dB
Channel Difference:	0.3 dB
Sensitivity re 1 kHz at 5 cm/sec:	2.3 mV
Speed Accuracy:	accurately variable $\pm 4\%$
Hum & Rumble:	$-50$ dB A-weighted
Wow & Flutter:	0.08% rms
Tone Arm Resonance:	7.5 Hz (see graph)
Dimensions:	48 x 41 x 18.5 cm
Weight:	11 kg

OVER THE YEARS there have been three basic systems for powering the ubiquitous turntable. All are supposed to meet and provide six primary parameters:

- (i) They must revolve at a specified constant rotational speed.
- (ii) The speed should remain constant even when the power supply from the mains varies.
- (iii) They should operate without introducing vibration which can be detected by the record player cartridge (and even magnified to produce secondary problems).
- (iv) They should have sufficient torque to overcome changes in the load with the tone arm at various positions on the record, and be able to bring the record player turntable up to speed in a minimum time.
- (v) The motor should not produce a magnetic field which could induce hum into the pick-up system.
- (vi) The units should be able to

operate for many hours, if not years, without serious deterioration.

Two types of motors have been used for this purpose over the years. Firstly, the *ac induction motor* which, whilst cheap, is nonetheless reliable, but follows fluctuations of the mains voltage, and secondly, the *synchronous motor* whose speed is determined only by the frequency of the alternating current.

In order to overcome the problems of noise and vibration from which some synchronous motors suffer, the best turntables have tended to utilise hysteresis synchronous motors which overcome these problems. Other motors, including servo-controlled dc and ac motors, are also used and recently we have seen a number of very cleverly designed record players featuring such systems.

Because the majority of the motors and systems that we have discussed run at higher speeds than the 33 1/3 or 45 revolutions per minute required by our turntable, it is necessary to introduce a speed change system between the motor and the turntable. This has been achieved in the past by two primary systems. The first, known as the idler driver system, is the most common and works on the principle of a rotating rubber idler providing a friction drive between the motor shaft and the inner face of the turntable rim. Whilst this system is well tried and proven, its critics point out with some justification that the rubber idler tends to wear out and that a certain amount of slippage is bound to occur. In addition, these systems tend to have a higher wow and flutter than their main competitors system which until

recently were belt drive units.

The belt drive system uses a rubber or plastic belt of unusually high quality to act as a speed reducer between the drive motor and the pulley which is formed on the base of the turntable. Because of the elastic properties of the belt it is able to reduce motor noise and vibration transferred to the turntable, and thus reduce noise and rumble. The major problem with belt driven turntables is that they have a higher level of wow and flutter than their idler-driven competitors.

## NOW DIRECT DRIVE

In the past three years a third and new breed of turntable has appeared on the market, and these feature very low speed motors directly coupled to the turntable. The motor shaft is also the turntable shaft. In these motors speeds are controlled by electronic servo mechanisms or through the use of multi-pole motors with sixteen or more poles.

We cannot comment on which of these two systems has the generally greater technical excellence (or higher cost) because some of the latest models of these respective classes, whilst in the country, have not yet been released for sale or review.

The Pioneer PL51 is what the manufacturers call "a professional direct drive stereo turntable with sophisticated dc servo-motor".

In appearance the turntable is not all that different from a number of Pioneer turntables which have

## PRINCIPLE OF MOTOR OPERATION

The outer rotor is accelerated in a clockwise direction, as one of three magnetic poles, positioned at 120° intervals on the rotor, is attracted by the electro magnetic field of one of three stator drive coils which are sequentially switched to provide a rotating magnetic field.

The switching sequence is determined by a pole position detector. Coils L1, L2 & L3 in Fig.1. are driven by an oscillator. The coupling to associated coils L4, L5 and L6 is a function of the position of the centre pole piece which is mechanically coupled to the rotor. In Fig.1, the coupling between L1 & L4 is tightest.

The voltage induced in L4 is rectified and used to switch power to drive coil A1, the rotor end of which becomes a south pole and hence attracts the north pole N1 on the rotor. The

movement of this pole (N1) induces a voltage in the sense coil A4 which is rectified and compared with a speed reference voltage in a comparator which in turn controls a constant current source which determines the current in the drive coils and hence speed.

As the centre pole piece rotates, this sequence is repeated and the following drive coil is activated thus causing the rotor to turn.

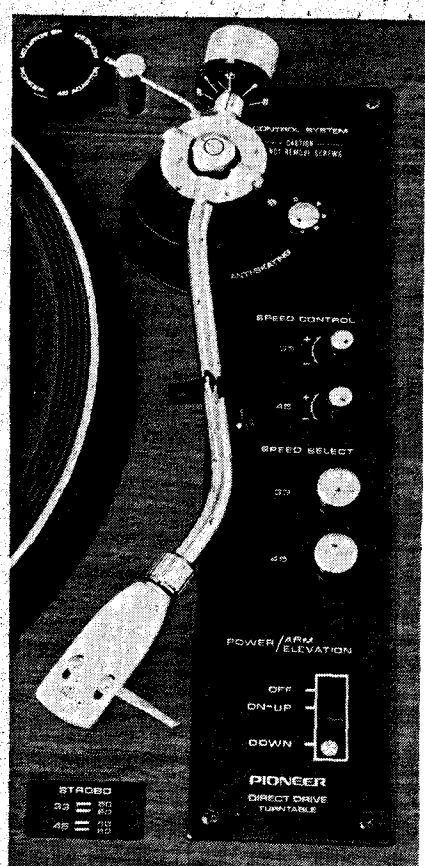
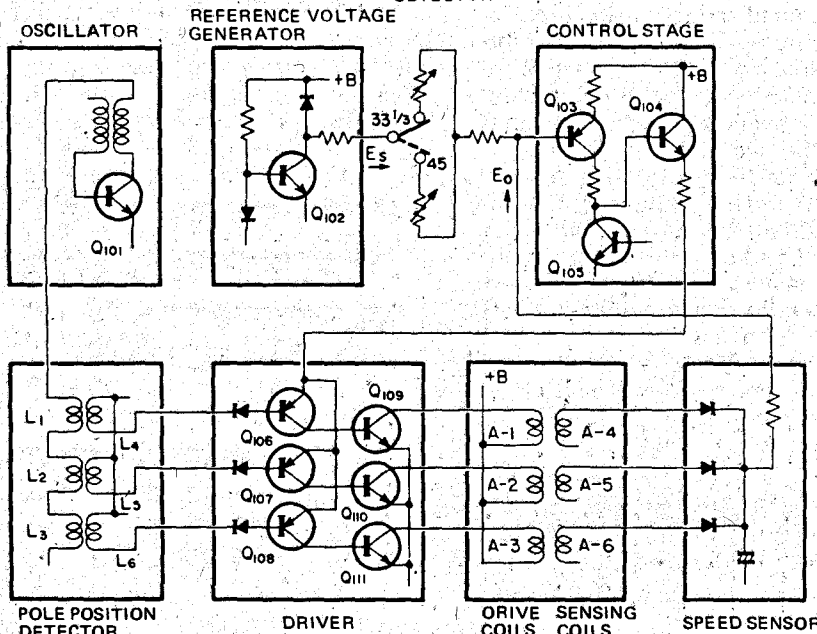
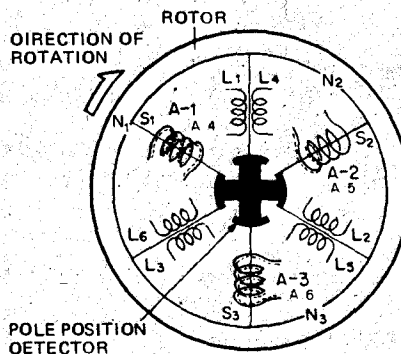



## for the sweetest sounds of all... TDK's "total performers"

There's no doubt about it. TDK's great new Dynamic-series cassettes offer serious home recordists sound reproduction unequalled by any other cassette sold today. And the reason is very simple. They deliver total performance!

Total performance means more than just full-range frequency response and high-end sensitivity. It also means having the proper balance of all the other characteristics essential to reproducing "real-life" sound. Like high MOL (maximum output level). Broad dynamic range. Wide bias tolerance. High signal-to-noise ratio. TDK's Dynamic-series cassettes have them all!

You'll quickly discover this fact when you record your favorite music on one of TDK's Dynamic-series cassettes. You capture all the highs and lows, all the harmonics and overtones, all the emotion and feeling

that gave the original performance its richness, fullness and warmth.

Look for TDK's "total performers" at quality sound shops everywhere. Extra Dynamic (ED) cassettes offer the discriminating audiophile an entirely new dimension in recording fidelity. Super Dynamic (SD), the tape that turned the cassette into a true high-fidelity medium, still has better-balanced total performance characteristics than any other brand made... and is also available in open reel. And Dynamic (D) is an entirely new hi-fi cassette that provides budget-minded recordists with excellent quality at moderate prices. All provide optimum performance on any cassette recorder, without need for special bias.

For sound you feel as well as hear, discover the dynamic new world of TDK's total performers!

*DYNAMIC-series cassettes are:*

**Extra Dynamic (ED):** top-of-the-line, for those who want the very best. 45, 60 and 90 minutes.

**Super Dynamic (SD):** first true hi-fi cassette started a revolution in the tape industry. 45, 60, 90 & 120-min.

**Dynamic (D):** characteristics superior to most "premium" cassettes. 45, 60, 90, 120 and world's only 180-min.

the new dynamic world of

**TDK**

Sole Australian Agents

CONVOY INTERNATIONAL PTY. LTD

4 Dowling Street, Woolloomooloo,

N.S.W. 2011

Telephone 358-2088

# PIONEER PL51

preceded it in production. For example, the smoked plastic cover of the turntable and the high quality friction damped spring loaded hinges are of comparable quality to the other units available.

The turntable features a high quality rubber mat on a 1.4 kg alloy die-cast aluminium turntable. The periphery of this turntable has four strobe rings engraved around it so that the platter speed can be directly checked using 50 Hz incandescent or fluorescent lighting — (i.e. normal room lights).

The controls are as simple as you could wish for. At the front is the operation lever, which has three positions — off, on-up, and down. Cueing across the turntable is a manual function as is returning the tone arm to its rest position. To operate the record player one simply places the record on the platter and selects "on-up". This turns the unit on, and lifts the tone arm from its rest position. The user then moves the arm across to the position desired over the record, selects "down", and the tone arm is cued directly to the point on the record below. To remove the tone arm from the record, one selects "on-up" again, whereupon the record arm lifts, one then manually returns the tone arm to the rest before selecting "off"

Immediately behind the operation lever are the two speed selectors. These are simple pushbuttons which electrically select the motor speed; behind these are two little adjustment controls for the 33 1/3 and 45 rpm settings (which provide  $\pm 4\%$  speed change).

The only remaining bit is a high quality 'S' shaped tone arm and good counterweight system, the lateral balance arm, and a good anti-skating control.

The plug-in head shell contains a Pioneer PC50 cartridge. This we have previously reviewed and found to be excellent — with a frequency response of  $\pm 3$  dB from 20 Hz to 20 kHz.

The anti-skating control is easily adjusted in accordance with the stylus pressure chosen, and whilst we have still to find a perfect anti-skating system which compensates correctly for all positions on a given record, the system used in the PL51 certainly seems to do its job well.

Unlike many other manufacturers, Pioneer provide a service manual with the PL51. This gives fairly comprehensive details of the principle of motor operation.

In operation, the application of power turns on the primary oscillator whose output is fed to the pole position detecting circuits — three

pairs of coupled coils. Depending on the degree of coupling between the mutual coils, voltage is induced in the detector coils which is then rectified and applied to a series of two stage transistor amplifiers, which power the drive coils Nos. A1 — A3 respectively. The rotating turntable induces a voltage in the sense coils A4 — A6 and these signals are rectified, summed, and applied to the control stage which acts as a constant current source for the first transistors in the driver stage, and by this means current control is effected on the drive coils.

Whilst this is a relatively simple feedback control system, in practice it works remarkably well and provides the lowest wow and flutter figures that we have yet measured. The manufacturers claim a figure of .06% (weighted rms). We found it to be 0.08% — as close as makes no odds.

The turntable is mounted in a cabinet which is claimed to isolate the unit from external vibration.

The isolators work quite well but do not provide sufficient attenuation of vibration caused by people walking close to the unit in rooms with wooden floors.

On the back of the cabinet are two RCA sockets and an earthing screw. A pair of screened low-capacitance cables are provided for connecting the unit to one's amplifier.

Fundamentally we must ask what is the use or advantage of a direct drive system of this type over and above the conventional systems which we have already described.

Firstly, the direct drive system can and does generate less wow, flutter and rumble than the conventional system with which it competes.

Secondly, this level of performance can be maintained for a longer period with a lesser change in performance. For example, after four years normal use, a rim-drive turntable can be expected to have 50% more wow and flutter than it had when brand new. This can of course be corrected by changing the idler wheel (which should be done as a matter of routine anyway).

Of lesser importance than the other factors, the direct drive unit does not require any adjustment if the mains frequency changes because of the use of a regulator circuit to supply the dc motor supply.

There can be no doubt, however, in our minds that a direct drive system is one step nearer to the perfection for which many audiophiles strive, and the PL51 is a good example of how many of these improvements can be embodied in what is still a fairly simple turntable. ●

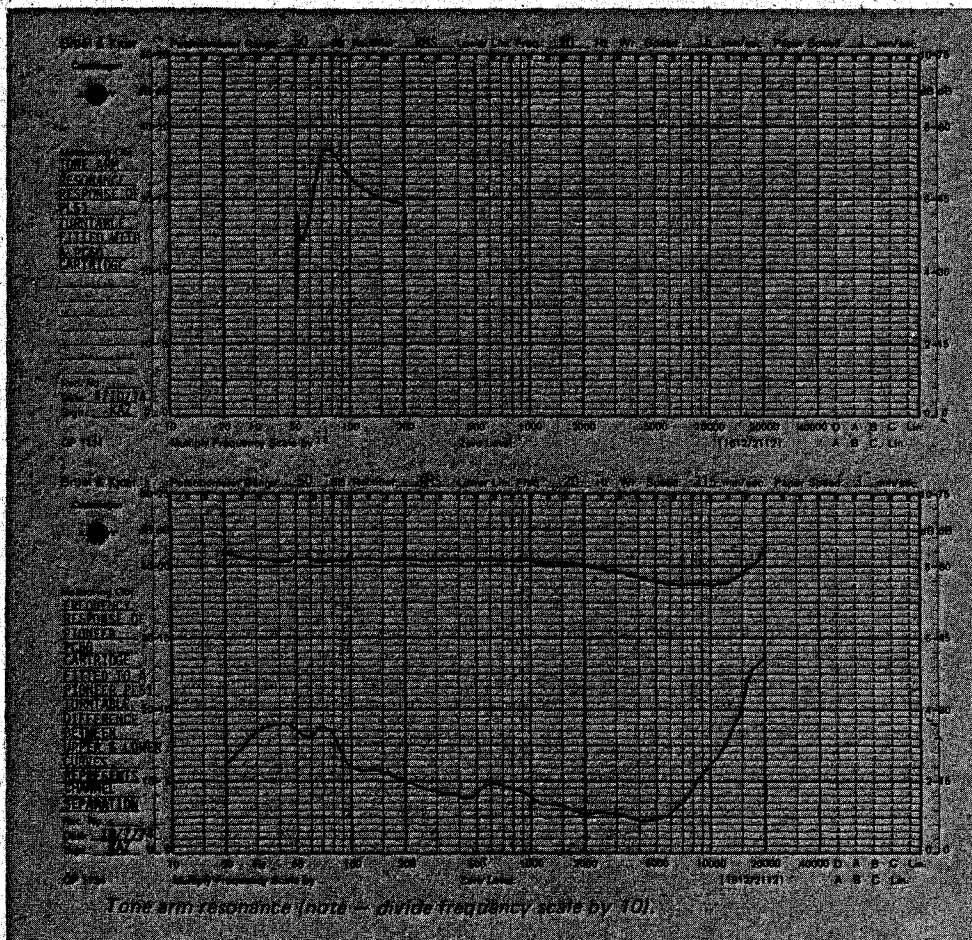

**Two things  
Albert Einstein  
could have put  
to good use.**



Albert Einstein had a hair problem. And a lot of mathematical problems.

The hair he could have fixed with a good brush. And with a lot of his other problems, 'Eveready' Gold Alkaline batteries could have helped out.

Just think what a man like Einstein could have done with a battery that out-performs all others in high drain electronic equipment.

A battery that delivers full and consistent power, even after being left idle for long periods.

A battery that isn't bothered by extreme changes in temperature.

Albert, we only wish we'd been there to help.

**EVEREADY** BATTERIES Products of **UNION CARBIDE**

'Eveready' & 'Union Carbide' are registered Trade Marks.

# The hungry leader.

At Altec, we're not taking our leadership position for granted. We're always trying harder — challenging ourselves to develop studio monitor speakers that stay a step ahead of constant improvements in the contemporary recording process. And we can prove it. Here's the latest data on monitors installed in U.S. studios, as published in Billboard's 1973 International Directory of Recording Studios.

MANUFACTURER	NUMBER OF MONITORS USED IN U.S. STUDIOS
Altec	514
JBL	256
EV	77
KLH	35
AR	29
Tannoy	28

But we're not really satisfied — even with this impressive track record. We're still trying to better ourselves. In fact, Altec has three all-new studio monitors available right now. They're a whole new generation of speakers designed to meet the whole new range of tomorrow's dynamic recording techniques. Your studio may need them. Why not call us for full details.

Altec gives you the best of both worlds proven leadership, plus an unrelenting commitment to doing a better job. That's because we've really grown to enjoy being #1 in studio monitor sales during the past three decades. And we intend to stay right there for at least the next three decades by always being our own biggest competitor — in research, in quality, in service and in satisfying the demanding needs of an ever-evolving industry. The domestic ALTEC recently introduced into Australia has already gained rapid response from the discerning Hi-Fi enthusiasts.

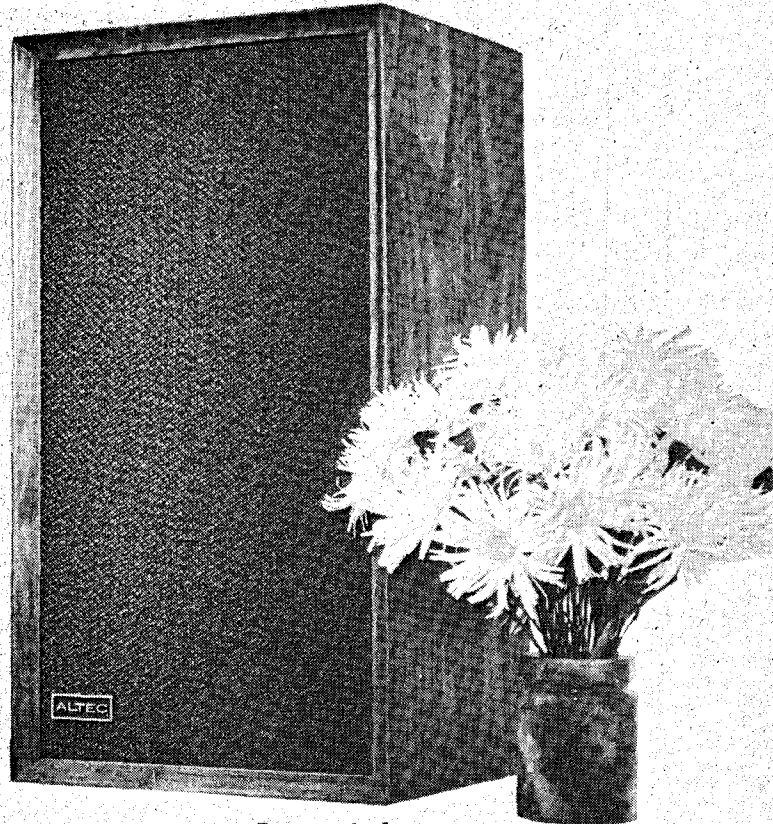

Domestic from

**\$320** pair

**ALTEC**

*the sound of experience.*

**Number one.  
And have been for  
nearly 3 decades.**

Limited numbers of 604E professional monitors available at \$285 each.  
Available in A.C.T. from DURATONE IMPORTS.

**KENT HI-FI**

412 KENT STREET, SYDNEY Ph. 29-6973

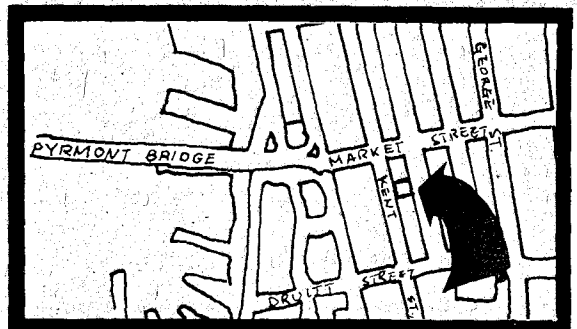

# Apollo Hi-Fi Centre

283 Victoria Road, Marrickville, N.S.W.  
Telephone: 560-9019



**presents**

## **KENWOOD** CENTAURUS

for the best in  
sound quality



KR 2400

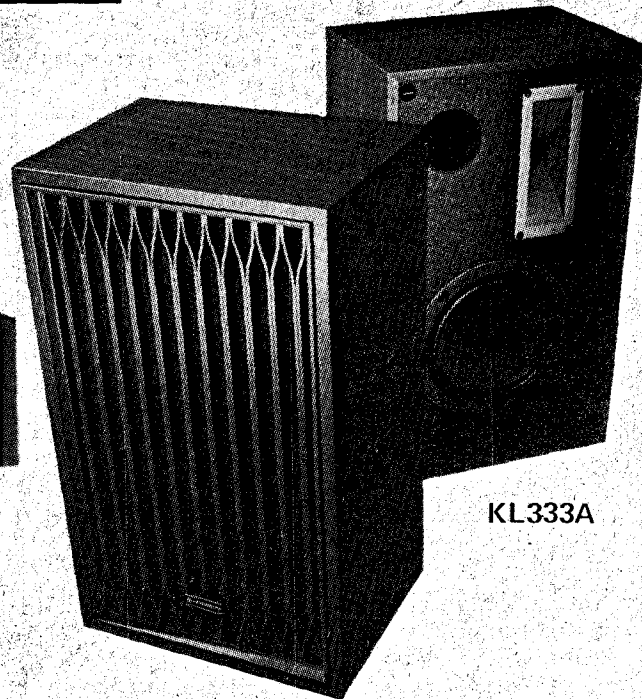

KL333A

WE ONLY SPECIALISE  
IN THE BEST  
AT THE LOWEST PRICES

*also agents for:*

AKAI JVC SONY  
KLH AR PIONEER  
LINEAR SOUND BOSE  
KENWOOD MONARCH  
ULTRA LINEAR PEAK  
HARMON KARDON SANSUI  
ADVENT  
AND MANY OTHERS



KP 2022A



# IRH COMPONENTS

## Established 40 Years and here to stay.

### Metal Glaze Resistors

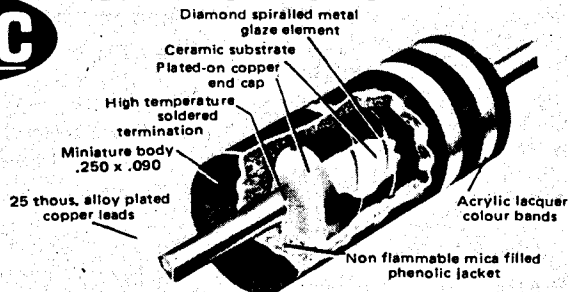

1/2 watt @ 70°C .250" x .090"  
Miniature Body Size

- Plus! Lower Temperature rise (40°C)
- Plus! Thick Film Reliability
- Plus! Generous Power Safety Factor
- Plus! Fully Insulated Non-flammable Mica Filled Phenolic Jacket

Result! THE SAFE ONE

### Wire Wound Resistors

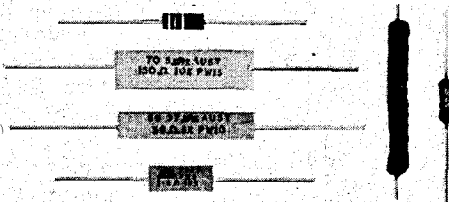

Inorganic **Fireproof**  
Rectangular Ceramic Construction  
or... Precision Wound Non-flammable  
Resin coated Tubular Styles

### Pots and Presets

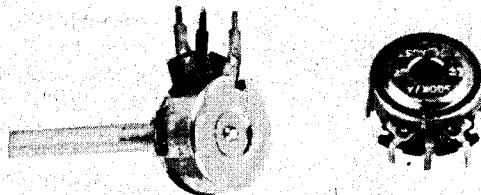

Standard and Miniature  
Carbon track Volume  
Controls and Pre-sets  
Wire Wound Potentiometers

### Ceramic Filters

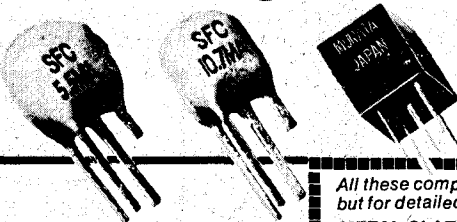

SFC-5.5MA for SOUND I.F. in TV  
SFC-10.7MA for FM I.F.  
SFD-455B for 455KHz I.F.

All these components are available through most electronic suppliers  
but for detailed technical information complete the coupon and post to-day

METAL GLAZE  WIRE WOUND  POTS & PRESETS  MURATA

NAME .....

ADDRESS .....

POSTCODE .....

**IRH COMPONENTS DIVISION**  
NATRONICS PTY. LIMITED  
The Crescent, Kingsgrove, N.S.W. 2208

Wholly Australian owned, and the largest manufacturer  
of resistive components in the Southern Hemisphere

G/574

# THE 555 TIMER

## How to use this versatile IC.

TIME DELAY circuits are easily built if the time delay required is between a few microseconds and a few seconds. But until recently it was usually simpler to use mechanical devices if longer repeatable delays were required.

Then in 1972 the US Signetics Corporation introduced their type 555 integrated circuit which was designed primarily for timing applications but has subsequently found a thousand and one other uses. It can for example operate in an astable mode switching continually from one state to the other.

The cheapest 555 IC is available for a little over \$2.00. It is an ideal device for use by both amateur enthusiasts and professional circuit designers.

Various makes and types of the basic 555 design are now available. One of the simplest and most versatile is the Signetics NE 555V, (other similar devices are also available from other manufacturers — see below).

The NE 555V is an 8-pin dual-in-line package which is very convenient for the experimenter. Signetics' NE555T has a circular metal case with eight leads (known as the TO-99 encapsulation). The electrical characteristics of the two types are identical.

A close tolerance version of the 555 is available from Signetics as type SE555T (in the circular TO-99 package). Although the SE555T can operate over a much wider

temperature range than the NE types, it is several times the price.

Electrically equivalent devices are available from Motorola under the types numbers MC1455 and MC1555 (the latter being the close tolerance version). National Semiconductor manufacture an equivalent device, the LM555.

Signetics also offer a 556 device. This contains two 555 units in a single encapsulation.

## CONNECTIONS

The eight connections of the 555 for both the dual-in-line and TO-99 devices are shown in Fig.1. Either of these devices may be employed in any of the circuits to be discussed.

## SIMPLE TIMING

The operation of the 555 as a simple timer is described using the circuit of Fig.2.

A negative going trigger pulse fed to pin 2 starts the timing operation. The potential at the + input of comparator 2 inside the 555 is one third of the supply voltage, since the values of the three resistors marked R are equal. The trigger pulse must therefore fall below one third of the supply voltage to start the timing operation.

Before the trigger pulse is received, the internal transistor Q<sub>1</sub> is conducting. All the current which passes through the resistor R<sub>A</sub> passes through the transistor; the external capacitor C remains uncharged. When a trigger pulse is received by pin 2 of the 555, however, comparator 2 switches the flip-flop and the latter cuts off Q<sub>1</sub>. In addition, the switching of the flip-flop switches the output stage.

The current flowing from the positive supply line through R<sub>A</sub> is now used to charge the capacitor C. When the potential across this capacitor reaches a value of two thirds of the supply line voltage, comparator 1 switches the flip-flop back to its initial state. We shall later see that the voltage which must be present across C for this switching to occur can be varied by the application of a control voltage to pin 5 of the device.

The switching of the flip-flop returns the output circuit to its quiescent state. In addition, it switches Q<sub>1</sub> to conduction and this transistor discharges the capacitor C ready for the next timing operation. The time delay provided by this circuit is equal to approximately 1.1 R<sub>A</sub>C when no connection is made to pin 5. This is

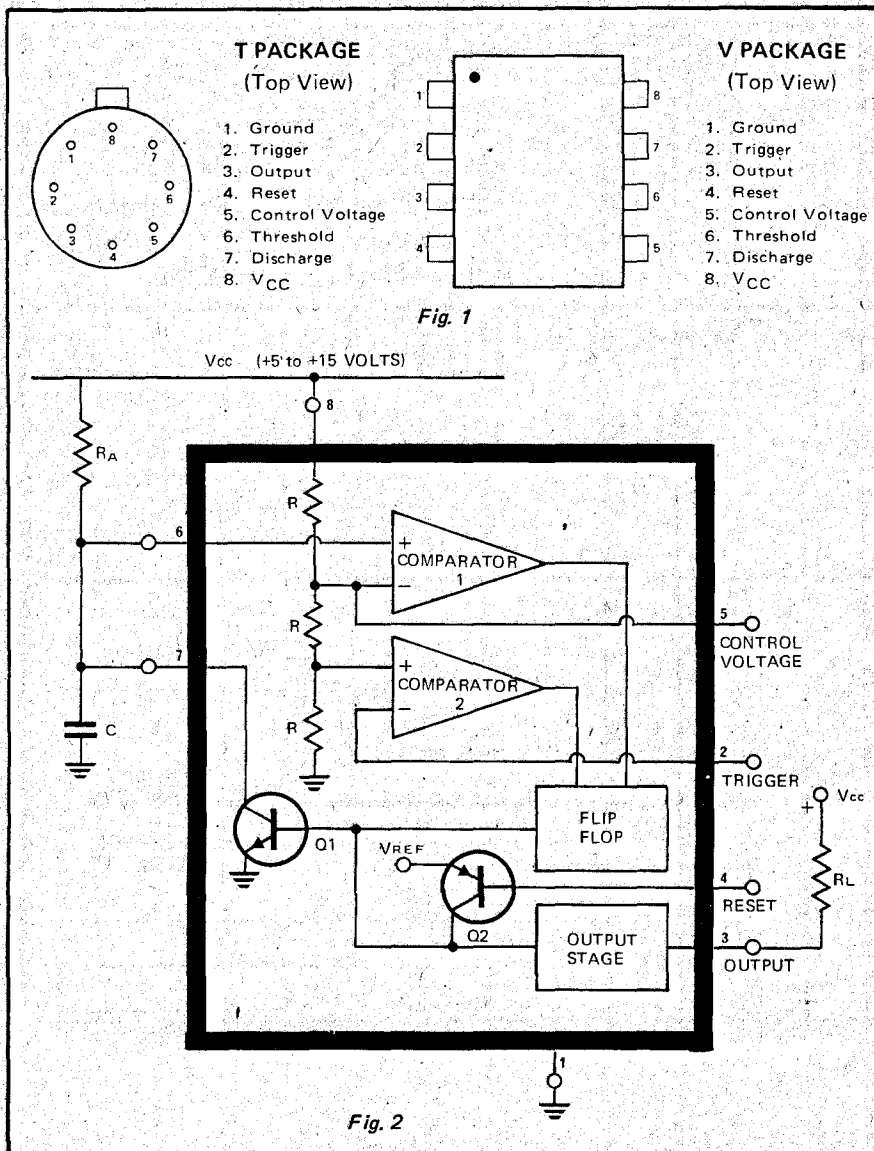

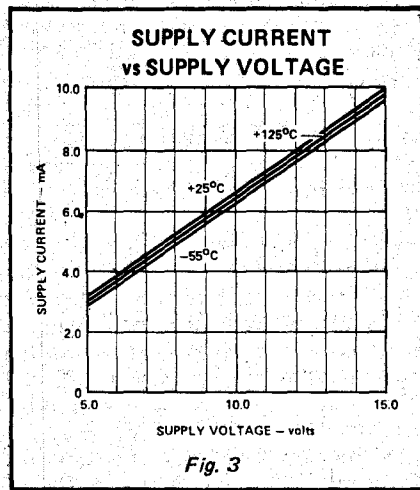

the time taken for the capacitor C to charge to a value equal to two thirds of the supply line potential.

### THE OUTPUT

In the circuit of Fig.2, the 555's output stage provides a change in the output voltage at the beginning and at the end of the delay period. The output voltage at pin 3 has two values; the 'high' value is only a little less than that of the positive supply line, whereas the 'low' value is only a little above ground potential.

Before the trigger pulse is applied to pin 2, the voltage at the output is in its 'low' state. It rises to the 'high' state at the moment of triggering and remains in this state until the end of the delay period, when it returns to the 'low' state.

If the circuit is connected as in Fig.2, current will flow through the load resistor when the output is in the 'low' voltage state, but only a small current will flow in the 'high' state. If, however, the load resistor is connected from pin 3 to ground, the large current will flow when the output is in the 'high' state. The maximum current which should be allowed to flow to or from pin 3 is 200 mA.

The output pulses from the 555 rise and fall very rapidly; the rise and fall times are typically about 100 ns.

### SUPPLY VOLTAGE

The supply voltage to a 555 device may have any value between 4.5 V and 16 V, but it is wise to place an upper limit of about 15 V on the supply voltage to allow for possible variations.

The current required to drive the 555 is only a few milliamps, as shown in Fig.3. However, the current taken by the output must be added to this current to find the total power supply current required.

If the supply voltage is increased, the current flowing through  $R_A$  to the capacitor will be increased in proportion. However, the voltage

across each of the resistors marked R in Fig.2 will also be increased in proportion to the supply voltage before comparator 1 is switched. Thus any change of supply voltage will produce a minimal effect on the value of the time delay, provided that the timing period is short compared with the rate of the supply voltage variation.

If the period of the power supply variations is much shorter than the delay period, a capacitor may be connected from pin 5 to ground. This holds the potential at pin 5 constant so that comparator 1 receives this constant reference potential. The timing period is short compared with the rate of the supply voltage variation.

If the period of the power supply variations is much shorter than the delay period, a capacitor may be connected from pin 5 to ground. This holds the potential at pin 5 constant so that comparator 1 receives this constant reference potential. The timing period is then almost independent of the supply voltage even if rapid variations of the latter take place.

### TIME DELAYS

As has already been stated the time delay is equal to  $1.1 R_A C$ . Thus one may use 100 k for  $R_A$  and 10  $\mu F$  for C to obtain a delay of 1.1 second. If one reduces C to 10 nF and keeps  $R_A$  at 100 k, the time delay will be 1.1 millisecond. If  $R_A$  is 10 megohms and C is 100  $\mu F$ , the delay will be 1100 seconds.

The maximum value of  $R_A$  which should be employed is about 20 megohms. A current of 0.1  $\mu A$  (in a typical 555) passes to pin 6 of the device, the maximum value of this current in any 555 is 0.25  $\mu A$ . If the value of  $R_A$  is 20 megohms, the current to pin 5 can produce an appreciable voltage drop across  $R_A$ .

## SPECIAL 555 IC OFFER

See page 53 for full details.

When electrolytic capacitors are used, the leakage current may produce an appreciable voltage drop across  $R_A$  if the value of the latter is high. A typical upper limit for the value of the timing capacitor is 100  $\mu F$  to 1000  $\mu F$ . It may be necessary to select such capacitors for low leakage.

If you do use electrolytics don't expect the timing interval to be accurately related to the nominal value of the capacitor, since such components have tolerance which are typically -50% to +100%. Similarly, high-K ceramic capacitors can have very wide tolerances.

### CONTROL VOLTAGE

The potential of pin 5 should not be within 0.75 V of the positive supply line voltage. It should be at least 1.5 V above the ground potential. This enables the transistors inside the device to operate correctly. If the supply voltage is 15 V, the full range of values of the control voltage shown in the table can be employed, namely from 0.1 to 0.95 times the supply voltage. If a smaller supply voltage is employed, however, the range of the control voltage which may be employed is smaller. For example, at the normal minimum supply voltage of 5 V, the value of the control voltage should not be smaller than 0.3 nor greater than 0.85 times the supply voltage.

The resistors marked R in Fig.2 each have a value of about 5 k. Thus one can vary the potential at pin 5 of the device by merely connecting a resistor

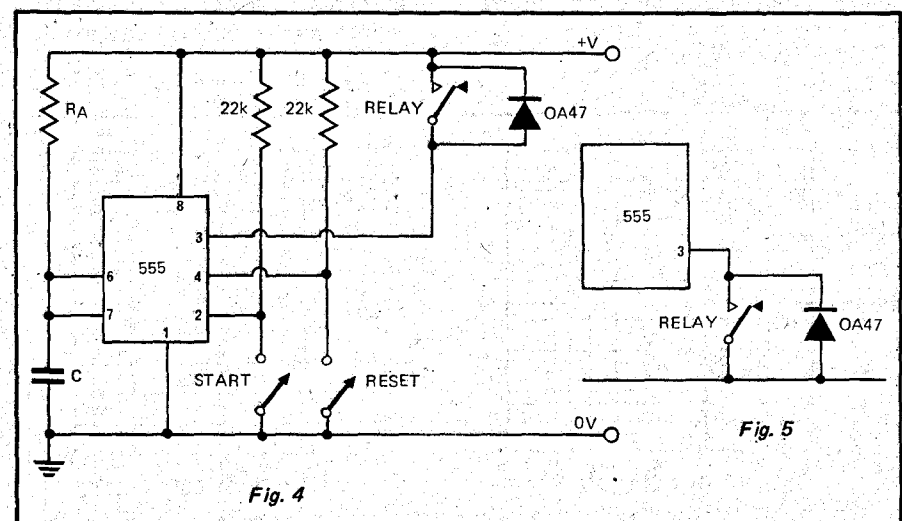

# THE 555 TIMER

from pin 5 to ground to reduce this potential or from 5 to the positive supply line to increase this potential. Generally a resistor of a few thousand ohms or more will be suitable.

## RELAY OUTPUT

The 555 device can be used to drive a relay directly, provided that the delay period exceeds about 0.1 second. The relay used must not draw an operating current of more than 200 mA. It should operate with a coil voltage of about the same value as the power supply voltage used to drive the 555 (maximum 15 V).

A typical circuit for using the 555 to drive a relay is shown in Fig. 4. The closing of the switch marked 'Start' commences the timing operation. The trigger pin 2 is returned via a 22 k resistor to the positive supply line to prevent false triggering.

If the 'Reset' switch is closed momentarily during the timing period, the circuit is immediately reset to its quiescent state and the timing ceases. A new timing operation will commence when another trigger pulse is applied to pin 2.

When the current passing through the relay pin 3 of the device is suddenly cut off at the end of the timing period, a high back emf is generated across the inductive relay coil. This back emf could damage the integrated circuit and must be suppressed by connecting a diode across the relay as shown in Fig. 4. A gold bonded germanium diode has been found to be especially suitable for this application.

In the circuit of Fig. 4, the relay is normally closed, but opens during the delay period. If the relay is connected between pin 3 and ground (as in Fig. 5), it will be energised only during the delay period. Thus one can choose whether one wishes to have the relay energised only during the timed periods or only at all other times.

Relay circuits of the types shown can

be used to construct a photographic enlarger timer provided that  $R_A$  is made variable and C is switched. If the relay is connected as in Fig. 5, the closing of the relay can be used to switch on the enlarger lamp when the circuit is triggered; the lamp is automatically switched off at the end of the delay period.

## TRIGGERING

The trigger input of the 555 is extremely sensitive, since the current required by pin 2 to trigger the circuit is only about  $0.5 \mu\text{A}$  for  $0.1 \mu\text{s}$ . Triggering can be effected merely by touching pin 2 with a finger. You can even trigger the circuit by moving your hand near to a wire connected to pin 2. This causes the potential of pin 2 to fall (by a capacitive effect).

It is possible for re-triggering to occur at the end of the delay period when an inductive load (such as the coil of a relay) is connected in the pin 3 circuit if an unsuitable diode (or no diode) is connected across the relay. This occurs only in the circuit of Fig. 5. When the current passing through the relay at the end of the timing period commences to fall, the voltage transient produced across the coil is picked up at pin 2 and the circuit is re-triggered before the relay can commence to open. The only outward sign that this is happening is the failure of the relay to open at the end of the timing period. Gold bonded germanium diodes, such as the 0A47, appear to prevent this effect, but silicon diodes (such as the 1N914) are not satisfactory.

## OUTPUT VOLTAGE

The output voltage varies somewhat with the pin 3 current. This variation is shown in Fig. 6 for the case when the output voltage is 'high'. It can be seen that the pin 3 voltage is roughly 1 V to 2 V below the positive supply line potential.

Figure 7 shows how the 'low' output potential varies with the current to pin 3 when a 10 V supply is used.

## ASTABLE OPERATION

The versatility of the 555 device is greatly increased by its ability to 'free-run' or operate as an 'astable oscillator'. A circuit of this type which continually produces output voltage changes at preset intervals is shown in Fig. 8. If desired, the load may be replaced with a diode in parallel with a relay (as shown in Figs. 4 and 5) and the relay will then close and open alternately.

In the circuit of Fig. 8, the capacitor C charges through  $R_A$  and  $R_B$  in series, but when the internal transistor  $Q_1$  of Fig. 2 is switched to conduction, C discharges through  $R_B$  only. Thus the charging time is longer than the discharging time.

The capacitor C continually charges from a potential of one third of the supply voltage up to a potential of two thirds of the supply and then discharges again to one third of the supply. The charging time is  $0.693(R_A + R_B)C$  and the discharging time  $0.693R_B C$ . For most practical purposes, one may use the factor 0.7 instead of 0.693. The frequency of operation is approximately  $1.44/(R_A + 2R_B)C$ .

In the astable circuit of Fig. 8, pin 6 is connected to pin 2. Thus when the voltage across C falls to one third of the positive supply line potential, the circuit is re-triggered and a new cycle commences automatically.

Operation of the 555 in the astable mode can be used to provide square wave output pulses for audio amplifier testing, etc. If the output is used to control a relay, the periodic opening and closing of the relay can be used to provide flashing lights on a Christmas tree or in a shop window. If  $R_A$  is made small and  $R_B$  is made large, the time for which the relay is open will not be very different from that for which it is closed.

In the circuit of Fig. 8, it has been assumed that pin 5 is not connected. However, the voltage at this pin may be altered as described previously and this will either increase or decrease both the charging and the discharging times.

## SIMPLEST ASTABLE CIRCUIT

An even simpler astable circuit is shown in Fig. 9. Only one resistor, one capacitor and the 555 are required.

When the output at pin 3 is in the 'high' state, C charges through the resistor R. Comparator 1 of Fig. 2 switches the flip-flop when the voltage across C becomes equal to two thirds of the supply voltage. The output then falls to its 'low' value and C discharges into pin 3 through R. When the

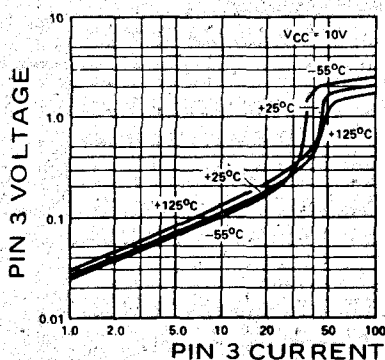

Fig. 6

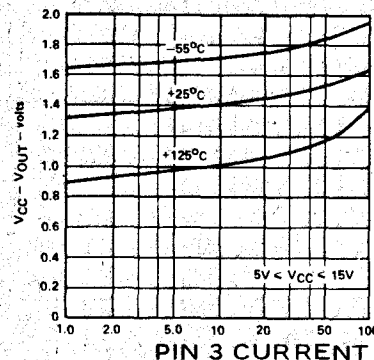
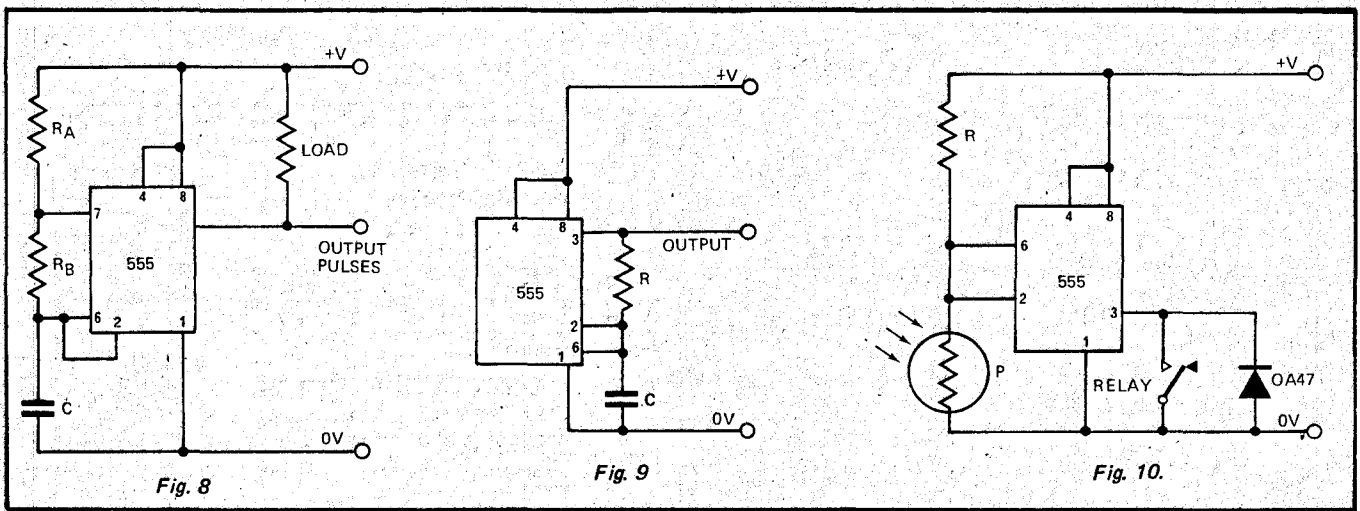

Fig. 7



potential at pin 2 reaches one third of the supply voltage, comparator 2 of Fig.2 is switched and C then commences to charge again from the output which is now in its 'high' state.

The charging and discharging times are each approximately  $0.7RC$ . If desired, a relay may be connected from the output to either ground or the positive supply line provided that a diode is connected in parallel with the relay as in Figs. 4 and 5. The relay will then automatically open and close whilst power is applied to the circuit.

### PHOTOSENSITIVE CIRCUIT

Although it is intended for use as a timer in both the monostable and astable modes, the 555 is essentially two voltage comparators which switch a flip-flop and the output stage. It can therefore be employed to provide different output levels as the voltage at the inputs to its comparators changes.

The circuit of Fig.10 shows how the 555 can be used as a photosensitive switch. When the intensity of illumination falling on the cadmium sulphide photosensitive cell P rises, the resistance of this photoconductive cell falls. The voltage at pin 2 will therefore fall and when this voltage reaches one third of the supply voltage, comparator 2 of Fig.2 will switch the flip-flop stage and the output. The relay then closes.

If the light intensity subsequently falls, the resistance of the cell P rises and so does the voltage across it. When this voltage reaches two thirds of the supply voltage, the comparator 1 of Fig.2 is switched. This causes the output voltage to fall and the relay opens.

If the relay and diode are connected between the positive line and pin 3, the relay will close when the light intensity falls and will open again when it rises.

The opening and closing of the relay occurs at different levels of illumination. This 'hysteresis' effect is usually advantageous, since it prevents

the relay from continually opening and closing (or 'chattering') when there are very small changes in the light intensity.

The type of circuit shown in Fig.10 could be used to switch office lighting or street lights on and off as the level of illumination changes.

The 555 device is a very versatile integrated circuit. We have considered a number of its possible applications in this article, but many more can be devised. For example, if the photoconductive cell P in Fig.10 is replaced by a thermistor, one could doubtless use the switching of the relay to control temperature. This would be another example of the use of the 555 as a comparator in an application not involving timing.

A variation of the basic 555 design is the 556.

This is in effect two 555 devices within a common package. Each half of the 556 behaves like a separate 555 timer and as such all of the applications described in this article are equally applicable to the 556.

One most useful application of the 556 IC is in obtaining extended time delays.

Both the 555 and 556 ICs use external timing capacitors, but even using low leakage electrolytics, these limit the normally practical timing

**TABLE 1**

Ratio of pin 5 voltage to the supply voltage Factor by which  $R_{AC}$  must be multiplied to obtain the timing period.

0.105	0.1
0.2	0.223
0.3	0.357
0.4	0.511
0.5	0.693
0.6	0.916
0.7	1.203
0.8	1.61
0.9	2.30

Table shows the effect of pin 5 control voltage on the timing period, when pin 5 is not connected, its potential is 0.667 times the supply voltage.

range to a maximum of ten minutes.

However by using a 'divide by N' network between the two halves of a 556, very much longer delays may be obtained.

The 556 timer may also be used as a tone-burst generator. In this application, the first half of the device is used as a one shot and the second half as an oscillator.

## SPECIAL OFFER

**Two 555 IC's for \$3!** (including sales tax - post free)

Electronics Today International has arranged for readers to obtain 555 IC's at the greatly reduced price of \$3 for two.

The IC's may be obtained from any of the firms listed below - either by calling in - or by mail order.

Dick Smith,  
162 Pacific Highway, Gore Hill, NSW 2065  
M.S. Components  
95-97 Regent St., Redfern, NSW 2016  
Radio Dispatch,  
869 George St., Sydney, NSW 2000  
Electrobit Pty Ltd,  
140 Auburn St., Wollongong, NSW 2500

Martin de Launay,  
Cnr. King & Derby St., Newcastle,  
NSW 2300  
The Electronics Shop,  
Shop 2A, Hackett Place, Hackett,  
ACT 2602  
A.J. Ferguson Pty Ltd,  
125 Wright St, Adelaide, SA 5000

# PRE-PAK electronics

## AUSTRALIA-WIDE AGENCIES

# AT YOUR SERVICE

Buy with confidence  
at your nearest store

ORDER BY MAIL OR CALL  
PERSONALLY, TODAY

### YOUR ONE STOP HOBBY SHOP PRE-PAK ELECTRONICS

**NSW: HEAD OFFICE:**  
718 Parramatta Road,  
Croydon, Mail to P.O. Box  
43, CROYDON, 2132.  
Telephone: 797-6144.

**NSW: NEWCASTLE:**  
Digitronics Aust. Pty Ltd, 12  
William St., Maryville, 2293.  
Telephone: 69-2040.

**NSW: HUNTER VALLEY:**  
Hunter Valley Electronics  
and Hi-Fi, 478 High St.,  
Maitland, 2320. Telephone:  
33-6664.

**NSW: WOLLONGONG:**  
Hi-Tec Electronics, 265  
Princes Highway, Corrimal,  
2518. Telephone: 84-9034.

**W.A.: WEST AUSTRALIA:**  
B.P. Electronics, 192-196  
Stirling Tce., Albany, 6330.  
Telephone: 41-3427.

**Q L D : N O R T H  
QUEENSLAND:**  
Philtronics, Cnr. Grendon &  
Palmer Sts., North Mackay,  
4740. Telephone: 78-855.

**BRISBANE:**  
Delsound Pty Ltd., 103  
Cavendish Rd., Coorparoo.  
4151. Telephone: 97-2509.

**CANBERRA:**  
The Electronics Shop, Shop  
2, Hackett Place, Hackett  
2602. Telephone: 47-6179.

**MELBOURNE:**  
Flight Electronics, 1 Derby  
Road, Caulfield East, 3145.  
Telephone 211-4788,  
211-4984.

**ADELAIDE:**  
A.E. Cooling Radio/TV, 6  
Trimmer Road, Elizabeth  
South, \*5112. Telephone  
255-2249.

**fiber Optics** **Sellout**  
SAVE 25%

Create your own lamps and special lighting effects with International Rectifier's fibre optic sprays and kits. Experiment with this new science of tomorrow, today - we have just reduced prices by up to 25% so don't miss this great opportunity. Instructions and advice are provided with every kit.

OP2020 LAMP KIT for "Capri" or "Tower". <i>Ideal for beginners - easy to assemble yourself.</i>	\$6.50
OP2040 LAMP KIT for "Fountain" <i>two-tiered spray of twinkling light.</i>	\$8.50
OP2050 LAMP KIT for "Fan" <i>A large spray of shimmering light.</i>	\$8.95
OP2060 LAMP KIT for "Cascade" <i>three-tiered spray of cascading light.</i>	\$14.50
OP8070 STARTER KIT - assortment. <i>Designed for experimenter with 24 page manual.</i>	\$18.06
OP376 JACKETED LIGHT GUIDE, <i>6ft length of versatile light guide - 37 fibres.</i>	\$6.65
OP4506 BULK MONO FIBRE. <i>36ft of 45 mil plastic fibres.</i>	\$9.35
OP1060 BULK MONO FIBRE. <i>360 ft of 10 mil plastic fibres.</i>	\$6.10
OP8030 EYELETS (Pack of 20)	\$1.60
OP8050 SPECIAL ADHESIVE (Bottle)	\$4.90

OUR 10 STORE BUYING MEANS

## LOWEST PRICE EVER

on quality NS Digital  
electronic calculators. **\$1745**  
NATIONAL MODEL 650 post \$1.00

SAVE \$10

Features:-  
● 6 Digit Capability. ● Addition or subtraction.  
● Chain or Mixed Calculations.  
● Automatic Squaring and Summing.  
● Compact Size - only 5" x 2 1/2" x 7/8".  
Place your order now while stocks last!  
Post and Packing \$1.

NATIONAL MODEL 950 **\$19.95**  
● 9 Digits + Battery post \$1.00

Same as 600 but has 9 digits and auto blanking after 20 secs to conserve battery. Numbers displayed are "stored" and may be easily returned.

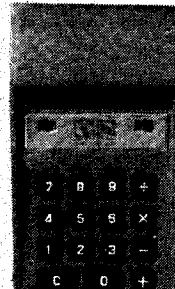

## AND 3 NEWEST MODELS

NATIONAL MODEL 820 - **\$29.45**

- 8 digit LED display.
  - Handy constant key.
  - Fully floating decimal point.
  - Full 12 months guarantee.
  - Unique battery saver feature.
  - Compact size - only 5" x 2 1/2" x 1".
- A real handy calculator.

NATIONAL MODEL 823T -

With MEMORY storage key, plus PERCENTAGE key, plus all features of Model 820. (size 5 1/4" x 3"

**\$37.95**

post \$2.00

x 1"). Simplicity, Versatility and Dependability are key features of this "beauty". And now, pleasantly affordable too.

NATIONAL MODEL 823R

**\$51.95**

post \$2.00

Note:  
Tax Concessions  
For Students  
Write for details.

As above, but includes no-lead re-chargeable batteries and charger. Available shortly.

OUR BEST VALUE EVER  
IN BARGAIN - PRICED PARTS

## SUPER-PAKS

<b>PAK 1</b> 100 Asst. Short Lead Resistors <b>\$1.00</b>	<b>PAK 51</b> 50 Hi-Stab resistors 0.5% tolerance 1/2 watt all different values <b>\$3.50</b>	<b>PAK 28</b> 25 Asst. 1uF to 500uF 3VW to 12VW Electros <b>\$2.00</b>	<b>PAK 8</b> 10 NPN unmarked, tested T05 Transistors <b>\$1.50</b>	<b>PAK 14</b> 30 Asst. Standard Size Tagstrips <b>\$1.00</b>
<b>PAK 3</b> 100 Asst. Popular 1/2W Resistors <b>\$1.75</b>	<b>PAK 46</b> 50 Asst. Mini 50VW Polyester Capacitors <b>\$3.50</b>	<b>PAK 30</b> 25 Asst. 10uF -500uF, 12VW - 80VW Electros <b>\$3.50</b>	<b>PAK 45</b> 10 NPN BC107-8-9 Unmarked Transistors <b>\$1.75</b>	<b>PAK 43</b> 3W Amp, 5 Transistors plus circuit, incl. AY6108-6109 <b>\$2.25</b>
<b>PAK 24</b> 100 Asst. 1W and 2W Resistors <b>\$2.00</b>	<b>PAK 39</b> 100 Asst. 400V Polyester Capacitors <b>\$3.50</b>	<b>PAK 31</b> 15 Asst. 500 - 3000uF, 12VW Electros <b>\$3.50</b>	<b>PAK 52</b> 15 Assorted Valve Sockets handy for repairs <b>\$1.75</b>	<b>PAK 47</b> 1 P.C.B. Etching Kit incl. P.C. <b>\$2.50</b>
<b>PAK 49</b> 20 Asst. Useful Pots <b>\$2.50</b>	<b>PAK 40</b> 100 Asst. 630V Poly Capacitors <b>\$4.25</b>	<b>PAK 26</b> 100 Asst. Low Voltage Ceramics <b>\$2.00</b>	<b>PAK 44</b> 6 Zener + 6 Silicon Diodes to 10W Rating <b>\$2.00</b>	<b>PAK 48</b> Transistor Radio Repair Kit - IF, Caps, Gang, V.C. etc. <b>\$4.89</b>
<b>PAK 32</b> 25 Asst. Radio and Inst. Knobs <b>\$2.00</b>	<b>PAK 42</b> 10 Asst. Modern pf Trimmers <b>\$1.75</b>	<b>PAK 41</b> 100 Asst. 500V - 5KV Ceramics <b>\$2.50</b>	<b>POST &amp; PACKING</b> Send 30c per PAK. We will ship to any part of Australia by best method.	

SEMICONDUCTOR Brand new, guaranteed

<b>P</b>	0A91 - 25c	C106Y1 - \$1.00	BC179 - 30c
<b>E</b>	IN914 - 20c	C122E - \$2.50	2N2646 - \$1.00
<b>C</b>	EM401 - 20c	SC146D - \$2.50	2N3638 - 50c
<b>I</b>	EM404 - 22c	5023 LED - 50c	2N3645 - 50c
<b>A</b>	EM408 - 28c	BC107 - 25c	2N6459 - 75c
<b>L</b>	A15A - \$1.15	BC108 - 25c	2N3054 - \$1.25
<b>S</b>	MB1 - \$1.20	BC109 - 25c	2N3055 - \$1.20
	MB4 - \$1.90	BC177 - 30c	AY6108/6109 -
	PA40 - \$6.00	BC178 - 30c	\$2.00



# PRE-PAK

ELECTRONICS and AGENCIES

Head Office: 718 Parramatta Rd.,  
Croydon NSW. 2132 Ph: 797-6144

GOODS AVAILABLE AT ALL 10  
STORES - ORDER NOW!

**NEW**



...for the sound buff

# LO-COST 10 WATT RMS STEREO KIT

## HI-FI TURNTABLE Supraphon Model HC-12

Direct  
Import  
Special  
only

**\$29.95**

Pack and  
Post \$2.00



**SPECIFICATIONS:**

3 speeds (16, 33, 45 r.p.m.), 4 pole induction motor, 240V, 50Hz operation, power consumption 16VA, low rumble content, performance complies with standards CSN36 7000, CSN36 8401.

**FEATURES:**

Includes ceramic cartridge (180mV output), manual operation only, hydraulic lowering device fitted, complete with mains and output leads.

Available in base/cover, ready to connect to amplifier or tape recorder, only \$49.95.

### "INCREDIBLE" 25 STEREO AMPLIFIER MODULE only \$14.95



- 6.2W RMS Ch.
- 24-30V DC, 1A
- Ready Built
- Low Distortion.
- Vol, Bass, Treble, Bal.
- 90 day warranty.

Complete, as pictured \$14.95 post \$1.00. Complete, with round or slider tone controls \$19.95, post \$1.00.

Complete, as above with power supply \$29.95, post \$1.00.

Regulated Power Supply, add \$6.95.

### Choice of two SLIM-LINE "INCREDIBLE" AMPLIFIERS

No. 1. Extruded aluminium front panel, slider pots, "Incredible" 25 Amp. with std. power supply 5 pin din socket, headphone socket, On/Off Switch and bezel... complete kit \$39.95, post.

No. 2. De-Luxe amp, with these extra features - Rumble/scratch filter, st/mono switch, speakers on or off, phone/tape input etc... complete kit \$44.50 post.

## NEW Solid State STROBE

Only **27.95**

Post and packing \$1

- Ready built
- High power
- Adjustable
- Fantastic

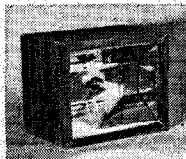

### STOP ACTION LIGHT!

Add LIFE to your parties... "freeze" fast or slow moving objects. Fully variable from 1 to 30 flashes per second. Wide angle flash with highly polished reflector. Strobe is complete, simply install power transformer and mains lead with full instructions.

## 3 great HYBRID POWER AMPLIFIERS

The SANKEN I.C. Hybrid Modules utilise the latest integrated circuit pre-amp/driver stages together with single-ended output transistors mounted in a single compact case. This is fitted with a thick aluminium base ready to bolt to any standard amplifier chassis for heatsinking purposes. The few external components required are input/output capacitors, feedback components, power supply, speaker etc. Internal protection is provided for intermittent short periods (5 secs), thus allowing normal fuse protection to operate.

**20% OFF** from **\$5.50**



### Sanken electric Co. NOW USED BY WORLD'S LEADING MANUFACTURERS

Freq. response: 20Hz - 100kHz, within 1/2dB, Harmonic Distortion: less than 0.5% at full power, typically .05% at lower power levels. Signal to Noise: 90dB typ

Full technical data/circuits available FREE with order, or sent separately on receipt of 40c postal note.

Model.	RMS.	Supply	Price.
S1010Y	10W	34V, 0.6A	\$5.50
S1025E	25W	48V, 0.8A	\$14.50
S1050A	50W	62V, 1.1A	\$23.90

### MITY AMP KITS

Based on the Sanken Hybrid Amplifiers, the MITY AMP Kits include ALL parts necessary to assemble a complete 10, 25 or 50 watt power amplifier (2 required for stereo).

**10 WATT AMPLIFIER \$9.25**  
pack and post 50c.

Power Supply Kit (unreg) ..... \$14.00

pack and post \$1.50

Power Supply Kit (reg) ..... \$19.50

pack and post \$1.50

**25 WATT AMPLIFIER \$16.95**

pack and post 50c.

Power Supply Kit (unreg) ..... \$16.50

pack and post \$1.50

Power Supply Kit (reg) ..... \$24.50

pack and post \$1.50

**50 WATT AMPLIFIER \$27.50**

pack and post 75c

Power Supply Kit (unreg) ..... \$23.00

pack and post \$2.00

Power Supply Kit (reg) ..... \$32.00

pack and post \$2.00

NOTE: All Power Supply Kits suit mono or stereo applications.

GUARANTEE: All Sanken Hybrid Amplifiers guaranteed 90 days from date of purchase.

## with Sanken S1010Y

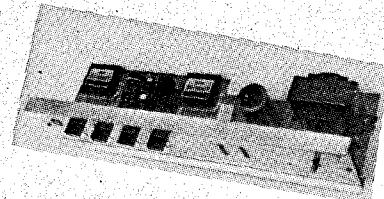

**\$33** ● Ceramic input.  
● Base and Treble controls.  
● Rumble and Scratch Filters.  
P & P \$2 ● Mains Power Supply.

Our newest amplifier kit with full 10 watts rms per channel output, modern extruded aluminium front panel and 45 mm slider controls. Build your own cabinet to save extra expense or mount amp under record player.

Any turntable will give satisfactory performance (we recommend our Supraphon HC-12) while speakers should be 8 ohms (see below). It is possible to use a magnetic cartridge with the addition of a magnetic pre-amp, however, we have obtained very good results with a ceramic cartridge.

The quality sound of the SANKEN Hybrid Amplifier S1010Y will truly amaze you and this low price is possible only because of our 10 store bulk-buying power.

Complete Amplifier Kit (as above) . \$33.00

Magnetic Cartridge Kit (Stereo) .... \$ 9.00

Model HC-12 Supraphon

Turntable (Ceramic) ..... \$29.95

Stereo Changer in base/cover ..... \$59.00

8" twin-cone Hi-Fi Speaker, ea ..... \$8.00

3" Tweeter to match ..... ea ..... \$5.20

As above, complete in a modern factory - made walnut cabinet 11" x 7" x 15 1/2" high - pair \$49.00.

Allow extra freight \$2 to \$3, accordingly.

### Famous SINCLAIR STEREO 60.

Shipment  
just  
received

Was  
**\$31.30**

NOW **\$27**

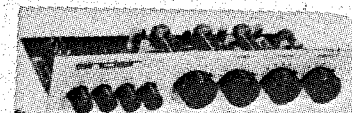

Use with SANKEN 10, 25 or 50 Watt MITY-AMPS. Design your own multi-purpose stereo sound system. Stereo 60 Pre-Amp and Control Unit.

Features: Input sensitivity = 3 mV. Input impedance = 50 K. Equalization R1AA = ± 1dB. Freq. response ±1dB = 20 Hz = 25 KHz. Distortion = 0.03%. Signal to noise = 70 dB.

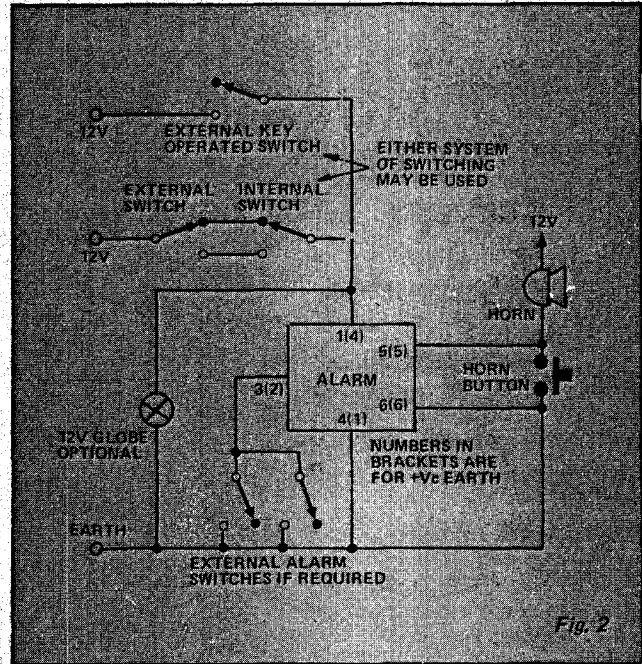
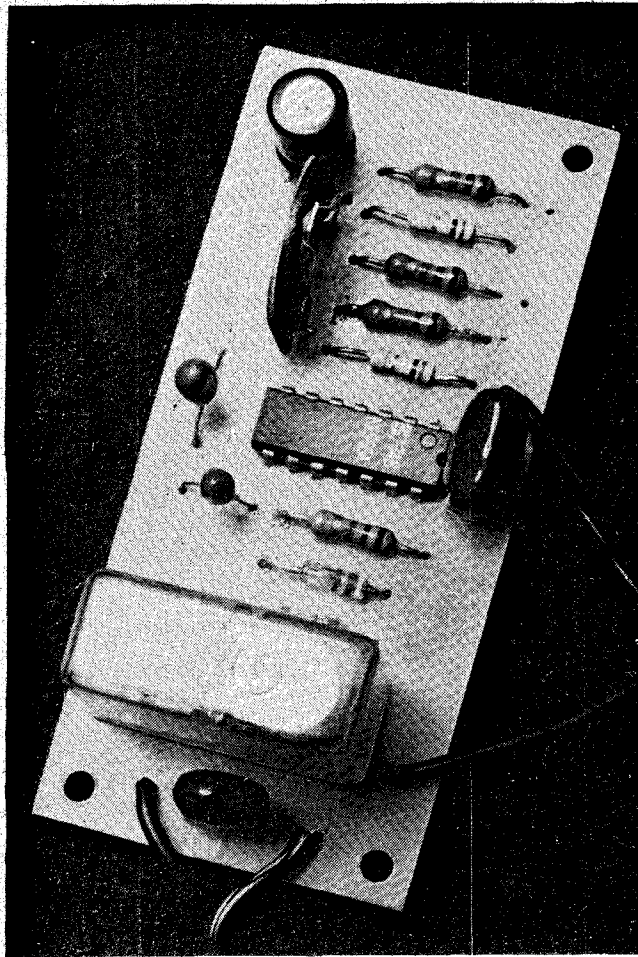

Fig. 2

**Protect your car with this simple effective circuit.**

ONE OF LIFE'S more devastating experiences is to walk out of your house in the morning and find that your car has disappeared!

But this need not happen to you, for an effective alarm system, as described here, may be quite easily constructed and installed at low cost.

The ETI 313 car alarm uses one single IC and a minimum of other components. It will, when actuated, blow the horn at one second intervals, and will continue to do so until deactivated by means of a key switch etc.

The alarm is triggered by any drop in

the battery supply voltage caused by an increase in loading on the vehicle's electrical system. Thus, if a door is opened, the interior light will be activated and the increase in electrical load will trigger the alarm.

This operating principle simplifies installation, for practically all vehicles have courtesy lights activated by switches on at least two of the doors — and it is a fairly easy task to install further switches on the other doors if required.

Both the boot and under bonnet areas may be protected in a similar manner — indeed many vehicles have lights already fitted in these areas, if not, it is a simple matter to fit them into the circuit such that they come on when the boot lid etc is opened.

These lights are of course very useful apart from their alarm function, but remember — they must operate at all times, not just when the ignition is on.

The alarm is sensitive enough to be activated by anyone pressing the brake pedal — or even by opening the glove box (where a lamp is fitted of course).

The unit is designed for use with cars having 12 volt electrical systems. It may be used with either positive or negative earth systems without modification.

In addition to the power sensing alarm mode other precautions may be

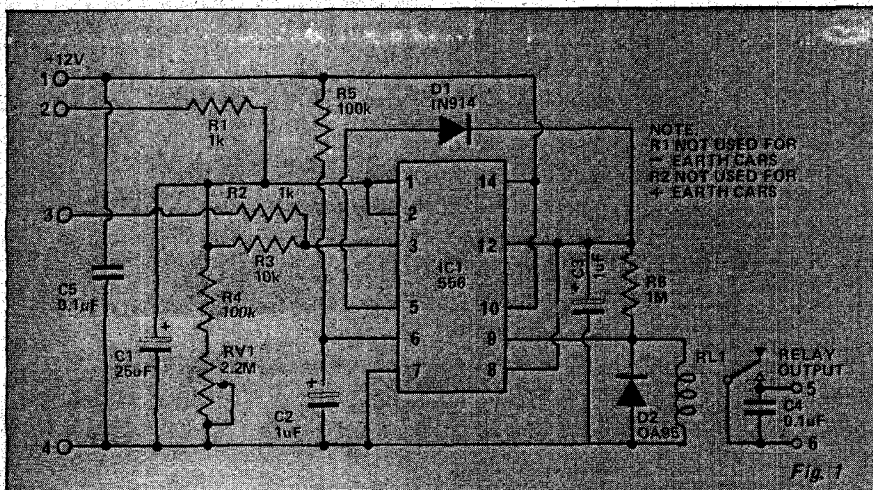

Fig. 1



taken by adding further alarm microswitches. For example microswitches may be fitted to the suspension such that if anyone tries to lift the car, in order to tow it away, the alarm will go off. If such switches are used they should be connected between terminal 2 or 3 or the alarm (see Fig 1 and 2), depending on whether the vehicle has a positive or negative earth system, and earth.

## CONSTRUCTION

Construction of the alarm is extremely simple and anyone capable of using a soldering iron should not have any difficulty. All components, including the relay, are mounted on a small PC board as shown in the component overlay diagram.

Note the polarity of electrolytic capacitors, the IC and diodes. In particular make sure that the germanium diode D2 is mounted in

the correct position and with the correct orientation. When soldering use a small, light-weight iron and preferably small gauge solder. Solder quickly and cleanly. Only apply the iron for sufficient time to cause the solder to flow around the joint. These precautions will ensure that components are not damaged by excessive heat. The unit should then be mounted in a small plastic, or metal, box.

Two different switching systems may be used to enable the alarm. Use either an external key switch mounted in a convenient, but not obviously seen location, or a two way system of concealed switches — one inside and one outside. The switch inside is used to enable the alarm (after opening the door) and the external one to disable the alarm before entering the car. This latter system has the advantage that anyone watching will not see where the external disable switch is located.

### PARTS LIST — ETI 313

R1,2	Resistor	1k ½ watt 10%	D1	Diode IN914 or similar
R3	"	10k ½ watt 10%	D2	Diode OA95 (must be germanium)
R4,5	"	100k ½ watt 10%	RL2	Relay 12 volt 280 ohm coil, 6A contacts. Associated Controls type E3201 or similar.
R6	"	1M ½ watt 10%	PC board	ETI 313
RV1	Potentiometer	2.2 meg	SW1	Switch SPST key operated
C1	Capacitor	25µF 25 volt electrolytic	SW2,3	SPDT toggle (see text) metal or plastic box to suit.
C2,3	"	1µF 25 volt electrolytic		
C4,5	"	0.1µF polyester		
IC1	Integrated Circuit	NE556		

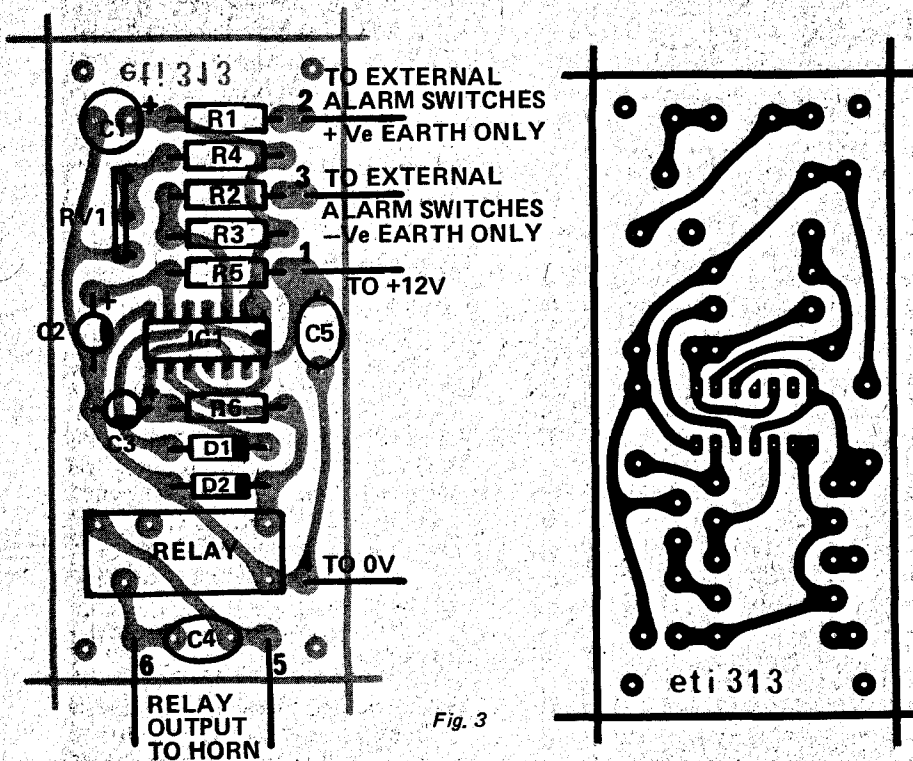

Fig. 3

## HOW IT WORKS

When a load, especially an incandescent lamp, is switched onto a battery the battery voltage will drop instantaneously and then return to normal. The amplitude and duration of this negative going spike in the supply is dependant on the size of the lamp used but is of sufficient amplitude, even with small globes, to trigger an alarm circuit.

The NE556 IC contains two NE555 timer ICs in a single case. One of the timer sections is used to detect the supply spike and to gate on the second timer which produces a one Hz output to the relay and horn.

Each timer section contains two comparators, a LOW comparator set at 1/3 supply and a HIGH comparator set at 2/3 supply. These comparators set a flip-flop which provides an output.

When the power is first applied, the voltage at pin 6 (input to the low comparator) is initially low for about half a second whilst C2 charges via R5. This sets the output of the flip-flop to a high state where it will remain regardless of further excursion in the voltage at pin 6.

The only way that the output may be set low again is for the input to the high comparator (pin 2) to be taken past its threshold. This threshold voltage is available at pin 3, and by using a voltage divider (R3, R4 and RV1) a slightly lower voltage is derived from it. This is used as a reference level to the HIGH comparator input (pin 2). Capacitor C1 is used to bypass any fast transients which may appear at the input (pin 2).

If the supply falls, the voltage on pin 3 will also fall. If it falls below the voltage at pin 2, the output will fall again to a low state and will stay there. The capacitor C1 will also be discharged via pin 1.

The second half of the IC is connected as a free-running multivibrator having a frequency determined by R6 and C3, of about 1 Hz. If the output of the first stage is high, the diode D1 will force the multivibrator to lock into the low state. When the output of the first stage goes low the multivibrator is freed to oscillate.

This one hertz output switches a relay which in turn controls the horn, or any other suitable device. The diodes across the relay prevent reverse voltages being generated which could damage the IC. This must be a germanium type for correct operation.

# oliver's

**ELECTRONICS SUPPLY**

24 hour mail-order service

*Super Value*



9 digit calculator with floating decimal point, Texas Instruments I.C.'s, 10 second fade on, 3" LED readout with instant recall, rechargeable nickel cadmium batteries

with separate charger, a gift at only \$24.90 guaranteed. (Post & pack \$1.00).



**Loudspeaker Kits**

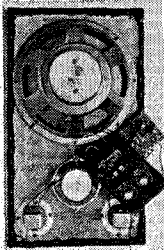

12", 3" 2 tweeters complete with baffle, grille cloth crossover networks, bass and tweeter attenuation, super sound for only \$59.95 (Post & pack \$1.50).



A.M. — F.M. Radio-Alarm clock.

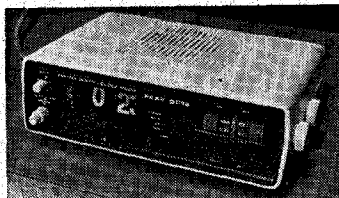

Quality reception on both radio systems health alarm with snooze period \$47.50. (Post & pack \$1.00).



188 Pacific Highway,  
St. Leonards, NSW 2065.  
P.O. Box 4,  
Phone 43-5305.

# now available.. for all audio systems

sanken hybrid audio power amplifiers

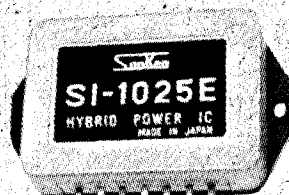

Series S1-1000A Sanken Audio Amplifiers are high power hybrid amplifiers for Hi-Fi, stereo, musical instruments, public address systems and other audio applications. Two power ranges of 25 and 50 watts rms output are provided. The amplifiers are completely self-contained, requiring only an output coupling capacitor, parasitic oscillation suppressors and a power supply. • Single-ended push-pull output. • Withstand a 5 second output short-circuit • Less than 1/2% distortion at 25 and 50 watts. • 1/2 dB response from 20 to 100,000 Hz.



Model S1-1010Y Sanken Audio Amplifiers are medium power hybrid amplifiers for Hi-Fi, stereo, musical instruments, public address systems and other audio applications. The amplifiers do not require a heat sink for operation at 25°C ambient or less. • Single-ended push-pull output. • Withstand a 5 second output short-circuit

Sanken Hybrid Voltage Regulator S1-3554M (5v, 3A). • High power hybrid voltage regulator of monolithic circuitry and a power transistor chip. • Power supply for TTL and DTL IC's in control and measuring equipment. • Few external components and no further adjustment required. • Built-in circuit protection against continuous overload and short circuit.

For full information please write or phone:

Exclusive Australian Agents: **TRISTATE ELECTRONICS PTY. LTD.**

Distributed by:

**GEORGE BROWN & CO. PTY. LTD.** Cnr Sussex & Druitt Streets,  
Sydney, N.S.W. 519-5855

**TECHNOLOGY PRODUCTS**, 70 Milton Parade, Malvern, Victoria  
20-7839

**FRED HOE & SONS PTY. LTD.**, 246 Evans Road, Salisbury North  
Brisbane, Qld. 47-4311

**CONTINUOUS MUSIC SYSTEMS & ACOUSTICS (W.A.)** 8

Oswald St., Victoria Park, W.A. 61-4464

**K.D. FISHER & CO.** 72 McClaren Street, Adelaide, S.A. 223-6294

# The timer of 1001 uses.

**signetics**

At last. A true standard IC timer with almost universal applications. The new low-cost 555. From Signetics-Linear, of course.

And the most extraordinary advantage of 555: it's so ordinary, and so simple to use. With designed-in flexibility that's never been matched, spec for spec.

555 functions interchangeably as a time delay, oscillator, pulse detector or power modulator. Timing from microseconds through one hour. With time delays completely resettable.

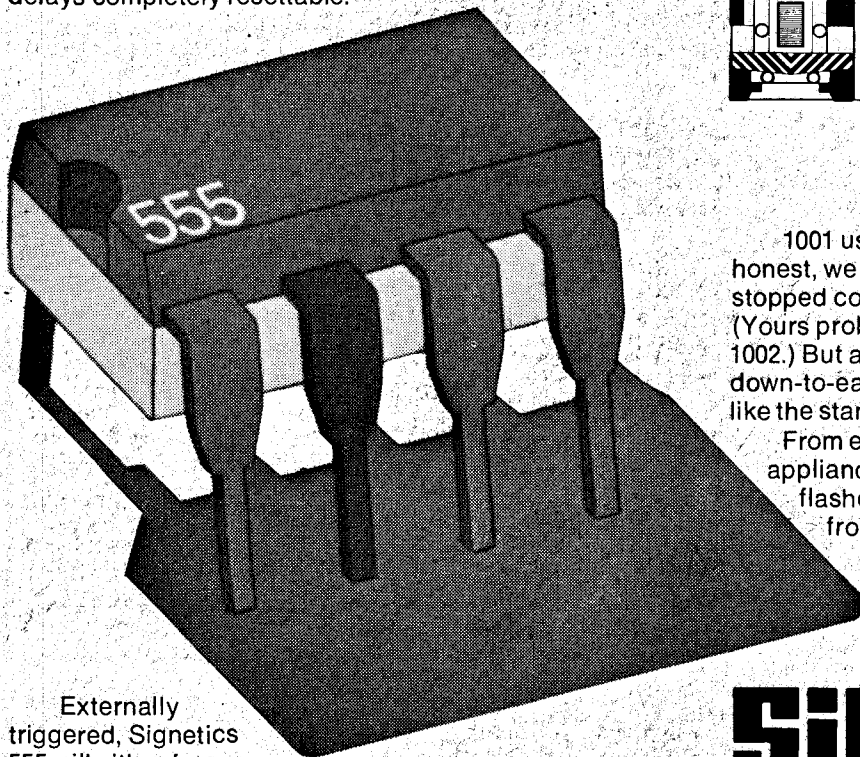
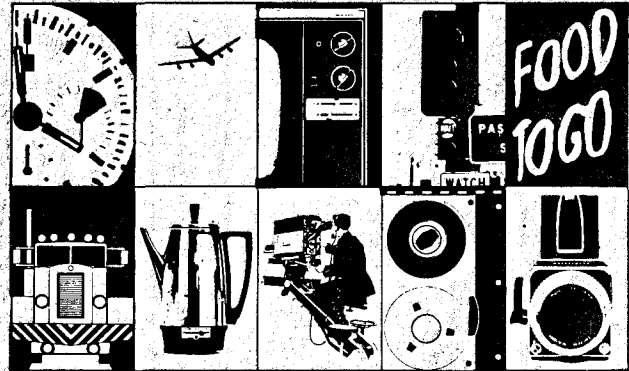

Externally triggered, Signetics 555 will either free run or latch, in adjustable duty cycles from 50% to 0.01%. Timing can be changed 10:1 with control. Operating from 5 to 15 volts with only a 1% change in timing. Output can source or sink 200mA. Temperature stability: 0.005% per °C.

And applying the adaptable 555 is practically child's play (if the kid knows basic math). Requires only a resistor and capacitor to do the job. With all kinds of options for starting the timing action. And you can operate 555 from just a single power supply.

All this, in one simple 8-pin dual in-line circuit. Available off-the-shelf now, from your distributor at rock-bottom cost.

1001 uses? To be honest, we haven't stopped counting yet. (Yours probably makes 1002.) But a versatile down-to-earth IC timer like the standard 555 suggests applications unlimited.

From exotic technology to household appliances... from copying machines to barricade flashers... Start thinking. And you can take it from there.

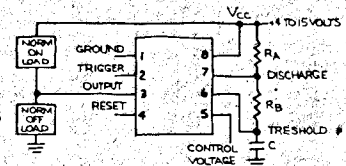

**signetics**

TECNICO ELECTRONICS



Premier Street, Marrickville, N.S.W. 2204. Tel. 55 0411  
2 High Street, Northcote, Vic. 3070. Tel. 489 9322  
Brisbane: 97 8222. Adelaide: 51 6895. Perth: 25 5722.

T8237/373

# METER BEATER

The completed unit. Note the crystal earpiece at bottom centre.



## CONSTRUCTION

The prototype was constructed on a 47 x 55 mm piece of 0.1 inch pitch Veroboard. This may conveniently be mounted in a small tin such as that shown in the photographs. The Veroboard tracers should be cut in the pattern as shown in Fig. 2. Note that in the component overlay (Fig. 3) the components are drawn as seen from the opposite (component) side of the board.

Take particular care to orientate ICs transistors and electrolytic capacitors as shown in the component overlay. Use a lightweight soldering iron and solder quickly and cleanly. Take particular care with the CMOS IC, IC2, (See ETI August 74, page 80).

As tantalum capacitors have tolerances of +50% to -25% it may be necessary to select values for R1 and R2 to obtain the time required for the 1/2 hour alarm. Once this is set the other times are right.

Build this simple 555 - based timer and avoid expensive parking fines.

FOR THE PRICE of two or three parking fines you can build the Meter Beater - and never get caught again!

The Meter Beater is simply a portable audible alarm which can be set for common parking meter periods - 1/2

hour, 1 hour and 2 hours. Several minutes before the expiry of the period it sounds a warning - giving you time to get back to your car. It is set by sliding one of the three switches visible in Fig. 1.

## PARTS LIST ETI 229

R3,4,5	Resistor	33k 1/4watt 5%
R6,7,8	"	33k 1/4watt 5%
R1	"	1M 1/4watt 5%
R2	"	4M7 1/4watt 5%
RV1	Potentiometer	preset 1 megohm
C3	Capacitor	0.0047µF polyester
C2	"	0.1µF polyester
C1	"	47µF 6.4 volt tantalum
IC1,3	Integrated Circuits	NE555
IC2	Integrated Circuits	CD4024AE, MC14024 or similar
Q8	Transistor silicon NPN type	BC108 or similar
S1,2,3	Switch	DPST slide
Transducer - see text, metal box, spacers, nuts and bolts.		

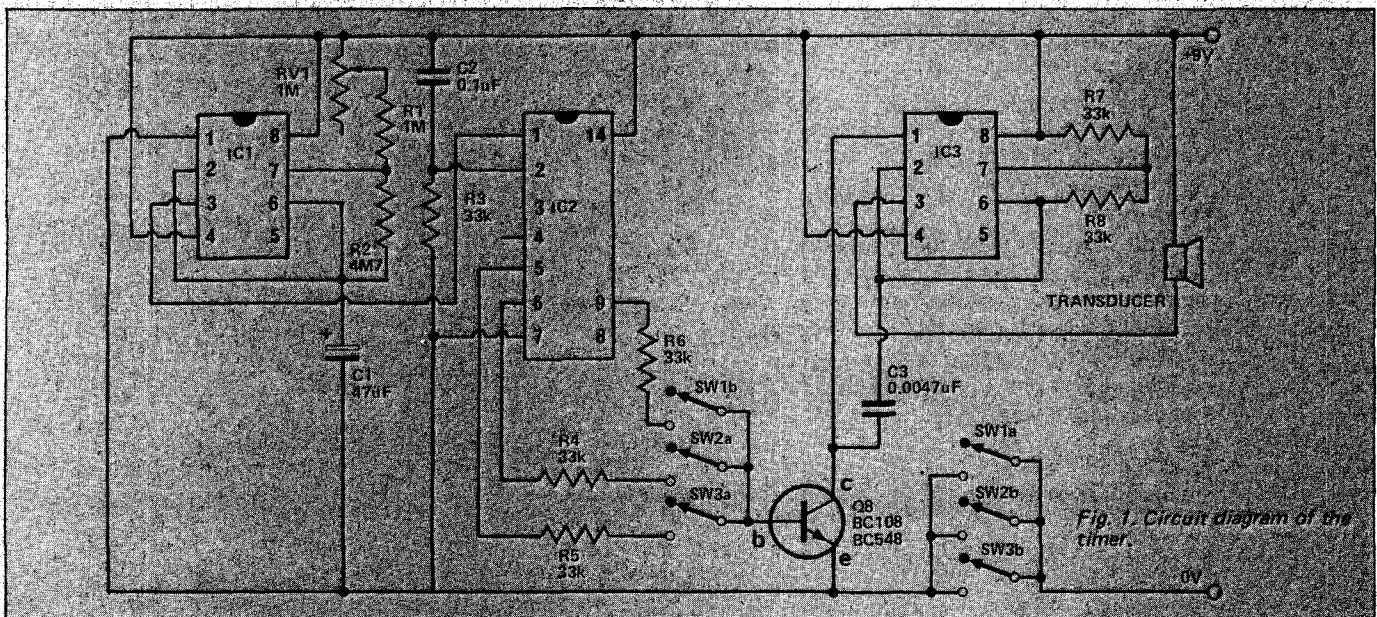

Fig. 1. Circuit diagram of the timer.

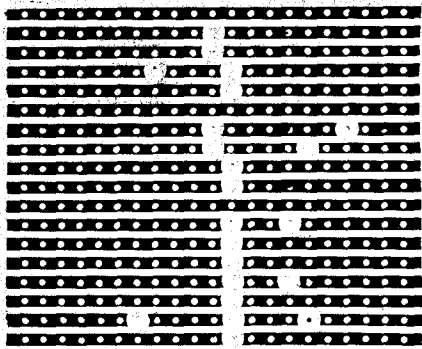
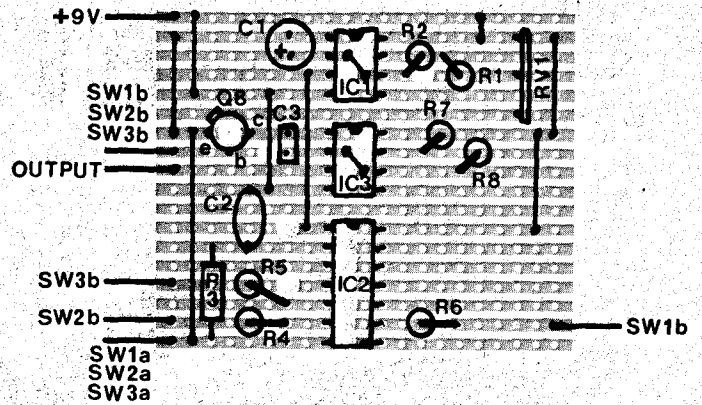

Fig. 2. Veroboard pattern. The tracks should be cut as shown. Full size 47 x 55 mm.

Fig. 3. Component overlay.



## HOW IT WORKS

The Meter Beater comprises three elements - a 555 timer connected as a very slow-running astable multivibrator; a seven stage ripple counter; and a 555 timer connected as an audio frequency astable multivibrator feeding an output transducer.

Potentiometer RV1, R1, R2 and C1 are the timing elements associated with the first 555 timer IC1. At switch on, the output of IC1, terminal 3, goes high. About 5½ minutes later it goes low, and two minutes later it goes high again. This is shown in the timing diagram. The first high period is longer than subsequent ones because during the first period the capacitor C1 has to be charged from zero up to 2/3 of battery voltage, whereas in later periods the capacitor is charging only from 1/3 to 2/3 of battery voltage. Hence each full cycle lasts about 6½ minutes.

The output pulses from IC1 are connected to the input of the seven stage ripple counter IC2. For those not familiar with this device - it comprises seven, bistable multivibrators (flip-flops) connected in series. One output terminal of each flip-flop (FF) is brought out to a pin and they are named Q1 to Q7 in the pin assignment diagram Fig.5. Assuming all outputs are first set low, i.e. logic 0, then when the first negative going edge of the input pulse reaches the input of FF1, its output

Q1 changes and goes high. When the next negative going edge reaches the input of FF1, its output changes again, i.e. goes low. See graph of output of Q1 on Fig.4. The negative going edges of the input pulse train are numbered 1 to 16. It can be seen that, at edge 2, the output of FF1 is negative going, and this, being connected to FF2 which is also negative edge sensitive, sends the output Q2 of FF2 high. It can be seen that the output of FF1 goes high at half the frequency of the input, and similarly, the outputs of the other FFs are at half the frequency of the preceding FF.

It can be seen that Q3 goes high after four negative going edges, Q4 goes high after eight negative going edges and Q5 goes high after 16 negative going edges.

It will be noted that only outputs Q3, Q4 and Q5 have been used in this project. Q1, Q2 and Q3 could have been used if IC1 had been made to oscillate much more slowly - but this would have involved higher timing resistors and capacitors - with associated problems of leakage current approaching charging current, and the consequent inaccuracy.

Now, reverting to the circuit diagram - it will be seen that each of the three switches is a double pole type and each performs two functions. One pole of each switch i.e. S1a, S2a and S3a connects the battery to the circuit, but S1b connects output Q3 to IC2 to Q8 (called Q8 to avoid confusion with

the outputs of IC2) an NPN transistor used as a switch. S2b connects output Q4 to Q8, and S3b connects output Q5 to Q8. Thus when S1 (the ½ hour switch) is closed, the battery is connected and output Q3 is connected to Q8. After about 25 minutes the output Q3 goes high and turns on Q8. This energises the second 555 timer IC3, for which R7, R8 and C3 are the timing elements. These timing elements set the 555 in the astable mode at audio frequency. The output is connected to the transducer which provides an audible alarm. Similarly when S2 (the one hour switch) is closed, the alarm sounds after about 50 minutes, and when S3 (the hour switch) is closed the alarm sounds after about 1 hour 45 minutes. The amount by which the alarm is ahead of the exact meter period is greater with longer periods, and this allows for the fact that one probably goes further from one's car when it is parked for two hours.

For the device to work it is obvious that all outputs of IC2 must be set low at switch on. The IC has a reset terminal, Pin 2, which must be set high so that all outputs are reset to low, and must be set low to enable counting to proceed. R3 and C2 provide these functions. At switch on, Pin 2 is 'flicked' high by the pulse through C2, but as C2 charges (which takes very little time) Pin 2 is brought down to negative rail voltage, allowing counting to proceed.

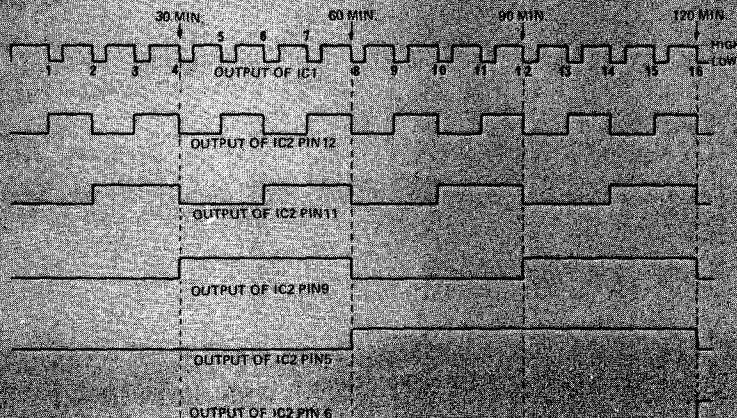

Fig. 4. Timing diagram for the unit.

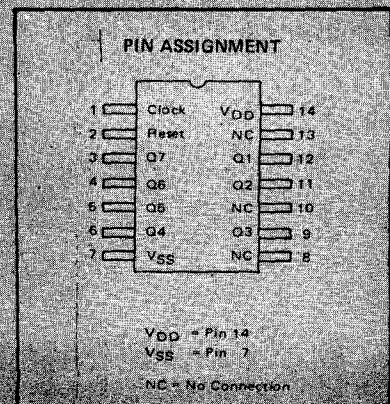

Fig. 5. Pin assignment diagram for the 555 timer IC.

## OUTPUT TRANSDUCER

The output transducer used in the prototype was a hearing-aid earpiece of about 400 ohms. However these are quite expensive. Alternatively a cheap lapel crystal microphone, mounted on the outside of the tin box, makes a good 'speaker' or a crystal radio earpiece may be used. If a magnetic earpiece is available it may be also used provided that it is fed through a small electrolytic capacitor — say 4.7 $\mu$ F. All of these will work quite well but the best of all, if available, is the hearing-aid earpiece. Whichever device is chosen it is not worn in the ear, but mounted on the lid of the tin box, by means of a small aluminium strap. The complete alarm may then be slipped into a pocket where it is easily heard.

The inside of the tin box and the lid should be insulated with plastic sheeting before fitting the 'works'.

### ADJUSTMENTS

The only adjustment provided is the preset pot RV1. This sets the duration of the "½ hour" alarm as close to half an hour as desired. However, as pointed out earlier, if the tantalum capacitor is well off the marked value,

then a change may be needed to R1 and R2 to obtain the correct adjustment range for RV1.

The switching transistor Q8 should be turned hard on, to obtain the maximum voltage across IC3. This may be checked by measuring the voltage across the transistor when it is on — i.e. the alarm is sounding. It should be less than 1 volt. If it exceeds 1 volt then the value of the base resistors R4, 5 and 6 should be reduced to ensure saturation.

### USE

To use the Meter Beater, simply switch it on after putting your money in a parking meter, using the switch appropriate for the time for which you've paid. Put the Meter Beater in a shirt pocket and in due time it will sound off a warning that you must be heading back to your car.

### OTHER USES

As will have been noted, only three of the outputs of IC2 have been used. The other outputs can be used for shorter or longer times if desired — up to nearly eight hours. Thus the unit is essentially a long period timer and may be adapted for such purposes as timing hire periods of, say, billiard tables; process timing; a medicine



Internal view of the completed timer showing how it is assembled into a small tin.

reminder alarm, and any similar long period applications.

### BATTERY LIFE

Battery consumption is very low — only about 4 mA, hence the 9 volt battery used should have a life of about 100 hours, at two hours use per day.

# Deitron

## 51 Kyle Parade, Kyle Bay, Telephone: 546-7000

The new Deitron DSA series amplifiers offer exceptional physical appearance, unbelievable performance and numerous extra facilities normally not incorporated in amplifiers in this price range.



### DSA 1212

Power output: 12w x 12w  
RMS  
Harmonic dist: 0.5% max.  
Freq. response: 20Hz —  
30KHz  
Dimensions: W13½" x  
D10 1/16" x H5½"

### DSA 1515

Power output: 15 x 15w  
RMS  
Harmonic dist: 0.5% max.  
Freq. response: 20Hz —  
40KHz  
Dimensions: W15 7/8" x  
D11 x H5½"

### DSA 2525

Power Output: 25 x 25w  
RMS  
Harmonic dist: 0.3% max.  
Freq. response: 20Hz —  
40KHz  
Dimensions: W15 7/8" x  
D11" x H5½"

For further information write to DEITRON INTERNATIONAL for your dealer list.

Why Pay More?  
The Price is Right  
at M.S.C.

# M.S.C. COMPONENTS

EVERYTHING IN ELECTRONICS

95-97 REGENT ST., REDFERN N.S.W. 2016  
P.O. Box 156 REDFERN 69-5922

HOURS OF TRADING:  
MON-TUES-WED & FRI: 9am - 5.30pm. THURSDAY: 9am - 7pm.  
SAT: 9am - 1pm. C.O.D.'s: Please add \$1.20 to Posting fee. NO ORDERS UNDER \$3.00 accepted. S.A.E. FOR REPLIES PLEASE. Post & Packing 50c where not included. PLEASE PRINT YOUR NAME & ADDRESS.

## THE GREAT NAME FOR ELECTRONIC COMPONENTS IN AUSTRALIA

### FIGARO TGS-SENSING SEMI-CONDUCTOR DEVICES.

The very latest in Gas detection devices, now available for the constructor and project man. The device is a sintered n-type semi-conductor which is composed mainly of tin oxide. Two devices are now available. These are for low voltage application. Type TGS 202. For detection of Carbon Dioxide. Type TGS 308. For detection of Liquid Petroleum Gas. Data sheet supplied for each device. Price \$4.50 each P & P 40c.



### 3 WATT AMPLIFIER KIT

Consists of the M5102AY Power I.C. which is a 10 lead I.C. in a modified JEDEC T01 Case. Supplied in a ready drilled and prepared P.C. Board, Heat-Sink, all necessary external components and full wiring instructions. \$6.95 plus 50c P&P.



### NOW AVAILABLE: THE LONG AWAITED PHILIPS 12" SPEAKERS.

Type No. AD 1265/W8 with 30 Watts R.M.S. Resonance frequency: 20 Hz; Frequency response: 20 Hz - 2 kHz; Crossover frequency: 800 Hz Our super price only \$19.95. P & P \$2.50



### CARGARD CAR BURGLAR ALARM

CARGARD 100HR A fully automatic car burglar alarm which can be installed in minutes in any 12 volt vehicle. (It detects any disturbance in the electrical system of the car e.g. when a door courtesy light operates - so it eliminates all special wiring, door switches and other installation problems). An electronic exit/entry delay is included in the module so the unit can be switched on from inside the car before the driver leaves. The output is a pulsating horn relay which automatically horns after three minutes. A full set of parts, assembled and tested with detailed instructions for the do-it-yourself man to install in any 12 volt car is available for \$29.50 \$1.00 post and packaging.



CARGARD is fully guaranteed by the manufacturers for 12 months from date of purchase.

### GO OUR PRICES CRASH ON SNETICS NE555 TIMER

Owing to an enormous purchase of these very versatile linear I.C.'s we can now offer these at the very low price of \$1.25 each or 10 for \$11.50.

FEATURES. Timing from Microseconds through Hours; Operates in both Astable and Monstable Modes; Adjustable Duty cycle; High current output can source or sink 200 mA; Output can drive TTL; Temperature stability of 0.005% per °C; Normally ON & OFF output.

ALSO SPECIAL OFFER OR SNETICS NE555 TIMER (Replaces TWO 555 Timers). Same features as above but in 14 pin DIL Package. \$2.15 each or 10 for \$20.00.

'STAR-PACS' Don't miss out on these. All PACS contain new & unused quality components and are not rejects. Our bulk buying make these prices possible.

PAC 'A' TOROIDAL CORES TMC type 107527 SB. External diameter 1 3/8" x 3/8" deep; Internal diameter 3/4"; approx. 6 for \$2.00 P & P 50c.



PAC 'B' TOROIDAL CORES TMC type 107763 JB. External diameter 2 7/8" x 7/8" deep; Internal diameter 1 3/8" approx. 2 for \$1.00 P & P 75c.



PAC 'C' PHILIPS BEEHIVE TRIMMERS. One of the most ingenious trimmers ever produced. Concentric air-spaced type. 3-30P & 10-90PF. 3 of each type. Only \$2.00 for the 6. P & P 30c.

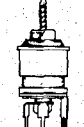

PAC 'D' MONSTER TAG STRIP PAC. 50 assorted tag strips. From 2 to 9 tags. With and without mounting feet \$7.50 value for only \$1.50 P & P 50c.



PAC 'E' MONSTER CAPACITOR PAC. 50 branded capacitors. Each pac contains 25 different Electrolytics & 25 different polyester, ceramic and mica capacitors. We guarantee 50 different types with no repeats. ALL NEW, UNUSED & PERFECT. \$15.00 value at only \$5.00 P & P 65c.

PAC 'F' 200 assorted 10% & 20% resistors. From 1/4 to 2 watt. All branded makes. Superb value at only \$2.00 P & P 65c.

PAC 'G' Containing 10 Unmarked but guaranteed BC177 or BC178. We cannot say how many of either type would be in a PAC, but this is tremendous value at only 95c P & P 30c.

PAC 'H' Containing 10 unmarked but guaranteed NPN transistors in T05 package. Believed to be the TT800 series transistors. Last few now remaining at 95c P & P 30c.

PAC 'I' 20 ARROW toggle switches. S.P.D.T. type Very sturdily constructed and with moulded Dolly. In original packs of 20. Unbeatable value at \$3.00 for 20. P & P 85c.



PAC 'J' 20 3.5mm Jack sockets. Open type \$1.50 P & P 15c.



PAC 'K' 10 3.5mm Jack sockets. Housed type. \$1.25 P & P 15c.



PAC 'L' 10 3.5mm Jack sockets. Housed switch type. \$1.75 P & P 15c.



PAC 'M' 10 assorted miniature type TRIMPOTS. 10 different values. Carbon track. Imported brand. Only \$1.00 P & P 20c.



PACK 'N' IBM Computer board. 10 boards containing at least 40 transistors, resistors, diodes & caps. Only \$3.00 P & P 65c.

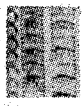

### A & R TRANSFORMERS

Great savings for 'Hard to Get' Transformers. All Listed are 240V Primary.

TYPE	SECONDARY	RATINGS	PRICE
1992	150.0-150 & 6.3V	1.7A	\$10.00
1993	225.0-225 & 6.3V	2A	\$ 9.00
2150	6.3 or 12.6V	2.5 or 1.25A	\$ 6.95
2155	16, 12.6, 9.5, 8.5, 7.5 & 6.3V	1A	\$ 6.25
5802	22 or 44V	2.5 or 1.25A	\$ 9.00
5808	6.3 or 12.6V	4 or 2A	\$ 7.60
5809	12.5 or 25.2V	5 or 2.5A	\$11.00
5879	6.3V	1A	\$ 5.50
6413	32V	2A DC FWD	\$12.95
6672	30, 27.5, 24, 20, 17.5 & 15V	1A	\$ 9.50
6978	15, 12.6, 10.5, 9, 7.5, 6.3V	2A	\$11.25
7243	50.40, 33.25 & 19V	2A	\$15.00
7909	12V	2.5A (30VA)	\$ 6.50
PS2A	BATTERY SAVER - 45, 6, 7 1/2 & 9V (Nominal Voltage)	0.1A	\$12.25
PS164	BATTERY SAVER - REGULATED 4.5, 6, 7.6 or 9V	0.3A	\$15.50
FERGUSON Low Height Power Transformers			
PF3596	2 x 6V each at 10VA	Approx 1A	\$ 6.00
PF3597	2 x 7.5V each at 10VA	ditto	\$ 6.00
PF3598	2 x 9V each at 10VA	ditto	\$ 6.00
PF3599	2 x 12V each at 10VA	ditto	\$ 6.00
PF3600	2 x 15V each at 10VA	ditto	\$ 6.00
PF3601	2 x 20V each at 10VA	ditto	\$ 6.00
PF3602	2 x 25V each at 10VA	ditto	\$ 6.00
PF2851	12.6V CT	150mA	\$ 6.00
PF3677	56V CT	1.5A	\$12.90
SCOPE	Soldering Iron transformer	3.3V 30A	\$10.20

All transformers listed above are subject to \$1.25 P & P.

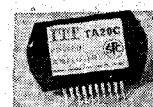

### GREATEST OFFER OF HYBRID POWER AMPLIFIERS EVER MADE.

Full descriptive Data supplied with each one.  
ITT TA-20C 20 watts \$5.95  
ITT TA-20C 20 watts \$11.95  
Sanyo STK015 (TA10B) 10watts \$7.00  
Sanyo STK032 (TA25C) 25watts \$15.75  
P&P 35c.

## NEW ASSEMBLY KITS for the HI-FI SOCIETY...

Enjoy "DO IT YOURSELF" and save money. Precision made to extremely high standards by I.T.T. West Germany, providing the ideal loudspeaker combination for each amplifier and each living room. Their excellent technical design, combined with a careful selection of the appropriate accessories guarantee high quality HI-FI sound reproduction. A 'FIRST' for M.S.C. ... 3 GREAT MODELS TO CHOOSE FROM.

KIT NO: BK 4-50. Contains 1 30W bass speaker, 1 Hemispherical Tweeter, 1 Two-way cross-over unit. Price \$65.95 Post \$3.00

KIT NO: BK 4-70. Contains 1 40W bass speaker, 1 mid-range speaker, 1 tweeter, 1 three-way cross-over unit. Price \$99.95 Post \$3.50.

KIT NO: BK 4-100. Contains 1 60W bass speaker, 1 hemispherical mid-range speaker, 1 tweeter, 1 three-way cross-over unit. Price \$169.95 Post \$4.50.

Each kit also contains the following: - Complete set of plug and socket connections, connection cable, sawing and drilling templates, fixing and sealing material, assembly instructions and firm sign (Logo). Also supplied is a comprehensive 20 page information & Data manual. ENCLOSURE KITS for the above kits can be easily assembled since each part has been accurately finished and everything fits exactly. Each kit is prepacked with easy Step-by-Step instructions and comes to you in a handsome carton gift pack. Each cabinet enclosure kit contains the following: 4 Veneered side panels, 1 Veneered rear panel, 1 Loudspeaker panel, grill cloth, adhesive (Blue tube), cold wood glue (orange tube), brackets & screws, assembly instruction.

Cabinet assembly Kit No: HBS 4-50 \$39.95 each Post \$3.00  
Cabinet assembly Kit No: HBS 4-70 \$43.95 each Post \$4.00  
Cabinet assembly Kit No: HBS 4-100 \$68.95 each Post \$5.00

SUPPLIES ARE LIMITED SO GET ON THE 'BANDWAGON' WHILE YOU CAN. PLACE YOUR ORDERS NOW ... NEXT SUPPLIES AVAILABLE DEC. '74.

### 'VORTEX'

Stereo Cassette Deck mechanism with tape eject facility and resettable counter. Easily operated by 5 push-button (piano key) controls, and includes high quality 'ALPS' recording, play-back and erase heads. Tape speed 4.7cm (1-7/8") sec. Plus or minus 1.5%. Wow and flutter less than 0.25%. Operates on 240VAC. Full data and specifications supplied with each purchase. Our price now only \$29 post free.



### BATTERY CHARGER 4

An all purpose battery charger for - cars - caravans - motorbikes - power boats, etc. Provides a HIGH CURRENT BOOST charge to quickly energise flat batteries or a LOW CURRENT TRICKLE charge to maintain the charge in batteries which are used intermittently. Charger 4 has these unique features: • Large scale ammeter for monitoring charging rate • Plug selection for 6V and 12V batteries • Fully guaranteed for 12 months.

M.S.C. Price Only \$29.95. Post and Packing \$1.50



# PHILIPS Motional Feedback Loudspeakers

Remarkable performance from truly bookshelf speakers.

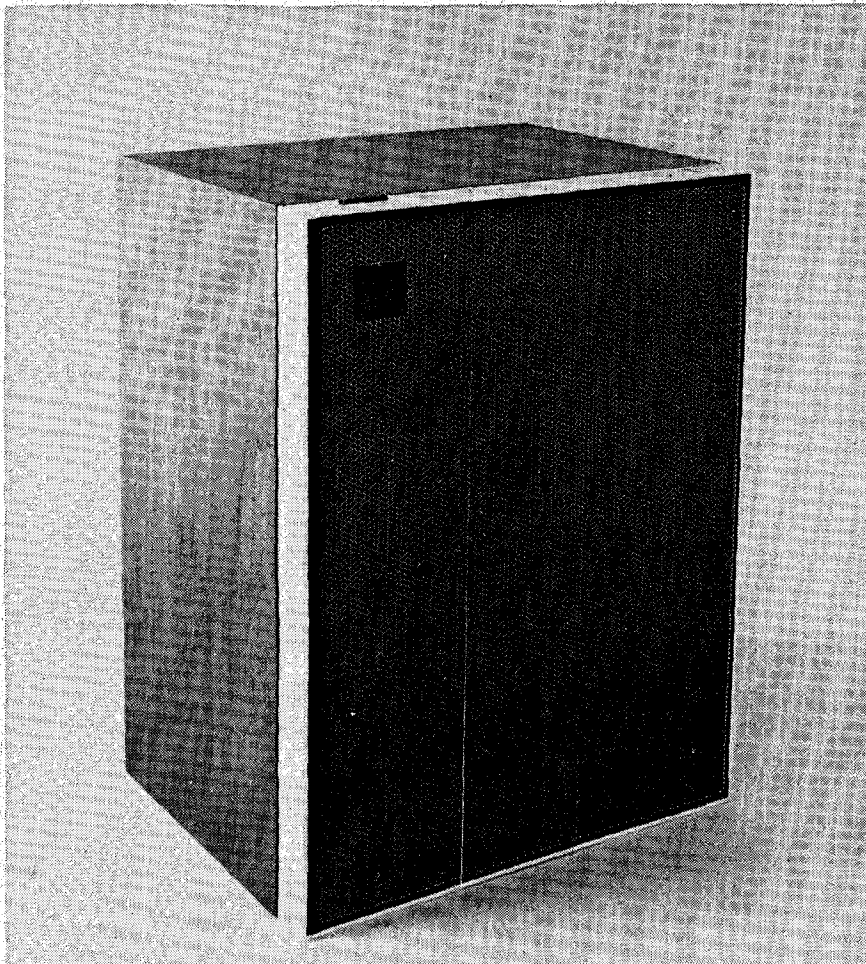

EVERYBODY WOULD LIKE to own a loud speaker that takes up zero space, does not detract from the room's appearance, and provides the sort of performance that one has come to expect from large bass reflex type enclosures, but few small loudspeaker systems have low frequency performance comparable to their big brothers.

The first attempt applied to overcome this limitation was that

proposed some ten years ago by Mullard, who introduced the concept of a small loud speaker system with low frequency response improved through the judicious use of bass boost. But this approach tends to result in a peaky response at the bass end. It also requires a loud speaker with plenty of low frequency travel, as well as a more powerful amplifier. Now, more powerful amplifiers are the vogue, so power is not a problem in

itself, but even so the bass boost approach does not necessarily result in a substantially better or cleaner sound.

Philips' approach is far more complex. They place a small piezoelectric accelerometer at the heart of the low frequency driver and separately connect this up as part of their feedback system. This accelerometer generates a voltage proportional to the acceleration of the cone and this output is compared electronically with the original audio signal. Any difference voltage is returned as a corrective signal to the amplifier. In this way any non-linear motion of the cone (with reference to the original electrical signal) is corrected, and the acoustical signal produced becomes a more faithful reproduction of the input signal.

The speaker line up consists of an AD 8065/W4 MFB 20 mm woofer, an AD 5060/Sq8 120 mm mid-range speaker (both the mid-range and woofer have flexible surrounds to permit the long diaphragm travel required to provide the acoustical output at high levels), and the well proven AD 0160/T8 25 mm diameter dome tweeter.

These are mounted in a vented enclosure a mere 280 mm wide and 380 mm high. Apart from these drive units, the enclosure also houses two amplifiers, one rated at 40 watts (for bass), the other at 20 watts (to drive the mid-range and treble units). When one realizes that the total depth of the enclosure is a mere 210 mm, one begins to appreciate just how small the acoustical section really is.

One distinct advantage of such a small size, of course, is that the enclosure is tremendously strong and extremely rigid, and with one minor exception, free of any resonances.

Philips claim that the overall unit has a 60 watt continuous sine wave power



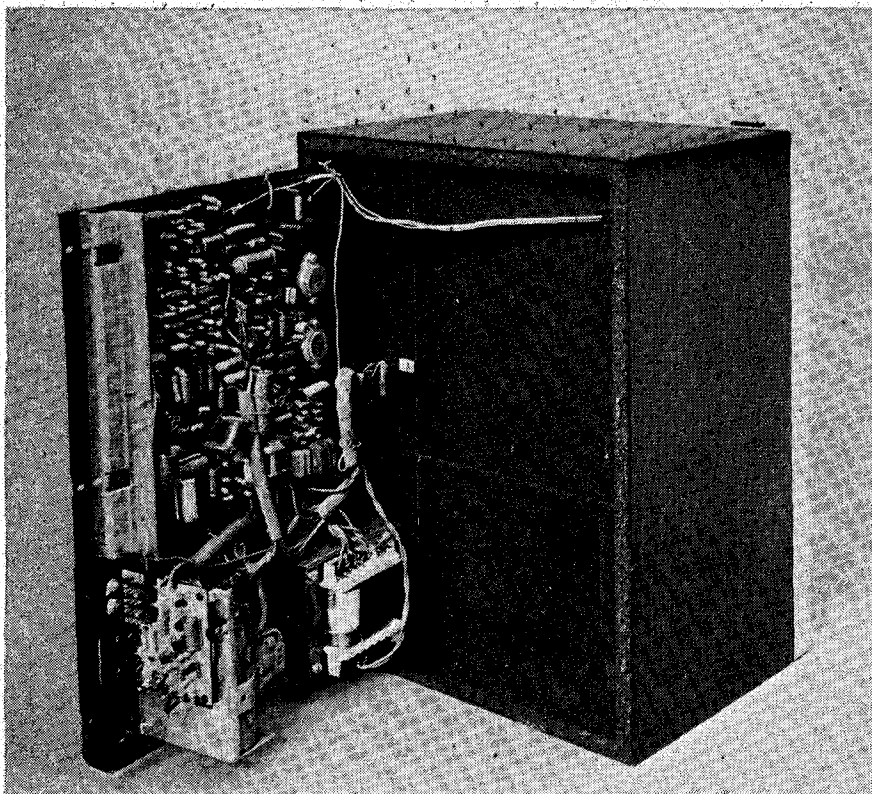

rating, but it would be almost impossible (except with pink noise testing) to truly drive both power amplifiers on a continuous basis to their maximum rating.

An electronic network is used to crossover (at 500 Hz) from the woofer to the mid-range speakers, and a passive network caters for the crossover between mid-range and dome tweeter — at 3.5 kHz.

Inputs are provided for connecting the Philips units to a preceding pre-amplifier (one volt input) or to a pre-amp/power-amp combination (7.5 volt input).

Each speaker is provided with a special power lead, using a Continental power socket on the rear of the amplifier, and (nominal) eight metre long lead fitted with DIN sockets for connecting to the pre-amplifiers or drive sources.

The power amplifiers are located behind a hinged metal cover which has located toward its base, a red power on-off switch, a mains voltage selection switch, a mains input and mains output supply socket, two buttons for selecting drive sensitivity, and left or right channel respectively,

and two DIN sockets for signal in and signal out respectively.

Included in the design is an electronic on-off switch which will only switch the amplifier on when it 'sees' an input signal and switches the amplifier off two minutes after it fails to see any new electronic signal. This is intended to reduce the power dissipation on the power amplifiers if the owner forgets to switch the unit off. The concept is good and is a useful design feature.

The total volume of each enclosure is 15 litres, of which six litres are taken up by the power amplifier. Thus the acoustic section is a mere six litres in volume — one of the smallest enclosures we have ever tested.

Our first interest was to determine how the unit sounded, and in particular whether its performance in the range 30 to 100 Hz could live up to the (advance) claims made by the manufacturers.

Our subjective test showed that the bass response is quite good down to 40 Hz, but without running more detailed tests we could not be readily sure how good or stable the unit was at frequencies *lower* than 40 Hz.

Free field tests showed that the frequency linearity in the range 50 Hz to 16 kHz is particularly smooth on pure sine wave testing, and every bit as good as the one-third octave band plotted-figures provided with the manufacturer's data sheet.

Performance under tone burst testing was particularly interesting. At 1 kHz the tone burst performance is quite good — not perfect but more than adequate. At 6.3 kHz, the tone burst performance adds at least an extra two cycles to the original signal as well as a small amount of subsequent ringing. This is a form of colouration which is audible, particularly so at high signal levels. The speaker does have a definite sound of its own and it is clear that at high drive levels the transient response is not as linear as could be desired.

We found it interesting that the overall system distortion on sine wave testing is particularly low, with the total harmonic distortion being substantially better than most other speakers that we have tested and very much better than any other small system that we have tested.

Philips do not want this system to be evaluated on the basis of size alone, for they state that its performance is as good as most large conventional speaker systems, and in this respect their claim is basically correct. Nevertheless we believe that the people who will buy this system will do so primarily because of its small physical size.

**MEASURED PERFORMANCE OF PHILIPS RH532  
MOTIONAL FEEDBACK LOUD SPEAKER  
SERIAL NO: 13479**

Frequency Response:	40 Hz to 16 kHz	+5 dB	-7
Total Harmonic Distortion: (for 90 dB at 2 metres on axis)	100 Hz	1 kHz	6.3 kHz
	0.7%	0.3%	0.35%
Sensitivity at 1 kHz: (for 90 dB at 2 metres on axis)	low	40 mV	
	high	3 V	
Cross-over Frequency:	500 Hz and 3.5 kHz		
Measured Impedance:	low	3 K $\Omega$	
	high	25 $\Omega$	
Dimensions:	283 x 378 x 212 mm		

# PHILIPS Motional Feedback Loudspeakers

## HOW THEY SOUNDED

In live testing with high quality programme content, such as Sheffield Lab's "Lincoln Mayorga & Distinguished Colleagues Volume III", CBS SBR23514 "Kurt Vonnegut's Slaughterhouse-Five", and the Philips special demonstration record Philips 6830 532 "Revolution in High Quality Sound Reproduction", the system demonstrates excellent power handling capacity and a very clean response at levels in excess of 95 dB at 2 metres on axis, but does have noticeable colouration at higher frequencies.

Surprisingly, the performance in the critical region 30 Hz to 150 Hz is far cleaner and substantially better than could have been expected from such a system.

We were really impressed that the majority of the claims made for the speaker were substantiated by our subjective and instrumental testing. We have never before heard a speaker system anywhere near as small which could deliver comparable quality sound. In fact it is hard to imagine any other system which could deliver so much performance whilst utilising so little space.

When used in conjunction with one or more of the special Philips record players, tape recorders or preamplifier systems, which are under development, the motional feedback loud speaker system will offer a practical, compact, high fidelity solution to one of the biggest problems facing the modern day flat dweller. (The unit can of course also be used in conjunction with almost

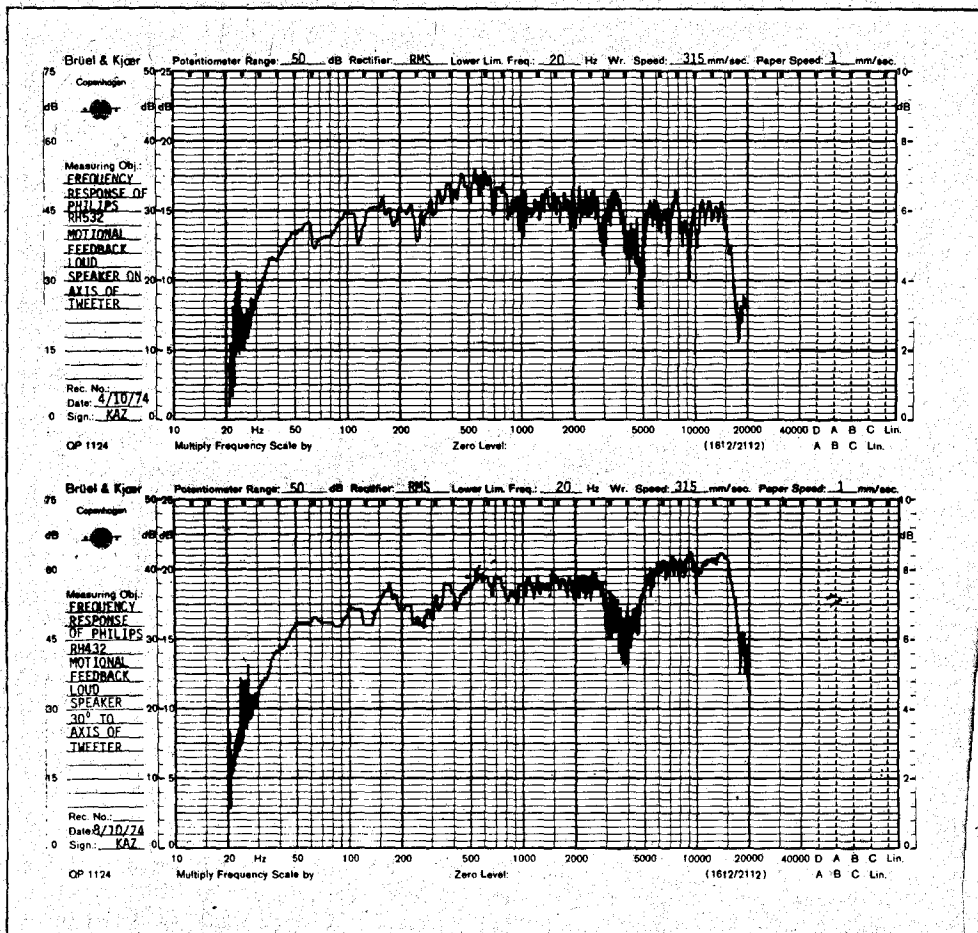

any existing pre-amp or pre-amp/power-amp combination — regardless of the power output.)

At a recommended retail price of

\$750 per pair, and considering the number of power amplifiers and their rating, the cost is far lower than might at first appear.

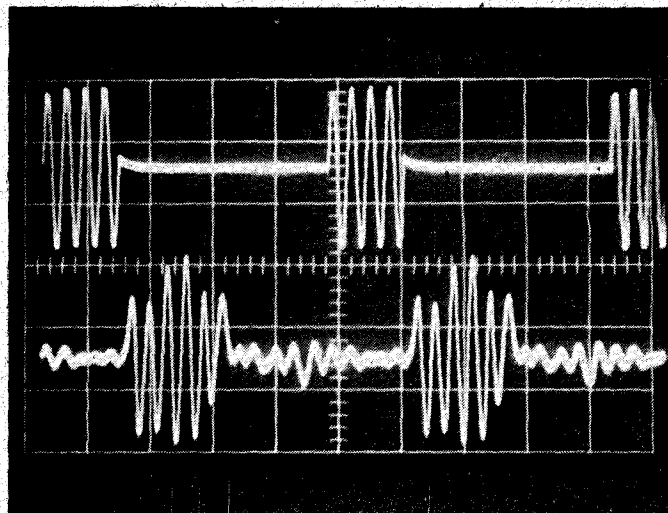
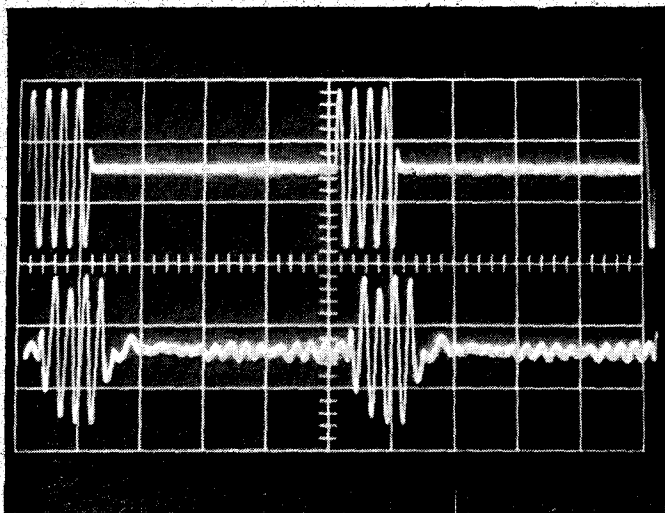

Our two tone-burst oscillographs clearly indicate how some minor colouration is generated in the treble register. LEFT: 1 kHz, RIGHT: 6.3 kHz — both at 4 ms/div. Oscillographs have been recorded using the ETI-designed tone-burst generator a feature of which is accurate control over starting and stopping phase angles and total number of cycles in each burst — note how cone movement continues at 6.3 kHz.

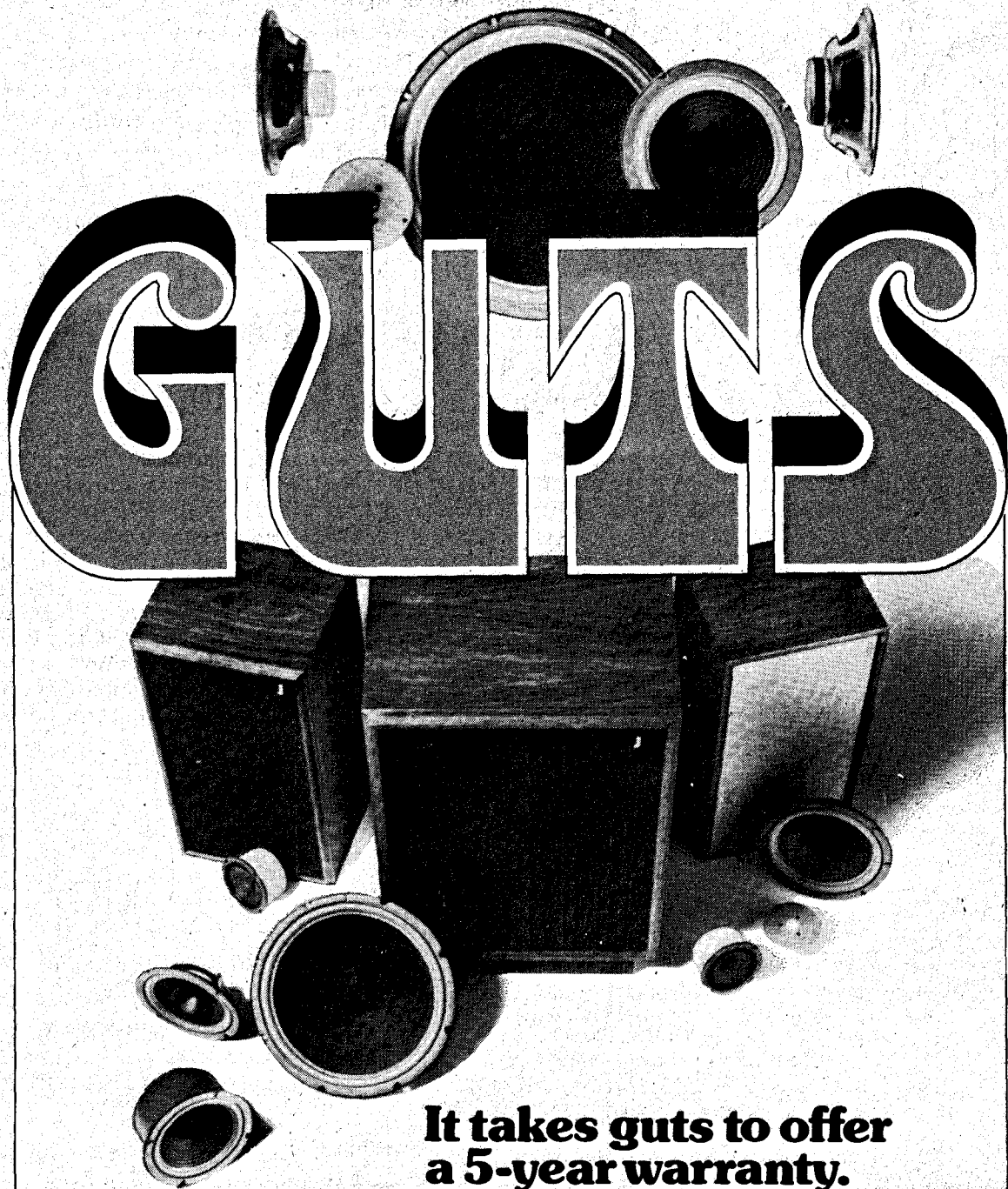

**It takes guts to offer  
a 5-year warranty.  
Good guts.**

Every Jensen high fidelity speaker comes with a 5-year warranty. It's the best in the business— an unconditional, 5-year warranty. And Jensen has the guts to give it to you. Good guts, as in our Models 4, 6 and 3, that have woofers with heavy magnets and Flexair® suspension for exceptionally clear sound. Or guts like our Sonodome® ultra-tweeters which respond well beyond audible ranges. Or, our mid-range elements with tuned isolation chambers to eliminate distortion. And special computer-designed crossover networks for optimum tonal blend. It's everything you need for excellence in speaker systems. It's the good guts inside Jensen.

AUSTRALIAN  
DISTRIBUTORS:

**BJD** Electronics Pty. Ltd.

202 Pelham St., Carlton, 3053 Vic. Ph. 347-8255  
65 Parramatta Rd., Five Dock 2046 NSW, Ph. 799-3156

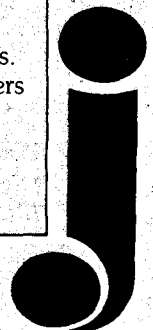



RTR Industries of California, to promote its products, use a phrase that has more meaning with each passing year... "total capability". If "High Fidelity" in reproduction is to be an end, "total capability" must be the means. In loudspeaker design, that demands a fundamental understanding of each speaker component. What better way is there to understand than to build. And this is exactly what RTR does, from the smallest tweeter and electrostatic panels, right up to the massive Magnum 25.

**"HIGH FIDELITY" - "TOTAL CAPABILITY" - "RTR INDUSTRIES"**

*For the true audiophile, a means to an end.*

# A NEW CONCEPT

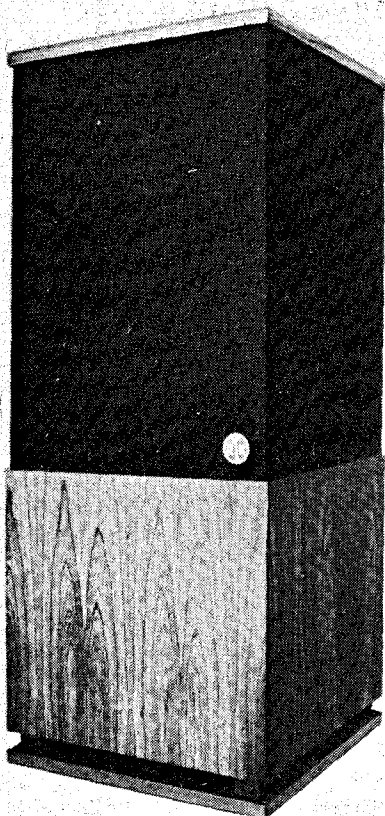

The RTR columns are a new concept in transducer application. Each elegant walnut enclosure houses multiple ultralinear butyl edge suspension woofers, one of which is planar resistive loaded. This technique yields maximum acoustic low frequency coupling, increased damping and a very smooth response curve. This powerful low frequency concept is the cornerstone of the RTR column speaker systems. The ideal speaker system should radiate uniformly hemispherically, and a RTR column achieves this ideal at the low frequency end of the spectrum. To achieve "total dispersion" at the high end of the spectrum, high frequency drivers are employed on three faces of the columns to produce an incredibly uniform polar energy response plot.

RTR column speakers, a "concert hall experience".



**MODEL 88/D**

Freq. Resp:— 40-18500 Hz.  
Size:— 11" x 26 1/4" x 11"  
Deep. Rec. Amp. Power:— 20-60 WRMS



**MODEL 180/D**

Freq. Resp:— 28-18500 Hz.  
Size:— 14" x 33 1/4" x 14"  
Deep. Rec. Amp. Power:— 25-60 WRMS



**MODEL 280/DR**

Freq. Resp:— 22-25000 Hz.  
Size:— 16 1/2" x 39" x 16 1/2"  
Deep. Rec. Amp. Power:— 25-100 WRMS

Go to your nearest RTR dealer, and have a "musical experience".

## THE MAGNUM 25

*The Magnum 25 is the largest transducer RTR builds... a 25" woofer with a 6" voice coil. It is the world's finest woofer and has no parallel.*

### SPECIFICATIONS

Power Handling:—	150 watts RMS
Free Air Resonance:—	12 Hz
Impedance:—	8 ohms
Freq. Response:—	15-800 Hz, properly loaded
B/L Product:—	7.5 pounds/amp.



**AUSTRALIAN DISTRIBUTORS:**

**BJD**

Electronics Pty. Ltd. 202 Pelham St., Carlton, 3053 Vic. Ph. 347-8255  
65 Parramatta Rd., Five Dock 2046 NSW, Ph. 799-3156

# AMCRON



BY CROWN INTERNATIONAL

## WHY

is the AMCRON DC300/A often regarded as

## 'THE REFERENCE STANDARD'?

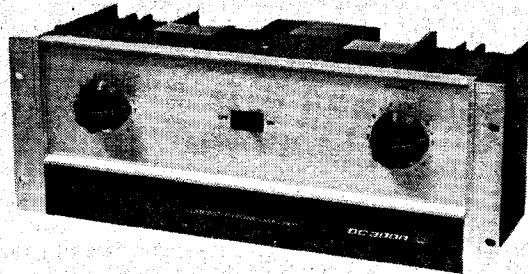

Because the DC300/A is the first totally redesigned amplifier since the original DC300. Most competitors are still using the six year old circuit designs pioneered by Amcron. Frankly, the DC300/A provides superior performance because of better design.

### POWER YOU CAN COUNT ON

One of the DC300A's most outstanding features is that it has double the number of output transistors. Each channel has eight 150-watt devices for 1200 watts of power dissipation per channel. The DC300/A is rated at 190 W/CH at 8 ohms, 340 W/CH at 4 ohms, 500 W/CH at 2.5 ohms, or plug-in two parts for 600 watts continuous mono power at 8 ohms.

### SUPERIOR OUTPUT PROTECTION

The DC300/A output protection circuitry is a radically new design which completely eliminates DC fuses and mode switches and further reduces service problems. It is superior in every way to the old VI limiting circuit pioneered by Amcron and now used by most other high power amplifiers, since it introduces no flyback pulses, spikes or thumps into the output signal, whether operating as a single or dual-channel amplifier.

Gone to is the need the baby amp by carefully juggling load configurations. The DC300/A can drive any speaker load-in fact, down to 1 ohm.

### LOWEST DISTORTION AND NOISE

The DC300/A's new IC front end sets new records for low distortion and noise. At the rated output, IM and harmonic is less than .05%, typically less than .025%, and hum and noise is -110 dB below the rated output, typically -120 dB.s,

### WHAT DO THE CRITICS SAY:

Hirsch-Houck Labs. stated:

The Amcron DC300/A almost defies comment. No load we could apply — including short circuits and large capacitors — had any significant effect on its operating characteristics. Most engineers would probably be impressed, as we were, by the incredibly low distortion of this amplifier. The absence of "crossover distortion" was apparent in the very low power IM measurements, which reached a maximum of a mere 0.014% at just about 3 milliwatts output. It is, in short, a most impressive amplifier, one that has no flaws or functional weaknesses that we could detect.

The Absolute Sound Magazine stated:

"The AR's (AR-3) with the DC300/A acquired a smoother more musical high end than I had thought possible with these speakers. By comparison, the (other brand 700 watt amplifier) actually sounded grossly distorted. I can only postulate that Amcron has had more success in eliminating crossover notch distortion ... there is no contest: The DC300/A is the best amplifier I have yet heard.

When you buy a DC300/A, you are buying more than just an amp. You are buying the Amcron company — a professional audio equipment manufacturer with a 26 year reputation for solid quality and lasting value. There are thousands of Amcron amps. in the field still working to their original specifications, and still outperforming most new amps.

The Amcron DC300/A! Still only \$795.00 R.R.P.

AUSTRALIAN  
DISTRIBUTORS:

**BJD**

Electronics Pty. Ltd.

202 Pelham St., Carlton, 3053 Vic. Ph. 347-8255

65 Parramatta Rd., Five Dock 2046 NSW, Ph. 799-3156

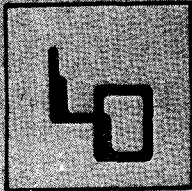

# Linear Design

BRINGS  
ON  
THE  
NEW

## For your listening pleasure — **THE EXCITING RANGE OF 'PARAMOUNTS'**

The hi-fi market has long needed a range of high-performance aesthetically pleasing speaker systems, for the hi-fi enthusiast who wants the best but can't afford overpriced imported systems.

The individual drivers in each of these systems are imported from one of America's largest speaker manufacturers, who have designed and engineered the "Paramount" range for Linear Design. The bass drivers are skilfully engineered bump-down chassis, to produce maximum cone excursions. This long-throw travel will allow for the reproduction of rich, deep bass notes without cone distortion. All the bass drivers also have the patented Alumine™ voice coil for maximum heat dissipation. All in all, a woofer that insures unparalleled

power handling capabilities and low distortion.

For high frequency reproduction, the "tweeters" are engineered with a moulded high density curvilinear cone for wide angle dispersion, and are acoustically dampened within sealed back housings. Large ferrite magnets insure superb transient response and definition. Of special design is the "phenolic ring" tweeter, as used in the models P 100 and P 300, that is a unique feature and further improves dispersion. The "phenolic ring" tweeter is used in many well-known U.S. speaker systems.

All the components are carefully selected and tested. This procedure gives you the ultimate in a speaker system, based upon your particular needs, power ratings and price range.

### PARAMOUNT 100:

An 8" woofer, with a 4 layer voice coil and butyl rubber edge suspension, insure the flattest low frequency response in the budget price bracket. This woofer, when coupled with the revolutionary "phenolic ring" tweeter, creates a system that is truly an advance of the statement-of-the-art.

Power handling:— 25 WRMS — Frequency response: 45-20,000 Hz.

Price:— \$129 per pair

### PARAMOUNT 200:

Elegant sound reproduction provides exciting listening with this "Paramount" three-way system. Powerful bass from a 10" polyurethane edged woofer, pure midrange clarity from a 4½" sealed back driver, and add a 3" curvilinear tweeter for reproduction well beyond the audible range, and you have a luxuriousness of sound that is difficult to imagine.

Power handling:— 50 WRMS — Frequency response: 41-20,000 Hz.

Price: \$199 per pair

### PARAMOUNT 300

The maximum in sound, the ultimate in quality, that's Linear Design's Paramount 300. Engineered to be the best 3-way speaker system on the market at a medium price, the 12" polyurethane woofer, 4½" midrange and the best of the "phenolic ring" tweeters, all superbly matched, span the frequency spectrum in a way that adds "culture" to your sound. The Paramount 300 will

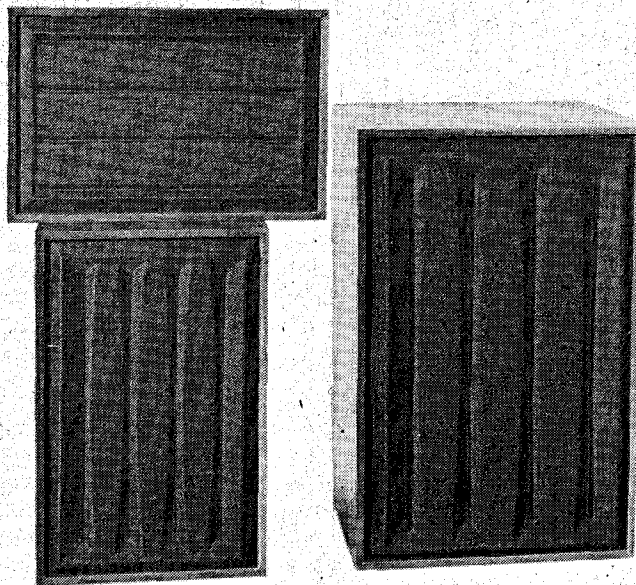

reproduce the gargantuan roar of the fourteen foot organ pipe, and the freshest tinkle of the glockenspiel with absolute clarity.

Power handling: 50 WRMS —

Frequency Response: 35-22,000 Hz.

Price: \$249 per pair

**When you're shopping for fabulous sounds, Listen to Linear Design's "Paramounts".**

AUSTRALIAN DISTRIBUTORS:

**BJD**

Electronics Pty Ltd.

202 Pelham St., Carlton, 3053 Vic. Ph. 347-8255

65 Parramatta Rd., Five Dock 2046 NSW. Ph. 799-3156

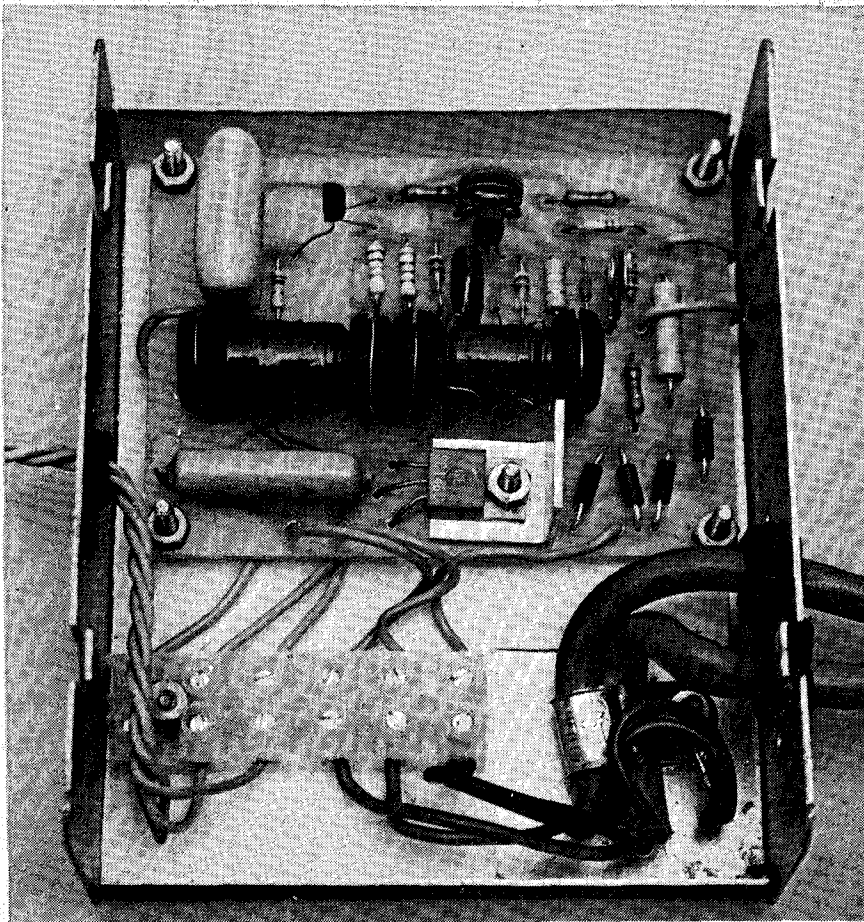

# PUSH BUTTON DIMMER

Simple circuit allows light control from a number of locations.

MANY CIRCUITS for light dimmers have been published over the years (including some by us) which are of very simple construction, and which use a rotary potentiometer. Whilst such circuits are adequate in most respects — especially in terms of cost, there are some strong reasons for a more sophisticated dimming system.

The first objection to simple dimmers is that they usually have an unsightly knob by which light level is adjusted. A second objection is that the light level can only be adjusted from the position where the dimmer is mounted.

The dimmer described in this project can be operated from one or more remote positions — e.g. doors on opposite sides of a room, top and bottom of a long flight of stairs, bedside tables — or even from a control point beside your armchair.

The unit has an on/off switch and

two (or more) sets of push buttons, one of which causes the light level to increase, smoothly from minimum to maximum in about three secs, and one which does the reverse. The adjustment may be stopped at any particular level, and that level will be maintained without change for periods up to 24 hours.

The dimmer will handle incandescent or fluorescent lamps up to 500 VA with the specified heat sink but, with a larger heat sink, may be used up to 1000 VA.

## CONSTRUCTION

Wind the choke and transformer in accordance with the details provided in Tables 1 and 2. Be particularly careful to provide adequate insulation between the primary and secondary of the pulse transformers.

If a printed circuit board is used, construction will be considerably

simplified. Mount all components on the board with the aid of the component overlay taking particular care with the orientation of diodes and transistors before soldering in position.

A small piece of aluminium (30 mm x 15 mm) bent at 90° in the centre of the long side, is used under the triac as a heatsink. The pulse transformer and the choke are mounted by means of rubber grommets and secured by tinned copper wire around the grommets and soldered into the holes provided.

After all components are soldered into place, and all external wires attached, the underside of the board should be washed with methylated spirits to remove any flux residue which could cause leakage.

The PC board should be mounted on spacers into an earthed metal box. A piece of insulation material, about 1 mm thick, should be positioned under the board to prevent any long component leads from touching the chassis.

A six-way terminal block should be used to connect all external wiring.

## SETTING UP

All setting up, adjustments should be made using plastic, or well insulated tools. This circuit is live at mains potential and therefore dangerous to handle. **BE EXTREMELY CAREFUL.**

Potentiometer RV2 should be adjusted to obtain the desired minimum light level setting, (with the down button held). Adjust potentiometer RV1 for maximum light level (with the up button held) to just past the point where maximum light level is obtained.

If the lamp load is fluorescent more care must be taken with these adjustments. Additionally the setting up must be redone if the fluorescent loading is changed.

When adjusting the maximum light point on a fluorescent load, slowly increase the light level until the lights just start to flicker. Then turn RV1 back until there is just a noticeable drop in light level. This increased setting difficulty is due to the inductive nature of fluorescent loads.

If the required minimum light level cannot be obtained within the range of RV2, increasing R6 will provide lower light level range, and decreasing R6 will provide a higher level range.

# PUSH BUTTON DIMMER

**TABLE I  
CHOKE WINDING DATA**

**CORE**

30 mm long piece of 9.6 mm dia ferrite aerial rod. (see main text).

**WINDING**

40 turns 0.63 mm dia (22 B & S) wound as two layers, each 20 turns, close wound using the centre 15 mm of the core only.

**INSULATION**

Use two layers plastic insulation tape over complete winding.

**MOUNTING**

Use a rubber grommet (9.6 mm I.D.) over each end and join to pc board using tinned copper wire in the holes provided.

**TABLE II  
PULSE TRANSFORMER WINDING DATA**

**T1**

**CORE**

30 mm long piece of 9.6 mm dia ferrite aerial rod.

**PRIMARY**

30 turns 0.4 mm dia (26 B & S) close wound on the centre 15 mm of the core.

**INSULATION**

Use two layers plastic insulation tape over primary winding.

**SECONDARY**

30 turns 0.4 mm dia (26 B & S) close wound on the centre 15 mm of the core. Bring wire out on the opposite side of the core to the primary.

**INSULATION**

use two layers plastic insulation tape over complete winding.

**MOUNTING**

use a rubber grommet (9.6 mm I.D.) over each end and join to pc board using tinned copper wire in the holes provided.

## HOW IT WORKS ETI 527

As with most modern dimmers, we have used a phase-controlled triac for power control.

The triac, which may be regarded as a switch, is turned on by a pulse at a pre-determined point in each half cycle, and automatically turns off at the end of each half cycle.

Most conventional dimmers use a simple RC and diac system to generate the trigger pulse, but this dimmer is in effect voltage controlled. The 240 volt ac mains is rectified by D1-D4. This full wave rectified waveform is clipped at 12 volts by R7 and ZD1. As no filtering is used, this voltage will fall to zero over the last half millisecond of each half cycle.

To provide the correct timing, and the energy required to fire the triac, a programmable unijunction transistor (P.U.T.) Q3 is used together with capacitor C3. A P.U.T. also acts like a switch in the following manner. If the anode (a) voltage is higher than the anode-gate voltage (ag), the anode to cathode (k) path becomes effectively a short circuit.

The voltage on the anode-gate, is set by RV2 and will be between 5 and 10 volts. Capacitor C3 is charged, via R6, and when the voltage across it exceeds that on terminal ag, the P.U.T. fires discharging C3 through the primary of pulse transformer T1. This induces a pulse in the secondary of T1 which gates on the triac.

As the voltage supply to R6 is unsmoothed the rise of voltage on capacitor C3 will follow what is called a cosine modified ramp. This gives a more linear change in light level versus control voltage.

Once C3 is discharged the P.U.T. may either stay on or turn off depending on the individual device. If it turns off it may well fire again if C3 charges quickly enough, but the operation of the dimmer is unaffected by either situation.

If C3 does not charge to the ag voltage before the end of the half cycle, the ag voltage will fall at the end of the cycle and the P.U.T. will fire. This is an essential part of the operation as it ensures synchronization of the timing to the mains. It is for this very reason that the 12 volt supply is not filtered.

To control the charge rate of C3 (and hence the timing of the turn on of the triac within each half cycle) an auxiliary timing network of R5 and D6 is used. As the value of R5 is much less than that of R6, C3 would charge much quicker via this path. If we set the input to R5 at, say, 5 volts, the capacitor C3 would charge to about 4.5 volts quickly and then at the slower rate set by R6. This is called a ramp and pedestal type of charging (illustrated on page 73).

As a result of the initial start given by R5, the P.U.T. would fire earlier, and the triac will turn on earlier, delivering more power to the load. Hence by controlling the voltage at the input of R5 we may control the output power.

Capacitor C2 is used as a memory device. It can be discharged by R1 via PB1 (up) or charged by R2 via PB2 (down). The capacitor C2 is connected from the positive side of the 12 volt supply and hence when the capacitor is discharged the voltage actually goes up with respect to the zero volt line.

Diode D5 is used to prevent the voltage rising above that set by RV1. The capacitor C2 is connected to the input of Q2 by R3. Transistor Q2 is a field effect transistor (FET) which has a very high input impedance. Hence the input current is virtually zero and the source tracks the gate voltage but at several volts level. The exact voltage difference depends on the individual FET.

Therefore if the gate voltage is changed, ie the voltage on C2, the voltage applied to R5 will also vary. By pressing either PB1 or PB2 the capacitor voltage and hence the triac firing point and the power delivered to the load may be varied.

Upon releasing the push buttons the capacitor will hold this voltage - EVEN WHEN THE POWER IS SWITCHED OFF - for extended periods of time. The memory time is dependent on a number of factors as listed below.

1. A capacitor with a leakage resistance in excess of 100,000 megohms is required. Use a good quality capacitor, preferably rated at 200 volts. If necessary try different brands.
2. The pushbutton switch should be rated for 240 Vac operation. These types have greater separation and hence insulation between the contacts. By physically disconnecting the pushbutton it is easy to determine whether this is a cause of low memory times.
3. Leakage across the PC board could be a problem. It will be noticed that there is a track running from the source of Q2 which appears to go nowhere. This is a guard line to prevent leakage from high voltage components. If you are using different construction methods make the junctions of R3 and Q2 and of R3 and C2 by mid air joints or by good quality ceramic standoffs.
4. The FET itself does have a finite input resistance. We tried many FETs without finding any that would not work. Nevertheless do not overlook this possibility.

The dimmer can be controlled from any number of stations simply by paralleling sets of pushbuttons. No damage will result from pressing both up and down buttons at the same time. However adding many stations increases the likelihood of leakage and consequent loss of memory time. The dimmer should be mounted in a dry dust-free position - as should the pushbutton. Do *not* try to use the dimmer or push buttons in a bathroom or kitchen as moisture will render the memory virtually useless.



Fig. 1. Circuit diagram of the dimmer.

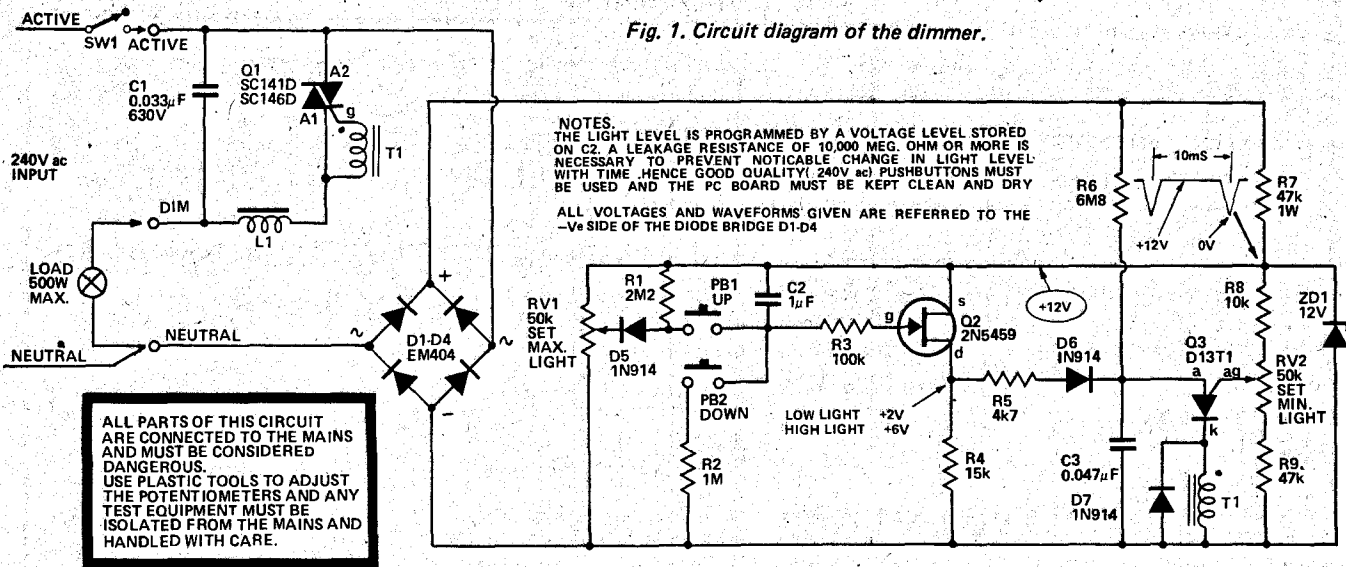

ALL PARTS OF THIS CIRCUIT ARE CONNECTED TO THE MAINS AND MUST BE CONSIDERED DANGEROUS. USE PLASTIC TOOLS TO ADJUST THE POTENTIOMETERS AND ANY TEST EQUIPMENT MUST BE ISOLATED FROM THE MAINS AND HANDLED WITH CARE.

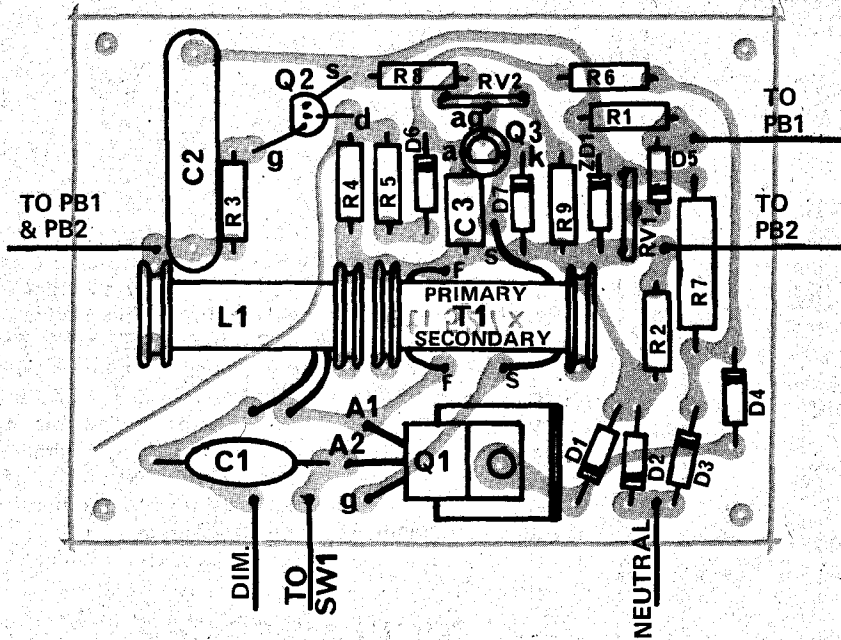
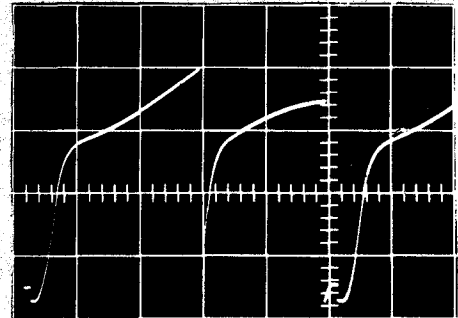

Fig. 2. Component overlay.



Ramp and pedestal charging (dimmer set to provide about half light output).

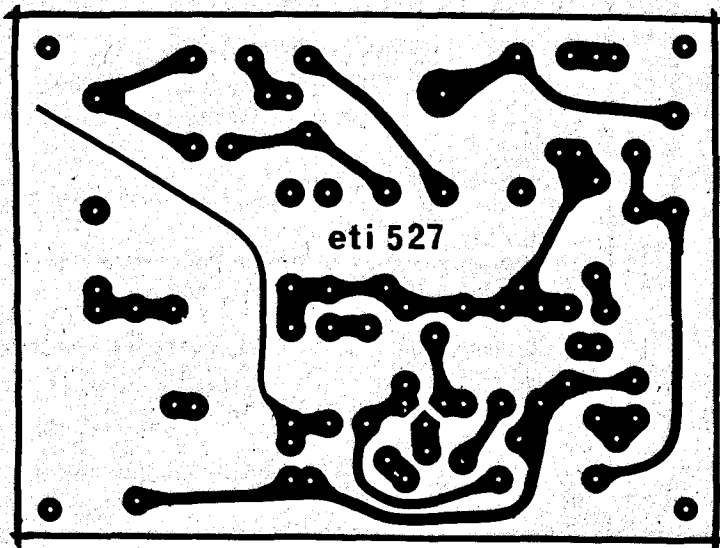

Fig. 3. Printed circuit board layout for the dimmer. Full size.

PARTS LIST - ETI 527

R5	Resistor	4 k7	1/2 W	5%
R8	"	10 k	"	"
R4	"	15 k	"	"
R9	"	47 k	"	"
R7	"	47 k	1 W	"
R3	"	100 k	1/2 W	"
R2	"	1 M	"	"
R1	"	2 M2	"	"
R6	"	6 M 8	"	"

RV1,2 Potentiometer 50 k trim type VSU or similar

C1 Capacitor 0.033 µF 630V polyester  
 C2 " 1 µF 200 V polyester  
 C3 " 0.047 µF polyester

D1-D4 Diode EM404, IN4004 or sim.  
 D5,6,7 Diode IN914 or similar  
 ZD1 Zener Diode BZX70C 12 or sim.

Q1 Triac SC141D, SC146D,  
 Q2 FET 2N5458, 2N5459 or sim.  
 Q3 PUT D13T1 or similar

L1 Choke see Table 1.  
 T1 Pulse transformer see Table 2.

PC board ETI 527.

6-way terminal block (240 V type)  
 Metal box  
 2 pushbutton switches, front plate,  
 power switch

# EVER HEARD OF A FIRST CLASS TV PICTURE WITHOUT A ROOFTOP ANTENNA OR INDOOR RABBIT- EARS?

## That's just what you get with **C.A.T.V. — Community Antenna Television**

C.A.T.V. — Can serve the entire community with sparkling TV reception. . . FM Stereo too!

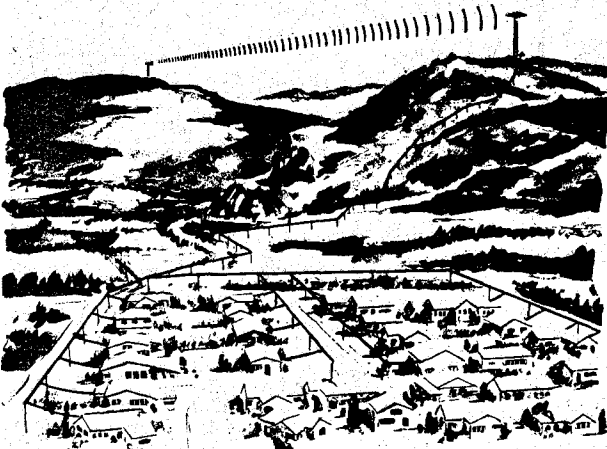

- \* NO SNOW!
- \* NO GHOSTING!
- \* TELEVISION RECEPTION AT ITS BEST . . . . BY CABLE!

The special receiving center distributes the channels over a coaxial cable network to ensure optimum reception at ALL locations. CATV eliminates the expense, the bother, the unsightly appearance of rooftop antennas and antenna maintenance. A simple unobtrusive wire connects your home to the system.

Many areas of Australia, both in the cities and country, receive poor television pictures. CATV can change all that, in many cases offer more channels, too!

*For further information, contact . . .*

**COMMUNITY BROADCASTING SERVICES** PTY. LTD.

73-75 Longland St., Newstead, Brisbane.  
Phone: 52-1210

# BUILD

*the new HEATHKIT® Semiconductor  
Curve Tracer*

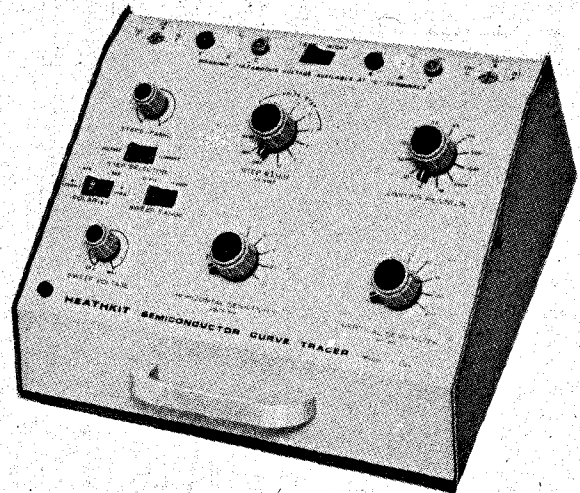

This easy-to-build kit lets you see on your oscilloscope screen the operating parameters of virtually all types of semiconductors. Use it for sorting, inspecting, testing of bipolar transistors, diodes, SCRs, triacs, FETs, etc. The IT-1121 Semiconductor Curve Tracer can be used with any scope with horizontal sensitivity of 0.5 V/div. and vertical sensitivity of 1 V/div. All major controls are stepped in a 1, 2, 5 sequence for maximum parameter resolution. Kit includes connecting leads, extra test leads for large devices or in-circuit testing, comprehensive fully illustrated manual.

Kit IT-1121 . . . . . \$105.88 inc. S/T

## SCHLUMBERGER INSTRUMENTATION AUSTRALIA PTY. LTD.

112 High St., Kew, Victoria.  
and at Suite 7, 134 Willoughby Rd., Crows Nest,  
New South Wales

### Agents:

SOUTH AUSTRALIA:  
Associated Services, 110 Tynte Str., Nth Adelaide, 207-2246

WEST AUSTRALIA:  
Dawson Instrumentation, 70B Hale Rd., Wembley Downs.  
41-4117.

QUEENSLAND:  
L. E. Boughen & Co., 30 Grimes St, Auchenflower. 70-8097.

### Distributors:

Digitronics Australia Pty Ltd., 12 William St., Maryville,  
N.S.W. 69-2040.  
Alan Oliver (Electronics) Pty Ltd., 188 Pacific Highway,  
St. Leonards, N.S.W. 43-5305.  
Associated Scientific Sales Pty Ltd., 29 Wollongong St.,  
Fyshwick, ACT. 95-9138.

# No noise nuisance.

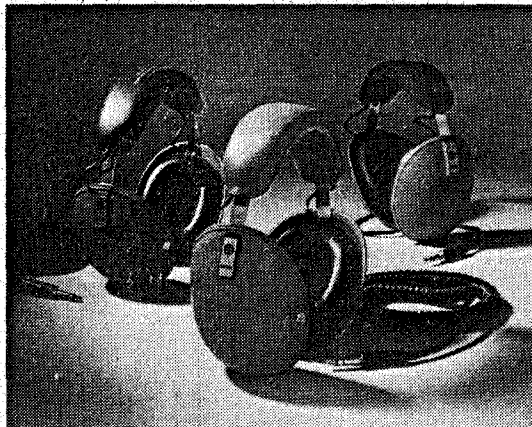

## Just sound enthusiast!

That's **you** . . . when you're listening on your full frequency stereo response Kenwood 'phones. Enjoy the full output of your hi-fi system without annoying your own family or the neighbours . . . day or night—even when you turn the volume right up. Just so long as you have one of Kenwood's three stereo headphones — KH-71, KH-51 and KH-31. They make stereo listening an absolute joy. Their comfortable fit — snug but not tight — ensures hours and hours of listening pleasure that's . . . **all yours.**

- **'OPENED BACK' SYSTEM.** Conventional headphones require you to press the ear cushions to your head while listening . . . a fatiguing necessity. The Kenwood KH series headphones introduce an original idea—the 'opened back' system for truer hi-fi enjoyment.
- **SPECIAL SPEAKER UNIT.** The specially developed, ultra low fo speaker unit reproduces perfectly the heavy resonant bass notes. The 'opened back' system is the result of this speaker.
- **YOUR 'SECOND SPEAKER' SYSTEM.** The beautifully finished KH series headphones are lighter than most other phones . . . they fit anybody and are easy to wear. They're an accessory you should have—call them your second speaker system.

### SPECIFICATIONS

	IMPEDANCE	FREQUENCY RESPONSE	MAXIMUM INPUT	SPEAKER UNIT	CORD	WEIGHT (without cord)
KH-71	8 Ω	20 ~ 20,000 Hz	0.5 WATTS	3"	3 m Cloth Cord (10 ft)	1.0 lbs (460 g)
KH-51	8 Ω	20 ~ 20,000 Hz	0.5 WATTS	3"	2 m Vinyl Cord (6.5 ft)	0.97 lbs (440 g)
KH-31	8 Ω	20 ~ 20,000 Hz	0.5 WATTS	3"	1.8 m Vinyl Cord (6 ft)	0.92 lbs (420 g)

'Open Air' Type Stereo Headphones by

*the sound approach to quality* —



# KENWOOD

N.S.W.: 215 North  
Rocks Rd., North Rocks  
2151. Tel.: 630 7400.  
Edmunds Moir & Co.,  
Pty. Ltd., 18 Wood St.,  
Newcastle West 2302.  
Tel.: 61 4991. M. & S.  
Engineering Supplies,  
Princes Highway, Fairy  
Meadow 2519. Tel.:  
84 8022. VIC.: 30 Kerr  
St., Fitzroy 3065. Tel.:

Distributed by:

**JACOBY  
MITCHELL**

41 7551. S.A.: 652 South  
Rd., Glandore 5037.  
Tel.: 293 6117. QLD.: 2  
Wren St., Bowen Hills  
4006. Tel.: 52 8266.  
W.A.: 10-12 Southport  
St., Leederville 6007.  
Tel.: 81 4144. N.T.:  
Norman Ross Discount  
Ltd., 47 Smith St.,  
Darwin 5790. Tel.:  
81 8133. TAS.:

Lawrence & Hanson Pty. Ltd., Hobart; Wills & Co. Ltd., Launceston.

**SAVE to 50%**

**electronic agencies**  
THE MAIL ORDER DISCOUNT HOUSE,  
P.O. BOX E5, CONCORD EAST, 2137

Money cheerfully REFUNDED if not fully satisfied.

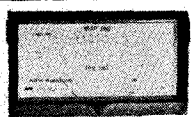

**Large 5" PANEL METER**  
\$7.50

- Latest taut-band suspension system.
- Sensitive 500µA movement.
- Knife-edge pointer.
- Easily re-scaled (presently scaled -20 to 3dB).
- size 5 1/2" x 3 3/4" x 2 1/2" deep (Master Insts. FB50).

**Quality ELECTRICAL TAPE**  
Famous "Bear" and "Tesa" Brand rolls of tape in varying sizes

No. 1 3/8" x 60 yds	2 for \$1.20
No. 2 1/2" x 72 yds	ea. 90c
No. 3 5/8" x 60 yds	ea. 90c
No. 4 1/2" x 72 yds PVC	ea. 90c

**IGNITION SUPPRESSOR KIT for car radio** \$1.95  
Easy to install, 10 piece kit includes 2 suppressor condensers, 1 resistor, various terminals, mounting screws and instructions. Parts alone worth lots more!

**VU STEREO METERS**  
Lge 1 1/4" x 1 3/8" Scales.  
\$6.95

Dual Meters in one case - will "dress-up" any amplifier or tape recorder - for a amateur or professional use.

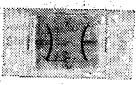

**SCOOP Purchase ACOS DUST JOCKEY RECORD CLEANER**  
only \$3.50



Cleans and protects valuable records automatically while playing self-adhesive mounting base suits any turntable - includes brush and roller for complete dust removals - free bottle of anti-static cleaning fluid.

**MICRO MINIATURE Plessey 3 pin plug socket set**

1-4	5-24	25+
85c	75c	65c

Picture shows ACTUAL SIZE of plug and socket together. Panel mounting socket suits test gear, industrial and commercial applications etc - gold plated pins, less than 1/2 normal price.



**30µF/400V A.C. CAPACITORS FOR LARGE STROBES**

A limited quantity of these "hard-to-get" heavy-duty paper block capacitors suitable for extra-powerful strobes is now available. Manufactured by Ducon and brand new. Add \$1.00 post. Price ea. \$5.00

**"REVOLVER" High quality imported TURNTABLES**

- 240V A.C.
- Tone Arm.
- Motor-board.
- Stereo.
- Ceramic Cartridge.

\$14.95



**LED 7 SEGMENT READOUTS**

each \$3.95 or 4 for \$14.00

These Hewlett-Packard 7 Segment LED's have common anodes, 0.3 inch display, 0 to 9 with decimal point and TTL compatibility. Last available at these prices.



**Philips RADIO TUNER in Kit form.**

Easy-to-build broadcast band tuner using Philips pre-aligned and tested tuner module and complete with large 6" all states dial.

Kit only \$19.90



**Great New VORTEX STEREO CASSETTE DECK**

as used in EA P/M 144 - \$29.00.

A complete cassette deck mechanism - 110 or 240V operation, with resettable counter and heads, fully guaranteed, low wow/flutter. Build your own cassette deck with VU and peak level indicators for under \$100.

Transformer available \$8.10.



**FREE FLYER! NEW WINTER CATALOGUE.**

Send S.A.E. (size about 10" x 6") with 25c postage stamp for our fantastic Winter Catalogue of stock lines, specials and bargain-priced components. You won't be sorry!

Over 5000 Brand New **QUALITY SPEAKERS** available ex stock at **FANTASTIC SAVINGS**



**SPECIALS**

2 1/4" 25 Ohm	\$1.00	6" 8, 15 Ohm	\$6.50	12" Lead Guitar/Organ	\$24.00
3" 3.5 Ohm	\$2.50	8" 8, 15 Ohm	\$7.50	25 Watts, ohm	\$24.00
4" 15 Ohm	\$2.50	12" 8, 15 Ohm	\$10.50	12" Lead/Bass/Organ	\$43.00
5" 15 Ohm	\$2.75	6WR 8, 15 Ohm	\$9.95	60 Watts, ohm	\$43.00
5" x 4" 15 Ohm	\$2.75	8WR 8, 15 Ohm	\$10.75	12" Lead/Bass/Organ	\$67.00
6" x 4" 15 OHM	\$2.90	12WR 8, 15 Ohm	\$13.50	100 Watts, ohm	\$67.00
7" x 3" 3.5 Ohm	\$2.90	8-30 8 Ohm	\$16.50	15" Lead/Bass/Organ	\$60.00
7" x 3" 15 Ohm	\$2.90	3TC 8, 15 Ohm	\$3.75	60 Watts, ohm	\$60.00
8" x 4" 4 Ohm	\$4.50	3UC 8, 15 Ohm	\$4.20	15" Lead/Bass/Organ	\$76.00
5" x 3" 15 Ohm	\$2.95	1" Philips Dome, 8 ohm	\$9.00	100 Watts, ohm	\$76.00

**Famous Brands**

- Magnavox
- Plessey Rola
- MSP
- CTS - USA

**SAVE MONEY EASILY**  
YOU CAN WITH OUR POPULAR **VALU-PACS**

- 133 RCA AUDIO LEADS - RCA phono plug each end of 1 metre shielded cable. Set of 2 for \$1.00.
- 134 IGNITION SUPPRESSOR RESISTORS - Insert in HT leads to suppress ignition interference. Pack of 3 for \$1.00.
- 135 CAR RADIO SUPPRESSION KIT - includes 2 suppressor condensers, 1 HT lead resistor, 6 adaptor lugs, mounting hardware etc., and illustrated instruction sheet. \$1.00.
- 136 - 240V NEON BEZELS - safe, plastic neon indicators in orange, green, clear colours; include in-built resistor, most popular types (normally 70c each). 3 for \$1.00.
- 137 EXPERIMENTERS PAK OF 30 ASST. ELECTROLYTICS - all voltages; all new, quality stock. Range 10µF to 2000µF, 6V to 50V. Current price, approx. \$6.72. Our bulk-buy price \$3.00.
- 138 SUPER EXPERIMENTERS PAK - containing 50 most popular useable electrolytic capacitors, guaranteed new and high quality. Range 22µF to 3300µF to 300µF, 6VW to 160VW. The normal price would be \$11.48, but the price now is only \$4.50. (Just 8c each).
- 139 100 OUCON CERAMIC CAPACITORS - first grade low voltage (25V or 100V), new and guaranteed best quality. All values easily identified and suitable for experimenting, project building etc. We offer a broad selection from 1µF to 1µF at a discount price of \$2.25.
- 140 100 ASST. HI-VOLT CERAMICS - A real good selection of top quality, 500V to 5KV tubular and disc ceramics. From leading manufacturers, these new, marked and guaranteed ceramics are ideal for radio/T.V. servicemen and hobbyists etc. 100 for \$2.50.
- 141 80 ASST. TOP QUALITY POLYESTER CONDENSERS - A good selection at a ridiculously low price - all are brand new, 400V to 630V D.C. ratings. Values are in the range .001µF, to .22µF, and at least 20 different values are included. A good chance for radio/T.V. servicemen to "stock-up". 80 for \$4.00.
- 142 12 INSTRUMENT KNOBS - this assortment of high quality knobs designed for instruments e.g. test equipment etc., is ideal for laboratory or professional use. Some are suitable for concentric shafts and all feature dual precision hex-key grub screws and matt black (non-glare) finish. Some have white indicators while others have brushed aluminium caps etc. 12 for \$1.00.
- 143 1400µF/65VW DUCON ELECTROS - brand new and guaranteed, insulated can type. 2 for \$2.00.
- 144 2000µF/25VW OUCON ELECTROS - brand new and guaranteed, insulated can type. 2 for \$1.50.
- 145 500µF/50VW PLESSEY ELECTROS - brand new and guaranteed, can type. 2 for \$1.00.
- 146 100µF VARIABLE CAPACITORS - Ceramic, insulated communications type, high voltage, compact size (3" x 1 1/2" x 1 1/2"), 1/4" diam. shaft. each: \$2.50.
- 147 2 POLE, 10 POS "OAK" TYPE ROTARY SWITCH - high grade water switch, new and compact in size. 2 for \$1.50.
- 148 1 Watt AUDIO AMP I.C. CHIP - 14 pin OIL package with heat fin. supply 9V max 200mA, complete with circuit diagram. each: \$1.00.

**LATEST Transistorised TV CAMERA Scoop!**



Ideal for closed-circuit television, amateur T.V. transmission, video recording etc. Operates direct into any standard T.V. receiver, mains powered, features 1" vidicon for bright, sharp image. This well-known Japanese import is normally priced out around \$299. - only 20 available so be early.

Full Price \$175

**NOW EVEN BIGGER DISCOUNTS** with our **SURPRISE DISCOUNT VOUCHERS**

We wish to show our appreciation to all customers who purchase any advertised or catalogue lines, either by mail or across the counter, by giving freely a SURPRISE DISCOUNT VOUCHER. The value of the voucher will vary according to the amount of goods purchased and will be in addition to any normal quantity discounts. The voucher may only be used on FUTURE orders. Thank you for your custom.

**Experimenter's UTILITY CABINETS**

Ideal for one-off projects, test equipment, small manufacturing etc; attractively styled black plastic box with aluminium front panel and 4 screws.

BU1 6.1/4" x 3.3/4" x 2"	\$2.10
BU2 7.1/16" x 4.3/8" x 2.3/8"	\$2.75
BU3 5.1/8" x 2.5/8" x 1.5/8"	\$1.75
BU4 4" x 2.1/8" x 1.5/8"	\$1.50
BU5 3.1/4" x 2.1/8" x 1.1/8"	\$1.40

NEW! Just landed.

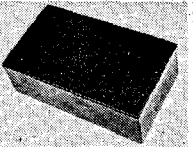

**BONANZA JACKPOT!**  
\$25 Value for only \$5.

For experimenters and constructors, a large assortment of new, highest quality electronic components samples, specials, and of fine components, incl. semiconductors etc. This is real anti-inflationary VALUE FOR YOUR MONEY!

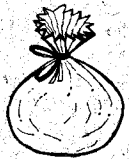

**NOW OPEN** 115-117 Parramatta Road, Cnr. Lloyd George Ave., CONCORD SOUTH. N.S.W. 2137

TRADING HOURS 12:00 to 6 PM Mon-Fri. 8:30 AM to 1 PM Sat. TELEPHONE 747-6472.

**BULK STORE AND WAREHOUSE**

NOTE: Add postage, rated 10% of order value. Extra post refunded. Minimum order value = \$2.00. C.O.D.'s send \$2.00 prepayment. Guaranteed 24 hrs despatch or money refunded. Please use this easy order form.

Any excess refunded.

# COLOUR ORGAN

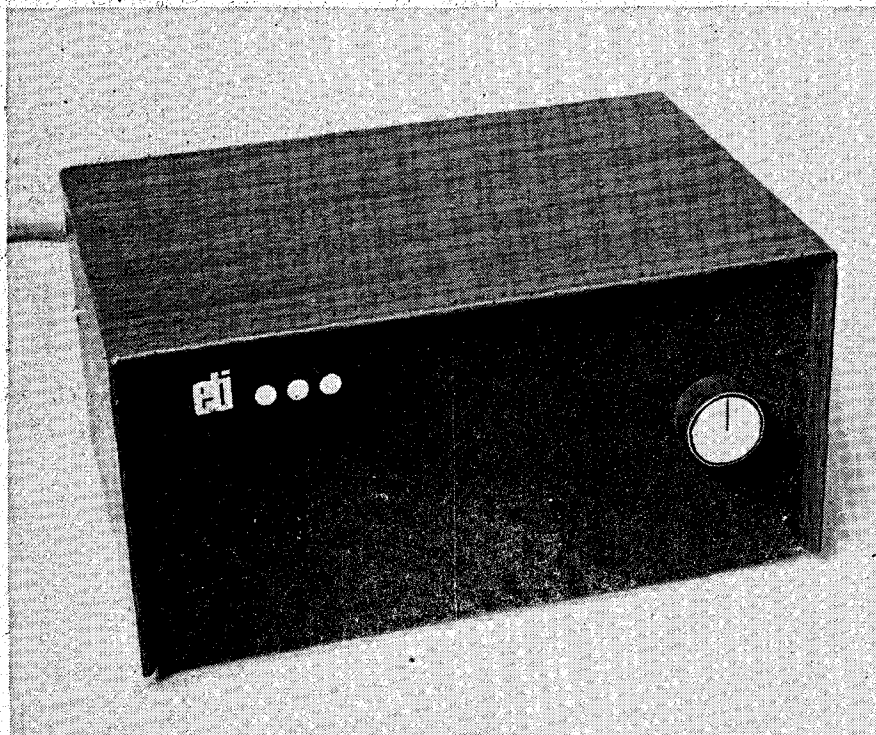

**eti** PROJECT 428

**Produce all the colours of the rainbow in synchronism with your music!**

THE SUBJECTIVE appreciation of music may be considerably enhanced by adding a coloured light display. If the three primary colours, red, green and blue, are projected onto a translucent screen, or some other diffuse material, and selectively modulated by the instantaneous amplitude and frequency content of the music you are listening to, the three colours mix to produce all the colours of the rainbow (as well as white) in synchronism with the content of the music.

A difficulty arises when you try to determine what frequency a 'blue' note should be, or for that matter red, green or any other colour. Bass instruments predominate the frequency range below 220 hertz. Vocals cover the midrange to about 1200 hertz. The higher fundamental notes of wind and string instruments complete the treble register to about 4000 hertz. Harmonics of course extend well beyond this.

It is generally agreed that red should represent low notes, green mid range, and blue the high notes. After much critical listening to tone oscillators and recorded music, in conjunction with light displays our panel of discriminating 'muso's' agreed that 'red' notes should extend to A — an octave below middle C. Green over the

next three octaves and then followed by 'blue'. This is accomplished by dividing the frequency spectrum into three bands by means of filter networks. The amplitude content of each band is averaged and used to modulate the brilliance of the associated lamps.

For best effect, the direct light from the lamps should not be seen. It is not very stimulating, and in fact can be disturbing, to watch globes flashing on and off. However, the lights can quite readily be arranged to shine behind a translucent panel or be reflected off a wall. Alternately large diameter spheres made from crushed glass or plastic are available as standard lighting fixtures. We tried one that had been converted to accommodate three 100 watt coloured globes. Another simple effective arrangement we tried consisted of a cone which we made from a large sheet of translucent drafting film. This was positioned over our 250 watt floodlights mounted inside a five-gallon drum. Incandescent blue lamps are generally inefficient so we added an extra blue lamp in order to achieve colour balance. A lot of creative fun can be had trying different arrangements!

To keep this project as economical as possible we used only one control to vary the input sensitivity. Individual

**WARNING.** All components on the board and the heat sink, upon which the triacs are mounted are at mains potential. Use extreme care as you would any exposed wiring carrying 240 volts. Avoid working on the unit whilst it is connected to 240 volt mains, make sure any test equipment you are using is isolated from earth, and that you yourself are well insulated from the floor by a rubber mat etc.

controls however can easily be added if desired. This involves substituting a log potentiometer with an appropriate series resistor in place of each of the resistors R23, R24 & R25.

## CONSTRUCTION

We wound the line filter chokes, L1, L2 & L3, on three pieces of ferrite rod 30 mm long. These were cut from a 9 mm dia. aerial rod. To cut the rod, first file a V groove around the circumference of the rod at the point where it is to be cut. The groove need only be about 0.5 mm deep and can be cut with the sharp edge of a small triangular file.

Grip the rod in a vice, at the notch, being careful not to screw up the vice too tightly, as the material is also very brittle and shatters easily. Now give the rod a gentle tap and the rod will part cleanly. Wind the choke as detailed in Table 1.

The trigger transformers are wound on pot cores having split bobbins, again as detailed in Table 1.

The heat sink should be constructed from a piece of aluminium as shown in Fig. 4. Carefully follow the component overlay, when assembling the board checking that all diodes, transistors and electrolytic capacitors are inserted the right way around.

The line chokes are secured to the PC board by tinned copper wire looped

*Main text continued on Page 79*

# COLOUR ORGAN

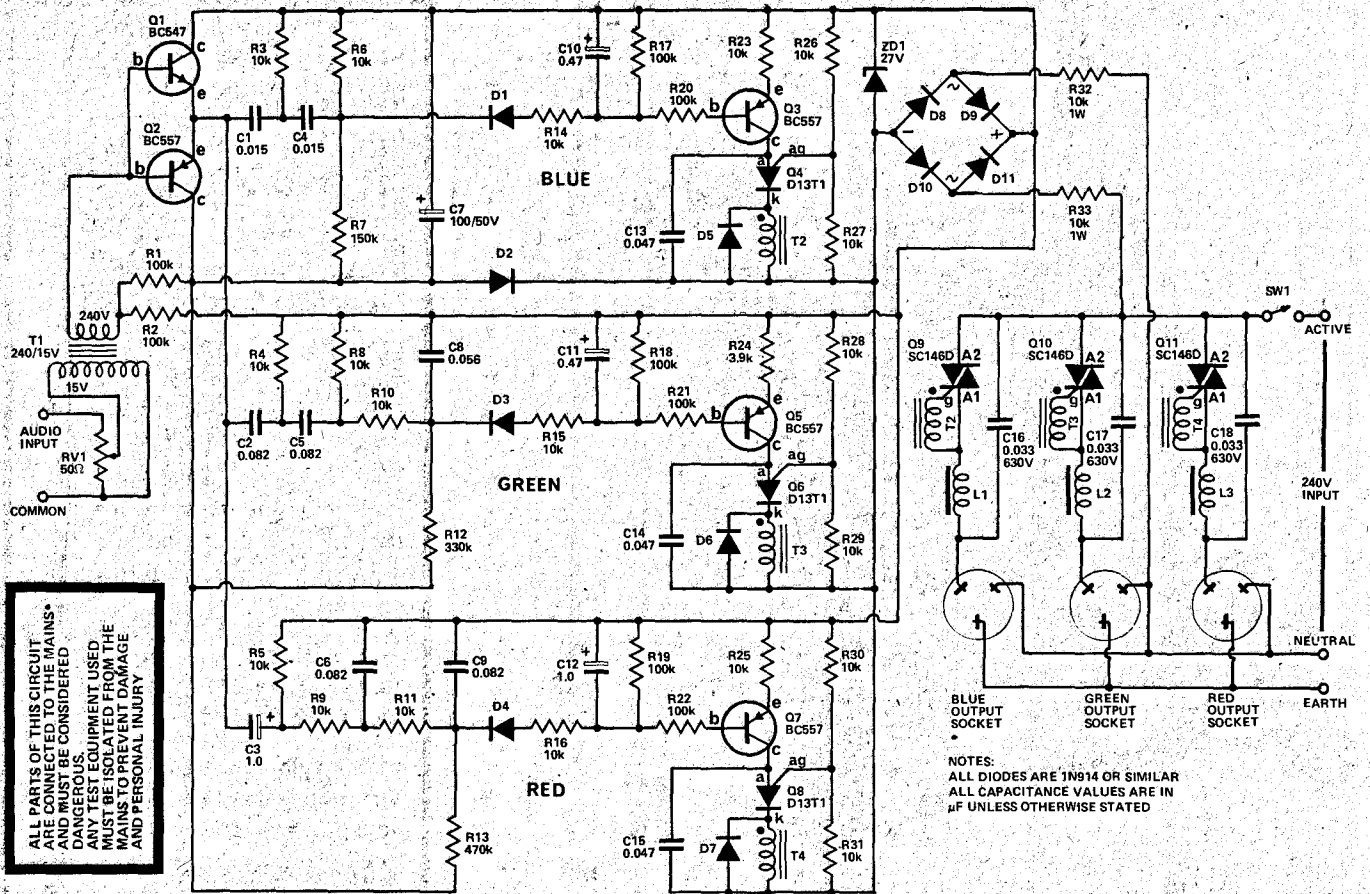

Fig. 1. Circuit diagram of the colour organ.

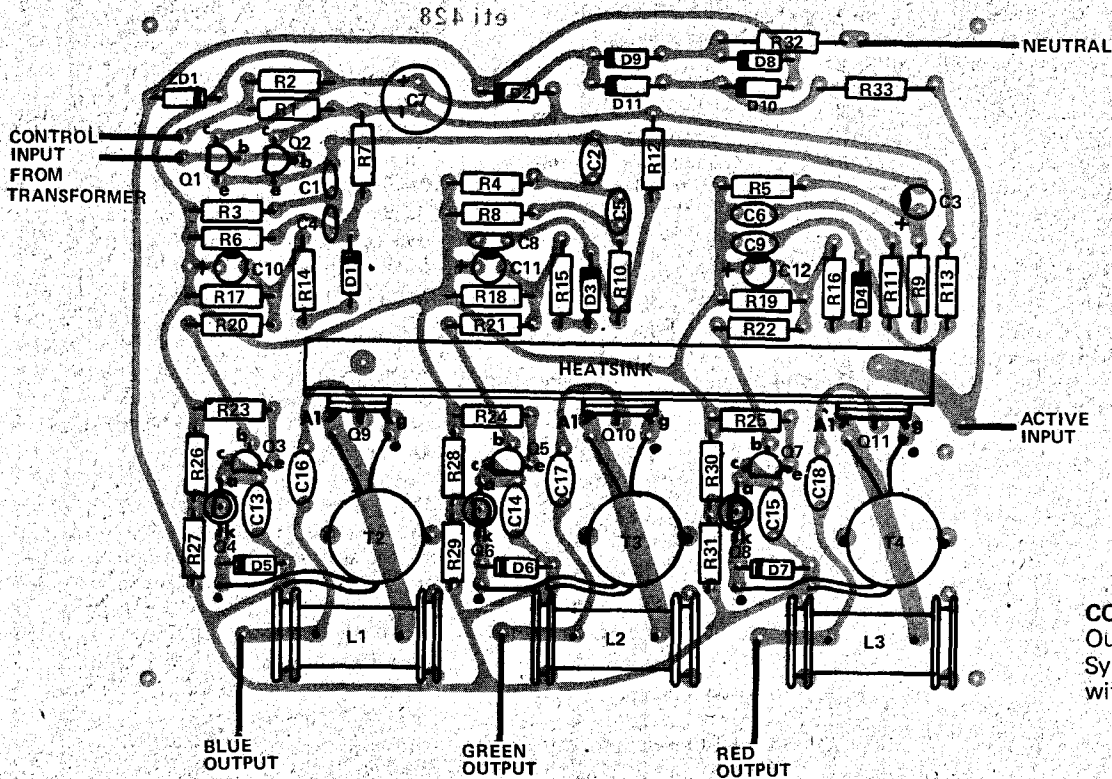
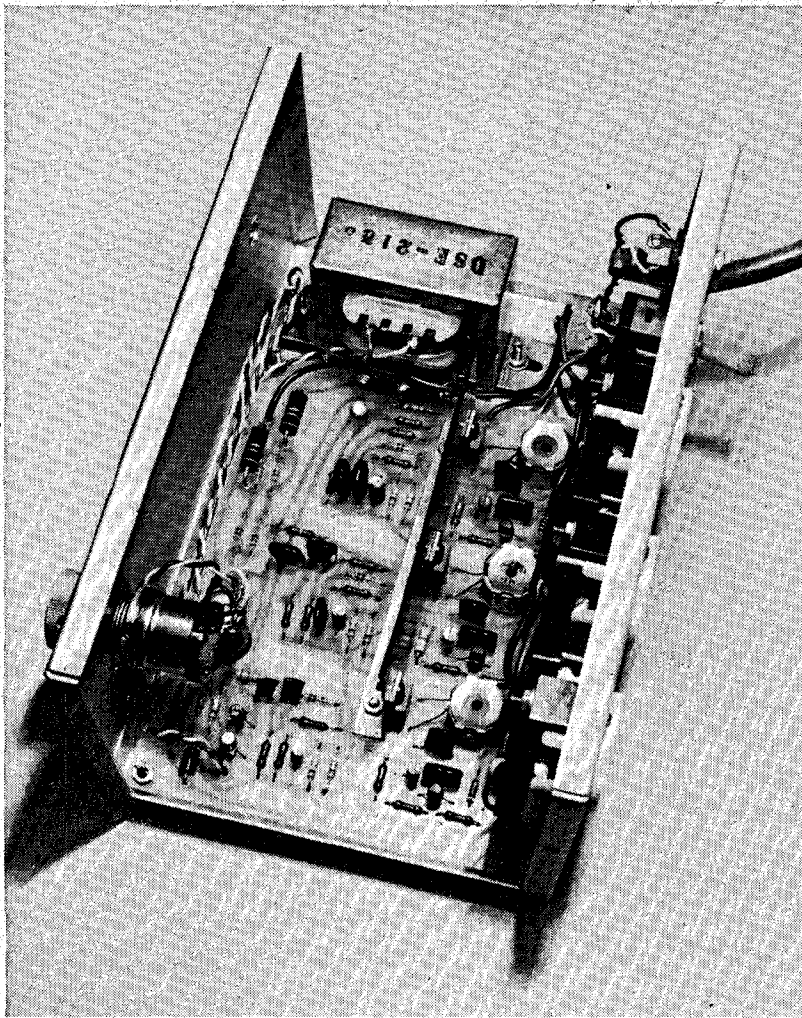

Fig. 2. Component overlay for the colour organ.

**COVER PICTURE**  
Our thanks to artist Carole Symonds for her assistance with our front cover picture.



**PARTS LIST - ETI 428**

R24	Resistor	3.9k 1/2W 5%
R3,4,5,6	"	10k 1/2W 5%
R8,9,10,11	"	10k 1/2W 5%
R14,15,16,23,25	"	10k 1/2W 5%
R26,27,28,29,30,31	"	10k 1/2W 5%
R32,33	"	10k 1W 5%
R1,2,17,18	"	100k 1/2W 5%
R19,20,21,22	"	100k 1/2W 5%
R7	"	150k 1/2W 5%
R12	"	330k 1/2W 5%
R13	"	470k 1/2W 5%
RV1	Potentiometer	50 ohm 2W
C1,4	Capacitor	0.015µF polyester
C16,17,18	"	0.033µF 630 V (Soanar green cap)
C13,14,15	"	0.047µF polyester
C8	"	0.056µF polyester
C2,5,6,9	"	0.082µF polyester
C10,11	"	0.47µF 35V electrolytic
C3,12	"	1.0µF 35V electrolytic
C7	"	100µF 50V electrolytic
Q1	Transistor	BC547, BC107 or similar.
Q2,3,5,7	"	BC557, BC177 or similar.
Q4,6,8	"	D13T1 or similar
Q9,10,11	Triac	SC146D or similar
D1-D11	Diode	1N914 or similar
ZD1	Zener Diode	BZY88 C27 or similar
T1	Transformer	240V/15V A&R2155, DSE2155 or similar
T2,3,4	Pulse Transformer	see table 2.

L1,2,3 Chokes see table 1.

SW1 Switch 240V ac 10A

PC board ETI-428

Heatsink to fig. 4.  
Three 3 pin outlets ring-grip type 105 or similar.  
Metal box to suit\*  
3 core flex and plug  
7 rubber grommets  
1 cable clamp  
1 knob  
terminal strip for mains connection.

\*we used a box 210 x 100 x 140 mm made by Precise Mechanics.

**HOW IT WORKS**

Audio is fed to the input from the loudspeaker terminals of the amplifier. RV1 controls the input sensitivity and transformer T1 steps up the input voltage as well as providing safety isolation from the 240 volt mains on the remainder of the circuit. Transistors Q1 and Q2 provide a low impedance drive for the three filters and present a constant load to the transformer thereby keeping the level independent of varying frequency.

The 'red' channel is driven via a two stage 12 dB/octave low pass filter. The principal frequency determining components are R9, R11 & C6, C9. Diode D4 rectifies the signal which is converted to an average dc level by R16, R19, R22, C12. This varies the bias on transistor Q7 which operates as a constant current source.

The instantaneous current is set by the applied bias, and by the value of Q7 emitter resistor R25. The resulting constant current charges C15 and when the voltage across C15 equals

the reference voltage set at the anode gate terminal (ag) of the programmable unijunction transistor (P.U.T.) Q8, the P.U.T. fires discharging C15 through the primary winding of trigger transformer T4.

The resultant pulse, from the secondary of T4, fires triac Q11 thus switching power to the red lamp. The firing cycle of the P.U.T. is synchronised to the 50 Hz mains by the unfiltered supply derived from Zener diode ZD1. Diode D7 bypasses the reverse flyback pulse from the triac and ensures the pedestal voltage of C15 remains constant.

The operation of the green and blue channels is similar with the exception of the filters. Components C2, C5, C8, R4, R8 & R10 form a bandpass filter for the green channel, whilst C1, C4, R3 & R6 make a high pass filter for the blue channel. Chokes L1, L2 & L3 in combination with capacitors C16, C17 & C18 are incorporated in order to reduce radio frequency interference.

be increased and possibly triacs rated to carry higher current substituted. Of course then ordinary domestic power outlets should not be used.

A 300 millivolt input is sufficient to drive the lamps to full brilliance. At one hundred hertz the input impedance is approximately 12.5 ohms, accordingly any amplifier capable of delivering a watt or more would suitably drive the unit.

Set the amplifier volume control to the normal listening level, then adjust the input sensitivity control such that the lamps only light up to maximum brilliance on musical peaks. If this control is not set correctly the input level will be too high with the result that the lamps will all light up together regardless of the frequency content of the programme. If everything is working at this stage, you can now watch the changing moods and drift into happy ecstasy!

Continued from page 77

round the grommets and then soldered to the board. As the triacs used are rated at 10 amps, the main limitation on the maximum load is the associated

domestic wiring which would limit the total load to 2400 watts. We have designed the heat sinks with this in mind. If it is required to drive heavier loads the area of the heat sink should

# COLOUR ORGAN

eti 428

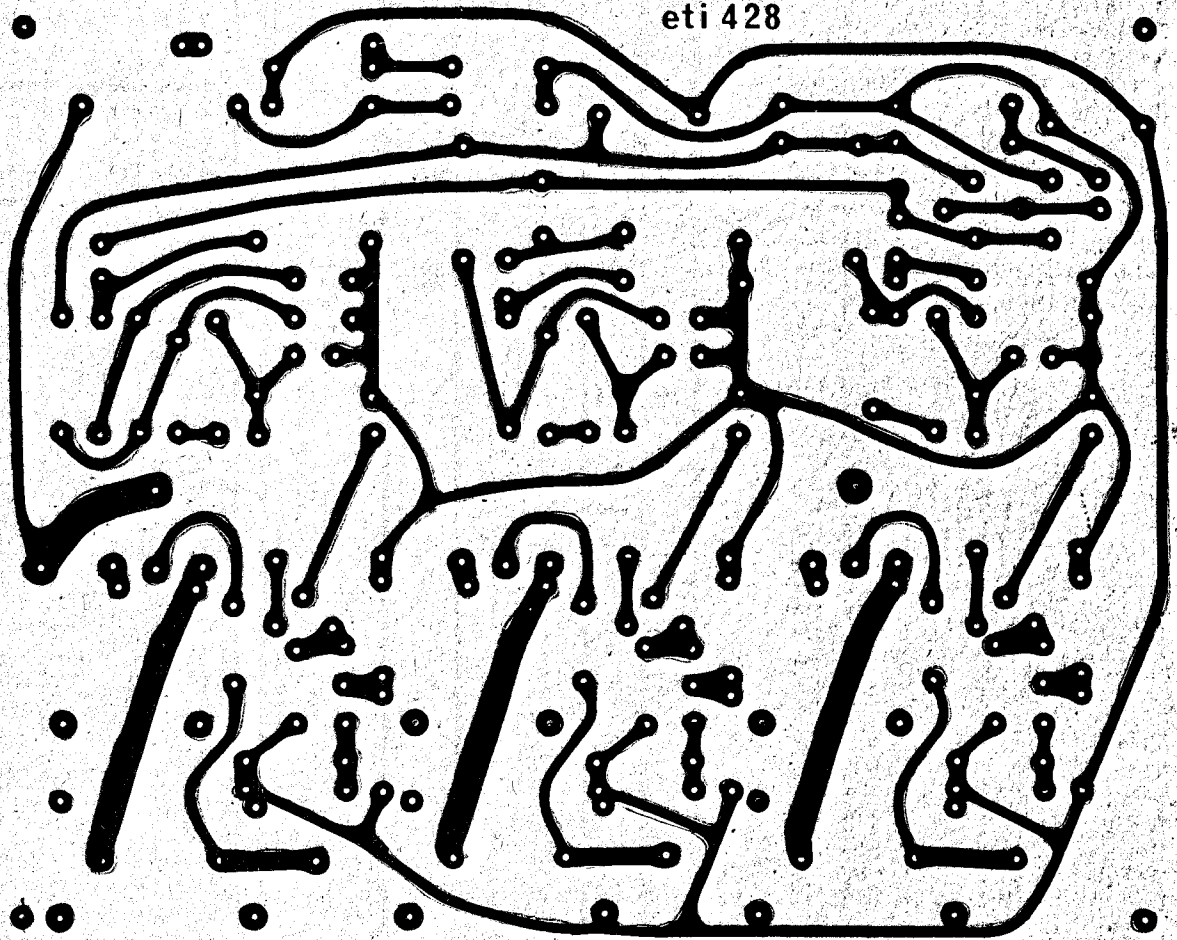

Fig. 3. Printed circuit board layout for the colour organ. Full size 127 mm x 158 mm.

**VEGER SPEAKERS**



**FANTASTIC REDUCTIONS**  
 Recommended retail price \$168.  
 OUR PRICE \$79.95 Terms C.W.O.  
**Fully Guaranteed**

15 inch heavy duty cast frame  
 High efficiency. Ultra high  
 power 300 watts continuous music  
 power 150 watts RMS  
 19 lb magnet. Flux 14,500 gauss  
 4 inch heat treated voice coil  
 8 ohm impedance  
 Full range. Bass range units  
 Maximum & Medium efficiency units  
 Send for catalogue, applications  
 and specific product details.  
 Cabinets of all types, finished  
 in vinyl or long life fibre  
 glass.  
 Various models of Veger speakers  
 are used by almost every musical  
 instrument manufacturer

KERSEN ELECTRONIC DEVELOPMENTS  
 P.O. Box 119, SEYMOUR. 3660.

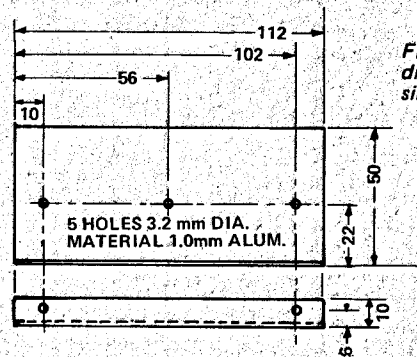
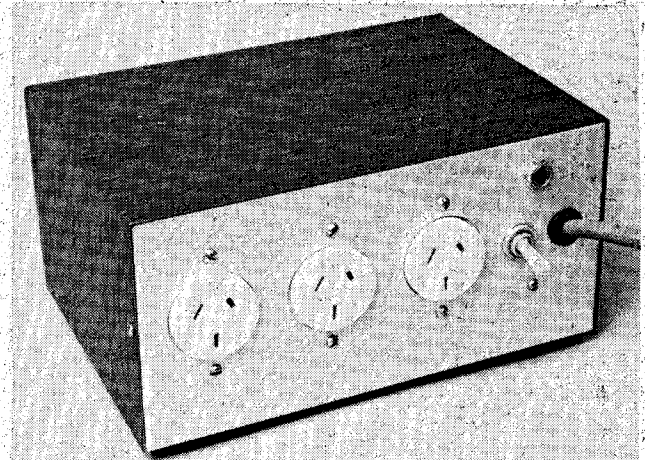
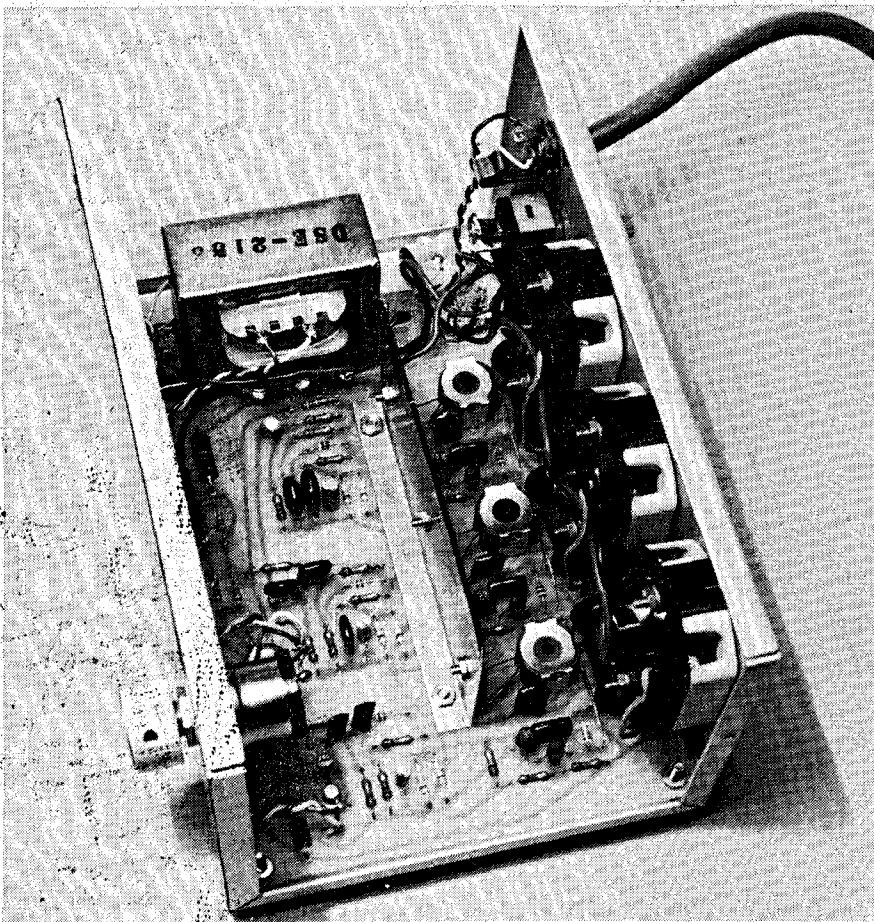

Fig. 4. Dimensions and drilling details for heat sink bracket.







# TOP VALUE for money

**K** kikusui  
**537**

75mm., 5MHz  
**OSCILLOSCOPE**

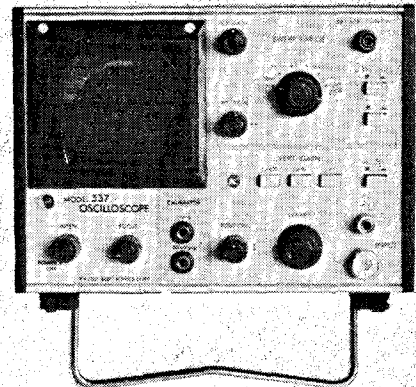

The **537** is a small, reliable precision instrument and is fully backed by the name Jacoby, Mitchell.

#### VERTICAL AXIS

Deflection Sensitivity: 10 mV/div. or over. Coupling: AC & DC. Frequency Response: DC 0.5 MHz. AC 2Hz-5 MHz. Input Impedance: 1 MΩ 36 pF.

#### HORIZONTAL AXIS

Deflection Sensitivity: 200 mV/div. Frequency Response: 2 Hz-400 kHz. Input Impedance: Approx. 220KΩ shunted by 25 pF.

#### TIME AXIS

Sweep Frequency: 10 Hz-100kHz and TV horiz. Synchronisation: Internal ( + & - ) or External.

For the full details and a demonstration contact:

**JACOBY**   
**MITCHELL**

215 North Rocks Rd., North Rocks, N.S.W.  
2151. Phone 630 7400  
OFFICES: Melbourne 41 7551 • Adelaide  
293 6117 • Brisbane 52 8266 • Perth 81 4144  
AGENTS: Wollongong 28 6287  
• Newcastle 61 5573 • Hobart 34 2666

TABLE 1 CHOKE WINDING DATA

L1, L2 & L3	
Core	30 mm length of 9.6 mm dia ferrite rod.*
Winding	40 turns 0.63 mm (22 B&S) wound in two layers, each 20 turns, close wound using the centre 15 mm only of the core.
Insulation	two layers of plastic insulation tape over complete winding.
Mounting	use rubber grommet (9.6 mm ID) over each end and join to DC board by looping turned copper wire round grommets and secured into holes provided.

\* Made from an aerial rod — file a groove around it at the desired cutting point then snap off.

TABLE 2 PULSE TRANSFORMER — WINDING DATA

T2, T3, T4	
Core	Philips P18/11 (any variation of P18 will do)
Former	Philips 4322-021-30280 (preferred) or 4322, 021, 30270
Clip	Philips 4302, 021, 20000.
Winding (double section bobbin)	
Primary	— 30 turns 0.40 mm (26 B&S) one section
Secondary	— 30 turns 0.40 mm (26 B&S) second section
Bring leads out at opposite ends of coil.	
Winding (single section bobbin)	
Primary	— two complete layers 0.40 mm (26 B&S) close wound
Insulation — two layers of plastic insulation tape	
Secondary	— two complete layers 0.40 mm (26 B&S) wire close wound
Bring leads out at opposite ends of coils.	

# SOON THERE'LL BE FOUR ESS AMT SPEAKER MODELS AVAILABLE IN AUSTRALIA

**The classic amt-1 at \$698\* a pair.  
The powerful amt-3 'Rock Monitor'  
multiple bass array at \$997\* a pair.  
The new amt-1 'Tower'  
transmission line system at \$898 a pair.  
The new amt-5 'Reference Bookshelf'  
system at \$396 a pair.**

(\*Increased prices due to devaluation)



All these ESS loudspeaker systems incorporate a Heil air motion transformer—the revolutionary unit which applies the principle of “squeezing” air to create sound, and which brought to high-fidelity reproduction a transparency and dynamic transient impact beyond the capabilities of conventional mass-limited “pushing” drivers.

In the amt-5—the least expensive and the physically smallest of the ESS systems—an exciting, newly-developed version of Dr. Heil’s original unit is used—the ESS Heil “power-ring” amt tweeter. This unit operates with the same unique high-velocity “squeezing” principle of the larger Heil air motion transformer, to achieve dramatic equivalent benefits. It is teamed with a powerful 12” air suspension woofer for deep, high-impact bass and a defined, uncoloured midrange.

The new-to-Australia amt-1 “Tower” is a 6 foot quarter wave length transmission line system. It is a high performance, luxury version of the amt-1—the speaker that introduced the Heil air motion transformer to the audio industry. Deep, full-bodied bass descending to 30Hz pedal tones is superbly matched to the open, detailed midrange and clear, pure highs that only the Heil amt can achieve.

As different to each other, in appearance and price, as the four ESS systems are, they all share a commanding advantage over conventional speakers . . . the revolu-

tionary sonic benefits inherent in the unique design principles of the Heil air motion transformers. The benefits of clean, uncoloured frequency response. Superb stereo imaging and dispersion. Flawless and sensitive definition. And a square wave rise time of 15 microseconds for impeccable attack—incredibly crispness and “bite”.

Far more space than an advertisement allows is needed to describe the technical differences and the resulting audible benefits of the ESS Heil air motion transformer systems. We will be happy to send you full details if you will take a moment to complete and return the adjacent coupon.



Made in U.S.A.

ESS, Inc., C/- Megasound Pty. Ltd., 220 West Street, Crows Nest, Sydney, 2065. Phone: 922-3423.

Heil Air Motion Transformer is the registered trademark for ESS loudspeaker systems incorporating design principles invented by Dr. Oskar Heil and licensed exclusively to ESS Inc.

# FILL IN AND POST THIS PAGE

**For technical details, review reprints,  
and sales literature on the revolutionary  
Heil Air Motion Transformer ESS speaker systems,  
fill in and post this page to . . .**

ESS, Inc., C/- Megasound Pty. Ltd., 220 West Street, Crows Nest, Sydney, 2065. Phone: 922-3423.  
(Full mailing to completed coupons only)

NAME .....

ADDRESS .....

POST CODE .....

I would like full technical information on **all** the ESS loudspeaker systems.   
The model most likely to fit my price budget would be



the amt-1



the amt-3  
'Rock Monitor'



the amt-1  
'Tower'  
transmission line system



the amt-5  
Reference Bookshelf system

I already own a high-fidelity sound system. YES  NO

My preferred hi-fi dealer is (name) .....  
(This is for our information only & your name will not be passed on to any dealer you might specify.)

My present speakers are .....

My present power amplifier is ..... Model No. ....

I intend to retain  upgrade  my existing amplifier.

My present cartridge is .....

My listening room dimensions are approximately .....

I judge my listening room to be  bright  average  dead.

ADDITIONAL COMMENTS/QUERIES .....

.....

.....

.....



(Tear Along Dotted Line)

# Introducing .....

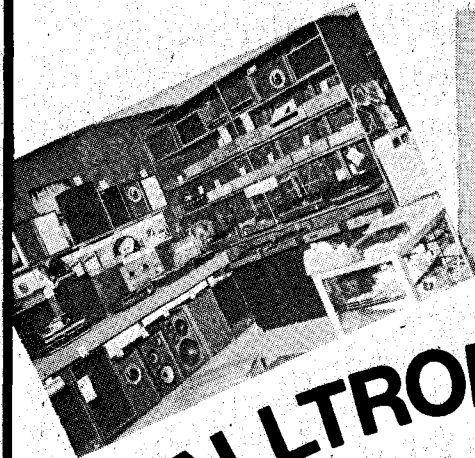

## ALLTRONICS INDUSTRIES

WE ARE NEWER SO WE HAVE TO BE  
BETTER (AND CHEAPER) RING US  
TO PROVE IT!

We are stockists for,

**Monarch BJD**  
**SONICS**

**W**  
WHARFEDALE **AR**

**SONY**  
jensen

**Sansui**

85 WILLOUGHBY ROAD, CROWS NEST Phone: 43-6452, 439-1064

## B&W

the royal family  
of sound

What makes B & W speakers different from every other speaker? It is the visual assurance that not only do they sound good, but they are, in fact, without unexpected peaks and valleys. Each B & W is checked in the factory on a special anechoic test section so that the handling performance of your speaker is plotted by B & K instruments from lowest to highest frequency. See the response of your speaker before you buy.

\*recommended retail price

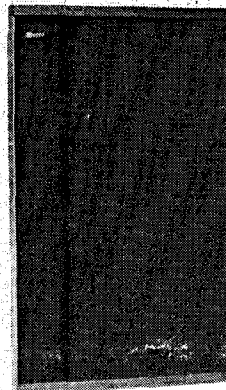

### The best value DM2 A Monitor Acoustic Line

For those who would like the crisp realism of the DM70 but in a smaller package, there is the DM2 Monitor, also less expensive. It is worth your while to make the comparison between the superb DM70 and the DM2 Monitor with its third order Butterworth cross-over network and 8th wave acoustic wave line system in an internal folded tapered pipe. Three speakers with superb straight line frequency response across the whole spectrum. In teak, white and walnut. \$475 per pair\*

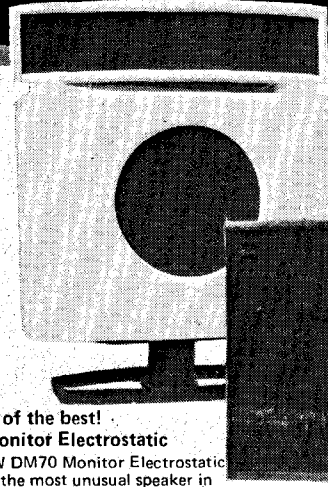

### The best of the best! DM70 Monitor Electrostatic

The B & W DM70 Monitor Electrostatic speaker is the most unusual speaker in the world. It combines a bass pump with a 30.5 cm piston with a free air resonance of 18 to 22 Hz, in a baffle type chamber which produces high power, low frequency wave forms with exact fidelity below 400 Hz. On top is a free standing electrostatic semi-circular array of 9 speaker units that have no moving parts. From 400 cycles up to well beyond human hearing levels, these exclusive B & W units reproduce sound just as it is at the microphone. You must hear these speakers to credit their faithful reproduction. In white and walnut. \$1100 per pair\*

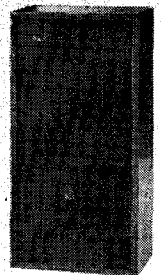

### B & W D5 Sound Value

A small speaker but a wonderful performance and at an extraordinarily keen price for those who want B & W quality on a budget. This speaker is a remarkable investment in quality sound. Only a little above the budget priced speaker but its fidelity and real timbre has to be heard. Walnut. \$199\*

### The mighty atom DM4 Monitor

So small in size, but enormous in sound reproduction from high to low frequency. This is the speaker that has just astounded critics all over the world. They said this type of sound could not come from a speaker just over one cubic foot. Walnut. \$366 per pair\*

B & W Approved Stockists: **Sydney:** U.R.D.; Arrow Electronics; Milversons (Chatswood & P'matta); Convoy Technocentre; **Victoria:** trade enquiries — K.J. Kaires & Co.; **STOCKISTS:** Gyatts Discount Stores; G.W. Williams; George Hawthorne Electronics; Beland Electronics; Livoli Hi-Fi; Vealls; **Geelong:** R.G. Appliance; **Brisbane:** Brisbane Agencies; **Adelaide:** Sound Spectrum; Sole Australian Agents; Convoy International Pty. Ltd., 4 Dowling St., Woollloomooloo. Tel. 358 2088.

# Have A Happy Kitmas

## No. 42 Varilight 1000W Dimmer E.A. April, 1973

Turn down the lights with this simple unit. Easy to build, easy to use, guaranteed results! The demand for this unit has been amazing. Many people have bought this unit so that they can set the background room lighting for watching T.V. This unit connects directly to the mains and should ideally be fitted by an electrician.

NOTE: Tinplate for chassis not included. \$7.50.

## No. 45 Dick Smith Decision Maker

Yes or No? To be or not to be? That is the question. The Dick Smith Decision Maker will give you the answer at the push of a button. We designed this one especially for the vacillating businessman who has to make quick decisions but is plagued by indecision. Use it in the office, at home or going shopping. It uses two LED display and 3 transistors and runs off a 9 volt battery. Fully self contained. \$8.75 (P & P 75c).

## No. 69 ZN414 Receiver E.A.

May 1974

The ZN414 is an I.C. which requires only two resistors, two capacitors, tuning gang and coil. 1.5 battery and earpiece to become a transistor radio. It can truly be built in a matchbox yet will give performance which will astound you. Can you afford not to build one! Includes all electronic parts and free circuits. \$6.75.



## No. 71 ET1 422 Stereo Amp Complete

### SPECIAL NOTE

Beware of cheaper prices. Our kit includes rear panel genuine METAL TO3 Pack 115W output transistors exactly to spec. No cheaper lower, power plastic types (special kit with cheaper plastic types for \$115 not recommended).

BEAT THIS SUPER KIT WITH OUR EXCLUSIVE FIBREGLASS BOARDS.

This stereo amplifier kit is complete in all details and conforms with the E.T. design of May 1974. A guaranteed 50W RMS per channel into 8 ohm loads, from 20Hz to 20KHz at 0.5 dB. Distortion less than 1%, typically 0.15%, many facilities including tape, tuner mike inputs, preamp output, main amp input at 3 basic sensitivities of 2.1mV, 21.0mV and 500mV. Kit comes complete in every way. Definitely the best build-it-yourself amplifier available and equal to many commercial units costing three times as much. Purchase the complete kit or build in these last stages. \$135.00 (P & P \$3.00).

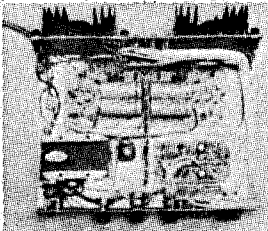

## No. 105 1.5 Watt Amplifier ET1 225 E.T. May 1974

A small amplifier is virtually indispensable to the experimenter. Can be used as an amplifier, signal tracer, monitor etc. Its uses are innumerable. It is very easy to build, is not very particular as to layout and extremely low priced. Runs off 12 volt D.C. \$4.90.

## No. 106 Temperature Meter ET1 226 E.T. May 1974

An extremely simple "press to read type" temperature monitor. Ideal for use with a number of sensors in different localities e.g. pools, outside temperature, inside temperature etc. Range is from 0°C to 100°C. Runs off 9 volts. \$10.75 (P & P 75c).

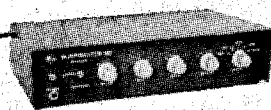

## No. 47 Musicolour MKII Colour Organ E.A. December, 1972

Add an optic dimension to your hi fi. Enjoy the added effect of coloured lights varying in intensity and contrast in co-ordination with the frequency and best of your music. The unit, which runs off 240V divides the music into three broad frequency bands and there modulates three separate light "channels" of up to 1000W each. By changing settings on each channel you can compose many different light concertos using the same piece of music. Can be used with any sound source capable of running phones. Works on voice too. Light up with your favourite radio announcer or commercial! \$59.00 (P & P \$1.50).

## No. 67 Ultrasonic Transmitter E.A. February, 1974

Based on our own imported Ultrasonic Transducer No. 105 and designs published in E.A. February '74, this little unit together with the Kit No. 68 Ultrasonic Receiver can be used as a door-way monitor or a burglar alarm system. It could also be used for remote control of various devices or even counting guests at a party - runs off a 9 volt battery. \$11.50 (P & P 75c).

## No. 68 Ultrasonic Receiver for the Ultrasonic Transmitter

Designed basically for relay operation but can be altered to virtually any form of readout. It now includes our super-sensitive transducer. Runs off a 9 volt battery. \$17.50 (P & P 75c).

## No. 11 Playmaster 143 Hi Fi Amp E.A. September, 1974

This unit is an improved version of the Playmaster 136 of which over 10,000 have been made. 12Watts per channel into 8 ohm at a typical 0.4% THD and within 22dB from 20Hz to 20KHz. Inputs are 2mV into 50K and 150mV into 500K. Noise figures 60dB down with all input open and 44dB X talk. An excellent unit which has been designed so that conversion to 4 channel can be made with a minimum of fuss. Ideal for the home environment and has provision for headphones. \$79.00 (P & P \$3.00).

## DICK SMITH WHOLESALE P/L

Head Office and Mail Orders to  
160-162 Pacific Highway, St. Leonards  
2065 Tel: 439 5311  
also at 361 Hume Highway, Bankstown  
Tel: 709 6600

# BOOKS

## COLOUR TELEVISION THEORY

G. Hutson, 326 pages. This book assumes the reader to have working knowledge of monochrome television principles. It deals almost exclusively with the PAL system, but a chapter is devoted to the NTSC system. The text begins with an easy read chapter on "light" physics to give the reader a basis on colour mixing, chromaticity diagrams etc.; the principles are dealt with step by step in an easy to understand form. Practical circuitry and diagrams accompany the text, to give an interesting explanation. Colour plates are included to show relevant colour information. A chapter is devoted to transmission, and describes the difference between PAL, NTSC, and SECAM. In all a complete, thoroughly absorbing easy to read text. This book is not only a must for all television technicians but of enormous interest and value to all interested in colour television. We are getting entire Australian shipment, so this book is virtually available only from us. \$12.50.

## New PAL Book

At last an Australian PAL book PAL colour TV for Servicemen by Cook, Wren 248 p \$15.00. This is a must. Written by an Aussie, this is the best book on Aussie PAL (and N.Z. too). Assumes B & W experience and covers theory in a not too technical way. Practical approach to solid state and IC circuits. Very thorough with heaps of diagrams, many in colour. Well written by a man with 30 years experience who set up training courses here. Projects and Circuits from Electronics Australia \$2.00. It's a beauty, all the popular tried and tested circuits from EA: Reaction timer, tape amp, bongos, microradio, train controller, tuner, novelties etc. etc. There's over 30 projects and 112 pages for only \$2.00.

# CHRISTMAS SUPER-SCOOP

We have 100 only Jayem L55 FET Multimeters for the real enthusiast at a knockout price. You'd normally pay the same for an ordinary meter but this one has 27 ranges, constant 10 Meg input impedance, battery operated and complete with vinyl case. The best Christmas gift at a saving of \$10. Yes the L55 is yours for only \$33.50. (P & P \$1.00). But hurry. Special probes R. F. Probe \$9.50. Temperature probe normally \$11 now \$6.50, 30kV probe normally \$11 now \$5. These are genuine reductions for the first 100 lucky customers.

KE117 2 station is a highly efficient solid state intercom capable of working over distances to 500 ft. Wall or desk mounting. Master has volume control. Supplied with 50 ft. cable. Normally \$13.50. 100 only reduced till Christmas to only \$10.50. Save \$3.00.



Denshi SR3A. The giant kit with 105 experiments, reflex radios, record player amplifier, wireless mic, burglar alarm, photoelectric warning device etc. This one has 43 stage circuit board and special control panel with speaker switch, volume control etc. plus separate extension speaker for intercom etc. Solar cell included plus 48 modules, Morse key, ear-piece, mic etc. Supplied with descriptive manual and excellent value at \$24.40.

Going away for a holiday? Then hurry and get a Watchdog installed. From the same manufacturer as Cargard, here's a complete alarm system for your home. Uses modules comprising alarm and separate siren, plus speaker and 3 reed switches. No soldering, runs off 12V battery \$46.00, or with 5 reed switches plus pressure mat and tape blocks etc. for \$64.00.



# For The Christmas Stocking

Add a tweeter to your system for only \$9.50. Philips AD061/78 handles 20W and covers 1.5 kHz to 22 kHz (full instructions in our cat.).  
Battery Charger 4 from A & R has dual ranges - trickle or 4A, immune to shorts or accidental reverse connection. Charges both 6 and 12V batteries. Handsome tough case with meter. The best around at only \$24.00 (P & P \$1.50).

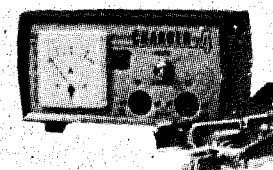

CIS460 Headphones feature the very latest styling with Mylar power cones giving a frequency response from 30 to 20,000 Hz. Independent volume controls built in. Only \$14.95.

Electric Car Aerial adds a touch of class to your humble motor. Push the button and up she goes to an enormous 43". Suits 12V supply of either polarity 12" underhang. Only \$21.00 (P & P \$1.00).

Car Stereo Speakers SKA046 requires only 2 1/2" depth, nominal 5" diameter handles 5W, response from 130 Hz to 9 kHz \$16.00 a pair (P & P \$1.00).

## BABANI AND BERNARDS BOOKS

- BP1 First Book of Transistor Equivalents and Substitutes 1.00
- BP2 Handbook of Raglo, TV and Ind Tube and Valve Equivalents 1.00
- BP3 Handbook of Tested Transistor Circuits 1.00
- BP6 Engineers and Machinists Reference Tables .50
- BP9 38 Practical Tested Diode Circuits for the Home Constructor .80
- BP11 Practical Transistor Novelty Circuits 1.00
- BP14 Second Book of Transistor Equivalents and Substitutes 2.20
- 129 Universal Gram-Motor Speed Indicator .25
- 161 Radio, TV and Electronics Data Book .75
- 196 AF-RF Reactance-Frequency Chart for Constructors .40
- 202 Handbook of Integrated Circuits (IC's) Equiv. and Substitutes 2.00
- RCC Resistor Colour Code Disc Calculator .25

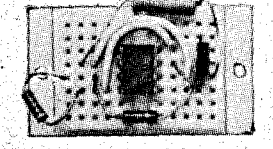

Mini IC Socket from EI Instruments for your IC lashups. Gives them a better chance of working for only \$3.00 and saves so much frustration. Or blow \$26.00 on the proper breadboard. Both operate to 30 MHz.  
pop a box of solder in. Ersin Multicore \$4.40 in 22 swg (500g) or 18 swg at \$4.50 or 16 swg at \$5.90.



EZ Hooks are handy for your test leads at only \$1.65 or the Mini at 95 cents. Or how about a scope probe case from EZ at \$1.60?

Perhaps your main Christmas present is a new car (he, ha). Even if it isn't protect your vehicle with a Cargard RB200 which is easily installed by any handyman. Highly recommended and supplied complete with horn at \$37.50.

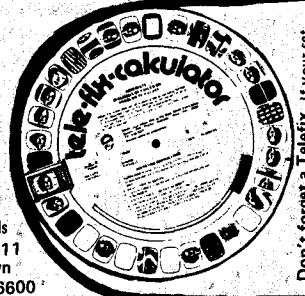

Don't forget a Telefix. If your set goes on the blink over the holiday period, how long will it take to get a serviceman? Anyone can locate 900 Telefix. Only \$2.50 (P & P FREE).

# VARIABLE SPEED SPEECH

Played-back recordings can be varied in speed without changing pitch!

THE PACE of modern technology has inevitably caused a demand for faster communications. We are all in a hurry. We need information *now*, and we cannot afford to spend too much time assimilating it.

In many areas improvements have been made which greatly facilitate the rate of information transfer. For example, in the computer field, getting the information in and out of the computer, rapidly, has been a continuing problem, but this has been alleviated partly by the development of such equipment as high speed printers, tape readers and CRT terminals.

In the audio/visual field special purpose projectors, multivision techniques and special television effects equipment have vastly improved the rate of visual information transfer.

But — where information must be transferred by spoken word — we have, until recently, made little if any progress.

In the fields of education, staff training, advertising, etc, some method of increasing the playback rate of recorded speech is urgently required. Such a system, known as VSC (Variable Speech Control) is now available.

## THE PROBLEM

Average speech rates range from around 110 words per minute for ordinary conversation up to about 175 words per minute for the average news commentator. This is in sharp contrast to the average reading rate of around 300 words per minute rising to 1000 WPM or more for trained speed readers. Obviously the comprehension

rate is far higher than practical speech rates.

On the other hand, a secretary endeavouring to type up the tape-recorded minutes of a meeting will find the speech rate about twice that for comfortable typing. Hence it is very desirable to be able to vary the playback rate over a range of half to twice the normal rate.

If you have ever played a record or tape at an incorrect speed you will be familiar with the effects of speed change. An increase in tape speed by any given factor results in an increase in frequency of all frequency components by the same factor. At best we get the "nutty squirrel" effect, at worst — an unintelligible gabble.

A decrease in speed results in an unintelligible rumble as all frequency components of the speech are lowered proportionately.

Although some special machines have been built for speech compression, these have been very expensive and hence not been within the reach of the average user. Over 60 million tape recorders are purchased each year for a variety of purposes and quite a large percentage of users would welcome a cheap variable speed device which would allow the playback rate to be varied to suit individual requirements. Such a unit should be available at a price which will allow it to be fitted to even the cheapest of cassette recorders.

## THE SOLUTION

The pitch change-with-speed phenomena, and a method of eliminating this change, is best illustrated with the aid of Fig. 1.

Speech may be considered to consist of short segments of various tones, called phonemes which make up any particular sound. Assume that we take a 40 millisecond sample of a waveform and find that it is a tone of 150 Hz, as shown in Fig. 1a. If the tape recorder is now replayed at twice normal speed, the tone burst will be compressed into half the time, that is, it will now be at 300 Hz.

We want the time compression but *not* the frequency change, so, to eliminate the latter, we must delete half the tone burst and expand the

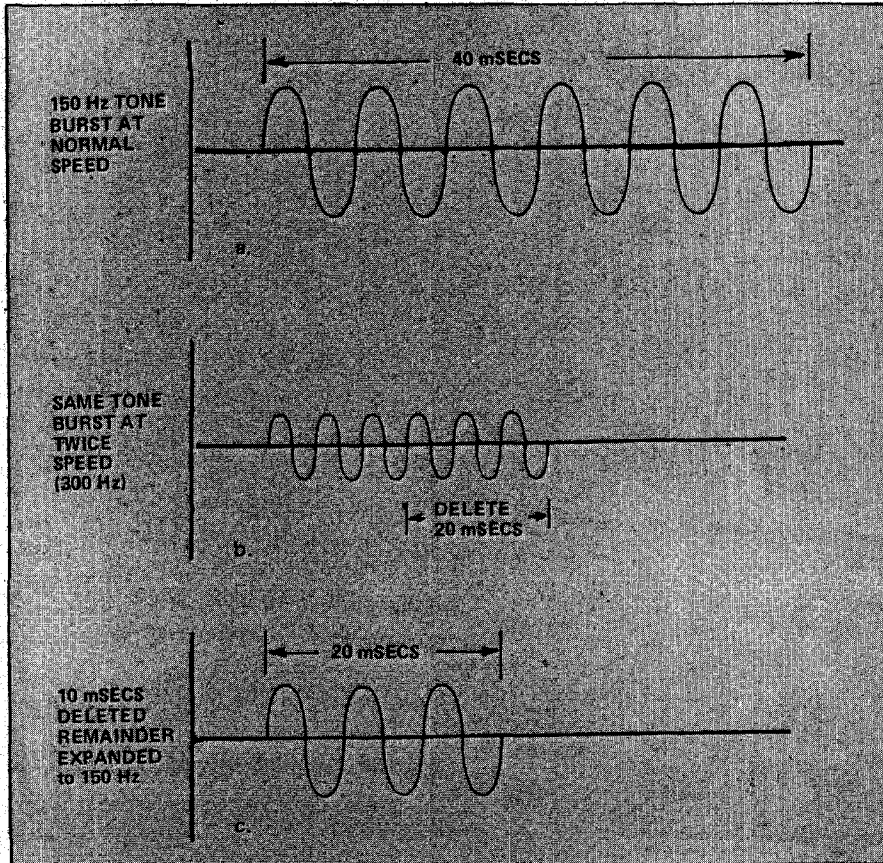

Fig. 1. The method of reproducing sound at normal pitch when replayed at higher than normal speed (in this case at twice speed).

remaining portion again. Thus we finish up with a tone burst of half the duration but at the same frequency, as shown in Fig. 1c.

This is in fact the principle of the new VSC system (Variable Speech Control). In normal speech there is a considerable amount of redundant information and the basic speech sounds are of around 100 millisecond duration. Hence by sampling the speeded speech and discarding redundant material the remainder may be stretched so that the resulting gaps are filled. Thus speech of normal pitch but at a much faster rate is produced.

The reverse process may also be used by compressing short samples and filling the resulting gaps with redundant material. This allows playback of speech at much slower rate than normal again with normal pitch.

There are two problems in this approach which must be overcome. The first is that the duration of the portion must vary to suit the change in speed. For example at three times normal speed two thirds of the sample must be discarded. The remaining one third is then expanded three times to produce gapless speech at the correct pitch.

The second problem is in expanding the remaining portion correctly. This problem may best be understood by reference to Fig. 2. Here we see the signal after speed up compared to the same signal when expanded (X2 speed). The delay required for each point on the waveform can be seen to increase with time during the sample period and some electronic means of achieving this must be provided.

## HOW IT'S DONE

The heart of the new system is a new IC developed jointly by Matsushita Electric and Philips. Known as the MN3001, it is an LSI device consisting of 512 dual bucket-brigade stages on a single silicon chip. The two sections may be connected in series to obtain 1024 stages, or, may be used in parallel to obtain double the output voltage obtainable from a single section.

A bucket brigade device consists of charge storage capacitors separated from one another by MOSFETS. When the FETS are gated by means of a pulse the charge on one capacitor is transferred to the next. Thus by clocking the device with a train of pulses the signal is shifted down the chain. The direction of shift is controlled by using a two phase clock.

Thus the bucket brigade device is a shift register but, it is an analogue shift register because the amplitude of each bit is transferred by the charge transfer process. Thus an analogue signal input

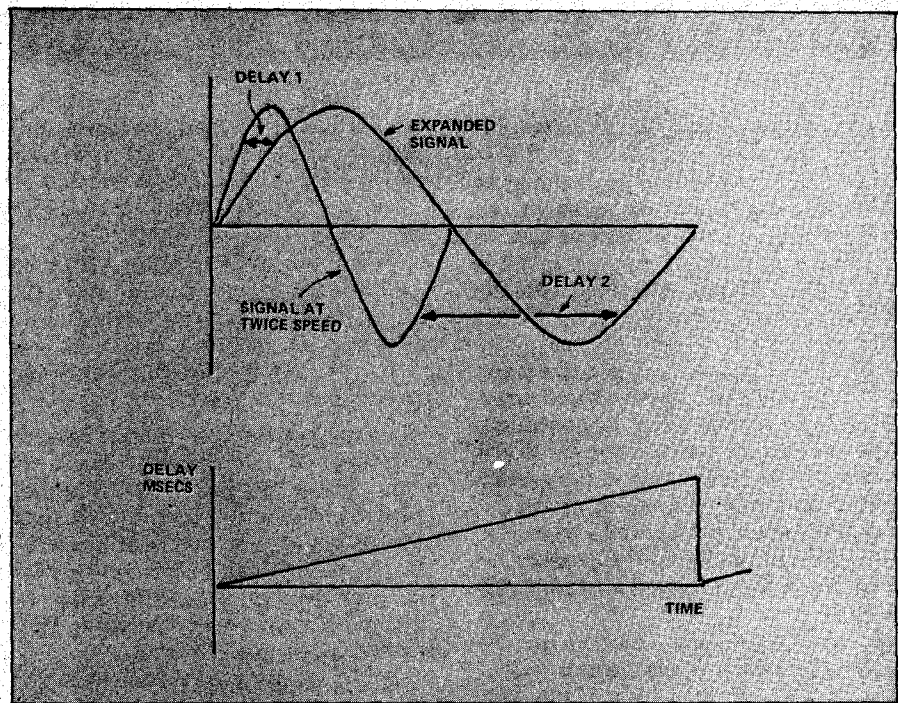

Fig. 2. When expanding a signal sample each segment of the waveform must be delayed, and the delay must increase linearly during the sample time.

This is shown by comparing the delay between pairs of points having the same phase angle, as for delay periods 1 and 2 shown above.

will be delayed by an amount which depends on the clock frequency. The lowest recommended clock frequency is 10 kHz and with a 512 stage device this gives a delay of around 26 milliseconds.

To return now to our VSC unit (Fig. 3) the audio signal, from the tape recorder head etc, is fed to the bucket

brigade device. Instead of using a fixed clock frequency we gradually increase (or decrease) the clock pulse duration during the bit shifting process of each sample. Thus each sample bit of the analogue signal is subjected to a progressively greater (or shorter) delay. The net result is a signal having the correct frequency components but

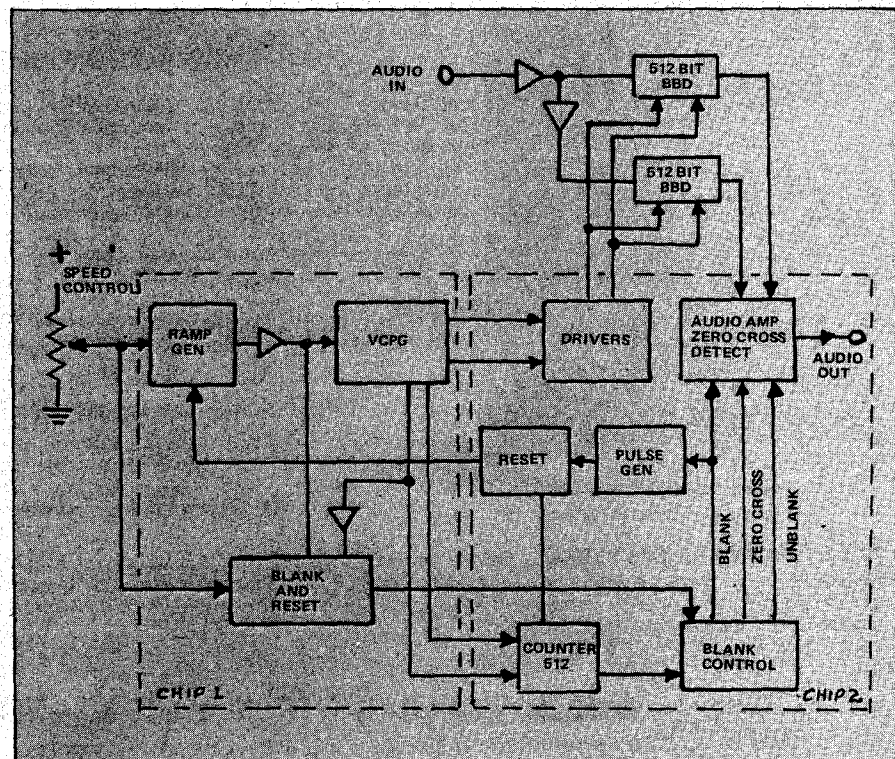

Fig. 3. Functional block diagram of the VSC system. Two chips are used for control and a third chip contains the dual bucket-brigade analogue shift reader.

# VARIABLE SPEED SPEECH

being played back at a faster (or slower) rate.

The speed control potentiometer, as well as determining the speed of the recorder, provides a control voltage to a ramp generator. If normal speed is set, a ramp is not generated and the bucket-brigade device merely delays the signal without other change. If the recorder is speeded up, a positive going ramp is generated, and if slowed down a negative going ramp is generated. The ramp is passed to a VCPG (Voltage Controlled Period Generator) and as the ramp sweeps it varies the clock pulse period from the generator such that a progressively greater (or smaller) delay is obtained during the sample.

Before the ramp overdrives the period generator a comparator causes the amplifier to be blanked at the reset zero crossing point of the audio (to avoid annoying switching noise). At the same time the ramp is reset and a staircase counter is started.

During the next 512 counts the amplifier remains blanked allowing the

sample stored in the analogue shift register, to be dumped out. At the end of the count the amplifier is gated on allowing the next sample to be loaded into the shift register.

Thus a discard period of 20 to 40 milliseconds is generated and the amplitude and polarity of the ramp will vary the playback rate from less than one half to three times normal speech rate.

Although only one bucket-brigade shift register is required, the use of two devices feeding a differential amplifier allows twice the output voltage to be obtained. Additionally, the differential amplifier will cancel out common mode noise, due to switching etc, thus improving the signal to noise ratio by 3 dB.

The development of the VSC process was carried out by a small group, specially set up in 1966, known as Cambridge Research and Development Group (CRDG). The basic design was first implemented with discrete FET storage stages and the advent of the Philips/Matsushita bucket-brigade

devices was a fortuitous development which allowed an IC design to be immediately feasible.

The design is now to production stage and three licensing agreements have been concluded with Sony Corp, Matsushita Electric Co and with Magnetic Video Corp of US. Additional licenses are likely to be appointed in the near future. In fact as we close for press we have just heard that Hitachi's new TSC-8800 cassette recorder has the system built-in.

At present the VSL system is constructed on three chips, one for the dual BBD device and two for the control logic. This system will allow low cost tape recorders to be modified for VSC at reasonable consumer price levels.

It is expected that, in the future, the entire system will be integrated onto one chip, using CMOS techniques. Such a low voltage, low power device will make VSC a technique which will probably be incorporated in all low-cost dictation equipment and cassette recorders as a matter of course. ●

## CHRISTMAS OFFER TO ALL ETI READERS

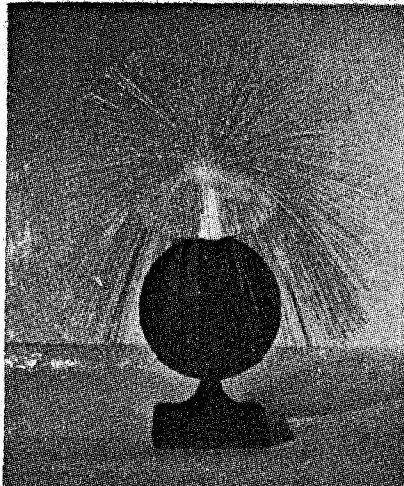

F120 "HEAVEN'S TOUCH"

### IMPORTED FIBER OPTIC LAMP

- Beauty and function incorporated into a unique lamp.
- In a room, they create an atmosphere so unique no other light is needed. Perfect for a party or relaxing at home.
- Extremely low energy requirement; yet revolutionary design creates thousands of multi-coloured optical fiber-lites.
- The operation of the colour wheel is completely silent.
- Overall height is approximately 20 inches.
- Base-chrome plated, Ball-black velvet.
- 240V operation, patent #3,431,410.

This lamp which will retail at approximately \$90.00 is available till December 1974 for an Introductory Price of \$52.50 including post and pack. DEALER ENQUIRIES WELCOME.

### RECHARGEABLE BATTERIES AND CHARGERS

We manufacture chargers for our calculators by the thousands and also import rechargeable batteries. For the first time now we are offering these chargers and batteries to the public for radios, tape-recorders, torches, etc., at a price you can afford. The chargers are also suitable as battery eliminators for your transistor radios. Send stamped S.A.E. for details.

**W.H.K. TECHNICAL CATALOGUE.** Our updated catalogue No.6 is available now, it contains information on liquid crystal displays, battery operated chromometer kits with 6-digit display, digital clock/calendar IC's, frequency meter kits, digital voltmeter kits, meters, anti-reflection filters, LED's, integrated circuits, CMOS IC's, data books, diodes, scientific calculator kits, etc. We request \$0.50 in stamps due to increased postal charges.



## W.H.K. ELECTRONIC & SCIENTIFIC INSTRUMENTATION

MANUFACTURER, IMPORTER & WHOLESALE MERCHANT  
2 GUM ROAD, ST. ALBANS, VICTORIA, AUSTRALIA 3021. PHONE 396-3742  
POSTAL ADDRESS: P.O. BOX 147, ST. ALBANS, VICTORIA, AUSTRALIA 3021



# The compliment we like best about the new Monarch Series 8:

# “It's no surprise!”

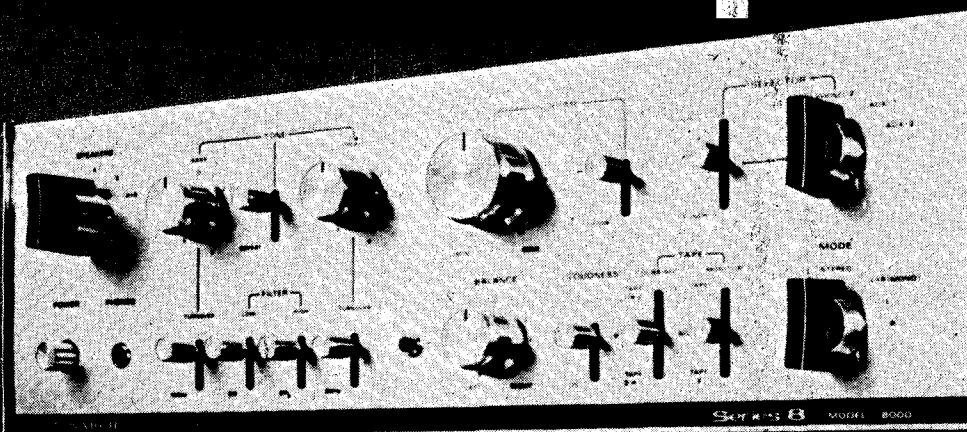

When people already think of one name as the best value for money, they naturally expect every new model to maintain the same high standards — or improve on them. So, Monarch's brilliant new Series 8 amplifiers will come as no great surprise.

No surprise — even though we've created a superb new amplifier, top-of-the-range Monarch 8000 to bring you continuous RMS power of 55 watts per channel at 8 ohms, with distortion of less than 0.1%; even though we've included tape dubbing and turnover controls; even though we've produced a frequency response of 10 Hz to 60,000 Hz; even though we're presenting three other new Monarch amplifiers — the 80, 88 and 800, which feature dramatic improvements in power and efficiency. It's no great surprise — because you expect Monarch to be the best... And it is, so all

Monarch amplifiers remain "kings" on a power-to-performance-to-cost rating.

Try any of them. The prices are as undistorted as the sounds. All with the same beauty of design you expect of top performers. And all have the Monarch two-year guarantee on parts and labour. You know you're getting Monarch quality. Without paying more.

Monarch 8000	—	110 watts RMS
Monarch 800	—	80 watts RMS
Monarch 88	—	48 watts RMS
Monarch 80	—	24 watts RMS



## MONARCH

AUSTRALIAN DISTRIBUTORS

## WEDDERSPOON

W. C. WEDDERSPOON PTY LTD

3 Ford Street, Greenacre, 2190

Telephone: 642 3993 642 2595

Showroom demonstration by appointment

AVAILABLE FROM REPUTABLE DEALERS EVERYWHERE

# CABLE TV - the wired city

A new era in home communication and consumer services.

SHORTLY after the introduction of the telephone, affluent Parisians had their houses wired via *two* channels to an auditorium where concert performances were given. Here the performances were picked up by carbon microphones, relayed to the individual residences, where subscribers listened via earphones. The service was not a success since the non-existence of amplifiers limited the scope of the system.

But it anticipated a technology that is only now emerging. It is one that has all the portents of changing our life pattern more radically than any of the communications media to date.

Many futurists believe that we are on the brink of a communications revolution. In the next decade or so, two technologies will be instrumental in this revolution — the proliferation of satellite communications and the rapid expansion of cable systems.

The two technologies complement each other. Satellites make it possible to send signals over long distances; co-axial cables make it possible for scores of signals, originating either from far away or a homeowner's own neighbourhood, to be received by individual subscribers.

Cable TV (CATV) is somewhat misnamed. The name implies direct "piping" of TV broadcasts to individual homes, especially in locations where it is impossible to receive satisfactory signals directly over the air.

In reality, the concept of cable TV is more than that, for the cables would not only carry TV and radio programmes but would provide an *interactive* medium for every aspect of community and commercial communications.

In the 1950's many cable operators in the USA began to make their own programmes. As areas of distribution increased, micro-wave links were set up for linking central off-the-air receiving stations to "headend" receivers in various locations of high density urban areas.

The cost of links were far cheaper than cables. Coupled to some headends were small cablecasting studios generating local programmes. The cheapest forms of local programme were "automated". For example, a TV camera might be permanently pointed at a clock-cum-weather indicator and left unattended. The picture would be sent

over an unused channel of the cable system to provide viewers with continuous time/weather information.

Aware of the potential, cable companies are planning the phasing-in of a diverse range of services. Ideas for cable system uses are almost inexhaustible, even though the technique is still in its infancy.

## GETTING THE SIGNAL "HOME"

Fig. 1 shows how cable distribution is an extension of this system to incorporate microwave links to distribute off-the-air signals to more than one cable system in an urban area (this is far cheaper than running a cable between stations). Also if the distance exceeds about 15 kilometres, too many repeaters would be required.

The main distributor cable in a CATV system is the trunk line. It is usually one to two centimetres in diameter but may be larger. The larger diameter cables are used for longer distances since they attenuate the signals less. Amplifiers must be placed along the cable length to maintain signal strength at useable levels. These trunk amplifiers are particularly critical components. Each one

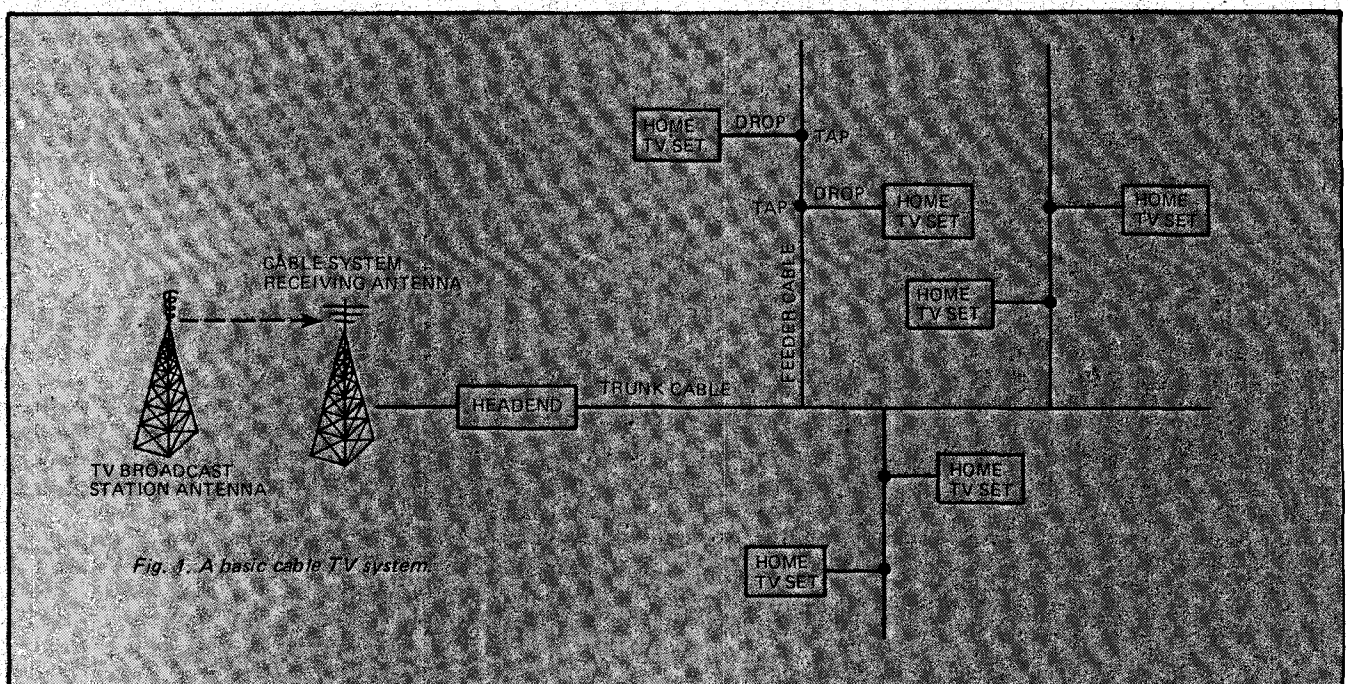
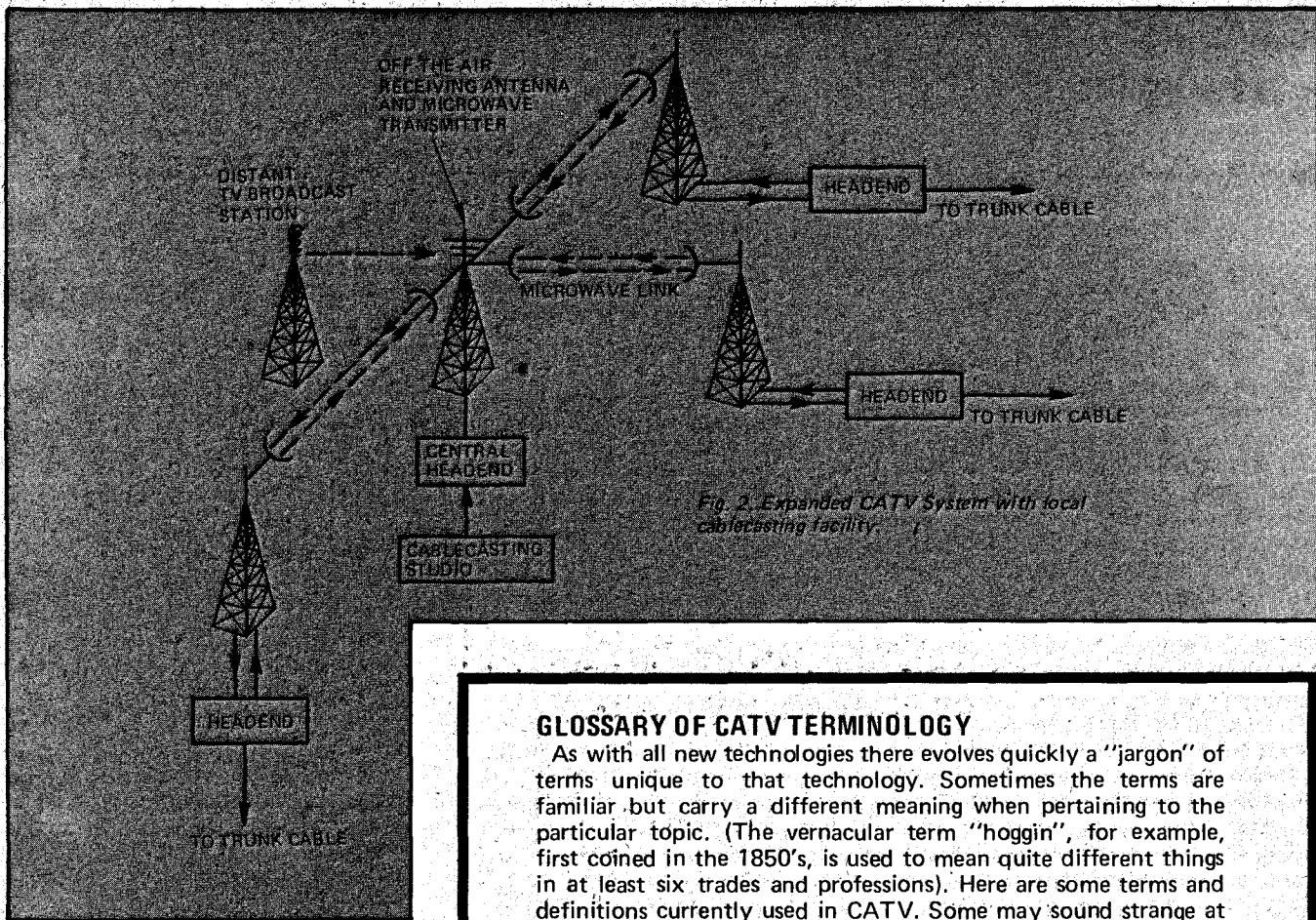

Fig. 1. A basic cable TV system.



degrades the signal quality slightly, and their effect in series is cumulative.

There is a practical limit to the number of amplifiers that can be cascaded before the signal quality becomes unacceptable. Where cable competes with good off-the-air signal, this limit is somewhere in the region of 20 to 30 amplifiers — corresponding to a cable run of about seven to fifteen kilometres from the headend.

When a trunk cable passes a street or other area of high subscriber density, a smaller feeder cable is attached, (usually about one centimetre in diameter). The trunk and the feeder are connected through a "bridging" amplifier which electrically isolates the trunk to that area. Line extender amplifiers are used to boost signals with feeder lines so that more subscribers can be served. Since feeder cable is cheaper than the larger trunk lines, the practice is to maximise the feeder-to-trunk ratio for lowest costs.

A small drop cable brings the signals from the closest feeder line to the home. The drop cable is usually 6.0 to 8.0mm diameter. A coupler or tap connects the drop to the feeder cable.

This coupler presents a low resistance to signals flowing to the subscriber's home but offers high resistance to

### GLOSSARY OF CATV TERMINOLOGY

As with all new technologies there evolves quickly a "jargon" of terms unique to that technology. Sometimes the terms are familiar but carry a different meaning when pertaining to the particular topic. (The vernacular term "hoggin", for example, first coined in the 1850's, is used to mean quite different things in at least six trades and professions). Here are some terms and definitions currently used in CATV. Some may sound strange at present, but should become commonplace in the future as the industry expands.

**Cablecasting** — Sending material originating from the cable operator's own studio facilities. These facilities are usually an appendage to a "headend".

**Downstream** — Direction of signals when sent from "headend" to subscriber.

**Drop** — Small cable which carries signal from "feeder" line to home.

**Feeder** — Secondary cable-spur used to distribute signals from "trunk" to residential streets or other high density subscriber areas.

**Guard-Band** — Band of frequencies used to separate "up" and "downstream" signals to prevent interference.

**Headend** — Sub-station, which processes off-the-air signals as well as adding signals of local origin. It then distributes them along the cable system to subscribers.

**Home Terminal** — The "black box" located in the home which interfaces the subscriber's TV with the "drop cable". Also incorporates selector for picking channels and "charge" facilities where "pay-cable" services available. Will also have a "data entry" terminal when two-way subscriber services become available.

**Link** — Microwave-link for connecting "headends" with a central off-the-air receiving station.

**Pay Cable/Pay TV** — Services offered via cable for which subscribers will pay extra charge over and above cable subscription fee.

**Round-robin** — Unidirectional cable-loop system proposed for two-way communication.

**Sub-split/Low-split** — Technique of separating "up" and "downstreams" signals on single cable systems.

**Tap** — Special linkage for connecting "drop" to "feeder" cable.

**Trunk** — Main distributor cable originating from "headend".

**Upstream** — Signal direction when subscriber communicates with "headend".

# CABLE TV - the wired city

reverse signals. This prevents interference emanating from the subscriber unit from entering the cable network. Special two-way taps are used when interactive communication facilities are required.

At the subscriber's home, the drop cable may connect to a small impedance matching transformer, or more commonly now, to a selector box which incorporates a switch for facilities available on CATV.

In the USA, conventional one-way CATV costs the subscriber about \$A40-\$A50 per home if most of the construction is above ground. Assuming that 50% of households subscribe for a service, the system's initial construction cost is about \$A80 to \$A100 per household. Many CATV systems that distribute only broadcast-TV signals have been built for considerably less. Higher percentages of subscribers for a given area also reduce the cost substantially.

Incorporating extra channels for other facilities, including provision for two-way services, requires new technical approaches and undoubtedly will raise the cost of construction of such a system to about \$A100 per subscriber. As with the simpler systems, the CATV companies absorb some of this in order to encourage new subscribers who would otherwise be deterred by the initial cost.

A US Department of Commerce study observes that in the USA alone: "Some 50 000 new engineering jobs will be generated over the next five years by the cable TV industry." This seems reasonable, in view of the things that cable TV can do besides entertain. "Technical personnel will be needed not only to instal and service cable systems but also to design auxiliary equipment - two-way TV - home print-outs - new cameras etc."

With the expansion of facilities, more channels are required than the 10 to 15 normally accommodated by a single cable system. Various methods are available for this and some are shown on Fig. 3.

Cable TV system manufacturers have not yet standardised on one system. Until they do it is virtually impossible for TV setmakers to incorporate a "cable compatibility feature" which will reduce the cost of interfacing a set with a cable system.

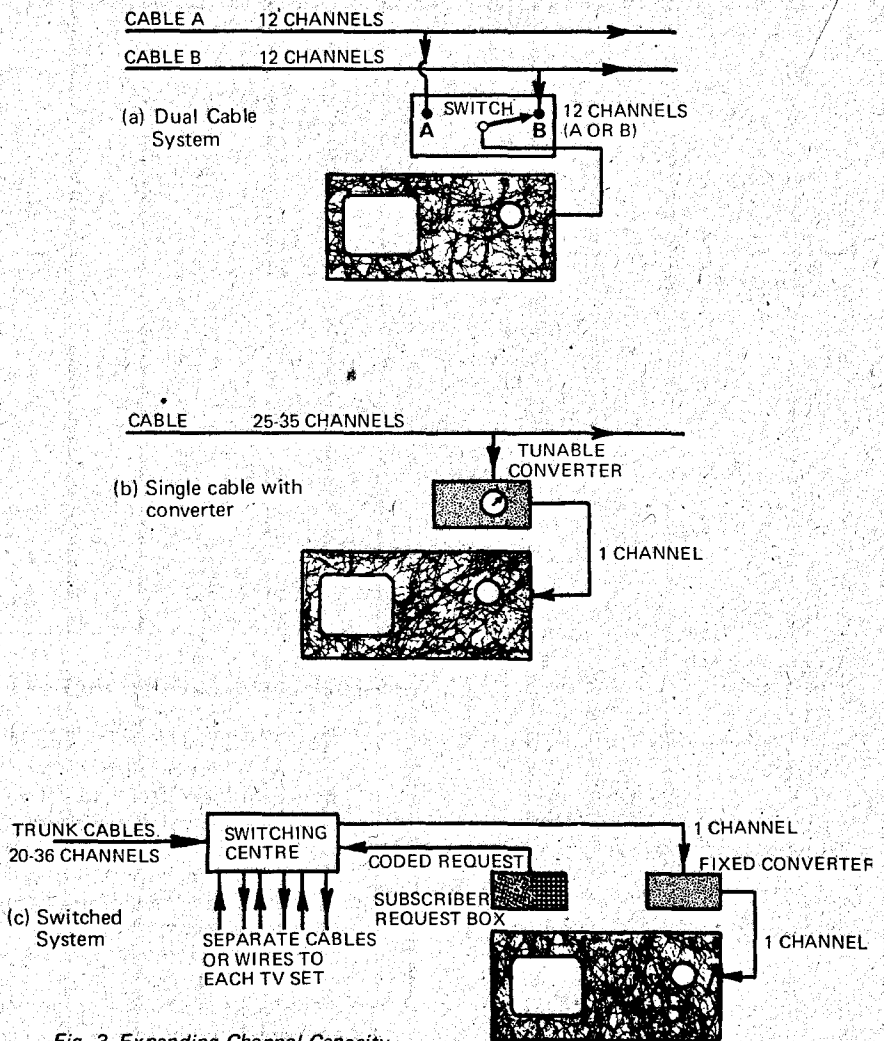

Fig. 3. Expanding Channel Capacity.

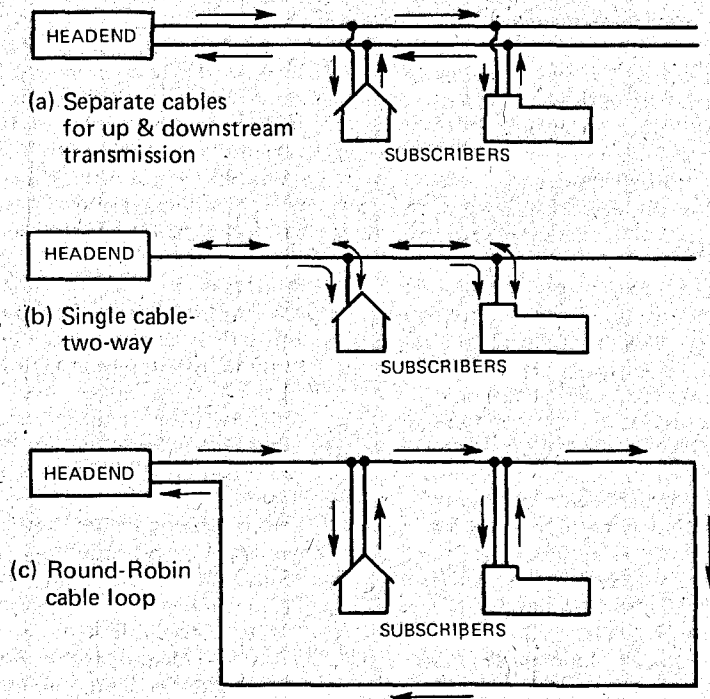

Fig. 4. Three techniques for two-way CATV.

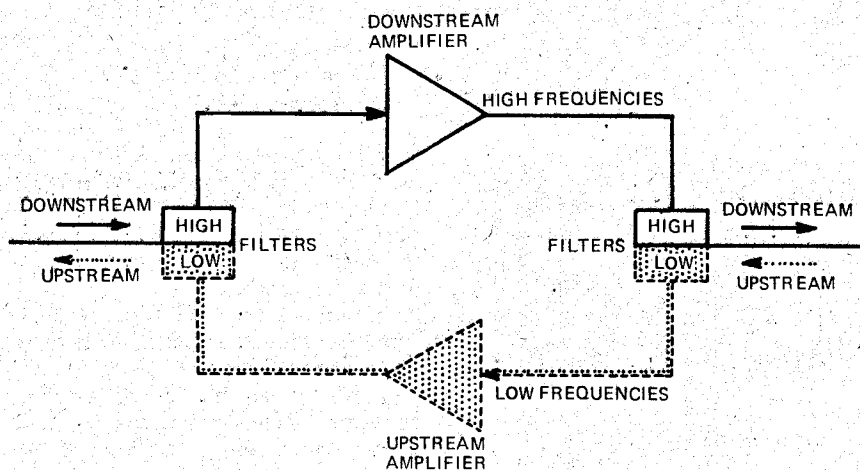

Fig. 5. Two-way amplifier system for a single cable CATV.

In the meanwhile a community's choice is between a dual cable system, a converter system or a hybrid of each.

### TWO-WAY – TOMORROW'S CABLE SYSTEMS

Two-way CATV by definition requires a cable system that can transmit information in both directions. The chief technical difficulty today is that each TV set or subscriber terminal introduces some noise into the upstream transmission path, and the cumulative effect from a large number of subscriber terminals may be intolerable. Improved receivers, taps, filters, and other components have to be designed before two-way cable systems can accommodate the tens of thousands of subscribers contemplated in major markets.

Two systems have been considered for two-way technology. The first uses separate cables for up and downstream transmissions. In the second, both up and down signals are sent simultaneously on the single cable but on different frequency carriers (Fig. 4a, 4b).

A third as yet hypothetical approach would be to use a one way round-robin cable loop to bring signals to and from subscriber locations (Fig. 4c).

Having a separate cable for upstream transmission has few technical problems and offers more upstream capacity, but is expensive. An ordinary telephone wire pair used for upstream path would satisfy most communications authorities' requirements for "non-voice return communication", but would provide little capacity for future services.

With a single cable the installation is much cheaper, but actual transmission methods are more complex. A coaxial cable is a good bi-directional carrier

medium. The most popular approach is to use the sub-VHF bandwidth below 54 MHz for upstream signals, retaining the 54-300 MHz bandwidth for downstream transmission. This is known as the "sub-split" or "low-split" technique.

Unfortunately amplifiers are unidirectional and require some by-pass path for signals going in the opposite direction. This is done by filtering to separate the frequencies (see Fig. 5). Since the filters are not as sharp as would be desired, a "guard-band" is used to prevent interference.

As a result, designers restrict upstream transmission to a range of 5-30 MHz, rather than 54 MHz. Thus the "sub-split" system limits the upstream bandwidth to about 25 MHz. This allows for not more than four standard TV channels.

### PAY-CABLE – A TECHNOLOGY FOR NEW SERVICES

Pay-cable will be the first of the new services offered by most cable systems. Viewers will pay an extra charge to watch first run movies, sports events, theatre productions, and other special programmes.

Pay-TV movies have already proved successful in hotels and motels. New types of terminals will be required, to deny programmes to those who do not want to pay for them, and to record proper charges for those who do.

The simplest technical approach is to send pay-TV programmes on special frequencies – and supply the subscribers with suitable converters. To guard against subscribers from tapping in for free, pay-TV promoters usually code or scramble their signals at the headend. A decoder as well as a converter is then required at the terminal. More elaborate security methods would apply to private

channels that only certain subscribers are entitled to receive. Private channels might be needed for police training classes or for assuring privacy for banking transactions in a two-way system.

Methods of charging the subscriber are varied. One suggested system would use a card – purchased in advance – shaped like a plastic credit card. This could be inserted in a special slot in the pay-TV terminal where the magnetically coded card would activate decoder circuits to provide an undistorted picture on the screen.

However whilst satisfactory for such a service this would not be practicable when related say, to "leasing" computer time on a time-sharing facility.

Since a cable system may have such a diversity of functions the major retarding factor for the expansion of the "wired city concept" is the lack of an optimised uniform standard. This is partially due to still outstanding technical problems, politics and inter-company rivalry. Everyone is trying to get on the bandwagon!

There are ever-mounting pressures from both the consumer and manufacturer for the "go-ahead" to adopt a system. Perhaps wisely, government authorities are taking a careful "wait-and-see" attitude.

The system eventually adopted will have to serve the community for at least several decades. Hence, it is essential that it will be a flexible one, catering for the easy assimilation of innovations that have yet to be conceived.

Perhaps the co-axial cable, with its associated problems is not the answer. Fibre-optic transmission lines could be chosen. Their new technology overcomes many of the limitations of existing systems.

In Australia it was recently announced that an experimental cable system is to be tried out in Canberra. With the imminent introduction of colour TV broadcasting many people, especially in high density urban areas, will find themselves in "impossible" propagation areas. There, for a variety of reasons, reception of colour signals will be totally unsatisfactory.

This will obviously generate pressures for a cable system, or other alternative. Whilst on one hand desirable, it could lead to the introduction of a "premature" system which would offer little more than its primary purpose. It is hoped that interim alternatives such as communal antenna systems, or local re-broadcasting on highly localised UHF/SHF wavelengths might be used until a national standard for CATV comes to fruition. ●

# CAMTEC

Eight-day holiday camps provide technology training for young people.

— A.J. Lowe reports



*Why doesn't it work? Expert help and adequate test equipment soon solve problems of perverse projects!*

EIGHT FULL DAYS of electronic construction; a store bursting with components; benches groaning under a mass of test gear; abundant projects to do; working prototypes to inspire; enthusiastic competent instructors to guide and help; other constructors nearby; a rack overflowing with free second-hand magazines; an amateur radio station to broadcast on; — does that sound like the electronic hobbyists dream?

To a hundred Australian high school students a year it's no dream, but a reality! This reality exists in a series of 'camps' (in buildings not in tents) known as CAMTEC, held each summer holiday at Mount Victoria, N.S.W. Three graded camps each year cater for high school boys in all grades — and girls from 5th and 6th form as well, at the senior camp.

Electronics is only one part of Camtec — photography is another. It's

interesting how many people pursue both of these activities, and so Camtec meets their need.

## ELECTRONICS

Beginners as well as advanced hobbyists, and those in between, find projects to match their skill and challenge their ambition. At the start of every camp a session is run for those who aren't so sure — and need to improve their touch with a soldering iron, their recognition of components, and their understanding of a multimeter, (in the interests of long life for multimeters as much as anything!).

Once past the preliminaries, campers select their programme. They may choose electronics or photography or a mixture of both. The choice of electronic projects is wide, and ranges from basic circuits such as multivibrator flashers to radio control

gear for model planes. Novelties such as the magic electronic candle which lights with a match, and goes out when you blow (damply) on it, appeal to younger lads, while 10 watt amplifiers, and modulated light beam communications provide a challenge for the more experienced. In between are ever-popular sirens of all types — and the louder the better, (a release for aggressive instincts perhaps); model train controllers, reaction timers, proximity relays, slave flash units, intercoms, counters, adders, power supplies, oscillators, radios, mixers, and many more.

One project which grows year by year is a synthesizer. This is expanded effect by effect, and note by note as another astable is added. Being polyphonic it produces acceptable music, although the keyboard is still a simple static printed circuit affair. In addition to music the machine produces very realistic train noises (steam of course), and the crossing-a-bridge effect has to be heard to be believed.

## RADIO

For those whose interest is mainly radio, the camp provides instruction for the Youth Radio Scheme exams run by the Wireless Institute of Australia. Each year several lads sit for these exams at camp, and the record of success has been very high. Training for Y.R.S. enthusiasts includes theory as well as practical work, and that moment of great delight — going on the air on the camp's radio station VK2BCT.

## CONSTRUCTION

Construction styles vary from very simple 'bread board' work — using nails in blocks of wood as anchor points, to finished pc boards that no hobbyist would be ashamed to show. When possible, projects are housed in cases and completely labelled and finished. Lads who bring their own projects to camp, including those that won't 'go', get expert help to complete them.

Campers are allowed to take projects home for the cost of parts which, in most cases, could not be recovered anyway.

## TESTING

To guarantee success with projects there is available a large amount of high grade test gear — signal generators, oscilloscopes, multimeters, bridges etc. Campers are shown how to

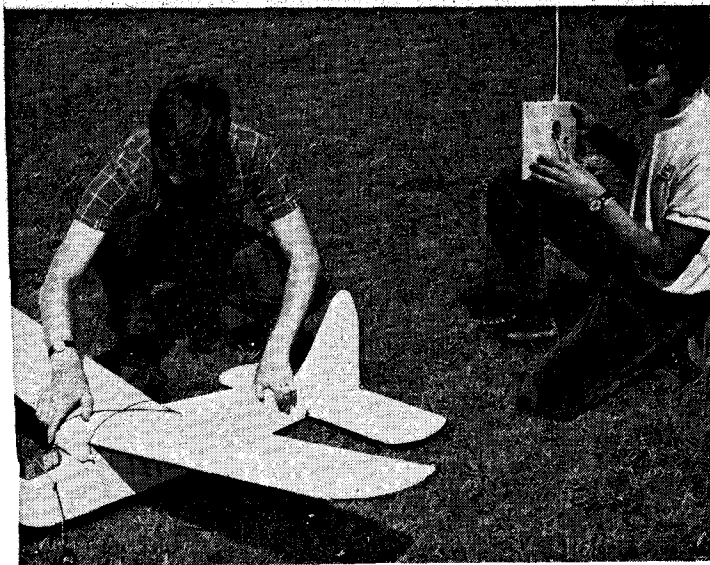

*First flight —  
with newly built  
R/C equipment.*

use this equipment, not simply to 'debug' a circuit, but to test performance of, say, an amplifier, and to see what is actually happening.

### HISTORY

Camtec (formerly known as Camp Technology) is the now 10 years old realisation of a dream by a young electronics engineer, Rob Hockley of Sydney. Back in the early sixties he saw the growing enthusiasm for electronics as a boys' hobby, and saw that there was little opportunity for it to be pursued except in isolation — with all the frustration that can entail. He saw that camps existed for those who were crazy about camping, hiking, mountaineering, art, music, sailing — but nothing for those bitten by the electronic bug. Camp Technology was set up to cater for those interests under the auspices of the Inter-Schools Christian Fellowship, a branch of the Scripture Union.

It still is part of the I.S.C.F. range of camps offered to high schoolers each year. Campers and staff have come to Mount Victoria from as far as Melbourne and Brisbane. The staff, without whom of course the camps would be impossible, are firstly convinced Christians, and in addition deeply involved in electronics or photography at a professional or advanced hobby level.

Generous help is given by the universities and technical colleges with the loan of test gear (though the camp is progressively acquiring its own), and by the industry in the provision of components, material, batteries and much more.

### FURTHER INFORMATION

Any reader wishing to know more about future camps should write or 'phone Mr. J. Wightman, 10/37 Eddystone Road, Bexley, N.S.W. 2207; 'phone (Sydney) 502-2083. ●



*100 watt 144 MHz  
FM transmitter  
built and used by  
CAMTEC people.*

## THE PAPUA NEW GUINEA UNIVERSITY OF TECHNOLOGY PRINCIPAL TECHNICAL INSTRUCTOR TECHNICAL INSTRUCTOR (Communications)

Applications are invited for the above positions to staff a course leading to the Diploma in Communications of this University. Equivalent to 3 years of full time study, this is a sandwich course extending over 4½ years, and will train the high level sub-professional personnel required by the communications industry in Papua New Guinea.

### Principal Technical Instructor

Under the general control of the Head of the Department of Electrical Engineering, the appointee will be responsible for detailed syllabus development, forward planning and administration, selection and ordering of equipment, and supervision of staff. He will also assist in the teaching programme.

Applicants should have extensive practical experience in communications, experience in training, in technical teaching and have administrative ability. Possession of tertiary qualifications would be an advantage. The successful applicant will be required to take up his duties at the earliest possible date.

### Technical Instructor

The appointee will be required to teach technical subjects within the Diploma in Communications course and to assist the Principal Technical Instructor with planning and syllabus development. Applicants should have good practical experience in communications, suitable technical qualifications, and desirable experience in the field of technical teaching.

Salary: Principal Technical Instructor: \$11,970 range \$12,921 per annum; Technical Instructor: \$7756 range \$8694 per annum or \$8929 range \$9443 per annum according to qualifications and experience. Allowances additional to salary totalling \$1260 are payable in certain circumstances. Other benefits include fully furnished housing supplied at a nominal rental, 6 weeks leave per annum, with fares paid to Australia; lower taxation than Australia.

Applications in duplicate should include full particulars of age, nationality, marital status and family, if any, qualifications, experience, present post, date of availability and the names and addresses of three referees from whom confidential enquiries may be made.

Lae, the gateway to the Papua New Guinea Highlands, is a pleasant tropical town situated on the Huon Gulf. The town's population total is approximately 5,000 Europeans and 25,000 Papua New Guineans. Sporting facilities are particularly well catered for and the 18 hole golf course is considered the best in the country.

*Applications close on 15th November, 1974 and further particulars on Lae and the position may be obtained from*

**The Registrar,  
The Papua New Guinea  
University of Technology,  
P.O. Box 793,  
LAE: PNG.**

# FANE



## HI-FI BASS LOUSPEAKERS FROM ENGLAND

**12"** The model B122/10LR is a 12" bass speaker featuring a rubber suspension which allows a fundamental resonance of 17Hz in free air. This low-resonance, combined with a 2" voice coil working within a carefully selected magnet structure makes the speaker ideal for a sealed cabinet of about 2 cu.ft. capacity. Efficiency of the B122/10LR is surprisingly high for this type of loading and the speaker is ideal for amplifiers with an output of 20-25watts r.m.s. per channel at 8ohms. **\$39.50**

**12"** The model B122/12LR, like the B122/10LR described above, is also suitable for sealed cabinets but because of its more powerful magnet structure a volume of about 3 cu.ft. is required to ensure the speaker gives its optimum performance. **\$49.50**

**15"** The Fane model B152/12LR is a 15" bass driver with a fundamental resonance of 15Hz in free-air. Once again a sealed cabinet provides ideal loading for this unit and the volume can be varied from 3 to 5 cu.ft. The performance in 5 cu.ft. is particularly outstanding as the resonance is kept in the region of 30Hz. This results in firm, non-resonant bass without any of the "boxiness" often associated with conventional speakers. Efficiency is reasonably high and power-handling is up to 30watts r.m.s. at 8ohms. **\$59**

## ES801 TONE ARM

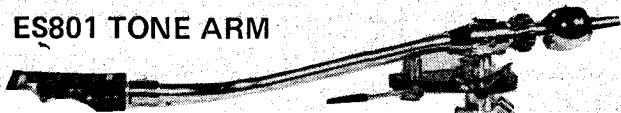

**\$39.50**

The ES801 Tone Arm is a high-quality product of excellent performance. All facilities are provided and include removable headshell, adjustable anti-skate, lateral balance, stylus pressure scale, oil-dampened cueing lift and plug-in connecting cable. The acoustic performance is characterised by lack of arm resonance and consistently low bearing friction. All in all a very reliable unit which fills the requirements of most domestic hi-fi systems. The ES801 is the best buy currently on the market at only **\$39.50**

## STAR SONIC S10E CARTRIDGE

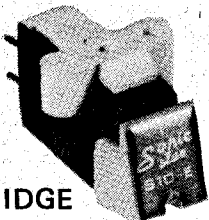

The Sonic S10E cartridge is outstanding value as it is a magnetic cartridge employing an elliptical diamond stylus. The unit has a compliance of 15 x 10<sup>-6</sup> cm/dyne at 100Hz which makes it suitable for using with most tone arms. Fitting the cartridge is extremely simple, because the standard 1/2" mounting system is employed. Frequency response is 10 to 25,000Hz and recommended tracking weight is 1 to 2 grams. A fantastic buy for only **\$15.00**



## EC-004 RECORD CLEANER

The EC-004 is most effective for removing dust from the path of the stylus whilst the record is being played. The super-fine brush effectively sweeps the grooves clean but does not damage the delicate record surfaces. At the same time a soft, plush covered cylinder treated with anti-static chemicals ensures that static build-up is eliminated and also collects any spurious dust swept aside by the brush. An adjustable counter balance weight is standard equipment and the stand is a heavy casting which can be placed in various positions to control the tracking performance of the arm. A must for record care at only **\$4.50**

## SUPER VALUE! AM/FM STEREO TUNER

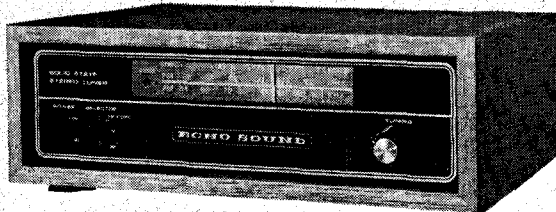

The new ERC-724 tuner is a carefully designed unit which will become a welcome addition to your existing stereo system. The AM section features an internal ferrite rod aerial which provides interference-free reception, for local stations and allows good interstate reception for evening listening. The FM stereo section covers the range 88-108MHz. The ERC-724, is a compact unit (23.5cm x 15cm x 8.5cm) attractively presented in a walnut cabinet. Guarantee is 12 months, including parts and labour. An excellent buy for only **\$64.50**

## NEW MODEL CHALLENGE LOUSPEAKERS

### 10" 10L-24 WOOFER

This robust unit features a 4 layer wound 1 1/2" voice coil which allows it to handle 30watts r.m.s. comfortably. The combination of extremely rigid cone and low-fundamental resonance ensures deep, positive bass when used in the recommended enclosure sizes. Outstanding value for **\$16.90**

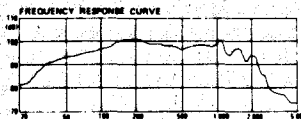

### 1" H-22 DOME TWEETER

The development of dome tweeters has been a major project of most loudspeaker manufacturers of recent years. The H-22 dome is one of the latest designs. The 1" diaphragm is made of carefully selected metallized mylar material which is free from resonances or rattles, and is of very small mass to allow maximum efficiency. Undeniable value for **\$8.50**

FREQUENCY RESPONSE CURVE

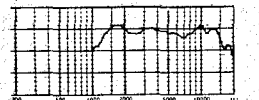

## NEW RELEASE HOKUTONE LOUSPEAKERS

### HT-60 1" DOME TWEETER

**\$13.50**

This magnificent unit features a combination of aluminium diaphragm and powerful magnet structure to produce an exceptionally clear non-resonant treble response. Efficiency is very high and dispersion is enhanced by the special acoustic diffuser surrounding the diaphragm.



### HM-24 2" DOME MIDRANGE

**\$16.50**

An advanced unit of super high efficiency which operates effectively from 900Hz to 8,000Hz. The low-mass 2" diaphragm allows improved transient response over conventional mid-range loudspeakers. The HM-24 is extremely well made and handles high power provided it is used with a suitable crossover network.

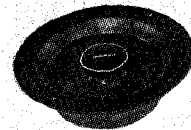

## CROSSOVER CAPACITORS

Some examples from our wide range include 3.3mfd mylar film **\$1.45** each, 2.2 mfd mylar film **\$1.20** each, 3.3 mfd mylar film **\$1.40** each, 5 mfd NP Electrolytics **45c** each, 30 mfd NP Electrolytics **60c** each and 60mfd Electrolytics **90c** each.

## CROSSOVER CHOKES

A comprehensive range is now available of high power, high efficiency inductors in the following values 0.25 Mh, 0.35 Mh, 0.5 Mh, 0.75 Mh, 3.55 Mh. Prices range from **\$1.00** to **\$5.00** each.

## CROSSOVER NETWORKS

A wide range of professionally designed networks are now available at very reasonable prices. Recommendations and quotes can be supplied, providing full details of loudspeakers intending to be used are provided.

## SPEAKER GRILLE CLOTH

An attractive selection of speaker grille cloths are available ex stock at very reasonable prices. Free sample pieces are available on request and will be forwarded per post anywhere in Australia together with our price list.



**INTERSTATE DEALERS!** We are expanding our operations to include interstate merchandising. Please contact us if any of the above items are of interest.

# Challenge

HI-FI STEREO PTY LTD

96 PIRIE ST.  
ADELAIDE  
STH. AUST. 5000  
PHONE: 223 3599



# DIRECT DISPOSALS MAIL ORDERS: 36 HELEN ST., VALLEY. BRISBANE Q'LAND.

ESTABLISHED OVER 29 YEARS

**SPECIAL!**  
**\$55**

075

**OUTBOARD LEG ASSEMBLY**

Tremendous purchase of these top quality MK. 11 model complete underwater assembly to suit any model two-stroke "VICTA" MOTOR MOWER ENGINE. Takes 2 minutes to fit engine to leg. Sturdily constructed and trouble-free; has 8" 3-bladed prop. 360° turning. Full 12 months guarantee. A Bargain. Full range of spares always carried if required in later years. These are exclusive to us.

Fitted with 1974 4 h.p. 125 c.c. "VICTA" zip start ball bearing motor, 12 months g'tee. **\$139**

**FRESNEL LENSES**

**\$4.50**

265

12 in. sq. x 1 mm. thick. f.l. 13, 1/2 in.

Precision worked in thin optical plastic and providing large area magnification equivalent to expensive glass lenses. Fine optical quality permits use as solar furnace elements, condensers, image magnifiers, light intensifiers, overhead and back projection optics, camera image brighteners (disco scenes). Use our low RPM geared motors to drive these. 8oz.

Double Fresnel Lenses (condenser) same size as above \$7.50 1lb.

**INDUCTION MICROPHONES**

complete with lead and plug

**\$2.45** 125

Designed for use with amplifiers or tape recorders.

Impedance about 2k ohm with sufficient output for valve or transistor equipment. Miniature size, fitted with rubber sucker which presses on to telephone in position giving maximum volume. 4oz

**Fantastic Purchase!**

**CONDENSER MICROPHONES**

**\$24.50** 124

One of the finest made. Used by the B.B.C. in their outside broadcasts. Our huge direct import just arrived makes this price possible. Freq. response 30—16,000 Hz; impedance 600 ohms; output level -68 dB at 1,000 Hz; Polar pattern unidirectional (cardioid); Max. sound level 125 dB. 20ft of shielded cable and on-off switch. Complete with battery. Us. \$45. 1lb.

**UNI DIRECTIONAL DYNAMIC MICROPHONE**

**CARDIOID TYPE**

**\$17.50** 123

Features dual impedance — 600 ohm and 50K ohm netted ball head, on/off switch, stand holder, 20ft. cable. Extremely wide range frequency response. This microphone has the unique facility of shutting out unwanted noise originating from the opposite direction of the microphone due to its unidirectional polar pick-up pattern. Exceptional value! 2lb.

268

**12 VOLT POWER UNITS, \$6.50**

Made in England by "Smoothflow", a division of "Meccano". 240 volt A.C. input, 12 volt D.C. output at .6 amp. Fully protected from damage by automatic cutout which resets itself automatically. Brand new in cartons with instructions. Ideal models, battery charger for small batteries (especially our Nife Batteries). Terrific bargain!

**163 COMPUTER BOARDS** 21b

Set of 3 comprising 2 boards 7" x 5" with 1 board 5" x 4" comprising minimum of 25 transistors plus hosts of diodes, resistors, capacitors, inductors, etc. \$3.95 set of 3. 21b

**5200 G.P.H.**

**\$18.95** 323

**MK. IV LATEST MODEL 5200 G.P.H. BALL BEARING CENTRIFUGAL PUMPS 6 MONTHS GUARANTEE**

Top quality 1 1/4" inlet, 1" outlet (O.D.) corrosion proof all metal centrifugal pump. Capacity up to 5200 g.p.h., pressure up to 85 PSI. Has two heavy duty sealed precision ball bearings to give smooth running and long trouble-free life. Features newly designed, replaceable carbon and ceramic seal. Handles heaviest loads and highest speeds — designed to pass solids such as sand, silt, dirt, etc., without damage, will pump salt water without harmful effect. Heads to over 170", suction lift to 25". Spare parts always available. Our very large production for export enables us to sell at this unbeatable price. Ball type foot valve for 1 1/4" hose \$4.95, 12oz.

3" pulley to suit \$1.95, 6oz.

This pump is also suitable for pressure spraying, use restrictor for reducing output. 5lb.

**240V EXTRACTOR FANS \$5.75**

**12 MONTHS GUARANTEE**

Brand new English 240 volt A.C. mains operated fans. Make ideal extractor fans for kitchens, caravans and other domestic and light industrial purposes. Continuously rated, smooth, silent-running induction motor, 4,000 r.p.m., balanced 3-bladed, 6 1/2" fan. Size 6 1/2" dia x 4" deep. 3lb.

**English Transformers**

**Brand new of the finest quality — \$17.50** 279

240 Volt AC input tappings 0—12—13.5—17 Volt output at 8 amps. Wt. 13lb.

4 amps. English selenium rectifiers (2 needed) to convert AC to DC \$1.50 ea.

315

**SPARE PARTS** always available if required in later years.

**3 MONTHS' GUARANTEE**

Exclusive release... **FAMOUS AMERICAN THOMPSON 1,000 G.P.H. ELECTRIC PUMPS & MOTOR \$25**

The world's most famous manufacturer of pumps! This is the third release of their pump and motor produced at a Govt. cost of \$185 each.

Pump and motor only \$25.00 Ball Foot Valve \$4.95 (2lb.) • TERRIFIC BUY — U.S. Govt. cost \$185 ea. • **AIRCRAFT QUALITY** — carbon seal, fully ball bearing non-corrosive housing and impeller • **CONTINUOUS DUTY MOTOR** — sealed, ball bearing brush motor • **PUMPS ALL LIQUIDS** — water, kero, petrol, diesel fuel, etc. 1 1/2" outlet pipe for hose) • **LASTING QUALITY** — sealed unit, corrosion and explosion proof. Electric motor is for 24/32 volts AC/DC (perfect on 12 volt) and draws only 5 amps. Will shift 1,000 g.p.h. at 15 p.s.i., 800 g.p.h. at 6" head. On 24 volts pump will lift 40ft., less on 12 volts. If primed or with foot valve, will suck 20ft. then lift 20ft., less on 12 volts. Pumps have threaded inlet for 1" waterpipe. Has two bolt mounting base. Use pump as water pressure system for taps — have on/off switch (\$1) near tap. 7lb.

**AIRCRAFT LINEAR ACTUATORS**

by "Plessey". Has 24/32 v. DC electric motor 2 amps. Drive shaft travels 3 inches in either direction in 6 seconds. Has load of over 100 lbs. in either pull or push. Overall length closed 8 1/2". Used extensively for remote turning of irrigation taps. Has adjustable slip clutch and inbuilt micro limit switches. As new cond. Govt. cost \$200, our price \$25. 2 1/2lb.

Also 3" stroke model "Lucas" 100lb. load \$25. 1 1/2" stroke in 25 secs., 600 lb. load \$45. 3 1/2lb.

**AIRCRAFT ROTARY ACTUATORS**

with incorporated micro switches 24/32 v. DC 3.5 RPM 2.5 ft. lb. Torque .65 amps as new cost \$15. Also 6ft. lbs. 5 amps \$25. 3 1/2lb.

**Multi-Speed MAINS MOTOR**

**\$4.95** 296

Exceptionally robust, brush-type, series wound motor

Six speeds: 500, 850, 1,100, 8,000, 12,000 and 15,000 r.p.m. (ideal polishing speeds) main drive shaft. Very powerful and useful motor. Size approx. 2 1/2" diameter, 5" long. 2 1/2lb

**POLARIZED REED SWITCHES**

6 contact—4 normally closed, 2 normally open, electro magnet winding to activate gold plated reed switches with incorporated magnets all housed in plastic case 1 1/2" x 1 1/2" x 1 1/2" up to 50 v. DC, 2 amps. up to 240 v. AC, 1 amp \$4.50. Also 4 open and 2 closed reed switches \$4.50. Reed switches can be easily removed from case.

**110 RPM GEARED MOTOR**

**\$5.95** 299

A beautifully made 240 volt geared motor with tremendous torque. Molybdenum steel gears with approx. 20:1 reduction, continuous duty. 4 threaded hole mounting can operate in any position. **BRAND NEW!** cost \$14 to make. Rush this bargain. 500 only. 21b

**SENSITIVE ALTIMETERS**

0-40,000' in Graduations of every 10' in first class serviceable condition

**Price \$35.00 POST FREE**

A must for Rolly Driving, Gliding, Sky Diving, etc.

**HAIR TRIGGER SWITCH MATS**

**\$5.95** 207

\* Wafer thin—undetectable under door mat or carpet.

\* Operates by foot pressure over any part of surface.

Tough polythene envelope has sealed-in multi-strip contact ribbon that completes a circuit whenever anyone—even a small child—steps on to mat under which it is concealed. Ideal for burglar alarms, customer entry warning in shops, automatic door opening switch. MAX. VOLTAGE 50V. MAX. CURRENT 1AMP. 144-CONTACTS PER SQ.FT.

Door mat—29in. x 16in. **\$5.95**

**SPECIAL PURCHASE!**

**NICKEL CADMIUM BATTERIES \$2.45** 206

Almost everlasting. Can be left uncharged without harmful effect. 1.5 volts, 7 amp hour. Can be coupled together for any voltage. 11b 30c Small nickel cad. batteries, 1.5 volt. 4 AH. 95c each. P&P. 20c 3oz.

**Special! 4 Channel QUAD ADAPTORS \$24.50** 118

First time in Australia! Converts your 2 channel stereo to 4 channel quadrasonic sound. Just add 2 speakers. Adjustable sound effect of rear speakers. Has effect suited for surround or concert hall. This is true quadrasonic sound. Max input 50 watts. 2lb.

**FAMOUS ENGLISH E.M.I. HI-FI SPEAKERS \$11.50** 120

13 1/2" x 8 1/2" complete with tweeter. Handles to 10 watts, 8 ohm impedance. 55-11,000 H.Z.; Brand New in cartons, 1974 production, Has ceramic magnet. 4lb

**"HUNTS" STARTER CAPACITATORS (condensers) \$4.75** 164

Brand new! To suit 240v A.C. 50-60 c.p.s. electric motors. Condensers rated type 1 275v R.M.S., 20 u.f. (20 m.f.d.), type 2 275v 30 u.f. 1lb.

**PARCEL POST RATES (FROM QLD.)**

Articles to 1/2 lb. . . 35c to anywhere in Australia.

Articles 1/2 lb. to 1 lb. . . 50c anywhere in Australia.

Articles over 1 lb. to max. 44 lb. —

QLD.: basic 65c plus 7c each 2 lb.

N.S.W., A.C.T.: basic 90c plus 15c each 2 lb.

VIC., S.A., N.T.: basic 90c plus 25c each 2 lb

W.A., TAS.: basic 90c plus 40c each 2 lb.

(EXAMPLE: 10 lb. parcel to N.S.W.: 90c Plus 75c = \$1.65)

## DIRECT DISPOSALS TRADING COMPANY

**SELF PRIMING PORTABLE ROTARY PUMP**

The mighty midget! Pumps up to 200 galls per hour plus (depending on rpm of drill). Needs no priming, mops up to the last drop. Use in seconds—just slip into chuck of drill. Accepts 1/2" plastic tubing or garden hose. Stainless steel drive shaft, neoprene impeller—nothing to corrode! 1000's of uses in home, factory, garden etc. Spares readily available.

**ONLY \$4.95** POST 30c

POST FREE IF WITH ANOTHER ARTICLE.

**WRITE FOR OUR NEW 16 PAGE CATALOGUE 25c**

**3 months full Guarantee on all goods**

Money cheerfully REFUNDED if not completely satisfied.

**240V EXTRACTOR FANS \$5.75**

**12 MONTHS GUARANTEE**

Brand new English 240 volt A.C. mains operated fans. Make ideal extractor fans for kitchens, caravans and other domestic and light industrial purposes. Continuously rated, smooth, silent-running induction motor, 4,000 r.p.m., balanced 3-bladed, 6 1/2" fan. Size 6 1/2" dia x 4" deep. 3lb.

**English Transformers**

**Brand new of the finest quality — \$17.50** 279

240 Volt AC input tappings 0—12—13.5—17 Volt output at 8 amps. Wt. 13lb.

4 amps. English selenium rectifiers (2 needed) to convert AC to DC \$1.50 ea.

315

**SPARE PARTS** always available if required in later years.

**3 MONTHS' GUARANTEE**

Exclusive release... **FAMOUS AMERICAN THOMPSON 1,000 G.P.H. ELECTRIC PUMPS & MOTOR \$25**

The world's most famous manufacturer of pumps! This is the third release of their pump and motor produced at a Govt. cost of \$185 each.

Pump and motor only \$25.00 Ball Foot Valve \$4.95 (2lb.) • TERRIFIC BUY — U.S. Govt. cost \$185 ea. • **AIRCRAFT QUALITY** — carbon seal, fully ball bearing non-corrosive housing and impeller • **CONTINUOUS DUTY MOTOR** — sealed, ball bearing brush motor • **PUMPS ALL LIQUIDS** — water, kero, petrol, diesel fuel, etc. 1 1/2" outlet pipe for hose) • **LASTING QUALITY** — sealed unit, corrosion and explosion proof. Electric motor is for 24/32 volts AC/DC (perfect on 12 volt) and draws only 5 amps. Will shift 1,000 g.p.h. at 15 p.s.i., 800 g.p.h. at 6" head. On 24 volts pump will lift 40ft., less on 12 volts. If primed or with foot valve, will suck 20ft. then lift 20ft., less on 12 volts. Pumps have threaded inlet for 1" waterpipe. Has two bolt mounting base. Use pump as water pressure system for taps — have on/off switch (\$1) near tap. 7lb.

**THE MOST USEFUL ATTACHMENT to your ELECTRIC DRILL**

**ONLY \$4.95** POST 30c

POST FREE IF WITH ANOTHER ARTICLE.

**3 months full Guarantee on all goods**

Money cheerfully REFUNDED if not completely satisfied.

# BUY STATE OF THE ART SOLID STATE COMPONENTS— Direct from the United States!

All listed prices are in Australian dollars, International Postal Money Orders (please send PO receipt with order for immediate shipment). Banque Chasiere check (preferably in US funds) and rated company cheques (with foreign exchange stamp approval affixed) will be accepted. Due to recent Australian government restrictions we are not able to clear personal checks... All goods are new unused surplus and are fully guaranteed. Orders will be shipped within two workdays of receipt of same. All customs forms will be attached. Minimum order amount is \$5.00, do not add postage — we pay postage. Surface mail for orders under \$10.00 and Air Mail for orders over this amount.

DATA SHEETS ARE PROVIDED FOR EACH ITEM PURCHASED

7400 SERIES TTL	DIP
7400	Quad 2-input NAND gate.....\$ .20
7401	Quad 2-input NAND gate..... .20
7402	Quad 2-input NOR gate..... .22
7404	Hex inverter..... .22
7405	Hex inverter*..... .20
7406	Hex inverter buffer/driver*..... .35
7408	Quad 2-input AND gate..... .22
7410	Triple 3-input NAND gate..... .20
7420	Dual 4-input NAND gate..... .20
7430	8-Input NAND gate..... .20
7440	Dual 4-input NAND buffer..... .20
7442	BCD-to-decimal decoder..... .80
7447	BCD-to-7 segment decoder/driver..... 1.00
7448	BCD-to-7 segment decoder/driver..... .80
7450	Expandable dual 2-wide 2-input AND-OR-invert gate..... .20
7451	Expandable dual 2-wide 2-input AND-OR-invert gate..... .20
7472	J-K master-slave flip-flop..... .30
7473	Dual J-K master-slave flip-flop..... .40
7474	Dual D-type edge-triggered flip-flop..... .40
7475	Quadruple bistable latch..... .75
7476	Dual J-K master-slave flip-flop with preset and clear..... .40
74178	Dual J-K master-slave flip-flop..... .40
7483	4-Bit binary full adder (look ahead carry)..... .80
7489	64-Bit read-write memory (RAM)..... 3.00
7490	Decade counter..... .90
7492	Divide-by-12 counter (divide by 2 and divide by 6)..... .60
7495	4-Bit right-shift left-shift register..... .75
74193	Synchronous 4-bit binary up/down counter with preset inputs.... 1.00

\*With open collector output

LINEARS	
NE540	70-Watt power driver amp.....\$1.00
NE555	Precision timer..... 1.00
NE560	Phase lock loop DIP..... 2.00
NE561	Phase lock loop DIP..... 2.00
NE565	Phase lock loop TO-5..... 2.00
NE566	Function generator TO-5..... 2.00
NE567	Tone decoder..... 2.50
NE5558	Dual 741 op amp MINI DIP..... .90
710	Dual comparator DIP..... .60
711	Dual comparator DIP..... .25
723	Precision voltage regulator DIP..... 1.00
741	Op amp TO-5/MINI DIP..... .55
747	Dual 741 op amp DIP..... 1.00
748	Op amp TO-5..... 1.00
CA3018	2 Isolated transistors and a Darlington-connected transistor pair..... .75
CA3045	5 NPN transistor array..... .75
CA3026	Dual differential amp..... .75
LM100	Positive DC regulator TO-5..... .50
LM105	Voltage regulator..... 1.00
LM302	Op amp voltage follower TO-5..... 1.25
LM311	Comparator DIP..... 1.00
LM370	AGC amplifier..... 1.00
LM703	RF-IF amp epoxy TO-5..... .25
LM1595	4-Quadrant multiplier..... 1.00
8093-8094	Tri-state quad buffer DIP.....\$1.00
8850-9601	One-shot multivibrator DIP..... 1.50
8811	Quad 2-input MOS interface gate 15V open collector DIP... .30

### POTTER & BRUMFIELD

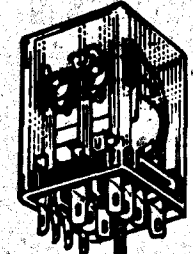

#### Type KHP Relay 4 PDT 3A Contacts

24 VDC (650 coil)..... \$1.00 EA.  
120 VAC (10.5 MA coil)..... \$1.00 EA.

### LSI CALCULATOR ON A CHIP

This 40-pin DIP device contains a complete 12-digit calculator. Adds, subtracts, multiplies, and divides. Outputs are multiplexed 7-segment MOS levels. Input is BCD MOS levels. External clock is required. Complete data is provided with chip (includes schematic for a complete calculator).  
Complete with data \$7.00  
Data only \$1.00



### SLA-1 OPCOA

Pin compatible with MAN-1.  
Large .334" character.  
Mounts on .4" centers.  
Left-hand decimal point.  
\$2.00 Each; 10 For \$16.00

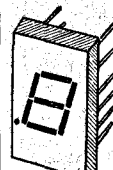

### FAIRCHILD "TRIMPOTS"



Brand new 20 turn precision trimmers. These are prime parts, mostly individually packed in sealed envelopes.  
Ten for \$7.50  
Please specify P or L (PCB or wire leads).  
Order NOW, these won't last!

FOLLOWING VALUES IN STOCK:			
10 Ohm	1K	50K	
20 Ohm	2K	100K	
50 Ohm	5K	200K	
100 Ohm	10K	250K	
200 Ohm	20K	500K	Each Only 89¢
500 Ohm	25K	1 Meg	

### COUNTER DISPLAY KIT—CD-2

This kit provides a highly sophisticated display section module for clocks, counter or other numerical display needs.  
The RCA DR-2010 Numitron display tube supplied with this kit is an incandescent seven-segment display tube. The .6" high number can be read at a distance of thirty feet. RCA specs provide a minimum life for this tube of 100,000 hours (about 11 years of normal use).  
A 7490 decade counter IC is used to give typical count rates of up to thirty MHz. A 7475 is used to store the BCD information during the counting period to ensure a non-blinking display. Stored BCD data from the 7475 is decoded using a 7447 seven-segment decoder driver. The 7447 accomplishes blanking of leading edge zeroes, and has a lamp test input which causes all seven segments of the display tube to light.  
Kit includes a two-sided (with plated through holes) fiberglass printed circuit board, three IC's, DR-2010 (with decimal point) display tube, and enough Molex socket pins for the IC's.  
Circuit board is .8" wide and 4 3/8" long. A single 5-volt power source powers both the IC's and the display tube.

CD-2 Kit Complete Only \$10.95  
Assembled and Tested \$13.00  
Board Only \$2.50

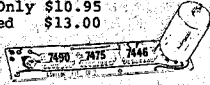

### RCA DR2010 NUMITRON



RCA DR2010 Numitron digital display tube. This incandescent five-volt seven-segment device provides a .6" high numeral which can be seen at a distance of 30 feet. The tube has a standard nine-pin base (solderable) and a left-hand decimal point. Each \$4.00  
SPECIAL 4 for \$17.50

### COUNTER DISPLAY KIT—CD-3

This kit is similar to the CD-2 except for the following:

- Does not include the 7475 quad latch storage feature.
- Board is the same width but is 1" shorter.
- Five additional passive components are provided, which permit the user to program the count to any number from two to ten. Two kits may be interconnected to count to any number 2-99, three kits 2-999, etc.
- Complete instructions are provided to pre-set the modulus for your application.

CD-3 Board Only \$2.25  
IC's, 7490, 7447 \$2.75  
RCA DR2010 tube \$5.00  
Complete kit includes all of the above plus 5 programming parts, instructions, and Molex pins for IC's. Only \$9.25



### LM309K: 5-VOLT REGULATOR



This TO-3 device is a complete regulator on a chip. The 309 is virtually blow out proof. It is designed to shut itself off with over-load of current drain or over temperature operation. Input voltage (DC) can range from 10 to 30 volts, and the output will be five volts (tolerance is worse case TTL requirement) at current of up to one ampere.  
Each \$1.50 5 for \$7.00

## Babylon Electronics Inc.

Post Office Box J, Carmichael, California. 95 608 U.S.A.

# For \$849.00\* you can have music that sounds like a million.

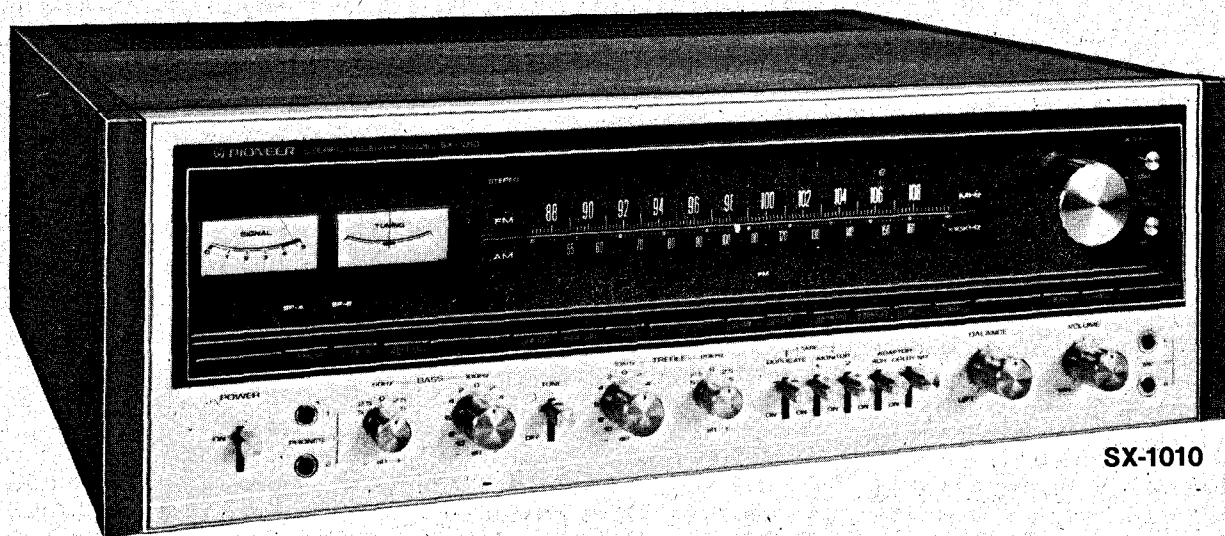

SX-1010

## Why the big price tag?

The SX-1010 is the most powerful two-channel receiver we've ever built. Designed to deliver an earth-moving 100 watts RMS per channel, the SX-1010 was created to surpass the demands of the most discriminating audiophile. In doing this, we've elevated music listening to an experience that goes beyond all previous norms. But, of course, the man who chooses this unit is above average as well.

## Why the big power?

To deliver really big sound. Not just in loudness—that only hurts the ears. But, big in

realism of tonal quality. Big in purity of reproduction. And big in faithfulness to the original performance. A skillful blend of advanced electronic engineering and a delicate sensitivity to the needs of the inner man. After all, isn't that what you really expect from a piece of Pioneer audio equipment.

At Pioneer, we uphold that trust with almost 40 years of exclusive commitment to audio excellence. And from our vast resources as one of the world's largest audio companies, we are privileged to offer seven new two-channel receivers. They're all great. It's just that some of them are greater (and naturally more expensive). Which one you choose depends on how

demanding you want to be. Stop by and see your local dealer for a demonstration. You don't have to be a millionaire to listen to music like one. But, it helps.

**PIONEER ELECTRONICS  
AUSTRALIA PTY. LTD.**  
256-8 City Road, South  
Melbourne, Victoria 3205  
Phone: 69-6605  
Sydney 93-0246, Brisbane  
52-8213, Adelaide 267-1795,  
Perth 76 7776

**PIONEER**  
High fidelity stereo. That's how perfection sounds.

\*Recommended retail price

# ELECTRONICS -it's easy!

# PART 12

## The operational amplifier — basic principles

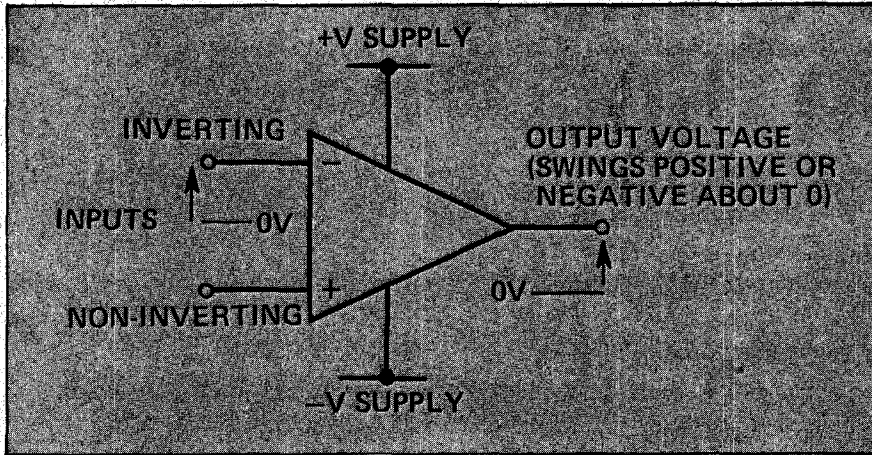

Fig. 1. The basic symbol and connections for an operational amplifier.

IN THE TWO previous sections we explored the role of basic amplifier circuits and investigated how adding extra passive components converts the basic active device into a practical amplifier building block.

These days the cheapest and most straightforward method of amplifying signals is to use one of the many, readily available integrated-circuit operational amplifiers (the op-amp). The methods of using op-amps are universal even though various types may differ in details such as stability and cost etc.

We will see that, provided the basic operational amplifier has a dc gain of 10 000 or more, and draws very little input current, the internal design is of little consequence.

The operation of the complete amplifier system (whether it be based on transistors, ICs or even valves) is determined primarily by the way components are connected around it. That is the basic op-amp unit can be made to perform literally hundreds of different functions by adding appropriate external circuitry. It is this extreme degree of versatility, plus the

extraordinarily low price of IC devices that make op-amp techniques so attractive.

Before we move on to see how such versatility is achieved, we must study the terms used to describe the characteristics and performance of operational amplifiers.

### LINEAR VERSUS DIGITAL

We have already described how a transistor stage may be used to amplify, with low distortion, continuously varying voltage or current signals. Circuits that perform this way — they increase the level of complex waveforms without changing them in any other way — are said to be LINEAR systems. By contrast, it is also possible to use the same basic active element so that it is either fully 'on' or fully 'off', depending on whether the input signal is above or below a preset level. The device actually moves through the linear region so quickly that it is no longer a linear device but a switch. There are many kinds of switching circuits and the entire range of such devices and circuits is loosely classified as DIGITAL (digital meaning ON/OFF or step by step operation). Digital devices and circuitry will be studied in more detail later in this course.

Integrated circuits, therefore, are catalogued by the makers as either linear or digital devices. The op-amp

Fig. 2. Transient response of a 741 type op-amp to a step input change. The test is performed using the circuit shown at left — basically a voltage follower circuit.

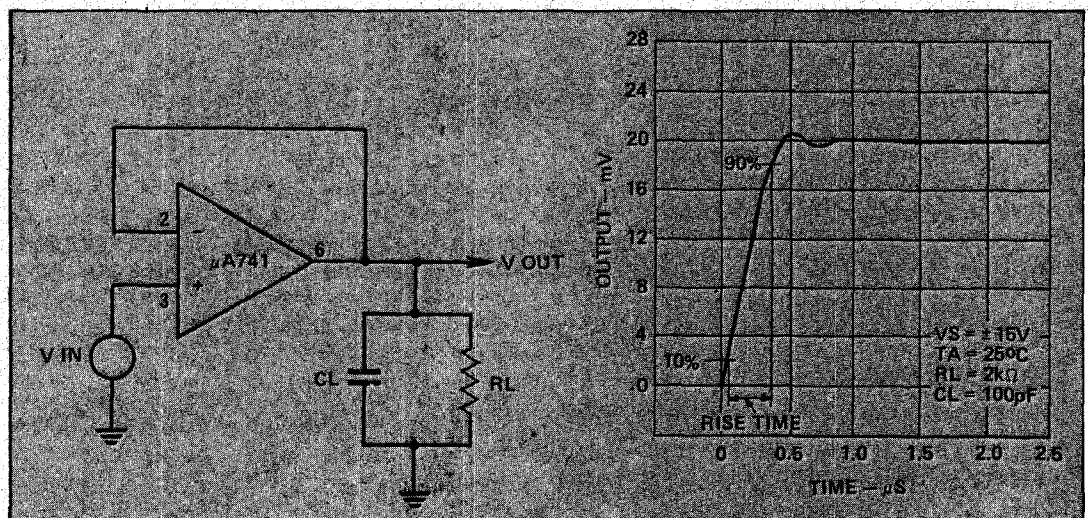

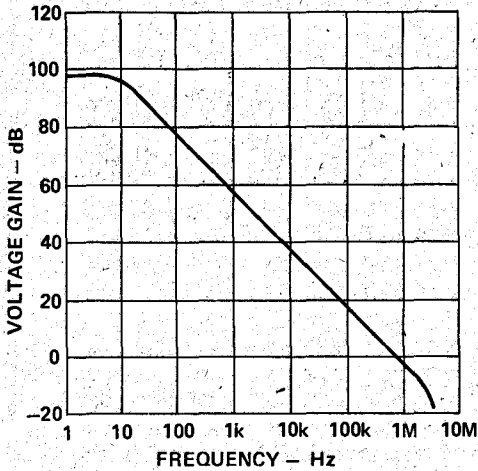

Fig. 3. The open loop (no feedback) frequency response of a 741 op-amp. The constant roll off of 6 dB/octave is built in to ensure stability.

selection form a sub-group of the linear range — others being voltage regulators, oscillators and special purpose units such as timing circuits. It is worth knowing that it is often possible to make a linear circuit perform a digital function but usually the reverse does not hold. In principle at least, the op-amp can be made to fulfill just about all signal processing black-box requirements but to conserve space and power, and to keep costs down, it is usually better to use special-purpose ICs for many applications. Selecting the right component is largely a matter of comparing the cost of various alternatives for the particular job. It may well be better to use a modified op-amp, or even a discrete circuit, to fill a special task rather than await delivery of an exactly right, but harder to procure, special IC.

### COMMON LINEAR TERMS

These terms tie in with the general schematic for an op-amp, given in Fig 1. The amplifier itself does not necessarily require a zero/volt connection, it amplifies the *difference* between voltages at the two input terminals.

### Large Signal Voltage Gain

This is the ratio of the maximum output voltage swing (under appropriate loading conditions) to the change in input required to drive the output from zero to this voltage. A typical value of gain is 200 000 with an output swing of  $\pm 10$  V. The input change, therefore, needed to provide full output swing is a mere  $50\mu\text{V}$ . This may seem alarmingly small — a copper to solder terminal connection (forming a thermocouple) will generate signals of the order of 5 to  $10\mu\text{V}$  with small temperature changes! In practice, however, it is rare to use the full gain capability. Gains approaching infinity

are necessary, however, so that the performance of the amplifier is entirely dependant on the input and feedback networks — not on the device itself.

### Input Offset Voltage

A differential voltage of only 50 microvolts is necessary to provide full output swing. However due to manufacturing tolerances the matching of the input transistors may not be exact and a small offset voltage may be required at the input to balance the amplifier under no-signal conditions.

This voltage is normally less than 6 mV, but could be troublesome in a low level dc amplifiers. Therefore provision is made on most op amps for connecting a potentiometer to null out this voltage, thus making the output zero under no-signal conditions.

### Input Bias Current

All operational amplifiers (and also transistor amplifiers) require a small steady-state input current called the input bias current.

### Input Offset Current

The difference between the two bias currents in a differential op amp is known as the input-offset current, and is specified at a particular temperature. With equal resistances in series with

the two input terminals, it is only this difference in bias currents which produces an offset error. When the input source impedances are high the effect of input-offset voltage is far less than that of bias and off-set currents.

A typical value of input offset current would be 50 nanoamps ( $50 \times 10^{-9}$  amps), but may be much lower in more expensive op-amps.

### Input Resistance

With one of the two inputs grounded, the input resistance is that seen looking into the other input. A general purpose op-amp exhibits around 0.5 megohm input resistance. Some better quality amps go higher and the ideal, as we shall see later, is an infinite input resistance.

Feedback, when applied, modifies this value considerably, may reduce it to zero (inverting amp) such that the input impedance is the value of the resistance in series with the input, or may increase it to several megohms (non-inverting amplifier).

### Output Voltage Swing

This tells us how far the output voltage can change in both positive and negative directions. It will always be a little less than the supply voltage. For a supply of  $\pm 15$  V a typical swing (without distortion occurring) would

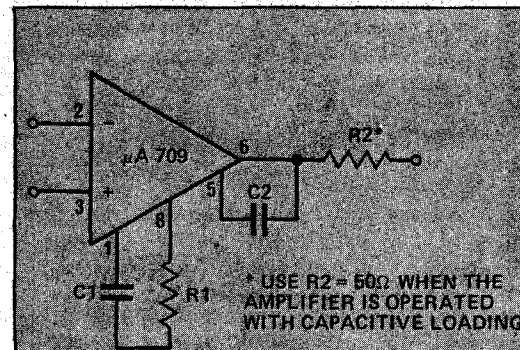

\* USE R2 = 50Ω WHEN THE AMPLIFIER IS OPERATED WITH CAPACITIVE LOADING

Fig. 4a. Some op-amps allow frequency response to be tailored by choosing external components. This set of curves is for the 709 op amp. Fig. 4b. The choice of components also determines the frequency response in the closed loop mode.

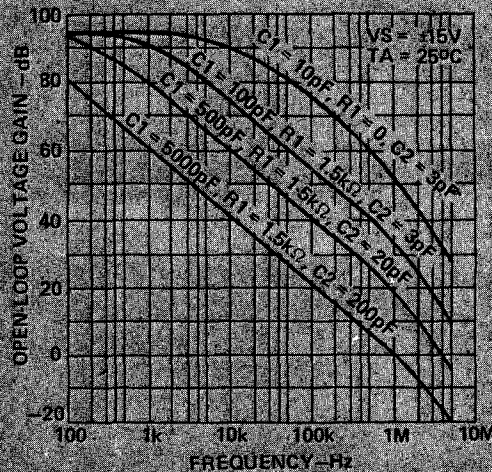

(a)

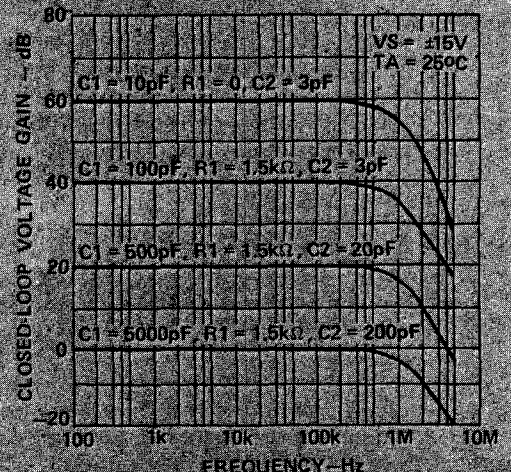

(b)

# ELECTRONICS -it's easy!

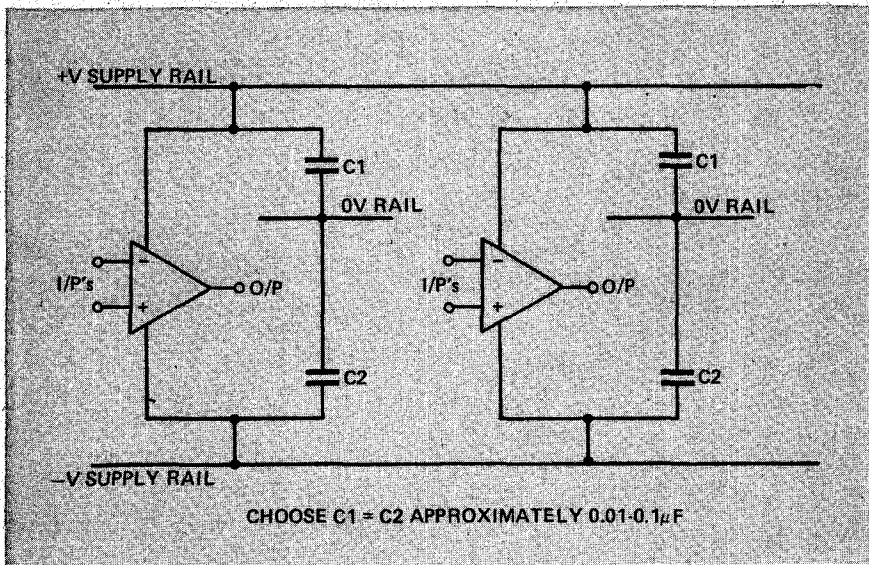

Fig. 5. Each op-amp should have decoupling capacitors across power supply lines to ensure that transients are not coupled from one amplifier to the other through the power rails.

be  $\pm 12$  to  $\pm 14$  V. Op-amps work satisfactorily over a wide range of supply voltages — voltages less than the maximum specified may be used.

## Input Voltage Swing

This value must not be exceeded if the amplifier is not to be damaged. In most modern op-amps, such as the LM301, 741, etc, the inputs can be taken to the supply rail together and in some amplifiers may be taken to opposite supply rails (that is, 30 volts between them) without damage. However some older types such as the 709 may only withstand a common mode voltage of  $\pm 8$  volts and a maximum differential voltage of  $\pm 5$  volts.

## Input common mode rejection ratio

This is the ratio of the input voltage range, to the maximum change in input offset voltage over this range. It is quoted in decibels being typically 80-90 dB i.e. if the inputs are moved by 10 V the offset voltage could change by 1 mV.

## Output resistance

A typical value of output resistance measured into the output terminal with the output near zero volts) is around 100 ohms. This measurement is made with a small signal level and at approximately 400 Hz to avoid dc drift problems. This however is the open loop (no feedback) output impedance and is substantially reduced when feedback is applied. The maximum load which can be

connected to an operational amplifier is not determined by the output impedance but by the current that the op-amp can supply (typically 10 mA).

## Output power

The normal op-amp is usually designed for low power output only. If power is required a power stage of discrete transistors (or special power ICs) is added after the op-amp.

## Supply Voltage Rejection Ratio

This relates the change in input offset voltage to the corresponding change in supply voltage producing it. It expresses how well the circuit ignores voltage supply variations due to mains fluctuations etc.

Typical values lie around  $100 \mu\text{V}$  change per volt of supply change. In

critical dc amplifiers the power supply, therefore, must be stabilised (that is, the voltage must not change with respect to zero). For example, if the design can tolerate only  $10 \mu\text{V}$  change in input offset voltage the supply must be stable to within 100 mV of its magnitude.

However for general applications rejection of supply voltage changes is sufficiently good that close regulation is not required.

## Power consumption

Even when an op-amp is not providing an output, that is when the output voltage is at zero, the circuit still consumes power. This value is usually quoted for zero output conditions (the greatest internal power loss across them) and is in the region of 100 mW.

## Peak output current

The output current must not exceed the stated value or internal permanent damage which may occur. Many designs, however, now incorporate protective circuitry that enables the output to be short-circuited without damage.

## Dynamic response of operational amplifiers

A dc amplifier, by definition, apparently has no need to handle fast changing signals. In fact, it is quite normal for it to need a good frequency response extending to tens of megahertz. Examples of this are the wide band ac amplifier having a response down to dc and a dc amplifier which will faithfully reproduce a sudden voltage change in a control system. In such cases the system designer needs to know more than just the dc large-signal gain of the op-amp — he needs to know the gain at all frequencies.

The response of the op-amp to a step input voltage is called its transient

Fig. 6a. General circuit configuration for an inverting amplifier.

Fig. 6b. General circuit configuration for a non-inverting amplifier.

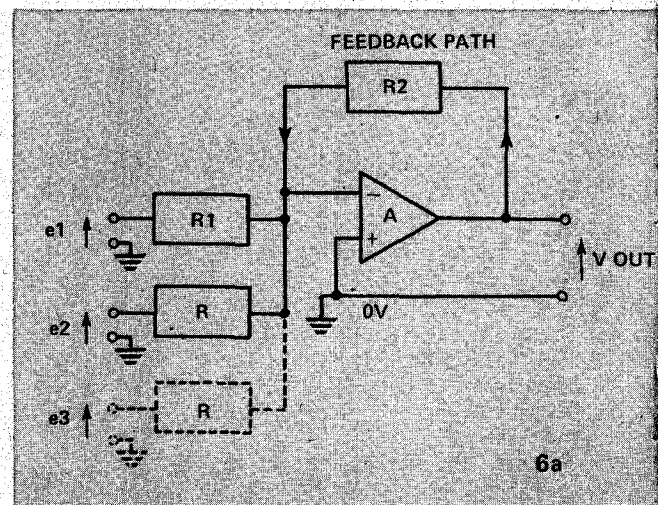

response. That is, this parameter defines how the output of the op-amp will follow an input change with time under closed-loop (with feedback) conditions. The usual way that this is quoted is by an amplitude/time graph — as given in Fig. 2 — which shows how the output changes when a 'perfect' step-rise in input voltage is applied. Note also that the diagram indicates the load resistance value, the capacitance of the load, the supply voltage and the device temperature: each of these will alter the shape.

A second dynamic characteristic is the frequency response. Figure 3 shows a typical response curve (note that such curves vary greatly with different amplifiers) for an op-amp without feedback (called open-loop operation). In general such curves always have the same basic shape; flat to begin with and then falling off at the same rate of 6 dB per octave (20 dB decade). There is a good reason for such a characteristic — it ensures stability in closed-loop working.

If the slope were increased the amplifier could introduce excessive phase shift. Thus the feedback could become positive rather than negative and the amplifier may oscillate. Some op-amps have facilities for the circuit designer to provide external compensation to the IC. This usually consists of an RC network or a single capacitor, the values being selected to suit the application. Figure 4 shows how these values alter the frequency response of the popular 709 type of op-amp.

A third important dynamic term is Slew Rate. A typical value is stated at 0.5 V/μs, meaning that the output can change no faster than half a volt in each microsecond. The value is quoted for a feedback connection of unity gain — at other values of gain the rate will be different. Thus although the amplifier may well handle a small signal at a given frequency a large

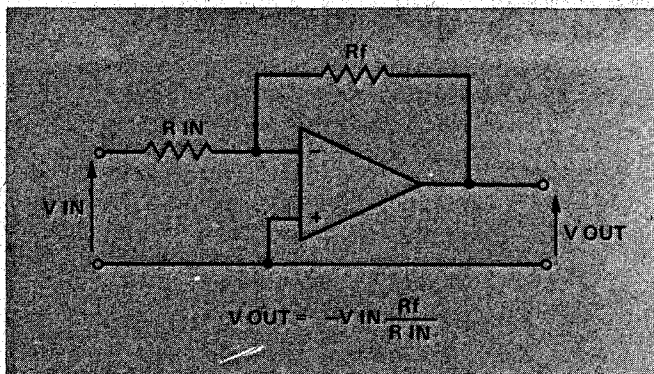

Fig. 7. In this configuration the stage gain is determined by the ratio of  $R_f$  to  $R_{in}$  — not by the device gain.

signal at the same frequency may well be distorted because of the slew-rate limitation.

The above terms are those commonly encountered. Other more obvious parameters are given — temperature range of operation, and lead temperature when soldering. The manufacturers of ICs also give a variety of curves for various parameters — voltage gain versus supply voltage, power dissipation versus temperature and many more. These are all helpful from time to time but, in general, the casual user will not need to explore them in depth.

### THE MAGIC OF FEEDBACK

The basic op-amp will only accept very small input signals because of its enormous gain. At first sight this seems to be a peculiar way to go about things for surely the optimum would be to design the internal circuitry to give the gain needed and no more. We will soon see that there is a better, and more versatile way of obtaining any required gain (by adding a simple network to the amplifier). For this concept to work correctly, the amplifier must have a very high gain.

The two basic amplifier circuits are illustrated in Fig 6. The circuit of Fig 6a is an inverting amplifier and that of Fig 6b a non-inverting amplifier.

For the purposes of our discussion we must assume that the amplifier has an infinite input resistance and infinite gain. The input signal (in Fig 6a) is applied via  $R_1$  and the output is fed back to the input via  $R_2$ .

Thus, as the ideal amplifier draws no current, the current in  $R_1$  is

$$I_{R1} = \frac{e_1}{R_1}$$

and the current in  $R_2 = \frac{e_o}{R_2}$

A theorem not yet covered (called Kirchoff's Laws) states that the sum of the currents at any point in a circuit must be zero. Therefore  $I_{R2} = I_{R1}$

By Ohm's Law:  $\frac{e_1}{R_1} = \frac{e_o}{R_2}$

Now the gain  $A = \frac{e_o}{e_1}$

$$\therefore A = \frac{R_2}{R_1}$$

How convenient! The gain of the amplifier may be set by adjusting the ratio of  $R_2$  to  $R_1$ . In a practical amplifier there is some error because the input impedance is not zero and the gain is not infinite. But providing the amplifier open-loop gain is in excess of 10 000 the error may be disregarded.

For the non-inverting configuration it may be shown that the gain is

$$A = 1 + \frac{R_2}{R_1}$$

Hence it may be seen that any reasonable gain may be programmed by simply selecting two resistors, and that drastic changes in device open-loop gain will have little effect on the closed-loop gain.

The open-loop gain should be at least 10 dB higher than the closed-loop gain at all working frequencies to maintain frequency response of the amplifier within 3 dB. (See graph of open-loop gain versus frequency.)

The effects of using feedback are as follows:—

#### Inverting Amplifier

Output impedance is reduced by the loop gain. That is, if the amplifier has a gain of 10 and the output resistance is 150 ohms, the closed loop output impedance falls to 15 ohms.

As the amplifier always tries to keep its input terminal at zero the input impedance is equal to the value of  $R_1$ . Distortion is reduced by feedback by  $1/A$ .

Common mode rejection is improved and the stability is improved.

#### Non Inverting Amplifier

Output impedance is reduced by the loop gain.

Input impedance is increased by the loop gain, (but is limited by common mode impedance and resistances connected between non-inverting input and ground.

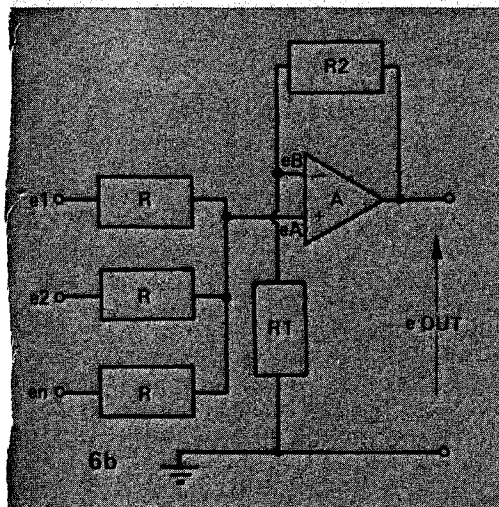

# ELECTRONICS -it's easy!

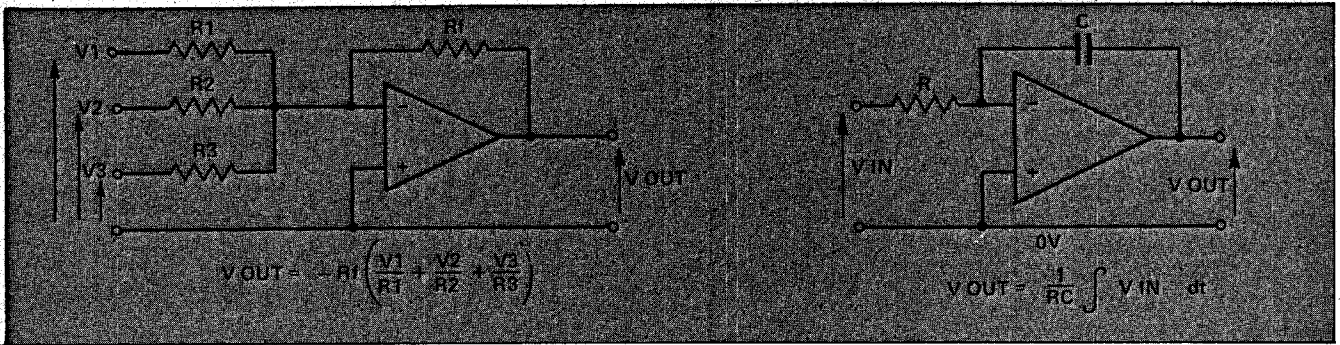

Fig. 8. If extra input resistors are added the amplifier sums the input voltages and amplifies them by the respective resistor ratios.

Fig. 9. To make an op-amp integrator we simply replace the feedback resistor with a capacitor. The gain of the stage is then determined by R and C.

Distortion is again reduced by 1/A. Common mode rejection is not good with this configuration, the amplifier is less stable than the inverting mode and the gain can never be less than unity.

## INVERTING ADDER

The fact that currents are effectively summed at the inverting input terminal may be exploited as shown in

Fig. 6a. The input signal voltages are summed by using a separate input resistor for each signal. The input signals are effectively isolated from each other as the summing point acts like a virtual earth.

Thus the output will be:-

$$e_0 = -R_2 \left[ \frac{e_1}{R_1} + \frac{e_2}{R_2} + \dots + \frac{e_n}{R_n} \right]$$

Fig. 10. This audio mixer accepts four input signals and combines them. Variable gain is provided by RV5. The circuit is basically a summing op-amp.

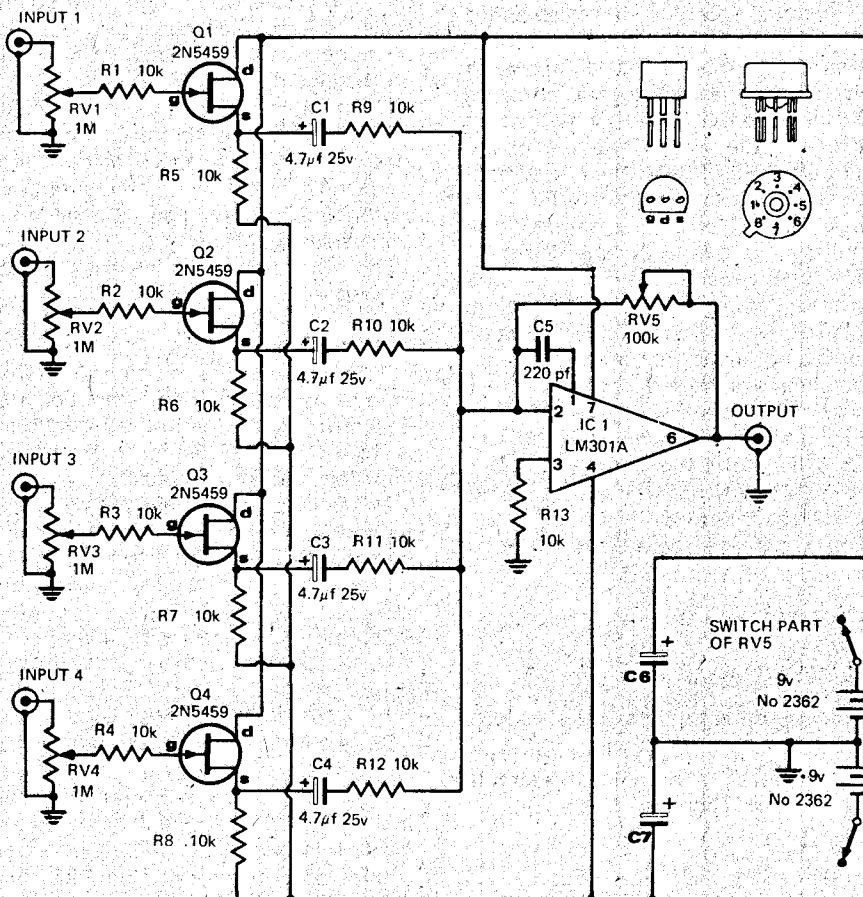

That is the output is the sum of the input voltages, each being amplified by the ratio of the feedback resistor to the individual input resistor. This simple circuit finds great use in audio mixers etc.

## USING OP-AMPS TO DO ARITHMETIC

The simple summing circuit described may be used to do arithmetic. For example assume we needed to continuously solve the problem  $X = A + 2B$ . We could simply apply a voltage proportional to A through an input resistor of 10 k to an amplifier having a feedback resistor of 10 k. The second input voltage proportional to B is applied through a resistor of 5 k. Thus the amplifier has unity gain to A and multiplies B by 2. These voltages are summed to provide our required function of 'X'. This is the basis of analogue computers. Analogue computers consist mainly of a group of operational amplifiers configured to solve a particular mathematical expression.

Other mathematical functions are also easily achieved. Subtraction is done by putting the input to be subtracted through a unity gain inverter before summing.

## INTEGRATION WITH AN OP-AMP

In many electronic instrumentation circuits there is need to integrate a signal with respect to time. For example there may be a call for a time delay having a precise timing interval. The integrator circuit uses a feedback impedance that is a capacitor - not a resistor. (The theory still holds when the impedances are of any type - R, L or C or even mixtures; it is the mathematical manipulation that becomes difficult.) It can be shown that the circuit given in Fig 9 has the following output to input relationship.



$$V_{out} = \frac{1}{RC} \int V_{in} dt$$

( $\int$  integration symbol)

The formula tells us that the output voltage is the true undistorted integral of the input signal with respect to time and that the value of R and C decide the gain of the stage.

The integrating op-amp circuit finds use as a ramp generator, as a basis of repetitive signal generation and is invaluable in solving mathematical equations in the analogue computer.

Although only one input resistance is used here it is quite feasible to use a number of input branches to combine summing with integration.

The above circuits, based on op-amps with feedback, provide just a few of the many arithmetical operations that can be obtained.

Combinations of different op-amp circuits can perform multiplication, division, squaring and square root functions, and solve simultaneous and differential equations. In normal electronic practice such op-amp circuits are used to provide accurate signal processing at low cost. Indeed, in many instances it is preferable to use analogue computational circuits in preference to digital methods — each case must be decided upon its merits in terms of cost, size, speed and versatility.

With these principles in mind it is

relatively easy to untangle what is happening in a seemingly complicated circuit like that given in Fig. 10.

This is a four-input mixer (ETI project 401). In this case the four inputs are amplified by field-effect transistors then ac coupled by capacitors and 10 k resistors to the inverting input of the op-amp which is connected as an adder. The second input is earthed via a resistor of similar value to the input resistors as this aids stability. The 100 k feedback potentiometer, RV5, provides variable gain — volume control, therefore, by adjusting the R<sub>f</sub> value to change the combined gain. A 220 pF capacitor is needed to adjust the performance of the op-amp as dictated by the maker — it is not part of the summing circuit proper.

Figure 11 illustrates one way of using an op-amp integrator. The gain of the stage is  $1/RC = 1/10k \cdot 100\mu F = 1$ . Note again that the positive input is earthed via a 10 k resistor. When an input is applied the output rises linearly with time and could keep going until the maximum available voltage is reached. Before this occurs the switch is closed, discharging the 100 $\mu$ F via the 100 ohm resistor. The result is a ramp signal that restarts its climb when the switch is operated and released. The switch may of course be an electronic one and such circuits are used to

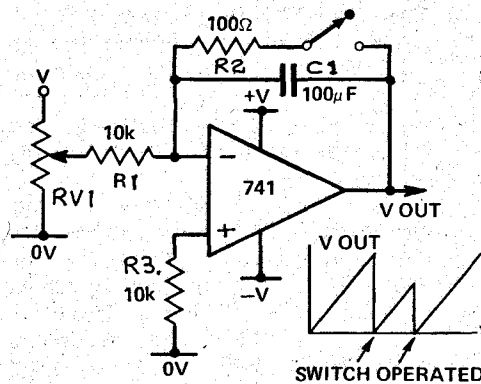

Fig. 11. The integrator may be used to generate sawtooth waveforms.

obtain sawtooth waveforms which are useful for a wide variety of applications.

### THE LIBRARY

If you have not already obtained a good set of application notes on the many uses of op-amps now is the time to act for they will prove invaluable when building your own systems.

It matters little whose notes are obtained. The basic op-amp circuits have remained reasonably stable for several years now. Perhaps the only point to consider is to ensure that the op-amp specified is both available and an inexpensive choice.

## ELECTRONICS — in practice

INTEGRATED circuits (whether linear or digital) are produced in a variety of packages (illustrated in Fig.12). The methods of mounting are different for each form and the beginner would be wise to restrict himself to dual-in-line, TO5 or TO99 versions. Care should also be taken not to overheat the devices when soldering.

Mounting sockets are available for around 40 cents each and these are invaluable for the experimenter — allowing an IC to be used many times without damage. However even at 40 cents the sockets are dear when compared to current IC prices of around one dollar. So a socket may not always be a justifiable expense.

An alternative is to mount the IC on a small piece of matrix board and wire in leads for input, output and power connections. This provides robust connections by which the amplifier may be wired into experimental circuits again and again without damage.

### A MULTI-PURPOSE AMPLIFIER

An operational amplifier is an ideal

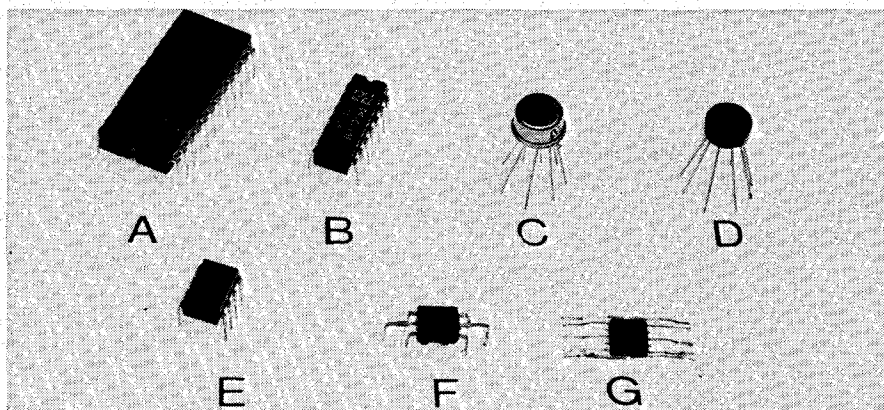

Fig.12. Typical integrated circuit packages. (a) 24 pin dual-in-line. (b) 14 pin dual-in-line. (c) TO5 metal can. (d) TO105 plastic. (e) 8-pin dual-in-line. (f) case 643A (used for low price consumer devices) (g) TO86 flat pack.

amplifier for experimental use. It enables a wide range of gains (or attenuation in the inverting mode) to be obtained and is hence very useful in the experimenter's workshop.

It is surprising how often a little extra gain or attenuation is needed when experimenting with electronic circuitry. Often the need is temporary, in order to establish what gain is

required in a particular circuit. Once this has been established the unit is replaced with the simplest stage that will do the job — e.g. a single transistor.

This project provides such a general purpose amplifier having a gain adjustable from 0.1 to 100, and with a choice of inverting or non-inverting operation.

The circuit given in Fig 13 is based on a Fairchild application note and uses the currently cheapest op amp, the 709 series. As power drain is low two dry cells may be used thus avoiding the expense of a mains power supply.

To obtain non-inverting or inverting operation, a changeover switch has been included to ground the appropriate input to the op amp. Components C1, R4 and C2 have been chosen to obtain the maximum bandwidth of 0.5 MHz.

The output impedance of the unit is less than an ohm but the peak output current should not exceed 20mA. The power dissipation of the amplifier must not exceed 250 mW so even 20mA may be too much under some circumstances.

The input impedance in the inverting mode is the value of R1. Hence if a higher input impedance is required then R1 should be increased. Note that R2, R3 and RV1 must also be increased proportionately to maintain the gain ratios.

Do not use values in excess of 10 megohm as stray capacity and leakage resistances will then affect stability and accuracy.

### CONSTRUCTION

The form of construction is largely a matter of individual preference. We suggest that a small diecast box be used. By mounting the switches and potentiometers through the bottom of the box (rather than onto the lid) the lid may be removed for access.

The gain control should be marked by experimentally verifying gains at

various positions of the control. A multimeter may be used to compare input and output, to determine gain, but use a low frequency (e.g. 400 Hz) from a low impedance source, so that the accuracy of the multimeter itself does not affect results.

### USING THE AMPLIFIER

Basically the unit is a single-input, variable-gain dc amplifier. We have seen in the theory section however that it can be used for other purposes.

To use the unit for amplifying ac, use a capacitor in series with the input to isolate any dc component of the previous circuit. Make sure that the reactance of the capacitor is less than the value of R1 at the lowest frequency of interest.

To mix signals, simply add additional 10k resistors from each input to the summing point (pin 2).

An integrator may be constructed by replacing R2 and RV1 with a capacitor.

Thus, as well as being a useful tool, the amplifier may be used to increase your understanding of op amp techniques.

A major feature article on operational amplifiers will be published in ETI next month.

There will also be a special reader's offer — two LM380 op-amp IC's for less than the normal cost of one!

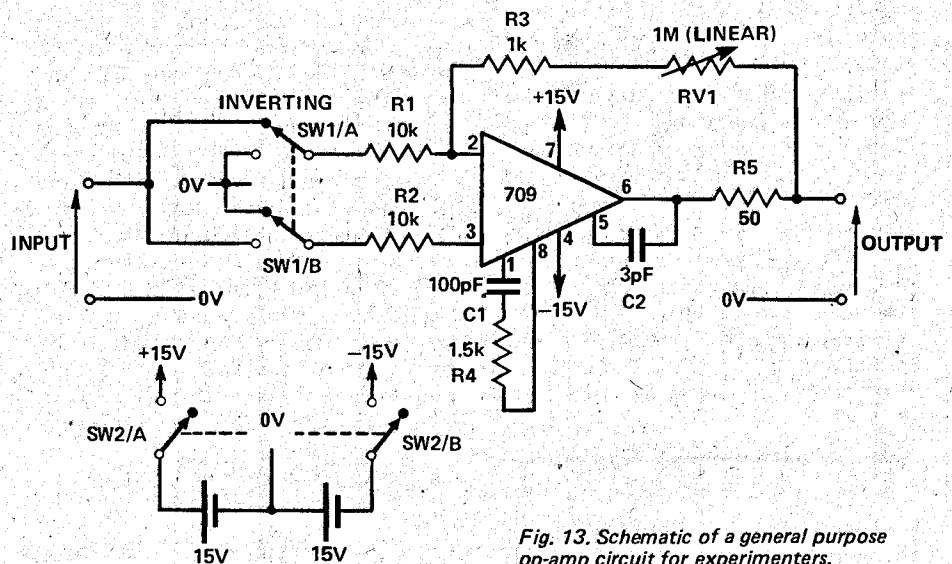

Fig. 13. Schematic of a general purpose op-amp circuit for experimenters.

IMPORTERS, DISTRIBUTORS, RETAILERS, SERVICEMEN  
TECHNICIANS, ENGINEERS — keep up to  
date with **AUDIO TRADER** —  
Australia's own audio  
trade magazine.

# AUDIO TRADER

- Company news
- Latest equipment news
- Who has which agency
- Who's working for who
- Up-to-the-minute marketing and promotional information
- Overseas news and developments — as they happen — not six months later!

If you are not already a subscriber to Audio Trader, you are missing vital information pertaining to your industry

Audio Trader is published monthly — it is obtainable **ONLY** by subscription from the publishers, **PRICE: \$15 a year including postage.**

**AUDIO TRADER, MODERN MAGAZINES (HOLDINGS) LTD, 15 BOUNDARY ST, RUSHCUTTERS BAY, N.S.W.**

So we thought you ought to know...  
**The new S.A.E. Mark III CM**  
**will not oscillate**  
**under any load conditions**  
 regardless of phase angle  
 that's what it won't do.

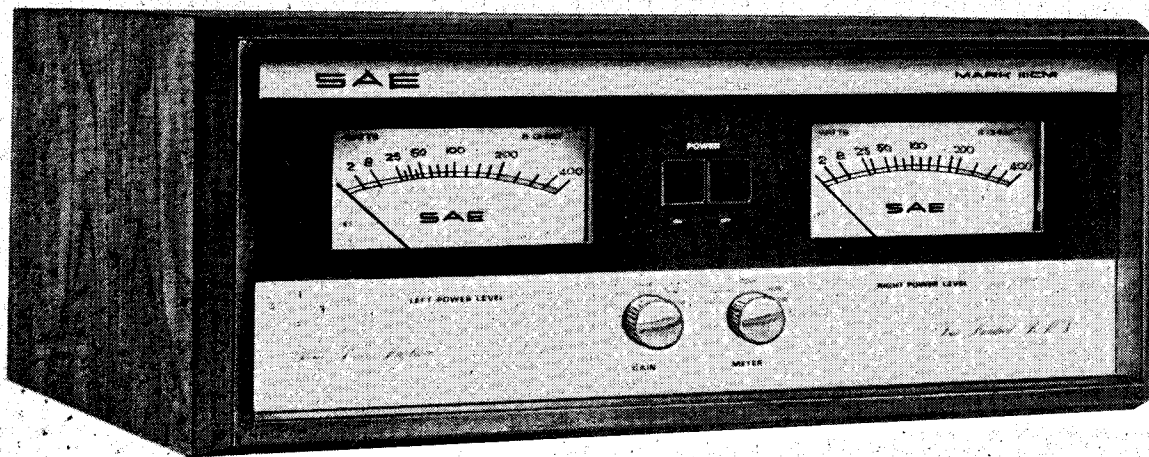

- Here's what it will do . . .
- **RMS Power Output:**  
 4 ohms—greater than 300 w/chan.  
 8 ohms—greater than 200 w/chan.
  - **Frequency response at 8 ohms:**  
 $\pm 25$  dB, 20 Hz to 20 KHz at full power.  
 $\pm 1$  dB, 1 Hz to 100 KHz at 1 watt.
  - **T.H.D.:**  
 8 ohms—Less than .1% 20 Hz-20 KHz at full power.  
 4 ohms—Less than .2% 20 Hz-20 KHz at full power.
  - **I.M.:**  
 8 ohms—Less than .05% at full power.  
 4 ohms—Less than .1% at full power.
  - **Signal to Noise Level:**  
 Better than 100 db below 200 watts RMS.
  - **Full 5-year parts and labour warranty.**

You mightn't be able to get one but at  
 least you know now which amplifier  
 won't oscillate.

Sole Australian Distributors



**LEROYA INDUSTRIES PTY LTD**

**Head Office:** 266 Hay St., Subiaco, Western Australia. 6008. Phone 81 2930.  
**N.S.W. Branch:** 100 Walker St., North Sydney, 2060. Phone 922 4037.  
**Victoria Branch:** 103 Pelham St., Carlton, 3053. Phone 347 7620.

**N.S.W.:** Douglas Hi-Fi  
 65 Parramatta Rd.,  
 5 Dock, 2046.

**VIC.:** Douglas Hi-Fi,  
 191 Bourke St.,  
 Melbourne. 3000

**S.A.:** Sound Spectrum,  
 33 Regents Arcade,  
 Adelaide, 5000.

**QLD.:** Brisbane Agencies,  
 72 Wickham St.,  
 Fortitude Valley, 4006.

**A.C.T.:** Duratone Hi-Fi,  
 Cnr. Botany St.,  
 & Atree Court,  
 Phillip, 2606.

**W.A.:** Douglas Hi-Fi, 883 Wellington St., Perth, 6000.

LER 062

# CALCULATORS AT LOWEST PRICES EVER!

## ADLER

## NOVUS



### 60

- Six Digit Bright Blue Fluorescent Display
- Floating Decimal Point
- Twelve Digit Answer in Multiplication
- Add, Subtract, Multiply and Divide
- Chain Calculations without re-entry
- AC Adaptor, Carry Case, Comprehensive Instructions.

\* \$29.89



### 80D

- Eight Digit Bright Blue Fluorescent Display
- Floating Decimal Point
- Automatic Constant
- Clear Last Entry Key
- Battery Low, & Overflow Indicator
- AC Adaptor, Carry Case

\* \$38.05



### 81

- Eight Digit L.E.D. Display
- Fixed or Floating Decimal Point
- Automatic Storage Memory
- Automatic Constant
- Squaring and Raising Powers
- Automatic % Calculators
- AC Adaptor, Carry Case.

\* \$65.00

New Rechargeable!



### 88T

17 SCIENTIFIC FUNCTIONS

- Basic Operations:
- Logarithms & Antilogarithms:
- Trigonometric Functions:

Addition, Subtraction, multiplication, division.  
 1 to 10<sup>99</sup>, x<sup>2</sup>, x<sup>y</sup>,  
 sin x, cos x, tan x,  
 arc sin, arc cos x,  
 arc tan x, radians or degrees.  
 Auto. Square root  $\sqrt{\quad}$   
 register exchange, change sign  
 Independent memory register  
 Automatic constant for  
 4 calculation modes (8 digits)  
 Entry: 8 digits  
 Results: 8 digits by 10<sup>8</sup>  
 Floating decimal point  
 automatic displacement to  
 the right (Underflow System)  
 9 digits L.E.D.  
 1 MOS-LSI-CHIP  
 4 disposable batteries 1.5V.  
 Micro size AAA 912 and  
 rechargeable Ni-CAD Battery  
 unit with AC MAINS operated  
 charger included  
 120mm x 73mm x 19mm.  
 (Length x Width x Depth)  
 180g approx. (batteries incl.)

- Special Functions:
- Memory:
- Constant:
- Capacity:
- Decimal Point System:
- Display:
- Technology:
- Power Supply:

- Dimensions:
- Weight:

\* \$116.30

### THE NS 600

- Add, Subtract, Multiply & Divide
- Bright, easy-to-read, 6-digit display.
- Shirt-pocket size (2.5" x 5" x 7/8")
- A weight of just five ounces.
- Inexpensive, 9-volt battery power.
- Optional AC adaptor.

\* \$14.98

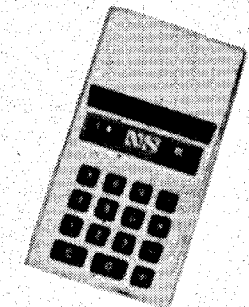

### THE NS 900

- 9-digit capacity gives you calculating room up to \$9,999,999.99
- Add, subtract, multiply & divide
- Bright, easy-to-read display with unique "Battery Saver" shut-off and restore key.
- Shirt-pocket size (2.5" x 5" x 7/8")
- A weight of just five ounces.
- Inexpensive, 9-volt battery power.
- Optional AC adaptor.

\* \$17.86

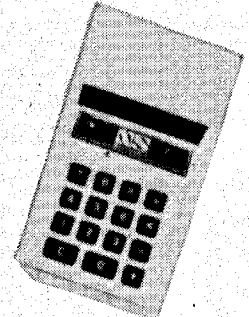

### THE NOVUS 820

- Add, subtract, multiply & divide
- Bright, easy-to-read, 8 digit display with unique "Battery Saver" shut-off and restore key
- Automatic constants
- Full-floating decimal system
- Long-lasting, inexpensive, 9 volt battery power
- Optional AC adaptor

\* \$23.51

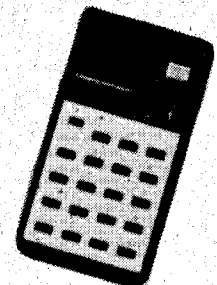

### THE NOVUS 823T

- Add, subtract, multiply & divide
- Storage memory
- Power Key
- Automatic constants
- Full-floating decimal system
- Bright, easy-to-read, 8 digit display with "Battery Saver" shut-off and restore key.
- The 823T, with long-lasting, disposable batteries.

\* \$32.25

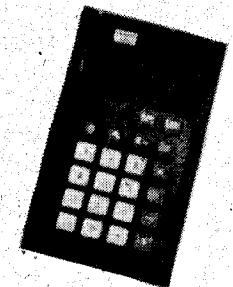

15% SALES TAX IF APPLICABLE - QUANTITY DISCOUNTS ON APPLICATION

**radioparts** GROUP  
 MELBOURNE'S WHOLESALE HOUSE

562 Spencer St., West Melbourne, Vic., 3003.  
 Phone 329 7888. Orders 328 2224. Telex: 32980

City Depot: 157 Elizabeth Street  
 Melbourne, Vic., 3000. Phone 67 2699

Southern Depot: 1103 Dandenong Road  
 East Malvern, Vic., 3145. Phone 211 8122

**OPEN**  
 Weekdays

8 a.m. - 5.15 p.m.

Saturday

8 a.m. - 11.30 a.m.

# IF YOU UNDERSTAND THE EXCELLENCE OF **AR** SPEAKERS YOU DESERVE TO HAVE ONE

The AR philosophy: "the design of equipment capable of reproducing music with the greatest possible accuracy, so that the work of the composer, performers and recording engineers is presented to the listener with the highest degree of precision possible."  
Speakers created by Acoustic Research

Inc. range from the modestly priced to highly complex engineering achievements. And the same care and expertise is carried throughout the range: when AR develops equipment of lower cost, it embodies only such compromises as will have least effect on the accuracy with which the music is reproduced.

## AR 3A

Long considered the reference standard loudspeaker the AR 3A uses a 12" woofer and two hemispherical domes for mid and high range. "Stereo Review" said of it . . . "The best speaker frequency response we have ever measured using our present test setup . . . virtually perfect dispersion at all frequencies."  
Highly detailed data available.

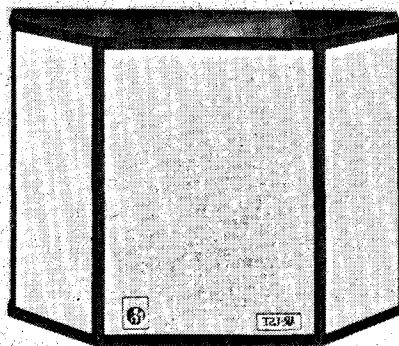

## AR 7

This speaker is very small (248 x 400 x 150 mm) and therefore particularly suitable for 4 channel use where space is at a premium. It uses a tweeter essentially the same as that used in the renowned AR 6. The smooth and well dispersed energy output of this speaker is well balanced by a newly designed woofer which offers a standard of low distortion bass exceeding that of speakers of much greater size and cost.

## AR 2AX

The performance standard in the design of the AR 2AX was the same as that for the 3A: natural reproduction of music without exaggeration or artificiality of sound. But where quality in the case of the AR 3A has been limited only by the state of the art and our own engineering skill, for the 2AX price was also a consideration. "American Record Guide" said '1970 brings us a better than ever 2AX and I am nuts about it'.

## AR-LST

The "Laboratory Standard Transducer" was designed for professional applications. It offers the recording engineer a quantitative standard for the monitoring of recording and mix down operations. It is also used in scientific applications where the accuracy and repeatability of acoustical measurement is a prime requirement. It is also available for individuals who want such a precision instrument in their homes.  
Highly detailed data available.

## AR 6

In the three years or so that the AR 6 has been available it has already become the speaker that all others are compared to in its price range. It employs the very best technology in its cone woofer and tweeter that the state of the art permits and stands comparison with the most expensive AR systems. Also available in unfinished pine.

## AR 5

The AR 5 is only different to the AR 3A inasmuch as it uses a 10" woofer and a slightly different crossover. As always the standard of accuracy is the comparison to live music. At AR the best reponse curve for a speaker system, like that for a microphone or amplifier, is the one that most closely matches the input. The specifications of the AR 5 are obtained, as in all models, from production units, not prototypes.



## AR 4XA

A new addition to the AR range and bringing you a third AR loudspeaker under \$300 a pair is the AR 4XA. A successor to the AR 4X, the AR 4XA uses the same woofer and cabinet as its predecessor but utilises the AR 6 tweeter and a modified crossover. An audition of the AR 7, AR 4XA or AR 6 will show even the most critical listener that the differences are subtle yet obvious.

### SPECIAL OFFER:

AR Demonstration Record  
"The Sound of Musical  
Instruments"

Only \$5.95. Write to  
W. C. Wedderspoon Pty Ltd  
P.O. Box 21, Greenacre, 2190

AUSTRALIAN DISTRIBUTORS

**WEDDERSPOON**

W. C. WEDDERSPOON PTY LTD

3 Ford Street, Greenacre, 2190

Telephone: 642 3993 642 2595

Showroom demonstration by appointment

### AR GUARANTEE:

The workmanship and performance in normal use of AR products are guaranteed from the date of purchase: 5 years for speaker systems, 3 years for turntables, 2 years for electronics.

# EQUIPMENT NEWS

## RF PROBE FOR H-P MULTIMETER

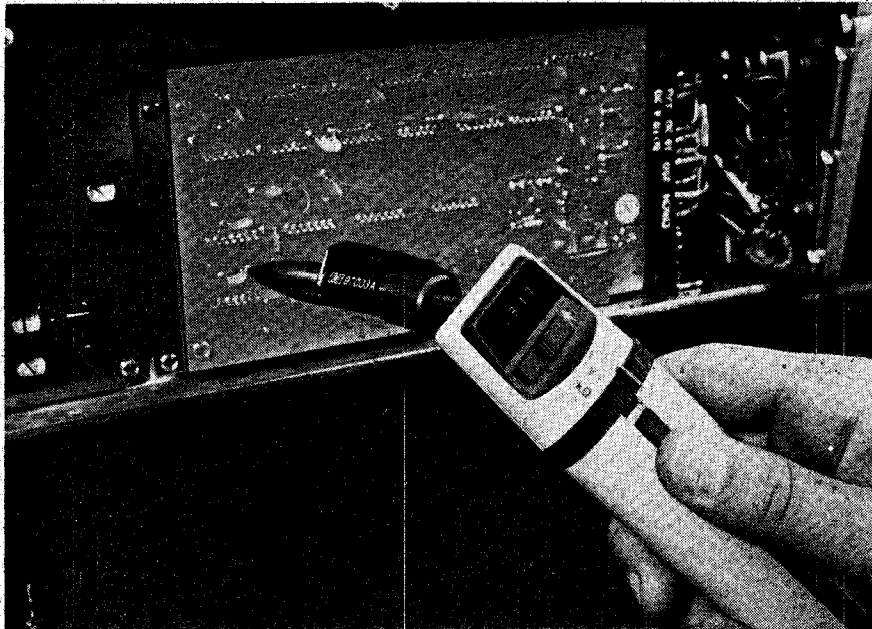

A new rf probe adds 100 kHz to 500 MHz ac measurement range to Hewlett-Packard's Model 970A Digital Multimeter. Accuracy within this frequency range is claimed to be greater than 1 dB. Voltages from 0.25 to 30 volts full scale are measured with this new model 97003A RF Adapter. Maximum ac input is 30 volts rms plus 200 volts dc.

The basic, pocket-sized 3½ digit multimeter measures ac and dc volts and ohms. Its ac voltage range is from 100 microvolts to 500 volts, 45 Hz to 3.5 kHz. Input resistance on the ac range is 10 megohms. The Model 97003A extends the usefulness of the multimeter into the rf

region. Input resistance of the adapter is greater than 25 000 ohms, shunted by less than 4 picofarads.

The Model 97003A is a peak detector calibrated to read the rms value of a sine wave input. It converts the ac input into a dc voltage. Thus, the 970A must be set to dc volts when the rf adapter is used. No other adjustments are necessary since the Model 9700A is fully autoranging with autopolarity.

Further details: Hewlett-Packard Australia Pty Ltd, 31-41 Joseph St, Blackburn, Vic. 3130.

## TM 500 DIGITAL-LOGIC HIGH PERFORMANCE PACKAGE

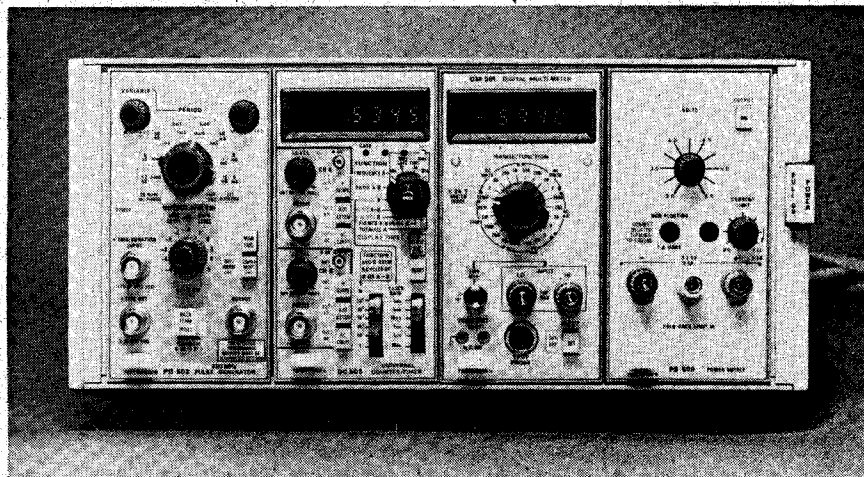

Conceived with the digital integrated circuit designer and user in mind, the Tektronix TM 500 Digital-Logic High

Performance Package is composed of three specially selected test and measurement modules and a power supply which plugs

into a new, high-current power mainframe. The measurement modules are a pulse generator, digital voltmeter and a digital counter. The power supply is a new module with output voltage and currents tailored to IC requirements. These plug-ins are part of the Tektronix TM 500 series of modular test and measurement instruments. This expanding line of more than 30 plug-in modules and power mainframes can be combined in various configurations to meet a wide variety of specific needs.

The High Performance Package includes a PG 502 Pulse Generator, a DC 505 Digital Counter/Timer, a DM 501 Digital Multimeter and a PS 505 Power Supply, all in a TM 504 power mainframe.

The PG 502 Pulse Generator features repetition rates up to 250 MHz, narrow pulse widths and fast risetimes, as well as independent top and bottom level control. Front panel controls provide manual trigger, squarewave output, complementary pulse output for high duty factors, and selectable back termination in the pulse output circuitry.

The DC 505 Universal Counter/Timer is a two-channel module with direct counting capability to 225 MHz, and interval and pulse width resolution of 100 picoseconds. Its seven operating modes are: frequency counting, frequency ratios, period timing, interval timing, width timing, electronic event counting, and manual event counting. Single-shot pulse width measurements down to 10 ns and triggering on signals as short as 5 ns are possible. An A during B mode opens new verification and troubleshooting possibilities in high speed logic circuits.

The DM 500 Digital Multimeter module provides all of the standard multimeter functions, along with a direct-reading temperature probe. The standard measurement capabilities include dc and ac voltage and current, and dBm and dBV. With the temperature-measuring feature (which is switch selectable to centigrade or fahrenheit) the user can locate hot spots in densely packed circuitry, verify operating temperatures of logic IC's, test relay drivers, and monitor outputs for the effects of temperature variation.

The PS 505 Power Supply module is a 3.0 to 5.5 Vdc adjustable floating supply, and in the power mainframe it can supply up to 4 A. Since either side of this floating supply can be referenced to ground, it is ideal for use with both TTL and ECL circuits.

The TM 504 power mainframe is a new addition to the TM 500 line. It is a heavy duty unit, with a large primary power supply and additional bracing and stronger supports. The TM 504 is suitable for bench use as well as transport to the field. All regular TM 500 plug-ins will fit into any of its four compartments, and its right hand compartment has special connections for high current modules such as the PS 505 Power Supply plug-in.

It is recommended that a Tektronix 485, 7904, or other high-performance oscilloscope be used in conjunction with this package in order to take full advantage of its capabilities.

## WWVB TIME SYNCHRONIZER

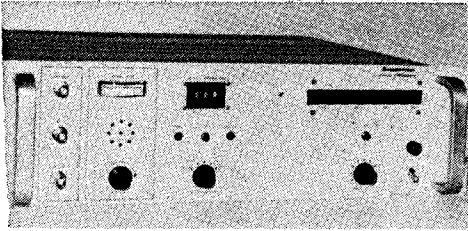

Datametrics has introduced a new Model SP-465 WWVB Time Synchronizer. This unit provides an economical and direct method for disseminating time and frequency information in synchronization with NBS Radio Station WWVB broadcasts anywhere within the boundaries of continental United States Time, synchronization accuracy of 1 millisecond and frequency synchronization to 1 part 10<sup>10</sup> is claimed.

The Model SP-465 is a valuable aid for engineers requiring time correlation of data gathered from different remote locations, as well as serving as a primary standard for the public utilities and metrology standard laboratories for time and frequency calibration.

Further details: John Morris Pty. Limited, P.O. Box 80, Chatswood, NSW 2067.

## SEMICONDUCTOR CURVE TRACER

Recently released by the Schlumberger Heath company is the model IT 1121 semiconductor curve tracer.

This unit is designed as an accessory to most conventional oscilloscopes to enable display of the operating parameters of semiconductors. The majority of semiconductors can be accommodated including SCR's, TRIACS and FETS.

Operating voltage is up to 200 V and for lower voltages a 1 amp sweep is possible.

To facilitate accurate operation an inbuilt calibration voltage is provided.

Further details: Schlumberger Instrumentation Australia (Pty) Ltd., 112 High Street, Kew. Vic. 3101.

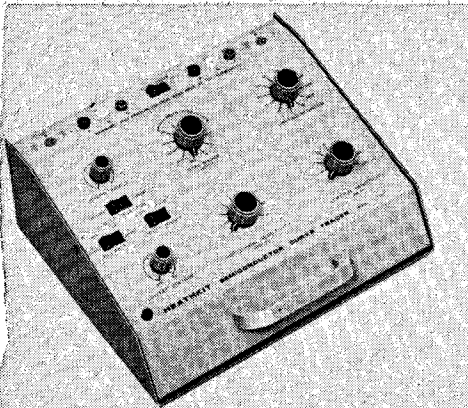

# BRIGHT ◆ STAR ◆ CRYSTALS

ESTABLISHED FOR THE PAST 35 YEARS FOR ALL YOUR REQUIREMENTS

STILL ON TOP

Bright Star Crystals are preferred by leading Manufacturers throughout the country for

**ACCURACY – STABILITY  
ACTIVITY – OUTPUT**

Consult us for Crystals for any Mobile Radio. All types available.

**DISCOUNT FOR QUANTITY ORDERS**

**AMATEUR AIRCRAFT and  
ULTRASONIC also available.**

Our modern factory equipment allows us to offer you PROMPT DELIVERY for all CRYSTAL requirements.

**DEVOTED EXCLUSIVELY TO  
THE MANUFACTURE OF  
PIEZO ELECTRIC  
CRYSTALS**

Contractors to Federal & State Government Departments.

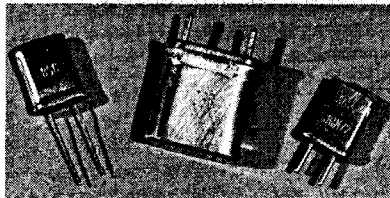

"All Types of Mountings"

### REPRESENTATIVES –

*Australia and New Zealand*  
Messrs. Carrel & Carrel,  
Box 2102, Auckland.

Rogers Electronics  
P.O. Box 3,  
Modbury North, S.A.  
Phone: 264-3296

Paris Radio Electronics,  
7A Burton Street,  
Darlinghurst, N.S.W.  
Phone: 31-3273

Fred Hoe & Sons Pty. Ltd.,  
246 Evans Road,  
Salisbury North, Brisbane.  
Phone: 47-4311.

W.J. Moncrieff Pty. Ltd.,  
176 Wittenoom Street,  
East Perth, 6000.  
Phone: 25-5722.

Write for a free comprehensive price list or quote for your requirements.

**BRIGHT STAR CRYSTALS P/L.**  
35, EILEEN ROAD, CLAYTON,  
VICTORIA, 546-5076

# THIS <sup>Lead Acid</sup> Battery ...

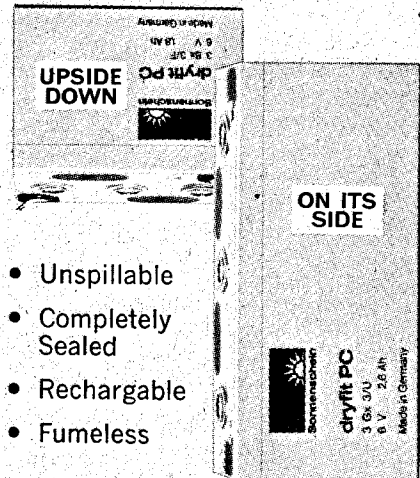

- Unspillable
- Completely Sealed
- Rechargeable
- Fumeless

## CAN <sup>be</sup> fitted in ANY POSITION

Sonnenschein batteries are of the lead-acid type, ideal for all forms of portable electronic equipment requiring 2, 6 or 12 volts at .9 to 7 AH capacity. Send for free comprehensive Technical Manual.



## Sonnenschein dryfit PC BATTERIES

### R.H. Cunningham Pty. Ltd.

TELEX: Melb. 31447, Sydney 21707

VIC.: 493-499 Victoria St., West

Melbourne. Phone: 329-9633.

N.S.W.: Sydney Phone: 9092388.

W.A.: Perth Phone: 49-4919.

S.A.: Arthur H. Hall, Phone

424506.

QLD.: L.E. BOUGHEN & CO.,

Auchenflower. Phone: 70-8097.

Please post free **Sonnenschein** literature.

NAME .....

ADDRESS .....

CITY ..... POSTCODE .....

ETI.11/74

# EQUIPMENT NEWS

## DUAL-BEAM OSCILLOSCOPE HAS 400 MHz BANDWIDTH, PLUG-IN FLEXIBILITY

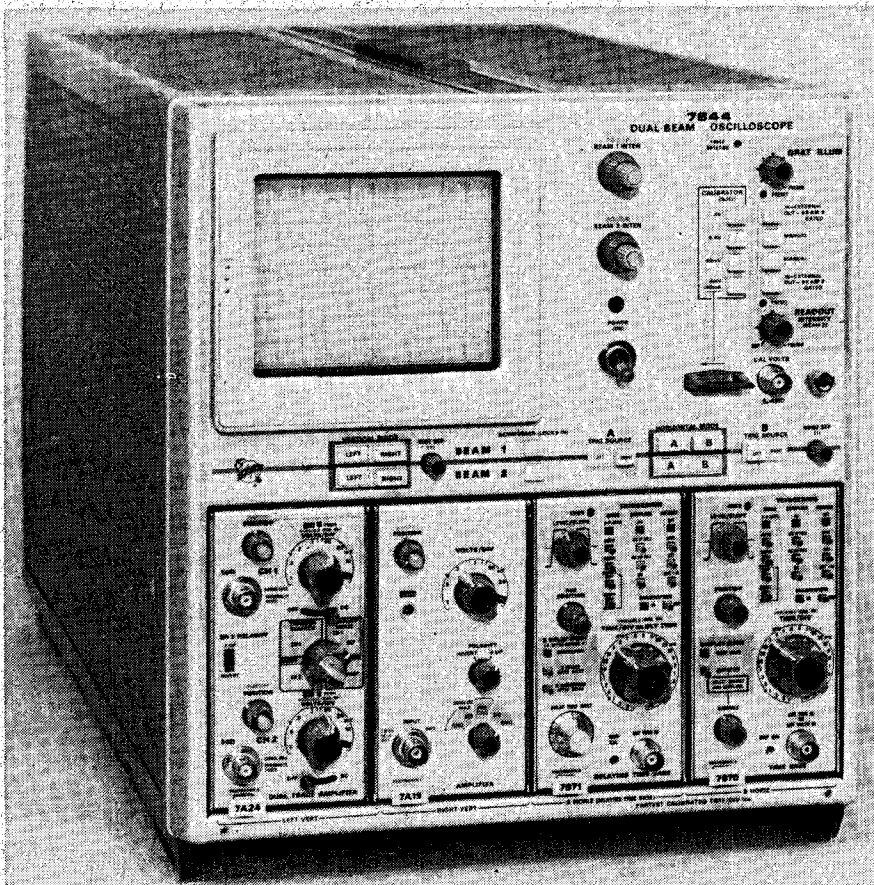

A 400-MHz bandwidth, dual beam oscilloscope which is optimally suited to analyzing simultaneous, fast, single shot events or fast events occurring at very slow repetition rates was introduced today by Tektronix Australia Pty. Limited.

The 7844 is essentially two oscilloscopes in one, where both independently and simultaneously use the same cathode ray tube (CRT) display area.

A second version introduced at the same time, the R7844 is functionally identical to the 7844 but is installed in a rackmount cabinet.

Based on TEKTRONIX flexible 7000-Series, the 7844 and R7844 have four compartments for which the user can select from over thirty different plug-ins to create the combination of performance range and package price to suit his requirements.

A 400 MHz bandwidth mainframe — making it the fastest dual-beam oscilloscope on the market — the 7844/R7844 can be combined with a wide range of input amplifiers to give just the system bandwidth needed. For example, with a 7A24 amplifier, the bandwidth is 300 MHz at 5 mV/div sensitivity. Or, with a 7A21N direct access plug-in, the bandwidth is 1 GHz at less than 4 V/div.

Both the 7844 and R7844 offer vertical and horizontal crossover. Any combination of the two available vertical amplifier

positions can be combined with any combination of the two horizontal positions for either or both beams. The most significant application of vertical crossover is to view non-recurring events simultaneously at two different sweep speeds.

If crossover is not required, the oscilloscopes can be ordered in an Option 21 configuration, which retains all features except crossover.

Both oscilloscope beams have full use of the eight centimetre by ten centimetre CRT screen. Full scan overlap allows simultaneous use of the full screen by both beams for observing signal coincidence.

Digital characters displayed on the CRT face — a Tektronix exclusive feature — give quick reference to the selected vertical deflection factors and horizontal sweep speeds. By installing any of five digital measurement plug-ins, in lieu of an analogue plug-in, a wide variety of digital measurement data can be displayed on the CRT along with the analogue trace.

Both graticule illumination and CRT character readouts can be pulsed by an external trigger or at a rate dependent upon sweep speed. When photographically recording single shot events, the graticule and/or character readout can be prerecorded before the event, or post-recorded following the event's capture on film.

## A-3 X-Y LABORATORY RECORDER

A new multi-range flat-bed X-Y recorder to be introduced by Philips this year offers high sensitivity, high writing speed and wide recording area, thus meeting the specific needs of research and development laboratories. Designated the PM 8125, the new DIN A3 recorder features 14 calibrated measuring ranges on both X and Y axis, starting at a very low 0.05 mV/cm, and going up to 1 V/cm. Variable span provides over-lapping on all ranges. Most significant however is the very high writing speed of 500 mm/s, which allows for accurate recording of fast changing signals, into the smallest details.

The design of the PM 8125 is based on the highly successful PM 8120, and A4 flat-bed X-Y recorder which has proven its outstanding features and high reliability in a wide range of applications.

The PM 8125 uses a null balance potentiometric measuring system with solid state amplifier and a new MOS FET chopper, this together with a dc servo system — tacho generator feedback provides the high recording accuracy of  $\pm 0.25\%$ , and a claimed reproducibility of  $\pm 0.1\%$ . The measuring system also features electronic overload protection and both gain and damping are factory adjusted. The inputs are floating and guarded, while temperature drift is below  $\pm 0.2\mu\text{V}/10^\circ\text{C}$  over an operating temperature range of 5 to  $40^\circ\text{C}$ .

The zero position of the PM 8125 can be continuously adjusted over the full scale and can be conveniently checked at the push of a button. An additional fixed offset of -100% can also be push-button selected.

Recordings can be made on any kinds of paper up to DIN A3 size, while the actual recording area is 250 x 380 mm. An electrostatic chart hold system is used and pin point light guides facilitate chart alignment.

The writing system accepts hard glass pens or nylon fibre tips and disposable ink cartridges of 3 cc. Penlift is electrical and remote pen-lift control is provided as standard.

An optional plug-on time base unit allows the recorder to be used for X-t and Y-t measurements.

The PM 8125 measures 150 x 482 x 450 mm (HxWxD) and weighs 15 kg. Power requirements are 100, 117, 217 or 235 V  $\pm 10\%$ , 50 and 60 Hz and power consumption is approx. 25 VA.

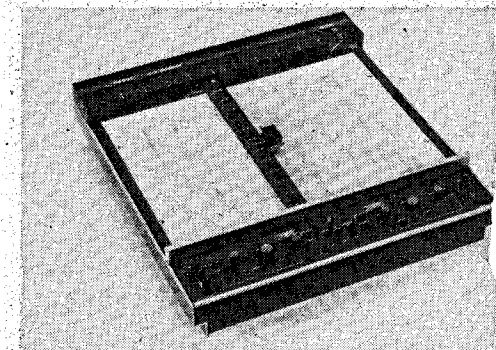



**NEW 0.1 Hz TO 13 MHz  
FUNCTION GENERATOR HAS  
INTERNAL SWEEP AND  
AM/FM MODULATION**

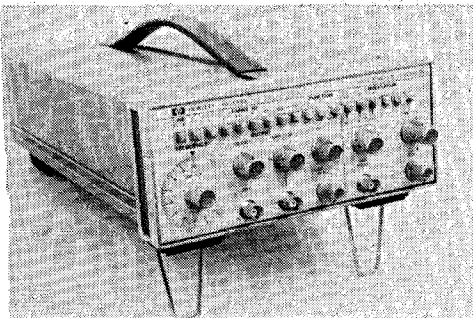

With two independent function generators in one package, this new Hewlett-Packard Model 3312A Function Generator gives the user the ability to generate a vast number of different waveforms. All of the more commonly used waveforms, plus those generated using the modulator, make the Model 3312A useful for sonar testing, pulse doppler testing and shock wave simulation as well as the traditional applications such as amplifier, receiver, filter and logic circuit testing.

The main generator covers 0.1 Hz to 13 MHz in eight ranges, and the modulator generator delivers signals from 0.01 to 10 kHz. Both the main and modulation generators provide, sine, triangle, square, pulse and positive and negative ramps.

The main generator can, by pushbutton control, be triggered or modulated by the modulation generator to provide sweep, AM, FM or tone bursts. The start/stop phase for trigger or burst can be varied from the front panel, and single or multiple cycles are selected by a rear-panel switch.

Output of the main generator is 10 volts peak-to-peak into 50 ohms for all waveforms. A four-position attenuator with a variable control adjusts the output over a 60 dB range. Dc offset up to 10 volts peak-to-peak is also included.

Dial accuracy is  $\pm 5\%$  of full scale. Sine wave flatness is within  $\pm 3\%$  (maximum output amplitude) from 10 Hz to 100 kHz and better than  $\pm 10\%$  from 100 kHz to 10 MHz. Sine wave total harmonic distortion at maximum output amplitude is less than 0.5% from 10 Hz to 50 kHz.

For triangular waveforms, deviation from the best straight line at 100 Hz is less than 1%. Square wave rise and fall time is less than 18 nanoseconds at full rated output.

Using the voltage-controlled oscillator (VCO) input for external frequency control, a sweep range of 1000 to 1 can be obtained. Simultaneous FM and AM is also possible using the VCO input.

This new Model 3312A will operate on line voltage of 100, 120, 220 or 240 +5%, -10% at line frequencies from 48 to 440 Hz. Power consumption is less than 25 volt-amps. The instrument weighs 3.52 kilograms (7lbs, 12oz).

Further details: Hewlett-Packard Australia Pty Ltd, 31-41 Joseph Street, Blackburn, Vic. 3130.

**DISPOSAL  
SALE**

*Of Surplus and Ex Government  
Electronic Gear*

**STOCK MUST BE CLEARED  
NO REASONABLE OFFER REFUSED**

**OPEN 9.30 AM - 5 PM Monday to Friday  
9 AM - 12 noon Saturday**

AVO Model 7 & 8 Multimeters. As new condition from \$35.00

No. 19 & No. 62 Transceivers. Plenty of part wrecked units any reasonable offer will buy.

A.W.A. RC Audio-Oscillator, 20Hz to 200kHz in 4 bands. HIZ & 600 ohm 240 Volt AC \$55.00

COAX CABLE 58 ohm Ascand 15 P1/24. Brand new 1/8" outside diameter. 12c per yard. \$10 per 100 yard reel.

LARGE QUANTITIES of hard to get valves, transformers, semi-conductors & components, dural tubing, cables multicore & coaxial, connecting leads Cannon type plugs multipin, relays, PMG types & miniature, telephone parts, teleprinter units, all types of panel meters new & used, test equipment, multimeters, signal generators, oscilloscopes, power supplies, standard racks and thousands of component parts, potentiometers, capacitors oil filled & electrolytic, high & low wattage resistors, transistor circuit boards, crystals.

**SPECIAL THIS MONTH ONLY**  
Standard P.M.G. Black Telephones Dial Type tested with Ericson Plug \$7.95 few only!

Ericaphon Plastic Telephone dial in base - latest type \$19.75 As new few only!

Ericson 800 Series Telephones dial type as new \$17.50 few only!

PMG Type Telephone Plugs, white plastic standard type Ericson 95c a pair.

4 Digit Counters. Post Office Type 40 Volt 50c each.



**RADIO DISPOSALS**

104 Highett Street, Richmond, Vic. 3121  
(Near Lennox Street) Phone 42-8136.

**Get the  
GRIPPING  
story of**

**LEVER WRENCH®**

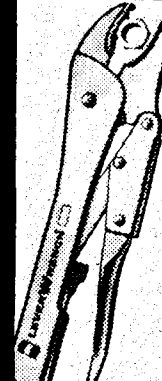

with  
self-  
adjusting  
jaws

**SULCO**

469 PACIFIC HIGHWAY, ARTARMON, N.S.W.  
Telephone: 42 4214

**SPECIALISTS IN PRECISION FASTENING TOOLS**

Local supplies  
and catalogues  
available

**CELESTRON SCHMIDT - CASSEGRAIN  
MULTI-PURPOSE TELESCOPES**  
ASTRONOMY - PHOTOGRAPHY - NATURE STUDY

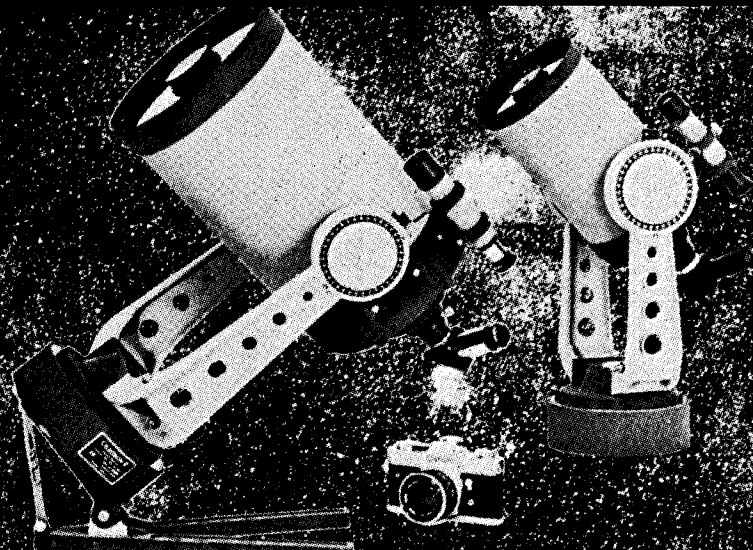

**CELESTRON 5" and 8" - Unsurpassed for optical excellence and versatility.**  
CALL AND SEE OUR SPECTACULAR DISPLAY AT OUR SYDNEY OR NEW  
MELBOURNE STORE - Mid City Arcade OR Bourke Street.

Send 20c for informative catalogue

- Telescopes - all types
- Build-it-yourself kits
- Binoculars
- Microscopes
- Star maps, atlases, books
- Weather Equipment

**ASTRO-OPTICAL SUPPLIES PTY LTD**  
11B Clarke St., Crows Nest  
Sydney, 2065 Phone: 43-4360

NAME .....

ADDRESS .....

..... Post Code .....

# MORROW ELECTRONICS

Australia's Finest Quality  
Public Address Systems

Design • Manufacture • Hire  
Sales 100-10,000 Watts

Also available custom guitar amplifiers in  
addition to our standard range.

- Complete quotes supplied anywhere in Australia
- Trade enquiries welcome

Contact:

62 Myall Avenue, ERINDALE. 5066  
Phone (08) 317574

NOW  
AVAILABLE

## KONO LEAD ACID BATTERIES

Outstanding in design and  
performance



### CONSTRUCTION

Fully sealed in reinforced plastic housing.

### LIFE

500-1000 charge cycles or 4-5 years on float service.

### DISCHARGE CURRENT

Maximum continuous discharge 200 times larger than the 20  
hr discharge rate.

# MIKE ELECTRIC

(AUST.) PTY. LIMITED  
118 Carnarvon Street, Auburn N.S.W. 2144  
Phone 648-5400

OKI dry reed inserts are one of the simplest and most economical switching devices available. Contacts of either gold diffused or rhodium material are hermetically sealed in a glass tube to provide reliable high speed operation.

Long life and freedom from corrosion are prime characteristics of the OKI range. Operation is activated by the presence of a magnetic field generated by either a coil or permanent magnet. The combination of a coil and reed insert forms a relay of the highest professional standard.

OKI reed inserts are unaffected by operation in grossly unfavourable environments and use in alarms, control systems and fail-safe devices of every kind is common. Typical applications include control and indication monitoring of position, liquid level, pressure, flow etc. Their high operating speed of typically 0.5 mS makes them also suitable for tachometer applications.

A standardised range is available ex-stock. Comprehensive literature is available on request to the Professional Components Division.

Plessey Australia Pty. Limited  
Components Division  
Box 2, P.O. Villawood, N.S.W. 2163  
Telephone: 72 0133 Telex: 20384  
Melb: Zephyr Products Pty. Ltd. 56 7231  
Adel: K. D. Fisher & Co. 223 6294  
Perth: H. J. McQuillan Pty. Ltd. 68 7111  
N.Z.: Henderson (N.Z.) 64 189

OKI DRY REED INSERTS

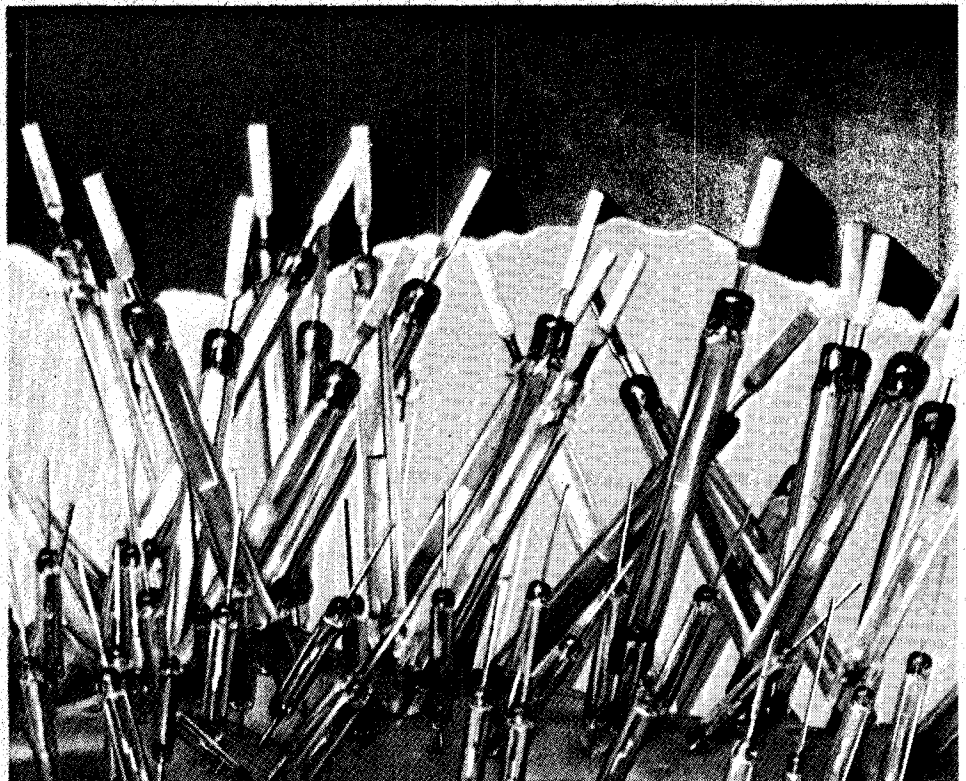

# PLESSEY



AC102/R1

# EQUIPMENT NEWS

## MULTI-CHANNEL COLOUR DISPLAY MONITOR

Derritron Electronics Limited of the UK, have introduced a multi-channel monitor to display in four colour vertical bar form up to a maximum of 40 channels of analogue signal inputs.

The equipment consists of a (330 mm) 13" Trinitron colour tube and an interface drive unit with a range from 16 to 40 channels using four channel modules.

Red, green and orange display the signal level amplitude, the fourth colour, blue provides a horizontal calibration graticule and vertical channel selection indication. Adjustable colour threshold levels provide high and low threshold indications across all channels. A low level on each bar is indicated in green, the colour changes to orange at normal operating levels between low and high threshold settings and to red above the high threshold setting.

Typical applications for the Multi Channel Colour Display Monitor are: The remote monitoring of large quantities of discrete signals where analogue meters have previously been used. Display of transducer outputs to temperature, pressure load and strain of complex machinery installations such as steel rolling mills or power generating stations. The individual channels from a broadcasting or recording mix-down desk. The simultaneous display of control and controlling functions of a multiple servo system. Any telemetered data with or without external synchronisation.

Further details: British Merchandising Pty Ltd, 49-51 Kent Street, Sydney 2001.

## MINIATURE ANALOGUE TAPE RECORDER

A miniature analogue tape recording system that can retrieve large quantities of information yet measures only a few cubic centimetres is claimed to be the smallest of its kind.

Its four-channel recording capability provides for cross-referencing of data in such a way that one parameter can be measured accurately relative to another. Each channel can store the equivalent of 3.5 million separate items or increments of information.

Data can be logged continuously for up to 24 hours. The unit possesses a true dc level recording capability and its frequency limitation is around 2 kHz. For long-term data logging, the device may be operated remotely for over three months.

As a result, the Microlog Tape Recorder is particularly suitable for the measurement of pollution levels, water levels, temperature, traffic flow, pH, salinity, and physiological parameters; and for recording events, acceleration and summations in a wide variety of industries and in different environments.

The recording unit is a miniaturised instrument-grade analogue cassette recorder measuring only 100 mm by 80 mm by 40 mm and weighing less than ½ kg complete with batteries and input amplifier. Two versions are offered, suitable for short-term and long-term experiments respectively. Both types utilise miniaturised plug-in amplifiers for handling all types of transducer signal.

Further details: Oxford Instruments Aust. P/L, 138 Bourke Road, Alexandria, NSW 2015.

## DIGITAL TRACKING VOLTMETER

The VID Tracking Voltmeter from Gay of Milan, marketed by Arlunya, is an instrument which, in addition to operation as a normal dc digital voltmeter, has a peak reading memory voltmeter capability with the ability to read "maximum" or "minimum"

A new "continuous conversion" principle is used in which the tracking voltmeter continuously follows the input signal, providing a steady state indication when the input is constant, and continuous updating when the input changes. When the input changes only the variation is digitised to cause an increase or decrease in the displayed value (and bdc) output and hence this "tracks" the input signal.

As a conventional dvm, the tracking voltmeter provides accuracy of  $\pm 0.05\%$  of reading,  $\pm 0.02\%$  of range with automatic polarity indication on four ranges of  $\pm 0.9999$  V,  $\pm 9.999$  V,  $\pm 99.9$  V and  $\pm 999.9$  V. The floating input provides an impedance of 10,000 M on the 1 V range and 1.1 M on the other three.

These specifications apply both for the normal mode and for the "maximum" and "minimum" peak holding memory modes. In the "maximum" mode the polarity switch can select either positive or negative peaks, whilst in the "auto" polarity position the absolute peak value (greater of positive or negative) is displayed, the polarity indicator acting as a polarity memory.

The unique "minimum" mode features the capability to measure and store the minimum instantaneous value of a varying dc voltage, for example a fast voltage drop.

The Gay Milano VID tracking voltmeter is only 180 x 50 mm panel size by 220 mm deep. Weighing 1.8 kg, it requires only 15 VA mains power.

Further details: Arlunya Pty Ltd, P.O. Box 113, Balwyn, Vic. 3103.

# FERGUSON

Manufacturers of: Electrical/electronic equipment, wound components and lighting control equipment.

## BRANCHES IN ALL STATES

FERGUSON TRANSFORMERS PTY. LTD.  
HEAD OFFICE:  
331 High St., Chatswood, 2067.

Phone: 02-407-0261

## COLOUR TELEVISIONS

Used colour TVs fully serviced, despatched to Australia from £80 sterling plus freight costs. Non workers from £40 sterling spare & service info. available.

send for details

T.E.S.T. P.O. Box 1,  
Kirkham, Preston PR4 2Ra  
ENGLAND.

## CORRECTION

In the October issue, the Hobipak Advertisement carried a price of 75c for a 4000/75 V Pigtail type. This should have read \$4.75. The publisher regrets any inconvenience. See Hobipak advertisement this issue page 27.

## HITACHI TAPES

### Pre-Devaluation Specials

	Normal	3-10	12
C.90	\$2.35	\$2.00	\$1.80
UDC.60	\$2.60	\$2.00	\$1.95
UDC.90	\$3.00	\$2.80	\$2.50

Head clearing tape \$1.60 or \$1.15 with order.

Postage up to 5 - 50c;

6-10 - 75c NSW, \$1.10 elsewhere

## Logan Brae

P.O. Box 24, Carlton, 2218.  
Telephone: 587-3475

# KITSETS SOUND



## KIT'S KOLUMN

Firstly this month, a cheerio call to Alfred E. Neuman of Gore Hill. It's a nice thought Alf, but we don't sell lifesize replicas of me, so you'll have to make other arrangements. What might solve some of your problems is that now we can supply all kits (not me) complete to the last screw. It's worth the journey from your place to our place to get decent stuff, isn't it? Why, we even get people coming from as far away as Bankstown...

## Got the 6v car blues

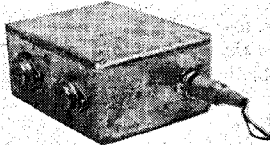

Alright, stop weeping. I know you can't buy a decent 6V radio or tape player. Why not buy a 12V one? What you do is build this beaut converter. Push your miserable 6V in one end and 12V comes out the other. Sorry Bug owners - not suitable for headlight conversion. P & P \$1. **\$19.50**

## Orgies in colour



Went to a party where someone had one of our Moodcolour 4 units hooked up to his Hi-Fi. Mick Jagger sings purple. Bowie's orange. The Fugs are blue. That's all I care to remember. All you lechers will love this. 4ch, each with adjustable bandwidth and 1kW load capability drive colour floodlamps. (You supply). Handles mono or stereo. Try it on your SFX album and blow your mind. Even the cabinet looks sexy. Erotic. Exotic. A wonder it hasn't been banned. Easy construction provided your hands aren't still shaking. P & P \$3. **\$71**

HE says I have to start answering your letters. OK. I'll start next month. Meantime... Keep your iron hot -

*KIT*

## STEINTRON WILL NEVER FORGIVE US: 10" SPEAKER SYSTEM, NOW **\$68**

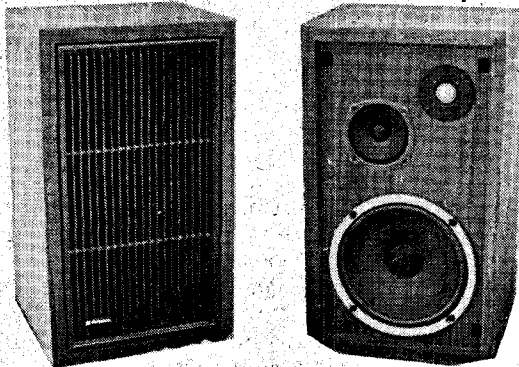

V100. Not a Kit. Advertised in our last catalogue at \$79. Down \$10 for November only and while pre-budget stocks last. 10" woofer; 5" midrange; 1 1/2" dome tweeter. Handles 30 watts RMS, has response 20-20kHz. Complete, ready to hook up to any decent amp. Timber enclosure 22 1/2" x 13" x 11 1/2". Freight \$10 each. Two for \$138, or price each for November dated orders only - \$69.

As you-know-who reads our ads pretty closely, we're not going to give away any secrets as to how we get our prices so low. This month, we're having some particularly generous spasms despite the pleas of our accountant. Have a dekkko at this lot...

## Everything goes boinggg

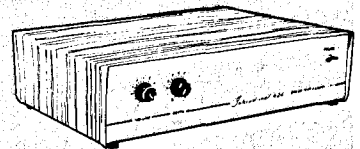

ETI'S superb new spring reverb unit. Our kit gives you everything you need to build it. More sophisticated and versatile than the 1972 version, in that it has its own mixing facilities and stereo operation. Use between preamp and main amp, or after disc pre-amp, or high level input and preamp. Input 100mV-1V. P&P \$2. **\$49-51**

## SAVE ON SPEAKERS BY BUILDING KIT



Sound leaves most 8" and 10" systems for dead! Specially designed and vented 1.6 cu. ft. enclosure, houses the new Plessey CFL (Controlled fibre length) C12PX 12" twin cone, wide-range speaker covering the bass and mid-range and the crystal-clear Plessey X30 1" dome tweeter covering the highs. Frequency response: 30-20,000 Hz. Power Handling capacity: 30 watts RMS \* OUR SPEAKER ENCLOSURE COMES PRE-ASSEMBLED AND VENEERED and requires only a small amount of final-assembly and strip veneering to complete! EACH 12" SYSTEM FOR ONLY **\$49-99**

## PLESSEY ROLA LOUDSPEAKERS



All with Plessey's 'CFL' - Controlled fibre length - for optimum resonance/efficiency combinations. All 8/15 ohm.  
**Small round & elliptical**  
X30: 20W/RMS. 3kHz-30kHz. 3-15/16". P&P 50c. **\$7.50**. C6MR: 20W/RMS. 450 Hz-6600Hz. 6-9/16". P&P 50c. **\$8.00**.  
**Low frequency woofers**  
C80: 20W/RMS. 35Hz-8kHz. 8-1/16". P&P 75c. **\$12.50**. C100: 20W/RMS. 40Hz-11kHz. 10-1/16". P&P 75c. **\$13.50**. C11P: 30W/RMS. 35Hz-8kHz. 12-3/32". P&P \$1.25. **\$19.80**.  
**Wide range twin cone**  
C12PX: 30W/RMS. \* 35Hz-13kHz. 12-3/32". P&P \$1.25. **\$21.00**. 12UX 50: 50W/RMS. \* 40Hz-13 1/2kHz. 12-3/32". P&P \$1.25. **\$39.90**.  
\* System power with suitable cross-over network and/or recommended enclosure.

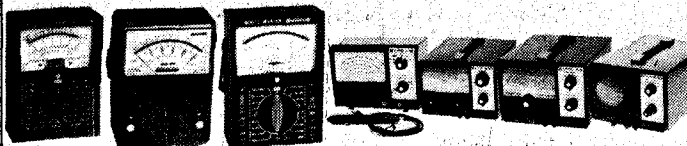

## Multimeters & Test Equipment

University Graham Multimeters: CT500: DCx6; ACx5; Current x 4; resistance x 4. Up to 5,000V DC. 20K ohms per volt DC; 10K ohms per volt AC. D'charge protected. P & P \$1. **\$19.95**

Model MVA50 Multimeter SDK ohms per volt D.C. with 5 D.C. ranges; 5 current ranges; 4 resistance ranges; 5 AC ranges. Can measure up to 1,000 volts and 10 amps. Only **\$29.95**. P & P \$1.00.

MVA 100: DCx7; ACx5; Current x 6; resistance x 4. Measures 10 amp AC & decibels. 100K ohms per volt. P & P \$1.50. **\$42.50**

All with test leads and batteries. This Test Equipment... VT 108 FET VOM 8 ranges 0.5 to 1.5kV, 11 Mag input, .3% accuracy. Ohms from 0.1 to 1000 Meg. Memory feature. **\$85**.

AG202A Audio Generator covers 20Hz to 200K Hz 10V rms output. Sine and square wave. External sync. **\$94**.

C01303A 75mm Scope has 20mV/cm sensitivity covers DC to 1.5MHz input R & C of 1 Meg and 30pF. **\$170**.

SG402 RF Generator covers 100kHz to 30MHz in 6 ranges. Output 0.1Vrms. High low attenuator. Modulation at 400Hz. **\$76**. Registered Pack/Post \$3.00.

## KITSETS

SYDNEY: 402 Kent St. Sydney, 29 1005. DEE WHY: 21 Oaks Ave. Dee Why, 982 9790. ADELAIDE: 12 Peel St. Adelaide, 87 5505. BRISBANE: 293 St. Paul's Tce. Fortitude Valley, 52 8391. MELBOURNE: 271 Bridge Rd. Richmond (Gallery Level, Church St. entrance) 42 4651. PERTH: 557 Wellington St. Perth (Opp. new bus terminal), 21 3047.



# jaycar

PTY. LTD.  
 Telephone 211-5077  
 P.O. BOX K39, HAYMARKET  
 N.S.W. AUSTRALIA 2000  
 405 Sussex St., Sydney

## ETI GRAPHIC EQUALISER

*professional system at a domestic price*

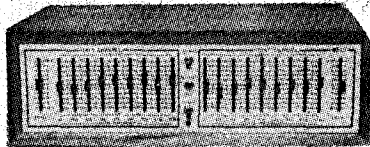

### Features:—

- 9 filters at octave intervals in each of 2 channels.
- $\pm 13\text{dB}$  range of control for each filter.
- less than .1% distortion
- frequency response .15 hertz to 30 kilohertz.

Comes with all coils prewound and a choice of either a timber cabinet or attractive marvi-plate cover making this kit ideal for professional P.A. or domestic stereo use.

Complete kit price \$96.00

## ETI 422 STEREO AMPLIFIER



High power — 50w RMS per channel less than .2% distortion  
 Complete Kit only \$118.00 (P&P \$3.00)

## ETI 420 4-CHANNEL AMPLIFIER

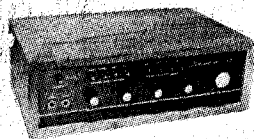

features 15watts per channel with sq decoding complete kit \$129.00  
 P&P \$2.50

## ETI 423 ADD ON DECODER AMP

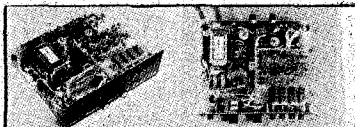

adapt your stereo to full 4 channel SQ operation \$65.00  
 P&P \$2.00

# SENSORS ON

## Medical electronics — 1800's style!

SINCE ELECTRICITY was harnessed in the laboratory at the start of the nineteenth century, the inventor has attempted to make use of it to cure ailments. Around 1830, the electromagnetic rotating generator was added to the already existing frictional methods of creating electricity. It was not long before the induction coil was also developed, finally giving the electro-medical practitioner a choice of high voltage continuous currents,

low voltage sinusoidal currents and high voltage impulsive currents which he could apply to the hapless patient in order to 'cure' various ailments. Indeed even today shock therapy and other forms of electrical treatment are still used as there is some useful basis to the concepts. Rather than discuss the routinely used methods in those good old Victorian days, I proposed to bring your attention to a couple of electrical methods that were rather

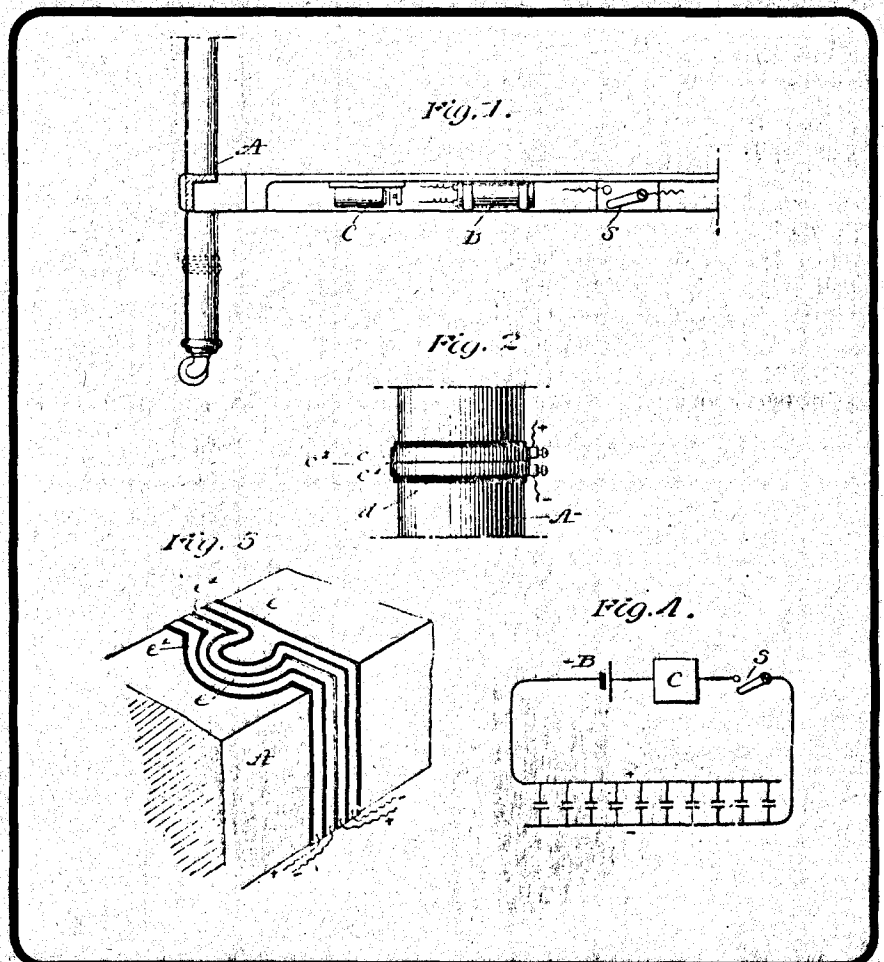

by Talus



hard to believe but nevertheless really were patented. They are both somewhat humorous to us now but we should remain humble when rushing to condemn the inventor of a century ago.

Have a good laugh but then reflect upon which might be the gaffes of our time.

The electrical bed-bug exterminator.

In February of 1898 a patent application was lodged (U.S. patent number 616049) to protect the idea of exploiting a electrical technique for preventing bed-bugs climbing the legs of the 'brass' bedstead.

The patent figures are represented in Fig. 1 — they will explain the inventor's idea. Mounted into the bedframe are a battery, induction-coil and what appear to be capacitors. The switch enabled the capacitors to be charged via the induction coil to a nice high voltage.

Clearly the idea was to electrocute the bug as it made the circuit across the rings around the leg or across the rings placed around the socket joint where the frame couples with the bed. If the shock did not kill the bedbugs, it would, said the inventor persuade them to go to another, unprotected bed.

Extracting poisons with electricity.

Another patent also granted in the U.S. patent office, related to the "new and useful Improvements in the

Electrical Extraction of Poisons from the Human Body" (Patent no. 606887 of 1898).

Whereas the bedbug exterminator had a valid basis, this one is a right tall story. Figure 2 is the illustration provided by the inventor as a "full, clear, and exact description of the same, . . . , in which the patient seated in a chair, the electric battery, and the conducting-wires leading from the electric battery to the positive and negative plates, which in the illustration are shown applied to the back of the neck of the patient and at the same time to the bare feet of the patient or person receiving treatment".

The inventor went on to explain how vegetable poisons were extracted by using the appropriate "vegetable receiver" — the contact made to the body. For animal poisons a chunk of steak was recommended.

In operation, claimed the inventor, the receiver is made in circuit to the negative electrode, the circuit completed and, hey presto, the poison will be drawn out by the current to deposit on the copper plates.

"From six to eight treatments of a half an hour each in duration will generally extract all of the poison of whatever kind it may be, and the copper plate will show as bright and clear as it was at first" — I'm not surprised there was no change in the plate.

**AM/FM Multiplex Tuner.** There is a shortage of tuners so get your's early. Separate AM and FM front ends. 10 transistors, 14 diodes. FM 88 to 108 MHz, AFC, 60dB S/N, 35dB sep, 600 mV output AM 535 to 1605 kHz ferrite rod. Multiplex adaptor built-in with indicator. 240 V operated in Walnut case. Guaranteed 12 months. Only \$75 (P & P Free). Hurry, demand is going to be heavy.



**LISTEN**

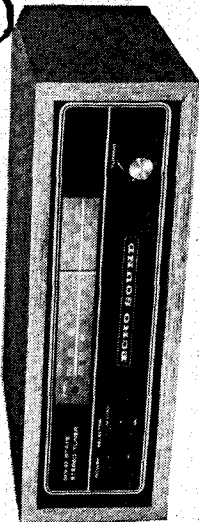

DICK SMITH WHOLESALE PTY. LTD., 160-162 Pacific Hwy., Gore Hill 2065. Tel. 439 5311  
ALSO AT 361 Hume Highway, Bankstown. Tel. 709 6600.

## BURGLAR ALARMS

Alarm Modules, Electronic Eyes, Photo Sensitive Cells, Sonar, Gas/Heat/Smoke Sensors, Sirens, Bells, Pressure Mats, Door Monitors, Car/Caravan/Home/Office hold-Up Factory Alarms, Key Switches, Reed Switches, Relays, Shock Recorders Aluminium Tape. You Name It We Have It.

N.S.W. Agent for

**NIDAC**

Manufacturers of superior and reliable equipment.

Phone 977-6433 For information or send 50c in stamps for illustrated catalogue.

PROTECTOR R.C. ALARM SYSTEMS CO.  
119-121 Pittwater Rd., Manly, N.S.W. 2095

# PROVEN PERFORMANCE MICRONTA® MULTITESTERS

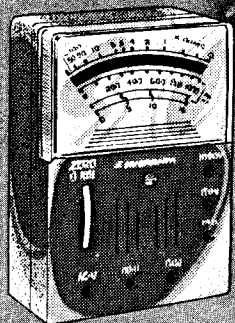

**POCKET MULTITESTER**

**8.95**

1000 Ohms/Volt AC/DC. 8 ranges. Handy for home & work shop. Easy read 2 colour 2" meter. With convenient thumbset zero adjustment, mirrored scale eliminates parallax. Very compact. 22-027

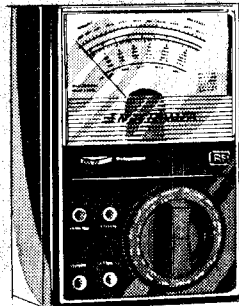

**18 RANGE 20,000 OHMS/VOLT**

**15.95**

Low priced VOM with 'expensive model' features. Single knob range selector with separate 'off' position. 3" meter, pin jack connections. Accuracy 3% on DC, 4% AC. Leads, battery, instructions. 22-201

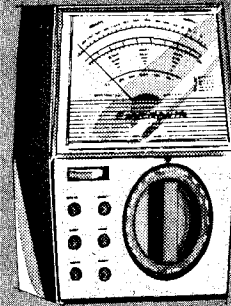

**25 RANGE 20,000 OHMS/VOLT**

**21.95**

Highly sensitive full range tester. 4" meter with colour-coded, mirrored scales. Single knob range selector. With leads, battery and instructions. 22-202

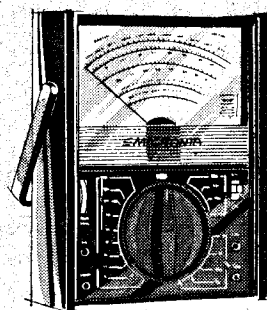

**27 RANGE 30,000 OHMS/VOLT**

**25.95**

High accuracy for servicemen, technicians, lab work. 4" meter, banana jack connections, polarity reverse switch. Leads, battery, instructions. 22-203

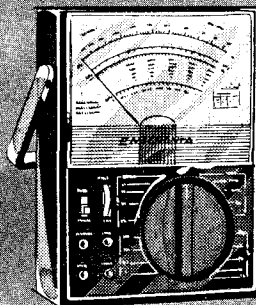

**43 RANGE 50,000 OHMS/VOLT**

**29.95**

Range-doubler circuit for more accurate readings both current & voltage. Ideal low voltage transistor servicing. 4 1/4" meter. Leads, battery, instructions. 22-204

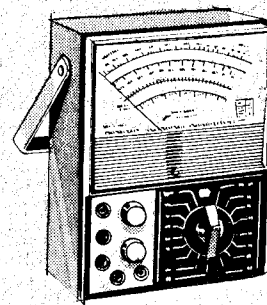

**27 RANGE 100,000 OHMS/VOLT**

**39.95**

One of the finest portable/bench models available. Fast accurate testing. Meter double jewelled 4" D'Arsonval Protection circuit. All extras! 22-205

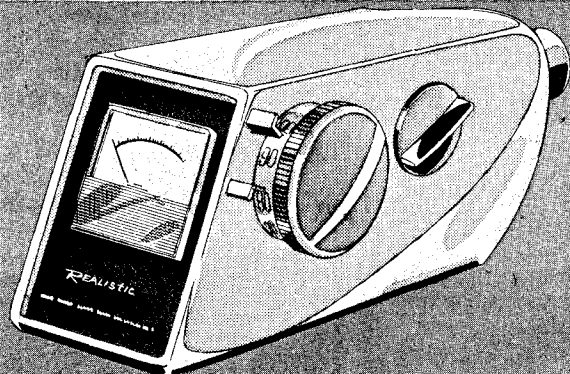

## REALISTIC® INCREDIBLE LOW PRICE ON SOUND LEVEL METER

**49.95**

An absolute must for audio buffs. Test sound levels in nightclubs, factories, soundproof rooms, stereo and PA systems. Reads 60-116 dB in five 16 dB ranges. Extremely accurate. Has external monitor jack. 1-v minimum output. Built-in battery tester. Compares favourably with \$200 units! Tandy self quality for less! 33-1028

RYDALMERE 280-316 Victoria Road ..... 638 6953  
EPPING 16 Langston Place ..... 86 1827  
PYMBLE 1112 Pacific Highway ..... 449 5046  
SEVEN HILLS 10b Regional Centre ..... 622 7507  
GOSFORD 42w Imperial Centre, Mann Street ..... 24 3392  
MERRYLANDS 209 Merrylands Road ..... 637 4448  
PBBEL TOWN 79 Dumaresq Street ..... 25 3524  
MUNSBY 3 Jurdett Street ..... 47 1673

MIRANDA Fountain Court Level, Miranda Fair 525 3350  
EMERTON 17 Jersey Road, Emerton Village 625 5870  
MAROUBRA 181 Maroubra Road ..... 34 5683  
MARRICKVILLE 111 Marrickville Road ..... 56 8048  
NEWCASTLE 788 Hunter Street West ..... 69 2207  
WOLLONGONG Westfield Shopping Town, Figtree  
**STORES IN  
CANBERRA·MELBOURNE·GOULBURN**

# TANDY ELECTRONICS

THE WORLD WIDE SUPER MARKET OF SOUND FOR 52 YEARS



**He's always been conscious of quality,  
his car, the way he dresses, his Hi-Fi...  
It's sort of a compliment to me, I guess...**



He used to think a great deal about everything he ever wanted in a sound system. Then he went a step further, beyond power, features and technology. When you go beyond this, you must arrive at the Marantz 4230 Quadradial Receiver. A superb piece of equipment with over 30 watts continuous power per channel for stereo and over 12 watts per channel for Quadriphonic.

He says it has the best AM-FM tuner in the business, featuring Marantz's exclusive Gyro-touch tuning. The built-in Dolby Noise Reduction System means noise free recordings now, and capacity to decode future Dolbyised FM broadcasts. There is every possible control to master any performance, and the Marantz's exclusive Vari-Matrix control brings stereo records to life in vibrant 4-channel sound and plug-in 4-channel decoder provision guarantees his Marantz can never be obsolete... I believe him!

Sometimes I'm just a little bit jealous of his Marantz equipment. But that's the way I am, that's the way he is and that's the way Marantz is... I do hope none of us change.

**marantz.**  
a very sensitive sound.

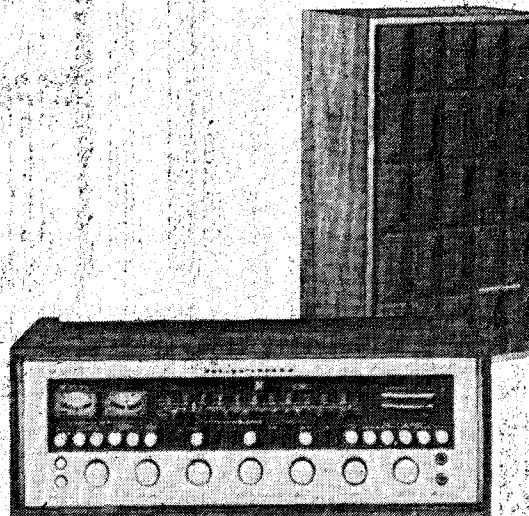

**For Brochure and a complete  
list of Marantz stockists  
write to Auriema (A'ASIA) Pty. Ltd.,  
15 Orchard Road, Brookvale. N.S.W. 2100.  
Telephone: 939.1900**

10970

## FERGUSON TRANSFORMER UPGRADED

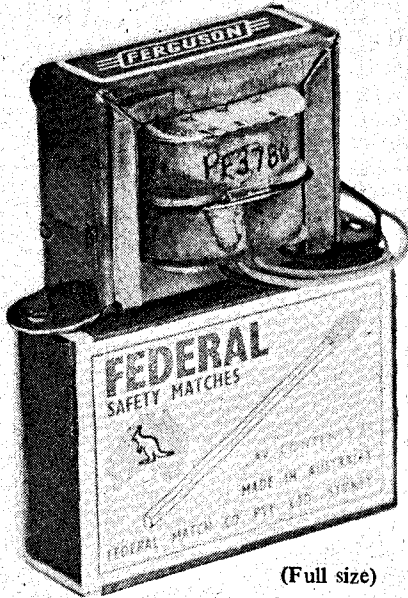

(Full size)

The Ferguson transformer type PF 2851 has been revised to meet the construction and insulation requirements of Australian Standard C126.

With the addition of PF 3786 and PF 3787 it now forms part of a trio in the "Ferguson" stock range which have been designed to meet the small power and small size requirements of the electronic industry.

These transformers are claimed to be the smallest locally manufactured stock types available, suitable for connecting to 240 volts 50 Hz mains.

The three transformers have two identical secondary windings which may be series or parallel connected. The choice of voltages are, 6, 12, 14, 18, 28 and 36 approximately 2.5 VA with no load volts being in the order of 25% above these values.

Further details: Ferguson Transformers Pty Ltd, 331 High Street, Chatswood, NSW.2067.

## PHASE CONTROL IC

A new (SL 440) control circuit announced by Plessey Semi-conductors provides variable phase control of power switching elements (such as triacs) in a variety of domestic and industrial applications. These include lamp dimmers, automatic lamp faders and motor speed control systems, as well as precision firing control of Ignitrons for high current welding systems.

Included within the circuit is a servo amplifier, a voltage controlled variable delay pulse generator, a load-current limit/inhibit safety facility, a cross-over detector and an internally stabilised low voltage dc supply which can be derived from the mains by simple low cost components.

In operation, an external timing capacitor is charged during each half-cycle of the supply waveform (50 or 60 Hz) at a constant rate which is controlled by the voltage output of the servo amplifier. When the charges reaches an internally defined level the conduction control circuit generates a 50 nano second (typical) firing pulse to trigger the triac. The cross-over detector resets the timing cycle when the supply waveform passes through zero, by completely discharging the timing capacitor during this time. The servo amplifier thus directly controls the conduction time of the triac and hence the power delivered to the load.

The servo amplifier allows for the facilities of electronic programming, tachometer feedback control or with just one extra capacitor gives automatic fading for light dimming.

Alternatively the servo amplifier can be by-passed and linear control of conduction angle effected manually by means of a high resistance potentiometer fed from the stabilised dc supply. This facility provides for accurate ganging of multiple power control circuits.

Encapsulation is in a 14 lead dual-in-line ceramic or plastic package.

Commercial enquiries should be addressed to Professional Components, Plessey Australia Pty Ltd, Christina Road, Villawood, NSW. 2163.

## MINIATURE CRYSTAL OVEN

A miniature crystal oven has been added to the wide range of quartz crystal associated products manufactured by Marconi.

The new oven has a capacity of 6.8 mm diameter and a depth of 6 mm to accommodate components housed in standard JEDC TO-5, TO-39, TO-99 or TO-100 outline packages. It is particularly suitable for use with microminiature crystal oscillators covering the 6-140 MHz frequency range, and with Q111 and Q115 crystals covering the 6-200 MHz frequency range. Both these types use TO-5 packages.

Ovens will maintain components at temperatures of 80°C, plus or minus 2°C, with an improvement factor of typically 80:1. (The improvement factor is the ratio of change in ambient temperature to the resulting change in oven temperature).

Versions are offered for operating temperature ranges from minus 10°C to plus 70°C or from minus 40°C to plus 70°C with supply voltages of 12 V, 15 V, 20 V or 24 V. Warm-up time from plus 25°C to within one degree Celsius of final oven temperatures is 90 seconds at a consumption of 6 W for the wider-temperature version; for the

narrower-temperature version it is 3 minutes at 2.8 W. Typical steady operational power consumption is 1 W for all versions.

Overall dimensions of the F3034 Oven are 25.5 mm by 15 mm high. The equipment is designed for mounting on 0.1 in (2.55 mm) grid printed circuit board.

Further details: Amalgamated Wireless (A'sia) Ltd., 422 Lane Cove Road, North Ryde NSW 2113.

## QUARTZ CRYSTAL FILTERS

A continuing programme of development of monolithic type quartz crystal filters has resulted in AWA adding two more 10.7 MHz filters to their existing range:

These locally manufactured filters were specifically designed for FM Mobile and SSB Communication equipments with bandwidth requirements of 7.5 kHz and 3 kHz respectively.

These acoustically coupled resonators achieve greater reliability, lower aging rates, and reduced size with improved economy.

Each filter is available in hermetically sealed enclosures of either 18.5 x 12 x 15 mm or 42 x 25 x 21 mm outlines.

The use of computer aided design for the manufacture of the filter elements and the electrode shadow masks provide a service for the custom design of other monolithic filters.

Further details: Crystal Section, Amalgamated Wireless (Australasia) Limited, Engineering Products Division, 422 Lane Cove Road, North Ryde, NSW. 2113.

## NEW TANTALUM CAPACITORS FROM SOANAR

Soanar Electronics Pty. Ltd., announce the introduction of a new and improved tantalum capacitor to their already extensive range of stock capacitors.

The new 'TAD' tantalum capacitors are produced by entirely automatic assembly methods to ensure constant high reliability and low cost, and offer the advantages of tantalum at prices comparable with aluminium electrolytics.

The superior dielectric provides high temperature stability, low leakage characteristics and long operational life. The absence of liquid electrolyte removes normal vacuum-pressure-altitude restrictions and ensures a low equivalent series resistance over a wide temperature range.

Uni-directional leads for P.C.B. mounting, small size and flame-resistant resin-dipped construction ensure 'TAD' tantalums are suitable for all by-pass, decoupling, blocking and filtering applications in entertainment, commercial and industrial electronic equipment.

Further details: Soanar Electronics Pty. Ltd., 30 Lexton Road, Box Hill, Vic. 3128.

# THE BEST THINGS IN LIFE ARE ALWAYS WORTH WAITING FOR ESPECIALLY AN INSTRUMENT FROM



Demand is GREAT, but when we manufacture such high quality and back it with a fast service facility (should you ever need it) is it a wonder?

Model bwd 539A is just one of the oscilloscopes in our wide range that colour TV engineers consider well worth waiting for.

## MODEL bwd 539A DUAL TRACE OSCILLOSCOPE

### VERTICAL AMPLIFIERS

DC to 12 MHz -3dB (both channels). (Flat within 5% over the entire video band width). 10 mV to 50V/cm in 12 steps.

**TIME BASE** - 200 n sec to 2.5 sec/cm including X 5 magnifier & 5:1 vernier.

**TRIGGER** - 5 Hz to 15 MHz. 1 cm defl. int. or 1V p.p ext. Internal from either channel. Instant selection of line or frame TV trigger at operators' discretion.

**PLUS DC to 1M Hz -3dB horizontal amplifier with 1° phase shift from DC to 100 kHz between X & Y amplifiers. Z mod in/out, 20V p.p. for full modulation at normal intensity. 8 x 10 cm display. 100% solid-state. <5% measuring accuracy including 10% input line voltage change.**

### PRICE

**\$375.00** (12 months warranty)  
plus tax if applicable.

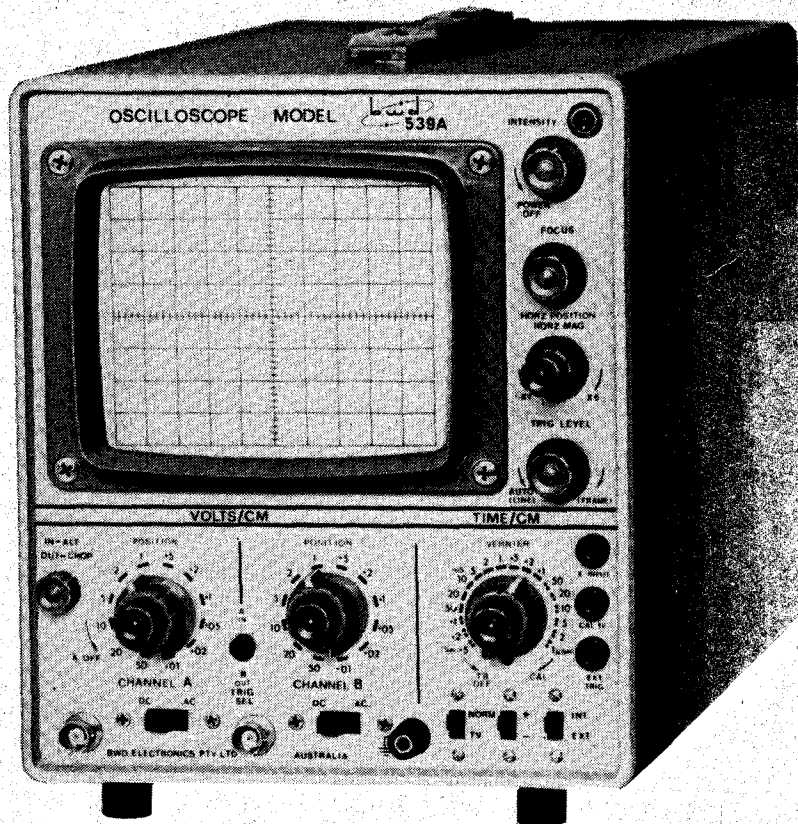

## B.W.D. ELECTRONICS PTY. LTD.

Designers and Manufacturers of the finest precision equipment.

25-27 Macquarie Road, Gaitherie, Vic. 3144 (Phone 24 4115 (2 lines))  
105-106 Gladstone Road, North Sydney NSW 2060 (Phone 247 92-6766)  
45-46 Macquarie Road, Gaitherie Vic. 3144 (Phone 24 4115)  
A W.A. Branch (Instrument Services) P.O. 24 4115  
\* Great Wellington Branch (Inland) P.O. 24 4115

WINNER OF AWARD  
FOR OUTSTANDING  
EXPORT ACHIEVEMENT

# Douglas-hifi

**MELBOURNE:** 185-191 Bourke St., City. Ph. 63 9321.  
**SYDNEY:** 65 Parramatta Rd., Five Dock. Ph. 798 4177, 798 4533,  
798 4355, 798 4711.  
Trade Enquiries: BJD ELECTRONICS P/L., Phone 799 3156.  
**PERTH:** 883 Wellington St. Phone 22 5177.  
**CANBERRA:** 53 Wollongong St., Fyshwick. Phone 95 3459.

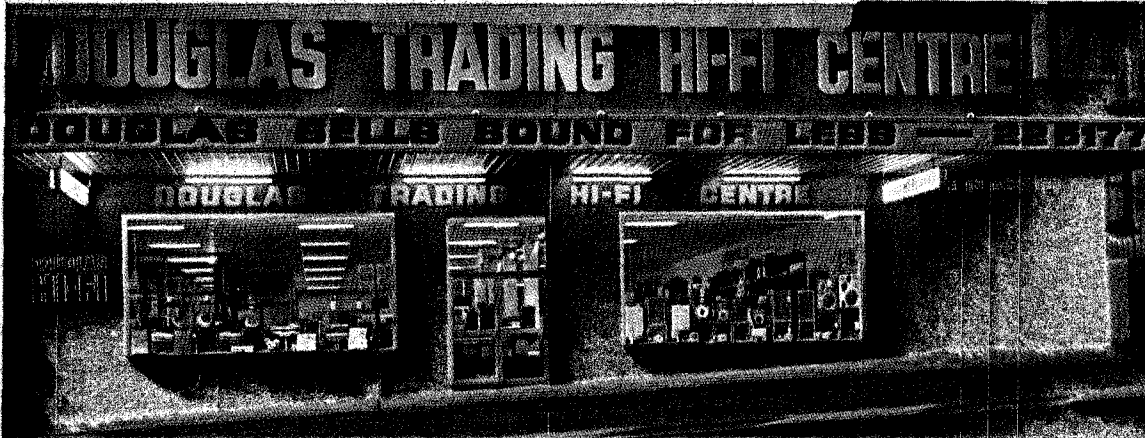

## DOUGLAS HI-FI PERTH

883 Wellington St., Perth, W.A.  
6000. (Opposite the markets.)  
Phone 22 5177.

If you're not impressed by Australia's biggest Hi-Fi showrooms, you'll certainly be impressed by the range and quality of our equipment – and our low prices.

More than 30 top brands, from 4 continents, displayed in a single showroom. There are hundreds of different models to choose from. And to make it easy for you to make the right selection, custom-built electronic comparators enable you to compare any combination of record player, tape deck, amplifier and speakers instantaneously. Because we buy bigger than anyone else, we buy cheaper. And we pass the savings on to you. Call in and prove for yourself that Douglas sells sound for less!

**BUY FOR CASH, LAY-BY OR EASY TERMS ARRANGED**

# HUGE NATION-WIDE BULK BUYING OFFERS SPECIAL LOW PRICES

## DOUGLAS HIFI

Buy the best tone of the typical system from Douglas HIFI in Melbourne, Sydney, Perth and Canberra.

**LINEAR DESIGN 169 SYSTEM** - Includes Garrard automatic turntable, stereo amplifier, diamond stylus, phono section for tape recording, 100 watts, 120 power tubes, 4000 ohm impedance, 100% electronically corrected, 100% component parts, 3 year warranty.

**LINEAR DESIGN 200 SYSTEM** - 454W, 100% electronically corrected, 100% component parts, 100% electronically corrected, 100% component parts, 3 year warranty.

**MODEL HAS THE CHEAPEST ALBUMS** - 100% electronically corrected, 100% component parts, 100% electronically corrected, 100% component parts, 3 year warranty.

**200 WATT SYSTEM** - 100% electronically corrected, 100% component parts, 100% electronically corrected, 100% component parts, 3 year warranty.

**JENSEN MODEL 15** - 100% electronically corrected, 100% component parts, 100% electronically corrected, 100% component parts, 3 year warranty.

**AKAI 4000DS** - 100% electronically corrected, 100% component parts, 100% electronically corrected, 100% component parts, 3 year warranty.

**AKAI PROFESSIONAL 3-HEAD TAPE DECK** - 100% electronically corrected, 100% component parts, 100% electronically corrected, 100% component parts, 3 year warranty.

**LINEAR DESIGN 2500 SYSTEM** - 100% electronically corrected, 100% component parts, 100% electronically corrected, 100% component parts, 3 year warranty.

**LINEAR DESIGN 200 SYSTEM** - 100% electronically corrected, 100% component parts, 100% electronically corrected, 100% component parts, 3 year warranty.

**LINEAR DESIGN 200 SYSTEM** - 100% electronically corrected, 100% component parts, 100% electronically corrected, 100% component parts, 3 year warranty.

**LINEAR DESIGN 200 SYSTEM** - 100% electronically corrected, 100% component parts, 100% electronically corrected, 100% component parts, 3 year warranty.



LINEAR DESIGN 169 SYSTEM



AKAI 4000DS 3-HEAD TAPE DECK

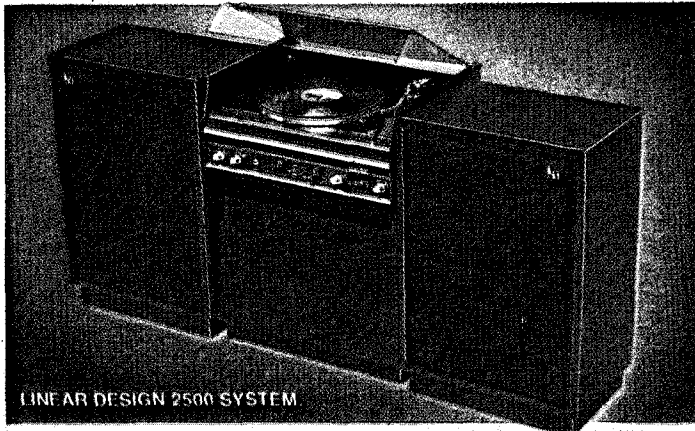

LINEAR DESIGN 2500 SYSTEM

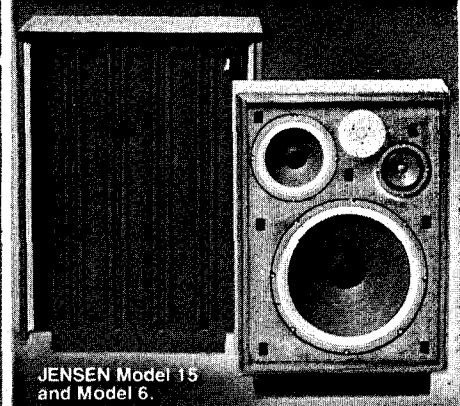

JENSEN Model 15 and Model 6

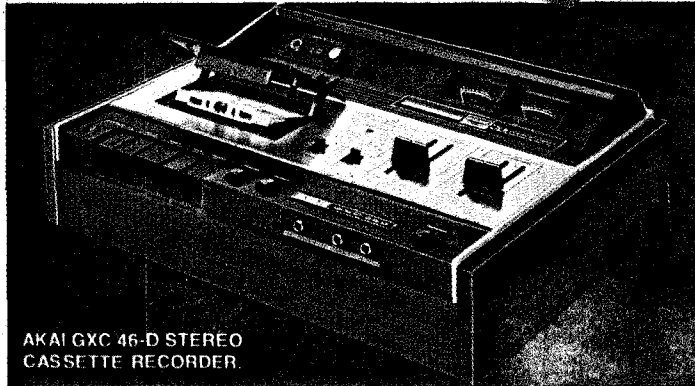

AKAI GXC 46-D STEREO CASSETTE RECORDER



LINEAR DESIGN AMPLIFIERS

**MAIL ORDERS A SPECIALTY!**  
ALL ORDERS SENT FREIGHT-FREE (and Insurance-Free) ANYWHERE IN YOUR STATE.

DOUGLAS SELLS SOUND FOR LESS! **Douglas-hifi**

# SYNTHESIZER BY & ARP

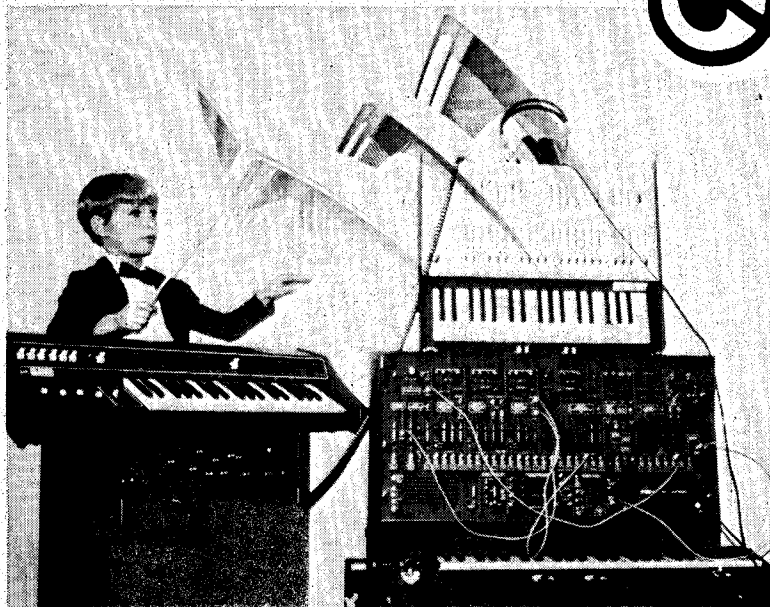

Units by courtesy of Boosey & Hawkes Artarmon

THE WORLD LEADING  
ELECTRONIC MUSIC  
MAKER ALSO  
EVANS P.A. UNITS  
SEE AND HEAR THESE  
UNITS AT ...

## A. OLIVER ELECTRONICS

188-192 PACIFIC HIGHWAY, ST. LEONARDS,  
POST OFFICE BOX 4. PHONE: 43-5305.  
HOT LINES: 633-3860, 439-4144

Designed to provide reliable, high-speed and long life operation, OKI series MRD and URD relays are employed in a wide variety of applications including transistor, integrated circuit, general purpose control, telephone and telegraph switching and data processing equipment circuitry.

OKI relays are extremely small and lightweight, highly sensitive and of magnetically shielded construction to enable close proximity mounting with each other without interaction.

A wide range of packages are available: all are shock, vibration and humidity resistant. Series URD are miniaturised versions of the MRD and include a 14 pin DIL package. They are particularly suitable for switching circuits with high output/input ratios.

OKI relays incorporate miniature reed insert switches and coil assemblies. Switch contacts employed in the range are of rhodium or gold diffused material for maximum reliability and life.

Comprehensive literature is available on request to the Professional Components Division.

**Plessey Australia Pty. Limited**  
Components Division  
Box 2, P.O. Villawood, N.S.W. 2163  
Telephone: 72 0133 Telex: 20384  
Melb: Zephyr Products Pty. Ltd. 56 7231  
Adel: K. D. Fisher & Co. 223 6294  
Perth: H. J. McQuillan Pty. Ltd. 68 7111  
N.Z.: Henderson (N.Z.) 64 189

OKI MRD & URD DRY REED RELAYS

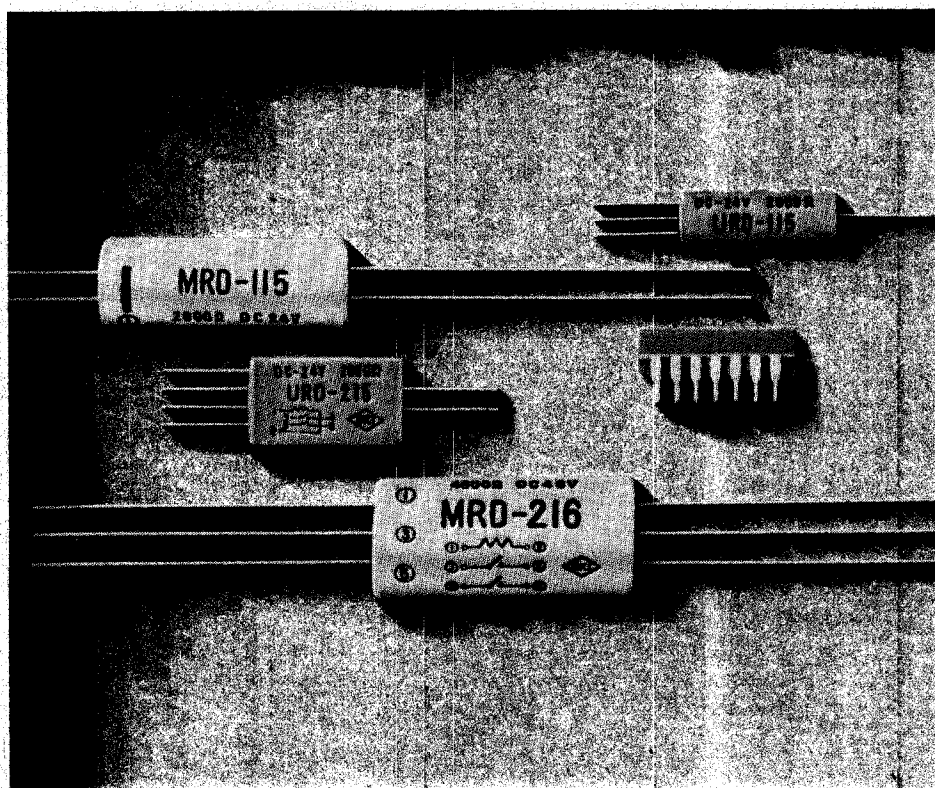

# PLESSEY



AC98/R1

# IDEAS FOR EXPERIMENTERS

A potpourri of circuits, ideas, hints and tips.

## PLOP ELIMINATOR

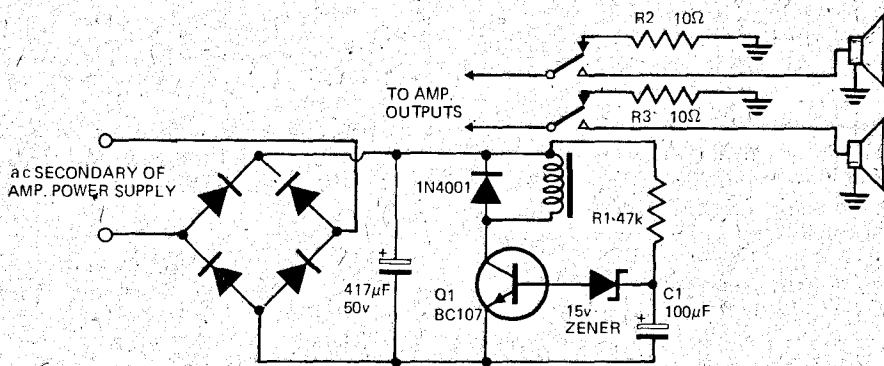

Many hi-fi amplifiers cause an only-too audible 'plop' in the speakers when switched on. The 'plop' is not only disconcerting but can also be damaging to low-power capacity speakers.

The plop is generally caused by the momentarily high inrush current to the series output capacitors.

The circuit shown here brings the speakers into circuit only *after* charge on the output capacitors has been established.

The unit is connected by wiring the rectifier bridge input to the AC

secondary winding of the amplifier power supply.

Immediately the amplifier is switched on, C1 charges through R1. When the voltage exceeds the Zener voltage of the diode in series with the base, the transistor conducts and closes the relay.

As soon as the power is shut off, the small smoothing condenser quickly discharges itself through the relay and de-energises it.

The two resistors R2 and R3 provide an alternative path for the onrush current when the amplifier is switched on.

## SHUTTER SAVER

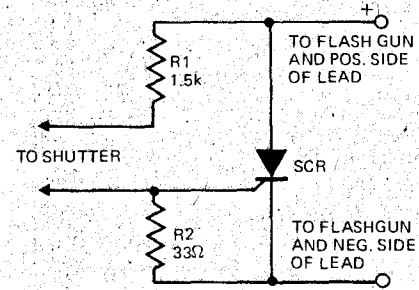

This three component device will keep sparks out of your camera shutter, when using a flash gun, by letting an SCR carry the firing current.

Closing the contacts in the camera shutter applies a triggering voltage, developed across the divider R1, R2, to the gate of the SCR, so firing the SCR and hence the shutter. The value of R1 must be as high as possible, but low enough to carry the needed gate current which may vary from 0.5 mA to a few milliamps. The value of R2 must be sufficiently high to develop necessary gate triggering voltage. R1 and R2 may need to be varied with SCR selected. The SCR should have a rating of 200 volts. If the device is used with a battery-capacitor flash, which operates at about 22 volts, R1 and R2 must be adjusted to suit.

The components can be assembled in a plastic pill tube, fitted in the middle of a flash lead.

## ONE TRANSISTOR AUDIO MIXER

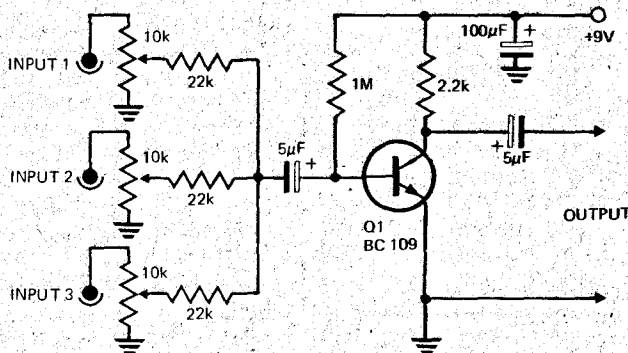

Three inputs are shown on our circuit but more can be added if required.

Each input has its own level control.

Sensitivity is 500 mV output for 25 mV input. This is more than adequate to drive most amplifiers.

As the name of this section implies, these pages are intended primarily as a source of ideas. As far as reasonably possible all material has been checked for feasibility, component availability etc, but the circuits have not necessarily been built and tested in our laboratory. Because of the nature of the information in this section we cannot enter into any correspondence about any of the circuits, nor can we provide constructional details.

Electronics Today is always seeking material for these pages. All published material is paid for — generally at a rate of \$5 to \$7 per item.

# IDEAS FOR EXPERIMENTERS

## LOW VOLTAGE STABILIZERS HAVE SHORT CIRCUIT PROTECTION

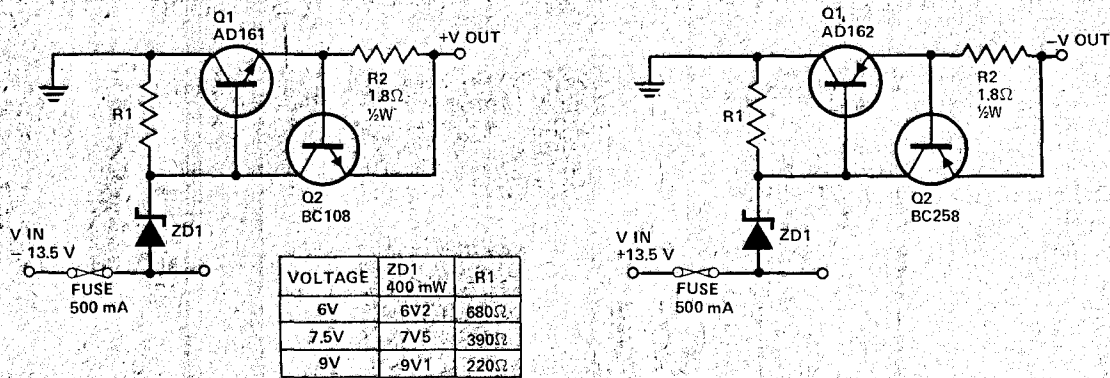

These short-circuit protected stabilisers give 6, 7.5 and 9 V from an automobile battery supply of 13.5 V nominal, however, they will function just as well if connected to a smoothed dc output from a transformer/rectifier circuit.

Two types are shown for both positive and negative earth systems.

The power transistors in each case can be mounted on the heatsink without a mica insulating spacer thus allowing for greater cooling efficiency.

Both circuits are protected against overload or short-circuits.

The current cannot exceed a value of 330 mA. Under normal operating conditions the voltage across R2 does

not rise above the 500 mV necessary to turn Q2 on and the circuit behaves as if there was only Q1 present.

If excessive current is drawn, Q2 turns on and cuts off Q1 protecting the regulating transistor.

The accompanying table gives the values of R1 for different zener voltages.

## DUAL POLARITY SUPPLY POWERS OP-AMPS

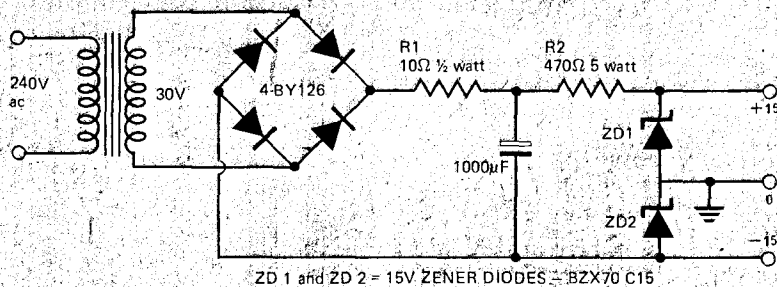

Ever been bothered by the lack of a dual supply for your op-amp circuits? This simple circuit gives positive and negative supply from a single transformer winding and one full-wave bridge.

Two Zener diodes in series provide the voltage division and their centerpoint is earthed. (N.B. the smoothing electrolytic must not be earthed via its case).

## STEP FREQUENCY OSCILLATOR

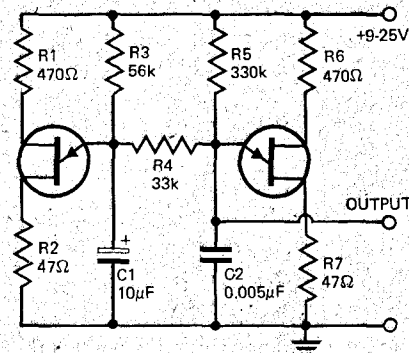

This circuit will produce a continuous sequence of increasing frequencies (in steps) until the highest is reached. The system then resets itself and starts again.

Two unijunction relaxation oscillators are cross-coupled together. On switching on capacitors C1 and C2 start to charge up through R3 and R5. The time constant C2-R5 is shorter; Q2 fires first and discharges C2. As C2 charges up again it will draw current through R5 and R3-R4. This will shorten the Q2 time constant, and in progressive cycles, as C1 charges up slowly, the Q2 time constant will keep shortening till Q1 fires, at which stage C1 will discharge and the whole cycle begins again.

Various sound effects can be obtained by varying R3, R4, C1 and C2.

## ELECTRONIC FUSE

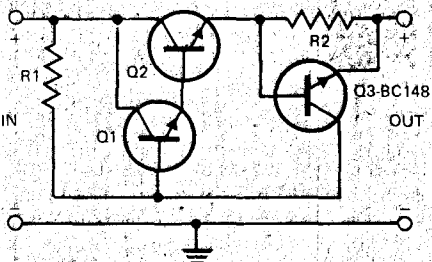

I <sub>max</sub>	R1	R2	Q1	Q2
5.0A	100Ω	0.12Ω	BFY50	2N3055
0.5A	1k	1.0Ω	BC107	BFY50
0.1A	4.7k	3.7Ω	BC107	BFY50

Here is a circuit for protecting modern transistorised gear which requires a faster action than can be

provided by an orthodox fuse.

Transistor Q2 is saturated by base current supplied by Q2, which is itself turned on by R1. The overall voltage drop between input/output is in the region of 2V. If a momentary surge in current or a short circuit in the load appears then the voltage drop across R2 will increase and when it reaches about 0.7V, Q3 will begin to conduct and its collector emitter voltage will drop to about 0.3 V. This in turn cuts off Q1 and Q2 thus breaking the supply current.

The tables gives circuit values for various currents. These are suitable for supply voltages up to 45 V.



## SINE/SQUARE WAVE CONVERTER

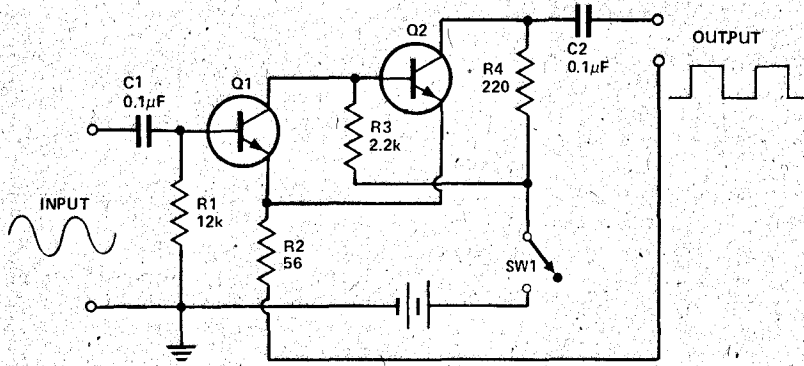

Many audio generators only give a sinusoidal output. However a square-wave output is often useful too.

This circuit will square any sinusoidal input over the range of 20 Hz to 30 kHz with an output of about one volt, input signal should be about 400 mV.

The waveform obtained is of much better purity than obtained by a diode

squaring circuit. The circuit is in fact suitable for use where square waves with a fast rise-time are required.

Transistors are germanium NPN types such as AC 127.

The power supply is 1.5 V and consumption is in the region of one to 2 mA.

## A VARIABLE ZENER DIODE

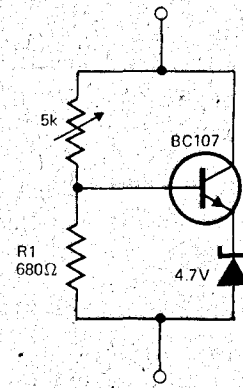

The circuit shown behaves like a Zener diode over a large range of voltages. The current passing through the voltage divider R1 - R2 is substantially larger than the transistor base current and is in the region of 8 mA. The stabilising voltage is adjustable over the range 5 - 45 V by changing the value of R2. The total current drawn by the circuit is variable over the range 15 mA to 50 mA. This value is determined by the maximum dissipation of the Zener diode. In the case of a 250 mW device this is of the order of 50 mA.

When stabilising higher voltages or operating at higher currents it is necessary to fit a small heatsink to the transistor.

## VARIABLE POWER SUPPLY GIVES POSITIVE OR NEGATIVE OUTPUT

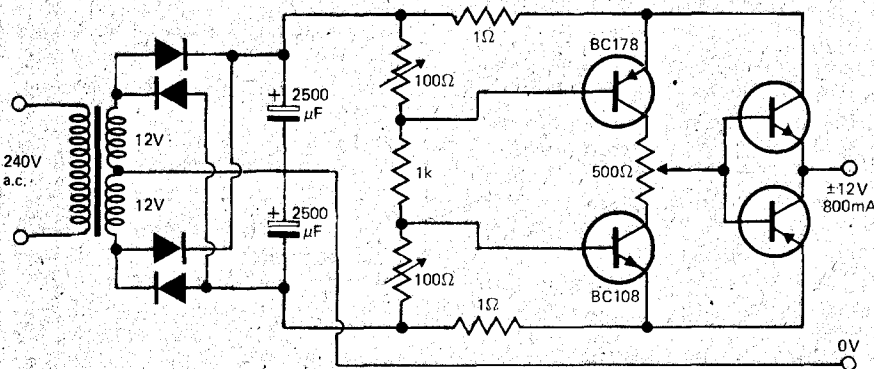

A variable power supply using complementary output transistors is capable of swinging the voltage at the output from +12 V through zero to -12 V.

The two output transistors can be types BD 135 - BD 136. These are both cut off when the 500 ohm

potentiometer is centred.

Rotating the potentiometer in either direction will give positive or negative output voltages up to 12 V and 800 mA. The series resistors (1 ohm) monitor output current and when this exceeds a level preset by the 100 ohm trimmers will current limit the output.

## WHITE AND PINK NOISE GENERATOR

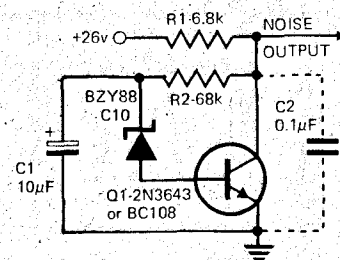

A basic noise generator can be built using one transistor and a Zener diode.

The 10 volt Zener acts as the noise source and also stabilizes the transistor operating point. Adding capacitor C2 will change the output from 'white' noise to 'pink' noise.

Output level for components specified will be about 15 V for white noise and about 14.5 V for pink noise.

The transistor should be a BC 108 or 2N3643 - other similar transistors will do.

## A VARIABLE ELECTRONIC CAPACITANCE MULTIPLIER

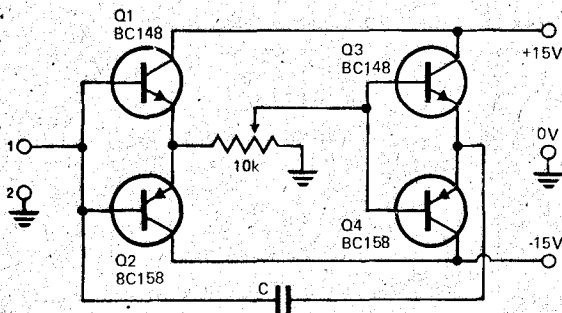

The circuit shown permits (with the aid of a potentiometer) the adjustment of capacitance appearing across terminals 1 and 2. The capacitance swing is of the order of 1000 - 1, the

minimum value being determined by the value of the capacitor C. By substituting a thermistor for the potentiometer, temperature dependent capacitance is obtained.

# IDEAS FOR EXPERIMENTERS

## STABLE HIGH-LINEARITY SAW-TOOTH GENERATOR

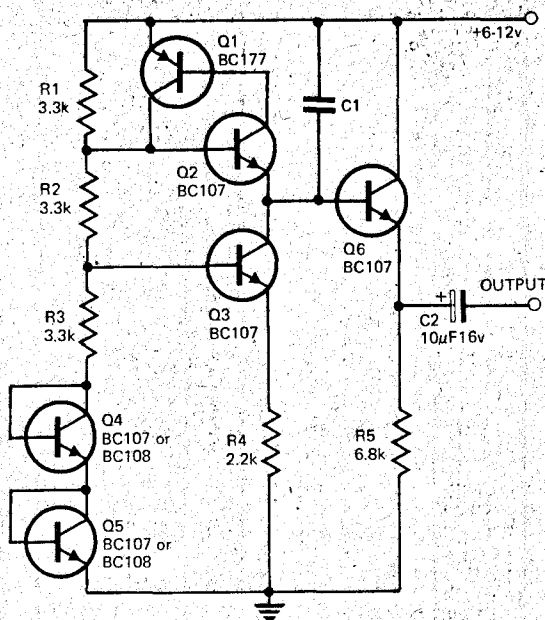

In this circuit two transistors Q1 and Q2 are connected so that they operate as a unijunction transistor.

Capacitor C1 is charged by a constant current source made up of transistors Q3, Q4 and Q5. This ensures a linear voltage rise. As soon as this voltage rises to the value as found at a point A of the circuit (less the base emitter voltage of Q2), the transistors Q1 and Q2 become conducting and C1 is discharged very rapidly.

The voltage rise across C1 is very linear and is applied to an emitter

follower stage. This ensures that there is no shunting effect by the load circuit which could be detrimental to the linearity of the output waveform.

The potential divider chain (R1-R2-R3) contains two transistors strapped as diodes and ensures good stability of the oscillator for variations in both supply voltage and temperature.

Frequency of operation can be calculated from the formula:

$$f = 1/R_4 \cdot C_1$$

where C and R are expressed in ohms and farads and f in Hz.

## ZENER DIODE NOISE GENERATOR

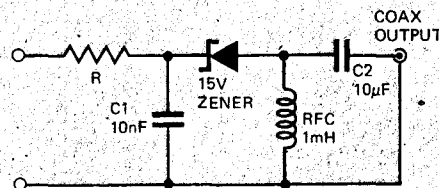

Zener diodes generate quite intense internal noise. This noise level is in the region of 30 dB above the inherent thermal noise and extends out to 150 MHz or so.

The circuit shown here may be used for adjustment of VHF converters and other receiving equipment.

It is energised by a dc source. The resistance R is adjusted so that between 6 and 8 mA flows through the circuit.

Capacitor C2 should preferably be ceramic. The signal output should be fed via a coaxial cable.

## SIMPLE CONSTANT CURRENT CIRCUIT

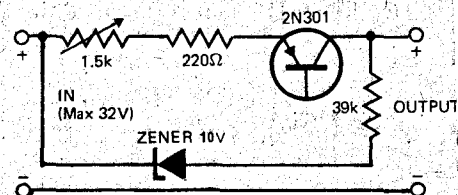

A series transistor is used as a variable resistor for this constant current supply.

The output current is held within 10% over a range of loads from a short circuit to 500 ohms. The required current is set by the potentiometer. The transistors specified will handle voltages up to 32 V.

# ELAC

IS SOLD & RECOMMENDED BY



GALLERY LEVEL  
ROSELANDS 2195  
750-6593

The turntable voted No.1 by an independent consumer organisation



SOLE  
AUSTRALIAN  
DISTRIBUTORS

## MAGNACORD INTERNATIONAL

276 CASTLREAGH ST. SYDNEY  
PHONE 61-9881

# HAM RADIO SUPPLIES

MAIL ORDER SPECIALISTS

67-7329

323 Elizabeth Street, Melbourne (2 doors from Little Lonsdale Street)

67-4286

## SOLID STATE 19 TRANSISTOR MULTI- BAND RADIO - 9 RANGES

\$79



AM, SW, FM,  
VHF, AIR, PB  
BATTERY/ELECTRIC  
COLOUR CODED 9 BAND DIAL

1. AM 535 to 1600 kHz, 2. Marine 1-5 to 4 MHz, 3 & 4. combined SW 4 to 12 MHz, 5. 30 to 50 MHz, 6. 88 to 108 MHz, 7, 8 & 9 combined VHF Aircraft 145 MHz-174 MHz incorporating weather band. Slider controls, Dial light, Fine tuning control, Flip-up Time Zone map, Telescope antennas complete with batteries and AC cord. \$79.00 p.p. \$1.40



## DIGITAL CLOCK RADIO

with 24 hour movement

Large lighted digits, 3 hour sleep switch automatic wake to radio or buzzer alarm. Slide controls.

\$39 pp. \$1.50

## AM/FM/AIR-PB-WB SOLID STATE

\$32.50



VHF MONITOR  
battery electric

### SPECIFICATIONS

Transistor: 12 Transistor, & 8 Diode;  
Frequency: FM 88-108 MHz, AM 540-1600 kHz, AIR-PB108-174 MHz;  
Power Output: Maximum 500 mW, Undistorted 280 mW; Speaker: 3" 8 ohms; Earphone: Magnetic 8 ohms;  
Power Source: DC 6V UM-2 x 4 pcs. or AC 230 Volt; Antenna: Ferrite bar for AM, Rod antenna for FM/AIR-PB-WB;  
Controls: Volume (w/on/off switch); Selector (AM/FM/AIR-PB-WB);  
Accessories: Earphone & batteries;  
Dimensions: 3 3/8" x 6 3/4" x 9 3/4";  
Weight: Approx. 3 lb.

## MODEL NC-310 DE LUXE 1 WATT 3 CHANNEL C.B. TRANSCEIVER

WITH CALL SYSTEM  
EXTERNAL AERIAL  
CONNECTION

### SPECIFICATIONS, NC-310

Transistors: 13  
Channel Number: 3, 27.24 OMHz  
Citiz. Band  
Transmitter Frequency Tolerance:  
±0.005%  
RF Input Power: 1 Watt  
Tone Call Frequency: 2000 Hz  
Receiver type: Superheterodyne  
Receiver Sensitivity: 0.7µV at 10 dB  
S/N  
Selectivity: 45 dB at ±10 kHz  
IF Frequency: 455 kHz  
Audio Output: 500 mW to External  
Speaker Jack  
Power Supply: 8 UM-3 (penlite  
battery)  
Current Drain: Transmitter:  
120-220mA  
Receiver: 20-130mA.  
Price \$49.50 per unit or \$99.00 pair

## CASSETTE CAR STEREO WITH 4 IC'S



Australia's best value in cassette players. Check these features:  
Mini sized modern styled slide controls  
Easily fitted under dash with no protrusions  
Full variable tone, balance, volume and fast forward controls  
New sideways cassette loading  
Latest solid state and IC circuitry.

12 VOLT NEGATIVE EARTH  
PRICE \$65 WITH SPEAKERS

## CASSETTE CAR STEREO WITH RADIO Combination Car Radio & Cassette Stereo Player.

New! Compact! Inexpensive! Australia's best value in a Cassette Radio Combination Unit. Features - all integrated circuit, monolithic IC amplifiers, push-in slot loading mechanism, eject & fast forward push buttons, dual volume & tone controls, extremely powerful radio. The compactness of this unit ensures easy fitting in or under dash of any car in Australia. Includes twin matched speakers. Price - \$89 with speakers

## SPECIAL NOTICE TO PURCHASERS OF RADIO RECEIVING AND TRANSMITTING EQUIPMENT.

The words "PMG approved type" in our advertisements do not mean that this equipment is covered by a PMG licence. But the equipment is of a type approved for licence application. Individual purchases of radio receiving and transmitting equipment must obtain a licence to operate from the PMG radio branch in their particular state. Some equipment sold by us cannot be licensed and therefore can only be operated by licenced amateurs.

SIGNED K.J. MILLBOURN

1 watt 2 channel transceiver with call system, 27.240 MHz. 12 transistor. PMG approved type.

SPECIFICATIONS: Transmitter - Crystal Controlled: 1 Watt input power to RF stage. Operating frequency - Any 2 channels in the 11-meter Citizens Band. Receiver -

Crystal controlled superheterodyne circuit with 455 Kc IF. Antenna - Built-in 60" telescopic whip antenna. Audio Output - 0.8 Watt maximum. Power supply required - 12 volts DC (Eight 1.5 volt DC battery cells). Loudspeaker - 2 1/4" PM type (built-in) Single units function as microphone on \$39.95, each, transmit.

### 5 WATT UNITS

MIDLAND model 13-862 watt 23-channel crystal controlled, frequency synthesized 27 MHz transceivers, all crystals included, 12 to 13.8V DC operation, noise limiter, S-meter, with mobile bracket, dual-conversion receiver with P.T.T. microphone, all for only \$99 P.P. \$2.00. For amateur use only.  
MIDLAND model 13-894 5 watt AM-SSB combination transceivers. 27 MHz all 23 channels crystals provided. 12 to 13.8 V DC operation, noise blanker, selectable sideband switch, clarifier, squelch control, S-Meter, mobile bracket with P.T.T. microphone, containing 29 transistors, 3 FET's, one IC and 53 diodes, all for only \$185 P.P. \$2.00 for amateur use only

## MULTIMETERS

### AS-100D/P \$34.50

High 100,000 Ω/Volt sensitivity on D.C.  
Mirror scale. Protected movement.  
AC/V: 6V, 30V, 120V, 300V, 600V, 1200V (10,000Ω/V).  
DC/V: 3V, 12V, 60V, 120V, 300V, 600V, 1200V (100,000Ω/V)  
DC/A: 12µA, 6mA, 60mA, 300mA, 12A.  
OHM: 2kΩ, 200kΩ, 20MΩ, 200MΩ  
db: -20 to +63dB.  
Audio Output: 6V, 30V, 120V, 300V, 600V, 1200V AC  
Battery: Internal  
Approx. size: 7 1/2" x 5 1/2" x 2 3/4"



## THIS MONTHS SPECIAL

Magnavox 8-30 speakers \$14.95



### MODEL OL-64D/P MULTIMETER

20,000 ohms per volt.  
DC volts: 0.025, 1, 10, 50, 250, 500, 1000 (at 20K o.p.v.), 5000 (at 10K o.p.v.). AV volts: 0-10, 50, 250, 1000 (at 8K o.p.v.). DC current: 50µA, 1mA, 50 mA, 500 mA, 10 amps.  
Resistance: 0-4K, 400K, 4M, 40 megohms. DB scale - 20 to plus 36 dB. Capacitance: 250pF to 0.02µF. Inductance: 0-5000 H. Size: 5 1/4" x 4-1/8" x 1 3/4" in.

Approx. size: 5 1/2" x 3-5/8" x 1 3/4". p.p. 50c

### CT-500/P. \$16.75

Popular, medium-size, mirror scale. Overload-Protected.  
AC/V: 10V, 50V, 250V, 500V, 1000V, (10,000Ω/V)  
DC/V: 2.5V, 10V, 50V, 250V, 500V, 5000V (20,000Ω/V)  
DC/A: 50µA, 5mA, 50mA, 500mA.  
OHM: 12kΩ, 120kΩ, 1.2MΩ, 12MΩ, db: -20db to +62db.



Approx. size: 5 1/2" x 3-5/8" x 1 3/4". p.p. 50c

### A-10/P \$55 p.p. \$1

Giant 6 1/2" Meter. Inbuilt signal injector. Overload Protected.  
AC/V: 2.5V, 10V, 50V, 250V, 500V, 1000V, (10,000Ω/V).

DC/V: 0.5V, 2.5V, 10V, 50V, 250V, 500V, 1000V at (30,000Ω/V) 5000V (10,000Ω/V).

DC/A: 50µA, 1mA, 50mA, 250mA, 1A, 10A!

OHMS: 10kΩ, 100kΩ, 1MΩ, 100MΩ  
db: -20 to +62dB

Signal Injector: Blocking oscillator circuit with a 2SA102 transistor.  
Approx. size: 6-2/5" x 7-1/5" x 3-3/5".

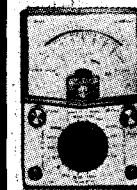

### H10K1 MODEL L-55 FET MULTIMETER

This amazing instrument features a 20 Meg ohm input impedance, 36 ranges from 300 mV full scale to 1200 volts and can measure as low as .2 ohm! Comes complete with probes and carry case.  
\$42.95 p.p. 75c.

### MODEL C1000 \$6.95 p.p. 50c

Is the ideal low cost pocket meter.  
AC volts: 10V, 50V, 250V, 1000V (1000Ω/V).  
DC volts: 10V, 50V, 250V, 1000V, (1000Ω/V)  
DC current: 1mA, 100mA  
OHMS: 150kΩ  
Decibels: -10db to +22dB.  
Dimensions: 4 3/4" x 3-1/8" x 1-1/8" 4 3/4" 3-1/8" x 1-1/8"

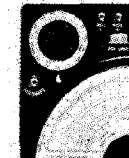

### 200-H. \$13.50 p.p. 75c.

90° quadrant meter. Pocket size.  
AC/V: 10V, 50V, 100V, 500V, 1000V (10,000Ω/V).  
DC/V: 5V, 25V, 50V, 250V, 500V, 2500V (20,000Ω/V).  
DC/A: 50µA, 2.5mA, 250mA.  
OHM: 60kΩ, 6MΩ  
Capacitance: 100pF to .01µF, .001µF to .1µF.  
db: -20db to +22dB.  
Audio Output: 10V, 50V, 120V, 1000V AC.  
Approx. size: 4 1/2" x 3 1/4" x 1-1/8"

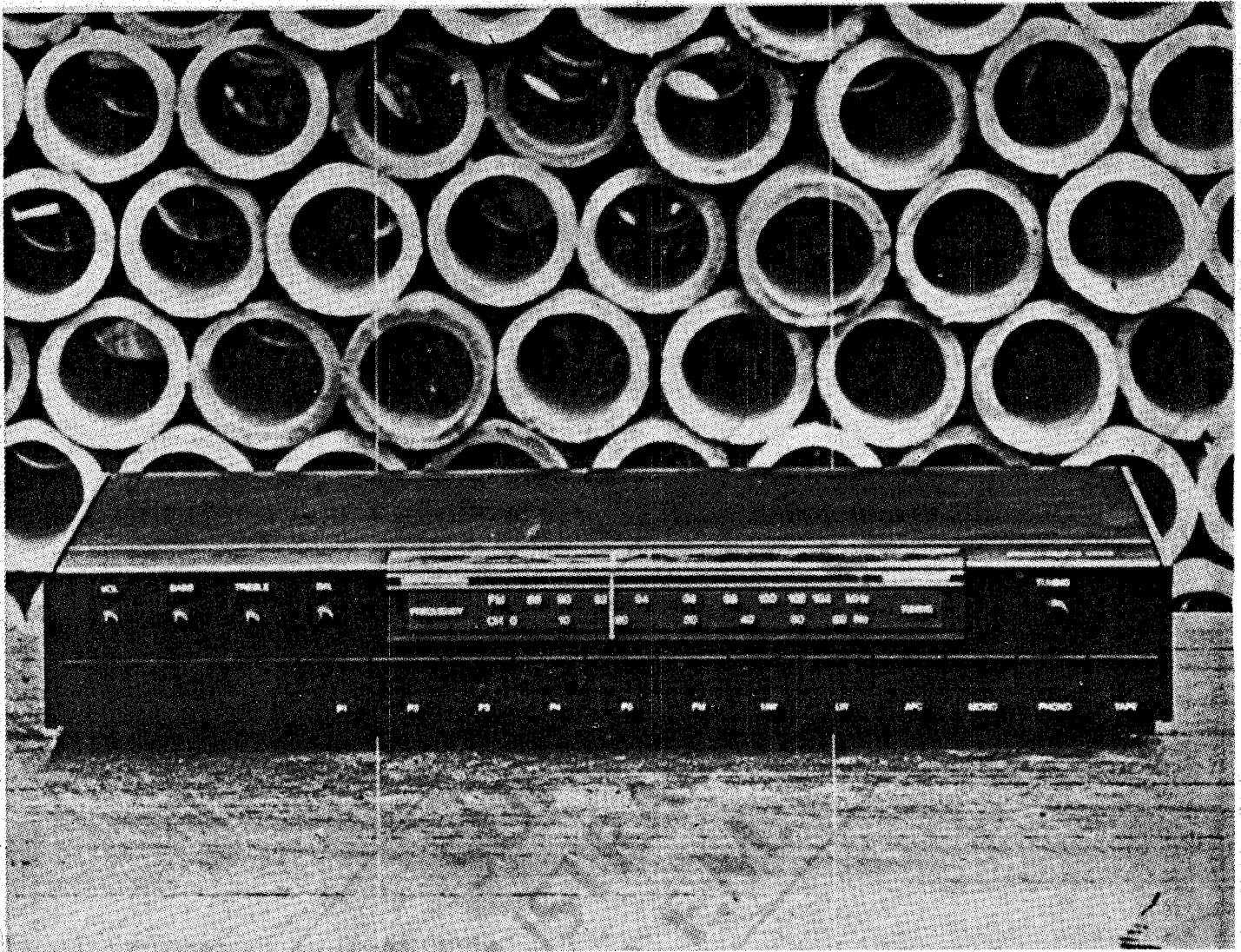

## scan-dyna 2000

— a new model in the Scan-Dyna series of Hi-Fi receivers. This new unit has the modern elegant design and advanced circuit techniques characteristic of all Scan-Dyna products.

The low, dark look and well-placed control knobs ensure that the Scan-Dyna 2000 receiver will look in place on most book-shelves.

Output is 2 x 25 watts (sine-wave power — into 4 ohms) — impressive considering the price.

Frequency ranges include FM, MW and LW. The Scan-Dyna 2000 has five preselected FM stations plus all facilities required in a Hi-Fi receiver.

**PRICE \$289.00**

**DURATONE IMPORTS**

3a Botany Street, Phillip,  
A.C.T. 2606  
Phone: 82 1333

### Amplifier-section:

**Power output:** 2 x 25 W sinus/4 ohm  
2 x 40 W music/4 ohm  
**Distortion:** Less than 1%/max. output  
**Frequency-response:** 20-20,000 Hz ± 1.5 dB  
**Effect band width:** 10-60,000 Hz  
**Signal-to-noise-ratio:** Better than 85 dB/max. output  
**Channel separation:** Better than 50 dB, 1 kHz  
**Inputs:** PU inp.: 47 Kohms/2 mV RIAA,  
Tape inp.: 470 Kohm/200 mV

### FM-section:

**IF:** With ceramic filters  
**Tuning range:** 87-104 MHz  
**Pre-selected stations:** 5 diode tuned  
**IHF M Sensitivity:** 1.8 μV  
**Limiting:** 1.8 μV/3 dB  
**Signal-to-noise-ratio:** 1.8 μV for 30 dB/100% mod 1 kHz  
**Distortion:** 0.4% for 100% mod., 1 kHz  
**Capture-ratio:** 2 dB  
**Channel separation:** Better than 35 dB, 1 kHz  
**Frequency response:** 50-15,000 Hz ± 1.5 dB  
**Pilot suppression:** 19 kHz better than 30 dB  
38 kHz better than 40 dB

### AM-section:

**Tuning range LW:** 145-360 kHz  
**Tuning range MW:** 510-1,660 kHz

**Sensitivity:** 1 μV/3 dB signal-to-noise ratio

**Signal-to-noise-ratio:** 53 dB/1 mV

### Control ranges:

**Turning knobs:** Tuning, volume with power-switch, bass, treble, balance  
**Pushbuttons:** Tape, phono, AFC, LW, MW, FM, mono, 5 pre-selected stations FM

### Connections:

**FM-Antenna:** 300 ohm balance, AM-Antenna and earth wire, phono, tape  
**Speakers:** 2 x stereo (4-16 ohm) headphones

### Other data:

**Indicators:** Meter for AM-FM tuning  
Meter for pre-selected stations  
**Power supply:** 220 V/50 Hz  
**Semiconductors:** 2 IC's  
47 transistors  
25 diodes  
25 cm deep  
55 cm wide  
9 cm high  
**Color:** Black  
**Weight:** 5.2 kos.

Scan-dyna 2000 meets specifications for DIN 45500

# INTERNATIONAL ELECTRONICS UNLIMITED

## LOGIC INTEGRATED CIRCUITS

Ea.	Ea.	Ea.
7400 \$ .19	7447 \$1.15	74141 \$1.23
7401 .19	7448 1.22	74145 1.15
7402 .19	7450 .24	74150 1.09
7403 .19	7451 .27	74151 .89
7404 .22	7453 .27	74153 1.29
7405 .22	7454 .39	74154 1.59
7406 .39	7460 .19	74155 1.19
7407 .39	7464 .39	74156 1.29
7408 .25	7465 .39	74157 1.29
7409 .19	7472 .36	74161 1.39
7410 .19	7473 .43	74163 1.59
7411 .29	7474 .43	74164 1.89
7413 .79	7475 .75	74165 1.89
7415 .39	7476 .47	74166 1.65
7416 .39	7483 1.11	74173 1.65
7417 .39	7485 1.39	74176 1.09
7420 .19	7486 .44	74177 .99
7422 .29	7489 2.75	74180 1.09
7423 .35	7490 .76	74181 3.65
7425 .39	7491 1.29	74182 .89
7426 .29	7492 .79	74184 2.69
7427 .35	7493 .79	74185 2.19
7430 .22	7494 .89	74190 1.59
7432 .29	7495 .89	74191 1.59
7437 .45	7496 .89	74192 1.49
7438 .39	74100 1.65	74193 1.39
7440 .19	74105 .49	74194 1.39
7441 1.09	74107 .49	74195 .99
7442 .99	74121 .57	74196 1.09
7443 .99	74122 .53	74197 .99
7444 1.10	74123 .99	74198 2.19
7445 1.10	74125 .69	74199 2.19
7446 1.15	74126 .79	74200 2.95

### LOW POWER TTL

74L00 .33	74L51 .33	74L90 1.69
74L02 .33	74L55 .33	74L91 1.45
74L03 .33	74L71 .33	74L93 1.69
74L04 .33	74L72 .49	74L95 1.69
74L06 .33	74L73 .69	74L98 2.79
74L10 .33	74L74 .69	74L164 2.79
74L20 .33	74L78 .79	74L165 2.79
74L30 .33	74L85 1.25	
74L42 1.69	74L86 .69	

### HIGH SPEED TTL

74H00 .33	74H21 .33	74H55 .39
74H01 .33	74H22 .33	74H60 .39
74H04 .33	74H30 .33	74H61 .39
74H08 .33	74H40 .33	74H62 .39
74H10 .33	74H50 .33	74H72 .49
74H11 .33	74H52 .33	74H74 .59
74H20 .33	74H53 .39	74H76 .59

### 8000 SERIES TTL

8091 .59	8214 1.69	8811 .69
8092 .59	8220 1.69	8812 1.10
8095 1.39	8230 2.59	8822 2.59
8121 .89	8520 1.29	8830 2.59
8123 1.59	8551 1.65	8831 2.59
8130 2.19	8552 2.49	8836 .49
8200 2.59	8554 2.49	8880 1.33
8210 3.49	8810 .79	

### 9000 SERIES TTL

9002 .39	9309 .89	9601 .99
9301 1.14	9312 .89	9602 .89

Please specify data sheets required with order. Add \$50 per data sheet for items priced less than \$1.00 each.

## CMOS

74C00 .39	74C74 1.15	74C162 3.25
74C02 .55	74C76 1.70	74C163 3.25
74C04 .75	74C107 1.50	74C164 3.50
74C08 .75	74C151 2.90	74C173 2.90
74C10 .65	74C154 3.50	74C195 3.00
74C20 .65	74C157 2.19	80C95 1.50
74C42 2.15	74C160 3.25	80C97 1.50
74C73 1.55	74C161 3.25	

## 4000 SERIES RCA EQUIVALENT

CD4001 .55	CD4013 1.20	CD4023 .55
CD4009 .85	CD4016 1.25	CD4025 .55
CD4010 .85	CD4017 2.95	CD4027 1.35
CD4011 .55	CD4019 1.35	CD4030 .95
CD4012 .55	CD4022 2.75	CD4035 2.85

## MEMORIES

1101	256 bit RAM MOS	1.75
1103	1024 bit RAM MOS	4.95
5260	1024 bit RAM Low Power	3.95
7489	64 bit RAM TTL	2.75
8223	Programmable ROM	4.95

## LOGIC PROBE KIT

- \* Ten nano/sec capability
- \* Checks TTL & DTL logic
- \* Dual slope memory
- \* Internally or externally powered
- \* Internal 5V regulator

Kit is complete with all necessary components, case probe, complete instructions and logic chart \$19.95

## PHONO AMP (for ceramic/xtal cartridge)

- \* 2 watt RMS at 8 ohms
- \* Build into turntable for self contained amp. with tone control
- \* Power supply not included - can use battery supply

Complete with components & instructions Mono \$ 7.95 Stereo 14.95

## POWER SUPPLY SPLITTER

- \* Ground reference for positive & negative output from single supply - any DC source to 20V
- \* Balanced output adjustment
- \* 1 amp-current capability with sink
- \* Increase usefulness of your power supply

Complete with all components & instructions \$4.95

## Hi Voltage Power Transistors - Prime Quality

Typically 40 Beta at 50 MHz. 10W, 1A max TO-5

NPN	400 VOLT	\$2.45 ea.	With combined
NPN	300 VOLT	1.20 ea.	total of 100
NPN	200 VOLT	.75 ea.	trans - 15% Off

## CALCULATOR CHIPS

5001 LSI (40-Pin) Add, subtr., mult. & div., 12-dig. Data supplied with chip \$3.95 ea.  
Data only - Refundable with purchase 1.00

5002 LSI similar to 5001 exc. des. for battery operated - Data supplied with chip 7.95 ea.  
Data only - Refundable with purchase 1.00

5005 LSI (28 pin) Full 4 funct. mem. 12-dig. displ. & calc. 7 seg. mltplx. outp. Data suppl. w/chip 8.45 ea.  
Data only - Refundable with purchase 1.00

MMS736 18 Pin, 6-dig., add, subtr., mult., div. 3.95 ea.

## DIGITAL CLOCK CHIPS

MM 5311 28-pin any readout 6-dig. BCD mux with spec. sheet 9.95 ea.

MM 5312 24-pin any readout 4 digit lpps output BCD mux with spec. sheet 6.95 ea.

MM 5313 28-pin any readout 6 digit lpps BCD mux with spec. sheet 7.95 ea.

MM 5314 24-pin LED-incandescent readout mux 6-digit with spec. sheet 8.95 ea.

MM 5316 40-pin norm. alarm set snooze alarm-timer 12 or 24-hr. operat. with spec. sheet 12.95 ea.

## LED's

MV108 Visible red TO 18 .25 ea.

MV50 Axial leads micromini dome .25 ea. 5/1.00

MV5020 Jumbo clear dome visible red .35 ea. 3/1.00

ME4 Intra red (invisible) diit. dome .60 ea.

## DISPLAYS

MAN1 Red, 7 seg., .270" \$2.50 ea.

MAN2 Red alpha numeric, .32" 4.95 ea.

MAN3A Red, 7 seg., .127" in line leads .79 ea.

MAN3M Red, 7 seg., .127" staggered leads 1.15 ea.

MAN4 Red, 7 seg., .190" 2.15 ea.

MAN5 Green, 7 seg., .270" 2.95 ea.

MAN7 Red, 7 seg., .270" 1.50 ea.

MAN8 Yellow, 7 seg., .270" 3.95 ea.

MAN66 .75" high direct viewing LED 4.65 ea.

DL707 Red, 7 seg., .3" 2.15 ea.

## OPTO ISOLATORS

MCD2 Diodes \$1.09 ea.

MCT2 Transistor .69 ea.

## LINEAR INTEGRATED CIRCUITS

300	Pos V Reg (super 723)	TO-5	\$ .79 ea.
301	Hi performance AMP	MINI-DIP, TO-5	.32 ea.
302	Voltage Follower	TO-5	.79 ea.
304	Negative Voltage Regul.	TO-5	.89 ea.
305	Positive Voltage Regul.	TO-5	.95 ea.
307	Op AMP (super 741)	MINI-DIP, TO-5	.35 ea.
308	Micro Power Op Amp	MINI-DIP	1.10 ea.
309H	5 V Regulator 200 ma	TO-5	1.10 ea.
309K	5 V TA Regulator	TO-3	1.65 ea.
310	Voltage Follower Op Amp	TO-5	1.19 ea.
311	Hi perf. Volt. Compartr.	MINI-DIP, TO-5	1.05 ea.
319	Hi-Speed Dual Compartr.	DIP	1.29 ea.
320	Neg. Reg. 5.2, 12, 15	TO-3	1.35 ea.
324	Quad Op Amp	DIP	1.95 ea.
339	Quad Comparator	DIP	1.69 ea.
340T	Pos. Volt. Reg. (6V-8V-12V-15V-18V-24V)	TO-220	1.95 ea.
370	ACC/Squelch AMPL	TO-5 or OIP	1.15 ea.
372	AF-IF Strip-detector	DIP	.79 ea.
373	AM/FM/SSB Strip	DIP	3.25 ea.
376	Pos. Volt. Regulator	MINI-DIP	.59 ea.
377	2W Stereo amp	OIP	2.69 ea.
380	2 Watt Audio Amp	OIP	1.49 ea.
380-8	.6W Audio amp	MINI-DIP	1.25 ea.
381	Low-Noise Dual Pre-Amp	DIP	1.79 ea.
382	Low-Noise Dual Pre-Amp	DIP	1.79 ea.
550	Prec. Voltage Regulator	DIP	.79 ea.
555	Timer	MINI-DIP	.99 ea.
703	RF-IF AMP	MINI-DIP	.45 ea.
709	Operational AMPL	TO-5 or DIP	.29 ea.
711	Dual Different. Compar.	DIP	.29 ea.
723	Voltage Regulator	DIP	.59 ea.
739	Dual Hi Perf. Op AMP	OIP	1.19 ea.
741	Comp. Op AMP	MINI-OIP, TO-5	.35 ea.
747	Dual 741 Op Amp	TO-5 or DIP	.79 ea.
748	Freq. Adj. 741	MINI-OIP	.39 ea.
1303	Stereo Pre-Amp	OIP	.89 ea.
1304	FM Mulpix Stereo Demod	DIP	1.19 ea.
1307	FM Mulpix Stereo Demod	DIP	.82 ea.
1458	Dual Comp. Op. Amp.	MINI-DIP	.69 ea.
LH2111	Dual LM 211 Volt. Comp.	DIP	1.95 ea.
3065	TV-FM Sound System	DIP	.69 ea.
3075	FM Det.-LMTR & Audio	DIP	.79 ea.

Please specify which data sheets are required with order. Add \$50 per data sheet for items priced less than \$1.00 each.

## ON ORDERS OVER \$25.00 DEDUCT 10%

ALL ITEMS ARE NEW, UNUSED SURPLUS PARTS - TESTED FUNCTIONAL. SATISFACTION IS GUARANTEED. THE PRICES AS LISTED ARE IN AUSTRALIAN DOLLARS. SEND BANK CHEQUE WITH ORDER. IF INTERNATIONAL POSTAL MONEY ORDER IS USED SEND RECEIPT WITH ORDER. SHIPMENT WILL BE MADE VIA AIR MAIL - POSTAGE PAID - WITHIN THREE DAYS FROM RECEIPT. MINIMUM ORDER - \$5.00.



**INTERNATIONAL ELECTRONICS UNLIMITED**  
P.O. BOX 1708 MONTEREY, CALIF. 93940 USA

# READER INFORMATION SERVICE AND ADVERTISERS' INDEX

For further information on Advertisers listed below complete the coupon/s stating information required including company and position held (if relevant). Cut out the coupon and post to:-

**ELECTRONICS TODAY INTERNATIONAL, RYRIE HOUSE, 15 BOUNDARY STREET,  
RUSHCUTTERS BAY, SYDNEY, 2011.**

## ADVERTISERS' INDEX

	Page No.
Akal	36,37
Allan Olivers Electronics	57
Alltronics	88
Amateur Astronomers	113
Apollo Hi-Fi	48
Applied Technology	40
Audio Engineers	17
Audio Trader	106
Auriema	121
Aust. General Electric	71
Aust. Musical Industries	2
Autel Systems	8-9
Babylon Electronics	98
B.J.D. Electronics	67-70
Boosey & Hawkes	126
Bright Star Crystals	111
B.S.R.	38
B.W.D. Electronics	123
Challenge Hi-Fi	96
Components, M.S.	63
Convoy	44,88
Cunningham, R.H.	111
Deitron	86
Dick Smith	76,119
Direct Disposals	97
Douglas Trading	12-13,124-125
Duratone	132
Edge Electric	20-21
Electronics Agencies	87
Ferguson Transformers	115
Glen Dor	15
Gwen Tinney	27
Ham Radio	113,131
Hewlett Packard	22
Hobipak	27
I.C.S.	27
Instron	136
International Dynamics	19,28
International Electronics Unlimited	133
I.R.H.	49
Jacoby Kenwood	14
John Carr	118
Kent Hi-Fi	47
Kitsets Aust.	116-117
Klarion Enterprises	39
Koenig	29
Leroya Industries	30,107
Logan Brae	115
Megasound	78-79
Mike Electric	114
M.S. Components	63
Morrow Electronics	114
Papua-New Guinea University	95
Pioneer Electronics	99
Plessey Aust.	11,114,126
Pre-Pak	80,81
Protector Alarm	119
Radio Parts	108
Ralmar	4
Rank Industries	16
Rowe, H.	113
Sulco	113
Supaspede	29
Tandy Electronics	120
Tecnico	62
Test	115
Thorn Sales	24
Toshiba Aust.	41
Trident Colour Television	31
Tristate Elect.	57
Union Carbide	46
Wedderspoon, W.C.	89,109,135
W.H.K. Electronics	18,86

**T.T.O. W.B. PALMER  
SERVICE SECTION  
17A GEORGE STREET,  
HOMEBUSH 2148**

Four reply coupons are provided here for your convenience. Please list only ONE advertiser and ONE product on each coupon. If you require information on more than four individual products, make as many copies of the coupons as you like (preferably typed) - again using one coupon form for each product.

**Send to: ELECTRONICS TODAY INTERNATIONAL,  
Ryrie House, 15 Boundary Street, Rushcutters Bay,  
Sydney, 2011.**

ADVERTISER.....

PRODUCT.....

NAME.....

ADDRESS.....

.....POSTCODE.....

COMPANY.....

POSITION..... 11:74

---

**Send to: ELECTRONICS TODAY INTERNATIONAL,  
Ryrie House, 15 Boundary Street, Rushcutters Bay,  
Sydney, 2011.**

ADVERTISER.....

PRODUCT.....

NAME.....

ADDRESS.....

.....POSTCODE.....

COMPANY.....

POSITION..... 11:74

---

**Send to: ELECTRONICS TODAY INTERNATIONAL,  
Ryrie House, 15 Boundary Street, Rushcutters Bay,  
Sydney, 2011.**

ADVERTISER.....

PRODUCT.....

NAME.....

ADDRESS.....

.....POSTCODE.....

COMPANY.....

POSITION..... 11:74

---

**Send to: ELECTRONICS TODAY INTERNATIONAL,  
Ryrie House, 15 Boundary Street, Rushcutters Bay,  
Sydney, 2011.**

ADVERTISER.....

PRODUCT.....

NAME.....

ADDRESS.....

.....POSTCODE.....

COMPANY.....

POSITION..... 11:74

# BETTER THAN BOSE!

That's right. Even though Bose are the most highly reviewed speakers in the industry; even though critics proclaim "Bose is best, big or small, high or low"—now there are two speaker systems better than Bose 901 and Bose 501!

## BOSE 901 SERIES TWO

Introducing the Bose 901 Series Two—it's everything that the original 901 was, and more: • Multiplicity of acoustically-coupled full-range drivers • Flat power radiation • Completely new Active Equalizer design, suited to program source variations never available before, and adapted to a much wider range of room environments (even drapes) • and SYNCOM™ II Speaker Computer quality control testing.

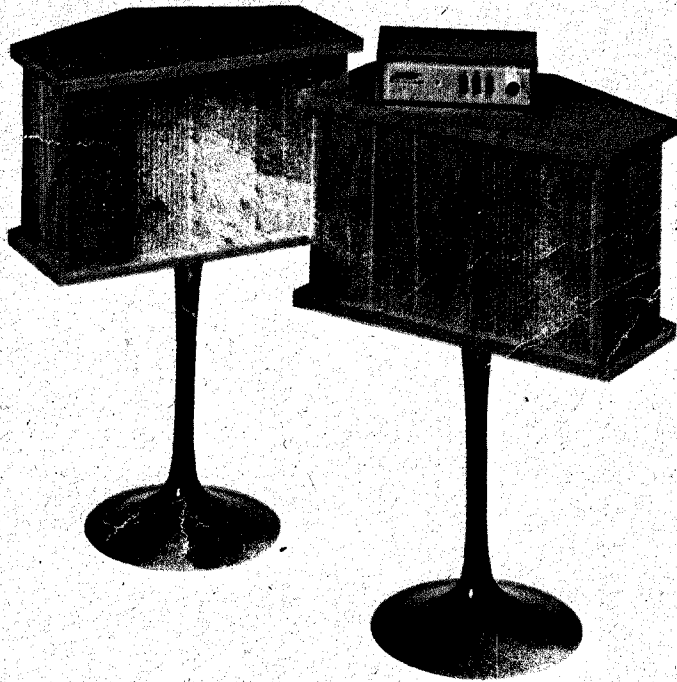

## BOSE 501 SERIES TWO

Also introducing the new Bose 501 Series Two—the other speaker with direct and reflected sound, and flat power radiation, at a price far lower than you'd expect to pay.

The new 501 Series Two features: • A new tweeter with double the magnet size of the original 501 and four additional components in the crossover network, for improved high frequency response and power handling capability • and 100% selection and matching of the woofers and tweeters with the SYNCOM™ II Computer—the unique computer designed by Bose and put into operation in August 1973 to achieve a new level of speaker performance.

We invite you to challenge us! Compare the Bose 901 Series Two to any other speaker, regardless of size or price; and compare the Bose 501 Series Two to any speaker up to the price of the 901 Series Two. You be the judge. If we have done our homework correctly, the comparison will be interesting and short!

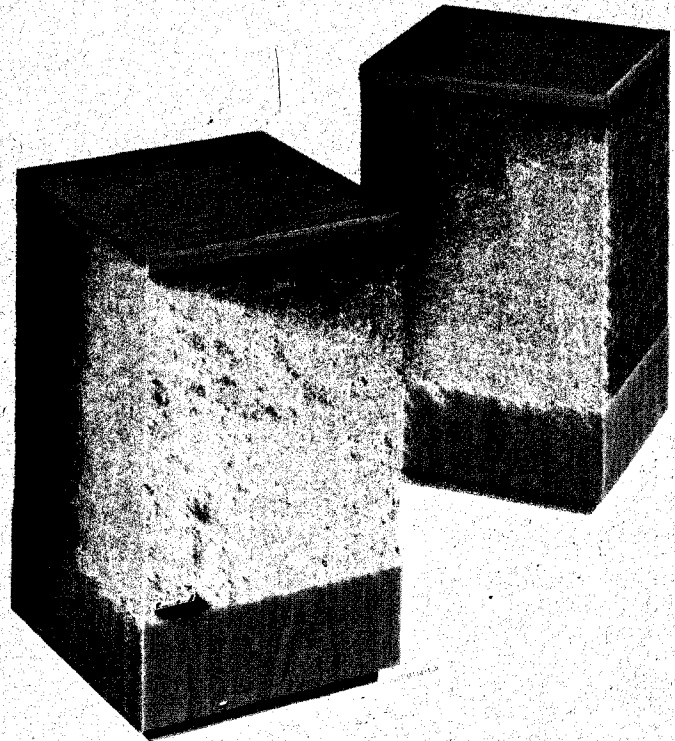

AUSTRALIAN DISTRIBUTORS  
**WEDDERSPOON**  
W. C. WEDDERSPOON PTY LTD

3 Ford Street, Greenacre. 2190  
Telephone: 642 3993 642 2595  
Showroom demonstration by appointment

**BOSE**

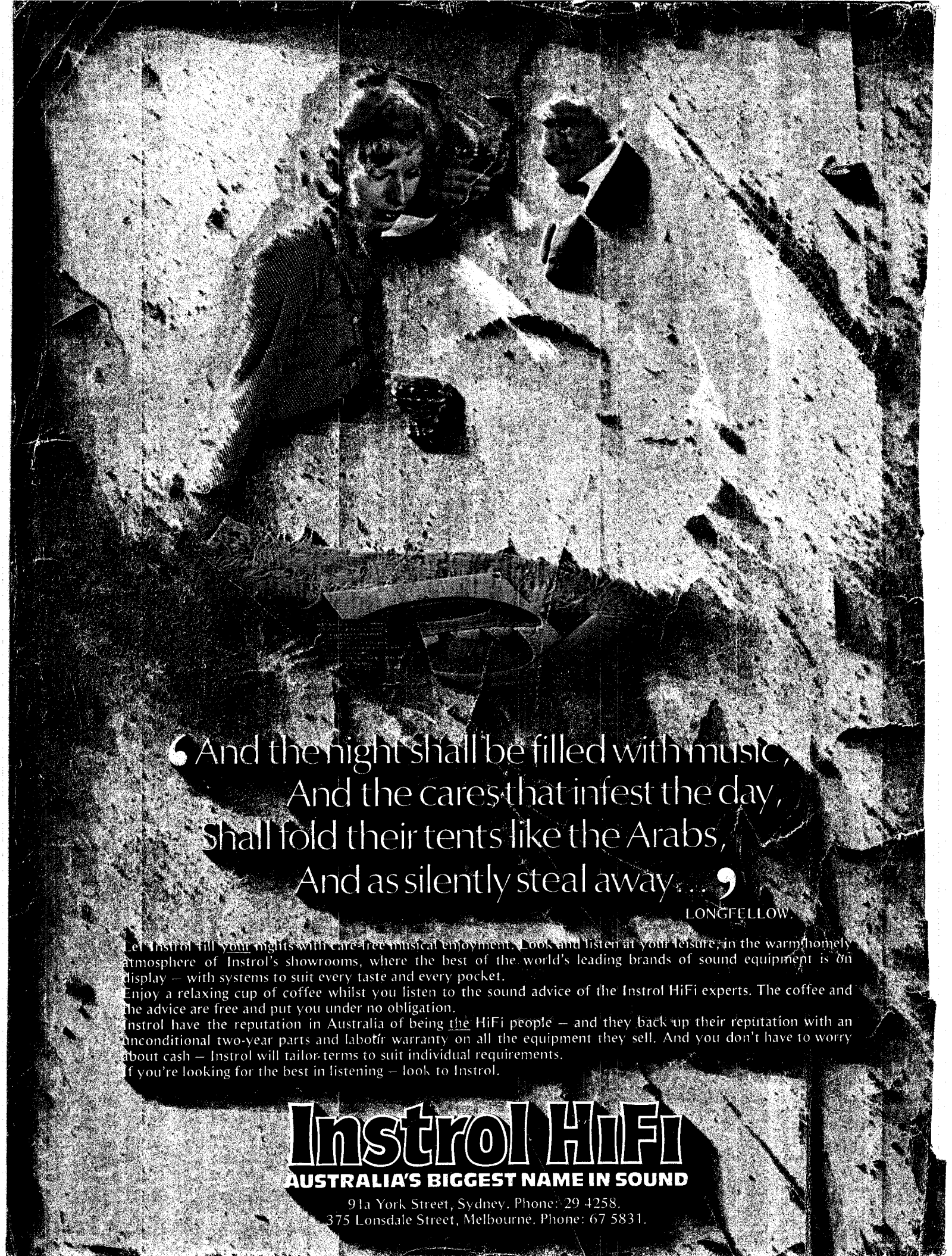

“And the night shall be filled with music,  
And the cares that infest the day,  
Shall fold their tents like the Arabs,  
And as silently steal away...”

LONGFELLOW

Let Instrol fill your nights with care-free musical enjoyment. Look and listen at your leisure, in the warm, homely atmosphere of Instrol's showrooms, where the best of the world's leading brands of sound equipment is on display – with systems to suit every taste and every pocket.

Enjoy a relaxing cup of coffee whilst you listen to the sound advice of the Instrol HiFi experts. The coffee and the advice are free and put you under no obligation.

Instrol have the reputation in Australia of being the HiFi people – and they back up their reputation with an unconditional two-year parts and labour warranty on all the equipment they sell. And you don't have to worry about cash – Instrol will tailor terms to suit individual requirements.

If you're looking for the best in listening – look to Instrol.

# Instrol HiFi

**AUSTRALIA'S BIGGEST NAME IN SOUND**

91a York Street, Sydney. Phone: 29 4258.  
375 Lonsdale Street, Melbourne. Phone: 67 5831.