

STILL ONLY \$2.60! NZ \$3.50  
DECEMBER 1985

# The AUSTRALIAN ELECTRONICS Monthly

excitement electronics



## DUAL-SPEED MODEM

to build



Listening Post software for the Commodore 64!

Microwave oven leak detector to build

Build our simple audio signal generator

Nakamichi CD player reviewed

### Intro to the 8088 micro

- Follow-up on the Listening Post project
- FORTH — the programmer's power tool
- Amateurs! — build a Morse 'memory keyer'
- A 'different' Xmas lights display
- Completing the Tilbrook preamp



# VZ-300 NOW ONLY \$99!!



## And It Gives You So Much More!

It's unbelievable! The amazing VZ-300 colour computer is at its lowest price ever!! Whether you're a computer expert or a first-timer, the VZ-300 has plenty to offer.

Now, for under \$100 there's a computer that will expand to meet your needs. With 18K RAM memory — expandable to an amazing 32K, high resolution graphics, and optional disk drive, printer and a host of extras available: the VZ-300 is unbeatable value!

Because it uses the most popular computer language in the world, 'Microsoft Basic', there's an incredible range of software available; games, business/management, education . . . there's dozens to choose from!

Look at these fantastic specifications!:

CPU. — Z80A running at 3.5MHz

Memory. — 16K Basic ROM

RAM — 18K expandable to 32K

Keyboard — 46 key full stroke with automatic repeat key.



Graphics — 32 columns x 16 lines. 128 x 64 dot (8 colour)/64 x 32 dots (9 colour) selectable colours.

With an unbelievable range of add-ons available your VZ-300 will give you years of service! When good value isn't good enough — DSE makes it even better! Cat X-7300

Dick Smith Electronics Pty Ltd

# COMPUTERSTOP



# The AUSTRALIAN ELECTRONICS Monthly

"Space-related technologies are rapidly assuming major significance around the world. They are seen by many governments to be necessary tools for the maintenance of strategic and commercial interests, and as primary sources of modern technological innovation that invigorates existing industries. They are of particular value in the management of large, sparsely populated countries such as Australia.

"Spacecraft are becoming an integral part of national and international systems for communications, meteorology, resources management, surveillance, remote sensing, navigation, search-and-rescue, and national security. Continued financial commitment by Australia to such systems is inevitable."

So says the opening paragraphs of the Executive Summary of the CSIRO's report from their 1984 Space Science and Technology Study Group. And they're prophetic words. Either Australia develops an industry group exploiting 'space-related technologies', or we join the ranks of the technological Third World.

One of the significant things this study group identified was that a space-related technology industry needs a 'kick-start' from the government in order to become established. As part of a programme to institute that kick-start, the CSIRO has setup the Office of Space Science and Applications (COSSA), headed by Dr Ken McCracken.

That action was one recommendation of eight made in the study group report. I'm glad to see it was so quickly implemented. Another I'd like to see rapidly implemented arises from Recommendation 3 which, in part seeks to encourage "... the development of a series of relatively small satellites which will establish system integration competence in Australian industry ... and in cooperation with industry, tertiary education institutions, and government departments and instrumentalities." The italics are theirs, but I'd like to emphasize that, too.

The USSR has had just such a programme operating for some years. Their ISKRA (translates as "spark") series of open-access communications satellites are designed and built by students from some 27 countries studying at the Moscow Aviation Institute. And the Russians aren't the only ones. The UOSAT series of satellites come from Surrey University in Britain.

If we are to train engineers in space-related technologies, who will enter the workforce over the next 5-10 years, then we must start with the students currently passing through our tertiary institutes. I propose that we establish a similar scheme here. There is a precedent. A group of students at Melbourne University produced the OSCAR 5 amateur radio satellite in the late '60s. Can we not re-ignite that technologically adventurous spirit once more?

**COPYRIGHT:** The contents of The Australian Electronics Monthly is fully protected by the Commonwealth Copyright Act (1968). Copyright extends to all written material, drawings, circuit diagrams, printed circuit boards, computer software and photographs. Although any form of reproduction is a breach of copyright, and we especially point out this extends to the construction of projects produced by our laboratory or our associates, we are not concerned about individuals constructing projects for their own private use, nor by bands for example, constructing one or more units for use in performances. Commercial organisations should note that no project or part project, including printed circuit boards produced by our laboratory or our associates and described in this magazine may be offered for sale, or sold, in fully or substantially assembled form, unless a licence has been specifically obtained to do so from the publishers, Kedhorn Holdings Pty Ltd, or from the copyright holders. We will take strenuous legal action against any person or firm found infringing our copyright as aforesaid.

**LIABILITY:** Whilst all efforts have been made to ensure that all constructional projects and circuits referred to in this issue will operate as indicated efficiently and correctly and that all necessary components to assemble the same will be available, no responsibility whatsoever is accepted in respect of the failure for any reason at all of the project or circuit to operate effectively or at all whether due to any fault in design or otherwise and no responsibility is accepted for the failure to obtain any components in respect of such project or circuit. In addition, no responsibility is accepted in respect of any injury or damage caused by any fault in the design of any such project or circuit aforesaid. The publisher accepts no responsibility for unsolicited manuscripts, illustrations, computer software or photographic material although all care will be exercised. Comments and test results on equipment reviewed refer to the particular item submitted for review and may not necessarily pertain to other units of the same make or model number.



Roger Harrison  
Editor



Roger Harrison VK2ZTB  
EDITOR



David Tilbrook B.Sc.  
PROJECT ENGINEER  
ADVERTISING/MARKETING  
John Whalen

PUBLISHER  
Adrian Farrow  
DRAUGHTING  
David Currie

PRODUCTION  
Marni Raprager  
Lisa Rathgen  
Philip Herrera  
Angela Wilcox

ACOUSTICAL CONSULTANTS  
Robert Fitzell Acoustics Pty Ltd, AAC

EDITORIAL ASSOCIATES  
Neil Duncan VK3AVK  
B. App. Sci., Dip. Ed., M. Ed. Studs  
Alan Ford FIAADP MBIM VK2DRR/G3UIV  
Tom Moffat VK7TM  
Jonathan Scott VK2YBN  
B. Sc./B. E. (Hons)  
Bill Thomas B.A.  
Kerry Upjohn M.A.

TYPESETTING  
Authotype Photosetters Pty Ltd  
397 Riley St. Surry Hills 211 5076  
Published by: Kedhorn Holdings Pty Ltd, an associated company of Westwick-Farrow Pty Ltd, WB Building, Cnr Fox Valley Rd & Kiole St. (PO Box 289) Wahroonga 2076 NSW.  
Ph: (02) 487 2700. Tlx: AA71460 Sydney Whats New: International AA10101 Whats New.

Subscriptions: \$31.20 Australia, NZ\$45 New Zealand; overseas rates on application.

Australian Electronics Monthly is printed in 1985 by Offset Alpine, Cnr Wetherill & Derby Sts, Silverwater, NSW, and distributed by Network Distributing Co. \*Cover price \$2.60 (maximum and recommended Australian retail price only, recommended New Zealand retail price, \$3.50). Registered by Australia Post, Publication No. NBP 7435 ISSN No. 0815-5046.

ENQUIRIES  
Advertising: John Whalen (02) 487 2700  
Editorial: Roger Harrison (02) 487 2700  
Technical: David Tilbrook (02) 487 1483 only after 4 30 pm EAST

Vic. Ad. Sales: Saddleton Cox & Assocs.  
13 Stewart St. Mount Waverley 3150.  
(03) 233 7933  
Pam Stewart or Leon Trimmings  
Melb Correspondent: Ian Boehm c/- Saddleton Cox, (03) 233 7933.  
Old Ad. Sales  
PO Box 247, Kenmore Qld 4069. (07) 202 6813.  
Sue Horne or Rosemary Lergessner  
W.A. Ad. Sales: Hugh Scott, 122 Aberdeen St. Northbridge WA 6000. (09) 328 9177  
COPYRIGHT © 1985, KEDHORN HOLDINGS P/L

# CONTENTS →



## ADVERTISERS INDEX

### COVERS

Dick Smith Electronics ..... IFC  
 Emona ..... OBC  
 Parameters ..... IBC

### INSIDE

Audiocraft ..... 65  
 All Electronic Components ..... 20  
 Captain Communications ..... 31  
 Convoy International ..... 12  
 Dick Smith Electronics ..... 19, 56  
 48-49, 108-109  
 Electronic Facilities ..... 58-59  
 Elmeasco ..... 63, 65, 75  
 Emona ..... 75  
 Energy Control ..... 113  
 Electronic World ..... 113  
 Falk ElectroSound ..... 29  
 GFS Electronic Imports ..... 63  
 Geoff Wood Electronics ..... 34  
 HiCom Unitronics ..... 47  
 Hypec ..... 95  
 Jaycar ..... 40-41, 52-53  
 Jemal ..... 70  
 JRT Software ..... 75  
 Microbee Systems ..... 6-7  
 Philips ..... 11  
 Promark ..... 50, 65  
 Old Audio ..... 65  
 Standard Communications ..... 20  
 Scan Audio ..... 20  
 Scope ..... 8  
 Wireless Institute  
 of Australia ..... 63



### COVER

This month's feature project is our direct-connect modem. The computer was supplied by Microbee Systems, and the telephone courtesy of Phonies, Mid City Centre, Sydney. Photography by Mark Rowland, design by Marni Raprager.

## PROJECTS TO BUILD

### DUAL-SPEED MODEM



#### AEM4600 Dual-Speed Modem

..... 80  
 Our feature project is simple to build, simple to operate and low in cost.

#### AEM6010 Ultra-Fidelity Preamp — Part 3

..... 51  
 And this is where the story really finishes! Final wiring and assembly details plus power-up testing completes the preamp.

#### AEM5502 Microwave Oven Leak Detector

..... 44  
 Concerned about leakage from your microwave oven? This inexpensive project is simple to build, but effective. With it you can put your mind to rest — or not.

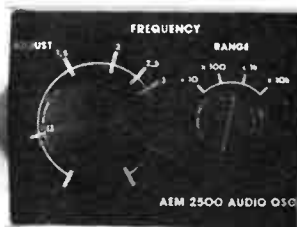

#### AEM2500 Simple Sine/Square Audio Signal Generator

..... 36  
 Here's one of the fundamental instruments required in every electronics lab, or hobbyist's workshop.

## CIRCUITS & TECHNICAL



#### AEM Data Sheet

..... 98  
 The '7910 FSK modem IC features this month — 'heart' of our Dual-Speed Modem feature project.

#### Benchbook

..... 110  
 Christmas tree lights with a difference! Here's an ingenious circuit to jazz up that set of boring old on/off/on/off Christmas tree lights you've been using for years.

#### 'FOR STARTERS'

— our popular series returns next month. You really should take a break over Christmas, you know!

## PRACTICAL COMPUTING

Listening Post Software ..... 69  
 Disk or tape software for the Microbee and Commodore 64.

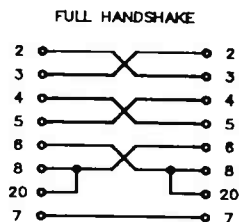

#### The Ins & Outs of RS232 — Part 2

..... 87  
 Here we get to the hookups, troubleshooting and your check list. In a mess with the old RS? Here's how to sort it out.

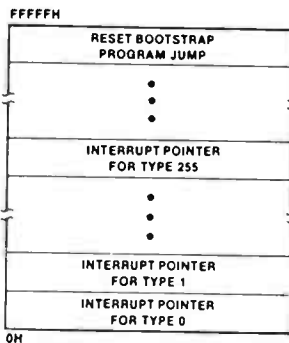

#### SoftTalk — the good ol' 88

..... 90  
 Bill Thomas gets into the Intel 8088 microprocessor — heart of the IBM PC, its many 'compatibles' and 'clones'.

#### Set Forth

..... 77  
 Here's a plain language introduction to what is described as "the programmer's power tool".

#### BeeBuzz

— Tom Moffat, after a marathon with the Listening Post this month, returns in January.

## COMMUNICATIONS SCENE

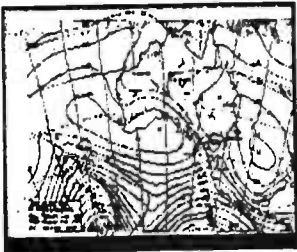

**Follow-Up to the AEM3500 Listening Post** ..... 66

*Here's what you've been waiting for! — Commodore 64 software and interface details, plus hints and tips on receivers, etc.*

**A Variable Speed CW Memory** ..... 60

*Here's a great little weekend project that finds that elusive DX for you. VK3AMK gives away his 'secret'.*



**CONTEST Win a Yaesu Scanner from Dick Smith!** ..... 64

*Here's your chance to own a top-line scanner, courtesy of Dick Smith Electronics.*

**Radio Communicators Guide to the Ionosphere** — Part 4 has been held over due to lack of space.

## FEATURE



## CONSUMER ELECTRONICS

**Review of Nakamichi's OMS-7 Compact Disc Player** ..... 23

*Now, was the test disc testing the player or the player testing the test disc? Employing four-times oversampling, the OMS-7 delivers stunning results. But we have a few questions to resolve.*

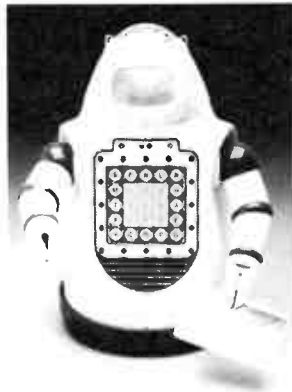

**CONTEST Win A Robot!** ..... 16

*Enter this great contest and you could win a great little robot that walks and talks!*

**Getting the Best TV Reception** ..... 17

*Cables, their haunts and habits. There's more to them than meets the eye.*

**Video Today and Tomorrow — the View From Japan** ..... 13

*It is not easy to get the Japanese industrialists to speak out frankly about the Japanese view of directions, past, present and future, in the burgeoning video industry.*

## NEWS & GENERAL

**AEM PRODUCT REVIEW — Meet Elami Jr, Your Robot Friend** ..... 33

*Here's a remarkably sophisticated product with a special appeal.*

**News Review** ..... 9

*History demolished!*

**Consumer Electronics** ..... 21

*B&W launch new monitors. Toolkit gives more scope.*

**Retail Roundup** ..... 35

*Where to get kits, boards and components for this month's projects.*

**Project Buyers Guide** ..... 73

*Avtek M ItriModem II features expansion bus.*

**Spectrum** ..... 57

*Fantastic February Field Day.*

**New Product News** ..... 97

*Light reflections on the time domain.*

**Admarket** ..... 113

*Readers' free adverts.*

**Subscriptions** ..... 98

**Printed Circuit Boards** ..... 50

**Crossword** ..... 96

**Last Month's X-word Answers** ..... 20

**Letters** ..... 112

**The Last Laugh** ..... 114

**OFFERS Kikusui CROs** ..... 30

**Pocket DMM For \$49.50** ..... 22

## NEXT MONTH!

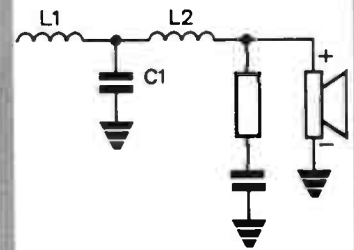

### TILBROOK'S 3-WAY LOUDSPEAKERS

Here comes the second in our series of superlative 'digital era' projects. Again employing Vifa drivers, this bass reflex 3-way design has impeccable performance unmatched at the price you can build it.

### HONESTY, FALLIBILITY AND POLICE RADAR

This article examines how police radars work, what they can and can't tell in any given situation. In layman's terms, it describes how the radars are used and what can go wrong. In addition it tells what to do if you feel you've been unfairly caught. The author discusses how the situation might be improved and what research is being done towards this.

### LCD SCREEN FOR YOUR MICROBEE

This project shows you how to convert your 16K or 32K 'Bee into a 'porta-Bee' using a locally-available liquid crystal display and a rechargeable 12 V battery.

### POWER AMPS, MOSFETS AND RATINGS

Prompted by a reader's letter, David Tilbrook discusses just how much output you can squeeze from MOSFET power amp circuits and the conditions under which they fail.

While these articles are currently being prepared for publication, unforeseen circumstances may affect the final contents of the issue.



# The Great business offer from Microbee



## THE 128K SMALL BUSINESS COMPUTER

Microbee Small Business Computers are already providing invaluable help to thousands of Businesses around Australia, indeed around the World. It would seem that there are few professions or areas of commercial endeavour that cannot be streamlined or made to be more "accountable" with a Microbee Computer.

### Butchers, Bakers, etc.

Users range from publishers to pathologists, even car yards are finding the Microbee Small Business System the cost effective technology tool that keeps their records straight, their correspondence in order, and keeps them in touch with the fast moving world of Data Communications and Videotext Services.

## SPECIAL OFFER

### 'Living Letters Package'

The Complete Word Processor with WordStar Pro Pack and DP100 Printer

**\$1995** Inc. Sales Tax



## The Software You Need

With the Microbee's now famous Bundled Software and CP/M operating system most routine computer functions are catered for without spending another cent, but it is highly likely that it is in the area of specialist applications software that Microbee scores most points. With so many third party software supplies able to provide specific solutions at realistic costs that don't in themselves create problems (check the prices of software to run on so called Compatibles).

### User Friendly Interface.

Every Microbee Small Business System has its own user friendly 'B-Shell' which allows the easy choice of software by simple one finger selection of self explanatory ICONS. A comprehensive Help system is supplied and 'housekeeping' functions are simplified.

### Australian Guaranteed

Built to exacting control standards and World class quality the Microbee System is particularly robust: remember the Microbee was first developed for use in schools, and in fact the same machine is in extensive use in schools, both in Australia and overseas.

## The Complete Business Package

The Microbee Small Business System comprises:

- Microbee 128K Computer
- Dual 400K 5.25" Disk Drives
- High Resolution Monitor
- DP100 Dot Matrix Printer
- Cables and full set of manuals plus

### Bundled Software

worth hundreds of dollars including— WordStar/Mailmerge 3.3, Microsoft Basic, Microsoft Multiplan, MicroWorld Basic, Telcom Communications Package, Full range of support utilities, Comprehensive Training Guides and Tutorials, A complete library of manuals so you can easily and quickly gain the maximum benefit from your system is also included.

### The Price

For the complete Small Business System only \$2395 including Sales Tax.

As many of the Microbee Systems out there are used extensively for Word Processing with little need for Microsoft Multiplan, the new 'Living Letters Package' has no Multiplan or Microsoft BASIC. But it does have The Complete WordStar Package to bring life to your writing and considerable savings to your pocket.

## EXCITING NEW OPTIONS

As part of Microbee's Product Innovation Program, new releases which will shortly be announced include:

The DP100 NLQ or Near Letter Quality Printer.

The MB 7030 High Resolution (0.38 pitch) RGB Colour Monitor.

The MB 3010 Green Screen Monitor.

The ESE Economy RGB Colour Monitor.



# microbee

## computer

Designed and manufactured  
in Australia by  
Microbee Systems Limited

PHONE  
ORDERS ACCEPTED 

### Microbee Technology Centres

#### New South Wales

1 Pattison Avenue,  
Waitara, N.S.W. 2077  
Phone (02) 487 2711

2/956 Hunter Street,  
Newcastle West, N.S.W. 2302  
Phone (049) 61 1090

Koala Crescent,  
West Gosford, N.S.W. 2250  
Phone (043) 24 2711

#### Microbee Education Technology Centre

Unit 2, Eden Park Estate,  
31 Waterloo Road,  
North Ryde, N.S.W. 2113  
Phone (02) 888 9866

#### Victoria

50-52 Whitehorse Road,  
Deepdene, Vic. 3103  
Phone (03) 817 1371

#### South Australia

117-119 Gouger Street,  
Adelaide, S.A. 5000  
Phone (08) 212 3299

#### Western Australia

141 Stirling Highway,  
Nedlands, W.A. 6009  
Phone (09) 386 8289

#### Queensland

455 Logan Road,  
Stones Corner, Qld. 4120  
Phone (07) 394 3688

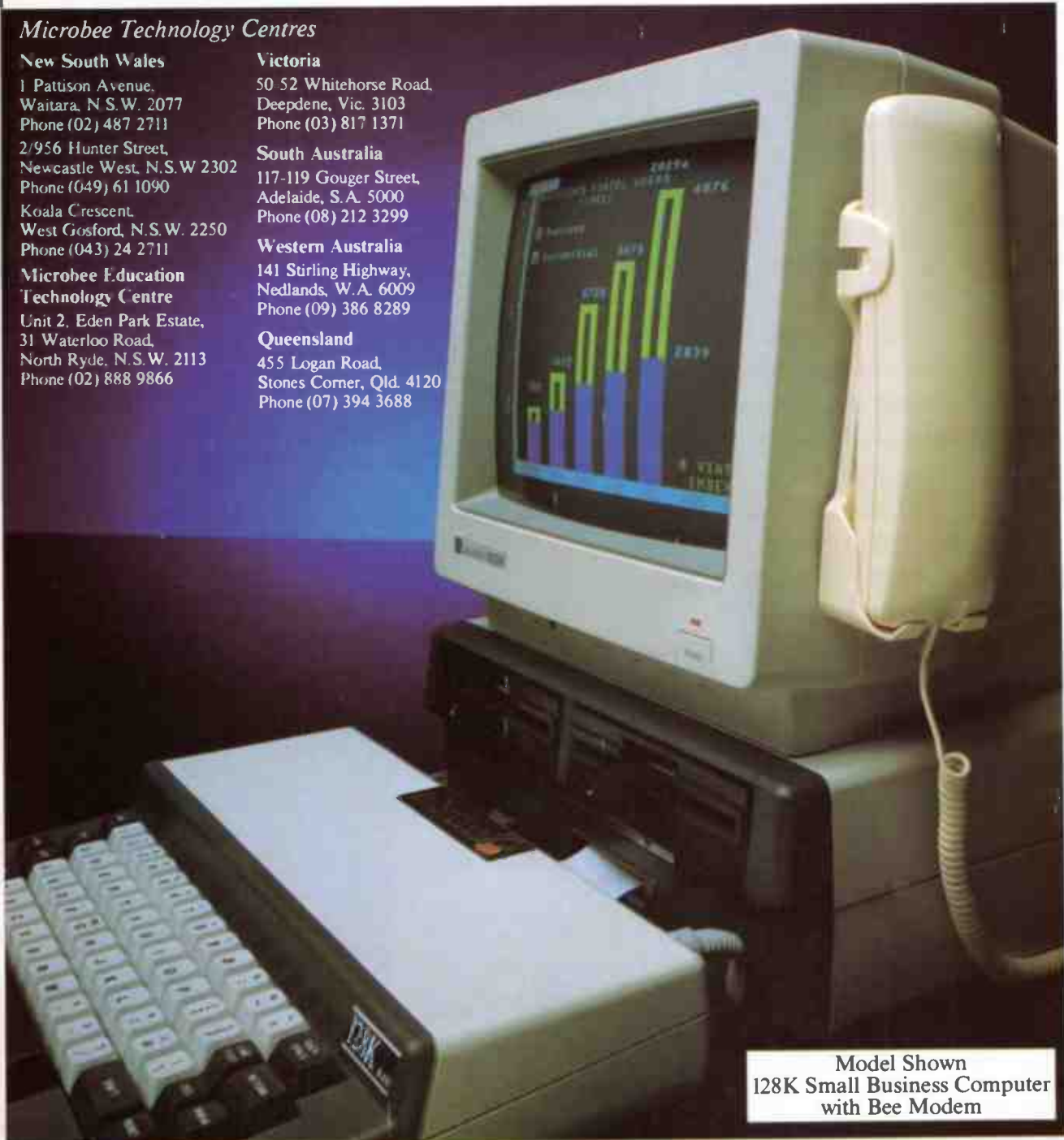

Model Shown  
128K Small Business Computer  
with Bee Modem

ART PROM 2868



# The thrilling new C-Series from KEF

Now the famed bestselling British speakers attain new standards of exceptional performance.

KEF'S C-Series speakers have been bestsellers for more than two decades, winning the loyalty and delight of audiophiles the world over. Now the elaborate research tools developed by this trail-blazing British manufacturer have produced numerous performances and aesthetic improvements in KEF'S remarkable range of six new C-Series models for 1985.

New cabinet design, new drive units, and radical new crossover networks for lighter amplifier load are just some of the features. And the innovative use of polypropylene as the revolutionary new cone material has brought the major benefits of reduced colouration and substantially improved efficiency. From the tiny but amazing C10 bookshelf speaker right through to the elegantly tall C80 with its exceptionally high sensitivity, these latest speakers by KEF are masterpieces for the money.

**KEF**

Australian Distributors  
**FALK ELECTRO SOUND GROUP**  
BOX 234 ROCKDALE 2216. PHONE (02) 597 1111

SEND IN  
FOR A FREE  
COLOUR BROCHURE  
to:

FALK ELECTRO SOUND GROUP BOX 234 ROCKDALE 2216.

Name: \_\_\_\_\_

Address: \_\_\_\_\_

Postcode: \_\_\_\_\_





# Historic electronics store demolished!

— DSE Gore Hill goes under the hammer

Mike Wilson, Managing Director of Dick Smith Electronics, struck the first blow for the demolition of the firm's historic Gore Hill store, which opened for business 13 years ago in December 1972, amid heckles from a 'rent-a-crowd' of protesters led by a slight, energetic, dark-haired man in horn-rimmed glasses whom nobody could identify.

Carrying banners declaiming "Don't desecrate Dick's" and "Free Norm" (who? — Ed.), and chanting "shame, shame, you're to blame", the protesters were herded away from the barriers by Police (I thought they were a pop band — Ed.) before the dignitaries (some bloke called Chuck — but who was the spunky lady with him?) arrived.

So much for the fun, here's the real story.

The Gore Hill store is being demolished to make way for a multi-storey development on the site. During its construction, DSE will have a retail store located virtually next door so that those customers who've found the location convenient can still shop there.

Upon completion of the development, a new retail store will open on the ground floor of the new building, so DSE will 'return' to the original site.

The Gore Hill site was Dick Smith Electronics' first 'proper' shop, having previously traded from the front bedroom of a small house in nearby Aitchison Street, Crows Nest.

The original Gore Hill store was on the ground floor of a two-storey building, with offices upstairs. It was from this location that Dick Smith built the chain of stores that spans Australia and New Zealand. Later, the whole building became offices and warehouse and a 'self-serve' retail store was opened next door.

The now-famous annual DSE catalogues were 'launched' from the Gore Hill headquarters, the first appearing in 1973. These catalogues became the cornerstone of what was then a unique mail order service in electronics, and have become an 'institution'.

Rapid company expansion

brought on 'bursting-at-the-seams' disease and headquarters moved to Carlotta Street, Artarmon four years later, in 1977.

Despite swallowing up surrounding building space there, 'bursting-at-the-seams' broke out again just two years later in 1979, necessitating a 'clean start'. A new headquarters building was designed from the ground up and installed, in 1979, on a site at North Ryde industrial park, where the company headquarters is still located (though somewhat enlarged). The largest Australian flag in existence flies from a flagpole out the front, on the corner of Lane Cove and Waterloo Roads, North Ryde.

## Anniversaries

Just to prompt a few memories, and to record appropriate things in this column, we'd like to remind you of a few anniversaries.

1985 marks the 75th anniversary of the Wireless Institute of Australia (WIA), the oldest radio society in the world! The various state divisions of the WIA held anniversary celebrations, the NSW Division (the 'founding' state) undertaking a number of activities, including a celebratory dinner and the assembly of a 'time capsule' with contributions from local amateurs. Australia Post joined in with the issue of a special stamp and envelope and the Department of Communications permitted the use of special callsign prefixes and special WIA callsigns. The Federal body of the WIA held a grand dinner in Melbourne, attended by a prestigious group of overseas visitors from Britain, Japan, Indonesia, Hong Kong,



New Zealand, Pakistan, Korea, Finland, the USA, The Peoples Republic of China, the International Telecommunications Union, the International Amateur Radio Union and our own Minister for Communications.

This year also celebrates the 50th anniversary of the birth of radio direction and ranging — radar. In 1935, experiments in Britain proved the feasibility of detecting aircraft and ships at a distance by the reflection of radio waves. A prominent Australian, Sir Robert Watson-Watt, was a principal in the development of radar during WW II.

The development of the magnetron, now widely used in domestic microwave ovens, was one device fundamental to the technological progress of radar.

## Bell me blues

Are we the only people having telephone problems? Our impression is that the network is gradually becoming overloaded, perhaps not surprising with the proliferation of modem users, bulletin boards, and other electronic information services like Telecom's Viatel, or E-Post etc. It seems

unlikely that Telecom expected or provided for the colossal increase in the use of the network.

In busy periods (mid-morning and late afternoon) it is quite normal to get the engaged tone although the called party later confirms categorically that his phone was not in use at the time.

Recently, the whole of Sydney's telephone service appeared to become unworkable. Apparently, the reason was a series of radio announcements that tickets for the latest Dire Straits concert were available at booking agencies. Telecom say that the flood of calls resulting from these announcements severely overtaxed the metropolitan network.

Whilst we can sympathise with Telecom planners at their failure to predict telephonic hysteria, it does seem possible that the margins for general growth built into network planning were thin to say the least. It really isn't going to be very impressive reading Telecom's self-congratulatory pieces about moving into the electronic age with Viatel, E-Post and the like if the ordinary telephone fails to work.

## JAYCAR — APOLOGY

### OOPS!

In the November issue of AEM, page 31, we advertised the Avtek MultiModems at the incorrect price. The correct price for these modems is as follows:

Standard MultiModem, cat. no. XC4820 — \$365

Autoanswer modem cat. no. XC4822 — \$399

We apologise for this oversight.



## That'll learn 'em

In response to the growing interactive commercial video disc market, Pioneer Australia has enlarged its operations with an expanded Video LaserDisc Division, additional customer service, and plans to introduce new product lines over the months ahead.

Pioneer's recently appointed Commercial Video LaserDisc

Manager, Doug Bell, describes the potential for the high quality audio visual medium in Australia as "enormous", and says "We have barely uncovered the tip of the iceberg. The true potential of the LaserDisc as a totally programmable and completely interactive learning or information bank is limited only by the imagination".

The company's expansion coincides with the introduction

of two new PAL products, giving Pioneer the capability to provide hardware and discs to suit either the PAL or NTSC format.

The new PAL player is the LD-V4000 which, like the NTSC model 4000 and 6000, is a third generation player with a number of unique benefits over earlier models. This series uses a solid state laser which is less than one fifth of the size of the gas laser used in earlier products, allowing the players to be smaller and lighter. All Pioneer's current range are 420 mm wide, stackable and front loading, making them much more versatile and easy to use.

A PAL microcomputer is the other new product. It is the MSX-standard PX-7 and is custom built for controlling and programming video disc players. Some of its special features are the ability to overlay computer images over disc images, and sound synthesising in stereo. Memory capacity is 48K, and a 16K EPROM cartridge or 3.5" floppy disc can be used as a storage medium.

Future products suitable for

commercial applications under development by Pioneer, include an automatic videodisc changer for extended presentations, and a portable video laser-disc player which is carried about like a briefcase and can broadcast directly to a television receiver.

For further information contact **Doug Bell, Pioneer Laser-Disc Division, on (03) 580 9911.**

## Australian solar lighting for Fiji

AmteX Electronics, a division of TLE Electrical Pty Ltd, inform us that they have scored an export first with the winning of an order for 10 solar systems to Fiji.

The 10 systems, each comprising a one metre by one-half metre wide Australian made solar panel, fluorescent lighting, cable and deep cycle batteries will be used to provide internal lighting in several Fijian homes.

AmteX is a supplier of solar systems to Australian government and industry, and is confident of developing new markets in the Pacific for the system.

### PARAMETERS MOVES IN SYDNEY

Parameters, Sydney, moved to larger modern premises at North Ryde in November.

Managing Director Bruce McCarthy said that the move will allow continued expansion of the Company's activities in the fields of industrial process control and industrial weighing as well as its test and measurement activities.

The new building will incorporate a lecture theatre for customer instruction and a large demonstration area for the Company's range of computer-based instrumentation.

The new address is: **25-27 Paul Street North, PO Box 261, North Ryde NSW 2113 (02) 888 8777.**

## Bi-annual trade fair for Munich

From October 1986, Munich's unique interlinking electronics fair concept will include a new international trade fair, SYSTEC 86, International Trade Fair and Congress for Computer Integration in Logistics, Development, Design, Production and Quality Assurance, will have its premiere on October 17th to 30th 1986, at the Munich Trade Fair Centre.

SYSTEC is being organised by the Munich Trade Fair Corporation (MMG) in co-operation with the SYSTEC Advisory Board, and will be held every two years.

The Advisory Board includes representatives of Digital Equipment, IBM, Matra Datavision, Nixdorf, PCS, Softlab and Sie-

mens. The Chairman of the SYSTEC Advisory Board is Eberhard Farber of PCS Peripherie Computer Systems.

The target groups the MMG has in mind for SYSTEC include development, design, production and system engineers in small, medium-sized and large companies.

The exhibition range will comprise information systems, logistics, CAD, CAM, CAE, CAT, etc. software, networking, testing systems, peripherals and variable automation systems.

The 1986 Congress, which is being sponsored by the Association of German Engineers (VDI), will be dealing with two general subjects, "Computer Application in Planning and Development and its System Aspects" and "Flexible Automation".



### TEN-GRAND OF TASCAM FROM TEAC FOR TECH

A donation of TASCAM audio equipment valued at around \$10 000 was recently made by Teac Australia Pty Ltd, to the School of Applied Electronics and Telecommunications at the Royal Melbourne Institute of Technology.

Tascam national product manager, Travers Falkiner (right), officially handed over the equipment to the Head of School at RMIT, Mr Kevin Alsop (left).

Mr. Alsop said the additional Tascam equipment would provide valuable hands-on experience for technicians and apprentices in broadcasting and audio courses at the School of Applied Electronics and Telecommunications.



# If it wasn't Philips you might think it was a trick

Philips' new high-performance dual-trace PM 3206 oscilloscope won't make your money do a disappearing act.

But its remarkable specification might make you think it had been pulled from a magician's hat.

In fact, the only trick Philips has up its sleeve is the ability to conjure up modern design and production techniques to keep costs down without compromising quality.

The formula of features for the 15MHz PM 3206 includes:

- Easy-to-use, reliable triggering, even on complex waveforms
- Wide sensitivity range 5mV-20V.
- Bright CRT with excellent display
- Robust construction tested to withstand the harshest environments.



## The new PM 3206 - it's magic!

Philips Scientific & Industrial  
 SYDNEY: Box 119  
 North Ryde 2113  
 Tel. (02) 888 8222  
 (Toll free (008) 22 6661)  
 MELBOURNE: Locked bag No. 5  
 Oakleigh South 3167  
 Tel. (03) 542 3600  
 (Toll free (008) 33 5295)

OS14



Test & Measuring Instruments

# PHILIPS

## A NEW MONSTER CABLE

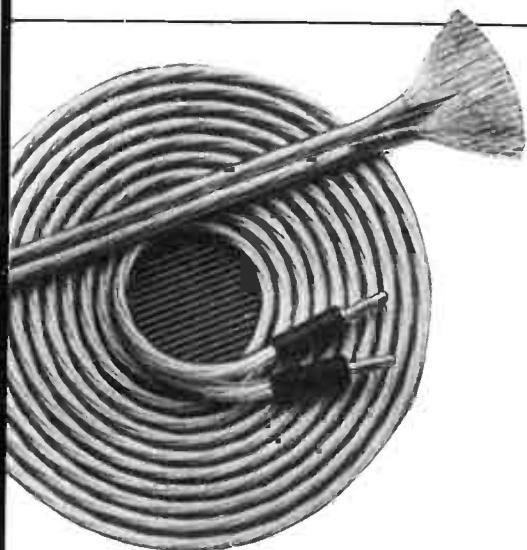

### So what could you possibly do to a speaker cable to make it sound better?

As you know Monster cable has been the reference standard for high performance speaker cables since it first appeared on the market. Since then we here at the Monster have furthered our research into the electro-magnetic behaviour of audio signals as they travel through wire. The results have been significant. Cable construction is the most important factor in speaker cable performance. Even small changes affect the sound, and not always for the better. But our knowledge of how to control complex current fields has allowed us to make sonic improvements to the original Monster at virtually no increase in cost. Brain power is a lot cheaper than copper! So, we've reconstructed the winding and stranding configuration of Monster Cable to conform to our latest research and the result is the new Monster Cable. The most obvious sonic differences are tighter bass, better imaging, (the ability to locate instruments across a speaker soundstage), and clearer, more open sound in the midrange. But don't take our word for it, take a listen for yourself.

Happy listening.

## FULFILLING THE PROMISE OF DIGITAL. INTERLINK CD.



### Super high resolution compact disc interconnecting cable.

#### Fulfilling the promise of digital.

Conventional cables run out of breath when trying to cope with today's digital sound. The incredible sonic capabilities of the compact disc player pushes all your components to their limit . . . including your connecting cables. The incredible resolution, awesome dynamic range, and powerful bottom end available from your compact disc player, is lost when you use ordinary interconnect cables.

#### Why a special cable for Compact Disc?

In addition to the high sonic performance that effortlessly and accurately transfers everything you player dishes out, Interlink CD is specially designed to compensate for the transient and phase distortions of the digital process as well as minimizing some of the "harshness" found in some CD program material. Using our revolutionary "Bandwidth Balanced™" technology we can control high frequency phase shift to produce a more enjoyable, thoroughly musical sound. Bass is tighter, transients are quicker, cleaner, and less smeared. The sound is more coherent with richer harmonic overtones and a 3 dimensional depth and "liveness" to the music. Interlink CD fulfills the promise of digital with music reproduction that brings you closer to the original performance.

**CONVOY  
INTERNATIONAL PTY. LTD.**  
400 Botany Road, Alexandria, NSW, 2015.  
Telephone 698 7300. Telex AA23111.



# Video today and tomorrow — the view from Japan

Malcolm Goldfinch

It is not easy to get people in Japan concerned with the video industry to speak out frankly about the Japanese view of mistakes, problems and directions past, present, and future, of this burgeoning industry.

Malcolm Goldfinch was able to do this on a recent visit to Japan. The views expressed are in response to questions he put to a number of well-informed Japanese executives, in both the consumer electronics and camera industries, which are now becoming integrated, and cross-manufacturing their specialties for each other.

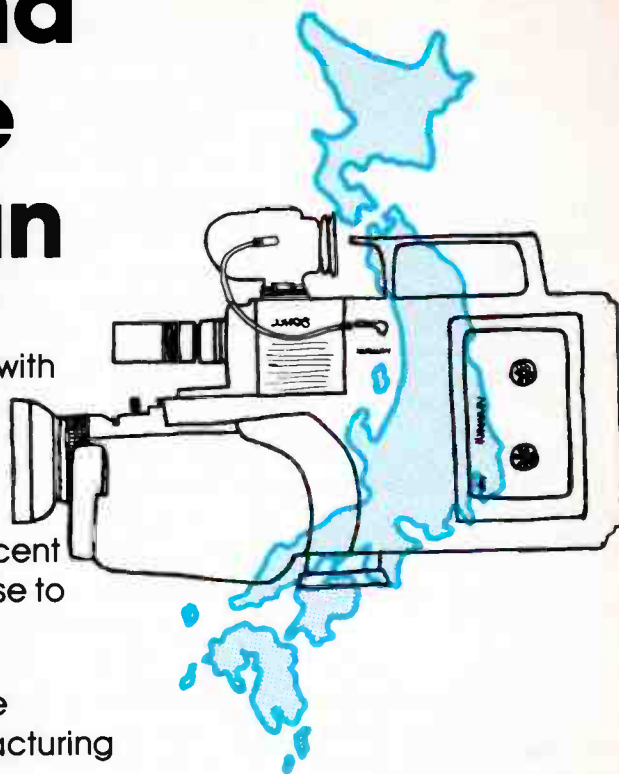

**Q. Where do you see the video industry at this moment?**

A. Without exaggeration, it is in the throws of a revolution. Now VHS has won the half inch format battle, the next conflict will be within the 8 mm format; but the greatest impact will come later from the move to digital technology. It has already started in the audio section of the V8 format.

**Q. Why did VHS win the half inch video format war when Sony started with a big lead for Beta?**

A. Video formats are like languages, and each area of use can only support one tongue. Professional video recognised this problem at an early stage, as once tape went into cassette it travelled easily and had to playback instantly with proper sync and colour balance over a network.

Home video was less fortunate, with so many formats around the world, and was further complicated by TV standards: NTSC, PAL with variations, SECAMs. Universality of VCR video standards was possible even if the TV standards were not.

The major market for home video was in the NTSC areas of Japan and the Americas, which was why Philips V-2000 format never really got going; having a home market split by PAL and SECAM TV.

This left only two contenders for a world standard, the original US leader, Sony Beta, and JVC-Matsushita (National) VHS. We give credit here to JVC for being front-runner in organising a powerful group of VHS manufacturers who benefited from the superior technology developed, largely by JVC.

It is significant that Sanyo, NEC and Toshiba, who were original Beta suppliers, have switched to making VHS to retain market share. As a result, Japan has the responsibility of undisputed leadership in the world of video.

**Q. Why didn't Sony make a VHS model?**

A. Pride is a very very important factor in the quality of Japanese goods; sometimes it is not so good for commercial decisions.

**Q. Has sales of portable video, for making home movies,**

**kept pace with VCR used for timeshift and library video?**

A. No, but this is because growth of home VCR use has been beyond anyone's imagination five years ago. Keeping up with demand for VCR has been a problem and portable video requires a lot of sales education effort with slow results. But, this is all changing now.

In consumer electronics, video is expected to remain the front runner, although it is approaching saturation levels for home VCR. Sales in units have been: 1983 — 3.7 million, 1984 — 4.3 m, 1985 estimated 4 m approximately.

The market has stopped growing for the first time, since last September, but the camcorder boom, with added impetus from the V8 format, is expected to make up losses.

The time for light, portable video, camcorders, has arrived and is expected to be a totally new market; perhaps not quite as big as the timeshift VCR proved to be.

**Q. How do you expect this to affect chemical photography?**

A. The photographic and camera industry will suffer; for home users it will largely become part of their video. Sony and Canon already have good colour print hard copiers; as well as other film companies. Film processors will make hard copies from video cassette (VC) if you do not own a copier. The consumer will accept a drop in definition because the choice of shot copied will always be the best pose.

**Q. Will the new V8 format dominate the camcorder market?**

A. A good question. Originally, V8 was promoted for this purpose, but no-one quite knows. Betamovie first established the one-piece camcorder but it required a Beta VCR as well to see the picture.

For VCR owners in any format, the camcorder will always be an accessory. But it will allow very simple edits to an "album tape" in the home VCR. This opens a whole new field of home entertainment.

**Q. Is there likely to be any future format battles now there is only one 8 mm format?**

A. I would like to say — no conflict. Sony is currently out in front with a whole range of V8 products within the for- ▶

mat and filling in many of the technical grey areas left. As Sony is technically very competent it is good that someone has taken a lead. Other manufacturers would be advised to see their offerings are fully compatible.

There is no secret about the disputes amongst the V8 consortium members that delayed the final format agreement. Not all these differences have been resolved they centre on the fact that the original object of V8 was to produce a camcorder of better than 2 kg and 1 kg lighter than the smallest VHS/Beta camcorder, but only Sony's just-released CCD-M8 has achieved this objective.

But, before the 8 mm agreement was reached, JVC had, by brilliant new technology, reduced their half inch head-scan drum to a size similar to the proposed V8 standard and marketed a 2 kg camcorder, including EVF and TV playback. It used a compact half inch VHS compatible VC that fitted all VHS machines, with a small adaptor. This was only slightly thicker than the V8 VC.

It also became common knowledge that Matsushita was about to use the same technology to release a full VHS camcorder with playback, yet only about half a kg more in weight. It was then the question of a new video format being necessary at all was widely canvassed by JVC.

A factor saving 8 mm was Kodak's involvement. And Pioneer, a long time video disc promoter, decided to join the magnetic tape, video world by way of V8, offering a badge-engineered camcorder, at the same time promoting a dual roll for the V8 format as a DAT (digital audio tape recorder) with 6 PCM stereo tracks, each lasting 4 hrs on long play, sampling 8 bits at 31.5 kHz for a S/N of 80+ dB and response from 20 Hz — 15 kHz.

Although the DAT is not fully ratified by the V8 conference, Pioneer and Sony have such a dual purpose VCR to V8 format, incorporating both TV and FM tuner, timing, on demonstration, and for imminent sale, JVC, Matsushita and Hitachi are reported to be on the way; yet they are not showing signs of releasing a camcorder in V8.

The whole scene is very confusing. Audio, video and digital are in a soup pot! With the digital audio capability, and perhaps a later digital video potential, there is a valid reason for a V8 format VC, at least.

#### **Q. Is light weight and compactness the most important objective in camcorders?**

A. No. I think many consumers will make compromises to get all the features they want in one package. Playback direct from the camcorder to any TV, and EVF (TV viewfinder), and even the use of a VHS standard VC, may prove to be as important as reduction in size and weight. Consumers will make this decision when they learn the options; also, deciding the importance of the extra cost and bulk for auto-focus.

Considering the Matsushita M1 full-VHS camcorder is only 2.5 kg, and the Sony CCD-V8, 2 kg, both without batteries, the extra half kilogram in VHS can look very attractive for the added advantage of being able to go to any library and hire a top film on VHS and play it on the hotel TV, just by plugging into the aerial inlet.

Also, who has not wanted to copy a VC? Akihabara dealers in Tokyo report good sales of full format VHS camcorders. The VHS group say they are winners, why confuse your customer with a new product. Toyota buyers mostly buy Toyotas, they say, don't they?

Hitachi, who announced a prototype V8 camcorder some time ago, with their VHS CCD camcorder selling well, now appears to have a similar outlook.

#### **Q. Well, where does the VHS group stand in relation to V8?**

A. Firstly JVC, the leaders, find their go-it-alone with the compact VHS camcorder GRC-1 VideoMovie is gaining great consumer acceptance. Bad experiences with failed formats in records, hi-fi and tape recorders have made consumers wary.

They prefer to keep to one well-established format and VHS has, what, say at a guess, 10 million VCR worldwide? A compact and compatible little VC in VHS will have a lot of appeal if they decide to add a camcorder.

JVC are reported doubling their current 40 000 per annum VideoMovie production rate to meet demand, and other VHS suppliers are reported considering production of a VHS-C camcorder.

Matsushita, on the other hand, is the most advanced of all in V8, having been the supplier of Kodak's V8 two-piece, portable video with tuner/timer dock, for over a year. So they are well into V8. This allows them, along with Hitachi who has also released a full function VHS camcorder, to concentrate on selling fully compatible camcorders to the big ownership of home VHS, VCR, most of whom are satisfied customers and like the idea of a portable which allows compatibility. The VC of a baseball match can be taken straight home and played on the home VCR, no connections required. This explains Betamovie's popularity.

#### **Q. Where does Beta and Betamovie go from here?**

A. Perhaps Sony would like that answer too. Recent attempts to upgrade Beta have resulted in compatibility problems which always upset and frighten consumers, many of whom are fanatical Beta supporters. First, there was NTSC Beta Hi-Fi which would not work under PAL TV standards, and the VHS system had to be adopted. Now there is a change in Beta video bandwidth. What they call high-band Beta has shown inherent problems; some call it "quality innovation".

For Beta Hi-Fi, the video carrier signal had to be shifted 400 kHz to make way for an adequate audio range, but FM audio with four carriers must be shifted by 600 kHz for side-band room, some 800 kHz in all. It was taken from FM audio, and although carriers were raised, the bandwidth was not and compatibility was impossible.

So the new Beta format VCs, which are increasing in numbers at video libraries, when used on existing Beta VCR, give a noisy or dim replay. Sony has not claimed "compatibility" between the Beta formats, but "co-existence". But this only applies to owners of Sony high-band Beta VCRs. Sony is a great company, highly respected for its technical competence, but attempts to win a new market share by turning to past supporters is not a way to regain their confidence.

#### **Q. Where does the camera industry stand in video now and in the future?**

A. The time for photography to join with the consumer electronics revolution has already arrived. From the beginning of portable video, camera people have been involved and in so doing learnt about electronic controls for aperture, measuring light and focus. The lens technology has all come from the camera industry and now the flow is back to the camera manufacturer as they design and manufacture their own video systems. Canon is the undisputed leader in video as they have always been heavily involved in electronics, calculators, copying machines and now computers too. But, for the last decade, the camera has been moving from being a calculator with a lens and film, to a computer with lens and floppy disc.

The microchip with a window, we know as a CCD (charge coupled device), is now used in many camcorders instead of picture tubes, and is about to replace the film in still cameras.

There has been a great resentment to the inroads of electronics into the camera industry, mainly in Europe and to a degree in America. In Japan, camera and film manufacturers have recognised that chemical imaging will be replaced by electronics, so they helped with the video success of Japan electronics companies, while envying them. Now, with the camcorder, they join them on equal terms.

Sony's Mavica was premature, but the concept is sound.



Matsushita and Canon as well, and the major camera companies, are well down the road to electronic photography.

**Q. What about the film companies, where do they go in electronic photography?**

A. Film companies are already trying to catch up with lost opportunities in the magnetic tape market. They were geared to be the logical manufacturers of recording tape, but, except for Agfa and Fuji, they left tape to chemical companies. Kodak now recognises this mistake quite openly and is selling VCs made by TDK to obtain a market niche.

As world pioneer of the V8 format, Kodak is leading the film industry into the heart of Silicon Valley. Here, Fuji has been making tapes for broadcast stations for many years, and lately 1/2" VCs supplied to leading VCR manufacturers of both formats. Now they are also entering the VCR field through the V8 format and supplying high density VCs. Konica and Kyocera are on the same track. TDK, probably acknowledged world leader in tape technology, is keeping at arm's length from hardware for tape use and is on good terms with all the industry for this reason. Without TDK's know-how, 8 mm may never have succeeded.

**Q. What does the digitising of video mean; you said at the beginning about video, "... but the greatest impact will come later from the move to digital technology. It has already started in the audio section of the V8 format."**

A. Firstly, may I answer the PCM, or digital audio part; they both mean the same thing. This is where 8 mm compatibility is breaking down. With VHS and Beta you had two different VCs; if they fitted into a VCR they worked with just a little tracking adjustment; until high-band Beta. With V8 there are options in the format for either modulated FM (mono) or PCM (stereo) audio. Some equipment will use one or the other and these VCs will be incompatible. In camcorders, for space, weight and cost reasons, a dual system appears out of the question. Also, the sizes of some VCs are not the same. Some can play only audio, and on the specific type of PCM VCR they came from.

The current V8 format PCM sound will not suit some hi-fi fans, so the Pioneer DAT audio system is an option used for the 6-track, 24 hour superior audio. Even this is not good enough for some, so a higher sampling frequency is also mooted with another sub-standard. No one seems to know for sure where these variations are leading and the VHS/Beta conflict could be repeated within the V8 format. Conference committees seldom reach a firm agreement. The success of Philips' compact cassette was due to their rigid and dictatorial control of one fully compatible standard.

The V8 video and audio specification may hold in analogue terms, but the audio variation in digital is very confusing at present. Only time can provide the answer.

**Q. And the digital video, when may we expect that?**

A. The digital camcorder, or two-piece portable, even the home VCR, seems to be a long way in the future. The NTSC markets will probably determine when this PCM change happens; your PAL areas will have to wait. It is likely that the whole decision will be governed by a radical change from NTSC to a HDTV (high definition) MUSE TV, now on demonstration by Japan's National TV Corporation NHK, it is their standard. The change is overdue and the logic of a new TV standard for NTSC areas, as the whole TV goes digital, is beyond question.

As you know, TV sets are now part digital, yo-yo-ing from analogue to digital and back. Satellite standards for signals in chrominance and luminance sampling are well advanced and the idea of digital signals, perhaps direct from the CCD in the camera, all through the chain to an analogue converter at the TV picture tube or array, must be the ultimate objective.

Any improved TV standard may require a broader frequen-

cy band for transmission and in the VCR. Hitachi has produced a prototype PCM VCR for NTSC video and audio with a bandwidth of over 4 MHz compared to the normal 3+ MHz, but recording time is about an hour. A MUSE HDTV bandwidth would be at least half as much again. Until these problems are overcome, PCM video will not be commercially possible. Only time can provide the answer.

I think I said at the beginning, the whole video industry is in a revolution; so is TV. The outcome can only be guessed at.

**Q. Please make a guess?**

A. Well, although the 8 mm format seems assured of a long term as a major format in magnetic recording, it may be mainly in the area of portable video, and in hi-fi. Unless the film makers are prepared to release hits on V8 at the same time as VHS, this format may never become a viable time-shift or pre-recorded, recorded-VC player.

Dubbing from camcorders into existing home VCR will be the first major use of V8 format. Buying a V8 format, home VCR will mainly be for the first-time buyer. As the VCR market is now approaching saturation in many countries, this may not be a big market.

As the V8 format is at its top extremity to record analogue video, there seems little chance of it accommodating digital video in current NTSC; HDTV would be well beyond reach. This leaves the 1/2" VHS format as first possibility for such a digital VCR for home use. It may even be PCM HDTV.

Just consider the same technology used to make V8 viable, now applied to VHS, and add the ability to double record in cross-azimuth depth, using the VHS hi-fi mode; not possible in V8. Using digital logic filters there would be little chance of crosstalk and the bandwidth is doubled. In depth recording, the second track may exclude the use of V8 7 µm tape technology, but new high density coatings could allow much depth recording and tighter bit density; aided by new record/playback heads used in V8, or even thin-film head technology. As I am guessing, such logical solutions are probably being tested under tight security in many R&D labs.

On the other hand I am not saying we must not discount a maverick solution to the digital problem. Still-video cameras tend towards a magnetic disc storage. If such a disc could have an adequate storage for some hours of replay, they could be the trump for digital video. Such a disc, using CD (compact disc) physicals, is well advanced at TDK and known as a CD-ROM (read only memory). Existing laser technology allows a once-only record function and unlimited playback. The disadvantage of a new disc for every recording is somewhat offset by instant programme location. The cost per disc will be the crucial factor, and as it is reputed to be a dye-based system in plastic, hopes are high for wide economic use of this CD-ROM; perhaps in video too.

**Q. It seems to me, that the consumer electronics, camera, and to some extent the computer industries, are all involved in this TV/video revolution. As Japan has what must be the largest single market share in the world of these products together; considering a near monopoly in video, you have a great responsibility to see that the revolution is an orderly one; both for Japan's interests, and the rest of the world?**

A. Agreed, and this is why the proposed V8 format was so widely circulated for approval. As a result, of the participating companies, 25 are outside Japan, while the Japanese companies have most of their trade offshore and regard themselves as truly international. This is the pattern you may expect for all new standards and formats; where Japan has an obvious initiative.

**Q. Perhaps we can review these questions and answers with what has happened in a year's time?**

A. Yes, that would be interesting; I hope, not too embarrassing. ♣





# Getting the best TV reception

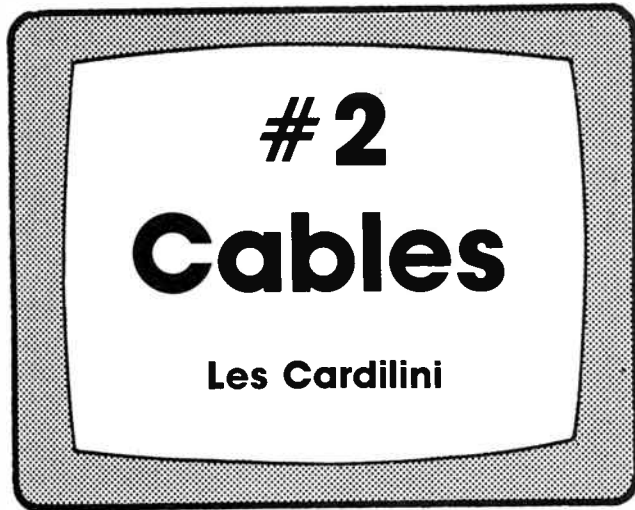

CHOOSING THE RIGHT CABLE for a TV antenna installation is an important step towards having an efficient system. In fact, if a certain well known motor mechanic had been brought up in the TV antenna business, he would probably insist, "cables ain't cables". This applies especially to feeders used for television and other radio frequency (RF) systems, where electrical currents behave quite differently from those in mains power wiring and electrical wiring in cars. Also, the relevant characteristics of a particular cable are likely to vary considerably between VHF and UHF television installations. Even on relatively short lengths of antenna feeder wire, the RF current at different points along the cable at any instant might be flowing in opposite directions. This phenomenon is not normally experienced on regular electrical wiring and I have had difficulty over the years in convincing some of my electrician friends that this condition not only occurs but is an everyday event in RF circuits. Also, RF energy picked up by the antenna may become trapped in the cable and bounce aimlessly backwards and forwards between the set and the antenna. When energy reflects in this way it sets up standing waves (VSWR) which can adversely affect reception, even on a good antenna in a strong signal area.

But just having the right feeder or cable is not the whole story, either. To get optimum results from the cable and antenna, the system must be carefully installed. Simple things that can go wrong during the installation, or bad planning where more than one outlet is to be provided in the system, can quickly knock dollars off the value of even the best antennas and feeders.

Many practices which are acceptable in general electrical wiring become quite unacceptable in RF systems such as TV installations. One of these is the seemingly innocent practice of connecting multiple points together, in parallel. Sometimes it works but more often than not it may cause snow or ghosting or both, on one or more channels. The sound, too, may be affected.

## Performance — the main factors

Perhaps the two main factors which govern the performance of antenna feeders, whether they be ribbon or coaxial cable (coax), are the *cable impedance* and *attenuation* or loss. Even faulty installation techniques and careless handling of the fittings ultimately affects either the circuit impedance or attenuation or both. These, in turn, affect the quality of reception.

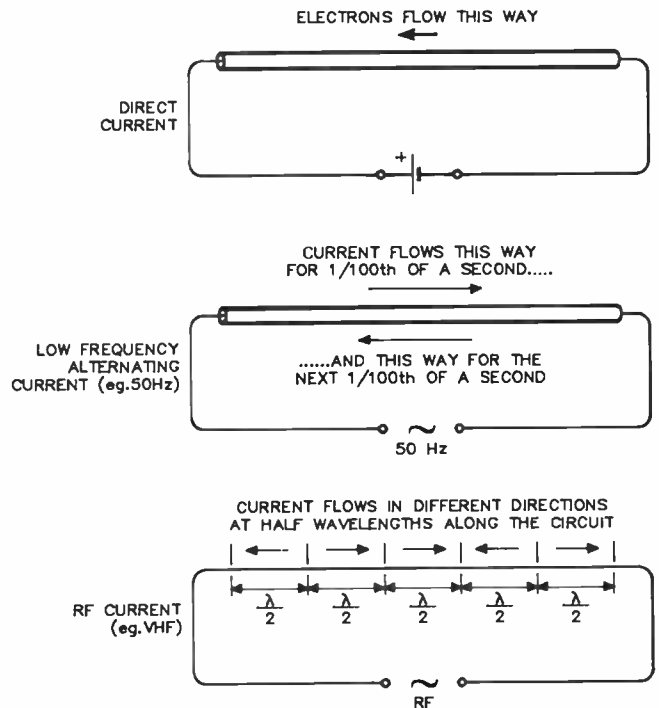

The impedance of a cable is affected mainly by:

- the diameters of the wire conductors.
- the distance between the wires, and
- the material between the wires, usually air or some form of insulation. This is called the dielectric.

The mathematical relationship between these variables determines what is called the *characteristic impedance* of the cable.

Whenever the cable is manhandled, cut, bent, placed under clamps, wet or stretched, one or more of its vital statistics is likely to vary and alter the cable impedance at that point. Accordingly, a simple understanding of each factor is the best guide to selecting and installing cables for TV reception. Standard values for TV installations are 75 ohms, for coax, and 300 ohms, for ribbon.

For the signal to be efficiently transferred from one part of the system to another the impedances of the two parts should be equal, or matched. This means that the signal energy cannot be effectively transferred from the antenna to the feeder unless the impedances of the antenna and the feeder are equal.

Likewise, signal energy cannot be effectively transferred from the feeder to the TV receiver unless the impedance of the feeder, or line, in the distribution system is equal to the impedance of the receiver antenna connection.

Assuming then the antenna picks up a strong enough signal, everything should be fine, if:

- the feeder and fittings such as splitters or dividers, do not attenuate the signal beyond acceptable limits, and
- correct impedance matching takes place wherever any two parts of the system are joined together, including feeder-to-feeder(s) in multiple point installations.

Where it is necessary to connect together circuits of different impedances an impedance matching device such as a balun must be used. The small box-like adaptor used for ▶

connecting 300 ohm ribbon to the 75 ohm socket on a receiver is a balun. Physically different, weatherproofed baluns are fitted to some antennas so that they may be used with either coax or ribbon feeders.

Attenuation is an important cable specification usually available in catalogues and technical literature published by the manufacturer. Where detailed figures are not available the cable may be described simply as either a regular grade or a low-loss type for a particular application.

Typically, attenuation is expressed in decibels per 100 metres, or per 100 feet, depending on the country of origin.

For example, the nominal attenuation of a particular cable might be ten decibels per one hundred metres, or

$$\text{Nom. Attn.} = 10 \text{ dB}/100 \text{ m.}$$

Fifty metres of this cable would have an attenuation of five decibels, 5 dB. Two hundred metres of the same cable would attenuate the signal by 20 dB. A linear relationship exists between the cable length and its dB attenuation. Accordingly, an average household run of, say, ten metres of cable having an attenuation of 10 dB per 100 metres would have a nominal attenuation of around 1 dB, a fairly acceptable figure.

Of course, the lower the decibel loss the better the cable, from an attenuation point of view. A three decibel loss in any system is a loss of *half* the available power. usually, losses of less than three decibels are tolerable but not always, especially in fringe areas where every decibel counts towards reducing snow and improving colour.

It is worth noting, too, that when the energy from the antenna meets a two-way splitter in the line, half the energy goes each way through the splitter. This is a 3 dB loss as far as each extension is concerned.

A ten decibel loss leaves only one-tenth of the original power, and a twenty decibel loss leaves only a hundredth. The relationship is logarithmic and each ten decibels raises the power ratio by a factor of ten.

The attenuation of most feeders, however, is not constant and increases significantly at higher frequencies. It is usual, therefore, to find attenuation specified for various frequencies throughout the VHF and UHF bands.

Television frequencies extend from around 50 megahertz (MHz) to 850 MHz, taking in the VHF and UHF bands. The upper VHF channels are in the region just above 200 MHz (see #1 in this series). The attenuation of cables varies dramatically over this 800 MHz wide range.

The following figures were supplied for popular, economy grade coax cables for TV antenna systems:

Nom. atten. at	dB per 100m	
	CABLE A	CABLE B
50 MHz	6.2	6.81
100 MHz	8.7	9.72
200 MHz	11.8	13.89
500 MHz	19.0	22.36
650 MHz	22.0	25.67
850 MHz	25.0	29.57

These figures emphasise the need to be fairly critical of cable required for UHF installations. Cable A has almost 20 dB extra loss at 850 MHz, the top of the UHF TV band compared with the lower channels in the VHF band. In terms of signal power, the loss at UHF is 100 times that incurred at lower VHF channels, such as Channel 0 and Channel 2.

Cable B has marginally higher losses at low frequencies but the losses are even greater at UHF, compared with cable A's performance.

The figures also highlight the need to keep antenna feeder in UHF systems as short as practicable to minimise losses

and retain video quality.

The manufacturer controls cable loss by choice of materials and how they are processed and assembled. The size and number of wires in each conductor and the dielectric material all affect attenuation. Even the outer covering influences cable attenuation. Some are specified only for use indoors where they will not be exposed to the rays of the Sun which may make them brittle and vulnerable to the effects of the elements.

In TV cables the losses caused by the dielectric are significant. Perhaps the best dielectric for the purpose would be a vacuum but this would be very expensive and difficult to maintain in practice. Next best is air but support is needed along the length of the wires, to prevent them from touching or shorting out.

Accordingly, low-loss feeders contain just enough solid dielectric to give this result. Foam dielectric in coax, and slotted ribbon feeder, are two examples. The dielectric in these cables consists largely of air and they may be more easily distorted or crushed out of shape than those which have a solid dielectric. They should be handled carefully.

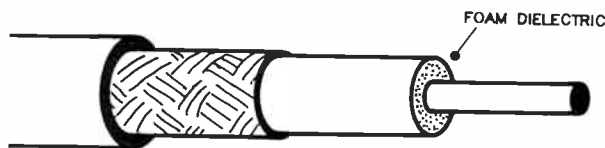
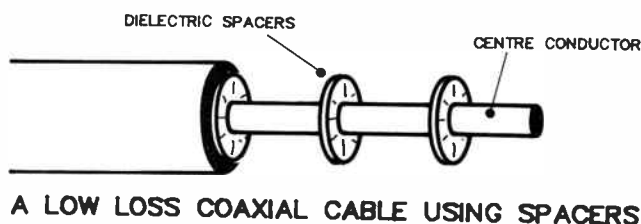
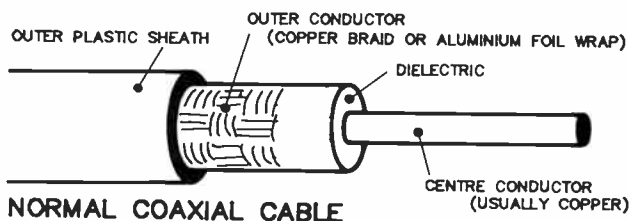

## Practical practices

Understanding the factors which affect the attenuation and impedance of feeder cables such as ribbon and coax should help the installer to get better results from an installation. The job becomes more of a commonsense exercise rather than one of trying to remember a never-complete list of do's and don'ts.

For instance, allowing water to seep into the un-protected end of cable out in the weather will change the dielectric. This in turn will change the impedance. The water will oxidise the conductors and the cable insulation leakage and losses will increase. In time, a considerable length of cable may become affected by moisture and capillary action in the cable. The antenna will be unable to efficiently transfer the signals to the feeder.

The exposed end should be sealed with a non-corrosive agent such as silicone rubber — before moisture enters the feeder. The sealant should be used effectively but sparingly so as not to change the characteristics of the cable.

Sharp bends in the feeder are another problem. They tend



## UHF/VHF Antenna With Reflector

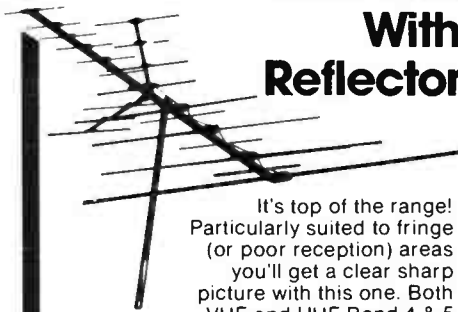

It's top of the range! Particularly suited to fringe (or poor reception) areas you'll get a clear sharp picture with this one. Both VHF and UHF Band 4 & 5 with inbuilt reflector for maximum gain/minimum ghosting! Cat L-4018

**\$79<sup>95</sup>**

## Got Two Antennas?

Well, now you only need run one lead! This UHF/VHF Diplexer allows you to connect the two antennas to one TV feed line! Cat L-4470



**\$8<sup>95</sup>**

# GET READY FOR THE SBS

## CHANGEOVER ON JANUARY 5!

SBS Ceasing transmission on VHF Channel 0 and transmitting on UHF Band 4 Channel 28 and UHF Band 5 depending on location — just check at your store. Australian made antennas for Australian conditions.

## High Gain UHF TV Antenna

Another quality antenna from DSE! Solve those reception problems once and for all. This band 5 UHF is designed for normal reception areas and features variable mounting clamp for easy mounting and aiming! Cat L-4028

**\$29<sup>50</sup>**



## Combined UHF/VHF Antenna

Why use two antennas when one will handle the job? Our combined UHF/VHF antenna is one of our most popular models. It's ideal for metropolitan reception areas! Great value for a dual purpose antenna! Cat L-4020

**\$59<sup>95</sup>**



## Economy UHF/VHF

It's made for those good reception areas! If you're close to the transmitter you won't suffer on quality but you will save money. Channels 0 to 11 VHF, FM and UHF Band 4 including Channel 28! Cat L-4027

**\$39<sup>95</sup>**

## UHF 4 Band Antenna

Couple it to your existing VHF antenna and you've got the best of both worlds. Gives excellent reception! Quality Australian made Channel 28 Band 4 antenna at a DSE low price! Cat L-4029

**\$39<sup>50</sup>**



It's made for those good reception areas! If you're close to the transmitter you won't suffer on quality but you will save money. Channels 0 to 11 VHF, FM and UHF Band 4 including Channel 28! Cat L-4027

**\$39<sup>95</sup>**

**GET THE MESSAGE!** The most efficient and reliable way to stay in touch . . .

**BONUS OFFER!!**

With every D-1022 and D-1012 Pager purchased you get 3 months Answerline Personalised Service . . . FREE when you pay the service contract! You save an incredible \$30!!!

## Full Alpha Numeric Display

National's top of the line! Get the complete message — without codes! The Alpha Numeric Pager is just packed with features to make communication simple and uncomplicated. Can store 1200 characters over 20 different messages — and you'll get them . . . no matter where you are! Cat D-1022



## National Digital Numeric Pager

Now there's a beeper that does much more than beep! The Digital Numeric Pager from National can tell you which number you have to dial or give you a complete coded message . . . instantly! When you need to keep in touch — make it easy, with a digital numeric pager from DSE. It's a lot cheaper than you think! Cat D-1012



**\$229**

**\$499**

**\$99**

All pagers: connection & service cost extra



## Beeple: Everyone's Pager!

Everyone can have the convenience of a personal pager with Beeple! The lowest cost pager around. Whether it's for business or around the home Beeple will keep you in touch instantly . . . for under \$100! Now communication is within everyone's reach at DSE! Cat D-1002



# DICK SMITH ELECTRONICS

PTY LTD

B069

Available all capital cities except Darwin & Hobart. Not available in country areas.

See Address details Page 108

December 1985 — Australian Electronics Monthly — 19

# DAVID TILBROOK HAS AROUND \$800 TO GIVE YOU, AND A SUPERLATIVE 2-WAY SPEAKER AS WELL!

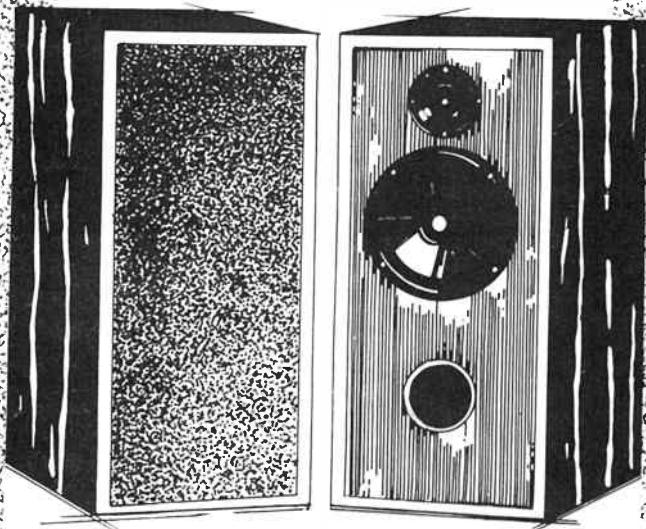

We're talking about the exciting new David Tilbrook designed speaker kit which uses VIFA's high performance drivers from Denmark. His 2-way, digital-ready 100 Watt capable masterpiece.

The name Tilbrook is synonymous with brilliant design and performance characteristics and this new system keeps the legend alive and well. The magazine 'The Australian Electronics Monthly' - where David is Project Manager - published full details of the design in their August issue. Already there has been considerable interest and many speakers have now been built with superb results.

You'll save around \$800 when you hear what you get from this system when compared to something you buy off the shelf with similar characteristics. If you compare its performance to fully imported, high priced, speakers from Mission, Heybrook, Monitor Audio, Bang & Olufsen and many others, you'll see that they too use these VIFA speakers.

This kit of 2-P21WO Polycone Woofers and 2-D25TG-55 Ferrofluid Cooled dome tweeters with Polymer Diaphragms, is available for \$350. Cross-overs, cabinets and loudspeaker stands are also available.

For further information and a reprint of the full details of the Tilbrook project, please telephone or write to the Sole Australian Distributors, who can also give you the name and address of your nearest stockist.

Stocked by Jaycar Electronics and leading hi-fi and electronic stores.

# vifa

Sole Australian Distributor: SCAN AUDIO PTY. LTD.,  
P.O. Box 242, Hawthorn 3122. Telephone (03) 429 2199.  
Queensland Distributor: Queensland Stereo Visual Supply,  
Telephone (07) 265 7945.

## The answers to last month's Weller Crossword

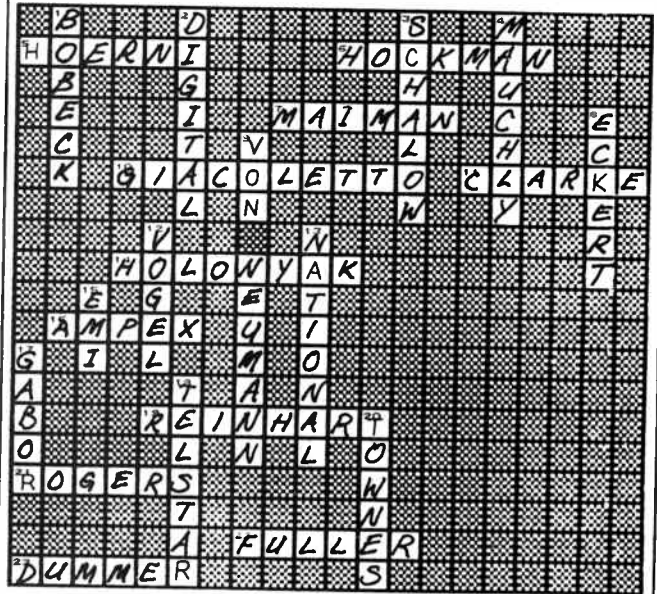

## ALL ELECTRONIC COMPONENTS

118-122 LONSDALE STREET,  
MELBOURNE, VIC. 3000, Australia  
Telephone (03) 662 3506



## JOIN THE GOLDRUSH!

ETI 1500 KITSET.  
Super unit featuring:

- Tune and discriminate
- 4 modes of operation
- VLF/TR design • Ground balance • Auto balance push buttons • Pre-wound search head • Very professional unit • Approximately 1/3 price of many similar commercial built up locators • Audio and meter indication. Lets you know when to rejoice

## COMPLETE KIT

Even inc Solder & Wire

# \$258.22

plus \$9 88 P & Reg. P.

"AN ENJOYABLE PASTIME  
WITH THE CHANCE TO  
MAKE A FORTUNE"



## Lay back your ears, here comes the B & W model 808

The conception of a design is generated from a requirement. It may be a requirement to produce a cost-effective product, or it may be a design to meet a wide variety of applications.

The requirement for B & W's Model 808 originated from the highly successful Model 801. B & W say that the 801 has, over the five years of its life, been used as the reference standard monitoring loudspeaker in virtually all the major studios and recording companies of the western world for the recording and assessment of classical music.

It was therefore a logical progression that the musicians and balance engineers involved in all the various facets of popular music should also take an interest in what their colleagues in the classical division were using.

Many balance engineers in the studios engaged in recording popular music used the 801 and commented most favourably.

Their complaint, and the limitation on its use, were quite simply that it did not produce sufficiently high sound levels for their particular requirement.

Some three years ago, EMI gave B & W a specification for this requirement which was expressed in three discrete areas:

- That the overall frequency linearity, freedom from colouration and distortion should be similar to 801
- That the sensitivity be doubled, to 91 dB for 1 Watt input, as opposed to 85



dB for the 801 • That the new loudspeaker system should be capable of peak outputs in the studio listening room on the order of 125 dB.

These parameters resulted in the design and production of five totally new drive units which meet or exceed the

specifications laid down, particularly those of freedom from distortion at these extremely high sound pressure levels. The result is the Model 808.

The Model 808 is available now. Contact Geoff Matthews, Convoy International, on (02) 698 7300.

### High grade, 4-hour chrome tape from BASF

BASF, who claim to be the only manufacturer of four hour high grade video cassettes in the market, has announced a hi-fi version of their best-selling chrome tape.

The new E240 chromdioxid hi-fi tape, specially formulated using thin film technology, offers significant benefits to tape users — even those without a video recorder with hi fi capability.

BASF Australia Consumer Products Manager, the ebullient Horst Hanfeld, says the tape offers improved luminance, chrominance, and signal-to-noise ratios in both mono and colour. The special formulation also has meant substantial reductions in the drop-out rate, an important pre-requisite for hi-fi recordings, say BASF.

Of particular advantage to music lovers, the new hi-fi cassette allows long audio recordings by three different means: recording the video picture with stereo hi-fi sound quality, recording picture from a video recorder and sound from a hi-

fi tuner, or recording audio only from a hi-fi tuner. The tape length is particularly suitable for longer classical recordings.

BASF's Super Grade Hi-Fi video cassette is also available in the three hour, E180, length.



### Dastardly deeds dogged by Dick's dialler alarm

There's a whole lot of noise once alarm systems are activated. That may scare the intruder away, but there's little consolation for the neighbours. Noise pollution laws regulate that alarms cut off after about ten minutes, which is fine for the neighbours.

But what about the owner? He arrives home from work to find

broken windows or locks or perhaps the house still smouldering from the day's bonfire.

Once, guard dogs were our most reliable form of security. Even the rise of sophisticated electronic systems has left us little better off. They may be more sensitive, harder to fool, but the end result is still — a lot of noise.

Now, Dick Smith Electronics has introduced a "21st Century Guard Dog" security system, which produces immediate response. There's no need to wait for neighbours to phone you, that's if they're at home when your system sounds off.

At only \$249, a neat dialler can be fitted to the alarm (fitting extra) and your entire home can be monitored 24 hours a day, seven days a week.

Once the alarm is tripped it automatically dials Voice Call who monitor your system, and pre-arranged action will be taken. They may call the police, the security service, or yourself at work.

The system can also be linked to your pocket pager and a series of beeps or tones will alert you instantly, identifying various emergencies such as bur-

glary, fire, power failure, etc.

Available now from all Australian Dick Smith Electronic Stores, cat. no. L-5100.

### Receiver from Dual

Dual, the well known and respected turntable manufacturer from West Germany, has been expanding into other facets of the hi-fi industry.

Their latest product now released on the Australian market is the Dual CR1320 receiver. This is 2 x 40 watt receiver with a synthesised tuner, digital frequency readout, auto-scan, and a 7 x 7 station memory. The unit features facilities for connection of compact disc or two tape recorders with direct tape-to-tape dubbing.

Adjustments of volume, balance, bass and treble are by way of slider controls conveniently arranged along the lower portion of the front panel.

Finished in a handsome anthracite black and selling for \$599, the Dual CR1320 seems a fine example of quality product from the Dual stable. Details from Falk ElectroSound, PO Box 234, Rockdale 2216 NSW. (02) 597 1111.

## A HANDHELD LCD 3½-DIGIT DMM FOR LESS THAN \$50

The Parameters 8005 features:

- 3½-digit liquid crystal display
- 5 functions
- 15 ranges
- side pushbutton operation
- 'pocket' size — 130 x 75 x 28 mm
- dc volts to 1 kV in four ranges
- ac volts to 750 V in two ranges
- resistance to 2M in four ranges
- diode test
- basic accuracy, 0.5% (dc V)
- fully overload protected
- safety 'finger guards' on probes
- fully shrouded safety probe plugs
- low battery indicator
- 12 months warranty!

**Special  
Offer Price:  
\$49.75**  
inc tax post and packaging



How to order:

COMPLETE THE COUPON AND SEND IT, TOGETHER WITH YOUR CHEQUE, MONEY ORDER OR CREDIT CARD DETAILS, TO:

'Parameters Multimeter Offer'  
Australian Electronics Monthly  
PO Box 289, WAHROONGA 2076 NSW

Please allow up to four weeks for delivery.

COUPON

PLEASE RUSH ME . . . Parameters 8005 dmm(s).

I enclose payment by:

Money Order  Cheque\*  Credit Card

Bankcard  Visa  Mastercard

Credit Card No.: .....

Expiry date: .....

Cheque or Money Order No: .....

\*Please make cheques or Money Orders payable to  
'Australian Electronics Monthly'.

Name .....

Address .....

Postcode .....

Signature .....

(Unsigned orders cannot be accepted)

## CONSUMER ELECTRONICS



### New Nakamichi auto-calibration deck

Nakamichi has released a new auto-calibration cassette deck, the CR-7, offering: • auto-calibration for azimuth, bias and record levels • playback head azimuth fine tuning (also via remote) • real-time counter • auto fade • FL central display system • cordless remote control.

The CR-7 discrete head cassette deck can be used in combination with normal hi-fi systems, and specifically conforms to the new Nakamichi

Home Audio Electronics System.

Released at the same time is the CR-5. Although the auto calibration and playback head azimuth tuning are not available on this model, the user is still assured of the same high quality performance.

The suggested retail prices are \$2100 for the CR-7 and \$1400 for the CR-5.

Further information can be obtained from the Australian distributor, Convoy International, on (02) 698 7300.



### C64 SPEECH SYNTHESISER

Promark Electronics is running a special on a great little synthesiser for the Commodore 64. Costing just \$45, the Currah Speech 64 module plugs into the cartridge expansion port and a flying lead with attached DIN plug connects to the audio/video socket on the rear of the computer.

The unit has internal software with a text-to-speech interpreter, making it simple to use. All you do is type in SAY, followed by a phrase enclosed in quotes. When you RUN it, the Speech 64 articulates the phrase.

In addition, you can get it to say virtually any word in the english language by programming in 'allophones' — which are 'word parts'. The unit has two different-pitched 'voices' and you can program intonation on the allophones to give the speech 'life'.

Contact Promark Electronics, PO Box 381, Crows Nest 2065 NSW, or call toll free, on (008) 22 6226.





## The Nakamichi OMS-7 compact disc player

Robert Fitzell  
AAAC

Nakamichi's supremacy in the design and production of cassette tape machines is unquestioned. Entering the 'fray' late in the piece, Nakamichi spent a lot of money on 'homework', learning the fundamental physics of the whole system. The same approach is evident from our examination of the OMS-7. While others have reviewed the current crop of CD players and found them 'perfect', clearly Nakamichi disagreed. The results are unquestionably superlative, but there is still the odd surprise. The question is, can you improve on "perfection"?

AS WITH MOST Nakamichi products, it has all been worth the wait. That is, providing you are prepared to spend the money necessary to invest in the relatively large cost of either the OMS-7 or the lower cost OMS-5. We have reviewed here, with immense pleasure, the Nakamichi OMS-7 CD player. In all respects the OMS-7 certainly is a magnificent piece of equipment. In fact, our test instruments are probably sick of the struggle to keep up.

There has been continuing debate concerning the audible

quality of compact disc players, particularly for reproduction of "acoustic" instruments. Nobody can fail to acknowledge the astonishing values obtained in laboratory testing from now quite economical compact disc players. However, many listeners will assert that their enjoyment is marred by the grainy or harsh reproduction by the players of the upper frequency range.

My own opinion is that the Nakamichi player is a laboratory standard source. When viewed objectively, the perfor- ►

mance achieved by the OMS-7 player in conjunction with the Denon test compact disc is nothing short of staggering. It is very easy to become complacent since the performance of compact disc players is known to be so good. However, one cannot but be impressed by the accuracy of reproduction, both on a laboratory bench and in listening tests, by the Nakamichi. My only criticisms are of a minor nature and will probably be considered insignificant by many potential purchasers.

## Features

The most important feature of the OMS-7 CD player is unseen — the quadruple oversampling by the digital filter. One of the main problems experienced with compact disc players, in fact many digital signal processes, has been that, what started out as a smooth waveform becomes converted to a pseudo-smooth waveform made up of a large number of very small steps.

Perhaps it should be interpreted as a tribute to the discriminatory powers of the human ear that this analogue to digital (A/D) conversion remains audible, and the approach Nakamichi has taken has been to increase the filter sample rate, in this case to four times the normal 44.1 kHz. For each of the 44 100 data samples per second contained on the compact disc the Nakamichi takes four samples and averages them to substantially reduce any read errors. That is, 176 400 samples are taken each second (176.4 kHz). This is truly approaching a laboratory standard of performance. The signal analyser which we use in our laboratory samples at 256 kHz, so is only just able to claim superior resolution.

The result of this very high sample rate is unusually smooth sound quality, particularly at higher frequencies and for traditionally difficult instruments such as violins and other stringed instruments.

Typical of Nakamichi, and showing their awareness that they do not need to blow their own trumpet, is that the owners manual which accompanies the player makes only passing mention of the benefits of the high sample rate. The manual, gives adequate description of the features of the player. In brief the manual covers:

1. Safety advice and disc care
2. Controls and features of the machine
3. Installation
4. Machine use
5. Remote control operation
6. Specifications

## The nuts and bolts

Constructionally I was not disappointed. As with the RX-505 cassette deck which we reviewed in the first issue (July '85) the quality of construction of the CD player is superb. Everything fits properly, is exceptionally robust, and gives the distinct impression of quality. Aesthetically, the machine is also unlikely to generate complaint, although I will repeat my criticism of the tape deck that persons with poorer eyesight will find the CD player difficult, at least at first. The aesthetics of the smaller labelling cannot be faulted, it simply makes the device more difficult to use.

The layout of the player is simple — a servo controlled disc

<b>REVIEW ITEM:</b>	Compact disc player
<b>MANUFACTURER:</b>	Nakamichi Corp.
<b>MODEL:</b>	OMS-7 and OMS-5 (OMS-7 actually reviewed)
<b>FORMAT:</b>	Standard front loading deck, remote controlled
<b>PRICE:</b>	\$2300 rrp.
<b>SUMMARY:</b>	We're still gasping . . . . .

tray, keypad type micro switches permitting eject/load, play, pause, stop, track skipping forward or backward and fast forward and reverse, the latter being operable during playback mode to permit cueing. Both the OMS-7 and OMS-5 permit automatic repeat, and both provide an excellent facility whereby remaining total disc play time may be checked.

In addition, the OMS-7 provides indexing, track number memorization for rapid track recall and the three outstanding features which set it apart from the OMS-5, remote control operation, a numerical track select keypad whereby the required track number may be simply typed in and recalled, and, surprisingly, an output level adjusted headphone socket. The second feature is invaluable where the machine is being tested with multi-track test discs, or being used professionally in broadcast or similar theatrical applications.

Both machines use a central LED display panel to show operational status.

The OMS-5 is a totally manual operation machine, but with identical circuitry and electronic performance. For professional use the OMS-7 is essential.

## Laboratory test performance

Most of our laboratory testing of the OMS-7 player used the Denon Audio Technical Test Disk. My impression at the end of testing is that, far from the Denon disk testing the performance of the Nakamichi, the player rather interrogated the compact disc! In relation to out of phase tests the phase cancellation between the two channels is audibly perfect.

Feeding both CD player output channels into a mono preamplifier and raising the gain to maximum there was absolutely no audible sound at all. Being a digital sound source this is not mathematically surprising! However, it is none the less quite exciting to experience. It is also quite exciting if the disc player advances on to the next track before you manage to lower the system gain!

## Distortion

Included on the Denon test disc are a number of subjective listening tracks which I will comment on later. The first objective measurements which we took were total harmonic distortion tests at nominal frequencies of 100 Hz, 1 kHz and 10 kHz at 0 dB levels.

The output traces are shown on Figures 1, 2 and 3, for a linear frequency scale and harmonic distortion products will centre on one of the vertical lines if they are present. The actual test frequencies were the digitally correct values of 100 Hz, 1001 Hz and 9999 Hz provided on the test disc as the nearest value to the traditional frequencies but being exactly a prime number divider of the sampling frequency of 44.1 kHz. Nominal THD in each case is — 80 dB which simply represents the measurement limit of our Hewlett-Packard analyser. In the case of 100 Hz and 1 kHz there is no evidence at all of harmonic distortion components. However, the 10 kHz does show a trace of third harmonic distortion at 30 kHz. Figure 3 also shows a number of high frequency components, well beyond the audible range (34 kHz, 54 kHz, 78 kHz and 98 kHz), which are clearly not harmonic distortion products. These components are identifiable as intermodulation products between the sampling frequency of 44.1 kHz and the source frequency of 10 kHz ( $44-10=34$ ,  $44+10=54$ ,  $2*44-10=78$ ,  $2*44+10=98$ ) and are, clearly, the most exciting find that we made in the course of our testing. There will also be an intermodulation product at 24 kHz ( $34-10$ ) although there is no evidence of this on the trace and its level is clearly very low.

Figure 4 gives two traces, the upper being a THD trace for



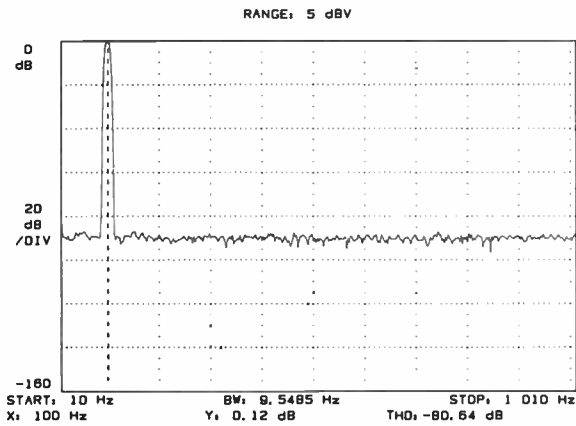

Figure 1. Left channel, 100 Hz THD. Right channel 0.11 dB; THD -80.71 dB, crosstalk -93 dB.

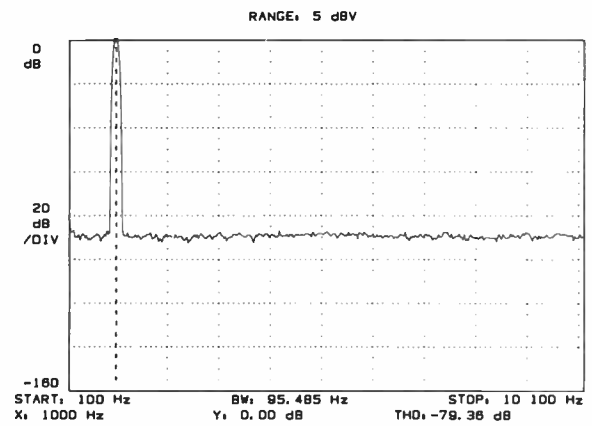

Figure 2. Left channel, 1 kHz THD. Right channel -0.01 dB; THD -79.88 dB, crosstalk -91.8 dB +.

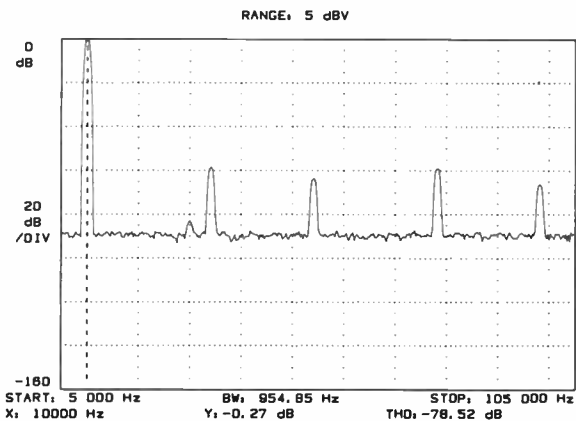

Figure 3. Left channel, 9999 Hz THD. Right channel -0.25 dB; THD -78.82 dB, crosstalk -90.92 dB.

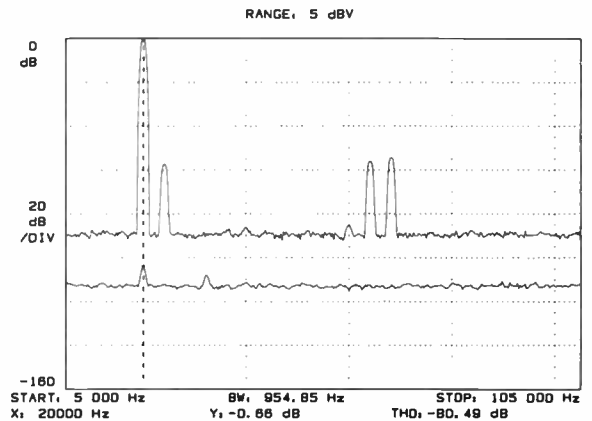

Figure 4. Left channel, 19 999 Hz THD. Right channel -0.57 dB, THD -80.49 dB, crosstalk -83.6 dB.

an input of 20 kHz (19 999 Hz actual) in which more ultra-high frequency intermodulation distortion products are present (at 24 kHz, 64 kHz and 68 kHz). Again these are identifiable (44-24, 44 + 24, 2\*44-20).

This aspect of the performance of CD players at high frequencies warrants considerably more attention. The highest visible IM product for the 20 kHz fundamental is 68 kHz, which could also have come from IM between 64 kHz and 4 kHz (24-20) and until the relative importance of these second-order effects is able to be properly assessed we cannot really identify the real causes of the IM distortion.

It is also impossible for us, at this stage, to determine how much the IM distortion effects are due to the player and how much is on the test disc itself. We have not used this particular test disc previously and despite many tests of CD players being reported in other magazines, in Australia and overseas, we have not previously seen one mention of the IM distortion we have so clearly found.

At this stage, all we can offer is to investigate this aspect further and to report our findings in a future article. We can say that as the fundamental frequency increases, particularly toward 20 kHz, the unwanted sideband products increasingly enter the audible frequency band — voila! . . . . harsh sound, "something is wrong at the top end"!!!!

All this is leading us away from the Nakamichi. As I said at the outset, my opinion is that the machine is a laboratory standard test item, and it does not seem at all inappropriate to be searching out fundamental problems of digital sound

using test results from the device. Particularly when one is dealing with a CD player that achieves excellent audition.

From subjective listening tests we know that the Nakamichi is at the top of the performance tree. Our next task will be to examine the performance of other CD players, perhaps across a price range, to see how their performance in respect of intermodulation distortion compares with the Nakamichi. The Nakamichi will be, I can assure you, the yardstick.

Back to the objective testing. Performance compatibility between left and right channels of the player was found to be excellent with the output level of left to right being at all frequencies within .02 dB. Total harmonic distortion at 0 dB is effectively identical for each channel and separation drops gradually from 93 dB at 100 Hz down to 90 dB at 10 kHz. THD at 20 kHz is again a nominal -80 dB, the system measuring limit. The lower trace of Figure 4 is channel separation with an input attenuation of 20 dB from which it is seen that channel separation at 20 kHz has dropped from the earlier values to 83.6 dB.

The effect of signal level on distortion performance of compact disc players has been noted before — it is the opposite of analogue devices in that THD lowers as level increases. The intermodulation distortion products with the filter frequency however remain relatively constant, so that the benefits of the exceptionally low THD performance at higher levels is somewhat lost as other components begin to affect performance.

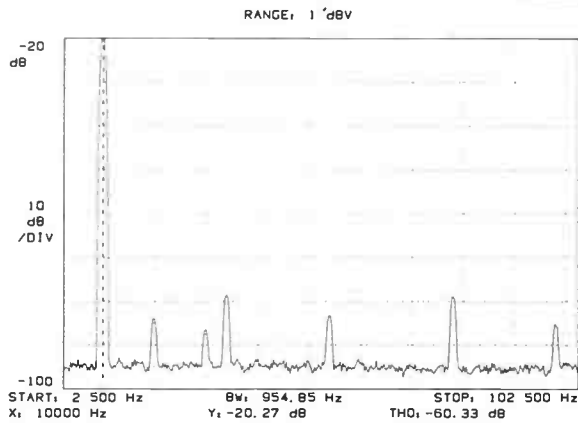

Figure 5.

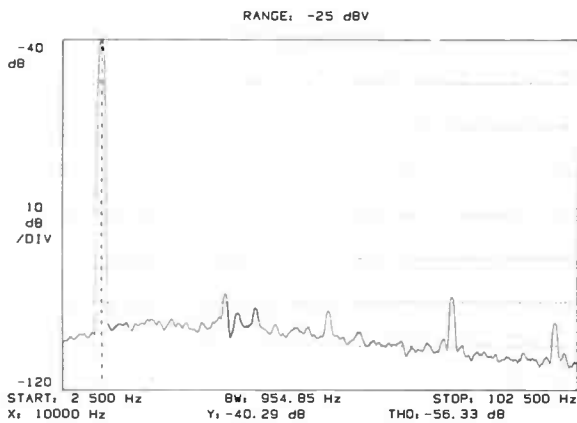

Figure 6.

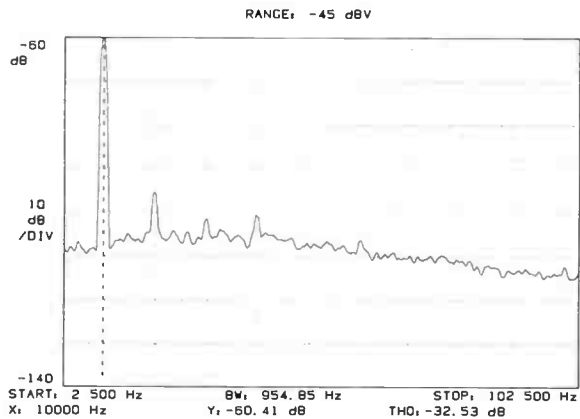

Figure 7.

Figures 5, 6 and 7 show THD testing for a 10 kHz input tone. As may be seen, the harmonic distortion products (i.e. ON the dotted lines at 10, 20, 30 kHz etc.) lower as the input level raises, with the THD value being given at the bottom of each figure. Observe, though, that the IM product frequencies given earlier remain constant and become strongly apparent.

Just to satisfy yourself, look also at Figure 3 again, remembering that the scale has been doubled. We have not been able to measure the absolute level of the IM distortion products, however, the trend of the distortion performance of the player can be gained from the results of Table 1. Blank entries simply mean we took no measurements.

Intermodulation distortion test results are given in Figures 8 and 9. Figure 8 gives the products and waveform for equal amplitude 11 kHz and 12 kHz at 0 dB whilst figure 9 shows 250 Hz and 8020 Hz, amplitudes 4:1, at 0 dB. In both cases it is difficult to find fault.

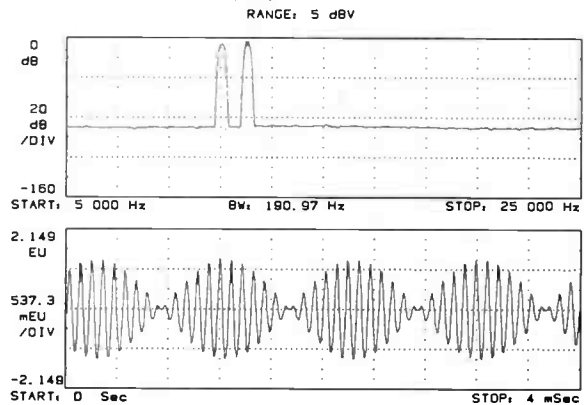

Figure 8. (a) — top. (b) — bottom.

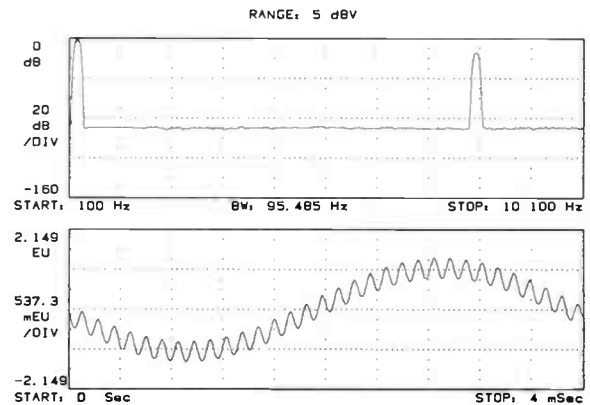

Figure 9. (a) — top; 250 Hz + 8020 Hz, mixed 4:1  
(b) — bottom; 0 dB and -12 dB (-1.84:-14.1).

## Frequency response

The swept tone frequency response for the OMS-7 is almost an anti climax at 20 Hz-20 kHz +/- 0.5 dB as specified. Figure 10 gives the results from our B&K level recorder using the test disc source and the trace is suitably impressive.

The slight steps at 1.7 kHz, 10 kHz and 16 kHz were repeatable and must therefore be considered true performance. We have set the trace 0.5 dB down on the chart just to assist the reader.

Figure 10. Frequency response, Nakamichi OMS-7, 0 dB input.

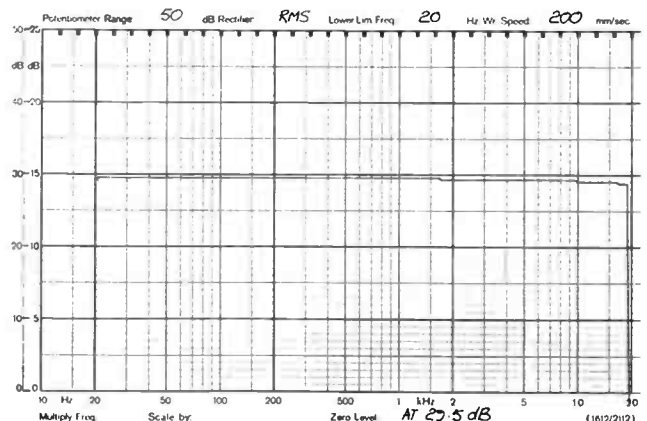



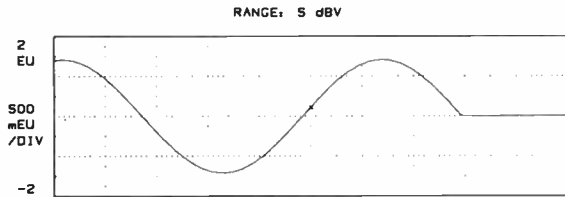

Figure 11. 401 Hz reproduction.

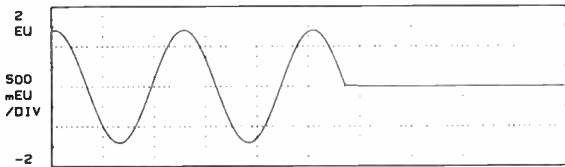

Figure 12. 1001 Hz reproduction.

### Tone bursts

Tone bursts at 401 Hz and 1001 Hz are shown on Figures 11 and 12 respectively. The traces show waveform and it is performance results like these — no overshoot or instability whatsoever — that shows just how accurate the digital source is.

Similarly, the 100 Hz square wave components and waveform shown in Figure 13 (a and b) show little instability, certainly up to the performance of many top amplifiers.

### Signal-to-noise

As usual, signal-to-noise is stunning at 92 dB linear, 200 Hz to 20 kHz, and 101 dB(A) for the same bandwidth.

The Denon disc does not provide test signals with and without emphasis and our test values should be compared with reports concerning other equipment for non-emphasis source material.

### Linearity

Our linearity tests were a little frustrating since all we could conclude was that the test disc tones were not linear. As noted earlier, performance from one channel to another varied typically by only 0.01 dB.

Repeated averaging of the same test tone gave variations from one sample to another also of the order of 0.01 dB only so confidence that any one result was repeatable was high. Variation from one 1001 Hz tone to another elsewhere on

TABLE 1: DISTORTION

Input Level	Total Harmonic Distortion				Filter Intermod Products			
	0dB	-20dB	-40db	-60dB	0dB	-20dB	-40dB	-60dB
100 Hz	-80	-74	-65	-38				
1000 Hz	-80	-71	-59	-36	-55			
10000 Hz	-79	-60	-56	-33	-60	-58	-58	<-58
20000 Hz	-80				-53			

TABLE 2: LINEARITY @ 1 kHz

Source Level	Measured Level (L and R channels)	
0 dB	0.0 (measured up to -0.3 dB)	
-24 dB	-23.99 (L)	-24.0 (R)
-60 dB	-60.22 (L)	-60.03 (R)

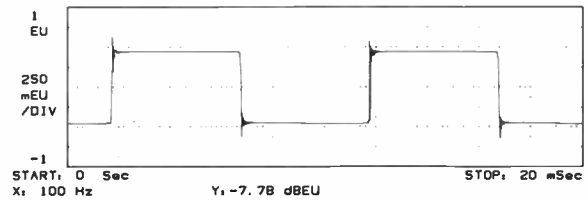
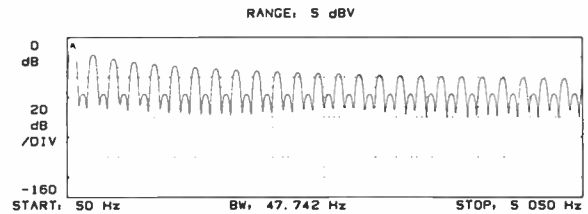

Figure 13. 100 Hz square wave at -10 dB (note error in amplitude).



the disc gave variation of 0.3 dB however, so the variations in linearity indicated below are very possibly due to the test disc as much as to the OMS-7. This conclusion was supported by the 100 Hz square wave test (Fig 13) stated to be -10 dB level but found to be something less than -7.8 dB.

### Comparison with specifications

In comparison with the manufacturers quoted specifications, we cannot find fault. Briefly the test results for the more important parameters compare as follows: ▶

TABLE 3: LINEARITY @ 10 kHz

Source Level	Measured Level
0 dB	-0.27 dB
-20 dB	-20.27 dB
-40 dB	-40.29 dB
-60 dB	-60.41 dB

TABLE 4 TESTS vs SPECIFICATIONS

	Manufacturer	Our Results
Wow & Flutter	unmeasurable	we agree
Frequency Response	5 Hz-20 kHz +/- 0.5dB	<20 Hz-20 kHz +/- 0.5 dB
Signal-to-noise	Over 92 dB(A)	101 dB (A)
THD @ 1kHz	0.003% (-90 dB)	<-79 dB
Channel Separation	over 92 dB	nominal 91 dB
		@ OdB,84 dB @ 20 kHz
IM Distortion	Not stated	Refer above

## aem hi-fi review

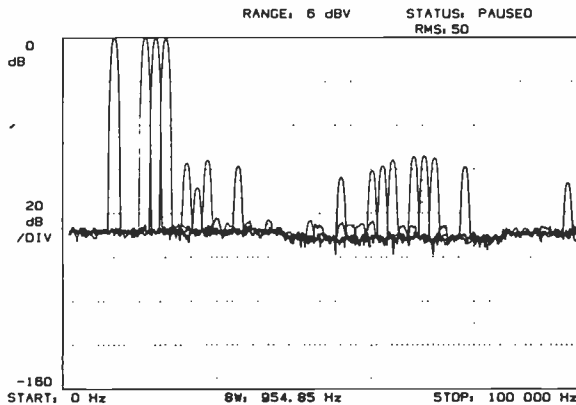

Figure 14.

No comments are made in the literature concerning spurious effects due to the digital sample process. Before finally leaving that topic to a future article we have included Figure 14, a wideband analysis of four separately recorded tones at 10 kHz, 16 kHz, 18 kHz and 20 kHz. Being separate recordings, the Figure does not show any effects due to intermodulation distortion between the four tones, only those due to the tones and the sampling filter, so the true picture will only be worse.

It is easy to see how a very wideband performance amplifier might be looking at a lot of energy that we never thought was there.

### Listening tests

One of the difficulties in describing state of the art equipment is to find sufficient superlatives to describe performance appropriately to compare with alternative machines, whilst leaving room for the future improvements which will inevitably come. We can bet that Nakamichi at least will bring out a future machine which leaves us all drooling. For the moment I, for one, will find it difficult to better the sound quality of the OMS-7, at least for compact disc.

The relative absence of background noise on compact discs I still find a little unnerving, at least for symphony and orchestral music which in the best instances are heard in an auditorium against the inevitable backdrop of (albeit quiet) audience noise. A compact disc can be nothing short of terrifying if the gain setting is wrong.

In the accompanying literature with your OMS-7 purchase you will find little to laud the acoustical performance of the machine — the manual simply states that quadruple oversampling completely eliminates sound deterioration common to the digital filter, and that is all. Nakamichi obviously rely on the discriminating listener to recognise the performance standard.

My own listening tests were conducted with a number of alternative loudspeakers and amplifiers and in a couple of rooms. I found the top end performance to be remarkably smooth, at both high and low levels. Stringed instruments do sound like strings, and whilst triangles probably sound quite good on most compact disc players I found them stunningly sharp without the square wave overtones commonly heard.

I was very impressed with the quality of orchestral sound — in my own opinion the most difficult source to reproduce well. detail is very good indeed, not so strident that one feels that one has just been rammed into the conductor's lap, but balanced in the way that only good string tone can permit.

Brass is another give-away, and whilst this source is prob-

ably more accurately a test of the loudspeaker, with a good loudspeaker or headphones I found the brass also to be very realistic.

The benefits of the wide dynamic range of the medium is apparent with orchestral recordings on compact disc, and particularly so on the OMS-7 player. Musician noise is frequently audible.

I did not have an acoustic piano source recording that I thought adequate to an objective listening task. At this stage on the basis of listening tests on electric piano material I will venture to say that, provided the softness achieved on string tone comes through, which I expect it should, then I will be very impressed. Certainly electric piano is excellent, being clearly identifiable for what it is with very accurate quality. The acoustic piano is, however, a much more stringent test since it carries such tonal complexity.

Pop music and electronic music on the OMS-7 compact disc player basically cannot be faulted, apart from the transparency of some very ordinary (so called) digital recordings being remakes of analogues on some obviously ordinary equipment.

It must be remembered that the Nakamichi is a top standard performer. As such, one of the problems a potential buyer will have will be to ensure adequate listening conditions. Do not expect to be discriminatory if listening in one room only and to one set of loudspeakers — probably against a cacophony of retail shop noise if you are unlucky.

The distinction in performance quality will be identifiable best at relatively low listening levels, but only with top grade amplification and loudspeakers. The player costs roughly \$2000 and if the old rules of thumb are still applicable then the player should not be expected to perform to its potential unless you are spending \$4000 to \$8000 or more on the rest of the system.

If you are spending less, still look at it, if only to enjoy the quality of a beautifully built piece of equipment. You may also be lucky. It wouldn't be the first time a lower cost system just happened to go together well and outperform some much more impressive rivals, and you may still feel the expenditure worthwhile.

The low cost system is, however, almost certain to be missing the one feature without which you cannot expect the CD player, any CD player, to perform to its potential — power, power and more power.

The Nakamichi player is a top-range machine capable of immense output peaks, and unless your amplifier and loudspeakers have similarly large overcapacity you simply will not get the performance. One of our test discs is the Telarc 1812 Overture with digitally recorded canons, and without about one kilowatt of power the orchestral level is simply too quiet at the output level at which the amplifier can handle the canons. So if you really do want top grade orchestral performance the OMS-7 (or 5) is the machine for you, but increase the mains fuse capacity if you like Bach, Mahler or Saent Saens.

Lastly, buying at the state of the art may cost more than the commercial standard, but it is likely that your top grade performer will still be up high in the tree after quite a few years and costing you nothing when your friends are having to update. The oversampled filter may also have a few hidden benefits which may or may not ever come to anything — standard sampling for disc playing perhaps four times as currently available.

### Summary

Sigh.....



# INDEXING P.C.B. HOLDER

## LOCKS IN 32 POSITIONS

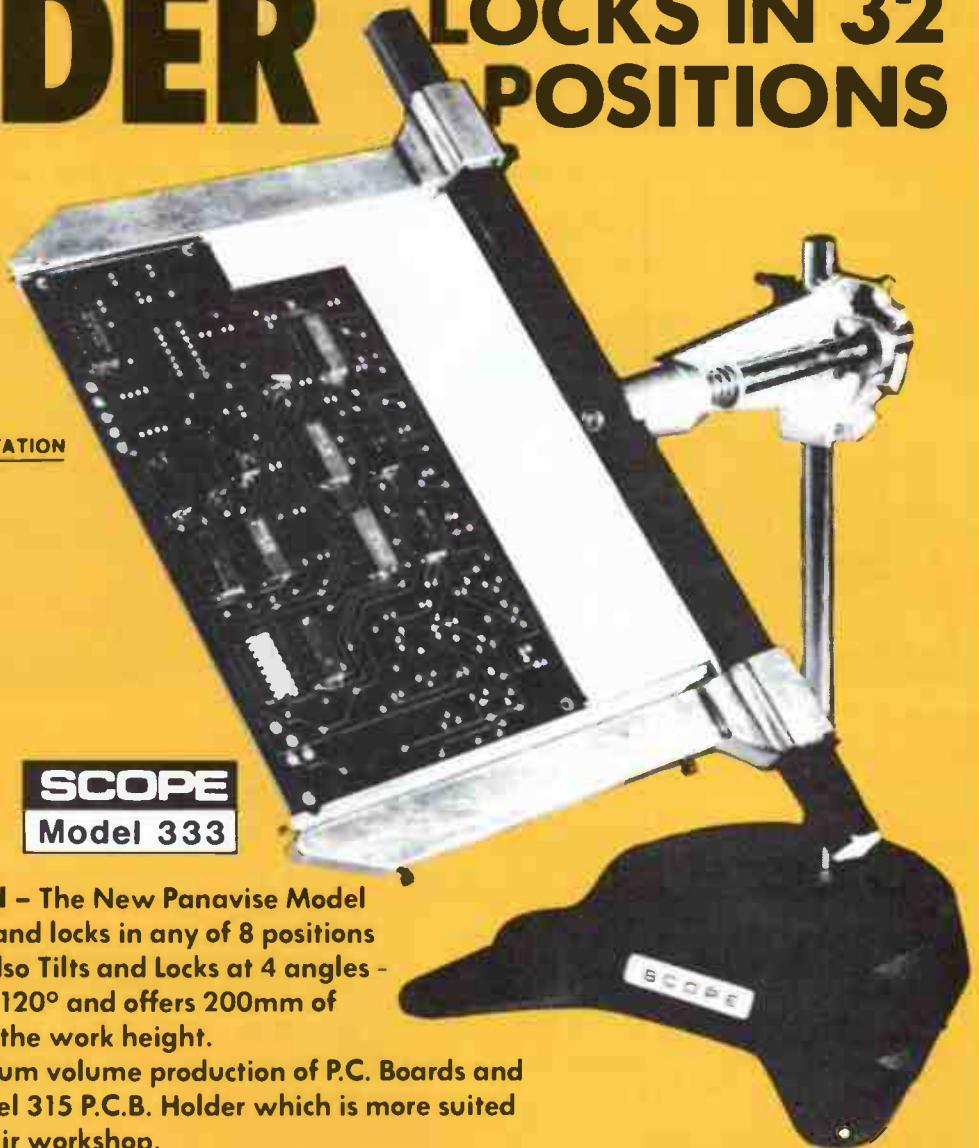
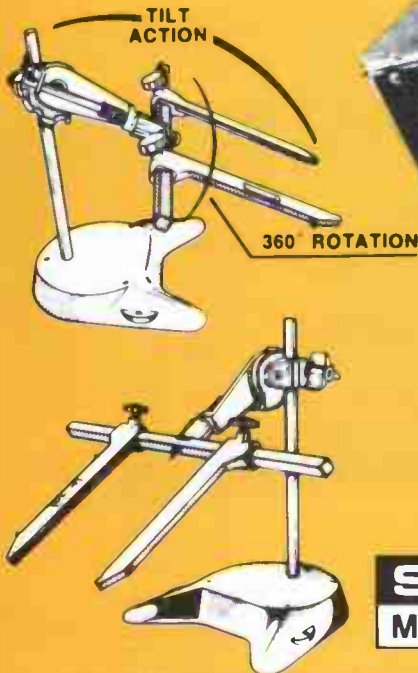

**SCOPE**  
Model 333

**TILT AND TURN ACTION** - The New Panavise Model 333 rotates the P.C.B. and locks in any of 8 positions in 45° increments. It also Tilts and Locks at 4 angles - 0° (vertical) 45°, 90°, 120° and offers 200mm of vertical adjustment to the work height.

This design is for medium volume production of P.C. Boards and complements the Model 315 P.C.B. Holder which is more suited to the service and repair workshop.

**HEAVY BASE** - Heavy cast iron base is dedicated to this Model and provides excellent stability and has three mounting holes which permits permanent attachment to a work bench.

**QUICK RELEASE ARMS** - Spring loaded arms hold boards securely, and provide rapid loading and removal of similar sized P.C.B.'s.

Cross bars are available to 750 (30") for working on large boards or multiple board work, using extra sets of arms.

**AVAILABLE FROM:**

**N. S. W.**

Geo. Brown & Co (02) 519 5855  
Pauls Merchants (02) 709 2311  
Scruttons P/L (02) 667 0511  
D.J. Coulter (049) 67 1455  
J. Blackwood (02) 609 0030  
A.E. Baker (02) 621 0044  
Sheridan (02) 699 6912  
Martin DeLannay (02) 267 1055  
Promark Electronics (02) 439 6477

**WESTERN AUSTRALIA**

Atkins Carlyle (09) 321 0101

**VICTORIA**

Radio Parts Group (03) 329 7888  
(03) 211 8122  
Geo. Brown & Co (03) 419 3986  
Ellitronics (03) 602 3499  
Ames Agency (03) 328 3001  
McGraths (03) 347 1122  
Ballarat Electronics (053) 31 1947

**SOUTH AUSTRALIA**

Gerard & Goodman (08) 223 2222  
Protronics (08) 212 3111  
A.J.F. Electrical Dist. (08) 269 1244  
Graphic Electronics (08) 42 6655

**QUEENSLAND**

Dunlop IBC (07) 892 0011  
St. Lucia (07) 527 466  
L.E. Boughen & Co (07) 369 1277  
Fred Hoe (07) 277 4311  
ECO (07) 376 5677  
Magraths (07) 832 3944

**TASMANIA**

G.H.E Electronics Hobart 34 2233  
L'yon 31 6533

FOR A FREE CATALOGUE  
SEND YOUR  
NAME AND ADDRESS TO:  
FREEPOST No.2  
SCOPE LABORATORIES  
P.O. BOX 63, NIDDRIE,  
VICTORIA, 3042  
AUSTRALIA  
No Stamp Required



**SCOPE**  
BOX 63 NIDDRIE  
VIC. 3042  
TEL (03) 338 1566  
TLX AA38318

# EXCLUSIVE AEM READER OFFER

## KIKUSUI OSCILLOSCOPES:

Here is a fabulous opportunity to own a top-quality, high performance oscilloscope from one of the world's leading CRO manufacturers, Kikusui. Save hundreds of dollars on the normal retail price — an offer exclusive to readers of Australian Electronics Monthly.

Emona Instruments of Sydney, in conjunction with the publishers of this magazine, is making these oscilloscopes available as a special offer exclusively to readers of Australian Electronics Monthly. The magazine is acting as a clearing house for orders.

**\*Offer extended!**

**Choose from analogue or digital —**

- **60 MHz/3-channel delayed-sweep model COS5060A**

- **Digital storage/20 MHz 2-channel model DSS5020**



### COS5060A Features:

- Dome Mesh CRT. 12 kV Acceleration potential
- 3 Channels
- 1 mV/DIV 20 MHz (at x 5 MAG)
- Maximum sweep speed 5 ns/DIV (x 10 MAG)
- Continuous, Simultaneous Delay Sweep Function (with two time bases)
- Alternate Sweep Function
- Trigger Function in Vert Mode
- Multi-Mode Display
- Built in Delay-line
- 6 inch Rectangular flat faced CRT with internal Graticule
- Dynamic Bias Circuit
- Linear Focus Circuit
- 2 Channel X-Y Operation
- Variable Hold-off function
- ADD Mode
- Trigger level Lock Function
- Newly designed TV Synchronisation Circuit
- CH1 Signal Output

### DSS5020 Features:

- Digital Storage**
- A high resolution made possible by the 8 bit vertical and 1024 word horizontal axes.
  - maximum sampling speed: 1 megasample/sec.
  - Effective bandwidth: dc-400 kHz.
  - Sine and pulse interpolation functions.
  - Enlargement of stored waveforms.
  - Pretrigger function for observation of the phenomenon preceding triggering.
- Non-storage**
- Roll function for continuous observation of a waveform.
  - A built-in jitter-cancelling circuit.
  - 1024 word reference memory.
  - Store interval function
  - A 2-channel oscilloscope with a dc-20 MHz bandwidth.
  - maximum sweep time: 50 ns/div.
  - maximum sensitivity: 1 mV/div.
  - Trigger function with a level lock.

## SPECIAL OFFER PRICES

**\*COS5060A 60 MHz/3-Channel**  
**\$1490.00 exc. sales tax**

**— save \$236!**

**\$1766.00 inc. sales tax**

This instrument's normal retail price is \$1726.00 exc. sales tax, \$2006.16 with tax.

Input probes are included

**SPECIAL BONUS!**  
 The first 30 orders received will get a 3½-digit Escort Multimeter thrown in, totally free of charge!

**\*DSS Digital Storage/2-Channel**  
**\$1650.00 exc. sales tax**

**— save \$283!**

**\$1952.00 inc. sales tax**

This instrument's normal retail price is \$1933.00 exc. sales tax, \$2242.28 with tax.

### HOW TO ORDER

Cut out, or photocopy, and complete the coupon. Send it together with your cheque, money order or credit card details to:

**'Kikusui CRO Offer'**

**Australian Electronics Monthly**

**PO Box 289, WAHROONGA 2076 NSW**

\*Please make cheques or Money Orders payable to:  
 'Australian Electronics Monthly'

**Delivery: Please allow up to four (4) weeks from receipt of payment for delivery to be effected.**

Name .....  
 ..... Postcode.....

**Please supply:**

.....  
**Sales Tax No** ..... (if applicable)

**Please add \$20 for packaging, delivery and insurance for delivery anywhere in Australia**

**TOTAL COST:**.....

**I enclose payment by:**

Money Order  Cheque\*  Amex   
 Bankcard  Mastercard  Visa

**Credit Card No:** ..... **Expiry date:** .. / .. / ..

**Cheque or Money Order No:** .....  
 (Unsigned orders cannot be accepted)

Address .....  
 Signature .....

\*If you would like to inspect either of these oscilloscopes, call into our office any weekday during business hours. We're located at: WB Building, Cnr Fox Valley Rd and Kiole St, Wahroonga NSW. The entrance is in Kiole St.



# AEM READER SURVEY

We have been publishing AEM since July 1985 and have been delighted with your response to our new publication. To make AEM an even better publication, completely in tune with your needs, we'd be delighted if you'd spend a few minutes and the price of a stamp to tell us a little about yourself, your needs in electronics and what you'd like to see in AEM.

## ABOUT YOU

Your age group

- Under 14   
 15-20   
 21-35   
 36-55   
 Over 55

Are you currently in or have you been professionally engaged in the electronics industry?  
 Yes  No

Your postcode .....

Are you a subscriber to Australian Electronics Monthly

Do you buy your copy of AEM from a newsagent

Do you buy your copy of AEM from an electronics retailer

Do you read the following magazines?

	Yes	No	Occasionally
Amateur Radio	<input type="checkbox"/>	<input type="checkbox"/>	<input type="checkbox"/>
Amateur Radio Action	<input type="checkbox"/>	<input type="checkbox"/>	<input type="checkbox"/>
73	<input type="checkbox"/>	<input type="checkbox"/>	<input type="checkbox"/>
Ham Radio	<input type="checkbox"/>	<input type="checkbox"/>	<input type="checkbox"/>
Australian Personal Computer	<input type="checkbox"/>	<input type="checkbox"/>	<input type="checkbox"/>
Byte	<input type="checkbox"/>	<input type="checkbox"/>	<input type="checkbox"/>
Your Computer	<input type="checkbox"/>	<input type="checkbox"/>	<input type="checkbox"/>
Electronics Today International (ETI)	<input type="checkbox"/>	<input type="checkbox"/>	<input type="checkbox"/>
Electronics Australia	<input type="checkbox"/>	<input type="checkbox"/>	<input type="checkbox"/>
Elektor	<input type="checkbox"/>	<input type="checkbox"/>	<input type="checkbox"/>
Practical Wireless	<input type="checkbox"/>	<input type="checkbox"/>	<input type="checkbox"/>
Practical Electronics	<input type="checkbox"/>	<input type="checkbox"/>	<input type="checkbox"/>
Radio Electronics	<input type="checkbox"/>	<input type="checkbox"/>	<input type="checkbox"/>
Electronics & Wireless World	<input type="checkbox"/>	<input type="checkbox"/>	<input type="checkbox"/>
Everyday Electronics	<input type="checkbox"/>	<input type="checkbox"/>	<input type="checkbox"/>

Do you own the following equipment?

- Analogue Multimeter   
 Digital Multimeter   
 Soldering Station/Iron   
 Oscilloscope   
 Signal Generator   
 Range of tools, pliers, screwdrivers, etc.   
 Higher level Test & Measurement equipment

Which if any piece of equipment do you next intend to purchase

.....

Would you like to estimate how much you have spent on your electronics hobby in the last 12 months \$ .....

Do you own a home computer?

- Amstrad   
 Apple II   
 Commodore 64   
 IBM PC or compatible   
 Microbee   
 Sega   
 Other .....

Do you frequent any of the following stores?

	Never	Quite Often	Frequently
Active Electronics	<input type="checkbox"/>	<input type="checkbox"/>	<input type="checkbox"/>
All Electronic Components	<input type="checkbox"/>	<input type="checkbox"/>	<input type="checkbox"/>
Dick Smith	<input type="checkbox"/>	<input type="checkbox"/>	<input type="checkbox"/>
David Reid	<input type="checkbox"/>	<input type="checkbox"/>	<input type="checkbox"/>
Jaycar	<input type="checkbox"/>	<input type="checkbox"/>	<input type="checkbox"/>
Magraths	<input type="checkbox"/>	<input type="checkbox"/>	<input type="checkbox"/>
Ritronics	<input type="checkbox"/>	<input type="checkbox"/>	<input type="checkbox"/>
Tandy	<input type="checkbox"/>	<input type="checkbox"/>	<input type="checkbox"/>

If you mark any of these stores as 'frequently' could you briefly explain why you give that store your preference

.....

.....

.....

## ABOUT AEM

The following types of articles appear regularly in AEM, which would you be most likely to read?

- Beginners Projects (Starting Out)   
 Practicalities   
 Benchbook   
 Communications   
 Hi-Fi Reviews   
 Computer Reviews   
 New Product Reviews   
 News   
 Projects

If you have built an AEM project did you find?

- |                                    | Yes                      | No                       |
|------------------------------------|--------------------------|--------------------------|
| Instructions easy to follow        | <input type="checkbox"/> | <input type="checkbox"/> |
| All aspects covered satisfactorily | <input type="checkbox"/> | <input type="checkbox"/> |
| Clearly laid out                   | <input type="checkbox"/> | <input type="checkbox"/> |
| Well illustrated                   | <input type="checkbox"/> | <input type="checkbox"/> |

Have you any comments on the project/s you built .....

.....

.....

What criteria do you use in building a project?

- Cost   
 Something I need   
 Challenge   
 New or interesting idea   
 To learn more about electronics   
 Availability of parts

What other computer or electronics projects would you like to see in AEM?

.....

.....

When you build a project, do you prefer to build from a kit   
 assemble the elements yourself

If you build from kits do you find

Quality is good overall

If you answered no, would you be prepared to spend say 10% more on improved quality .....

**Thank you for your help in going to make AEM an even better magazine. Please post your questionnaire to**

**Australian Electronics Monthly  
 PO Box 289  
 Wahroonga 2076**

If you don't wish to cut your magazine, a photostat will substitute.

# ELECTRONIC FACILITIES

## SPECIAL OFFER TO ALL AUSTRALIAN ELECTRONICS MONTHLY READERS.

### A SEMICONDUCTOR SPECIAL.

This pack of selected 74LS IC's is ideal for any hobbyist or professional alike. The pack contains the most common IC's that are used for your designs, projects or servicing.

All IC's in this special offer are top quality NATIONAL PANASONIC brand.

### A ONCE IN A LIFETIME SPECIAL.

#### 5 of Each

74LS00  
74LS02  
74LS04  
74LS08  
74LS10  
74LS123  
74LS132  
74LS138  
74LS139  
74LS14  
74LS164  
74LS165  
74LS175  
74LS20  
74LS22  
74LS240  
74LS244  
74LS245  
74LS57A  
74LS30  
74LS32  
74LS373  
74LS374  
74LS393  
74LS74A  
74LS86

130 IC's FROM NATIONAL PANASONIC.



**ONLY  
\$67.60**

Plus \$2.50 P&P

Would normally retail about \$140.00

THIS IS AN OFFER THAT YOU CANNOT MISS OUT ON.

PLEASE SEND your mail order to:

**ELECTRONIC FACILITIES** Pty Ltd

PO BOX 351  
Artarmon N.S.W. 2064

MONEY ORDER  CHEQUE

NAME .....

ADDRESS .....

67 Dickson Avenue, Artarmon  
Sydney NSW 2064 Australia  
Telephone: 439 3786  
Telex AA177084



TOLL FREE (008) 22 6385



# Meet Elami Jr — your robot 'friend'

IN THE SEPTEMBER ISSUE editorial I said, "I never cease to be amazed at the level of technology incorporated in electronic products designed and manufactured for use in the home." This little product reinforces that view very strongly indeed!

Elami Junior (or 'Jr.') is a product made possible by advanced semiconductor technology that permits the large-scale integration (LSI) of complex circuitry that can be housed in a relatively small, many-legged 'chips'. Inside Elami Jr are five LSI chips, one run-of-the-mill CMOS IC and a small number of transistors and diodes, all housed on a circular printed circuit board measuring about 130-140 mm in diameter!

For the technically curious, and for the record, Elami's electronics comprises a custom 6805 8-bit microprocessor, a 4K ROM, a General Instruments (GI) SP0256 speech synthesizer and two GI SPR128 128K custom speech ROMs. The rest is incidental electronics, largely for controlling Elami Jr's functions.

## Features and functions

Elami Jr is a programmable robot with motor-driven wheels in the base to provide motion, a liquid crystal 'face' capable of four "expressions", a 25-key 'sensor-touch' (not buttons) keyboard for programming, a speech synthesizer that provides a 'talking keyboard' plus built-in phrases and counting.

There is an infra-red sensor on the front, located at the top centre of the keyboard, that 'senses' objects by transmitting weak infra-red rays and looking for reflections. Whenever it 'sees' an object, this automatically triggers the robot into backing off, at the same time sounding an alarm, then turning left before continuing its program. Around the base is a 'tactile bump sensor' ring. In the same way, if the robot bumps into a low object with this ring, it automatically moves away while sounding an alarm, then turns left and continues its program.

Surrounding the keyboard are 16 LEDs that provide the 'flashing lights' beloved of children, sci-fi fans and electronic hobbyists. On top of the 'head' are another six LEDs for the same purpose. Two LEDs, located either side of the infra-red sensor atop the keyboard, serve as battery indicators.

The two arms can be positioned manually in 13 indexed positions and move in a roughly 180 degree arc (straight down to straight up). The grippers on the ends of the arms are simple spring-loaded jaws. The 'head' cannot move.

The 'face' on Elami Jr must be its major attraction as people respond to it in a remarkable way. I suspect this feature has a strong psychological 'pull' because it makes the thing appear more human-like. It's a simple liquid crystal display with four "expressions" (all programmable!)—sleepy, happy, angry

and surprised. In addition, during speech, the face can be made to appear with an open mouth (static talking) or with a moving mouth (dynamic talking).

Programming has been greatly simplified by the use of 16 single-key commands, all of which are letters. You can program all movements and other functions with a straightforward combination of these commands. The D key provides a demonstration which puts Elami Jr through its paces — and what a show!

The movement commands provide *forward*, *backward*, *left turn*, *right turn*, *left curve*, *right curve* plus two speeds. You can also pause for a selected number of seconds from one to nine and repeat commands from one to nine times. As you would expect, Elami Jr prefers hard, smooth surfaces but still works quite effectively on carpet, depending on the depth and resilience of the pile.

The speech synthesizer provides a selection of five phrases — "Hello, I am Elami", "Have a nice day", "I love you", "I am happy" and "Follow me" — eight words (like "Please", "Thankyou", "Good-night" — at least it has manners), plus counting from one to ten and reciting the alphabet. The worst word it says is the Americanese "Mommy", but I guess we could expect that. The speech functions are all activated by two-key commands comprising the letter T followed by a number from 1 to 9, or a letter from A to F. e.g. T2 causes Elami to articulate "I am happy". See, you can even have the robot tell lies!

Each Elami comes with a little plastic laminated card showing its creation date, serial number and individual 'security code'. You can only operate your robot by entering your security code. That's an attractive feature with a whole host of uses — like keeping big brother's hands off your robot!

Elami Jr stands 295 mm high and is about 220 mm wide, elbow to elbow. It is powered by four C cells (for the motors) and four AA cells (for the electronics) and weighs, all up, 1.5 kg with the batteries. Rechargeable batteries may be used and an optional charger is available. It is made of sturdy plastic of an off-white colour with red trim.

The 14-page handbook is clearly and simply set out and contains sample programs to illustrate the various functions. There is a comprehensive series of visually illustrated sample movement commands running from a simple forward-turn-and-circle to even zig-zag commands. Learning the rudiments of programming logic with Elami Jr should not only prove educational, but fun too!

In addition to the manual, a laminated plastic card is supplied with 'at a glance' operation instructions — a very handy idea.

While Elami Jr appears — and appeals — as a toy, it is more than that. Going through the step-by-step logic of programming Elami Jr to do even simple tasks is a good exercise

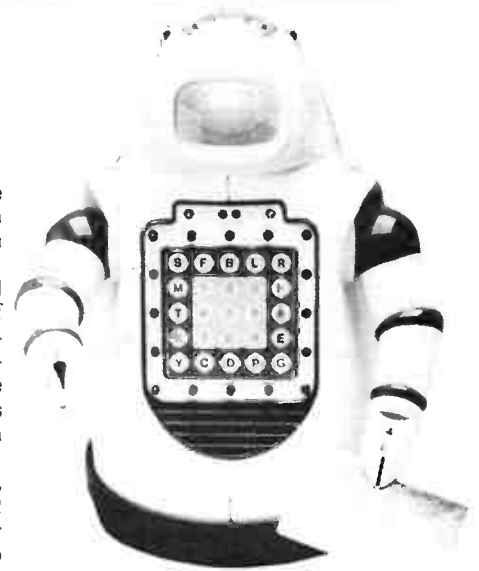

Facial expressions

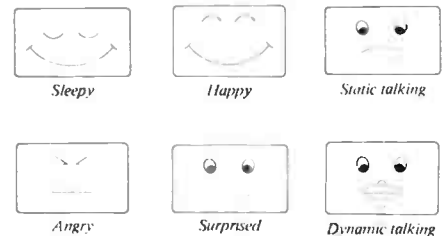

in clear thinking, a fundamental requirement to learning computer programming at any level. All child's play (even adults' play!) is largely a learning experience, and this product can potentially provide a pretty powerful learning experience.

## The 'real' test

Well, the 'acid test' is to have a young person 'do it' for themselves and report the results. Who better than my 12 year-old son. I thought? So here's what Corey thought of Elami Jr.

"This fantastic robot is stacks of fun for young and old. With its 25-key keyboard you have around 40 commands to create programs.

"When I first turned Elami on, to my surprise it started talking! And it talks very nicely, indeed. The 'voice' is a little squeaky, but quite clear, not like some synthesizers I've heard.

"The manual is set out in a way such that the person reading it, no matter how little experience they have had with robots, can easily understand it. I think, in Elami's case, what you see is not what you get — I got more than I bargained for.

"My first program amazed me — success at first try! I got Elami to flash the lights, speak to me and put on a happy face. That encouraged me to try more things. The face makes Elami different to all the other robots I've seen. It's just great.

"I would recommend Elami Jr to young or old — as a 'playmate' or a novelty."

Roger Harrison,  
Corey Harrison

# EVERYTHING YOU NEED TO MAKE PRINTED CIRCUITS

FULL RANGE OF RISTON MATERIALS, CHEMICALS CALL FOR PRICES

NOW STOCKING COMPLETE RANGE OF E-Z CIRCUIT DRAFTING AIDS

## Dual in Line Packages All \$4.37/pack

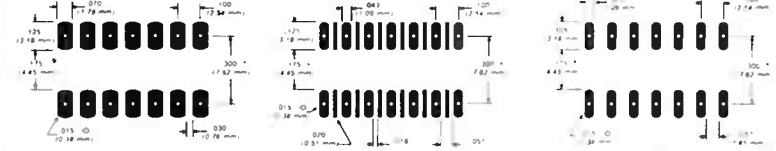

Cut Pad				Cut Pad With Conductors				Narrow Cut Pad					
No. of Leads	Qty/Pkg.	Scale	Catalog Number	No. of Leads	Qty/Pkg.	Scale	Catalog Number	No. of Leads	Qty/Pkg.	Scale	Catalog Number		
14	32	1X	EZ6014	Use where conductor traces must be routed between pads	14	32	1X	EZ6780	Use where a longer terminal area is desired. Can be used with conductors between terminals.	14	32	1X	EZ6014
	28	2X	EZ6038			28	2X	EZ6781			28	2X	EZ6071
16	32	1X	EZ6004		16	32	1X	EZ6783		16	32	1X	EZ6453
	28	2X	EZ6109			28	2X	EZ6784			28	2X	EZ6244
18	28	1X	EZ6900		40	8	1X	EZ6984		40	8	1X	EZ6987
	26	2X	EZ6901			8	2X	EZ6985			8	2X	EZ6988
24	12	1X	EZ6595										
	12	2X	EZ6598										
28	12	1X	EZ6903										
	12	2X	EZ6904										
40	8	1X	EZ6906										
	8	2X	EZ6907										

## Pre-Spaced Pads \$4.37/pack

Center to Center Spacing	Pad Type	Scale	Pads Per Strip	Strips Per Pack	Catalog Number
100"		1X	40	6	EZ5000
		2X	20	7	EZ5001
		1X	40	6	EZ5003
		2X	20	7	EZ5004
156"		1X	40	6	EZ5017
		2X	20	7	EZ5018
		1X	40	6	EZ5020
		2X	20	7	EZ5021
		1X	25	6	EZ5014
		2X	13	7	EZ5015

## P.C. Drills

Take your pick of tungsten carbide or high speed steel. Available in 0.8, 0.9, 1.0 and 1.2mm T.C. drills \$5.85 each H.S. Steel \$1.75 each.

## Donut Pads

The basic all-purpose PC terminal area for termination of wire or component leads extending through the PC board. ID aids in accurate pad location to grid centers.

E-Z CIRCUIT Tape Donut Pads are unsurpassed for uniformity and accuracy. These photographically opaque terminal areas are accurate to ± .002" (0.05mm). E-Z Circuit opaque black pads are only .005" (0.13mm) thick.

## \$3.35/pack

1. Select the largest possible pad. Allow enough room for conductor traces and the physical conditions of artwork preparation and manufacturing of the actual board (MIL-STD-275).
2. A small ID makes registration easy, but may make it difficult to locate pad center after photo reduction.
3. Choose an ID smaller than hole to be drilled. (Drill size for plated-through holes must be larger than final hole.)
4. Use Multi-Pad configurations for multi-pad terminal patterns. It is much easier, much faster, and much more accurate to lay down a whole pattern printed to specific tolerances than to tediously position individual pads.

## STANDARD INCH

OD	ID	Cat. No.	Qty/Pkg.
0.80	0.31	EZD216	96
1.00	0.31	EZD101	96
1.20	0.31	EZD239	96
1.25	0.31	EZD102	96
1.50	0.31	EZD144	96
1.56	0.31	EZD103	96
1.60	0.40	EZD247	108
1.87	0.31	EZD138	108
2.00	0.31	EZD139	108
2.50	0.62	EZD109	128
3.00	0.62	EZD111	112

## Precision Slit Tapes

"Super" 201 is a flexible extra-strong photographically opaque, pressure-sensitive precision slit tape with exceptional adhesive characteristics. It will not creep or lift if stretching is avoided during application. "Super" 201 is extremely flexible and has a non-reflective matte finish. Only .005" (0.13 mm) thick.

- Precision slit to exacting tolerances to assure highest quality PC artwork and photography
- Manufactured from the same high quality materials as E-Z CIRCUIT PREKUT TAPE SHAPES to insure compatible PC artwork and photography

## STANDARD INCH

20 Yds./Roll

Tape Size		Cat. No.
in.	mm	
.020	0.51	EZC3000 \$3.05
.026	0.66	EZC3002 \$3.05
.031	0.79	EZC3004 \$3.25
.040	1.02	EZC3006 \$3.25
.050	1.27	EZC3008 \$3.25
.062	1.57	EZC3010 \$3.35
.080	2.03	EZC3012 \$3.35
.093	2.36	EZC3014 \$3.35
.100	2.54	EZC3016 \$3.35
.125	3.18	EZC3018 \$3.35
.200	5.08	EZC3020 \$3.46
.250	6.35	EZC3022 \$4.57
.500	12.70	EZC3024 \$5.70

## Accurate Grids

Grids are produced on accurate, stable film with 0.1" pattern for maximum accuracy. Matte one sided. .003" thick.

Sheet Size	Catalog Number	Price
8" x 11" (216 x 279 cm)	EZ1463	\$2.63
11" x 17" (279 x 432 cm)	EZ1466	\$4.87

## Edge Connectors \$4.37/pack

Center to Center Spacing	Scale	Contacts/Strip	Catalog Number	Strips/Pack
100"	1X	44	EZ6805	2
	2X	22	EZ6809	5
125"	1X	35	EZ6704	2
	2X	17	EZ6716	4
156"	1X	28	EZ6708	3
	2X	14	EZ6720	5

## DIN41612 Connectors All \$4.37/pack

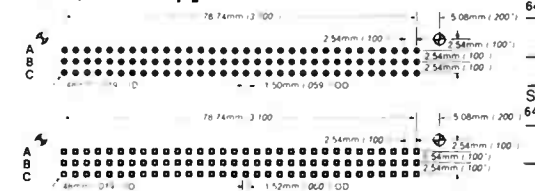

DIN41612 connectors patterns have three row designations A, B and C. Three pattern combinations are available AB, AC and ABC. They are also available with round or square pads.

### ROUND PAD

64-Pin Pattern (A-B)				64-Pin Pattern (A-C)				96-Pin Pattern (A-B-C)			
Scale	Symbols Per Pkg.	Catalog Number	Price	Scale	Symbols Per Pkg.	Catalog Number	Price	Scale	Symbols Per Pkg.	Catalog Number	Price
1X	2	EZ6869	1X	2	EZ6875	1X	2	EZ6871	2	EZ6871	2
2X	2	EZ6870	2X	2	EZ6876	2X	2	EZ6872	2	EZ6872	2

### SQUARE PAD

64-Pin Pattern (A-B)				64-Pin Pattern (A-C)				96-Pin Pattern (A-B-C)			
Scale	Symbols Per Pkg.	Catalog Number	Price	Scale	Symbols Per Pkg.	Catalog Number	Price	Scale	Symbols Per Pkg.	Catalog Number	Price
1X	2	EZ6878	1X	2	EZ6891	1X	2	EZ6884	2	EZ6884	2
2X	2	EZ6879	2X	2	EZ6892	2X	2	EZ6885	2	EZ6885	2

## Knife & Blades

- X-Acto Knife Holder \$3.56
- Use to apply E-Z CIRCUIT pressure-sensitive printed circuit drafting aids
- Use to cut and trim E-Z CIRCUIT pressure-sensitive printed circuit artwork tape
- Ideal for trimming E-Z CIRCUIT pressure-sensitive Copper Tape and Component Mounting Configurations
- Includes X-Acto blade (Order No. EZ3108, shown below)

## X-ACTO REFILL BLADES

- No 16 Blades \$3.05
- 5 blade pack
- No 11 Blades \$3.05
- 5 blade pack

8.30 to 5 Monday to Friday. 8.30 to 12 Sat.  
Mail Orders add \$3.00 to cover postal charges.  
Next day delivery in Sydney add \$5.00.  
All prices INCLUDE sales tax.  
Tax exemption certificates accepted if line value exceeds \$10.00.



## GEOFF WOOD ELECTRONICS PTY LTD

Incorporated in N.S.W.  
656A Darling St, Rozelle 2039  
(One door from National Street)  
Tel: 810 6845



\$10.00 minimum

specialising in electronic components for the professional and hobbyist.



## Tools give constructors more scope

Scope Laboratories, the Melbourne-based manufacturer of soldering irons and related tools, has a super offer going for purchasers who select their 20 watt/240 V general purpose iron — pay an extra \$1.00 on the price of the iron and you get a small toolkit.

The toolkit is an optional purchase, but worth having as it contain a small Philips head screwdriver, a small flat-blade screwdriver, tweezers and a coil of resin-cored 60/40 solder.

These days, you'll find Philips head screws securing the lids of most small plastic 'jiffy' boxes, diecast boxes etc, so you'll find the Philips head screwdriver just right for them. Most Asian-built electronic equipment uses Philips head securing screws, too.

Instrument knob grub screws are generally slotted and require a small flat-bladed screwdriver. The one in the pack is ideal for use on knobs, as well as the smaller BA and Whitworth screws which feature slotted heads.

You'll find the Scope iron in blister packs at hardware stores and selected electronics retail-



ers. Look for the "EXTRA" toolkit packed inside the blister. If you're local supplier doesn't stock the Scope iron with toolkit, Scope may be able to advise you of the nearest stockist. Contact Scope Laboratories at 3 Walton St, Airport West 3042 Vic. (03) 338 1566.



### JAYCAR'S BRISBANE STORE

If you're a Brisbane resident and you've not ventured into Jaycar's Logan Road store, you're probably doing yourself a disservice. It carries all the components and kits that were previously only available from Jaycar's Sydney stores or mail order.

There's plenty of parking off Deshon Street and you'll get a friendly welcome from store manager Simeon Cran and his two sidekicks, Frank and John.

If you want to audition David Tilbrook's AEM6102 two-way speakers, then rock on over to 144 Logan Rd, Buranda.

### PROJECT BUYERS GUIDE

The AEM6010 preamp will be stocked as a kit by Jaycar and Dick Smith Electronics, so far as we know as this issue goes to press. In addition, Geoff Wood Electronics in Sydney has pc boards and can provide all your component requirements for it. All Electronic Components in Melbourne will likely be in a similar position.

The AEM4600 Dual-Speed Modem will be widely available in kit form, we understand. Jaycar, Geoff Wood Electronics and Dick Smith Electronics have indicated they're looking at stocking kits. Most parts for it are readily available. Refer to the '7910 data sheet for suppliers of the 'world chip' which is the heart of the project.

The AEM5502 Microwave Oven Leak Detector might be stocked as a kit by Dick Smith Electronics and possibly Altronics in Perth. Printed circuit boards, with black silk-screened annotation will be available from Geoff Wood Electronics in Sydney and possibly All Electronic Components in Melbourne. The meter is stocked by Altronics (cat. no. Q 0600), Dick Smith Electronics (cat. no. Q-2100) and Jaycar (cat. no. QP-5056). The Hewlett-Packard 2800 hot-carrier diode is widely available.

The AEM2500 Audio Signal Generator is another project that looks likely to be widely available as a kit. The only 'special' component employed in this project is the R53 thermistor made by ITT. Jaycar stocks it, cat. no. RN-3400. You might also enquire from All Electronic Components in Melbourne or Geoff Wood Electronics in Sydney.

If you don't need to purchase a complete kit of any of our projects, and are seeking pc boards, you'll find them stocked by All Electronic Components (Melbourne) and Geoff Wood Electronics (Sydney). In the event you can't get what you want, we keep limited stocks at the magazine. Call us on (02) 487 2700.



### How could you resist?

Now, any hobbyist worth their weight in used solder must have a 'junk box'. It's the prime source of components for fiddling with circuit ideas or for saving money on the latest projects — buy only the bits you don't have in the junk box!

Every now and then, you need to 'top up' the junk box. One of the best ways to do it is to buy bags of 'specials'. Look around and you'll find bags of resistors, capacitors, semiconductors, etc. If you sneak down to any of Zap Electronics' stores in Sydney, you'll find half-kilogram bags of resistors on special for just \$9.90. They're all mixed values and wattages, but mostly quarter-watt types. As resistors weigh but a poofteenth of a gram, there must be Christmas-knows how many resistors in each bag.

You'll find Zap stores located at 16 Anderson St, Chatswood; 60 George St, Parramatta; 51 Burwood Rd, Burwood; and 270 George St, Liverpool. If you can't get to one of them, Zap takes mail orders sent to 10A First Ave, Eastwood 2122 NSW. (02) 858 2288.

### Locating lost keys

No doubt you've mislaid your car and/or house keys at one time or another. Murphy's law sees to it that they cannot be located when you need them most.

Hi-Com Unitronics, a Sydney-based electronics importer and retailer, has a great little alarm that operates on a change in light level. Open the draw, briefcase or whatever you put your keys in, and the device plays "It's a Small World After All".

If you left your keys on a desk or shelf top, just turn off the room lights for tens seconds or so, then on again, and the alarm will sound.

Called the "Keylocator", the device has lots of other uses. Put in the biscuit tin and you'll know when someone's sneaking a bikkie!

The Keylocator costs just \$9.90. Contact Hi-Com Unitronics, 7 President Lane, Caringbah 2229 NSW. (02) 524 7878.

# aem project 2500



## Build this simple audio frequency generator

David Tilbrook

Here's an easy to build, cost effective audio signal generator offering wide frequency coverage from 10 Hz to 100 kHz, sine and square wave output and battery operation for portability and freedom from hum.

A GENERAL PURPOSE audio generator is one of the most useful pieces of test equipment for the professional or amateur electronics laboratory. Unfortunately the least expensive commercial units with reasonable performance cost several hundred dollars. With this in mind we set about to design a low cost audio oscillator that would be suitable for the vast majority of hobbyist applications by providing a realistic combination of features and performance.

After studying the performance of a number of commercial instruments it was decided to provide the oscillator with both sine and square wave outputs. The sine wave distortion performance had to be set at a reasonably low level without causing an unnecessary increase in the cost or complexity. Although there are applications which require an extremely low distortion sine wave these applications also require the use of expensive additional equipment such as noise and distortion analysers or Fourier analysers. For many applications the additional expense of providing superlative distortion performance simply is not warranted. If you require such an oscillator, however, keep reading AEM as we have one planned for the not too distant future.

### Design features

In order to obtain the required distortion performance, and at the same time obviate the necessity of sine wave 'shaping' ad-

justments, it was decided to employ the popular Wein Bridge oscillator circuit technique. A total frequency range from below 10 Hz to beyond 100 kHz is covered in four ranges. Level adjustment is provided by means of a stepped attenuator in conjunction with a fine output level adjust potentiometer.

The step attenuator provides ranges of 3 V, 1 V, 300 mV, 100 mV and 30 mV full output. Both this control and the fine attenuator are located in the circuit at the input of a final output buffer stage to ensure that the unit has a low output impedance that is not affected by the settings of the output level controls. The buffer stage is formed using an NE5534N operational amplifier which is capable of driving a 600 ohm load to its full output supply voltage.

A separate square wave output is also provided by using another operational amplifier, here a CA3130, to act as a comparator. In this configuration, the op-amp is used with no negative feedback applied to the stage to decrease its gain. The inverting input of the device is connected to earth while the sine wave input signal is connected to the non-inverting input. During positive half cycles of the sine wave input the full gain of the op-amp is applied and the output stage of the op-amp is driven hard against the positive supply rail. Similarly, during negative half cycles the op-amp output is driven hard against the negative supply voltage. The result is a square wave output with a peak voltage equal to the supply rail.

We decided to provide separate sine and square wave outputs so that their levels could be set independently and the separate outputs used simultaneously. The square wave output, for example, could be used as an external trigger to an oscilloscope to ensure a perfectly stable trace while using the sine wave to test the frequency response or gain of an amplifier stage. This is a particularly useful function if, for example, a low level amplifier stage is under test. In this case, the sine wave output of the oscillator is applied to the input of the stage and the output level attenuators would be set so that the generator provides an output level similar to that expected during operation. If the input level is very small, such as in the case of the low-level amp



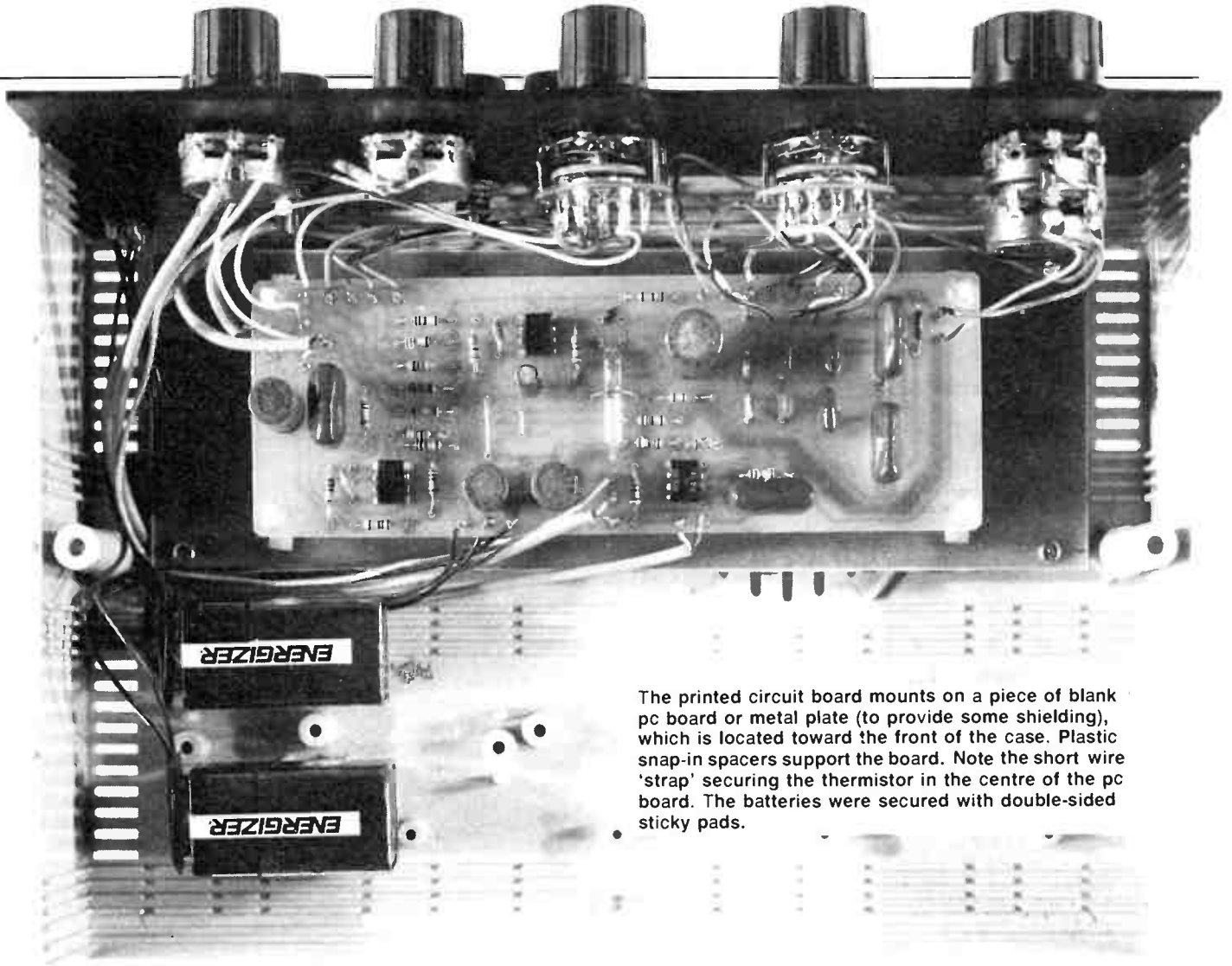

The printed circuit board mounts on a piece of blank pc board or metal plate (to provide some shielding), which is located toward the front of the case. Plastic snap-in spacers support the board. Note the short wire 'strap' securing the thermistor in the centre of the pc board. The batteries were secured with double-sided sticky pads.

stage, any hum or noise present in the stage will represent a significant proportion of the total output signal this often makes it extremely difficult to obtain a stable trace on an oscilloscope. To overcome this problem the square wave output from the generator is applied to the external trigger input of the CRO and a stable trace results.

The square wave output can, of course, also be used as a general purpose square wave source, but since the 1k output attenuator, RV3, lies after the op-amp the output impedance on the square wave output terminals will be a function of the position of the wiper of the pot. The highest impedance (approx 1k) will occur when the wiper is setup approximately to its centre position. In practise, this does not cause a problem since the output is protected from excessive loads by the 560R resistor, R16.

## The Wein bridge

A detailed description of the operation of the oscillator is given in the circuit operation section of this article. However, an introductory discussion of the oscillator principle is warranted at this stage since the Wein bridge is a very common and important circuit. Figure 1 shows the basic circuit of the Wein bridge.

If an ac signal is applied to the input there are two voltage dividers formed by the network. The first of these is a simple resistive potential divider which is formed from R1 and R2. If we regard point B as a ground reference we can see that any input signal applied to point A will be attenuated by the voltage

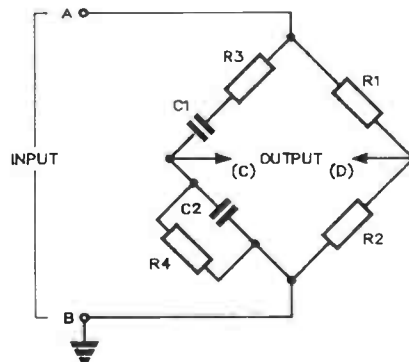

Figure 1. Basic Wein bridge circuit.

divider R1/R2 and a reduced replica of the input signal appears between points D and B. Assuming ideal resistors (i.e. resistors with no capacitive or inductive component), this output voltage will be independent of frequency. Both the phase and amplitude will be constant for all input frequencies. The second of the two voltage dividers is formed by the resistor/capacitor networks R3/C1 and R4/C2. Each of these networks gives rise to frequency dependent phase shifts.

The network C1/R3 gives rise to a phase lead, while C2/R4 gives rise to a phase lag. The phase of the signal at point C with respect to the earth point B will have the same phase as the input signal at only one frequency, when the phase lead and phase

# aem project 2500

lag are equal. At this point the signal is a maximum.

To build a sine wave oscillator using this phenomenon, we incorporate the Wein bridge as part of the feedback loop around an operational amplifier, as shown in Figure 2.

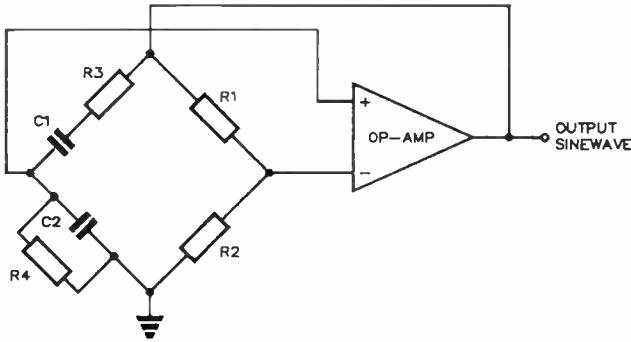

Figure 2. The Wein bridge incorporated with an op-amp to form a sinewave oscillator.

The outputs from the potential dividers are applied to the two inputs of the op-amp. If the ratio of R1 to R2 is set correctly, the circuit will have overall positive feedback at the frequency determined by the phase cancellation discussed above. So the circuit will oscillate at this frequency. The problem is to ensure that the two resistors have exactly the right ratio. If the ratio R1/R2 is too high, the amplitude of oscillation builds up until it reaches the supply rails and a clipped waveform results. If the ratio is too small oscillation stops altogether. The adjustment of this ratio is absolutely critical if a low distortion, amplitude-stabilised sine wave is to be obtained.

To ensure that the ratio R1/R2 is always correct, resistor R1 is replaced by a negative temperature coefficient thermistor. This is basically a resistor that will vary its own resistance according to its power dissipation. If the amplitude of oscillation is too high the power dissipation within the thermistor will be high and its resistance will decrease. If the value of R2 has been chosen correctly, this decrease in resistance will decrease the ratio R1/R2 sufficiently to return the waveform to a clean sine wave. Similarly, if the sine wave amplitude starts to decrease, the

decreasing power dissipation in the thermistor causes an increase in its resistance and the level is returned to normal. This system works extremely well and this oscillator has an amplitude linearity within fractions of a dB over its entire frequency range.

All thermistors have a certain settling time during which the amplitude will tend to display some 'ringing', where the amplitude rises and falls before reaching a steady value. This fairly well damped, however, and stabilises after only a second or two. This 'settling time' arises out of the thermal inertia of the ther-

## AEM2500 CIRCUIT OPERATION

The circuit is based around a Wein-bridge sine wave oscillator formed by op-amp IC1 and the associated Wein-bridge. To enable selection of the frequency range, switching is provided by enabling the resistance in the RC arm of the bridge to be varied. This is accomplished by using the potentiometer RV1 and the series resistors R1 and R2 to form the resistance. This provides adjustment over approximately one decade. To enable frequencies over the complete audio spectrum to be generated, range switching is provided by switching the capacitors in the RC arm of the Wein-bridge using the dual rotary switch SW1. Amplitude stability is provided by the use of thermistor TH1 in the feedback loop around IC1. Capacitors C11 and C12 ensure stability of the oscillator by decreasing overall gain for frequencies outside the operating frequency range.

The output from the oscillator is fed to both a voltage comparator used to generate the square wave output, and via an attenuator to an output buffer stage to the sine wave output.

The sine wave attenuator consists both of a stepped attenuator, formed by resistors R6-R10, in conjunction with the 1k resistance provided by the potentiometer RV2 which also provides a continuously variable output. The attenuator output is fed to a buffer stage formed by IC2 and its associated resistors and capacitors. This ensures that the sine wave oscillator has a sufficiently low output impedance to be useful in the vast majority of applications. The feedback loop is isolated from the output by incorporation of a series resistor R15 in the output while C16 provides dc isolation.

The voltage comparator compares the input sine wave with a ground reference present on its inverting input. The resulting square wave therefore has identical phase characteristics as the input sine wave. Resistors R17 and R18, together with the zener diode ZD1, buffer the supply to the comparator to prevent excessive coupling of the square wave into the sine wave output which would seriously degrade the sine wave distortion performance.

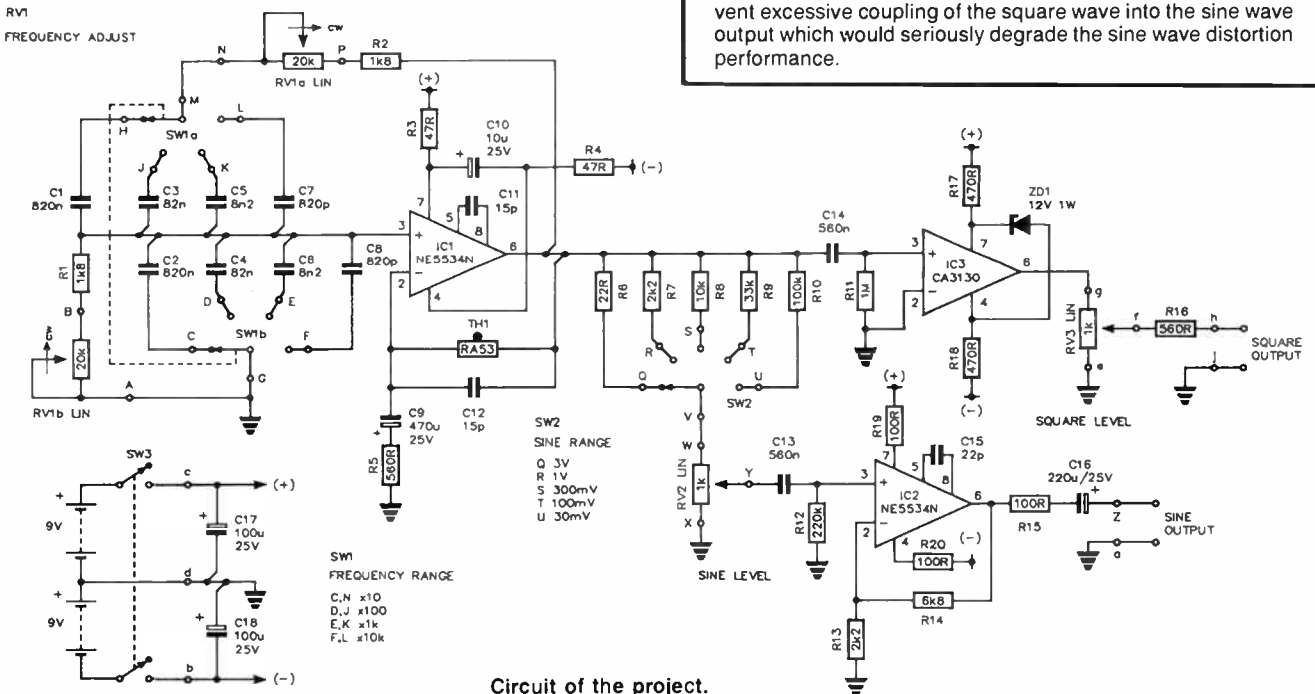



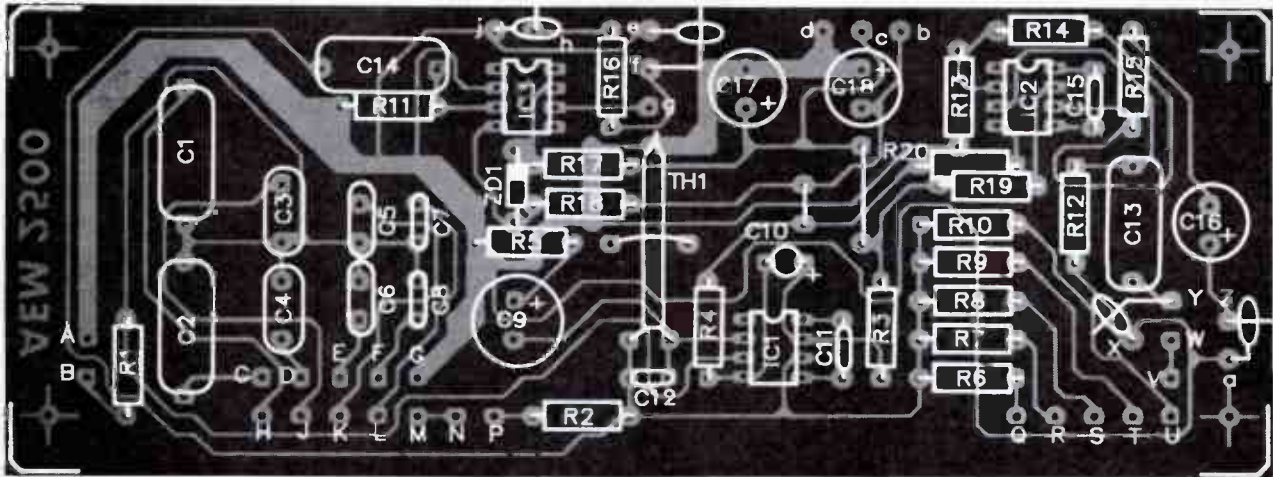

mistor. The thermistor changes its resistance as a result of the temperature of its resistive element; but this element has mass and will therefore take a certain time to change temperature. It is this thermal inertia that enables the device to average the power dissipation within it.

A problem arises, however, at very low frequencies. If the frequency of oscillation is decreased, the period of oscillation can start to approach that of the thermistor settling time. When this happens the thermistor cannot average the power dissipation over a sufficiently large number of cycles, and the temperature, and hence the resistance, of the thermistor begins to be modulated sinusoidally. The effect of this is to increase the distortion of the sine wave at low frequencies.

The only solution to this problem is to use a thermistor with more thermal inertia and hence a longer settling time. In fact, this is not a trivial problem to overcome! Even if the thermistor is replaced with an alternative scheme such as a FET feedback circuit, the accompanying circuitry must still have a certain settling time and all simple circuits suffer from the same problems as the thermistor.

During the development of this project we tried several other feedback systems, and devised one that gave extremely good performance. This system was, however, far too complicated for this project so we have reserved it for the extremely low distortion oscillator planned for a later date. None of the simpler systems tried were as good as the thermistor circuit and were consequently discarded.

## Construction

The construction of the oscillator is not difficult, particularly if you use our AEM2500 pc board design. The first step is to assemble the pc board which is then mounted in the chassis and connected to the components on the front panel via hookup wire.

Start by soldering the resistors and non-polarised capacitors to the pc board. Once these are in place, progress to the semi-conductors. This circuit uses three op-amps which can be mounted using IC sockets if required. Be careful to insert the ICs the correct way around. If these are inserted incorrectly and the unit is powered up, they will almost certainly be damaged. Finally, solder the electrolytic capacitors in place being careful to ensure that these are inserted with the correct orientation.

The wiring between the pc board and the front panel components needs to be done carefully as it is a little complicated. The accompanying wiring diagram shows these connections and this phase of the construction should not be too difficult if the wiring is done neatly. The solder connections to the pc board can be done prior to mounting the pc board in the chassis. The con-

Printed circuit component overlay. The alphabetically labelled points have pc stakes inserted and connect to corresponding points on the front panel components (see over).

## PARTS LIST AEM4501

### Semiconductors

IC1, IC2 ..... NE5534N  
 IC3 ..... CA3130  
 ZD1 ..... 12V,1W

### Resistors

all 1/2 W, 5%  
 R1, R2 ..... 1k8  
 R3, R4 ..... 47R  
 R5 ..... 560R  
 R6 ..... 22R  
 R7 ..... 2k2  
 R8 ..... 10k  
 R9 ..... 33k  
 R10 ..... 100k  
 R11 ..... 1M  
 R12 ..... 220k  
 R13 ..... 2k2  
 R14 ..... 6k8  
 R15 ..... 100R  
 R16 ..... 560R  
 R17, R18 ..... 470R  
 R19, R20 ..... 100R  
 RV1 ..... 20k/A dual lin.  
 RV2, RV3 ..... 1k/A lin.

### Capacitors

C1, C2 ..... 820n greencap  
 C3, C4 ..... 82n greencap  
 C5, C6 ..... 8n2 greencap  
 C7, C8 ..... 820p polyester  
 C9 ..... 470u/25 V electro.  
 C10 ..... 10u/25 V electro.  
 C11 ..... 15p ceramic  
 C12 ..... 15p ceramic  
 C13, C14 ..... 560n greencap  
 C15 ..... 22p ceramic  
 C16 ..... 220u/25 V electro.  
 C17, C18 ..... 100u/25 V electro.

### Miscellaneous

AEM2500 pc board; TH1 ... RA53 thermistor; SW1, SW2 ... 2-pole, 6-position Lorlin rotary; SW3 ... DPDT miniature toggle; 2 x 9 V batteries type 216; plastic instrument case; 2 x 216-type battery clips; assorted mounting hardware; 35 pc stakes; hookup wire; knobs, etc.

**Expected cost: \$60-\$72**

## AEM2500 AUDIO OSCILLATOR

## MEASURED SPECIFICATIONS

<b>Outputs:</b>	Separate sine and square wave
<b>Frequency range:</b>	<10 Hz to >100 kHz, in four ranges
<b>Total Harmonic Distortion:</b>	<0.5%
<b>Amplitude stability:</b>	<0.1 db from 10 Hz to 100 kHz
<b>Sine output level:</b>	Adjustable by output range switch and vernier control. Ranges — 3 V (max.) 1 V 300 mV 100 mV 30 mV
<b>Square output level:</b>	Adjustable by output vernier control. 0 — 6 V peak-to-peak
<b>Power supply:</b>	2 x 9 V, No. 216 batteries
<b>Power consumption:</b>	20 mA total.



# XMAS TIME IS KIT GIVING TIME

(to yourself that is. . .)

**Join the Compact Disc Owners Club - ring (02) 747 1888 or call in to one of our stores for details.**

## NEW KITS FROM JAYCAR

The big news this month is from Electronics Australia. They announce 2 major projects in their December issue.

The first project is the world beating AM stereo/FM stereo fully synthesised Hi Fi tuner. The staff of EA have designed a tuner which they believe has no peer. Nothing from Japan, Europe or the USA can beat it. Because of the complexity, this project will run over several months.

Jaycar as usual will be providing a full kit of this project. It will include a fully punched chassis with all original components. We have not finalised costing yet BUT save your pennies! You won't believe the sound once you have built it.

Project No.2 is a fully functioning 5 axis robot arm with substantial and payload capability. This robot features a unique construction material - blank printed circuit board!! All axes are precision servo-controlled and a considerable amount of software is provided. Truly an exciting and world class project! Also of note is the Dave Tillbrook designed ultra-fidelity preamp. Jaycar will have a full kit of this one too!

## ☆☆ NEW ☆☆

### Motor/Gearbox Kit

This fantastic new kit enables you to produce a shaft speed between 3 and 2,000 RPM!

It uses a small DC motor with a modular gearbox attached. You are supplied with gear wheels, spacers etc to configure your gearbox to almost any speed within the 3-2,000 RPM range. Measures only 48(H) x 25(W) x 37(D)mm (not including output shaft) Cat. YX 2600

**ONLY \$14.95**

## OTHER POPULAR KITS

Please excuse the lack of photographs - not enough space.

### Electronics Australia Popular Kits

#### ☆ Playmaster Series II 200W MOSFET Amp

Cat. KA-1500 Fully integrated amp kit. No compromise type design. A classic.

**ONLY \$459.00**

**Car Booster Amp** - EA August 1985. This brute gives you 2 x 50W RMS in your car! Cat. KA 1600

**ONLY \$179.00**

#### 300 WATT Inverter (New Design)

Ref. EA September 1985. New rugged project featuring high impact plastic case, double power outlets, auto start up, easy construction and lower cost than old model. Cat. KA 1610

**ONLY \$199.00**

#### 8 Sector Burglar Alarm

Ref. EA January/February 1985. the TOTALLY PROFESSIONAL alarm for the concerned householder. Very comprehensive. Cat. KA 1580

**ONLY \$149.00**

#### "PEST OFF" Ultrasonic Pest Repeller

EA November 1985. A mozzie season special. See last months EA for more information. Cat. KA 1620

**ONLY \$39.95**

#### Bench Type Digital Capacitance Meter

Ref. EA August 1985. measure from 1pF to 99.9uF with this handy piece of equipment. Cat. KA 1595

**ONLY \$79.95**

## ELECTRONICS TODAY INTERNATIONAL

### ETI 5000 Series Amps

Still without doubt our most popular Hi Fi amp kits ever! You KNOW that you always wanted the best. Now that it's Xmas time why not shout yourself a system on your Bankcard?

**ETI 699 Modem** - Ref. May 1985. One of the most popular ETI kits for years. 300 Baud, built to Telecom specs. and very low cost! Cat. KE 4695

**ONLY \$149.00**

### ETI 1404 4 Input Mixer

Ref. July 1985. Jaycar's SHORT FORM kit now includes the Cannon connectors at no extra cost. Cat. KE 4700

**\$99.00 - A Bargain!!**

### ETI 341 Electronic Jumper Leads

A nifty and easy way to recharge a flat battery in a car without lifting the bonnet! Cat. KE 4703

**ONLY \$39.95**

### ETI 698 Microbee Dialler

Ref. July 1985. A handy addition to the Bee if you are into communication. Cat. KE 4696

**ONLY \$23.95**

### ETI 342 Pulse Shaped Discharge Ignition

Ref. April 1984. Brilliant Design. A must for high performance ignition enthusiasts. Can be Hall Triggered. Complete kit. Cat. KE 4690

**ONLY \$79.50**

### ETI 675 RS-232 to Centronics Interface

One of our most consistently popular kits. Cat. KE 4666

**ONLY \$29.95**

## AUSTRALIAN ELECTRONICS MONTHLY KITS

### AEM 3500 'The Listening Post'

Ref. July 1985. Decode all that info on your short wave radio to show Morse code, RITTY, Weather maps etc. Wonderful! (A personal computer is required) Cat. KM-3015

**\$29.50 Very Popular**

### AEM 6500 60/120W Utility Mosfet Amp

Modules designed by David Tillbrook. Brilliant performance 60W or 120W versions. Cat. KM-3010 (60W)

**ONLY \$49.50**

**ONLY \$65.00**

### AEM 8500 Courtesy Light Extender

Ref. November 1985. Fit this to your car and your cabin light will stay on for a specified period - just like the very expensive cars! Cat. KM-3025

**ONLY \$8.95**

### AEM 9500 Beat Triggered Strobe

Dance to the inbeat flash or the strobe or operate it in conventional fashion! Complete kit. Cat. KM-3018

**ONLY \$59.00**

Jaycar also carries dozens of other EA kits - just ask!!

**MAIL ORDER HOTLINE (02) 747 1888**



## ☆☆ NEW ☆☆ 300 WATT INVERTER WITH AUTO START NOT A KIT - BUILT, TESTED & GUARANTEED

This is the built version of the 'Electronics Australia' September 1985 project!

Just think how handy it would be to have 240 volts AC mains power when camping, or for your boat or caravan - well this brilliant new design is the answer.

- Super compact - tough ABS case
- Uses high efficiency toroid transformer which keeps the weight down, battery drain and heat dissipation
- Auto start draws power from your battery on when appliance is plugged in and 'turned on' i.e. battery can be left permanently connected
- Thermal overload automatically shuts down if/when output stage is overheated (through high ambient temperature and high load or combination thereof - automatic reset)
- Current regulated inverter ensures the unit is being used within designed overload limits
- Current overload unit self limits - LED indicates overload condition

COMPLETE KIT VERSION

**ONLY \$199.00**

FULLY BUILT & TESTED

**ONLY \$249.00**

Cat. KA 1610

Cat. MI-5000

## INFRA RED MOVEMENT DETECTOR

The infra red or IR detector for short, falls into the Black Magic category. It basically is a high gain passive tuned receiver of a particular IR band. The heart of the unit consists of a high gain lens (antenna?) which has a 'Commutated field of view. Its reception pattern is comb like, but highly tuned to the IR wavelength of human bodies. When a human passes within proximity of the pickup area, the lens will selectively pick up IR radiation and then not. Movement across the pickup area will result in a series of pulses sent to a detector circuit. IR detectors are very reliable as they do not transmit and will not respond to non heat radiating objects. Curtains, for example, can wave about without tripping the alarm. Even the cat is unlikely to trip the unit.

### FEATURES:

- 12V DC powered
- Small 77mm x 62mm x 51mm
- Double sensor
- Computerised OC to lower failure rate
- Built-in test lamp
- Alarm output SPST 30V DC @ 1A
- NO or NC terminations

Cat. LA 5017

**SAVE \$20.00 ONLY \$89.00 ea**

**OPEN THURS NIGHT 'TILL 8.30 p.m. YORK ST. CITY HURSTVILLE CARLINGFORD BRISBANE**

## AEM 6010 ULTRA FIDELITY PREAMP

Ref. Australian Electronics Monthly. As we write this kit is nearing completion. By the time that you read this we will have the full kit price. Call in or ring us for further details.

## AEM4600 'DUAL-SPEED' MODEM



Get into the computer communications revolution with this fantastic new modem from Australian Electronics Monthly. Designed to meet Telecom specs, it features 300/300 and 1200/75 baud operation giving you access to all those bulletin boards and information services across the country. It employs simple, single board construction with the power supply on-board. If your computer has an RS232 serial interface (which most have, these days), then this modem's for you.

**ONLY \$169.00!**

Cat. KM3030





# DO IT YOURSELF IN DECEMBER & SAVE!

## INTERCOM BARGAINS HUGE SCOOP PURCHASE!!

**DEAL 1**  
2 station telephone system with call button. Units can be up to 2km apart. Quality units. Size 76 x 224 x 80mm.  
Cat. AJ-5506  
**\$69.95 per pair (system)**

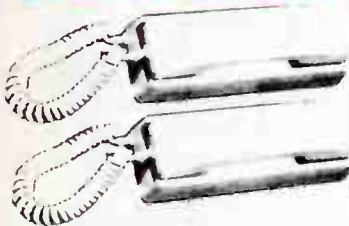

**DEAL 2** 10 station all master common talk telephone system. Allows one conversation at any one time between two and/or all stations - suitable for installations requiring between 3 to maximum 10 stations - call selector button to each station - each unit with readily identifying function box (previous wiring experience not required) - adjustable volume control - wiring 13 strands (for 10 installation) - distance to 1000 metres - power source (each unit) 12V DC - idling current 1.9mA - Dimensions 225 x 100 x 80mm  
Cat. AJ-5508  
**\$69.95 per station**



## TRANSFORMER BARGAINS!

Two small power transformers at never-to-be-repeated prices. Stocks strictly limited.

**ALT-2** 240V to 6, 9 & 12V AC at 300mA. Conventional chassis mount  
Cat. MM-1994

**ONLY \$3.95**

**ALT-3** 240V to 6, 9 & 12V AC at 500mA. Chassis mount  
Cat. MM-1996

**\$4.95**

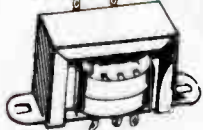

## SCOOP PURCHASE 600 Ohm line transformers SLASHED!!!

Another amazing below cost buy! Australian made chassis mount 600 600 ohm line isolating (or matching) transformer at a bargain price. Both primary & secondary windings are an identical 600 ohms. The transformer measures 27(W) x 20(D) x 21(H)mm and features a grain oriented silicon steel for hi fi. There is no doubt that the unit would pass line level, even +4dB/m without trouble, probably more.  
Cat. MT-4725

**1-9 \$2.95; 10-24 \$2.50  
25+ \$2.25 each**

## ☆☆ NEW ☆☆ CENTRONICS 57 Series Micro Ribbon IDC Line/ Chassis Socket

Quality moulded unit with strong plug retaining clips. Can be chassis mounted or use as a line socket.  
Cat. PS-0896

**\$17.50 each  
10 up \$16.50 each**

IDC plug to suit & solder type are available.

**OPEN SATURDAY  
'TILL 4 p.m.  
ALL STORES**

## Channel 0-28 to go UHF only in JANUARY!

The multicultural channel (0-28) will cease VHF transmissions at the end of December 1985. In order to receive this network properly (which has some GREAT programs on it), you will need a TV antenna with elements cut for the shorter wavelength bands. All commercial channels have UHF channels as well.

Why not use this opportunity to update that old antenna so that your reception continues? Remember you will probably have time over the holiday break and you won't miss a great deal of worthwhile TV as it is a non-ratings period. You may also find you get a better picture on the UHF commercial channels than VHF.

We at Jaycar have updated our range of TV antennas/accessories to provide you with the most cost effective solutions to your antenna problems.

Call into Jaycar for expert advice!

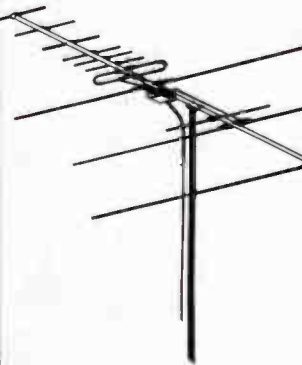

## TV GUTTER MOUNT BRACKET

This is basically a short section of galvanised mast with a clamp at one end. It fixes to a rain gutter or other suitable fixing place. You then have a light duty mast to mount an antenna! 10 metres of 300 ohm terminated lead is included. Ideal for the Quick Rig (Cat. LT-3175).  
Cat. LT-3914

**ONLY \$9.50**

## ☆☆ NEW ☆☆ AUTOMOTIVE TYPE 2 PIN PLUG/SOCKET CONNECTOR

Butlet type moulded plug and socket fits into a matching moulded receptacle. Generous quantity of lead supplied each way. Ideal polarised automotive/marine connector.  
Cat. PP-2016

**ONLY \$2.85**



## ECONOMY RECEPTION

### "Quick Rig" VHF/UHF

#### Primary Reception Antenna

This is our lowest cost VHF/UHF antenna. It is supplied with U-bolt for most mounting. Because it does not present a large wind load it can be gutter mounted via the gutter mount mast bracket. (See Cat. LT-3914).

The Quick Rig is all you need if you live in the majority of the metropolitan areas of the major coastal cities.  
Cat. LT-3175

**ONLY \$44.95  
MAST EXTRA**

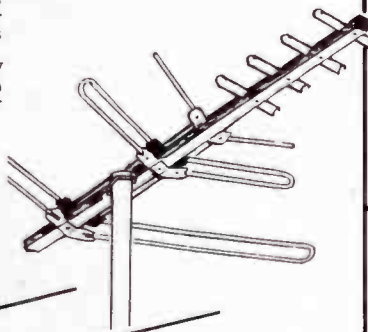

## ☆☆ NEW ☆☆ "GHOST BUSTER" All new VHF/UHF Anti-Ghosting TV Antenna

- ★ Superb front-to-back ratio
- ★ High gain on UHF & VHF
- ★ 75 ohm output
- ★ Very strong but light
- ★ Registered unique design

We expect this to be our hottest seller!  
Cat. LT-3150

**ONLY \$99.50**

75 ohm 'F59' type male connector  
Cat. PP-0640 **ONLY \$1.20**

Call in to Jaycar for a great range of TV accessories including cable, splitters, diplexers, amplifiers etc.

## MULTI FEATURE RECHARGEABLE TORCH

Cat. VS-5035

**ONLY \$29.99**

Firstly other brand name versions of this product sell for around \$45. This unit is better and has more features.

- ★ Automatically comes on as an emergency light
- ★ Exclusive in-built magnet for attachment to steel surfaces - e.g. car
- ★ Cost INCLUDES charger & NiCads
- ★ Swivel head for vertical operation
- ★ Red filter supplied for flashing emergency light use
- ★ Wall fixing screws supplied
- ★ Wall cradle supplied

**NOT \$43  
ONLY \$29.99**



## TRANSISTOR ASSISTED IGNITION

Ref. EA January 1983

Latest version of this fantastically popular kit! The Jaycar kit comes COMPLETE down to the plastic TO-3 transistor covers, genuine heatsink and DIE CAST BOX - as used in the original EA unit. Beware of kits that use flimsy sheet metal. This kit is designed to be used with contact breaker points. If you want Hall-Effect breakerless option we suggest the KA-1506.  
Cat. KA-1506

**ONLY \$37.95**

## TAI HALL-EFFECT "BREAKERLESS"

Ref. EA December 1983

This kit is virtually identical to the KA-1506 except that it contains the interface electronics for the KJ-6655 Hall-Effect Triggerhead.  
Cat. KA-1506

**ONLY \$39.95**

## CONTACTLESS HALL- EFFECT "BREAKER POINTS"

See EA December 1983

A professionally engineered electronic ("breakerless") contact breaker system. Each kit contains the following:

- ★ Hall Effect Triggerhead
- ★ Magnetic rotors for both 4 & 6 cylinder cars
- ★ Over 6 cam lobe adaptors
- ★ Over 12 different adaptor plates for your particular distributor
- ★ Other hardware (i.e. screws)
- ★ Removes from car when you sell it.
- ★ As easy to install as a set of points
- ★ Simple instructions included

Cat. KJ-6655

**ONLY \$32.50**

## OPEN THURS NIGHT 'TILL 8.30 p.m.

**YORK ST. CITY  
HURSTVILLE  
CARLINGFORD  
BRISBANE**

# Jaycar ELECTRONICS

Incorporating ELECTRONIC AGENCIES  
**NUMBER 1 FOR KITS**

**N.S.W.  
SHOWROOMS**

**SYDNEY:** 117 York Street Tel (02) 267 1614  
**CARLINGFORD:** Cnr Carlingford & Pennant Hills Road Tel (02) 872 4444  
**CONCORD:** 115/117 Parramatta Road Tel (02) 745 3077  
**HURSTVILLE:** 121 Forest Road Tel (02) 570 7000  
**GORE HILL:** 188/192 Pacific Highway (Cnr Bellevue Avenue) Tel (02) 439 4799

**QUEENSLAND  
MAIL ORDERS:**

**BURANDA:** 144 Logen Road Tel (07) 393 0777

**HEAD OFFICE:**

115-117 Parramatta Road, CONCORD 2137  
Tel (02) 747 2022 Telex 72293

**SHOP HOURS**

Carlingford Hurstville Gore Hill Brisbane  
Mon-Fri 9am - 5:30pm  
Sydney and Concord  
8:30am - 5:30pm

See Box for other shop hours

**POST & PACKING**

\$5	\$9.99	\$2.00
\$10	\$24.99	\$3.75
\$25	\$49.99	\$4.50
\$50	\$99.99	\$6.50
\$100	\$198	\$8.00
Over \$199		\$10.00

COMET ROAD FREIGHT ANYWHERE IN AUSTRALIA ONLY \$13.50



**MAIL ORDER VIA  
YOUR PHONE**

**FREQUENCY**

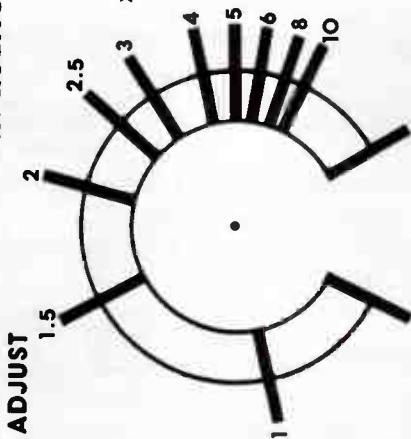

**RANGE**



**RANGE**

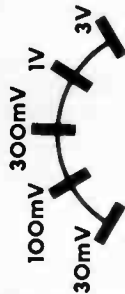

**SINE**

**LEVEL**

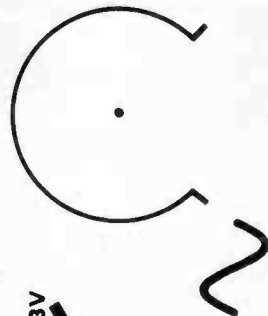

**SQUARE**

**LEVEL**

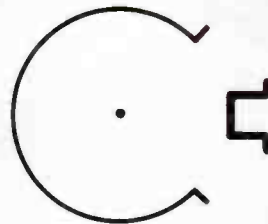

**POWER**

**AEM 2500 AUDIO OSCILLATOR**

Full-size reproductions of the front panel and printed circuit artworks.

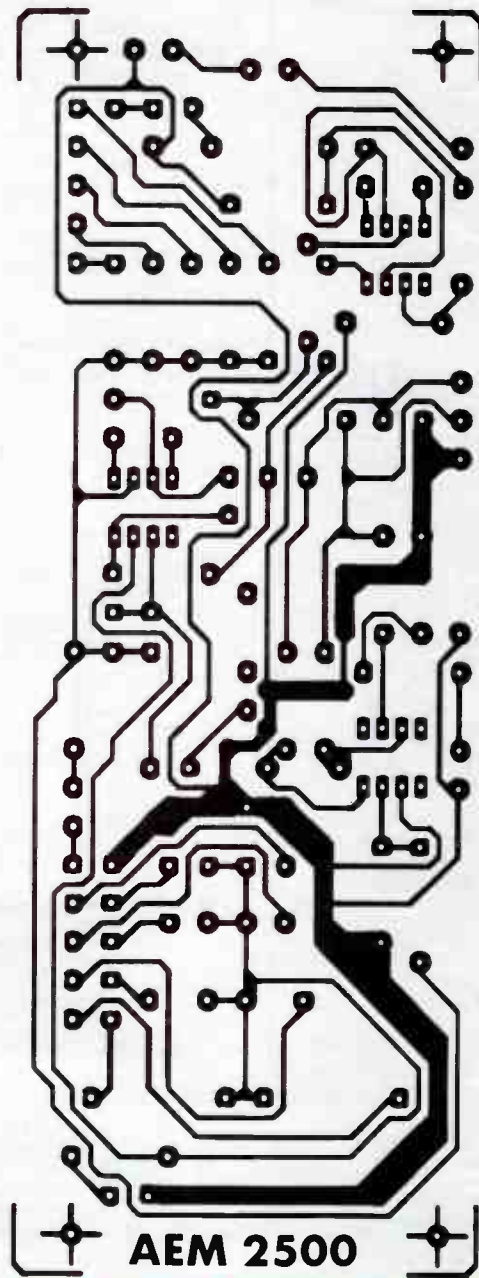

SEE 'RETAIL ROUNDUP' FOR A GUIDE TO KIT SUPPLIERS WHO MAY STOCK THIS PROJECT

nections between the pc board and the front panel can then be made after, soldering to the pins on the top side of the pc board. This tends to make it somewhat simpler to assess the necessary lengths of hookup wire required and helps to ensure a neat job.

The connections to the batteries are made using the standard battery terminals available for this purpose.

There is no specific set-up procedure required for the oscillator since no adjustments are necessary. The usual procedures should be adopted, however, before powering up. Check that all of the components are soldered in place correctly. Be sure to check the orientation of the ICs and the electrolytic capacitors. If all is well the oscillator can be checked either by connecting its output to a CRO or to the input of an amplifier. If the amplifier approach is to be used, set the frequency to around 1 kHz and switch the output attenuator and set the fine adjust attenuator to their minimum settings before turning the oscillator on.



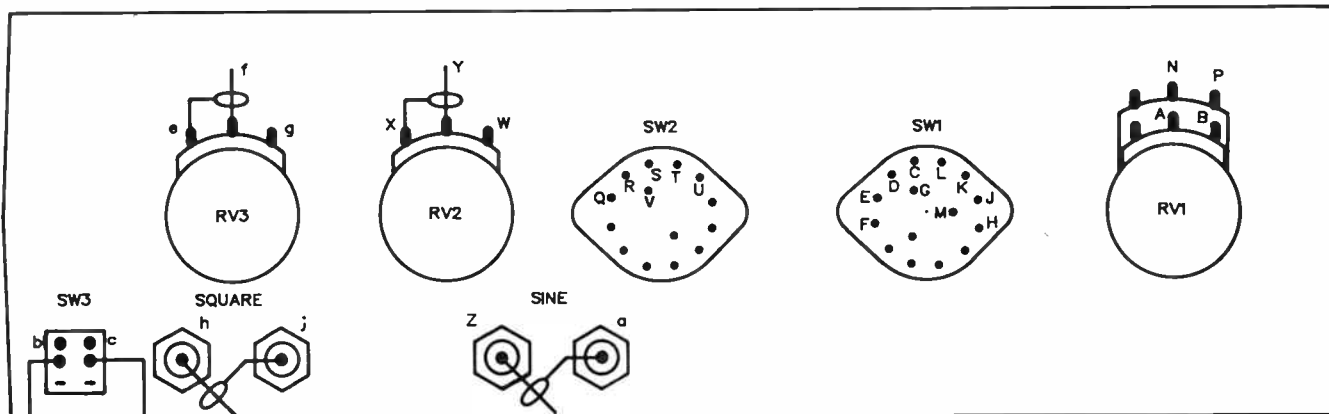
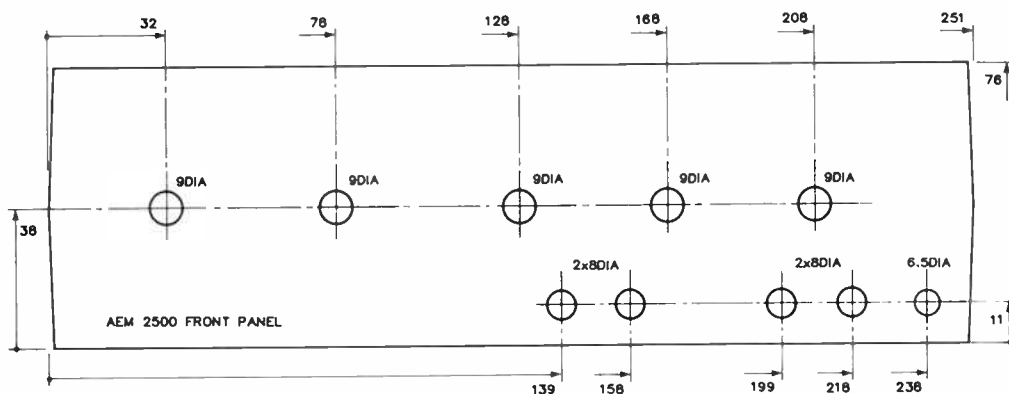
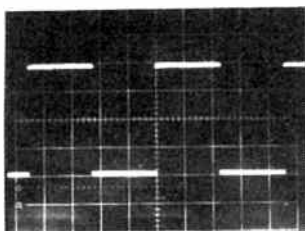

Diagram indicating how the front panel components are wired to the terminals on the pc board.



Front panel drilling details for the H 0482 case.



A: square wave, about 10 Hz. (2 ms/div.)

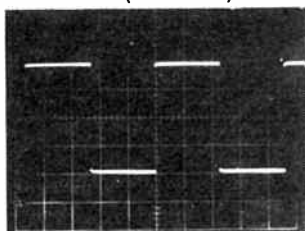

B: square wave, about 1 kHz. (200 us/div.)

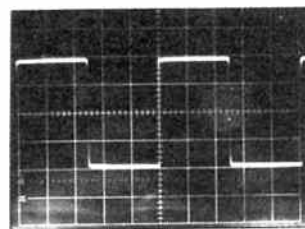

C: square wave, about 10 kHz. (20 us/div.)

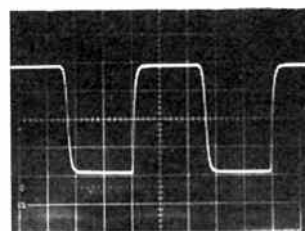

D: square wave, about 100 kHz. (2 us/div.) It's just starting to 'round off'.

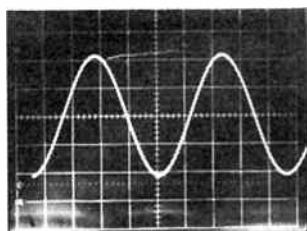

E: sine wave, about 10 Hz. (20 ms/div.)

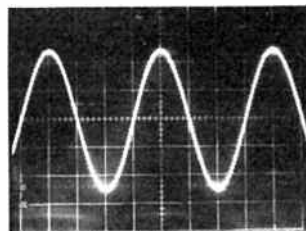

F: sine wave, about 1 kHz. (200 us/div.)

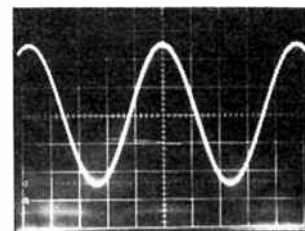

G: sine wave, about 100 kHz. (2 us/div.)

## LEVEL

We expect that constructors of an **INTERMEDIATE** level, between beginners and experienced persons, should be able to successfully complete this project.

Once the oscillator has been switched on, wind up the output controls slowly. This applies particularly when testing the square wave output. If the output level control is set to maximum the oscillator will deliver around 9 V peak, which is more than ample to overload most power amps!

I trust you find the project as useful as I found the first audio signal generator I built (very much like this one), which I have now 'retired'.

# Simple, effective microwave oven leak detector

David Tilbrook  
Roger Harrison

The convenience, simplicity and speed of the microwave oven accounts for its tremendous popularity. An off-shoot of radar technology, the domestic units are well-designed 'mature' products, safe to use if properly cared for. But age, accidents, wear and tear can take their toll. This project provides a simple means of applying a periodic safety check, and is inherently 'fail safe'.

CONSUMER MARKET RESEARCHERS point out that the 'penetration' of microwave ovens in Australian homes is extremely high, especially when compared to other Western countries with similar domestic population make-ups. Australians, it seems, embrace 'new technology' consumer products with a wholehearted acceptance virtually unequalled elsewhere in the world. The introduction of colour TV, video recorders and compact disc players, along with microwave ovens, provide direct testament of this.

Cooking with microwaves has many advantages — as no doubt you've found, being a microwave oven owner. However, as we've all read in the popular newspapers, if not the technical press, microwave energy can be dangerous. Microwave oven designers have taken great care to confine the energy within the cooking chamber. The door fits flush and is held firmly shut, special seals preventing 'leakage' around the door. The viewing window incorporates an internal metal mesh grille to prevent microwave radiation through it. Safety 'cutout' switches are incorporated in the door that isolate the power from the microwave generator when the door is open.

However, Murphy's Law ensures that the real world is not perfect. A mishap or rough handling may warp the door, per-

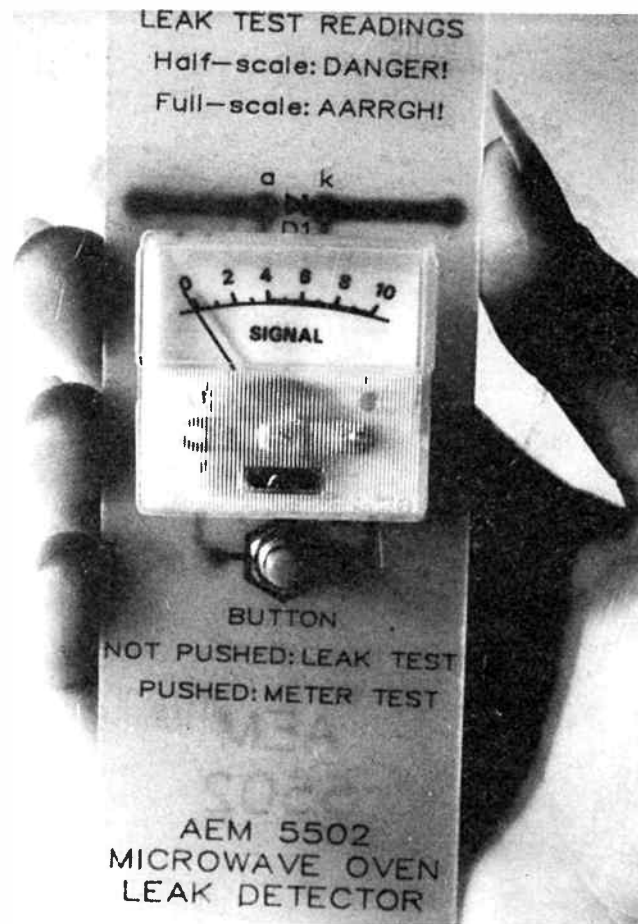

The finished unit — simple, yet functional. Our prototype pc board was made with screen-printed instructions for use, as well as a component overlay.

mitting energy to 'leak' from the resultant gap — even though it may be very slight indeed. Thus, for one's peace of mind, it seems eminently sensible to have some means of checking for 'unsafe' leakage.

## Leaks and leak detection

Let us state right at the outset, that ALL microwave ovens leak to some extent. However, it is the level of leakage that is important. It has been established that a level of microwave radiation (at the frequencies employed by microwave ovens) around 50 milliwatts per square centimetre is a 'safe maximum', under given circumstances, for humans. The eyes are particularly susceptible, apparently. Given this, if you could detect leakage at levels around one-tenth to one-hundredth the given 'safe maximum', then you'd have an adequate warning margin.

Commercial designs we have seen, while generally adequate in operation, have no means of indicating to a user that they are, in fact, operative. Thus, if for some reason the detector were faulty or damaged, the unit would always give a 'safe' indication. Frankly, this worried us a little.



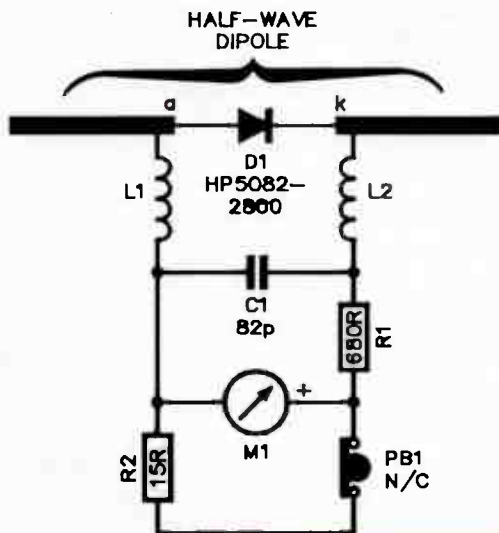

### AEM5502 CIRCUIT OPERATION

A half-wave dipole antenna, made up of two tracks on the printed circuit board and resonated at 2540 MHz, is employed to pick-up microwave energy at roughly this frequency.

A hot-carrier diode (D1), which has an extremely fast response, rectifies the energy impinging on the dipole. At each alternate half cycle, the cathode (k) of D1 goes positive with respect to the anode. This positive half-cycle pulse charges capacitor C1 via the two small inductors ('RF chokes') etched from copper on the board, labelled L1 and L2.

The meter M1 has a full-scale sensitivity of 250 uA. Here, it reads the voltage developed across C1. The meter's sensitivity is reduced by the series resistor R1 and the 'shunt' resistor in parallel, R2.

The pushbutton PB1 is a normally-closed type and when not operated, R2 is in parallel with the meter, thus providing the required sensitivity during 'LEAK TEST' operation of the instrument. When the button is depressed, R2 is removed from the circuit and the sensitivity of M1 is increased for the 'METER TEST' operation. With the values shown, the increase in sensitivity is about ten times.

### Design features

The design presented here can sense the (safe) 'stray' leakage of a microwave oven and thus indicate that the unit is properly working, so you can go on to making a leakage check with confidence. It incorporates a meter, not seen on commercial designs, which gives an indication of the strength of the microwave energy leakage. Commercial designs simply employ a "yes/no" LED indicator.

The unit is constructed on a printed circuit board, no case being employed. The board has been designed to be conveniently held in either hand. In addition to a silk-screened component overlay as a constructional guide, brief, but sufficient, instruction are also silk-screen printed on the board for convenience — the instructions are then always at hand! For this reason, we recommend constructors use a silk-screened pc board when building the project.

As it is recommended that a leakage test be carried out with the detector at a distance of approximately 40 mm from the external surface of the oven, the 'business' end of the board extends 40 mm from the detector diode and antenna. You simply place the end of the board on the surface of the oven where you wish to test for a leak — no need to 'judge' the distance.

The pushbutton permits the instrument to be used for a leak test when it's not pushed. When you push the button the meter sensitivity is increased by a factor of about ten and you can readily obtain a meter deflection from the residual oven leakage.

The detector is basically a microwave crystal set! A dipole antenna, resonant at the frequency used by microwave ovens, picks up the leakage energy which is simply rectified by the diode placed at the centre of the dipole. The dc so produced is coupled to a sensitive microammeter which gives a reading according to the strength of the radiation. Resistors 'scale' the sensitivity of the meter so that full-scale deflection is given at the required energy level.

The unit has been designed to give a full-scale reading with a leakage level of about 5 mW/cm<sup>2</sup> with the button in the 'normal' (not pushed) position. The slightly humorous warnings under "leak test readings", thus indicate any leakage that is well below the 50 mW/cm<sup>2</sup> 'limit'.

### Construction

Assembly of the project is very straightforward. You **must** use the pc board design presented here, else repeatable results will not be obtained. The board has to have a fibreglass substrate, not phenolic, for the same reason. The silk-screened annotation printed on our prototype is not essential, but is nonetheless a handy feature.

### THE MICROWAVE OVEN

The 'thing' that generates all the energy in a microwave oven is known as a **magnetron**. These devices are a powerful, vacuum tube self-excited oscillator. They were developed during WW II for use in radar transmitters to provide the powerful pulses necessary. The types made for microwave ovens operate at around 2540 MHz (2.54 GHz).

The microwave oven employs a simple power supply for the magnetron, and 'safety lock' switches are employed to prevent accidental exposure to the powerful microwave radiation during oven operation.

The cooking chamber simply comprises a metal-walled cavity with some means of ventilation to allow the escape of steam, etc. The microwave energy is coupled from the magnetron to the cooking chamber via a short 'waveguide' duct (which performs a similar task to the coaxial feedline used to conduct energy from a transmitter to its antenna). Some dispersal mechanism 'spreads' the energy within the chamber to prevent RF 'hotspots' and 'deadspots'. Often a 'carousel' rotates the food within the chamber, or a set of metal vanes reflects the energy around.

Some means of controlling the power supplied to the cooking chamber is always incorporated, along with a timer to control how long the food is cooked.

Water in the food is the primary absorbing agent of the microwaves. Dry food and glass or ceramic containers are, for the large part, generally unaffected by the microwave energy. The heat generated by microwave absorption is conducted through the food, which aids the cooking process. In general, the microwave energy only penetrates 15-25 mm below the surface of the food, largely depending on the type of food.

Domestic microwave ovens generally have a power consumption of 1200 watts or more (not counting any electric 'browning' elements). Magnetrons are relatively efficient devices, and around half the input power appears as microwave energy. This is markedly more efficient than conventional cooking appliances, hence the speed advantage of microwave cooking.

The 'wasted' magnetron power appears as heat in the device and for this reason, a fan is employed to keep it cool, exhausting via the rear of the cabinet in all the models we've seen.

## LEVEL

We expect that hobbyists who are **BEGINNERS** in electronics construction should be able to successfully complete this project.

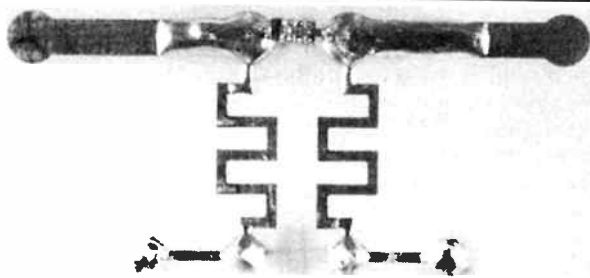

The diode is soldered on the rear side of the board, in the middle of the dipole.

The meter mounts directly on the non-copper (component) side of the board. First check that the holes through which its terminals must pass are drilled the right diameter. The meter, however, is mounted last of all.

Start with the diode. It mounts on the copper side of the board, directly at the centre of the dipole. Make sure you get it the right way round. It must sit flush against the board and be soldered in place with virtually no leads. Do this quickly, and with a hot iron. The diode is quite robust and should withstand this providing you don't apply undue mechanical stress or overmuch heat.

The ceramic capacitor and the two resistors mount on the top side of the board. Solder them in place next. Mount the pushbutton and solder its two connections to the pads on the

board using short lengths of tinned hookup wire.

To mount the meter, place a small blob of Silastic, or similar glue, on the rear and mount it on the board, seating it firmly against the board face. Solder the two meter terminals.

That's it! If you so wish, the rear of the board can be protected simply by spraying-on clear lacquer.

Now you can test it.

## Using your leak detector

Place a bowl or plate of food in the oven and set it going for a period of a minute or so. Hold the board horizontal, with the meter facing up and place the end of the board against the oven surface. Depress the button with your thumb and move the detector around. You should see the meter needle 'kick up' at a variety of positions as you move around.

If the meter needle moves backward, you've got the diode back-to-front!

You should try turning the board so that the dipole's vertical (meter facing left or right) and repeat the procedure (still holding the button down).

With the button not pushed, repeat the procedure. You should see barely a flicker from the needle at the positions it read well up-scale in the previous tests. For the most part, it will likely not show any sign of movement.

Note that, when carrying out a leak test, it is always advisable to place a 'load' of food or water in the chamber. The manufacturers generally recommend that you always operate the appliance with something in the oven to avoid possible damage to the magnetron microwave generator.

You should expect a variation in response with different ovens. This is of little concern as the residual leakage of ovens will depend on a wide variety of factors and is, in any case, normally less than about 0.5 mW/cm<sup>2</sup>.

If your microwave oven gives a significant indication of leakage, contact your distributor or service centre. 🐦

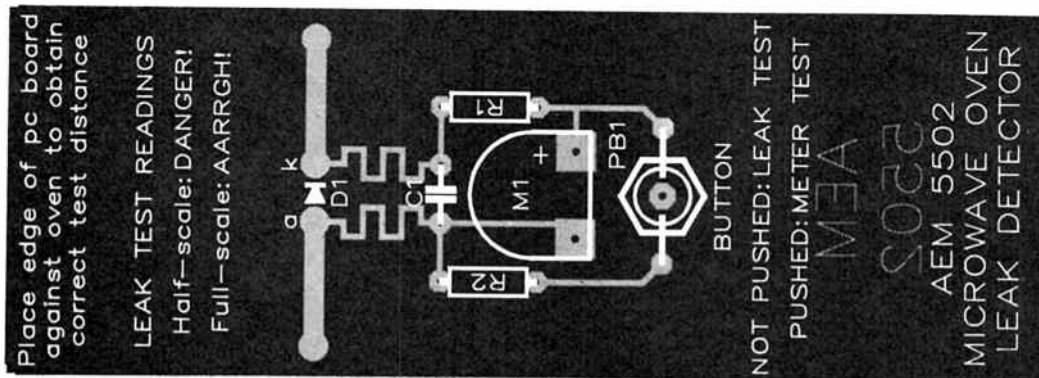

## AEM5502 PARTS LIST

### Semiconductors

D1 ..... HP5082-2800  
hot carrier diode

### Resistors

all 1/4 W, 5%  
R1 ..... 680R  
R2 ..... 15R

### Capacitors

C1 ..... 82p ceramic

### Miscellaneous

M1 ..... 250 uA 'signal' meter (e.g. DSE Cat. No. Q.2100 or similar).

AEM5502 pc board; about 30 mm of tinned copper wire.

**Expected cost:**  
**\$14-\$16**

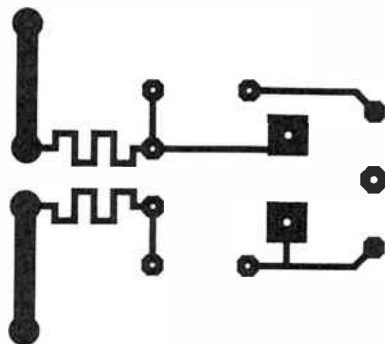

AEM  
5502

Full-size reproduction of the pc board artwork.





# THE IDEAL XMAS KIT!

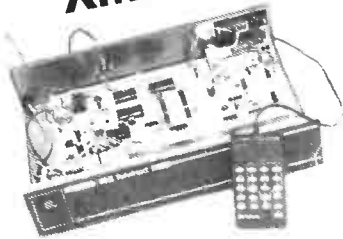

## Teletext Decoder

Get the most from your television with this amazing value Teletext Decoder! There's a mine of information just waiting to be plucked out of the air waves. You'd pay around \$1000 for a Teletext TV; now you can have the same facility for under \$250  
Cat K-6315

**\$229**

## IR Controller

Now, Teletext convenience from your armchair! The Infra-red Teletext Controller is ideal when you just want to sit down and rest. Remote pack has all the same controls as the wired decoder!  
Cat K-3425

**\$49.95**

Buy both and pay

**\$250**

SAVE \$28.95

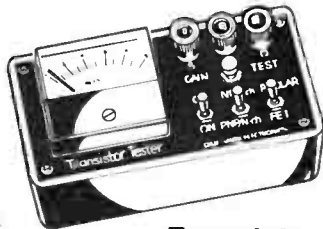

## Transistor Tester

Find that fault — fast! With this fabulous Transistor Tester kit. This one tests bipolar transistors, diodes, F.E.T.s and even S.C.R.s and P.U.T.s! Can even be built by a beginner. A useful and practical piece of equipment you just can't do without! Cat K-3052

**\$19.95**

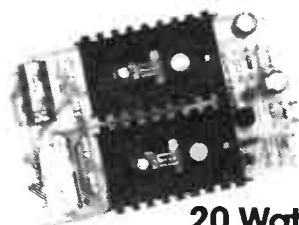

## 20 Watt Amp Module

A handy device for any hobbyist to add to his workbench! A general purpose 20W amp module for television, tape recorders, musical instruments, etc. Uses discreet transistors for reliability and it's great value for money! Cat K-3445

**\$15.95**



## Digital Readout Function Generator

The ideal gift because it's essential for any workshop! Hobbyists, technicians, engineers, etc... all need one! Produces sine, triangle and square waves from below 20Hz to 170kHz with a wide range of output levels! Astounding value!  
Cat K-3520

**\$89**

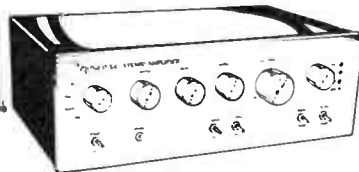

## Playmaster Mosfet Amplifier

The ideal compromise between economy and power! The original Playmaster with an incredible 45 watt output and features you'd pay \$55 more for anywhere else! Give one of these kits for Xmas and it'll be remembered for years!  
Cat K-3515

**\$199**

## Bookshelf Speakers

Now you can have both quality and performance from a 2 way speaker system without it being a lifetime investment! These amazing speakers were designed by DSE and Magnavox to bring you the best value bookshelf speakers available — and that's just what we've done! Cat K-4000

**\$229**

## Complete Security Home Alarm

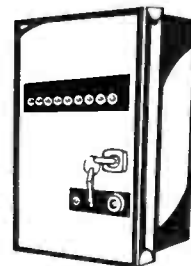

A comprehensive Home Alarm at a low, low price! This superb kit gives you features you'd normally pay hundreds for. 8 sectors, security key operation, built-in mains supply and battery backup... everything! It's a total alarm system at a bargain price!  
Cat K-3424

**\$120**

# IT'S THE PERFECT GIFT! A CHRISTMAS KIT FOR THE ELECTRONICS TINKER!



## SIGHT AND SOUND KITS

K-3035 Mixer preamp	SAVE \$5	\$24.95
K-3143 Musicolour Mk IV		\$109.00
K-3153 Beat Triggered Strobe		\$59.00
K-3415 AM Stereo Decoder		\$39.95
K-3441 60 Watt M/Fet Module (Complete)		\$49.00
K-3443 120 Watt M/Fet Module with Heatsinks		\$69.00
K-3445 20 Watt Amp Module		\$15.95
K-3446 Busker Amp (Shortform Only)		\$79.95
K-3500 Graphic Equaliser		\$129.00
K-3509 Sound Bender		\$32.50
K-3512 Music Generator		\$11.95
K-3515 50 Watt M/Fet Amp		\$199.00
K-3516 100 Watt M/Fet Amp Series 200		\$439.00
K-3060 TV CRO Adaptor		\$33.95
K-3232 M/Head Amp Mk 2		\$32.95
K-3235 UHF TV Downconverter		\$39.95
K-3419 Stereo Enhancer		\$79.95
K-3421 Stereo Simulator		\$23.95
K-3422 VCR Sound Processor		\$52.95

K-6315 Teletext Decoder \$229.00  
K-3425 IR Controller (Teletext) \$49.95

BUY BOTH AND  
PAY ONLY \$250  
SAVE \$28.95

K-3426 IR Repeater	\$34.50
K-3463 Video Enhance	\$33.95

K-3472 TV Pattern Generator	\$33.95
K-6325 Stereo TV Decoder	\$199.00
K-3370 Led Level Meter	\$15.95
K-3036 4 Input Mixer preamp	\$59.95
K-4000 Book Shelf Speakers	\$229.00
K-4001 Low Cost Amp	\$99.00
K-3427 General Purpose Preamp	\$7.95
K-3505 Super Siren	\$14.95
K-3082 Fluoro Starter SAVE \$1.00	\$3.95
K-3095 Micro Wave Leak Detector	\$13.95
K-3333 Negative Ion Generator	\$34.50

NEW IMPROVED DESIGN

## ALARMS AND CAR ACCESSORIES

K-3250 Car Alar	\$11.95
K-3251 U/Sonic Movement Detector	\$23.95
K-3252 Deluxe Car Alarm	\$64.95
K-3253 Car Alarm Mk II	\$29.95
K-3254 4 Sector Home Alarm	\$23.95
K-3255 Ignition Killer	\$16.95
K-3424 Home Alarm	\$120.00
K-3240 Led Tacho	\$23.95
K-3245 Brake Lamp Flasher	\$14.95
K-3301 T.A.I	\$34.95

## AMATEUR RADIO KITS

K-3490 Shortwave Antenna	\$16.95
K-6300 UHF Amateur Transceiver	\$189.00
K-6302 UHF Trans. Upgrade	\$14.50
K-6306 70cm Preamp	\$19.95
K-6308 VHF Amateur Transceiver	\$189.00
K-6310 VHF/UHF Power Supply	\$49.95
K-6312 SWR/PWR Meter	\$39.95
K-6318 VZ-200 RTTY Decoder	\$69.50
K-6335 Cat FAX/RTTY Decoder	\$79.95
K-6330 HF Transceiver	\$349.00
K-6345 Radio Direction Finder	\$139.00

## ASSORTED KITS

K-3052 Transistor Tester	\$19.95
K-3084 Speed Controller	\$19.95
K-3439 Freq/Period Counter	\$119.00
K-3450 LCD Panel Meter	\$34.95
K-3451 Counter Module	\$23.95
K-3453 Appliance Meter	\$39.95
K-3468 RLC Bridge	\$44.50
K-3469 Audio Oscillator	\$44.50
K-3520 Function Generator	\$89.00
K-3432 500 MHz Pre-scaler	\$34.50
K-3335 Negative Ion Gen. Kit WAS \$39.00	\$24.50
K-3438 480 Power Supply	\$21.95
K-3448 VK Powermaster	\$99.00
K-3449 13-8V 5 Amp Power Supply	\$42.50
K-3475 30V Variable Power Supply	\$54.95





# THERE'S NO BETTER WAY TO GET INTO ELECTRONICS THAN WITH THE FUNWAY SERIES! GIVE ONE THIS CHRISTMAS AND IT'LL BE APPRECIATED FOR YEARS TO COME!

## FUNWAY VOLUME 1

Great for the kids!

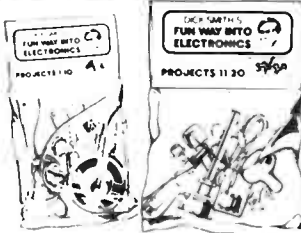

### Projects Kits 1-10

The ideal place to start! Project Kits 1-10 assumes you know nothing about electronics and gets you building 10 useful projects . . . instantly! There's no soldering so you can take your project apart and build the next one. Everything is included! Cat K-2600

Instructions for these kits are in Funway 1

**\$7<sup>95</sup>**

### Project Kits 11-20

Another ten fantastic kits to build! There's really useful things like the Beer Powered Radio and the World's Simplest Transmitter. You'll have hours of fun and learn heaps to boot! Cat K-2610

(Also requires components from Project kit 1-10 to build these kits).

**\$8<sup>50</sup>**

## FUNWAY VOLUME 2

Finished Funway 1 — looking for something else to do? Funway 2 gives you 20 new and exciting projects. They're bigger and they're better! Now you can do it the modern way — with printed circuit boards and soldering. The funway to learn!

K-2621 Flashing Brooch	\$2.95	K-2631 Wireless Mic	\$6.95
K-2622 Canary Door Bell	\$4.95	K-2632 Light Activated Switch	\$5.95
K-2623 Morse Practice Set	\$6.50	K-2633 Metal Pipe Locator	\$6.95
K-2624 Universal Timer	\$6.50	K-2634 Sound Activated Switch	\$7.50
K-2625 Led Dice	\$5.95	K-2635 Home/Car Alarm	\$6.95
K-2626 Mono Phonic Organ	\$8.50	K-2636 Electronic Siren	\$5.50
K-2627 Pkt Transistor Radio	\$8.50	K-2637 Led Level Display	\$9.50
K-2628 Touch Switch	\$5.95	K-2638 Intercom Unit	\$9.50
K-2629 Mosquito Repeller	\$5.50	K-2639 Led Counter Module	\$8.95
K-2630 Basic Amp	\$6.95	K-2640 Shortwave Receiver	\$7.50

### Funway 1 Gift Box

The best Christmas present you could give! Contains Funway Volume 1 and everything you need to build any of the 20 different projects in the Funway 1 series. And it all comes in a re-usable plastic parts tray! Cat K-2605



WAS \$24.50

**\$19<sup>95</sup>**

### Funway Gift Pack Volume 2

The perfect gift and you'll save money! This pack has been specially selected for quality and value! You get Funway Volume 2, a quality DSE soldering iron, a pack of solder, 9 volt battery and the 'Wireless Microphone' kit! You're ready to start! Cat K-2620

Funway Value! **\$19<sup>95</sup>**

## FUNWAY VOLUME 3

It's the next step! Now you're becoming a more advanced hobbyist you'll need extra challenge. 10 great projects to build and many of them can be built in different forms — so there's plenty to keep you going! You'll have a great time with this lot and end up with plenty of useful devices to be proud of!

K-2660 Auto Minder	\$4.95	K-2665 Light and Sound	\$6.95
K-2661 Two Up	\$6.95	K-2666 Combined Timer-Lock	\$9.50
K-2662 Pokey	\$14.95	K-2667 Mini Amp	\$14.95
K-2663 Cricket	\$9.95	K-2668 Binary Bingo	\$12.95
K-2664 Mini Colour Organ	\$6.95	K-2669 Mini Synthesizer	\$12.95

### FUNWAY I, II AND III GIFTBOX

There's 24 fantastic kits to build! The most popular kits from each Funway series. Hours of fun — you'll go from beginner to electronics expert in next to no time! Incredible value Xmas gift — you'll save heaps! Cat K-2680

ONLY **\$49<sup>95</sup>**

### NEW JUMBO FUNWAY BOX

The ideal way to learn all about electronics! Step by step through 30 projects from beginner to expert. Everything you need is right here — all components, PCBs and your very own soldering iron! Make electronics fun with Funway this Christmas! Cat K-2690

ONLY **\$89<sup>95</sup>**



### Fun Way Volume 1

Where it all began! The best selling manual now used as an introductory text book in countless schools, colleges and youth groups. The ideal introduction for beginners from 6 to 66! Cat B-2600

**\$4<sup>95</sup>**



### Fun Way Volume 2

It takes over where Funway 1 finishes, with 20 exciting new projects to try out. But these projects are different! They're all built the modern way — on printed circuit boards. Cat B-2605

**\$6<sup>95</sup>**



### Fun Way Volume 3

Another 100 pages of fun. It's the logical progression for those who have worked through Funway Vol. 1 and 2. It's for the more advanced hobbyist, because Funway Volume 3 projects are based on Integrated Circuits. Cat B-2610

**\$6<sup>95</sup>**

### Funway 3 Bonus Pack

It's extra value! You get the two most popular kits in this series . . . and we throw in the book **FREE!** You get 'Electronic Cricket' and the 'Miniature Amplifier' valued at \$24.90 PLUS, Funway 3 book at no extra charge! Cat K-2670

Ideal for Christmas! **\$24<sup>90</sup>**

**SEE PAGE 108 FOR ADDRESS DETAILS**

**DICK SMITH ELECTRONICS**

PTY LTD

# THOMSON TOPICS



## NEW PRODUCTS FROM THOMSON-CSF

### SINGLE CHIP DPSK MODEM

The EFG751 CMOS features 600 and 1200bps TRANSCODING in BELL 212A and V22-B format and offers low power drain, mixed digital and analogue processing and simple interfacing - ask for full data and applications.

CASE CB-132

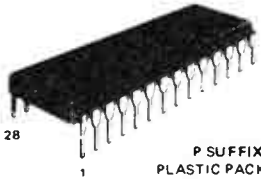

28 P SUFFIX PLASTIC PACKAGE

### VIDEO 8 BIT FLASH CONVERTER

The EF8308 performs up to 20MSPS for digitising video, radar, etc., instrumentation and analysis. Power drain is 400mW from  $\pm 5V$  supplies and interfacing is very simple - available now.

TYPICAL CIRCUIT CONFIGURATION

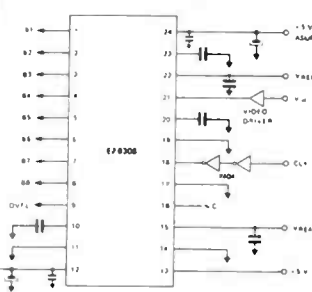

### ISOTOP DARLINGTONS

The ESM Series Darlingtons are ideal for motor drives and power converters in ratings to 85A and 1000V (VCEV). The isolated package greatly simplifies mounting. The transistors are fast and efficient: call for data, we have a full range of fast diodes as well.

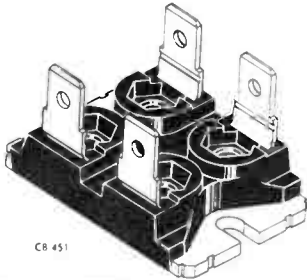

CB 451

### SWITCHED CAPACITOR FILTERS

The TS 85XX HCMOS IC's are used to implement low pass, band pass or high pass functions from 3 to 8 orders in CAUER, BUTTERWORTH and TCHEBYCHEV configuration. They handle input signals from DC to 50kHz, are digitally controlled and are used to make extremely sharp, low drift filters. 2 Op amps are included (16 pin pack) and power drain is from 500  $\mu$ W per order on  $\pm 5V$  supplies - available now.

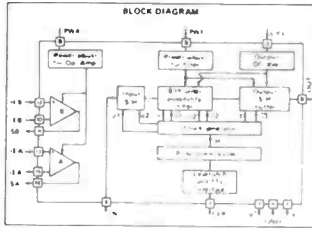

### DUAL 2 Amp SOURCE DRIVER

The TDF1778 is essentially a blow-out proof power driver for inductive and resistive loads - running on 8-32V and withstanding up to 60V. It is programmable for max current, remote shutdown, thermal overload and alarm LED output - very economical to buy.

SCHEMATIC DIAGRAM

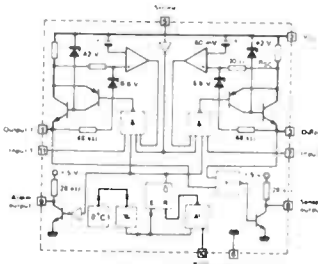

### CMOS DTMF GENERATOR

The EFG7189 can be addressed by serial or parallel data, and provides the standard 16 tone pairs from the on-chip sine synthesisers using a low cost 3.579 MHz Crystal - very cheap and available now.

BLOCK DIAGRAM

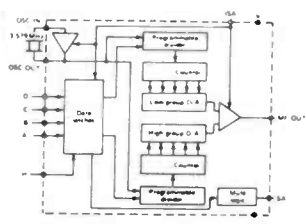

# The AUSTRALIAN ELECTRONICS Monthly

## PC BOARD SERVICE

If your local retailer or board manufacturer is unable to supply you an AEM board, we are carrying a limited number of rolled-tin over copper circuit boards complete with silk screen component over-lay.

### Project

- 1500 Metronome
- 3500 Listening Post
- 6500 Universal Mosfet Amp Module
- 9500 Beat-Tinged Strobe
- 6102 2-Way Speaker
- 5501 Negative Ion Generator
- 4500 Microtrainer
- 6501 4-Input Mixer
- 6010 Ultra-Fidelity Pre-amp
- 4501 8 Channel Computer Relay Interface
- 6502 Order 6500 and 6501
- 8500 Courtesy Light Extender
- 6010 Ultra-Fidelity Amp
- 4502 Real Time Clock

### Retail Price

- \$ 4.67
- \$ 8.06
- \$ 9.69
- \$11.32
- \$21.75
- \$12.35
- \$28.47
- \$20.40
- \$19.06
- \$19.06
- O/A
- O/A
- O/A

Note: The boards found in this issue are also available, price on application.

Please rush me the following boards

Project No. Price \$

Allow a minimum of 4 weeks delivery  
Price includes postage & packing  
New Zealand, add \$1.00 to these charges

All cheques or money orders should be made payable to  
Australian Electronics Monthly

Name .....

Address .....

Postcode .....

I enclose my cheque/money order for .....

Please tick payment method

Cheque/money order  Bankcard  Visa

Mastercard  American Express

Card No. .... Expiration .....

Signature .....

((Note: Unsigned credit card orders cannot be accepted))

You can buy the boards at our offices if you wish, at any time during business hours. We're located at WB Building, Cnr Fox Valley Rd and Kiggle St, Wahroonga NSW, the entrance is in Kiggle St.

# Promark Electronics PTY. LTD.

SYDNEY  
02-439 6477

MELBOURNE  
03-878 1255

TOLL FREE  
008-22 6226



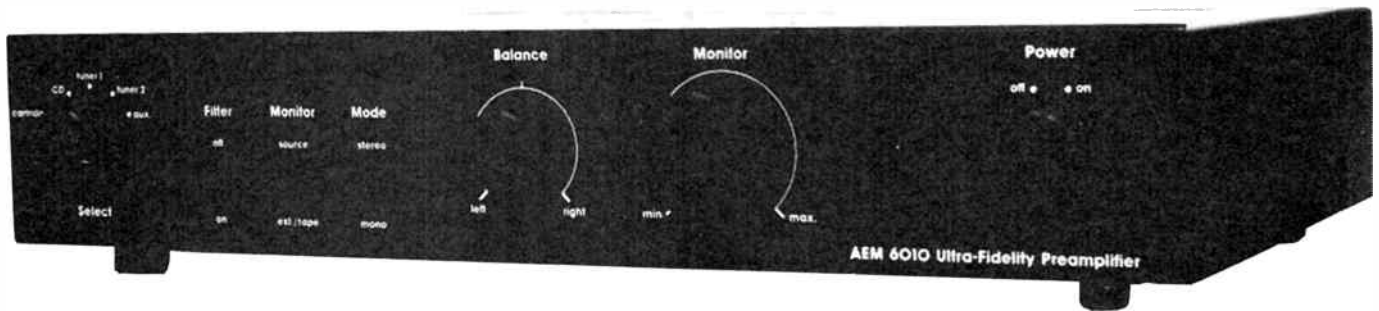

## An 'ultra-fidelity' preamplifier

Part 3  
David Tilbrook

This stage completes the construction, interwiring and assembly of the preamp into the chassis.

BY THIS STAGE, you will have completed the assembly of the four printed circuit boards. Give them all a careful visual inspection. A little time spent doing this now can save lots of frustration later. Check that you have the six capacitors indicated in the penultimate paragraph of Part 2, soldered to the rear of the 6010ma board. All clear? Now we can get down to the 'final leg' — assembling them in the chassis and completing the necessary interwiring.

It is probably wise to use shielded cable for all the interconnections that carry audio signals within the preamp such as those to and from the rear panel sockets. Shielded cable is not difficult to use once a few basic techniques have been mastered. The area that causes most of the problems is usually that of removing the outside insulation without cutting the shield wires. The easiest way to overcome such problems is to invest in an inexpensive pair of insulation strippers. This is a very useful tool for an electronic experimenter and saves considerable time when preparing shielded cables. The easiest type of shielded cable to use is the lightest gauge, single conductor type although there are some excellent multi-conductor cables available.

Once the pc boards have been constructed to this stage they should be positioned in the chassis to be made for the remaining lengths of hookup cable required. Each connecting cable should be cut to length, trimmed and soldered onto the low level amp and line amp pc boards. Once all of the cables are soldered into place the remaining pc boards can be bolted into place and the other ends of the shielded cables terminated to the front and rear boards. This is not difficult since the connections are made to the copper side of the pc boards.

The front panel pc board is held in place by the mounting nuts on the two Lorlin switches and then the three toggle switches. The toggle switches selected for this project are



Showing how the dual-gang volume pot is wired to the front panel pc board.

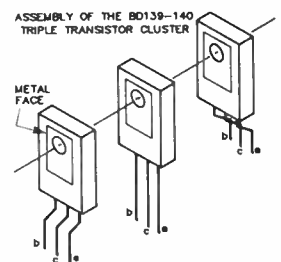

supplied separate from the black linear paddles which should only be fitted to the switches at the last stage. These switches are supplied with both a standard mounting nut and a black dress ring. The standard nut should be adjusted so that the dress ring tightens down correctly on the front panel of the preamp.

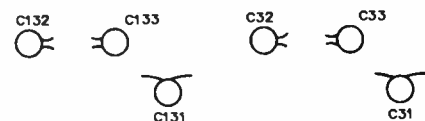

Placement of the capacitors on the rear side of the board.

# "CHRISTMAS GIFTS FROM JAYCAR -

## AT LAST! A low cost 10 Amp Digital Multimeter with transistor test facility

Digital multimeters are very popular these days but good quality ones with 10 amp scales generally cost well over \$100. We think that is too expensive so we've decided to do something about it.

Jaycar is pleased to announce a direct import digital multimeter with sensational specifications at an unheard of price!

Check the specs!

DC VOLT	0.1mV - 1000V
AC VOLT	0.1mV - 700V
DC CURRENT	1uA - 10A
AC CURRENT	1uA - 10A
RESISTANCE	0.1 - 20 Mohm
CONTINUITY	less than 30 ohm @ 1mA
hFE TEST	0-1000 10uA 2.8V NPN/PNP
DIODE TEST	1mA

Basic accuracy of Volts, Current & resistance is between 0.5 - 1.2% depending on range.

### FEATURES

- ★ 0.5 high digits
- ★ High quality probe set supplied!
- ★ Vinyl carry case supplied!
- ★ Built in tilting ball!
- ★ LED & buzzer continuity test!
- ★ Precision thin film resistors used for long term accuracy!
- ★ CMOS logic 1000-2000 hours battery life!
- ★ Single function range switch
- ★ Complete with battery, spare fuse (2AG) and instruction manual!
- ★ Protected ON/OFF switch!
- ★ Auto polarity
- ★ Protected
- ★ Floating decimal point

Cat. QM-1530



**\$89.95**

## AT LAST! A low cost 10 Amp Digital Multimeter/ Transistor Tester & Capacitance Meter!

Jaycar is proud to announce a genuine low cost high performance combination Multimeter/Capacitance meter for the enthusiasts! This unit is all the most commonly needed test gear rolled into one!

Similar units are on the market to sell from around \$150 to over \$200. Why pay more when you can get a Jaycar direct import for less?

DC VOLT	0.1mV - 1000V
AC VOLT	0.1mV - 700V
DC CURRENT	1uA - 10A (20A max 30 secs)
AC CURRENT	1uA - 10A (20A max 30 secs)
RESISTANCE	0.1 - 20M ohms
CAPACITANCE	1pF - 20uF (2%)
CONTINUITY	less than 30 ohms @ 1mA
hFE TEST	0-1000, 10uA 2.8V
DIODE TEST	1mA (Buzzer & LED)

- FEATURES
- ★ 0.5 high digits
  - ★ High quality probes supplied!
  - ★ LED and Buzzer continuity test
  - ★ Precision thin film resistors for long term stability
  - ★ CMOS logic 1000 - 2000 hours battery life!
  - ★ Meter protection Fused
  - ★ Complete with battery, quality probes, spare fuse
  - ★ Floating decimal point
  - ★ Auto polarity
  - ★ Impact resistant case

Cat. QM-1540



**\$129.00**

Join the Compact Disc Owners Club - ring (02) 747 1888 or call in to one of our stores for details.



Cat. SL-2700

## DESK MOUNTED LAMP MAGNIFIER

This unit magnifies any object under a clear cool fluorescent light. The magnification is the maximum obtainable (lens 127mm diameter biconvex 4 Dioptres, focal length 254mm) consistent with minimum distortion and eyestrain and good off angle viewing. It is NOT cheap, but then again it will definitely last a lifetime. It is built like a Rolls Royce (We doubt whether 20 years continuous use would wear out the German made flexible arms for example). Spare fluoro tubes are available either from us or electrical outlets. If you have trouble with fine PCB work or component identification but still want both hands free, this is for you. We thoroughly recommend this quality Australian made product.

### Technical Information

Illumination 22W Fluorescent  
Weight 8.16kg  
Lateral Extension 254mm  
Vertical Extension 254mm  
Fixing Heavy table base (grey) with two chrome plated flexible arms.  
Lens (see text)



**ONLY \$169** MAGGY LAMP

**NOTE:** This is the GENUINE 'Maggylamp' - don't fall for cheap substitutes.

## FREE DEMONSTRATION!

We now have the Dave Tillbrook designed Vifa B" 2 way speakers on demonstration at our Sydney city and Gore Hill stores and in our Brisbane store. Call in now!!

Call in to any Jaycar store in December and see our great range of Christmas gifts. We simply do not have time to list them all.

**YOU WILL NOT BE SORRY!**

## Squeaky Clean Mains Filter

Two fantastic low cost models. MS 4010 will supply up to 4 appliances. Each 240V socket is isolated from the other. i.e. interference from disc drives is de-coupled from the CPU power supply etc. It will supply up to 4 outlets with a total load of 6 amps (unswitched).

Cat. MS 4010

**ONLY \$125.00**

**Single 7.5 amp line socket type filter.**

Cat. MS 4012

(Unswitched)

**ONLY \$34.95**

## ☆☆ NEW ☆☆☆ BALANCE (Curve M-N) POTS

For Playmaster Series 200 Amp Kits  
Were the balance pots missing from your Playmaster 200 amp kit? It certainly would not have been if you purchased a Jaycar kit.

Jaycar has sufficient stocks of the ORIGINAL balance pots (as used in the EA prototype) for other uses. Please note, however, that these pots are the 1/4" shaft pot (with flat) as ORIGINALLY used by EA. They are not metric pots.

You can purchase one of these pots and so finish off your valuable project.

Cat. EE-4200

**ONLY \$3.95**

## BACK IN STOCK VOYAGER CAR COMPUTER FUEL FLOW SENSORS

At last after being out of stock for a year we now have stock. If you are a Voyager owner it may be prudent to buy a spare. The Voyager is now out of production in the UK and we do not expect to ever get any more of this item.

Cat. XC 2036

**ONLY \$45.00**

## ☆☆ NEW ☆☆☆ SOLAR BATTERY CHARGER

Cat. MB-3502

**ONLY \$16.95**

This is a genuine new product which we feel will have tons of appeal.

The solar panel in the lid will charge up to 4 x AA Nicads in a fairly short time! It is ideal for yachts, campers or anywhere where 240V is not readily available. It is NO DEARER than an ORDINARY NiCad charger but takes about the same time to charge in reasonable sunlight.

Solar Panel on lid

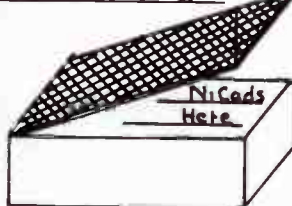

## ☆☆ EXCLUSIVE!! ☆☆☆ GREAT NEW BOARD GAME FOR XMAS! "TUOHK"

A great treat for Jaycar customers who own a Commodore VIC-64

Jaycar is the exclusive NSW distributor of the great new board game called "University of Hard Knocks". Basically the game works like this:

You load a cassette into your VIC-64 which contains 5000 Trivia type questions.

Community chest or Chance

Type statements

Other instructions

You then lay out the attractive vinyl covered playing board and play the game. The computer provides all questions and answers as well as the odd setback if you land on the wrong square. The game can also be played at different levels so accommodating people playing at the same time with different degrees of general (trivial?) knowledge.

The game progresses until you achieve a "Degree" in the trivia subjects that you have mastered.

No computer skill is required. The computer simply provides information to operate the board game.

Around the same price as conventional board games.

Cat. XG 6000

**ONLY \$49.95**

All game pieces etc included.



Call in or telephone Jaycar for a FREE copy of our GIANT XMAS MAILER. It's full of incredible bargains!

## ☆☆ NEW ☆☆☆ HEADPHONE WITH INBUILT MICROPHONE

★ Quality dynamic mic insert. Omnidirectional, 600 ohm impedance, 84dB sensitivity, cord length 7 feet.  
★ Headphone 40mm Mylar drivers, 400mW rating, 28-32 ohm impedance, stereo, 6 foot cord.  
These quality phones feature an excellent ymbal mic boom adjustment. This multi axis adjustment enables you to position the mic comfortably close to your mouth - no matter what shape head you have!

Cat. AA 2020

**ONLY \$29.95**

- ★ Ideal for pop groups
- ★ CB, amateur radio use etc
- ★ Telephone etc



## 240V NEGATIVE AIR IONISER

Whilst the scientific proof is thin, many people swear by the efficacy of negative ionisers. This unit is locally made and highly regarded.

Cat. YX 2900

**ONLY \$69.95**



## MAIL ORDER HOTLINE (02) 747 1888

## ETONE 10" SUBWOOFER

As used in the Electronics Australia subwoofer system.  
★ Size 10" (250mm) ★ Cast frame. QT = 0.39, VAS = 63.  
★ Power handling 100 watts rms ★ Free air resonance 32Hz ± 1Hz ★ Voice coil diameter 2" ★ Magnet assembly 3kg (6.6lbs)

Cat. CW-2119

**ONLY \$99.95**

## AA NICADS RECHARGEABLE BATTERIES

AA size, 1.2V 450mA. Charges at 45-50mA (14-16 hours). Will outlast well over 1000 recharge cycles with average use.

Cat. SB 2452

1-8 \$2.50  
10-24 \$2.20  
25-99 \$2.00  
100 up \$1.80 each

## OPEN THURS NIGHT 'TILL 8.30 p.m.

**YORK ST. CITY HURSTVILLE CARLINGFORD BRISBANE**

## QUARTZ CRYSTAL CLOCK MOVEMENT

• Very compact and reliable • Self starting one second stepping motor has strong torque • Powered by 1.5V AA battery that lasts for one year • Supplied with one set of hands • ±1S second/month accuracy • 56mm square, 15mm deep • Complete with data sheet, instructions

Cat. XC 1000

**ONLY \$12.95**



# HOW APPROPRIATE - FOR YOU"

## "VIFA" 8" 2 WAY SPEAKER KITS

See AEM magazine in August  
**TWEETER D25TG** Cat. CT-2020  
**\$59.95 ea \$119/pair**  
**WOOFER P21WO** Cat. CW 2132  
**\$149 ea \$298/pair**  
**CROSSOVER NETWORK**  
 Not a kit, now a factory built precision unit  
 Cat. CX 2630  
**\$69.95 ea \$139/pair**  
**TOTAL PRICE \$557.90**  
**SPECIAL PACKAGE PRICE \$499**  
**SAVE \$58.90!!**



## REVOLVING LIGHT BEACON

Cat. LA-5108  
**ONLY \$38.50**  
 This is the REAL THING! A true motor driven revolving BEACON with automotive type 12V lamp. Ideal for tow trucks and other emergency vehicles as well as burglar alarms etc.



## UV EPROM ERASER

Erase your EPROMs quickly and safely. This unit is the cost-effective solution to your problems. It will erase up to 9 x 24 pin devices in complete safety, in about 40 minutes for 9 chips (less for less chips)

Erase up to 9 chips at a time  
 Chip drawer has conductive foam pad  
 Mains powered  
 High UV intensity at chip surface ensures thorough erase  
 Engineered to prevent UV exposure  
 Long life UV tube  
 Dimensions 217 x 80 x 68mm  
 Weight 670 grams  
 Cat. XE 4950



**ONLY \$99.50**

## "QUARTZ KIT" set of 6 LCD Watches

Cat. XW 0270

**ONLY \$14.95**

This is once again an ideal childrens gift. 6 separate cases are provided to maintain the child's interest. The watch module itself snaps into the case. This module is actually Japanese made and is of high quality.



## QUARTZ ALARM CLOCK

Cat. XC-0114

**ONLY \$9.95**

This style of clock has been around for some time now but now at a very low price. Note the special cradle that allows you to wall mount the clock and remove it when necessary.



## ULTRA SLIM QUARTZ

Cat. XW 0310

**ONLY \$8.95**

This ultra thin watch is a copy of the latest "high fashion" watches from Japan. Note the triangular yellow function change button on the face of the watch - not the small difficult to operate button normally found on the side.



## Quartz Stop Watch

Cat. XW 0380

**ONLY \$16.95**

Attractive all weather watch with all stopwatch functions as well as 5 function watch! (i.e. day, date etc). Note the generous length knitted lanyard. Very easy to use!

## ELECTRONIC TELEPHONE DIRECTORY

Cat. YT 6500

**ONLY \$59.95**

Firstly, it must be emphasised that this is a very high quality product.

- ★ It can store up to 64 separate telephone numbers or other numbers
- ★ It is a clock (an excellent travel clock in fact)
- ★ It has an alarm in the clock function
- ★ It is a full function calculator
- ★ It is supplied with a quality Dralon pouch
- ★ It uses readily available AAAA batteries



## ☆☆ NEW ☆☆ TELEPHONE CALL DIVERTER

Cat. YT 6505

**ONLY \$159.00**

This piece of equipment enables you to REROUTE that important telephone call to ANOTHER LOCATION unbeknownst to the caller! A more satisfactory solution in many ways than a complicated telephone answering machine.

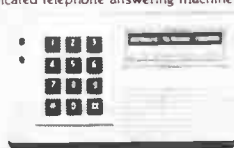

**OPEN THURS NIGHT 'TILL 8.30 p.m. YORK ST. CITY HURSTVILLE CARLINGFORD BRISBANE**

## Hands-Free 10 Memory Desk/Wall Telephone

● Loud and clear fully duplex hands free 2 way speaker ● 10 direct access memories ● Telephone line powered ● Unauthorised call restriction lock (optional) ● Adjustable volume control switch on handset ● Adjustable speaker volume control ● Privacy muting button ● Ringer Hi-Lo control ● Ten 12 digit memories plus one 22 digit last number redial ● Wall mounting or table use ● Programmable PABX pause  
 Cat. YT-7092

**ONLY \$175.00**

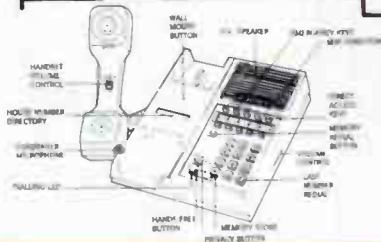

## KID'S LCD NOVELTY GAMES

Cat. XT 1500

Cat. XT 1501

Cat. XT 1502

Cat. XT 1503

Cat. XT 1504

Marshall  
 Tom's Adventure  
 Coffee House  
 Home Sweet Home  
 Nursey

**ALL PRICED AT \$15.95 each**

Very popular when they were retailing last Christmas at \$34.40. Now they are at a much more realistic price. Ideal Xmas gift for 4-8 year olds - batteries included.

## "CALLMASTER" Telephone Answering Machines

Two models available: both Telecom Approved (Telecom Permit # CB1-16-18) and Electricity Authority approved (Certificate # CS2029N). ● Dual cassettes. Once only outgoing recorded announcement. You can play back the messages on any cassette player including your car. ● Large incoming message capacity - up to 150 messages on a C-60 (12 seconds average call). ● Easy change of outgoing message. ● Callmaster stops at end of incoming message. Eliminates blank spots on the tape. ● Precision and quality Japanese made. Need we say more? ● 12 months warranty  
 Cat. YT 7010

STANDARD TA100

\$245.00

Cat. YT 7020

**REMOTE CONTROL VERSION** (all the features of the TA100 plus remote control)

**ONLY \$319.00**

**OPEN SATURDAY 'TILL 4 p.m. ALL STORES**

# Jaycar ELECTRONICS

Incorporating ELECTRONIC AGENCIES  
**NUMBER 1 FOR KITS**

**N.S.W. SHOWROOMS**

SYDNEY: 117 York Street Tel. (02) 267 1614  
 CARLINGFORD: Cnr Carlingford & Pennant Hills Road Tel. (02) 872 4444  
 CONCORD: 115/117 Parramatta Road Tel. (02) 745 3077  
 HURSTVILLE: 121 Forest Road Tel. (02) 570 7000  
 GORE HILL: 188/192 Pacific Highway (Cnr Bellevue Avenue) Tel. (02) 439 4799

**QUEENSLAND MAIL ORDERS:** P.O. Box 185, CONCORD 2137  
**HEAD OFFICE:** 115-117 Parramatta Road, CONCORD 2137  
 Tel. (02) 747 2022 Telex 72293

### SHOP HOURS

BURANDA: 144 Logan Road, Tel. (07) 393 0777  
 Carlingford Hurstville Gore Hill Brisbane  
 Mon-Fri 9am - 5:30pm  
 Sydney and Collierville  
 8:30am - 5:30am

See Box for other shop hours

### POST & PACKING

\$5	\$9.99	\$2.00
\$10	\$24.99	\$3.75
\$25	\$49.99	\$4.50
\$50	\$99.99	\$6.50
\$100	\$198	\$8.00
Over \$199		\$10.00

COMET ROAD FREIGHT ANYWHERE IN AUSTRALIA ONLY \$13.50



**MAIL ORDER VIA YOUR PHONE**



Overall view of the front panel pc board, showing how the switches mount on the front (non-copper) side.

The toggle switches and DIN sockets fitted to the rear panel mount through both the rear panel and the rear panel pc board and are wired using the shielded cables and hookup wires already soldered to the main pc boards.

The final stage in construction is to fit the toggle switch linear paddles and the knobs. The toggle switches have flats on the selector so the linear handles will only go on one way.

In the prototype unit we used 22 mm black knobs for the selector switch, balance control and power switch. A larger, 28 mm, black knob was used for the monitor volume control.

### Powering up

Before applying power to the unit recheck as much as possible. Check the orientation of diodes and polarised capacitors, check that the correct types of transistors have been inserted and check the power supply connection between the line and low level pc board. If these are incorrect it will almost certainly damage the low-level pc board assembly.

If all is well, connect a 35-0-35 V RMS transformer to a DIN plug according to the wiring diagram and apply power to the preamp. When the unit is switched on the amplifier muting relay should be heard to click approximately one second after switching on. The relay should switch immediately the preamp is switched off. Check that the power LED on the front panel is operating when the preamp is switched on.

If all is well turn the preamp off and connect it to a power amplifier, signal source and loudspeakers. Ensure that the balance is centred and the monitor volume is turned fully down. Switch the preamp on and slowly wind up the volume to a comfortable listening level and check the project behaves as you would expect.

If you intend to build the AEM6000 power amplifier (... coming!) you will only need to use the external transformer temporarily. The power amp will be provided with a suitable ac outlet to run the preamp and other accessories that are planned for this range of AEM audio electronics.

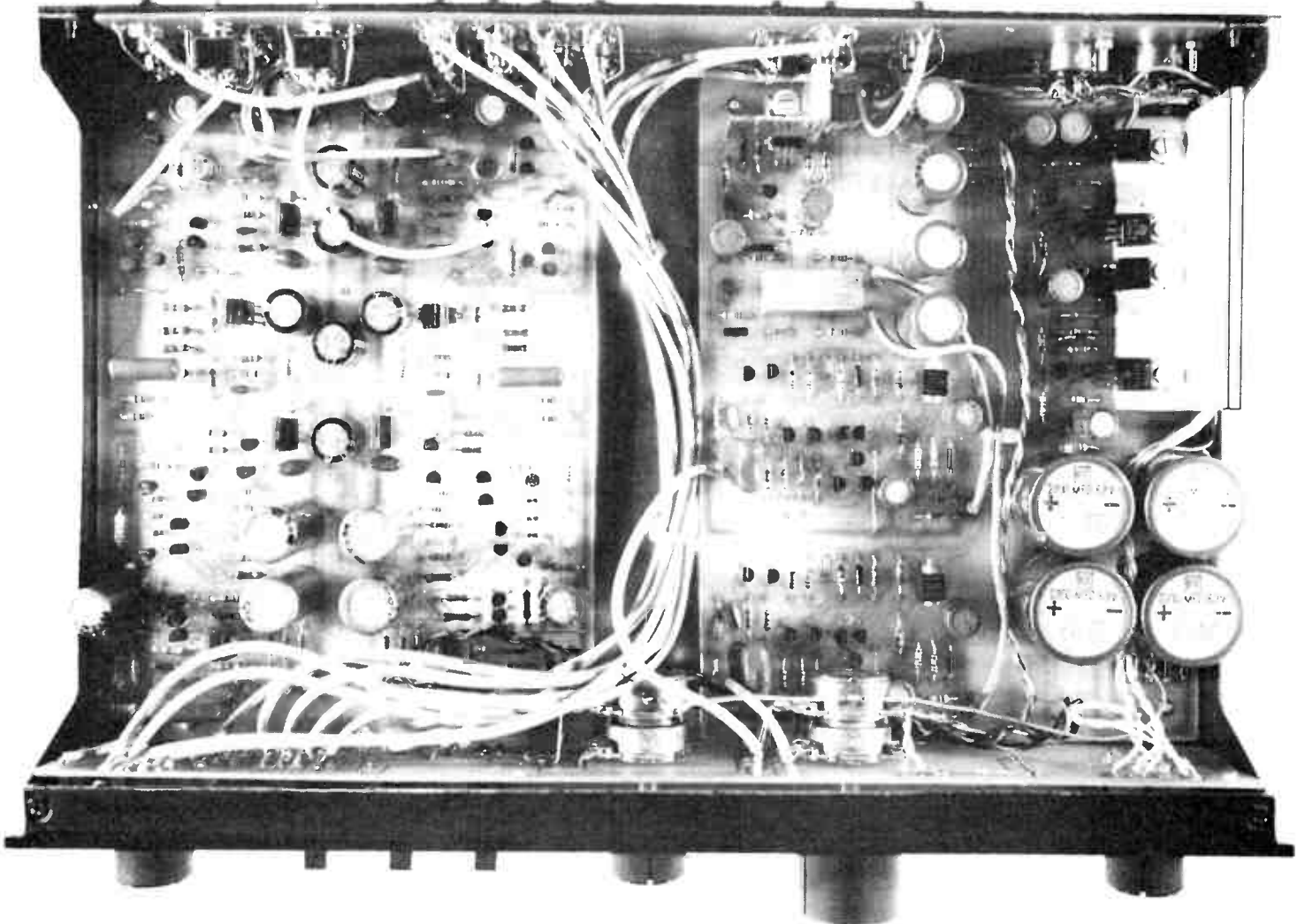



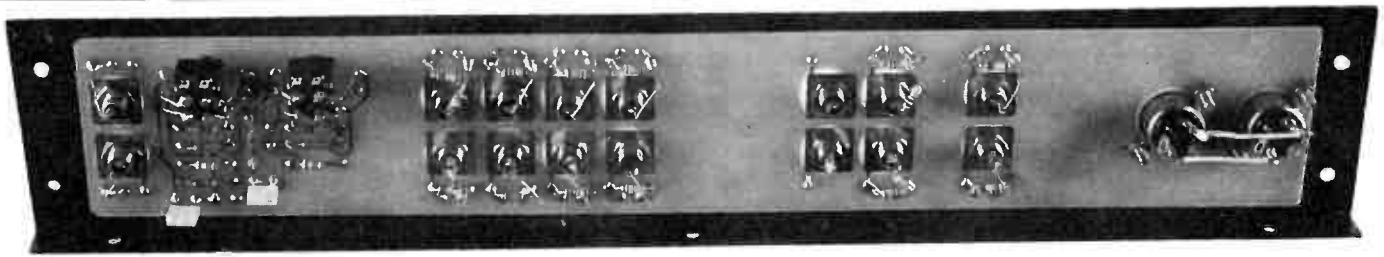

Overall view of the rear panel pc board. In this case, the components mount on the copper side of the board.

Overall wiring diagram. Reference to this and the internal photograph makes it all clear.

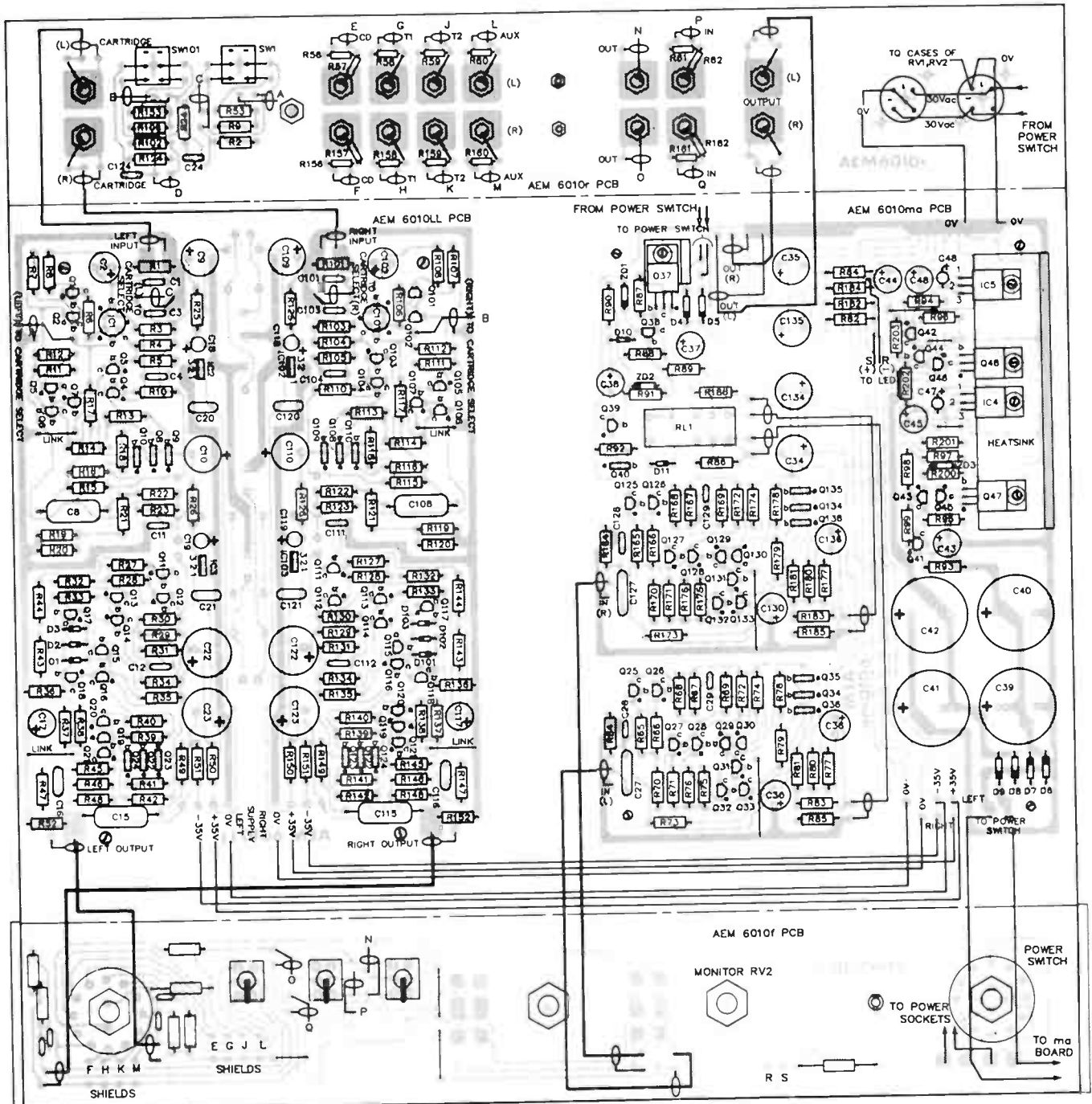

# SCAN THROUGH THESE CHRISTMAS CRACKERS!

## 6 Band MW/FM/SW Radio

Deluxe features at an economy price! 6 bands covering standard AM & FM PLUS 4 shortwave bands! Packed with features you'd expect to pay \$\$\$ more for. Comes complete with protective carry case and quality headphones — at no extra cost! Cat D-2835



**\$79**



**\$119**

## 6 Bands and . . . Radio Direction Finder

The ultimate in versatility! For the avid radio listener or boat owner this one's a must. Has 6 bands including all 40 CB channels plus shortwave and VHF. That's not all — use it as a direction finder against AM radio stations or as a PA amp with optional mic! Cat D-2832

## The Shortwave Big-Daddy

Our MW/FM/SW 9 Band Radio is astounding value! Superb performance over AM FM and all 7 SW bands. Offers fantastic sensitivity, selectivity, interference rejection and stability as well as a host of inbuilt features. The ideal gift when you're serious about giving!

Cat D-2837

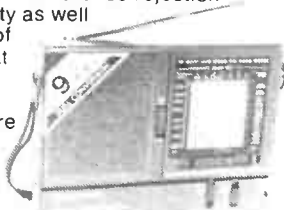

**\$119**



## Programmable World Receiver

Direct Key-in World Receiver with Quartz Alarm Clock/Timer — there's hardly a feature it hasn't got! 5 tuning functions including auto scan, direct key in and preset recall. Nine station memory, full AM band (LW, MW and SW), sleep timer in 9 selections (10-90 minutes), LCD display and much, much more! Cat D-2831

**\$329**

## Air Band VHF Radio with . . . AM & FM

Wow! This budget aircraft band radio will have you listening to the pilots and air traffic controllers! Also covers the normal AM and FM bands so you can use it as

normal radio. An exceptionally reliable unit and they're great value as well! Cat D-2836



**\$29<sup>50</sup>**

### BONUS OFFER

With any radio above \$50  
A copy of the World Radio TV Handbook 1985 edition B-2085. That's right—valued at \$32.50 and it's for nothing. Hurry it's for this month only!  
**FREE!**

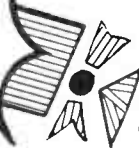

## Yaesu FRG 9600 Scanner



Yes, the ultimate communications receiver has arrived! From Yaesu the FRG-9600 is an all mode scanning receiver providing features never offered before at this price! Covers 60-900 MHz continuously with a massive 100 keypad programmable memory! Cat D-2825

**\$799**

B067

## MX-4000 Desk/Car Mount Scanner

The tiny unit that's big on features! Covers 8 bands including 800 Megs and aircraft. Search and scan, priority controls, large LCD display, 20 programmable channels . . . the list goes on! An ideal quality Christmas gift! Cat D-2818



**\$599**

## HX2000 Handheld Scanner.

It performs like a fixed model! Up to 525MHz including aircraft band and 20 memory channels all in one tiny unit! Priority scan and search, whip antenna, Nicads . . . you get the lot! Cat D-2815



**\$449**

## Pick Up A Saving!

Our Scanner Antenna for 65-520 megs is fantastic value. You'll Save \$10.00. Cat D-4432

WAS \$57<sup>50</sup> **\$47<sup>50</sup>**

If you've been "should I or shouldn't I" -ing lately, then now you have no excuse!

**BONUS OFFER**  
Free Australian Radio Frequency Handbook with every Scanner purchase **\$8<sup>95</sup>** Valued at

# DICK SMITH ELECTRONICS

PTY LTD



See Address details Page 108



# Fantastic February field day for families, friends and fans of amateur radio

The Central Coast Amateur, Radio Club each February runs Australasia's most popular amateur radio field day. It's a fun-filled frolic for foxhunters, fiddlers, fantics, their families and friends.

Next February it will be held on Sunday the 23rd; the venue is the same as ever — the Gosford Showground, Showground Rd, Gosford. The fun flicks on at 8.00 am and fades off at 5.00 pm. If you haven't got wheels, it's easy to get to. Trains departing from Newcastle and Sydney arrive at Gosford between 8.30 am and 10.30 am and the Club provides courtesy

transport from Gosford station to the showground. Return transport is available in the evening.

Field day events include on-air 'scrambles' (work as many as you can in the given time), direction-finding foxhunts (find the hidden transmitter) and 'talk-in' foxhunts. There will be plenty of commercial displays and the 'disposals' hall is always hugely popular for the bargains you can pick up. It's a great day for meeting those 'voices on the air' and renewing old acquaintances.

The field day always goes on, rain or shine. For full details send a stamped, self-addressed envelope to **CCARC, PO Box 238, Gosford 2250 NSW.**

## Amateur radio club special night & display

The Liverpool and district amateur radio club is holding a 'special night' for its December meeting, featuring an operational display of portable amateur equipment typical of what might be used for 'emergency' operation.

Amateurs have often been the only line of communications immediately following disasters, such as during the recent earthquake that devastated Mexico City and ten years ago in Darwin, following Cyclone Tracey.

The Liverpool club extends a welcome to all and sundry to their December meeting which is to be held on Tuesday 10th, 1930 hrs (7.30 pm, right?) at Liverpool Public School, Bigge St, Liverpool NSW. Conveniently, the school is right opposite the Liverpool railway station.

If you're a local and want to get your amateur licence, the club conducts courses for both the full (AOCP) and novice (NAOCP) exams. They boast a very successful pass rate for candidates who, in the main, have had little or no experience in radio or electronic theory.

The courses run for about 13 weeks and cost \$30. Concessional rates apply for students and pensioners.

The Liverpool Club callsign is VK2AZD and they maintain the VK2RLD two-metre repeater. Further details on the club can be obtained at monthly meetings, the 2nd Tuesday of each month, or via **PO Box 690, Liverpool 2170 NSW.**

## If you can't beat 'em, join 'em . . . both

At last it seems someone's come up with a sensible approach to the time-wasting squabble over packet radio protocols, which has recently filled a lot of space in other journals.

In their continuing endeavour to promote and foster Packet Radio, the Sydney Amateur Digital Communication Group (SADCG) has commenced development of a complete Australian-designed Amateur Packet Radio System.

Rather than enter into conflict with various groups that have

## Not strictly for Bird fanciers

Sitting on my desk is the "Bird", which the family, realising it does not represent any extra-marital interest, has learned to treat with the respect it deserves. The Bird ThruLine RF power meter has long been an industry standard for measuring RF in both directions, i.e. up the spout where it is supposed to go, and back down again where it isn't.

We now hear from the Bird Electronic Corporation of their Relative Field Strength Meter model 4041. "Most field strength meters are built with resonant reactive networks which limit their usefulness," chirps Bird.

"This new relative field intensity instrument employs a broadband non-reactive circuit and modern RF solid state technology.

"To make measurements is simple, quick, and convenient. In the presence of an RF field, turn the model 4041 on, adjust the gain for approximate mid-scale deflection and perform antenna-transmitter peaking simply by obtaining the maximum field intensity reading on the meter while optimising antenna match."

Typical relative field strength

purchased semi-commercial equipment, the SADCG has set their design objectives around a system that will satisfy most groups. Both the Vancouver V.2 and the ARRL AX25 version 2 protocols will be handled.

Design has now been completed of a high performance AFSK radio modem board based on the AMD7910 'World Modem' chip. This modem provides both CCITT and Bell modem frequencies. It is tailored for use in UHF, VHF and HF voice grade channels and incorporates a PTT "watch dog" timer. The AMD 7910 was selected because of its ability to handle noisy conditions as found on HF and



Meter sensitivity with the gain control at maximum is fsd on the meter with one watt of radiated power at 150 MHz from a 2-metre portable at 8' distance.

The self-sufficient model 4041 is similar in performance to Bird's Relative Field Strength Element Model 4030, which does not have a meter of its own, but is an accessory to portable ThruLine Wattmeter models 43, 4431, etc.

To avoid readers flocking (groan! — Ed) to Cleveland, Ohio stalk down the distributors. **RF Devices, PO Box 161, Miller, 2168 NSW. (02)607 8811.**

satellite operations.

The modem will interface via RS-232/V24 to a TNC or computer. It can be easily interfaced to amateur transceivers. The circuit has the option to generate a DCD signal from either the external squelch signal from the radio or internally generated DCD from the 7910, or both. Various connections are available for LED monitoring of circuit conditions such as CTS, TXD, etc.

The radio modem printed circuit board, together with construction information, is available for \$22 post free from the **SADCG, PO Box 231, Frenchs Forest 2086 NSW.**

# ELECTRONIC FACILITIES

## TECHNOLOGY TO MAKE IT HAPPEN

### 74LS SERIES

### 4000 SERIES CMOS

### TRANSISTOR

PART NUMBER	PRICE EA	PART NUMBER	PRICE EA	PART NUMBER	PRICE EA
74LS00	.55	4001B	.50	BC547	
74LS02	.55	4002B	.50	NPN SILICON	.15
74LS04	.55	4006B	.85	BC548	
74LS05	.55	4007UB	.50	NPN SILICON	.15
74LS08	.55	4008B	.85	BC549	
74LS10	.55	4011B	.50	NPN SILICON	.15
74LS11	.55	4012B	.50	BC557	
74LS13	.55	4013B	.90	PNP SILICON	.15
74LS14	.65	4015B	1.20	BC558	
74LS20	.55	4016B	.80	PNP SILICON	.15
74LS22	.50	4017B	1.40	BC559	
74LS30	.60	4020B	1.40	PNP SILICON	.15
74LS32	.60	4023B	1.50	BC327	
74LS38	.65	4024B	1.10	PNP SILICON	.20
74LS42	.65	4025B	.90	BC337	
74LS74A	.55	4040B	1.60	PNP SILICON	.20
74LS83A	.75	4044B	.95	<b>OVER 25 ITEMS OF ANY TYPE</b>	
74LS86	.50	4049B	.50	LESS 7½%	
74LS90	.75	4069UB	.50	<b>MEMORY</b>	
74LS93	.80	4071B	.50	<b>PART NUMBER      PRICE EA</b>	
74LS109	.75	4081B	.50	4164P-15A	
74LS123	.90	4085B	.50	150ns 64K	
74LS125A	.65	4093B	.50	DYNAMIC RAM	1.80
74LS126	.75	40160B	1.65	6264LP-15	
74LS132	.90	40174B	.90	150ns 8K X 8	
74LS136	.75	4503B	.65	STATIC CMOS RAM	6.30
74LS138	.90	4510B	1.60	2764-25	
74LS139	.85	4512B	1.60	250ns 8K X 8 EPROM	4.90
74LS157	.65			6116LP-3	
74LS161A	.75			150ns 2K X 8	
74LS162A	.80			STATIC CMOS RAM	3.50
74LS164	.85			2716-45	
74LS165	.90			450ns 2K X 8	
74LS174	.75			EPROM	5.95
74LS175	.75			2732A	
74LS190	.95			250ns 4K X 8	
74LS192	.80			EPROM	5.60
74LS240	1.45				
74LS244	1.45				
74LS245	1.45				
74LS247	.95				
74LS251	.85				
74LS257A	.90				
74LS258A	.90				
74LS259	.90				
74LS365A	.90				
74LS367A	.75				
74LS368A	.80				
74LS373	1.45				
74LS374	1.45				
74LS377	1.45				
74LS390	1.40				
74LS393	.95				
<b>OVER 25 ITEMS OF ANY TYPE</b>		<b>OVER 25 ITEMS OF ANY TYPE</b>		<b>OVER 25 ITEMS OF ANY TYPE</b>	
LESS 7½%		LESS 7½%		LESS 7½%	



# ELECTRONIC FACILITIES

## SPECIAL DEVICES

MN 6631A 5-Channel CMOS electronic switch	\$5.94
MN 6632A 2-Channel CMOS electronic volume control	\$8.64
MN 1280S CMSO LSI for power supply voltage detector	\$2.28
MN 6514 Switched capacitor low-pass filter CMOS LSI	\$4.68
MN 6515 Switched capacitor band-pass filter CMOS LSI	\$4.68
MN 6516 Switched capacitor high-pass and low-pass filter CMOS	\$5.94
OH-001-Q GaAs Hall effect element	\$3 90

## ELECTROLYTIC CAPACITORS

[ALL ELECTROLYTIC CAPACITORS ARE RB' TYPE SINGLE ENDED]

1/50	.15
4.7/35	.15
10/35	.20
22/35	.20
33/25	.20
47/35	.25
100/25	.25

OVER 25 ITEMS OF ANY TYPE LESS 7½%

## RESISTORS

E 12 1/4 w carbon film resistors  
\$3.00 per 100. Min of 50.

## TOP QUALITY LOW COST HEATSINKS

225	.95
The 225 SERIES heat sink is a press-on, low cost unit for TO 5 devices.	
270	.55
This series is designed for use with plastic-cased TO-220 style devices.	
637	\$1.50
The 637 SERIES are high performance heat sinks designed for plastic power transistors.	
673	.95
The 673 SERIES heat sink is designed for use with either the TO-3, TO-66, or two TO-220 style devices where low height is required.	



225



270

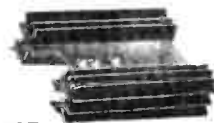

637



673

OVER 25 ITEMS OF ANY TYPE LESS 7½%



**ELECTRONIC FACILITIES PTY. LIMITED**

67 Dickson Avenue, Artarmon.  
Sydney N.S.W. 2064 Australia.  
Telex AA177084

ALSO AVAILABLE FROM

**BRIAN CATT INDUSTRIES PTY LTD**  
10/59-61 Gympsea Bay Road, Gympsea.  
N.S.W. Australia 2227  
PO BOX 146, Cronulla.  
N.S.W. Australia 2230  
TEL (02) 526 2222 526 2900  
Telex: AA 70492

**Mail Orders:** PO Box 351, Artarmon, N.S.W. 2064 TOLL FREE (008) 22 6385 Sydney 439 3786



**DEALER AND TRADE ENQUIRIES WELCOME.**



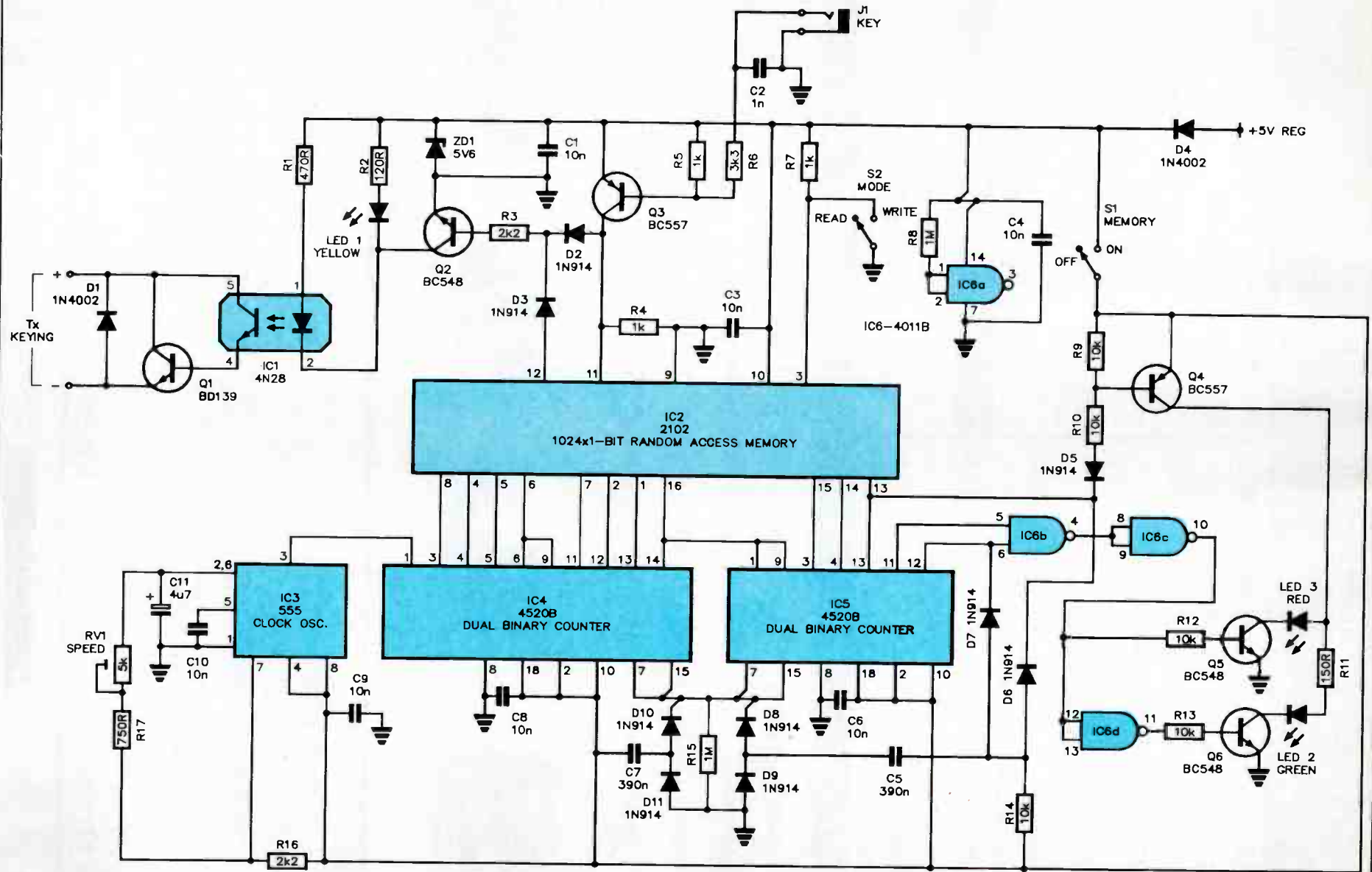

Circuit 1.



# A variable speed CW memory

Geoff Wilson VK3AMK

This device will send a brief CW message repeatedly at a speed which may be varied over a wide range. The message length is normally about 45 seconds which is adequate for short calls etc. It can be reprogrammed as needed in a matter of moments with the absolute minimum of fuss. It is ideally suited for use on bands where the normal levels of activity are low but the potential for working DX exists nevertheless. Operation over the last two years has proved it to be very useful for raising DX stations on what may appear to be "dead" bands.

ESSENTIALLY the device described will run a brief message such as most amateurs would use to call "CQ", run an ident etc. Certainly, a proper EPROM-based device would be better, but the idea behind this was firstly simplicity. It can be programmed rapidly without such things as EPROM burners and is highly flexible. If the band is likely to be open to ZL then put in " CQ ZL", if you want JAs on six metres then "CQ JA DE VK . . . ", if you want to establish if two metres is open on sporadic E, then "DE VK . . . " etc.

The basic device was first built about two years ago and is original, with ideas scrounged from the reference list. Apart from my own unit, others built from my design have been used by VK2BHO, VK3ANP and VK4ALM and used by me on six metres to raise DX. The only problems I have encountered have been: (a) Lack of a suitable board due to no facilities (such as computer-aided design!), and (b) the depart-

ure from common supply sources of the flashing red LED (LED3). For some reason, Dick Smith, stopped stocking them this year. It is not essential to have a flashing LED but it is a very handy indicator in this application.

I have made many variations on the basic circuit, including digital readout of the memory timing, variable delay times between transmit cycles etc, all of which work well but don't really mean much for the average operator. After all, the aim was for something simple and I think that is best.

## The circuit

Refer to Circuit 1. When the key connected to J1 is closed, Q3 conducts, providing a data input to IC2 (the memory) and also turns on Q2. As Q2 conducts, IC1 (an opto-coupler) in conjunction with Q1, keys the transmitter. IC1 provides complete isolation of the memory circuitry from the transmitter keying line. LED1 (yellow) lights to show when the transmitter is being keyed. The use of LED1 & R2 is optional, but recommended.

Keying is independent of the memory operation and a hand key connected to J1 can be used to key the transmitter at any time power is applied to the unit without having to change plugs etc. Note however, that there is 5 V across the key jack if using an external keyer which is voltage or polarity conscious. If desired, D1, Q1, IC1 and R1 may be replaced by a 5 V relay to switch high voltages or if relay noise is not an important factor during keying.

Data is entered into the memory via pin 11 of IC2. Output data from the memory goes from pin 12 of IC2 to the base of Q2 to switch the keying circuitry. Diodes D2 and D3 isolate the input and output data lines of IC2 from each other.

IC3 operates as a clock oscillator, the frequency of which is varied by RV1 (speed). This controls the keying period from a minimum of about 16 seconds to a maximum of about 66 seconds. The clock pulses from IC3 go to ICs 4 & 5 which are dual binary counters providing the address lines to the memory, IC2.

The second half of IC5 is used to control the ratio of the keying and listening periods and does so by using the same clock pulses from IC3. This also operates the enable circuitry of IC2 and in conjunction with IC6(b), (c) & (d) plus LEDs 2 & 3, indicates the approximate memory time available.

Operation of the timing circuitry can probably be better understood by referring to Figure 1 which shows the waveform at pins 11, 12 & 13 of IC5. The memory is enabled while pin 13 remains LOW, the transmit period, but is disabled

... to page 106. ▶

### MEMORY PARTS LIST

C1, 3, 4, 6, 8, 9, 10	10n/50 V ceramic
C2	1n/50 V ceramic
C5, 7	390n/100 V polyester
C11	4u7/25 V electrolytic
D1, D4	1N4002
D2, 3, 5-11	1N914
IC1	4N28 Opto-coupler
IC2	2102 1K x 1-bit static RAM
IC3	NE555 universal timer
IC4, IC5	4520B dual binary counters
IC6	4011B quad 2-input NAND gates
J1	Key jack
LED1	Yellow 5mm LED
LED2	Green 5mm LED
LED3	Red 5mm flashing LED
Q1	BD139
Q2, 5, 6	BC548
Q3, Q4	BC557
R1	470R (all Rs 1/4 W 5%)
R2	120R
R3, R16	2k2
R4, 5, 7	1k
R6	3k3
R8, 15	1M
R9, 10, 12, 13, 14	10k
R11	150R
R17	750R
S1, S2	SPDT miniature switch
RV1	5k log pot
ZD1	1N4734 5V6, 1 W zener

... from page 18.

to distort the regular pattern of the electric and magnetic fields which convey the energy down the line. Any discontinuity in the signal path, again, may cause reflections and ghosting. Too sharp a bend in coax is likely to place undue strain on both the shielding and centre conductor which might break.

Another problem with sharp bends, in both coax and flat ribbon, is that the distance between the conductors may vary in the vicinity of the bend. Signals on the line will see a different impedance at this point and some signal 'reflection' will take place. For similar reasons, the cable should not be squashed under foot, in doors, under clamps or while it is wound up waiting to be used.

While on the subject of clamps; metal staples, tacks and fixing clips should be used sparingly on TV feeders as they also affect the impedance of the cable at the point at which they are used. Certainly, nails and pins should not be driven into coax or through the dielectric between the conductors of a ribbon feeder. In coax they almost certainly will short the cable but in both instances the continuity of the cable characteristics will suffer.

In fact, even minor irregularities in the cable may manifest themselves as impedance changes and because no cable is perfect in every respect, reflections occur in most cables despite their being properly matched to other parts of the system. This fact is recognised in a cable specification, the "return loss ratio".

## Reflections and loss

The return loss ratio is a measure of how much energy travelling down a cable will be reflected by the cable itself, in an otherwise perfect system.

$$\text{Return Loss Ratio} = \frac{\text{Energy reflected}}{\text{Energy fed into the cable}}$$

In practice the return loss ratio is expressed in decibel form and should be as high as possible. Practical figures range from around 20 dB upwards and tend to indicate the evenness of dimension and material consistency along the length of the cable or feeder.

Special care is needed to maintain a high return loss ratio in low-loss feeders. The wire conductors in these cables are usually separated by small spacers set several centimetres apart along the feeder. Between the spacers the conductors are free to sag or come together if carelessly handled or

RETURN LOSS - VSWR CHART	
RETURN LOSS	VSWR
2dB	8.71
4dB	4.42
6dB	3.01
8dB	2.32
10dB	1.92
12dB	1.67
14dB	1.50
16dB	1.37
18dB	1.28
20dB	1.22
22dB	1.17
24dB	1.13
26dB	1.11
28dB	1.08
30dB	1.07
32dB	1.05
34dB	1.04
36dB	1.032
38dB	1.026
40dB	1.020

stored. Changes in the spacing between them will cause variations in the line impedance which in turn will cause reflections.

The sum of all the reflections which occur along the length of the feeder is, in essence, the return loss.

Terminals and wire should be carefully cleaned before connections are secured. Corrosive substances in perspiration from the skin, and moisture may cause troubles in the future by increasing losses at the termination.

Impedance changes at the faulty joint might also cause reflection of the energy on the cable and ghosting in the picture. Increased attenuation will tend to make the pictures snowy.

Essentially, cables for TV installations should be selected primarily on their impedance. On this basis, similar cables used for, say, CB or amateur radio antenna systems may not be suitable for use as television antenna feeders, and vice versa.

### Hills Industries

Catalogue Number	DSC 3.2		DSC 2.1		DSC 1.2	
Diameter of inner conductor	mm	0.81		1.27		2.33
Diameter over dielectric	mm	3.64		5.59		10.06
Diameter over outer conductor	mm	4.51		6.46		10.93
Nominal overall diameter	mm	6.31		8.36		13.07
Nominal attenuation						
at 50 MHz	dB/100m	1.6	dB/100m	1.0	dB/100m	0.6
100 MHz		2.3		1.5		0.8
200 MHz		3.2		2.1		1.2
400 MHz		4.7		3.1		1.8
600 MHz		5.8		3.8		2.3
800 MHz		6.7		4.5		2.7
1000 MHz		7.6		5.1		3.1
Impedance ±2.5 ohms		75		75		75
Nominal Capacitance pF/m		52		52		52
Velocity Ratio		0.85		0.85		0.85
Nominal Return Loss Ratio	dB					
10 - 300 MHz		17		17		20
300 - 860 MHz		14		14		17
Minimum bending radius	mm	35		45		65



**WIRELESS  
INSTITUTE  
OF  
AUSTRALIA**  
FOUNDED 1910



Get with the strength of the W.I.A., which represents the Radio Amateur at Local, National and International level and offers the following services:

- ★ Monthly "AMATEUR RADIO" Magazine, included in membership fee.
- ★ World-wide QSL service.
- ★ Assistance to members with legal problems arising out of the pursuit of their hobby.
- ★ A Weekly Sunday Broadcast to Amateurs and Short Wave Listeners.
- ★ Novice and full call courses
- ★ Trial Novice and AOCPP theory exam papers
- ★ Advice on Radio Mast approvals
- ★ The ONLY representation of the RADIO AMATEUR in legislative matters.

Join the 8,600 Amateur members in the W.I.A. by forwarding this coupon to  
**W.I.A., P.O. BOX 300,  
CAULFIELD SOUTH,  
VIC. 3162**

Please forward a membership application form and further details to:

Mr, Mrs  
Miss .....  
Ms  
Address .....  
.....  
Callsign .....  
Postcode .....

**PROGRAMMABLE  
POCKET  
SCANNER**

**—MICROCOMM—  
SX-155**

**PROFESSIONAL  
POCKET SCANNER  
WITH OVER 16,000  
CHANNELS & 160  
MEMORIES**

**26  
to  
32,  
68  
to  
88,  
138  
to  
176  
and  
380  
to  
514  
MHz**



The Microcomm SX 155 represents the latest developments in State-of-the-art LSI CMOS technology as applied to scanning monitor receivers. It incorporates many features, a lot of which are not even found in today's larger base scanners.

For example the SX 155 has 160 memory channels which can be programmed in either of two modes. The first allows you to manually program the entire 160 channels. The second mode provides for manual programming of the first 40 channels with the top 120 reserved for use by the SX 155 while in its SEARCH mode. It uses these channels to automatically store frequencies on which it has found signals during the search phase.

The SX 155 also features a Priority Channel (for that important frequency) An LCD display providing readout of all receiver functions including an accurate crystal controlled 24 hour clock. Supplied complete with rechargeable Nicad batteries, charger, and rubber duck antenna, the SX 155 is a must for anybody with an interest in monitoring.

**PRICE \$449  
+ \$14 P & P**

AUSTRALIAN DISTRIBUTOR  
**GFS ELECTRONIC IMPORTS**  
Division of DERIBAR PTY LTD  
17 McKeon Road, Mitcham, Vic. 3132  
PO Box 97, Mitcham, Vic. 3132  
Telex: AA 38053 GFS  
Phone: (03) 873 3777 3 Lines

**FLUKE 70 SERIES  
LOW COST  
ANALOG/DIGITAL  
MULTIMETERS —**



**YOUR FIRST CHOICE  
FOR FEATURES,  
QUALITY & VALUE**

FLUKE 73	FLUKE 75	FLUKE 77
Analog/digital display	Analog/digital display	Analog/digital display
Volts, ohms, 10A diode test	Volts, ohms, 10A mA, diode test	Volts, ohms, 10A mA, diode test
Autorange	Audible continuity	Audible continuity
0.7% basic dc accuracy	Autorange/range hold	Touch Hold™ function
2000+ hour battery life	0.5% basic dc accuracy	Autorange/range hold
3-year warranty	2000+ hour battery life	0.3% basic dc accuracy
	3-year warranty	2000+ hour battery life
		3-year warranty
		Multipurpose holster

FROM THE WORLD LEADER  
IN DIGITAL MULTIMETERS.



See the 70 Series at leading electronics stores or contact us for data

**ELMEASCO**  
Instruments Pty. Ltd.

<b>NEW SOUTH WALES</b> 15 McDonald Street, MORTLAKE P.O. Box 30, CONCORD NSW 2137 Tel (02) 736 2888 Telex AA25887	<b>VICTORIA</b> 12 Maroondah Highway, RINGWOOD P.O. Box 623, RINGWOOD VIC 3134 Tel (03) 879 2322 Telex AA30418 ELTENT	<b>QUEENSLAND</b> Tel (07) 369 8688 <b>S. AUSTRALIA</b> Tel (08) 344 9000 <b>W. AUSTRALIA</b> Tel (09) 481 1500
---	---	--



# WIN WIN WIN

## this fabulous Yaesu scanner from Dick Smith Electronics

Don't miss this opportunity to win a really top-line scanner — this Yaesu FRG-9600 scanner from Dick Smith Electronics. It has many functions and features not seen on other scanners — especially the ability to receive single sideband (SSB) signals. In reviewing the FRG-9600 in the September '85 issue of AEM, Roger Harrison said:

*"The FRG-9600 is a well-thought-out unit, easy to use and with facilities and features that will appeal to many — whether newcomers to scanning on the VHF/UHF spectrum or 'old hands'."*

Dick Smith Electronics, in conjunction with Australian Electronics Monthly, is offering a Yaesu FRG-9600 scanner as the prize in this simple contest. The unit provides continuous coverage from 60 through 905 MHz and features 100 memory channels. Five reception modes are provided — FM narrow and wide, AM narrow and wide, plus SSB (unique to

the Yaesu.) The unit can scan over the full frequency range, preset frequency limits or across the memory channels. Provision is made for 'priority' channel selection, which is momentarily tested every three seconds, when activated, while listening to other channels. Selectable tuning steps are provided on the different reception modes. A 24-hour clock/timer is incorporated. The large display shows frequency or time on a 7-segment fluorescent readout along with a channel and mode display, plus a digital signal strength meter. A special feature is the tuning knob, which is an index switch, but the unit can also be tuned using UP and DOWN channel-step keys. The FRG-9600 can be optionally computer controlled via Yaesu's CAT interface system. It operates from a nominal 13.8 V supply and may be bench (base) or vehicle (mobile) mounted.

All you have to do is complete the questions below and tell us in 30 words or less what it is about the Yaesu FRG-9600 scanner that attracts you.

☆ **PRIZE WORTH \$729** ☆



**Send your entry to:**  
**YAESU FRG-9600 SCANNER CONTEST**  
**Australian Electronics Monthly**  
**PO Box 289, Wahroonga NSW 2076**

You may enter as many times as you wish, but you must use a separate entry form for each entry and include a month and page number cut from the bottom of this page. You must put your name and address on the entry form and sign it where indicated. That is, photocopies are acceptable but an original month/page number from a copy of this month's magazine must accompany each entry form. Please read the contest rules carefully, especially if sending multiple entries.

The winning entry will be drawn by the Editor, whose decision is final, no correspondence will be entered into regarding the decision.

Winners will be notified by telegram the day the results is declared and the winner's name and contest results published in the next possible issue of the magazine.

**RULES** Contestants must enter their names and addresses where indicated on each entry form. Photostats or clearly written copies will be accepted, but if sending copies you must cut out and include with each entry an original page number and month cut from the bottom of the page of the contest. This contest is invalid in states where local laws prohibit entries. Entrants must sign the declaration, accompanying the contest, that they have read the above rules and agree to abide by their conditions.

**CLOSING DATE OF THE CONTEST** is the last mail of January 31, 1986. Entries received within seven days of that date will be accepted if postmarked prior to and including the date.

Q1: What reception facility is unique to the Yaesu FRG-9600?

A1: .....

Q2: Does the FRG-9600 employ triple or double conversion, or both?

A2: .....

Q3: Who first imported Yaesu equipment into Australia in the early 1960s?

A3: .....

Q4: About how long has Dick Smith Electronics been selling Yaesu equipment?

A4: .....

Q5: What is the minimum tuning step of the FRG-9600 and in what mode?

A5: .....

Now tell us in 30 words or less what it is about the FRG-9600 that attracts you:

.....  
 .....  
 .....  
 .....

Name .....

Address .....

Postcode .....

I have read the rules of the contest and agree to abide by their conditions:

Signed .....



# Cop This!

## I.C. SPECIALS FROM Promark

EX STOCK!

EX STOCK!

EPROMS	
2716-450NS.....	\$2.35
2764-250NS.....	\$3.60
27128-450NS.....	\$4.35

CMOS EPROMS	
27C16.....	\$5.30
27C32.....	\$6.60

C-RAMS	
HM6264LP-15.....	\$5.48
HM6116P-3.....	\$3.65

MICRO PROCESSORS	
UPD 8748HD.....	\$ 8.00
UPD 8749HD.....	\$10.00
EF 68000 P-8.....	\$29.50
EF 68000 P-10.....	\$44.50

D-RAMS	
ET 4164-150NS.....	\$0.95
HM50256-150NS.....	\$6.20

LINEAR	
TL084DP.....	\$0.92
TL082DP.....	\$0.54
TL062DP.....	\$0.54
UA776DP.....	\$0.42
UA741DP.....	\$0.26
LM324DP.....	\$0.25
TL074DP.....	\$1.20

LM358DP.....	\$0.28
MC4558DP.....	\$0.30
LM339DP.....	\$0.28
LM1458DP.....	\$0.28
TL494DP.....	\$1.45
TL064DP.....	\$1.10

V-REGULATORS	
STEEL	
LM338K.....	\$5.50
LM323K.....	\$2.45

T0220	
LM317SP.....	\$0.58
LM337SP.....	\$0.58
UA7805/12/15.....	\$0.35
UA7905/12/15.....	\$0.35

EF7910P..... \$22.15  
 ALL FIRST GRADE PRODUCTS FROM THOMSON, HITACHI AND NEC  
 All prices + 20% tax, \$4 00 freight, minimum order \$50 00 before tax and freight.

If you use big bags of this stuff - call Clive Barry or Vivian in Sydney, or Ian, NIGEL or Lena in Melbourne, and we will fix you up with even better prices!



**Promark Electronics** PTY. LTD.  
(inc. N.S.W.)

SYDNEY 02-439 6477 MELBOURNE 03-878 1255 TOLL FREE 008-22 6226

WORKS 694



### ARE YOUR SPEAKERS SOUNDING A LITTLE TIRED AND LAZY?

PERHAPS YOU WOULD LIKE TO UPDATE SOME DRIVER OR MAYBE YOU'RE A BIT OF A WIZZ AT BUILDING THEM.

WE HAVE THE COMPLETE RANGE OF DYNAUDIO SCANSPEAK AND VIFA DRIVERS PLUS SOME IDEAS ON BUILDING ENCLOSURES

• DANISH EXCELLENCE THESE SPEAKERS ARE USED BY MANY MANUFACTURERS AROUND THE WORLD

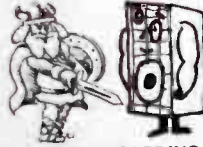

SEND NOW FOR INFORMATION REGARDING THESE WORLD FAMOUS DRIVERS.



Queensland Stereo Visual Supplies

P.O. BOX 227, ZILLMERE, QLD. 4034. PH: (07) 265 7945

### HI FI SPEAKER KITS

HAVE FUN, SAVE MONEY BUILDING THE LATEST HI FI SPEAKER KITS. RAW DRIVERS, X-OVERS, PLANS, REPLACEMENT SPEAKERS AND ACCESSORIES FROM THE WORLD'S FINEST MANUFACTURERS FOR AUDIOPHILES AND BEGINNERS

DYNAUDIO-FOSTER-KEF- MAGNAVOX- PEERLESS-PHILIPS- SCANSPEAK-VIFA and MORE. KEF CONSTRUCTOR KITS FROM \$399.00  
 - SCAN SPEAK SERIES 200 KIT FROM \$650.00  
 - VIFA AEM6102 KIT FROM \$399.00 -  
 DYNAUDIO DAK2 120 KIT FROM \$469.00.

**Audiocraft**  
 AUSTRALIA'S MAIL ORDER SPECIALISTS HI FI KIT

SEND \$2.00 FOR OUR LATEST CATALOGUE TO AUDIOCRAFT DEPT AE PO BOX 725 TOOWONG BRISBANE 4066 ENQUIRIES MON-FRI 9AM-4PM PH 07-870 8785 CREDIT CARD PHONE ORDERS AVAILABLE WE SHIP ANYWHERE IN AUSTRALIA AND EXPORT TO NEW ZEALAND AND PACIFIC MAIL ORDER DISTRIBUTORS OF FINE SPEAKER COMPONENTS AND ACCESSORIES FROM AROUND THE WORLD FOR THE DIY, (DO IT YOURSELF) HOME CONSTRUCTOR MARKET

PO BOX 725 TOOWONG BRISBANE AUSTRALIA 4066, PH 07 - 870 8785

## AUSTRALIAN ELECTRONICS MONTHLY

### Small Spaces.

Great Advertising potential for very little cost. Reaching around 40,000 readers for just \$190.00

# \$30 OFF!

Special End of Year Offer

Offer closes 31.1.86

## FLUKE 80TK CONVERTS YOUR DIGITAL MULTIMETER INTO A K-TYPE THERMOCOUPLE THERMOMETER

### 80TK SPECIFICATIONS

Temperature Measurement Range
-50 to 1000°C
-58 to 1632°F
Battery Life: 1600 Hours (9V)



Treat yourself to a new Fluke Digital Multimeter and you can have the 80TK Thermocouple Adaptor for just \$69 (ex tax) or \$81.40 (inc tax) - a saving of \$30 on the recommended price!

The 80TK plugs into any Fluke DMM to give accurate temperature measurements from -50° to +1000°C using a K type bead thermocouple (included). Micro-connector or screw terminals accept a wide range of Fluke or other probes. Measures in °C and °F

See the 80TK and the complete Fluke Multimeter range at participating distributors.

Offer not available in States or Territories where it contravenes applicable laws.

## ELMEASCO Instruments Pty. Ltd.

<b>NEW SOUTH WALES</b> 15 McDonald Street. MORTLAKE P.O. Box 30, CONCORD NSW 2137 Tel: (02) 736 2888 Telex: AA25887	<b>VICTORIA</b> 12 Marondah Highway, RINGWOOD P.O. Box 623, RINGWOOD VIC 3134 Tel: (03) 879 2322 Telex: AA30418 ELTENT	<b>QUEENSLAND</b> Tel: (07) 369 6688 <b>S. AUSTRALIA</b> Tel: (08) 344 9000 <b>W. AUSTRALIA</b> Tel: (09) 481 1500
---	--	---

# Follow-up to the AEM3500 Listening Post project

**Tom Moffat VK7TM**  
**Tony Woods VK6ATW**

Response to this simple, versatile project has exceeded all expectations. Here we present software for the Commodore 64 and additional Microbee software (for Epson printers), plus how to choose and use modern shortwave receivers for those who are not familiar with them.

RESPONSE TO THE LISTENING POST project, published in the July issue\* (the 1st!), has been just *phenomenal*. Electronics retailers stocking the kit report that it's a 'best seller'. The magazine has been inundated with requests for software for a variety of computers, Commodore 64 software being the most in demand, followed by something for the Apple. Some constructors reported difficulties 'finding their feet' with shortwave receivers. Well, here we present some follow-up details in response to reader feedback.

## Listening Post and the C64

Presented here is a listing, for Commodore 64 owners, that decodes radioteletype (RTTY) and radio facsimile pictures (FAX), courtesy of Tony Woods VK6ATW. Both tape and disk versions are given. The beauty of the software is that it takes advantage of the C64's bit-mapped screen and FAX pictures are displayed on-screen as you receive them. You can save them to disk or tape, too. To obtain a printout, the "DOODLE" program from Omni Unlimited (available from most computer suppliers) is used and you can dump a FAX picture to most printers.

Here's a "SIG. WX" FAX weather chart printout from AXI Darwin on 10 555 kHz, 1-10-85.

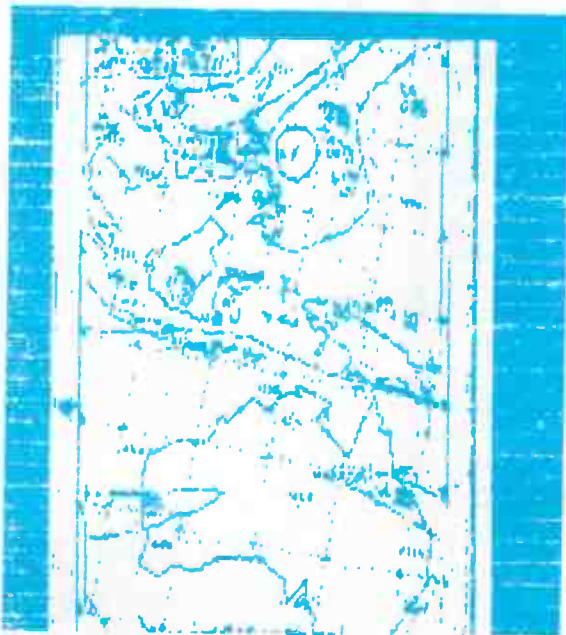

\*Back issues are available for \$3.60, post paid anywhere in Australia, A\$4.60 to PNG or NZ.

First, however, you have to hookup the Listening Post project to your C64.

"FSK/FAX OUT" (A in the pc board overlay) from the Listening Post connects to Pin H of the C64 user port when you want to receive RTTY. Connect it to Pin 9 of the C64 joystick port 1 when you want to receive FAX. The GND (C on the pc board) connects to Pin 8 of the joystick port, and the required +5 V power supply is also obtained from the joystick port, pin 7. Actually, you can link Pin H of the user port and Pin 9 of the joystick port as the software selects each separately.

## MICROBEE LISTING FOR EPSON PRINTERS

0100:	3E	CF	D3	01	3E	FF	D3	01	11	18	03	0E	09	CD	05	00
0110:	CD	DD	02	18	FB	1E	00	CD	DD	02	28	30	E6	5F	21	EF
0120:	03	FE	54	20	02	CB	C6	FE	50	20	02	CB	86	FE	46	20
0130:	02	1E	01	FE	4C	20	02	1E	00	FE	42	20	02	CB	E6	FE
0140:	41	20	02	CB	A6	D6	11	38	0F	FE	0A	30	0B	21	69	03
0150:	06	00	4F	09	7E	32	EE	03	DB	00	2F	E6	03	20	B8	3A
0160:	EF	03	E6	F0	4F	CD	C9	02	CD	C6	02	DB	00	1F	3F	CB
0170:	19	30	F5	CD	C6	02	3E	7F	A1	47	3A	EF	03	CB	67	28
0180:	28	CB	39	CB	39	01	72	03	06	00	50	79	FE	36	20	02
0190:	1E	01	FE	3E	20	02	1E	00	19	09	46	3A	EF	03	CB	47
01A0:	28	07	78	FE	20	30	02	CB	F8	78	FE	0B	C4	06	03	C3
01B0:	17	01	0E	FE	CD	DD	02	DB	00	E6	02	28	F7	26	00	24
01C0:	CD	DD	02	CD	C2	02	DB	00	E6	02	20	F3	78	87	94	CB
01D0:	79	20	08	79	B7	28	02	0E	7F	18	02	CB	11	CD	1A	02
01E0:	7B	D9	4F	7B	87	91	30	01	59	26	00	24	28	1B	CD	C2
01F0:	02	DB	00	E6	02	28	F4	78	87	BC	30	18	87	83	94	38
0200:	08	CD	1A	02	DD	2A	02	18	03	CD	2A	02	3E	20	DD	06
0210:	03	D9	18	9E	CD	1A	02	D9	18	9A	7C	87	92	30	03	5C
0220:	18	06	7A	87	94	30	01	5A	54	C9	D9	79	21	B2	03	0E
0230:	34	ED	B1	3E	9A	20	03	3E	5A	91	CD	06	03	D9	C9	21
0240:	00	10	11	01	10	01	B6	67	36	00	E5	ED	E0	06	14	CD
0250:	D8	02	38	F9	10	F9	CD	D3	02	30	FB	E1	11	4E	02	01
0260:	80	2D	C5	06	03	CD	D3	02	7E	36	01	B1	77	23	1B	7A
0270:	B3	20	F2	3E	B0	3D	E3	E3	20	FB	11	4E	02	ED	52	CD
0280:	DD	02	10	E1	C1	CB	D9	30	D9	19	10	D6	3E	07	CD	06
0290:	03	06	20	21	00	10	E5	21	E6	03	11	03	00	CD	B4	02
02A0:	E1	11	4E	02	DD	B4	02	10	ED	21	E8	03	1E	02	CD	B4
02B0:	02	C3	08	01	CD	DD	02	7E	CD	0B	03	23	1B	7A	B3	20
02C0:	F3	C9	06	05	18	07	CD	C9	02	3A	EE	03	47	CD	D3	02
02D0:	10	FB	C9	3E	89	3D	00	20	FC	DB	00	0F	C9	CD	FE	02
02E0:	B7	C8	E1	FE	12	CA	15	01	FE	0D	CA	B2	01	FE	06	CA
02F0:	3F	02	FE	10	28	9B	FE	1B	CA	00	00	E5	87	C9	05	D5
0300:	0E	06	1E	FF	18	0A	C5	0E	02	18	03	C5	0E	05	D5	5F
0310:	E5	CD	05	00	E1	D1	C1	C9	4C	49	53	54	45	4E	49	4E
0320:	47	20	50	4F	53	54	3A	20	53	65	60	65	63	74	20	66
0330:	75	6E	63	74	69	6F	6E	2E	2E	2E	20	DD	0A	E5	52	3D
0340:	52	54	54	58	20	20	50	4D	3D	4D	4F	52	53	45	20	2D
0350:	5E	46	3D	46	41	58	20	20	5E	50	3D	50	52	49	4E	54
0360:	46	41	58	20	2E	2E	2E	3F	24	0E	00	0B	08	06	05	04
0370:	02	01	05	05	45	33	0A	0A	41	2D	20	20	53	27	49	38
0380:	55	37	0D	0D	44	00	52	34	4A	87	4E	2C	46	25	43	3A
0390:	4B	28	54	35	5A	22	4C	29	57	32	48	00	59	36	50	30
03A0:	51	31	4F	39	42	3F	47	24	04	04	0D	2E	58	2F	56	3D
03B0:	0B	0B	9E	D6	AD	CA	C8	B3	A1	95	D2	DF	CF	C7	C3	C1
03C0:	00	D0	D8	DC	DE	B8	AA	00	D1	7F	8C	85	F9	E8	EA	F4
03D0:	FC	E2	F6	E0	F8	E7	F5	E4	FB	FA	F7	E6	ED	F2	FD	FD
03E0:	F1	E1	F3	E9	EB	EC	18	31	0D	0A	1B	4B	4E	02	00	10
03F0:	00	00	00	00	00	00	00	00	00	00	00	00	00	00	00	00



In using the Listening Post, it was found easier to tune with a 1n5 greencap connected in series with C7 (4n7).

When you run your program, you select FAX operation with the F key, or RTTY with the T key. This will set up the input and give you the menu for the mode selected. Here are the two menus, as they appear on-screen:

```

SHIFT=MOVE PICTURE TO LEFT TO ALIGN          F1  45 BAUDS
L  LOAD                                         F3  50 BAUDS
S  SAVE                                         F5  75 BAUDS
N  NORMAL PICTURE                             F7  110 BAUD
R  REVERSE PICTURE                            F8  STOP
F3  60 L.P.M.                                  RADITELETYPE MENU
F5  120 L.P.M.
F7  240 L.P.M.
F1  TO STOP
FACSIMILE MENU                                CREATED BY TONY WOODS

```

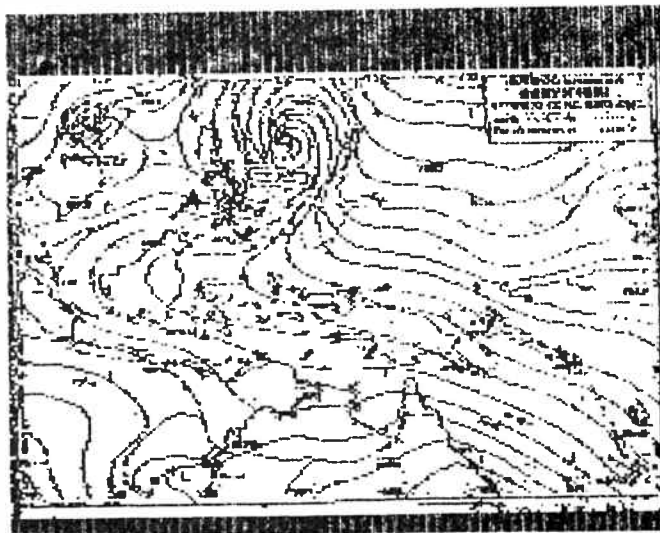

Here's a print of a 'northern analysis' (wind) FAX weather picture transmission received at my location in Karratha, W.A., from AXI Darwin on 7535 kHz, 1-10-85. Note the cyclone over the Philippines.

The RTTY menu is straightforward. A selection of the four common Baud rates is provided. If you get a garbled display, you may be receiving the signal inverse to what the program expects. The R and N keys will select 'reverse' or 'normal' while the message being received is being printed on-screen. The F8 key will stop current decoding and return you to the menu.

The FAX program has a number of features in addition to those already mentioned. Firstly, you can save a FAX picture to disk or tape — very handy for later viewing, especially if you don't have a printer. A FAX screen is saved just before the last few lines on the screen and takes about 20 seconds (37 blocks) using disk, around three minutes using tape. The file name for saved FAX is DDF. This was used so that the saved picture/map can be loaded into the DOODLE program for printing. To save other FAX pictures, re-name ▶

Details on how to hookup the Listening Post to your Commodore 64.

	RTTY	FAX
FSK/FAX OUT (A)	Pin H, user port	Pin 9, joystick port 1
GND (C)	Pin 8, joystick port	
+5 V	Pin 7, joystick port	

### C64 LISTENING POST, for tape machines

```

0000 00 00 00 00 00 00 00 00 00 00 00 00
0001 37 33 00 00 00 00 00 00 00 00 00 00
0002 00 00 00 00 00 00 00 00 00 00 00 00
0003 00 A9 90 20 D2 FF 4C CD
0004 00 A9 93 20 D2 FF A2 00
0005 00 99 0A 20 D2 FF E8 E0
0006 CC D0 F5 20 E4 FF C9 00
0007 F0 F9 C9 4C D0 08 A2 00
0008 20 50 08 4C 70 0D C9 53
0009 00 E9 4C 0D 08 EA EA EA
0010 00 5C 08 9D 35 0A E8 E0
0011 03 D0 F5 60 4C 65 08 EA
0012 4C 2E 09 EA 38 A9 01 A2
0013 01 A0 01 20 0A FF A9 03
0014 A2 85 A0 08 20 D0 FF A9
0015 00 20 05 FF 4C 86 0D 90
0016 E3 4C AF 08 00 44 44 46
0017 A9 93 20 D2 FF A2 00 0D
0018 05 08 20 D2 FF E8 E0 26
0019 00 F5 20 E4 FF C9 00 F0
0020 F9 C9 46 D0 03 4C 21 08
0021 C9 54 D0 F9 4C 59 0C 20
0022 E4 FF C9 00 F0 F9 C9 85
0023 00 F5 4C CD 08 A2 00 0D
0024 00 08 9D 35 0A E8 E0 03
0025 D0 F5 4C F8 08 AD 11 D0
0026 8D 00 C0 AD 18 D0 8D 01
0027 C0 AD 00 DD 8D 02 C0 4C
0028 08 08 EA AD 00 C0 8D 11
0029 D0 AD 01 C0 8D 18 D0 AD
0030 02 C0 8D 00 DD 4C 8B 08
0031 20 E4 FF C9 00 F0 F9 C9
0032 4E D0 04 A9 10 85 36 C9
0033 52 D0 04 A9 01 85 36 EA
0034 EA 20 E4 FF C9 00 F0 F9
0035 C9 86 D0 03 4C EC 09 C9
0036 87 D0 03 4C F9 09 C9 8B
0037 D0 E7 4C 06 0A EA A9 0D
0038 85 FE A9 40 8D 00 DC A9
0039 00 85 FB A9 60 85 FC A2
0040 08 20 5B 09 AD 19 D4 0A
0041 58 26 FE CA D0 F3 20 E4
0042 FF C9 85 90 03 4C E3 08
0043 4C 6A 09 EA A9 19 8D 0E

```

```

0960 DD AD 0D DD 29 01 F0 F9
0961 60 EA A5 F8 18 69 08 85
0962 FB A5 FE 91 F8 90 C8 EA
0963 20 93 09 E6 FB A6 FB E0
0964 08 D0 E7 E6 FC 98 18 69
0965 40 A8 D0 B3 20 88 08 4C
0966 3F 09 08 A9 00 85 4A A9
0967 7F 85 48 A9 00 85 4C C6
0968 4A D0 FC C6 48 D0 F8 C6
0969 4C EA D0 FB C6 4A D0 F7
0970 A9 00 85 4A A9 7F 85 48
0971 09 00 85 4C C6 4A D0 FC
0972 C6 48 D0 FB C6 4C EA D0
0973 FB C6 4A D0 F7 A9 00 85
0974 4A A9 7F 85 48 A9 00 85
0975 4C C6 4A D0 FC C6 48 D0
0976 FB C6 4C EA D0 FB C6 4A
0977 D0 F7 EA 60 A9 47 8D 04
0978 DD A9 0F 8D 05 DD 4C 1E
0979 0A A9 86 D0 04 D0 A9 07
0980 8D 05 DD 4C 1E 0A A9 4C
0981 8D 04 D0 A9 05 8D 05 DD
0982 4C 1E 0A EA EA EA EA EA
0983 EA EA EA EA EA EA EA EA
0984 70 18 D0 08 A5 36 A2
0985 00 9D 00 5C 9D 00 5D 9D
0986 00 5E 9D 00 5F CA D0 F1
0987 60 A9 60 85 FC A9 00 85
0988 FB A0 00 91 FB 8D 00 FB
0989 E6 FC A6 F8 E0 8D 00 F3
0990 60 00 8D 8D 53 48 49 46
0991 00 3D 4D 4F 56 45 20
0992 54 09 43 02 55 52 45 20
0993 54 4F 20 4C 45 46 54 20
0994 54 4F 20 41 4C 49 47 4E

```

```

0AC0 0D 0D 00 00 4C 20 20 20
0AC1 20 4C 4F 41 44 0D 0D 53
0AC2 20 20 20 20 53 41 56 45
0AC3 0D 0D 4E 20 20 20 20
0AC4 00 4E 4F 52 4D 41 4C 20
0AC5 50 49 43 54 55 52 45 0D
0AC6 0D 52 20 20 20 20 20
0AC7 52 45 56 45 52 53 45 20
0AC8 50 49 43 54 55 52 45 0D
0AC9 0D 46 33 20 20 20 20
0ACA 36 30 20 4C 2E 50 2E 4D
0ACB 2E 0D 0D 46 35 20 20 00
0ACC 20 00 31 32 30 20 4C 2E
0ACD 50 2E 4D 2E 0D 0D 46 37
0ACE 20 20 20 20 00 32 34 30
0ACF 20 4C 2E 50 2E 4D 2E 00
0AD0 0D 46 31 20 20 20 00 54
0AD1 4F 20 53 54 4F 50 0D 00
0AD2 43 52 45 41 54 45 44 20
0AD3 42 59 20 54 4F 4E 59 20
0AD4 57 4F 4F 44 53 0D 00 0D
0AD5 46 20 20 20 20 46 41 43
0AD6 53 49 4D 49 4C 45 0D 00
0AD7 0D 54 20 20 20 52 41
0AD8 44 49 4F 54 45 4C 45 34
0AD9 50 50 45 EA E6 FC A6 FC
0ADA E0 7C 90 23 A9 01 A2 01
0ADB A0 00 20 BA FF A9 03 A2
0ADC 85 A0 08 20 8D FF A9 5C
0ADD 85 25 A9 00 85 24 A2 00
0ADE 00 09 A9 24 20 D8 FF 60
0ADF EA EA 0D 46 31 20 20 20
0AE0 02 35 20 42 41 55 44 53
0AE1 0D 0D 0D 46 33 20 20 20
0AE2 35 30 20 42 41 55 44 53
0AE3 0D 0D 0D 46 35 20 20 20
0AE4 37 35 20 42 41 55 44 53
0AE5 0D 0D 0D 46 37 20 20 20
0AE6 31 31 30 20 42 41 55 44
0AE7 53 0D 0D 46 38 20 20
0AE8 20 53 54 4F 50 EA 20 E4
0AE9 FF C9 00 F0 F9 C9 85 0D
0AEA 0D A9 F8 8D 04 DD A9 2A
0AEB 8D 05 DD 4C 78 0C 8B

```

```

0C20 D0 0D A9 0F 8D 04 DD A9
0C21 27 8D 05 DD 4C 78 0C C9
0C22 87 D0 0D A9 0A 8D 04 DD
0C23 A9 1A 8D 05 DD 4C 78 0C
0C24 C9 88 D0 0D A9 C0 8D 04
0C25 DD A9 11 8D 05 DD 4C 78
0C26 0C C9 8C D0 81 4C 88 08
0C27 EA A9 93 20 D2 FF A2 00
0C28 8D 8A 08 20 D2 FF E8 E0
0C29 48 D0 F5 4C 06 0C EA 20
0C30 9F FF EA EA EA EA EA EA
0C31 A9 93 20 D2 FF D0 84 FF
0C32 A5 00 8D 01 DD 8D 03 DD
0C33 4C 8E 0C 20 8E 0C 4B A9
0C34 FE 20 8E DD 8D 0E DD EA
0C35 EA EA EA EA EA EA EA EA
0C36 EA A9 81 0D 0E DD 8D 0E
0C37 AD 0D DD A9 01 2C DD
0C38 D0 F8 68 60 20 04 0D
0C39 20 23 D0 EA EA EA EA EA
0C40 A9 08 85 FB 20 8B 0C 20
0C41 8D 04 6F 85 FB 85 FB
0C42 CA D0 F1 C9 04 D0 84 A2
0C43 86 FC C9 00 D0 04 A2
0C44 20 86 FC 18 65 FC AA 8D
0C45 2F 0D C9 0D D0 02 09 20
0C46 D0 2F 20 8E 0C 20 E4
0C47 FF C9 8C D0 03 4C 19 08
0C48 C9 52 D0 04 A9 FF 85 FD
0C49 C9 4E D0 04 A9 08 85 FD
0C50 10 4C 88 0C EA 60 20 18 0D
0C51 F0 F8 60 AD 01 DD 45 FD
0C52 29 18 60 20 15 0D 20 8E
0C53 0C 20 18 0D F0 F5 60 00
0C54 02 3F 2E 00 00 3F 39 31
0C55 30 36 24 32 29 28 35 28
0C56 3A 25 2C 02 34 20 0D 37
0C57 38 27 20 0D 0A 33 00 0D
0C58 56 58 4D 20 47 42 4F 51
0C59 50 59 48 57 4C 5A 54 48
0C60 43 46 4E 4A 52 44 0D 55
0C61 49 53 20 41 0A 45 00 EA
0C62 11 D0 8D 00 C0 AD 18
0C63 D0 8D 01 C0 AD 00 DD 8D
0C64 02 C0 4C 1E 0A EA 20 E4
0C65 FF C9 00 F0 F9 C9 85 0D
0C66 F5 4C E3 08 00 00 00 00

```

it as follows:

OPEN15.8.15: PRINT 15 , R:DDF = DDF

where you can have any value you choose.

When you select FAX mode, keys F3, F5 and F7 are used to select the 'speeds' (lines per minute — LPM) required. A little fiddling and you'll soon become familiar with this. If the picture comes up negative, use the R key to invert it, the N key operates the opposite way to the R key.

To save a FAX picture, press S. Save under file name DDF (as explained above). To view a saved FAX picture, press L.

The programs are written in machine code because BASIC is too slow. Note that disk and tape versions are given, so use the one appropriate to your machine's configuration. Both programs have been written to occupy the beginning of BASIC's program area at 800 hex (2048 decimal). To load one of these into your computer you may either purchase the software from themagazine (see coupon later) or use a machine code 'monitor' program to hand load the hex code listing given here.

The Commodore ASSEMBLER or MON64 monitor are suitable programs for loading machine code listings. After entering the code and checking it against the listing, save the memory range 800 H to D93 H against the name of the program entered.

## 'NORMAL'/'INVERSE' RTTY

Now it's circuit diagram time! The Listening Post project was designed to provide a **logic high** signal to the computer when a **high audio tone** is being received. Unfortunately, some transmitter operators see things the other way, and their teletype signals may come out "upside-down". With a short-wave receiver this is no problem; you just switch to the opposite sideband. But on the two metre FM nets (146-148 MHz), you have to take the tones as they come.

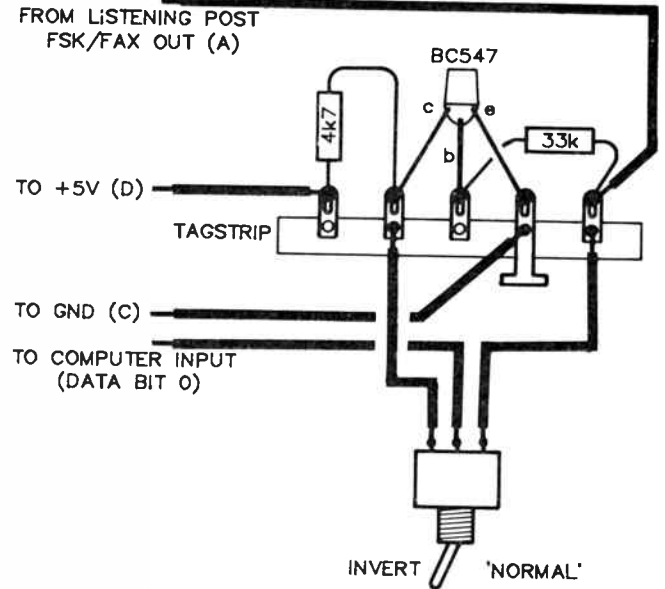

If you want to hear an interesting reaction, just tell the guy on the other end he's sending upside-down.

There seems to be some dispute about what is right and wrong (amateur radio politics again) so included here is a circuit to right-side-up the upside-downs. You connect it between the output of Listening Post and the data input of your computer. It could be built on a bit of Vero board, on a tag-strip or even suspended by its own components. It should then fit into the project case. Then, when you find someone sending upside-down, don't stir up the hornet's nest; just hit the switch!

## C64 LISTENING POST, for disk machines

0800 00 0B 08 8F 07 9E 32 30	0960 DD AD 0D 0D 29 01 F0 F9	0AC8 20 4C 4F 41 44 0D 0D 53	0C30 87 D0 0D A9 0A 8D 04 DD
0808 37 33 00 00 30 00 00 00	0968 60 EA A5 F8 18 69 08 85	0AD0 20 20 20 20 53 41 56 45	0C38 A9 1A 8D 05 D0 4C 78 0C
0810 00 00 00 00 00 00 00 00	0970 FB A5 FE 91 FB 90 C8 EA	0A08 00 00 4E 20 20 20 00 20	0C40 C9 8B 00 0D A9 C0 8D 04
0818 00 A9 90 20 D2 FF 4C CD	0978 20 93 09 E6 FB A6 FB E0	0AE0 00 4E 4F 52 40 41 4C 20	0C48 DD A9 11 8D 05 DD 4C 78
0820 08 A9 93 20 D2 FF A2 00	0980 08 D0 E7 E6 FC 98 18 69	0AE8 50 49 43 54 55 52 45 00	0C50 0C C9 8C D0 B1 4C 88 08
0828 0D 99 0A 20 D2 FF E8 E0	0988 40 A8 D0 B3 20 8B 0B 4C	0AF0 0D 52 20 20 00 20 00 00	0C58 EA A9 93 20 D2 FF A2 00
0830 CC D0 F5 20 E4 FF C9 00	0990 3F 09 08 A9 00 85 4A A9	0AF8 52 45 56 45 52 53 45 20	0C60 8D BA 0B 20 D2 FF E8 E0
0838 F0 F9 C9 4C D0 08 A2 00	0998 7F 85 4B A9 00 85 4C C6	0B00 50 49 43 54 55 52 45 00	0C68 4B D0 F5 4C 06 0C EA 20
0840 20 50 08 4C 70 D0 C9 53	09A0 4A D0 FC C6 48 D0 FB C6	0B08 00 46 33 20 20 00 20 00	0C70 9F FF EA EA EA EA EA 20
0848 D0 E9 4C 8D 08 EA EA EA	09A8 4C EA D0 FB C6 4A D0 F7	0B10 36 30 20 4C 2E 50 2E 40	0C78 A9 93 20 D2 FF 20 84 FF
0850 8D 5C 08 9D 35 0A E8 E0	09B0 A9 00 85 4A A9 7F 85 4B	0B18 2E 00 0D 46 35 20 20 00	0C80 A5 00 8D 01 D0 8D 03 DD
0858 03 D0 F5 6D 4C 65 08 EA	09B8 A9 00 85 4C C6 4A D0 FC	0B20 20 00 31 32 30 20 4C 2E	0C88 4C BE 0C 20 8E 0C 48 A9
0860 4C 2E 09 EA 38 A9 08 A2	09C0 C6 4B D0 FB C6 4C EA D0	0B28 50 2E 4D 2E 0D 0D 46 37	0C90 FE 2D 0E D0 8D 0E D0 EA
0868 08 A0 01 20 BA FF A9 03	09C8 FB C6 4A D0 F7 A9 00 85	0B30 20 20 00 20 00 32 34 30	0C98 EA EA EA EA EA EA EA EA
0870 A2 85 A0 0B 20 BD FF A9	09D0 4A A9 7F 85 4B A9 00 85	0B38 20 4C 2E 50 2E 4D 2E 0D	0CA0 EA A9 81 0D 0E D0 8D 0E
0878 00 20 D5 FF 4C B6 0D 90	09D8 4C C6 4A D0 FC C6 4B D0	0B40 0D 46 31 20 20 20 00 54	0CA8 DD AD 0D 0D A9 01 2C 0D
0880 E3 4C AF 08 00 44 44 46	09E0 F8 C6 4C EA D0 FB C6 4A	0B48 4F 20 53 54 4F 50 00 0D	0CB8 D0 F0 FB 68 60 20 04 0D
0888 A9 93 20 D2 FF A2 00 80	09E8 D0 F7 EA 60 A9 47 8D 04	0B50 43 52 45 41 54 45 44 20	0CBB 20 23 0D EA EA EA EA A2 05
0890 65 08 20 D2 FF E8 E0 26	09F0 D0 A9 0F 8D 05 D0 4C 1E	0B58 42 59 20 54 4F 4E 59 20	0CC0 A9 00 85 FB 20 8B 0C 20
0898 D0 F5 20 E4 FF C9 00 F0	09F8 0A A9 86 8D 04 DD A9 07	0B60 57 4F 4F 44 53 0D 0D 0D	0CC8 18 D0 46 FB 05 FB 85 FB
08A0 F9 C9 46 D0 03 4C 21 08	0A00 8D 05 D0 4C 1E 0A A9 4C	0B68 46 20 20 20 20 46 41 43	0CD0 CA D0 F1 C9 04 D0 04 A2
08A8 C9 54 D0 F9 4C 59 0C 20	0A08 8D 04 D0 A9 05 8D 05 D0	0B70 53 49 4D 49 4C 45 0D 0D	0CD8 00 86 FC C9 00 D0 04 A2
08B0 E4 FF C9 00 F0 F9 C9 85	0A10 4C 1E 0A EA EA EA EA EA	0B78 00 54 20 20 20 52 41	0CE0 20 86 FC 18 65 FC AA 8D
08B8 D0 F5 4C CD 08 A2 00 8D	0A18 EA EA EA EA EA EA EA 20 44	0B80 44 49 4F 54 45 4C 45 54	0CE8 2F 0D C9 D0 00 02 09 20
08C0 60 08 9D 35 0A E8 0E 03	0A20 0A 20 57 0A 20 62 0A 20	0B88 59 50 45 EA E6 FC A6 FC	0CF0 20 D2 FF 20 8E 0C 20 EA
08C8 D0 F5 4C F8 08 AD 11 D0	0A28 81 0A 20 6D 0A AD 11 D0	0B90 E0 7C 90 23 A9 01 A2 08	0CF8 FF C9 8C D0 03 4C 19 08
08D0 8D 00 C0 AD 18 D0 8D 01	0A30 09 A0 8D 11 D0 4C 2E 09	0B98 A0 00 20 BA FF A9 03 A2	0D00 C9 52 D0 04 A9 FF 85 FD
08D8 C0 A0 D0 DD 8D 02 C0 4C	0A38 EA EA EA EA EA EA EA EA	0BA0 85 A0 08 20 8D FF A9 5C	0D08 C9 4E D0 04 A9 00 85 FD
08E0 88 08 EA AD 00 C0 8D 11	0A40 EA EA EA EA AD 02 D0 09	0BA8 85 25 A9 00 85 24 A2 00	0D10 4C 88 0C EA 60 20 18 0D
08E8 D0 AD 01 C0 8D 18 D0 AD	0A48 03 8D 02 D0 AD 00 D0 29	0BB0 A0 80 A9 24 20 D8 FF 60	0D18 F0 FB 60 AD 01 D0 45 FD
08F0 02 C0 8D 00 DD 4C 88 08	0A50 00 09 02 8D 0D 60 AD	0BB8 EA EA 00 46 31 20 20 20	0D20 29 10 60 20 15 0D 20 8E
08F8 20 E4 FF C9 00 F0 F9 C9	0A58 18 D0 29 F0 09 08 8D 18	0BC0 02 35 20 42 41 55 44 53	0D28 0C 20 18 0D F0 F5 60 00
0900 4E D0 04 A9 10 85 36 C9	0A60 D0 60 AD 18 D0 29 0F 09	0BD0 35 30 20 42 41 55 44 53	0D30 02 2F 2E 00 00 3F 39 31
0908 52 D0 04 A9 01 85 36 EA	0A68 70 8D 18 D0 60 A5 36 A2	0BD8 0D 0D 0D 46 35 20 20 20	0D38 30 36 24 32 29 28 35 28
0910 EA 20 E4 FF C9 00 F0 F9	0A70 00 9D 00 5C 9D 00 5D 90	0BE0 37 35 20 42 41 55 44 53	0D40 3A 25 2C 02 34 24 0D 37
0918 C9 B6 D0 03 4C EC 09 C9	0A78 00 5E 9D 00 5F CA D0 F1	0BE8 0D 0D 0D 46 37 20 20 20	0D48 38 27 20 20 0A 33 00 00
0920 87 D0 03 4C F9 09 C9 8B	0A80 60 A9 60 85 FC A9 00 85	0BF0 31 31 30 20 42 41 55 44	0D50 56 58 4D 20 47 42 4F 51
0928 D0 E7 4C 06 0A EA A9 00	0A88 FB A0 00 91 FB 88 D0 FB	0BF8 53 0D 0D 0D 46 38 20 20	0D58 50 59 48 57 4C 5A 54 48
0930 85 FE A9 40 8D 00 DC A9	0A90 E6 FC A6 FC E0 8D 00 F3	0C00 20 53 54 F0 5E EA 20 E4	0D60 43 46 4E 4A 52 44 0D 55
0938 00 85 FB A9 60 85 FC A2	0A98 60 00 8D 53 48 49 46	0C08 FF C9 00 F0 F9 C9 85 D0	0D68 49 53 20 41 0A 45 00 EA
0940 0B 20 5B A9 AD 19 D4 0A	0AA0 54 00 3D 4D 4F 56 45 20	0C10 8D 0A 9F 8D 04 D0 A9 2A	0D70 AD 11 D0 01 C0 AD 0D 8D
0948 58 26 FE CA D0 F3 20 E4	0AA8 50 49 43 02 55 52 45 20	0C18 8D 05 D0 4C 78 0C C9 86	0D80 02 C0 4C 1E 0A EA 20 E4
0950 FF C9 85 90 03 4C E3 08	0AB0 54 4F 20 4C 45 46 54 20	0C20 D0 0D A9 0F 8D 04 D0 A9	0D88 FF C9 00 F0 F9 C9 85 D0
0958 4C 6A 09 EA A9 19 8D 0E	0AB8 54 4F 20 41 4C 49 47 4E	0C28 27 8D 05 D0 4C 78 0C C9	0D90 F5 4C E3 08 00 00 00



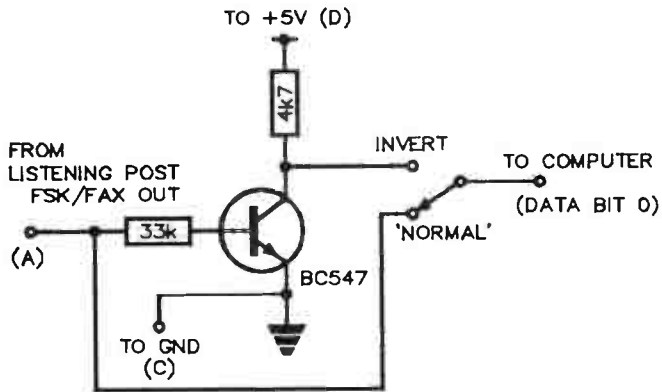

If you require 'hardware inversion' of RTTY signals (or FAX for that matter) for your Listening Post, here's how it's done. The Microbee software has no provision for signal inversion, so Microbee owners will need this add-on modification to obtain signal inversion.

## RECEIVERS, AND HOW TO USE THEM

The receivers being offered to enthusiasts nowadays are really remarkable value for money. Several years ago I worked at the NASA space tracking station at Bermuda. Back in those days, the American space programme had a blank cheque; only the best of everything would do. One requirement we had was to be able to continuously receive the American time and frequency standard station "WWV". Simple, reliable receivers were then available especially for WWV reception. They had crystal-locked channels on the WWV standard frequencies of 5, 10, 15 and 20 MHz. But they weren't considered good enough.

What we had were three identical general-coverage tunable receivers made by the Collins Radio Company. These were the absolute top of the line, and I even remember the model number: 51-S1. Each one would have been worth thousands of dollars. They were mounted in a 19" metal rack, one above the other. The first was tuned to 5 MHz, the second to 10, and the third to 15 MHz. And there was a little switch on another panel that selected which receiver was to deliver the audio signal you wanted to listen to.

Sometimes, when I needed to regain my strength from chasing women and boozing and all that other stuff you do in Bermuda, I would go back to the NASA station after hours to play with one of the Collins receivers. As I tuned around and twiddled its many knobs, signals would fairly 'jump out' of the speaker as if the transmitters were next door instead of half a world away. It was glorious! But I knew I could never own one.

Well, I was wrong. I never got a Collins receiver, but I'd say the one I'm using now is just about as good as that old Collins was.

Technology has caught up; my latest receiver, a FRG-8800 by Yaesu, has its own microprocessor and Collins-level performance, and it retails for around \$800. It doesn't have quite as many knobs, but those that remain serve the same functions as those on the Collins. And they are meant to be twiddled in the same classic way that has served generations of radio operators. Maybe the best way to learn about the new breed of receivers is to go through them control by control.

### Tuning

Sometimes known as "the big knob in the middle", the tuning control is the one you'll have your hand on the most. The purpose of the tuning control, of course, is to shift the frequency of the receiver up or down to the channel you want

# LISTENING POST SOFTWARE

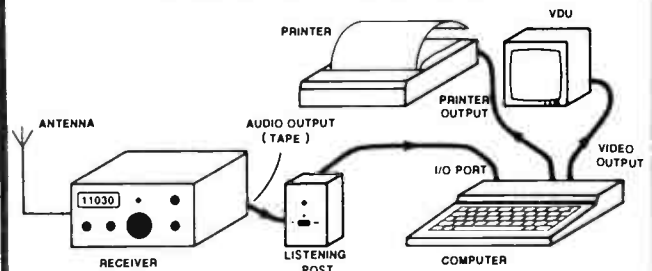

Decode **RADIOTELETYPE/RADIO FACSIMILE PICTURES** &/or CW using your computer and the AEM3500 Listening Post project.

Software for our very popular AEM3500 Listening Post project, from the first issue (July '85) is available, on either cassette or disk, to suit any model Microbee, the Commodore 64 and Apple II-series computers.

All it costs is just:

**\$17.00**

plus \$2.50 post & handling

All you have to do is: ● send us a blank C10 cassette, or a formatted 3.5" or 5.25" diskette (to suit your machine). ● Fill out the address label below and firmly attach it to your tape or diskette. ● Complete the COUPON and send it to us, together with your labelled tape or diskette, enclosing payment by cheque or Money Order or you Credit Card details.

Enclose your blank tape or diskette in a jiffy bag for protection. Put 5.25" diskettes between stiff cardboard.

All mail orders will be despatched by certified mail.

Please allow for normal turnaround post delays prevailing at time of sending order.

We will gladly re-record any software that does not run.

Fill in and cut out this coupon, cut off and attach the return address label to your tape or diskette and send it to

**LISTENING POST SOFTWARE**  
Australian Electronics Monthly  
PO Box 289, WAHROONGA 2076 NSW

### COUPON

Yes please! Rush me software for the Listening Post. I require the software to suit the:

Microbee &	Commodore 64	Apple II
... C.10h 8510-type	.....	.....
... Epson FX80-type printer	(most printers)	(most printers)

(tick appropriate one).

Cost: \$17.00 plus \$2.50 post & handling

**TOTAL: \$19.50**

I enclose payment by:

Credit Card No.:

Expiry Date: . . . / . . . / . . .

Signed: .....  
(Unsigned orders cannot be accepted)

Cheque or Money Order No. ....  
(\* Please make cheques or Money Orders payable to 'Australian Electronics Monthly')

### RETURN-ADDRESS LABEL

**RUSH ME TO:** ..... (name)

Address .....

Postcode .....

# JEMAL PRODUCTS

“THE ONE STOP  
TECHNOLOGISTS”

## ONLY A PHONE CALL AWAY

Ph: (09) 350 5555

### ALL DELIVERIES AIR OVERNIGHT

- ARTWORK
- P.C.B. PRODUCTIONS
- SAME DAY PROTOTYPES
- CLOSE LIMIT SHEET METAL
- PANELS
- CHASSIS
- RACKS
- FINE SCREEN PRINTING
- ASSEMBLY
- FLOW SOLDER
- PREFORMING
- WIRE PROCESSING
- COMPONENT SOURCING
- A.T.U. FACILITY

### — JEMAL PRODUCTS —

5 FORGE STREET,  
WELSHPOOL, W.A. 6106

Ph: (09) 350 5555

Tlx: 95494 JEMCO

to receive. Simple? Maybe in the old days, when the tuning knob was coupled directly to a “variable frequency oscillator” or VFO. But now it’s usually hooked to a microprocessor.

In those early VFO-based receivers, the receiving frequency was controlled by a variable capacitor (to which the knob was connected), and a coil. Together they formed a “resonant circuit” that was supposed to oscillate in a stable and constant manner. But other things came into it . . . the air temperature, how long the receiver had been switched on, the power line voltage and, so it seemed, the phases of the moon and what you had for breakfast that morning! These circuits would quite happily trot off to some other frequency, completely abandoning the one you were trying to listen to. This is called “drift”. Some really crook receivers could skip across half a dozen stations on their own in less than an hour! The best ones were fairly tolerable.

When large scale integrated circuits became available, the old free-running VFO bit the dust. Now we have synthesisers that can generate something like 30 000 discrete frequencies, based on the oscillations of a crystal. Crystal oscillators drift only very little, so if you tune a station with a receiver that uses a synthesiser, it should stay tuned within very narrow limits. The knob on such receivers is sometimes connected to a perforated disk that interrupts a beam of light. As the knob spins, the beam pulses on and off, and each pulse steps the synthesiser up or down one of its 30 000 frequencies. This arrangement, by the way, is still called a VFO by many manufacturers.

Synthesised receivers generally have a numeric keyboard, much like a calculator, that lets you enter some desired frequency directly. If you just want to sniff around, you use the keyboard to call up some frequency in the general area of interest and then use the tuning knob to zero in on interesting signals.

#### Attenuator/RF gain

This would be one of the most misunderstood receiver functions. It varies the overall amount of amplification available in the receiver, and it’s definitely NOT a case of “the more the merrier”. The attenuator, or RF gain control, allows you to optimise the receiver’s performance, given a certain level of unwanted noise, the strength of the signal you want, the strength of signals nearby, and the general condition of the

Tuning controls. The one at left is a ‘traditional’ type knob tuning, while that on the right is from a synthesised receiver — you enter the desired frequency on the keyboard.





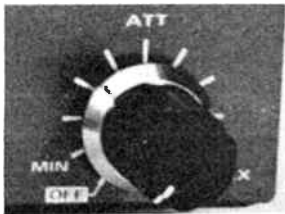

The 'RF attenuator' or 'RF gain' may be a continuous control, as at left, or a switch-type, as at right.

frequency band you're working in. It all sounds complicated, but it's really just a matter of using your ears.

As an experiment, just tune the receiver to 25 MHz or so, and turn the RF gain flat out or the attenuator to 0. If you crank the volume up you'll hear a great rushing noise, but little else. With reception conditions like they've been for the past few months it's unlikely you'll hear anything, other than your receiver straining its little guts out to get something that isn't there. It represents the low extreme of signal levels.

Now, preferably at night, tune to the normal broadcast band, or maybe one of the lower shortwave broadcast bands; perhaps around 6 MHz. You will likely hear a great jumble of signals, all very strong, and few of them making sense, except for the big wallopers like Radio Moscow. Now comes the good bit: if you grab your RF gain control or attenuator and bring the signals down a bit, you'll discover you can begin to separate them . . . the strong and the weak are no longer mixed and you can pick and choose the ones you want. Your signal strength meter will probably fall, but who cares? You're listening with your ears, not your eyes, remember?

What was happening was this: with everything 'flat out', those big big signals were overloading some of the receiver's amplifiers, distorting, and spreading into adjacent channels. Weak signals in those channels were buried in the distortion products generated inside the receiver. Reducing the overall gain allowed the signals to pass through undistorted, in the correct relationship with each other. And at the far end, your ears picked them out, aided by the receiver's filter. Most receivers have a circuit that does a lot of this work for you . . . it's called an "automatic gain control", or AGC. But it's still best to give it a head start with your manual control. This will provide the best possible performance.

### The filters: wide and narrow

We've just seen that proper twiddling of the tuning and RF gain controls can provide us with a nice collection of great big signals and little bitty signals and everything in between, to pick and choose from. Now, if the one you're after is the weak one (and it usually is!), you must try to reduce the influence of the big ones as much as possible. Ideally, we could just drive a couple of "wedges" down into the band and push the big fellers aside, exposing the little signals to our attention. This is the function of the filter.

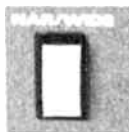
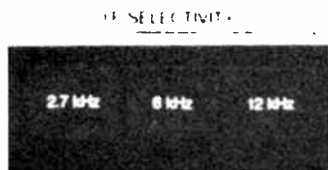

Filter selection. You might get a selection of bandwidths, as at left, or just 'narrow' and 'wide' as at right.

The filter selects a slice of the band, and rejects everything else. The filter marked "narrow" probably allows through a chunk of the spectrum about 2700 Hz wide, or so. This is because the bandwidth of human speech is usually assumed to be from 300 to 3000 Hz. When you tune the receiver you're actually sliding this "slice" up and down through the spectrum. It's like a slit, and you look at a little piece of the spectrum through it as it passes, or when it stops. If you have a choice of a "wide" filter, it may be around 6 kHz to 10 kHz

wide to allow the higher audio notes of music to pass through. Another filter may be for CW, that is, Morse Code. It may be only 300 Hz wide, as code comes through as a single tone.

You generally choose the filter for the application, using the wide filter for broadcast stations (unless you're trying to extract a weak one from among strong ones). The narrow filter is for voice (or voice-bandwidth signals), and the CW filter is sometimes useful for some kinds of radioteletype transmissions, apart from morse signals.

### Mode: AM, SSB, CW, FM

Without getting too technical, the single sideband method of transmission was developed because it gives an eight times advantage over an AM transmission of the same power. An AM signal consists of a "carrier", and two "sidebands". In SSB, the transmitter 'throws away' the carrier and one of the sidebands, transmitting the remaining sideband. This can be either the one higher in frequency than the carrier (upper sideband — USB), or the lower one (lower sideband — LSB). Some stations can transmit two programmes at once, one on each sideband (but that's of no concern here).

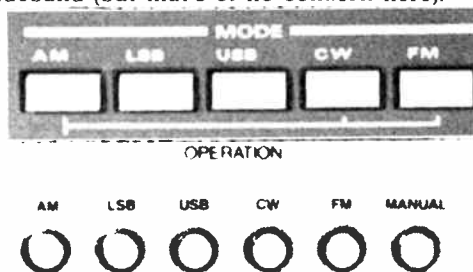

Mode selection. Just push the right button! With the Listening Post, the single sideband (SSB) reception mode is generally used.

A receiver for AM is pretty simple, as anyone who has built a crystal set knows. But an SSB receiver must re-supply the missing carrier the transmitter threw out before the signal can make any sense. It must then use a narrow filter to select either the upper or the lower sideband. If you are tuned to an AM signal, but have your mode switch on SSB, you will most likely hear a loud "howl" as the incoming carrier and the carrier your receiver is re-inserting "beat" against each other, providing an audible difference.

Conversely, if you are tuned to an SSB station but your receiver is set for AM, you'll hear something that sounds like Donald Duck with a hose shoved down his throat! You'll soon learn which position to use for what, just to minimise the strange noises.

FM (frequency modulation) is a pretty special case, normally used only if you can receive on the VHF bands. For radioteletype and facsimile (see the Listening Post project) you almost always use the SSB reception mode. This is because these signals are simply frequency-shifting carriers, and you have to use SSB to make them "howl", otherwise there will be no audio output at all.

That pretty well covers the receiving device itself, but we still have to contend with that old antagonist of neighbours and city councils, the antenna.

### Yes folks, the antenna!

First, let's repeat rule number one: You Must Use An Outside Antenna. **YOU MUST USE AN OUTSIDE ANTENNA!**

Just about any type of antenna will work, but it must be outside the house, and the lead connecting it to your receiver must be shielded! **SHIELDED! YOU HEAR ME?** There. That's off my chest. If it isn't shielded, and you're running a computer nearby, you'll hear all computer noise and few signals. If you want some ideas on antennas, may I suggest you read the article on "Simple Antennas for Suburban Sites" in the first (July '85) issue of AEM.

You think you've got a good antenna? Been up for awhile, and it still works? I thought I had a good antenna, as I lectured other people about why they should have one. Mr Confidence! But now I must bury my head in shame and relate the following tale:

## Why my Listening Post died

Sunny Hobart, you must realise, lies straight in the path of the Roaring Forties. And when one lives halfway up the side of Mt Wellington, one must expect occasional breezes beyond those described as "gentle".

We've had three trees blown down this year. Actually, numbers two and three were the same tree blown down twice. One northerly storm knocked it over, where it lay in repose as I tried to figure out where I could bot a chainsaw. A couple of days later a southerly buster came through, stood the tree back up, and then blew it over the other way, onto the house. It was during this disturbance that my 30 foot Hills television mast, which holds up my shortwave antenna, also came down in a heap when a guy wire broke.

We must digress at this stage to introduce One-Eye, the family possum. She has lived here for at least five years, during which time she has appeared every few months with a baby possum on her back. The kids love it! One-Eye rules the roost here, banishing any other possums that might stray onto the property. This has resulted in many wild brawls, including the one that cost her an eye. One-Eye has some unusual tastes in food. Although possums are supposed to be vegetarians, she gobbles up meat scraps like they're going out of style. And she's developed a strong liking for vinyl.

During reconstruction of the fallen antenna mast, I noticed strange puncture marks in the covering of the coaxial cable that led from my Listening Post to the big wire antenna at the top of the mast. And that night, when I went outside, there was One-Eye with her hands wrapped around the rolled-up length of coax, gutsing herself on the vinyl covering. When I checked the puncture marks I had noticed earlier, I found that One-Eye had completely severed the shield of the coax, although the vinyl covering, from a distance, had appeared intact.

The entire length of coax was a wreck, and had to be replaced. But with the new piece installed, the Listening Post sprang into life as it never had before. The old coax, under the influence of One-Eye, had been getting gradually worse and worse, so slowly that the change was barely noticeable. And all this time I had been preaching to people to use a good antenna when my own had been just about non-existent!

The new installation has now been possum-proofed, with the coax within One-Eye's reach being run through aluminium tubing. And to think that all this time I had been blaming failing reception on the condition of the radio bands! It certainly pays to check things now and then.

## Ears for the Listening Post

Many people have asked about what kind of receiver to use for the Listening Post project. The answer is, in general, to get the best one you can afford. Any receiver used for communications monitoring with a computer MUST be able to receive single-sideband voice signals, since this is the reception mode also used for radioteletype, facsimile, and Morse code. The receiver MUST be able to be used with an outside antenna; you must be able to collect the signals from an area outside the noise and interference radiated by your computer. In an earlier column (Bee Buzz, Sept '85) I discussed ways to cut down the noise from the computer, but some noise is always present and the signals we are looking for are sometimes very weak.

The first issue of AEM showed the Listening Post being used with a Bearcat DX-1000 receiver. This is the one I developed the project on and it's typical of the current breed

of synthesised receivers. (I'm using a Yaesu FRG-8800 now, who knows what will be next?)

It's also quite practical to use the older analogue (non-synthesised) receivers with the Listening Post, but they must have fairly stable oscillators to stay on frequency. Even then you must manually give the frequency a tweak every few minutes. Still, they're becoming available second-hand at quite attractive prices, and you'll find they do a reasonable job. I used one (a Drake SSR-1) for several years, with good results.



The Bearcat DX-1000, the receiver I used in developing the Listening Post. I now use a Yaesu FRG-8800.

Since that first article (July '85) I've had a chance to try some synthesised receivers that are somewhat down-market from the Bearcat/Yaesu class.

Sony has a line of little portables that are fully synthesised, and also contain such features as pre-set channels and digital clocks. A popular one of these is the ICF 2001-D model. It receives AM, FM and single sideband, and includes the standard broadcast, longwave, aviation, and shortwave bands. It works well with the Listening Post, but only with an outside antenna. (Are you sick of me yet? Are you ready to scream?)

Another one from Sony is the ICF 7600-D. What a little gem! It's about half the size of the other Sony; I got one at home over a weekend to play with, which I carried home on my trusty bicycle, it's that portable. If I owned one of these I could see it going on a lot of bushwalking trips, as well as working with the Listening Post. Some of its disadvantages are not quite as much frequency coverage, and the lack of a "proper" single sideband detector. It seems to provide a "beat frequency oscillator" for this purpose which works all right, but it's not quite as crash-hot as its bigger brother, or the Bearcat or Yaesu. Still, it goes well with clear signals, and it's so tiny . . .

As far as hooking all these lovely machines up to Listening Post, all you need is a bit of audio. The Bearcat has a "recorder" output on the back that works nicely. The Yaesu has a "line" output; again, no problems. One to watch out for is the Sony; its "recorder" output is at "microphone" level (all of them should be, really) but there's not enough "oomph" to drive the XR-2211 chip on the Listening Post. Plug into the speaker and you'll be OK.

You'll notice I haven't mentioned prices on these receivers. An approximation would be that the Sony 2001 is about 2/3 a Bearcat, and the Sony 7600 is about half a Bearcat. With the devalued Australian dollar they're all going up at the speed of light, so any prices quoted would be terribly wrong by the time you read this. It's a shame, really. The Japanese stuff is so nicely made and presented, especially Sony. As well, the cost of Japanese labour is skyrocketing and if it keeps up none of us will be able to afford what they make. It happened to American and European goods, and Japan will be next if they don't watch it. ♣



## Avtek Multimodem II features expansion bus for plug-in developments

Sydney-based modem manufacturer Avtek Electronics has just launched an exciting new version of the popular Multimodem. Designated the "Multimodem II" it provides all the features of its predecessor, plus important new developments that they say more than match overseas and local competitors.

The modem provides both 1200 and 300 baud as well as CCITT and BELL standards. Avtek continues to use the extremely reliable 'world modem' chip which incorporates digital filtering and error correction.

A dedicated IC is now used for the ring detect circuit. Most modems (including the earlier Multimodem) are sensitive to ring voltage and will auto-answer at different times, depending on the strength of the ring. The new modem has a circuit which actually distinguishes the ring from other line signals. The modem answers instantly on strong or weak signals.

A unique feature of the modem is the expansion buss. The Multimodem can be expanded via a whole array of outputs on the circuit board.

The baud rate convertor option is now built into the modem. It is of special interest to those with microcomputers such as the IBM PC and Commodore, especially when Viatel facilities are needed, requiring a 1200/75 split baud rate. The baud rate convertor makes complex cabling and software arrangements unnecessary.

For further information call **Avtek Electronics, PO Box 651 Lane Cove 2066 NSW. (02)427 6688.**

### Attention modem constructors

Promark Electronics stocks the EF7910 single-chip modem, a Thomson-CSF device which is pin-compatible with the Am7910 'world chip'.

This is pin selectable for baud rates 300, 600 or 1200 bits per second and is compatible with the applicable Bell and CCITT recommended standards for 103/115 108, 202, V21 and V23 type modems.

Digital signal processing techniques are employed in the EF7910 to perform all major functions such as modulation, demodulation and filtering.

The EF7910 contains on-chip analogue-to-digital and digital-to-analogue converter circuits to minimize the external components in a system. This device includes the essential RS-232/CCITT V24 terminal control signals with TTL levels.

For further information contact: **Promark Electronics, PO Box 381, Crows Nest 2065, NSW. (02)439 6477.**

### T.I. expands ROM family

Texas Instruments has announced a new read-only memory device, the

TMS2364, a 64K ROM. It offers a 150 ns maximum access time, comes in the 28-pin industry standard package and is designed to complement TI's other 64K ROM, the TMS 4764 24-pin device.

The chip represents a cost-effective alternative to EPROMs in high-volume applications such as automotive and industrial controls, printers, personal computers and telecommunications equipment, TI say.

It is fabricated using N-channel silicon-gate technology for high speed and simple interface with TTL and CMOS circuits.

Further details from: **Texas Instruments Australia Limited at North Ryde, NSW. (02)887 1122.**

### Rich raids rip-offs

We are delighted to hear of the progress of the Anti-Software Piracy Association which says it is now poised to launch its second major raid against Hong Kong software pirates.

The Association, which originally consisted of Imagineering, Australia's largest distributor of microcomputer software and peripherals, Lotus Development

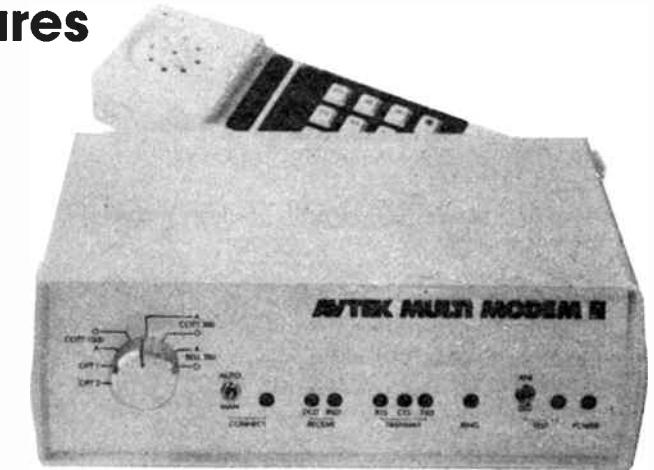

Corp and Ashton-Tate, now has MicroPro and Broderbund as members.

Imagineering's managing director, Jodee Rich, says MicroPro and Broderbund have contributed substantial sums of money to ASPA's fighting fund, which originally totalled \$US100 000.

Rich says ASPA was happy with the results of its first major raid in Hong Kong, and believes a second raid will be even more successful. He says the Association will concentrate on Hong Kong for some time, as the market is big enough to support legitimate software sales and support.

"It will be even more attractive as a market for major software distributors if ASPA cleans up existing piracy — and that could be good for software buyers in the long run," he says.

Rich says the activities of

ASPA has also moulded prominent opinion in the colony. He says that having had piracy brought to their attention, many leading corporate decision-makers are less than proud of Hong Kong's reputation as a pirates' haven.

This is an opportunity for us to endorse the view that software development will only flourish if distributors and users will show a little fairness.

We believe that the computer shopkeeper who copies proprietary software illegally to help market his machines is no more honest than the shoplifter whom he would certainly prosecute, and those few teachers who encourage pupils to copy games and other software not in the public domain are hardly teaching them a sense of right and wrong.

### GAMES SOFTWARE CHRISTMAS WRAP-UP

Imagineering has decided to bundle some of this year's hottest-selling Commodore 64 games for the Christmas season. They will be bundled in four packs, each selling for \$29.95.

**Pack One**, a cartridge pack, will include **Choplifter** and **Lode Runner**, both from Broderbund. **Pack Two**, a cassette pack, will include **River Raid**, **Pitfall II** and **H.E.R.O.** — all from Activision. **Pack Three**, another cassette pack, will include **Ghost Busters** and **Pitfall I** from Activision, and **Beachhead** from Access Software.

**Pack Four** will be a floppy disc pack including **Beachhead** and **Pitfall II**. Pitfall II, according to Imagineering's consumer products manager, Alan Bowman, has not been released on disk before. Bowman believes the bundling exercise will create considerable excitement. "We felt it was time the consumer was given some real value in games," he said. "Although we will still be selling these games as separate titles, the bundling is designed to give great Christmas buying value." Each title will sell for \$19.95 and the \$29.95 price tag of each bundled package reinforces the value, Bowman said.

Details from **Imagineering, 77 Dunning Ave, Rosebery 2018 NSW. (02) 662 4499.**



## How Mozart's keeping up with the Commodore

While "Amadeus" is packing them in at the cinema, other would-be Mozarts are seated at their home computers playing his music.

Commodore has released "Popular Classics", the first in a series of Music Maker Playalong Album Programs for the Commodore 64.

Using a musical keyboard overlay the Commodore "pianist" can play any of such famous works as Brahms' Hungarian Dance No. 5, Sonata in C Major by Mozart, Tchaikovsky's Concerto No. 1 in B Minor, or Emperor Waltz by Strauss (ancestor of the well known Levi).

In single-key mode our genius-to-be can tap out the timing. Each note of the melody will play, together with the accompaniment. Prompting on screen and computer-controlled timing are added in Rehearsal Mode. With this tutoring budding Mozarts can quickly become efficient, we're told.

The chance to display talent comes with Performance Mode. A few beats of the built-in metronome and the Commodore musician plays the entire melody along to the accompaniment. He/she can speed up or slow the tempo according to his/her ability or preference.

By connecting the Commodore 64 to a Midi-equipped keyboard further sophistication is possible. Playalong albums have three musical parts to the melody which can be directed to different channels on the Midi.

This allows the keyboard sound to be split into different "instruments".

If all this sounds too much like work, then our weary musician can relax, put his feet up, pour himself a drink and select Concert Mode. Now he can listen to his favourite classics while watching exciting screen graphics.

Each Commodore Music Maker Playalong Album comes complete with User Guide, Music Book and both cassette and disk. Music Maker Playalong Albums are available from Commodore dealers at a cost of \$25 each.

Maestro!

## On the buses

Pro-Log, in Melbourne, has announced more STD bus products.

The 7614 64-line digital I/O bus card STD provides 64 lines of input/output which can be configured in groups of eight as inputs or as outputs with read-back. Alternatively, they can be configured with as many as 32 lines of bidirectional I/O.

The card, which is also available in a previously announced CMOS version, features latching connectors to securely lock cables into place. The 7614 decodes either an 8-bit or 10-bit I/O address, thereby making it compatible with the Z80, 8085, 6800, and 8088 processors.

Priced at \$346 in single quantities, the 7614 is available immediately and comes with Pro-Log's standard two-year limited warranty on parts and labour.

Pro-Log has also announced three new CMOS cards for the STD bus, including an 80C88 processor card, a 64K memory card, and a 64-line I/O card.

The 78C61 processor card integrates the 80C88 (a CMOS 8088) and five JEDEC memory sockets for EPROM or RAM into a card that can be populated with 136K of memory and address a full 1M. One socket is configured for a byte-wide RAM, a second socket is for EPROM, and the three remaining sockets can accommodate either RAMs or EPROMs. The 80C88 microprocessor has a 20-bit memory address bus and a 16-bit I/O bus. The latter bus provides a 64K I/O port capacity.

The 77C09 memory card can be expanded in 8K byte-wide increments of either RAM or ROM to a maximum of 64K. The

card works with STD bus systems using either a 20-bit address bus (such as the 80C88) or a 16-bit address bus (such as the CMOS Z80 or 80C85). In addition, the 77C09 is available with an optional Lithium battery that can typically retain data for up to ten years.

The 76C14 is a general purpose, high-density I/O card that provides 64 I/O lines (eight ports) and latching header connectors for reliable cable connections to the system. The eight ports can be configured for input, output, or output with read-back capability. Alternatively, the 76C14 can be configured as four bidirectional I/O ports. The card decodes either an 8-bit or 10-bit I/O address, providing compatibility with any 8-bit or 80C88 CMOS processor cards.

For details, call Prolog on (03)836 3533.

## New Intel DRAM controller

Intel has introduced the first CMOS dynamic RAM (DRAM) controller, a high performance VLSI chip called the 82C08.

This chip is designed to easily interface 64K and 256K DRAMs to microprocessors made by Intel and other manufacturers.

It requires very low operating currents (both in active mode and in power-down mode, during which only the RAM is engaged), making possible a range of low-power and battery back-up applications.

The new chip, a CHMOS (Intel's high-performance CMOS process) version of Intel's 8208, provides all the signals necessary to control 64K and 256K CMOS DRAMs, such as Intel's CHMOS 51C64 (64K) and 51C256 (256K) DRAMs.

It supports all Intel microprocessors, including the high-performance iAPX286, as well as Multibus-based systems. And because the 82C08 operates synchronously or asynchronously, it also runs with other, non-Intel microprocessors.

The little beauty draws less than 30 mA in active mode, allowing a smaller power supply for greater compactness, lower cost and heat. In power-down mode only the system RAM receives power (the controller chip refreshes the RAM automatically), reducing current re-

## NO FLICK FOR VIC

It seems that with the demise of so many user groups and newsletters, the news of yet another good user group mag. getting 'the flick' is of little consequence these days.

However, the news that one IS TO CONTINUE DESPITE THE DEMISE OF THE ASSOCIATED COMPUTER *really is* news! What we're talking about is fondly known as "VIC", the journal of the ACT VIC-20 Users Association — and a right good journal, too!

Now in its third year of publication, with 16 bi-monthly issues under the belt, VIC continues strongly, catering for all VIC-20 colour computer owners, packed with "the right stuff", very little advertising/news/bump cluttering its pages.

All that for \$2.00 an issue, which must be value in this ever-inflationary world.

The ACT VIC-20 Users Association also distributes a public domain software collection, any item available for a small copying fee; the library comprises around 900 programs.

Full information from the indefatigable and still enthusiastic Chris Groenhout, 25 Kerford St, Watson 2602 ACT. (062) 41 2136.



## XMAS SPECIALS!

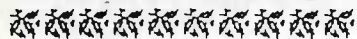

### DT-01 DIGITAL EXPERIMENTER



Ideal for education, as everything you need to build and test your circuit is provided in one fold-away book-type package.

**\$149**

Batteries & Logic probe optional + sales tax

## Escort Handhelds



EDM-1116

Multipurpose DMM

- 3½ digit LCD display
- Capacitance ranges 2nF to 20nF, (1pF res.)
- Transistor testing
- Other ranges DCV, and Diode testing
- 0.05% basic accuracy

EDM-1116

Full 12 month Warranty

**\$100**

+ sales tax



COS5020 20MHz, 2CH



Compare the features and you'll see that for our price they're not worth being without:

- 20nS/DIV sweep
- Trigger Level lock
- Variable Hold-Off
- Auto focus

Warranty 2 years.  
2 Quality Probes INCLUDED.

**\$629**

+ sales tax

Drop-in to our showroom, we're open Saturday mornings too.



## EMONA INSTRUMENTS

A division of Emona Enterprises Pty Ltd

1st Floor  
720 George St  
Sydney 2000.  
Phone: (02) 212 4599

# AUTHOR! AUTHOR! AUTHOR!

So you've written this great article.

Tell us all about it then!

Maybe you've developed a project you think others might be interested in?

We'd like to hear from you!

Perhaps you'd just like to write in and comment on the magazine, tell us what you think of it and what you'd like to see us doing.

We're only too happy to hear from you! (All bouquets gratefully accepted, brickbats next door, please!)

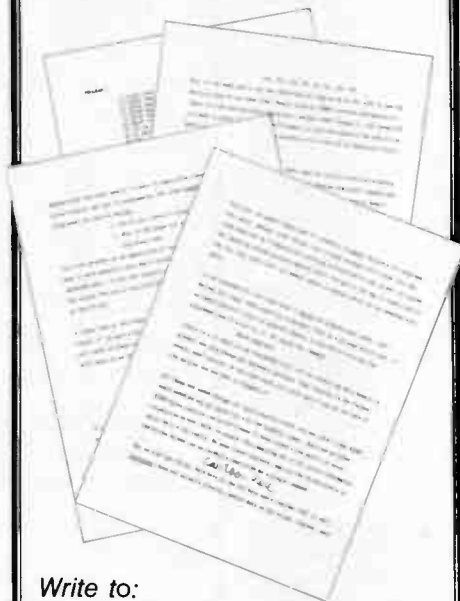

Write to:

Roger Harrison  
Australian Electronics  
Monthly  
PO Box 289  
WAHROONGA 2076 NSW

## FOR QUALITY AND VALUE TALK TO THESE PEOPLE ABOUT FLUKE MULTIMETERS

### A.C.T.

Actec Pty Ltd  
34 Geelong St Fyshwick  
(062) 80 6576

### N.S.W.

Ames Agency Pty Ltd  
605 Elizabeth St Redfern  
699 4524

George Brown & Co Pty Ltd  
174 Parramatta Rd  
Camperdown - 519 5855  
Newcastle - 69 6399  
Canberra - 80 4355

Bryan Catt Industries Pty Ltd  
10/59 61 Gyniea Bay Rd  
Gymea  
526 2222

Collier Tools (Aust) Pty Ltd  
185 Parramatta Rd  
Homebush  
763 1888

D G E Systems Pty Ltd  
103 Broadmeadow Rd  
Broadmeadow  
(049) 69 1625

Davred Electronics Pty Ltd  
127 York St Sydney  
267 1385

W F Dixon & Co Pty Ltd  
P.O. Box 42 Wickham  
(049) 61 5628

Macelec Pty Ltd  
99 Kenny St Wollongong  
(042) 29 1455

Paul's (Merchants) Pty Ltd  
22 Canterbury Rd  
Bankstown  
709 2311

Radio Despatch Service  
869 George St Sydney  
211 0291

Selectro Parts Pty Ltd  
482 Hume Hwy Yagoona  
708 3244

Standard Communications Pty Ltd  
6 Frank St Gladesville  
896 1755

Geoff Wood Electronics Pty Ltd  
656A Darling St Rozelle  
810 6845

### WESTERN AUSTRALIA

Atkins Carlyle Ltd  
1 Milligan St Perth  
321 0101

Dobbie Instruments (Aust) Pty Ltd  
9 Boag Rd Morley  
276 8888

Cairns Instrument Services  
32 Wickham St East Perth  
325 3144

Willis Trading Co Pty Ltd  
165 Albany Hwy  
Victoria Park  
470 1118

### VICTORIA

Radio Parts Pty Ltd  
562 Spencer St  
West Melbourne  
329 7888

G B Telespares Pty Ltd  
504 Queensbury Rd  
North Melbourne  
328 3371

Browntronic Pty Ltd  
93 Sackville St Collingwood  
419 3986

R K B Agency  
20 Council St Hawthorn  
82 7704

A J Ferguson & Co Pty Ltd  
558-568 Swanston St Carlton  
347 6688

SIRS Sales Pty Ltd  
4 Edols Pl North Geelong  
(052) 78 1251

### TASMANIA

George Harvey Electrics  
Head Office  
76 York St Launceston  
(003) 31 6533  
Hobart - (002) 34 2233

### SOUTH AUSTRALIA

Protronics Pty Ltd  
174 Wright St Adelaide  
212 3111

Trio Electrix Pty Ltd  
177 Gilbert St Adelaide  
212 6235

Redarc Electronics  
253 Main Rd Blackwood  
278 7488

### QUEENSLAND

L E Boughen & Co  
33 Railway Tce Milton  
369 1277

Colourview Wholesale  
5 Commerce St Salisbury  
275 3188

Fred Hoe & Sons Pty Ltd  
246 Evans Rd Salisbury Nth  
277 4311

Nortek  
36 Punari St Townsville  
(077) 79 8600

St Lucia Electronics  
71-77 Brunswick St  
Fortitude Valley  
52 7466

Selectro Parts (Qld)  
44 Esher St Ekibin  
394 2422

### NORTHERN TERRITORY

Thew & McCann (NT) Pty Ltd  
Menmuir St Winellie Darwin  
(089) 84 4999



## ELMEASCO Instruments Pty. Ltd.

NEW SOUTH WALES  
15 McDonald Street,  
MORTLAKE  
P.O. Box 30, CONCORD  
NSW 2137  
Tel: (02) 736 2888  
Telex AA25887

VICTORIA  
12 Maroonah Highway,  
RINGWOOD  
P.O. Box 623, RINGWOOD  
VIC 3134  
Tel: (03) 879 2322  
Telex AA30418 ELTENT

QUEENSLAND  
Tel: (07) 369 8688  
S. AUSTRALIA  
Tel: (08) 344 9000  
W. AUSTRALIA  
Tel: (09) 451 1500

quirements to the microampere range.

The new chip directly addresses and drives up to 1M of memory without external drivers, and offers automatic RAM warm-up, five programmable refresh modes and no-wait-state performance.

The 82C08 is pin-compatible with the 8208, providing a low-power upgrade path for existing systems, is available in sample quantities now, and is scheduled for volume production shortly. See **Total Electronics**.

**Take it easy**

**I**mageering has announced the release of Easy, a new wordprocessing package from MicroPro, that's perfect for the first-time user who doesn't do heavy-duty wordprocessing, they say.

Priced at \$225, Easy is designed for those who use wordprocessing as a secondary function to their use of a spreadsheet or database.

"If you have never used a wordprocessing package before, you can sit down with Easy on your computer and produce a document within 30 minutes," Imageering's marketing controller for government and educational software, Renata Nelipa, says.

Easy is said to have a short learning curve because of the program's heavy reliance on prompts and menus and extensive on-line help screens. Most of the commands needed for day-to-day work are easy to remember.

Editing procedures for inserting and deleting text, moving and copying blocks of text and navigating around the document will seem very straightforward to experienced wordprocessing users. The novice user won't have any difficulty either because prompts rather than function keys lead the way.

Easy has the capacity for enhanced printing with boldface, underlining, superscript and subscript. It supports 121 popular printers, which Imageering claim is more than any other wordprocessing program in this same category and price range.

MicroPro has given the Easy user an upward migratory path. You can progress to MicroPro's WordStar and WordStar 2000 because Easy's files are compatible with both these products.

Further information from Imageering, 77 Dunning Ave, Rosebery 2018. (02) 662 4499.



**Printers becoming increasingly dotty**

**A**mongst the advances in technology which benefit both the computer hobbyist and professional, the printer is in the forefront. Press releases arrive in rapid succession (and like bills, somehow in spite of postal strikes) trumpeting (or should it be matrixing) the latest product. Of course the latest printers are faster, quieter, cheaper and more versatile than the one I've just bought.

We hear that NEC has "put the industry into a panic" with the release of their P5 printer. This is expected to eat heavily into the daisy wheel printer market, they say.

Its strongest point is very high speed letter quality. This comes as a result of a newly engineered 24-pin print head. Most printers still use 9-pin heads. NLQ (near letter quality) mode on these printers can only be achieved by multiple passes. This is very slow, often slower than an equivalent daisy wheel printer. However, NEC claims the P5 achieves 94 cps in letter quality mode.

The other very noticeable thing about the P5 is the low level of noise. Most matrix printers sound like a mixture of the buzz saw and dentist's drill. The P5 is very quiet anyway, but an exclusive "quiet mode" reduces noise to vanishing point, they claim.

The P5 will also operate at a 264 cps for quick drafts or computer listings.

The printer has a built-in buffer which can be upgraded to 40K if required in two 16K increments, so there is no need for external print buffers. Indeed, with the full 40K, effectively the printer is its own spooler.

The other handy feature is plug-in fonts. The P5 has built in 10, 12, and proportional pitch fonts, and more can be added, plugging directly into the printer.

The price of the P5 is very attractive at \$1765 plus tax. Further information from: Natwick Management 2/25 Burns Bay Road, Lane Cove NSW. (02) 428 1666.

**A wee DRAM or two**

**T**exas Instruments has begun volume production of its 256K x 1 Dynamic Random-Access Memory (DRAM).

This 256K DRAM uses the same refresh scheme used in the 64K DRAM and is directly upward compatible, allowing an immediate quadrupling of system memory capacity without redesign or additional hardware.

Alternatively, the device may be used to reduce physical system size while maintaining memory capacity.

The 256K DRAM is expected to be the largest-selling component in the history of the semiconductor industry, with, according to Dataquest estimates, shipments of three billion units predicted worldwide for 1989, the peak year of production.

The TMS4256 and the TMS4257 are the first of a TI family of 256K DRAM components and modules using these components.

Further information from: **Texas Instruments Australia Limited, 6-10 Talavera Road, North Ryde 2113, NSW. (02)887 1122.**

**GALAH COMPUTING ANNOUNCES FIRST PRODUCT**

Despite the Editor's mirth in *The Last Laugh* last month, Galah Computing is alive and well. Our first product has not been developed but this is only due to a lack of energy, money, and expertise. Our copious R & D department, although engaged almost full time researching methods of completing forms for the AIRDIB grant, has a very clear idea of the ultimate personal computer, although if we were blessed with the three missing ingredients above we might still hesitate to join the never ending stream of new computer releases.

Seriously, however, here is our specification and if a unit exists to satisfy it we would like to hear about it:—

- Whole unit in single package with no ugly square IBM look-alike boxes, troublesome interconnecting leads etc, but with the screen tiltable within a reasonable range.
- In-built 100 Megabyte hard disk.
- Two 3.5" floppy disk drives — double sided double density.
- In-built modem with auto-dial auto-answer, decadic or DTMF dialling.
- RS232, IEEE and Centronics interfaces.
- High resolution colour VDU.
- 1 Mbyte RAM.
- In-built calendar and clock with battery backup, also protecting RAM in the event of short term power failure.
- Full anti-spike and brownout power filtering.
- Really good RF shielding.
- Standard Qwerty keyboard with no attempt to copy IBM design.
- Numeric keypad and programmable function keys.
- Switchable compatibility, CP/M, MSDOS, etc.
- On-board firmware: a range of standard systems such as database, spreadsheet, wordprocessing. Easy user access to these in, say, lozenge form ( . . . suck lozenge for one hour and know all about it? — Ed.)
- On-board sound generator (with speaker).

What is your ideal home/small business machine? Readers with comments or additions to the above specification are invited to drop a note to *Bytewide*. We might even consider an all-singing, all-dancing AEM design.

Meanwhile, Galah's purchasing team are scouring Lisle Street in London's West End ( . . . remember all those war surplus shops that later became brothels? — Ed.) for sources of parts to build the above. But the last purchase was mystifying, and we haven't heard from them since. . .

**Chief Galah**



# Set Forth

Roy Hill

Ever pondered about a 'strange' computer language muttered about in hushed tones at computer group meetings – called "Forth"? Do not be afraid, oh gentle hackers – it's not some exclusive code known only to a select group, it's more like the "tool" to set your computing creativity free!

TO DEFINE the concept of Forth is rather difficult. For a start, Forth is really not a language, in the same way that databases aren't really languages. Neither is it a piece of applications software. Databases fit quite well into this category. Forth also fails to fit the "language" criterion in that it is both a compiler and an interpreter, almost at the same time. Forth has also taken an extremely long time to gain even a small acceptance in the computing fraternity. In the words of its inventor, Charles Moore, "Forth is a polarizing concept. There are people who love it and people who hate it. It's just like religion and politics. If you want to start an argument, say, 'Boy, Forth's really a great language' " (1).

The most satisfactory definition of Forth, I believe, is my own. Forth is: "a programmer's version of the power drill with its accessory kit." In this sense, it is one of the tools that a builder can use to create the final product, which may, for example, be a house. How well the house is built depends upon one thing – how well the builder knows the uses of his tools.

---

## ***Forth is a programmer's version of the power drill with its accessory kit.***

---

One of the most frequent criticisms of Forth is the lack of standardisation in the "language". This is just like criticising a builder because his house is not identical to the rest of the houses in the street. The whole "raison-de-etre" for Forth is this very lack of forcing square blocks to fit round holes. Allow me to continue to use the building analogy. If I wish to cut a piece of wood for my house, I may choose to use my power saw accessory. Another builder may very well choose to use the jigsaw accessory. Neither of us is either right or wrong in our selection of the tool, we may just have a reason for preferring one to the other.

Forth is, therefore, exactly what a 'proper' programming tool should be – a 'mind amplifier'. There are many documented examples (2,3) of this fact. SAVVY, one of the latest generation of databases is written in Forth, a Forth system is floating around in a satellite in space, and a complete stand-alone Forth computer (4) is available in Australia.

Forth was developed (rather than invented) over a four year period between 1969 and 1972 by Charles Moore, a programmer at the Kitt Peak Observatory in the USA, who was less than satisfied with the programming tools then available (1).

## **Lifting the hood**

Let us now lift the hood and see what Forth is all about. Firstly, Forth is extremely compact. A fully operational system only occupies from 12 to 16K of memory and "stripped-down" versions run in as little as 2K. Forth is also very cheap to implement on most systems.

My favourite of Forth is a public domain version (5) which costs the staggering sum of \$38 and contains a complete

40/80-column screen-oriented editor that uses all the familiar Wordstar control commands. This package also contains a complete program/file management system which operates on an index and obviates the need to access the rather messy Forth source code development system called "screens". The dearest system I know of costs from \$700 to \$2000 (6), depending on the options selected. However, this is a fully fledged commercial control version of Forth and is fully supported by the Australian distributor.

Control is where Forth really proves its value though. Forth is far quicker to write than and executes at about 60% to 80% as fast as assembly language, depending upon the ability of the Forth programmer. Programs which would be hopelessly slow in BASIC (e.g: real-time data acquisition programs for high speed processes and instruments) are ideally written in Forth. For highly time-critical routines (e.g: the actual data capture) nearly all versions of Forth have a fully implemented assembler which contains all of the conditional structured control commands that we would dearly like to see in a conventional assembler, e.g: IF-THEN-ELSE, WHILE-REPEAT-UNTIL, BEGIN-AGAIN.

The motor of Forth is the Stack. This is the same sort of stack that can be found on a variety of calculators that use a particular variety of formula processing called RPN. (Reverse Polish Notation – after its Polish inventor). Use of the stack involves placing numbers thereon, and then proceeding to apply calculations sequentially to these numbers. This is best illustrated using an example.

In conventional mathematics, a formula might be  $x = (6 + 2) * (7 + 8 / 2)$ . This would evaluate to  $x = 88$ . Using RPN, we would say  $82 / 7 + 62 + *$  and obtain the same result. Purists would argue that RPN is far more complicated than conventional parenthetical mathematics, but RPN has many advantages for the Forth user.

---

## ***Forth is far quicker to write . . . and executes at about 50% to 80% as fast as assembly language. . .***

---

The stack is an ideal method of passing calculated values from one word to another. In fact, although Forth does provide the means for handling variables and constants, a clever Forth programmer can perform 90% of his data handling via the stack. One of the most important tasks of the Forth programmer is to keep track of the items on the stack at any given time. (A suitable Forth coding form is shown in Figures 1 and 2). To continue the electric drill analogy, if the motor of Forth is the stack, then the gear-box is most definitely the Forth word.

Words are to Forth what "reserved words" are to BASIC. They are means by which the Forth programmer manipulates data on the stack and in memory and also the means by which communication outside the program occurs. ▶

On the simplest level, Forth words are very familiar programming symbols such as + - / and \*. However, the words SWAP DUP ROT and OVER may not be so familiar, but are equally as important. Forth uses words in the same manner that we, as humans, do. Forth places its words in a **Dictionary** and programmers may organise groups of specialised words into sub-dictionaries known as **Vocabularies**.

A Forth word may be executed by selecting the appropriate vocabulary (Forth itself is the main vocabulary) and then typing the name of the word to be executed. For example, I may have a vocabulary called ROCKET, which contains the words MAIN IGNITE ENGINE BOOSTER etc. I may then define a new word FIRE which comprises some (or all) of the words defined in this vocabulary.

A Forth programmer writes his program by selecting the appropriate Forth words to operate on his data and then combines these words into a single new word that accomplishes the desired result. A typical example of this would be to define a word called SQR, which would calculate the square of any number placed on the stack. To perform this requires that we compile our new word SQR. This is signalled to the Forth compiler by using a colon sign to indicate the start of compilation and a semicolon to indicate the cessation of compilation:-

```
: SQR DUP * . ;
```

The colon tells Forth to place a new word in its *dictionary* and give it the name SQR. DUP tells Forth to duplicate the number on the top of the stack so that there are two copies. '\*' multiplies the two top numbers on the stack and the period is Forth's way of printing out the number left on the top of the stack. The semicolon tells Forth to cease the compilation process and if the compilation was successful, the new definition can be executed in the interpretive mode. There are several noteworthy points to mention here:

1. Unlike BASIC, Forth differentiates between upper and lower case, thus the word *sqr* is not interchangeable with the word SQR.
2. Most Forth operations perform in destructive manner on the stack. That is, they remove the numbers that they are operating on from their positions on the stack.
3. It is important to differentiate between execution mode and compilation mode. In compilation mode, no numbers are being manipulated. This only occurs in execution mode. (There are some notable exceptions to this rule, but they won't be discussed here.)
4. Forth only operates on integer quantities. There are several floating point packages available, (several in the public domain <sup>(3)</sup>) but these are not standard on most systems.

In case the idea of integer only arithmetic seems a bit repugnant to the reader, there are two important facts to remember:

1. Integer arithmetic is compact. Because the computer doesn't have to keep track of decimal points, integer numbers require far less (usually half) storage than do floating point numbers.
2. Integer arithmetic is fast. Execution speeds for integer arithmetic can be up to six times faster than comparable floating point calculations. Pseudo-floating point operations can be performed by using scaling techniques if this becomes necessary. Control applications (the place where Forth is most at home) usually only deal with integer quantities.

One further argument in favour of integer arithmetic — the

n<sub>1</sub> n<sub>2</sub> n<sub>3</sub> FASTDUP - - -  
n<sub>1</sub> - Lower Screen  
n<sub>2</sub> - Upper Screen  
n<sub>3</sub> - Buffer Size (in blocks)

Program: Fastdup (for Screens) By: HILL		Date: 11/1/85	
R	Stack (Top→)	FORTH	Comment
	∅	VARIABLE LOSCR	Low Screen
	∅	VARIABLE HISCR	High Screen
	∅	VARIABLE NUM	Number of RAM Buffers
	∅	VARIABLE CURR_BUF	Keep count of which buffer
		: SET_BUF	Set current
	ADDR+2	FIRST 2+	buffer to
		CURR_BUF !	FIRST
		;	
		: CALC	Calculate the
	hi	HISCR @	number of
	hi lo	LOSCR @	loops and
	diff diff	- DUP	leave on stack
	diff diff	<	with remainder
	diff	IF	
	diff 0	0 ERROR	Error check
	diff	THEN	for incorrect
	diff n <sub>3</sub>	NUM @	Screen Range
	Rem Quot	/MOD	
		;	

CURRY ASSOCIATES  
P.O. Box 11324 Palo Alto, CA 94306  
FORTH PROGRAMMING AIDS

Figure 1.

original version of Applesoft was an integer-only BASIC interpreter. A large number of fairly sophisticated programs were written in integer BASIC.

Perhaps one of the greatest disadvantages of Forth is the documentation process. Forth has been described <sup>(2)</sup> as a "write only language". Most modern languages are fairly good at self-documenting. Forth is a notable exception. One has to force oneself to thoroughly document Forth source code (called SCREENS) or pay the penalty of bad memory. I have fallen into the documentation trap myself. A Forth program that I omitted to document took me two days to decode when a modification became necessary. In fairness to Forth, I should point out that most programs and applications can be made to be self-documenting, simply by choosing meaningful word names. The only justifiable reason for using abbreviated word names is when space considerations are important. For example, our definition of FIRE in the ROCKET vocabulary could either be like this:-

```
: FIRE MAIN-ENGINE IGNITE BOOSTER IGNITE ;
```

or, alternatively, our definition could look like this:-

```
: FIRE M-E IG BO IG ;
```

The first version is pretty well self-explanatory, but the second .....

Leo Brodie <sup>(7)</sup> also makes this point quite well. To demonstrate what Forth documentation should contain, I have provided two accompanying figures. Figure 1 illustrates a Forth coding sheet <sup>(8)</sup> showing several short colon defini-



Program:	By:	Date:	
R	Stack (Top →)	FORTH	Comment

CURRY ASSOCIATES  
P.O. Box 11324 Palo Alto, CA 94306  
FORTH PROGRAMMING AIDS

Figure 2.

tions, and Figure 3 shows these same colon definitions as part of a Forth source code screen.

**A peek at the SCREEN**

As readers have probably realised, the main form of source code for Forth is the SCREEN. Colon definitions (i.e: compiled words) can be written directly from the terminal, but additions or corrections cannot be made to the compiled word. It must be re-defined with the additions/corrections included in the new definition. Forth screens are the main form of mass storage. These usually occupy 1K of memory space, both within the computer and on disk or tape. Forth editors (used for the creation/modification of screens) take advantage of this fact and a screen is usually either 24 lines x 40 columns for a standard 40-column video (note: 64 bytes are inaccessible) or 16 lines by 64 characters for an 80-column screen. My favourite version of Forth (5) — I have seen quite a few — allows full access to the 1K bytes in both modes. In 80-column format I have 64 x 16 and in 40-column format I have two half screens (I can toggle between the two) of 32 x 16.

**A word on Editors**

Editors range from very simple line oriented editors (ughh!!!) which are often found on minimal Forth systems, to full-blown screen oriented editors which can be implemented as overlays and removed from the system when not in use. Some of the latter can be 20K bytes worth and can almost be used as word processors.

**Individually tailored**

The most interesting feature of Forth is the ability to alter the system to suit the needs of the individual user. Words not required in a final system (e.g: a dedicated controller) can

be removed from the dictionary to save space. In fact, some systems (4,5) even allow the space normally taken by the name of the word to be recovered. Forth is the only "language" I am aware of in which one can readily modify the compiler. That's right! My late, lamented SYM-1 microcomputer had a version of Microsoft BASIC with IF-THEN, but no ELSE. To write it in would have required a major programming exercise. With Forth, extensions to the compiler are so simple as to be trivial — modify existing compiler directives — add new ones — create new classes of variables and constants — the list is endless.

```

100 LIST
SCR # 100
 0 ( Fast Screen Duplicator 1/11/85 )
 1
 2 0 VARIABLE LOSCR
 3 0 VARIABLE HISCR
 4 0 VARIABLE NUM
 5 0 VARIABLE CURR_BUF
 6
 7 : SET_BUF ( Set current Buffer to First
 8             )
 9             FIRST 2+ CURR_BUF ! ;
10
11 : CALC ( Calculate the number of times
12         to loop and leave on the stack )
13     HISCR @ LOSCR @ - DUP 0< IF 9
14     ERROR THEN NUM @ /MOD ;
15
16
17
18
19
20
21
22 -->
23
OK
```

Figure 3.

**A final word**

Finally, I would like to commend several books to the aspiring Forth programmer. During my apprenticeship with Forth, I have found several books to be invaluable. Two books by Brodie (7,9) are excellent bedside reading and my reference guide is a two-volume set by McCabe(10).

**REFERENCES AND BIBLIOGRAPHY**

- 1. Byte (Forth Issue) August, 1980 p76 ff.
- 2. Ibid, p6 ff.
- 3. Forth Dimensions (Journal of the Forth Interest Group — FIG) Volumes 1 to 6.
- 4. RSC Forth Board (about \$160 in minimum system version), available from Energy Control, P.O. Box 6502, Goodna 4300 Qld.
- 5. Maestro Forth System, available for Apple II and Apple IIE from Maestro Distributors, Calool St, South Kincumber NSW.
- 6. Australian Industrial Electronics Pty Ltd, 32 Taxted Pde, Wantirna Vic. (Gary Brown). This is a complete control system of Forth for use in industrial control applications. The system is called PolyFORTH as has been developed by FORTH Inc. — a Charles Moore company.
- 7. Brodie, Leo; Thinking FORTH, p57, Prentice-Hall, 1984.
- 8. Curry Associates, P.O. Box 11324 Palo Alto, California 94306, USA. This is a public domain Forth coding sheet which is freely available for reproduction.
- 9. Brodie, Leo; Starting FORTH, Prentice-Hall, 1981.
- 10. McCabe, C. Kevin, FORTH Fundamentals Volumes 1 and 2, Dilithium Press (A.N.Z. Book Company — French's Forest NSW) 1983.

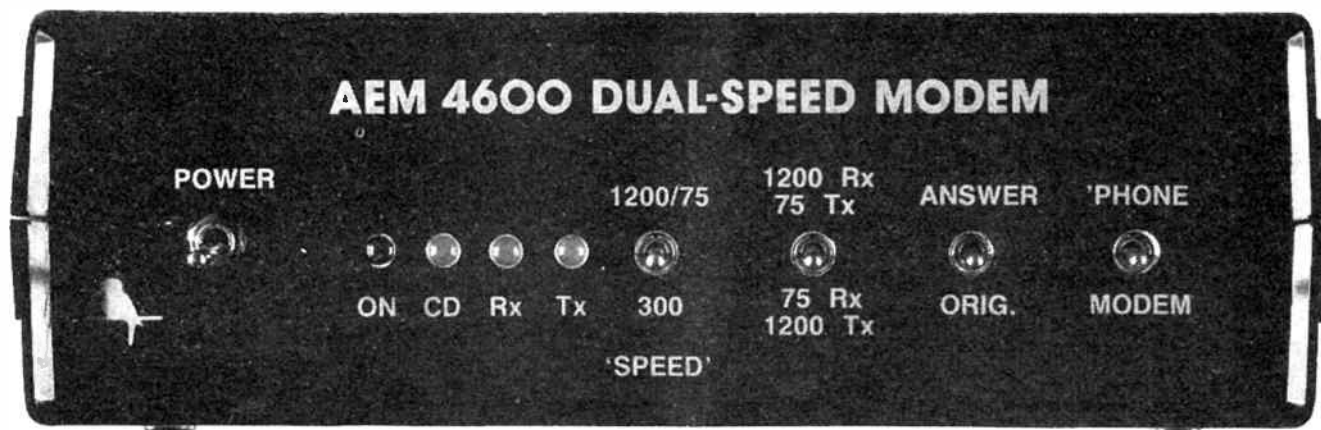

## A 'dual-speed' direct-connect computer modem

Robert Broomhead

Get into the computer communications revolution with this simple to build and operate modem. It features both 300/300 and 1200/75 baud operation which covers the majority of popular applications.

ONE OF THE MOST POPULAR accessories for personal computers these days is the modem. It is a gadget that plugs into your computer's serial port and provides a means of 'talking' to other computers over a telephone line. You can send and receive programs, messages, document files or whatever. A number of computer clubs, computer stores and private individuals have set up computer 'bulletin boards' which you can dial-up using a modem.

A bulletin board is a computer system with an automatically answering ("auto-answer") modem hooked up to it which, when you call it up with your computer and modem, provides access to a host of useful and interesting activities and services. You can copy ('down load') programs from the bulletin board, send and receive messages to other bulletin board users ('electronic mail'), send ('upload') programs for others to use, etc. Bulletin boards are quite popular.

Then there's Viatel, Telecom's videotext service which is rather like a 'commercial' bulletin board. Banks, travel agencies, airlines, financial services, electronics companies etc. provide their services through Viatel. You can use a personal computer and modem to access Viatel, providing the computer meets the appropriate software and hardware requirements so that the video can be correctly received and displayed, and provided the modem meets the relevant Viatel communications requirements.

### Computer communications

This is no place for a lengthy discourse on the subject of computer communications techniques and standards. However, a little background information will put you in the picture.

To get one computer to talk to another over a telephone line — or any 'long', two-wire line — you can't just connect the serial interface of each to the line. The serial interface on your computer uses direct current (dc) signalling. That is, it will drive the line voltage positive or negative, or just positive and zero, to send digital 1s and 0s. The serial interface expects to see some reasonable representation of the original voltage levels in order to work. The thing is, long lines don't transmit dc pulses very well. Telephone lines, in particular, do not provide a dc path between telephones across the city, or across the nation. Telephone lines expect ac signals — the voice (sound waves converted to electrical waves) — and will transmit voice-frequency signals, which generally span from about 300 Hz to about 3000 Hz (3 kHz), quite well.

Thus, to send on/off (dc) signals from a computer down the telephone line, the on and off levels (1s and 0s) are first converted to tones in the voice-frequency band. To receive the transmitted computer signal, these tones have to be re-converted to dc on and off levels.

A device to convert the on/off levels to tones is termed a *modulator*, while a device that re-converts the tones to on/off levels is called a *demodulator*. Hence the term **modem**, from *modulator* and *demodulator*.

If you are at all familiar with your computer, you will doubtless know that, when using a serial printer, you need to set the computer's data output rate and the printer's data operating rate to the same 'speed'. Those on/off 1s and 0s you send out the serial port are called 'bits'. When you send one bit per second, the data speed is said to be 'one Baud'. The



Baud is named after Jean Maurice Emil Baudot, a Frenchman who devised the teletype code.

Now, it's quite possible to employ any Baud rate you want for sending and receiving computer data. However, a number of conventions have been established, for great and good reasons (some technical, some just for convenience), for specific applications. But before we examine the common speeds, there's another thing we have to consider.

When you type a character on your keyboard, and your computer sends it to another, down the line, that character can appear on your screen in one of two ways. Your computer can send it to the screen, or to the computer at the other end of the line can 'echo' the character, sending it back to you, whence it is displayed on your screen. The character is displayed on the receiving computer's screen upon receipt. This sending and receiving is called 'duplex' operation. When your computer displays the character, that's termed **half duplex** operation. When the remote computer echoes the character, that's called **full duplex** operation.

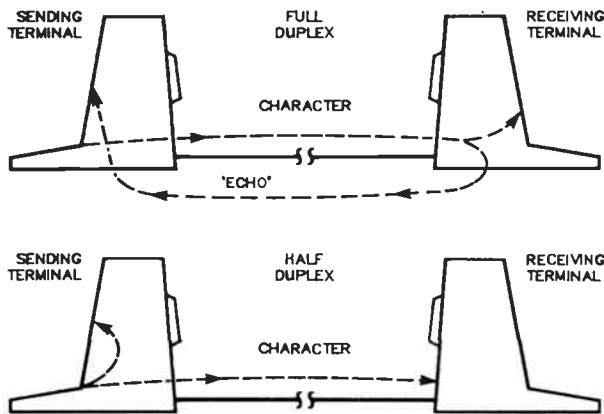

Full duplex operation assures you that the equipment at the other end is receiving you.

Back to the communications speeds. There are two widely used Baud rate standards: 300 Bauds in both directions plus 1200 Bauds one way, 75 Bauds the other. Other standard speeds are, of course, used — such as 600 Bauds both ways and 1200 Bauds both ways. However, this project has been designed to provide communications at the two most popular Baud rate standards. In general, full duplex communications is employed when using 300 Bauds, and half duplex when using 1200/75 Bauds. In the latter case, you must decide who's going to transmit at 1200 Baud or 75 Baud. Whoever transmits at 1200 Baud, must receive at 75 Baud. Thus, whoever receives at 1200 Baud, must transmit at 75 Baud. Otherwise, you won't be able to 'talk' to each other!

A complication arises because of the need to transmit in both directions. The tone pair used to transmit the 1s and 0s in one direction cannot be the same tone pair used to transmit in the opposite direction. Thus, separate tone pairs are employed. In order that one modem can 'talk' to another, the frequencies used for the tone pairs must conform to some common standard. To separate them, if you initiate the call, then you are said to **originate** it. The person you are calling is thus at the **answer** end. This terminology is used to sort out the tone pairs.

The standard frequencies for data communications employed in Australia were set down by an international communications consultative body called the CCITT. For 300 Baud communications, their document 'V.21', gives the specification. Because serial communications is used, these

relate to the RS232 signal levels where a digital 1 (termed a 'mark') is a negative voltage between -3 V and -12 V, and a digital 0 (termed a 'space') is a positive voltage between +3 V and +12 V. For 1200 Baud communications, the CCITT document V.23 sets out the relevant frequencies. Table 1 sets out the various frequencies for the different modes and Baud rates.

TABLE 1: The standard tone pairs

Modem	Baud Rate	Duplex	Transmit Frequency		Receive Frequency		Answer Tone Freq Hz
			Space Hz	Mark Hz	Space Hz	Mark Hz	
CCITT V.21 Orig	300	Full	1180	980	1850	1650	-
CCITT V.21 Ans	300	Full	1850	1650	1180	980	2100
CCITT V.23 (Mode 2)	1200	Half	2100	1300	2100	1300	2100
CCITT V.23 Back	75	-	450	390	450	390	-

## Project design features

The project supports 300 Baud full duplex operation and 1200/75 Baud half duplex operation. That is, you can transmit and receive at 300 Baud in both directions or 1200 Baud one way, 75 Baud the other. A switch has been incorporated allowing you to select either 1200 Baud transmit with 75 Baud receive, or 75 Baud transmit with 1200 Baud receive.

Most bulletin boards employ 300 Baud full duplex, a few have 1200/75 Baud facilities. Telecom's Viatel videotex service employs 1200/75 half duplex operation. You transmit at 75 Baud and receive at 1200 Baud. This has the advantage that, when receiving at 1200 Baud, Viatel writes information to your screen at the fastest rate; four times the speed if you were using 300 Baud communications.

Four front panel toggle switches provide all the operating functions. One selects the 'speed'. To the right of this is a switch which allows you to select transmit/receive Baud rates in the 1200/75 Baud mode. Further to the right is the "answer/originate" switch. Four LED indicators allow you to keep an eye on what's happening at any time. The ON indicator is obvious. On its right is the 'CD' LED which lights up when you've detected another modem's signalling tone, termed the 'carrier'. This lets you know when communications can proceed. Then comes the 'Rx' LED which flashes as data is being received. Last on the right is the 'Tx' LED which flashes as you transmit data.

A 25-pin D connector on the rear panel of the unit provides for connection to your computer. The interface signals comply with the RS232 standard. Only the minimum signal lines have been implemented to make interfacing as simple and as 'universal' as possible.

The project was designed around the '7910 "world modem" chip which does pretty well all the work. A comprehensive data sheet on the '7910 is published elsewhere in this issue. This device was originally developed by the US-based company, Advanced Micro Devices, and is known as the ▶

## LEVEL

We expect that constructors of an

## INTERMEDIATE

level, between beginners and experienced persons, should be able to successfully complete this project.

# aem project 4600

**TABLE 2: Main and Back channel pins**

Pin No.	Function
10	Transmit data input, MAIN channel
28	Transmit data input, BACK channel
26	Received data output, MAIN channel
15	Received data output, BACK channel
25	Carrier detect output, MAIN channel
27	Carrier detect output, BACK channel
12	Request to send, MAIN channel
11	Request to send, BACK channel
17	Answer/Oriinate select line
18	300 Baud — 1200/75 Baud select line

**TABLE 3: Pin 'activity' in each mode**

Pin No.	300B Orig.	300B Answer	1200B Tx/75B Rx	75B Tx/1200B Rx
10	TRANSMIT	TRANSMIT	TRANSMIT	NOT USED
28	NOT USED	NOT USED	NOT USED	TRANSMIT
26	RECEIVE	RECEIVE	NOT USED	RECEIVE
15	NOT USED	NOT USED	RECEIVE	NOT USED
25	CARRIER DET.	CARRIER DET.	NOT USED	CARRIER DET.
27	NOT USED	NOT USED	CARRIER DET.	NOT USED
12	+5 V	+5 V	+5 V	0 V
11	0 V	0 V	0 V	+5 V
17	0 V	+5 V	NOT USED	NOT USED
18	0 V	0 V	+5 V	+5 V

## AEM4600 CIRCUIT OPERATION

The 'heart' of this project is the '7910 'world chip' modem device, IC1. A full data sheet on this device is reproduced elsewhere in this issue. The function of this device is, firstly, to generate two tones in the voice-frequency band — one tone to represent a digital 1, the other to represent digital 0 — which may then be transmitted down a two-wire data line or a telephone line; secondly, the device can detect the presence of two such tones transmitted to it and convert them to digital 1s and 0s. In this way it can transmit and receive digital data over a two-wire voice-frequency line. It can transmit and receive at a variety of selectable data rates, or Baud 'speeds', employing a variety of standard tone frequencies.

The most widely used Baud-speed standards in this country are 300 Bauds in both directions ('300/300') and 1200 Bauds one-way, 75 Bauds the other (1200/75). The most widely used standard tone frequencies are the CCITT V.21 and V.23 tones, detailed in Table 1.

The easiest way to treat the world chip is as an audio oscillator, and two filters. Take the 300 Baud mode. The digital data to be transmitted is applied to pin 10 of the '7910. When it goes low, then the oscillator switches to Frequency No. 1. When pin 10 goes high, the oscillator switches to frequency No. 2. The output of the oscillator appears at pin 8 where it is fed into a 'hybrid' circuit (more on this later).

Data is received on pin 5 of the '7910. If frequency No. 1 arrives here, the corresponding internal filter (No. 1) will detect it and pin 26 will go low. If frequency No. 2 arrives, filter No. 2 will detect it and pin 26 will go high. The actual frequencies vary with the particular mode of operation selected.

Thus, in this way, digital data sent by your computer, or intended for reception by your computer, is converted from the digital form (on/off — 1s and 0s) to the analogue form (two tones) when sending, and from the analogue form to the digital form when receiving.

The hybrid circuit comprises the op-amp IC2 and surrounding components. Its function is to enable two-way data transmission over a single pair of wires.

A transmitted signal coming from pin 8 of the '7910 (IC1) is passed to the line isolation transformer, TR2, via R11-C7-R12-C13. The back-to-back zeners, ZD1-ZD2, prevent excess signal level being coupled to the line by 'clipping' the signal peaks at  $\pm 3.9$  volts.

When receiving, signals from the line are coupled to the non-inverting input of op-amp IC2 via the line isolation transformer

and C13. The output of IC2 feeds the receive input of the '7910, pin 5, via a 2:1 voltage divider comprising R15/R16. R14 provides feedback for IC2. The two zeners, ZD1 and ZD2, clip any 'spikes' or other high level signals coupled in from the line, preventing overload of the '7910's receive input.

On the other side of IC1 we have the 'main' and 'back' channel digital inputs, pins 10 and 28 respectively, along with main and back channel digital outputs, pins 26 and 15. These are TTL-level inputs and outputs. The main and back channels are kept separate on the '7910 as there are a few computers on the market requiring them to be used that way. However, most personal computers (e.g. the Microbee) use only two data lines — transmit and receive, so therefore we can link our main and back channel inputs and outputs together. Hence, pins 10 and 28 are linked directly together, and pins 26 and 15 are combined with an AND gate, IC6a.

For those wondering what is meant by 'main' and 'back' channels, let me explain.

When transmitting at 300 Baud you are doing so in the 'full duplex' mode, i.e. sending and receiving data at 300 Baud at the same time. We have common Baud rate, so therefore we can use the main channels for both transmitting and receiving data. However, when using the 1200/75 mode we have two separate Baud rates — 1200 Baud one way and 75 Baud the other — and we are transmitting in the half duplex mode. That is, we can only transmit OR receive at any one time. Here it is necessary to use the BACK channel.

By convention, 75 Baud is always transmitted through the back channel. Therefore, to receive at 1200 Baud and transmit at 75 Baud, the main channel would be used for receiving data, and the back channel for transmitting data. Conversely, if we were receiving at 75 Baud and transmitting at 1200 Baud, this time we'd be using the back channel to transmit the data and the main channel to receive the data.

In this project, the main and back channels of the modem chip are linked together and I have allowed the internal switching of the modem IC to take care of selecting the respective main and back channels for the transmitting and receiving of data.

The only thing we have to tell the '7910 is the Baud rate,

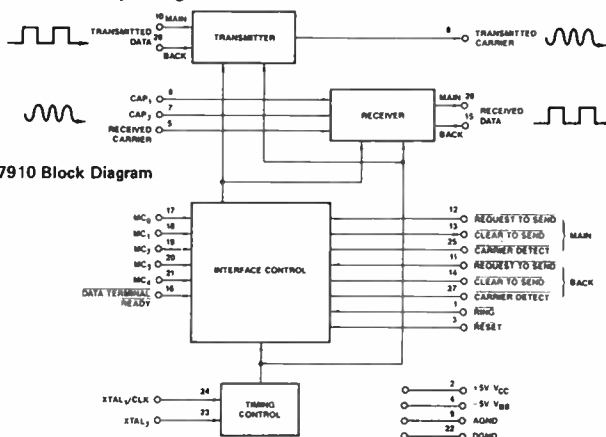

*N.B. Missing caption under overlay, p.84 — All circled pads are soldered top and bottom on component leads, or linked. There are some minor differences to the prototype pictured*



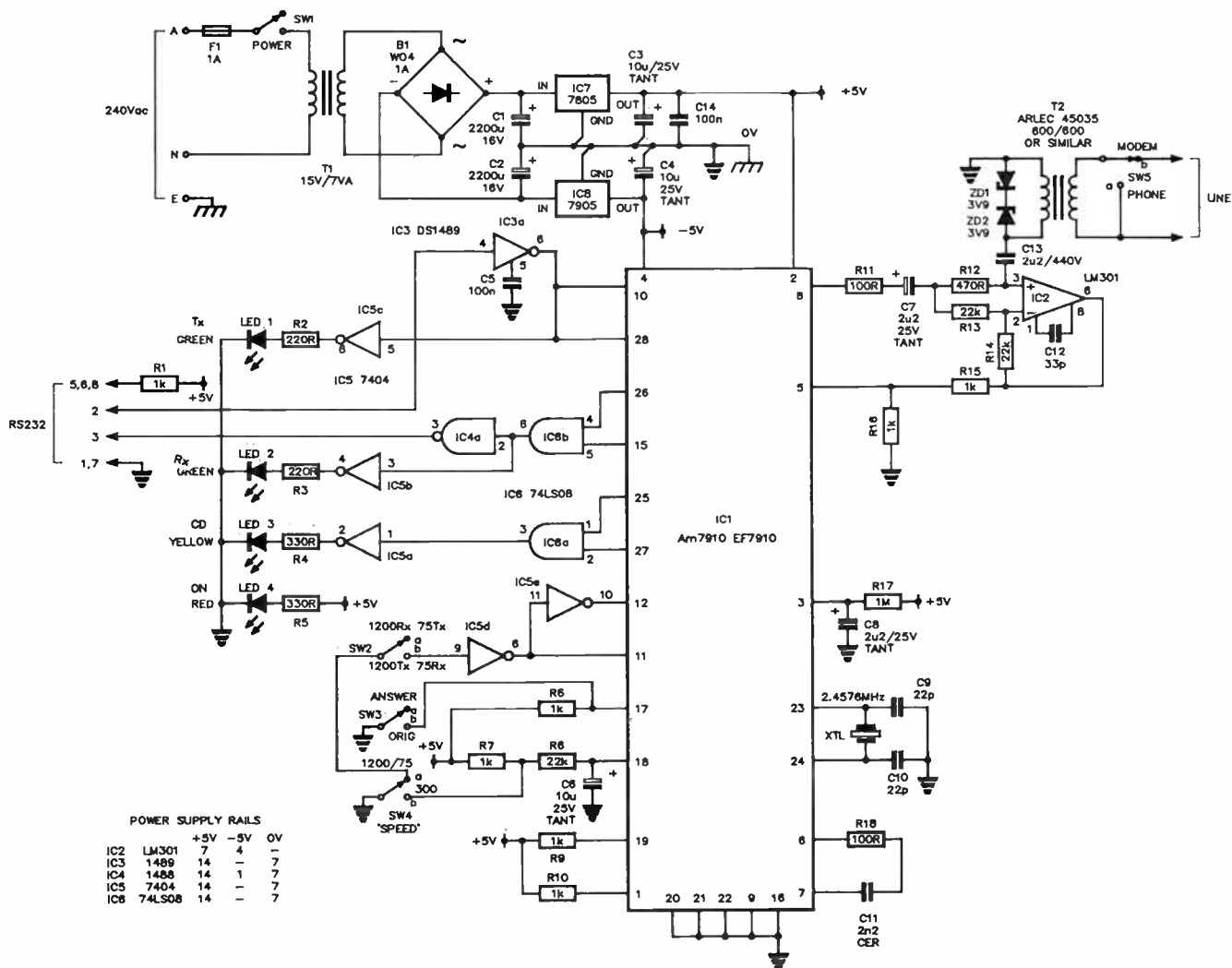

whether we want to be in the originate or answer mode (300 Baud mode only), and whether we want to send data at 75 Baud or receive data at 75 Baud (1200/75 Baud rate mode only). Table 2 lists the '7910 main and back channel pins and the associated function select pins. Table 3 shows the pin functions, signals or levels applied in each mode.

The received data output appears at pin 6 of IC6b. This TTL-level signal is buffered by IC4a, one buffer from a 1488 line driver IC. Its output, pin 3, drives pin 3 of the RS232 connector (RXD). The 'Rx' indicator, LED2, is driven by IC5b, one buffer from the 7404, its input (pin 3) being taken from the output of IC6a, where the received data appears.

Data for transmission comes into the modem on pin 2 of the RS232 connector (TXD). IC3a, one buffer from a 1489 line receiver, buffers this providing a TTL-level out from the +/- swing of the RS232 input; its output (pin 6) driving the commoned main and back channel transmitted data pins of IC1 (10 and 28) which require a TTL-level signal. Pin 6 of IC3a also drives a buffer from the 7404 hex inverter, IC5c, which drives LED1, the 'Tx' indicator.

The two main and back channel carrier detect outputs, pins 25 and 27 respectively, are commoned with an AND gate (IC6a), the output of which is buffered by one inverter from IC5 to drive LED3, the 'CD' indicator.

The two line drivers, IC3 and IC4, provide a 'true' RS232 interface. IC4a swings the RXD output (pin 3 of the RS232) between +5 and -5 V, while IC3 will accept either correct RS232 level or TTL-level inputs.

The project is intended as a direct-connect modem, that is, it does not require an acoustic coupler when connecting it to

a line. Connection to the line is made via a 600 ohm line isolation transformer (T2). This transformer has two functions, firstly to match the line impedance (nominally in the vicinity of 600 ohms), and secondly to provide ac/dc isolation of at least 3.5 kV between the modem and the line. Capacitor C13 also provides a degree of isolation.

The power supply employs a pc-mount transformer, T1. Its secondary is bridge-rectified by B1 to provide a positive and negative rail. Capacitors C1 and C2 smooth the rectifier output and two three-terminal regulators, IC7 and IC8, provide regulated +5 V and -5 V rails respectively. Capacitors C3 and C4, keep the regulators stable. C14 is a supply rail bypass for IC4.

Power-on reset for IC1, with a short time delay, is provided by R17/C8.

The modem IC's internal oscillator is used (pins 23 and 24), employing the required 2.4576 MHz crystal. Capacitors C9 and C10 are as-specified in the '7910 data sheet.

Likewise, R18 and C11, linking pins 6 and 7 of the modem chip IC1, are as suggested in the data to provide correct operation of the internal analogue to digital conversion.

The 'minimal' handshaking pins of the RS232 connector, pins 5 (CTS), 6 (DSR) and 8 (DCD) are linked together and pulled high via R1. The RS232 connector signal ground (SG) and frame ground (FG) pins, 7 and 1 respectively, are linked via the common ground line on the pc board.

The modem is switched on-line and off-line by SW5, a single-pole, double-throw toggle switch. In the off-line position, the line side of T2 is shorted so that line noise coupled across the switch is not picked up by the receive section of IC2, which would otherwise light the 'carrier detect' (CD) indicator.

# aem project 4600

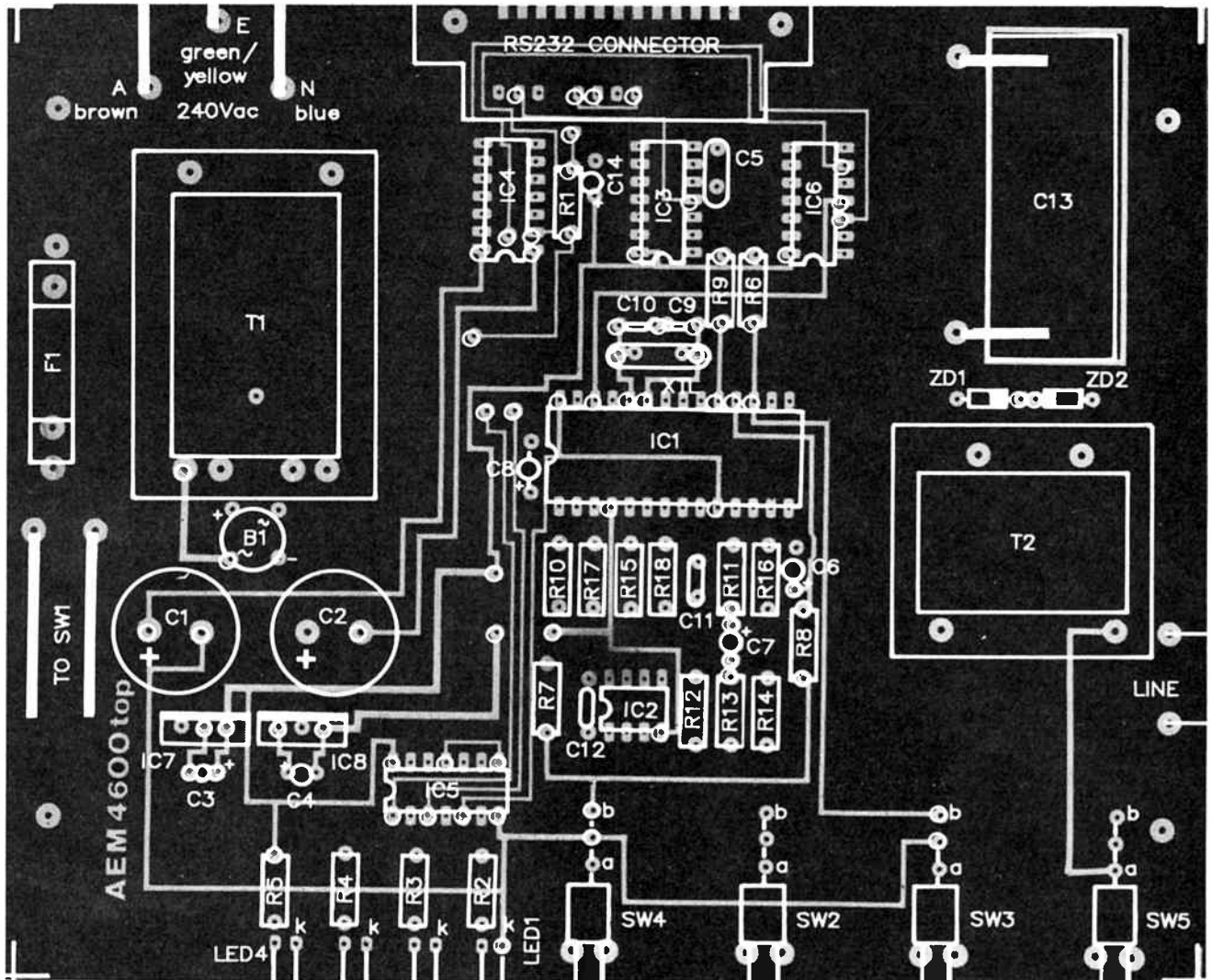

## AEM4600 PARTS LIST

### Semiconductors

B1	WO4, 1 A bridge
IC1	Am7910, EF7910
	FSK modem chip
IC2	LM301, $\mu$ A301
IC3	DS1489 line Rx
IC4	DS1488 line Tx
IC5	7404
IC6	74LS08
IC7	7805
IC8	7905
LED1, LED2	5 mm green LED
LED3	5 mm yellow LED
LED4	5 mm red LED
ZD1, ZD2	3V9/1 W zener

### Resistors

	all 1/2 W, 5%
R1	1k
R2, R3	220R
R4, R5	330R
R6, R7	1k
R8	22k
R9, R10	1k
R11	100R
R12	470R

R13, R14	22k
R15, R16	1k
R17	1M
R18	100R

### Capacitors

C1, C2	2200 $\mu$ /16 V RB electros
C3, C4	10 $\mu$ /25 V tant.
C5	100n greencap
C6	10 $\mu$ /25 V tant
C7, C8	2 $\mu$ 2/25 V tant
C9, C10	22p ceramic
C11	2n2 ceramic
C12	33p ceramic
C13	2 $\mu$ 2/440 V (see text)
C14	100n greencap

### Miscellaneous

F1	1 A, 3Ag fuse
Sw1	SPDT 250 Vac rated panel mount toggle switch.
SW2-5	SPDT pc-mount miniature toggle switches, C&K 7101 or similar.

T1 ..... pc-mount transformer, Arlec AL7VA/15, Ferguson PL18/5VA or similar.

T2 ..... 600:600 ohm Telecom-approved line transformer, Arlec 45035, Ferguson MT620 or similar

XTL ..... 2.4576 MHz quartz crystal in HC/18U can.

AEM4600 pc board; instrument case, about 200 x 160 x 70 mm, eg: DSE H2505 or Altronics H 0480; Scotchcal for front panel or silk-screened panel; Molex pins; line cord; mains cable and 3-pin plug; 25-pin D connector, either right-angle pc-mount type or solder type; 2 x pc-mount fuse clips; screws and spacers to mount pc board; nuts and bolts, hookup wire, etc.

**Expected cost:**  
**\$145-\$155**

## DIRECT-CONNECT MODEMS AND YOUR RESPONSIBILITIES

Any device which you intend to connect to a Telecom line must be 'type-approved' as an attachment. It is an offence under the Telecommunications Act 1975 to attach any apparatus to a telephone line which is part of the public switched telephone network other than an approved device or an appliance leased from Telecom.

You are at perfect liberty to construct and use the modem described here over, for example, an internal building intercom line or other private 'twisted pair' line, or with a packet radio terminal node controller (TNC).

The electrical, electronic and physical design and layout of the project has been done to comply with relevant type-approval specifications and for electrical safety. In particular, the mains and line transformers both comply with Australian Standard AS3126, and Telecom typed-approved line transformers have been specified in the parts list.

The Telecom specifications relating to this sort of equipment include documents 1050, 1053, 1222, 1240, 1302 and 1364. Authorization for type approval must be made on Telecom's Form TS139 "Data and Non-Voice Equipment Directly Connected to the Telecom Network".



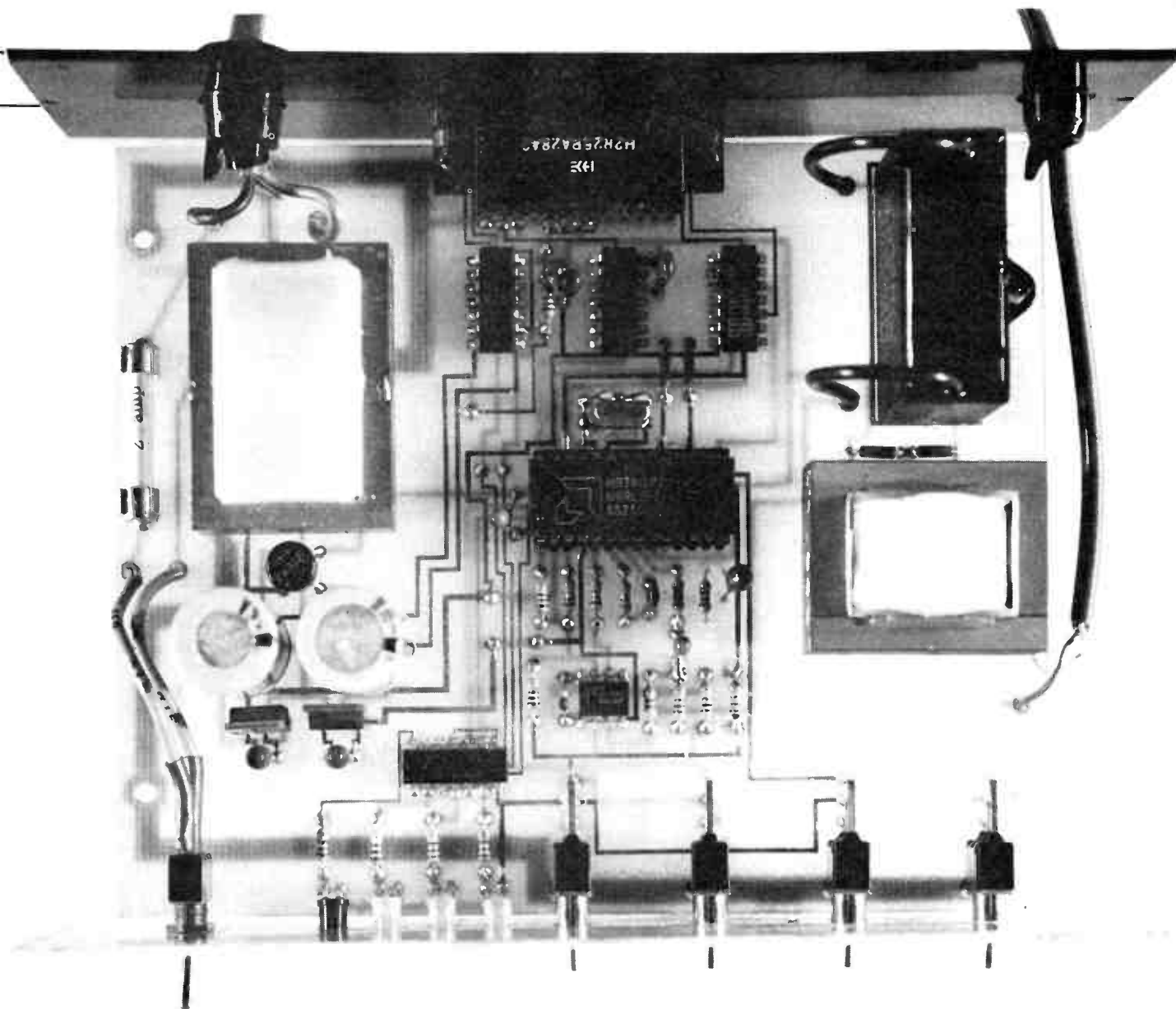

Am7910. A pin and function compatible device was recently released by the French manufacturer, Thomson Semiconductors, and is known as the EF7910. AMD is represented in Australia by R&D Electronics, while Thomson Semiconductors is represented by Promark Electronics.

While the '7910 is capable of a wide variety of operating modes on several standards, I have only implemented the popular ones here.

Simple, single-board construction has been employed to keep costs down and to simplify assembly. A double-sided board is necessary, but through-plated holes are not required. The power supply is on-board. In laying out the board, and in other aspects of the design, I have taken care to comply with the relevant safety standards and type-approval specifications (see accompanying panel). In particular, the mains and line isolation transformers specified in the parts list meet the relevant requirements, while C13 is a special type to provide additional isolation. It is distributed by Captron in Melbourne. The prototype was housed in a common, sturdy plastic instrument case with a Scotchcal front panel.

The photograph inside the prototype shows a pc-mount, right angle RS232 connector. However, provision has been made on the pc board to mount a solder-type connector over the edge of the board, soldering to the pads provided. Link pins 1, 2, 3, 5, 6, 7 and 8 to the pads used by the other connector type with short lengths of hookup wire.

## Construction

The construction of the modem is fairly simple, and should be within the capabilities of most electronic hobbyists who've had some constructional experience.

The first step is to ensure that you have all the necessary parts required to build the modem, refer to the parts list for a list of everything you will need. make a visual check of the pc board to ensure all the holes are drilled and of the right diameter. See that there are no solder 'bridges' between close-spaced pads or tracks.

Referring to the circuit board overlay, load all the components onto the circuit board, stage by stage, starting with the lowest profile components, the resistors and capacitors, work your way up to the highest profile components (transformers etc). This avoids the circuit board from becoming overcrowded while the small fiddly components are being installed. See that you get polarised capacitors and the semiconductors the right way round. Instead of an IC socket, I used Molex pins for IC1. Note that the two supply filter capacitors (C1 and C2) need to sit up about 4-5 mm from the board to enable you to solder them top and bottom sides of the board. Also, note where pads are soldered on both sides of the board.

Next, take up your soldering iron and carefully solder all the components to the board, taking care not to allow any tracks to be shorted together by the use of excessive amounts ▶

# aem project 4600

of solder, or to damage tracks by overheating. Having soldered your board it is a good idea to check your work one more time for any mistakes as it is often cheaper to fix them now, than after the modem has been powered up.

Check the LED mountings against the internal photograph. There should be enough lead length to bend the LED over in order to fit them through the panel holes.

With your board completed you can now start preparing your case. Take the rear panel layout and mark out your rear panel with a scribe or some other sharp pointed tool. Next, using sharp drill bits of the right size, drill the plastic rear panel taking care not to crack or split it by applying too much pressure, or by using a blunt or damaged rill bit. Having drilled the panel, take your needle files or small round files and enlarge the hole for the RS232 connector to the correct size. Check that it fits the hole. On completing the rear panel, take the same approach with the front panel and drill suitable holes for the switches and LEDs, again taking care that the holes are in their correct places.

If you have a Scotchcal label, now is the time to carefully attach it to the front panel. Wetting the panel and sticky side of the Scotchcal allows you to position it more readily.

You are now at a stage where the board can be mounted in the case. Using cable-grip grommets, mount the power and line cords to the rear panel, allowing enough length of cable inside the case so as to be able to terminate them to the circuit board at their respective points. Use small nuts and bolts when mounting the RS232 connector to the rear panel.

Next, mount the board in the case. Cut four small spacers from 3-4 mm plastic tubing about 10 mm long. These are used to give the circuit board a bit of height off the bottom of the case used. Use 15 mm long self-tapping screws to mount the board to the bottom lid of the case, aligning the screws with the mounting holes provided.

The next step is to terminate the mains cable, power switch and line connection to the circuit board. Take care with this wiring as loose strands of wire left floating around could be hazardous. Note that the mains active wire to the power switch goes to the upper contact, not the middle (pole) contact.

With all this completed, leave IC1 (modem chip) out of its socket and power the modem up. With a multimeter, check that you have +5 volts on pin 2 of the world chip socket, and -5 volts on pin 4 with respect to ground (pin 9). If you have the correct voltages, power your modem down (waiting for the main filter capacitor to discharge) and re-install your world chip. Of your voltages were not correct, re-check your circuit board wiring.

## Getting it 'on the air'

Drag out and dust off your old microcomputer and fire it up with a 300 Baud terminal program. The protocol required is 300 Baud full duplex, 7 data bits, 1 stop bit, no parity.

With an RS232 lead, connect your computer to the modem. If you don't have one, consult your computer's operating manual for details of the RS232 pinouts and a cable can be made up. For most computers (e.g. the Microbee) the easiest way to make up an RS232 cable is to use a length of 25-way ribbon cable and fit a DB 25 ID (insulation displacement) connector to each end, providing a 1-to-1 pin wiring.

With the modem connected to your computer, power it up and type some characters on your keyboard. You should notice the Tx light flashing on the front of the modem. If your Tx light fails to flash, you may possibly have a problem with your RS232 cable. If your computer is a Microbee, the easiest way to check the cable is to disconnect it from the modem and with an alligator clip, short pins 2 and 3 of the DB25 plug together. Now, type something on your keyboard and you should see it being echoed to the screen. If not, check your cable. If the problem is not with your cable, re-check all your wiring of the circuit board.

If your Tx light flashes, connect your modem to another modem and computer which also has a 300 Baud terminal program installed. With the two modems connected together, set them both to 300 Baud, one in the **originate** mode and one in the **answer** mode. You should note that the carrier detect (CD) light on your modem has lit, indicating that your modem is receiving a carrier that it recognises from the other modem. Typing characters on your computer's keyboard should appear on the other computer's screen and vice versa. If this works OK then you have a working modem!

It should also be noted that, as data is being received from the other modem, the Rx LED on your modem should flicker, indicating the flow of data.

There you go, you now have a functioning modem!

The 1200/75 Baud rate can be checked in the same fashion as the 300 Baud was tested, but making sure one modem is set to 1200 Baud transmit/75 Baud receive, and the other set to 75 Baud transmit/1200 Baud receive. It will also be necessary to set the Baud rate of your terminal program to match the Baud rate of the modem to which it's connected. 🐘

SEE 'RETAIL ROUNDUP' FOR A GUIDE TO KIT SUPPLIERS WHO MAY STOCK THIS PROJECT

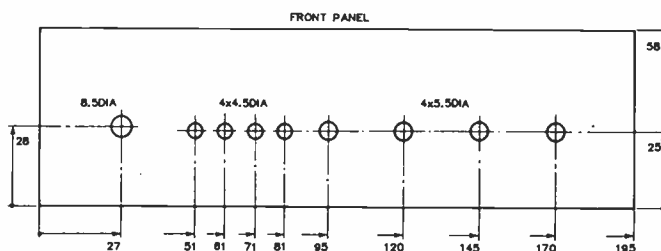
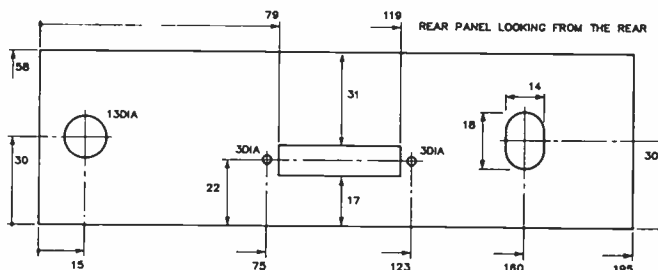



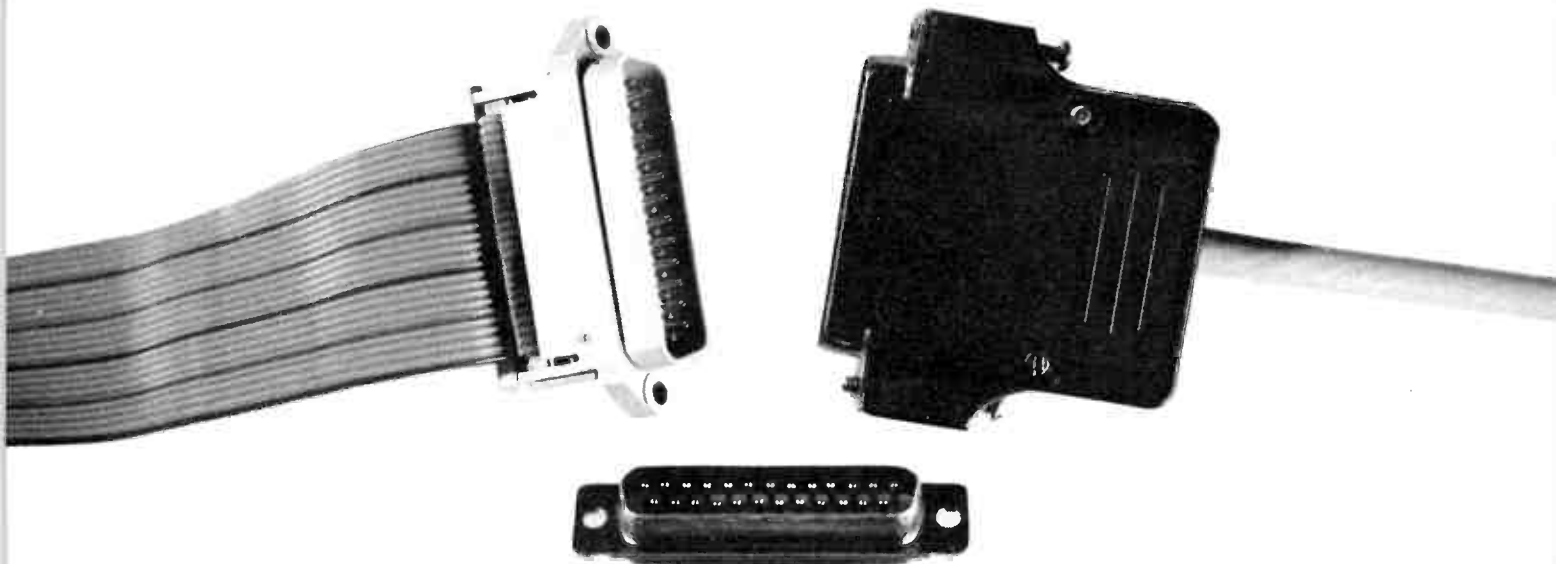

# The ins and outs of RS232

## Part 2 Roger Harrison

Continuing our discourse on the serial interface 'standard', in this article we get into the interconnections – 'null modems', handshaking, and the like.

ARMED WITH DOCUMENTATION of the pin assignments of your equipment's RS232 connector, you can proceed to hook it up with confidence whenever the need arises. Even if all you know about a piece of equipment is just a list of the pins used on the D-connector, you can work out the pin assignments and at least have a starting point.

### The hookup

First of all, we'll assume you've obtained the right connectors (check the sexes! — both male?, both female?, one of each?). You'll need a cable with at least the minimum number of required conductors. It is advisable to use shielded cables for runs in excess of six metres (20 feet), although I've seen plenty of instances where 30 metre-plus runs of unshielded cable were used without misadventure.

Before going any further, let us state the Golden Rule: ALWAYS WIRE PIN 7 TO PIN 7.

The simplest connection is the 'straight-through', where the equipments are of opposite sex (i.e: one's a DTE, the other's a DCE). You could just join all pins directly to their counterparts, pin 1 to pin 1, pin 2 to pin 2, etc. But that's a rarity. If no handshaking is involved, and the equipments are of opposite sex, then all you have to do is make up a three-wire 'straight-through', as shown here, linking pins 2, 3 and 7 on each:

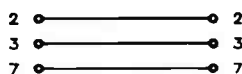

The simplest hookup — a DTE to a DCE, no handshaking required.

Where handshaking is used, the prime functions implemented are RTS (request to send — pin 4) and CTS (clear to send — pin 5). In addition, you'll often find DSR (data set ready — pin 6) and DTR (data terminal ready — pin 20) implemented with occasionally, DCD (data carrier detect —

pin 8) thrown in for good measure. If you're hooking up equipments of opposite sex, with handshaking between them, your cable is wired like this:

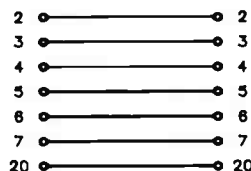

Linking DTE to DCE, with handshaking. Note than pin 8 may also be implemented, in which case link them at each end.

Where both equipments are of the same sex and no handshaking is required all you need is a three-wire cable, but this time, pin 2 on one links to pin 3 on the other, with pin 7 straight through:

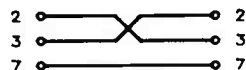

Linking same-sex equipment, DTE-DTE or DCE-DCE, no handshaking required. Also called a simple 'null modem'.

This hookup is generally known as a **null modem** and is often used to link together two computers so that they can 'talk' to one another. It's great for transferring files. Pins 2 and 3 are cross-connected because each computer will be a DTE and transmit data on pin 2 and receive data on pin 3. Some computers and terminals have a switch which allows reversing pins 2 and 3. If you're that lucky, the simple straight-through cable can be employed and you throw the switch — *but only on one* if both have the facility.

If your computer or terminal requires handshaking signals, you can defeat it and 'fool' the computer by 'strapping' pins 4 and 5 together at each plug if RTS and CTS are implemented. If DSR, DCD and DTR are implemented, you can strap ►

these three pins together at each plug. Your null modem hookup will now look like this:

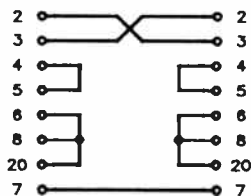

**Null modem with 'fooled' or defeated handshaking. This gets the two DTEs 'talking', but there is really no handshaking between them.**

A variation involves linking pins 5-6-8-20 where RTS (pin 4) is not implemented, usually only on DCE-sex gear. This just fools the equipment at each end into telling itself "all systems go". Such a hookup looks like this:

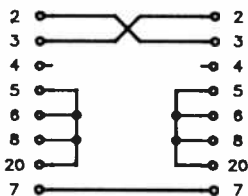

**Null modem with defeated handshaking, generally used for linking DCE to DCE where RTS is not implemented.**

When linking a DTE to a DTE, with full handshaking, then RTS on one connects to CTS on the other, in addition to DCD and DTR being cross-connected between equipment. As DSR is usually implemented also, strap it to DCD at each end. Such a hookup is wired so:

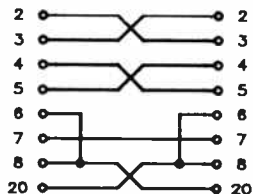

**Linking DTE to DTE, with full handshaking.**

Linking a DCE to a DCE with full handshaking is a little different. Here, DSR and DCD are cross-connected with DTR linked to DCD at each end. You get a hookup like so:

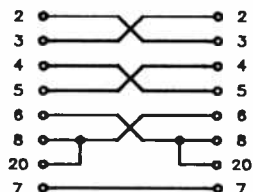

**Linking DCE to DCE, with full handshaking.**

That should cover the vast majority of hookups you'll encounter. However, if you have to battle along without documentation, or, despite the documentation a hookup refuses to get the equipment talking, then you need to try out a variety of hookups. Even if you go to the tedium of wiring-up seven different cables, as above, there'll be times when you encounter some perverse peripheral which has been implemented half-DTE/half-DCE.

The solution, which should be cheaper and more 'univer-

**SOFTWARE HANDSHAKING — X-ON/X-OFF**

Where hardware handshaking is not implemented, the software may employ handshaking signals, known as "X-on/X-off". This is usually 'installed' in the DTE setup procedure (on a terminal or computer), along with parity, baud rate, etc.



**A low-cost RS232 patch box. This is the Arista 'mini patch box' where short links can be soldered between the required pin connections to test out a hookup. When it works, you just clip the lid on. It comes complete with brief instructions and suggested hookups. (Courtesy Geoff Wood Electronics).**

sal' than the seven cables, is a 'patch box'. This simply comprises a pair of DB25 plugs mounted on a small box, or trailing on ribbon leads from the box, with all 25 pins brought out to some sort of connector scheme allowing you to link anything to anything with short 'patch' leads. Very handy. They cost anywhere from around \$25 to \$100+.

When using a patch box, remember the Golden Rule — link pin 7 to pin 7. Some patch boxes have them permanently linked, anyway. The more sophisticated, and expensive, patch boxes provide indicator LEDs on each line so that you can see which lines are high, low, active or inactive.

**Troubles and troubleshooting**

If, despite documentation, or if you're attempting a hookup without documentation, your two equipments refuse to talk to one another, you'll need to determine just what's going on.

The first thing to do is check the integrity of the cable. See that there really is a connection between the pins implemented. The next thing to do is check the activity on the nine main pins. Pin 1 may not be used, but if it is, it should link the equipment chassis. Pin 7 is your signal reference (note that it may be linked to pin 1). Refer to Figure 3 (Part 1) for what to expect.

What equipment do you use? Ordinary logic probes can be pressed into service, but their main drawback is that you can only check one line at a time. You may need to see what's

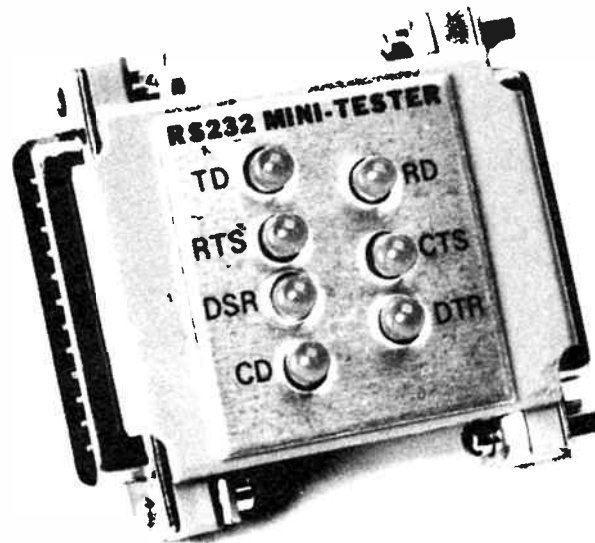

**A simple RS232 'mini-tester'. This has two plugs wired straight-through, with LED indicators on the seven main signal lines. (Arista product, courtesy Geoff Wood Electronics).**



happening simultaneously on several lines. A multi-channel oscilloscope can be handy — but expensive. As you're only looking at 'highs' and 'lows', simple LED indicators are sufficient for many purposes. Simple RS232 testers are available, comprising a pair of DB25 plugs and an array of LEDs which show the status of the signal lines. The simplest just has seven LEDs for the seven main signals: TXD (2), RXD (3), RTS (4), CTS (5), DSR (6), DCD (8) and DTR (20).

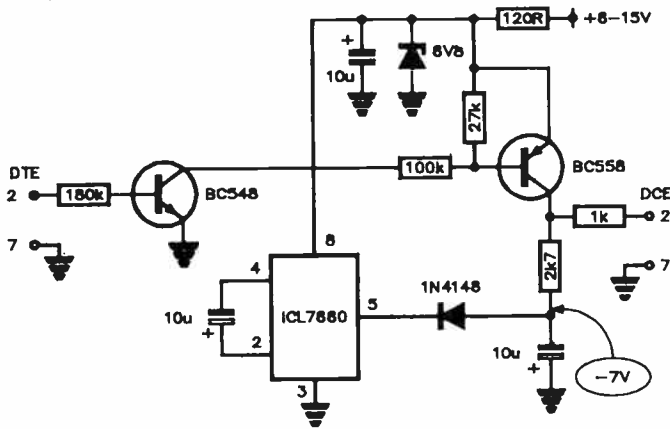

Some equipment (usually a computer) will incorporate an RS232 interface where the TXD (transmit data) line is a TTL device output and low is only somewhere between +2.4 V and 0 V, rather than -3 V and -12 V, as specified in the RS232 standard. The Microbee is a classic example.

As often as not, most peripherals — printers, modems and the like, will be quite happy with this situation, but the occasional equipment will not tolerate it, having 'true' RS232 input which needs a low greater than -3 V to operate correctly. Thus, despite having the correct hookup, your DTE will not drive your DCE.

The solution is to provide a 'level-shift' interface, where the TXD line, instead of swinging between the TTL levels, is made to swing between a positive voltage of between +3 V and +12 V and between -3 V and -12 V, as required. A suitable circuit is illustrated in Figure 4. This employs an Intersil ICL 7660 positive-to-negative voltage converter, to provide a -7 V supply rail. An NPN-PNP transistor pair provides an uninverted TXD signal at the output, swinging between the positive supply rail and the -7 V negative supply rail, from a TTL input.

The BC548 turns on and off with the TTL-level drive signal, its collector turning on and off the base current to the

### LINE IMPEDANCES, DRIVERS AND RECEIVERS

The RS232 standard requires that a 'line input' have a dc resistance of between 3000 and 7000 ohms, with a parallel capacitance of no more than 2500 pF. In addition, the standard specifies it should not be inductive and that the open circuit voltage not exceed 2 V. The source impedance and capacitance of a 'line output' is not specified, but it must be able to deliver between 5 V and 15 V (when the line input is at 0 V) and the open-circuit output voltage must not exceed 25 V. In addition, a line output should not deliver more than half an amp (0.5 A) when shorted to any other line (including ground).

National Semiconductor, many years ago, introduced a pair of ICs specifically for interfacing DTE and DCE devices. The DS1488 is a "quad line driver", while the DS1489 is a "quad line receiver". Both meet the RS232 and CCITT V.24 specifications. Typically, the 1488 has an output resistance between 3000 and about 1000 ohms. The 1489 has an input resistance of 4k.

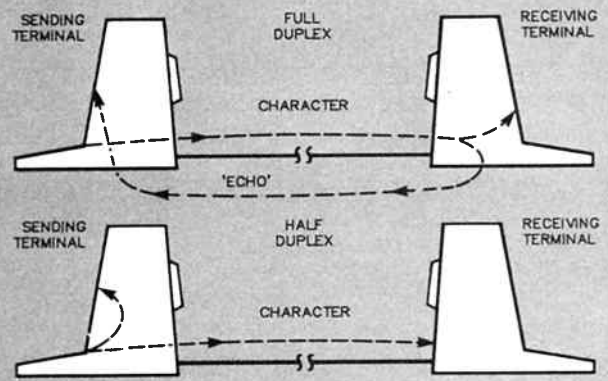

### DUPLEX — THE ECHO PROBLEM

You will sometimes come across the term 'duplex' in conjunction with terminals, computers operating in 'terminal' mode, or modems. A hardware or software switch provides for "full duplex" or "half duplex" operation.

**Full Duplex:** when the terminal equipment transmits a character, the receiving terminal will immediately 'echo' the character back to the transmitting terminal equipment which then displays it on-screen. It's used to assure you that the equipment on the other end is listening to you. Some bulletin boards operate in full duplex mode you may notice.

**Half Duplex:** in this case, the terminal equipment puts the transmitted character on its own screen and the receiving terminal does not echo it. If the receiving terminal is not awake and you're transmitting in half duplex mode, you won't know if the characters are being received.

A problem will arise if your terminal is set to half duplex operation and the receiving terminal echoes the received characters. In this case, your screen will display each character *ttwwiiicce!*

BC558. When a high is transmitted, the BC548 turns on, turning on the BC558, the collector voltage of which rises to almost the positive supply rail voltage. When a low is transmitted, the BC548 turns off, having no base current supplied, and the BC558 turns off. The output will then be 'pulled down' to the negative supply rail via the 1k and 2k7 resistors.

A circuit such as this is readily constructed on matrix board or Veroboard. It could be powered from the computer if a positive supply between about 8 V and 15 V is available on the DB25 connector.

### The check list

When commissioning an RS232 hookup, there are eight checks you should run through every time.

- 1) **Bits per character?** — 5, 6, 7 or 8.
- 2) **Stop bits?** — 1 or 2.
- 3) **Baud rate?** — 110, 150, 300, 600, 1200, 1800, 2400, 4800, 9600 (or other).
- 4) **Parity?**  
On Tx — none, even, odd, set to 0, set to 1.  
On Rx — none expected, ignore, expect odd, expect even.
- 5) **Duplex?** — full or half.
- 6) **On line?** — if on/off-line switch provided, set it on.
- 7) **Mark high or mark low?** if switch provided to invert polarity of mark/space, set for *negative mark on data lines*. For handshaking *high is GO, low is STOP*.
- 8) **Handshaking?** — via the interface or X-on/ack-off.

Armed with the information presented here, you should be able to solve the majority of difficulties you may encounter with RS232 'standard' interfaces. Good luck! 🐉

# The good ol' 88

There are many personal computers on the market today, but most of them have one thing in common. VLSI and LSI chips form the heart of the designs. These chips generally belong to one of four basic design families. These are the Motorola 6800/68000 family, the Intel 8080/8085/8086 family, the Zilog Z-80 /Z8000 family and the Rockwell 6502 family. The chips are not necessarily manufactured only by those companies, but they introduced the design and have licensed others to manufacture them. There are many other microprocessor chips available, but those mentioned have a huge proportion of the personal computer market. The recent crop of personal computers has moved to the 16-bit architecture of the 8086 and 68000 families, but support chips from earlier 8-bit versions are frequently used.

WHEN IS a microprocessor a 16-bit microprocessor? The transition from 8-bit processors to 16-bit processors has caused some confusion in naming conventions. Some manufacturers have provided a hybrid configuration as well as a true 16-bit processor. An example of this is the Intel 8088, a member of the 8086 family. The internal bus is 16 bits wide, but the interfaces external to the microprocessor chip are only 8 bits wide. It executes exactly the same instruction set as the 8086, which is a 'true' 16-bit microprocessor. A similar compromise is appearing in the 32-bit microprocessors that are now beginning to appear.

One benefit of the hybrid versions is to support the peripheral hardware from the earlier architecture. When the 8086 first appeared, the existing support cards (memory, I/O, etc.) did not support the 16-bit data bus. A hybrid configuration allows the power of the improved instruction set to be used with older support cards. From a software view, the hybrid processors can be considered 16-bit (or 32-bit) machines whenever the machine code can be run on either the 'hybrid' or 'full' processor. Code should be written to maximise performance on the widest data path possible.

## The 8086 family

Intel's 8086 was the first of the 16-bit architecture microprocessors to get a substantial foothold in the personal computer market. The 8088 and, to a lesser extent the 8086, are now very widely used.

In the last couple of years 'improved' versions have also been making an appearance. There are the 80186 (or iAPX186) and 80286 (or iAPX286) microprocessors. These chips provide all the function of the earlier 8086-type chips and offer new features and speed. Depending upon mode of operation, they are code compatible with earlier versions.

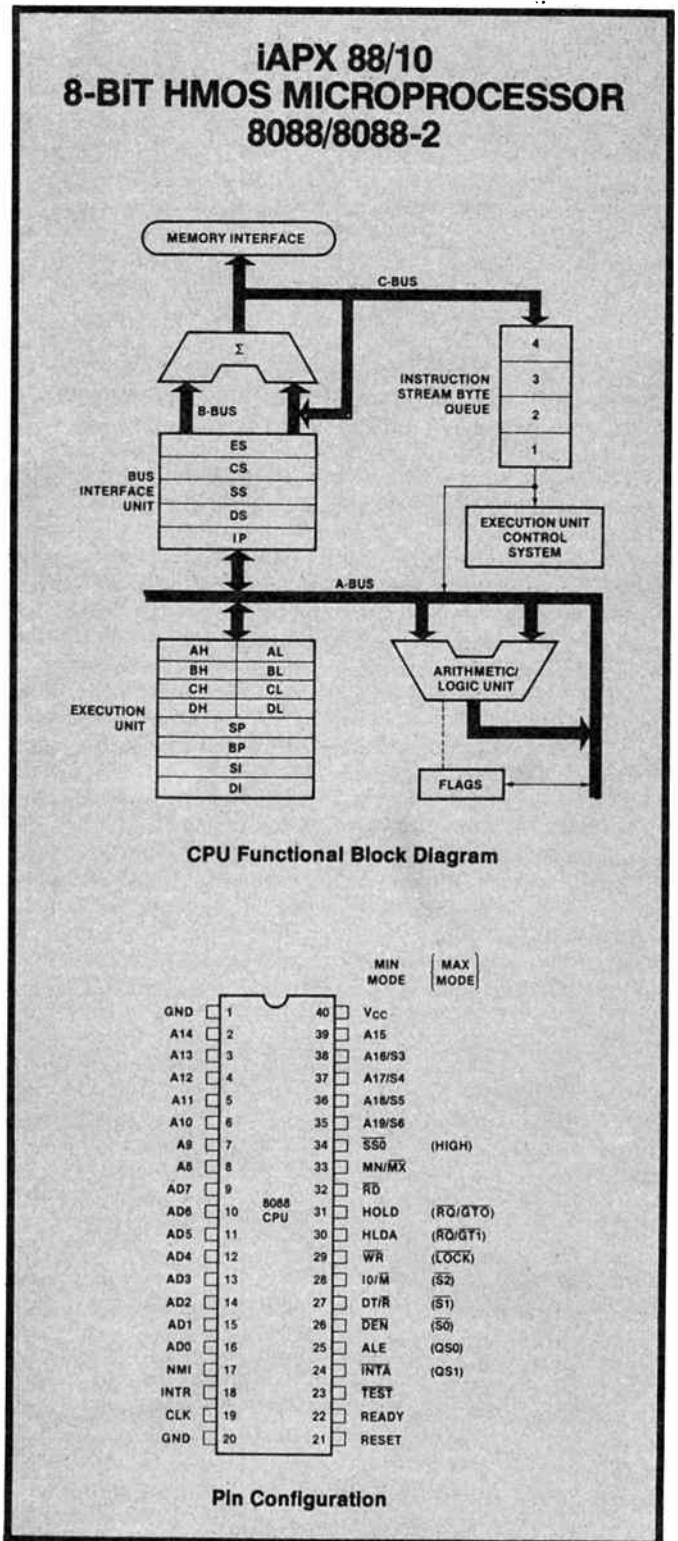



## The 8088

Probably the greatest number of Intel-based personal computers currently use the 8088 for a microprocessor chip. This microprocessor provides a 16-bit instruction set and an 8-bit data interface. Although operations may be performed upon 16-bit data, the processor requires two 'fetches' to get the data into the chip. This chip is hardly state of the art, but we can expect it to be around for quite some time yet. Don't forget, there are still quite a few Z-80s being installed in brand new PCs today.

What kinds of instructions can the 8088 perform? Lots! The first thing to note is that the 8088 can perform almost every instruction upon a byte of data or upon a 'word' (16 bits) of data. There are five general groups of instructions: *Data Transfer*, *Arithmetic*, *Bit Manipulation*, *String* and *Program Control*. In addition, there are processor control instructions which are used to control the operation of the microprocessor chip or external devices. For each type of 'logical' instruction there may be several machine instructions from which to choose. An example would be the move (MOV) instruction. This simply tells the processor to transfer a byte or word of data from one location to another.

There are actually seven different machine instructions that can be used to move data, varying in length from two to seven bytes and requiring from two to 28 clock cycles to execute. The fastest moves data contained in the instruction to a register and the longest moves data contained in the instruction to a memory location that is not in the current data segment. Unless you are trying to write in the binary 'machine code', the Assembler has the job of sorting out which version of the 'logical' instruction to use.

I just walked onto the first 'chicken and egg' trap! What's a data segment? About nine or ten paragraphs from now, there's a bit on segments and segment registers, but not in the previous paragraph. The concepts of instructions and the flags, registers and memory locations which they reference are quite inter-twined. So, before taking a look at the various families of instructions, a very brief rundown on the register names, addressing and flags might be in order.

There are eight data-type registers called **AX**, **BX**, **CX**, **DX**, **SI**, **DI**, **BP** and **SP**. These are generally used for data manipulation or as an additional component when calculating a memory address. There are four other registers used exclusively for addressing. These are the segment registers **CS**, **DS**, **ES** and **SS**. The segment registers each point to a 64KB block of memory. They could all point to the same 64KB block, but seldom do. The **CS** register points to block where the instructions are kept. The **DS** and **ES** registers point to the block (or blocks) where data is held. The **SS** register points to the block for the stack segment. Addresses are calculated from the values obtained from the segment register, an 'offset' into the block as specified by the instruction and maybe values contained in one or two of the 'data registers.' And there are a whole heap of restrictions as to who can keep company with whom! More on that later. A common form of writing one of these combinations is, say, **DS:DI**. This means: 'Use the value obtained from the **DS** segment register and add to it the value in the **DI** data register.' And presto, you have an address.

Flags are one-bit memory locations which keep track of certain activities within the MPU chip itself. An example of how a flag would be used occurs after an addition. It would be nice to know two things. First, was the sum too large for the destination register? If you tried to add  $200 + 200$  and place the result in the 8-bit register, you would end up with an an-

swer of 144, which isn't really what you had in mind. Each of the operands (200) fit into an 8-bit field, but the answer needed nine bits. When this occurs, the 'overflow flag' would be set. Second, if you are using signed arithmetic, it would be nice to know if the result was positive, negative or zero. There are two flags to tell you this, the 'zero flag' and the 'sign flag.' The zero flag is set to 1 if the result is zero, and 0 if it is not. The sign flag is set to 0 if the result was positive and 1 if it was negative. By the way, zero is considered a positive number. These flags can be tested after the addition to make sure the answer fits where you thought it would or to see if it is in the correct range. A sign flag set to negative after calculating your bank balance could be used to set off an alarm, dial up your automatic banking system and hurriedly transfer funds into your account. Useful things these flags!

## Instruction families

The Data Transfer Instructions consist of **MOVE**, **PUSH**, **POP**, **XCHG** (exchange), **XLAT** (translate), **IN** (read I/O) and **OUT** (write I/O). **PUSH** and **POP** use the memory location at address **SS:SP** as a last-in first-out (LIFO) stack, automatically updating **SP** to point to the last entry in the stack. Three other instructions are used to set up registers and segment registers for addressing. These are **LEA** (Load Effective Address), **LDS** (Load Data Segment) and **LES** (Load Extra Segment). **XLAT** provides a simple mechanism to change a byte of data from one format to another. **XCHG** swaps the contents of two data locations in one instruction. This ensures that the processor cannot be interrupted when checking the value of data in a particular location. It's also an easy way to shift data between registers without anything being overwritten. The first three instructions may also have the 'flag bits' as operands.

The arithmetic instructions are **Add**, **Subtract**, **Multiply**, **Divide**, **Increment**, **Decrement**, **Negate** and **Compare**. These instructions are performed on either signed or unsigned binary integers. Should the data be in a decimal (packed) representation, there are a multitude of instructions to reformat the data after a binary manipulation has been performed. **Negate** provides the 2s complement of the selected data. Two instructions can be used to convert a byte in **AL** to a word in **AX** or a word (16 bits) in **AX** to a double word in the **AX-DX** register pair.

Bit manipulation instructions operate on either a byte or word of data, but affect the data on a bit by bit basis. The instructions are **NOT** (invert), **AND**, **OR**, **XOR** (exclusive-OR), **TEST**, **SHIFT**, and **ROTATE**. The first four simply perform the Boolean operations.

**Test** allows one or more bits of the data to be selectively tested. This is the only instruction which can directly access a single bit of data. **Shift** and **Rotate** alter the data by moving it one bit to the right or left. **Shift** fills in vacated bit positions with zeros, whereas **Rotate** moves the bit out from one end into the other. **Rotate** may also use the Carry Flag as an intermediate holding location which can be tested by other instructions.

The string instructions provide the facility to move or test up to 64K bytes or 32K words with one instruction. For these instructions, **DS:SI** form the address of the source data and **ES:DI** form the address. **CX** is always used as the counter for the operation. The Direction Flag determines whether **CX** will be incremented or decremented. These instructions are normally preceded by the **REPEAT** command. Various forms of the **REPEAT** provide testing of data equality (or inequality) ▶

ty) as well as testing the CX counter. If the conditions are met or the counter reaches 0, the 'repeat loop' is terminated. The instruction is interruptable after each byte or word operation takes place.

Program control, or program transfer, instructions are used to alter the sequence of instructions to be executed. These are **Call, Return, Jump, Conditional Jump, Loop, Interrupt** and **Return from Interrupt**.

Call and Return perform the usual operations. During a Call, the return address is pushed onto the stack and control is passed to the address specified in the Call instruction. Return "pops" that address off the stack and returns control to the main program. Interrupt and Interrupt Return do much the same except that the flags are also saved on the stack.

Jump and Conditional Jump transfer control to another part of the program. There is no return. A conditional jump tests one or more flags. If the conditions are met, the jump is taken. If not, the next sequential instruction is executed. Conditional jump instructions have a very limited range. The target of the jump must be within the range of -128 to +127 bytes from the address of the conditional jump instruction. This can often cause a bit of a problem when programs are being modified.

The LOOP instruction operates much like the REPEAT prefix. If the CX counter is non-zero and the equality (or inequality) condition is met, control is transferred to the address specified in the LOOP instruction. Otherwise, the next sequential instruction is executed. The Direction Flag determines whether CX is to be incremented or decremented each pass through the loop.

Process or control instructions are used to set or clear Flags, Wait or synchronize external devices. The Carry and Direction Flags may be directly altered by the program. The Interrupt Enable Flag may be cleared to stop external interrupts from being processed. When set, interrupts will again be allowed.

The 8088 may be set in a Wait state by two instructions. HALT stops the processor until a reset or hardware interrupt is received. WAIT stops the processor until the /TEST line goes low. A third, 'quasi wait,' condition exists in the No-op instruction. The processor simply performs no operation each time it is encountered.

To synchronize with external devices or a shared bus, the ESCape and LOCK instructions are provided. The ESC instructions sets pins on the 8088 which may be sampled by an external chip (say an 8087 arithmetic co-processor). When the Escape is executed, the co-processor can read data as the 8088 fetches it into storage. The co-processor can then operate on the data and place the result in main storage. The 8088 continues to process as normal.

The Lock instruction allows the 8088 to tell the bus manager that it requires exclusive access to the bus during the following instruction. This ensures that no other processor sharing the same bus devices will interfere with the operation to be performed. Most PCs do not make use of this instruction.

## How the instructions are executed

The 8088 can be internally divided into two functional components. The first is the 'Execution Unit (EU)'. This contains the Arithmetic/Logic unit (ALU), the data registers and the status flags. The second component is the 'Bus Interface Unit (BIU)'. This component contains the Segment registers, instruction pointer and instruction cache and provides the interface to memory and I/O devices. The recent AEM 4500 MicroTrainer project provided functions similar to the Exe-

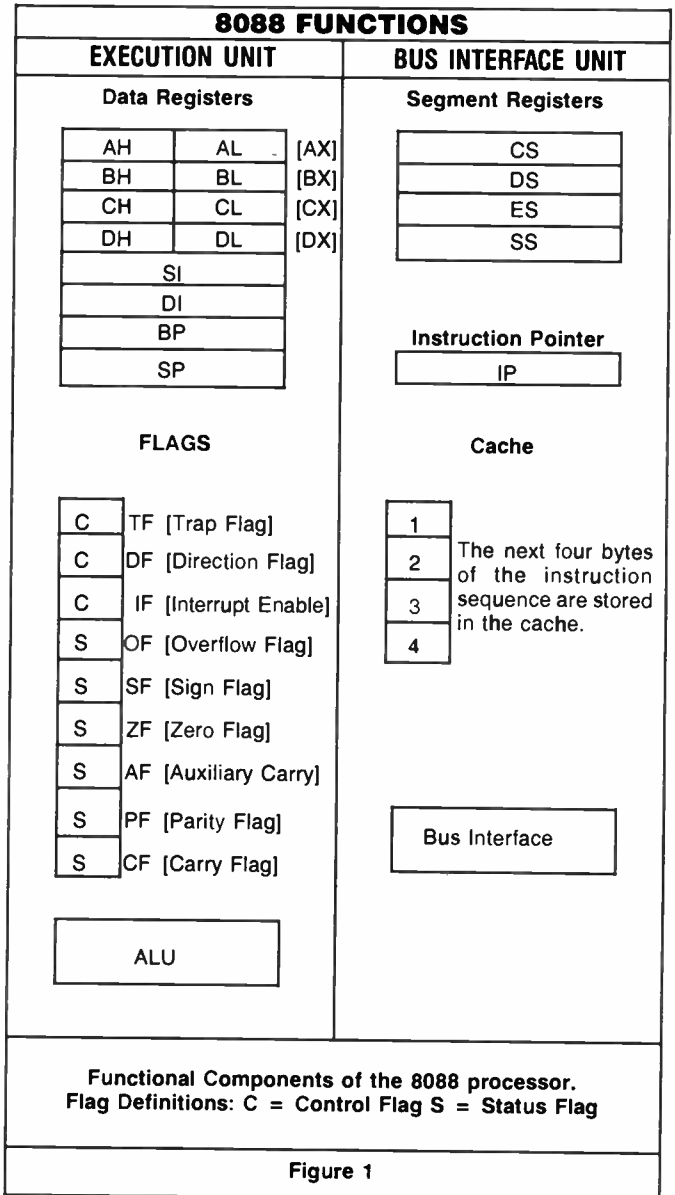
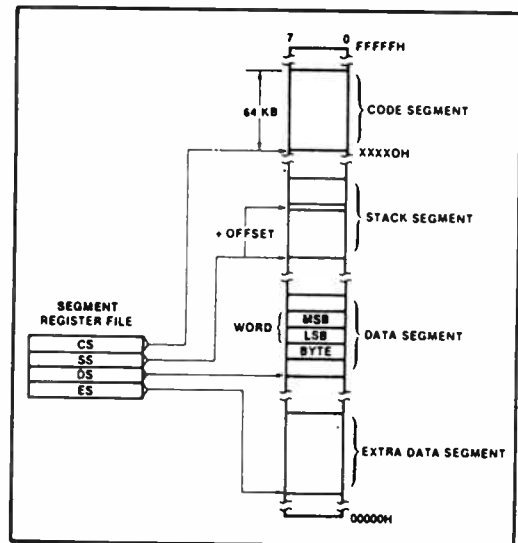

Figure 1



Memory Organization



cutation Unit. The BIU takes over the function of setting the input switches for the MicroTrainer, plus a bit more.

The two components function in tandem. The BIU fetches instructions from memory and stores them in the 'instruction cache'. The instruction cache is a four byte storage area. When the EU has no work to do, an instruction is transferred from the cache to the EU. While the EU is executing the instruction, the BIU begins fetching another instruction from memory. In this way the EU should have another instruction waiting when it completes the current instruction. There should be little or no waiting for the next instruction to be fetched from memory. Should the currently executing instruction require DATA from memory, the request is passed to the BIU to fetch the data. In this instance, the EU must wait for the data fetch to complete (four to five clock cycles) before it can complete the instruction and go onto the next one.

## The execution unit

The Execution Unit is shown in Figure 1. There are eight 16-bit registers available (AX, BX, CX, DX, SI, DI, BP, SP). Four registers (AX, BX, CX, DX) may also be used as pairs of 8-bit registers. AH is either the high order byte of AX (bits 15-8) or is an 8-bit entity in its own right. The AL register is either the low order byte of AX (bits 7-0) or an 8-bit entity. The AH and AL registers may be loaded and manipulated independantly or AX loaded as a 16-bit chunk of data with the high and low order bits independantly available for computations (or whatever). The BX and DX registers may be used similarly.

The SI, DI, BP and SP registers are 16-bit only registers which in practice are used primarily for addressing, but which may almost be used as 'general purpose' registers. BP is referred to as a 'base register'. SI and DI are referred to as 'index registers'. The SP register, called the Stack Pointer, is used to index into the stack segment. BX may also be used as a 'base register' to provide register-modified addressing.

A 'general purpose' register is one that can be used in any instruction for any function. The 'index registers' just mentioned cannot be used for some arithmetic instructions, hence the 'almost.'

Intel has created an architecture more suited to main storage variables than register variables. None of the registers are true 'general purpose' registers and many instructions for the 8086 family require that specific registers be used as operands. This limits the number of registers available to hold a variable over a long period. Figure 2 describes the more common 'implied' usages.

The flags fall into two categories, 'control' and 'status'. The control flags indicate how the processor will perform certain functions. The control flags are set or cleared under program control. Instructions have been provided to do this. The 'interrupt flag' states whether interrupts from hardware external to the chip will be processed. At times, a routine may be so sensitive that its processing must not be interrupted. An example of this is an interrupt handler itself. The 'direction flag' indicates whether 'auto-increment' or 'auto-decrement' will be used. The 'trap flag' is used to provide single-step operation. This allows the execution of a program to be examined instruction by instruction. To do this requires a 'debugging' program to also be run in order to display the results at each step.

The STATUS Flags provide information concerning the instruction just executed. Not all Status Flags are changed after each instruction and in fact some instructions will not alter any Status Flags at all. The Status Flags are used to determine whether a CONDITIONAL JUMP will be taken or

REGISTER USAGE		
Word	Byte	Function
AX	AL	These registers are the traditional accumulators. All arithmetic operations may be performed. Multiplication and division must use these registers. They cannot be used for addressing. When using AX or AL as the destination register, the instructions are often shorter, resulting in greater throughput.
BX		The BX register may be used as an index register for address calculations. It can be used as the source or destination register for most other operations. This is the nearest thing to a general purpose register in the chip.
CX	CL	CX is used as an implied counter in string, repeat and loop operations. It is the only counter allowed in these operations unless you wish to generate the logic yourself. CL is used as a counter for shift and rotate operations. Again, this is the only register allowed. It can be the source or destination for most instructions, but cannot be used for indexed addressing.
DX		DX is used in multiplication or division when the product or dividend requires 32 bits. It cannot be used as an index register.
SI, DI		Both registers are for word operations only. They are required for string operations. SI conventionally points to the source memory address and DI points to the destination address. Both registers can be used for most arithmetic and bit operations.
BP		BP is a 16-bit index register which is based upon the stack segment register rather than the data segment register. This can occasionally lead to confusion. Most arithmetic and bit operations may be performed.
SP		SP is the stack pointer register. Much care must be taken when manipulating this register as CALLs, RETURNs and INTERRUPTs depend upon its integrity. The register is incremented or decremented by POP, RETURN, PUSH and CALL instructions.
CS		Code Segment register. This is used to form the effective address of the next instruction to be executed. The value obtained from CS is always added to the Instruction Pointer to form the non-indexed portion of the effective address.
DS		Data Segment register. Points to a 64K segment used to store data. Most memory-based operations assume that DS points to the correct data area. The data segment register generally contains a different value than the CS register. Valid index registers are BX, SI, DI and BP. (Take care when using BP).
ES		Extra Segment register. Points to an additional 64K data area. It is used in string operations to point to the destination segment. Often, DS and ES point to the same segment unless large amounts of data are involved.
SS		Stack Segment register. This register is used to point to an area where PUSH, POP, CALL and RETURN instructions can store data. This area is normally independant of other data segments. Some programs use the stack segment for storage of variables. SP and BP are the index registers.
Register conventions for 8088 and 8086 processors.		

Figure 2

not. The various forms of these flags are shown in Figure 2.

The ALU performs the operations defined by the instructions. The types of operations it performs are defined by the instruction set of the microprocessor. The ALU in the 8088 will perform much more complex operations than that of the MicroTrainer. When the instruction is to operate upon data obtained from storage, the request for the data is passed to the Bus Interface Unit (BIU). The operation will complete only when the requested data has been fetched by the BIU and then passed to the ALU.

## The bus interface unit

The BIU is responsible for the transfer of data from the microprocessor chip to external memory or I/O devices. It also calculates the Effective Address in memory from the information provided in the instruction. Some of this information is explicit and some is implied. To calculate an address the BIU uses four registers (CS, DS, ES and SS). These registers are referred to as the SEGMENT registers. Each segment register is a 16-bit pointer to a 64 kilobyte (KB) block of storage. The instructions assume that all data or other instructions can be located in one of these 64KB blocks. The 8088 has the ability to address 1024KB of storage, so it must be possible to change the value in the segment registers to access all memory. This can be done by normal arithmetic type instructions or by special instructions for the segment registers.

The CS register points to what is normally called the CODE SEGMENT. The BIU fetches instructions only from the Code Segment. Control of the data in the CS register is therefore of great importance. If it is corrupted, the program goes off into never-never land. The address of the current instruction is calculated from the CS register and the Instruction Pointer (IP). The IP may be incremented to point to the next instruction or altered by a program control instruction. When the address of the new instruction is available within the Code Segment, it is called a NEAR instruction. If a new CS pointer is required, it is called a FAR program transfer. A FAR program transfer will change the value in both the CS and IP registers.

The DS register points to the DATA SEGMENT. Instructions which use memory locations to hold data assume that the data is contained in the current data segment.

The ES points to what is known as the EXTRA SEGMENT. This is much like the data segment, except that only a few instructions make use of the pointer in the ES register. For the most part, those that do are string instructions which engage in a transfer of data from one memory location to another without passing data through one of the registers. Some programs may not use an independent Extra Segment but initialize it to point to the same 64KB block as the DS register.

The SS points to the STACK SEGMENT. All programs require a stack segment. The SS register, and the SP register mentioned earlier, are used to determine the location in the stack segment available to store an address or data. The stack segment is often referred to simply as the STACK. The Call and Return instructions use the stack to remember where in the program the routine was called from. Push and Pop instructions use the stack to temporarily store data while the registers are used for some other purpose. Variables may be stored on the stack by some programs.

And now, having nicely identified which segment register is used for what, we find there is an instruction known as a 'segment override'. If you wish to use an instruction which assumes that data is in the DS segment, but the data is really in the ES segment, you can insert an instruction which says,

'instead of using the DS register to find the address of the data, use the ES register'. Segment overrides may be used on most instructions and can refer to any one of the four segment registers. The override is valid for the execution of one instruction only.

## Calculating the effective address

There is now a plethora of registers which may take part in the calculating of an address. There are base registers, index registers, segment registers and a thing called the displacement. The displacement is coded in the instruction and is an offset into the appropriate segment. All of these numbers are maximum 64K, so how do we put them all together to make an address from 0 to 1024K?

First, there are the segment registers. These do not point to a single storage address, nor do they define a unique 64KB block of storage. They point to a unique 16-byte block of storage! (16x64KB = 1024KB). The value in the segment register is multiplied by 16 and placed in a 20-bit register. The values from the base and index registers and the displacement are added to that 20-bit value. That means of course that the segments can overlap since they are on 16-byte boundaries. This allows for more efficient use of storage, as only the allocated storage should be addressed in any segment. Why not start the data segment 1000h bytes after the beginning code segment, if only OFFEH bytes are used for the instructions? The program shouldn't grow!

The absolute address of a storage location is known as the Effective Address (EA). The most complex EA is calculated as:

$$EA = (\text{segment reg.} \times 16) + \text{base reg.} \\ + \text{index reg.} + \text{displacement}$$

The more registers included in the computation, the longer it takes the 8088 to work it all out and hence, the longer it takes to actually execute the instruction. When defining the number of clock cycles required for an instruction one of the little add-ons is +EA.

Intel has developed a, shall we say, unique method of storing 16-bit addresses (and data) in storage. Instead of simply putting bits 15-8 in the first byte and bits 7-0 in the second, Intel does it just the opposite. Bits 7-0 are stored in the first byte and bits 15-8 in the second. Just to confuse us all, when the data is loaded into a register, it is combined correctly. When defining data in storage, you have to remember how you want to access it. If you load it a word at a time the data must conform to the 'reverse representation', but if it is to be accessed a byte at a time, the normal order is used. This format also applies to the displacement coded as part of the instruction.

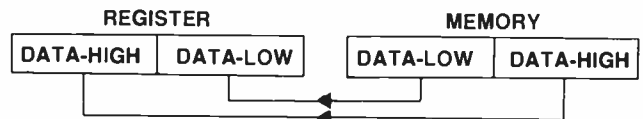

## Interrupt processing

Many I/O devices communicate with the microprocessor chip by issuing an interrupt when there is data to be processed. This frees the processor from continually 'polling' the I/O devices to see if there is any data to be processed. It also frees the programmer from a lot of headaches.

When the INTR (interrupt) line is active the processor completes the instruction that is currently active and checks the interrupt flag. If Interrupt-Enable is set, the processor sig-



nals the interrupting device that the interrupt is acknowledged. The interrupting device then places an 8-bit code on the data bus. The processor then translates this 'interrupt code,' into an 'interrupt vector' by multiplying the code by four. The bottom 1024 bytes (256 × 4 bytes) of storage are reserved for addresses of routines to handle interrupts. In true Intel fashion, the addresses are in reverse order. That is, the first byte is the low order byte of the displacement. The second byte is the high order byte of the displacement. The third is the low order byte of the segment and the fourth byte is the high order byte of the segment.

DISPL-LOW	DISPL-HIGH	SEGMENT-LOW	SEGMENT-HIGH
-----------	------------	-------------	--------------

Upon receiving the interrupt, the flags and the address of the next instruction that would have been executed are pushed onto the stack and control is transferred to the address specified in the interrupt vector. The Interrupt Flag is cleared (interrupts disabled). The interrupt routine executes and returns control back to the program by issuing an IRET (Interrupt Return) instruction. The interrupt routine is also responsible for enabling interrupts.

Interrupts may also be issued by the program. In this case the interrupt code is part of the instructions. Except that no hardware is involved, software interrupts are handled in the same manner as hardware interrupts. This is useful for testing interrupt routines or for communicating between programs. Most operating system facilities are invoked via software interrupts.

There is another interrupt pin on the 8088 known as the Non-Maskable Interrupt (NMI). This pin has been assigned Interrupt Code 2. It is intended to be used whenever there is a catastrophic error in the system. The Interrupt Flag is ignored and the interrupt processed with the highest priority. Otherwise, it's just another interrupt.

### In summary

What does all this mean? The 8088 microprocessor is a powerful but complicated chip. To drive (program) it correctly you'll have to understand some of its workings and have adequate documentation available. Intel provide hardware and programmer's guides that are essential reading and go into much more detail than this article. But it may make it a bit easier to get going. Other sources of information are assembler or compiler manuals. Good programming. 🐘

### AEM4500 MICROTRAINER DEMO SOFTWARE SIMULATOR

If you're a student learning about microprocessing, or a lecturer teaching microprocessing, or just an interested hobbyist, you might be interested to know that Bill Thomas has written a software simulation of the AEM4500 Microtrainer project (Sept. 1985 issue) that runs on the IBM PC.

The software displays the relevant circuit on-screen to show both 4-bit and 6-bit operation. The on-screen display exactly emulates the operation of the Microtrainer, including input switch operation and all the indicators so that you graphically see everything that happens following input of data and clock toggling.

All it costs is just:

**\$20.00**

including postage and handling.

Just send us a blank 5¼" disk and we will provide you with the Microtrainer Demo file and documentation. Cheques or Money Orders should be made out to *Australian Electronics Monthly*. Don't forget to include your full name and address.

Send orders to:

AEM Microtrainer Software Simulation, PO Box 289, Wahroonga 2076 NSW.

## MERRY CHRISTMAS AND A HAPPY NEW YEAR

**Hytec Electronics will be closed between 24/12/85 till the 13/1/86.**

The reason, we're all heading overseas to search out more top quality products at the best prices in town.

So look to our advert in the March issue of *Australian Electronics Monthly*, and save your money for the top specials we will have in March.

I would like to thank you for your support in 1985.

Best Wishes  
Colin Mead and Staff.

**To show you a sample of whats coming, our Christmas special.**

SP-1000 Printer.

Features:

Impact dot matrix.

6 kinds of horizontal graphic density.

Bi-directional logic seeking in text, Uni-directional in graphic.

96 ASC11 characters and 8 country character sets.

9 Pins.

Original plus 2 copies.

**Only \$370.00**

Includes Tax



**A ONCE ONLY OFFER**

**8" single sided double density disc. 10 per box. Special price \$15.00 per box.**

MAIL ORDER Hot Line 02 808 3050

**HYTEC ELECTRONICS PTY. LTD.**

21 Ryedale Road, West Ryde NSW 2114.

PO Box 438 Ryde, NSW 2112. Telex: AA71551

Here is our fifth crossword with a prize of the magnificent Weller WTCPN Controlled Output Soldering Station for the winner. This month we are back to some fairly tough words, but to make it a little easier we've once again included the dreaded 'Cryptic Crushers'. Post us your answers, even if you've missed one or two (it might still win) by no later than January 17. Our Crosswords are prepared using 'Crossword Magic' supplied by Edsoft Pty Ltd, 20 Blackburn Rd, Blackburn, Victoria.

The announcement of the winner of the October 1985 crossword has been delayed due to the extensive NSW postal strike. The winner together with the November winner will be announced in the next issue. The answers to last months crossword are on page 31.

## WELLER CROSS WORD COMPETITION NO. 5

CooperTools



### THE PRIZE

A transformer-powered soldering station, complete with a low voltage temperature-controlled soldering pencil. The special Weller 'closed loop' method of controlling maximum tip temperature is employed, thereby protecting temperature sensitive components, while the grounded tip and non-inductive heater protects voltage and current sensitive components. The soldering pencil features stainless steel heater construction, a non-burning silicon rubber cord and a large selection of iron plated tips in sizes from 8mm diameter to 6mm diameter with a choice of tip temperature of 315°C/600°F, 370°C/700°F and 430°C/800°F. The transformer case features impact-resistant noryl for durability and protection against accidental damage, a quick connect/disconnect plug for the soldering iron, extra large wiping sponge, tip tray to store extra tips, plus an improved oil-on switch with a long-life neon indicator light, a non-heat sinking soldering pencil holder, and a flexible 3 wire cord.

## SEND YOUR ENTRY IN BY LAST MAIL JANUARY 17

We will accept entries postmarked no later than January 18

### ACROSS

- Transient distortion of a pulse signal which the response temporarily exceeds the final value
- When the carrier wave is not transmitted in AM radio transmission
- Emission of light from the screen of a CRT after removal of excitation by the electron beam
- An artificial load
- A circuit for the production of pulses of predetermined duration the leading edge of which is triggered by the leading edge of input pulses. (U.S.)
- A signal which prevents an action happening
- Computers — in which the more positive of two voltages selected as the logic levels is designated the 1 state
- The property and structure of a semiconductor among other devices
- Known as Ground in the U.S.
- The range of frequencies over which the gain of amplifier falls within the prescribed limits
- Term used to describe peripheral equipment under the control of a computer

### DOWN

- A transmission path from one point to another via the ionosphere
- A picture tube in which the electron beam scans a single phosphor strip in a horizontal direction
- A device for providing power from the mains in a unit where batteries were formerly used
- The property of an electrical resonant circuit which causes a progressive fall in the amplitude of free oscillations
- Radio waves of constant amplitude and frequency
- A metal structure designed to dissipate heat

### CRYPTIC CRUSHERS

#### ACROSS

- Generally happens at the end of a runway
- To stop a courier
- Following a glass of brandy
- Milk through a teat
- A laden freight train going in circles

- No! with a shake of the head
- It's claimed 'never' by a woman
- Condition of a hard-boiled egg
- Found with fire and water
- How wide is this little orchestra
- Hope your budget is like this

#### DOWN

- With a skip and a jump
- Queenslander's tinny (only joking Queenslanders)
- An animal liber removing the chicken coop
- Effect of a little rain
- Her majesty could get R.S.I. from this
- Hot washing up place

## SEND YOUR ENTRY IN BY LAST MAIL DECEMBER 17.

The competition is open to all persons normally resident in Australia or New Zealand, with the exception of members of the staff of Australian Electronics Monthly, the printers, Offset Alpine, and/or associated companies. The winning entry will be drawn by the Editor, whose decision is final; no correspondence will be entered into regarding the decision. Winners will be notified by telegram the day the result is declared and the winner's name and contest results published in the next possible issue of the magazine.

Cut out or photocopy the entry form, complete it and send to:

"Weller Crossword"  
 Australian Electronics Monthly  
 PO Box 289,  
 Wahroonga NSW 2076

We will accept entries postmarked no later than December 18

In case two or more entrants correctly complete the crossword, we'll have to judge who's best at waxing lyrically, in 30 words or less, over: **"Why I think the Weller WTCPN is the soldering station for me".**

.....  
 .....  
 .....  
 .....  
 .....  
 .....

Name .....

Address .....

.....  
 .....  
 Postcode .....



## Light reflections on the time domain

For those who have become tired of playing around with mere wires, there are always fibre optics. The well-known Vicom group of companies has entered this interesting field with an instrument by Laser Precision Corp of USA known as an optical time domain reflectometer (OTDR).

This instrument, known as the TD-9220, is said to offer unsurpassed accuracy for testing and trouble-shooting multimode or single mode cable under any environmental condition. It offers real-time display, digital storage, and a host of other features.

The latest developments from Laser Precision include a fully portable ruggedised OTDR with

plug-in modules for various fibre optic standards including the 1300 nm singlemode system.

Other instruments in the range include the AM-4000 attenuation/power meter and the AP4200 optic power source.

Full technical information is available from your nearest Vicom office at Melbourne, Sydney, Brisbane or Wellington.

## Choke . . . cough, gasp

Many RFI problems arise from cables acting as antennas. Mains, microphone, loudspeaker, telephone and data cables can all emit or receive unwanted signals which spoil the performance of electronic equipment.

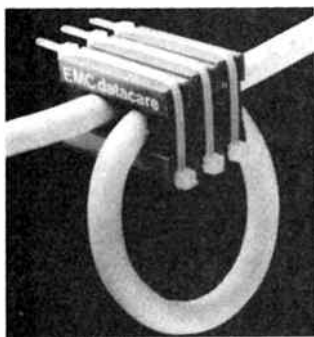

Usually these are of the "common mode" type; that is, they can be visualised as travelling along the 'outside' of the cable and can be reduced without affecting the normal function of either the "culprit" or the "victim" circuit.

A neat little device to solve the problem has been announced by EMC Datacare Ltd of Power Court, Luton, Bedfordshire, England.

The picture shows the clip-on radio-frequency choke which is designed to help solve problems of radio-frequency interference (RFI) that can afflict domestic radio, television and audio equipment, as well as computers, process control and

telecommunications systems.

The common-mode chokes, comprising pairs of ferrite "U" cores, can be installed on cables of up to 10 mm diameter in-situ, without removing any connectors; it is not even necessary to have access to the cable ends.

For large or rigid cables, several pairs of cores are required; for smaller flexible cables, multiturn chokes may be made from the same components to provide substantial impedance to interference currents.

The clip-on choke is available as a kit known as D918 which comprises eight D910 choke cores and associated hardware. It is supplied complete with application notes to help the user install them successfully.

## Count on them

Racal-Dana has introduced a new family of universal counters to supplement its already wide range of counters and general test equipment.

The 1900 family are a new generation of processor controlled counter/timers that provide many new features not previously found on this type of equipment.

All models feature frequency and period resolution of nine digits in one second, whatever the frequency. Single-shot time interval resolution of 1 ns enables rise and fall times to be measured on pulses as narrow as 5 ns.

Peak signal amplitude measurement adds a new dimension



to system performance with phase measurement being another important new feature.

The microprocessor control allows mathematical functions to be performed and readouts given directly to any convenient unit such as mph, rpm, litres-per-second, parts-per-million, or any exponent format, thereby allowing results to be interpreted quickly and easily — no conversions, no calculations.

Further details from: Racal Electronics Pty Ltd at North Ryde, NSW. (02)888 6444.



## The Armstrong method of pcb design

For those unable to afford the computerised auto-routing pcb design package described in last month's AEM, there is always the old manual method. I don't mean back to marking pens and shaky hands but the use of printed circuit drafting aids: DIP patterns, tapes, rings, squares, teardrops, ovals and donut pads, not to mention component silkscreen stick-ons, grid underlay cutter, and drilling targets.

Armed with tungsten carbide cutter, compasses, rolling cutter, and microscope (10 X), the humblest hardware hacker be-

comes an overnight pcb draftsman par excellence (at least in his own eyes).

All the above goodies are laid out mouthwateringly in a beautiful brochure by DMC Drafting Aids, distributed by Koloona Industries at Riverwood. An indispensable Koloona catalogue for those who do produce their own boards, the booklet is free of any of the peculiar Japanese-to-English translations often seen.

Talk to Koloona about the catalogue, and perhaps they will send you an up to date pricelist with it. They can be found at 1/68 Belmore Road South, Riverwood 2210 NSW. (02) 53 8228.

## The Fujitsu hold

Mechanical relays are still alive and well, and Fujitsu holds a good grip on the market, we're told.

IRH Components has just released additional relays in the Fujitsu FBR600 series, which have a substantial foothold. These are miniature pc-mounting types and feature 16 amp switching capacity at 240 Vac in SPST format. Single coil magnetic latch types are also available in SPST and DPDT format.

The Fujitsu FBR600 series is popular because of its 5 kV RMS or 10 kV impulse contact to coil isolation and has SECV approval (CS80157V).

These relays also meet the requirements of Telecom Australia, specification 1053 Issue 2 and 1054 Issue 2 with Approval Number RA80/157.

Coil dissipation is only 0.5 watt at 20°C for all types. The coil range available covers five to 60 V with 5, 6, 12, 24 and 48 V being preferred types.

Full details from IRH Components, Kingsgrove, NSW. (02)750 6444.

## SUBSCRIBE NOW AND RECEIVE A SPECIAL FREE GIFT

When you subscribe to Australian Electronics Monthly, not only do you receive the brightest, most informative and most useful magazine around, but we'll give you a free gift of your choice!

Fill in the subscription form here, post it to us and we'll start your subscription from the next issue and send you your free gift.

### GIFT CHOICE 1

A pack of 23 selected 74LS ICs to the value of approx. \$27. This super pack contains the most common ICs, and are ideal for design, servicing, project construction, etc.



### GIFT CHOICE 2

A set of C. K. Allen Keys. Top West German quality. These little beauties are always in need and come in nine different sizes. They're ideal for anyone with an interest in electronics.



Not actual size

### GIFT CHOICE 3

Best quality West German screwdrivers from C.K.

We use these in our laboratory and consider them excellent as they are specifically designed for electronics requirements.

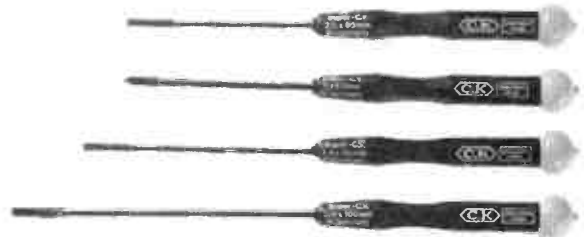

### GIFT CHOICE 4 \$10 Gift Voucher

If you elect to take our Subscribers' Gift Voucher, you can use it to get a \$10 discount when you purchase any item or items by mail order or in-store from any of your favourite electronics or computer retailers honouring the voucher when you make a purchase in excess of \$20. This offer is currently available from Jaycar, All Electronic Components, Applied Technology and Magraths.

Please forward me 12 issues of Australian Electronics Monthly and the gift  GIFT CHOICE 1  GIFT CHOICE 2  GIFT CHOICE 3  GIFT CHOICE 4

All cheques or money orders should be made payable to Australian Electronics Monthly.

Price for subscription is \$31.20 N.Z. \$A52.80 airmail

Please tick payment method  Cheque/money order  Bankcard  Visa  Mastercard  American Express

Card No. .... Expiration .....

Signature ..... (Note Unsigned credit card orders cannot be accepted)

Name .....

Address .....

..... Post Code .....

Allow a minimum of 4 weeks delivery of your gift



# The '7910 FSK modem chip

Advanced Micro Devices introduced their 'world-chip' modem IC, the Am7910, in 1981, offering great simplification of modem design and construction for computer communications using frequency-shift keyed voiceband frequencies over the switched public telephone network.

The Am7910 is fabricated using N-channel metal oxide silicon (MOS) technology and is housed in a standard 28-pin dual-in-line (DIL) package. Advanced Micro Devices are represented in Australia by R&D Electronics, PO Box 206, Burwood 3125 Vic.

Thomson Semiconductors, part of the French Thomson-CSF group, introduced a second-source pin and function compatible device for this modem IC in 1985, known as the EF7910. This is fabricated using HMOS technology and only a few minor parameters differ from the AMD device. Thomson Semiconductors are represented in Australia by Promark, PO Box 381, Crows Nest 2065 NSW.

The 7910 is a single-chip asynchronous Frequency Shift Keying (FSK) voiceband modem. It is pin selectable for baud rates of 300, 600 or 1200 bits per second and is compatible with the applicable Bell and CCITT recommended standards for 103/113/108, 202, V.21 and V.23 type modems. Five mode control lines select a desired modem configuration.

Digital signal processing techniques are employed in the 7910 to perform all major functions such as modulation, demodulation and filtering. The 7910 contains on-chip analog-to-digital and digital-to-analog converter circuits to minimize the external components in a system. This device includes the essential RS-232/CCITT V.24 terminal control signals with TTL levels.

Clocking can be generated by attaching a crystal to drive the internal crystal oscillator or by applying an external clock signal.

A data access arrangement (DAA) or acoustic coupler must provide the phone line interface externally.

The 7910 is fabricated in a 28-pin package. All the digital input and output signals (except the external clock signal) are TTL compatible. Power supply requirements are  $\pm 5$  volts.

- Complete FSK MODEM in a 28-pin package - just add line interface
- Compatible with Bell 103/113/108, Bell 202, CCITT V.21, CCITT V.23 specifications
- No external filtering required
- All digital signal processing, digital filters and ADC/DAC included on-chip
- Includes essential RS-232/CCITT V.24 handshake signals
- Auto-answer capability
- Local copy/test modes
- 1200 bps full duplex on 4-wire line
- Pin-programmable mode section.

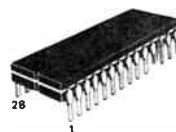

## PIN ASSIGNMENT

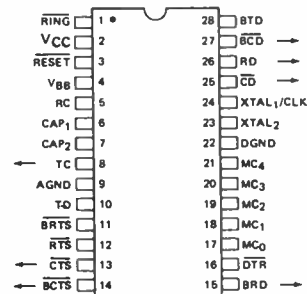
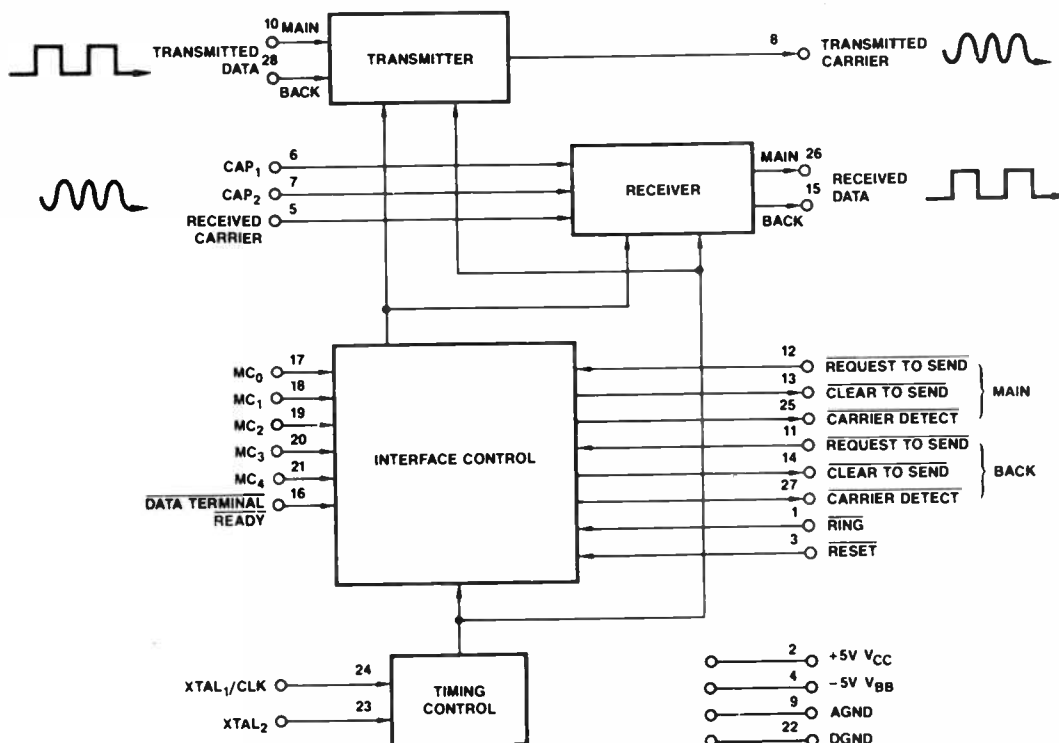

Figure 1. 7910 Block Diagram



## ABSOLUTE MAXIMUM RATINGS

Storage Temperature	-65 to +125°C
Ambient Temperature with Power Applied	
Commercial (C) Devices	0 to +70°C
Industrial (I) Devices	-40 to +85°C
V <sub>CC</sub> with Respect to V <sub>DGND</sub>	+6V/-4V
V <sub>BB</sub> with Respect to V <sub>DGND</sub>	-6V/+4V
All Signal Voltages with Respect to V <sub>DGND</sub>	±5V

Stresses above those listed under ABSOLUTE MAXIMUM RATINGS may cause permanent device failure. Functionality at or above these limits is not implied. Exposure to absolute maximum ratings for extended periods may affect device reliability.

## OPERATING RANGE

Positive Supply Voltage	+4.75 to +5.25V
Negative Supply Voltage	-4.75 to -5.25V
V <sub>AGND</sub>	-50 to +50mV
V <sub>DGND</sub>	0V
Temperature	
Commercial (C) Devices	0 to +70°C
Industrial (I) Devices	-40 to +85°C

Operating ranges define those limits over which the functionality of the device is guaranteed.

# Am7910

## DC CHARACTERISTICS over operating ranges unless otherwise specified

Digital Inputs: TD,  $\overline{RTS}$ , MC<sub>0</sub> - MC<sub>4</sub>,  $\overline{DTR}$ , RING, BTD, BRTS  
 Digital Outputs: RD,  $\overline{CTS}$ , CD, BRD, BCTS, BCD

Parameters	Description	Test Conditions	Min	Typ	Max	Unit
V <sub>OH</sub>	Output HIGH Voltage	I <sub>OH</sub> = -50μA, C <sub>LD</sub> = 50pF	2.4			Volts
V <sub>OL</sub>	Output LOW Voltage	I <sub>OL</sub> = +2mA, C <sub>LD</sub> = 50pF			0.4	Volts
V <sub>IH</sub>	Input HIGH Voltage		2.0		V <sub>CC</sub>	Volts
V <sub>IL</sub>	Input LOW Voltage		-0.5		+0.8	Volts
V <sub>IHC</sub>	External Clock Input HIGH (XTAL <sub>1</sub> )		3.8		V <sub>CC</sub>	Volts
V <sub>ILC</sub>	External Clock Input LOW (XTAL <sub>1</sub> )		-0.5		0.8	Volts
V <sub>IHR</sub>	External Reset Input HIGH (RESET)		3.8		V <sub>CC</sub>	Volts
V <sub>ILR</sub>	External Reset Input LOW (RESET)		-0.5		0.8	Volts
I <sub>IL</sub>	Digital Input Leakage Current	0.0 ≤ V <sub>IN</sub> < V <sup>+</sup>	-10		+10	μA
I <sub>ILR</sub>	Reset Input Leakage Current	0.0 ≤ V <sub>IN</sub> < V <sup>+</sup>	-0.75		+0.75	μA
I <sub>CC</sub>	V <sub>CC</sub> Supply Current	C Devices			140	mA
		I Devices			160	
I <sub>BB</sub>	V <sub>BB</sub> Supply Current	C Devices			15	mA
		I Devices			20	
C <sub>OUT</sub>	Output Capacitance	f <sub>C</sub> = 1.0MHz		5	15	pF
C <sub>IN</sub>	Input Capacitance	f <sub>C</sub> = 1.0MHz		5	15	pF
<b>Analog Input (RC):</b>						
R <sub>IN</sub>	Input Resistance	-1.6V < V <sub>RC</sub> < +1.6V	50			Kohms
V <sub>RC</sub>	Operating Input Signal		-1.6		+1.6	Volts
V <sub>RCOS</sub>	Allowed DC Input Offset	REF V <sub>AGND</sub>	-30		+30	mV
<b>Analog Output (TC):</b>						
V <sub>TC</sub>	Output AC Voltage	R <sub>L</sub> = 600Ω	-615		+615	mV
V <sub>TCOS</sub>	Output DC Offset		-100		+100	mV

The products described by this specification include internal circuitry designed to protect input devices from damaging accumulations of charge. It is suggested, nevertheless, that conventional precautions be observed during storage, handling and use in order to avoid exposure to excessive voltages.

## EF7910

### ELECTRICAL DC CHARACTERISTICS over operating range, referred to V<sub>DGND</sub>

0°C < T<sub>A</sub> < +70°C, V<sub>CC</sub> = +5.0 V ± 5%, V<sub>BB</sub> = -5.0 V ± 5%, V<sub>AGND</sub> = 0 V ± 50 mV, V<sub>DGND</sub> = 0 V

Digital inputs : TD,  $\overline{RTS}$ , MC<sub>0</sub>-MC<sub>4</sub>,  $\overline{DTR}$ , RING, BTD, BRTS

Digital outputs : RD,  $\overline{CTS}$ , CD, BRD, BCTS, BCD

Characteristic	Symbol	Min	Typ	Max	Unit
Output HIGH voltage (I <sub>OH</sub> = -50 μA, C <sub>LD</sub> = 50 pF)	V <sub>OH</sub>	2.4	-	-	V
Output LOW voltage (I <sub>OL</sub> = +2 mA, C <sub>LD</sub> = 50 pF)	V <sub>OL</sub>	-	-	0.4	V
Input HIGH voltage	V <sub>IH</sub>	2.0	-	V <sub>CC</sub>	V
Input LOW voltage	V <sub>IL</sub>	-0.5	-	+0.8	V
External clock input HIGH (XTAL <sub>1</sub> )	V <sub>IHC</sub>	3.8	-	V <sub>CC</sub>	V
External clock input LOW (XTAL <sub>1</sub> )	V <sub>ILC</sub>	-0.5	-	0.8	V
External reset input HIGH (RESET)	V <sub>IHR</sub>	3.8	-	V <sub>CC</sub>	V
External reset input LOW (RESET)	V <sub>ILR</sub>	-0.5	-	0.8	V
Digital input leakage current (0 ≤ V <sub>IN</sub> ≤ V <sub>CC</sub> )	I <sub>IL</sub>	-10	-	+10	μA
V <sub>CC</sub> supply current	I <sub>CC</sub>	-	-	125	mA
V <sub>BB</sub> supply current	I <sub>BB</sub>	-	-	25	mA
Output capacitance (f <sub>C</sub> = 1.0 MHz)	C <sub>OUT</sub>	-	5	15	pF
Input capacitance (f <sub>C</sub> = 1.0 MHz)	C <sub>IN</sub>	-	5	15	pF

### ANALOG INPUT (RC) :

Input resistance (-1.6 V < V <sub>RC</sub> < +1.6 V)	R <sub>IN</sub>	50	-	-	kΩ
Operating input signal	V <sub>RC</sub>	-1.6	-	+1.6	V
Allowed DC input offset (REF V <sub>AGND</sub> )	V <sub>RCOS</sub>	-30	-	+30	mV

### ANALOG OUTPUT (TC) :

Output voltage (R <sub>L</sub> = 600 Ω)	V <sub>TC</sub>	-1.1	-	+1.1	V
Output DC offset	V <sub>TCOS</sub>	-	±200	-	mV

## INTERFACE SIGNAL DESCRIPTION

### MC<sub>0</sub>-MC<sub>4</sub> (CONTROL INPUTS)

These five inputs select one of thirty-two modem configurations according to the Bell or CCITT specifications listed in Table 1. Only 19 of these 32 modes are actually available to the user.

Modes 0-8 are the normal operation modes. The 1200 Baud modes can be selected with or without a compromise equalizer.

Modes 16-25 permit loop back of the EF7910 transmitter and receiver. No internal connection is made. The user must externally connect the TRANSMITTED CARRIER pin (Figure 2) to the RECEIVED CARRIER pin if analog loopback is required. For digital loopback, external connection of RECEIVED DATA and TRANSMITTED DATA is required. Whenever a mode in this group is selected, the effect is to set all transmit and receive filters to the same channel frequency band so that loopback can be performed.

Modes 9-15 and 26-31 are reserved and should not be used.

### DATA TERMINAL READY ( $\overline{DTR}$ )

A LOW level on this input indicates the data terminal desires to send and/or receive data via the modem. This signal is gated with all other TTL inputs and outputs so that a low level enables all these signals as well as the internal control logic to function. A HIGH level disables all TTL I/O pins and the internal logic.

### REQUEST TO SEND (RTS)

A LOW level on this input instructs the modem to enter transmit mode. This input must remain LOW for the duration of data transmission. The signal has no effect if DATA TERMINAL READY is HIGH (disabled). A HIGH level on this input turns off the transmitter.

### CLEAR TO SEND ( $\overline{CTS}$ )

This output goes LOW at the end of a delay initiated when REQUEST TO SEND goes LOW. Actual data to be transmitted should not be presented to the TRANSMITTED DATA input until a LOW is indicated on the CLEAR TO SEND output. Normally the user should force the TD input HIGH whenever  $\overline{CTS}$  is off (HIGH). This signal never goes LOW as long as  $\overline{DTR}$  is HIGH (disabled). CLEAR TO SEND goes HIGH at the end of a delay initiated when REQUEST TO SEND goes HIGH.

### CARRIER DETECT ( $\overline{CD}$ )

A LOW on this output indicates that a valid carrier signal is present at the receiver and has been present for at least a time, t<sub>CDON</sub>, where t<sub>CDON</sub> depends upon the selected modem configuration (Table 3b). A HIGH on this output signifies that no valid carrier is being received and has not been received for a time, t<sub>CDOFF</sub>. CARRIER DETECT remains HIGH when  $\overline{DTR}$  is HIGH. Values for t<sub>CDON</sub> and t<sub>CDOFF</sub> are configuration dependent and are listed in Table 3b.

### TRANSMITTED DATA (TD)

Data bits to be transmitted are presented on this input serially; HIGH (mark) corresponds to logic 1 and LOW (space) corresponds to logic 0. This data determines which frequency appears at any instant at the TRANSMITTED CARRIER output pin (Table 3a). No signal appears at the TRANSMITTED CARRIER output unless  $\overline{DTR}$  is LOW and  $\overline{RTS}$  is LOW.

### RECEIVED DATA (RD)

Data bits demodulated from the RECEIVED CARRIER input are available serially at this output; HIGH (mark) indicates logic 1 and LOW (space) indicates logic 0. Under the following conditions this output is forced to logic 1 because the data may be invalid:

1. When CARRIER DETECT is HIGH
2. During the internal squelch delay at half-duplex line turn around (202/V.23 modes only)
3. During soft carrier turnoff at half-duplex line turn around (202 mode only)
4. When  $\overline{DTR}$  is HIGH
5. When  $\overline{RTS}$  ON and BRTS OFF in V.23/202 modes only
6. During auto-answer sequence



## BACK REQUEST TO SEND (BRTS)

Since the 1200 bps modem configurations, Bell 202 and CCITT V.23, permit only half duplex operation over two-wire lines, a low baud rate "backward" channel is provided for transmission from the main channel receiver to the main channel transmitter. This input signal (BRTS) is equivalent to REQUEST TO SEND for the main channel, except it belongs to the backward channel. Note that since the EF7910 contains a single transmitter, RTS and BRTS should not be asserted simultaneously. BRTS is meaningful only when a 202 or V.23 mode is selected by MC<sub>0</sub>-MC<sub>4</sub>. In all other modes it is ignored.

For V.23 mode the frequency appearing at the transmitted carrier (TC) output pin is determined by a MARK or SPACE at the back transmitted data (BTD) input (Table 3a).

For 202 mode a frequency of 387Hz appears at TC when BRTS is LOW and BTD is HIGH. No energy (0.0 volt) appears at TC when BRTS is HIGH. BTD should be fixed HIGH for 202 back channel transmission. The signal, BRTS, then is equivalent to the signal, Secondary Request-to-Send, for 202 S/T modems, or Supervisory Transmitted Data for 202 C/D modems.

## BACK CLEAR TO SEND (BCTS)

This line is equivalent to CLEAR TO SEND for the main channel, except it belongs to the back channel. BCTS is meaningful only when a V.23 mode is selected by MC<sub>0</sub>-MC<sub>4</sub>. This signal is not used in Bell 202 back mode.

## BACK CARRIER DETECT (BCD)

This line is equivalent to CARRIER DETECT for the main channel, except it belongs to the backward channel. BCD is meaningful only when a 202 or V.23 mode is selected by MC<sub>0</sub>-MC<sub>4</sub>. For V.23 back channel mode, BCD turns on when either the MARK or SPACE frequency appears with sufficient level at the received carrier (RC) input.

For 202 back channel mode, BCD turns on in response to a 387Hz tone of sufficient level at the RC input. In this case BCD is equivalent to the signal, Secondary Received Line Signal Detector, for 202 S/T modems, or Supervisory Received Data for 202 C/D modems.

## BACK TRANSMITTED DATA (BTD)

This line is equivalent to TRANSMITTED DATA for the main channel, except it belongs to the back channel. BTD is meaningful only when a 202 or V.23 mode is selected by MC<sub>0</sub>-MC<sub>4</sub>. For 202 back transmission of on/off keying, BTD should be fixed at a HIGH level.

## BACK RECEIVED DATA (BRD)

This line is equivalent to RECEIVED DATA (except clamping) for the main channel, except it belongs to the back channel. BRD is meaningful only when a V.23 mode is selected by MC<sub>0</sub>-MC<sub>4</sub>. Under the following conditions this output is forced HIGH:

1. BRD HIGH
2. DTR HIGH
3. V.21/103 mode
4. During auto-answer
5. When BRTS ON and RTS OFF in V.23 modes only

## TRANSMITTED CARRIER (TC)

This analog output is the modulated carrier to be conditioned and sent over the phone line.

## RECEIVED CARRIER (RC)

This input is the analog signal received from the phone line. The modem extracts the information contained in this modulated carrier and converts it into a serial data stream for presentation at the RECEIVED DATA (BACK RECEIVED DATA) output.

## RING

This input signal permits auto-answer capability by responding to a ringing signal from a data access arrangement. If a ringing signal is detected (RING LOW) and DTR is LOW, the modem begins a sequence to generate an answer tone at the TC output.

## XTAL<sub>1</sub>, XTAL<sub>2</sub>

Master timing of the modem is provided by either a crystal connected to these two inputs or an external clock inserted into XTAL<sub>1</sub>. The value of the crystal or the external clock frequency must be 2.4576MHz ± 0.1%.

## V<sub>CC</sub>

+5 volt power supply. (±5%)

## V<sub>BB</sub>

-5 volt power supply. (±5%)

## DGND

Digital signal ground pin.

## AGND

Analog signal ground pin (for TRANSMITTED CARRIER and RECEIVED CARRIER).

TABLE 1.

MC <sub>4</sub>	MC <sub>3</sub>	MC <sub>2</sub>	MC <sub>1</sub>	MC <sub>0</sub>	
0	0	0	0	0	Bell 103 Originate 300bps full duplex
0	0	0	0	1	Bell 103 Answer 300bps full duplex
0	0	0	1	0	Bell 202 1200bps half duplex
0	0	0	1	1	Bell 202 with equalizer 1200bps half duplex
0	0	1	0	0	CCITT V.21 Orig 300bps full duplex
0	0	1	0	1	CCITT V.21 Ans 300bps full duplex
0	0	1	1	0	CCITT V.23 Mode 2 1200bps half duplex
0	0	1	1	1	CCITT V.23 Mode 2 with equalizer 1200bps half duplex
0	1	0	0	0	
0	1	0	0	1	
0	1	0	1	0	Reserved
0	1	0	1	1	
0	1	1	0	0	
0	1	1	0	1	
0	1	1	1	0	
0	1	1	1	1	
1	0	0	0	0	Bell 103 Orig loopback
1	0	0	0	1	Bell 103 Ans loopback
1	0	0	1	0	Bell 202 Main loopback
1	0	0	1	1	Bell 202 with equalizer loopback
1	0	1	0	0	CCITT V.21 Orig loopback
1	0	1	0	1	CCITT V.21 Ans loopback
1	0	1	1	0	CCITT V.23 Mode 2 main loopback
1	0	1	1	1	CCITT V.23 Mode 2 with equalizer loopback
1	1	0	0	0	CCITT V.23 Mode 1 main loopback
1	1	0	0	1	CCITT V.23 Back loopback
1	1	0	1	0	Reserved
1	1	0	1	1	
1	1	1	0	0	
1	1	1	0	1	
1	1	1	1	0	
1	1	1	1	1	

Figure 2. Loopback Configurations

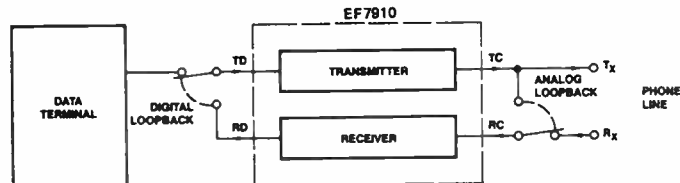
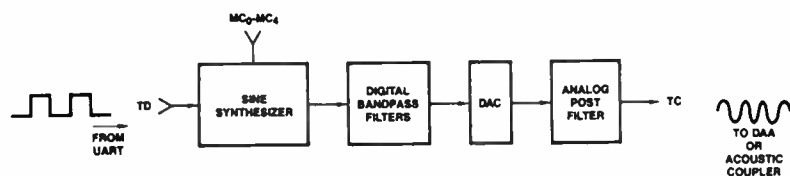

Figure 3. Transmitter Block Diagram



## CAP<sub>1</sub>, CAP<sub>2</sub>

Connection points of external capacitor/resistor required for proper operation of on-chip analog-to-digital converter.

Recommended values are: C = 2000pF ± 10%,  
R = 100Ω ± 10%.

## RESET

This input signal is for a reset circuit which operates in either of two modes. It automatically resets when power is applied to the device, or it can be activated by application of an external active low TTL pulse.

## THEORY OF OPERATION

The EF7910 MODEM consists of three main sections, shown in the block diagram of Figure 1 - Transmitter, Receiver, and Interface Control.

## TRANSMITTER (Modulator)

The transmitter, shown in Figure 3, receives binary digital data from a source such as a UART and converts the data to an analog signal using frequency shift keying (FSK) modulation. This analog signal is applied to the phone line through a DAA or acoustic coupler. FSK is a modulation technique which encodes one bit per baud. A logic one applied to the TRANSMITTED

DATA (TD) input causes a sine wave at a given frequency to appear at the analog TRANSMITTED CARRIER (TC) output. A logic zero applied to input TD causes a sine wave of a different frequency to appear at the TC output. As the data at the TD input switches between logical one and zero, the TC output switches between the two frequencies. In the EF7910 this switching between frequencies is phase continuous. The frequencies themselves are digitally synthesized sine functions.

The frequencies for each modem configuration available in the EF7910 are listed in Table 3a.

The process of switching between two frequencies as in FSK generates energy at many more frequencies than the two used in the modulation. All the transmitted information can be recovered from a frequency band B Hz wide, where B is the bit rate or maximum rate of change of the digital data at the TD input. This band is centered about a frequency, f<sub>C</sub>, where f<sub>C</sub> = f<sub>1</sub> + (f<sub>2</sub> - f<sub>1</sub>)/2  
(f<sub>1</sub> = lower of two FSK frequencies)  
(f<sub>2</sub> = higher of two FSK frequencies)

In addition to this primary information band, there exist side bands containing redundant information. It is desirable to attenuate these bands for two reasons:

1. The phone companies have specifications on the amount of energy allowed in certain frequency bands on the line.

# modem data sheet

## 7910

2. If two independent information channels are present simultaneously on the line (e.g. 300 bps full duplex or 1200 bps half duplex with back), the redundant transmitter components may fall in the frequency band of the local receiver channel and interfere with detection. In the EF 7910 these redundant and undesirable components are attenuated by digital bandpass filters.

Following the digital bandpass filters, the filtered FSK signal is converted to an analog signal by an on-chip DAC operating at a high sample rate. This analog FSK signal is finally smoothed by a simple on-chip analog low pass filter.

### RECEIVER (Demodulator)

A simplified block diagram of the EF 7910 FSK receiver is shown in Figure 4. Data transmitted from a remote site modem over the phone line is an FSK-modulated analog carrier. This carrier is applied to the RECEIVED CARRIER (RC) pin via a DAA or acoustic coupler. The first stage of the demodulator is a simple on-chip analog low pass anti-alias filter. The output of this is converted into digital form and filtered by digital bandpass filters to improve the signal to noise ratio and reject other independent channel frequencies associated with the phone line in the case of full duplex configuration. The bandpass filtered output is digitally demodulated to recover the binary data. A carrier detect signal is also digitally extracted from the received line carrier to indicate valid data.

### INTERFACE CONTROL

This section controls the handshaking between the modem and the local terminal. It consists primarily of delay generation counters, two state machines for controlling transmission and reception, and mode control decode logic for selecting proper transmit frequencies and transmit and receive filters according to the selected modem type. Inputs and outputs from this section are as follows:

REQUEST TO SEND (Main and Back)  
 CLEAR TO SEND (Main and Back)  
 CARRIER DETECT (Main and Back)  
 RING  
 MCO-MC4  
 DATA TERMINAL READY

Internal logic clamps protocol signals to different levels under certain conditions (e.g., initial conditions).

When Bell 103/113 and V.21 modem configurations are selected, the back channel signals are non-functional.

Figures 7 and 8 depict the sequencing of the two state machines. State machine 1 implements main or back channel transmission and the auto-answer sequence. State machine 2 implements reception on main or back channel.

The state machine powers on to the state labelled INITIAL CONDITIONS. Handshake signals are set to or assumed to be the levels listed in Table 2. The machine then waits for DATA TERMINAL READY (DTR) to be turned on. Whenever DTR is turned to the OFF state from an ON condition, each state machine and external signals return to the initial conditions within 25 microseconds. After DTR is turned ON the EF 7910 becomes operational as a modem and the state machines proceed as depicted in the flowcharts.

The definitions of the terms Full Duplex and Half Duplex used in these flowcharts are depicted below (Figs. 5 and 6). "Full Duplex" applies to all 103/113, V.21 modes. "Half Duplex" applies to 202 and V.23, both forward and backward channel.

**Full Duplex:** Data can be transmitted and received simultaneously at a rate of 300 baud. Two independent 300Hz channels are frequency multiplexed into the 3000Hz bandwidth of the phone line. The EF 7910 configurations for the Bell 103/113 and CCITT V.21 can be operated full duplex.

**Half Duplex:** In half duplex with back channel, the modem may transmit at 1200/600 baud and receive at 5/75 baud. Alternatively it may transmit at 5/75 baud and receive at 1200/600 baud. Examples are Bell 202 and CCITT V.23.

TABLE 2.  
INITIAL CONDITIONS

Data Terminal Ready (DTR)	OFF
Request to Send (RTS)	OFF
Clear to Send (CTS)	OFF
Transmitted Data (TD)	Ignored
Back Channel Request to Send (BRTS)	OFF
Back Channel Clear to Send (BCTS)	OFF
Back Channel Transmitted Data (BTD)	Ignored
Ring (RING)	OFF
Carrier Detect (CD)	OFF
Received Data (RD)	MARK
Back Channel Carrier Detect (BCD)	OFF
Back Channel Received Data (BRD)	MARK

Figure 5. Full Duplex

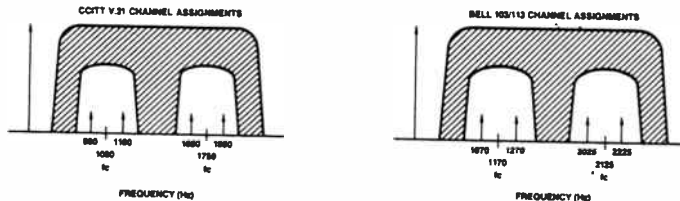
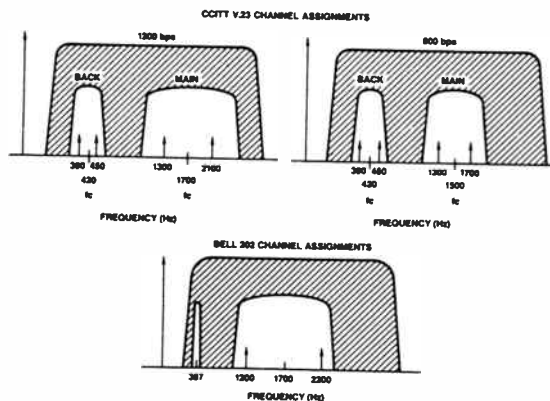

Figure 6. Half Duplex



### CALL ESTABLISHMENT

Before two modems can exchange data, an electrical connection through the phone system must be established. Although it may assist in call establishment, a modem typically does not play a major role. A call may be originated manually or automatically and it may be answered manually or automatically.

**Manual Calling** - Manual calling is performed by a person who dials the number, waits for an answer, then places the calling modem into data transmission mode.

**Automatic Calling** - Automatic calling is typically performed by an automatic calling unit (ACU) which generates the appropriate dialing pulse or dual-tone sequence required to call the remote (called) modem. The ACU also has the ability to detect an answer tone from the called modem and place the calling modem into data transmission mode.

**Manual Answering** - Manual answering is performed by a person who hears the phone ring, lifts the receiver, causes the called modem to send an answer tone to the calling modem, and places the called modem into data transmission mode.

**Automatic Answering** - Automatic answering is performed by a called modem with a data access arrangement (DAA). The DAA detects a ringing signal, takes the phone circuit off-hook (corresponding to lifting the receiver) and instructs the called modem to commence the auto-answer sequence. Next the called modem sends out silence on the line, followed by an answer tone. When this tone is detected by the calling modem, the connection is considered to have been established.

The EF 7910 provides assistance for automatic answering through the RING signal as follows. Observe the upper right-hand portion of Figure 7(a). Assume that DATA TERMINAL READY (DTR) has recently been asserted to cause exit from the initial conditions. Note that if DTR remains OFF, RING is ignored. Assume also that RTS and BRTS are OFF and that the mode control lines (MCO-MC4) select a normal modem configuration, not a loopback mode. Automatic answering is initiated by receipt of a LOW level at the RING input, causing entrance to the auto-answer sequence depicted in Figure 7(c).

The EF 7910 outputs silence (0.0 volt) at its TRANSMITTED CARRIER (TC) output for a time,  $t_{sil}$ , followed by the answer tone for a time,  $t_{AT}$ . The CARRIER DETECT (CD) pin is clamped OFF and the RECEIVED DATA (RD) signal is therefore clamped to a MARK (HIGH) during the auto-answer sequence. Upon completion of the answer tone, CD is released. If the mode lines (MCO-MC4) select a 202 or V.23 mode, the transmit filters are set to the forward channel and the receive filters are set to the back channel during the auto answer sequence.

At the end of the auto-answer sequence, return is made to point A in the loop at the upper right-hand portion of Fig. 7(a). Note that since the answer flag has been set, the auto-answer sequence cannot be entered again unless DTR is first turned OFF, then ON. At this point the phone line connection has been established and data transmission or reception may begin.

The RING input may be activated from a conditioned DAA Ring Indicator output for automatic answering or it may be activated by a switch for manual answering. Tying RING HIGH will disable the auto-answer function of the EF 7910.

### DATA TRANSMISSION

#### Full Duplex

Following call establishment, full duplex data transmission can be started by either the called or calling modem. In other words, if the connection has been established and the modem is looping through point A in Figure 7(a), it no longer matters which is the called and which is the calling modem. Data transmission is initiated by asserting REQUEST TO SEND (RTS). At this time the TRANSMITTED DATA (TD) input will be released and a modulated carrier can appear at the TRANSMITTED CARRIER (TC) output. Following a delay,  $t_{RCON}$ , CLEAR TO SEND (CTS) will turn ON. At this time, data may be transmitted through the TD input. It is a common protocol for the user to always present a MARK at the TD input before RTS is asserted and during the  $t_{RCON}$  delay.

Data transmission continues until RTS is turned OFF. Following a short delay,  $t_{RCOFF}$ , CTS turns OFF. As soon as RTS goes OFF, the TD input is ignored and the TC output is set to 0.0 volt (silence). After CTS turns OFF, the state machine returns to point A in Figure 7(a).

#### Half Duplex

When a half duplex mode is selected (202 or V.23), data transmission can be either on the main channel at 1200/600 baud or on the back channel at 5/75 baud. In normal half duplex operation a single modem is either transmitting on the main and receiving on the back channel or vice versa. In the EF 7910 control of the transmitter and receiver filters to the proper channel is performed by RTS. When RTS is asserted, the transmitter filters and synthesizer are set to transmit on the main channel; the receiver filters are set to receive on the back channel. Therefore, whenever RTS is on, BRTS should not be asserted since the transmitter cannot be used for the back channel. When RTS is OFF and a half duplex mode is selected, the transmitter filters and synthesizer are set to the back channel; the receiver filters are set to the main channel. If RTS and BRTS are asserted simultaneously, RTS will take precedence. However, if BRTS is asserted before RTS and the back channel data transmission sequence has been entered (Figure 7(b)), RTS will be ignored until BRTS is turned OFF.

The state machine sequences for main and back channel transmission differ slightly and are depicted in Figure 7. Assume the state machine is idling through point A in Figure 7(a).

#### Main Channel

This transmission sequence is entered if a 202 or V.23 mode is selected and RTS is asserted. Since the receiver is now forced to the back channel, the RECEIVED DATA (RD) signal is clamped to a MARK; and the CARRIER DETECT signal is clamped OFF. The TRANSMITTED DATA input (TD) is released and a carrier appears at the TRANSMITTED CARRIER output which follows the MARK/SPACE applied to TD. RTS turning ON initiates a delay,  $t_{RCON}$ , at the end of which the CLEAR TO SEND (CTS) output goes LOW. When CTS goes LOW data may be transmitted through input TD. Data transmission continues until RTS is turned OFF. At this time several events are initiated. First a delay,  $t_{RCOFF}$ , is initiated at the end of which CTS turns OFF. The TD



Figure 7(a). Transmit Main Channel State Diagram

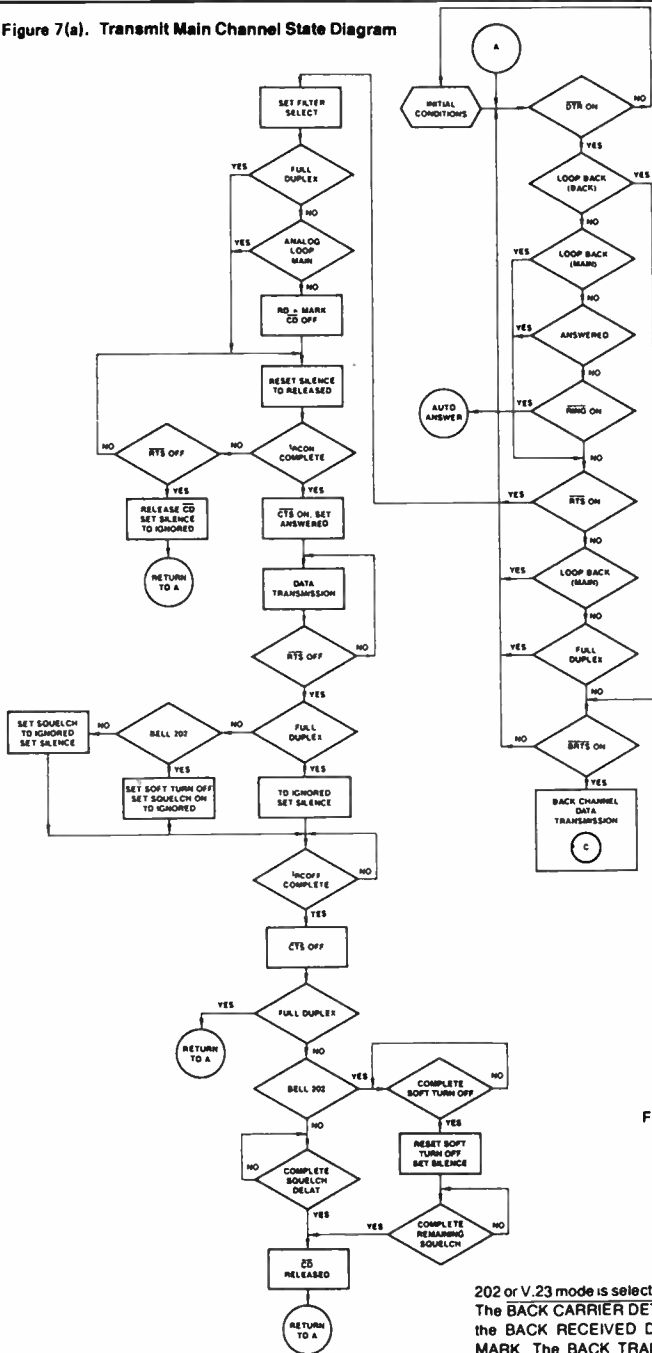

input is ignored as soon as  $\overline{RTS}$  goes OFF. If a 202 mode is selected, a soft turn-off tone appears at the TC output for a time,  $t_{STO}$ , followed by silence (0.0 volt). For both 202 and V.23 modes a squelch period,  $t_{SQ}$ , is initiated when  $\overline{RTS}$  goes OFF. During this period the CD output is clamped OFF, forcing the RD output to a MARK condition. The squelch period begins as soon as  $\overline{RTS}$  goes OFF and thus overlaps both  $t_{CDOFF}$  and  $t_{STO}$ . At the end of the squelch period, the state machine returns to the idle loop at point A in Figure 7(a).

The reasons for squelch and soft-turnoff are as follows:  
**Soft Turn-Off:** When  $\overline{RTS}$  is turned OFF at the end of a message, transients occur which may cause spurious space signals to be received at a remote modem. During soft turn-off the modem transmits a soft carrier frequency for a period,  $t_{STO}$ , after  $\overline{RTS}$  is turned OFF. This results in a steady MARK on the RECEIVED DATA (RD) line of the remote modem.  
**Squelch:** The local receiver must be turned OFF after  $\overline{RTS}$  is OFF, until the start of carrier detect, so that line transients are not demodulated. The process of disabling the receiver after  $\overline{RTS}$  is turned OFF is called squelching.

**Back Channel**

This transmission sequence, shown in Figure 7(b), is entered if a

202 or V.23 mode is selected,  $\overline{RTS}$  is OFF, and  $\overline{BRTS}$  is asserted. The BACK CARRIER DETECT (BCD) output is forced OFF and the BACK RECEIVED DATA (BRD) output is clamped to a MARK. The BACK TRANSMITTED DATA input (BTD) is released and a carrier appears at the TC output which follows the MARK/SPACE applied to BTD. Turning ON  $\overline{BRTS}$  initiates a delay,  $t_{BRCON}$ , at the end of which the BACK CLEAR TO SEND (BCTS) output goes LOW. When BCTS goes LOW data may be transmitted through input BTD. Data transmission continues until  $\overline{BRTS}$  is turned OFF. The input BTD is immediately ignored and the TC output is silenced (set to 0.0 volt). Following a short delay,  $t_{BRCOFF}$ , the output BCTS goes OFF. The signals BCD and BRD are released and the state machine returns to idle at point A of Figure 7(a).

In 202 back channel mode, BTD should be tied HIGH. Then  $\overline{BRTS}$  controls the ON/OFF keying modulation. When  $\overline{BRTS}$  is LOW, 387Hz appears at the TC output; when  $\overline{BRTS}$  is HIGH, 0 volt appears at TC.

**DATA RECEPTION**

Data reception is controlled by state machine 2 and depicted in Figure 8. At power on the machine enters initial conditions and remains there until  $\overline{DTR}$  is asserted. It then loops until either CARRIER DETECT (CD) or BACK CARRIER DETECT (BCD) occurs.

**Full Duplex**

In full duplex data reception, CARRIER DETECT may appear

Figure 7(b). Transmit Back Channel State Diagram

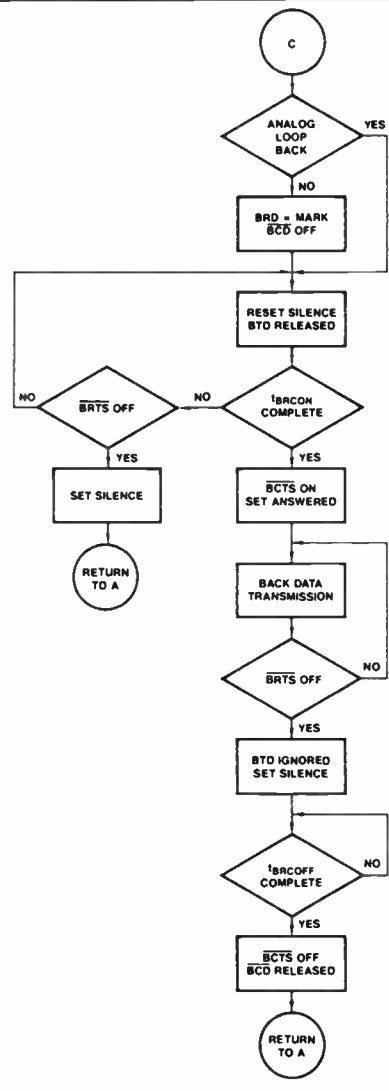
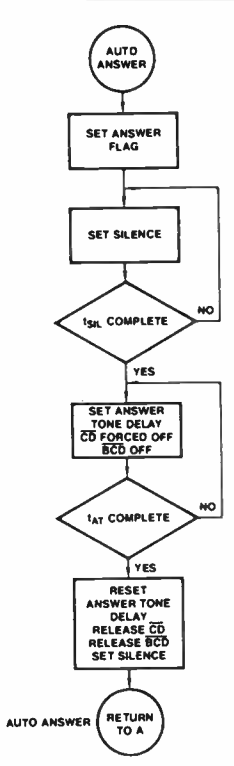

Figure 7(c). Auto Answer State Diagram



at any time after the phone connection has been established. Reception is independent of transmission. When the receiver detects a valid carrier for at least a time,  $t_{CDON}$ , the output CD is turned ON, the RECEIVED DATA (RD) output is released, and valid data can be obtained at RD. Data is received until the receiver detects loss of carrier for at least a time,  $t_{CDOFF}$ . At this time the CD output is turned OFF and RD is clamped to a MARK. The state machine returns to the idle loop at point E.

**Half Duplex**

As discussed in the data transmission section above, when a half duplex mode has been selected, the signal  $\overline{RTS}$  controls whether the main channel is transmitting or receiving. The back channel can only do the opposite from the main. If  $\overline{RTS}$  is OFF, then CARRIER DETECT may be asserted and the data reception sequence is identical to that discussed above for full duplex reception. As long as  $\overline{RTS}$  remains OFF, BACK CARRIER DETECT will never be asserted. If  $\overline{RTS}$  is ON, then CARRIER DETECT will never be asserted. Instead the receiver will look for a valid carrier in the back channel frequency band. If a valid carrier exists for at least a time,  $t_{BCDON}$ , the output BACK CARRIER DETECT (BCD) is turned ON, the BACK RECEIVED DATA (BRD) output is released and valid data can be obtained at BRD. Data is received until the receiver detects loss of back channel received signal for at least a time,  $t_{BCDOFF}$ . At this time the BCD output is turned OFF. Data output, BRD, is clamped to a MARK if a V.23 mode is selected. For 202 back channel mode, BCD represents the received data. The BRD output can be ignored. The state machine returns to the idle loop at point E.

**LOOPBACK**

Ten modes exist to allow both analog and digital loopback for each modem specification met by the EF7910. When a loopback mode is selected, the signal processing (filters, etc.) for both the

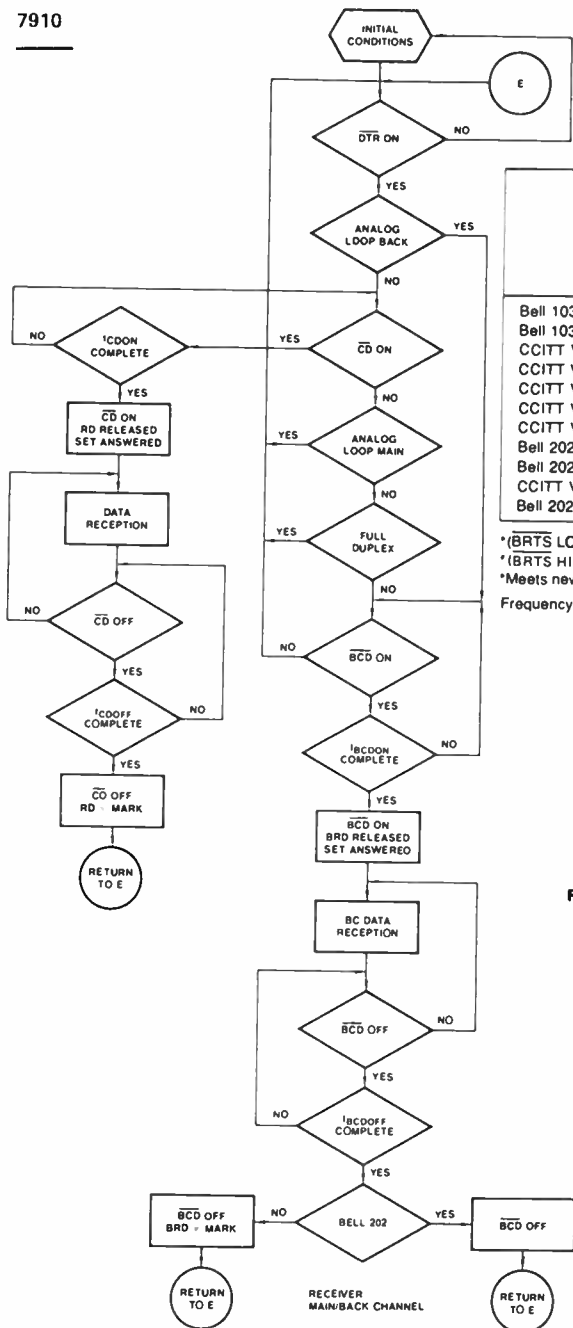

TABLE 3(a). FREQUENCY PARAMETERS

Modem	Baud Rate (BPS)	Duplex	Transmit Frequency		Receive Frequency		Answer Tone Freq Hz
			Space Hz	Mark Hz	Space Hz	Mark Hz	
Bell 103 Orig	300	Full	1070	1270	2025	2225	-
Bell 103 Ans	300	Full	2025	2225	1070	1270	2225
CCITT V.21 Orig	300	Full	1180	980	1850	1650	-
CCITT V.21 Ans	300	Full	1850	1650	1180	980	2100
CCITT V.23 Mode 1	600	Half	1700	1300	1700	1300	2100
CCITT V.23 Mode 2	1200	Half	2100	1300	2100	1300	2100
CCITT V.23 Mode 2 Equalized	1200	Half	2100	1300	2100	1300	2100
Bell 202	1200	Half	2200	1200	2200	1200	2025
Bell 202 Equalized	1200	Half	2200	1200	2200	1200	2025
CCITT V.23 Back	75	-	450	390	450	390	-
Bell 202 Back	5	-	*	*	**	**	-

\* (BRTS LOW) and (BTD HIGH): 387Hz at TC  
 \* (BRTS HIGH) or (BTD LOW): 0 volt at TC  
 \* Meets new CCITT R20 frequency tolerance.  
 \*\* 387Hz at RC: BCD LOW  
 \*\* No 387Hz at RC: BCD HIGH  
 Frequency tolerance is less than ±0.4Hz with 2.4576MHz Crystal. Except Bell 202 which is +1Hz (1200 Hz, mark)

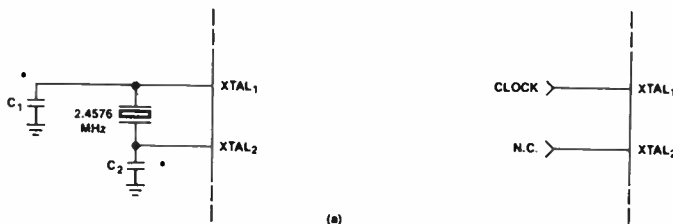

Figure 12. Clock Generation

TABLE 4. CLOCK PARAMETERS

Symbol	Parameters	Min	Typ	Max	Units
t <sub>CY</sub>	Clock Period	406.86	406.9	406.94	ns
t <sub>CH</sub>	Clock High Time	165			ns
t <sub>CL</sub>	Clock Low Time	165			ns
t <sub>CR</sub>	Clock Rise Time			20	ns
t <sub>CF</sub>	Clock Fall Time			20	ns

Figure 8. Receiver Main/Back Channel State Diagram

transmitter and receiver is set to process the same channel or frequency band. This allows the analog output, TRANSMITTED CARRIER, and the analog input, RECEIVED CARRIER, to be connected for local analog loopback. Alternatively the digital data signals, TD and RD or BTD and BRD, can be connected externally, allowing a remote modem to test the local modem with its digital data signals looped back.

When a loopback mode is selected, the state machine sequences are altered slightly. First, auto-answer is disabled. Second, if a half duplex loopback mode is selected (202 or V.23), the local CARRIER DETECT/BCD is not forced OFF when RTS/BRTS is asserted.

The 202 and V.23 main loopback modes allow use in a 4-wire configuration at 1200 bps.

### CLOCK GENERATION

Master timing of the modem is provided by either a crystal connected to the XTAL1 and XTAL2 inputs or an external clock applied to the XTAL1 input.

#### Crystal

When a crystal is used it should be connected as shown in Figure 12. The crystal should be a parallel resonance type, and its value must be 2.4576MHz ± 0.1%.

#### External Clock

This clock signal could be derived from one of several crystal-driven baud rate generators. It should be connected to the XTAL1 input and the XTAL2 input must be left floating. The timing parameters required of this clock are shown in Figure 12 and the values are listed in Table 4.

### POWER ON RESET

The reset circuit operates in either of two modes

#### Automatic Reset

In this mode an internal reset sequence is automatically entered when power is applied to the device. One resistor and one capacitor must be connected externally as shown in Figure 13. Values shown will work with most power supplies. Power supply (V<sub>CC</sub>) rise time should be less than one half the RC time constant.

#### External Reset

In this mode the device may be forced into the reset sequence by application of an active LOW pulse applied to the RESET input. The reset must not be applied until the V<sub>CC</sub> supply has reached at least 3.5 V. Timing is diagrammed in Figure 14.



TABLE 3(b). TIMING PARAMETERS

Symbol	Description	Bell 103 Orig	Bell 103 Ans	CCITT V.21 Orig	CCITT V.21 Ans	CCITT V.23 Mode 1	CCITT V.23 Mode 2	CCITT V.23 Mode 2 EQ	Bell 202	Bell 202 EQ	CCITT V.23 Beck	Bell 202 Beck	Units
$t_{RC(ON)}$	Request-to-Send to Clear-to-Send ON Delay	208.3	208.3	400	400	208.3	208.3	208.3	183.3	183.3	-	-	msec $\pm 0.3\%$
$t_{RC(OFF)}$	Request-to-Send to Clear-to-Send OFF Delay	0.5	0.5	0.5	0.5	0.5	0.5	0.5	0.5	0.5	-	-	msec $\pm 0.25\%$
$t_{BRC(ON)}$	Back Channel Request-to-Send to Clear-to-Send ON Delay	-	-	-	-	-	-	-	-	-	82.3	-	msec $\pm 0.64\%$
$t_{BRC(OFF)}$	Back Channel Request-to-Send to Clear-to-Send OFF Delay	-	-	-	-	-	-	-	-	-	0.5	-	msec $\pm 25\%$
$t_{CD(ON)}$	Carrier Detect ON Delay	94-106	94-106	301-312	301-312	11.4-15.4	11.4-15.4	11.4-15.4	18-22	18-22	-	-	msec
$t_{CD(OFF)}$	Carrier Detect OFF Delay	21-40	21-40	21-40	21-40	5.4-13.3	5.4-13.3	5.4-13.3	12.4-23.4	12.4-23.4	-	-	msec
$t_{BCD(ON)}$	Back Channel Carrier Detect ON Delay	-	-	-	-	-	-	-	-	-	17-25	17-25	msec
$t_{BCD(OFF)}$	Back Channel Carrier Detect OFF Delay	-	-	-	-	-	-	-	-	-	21-38	21-38	msec
$t_{AT}$	Answer Tone Duration	-	1.9	-	3.0	3.0	3.0	3.0	1.9	1.9	-	-	sec $\pm 0.44\%$
$t_{SIL}$	Silence Interval before Transmission	1.3	1.3	1.9	1.9	1.9	1.9	1.9	1.3	1.3	-	-	sec $\pm 0.64\%$
$t_{SQ}$	Receiver Squelch Duration	-	-	-	-	156.3	156.3	156.3	156.3	156.3	-	-	msec $\pm 3.3\%$
$t_{STO}$	Transmitter Soft Turn-Off Duration	-	-	-	-	-	-	-	24	24	-	-	msec $\pm 2.3\%$
$t_{RI}$	Minimum RI Low Duration	-	25	-	25	25	25	25	25	25	-	-	$\mu$ s

**NOMINAL PERFORMANCE SPECIFICATIONS TRANSMITTER (All Modern Types)**

Input Data Format: Serial, asynchronous, standard TTL levels  
 Modulation Technique: Binary, phase-coherent Frequency Shift Keying (FSK)  
 TC Output Level: -3dBm into 600 $\Omega$   
 Frequency Accuracy:  $\pm 0.4$ Hz all modems except Bell 202 (mark) +1.0Hz Bell 202 (mark)  
 Harmonics: -45dB from fundamental for single tones  
 Delay uncertainty for TD logic input change to TC frequency change:  $\leq 8.3\mu$ s  
 Out-of-band energy: See Figure 15

**RECEIVER**

Output Data Format: Serial, asynchronous, TTL levels  
 Demodulation Technique: Differential FM Detection  
 Sensitivity at Receiver Input: 0dBm to -48dBm  
 Frequency Deviation Tolerance:  $\pm 16$ Hz  
 Carrier Detect Threshold:  
 ON > -43dBm  $\pm 1$ dB  
 OFF < -48dBm  $\pm 1$ dB

Figure 13. Automatic Reset

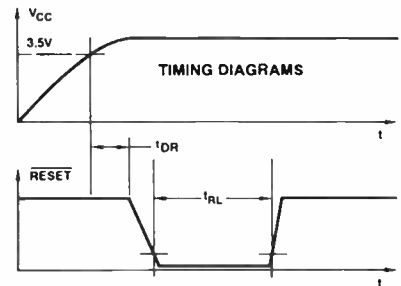
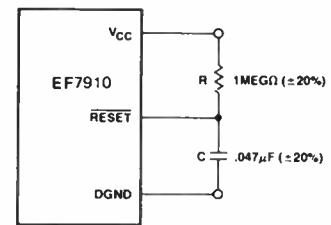
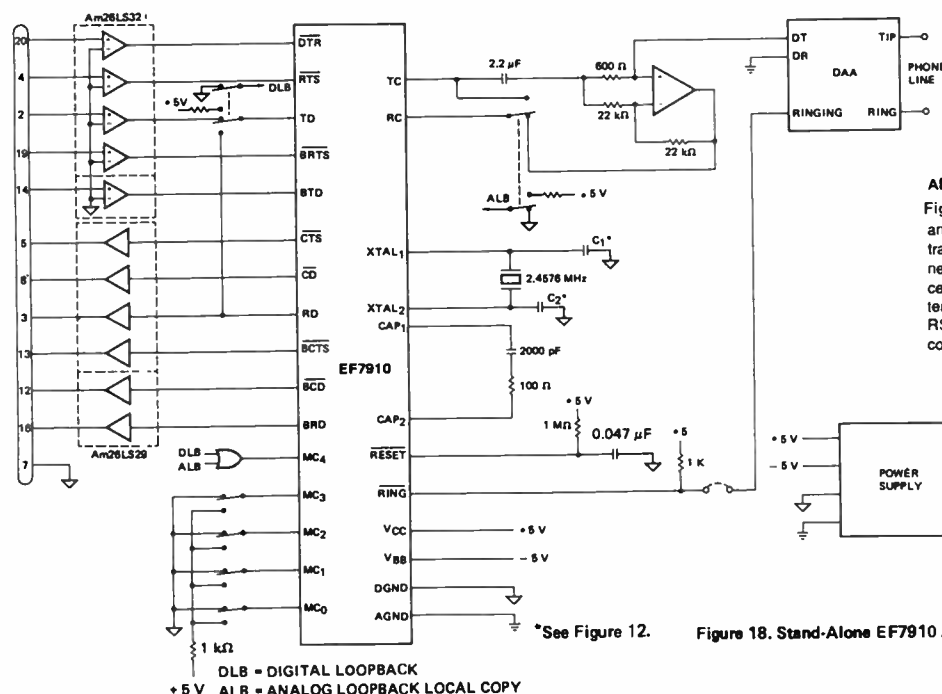
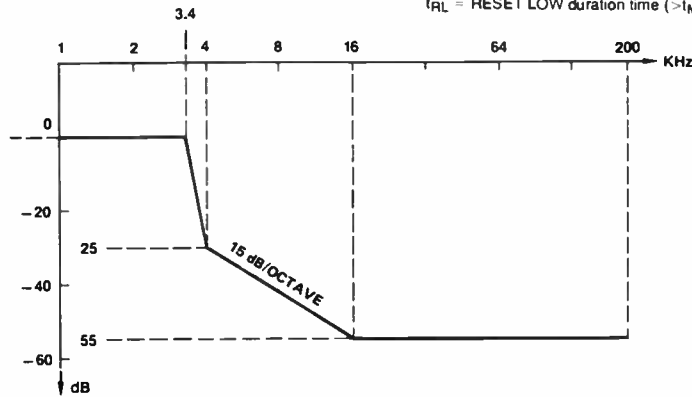

Figure 14. External Reset

$t_{DR}$  = delay from the time  $V_{CC}$  reaches 3.5V and the falling edge of  $\overline{RESET}$  signal ( $> 1\mu$ s)  
 $t_{RL}$  =  $\overline{RESET}$  LOW duration time ( $> t_{MCK} = 406$ ns)

Figure 15. Out-of-Band Transmitter Energy



**APPLICATIONS**

Figure 16. depicts a stand-alone EF7910 configuration. An op amp and three resistors provide a duplexor function to put the transmitter output onto the line while receiving adjacent channel data from the line. Connection to the line is via a Data Access Arrangement (DAA). Note the lack of external analog filters. The TTL handshake signals may be level converted to RS-232, RS-422, or V.24 using appropriate devices. Mode control lines are hardwired or connected to switches.

\*See Figure 12. Figure 18. Stand-Alone EF7910 Application

... from page 61.

as pin 13 goes HIGH. During the period that pin 13 is HIGH, Q4 is off, removing the supply to LEDs 2 & 3. This period is half the duration of the transmit cycle and forms the receive period.

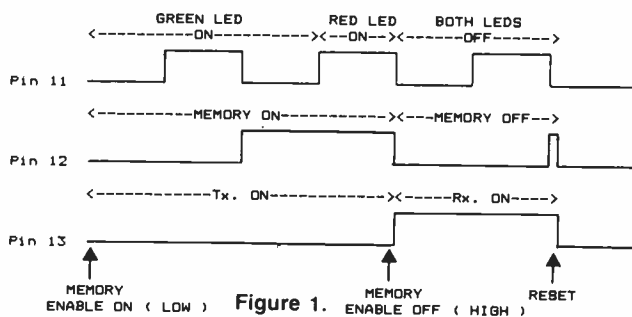

Figure 1.

Transistor Q4 is switched by IC5 to ensure that the green & red LEDs are only on during the appropriate portion of the operating cycle. The LEDs are run at full current rating via Q5 and Q6 to give maximum brightness, which can be important in strong light. IC6(b) is a NAND gate and combined with the inverters IC6(c) & (d) switches the inputs to Qs 5 & 6 as required. NOTE: IC6(a) is reserved for later modification and must be connected as shown.

During the WRITE period (when keying is being entered into the memory) and the READ period (when the memory is keying the transmitter) LEDs 2 & 3 operate as follows: From the start of the period to 75% of the period LED3 (flashing RED) is on indicating that the available time in the memory is running out and keying should cease as soon as possible after the LED starts flashing.

The ratio between the green and red LEDs remains 75%:25% regardless of the keying speed set by RV1 but the number of times that LED3 flashes each cycle will vary with the setting of RV1. If RV1 is set for, say, 16 seconds per cycle, LED3 may flash nine or 10 times. If RV1 is set for 66 seconds LED3 may flash 35 to 40 times.

During the READ period the LEDs indicate the program timing. If this facility is not required, change S2 to a DPDT and add the second switch section between R10 & D5 so that it is closed in the WRITE position and open during READ. The timing LEDs will then operate only during the WRITE cycle.

S1, S2 & RV1 are the only controls required for all functions. S1 (MEMORY ON/OFF) controls the supply to the clock oscillator, binary counters and timing display LEDs. IC2 must be supplied with 5 V at all times to maintain data in the memory. Turning S1 to OFF does not destroy data as IC2 is supplied directly from the positive rail.

Switch S2 (READ/WRITE) selects either the READ or WRITE mode by taking pin 3 of IC2 HIGH or LOW. RV1 (speed) sets the READ or WRITE rate as required.

To ensure that each time a message is transmitted it starts at the beginning and not at random, a reset pulse is applied to the binary counters each time S1 is turned ON. A brief positive pulse goes from the +5 V rail to pins 7 & 15 of ICs 4 & 5 via C7 and D10. This resets the counters to zero. A similar reset pulse is sent via R14, C5 and D8 at the end of the receive period to initiate the next cycle as pins 12 & 13 of IC5 go HIGH.

DO NOT exceed 5 V on the supply rail, the CMOS ICs will operate on higher voltages but the memory is a 5 V device. Diode D4, in series with the supply rail, protects the circuit from accidental reverse voltage and over-voltage protection is provided by ZD1.

To enter a message, set S2 to WRITE and RV1 to mid-range. Set S1 to ON and the GREEN LED will light. After about 30 seconds the green LED will go off and the flashing red LED then operates. When the flashing red LED goes off, the trans-

mit period has finished and the memory is disabled. This cycle clears any random noise in the memory, or a previous message.

Wait until the green LED comes on again, then start keying immediately. Stop keying as soon as possible once the red LED starts flashing. Any keying after the red LED stops flashing will not be entered into the memory. When the red LED has gone off, set S2 to READ. Set S1 to OFF, then reset it to ON. The CW should then commence immediately (as the green LED comes on), unless you started keying a little late while writing your message in.

If the message was too long for the available time, rewrite it again but key a little faster. For best results do not write a message with RV1 set below mid-range, otherwise the reliability of the keying may suffer. Any speed may be used to READ a message.

To stop the message, set S1 to OFF. If S1 is left ON the message will auto-repeat as long as power is supplied.

## Modification for 2K memory

The maximum period of any message which can be written into the memory is limited to about 45 seconds. If a message exceeds this time the keying may become erratic and the characters unreadable.

Another problem arises when the input keying is at a slow rate and the full memory period elapses before the message has been completed, e.g: when using a slow, simple, computer-generated message. (See "CW using the Microbee").

The stability and length of message problems can be overcome by the addition of another 2102 memory (IC7) in parallel with the existing memory (IC2). This increases the period available from around 45 seconds to 90 seconds which is more than adequate, even with slow keying.

It is then possible to WRITE a message relatively slowly and READ it at a faster rate while maintaining good keying quality. (Refer to Circuit 2).

By using two NOR gates (IC8(a) & (b)) and three inverters (IC6(a), IC6(c) & (d)) memory 1 (IC2) and memory 2 (IC7) can be sequentially switched to produce a 2K memory without any significant break in the data input or output flow. Each memory is enabled as pin 13 is taken LOW and disabled as pin 13 goes HIGH.

The memories are enabled as follows: Pins 13 & 14 of IC5 both LOW turns IC2 ON but hold IC7 OFF. Pin 13 of IC5 HIGH and pin 14 of IC5 LOW turns IC7 ON and holds IC2 OFF. Pin 13 of IC5 LOW and pin 14 of IC5 HIGH holds BOTH IC2 and IC7 OFF and forms the receiving period of the cycle. (Refer to Figure 2).

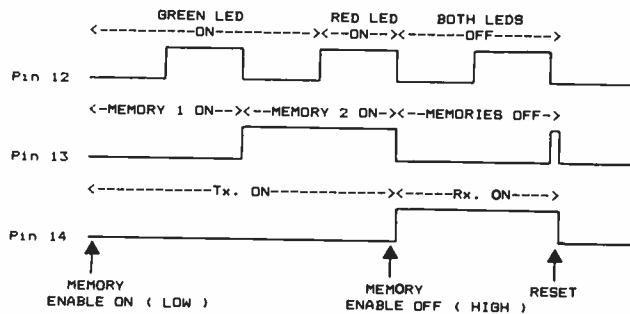
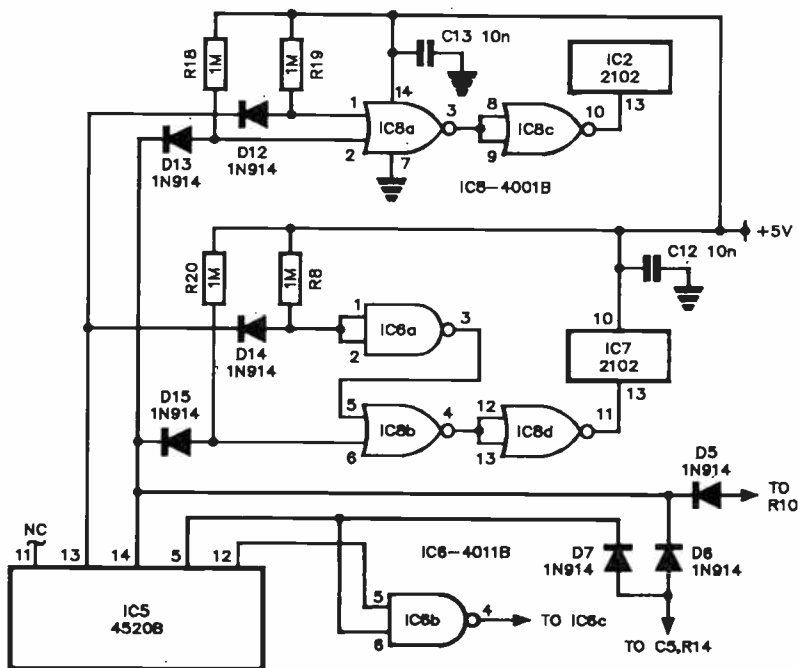

Figure 2.

All pins of IC7 are wired in parallel with the matching pins of IC2 except pin 13, the enable line. Two additional 10n capacitors, Cs 12 & 13, are used to bypass pin 10 of IC7 and pin 14 of IC8. Resistors R8, 18, 19 & 20 are connected to the +5 V rail and hold the inputs to IC6(a), IC8(a) & (b) HIGH. Diodes D12-15 isolate the input gates and allow them to be taken LOW by IC5.





Circuit 2.

When changing to the 2K option the following modification is made to the outputs of IC5. Pins 5 & 6 of IC6(b) are changed so that pin 5 of IC6(b) goes to pin 12 of IC5 instead of pin 11 and pin 6 of IC6(b) goes to pin 5 of IC5 instead of pin 12. Diodes D5 and D6 are changed so that they both go to pin 14 of IC5.

Diode D7 remains connected to pin 6 of IC6(b). Pin 13 of IC2 is connected to pin 10 of IC8(c) instead of pin 13 of IC5. Pin 13 of IC7 is connected to pin 11 of IC8(d).

### CW using the Microbee

Many amateurs now have access to a microcomputer and for generating messages such as those used with this memory, they are ideal. It is relatively easy to program a correctly spaced message that would be very difficult to equal with hand sending.

The Microbee will produce CW by using the following BASIC program and the PLAY tones. Tone number 24 was selected as being the most suitable for this purpose. The spacing used is one space between each dit or dah, three spaces between letters and seven spaces between words. Refer to the Microbee User's Manual, pages 115 & 116 for further information.

"CQ DX" is written as below:

```
00100 REM "CQ DX"
00110 PLAY 0,10
00120 PLAY 24,3;0,1;24,1;0,1;24,3;0,1;24,1;0,3
00130 PLAY 24,3;0,1;24,3;0,1;24,1;0,1;24,3;0,7
00140 PLAY 24,3;0,1;24,1;0,1;24,1;0,3
00150 PLAY 24,3;0,1;24,1;0,1;24,1;0,1;24,3;0,7
```

In this example, CQ is treated as two letters, followed by a word space, D is followed by a letter space, X is then followed by a word space. 24,1 = dit; 0,1 = space between dits and dahs; 24,3 = dah; 0,3 = letter space; 0,7 = word space. The space 0,10 in line 100 leaves a short gap between starting the program and the first letter.

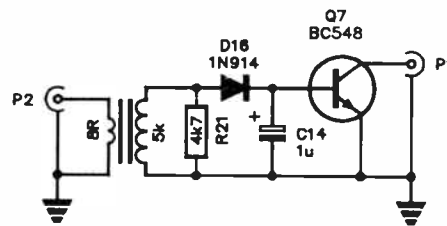

Circuit 3.

#### TONE DECODER PARTS LIST

C14	1u/16 V. electrolytic
D16	1N914
P1	Plug to suit J1
P2	Plug to suit recorder external speaker socket
Q7	BC548
R21	4k7
T1	8R:5k speaker transformer

#### 2K MEMORY PARTS LIST

C12, C13	10n/50 V ceramic
D12-15	1N914
IC7	2102 1K x 1-static RAM
IC8	4001B NOR gate
R18-20	1M, 1/4 W 5%

Note: IC6(a) and R8 are part of Circuit 1.

After the message has been composed and played to ensure it is correct the tones can be recorded onto tape from the Microbee either by placing a microphone close to the internal speaker or by a direct patch to the recorder. When replayed, the output from the recorder can then be used with a simple tone decoder circuit to operate the CW memory. A series of messages can be made up for use as and when required to program the memory. The only critical settings are the record and play levels but they can quickly be set to the optimum to give clean keying.

The decoder operates very simply: (Refer to Circuit 3). Transformer T1 interfaces with the recorder external speaker outlet and the audio tones are rectified by D16. The voltage across C14 causes Q7 to conduct, switching the input line to the memory unit exactly as though a key is being used each time an audio tone reaches D16.

#### References:

- "Versatile CW Identifier" by Michael J. Di Julio, WB2BWJ, *Ham Radio*, October 1980, p.22-25.
- "Simple CW Memory" by Ray Megirian, K4DHC, *Ham Radio*, November 1980, p.46, 47.
- "CW Memory Modification" by Gene Shapiro, W0DLQ, *Ham Radio*, May 1981, p.93.
- "Programmable Keyer" by Gil Sones, VK3AUI, *Amateur Radio*, October 1983, p.19, 20.
- "Beacon Generator", author unknown, *Kyoto 6 Metre DX Club*, Japan.
- "User's Manual, Microworld 16K BASIC", *Microworld*, 1982.
- "Digital Electronics Revealed" by Colin Mitchell, *Talking Electronics*, 1983.
- "Circuit Techniques", Volumes 1-4, An ETI publication series, 1981-1984.

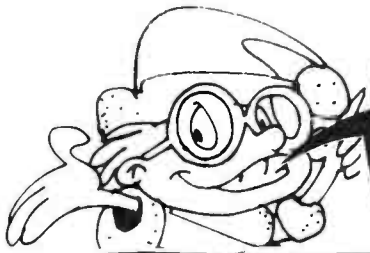

# THE PERFECT GIFT FOR THE ELECTRONICS TINKERER! PUT A SMILE ON SOMEONE'S FACE THIS XMAS. YOU CAN'T DO BETTER!

**SAVE!**

**Multimeter Capacitor Checker**

**WAS \$119** **\$99**

It's four tools in one and a must for any hobbyist, technician, etc! Not only do you get the normal ranges found on a digital multimeter but it also has five ranges of capacitance checking, two ranges of conductance PLUS diode check position! For Xmas you'll save an amazing \$20!!! Cat Q-1460

**SAVE!**

**Mini Multimeter With Bonus Carry Case!**

**\$13<sup>50</sup>**

A fantastic little multimeter for the beginner or for anyone who gives their multimeters a hard time! It's an 11 range, 2000 ohm/volt pocket sized meter that's ideal for general work! It's rugged and reliable and right now comes with a bonus carry case... FREE! Cat Q-1010

**Battery Lamp and Fuse Tester.**

**Free pack of 2 Alkaline Batteries S-3281**

**VALUE!**

**\$13<sup>75</sup>**

Don't throw those old batteries away — you could be throwing good money out! This battery, lamp and fuse tester checks a huge range of cells from 1.5V-9V actually under load! Checks Nicads, calculator and watch batteries and miniature lamps and cartridge fuses! Cat Q-1525

## STORE LOCATIONS

NSW		VIC		QLD		WA		NT		SA	
Swift & Young Sts	Albury	21 8399	Treloars Bldg Brisbane St	Tamworth	66 1961	Gold Coast Hwy & Welch St	Southport	32 9863			
T55 Terrace Level	Bankstown Sq	707 4888	263 Keira St	Wollongong	28 3800	Bowen & Ruthven Sts	Toowoomba	38 4300			
Shop 1, 65-75 Main St	Blacktown	671 7722	96 Gladstone St	Fyshwick	80 4944	Ingham Rd & Cowley St West End	Townsville	72 5722			
613 Princess Hwy	Blackhurst	546 7744	VIC			Cnr Pacific Hwy & Kingston					
Oxford & Adelaide Sts	Bondi Junction	387 1444	Creswick Rd & Webster St	Ballarat	31 5433	Wardridge Rd	Underwood	341 0844			
531 Pittwater Rd	Brookvale	93 0441	145 McCrae St	Bendigo	43 0388	Wright & Market Sts	Adelaide	212 1962			
Campbelltown Mall Queen St	Campbelltown	27 2199	Shop 46 Box Hill Central Main St	Box Hill	890 0699	Main South & Flagstaff Rds	Darlington	298 8977			
Shop 235, Archer St Entrance	Chatswood Chase	411 1955	Hawthorn Rd & Nepean Hwy	East Brighton	592 2366	Main North Rd & Darlington St	Enfield	260 6088			
147 Hume Hwy	Chullora	642 8922	260 Sydney Rd	Coburg	383 4455	24 Park Terrace	Salisbury	281 1593			
162 Pacific Hwy	Gore Hill	439 5311	1150 Mt Alexander Rd	Essendon	379 7444	WA					
315 Mann St	Gosford	25 0235	Nepean Hwy & Ross Smith Ave	Frankston	783 9144	Wharf St & Albany Hwy	Cannington	451 8666			
4 Florence St	Hornsby	477 6633	Shop 9 110 High St	Geelong	43 8522	66 Adelaide St	Fremantle	335 9733			
Elizabeth Dr & Bathurst St	Liverpool	600 9888	291-293 Elizabeth St	Melbourne	87 9834	William St & Robinson Ave	North Perth	328 6944			
450 High St	Maitland	33 7866	Bridge Rd & The Boulevarde	Richmond	428 1614	Centreway Acde, Hay St	Perth City	321 4357			
173 Maitland Rd, Tighes Hill	Newcastle	61 1896	Springvale & Dandenong Rds	Springvale	547 0522	TAS					
Lane Cove & Waterloo Rds	North Ryde	88 3855	QLD			25 Barrack St	Hobart	31 0800			
George & Smith Sts	Parramatta	689 2188	157-159 Elizabeth St	Brisbane	229 9377	NT					
The Gateway High & Henry Sts	Penrith	32 3400	166 Logan Rd	Buranda	391 6233	17 Stuart Hwy	Stuart Park	81 1977			
818 George St	Railway Square	211 3777	Gympie & Hamilton Rds	Chermside	359 6255						
125 York St	Sydney	267 9111	Queen Elizabeth Dr & Bernard St	Rockhampton	27 9644						

### Dear Customers.

Quite often, the products we advertise are so popular they run out within a few days, unforeseen circumstances might hold up shipments so that advertised lines are not in the stores by the time the advert appears. And very occasionally, an error might slip through our checks and appear in the advert (after all, we're human too!) Please don't blame the store manager or staff if they cannot solve a dock strike on the other side of the world, nor fix an error that appeared in print. If you're about to drive across town to pick up an advertised line, why not play it safe and give them a call first — just in case! Thanks Dick Smith Electronics

### MAJOR DICK SMITH ELECTRONICS AUTHORISED RESELLERS

NSW: • Ballina: A. Cummings & Co. 91-93 River St 96 2284 • Bathurst: Electronic Shop, 74 Bentick Street, 31 4421 • Bowral: Barry Gash Electronics, 370 Bong Bong St 61 2577 • Broken Hill: Hobbies & Electronics, 31 Oxide St 88 4098 • Charlestown: Newtronics 131 Pacific Hwy 43 9600 • Coffs Harbour: Coffs Harbour Electronics, 3 Coffs Mall, Park Ave. 52 5684 • Deniliquin: Deni Electronics, 220 Cressy St. 81 3672 • East Maitland: East Maitland Electronics, 99 High St 33 7327 • Gosford: Tomorrow's Electronics & Hi-Fi, 68 William St, 24 7246 • Lismore: Decro 3A/5-18 Carrington St, 21 4137 • Port Macquarie: Hall of Electronics, Horton Centre, Horton St, 83 7440 • Orange: Fyfe Electronics 173 Summer St, 62 6491 • Tumut: Tumut Electronics Wynyard St, 471 631 • Tweed Heads: Stuart Street Wholesale, Sh. 3, 4 Stuart St. • Swansea: Swansea Electronics, 184 High St, 71 1674 • Wagga: Philips Electronics 82 Forsyth St, 21 6558 • Windsor: M & E Electronics, Sh. 7, McEwans Arcade, 206 George St, 77 5935 • Young: Keith Donges Electronics 186 Boorowa St, 821 279 VIC: • Hamilton: John Thompson & Co., 138-148 Gray St, 72 2000 • Echuca: Webster Electronics, 220 Packeham St 82 2956 • Mildura: McWilliams Electronics 110A Langtree Ave, 23 6410 • Morwell: Morwell Electronics, 95 George St, 34 6133 • Shepparton: GV Electronics Centre 100 High St, 21 8866 QLD: • Alherton: Maartens Music Centre 55 Main St, 91 1208 • Bundaberg: Bob Elkin Electronics, 87 Bourong St, 72 1785 • Cairns: Electronic World Shop 27 K-mart Westcourt Plaza, 518 555 • Gladstone: Supertronics Cnr Hebert & Auckland Sts 72 4321 • Mackay: Stevens Electronics, 42 Victoria St, 51 1723 • Maryborough: Keller Electronics, 218 Adelaide St, 21 4559 • Mt Isa: Outback Electronics 71 Barkley Hwy 433 331 • Rockhampton: Purely Electronics, 15 East St, 21 058 SA: • Mt Gambier: Hutchessons Communications, 5 Elizabeth St, 25 6404 • Whyalla: Eyre Electronics Shop 15 Forsyth St, 45 4764 WA: • Albany: Micro Electronics 133 Lockyer Ave 41 2077 TAS: • Launceston: Advanced Electronics 5A The Quadrant, 34 1399 NT: • Darwin: Ventronics 24-26 Kavanagh St, 81 3491

### DSX PRESS ORDER SERVICE

Use your Bankcard, Mastercard or Visacard  
Just phone 008 226610 (toll free) for  
fast 24 hour despatch of your order  
Enquiries: B. Mackay 08 9682101

POST & PACKING CHARGES	Order Value	Charge	Order Value	Charge
	\$5.00	\$9.99	\$2.00	\$50.00
	\$10.00	\$24.99	\$3.50	\$75.00 or more
	\$25.00	\$49.99	\$4.50	

Terms available to approved applicants

SA Customers: 10 Pulteney St Adelaide  
Adelaide 10 Pulteney St Adelaide



welcome here



PTY LTD

P.O. Box 321, North Ryde N.S.W. 2113. Tel: 888 3200



# EVERY HOBBYIST WANTS A WELL EQUIPPED WORKSHOP! MAKE ONE HAPPY WITH THESE SUPER VALUE TOOLS AND COMPONENT PACKS!

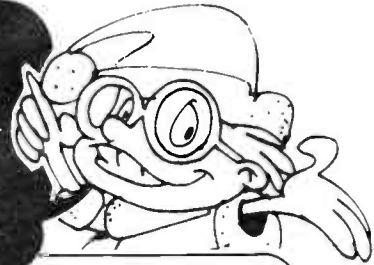

**BONUS!**

**Scope Cordless Soldering Gun!**

Now you can work anywhere! The scope rechargeable soldering iron lets you work in the field... anywhere without a power point! A huge 60 watt capacity it will get the heat where you want it in just six seconds. Now you can have portable power and **SAVE!** Get a **FREE Bonus Charger, spare Tips and Element with cordless iron!** Cat T-1600

Don't pay \$99 elsewhere

**NOW \$85**

**BONUS!**

**Soldering Iron!**

Buy one of our fantastic value 20 watt, 240 volt soldering irons and you'll get Bonus Solder and 4 piece Solder Aid Set **FREE!** You'll save \$5!! The ideal Xmas gift for any workshop! Cat T-1330

STOCK LIMITED

Valued at \$15.90

**\$10<sup>95</sup>**

**BONUS!**

**DSE Soldering Iron!**

VALUE \$16.95

No workshop should be without a quality DSE soldering iron! With every DSE 15 watt 240 volt soldering iron we're giving away a Bonus roll of Desolder Braid... and it's **FREE!** You'll save \$3 with our DSE Xmas Bonus Offer! Cat T-1310

LIMITED STOCK

**NOW \$13<sup>50</sup>**

**Quality 38 Piece Tool Set!**

Give a gift that means something! This quality 38 piece tool kit would be at home in any workshop. Comes with multitester, wire cutters/strippers, pliers, screwdrivers, tape, and assorted connectors. All in a sturdy plastic carry case! Cat T-4832

Over \$35 Value!!!

WORTH OVER \$35!

**\$29<sup>95</sup>**

**Die Set**

Wow! It's a six piece die set! Comes complete with instructions & hinged plastic carry case! Cat T-4905

WAS \$29.50

**NOW \$26<sup>50</sup>**

**Tap Set!**

If you've got a die set you'll need a tap set so you can do a professional job! Here's fantastic value! A five piece tap set with 2mm to 5mm taps and 4 jaw tap holder. You'll save over 25%! Cat T-4910

WAS \$13.50

**NOW \$9<sup>95</sup>**

**68 Piece Deluxe Repair Kit**

Ideal for auto electricians, technicians, handy-person, etc! You get wire cutter/strippers, long nose pliers, 12V circuit tester, screwdrivers, insulating tape, spare wire plus an assortment of the most used connectors. All in a sturdy plastic carry case! Cat T-4834

WORTH OVER \$25!

**\$14<sup>95</sup>**

**SUPER VALUE!**

**Hole Punch Set**

You'll save with this handy hole punch set! Ideal for chassis work. You get 12mm tapered reamer, Tommy bar and 5 punches from 16mm to 30mm. It'll handle steel up to 22 gauge and aluminum up to 16 gauge. You won't need any more! Cat T-4900

WAS \$29.95

**NOW \$27<sup>50</sup>**

**Cable Snippers**

Wow, the highest quality Boker 5056 cable snippers! They're a must for any workshop. A quality German made tool that will give you years of reliable service! It's like owning the Rolls Royce of wire snippers! Cat T-3202

WORTH OVER \$25!

**\$14<sup>95</sup>**

## COMPONENTS — BUY IN BULK & SAVE

**Resistor Pack**

Over 300 computer selected 1/4W types for this ridiculous Xmas Special low price! Ideal for any workshop — professional or hobbyist! You'll save on our regular price and get the lot for over 66% less than the individual price! Cat R-7010

WAS \$6.95

**NOW \$5<sup>00</sup>**

**Ceramic Capacitors**

Quality ceramic capacitors in a specially selected pack! Over 60 in all. Voltages from 50V to as high as 630V. Save a fortune on one-off prices and save again with our Xmas Special! Cat R-7050

WAS \$4.95

**NOW \$3<sup>95</sup>**

**Metal Film Resistors**

Save heaps! Over 300 precision 1% 1/4W E-12 metal film resistors for this all time low price. Now there's no excuse for not using metal film resistors in your projects! Cat R-7015

WAS \$13.95

**NOW \$12<sup>00</sup>**

**Signal Transistors**

100 of the most used transistors the hobbyist, technician etc can have! You get DS547, 548 and 549s NPNs, DS557 & 558s and BC 159 PNP — all in one extremely useful pack! Cat Z-3000

WAS \$11.95

**NOW \$10<sup>95</sup>**

**E-24 Metal Film 1% Resistors**

The savings are even bigger! Over 300 E-24 metal film 1% resistors for those who really need precision resistors. Covers over 60 values from 11ohm to 910k ohms: computer chosen for maximum usefulness! Cat R-7020

WAS \$17.95

**NOW \$15<sup>00</sup>**

**Signal Diodes**

100 quality diodes that can be used in anything from crystal sets to computers! With OA90, OA91/DSOA91, OA95, OA47 and 1N914 silicon diodes all in one pack! Put one in the junk box now and save!

WAS \$11.95

**NOW \$9<sup>95</sup>**

**Electrolytic Pack**

Enormous savings on Electrolytics! 55 top quality single ended electrolytics. There's bound to be the one you need! From 2.2uF to 470uF and voltages from 10 to 25! You won't forgive yourself if you miss it! Cat R-7030

WAS \$6.95

**NOW \$5<sup>95</sup>**

**Power Diode Pack**

Now, 57 diodes and SCR's for half of what you'd pay to buy them separately! And there's no useless rubbish values either. They're the most used values — so you'll always have just what you need. Cat Z-3010

WAS \$14.95

**NOW \$9<sup>95</sup>**

**Greencap Pack**

60 quality greencaps. And there's no weird, rubbish values in this pack. They're all popular greencaps and they're rated at 100 volts too! Values from .001uF to 0.22uF! Cat R-7040

WAS \$9.95

**NOW \$8<sup>95</sup>**

**Premium LED Pack**

100 premium quality 5mm LEDs to get your projects looking great! You get red, green, yellow and orange — enough for anything! That's \$33 worth for under \$20. You save \$4 off our regular price! Cat Z-3015

WAS \$23.95

**NOW \$19<sup>95</sup>**

**SPECIAL!**

**250 Mixed Capacitors**

Unbelievable value! No workshop should be without you. You get 250 mixed capacitors of varying value. Cat R-7110

WAS \$9.95

**NOW \$8<sup>95</sup>**

**Microswitch Pack.**

Throw one of these into the junk box — you can't go wrong. 10 quality microswitches in one pack! Cat J-1036

WAS \$7.50

**\$6<sup>00</sup>**

**Signal Mixed Transistors**

100 commonly used signal transistors in one pack. Incredibly handy to have around. Cat J-1037

WAS \$9.90

**\$8<sup>50</sup>**

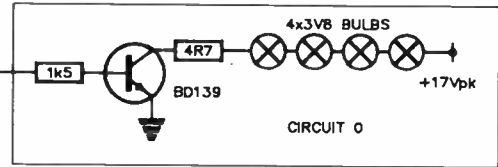
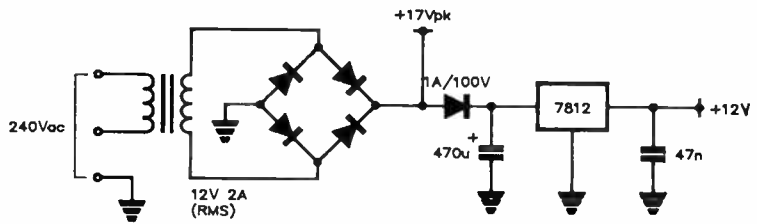
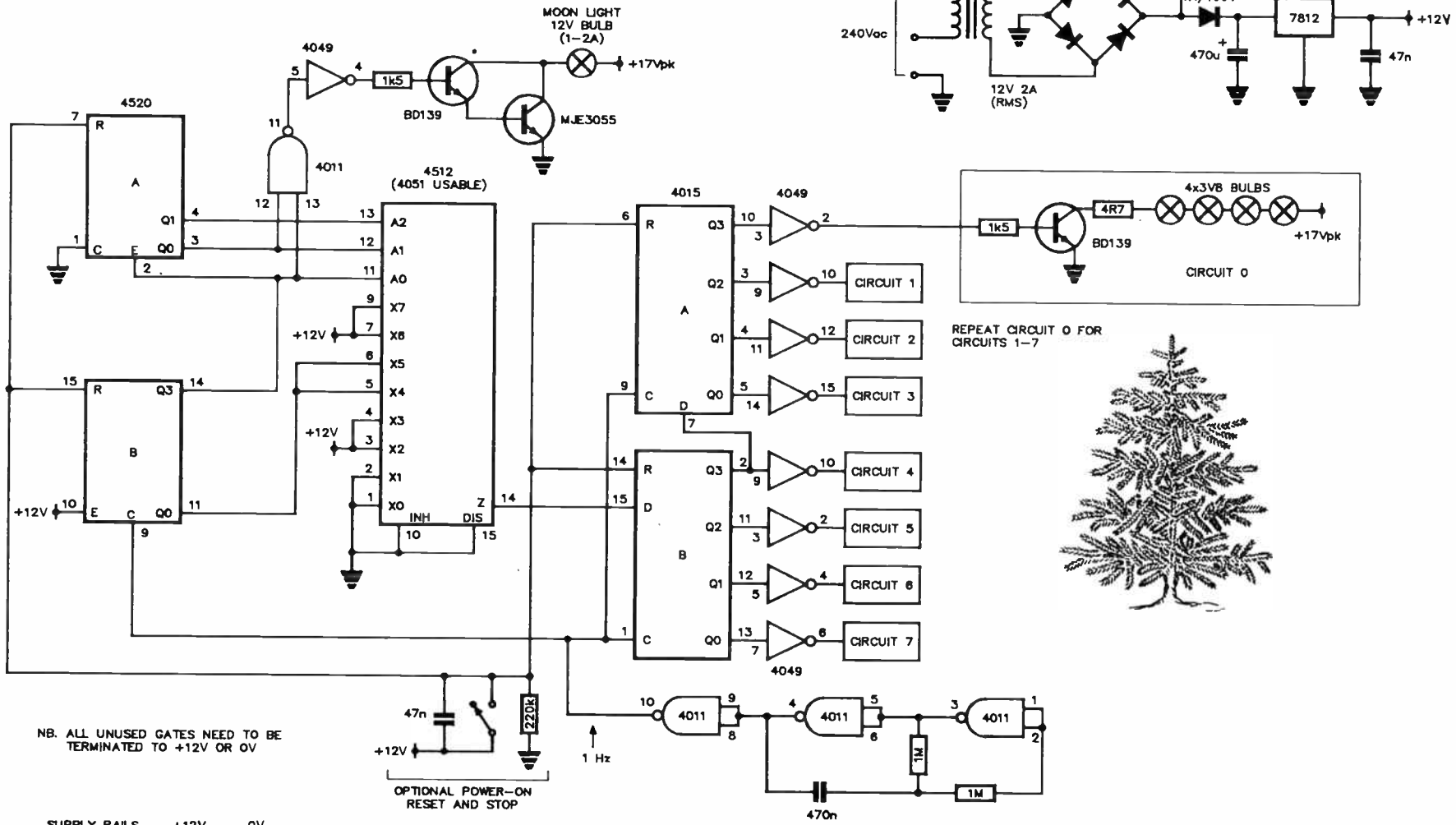

REPEAT CIRCUIT 0 FOR CIRCUITS 1-7



NB. ALL UNUSED GATES NEED TO BE TERMINATED TO +12V OR 0V

SUPPLY RAILS	+12V	0V
4015	PIN 16	PIN 8
4520	PIN 16	PIN 8
4011	PIN 14	PIN 7
4049	PIN 1	PIN 8
4512	PIN 16	PIN 8



# Christmas tree lights with a difference

The multicoloured lights that one can readily buy are of a simple steady on or flashing design. After watching such lights for a while, one can get bored. Another disadvantage is that, because they operate from mains, there is a small but certain risk of shock — especially with metallic decoration touching the lights. So I decided to sit down and cook up a Christmas tree lighting circuit with a difference. This was six years ago, and the circuit has been on the tree many times and been admired by many visitors and suffered no component failures.

The circuit uses simple CMOS components — shift register, data selector, counter and eight light circuits, to create a number of different lighting sequences. The sequences start with the lights turning on one circuit at a time at a one-second rate. They stay on for eight seconds then gradually turn off. Once off, a blue floodlight turns on for eight seconds, simulating a moonlight. Next, the lights start turning on gradually again, but in an alternating pattern. The light circuits stay flashing in alternation for eight seconds, then gradually turn off, after which the tree is moonlit once more. The sequences then repeat.

To achieve the above lighting sequences, a 4015 dual 4-bit shift register (IC1) was used. Its eight outputs control the eight light circuits with four series-connected bulbs in each. Because each light circuit requires about 250 mA of current, the register outputs are buffered by 4049 inverting buffers (IC4, 6) and BD139 transistors. A 4.7 ohm resistor in series with the collector of each BD139 protects the transistor against current surge when the cold bulbs are turned on. This also serves to prolong the life of the bulbs, in addition to the bulbs operating on reduced voltage.

The data that controls the on/off state of the lights is clocked from an eight channel data selector 4512 (IC5 pin 14) into the shift register by a nominal 1 Hz oscillator made from IC3, pins 3 and 4.

The same oscillator also clocks a 4520 counter (IC2) which controls the selection of data to be clocked from the data selector into the shift register. The following table lists the address lines A2, A1, A0 of the data selector and the effect of the selected data on the lights. The addresses 011 and 111 are used for the moonlight activation. Whenever A1, A0 are 11, NAND gate IC3 pin 11 goes low, which, after inversion by the buffer, IC6 pin 6, turns on the BD139 and MJE3055 transistors (in Darlington configuration) which activate the moonlight. Each address state is active for a nominal eight

seconds. Since there are eight address states, the light sequences repeat after a nominal 64 seconds.

## A2A1A0 EFFECT

0 0 0	X0 = 0 (of IC5) is shifted into register IC1. CCT 7 lights first, followed by CCT 6 to 0 at one second intervals. On power-on however, the registers and the counter will be reset, causing (in this instance) all circuits to be on at once.
0 0 1	X1 = 0 maintains all circuits on for eight seconds.
0 1 0	X2 = 1 is shifted into IC1. CCT 7 turns off, followed by CCT 6 to 0 at one second intervals.
0 1 1	X3 = 1 maintains all circuits off for eight seconds while moonlight is on.
1 0 0	X4 = 0101 . . . (produced by ½ Hz square wave from IC2 pin 11) is shifted into register. This causes CCT 7 to turn on. A second later, CCT 6 turns on but CCT 7 turns off. Another second later, CCT 5 turns on, CCT 6 off, CCT 7 on, etc.
1 0 1	X5 = 0101 . . . causes CCT 7, 5, 3, 1 to flash in alternation with CCT 6, 4, 2, 0 at a one-second rate.
1 1 0	X6 = 1 — this gradually turns off the alternating pattern, starting with CCT 7.
1 1 1	X7 = 1 — all circuits are off for eight seconds while moonlight is on.

An optional switch can be connected which, when on, will keep the counter and the register reset, which will turn all lights on.

The circuit can be squeezed onto a 95 x 76 mm Veroboard (although a bigger board would make construction easier). The majority of components listed are available from Jaycar Electronics. A 7812 regulator can be used instead of 78L12. Also 4 x 3A rectifiers can be used instead of a 2A bridge. Although the 4051 is functionally similar to the 4512, the pin connections for the two are different and the 4051 has not been tried out in the circuit.

Extra care is always necessary in wiring in the mains cable, ensuring that the exposed metal parts (such as the aluminium box) are connected to the green earth wire of the mains cable. The active and neutral connections of the mains cable to the transformer need to be insulated with sleeving or insulation tape for safety.

Probably the biggest problem that can be encountered in this project is obtaining the 3.8 V screw-type (MES) torch bulbs — they appear to be less readily available now than they were a few years ago. Two alternatives are available. One is to use 2.5 V screw bulbs with six per circuit, but this adds up to 48 bulbs total instead of 32 which may be excessive. The other alternative is to use four 2.5 V screw bulbs and add a 12 ohm 1W resistor in series with each 4.7 ohm resistor already at the BD139 collectors.

George Polkorn,  
Castle Hill, NSW



## PARTS LIST — XMAS LIGHTS

1 x 4520 dual binary counter	2 x 47n ceramic or polyester cap
1 x 4512 (or 4051) 8-channel multiplexer	1 x 470u/25 V electrolytic cap
1 x 4015 dual 4-bit shift register	1 x 12 V/2 A transformer
2 x 4049 hex inverting buffers	1 x 12 V 1.2 A globe
1 x 4011 quad 2-input NAND gate	32 x 3.8 V MES torch bulbs (see text)
1 x 78L12 3-terminal 12 V +ve regulator	32 x bulb holders
9 x BD139 (or similar)	1 x box, say 150 x 100 x 70 mm
1 x MJE3055 (or similar)	25 metres of hookup wire
1 x 2A bridge rectifier (or 4 x diodes)	2 metres of mains cable
1 x 1A/100 V diode	1 x 3-pin mains plug
9 x 1k5, ½ W 5% resistors	1 x grommet
1 x 220k ½ W 5% resistors	1 x 3-way mains terminal block
2 x 1M ½ W 5% resistors	1 x mains-rated toggle switch
8 x 4R7 ½ W 5% resistors	Veroboard, about 76 x 95 mm
1 x 470n ceramic or polyester cap	

**Benchbook** is a column for circuit designs and ideas, workshop hints and tips from technical sources of the staff or you — the reader. If you've found a certain circuit useful or devised an interesting circuit, most likely other readers would be interested in knowing about it. If you've got a new technique for cutting elliptical holes in zippy boxes or a different use of used solder, undoubtedly there's someone — or some hundreds — out there who could benefit from your knowledge.

We'll pay from \$10 to \$100 for each item published. Send your gems to **'Benchbook', Australian Electronics Monthly, PO Box 289, Wahroonga NSW 2076**. Please include your postal address for publication with your item(s).

As far as reasonably possible, material published in **Benchbook** has been checked for accuracy and feasibility etc, but has not necessarily been built and tested in our laboratory. We cannot provide constructional details or conduct correspondence or technical enquiries.

# letters

## Motional feedback

Dear Sir,

I read with interest the review article in the September issue of the Philips F9638 motional feedback (MFB) loudspeaker. The problems with handling high levels of signal, the detection of an apparent resonance at approx. 44Hz and difficulties in handling faster rates of sweep frequency excitation all point to problems in execution of the design. Also, a first crossover frequency near 900 Hz (assuming the choice of a bass driver with negligible flexure modes up to, say, 1000 Hz) would improve the benefits to be derived from systems of this type.

The original Philips MFB system was subjectively free of these problems but was relatively expensive for market expectations at that time. Subsequent attempts to produce a smaller, cheaper unit proved subjectively unsatisfactory, mainly due to an apparent design misapprehension that the MFB could overcome problems of excessive cabinet resonances. It did not, of course.

Not mentioned in the review article were the benefits possible from the use of MFB:

- 1) Substantial reduction of distortion due to nonlinear compliance of the suspension.
- 2) Substantial reduction of non-harmonic distortion caused by cohesive (internal) friction in suspension materials (particularly at low signal levels).
- 3) Suppression of resonances of the voice coil movement (bass resonance effects) due to diaphragm and voice coil inertia and compliance of suspension and sealed box volume.

These benefits are valid only as long as the drive amplifier is not overloaded, and also depend upon freedom of the diaphragm from break-up modes, since it is the motion of the voice-coil that is normally controlled.

If only the bass driver, to avoid complexity, is subject to motional feedback, it is desirable that the bass diaphragm should be significantly free of break-up at least to a frequency approaching 1000 Hz, so that the low frequency crossover should be close also to 1000 Hz.

Features (1) and (3) taken together mean, also, that low frequency response is insensitive to amplitude dependence. Also, useful response, provided overloading is avoided, can be extended below the bass resonant frequency, as is also done in some specialised bass woofer designs. Feature (2), provided a fair-

ly high low frequency cut-off is achieved, is more important than is often realized, since it extends the useful dynamic range of the loudspeaker system as compared with the same units driven passively.

Speakers, driven passively, sound much more effective when driven at high levels, and at normal to low levels appear to be much less "transparent" than feedback controlled equivalents. Feature (2) is of great significance if full benefits of wide dynamic range are to be achieved using CD digital systems. Also it is important for improved listening quality at comfortable levels for home listening.

From the description given of subjective effects of the F9638 loudspeaker system, it appears that it may be subject to relatively early onset of overloading. Also, the relatively low bass frequency crossover suggests that the bass driver may not be as effective as it could have been to extract the best qualities possible from such a system. The problems no doubt arise in part from attempts to control the cost factor. That it performs well when played soft and low suggests that the muddying affect of cohesive friction have been reasonably effective. The apparent detection of a bass resonance is disconcerting and is presumably caused by the early onset of overloading.

H.W. Holdaway  
Coogee, NSW

## 8-channel relay interface

Dear Sir,

Congratulations on an informative and interesting magazine. My letter is prompted, however, by concern over the design used in the 8-Channel Relay Interface for Computers in your October 1985 issue (project AEM4501).

The relay switching transistors are driven by the 74LS259 direct, being switched on in the high state of the outputs. According to the description given, the current flowing from these outputs is typically 7 mA. However, in common with most other 74LS devices, the output in the high state is only rated to deliver a maximum of 400 microamps. The 'top' transistor in the totem pole outputs of the 74 and 74LS devices is a much smaller transistor than the 'bottom' transistor, as its usual application is to drive other 74 and 74LS device inputs to the high state where they require very little current. These figures can be seen in any data sheet, including the one for the 74LS259 in your October issue.

From my experience, I believe the circuit will work initially in most cases, but will probably suffer from a high failure rate of the 74LS259.

I propose a simple solution which will avoid the need to modify the pc board or circuit arrangement. The BC547 transistors can be replaced with Motorola MPS-A12 Darlington transistors, and R3 to R10 replaced with 12k resistors. This will limit the output from the 74LS259 to well within its capabilities, while still providing sufficient drive to operate the relays.

R.N. Lehmann,  
Elizabeth East, S.A.

Many people misunderstand the ratings of TTL and other 'family' devices. The crux is that the ratings are designed so that a complete system of devices — gates, counters etc — can be interconnected and will work together (providing fan-out limits are not exceeded). The 400 uA 'output high' current quoted in the data sheet means that the minimum LSTTL high level voltage of 2.4 V is guaranteed, providing you don't take more than 400 uA from the output in question. It has nothing to do with any absolute maximum rating that would cause device failure if exceeded.

Your suggestion to substitute Darlington transistors for the BC547s and to increase the base resistors would marginally increase the maximum ambient temperature before failure, but I consider the original circuit to be entirely adequate in this regard.

When you use an LSTTL device to drive non-TTL loads you can draw much more than 400 uA, albeit at lower output voltages, as the typical output characteristics in the graph here shows. This is actually Figure 4, reproduced from page 3.3 of the Signetics TTL data book. The graph is actually for standard TTL, but note that LSTTL can source nearly twice the current shown.

The crunch to all this 'extra' current comes in the form of heat which must be dissipated to stop the chip from heating up to the point of failure. The manufacturers supply the information necessary to calculate the extra heating in the 'packages' section of the data books. The relevant figures are the thermal resistance from junction-to-ambient, which tells you how many degrees the junction will reach when dissipating one watt of power to the air through the case with no heatsink.

For the 74LS259's 16-pin plastic DIP package, we find a rating of 137° C/W for Signetics devices. (Motorola quotes 120° C/W for their 16-pin DIP). The maximum



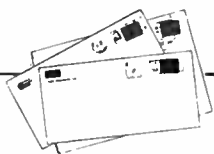

# ADMARKET

Readers' free adverts

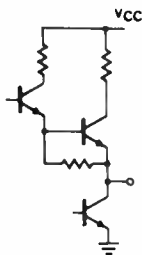

Totem pole output circuit of TTL devices

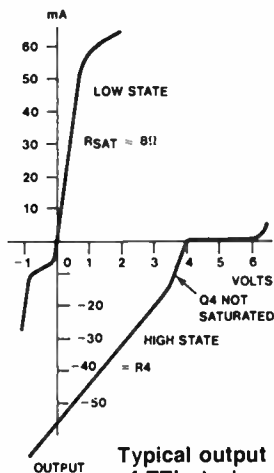

Typical output characteristics of TTL devices

supply current is 36 mA. If we multiply this by the  $V_{cc}$  rating of 5 V, we get the normal power dissipation of 180 mW. The normal junction temperature is therefore 180 mW times 137 C/W or 25°C above ambient.

The extra power due to the loading in the relay driver circuit is 7 mA times 2.8 V, or 20 mW. The worst case total for all eight outputs is 160 mW. Multiplying the power by the previously quoted thermal resistance results in a temperature of 22°C. This means that the maximum junction temperature is now 47°C over ambient because of the extra current being drawn. The point at which the collector-base junctions break down is around 150°C, so the maximum ambient temperature rating is just over 100°C for the circuit as published. The TTL data books quote 70°C as the maximum ambient for commercial grade devices, so the additional current should not cause problems.

If that sounds ominous in regard to reliability, then consider this — a few years ago I built a BIG digital clock which used 74LS374s to drive transistors, only the current being drawn from each of the outputs was 45 mA! The clock is still running perfectly and has never had a component failure, despite operating outdoors in all weathers.

Geoff Nicholls

## Rockwell MODEMS



Superior Performance at an affordable price CCITT

R1212-1200 BPS FDX R48 -4800 BPS HDX  
R2424-2000 BPS FDX R96 -9600 BPS HDX

Device Sets Avail. Quantity Orders.

**energy CONTROL**

73 Eric Street Goodna Qld 4300  
PO Box 6502 Goodna Qld 4300  
Phone (07) 288 2455 Telex AA43778 ENECON  
New Zealand Office  
Phone (4) 72 6462 Telex NZ30135 AUDITOR  
E.O.&I.

## HARD TO GET ITEMS are now EASY TO GET

● Components  
● Tools ● Kits  
● Books

For  
Hobbyist & Professionals

Ian J. Truscotts

# ELECTRONIC WORLD

30 Lacey St, Croydon. Vic.  
(03) 723 3860 — 723 3094

● MAIL ORDER WANT LISTS WELCOMED

### READERS-CLUBS-ASSOCIATIONS

WE'LL PUBLISH your advertisement of up to 32 words (maximum), totally free of charge.

Write or type out your copy on a clean sheet of paper. But please make it legible, otherwise it may not turn out as you intended! Copy must be with us six weeks prior to the month of issue.

Every effort will be made to publish your advertisement but no responsibility for so doing is accepted or implied.

### CONDITIONS

You must include your name and phone number and/or address within the 32 words (for amateurs, 'QTHR' is acceptable). Accepted abbreviations such as DSDD, 100 W RMS, ONO etc, may be used. Please include your name and full address plus phone number with a covering letter. Private advertisements only will be accepted. We have 'small ads' for traders, who should contact our advertising representatives.

**SELL: SERIES 5000** power amp, audiophile grade passive components, less 5 W resistors. \$20.00/channel, including post. P. Roberts, One Training Group, Sanananda Barracks, Wacol 4076 Qld. (07) 271 0281.

**SELL: TRS80 MODEL 1, LEVEL II.** 48K mem., monitor, cassette and manuals. Thirty tapes full of programs. Package deal \$320.00, free delivery. Phone Les. (02) 69 6622.

**SELL: CRADLE-TYPE RELAYS**, 48 V, 110 V, 2 C/O, 4 C/O contacts. Total of 64 relays. All brand new, Potter & Brumfield brand. V. Savaris. (07) 265 1259.

**SELL: BACK ISSUES ELECTRONICS MAGAZINES**, Australian and overseas, from 1957 (Amateur Radio Action, CQ, Electronics World, ETI, etc). Over 300 issues. \$1.00 each or the lot, \$150. David. A.H. (03) 707 3281.

**SELL: VZ300 COLOUR COMPUTER**, used once. All original accessories and packaging. \$80 ONO. **BEETHOVEN MICROBEE SOUND SYNTHESISER** in good condition, with software. \$80 ONO. Phone Douglas (02) 560 8348, afternoons.

**WANTED: ROCKWELL AIM65** with LED display, printer and full keyboard. Ring Sydney, (02) 502 1029 A.H., ask for Michael.

# The Last Laugh

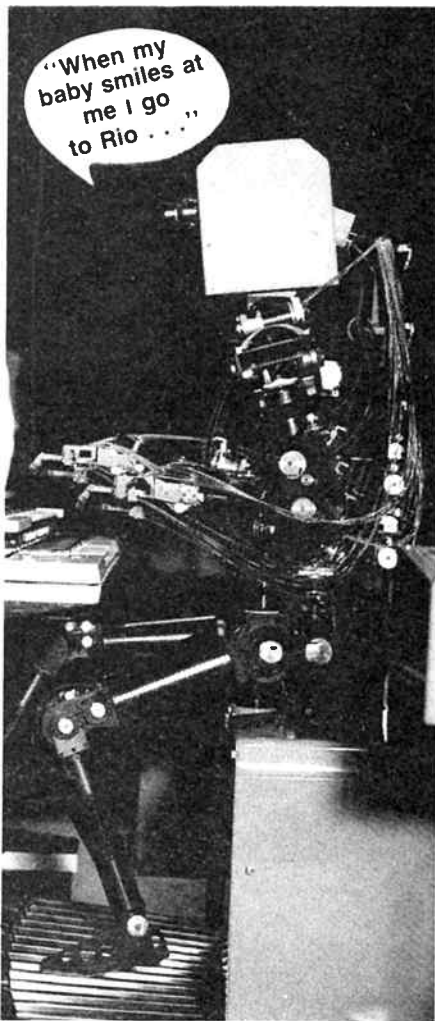

AN ACQUAINTANCE of ours works as a specialist consultant in the medical electronics field. He designs, has manufactured, commissions and services some very sophisticated patient monitoring systems and medical laboratory instrumentation. Lovely equipment it is, just bristling with knobs, dials, flashing LEDs, with probes and sensors for placement in, on over or around various bodily orifices or appendages as appropriate.

He says he gets that "warm inner glow" whenever his machines 'wake up' with a spectacular display of urgently winking lights, rolling LCD digits, discreet beeps and similar indications as a patient drifts out of a deep coma to semi-consciousness. I think, thank goodness the poor patient is too groggy to be aware of the machine's neurotic freneticism, else they'd want to slip back and leave the worries of the frantic world behind! But I digress.

Said acquaintance was launched on his career at about age 10 when he explored behind the family radiogram. A

wonderful thing of design and craftsmanship it was. The sort of thing you see in inner-city 'junque' shops these days. It had a wood-veneered cabinet (with an open back), stood as tall as he did, proudly boasted a Rola ("the finest loudspeaker in the world") 12" speaker and sported a large square, glass-fronted dial with a large wire pointer that moved behind the stations painted on the rear of the glass. Did I digress again?

Anyway, in the rear he pushed, prodded and poked until he gained some sort of response — a little hum as he touched the grid cap of the low level audio stage. Lifting the chassis, he prodded underneath. Aha! much more response — a healthy 'bite' from the hundred volts or so of high tension! ("Ooh, mummy — look at all the pretty coloured stars!")

Drawn by the commotion, his mother admonished him with "Richard! Don't you know yet not to push or poke things when you don't know what they do?!"

Undaunted, Richard went on to a career in electronics engineering. When the solid-state revolution swept through, Richard saw an opportunity in medical electronics, having spent some student vacations servicing X-ray machines. He found the field lucrative.

A short while ago, he acquired a long-lusted-after possession. A fire-engine red Porsche. Cherishing his acquisition, he designed, constructed and installed a 'smart' burglar alarm. Richard does not speak about its principle of operation as his patent attorney has the papers. Rumour has it that this alarm can 'smell' the owner and alarms itself even on 'unfamiliar' passengers. (No, it's not a Queensland blue heeler).

A short time after acquiring the Porsche, Richard acquired a new girlfriend. We'll omit a description to avoid embarrassment. Let your imagination have free reign. (Aahh, Norman Lindsay, why did you leave us in the lurch?)

One evening, Richard and friend went out for a late-ish dinner. However, when picking her up, he warned her that he'd have to make a few short calls before getting to the restaurant. Call number one was to his inner-city service centre and took 15 minutes. Friend cooled her heels in the car. Call number two, at a large-ish inner-city public hospital 15 minutes away, took about 20 minutes. Friend impatiently cooled her heels in the car. Call number three was to a small, quiet private hospital in a leafy peninsular suburb on the harbourside. Richard parked in the visitors' car space out front. All was quiet, only a discreet light at the entrance glowed gently in the darkness.

Searching for something to read, to while away the increasingly lengthening 'calls', friend opened the glove box. "Maybe I can read the street directory," she muttered between clenched teeth. Inside, there was no road map, but she spied a pushbutton. She pushed it . . . no response. She pushed it again . . . no response. Presently, a light on the dash began to flash on and off about twice a second. Quickly, she opened the glove box and frantically pushed the button again. Too late! Honk-Honk-Honk!, went the horn as all the car's lights flashed on and off in unison.

Charging outside, Richard found friend cringing in her seat in front of the open glove box. It all flashed back in his mind's eye, the day he explored behind the radiogram, as he tersely echoed his mother's words, "Don't you know yet not to push or poke things when you don't know what they do?!"

## Galah discovers Viatel

We just knew that story about Galah computing wouldn't go away!

The Chief Galah got on the blower the day the November issue came out. "Great stuff," he said, "but let me tell you about the latest product our R&D team's working on." (Loud editorial groans — press releases should be submitted on typed paper, not phone in. The editor's shorthand has RSI).

It seems the Chief Galah splurged on a Viatel terminal and paid a sub. to Telcom to see what it was all about. (Expensive curiosity, he has). Well, after exploring Microtex on page 666 (games, user bulletin boards, etc), booking his holiday in Surfer's and checking out the overdraft in his Commonwealth Bank joint account (maybe he's into real estate and buys a lot of joints? . . .), Chief Galah returned to his newspaper clippings file for press releases on Viatel. He says they're more informative than the real thing — and cheaper, too.

He found one that said, eventually, you'll be able to do the family's weekly shopping through Viatel. That's when he had his inspiratorial (combination of inspirational and conspiratorial) flash. Just what every home needs — an RS232 grocery interface capable, in the first instance, of digitising chicken slices and margarine tubs and reconstituting them at speeds of 1200 bauds! "I'll make a fortune!" he speculated.

"Just think," he enthused, spitting into the 'phone, "I'll make another fortune selling my next model when MacDonalds becomes a Viatel service provider — it'll transmit and reconstitute whole hamburgers!"



The economical & effective way to

# Learn Digital Electronics

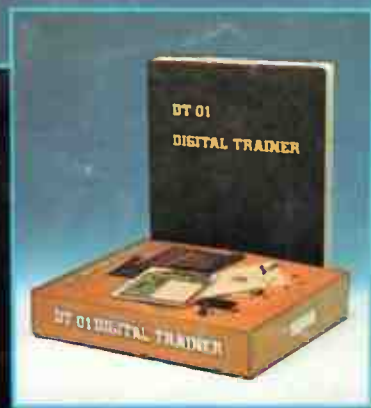

Book type carry case with waterproof color package



Handy, take it home for study



Convenience of AC/DC selection

Here's the IDEAL Christmas gift for the hobbyist or that budding electronic wizz in your family. The D.T. 01 offers the hobbyist hands-on experience in the design of digital circuits but without the need for an untidy bench full of instruments. Look to the Digital Trainer 01 — it will secure your child's future.



Drop-in to our showroom, We're open Saturday mornings too.



**EMONA INSTRUMENTS**

A division of Emona Enterprises Pty Ltd.

**Office & Showroom:**

1st Floor, 720 George St., Sydney NSW 2000

Ph: (02) 212 4599

(Above Mick Simmons Sports Store)



# Test us..

No matter what you're after in a multimeter, Parameters has it. Top value digitals and analogues, clamp meters and probe testers.

All digital meters feature  
 ● Easy to read LCD displays ●  
 Overrange and low battery indicators ●  
 Overload protected on all ranges ●  
 10A current ranges ●  
 Diode test ●  
 Complete with case and probes  
 ● 12 month no-nonsense warranty

**1. 7040 3½ digit DMM**  
 33 ranges  
 0.1% DCV accuracy  
 \$99.00

**2. 7080 3½ digit DMM**  
 37 ranges  
 0.1% DCV accuracy  
 Capacitance measurement  
 — HFE measurement  
 \$128.80

**3. 8040 4½ digit DMM**  
 31 ranges  
 0.05% DCV accuracy  
 HFE measurement  
 Audible continuity test  
 \$201.25

**4. CM100 Capacitance Meter**  
 3½ digit, 0.1% accuracy  
 8 ranges 0.1 pF-2000 µF  
 \$171.35

**5. 260 Clamp meter**  
 AC current to 1000A  
 AC 750V, DC 1000V  
 Resistance to 2MΩ  
 Diode test  
 \$194.35

**6. 2010BZ multimeter**  
 24 ranges, 20,000Ω/VDC  
 Continuity buzzer  
 \$39.68

**7. 5050E FET multimeter**  
 43 ranges including 0.1 µA  
 DC and 12A AC  
 Input imp. approx. 10MΩ  
 Polarity reversal switch  
 \$85.68

**8. 2447 Circuit tester**  
 A convenient probe-style  
 multimeter.  
 12 ranges + continuity test  
 DCV, ACV and resistance  
 \$108.10

## Parameters Pty Ltd.

SYDNEY: Centrecourt, 25 Paul Street Nth., North Ryde 2113. (02) 888 8777.  
 MELBOURNE: 1064 Centre Road, Oakleigh South 3167. (03) 575 0222  
 ADELAIDE: Trio Electrix (08) 212 6235. BRISBANE: L.E. Boughen & Co. (07) 369 1277.  
 HOBART: Imbros (002) 34 9899. NEWCASTLE: DGE Systems (049) 69 4242.  
 PERTH: W.J. Moncrieff (09) 325 5722. TOWNSVILLE: Nortek (077) 79 8600.  
 CAIRNS: Thompson Instrument Services (070) 51 2404.  
 WOLLONGONG: Macelec (042) 29 1455.



Due to currency fluctuation prices are subject to change without notice. All prices are recommended only and include sales tax. Tax free prices on request.