

New — Commodore Column!

NOVEMBER 1985 S2.60* NZ S3.50

The AUSTRALIAN ELECTRONICS Monthly



excitement electronics

David Tilbrook's

'DIGITAL ERA' PREAMP



Simple courtesy light extender to build for your car

The ins. & outs of RS232

- The new 8mm video tape technology
- A keyboard in the hamshack
- Build a real time clock for your Microbee
- For 'starters' — numbers big and small
- Star Project — a 30 watt PA.

Two great contests: WIN A PERSONAL COMPUTER! WIN A YAESU SCANNER!

Here At Last!

PLAYMASTER SERIES 200 HI-FI MOSFET AMPLIFIER KIT.



It's a Breakthrough!!

The new Playmaster Series 200 has broken through the Price/Performance barrier! For features, performance or price you won't find a better commercial amplifier anywhere! Even the fancy names with their big price tags don't have features like this!

Features like electronic input switching. Circuitry which handles just about any input: magnetic cartridge, CD player, hi-fi VCR, cassette, tuner, etc, etc. PLUS plenty of headroom with a massive 100 watts per channel output power.

And with its unique design — it's amazingly simple to construct! All potentiometers, input/output connectors, etc are mounted directly onto the PCB. And don't forget — when you buy a DSE kit you get everything you need! Things like; solder-masked PCBs, factory-wound power transformer, step by step construction manual and, if all else fails: our exclusive 'Sorry Dick, it doesn't work' repair service.

Why so long coming?

Our R&D staff have been refining this kit ever since publication: we ensure our kits are "bug free" before release, so you don't have problems during construction. Who needs problems — especially with an expensive kit such as this? All refinements to the original design have been checked out by Electronics Australia magazine.

All this PLUS . . .

Outstanding Specifications!

- 100W RMS/channel into 8 ohms
- Frequency response: 8Hz-20kHz (-0.3dB)
2.8Hz-65kHz (-1dB)
- Hum — 100dB below full output
- Unconditional stability into any load
- RIAA equalisation within 0.3dB
- Distortion <0.01% max (typical 0.003% 20Hz- 20kHz)
- Sensitivity: Phono 2mV (80dB s/n)
Line 300mV (90dB)
CD 2V (94dB)

Cat K-3516

As described in EA.

\$439

**DICK SMITH
ELECTRONICS**

PTY LTD

B058

The AUSTRALIAN ELECTRONICS Monthly

AUSTRALIA AND AUSTRALIANS through the '50s and '60s were accused of hiding behind a "cultural cringe", of denigrating anything or all that was — or aspired to be — fine in art, literature and music, of turning our backs on our essentially western European cultural heritage. All that seems to have changed since the mid-1970s (did the opening of the Sydney Opera House and the coming of FM stereo broadcasting have anything to do with that?).

It seems to me that we have a technological parallel in the 1980s — a sort of "technological cringe". A recent survey of Australian businessmen conducted by PA Technology, a subsidiary of the British Consulting Firm, PA Consulting Pty Ltd, found that compared to our Japanese counterparts, we emerged as complacent, insular and naive about technology and innovation. The survey pointed up that the view of Australian businessmen to expenditure on research and development was one of "tactical necessity" rather than a planned strategy for economic growth.

I am appalled!

In the table of technology-based exports per head of population drawn up by the Organisation for Economic Co-operation and Development (OECD), Australia ranks 19th out of the 23 listed countries, which is even behind New Zealand, and well behind those countries with a similar population and structure, like The Netherlands. And it's not for want of expertise, it's that we are hopeless at converting our 'intellectual resources' into products which generate dollars and cents. With just 0.3 per cent of the world's population, Australia produces some 2 per cent of the world's scientific papers. It seems others benefit at our expense.

Australian companies spend an average of just 2.7 per cent of revenue on private applied research, compared to the world average of 4.1 per cent. If we're not to slip further behind, that picture will have to be very nearly reversed. PA Technology Australia's general manager, Dr James Fox, while recognising that there was a lot investment going into the new 'high-tech' company launches, cautioned the directors of large and traditional companies that they must reorganise their competitive priorities and set aside 5 per cent of revenue for R & D. He's right, but conservative, I think.



Roger Harrison
Editor

COPYRIGHT: The contents of The Australian Electronics Monthly is fully protected by the Commonwealth Copyright Act (1968). Copyright extends to all written material, drawings, circuit diagrams, printed circuit boards, computer software and photographs. Although any form of reproduction is a breach of copyright, and we especially point out this extends to the construction of projects produced by our laboratory or our associates, we are not concerned about individuals constructing projects for their own private use, nor by bands for example, constructing one or more units for use in performances. Commercial organisations should note that no project or part project, including printed circuit boards produced by our laboratory or our associates and described in this magazine may be offered for sale, or sold, in fully or substantially assembled form, unless a licence has been specifically obtained to do so from the publishers, Kedhorn Holdings Pty Ltd, or from the copyright holders. We will take strenuous legal action against any person or firm found infringing our copyright as aforesaid.

LIABILITY: Whilst all efforts have been made to ensure that all constructional projects and circuits referred to in this issue will operate as indicated efficiently and correctly and that all necessary components to assemble the same will be available, no responsibility whatsoever is accepted in respect of the failure for any reason at all of the project or circuit to operate effectively or at all whether due to any fault in design or otherwise and no responsibility is accepted for the failure to obtain any components in respect of such project or circuit. In addition, no responsibility is accepted in respect of any injury or damage caused by any fault in the design of any such project or circuit aforesaid. The publisher accepts no responsibility for unsolicited manuscripts, illustrations, computer software or photographic material although all care will be exercised. Comments and test results on equipment reviewed refer to the particular item submitted for review and may not necessarily pertain to other units of the same make or model number.



Roger Harrison VK2ZTB
EDITOR



David Tilbrook B.Sc.
PROJECT ENGINEER
ADVERTISING/MARKETING
John Whalen

PUBLISHER
Adrian Farrow

DRAUGHTING
David Currie

PRODUCTION
Marni Raprager
Lisa Rathgen
Philipp Herrera
Angela Wilcox

ACOUSTICAL CONSULTANTS
Robert Fitzell Acoustics Pty Ltd. AAC

EDITORIAL ASSOCIATES
Neil Duncan VK3AVK
B. App. Sci., Dip. Ed., M. Ed. Studs
Alan Ford FIAADP MBIM VK2DRR/G3UIV
Tom Moffat VK7TM
Jonathan Scott VK2YBN
B. Sc./B. E. (Hons)
Bill Thomas B.A.
Kerry Upjohn M.A.

TYPESETTING
Autotype Photosetters Pty Ltd
397 Riley St. Surry Hills 211 5076
Published by: Kedhorn Holdings Pty Ltd, an associated company of Westwick-Farrow Pty Ltd, WB Building, Cnr Fox Valley Rd & Kiole St, (PO Box 289) Wahroonga 2076 NSW.
Ph: (02) 487 2700. Tlx: AA71460 Sydney Whats New. International AA10101 Whats New.

Subscriptions: \$31.20 Australia, NZ\$45 New Zealand; overseas rates on application.

Australian Electronics Monthly is printed in 1985 by Offset Alpine, Cnr Wetherill & Derby Sts, Silverwater, NSW, and distributed by Network Distributing Co. *Cover price \$2.60 (maximum and recommended Australian retail price only, recommended New Zealand retail price, \$3.50). Registered by Australia Post, Publication No. NBP 7435 ISSN No. 0815-5046.

ENQUIRIES
Advertising: John Whalen (02) 487 2700.
Editorial: Roger Harrison (02) 487 2700.
Technical: David Tilbrook (02) 487 1483 only after 4.30 pm EAST.

Vic. Ad. Sales: Saddleton Cox & Assocs, 13 Stewart St, Mount Waverley 3150; (03) 233 7933.
Pam Stewart or Leon Trimmings
Melb Correspondent: Ian Boehm c/- Saddleton Cox, (03) 233 7933.
Qld Ad. Sales
PO Box 247, Kenmore Qld 4069, (07) 202 6813.
Sue Horne or Rosemary Lergessner
W.A. Ad. Sales: Hugh Scott, 20/415 Charles St, North Perth WA 6006, (09) 444 8587
COPYRIGHT © 1985, KEDHORN HOLDINGS P/L

CONTENTS →

ADVERTISERS INDEX

COVERS

Dick Smith Electronics IFC
 Philips IBC
 Emona OBC

INSIDE

Applied Technology 14-15, 99
 Avtek 85
 Audiocraft 109
 All Electronic Components 33
 Altronics 54
 Dick Smith Electronics 24-25,
 83, 100
 Electronic Facilities 66
 Elmeasco 63, 65, 75
 Emona 6
 Energy Control 75
 GFS Electronic Imports 65
 Geoff Wood Electronics 91
 Hypec Electronics 76-77
 Hi-Com Programs 109
 Jaycar 30-31, 70-71
 JRT Software 93
 Koloona 103
 Parameters 28
 Promark 67, 75
 Queensland Stereo Visual 109
 Scope 16
 Sheridan Electronics 29
 Scan Audio 20
 Wireless Institute of Aust 65
 Zap Electronics 109

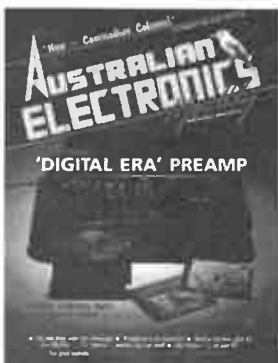

COVER

Tilbrook's 'ultra-fidelity' preamp, designed for the digital era. CD player by Nakamichi (the OMS7), courtesy of Convoy International. Photo by Mark Rowland.

PROJECTS TO BUILD

AEM8500 Vehicle Courtesy Light Extender 35

No more fumbling in the dark when you get in or out of your vehicle at night. This simple project keeps the interior lights on for a short period.

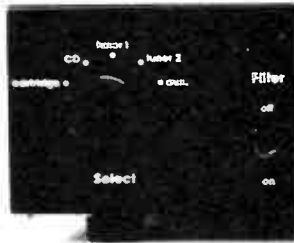

AEM6010 Ultra-fidelity Preamp 38

Completion of the preamp construction and chassis assembly.

AEM4502 Real Time Clock for the Microbee 55

Here's a simple add-on that plugs into the parallel port when you need it, but 'remembers' the date and time while unplugged.



STAR PROJECT 30 Watt Public Address Amplifier 48

This rugged design is simple to build, low in cost and has proved a reliable performer.

CIRCUITS & TECHNICAL



AEM Product Review — digital LC meter 62

A look at the Emtek DLC-400 handheld digital inductance-capacitance meter.

AEM Data Sheet 94

The 58174 real time clock chip — heart of the AEM4502 Microbee RTC this month.

FOR 'STARTERS' Numbers Big & Small 111

Scientific number notation explained.

Benchbook 112

Our monthly collection of hints, tips and circuits for the hobbyist.

PRACTICAL COMPUTING

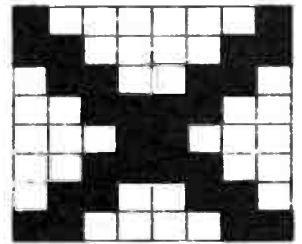

NEW! Commodore Codex 94

Neil Duncan kicks off our column for Commodore computer owners with a discourse on VIC-20 graphics.

BeeBuzz 98

A look at something different.

SEE HERE! SEE, HEAR!

Messrs Harrison and Tilbrook will be appearing in Jaycar's York Street Store, Sydney, on the morning of the third Saturday in November (the 16th), from 10.30 am to noon. You'll be able to hear for yourselves the AEM6102 two-way bass reflex speakers, and possibly the new 'ultra-fidelity' preamp. You're free to quiz the lads on any subject electronic that takes your interest, or discuss the latest in projects, etc. Don't miss it!

COMMUNICATIONS SCENE

A Keyboard in the Hamshack
.....68

Neil Duncan VK3AVK goes into the trials, tribulations and rewards of getting a computer on-air.

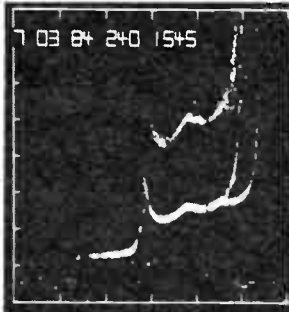

Radio Communicators
Guide to the Ionosphere, Part 3
.....73

Introduction to the ionosphere.



CONTEST
Win a Yaesu Scanner
from Dick Smith!
.....78

Here's your chance to own a top-line scanner, courtesy of Dick Smith Electronics.

FEATURE

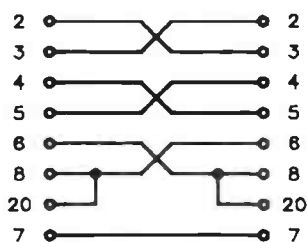

FULL HANDSHAKE

CONSUMER ELECTRONICS

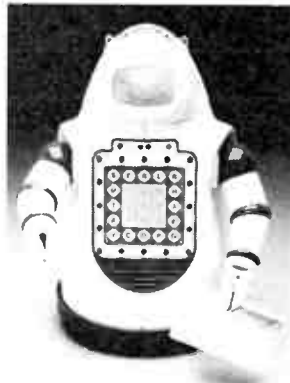

CONTEST!
Win A Robot!
.....21

Enter this great contest and you could win a great little robot that walks and talks!



V8 — The new 8 mm
Video Tape Technology
.....22

This new tape standard looks set to revolutionise both the video and audio scenes.

The Ins & Outs of
RS232
.....87

Clear up the confusion and get those devices talking to one another!

NEWS & GENERAL

Courses & Careers in
Electronics and
Computing, Part 2
.....8

Guide to employment prospects and tertiary courses.

News Review
.....7
Tax dropped on satellite receivers.

Consumer Electronics
.....19
Compact disc club to reduce hassles?

Retail Roundup
.....33
Kit & component buyers' guide.

Bytewise
.....82
IBM launch JX.

Spectrum
.....64
New RF power capacitors.

New Product News
.....101
HP technical workstations.

Admarket
.....28

Subscriptions
.....34

Last month's
X-word answers
.....102

Letters
.....113

The Last Laugh
.....114

OFFERS
Kikusui CROs
.....13

6-Pen, A3 Plotter
.....92

Pocket DMM FOR \$49.50
.....32

Solar Charger/Supply
.....32

NEXT MONTH!

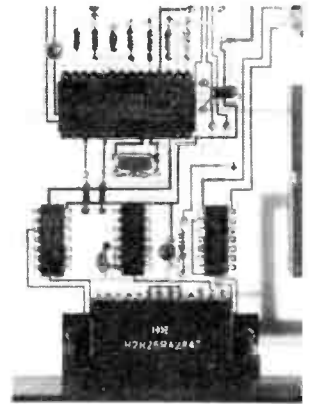

DUAL-SPEED MODEM
Our feature project next month is a 1200/75:300/300 baud modem that you should be able to build for less than \$140. No hard to get special parts are used. Look out Viatel, here come the hackers!

THE NEW VIDEO TECHNOLOGY
Malcolm Goldfinch looks further into the new 8 mm tape technology and reports on talks he had with some of the Japanese 'movers and shakers' on a recent foray to Japan.

SET FORTH
Here's a plain language introduction to this interesting control language now becoming widely available for popular computers.

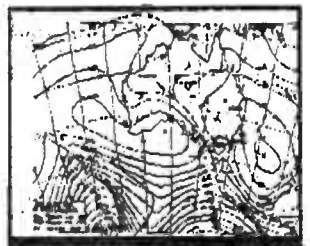

LISTENING POST FOLLOW-UP
You asked for it! Next month we'll have a follow-up on our popular first issue feature project — including software for the Commodore 64.

While these articles are currently being prepared for publication, unforeseen circumstances may affect the final contents of the issue.

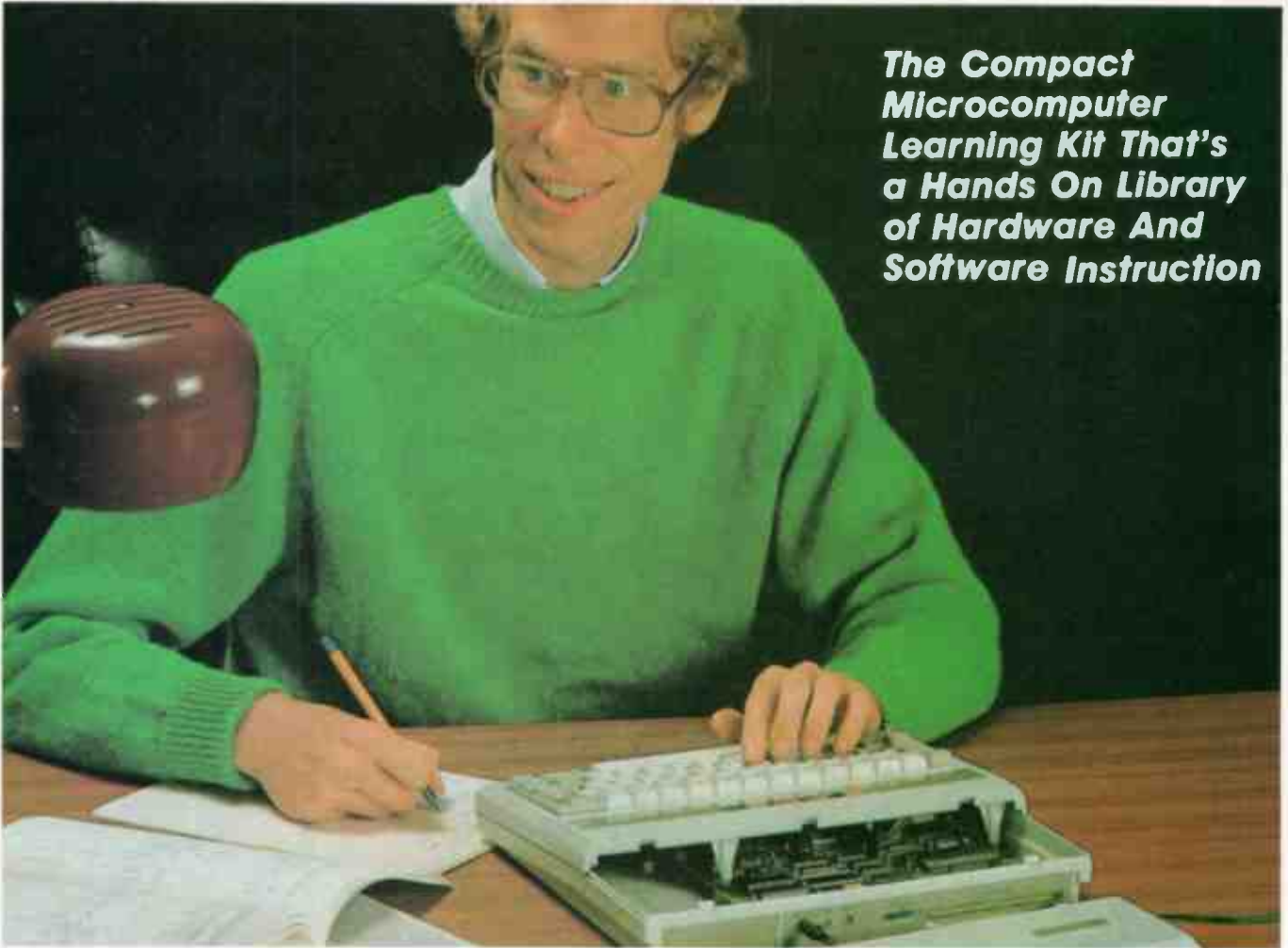

**The Compact
Microcomputer
Learning Kit That's
a Hands On Library
of Hardware And
Software Instruction**

MEET THE MICROPROFESSOR I/88

Learn the 8088

The MicroProfessor I/88 has everything you need to understand the fundamentals of the 8088 microprocessor.

Improve Your Computer Skills

Your computer skills will increase dramatically as the MicroProfessor translates important concepts into practical experience. Learn programming, assembly language, and also how to burn in your own chips. And with a wealth of accessories, including a printer, EPROM programming board and Forth Language option, there's no limit to the applications you can develop.

A Portable Learning Environment

Learning shouldn't be limited to the classroom. That's why we made the MicroProfessor lighter and less bulky than the average textbook. Supported by easy to understand manuals, the MicroProfessor leads you through

dozens of experiments. You can even open the MicroProfessor's case to look at the system board's components as you learn their functions.

An Affordable Computer Education

Today, tight budgets are a fact of life. At less than half the price of comparable learning kits, the MicroProfessor is a very attractive educational resource.



Multitech INDUSTRIAL CORP.



EMONA COMPUTERS PTY LTD

A division of Emona Enterprises Pty Ltd

1st Floor 720 George Street
Sydney, 2000. Phone: (02) 212 4599

Tax dropped on AUSSAT receivers

In a move to boost sales and penetration of AUSSAT receivers, the government has decided to waive sales tax on equipment for domestic use bought to receive satellite radio and television services broadcast via AUSSAT.

Mr Michael Duffy, the Minister for Communications, said the government had taken this step in a deliberate move to keep costs down. Cost of domestic receivers is expected to drop at least \$500.

Costs of earth stations, as already indicated by distributors, range upward from \$2250 (excluding sales tax) for a 1.5 metre diameter dish setup. Exact price would be subject to usual market place negotiations between seller and buyer, according to the Minister's press release.

Mr Duffy said the sales tax decision would also be welcomed by the earth station industry because undoubtedly it would boost sales.

"The decision is a good example of the government's goodwill towards country people who have long been deprived of radio and television services taken for granted by city dwellers," he said.

Mr Duffy said agreement with the Treasurer, Mr Paul Keating, on the sales tax issue followed discussions with the Commissioner for Taxation and representations received from outback residents.

The tax-free earth stations are based on the department of communications earth station specification (DOC 512). The exemption did not apply to earth stations designed to receive signals from satellites other than AUSSAT, such

as Intelsat.

Earth station receivers comprising a dish antenna and outdoor electronics unit were previously taxed at the 20% rate, with an indoor electronics unit previously taxed at the 32.5% rate.

Plessey Australia Pty Ltd has published a list of independent distributors who will be supplying dealers with earth station packages from November, 1985. They are:

Acesat Satellite receiver Corp Pty Ltd 856 Princes Highway Sutherland 2232 NSW. (02) 521 5994

Videosat Pty Ltd 83 Alexandria Parade Wahroonga 2076 NSW. (02) 48 5474

Videoscan Pty Ltd Suite 31, 280 Pitt Street Sydney 2000 NSW. (02) 267 5530

AWA-Thorn Consumer Products Pty Ltd 348 Victoria Road Rydalmere 2116 NSW, (02) 638 9022

Communications Technology Corp Pty Ltd 4 Charles Street Stuart Park 5790 N.T. (089) 818 150

point of view and general applications techniques are discussed at length.

The book might be suitable both as a textbook for students engaged in university and T.A.F.E. courses and as an aid to sound design for practising engineers.

The contents cover:

- Power semiconductor devices
- Naturally commutating converters
- ac Regulators
- dc Switching regulators
- Static power inverters



● Application techniques

The book is available only from Westinghouse Systems Pty Ltd, PO Box 267, Williamstown, 3016 Vic.

Need it? Can't buy it? Then rent it!

For those on a limited budget or for the project leader with a short term instrumentation requirement, an alternative to purchasing expensive test gear is to rent it. Tech Rentals Pty Ltd of 12 Maroondah Highway, Ringwood Vic. (03) 879 2266, is the largest firm in Australia offering this service.

They have just released a new rental catalogue, their largest yet, which contains an improved range of test, measurement, and computer equipment. In addition, the catalogue includes for the first time a sale listing of ex-rental equipment.

On a topical note, Tech Rentals tell us that they are a major sponsor of the Perry Corp. yachting syndicate Taskforce 1987 Limited (see p.7 August AEM) who are mounting a challenge to defend the America's Cup. Tech Rentals has provided a range of computer

equipment to assist analysis of the trials for the syndicate's 12 metre yacht Kookaburra.

Shop at Dick Smiths through Viatel

The age of hi-tech is, perhaps, creeping up faster than we realise. Dick Smith Electronics, joining in the spirit of advancing technology, has contracted 250 pages on Viatel.

The on-line service, through "Cable Shop", means that people can call up the DSE catalogue on their home computer or Videotext terminal and make purchases through their credit card.

At present, DSE has 20 pages and it is envisaged that all 250 pages contracted will be filled in a short time.

Viatel is an inexpensive information and trading service available through Telecom's 'phone lines. You hook your computer to the service and immediately have access to thousands of 'pages' of information.

When the entire 250 pages are filled it will not only present DSE's catalogue but also specials, data and enthusiast's information. And there's no charge to call up these pages.

Power in print

A useful book titled "An Introduction to Power Electronics" by B.M. Bird and K.G. King has just been published by John Wiley & Sons. This book covers the broad range of semiconductor power converters, from simple rectifiers to inverters and dc switching regulators. "It uses a theoretically sound and logical treatment which is at the same time essentially practical," we are told.

Power semiconductor devices are considered from a user's

Courses and careers in electronics and computing

Part Two Kerry Upjohn

Last month's article discussed career options in the electronics and computing industries. Information was provided on the types of courses available through the various T.A.F.E. colleges, and the employment levels in the electronics industry were discussed with particular emphasis on the electronics and computing courses for people wishing to work in the trades areas. The second or "middle level" of employment was also introduced with information supplied on courses suitable for prospective technical officers, engineering assistants and draftspeople.

THIS SECOND ARTICLE will consider some of the middle level courses offered by the Institutes of Technology and also briefly mention a sample of the degree courses offered by the institutes, C.A.E.s and universities. These articles are not an extensive guide to the student but rather give a taste of the various options open to him/her.

PROFESSIONAL ENGINEERS

The third level of employment in the electronics industry is the professional engineer. An electronic engineer has obtained an engineering degree from an Institute of Technology, C.A.E. or university. The engineer usually specialises in a particular field, for example electronics, power control, computer systems or electrical engineering. Competition for places within these professional courses is very high as the student intake into these institutions is restricted by various quotas. Admission requirements are the HSC or its equivalent with good passes in English, maths, physics and sometimes chemistry. Students are recommended to attempt comprehensive studies in maths whilst at school, such as applied or pure maths rather than the less specialised general course.

Electronic engineers are involved in the planning, designing, development and supervision of the installation and maintenance of a large variety of electronic equipment. Their work may involve specialisation in various fields such as computer systems, industrial equipment, power control, digital or analogue instrumentation, communication and microwave systems etc. Engineers are often responsible for establishing standards of performance and safety in these fields. Usually, the engineer supervises and co-ordinates the work of other engineers, technical officers, tradespeople and various other workers. It is essential that the engineer possesses good communication skills, knowledge of the scientific principles in the field, coupled with practical expertise.

The basic electronics engineering degree course is usually four years full time or the part time equivalent. For the first two years the student studies advanced maths and physics and a range of subjects providing basic instruction in the

theoretical and practical principles of electronics. Years three and four provide more specialisation and the student chooses from a number of elective subjects such as power control, digital and analogue electronics, computer systems etc.

Degree courses provide training in the theoretical aspects of electronics and enable the student to practice developing new designs and solving problems according to scientific principles. They do not have a large emphasis on technical training as it is assumed that students will have gained this by designing and building their own projects rather than learning these techniques through the course. As a general rule, C.A.E.s and ITs have a heavier industrial/technical slant than the universities.

Electrical engineering is the study of electricity, its methods of production and the various ways it can be used for industrial and domestic purposes. Electrical engineers also have a number of career options, from the design and operation of power plants to the development of electrical equipment such as transformers, power controls and various testing devices. Again, the degree is offered over four years full time study. Sometimes institutions only offer a degree in electrical engineering and offer electives in such areas as electronics, industrial control systems etc. The majority of electrical engineers are employed by government utilities and their employment opportunities are usually in the capital cities in each state.

PROFESSIONAL POSITIONS IN COMPUTING

As a result of the rapid expansion of the computing industry over the last decade, there are many career opportunities available to graduates in this field. To pursue a career in computing it is now essential to have a degree from an IT, C.A.E. or university either in computing science or electronics/electrical engineering specialising in computer systems. Various professional qualifications are recognised by the Australian Computer Society and these include the previously mentioned degrees as well as qualifications in data processing and computer programming offered by Business and Economics faculties which are outside the scope of this



article.

Computer specialists are divided into several categories and these include programmers, systems analysts, computer scientists and customer engineers. At present there is a great need for professionals in these fields due to the inroads made by the computer in business, industry, engineering and science. According to The Institution of Engineers, Australia, there is a great shortage of engineers who are qualified to specialise in computer systems and hardware, as much of the present interest in computers is in the software area.

Computer programmer

The computer programmer has the special skills required to write a programme of instructions to be carried out by the computer. These programmes are written in special languages such as BASIC, Fortran, Cobol etc. They determine how the computer will process the information and control the operation of the machine. Programmers usually have tertiary qualifications in computing, although sometimes companies run in-service courses for their own employees.

Programmers usually specialise in one or two computing languages and in a specific type of application such as scientific, engineering or commercial fields. Programming courses are available at Nepean (Westmead and Kingswood), Northern Rivers (Lismore), Riverina (Wagga Wagga), Mitchell (Bathurst) and Canberra C.A.E.s where a three-year degree course or two-year diploma in computer programming is available.

Systems analyst

Systems analysts as their name suggest, specialise in designing computer systems for companies and businesses who wish to use computers. They suggest ways of processing the information required and give advice on the hardware and software necessary to perform the specific task. Often they design and write their own programmes. They require a wider knowledge of computers than programmers, coupled with a knowledge of the requirements of scientific and industrial applications in computing.

Computer scientists

The computer scientist does research and design work in computers and operating systems. They should be able to design new computer hardware, define new languages and create computer systems. These people have either a degree in electronic/electrical engineering with specialisation in computers and microprocessors or a degree in computer science. Subjects studied in both cases could include computer architecture, artificial intelligence, computer systems etc.

Customer engineer

The customer engineer's job is to ensure that the computers under her supervision are functioning smoothly and to anticipate and prevent problems from occurring. When the computers malfunction and problems occur, as they invariably do, the customer engineer attempts to solve them by giving ▶

ing the machine a series of foolproof instructions. Unlike the programmers and systems analysts, the customer engineer specialises in both hardware and software systems.

INSTITUTES OF TECHNOLOGY

The Institutes of Technology offer training for the middle level positions of technical officer through their diplomas and also cater for the professional engineer in their degree courses. Courses vary slightly according to each Institute but the admission requirements are basically similar. For degree courses they require HSC levels of English, maths, physics and sometimes chemistry. Students are encouraged to obtain a good grounding in maths and the courses of applied and pure maths are preferable to general mathematics.

Entry to the Institutes is through the Admissions boards and committees in the various capital cities. Applications are usually required during the first week in October but there is provision for late entries until mid-December. This article offers a brief summary of some of the courses offered. If you need more detailed information on the range of subjects etc, consult the handbooks available from the individual Institutes.

NSW Institute of Technology

The NSWIT offers a Bachelor of Electrical Engineering degree which is taken either part time over six years or as a "sandwich" pattern where the student alternates between full time work and study at the institute. There is considerable emphasis on technical training and successful completion of the degree requires 144 weeks of industrial experience. This training is organised by the Institute on either a traineeship, sponsorship or freelance basis. NSWIT also has a transfer agreement with Riverina and Nepean C.A.E.s where it is possible for the student to take the first stage of the degree at these colleges and then transfer to the Institute to complete it.

The electrical engineering degree allows the student to specialise in the branches of power control or communications with electronics and computing as options. This degree is recognised by The Institution of Engineers, Australia, and it is hoped to introduce a degree in computer engineering in the near future.

People hoping to specialise in computing have two other options in the Bachelor of Applied Science (Computing) and Bachelor of Applied Science (Maths). The first degree does not have a mathematical emphasis, although it is recommended that students take at least two-unit maths. Subjects offered include programming principles, information and computer systems and systems analysis. All aspects of computing are offered short of the actual design and construction of hardware systems. The degree is offered on a full time and part time basis and entry to the course is very competitive. Last year the minimum aggregate mark in the HSC was 365.

Further Information: The Universities & Colleges Admission Centre, Box 7049, G.P.O. Sydney 2001; (02) 232 1699 or NSWIT, PO Box 123, Broadway 2007 N.S.W.

Caulfield Institute of Technology

Caulfield IT offers a Bachelor of Electrical Engineering over four years, with three years of core subjects followed by a year specialising in electives. It has the unique arrangement whereby the student wishing to move into management or administration may do an engineering/business stream. A Bachelor of Business degree may be obtained with an extra year's study after completing the B.Eng.

There is also a three year diploma course specialising in power and communications engineering. This para-professional course is integrated with the degree course and students obtaining their diploma can continue to study for their degree if they wish.



Entry requirements for the degree and diploma courses are similar, as HSC standard is required with good passes in English, maths, physics and chemistry. A Tertiary Orientation Programme is available for people without year 12 qualifications.

Further Information: Victorian Universities Admissions Committee, 40 Park Street, Sth Melbourne, Victoria 3205; (03) 690 7977.

Swinburne Institute of Technology

Swinburne IT offers several degrees in computing as well as the Bachelor of Electrical/Electronics Engineering. The Electronics degree is four and a half years full time and is offered on a part time basis over a minimum of seven years. Swinburne emphasises a co-operative academic and work environment as students undertake twelve months paid industrial experience concurrently with their degree. The electronics course allows specialisation in control systems, electronics and computers and is recognised by The Institution of Engineers, Australia. The Certificate of Technology in Electronics and Electrical Engineering is a three year full time or four year part time course designed to train technical officers, engineering assistants and draftspeople.

Several computer courses are offered at Swinburne through the Department of Applied Science. Students major in either computer science and instrumental science or in maths and computer science. Both degrees take three and a half years to complete and are suitable for people wishing to become computer scientists, programmers and systems analysts. Computer operations and the principles of computing are studied and two semesters of work experience are required.

The Bachelor of Applied Science with major studies in instrumental science is electronics orientated and is offered over four years with twelve months spent in paid employment as part of the course. It covers the principles of measurement and instrumentation and allows the student to specialise in analogue systems and digital electronics. This

degree can be taken with a co-major in computer science. Swinburne also offers a Bachelor of Business (Data Processing) which offers subjects in computer systems, commercial programming and information systems.

Further Information: Swinburne IT, John Street, Hawthorn 3122 Vic; (03) 819 8911 or the Victorian Universities Admissions Committee.

Royal Melbourne Institute of Technology

The School of Applied Electronics and Telecommunications at RMIT offers several courses suitable for people wishing to become technical officers. Courses include the Electronics Technician (Digital) course and the Computer Field Service course. A combination of these courses qualifies students to work in the installation, maintenance and programming of microcomputers. The Electronics Technician Course is offered with specialisation in the fields of communications, digital electronics, television receivers and TV transmission.

The Electronics Mechanics Course is a trades course designed for apprentices and non-apprentices alike, and is taken over two or three years. Several elective subjects are offered in communications, radio, broadcasting, computers, industrial and digital electronics.

RMIT also offers a wide range of degree courses in electronics and computing similar to those offered at Swinburne IT.

Further Information: School of Applied Electronics and Telecommunications, RMIT, PO Box 360, Carlton South 3053 Vic; (03) 663 5611.

Footscray Institute of Technology

The Department of Electrical and Electronic Engineering at Footscray IT offers a B.Eng. degree with specialisation in communications, power and electronic control and digital and computer systems. For the first and second years, the student studies basic electronic and electrical principles, applied sciences, written communications and an introduction to computers and circuits. The third and fourth years enable students to take electives in their chosen fields. This degree is recognised by The Institution of Engineers, Australia, and The Institution of Radio and Electronics Engineers, Australia (I.R.E.E.).

Footscray IT also offers an Associate Diploma in Digital Electronics and Computing for technical officers wishing to pursue these fields. These courses are two years full time and four years part time. A graduate diploma in communication systems is also available to professionally qualified engineers who have been working in the industry for two years.

Specialist computing courses are also offered. The Bachelor of Applied Science (Maths and Computing) is a three year full time or six years part time course. It offers major studies in computer science and graduates qualify for Associate membership of the Australian Computer Society after completing their first professional year. Subjects include; an introduction to computer fundamentals, high level data processing, systems design and software engineering. A diploma in Commercial Data Processing is also available through the Faculty of Business.

Further Information: Footscray IT, PO Box 64, Footscray 3011 Vic; (03) 688 4200.

Queensland Institute of Technology

Offers both degree courses and several middle level courses in computing and engineering. The Bachelor of Engineering (Electrical) is a four year full time course offering specialisation in two streams. The first is power and control and the second electronics and communications. Entry is dependent on a tertiary entrance score of 810 or better and passes in English, physics, maths and chemistry.

There is provision for the combined degree of Bachelor of

Engineering/Applied Science with specialisation in electronics and computing systems. Electives are selected from both faculties. Queensland IT also offers an Associate Diploma in Electrical Engineering which qualifies the student for the position of technical officer. Electives may be taken in electrical power, telecommunications, electronics and industrial systems. The course is two years full time or four years part time and the entry requirements are a tertiary entrance score of 745 and passes in English, maths, physics and chemistry.

Courses for people wishing to specialise in computing are the three year full time Bachelor of Applied Science (Computing) and the Bachelor of Business (Computing).

Further Information: Registrar, Queensland IT, GPO Box 2434, Brisbane 4001 Qld; (07) 223 2111.

South Australian Institute of Technology

The South Australian IT offers a combination of professional degree courses and programmes suitable for technical officers. The Bachelor of Engineering (Electrical/Electronics) is offered on a four year full time basis and six years part time. Industrial experience necessary for the completion of this degree takes approximately nine months. Minimum entry is registration (matriculation) or equivalent. The first two years of the Electronics degree consist of the core subjects of applied science, introductory engineering subjects and the final two years allow specialisation in communication, analogue or digital electronics. The Electrical Engineering degree is a broader course offering options in process control, computing systems and applications as well as electronics subjects.

There is also an Associate Diploma in Electrical Engineering which is offered on a three year part time basis. Entry requirements are association with passes in maths, physics and chemistry or the completion of the Technicians' Certificate.

Computing courses include an Associate Diploma in Computing (two years full time/four part time). Prospective students must gain their association with 265 or more points. Subjects include; the technology of computer systems, computer programming and various business electives. The Bachelor of Applied Science (Computer Studies) is a three year full time professional course, however, it is more business orientated as it is envisaged that graduates will work in commerce, industry or government.

For people wishing to combine the majors of mathematics and computing, there is the Bachelor of Applied Science (Mathematics and Computing). This course has a heavier mathematical and scientific bias than the previous course. Subjects studied are computer systems, maths, programming systems, statistics and material on numerical computation. The engineering degree courses and the computing courses are recognised by The Institution of Engineers, Australia, and the Australian Computer Society respectively.

Further Information: School of Electrical Engineering, Sth Australian IT, PO Box 1, Ingle Farm 5098 SA; (08) 260 2055 ext. 2383.

UNIVERSITIES AND C.A.E.s

As mentioned earlier, the entry requirements of the universities and C.A.E.s are basically similar. So there's no need to describe the entry requirements of each one. Usually engineering courses are four years full time or the part time equivalent. The Institution of Engineers, Australia, recommends that students spend a minimum of twelve weeks gaining industrial experience and so this is a compulsory requirement of the engineering degree. It is recommended that students have studied at least three-unit maths and two units in both physics and chemistry or else four units of multistrand science. Engineering requires a good grounding in ▶

science and maths, so it is essential to achieve reasonable passes in these subjects. Competition for places in engineering is very fierce and so it is wise to achieve better passes in these subjects than the minimum requirements.

Many universities offer degree courses in electronics and electrical engineering and some such as Newcastle University offer a degree in Computer Engineering. It is also possible to combine the Bachelor of Engineering (B.E.) degree with a Bachelor of Science (B.Sc.) degree with an extra year of full time study. This option is available at several universities for example Sydney, N.S.W. and Queensland. Computing courses are often offered through the Computer Science Department and may be taken as part of a science or engineering degree. The science degrees are three years full time rather than the four years required by Engineering Faculties.

Many C.A.E.s offer computing subjects as part of their Applied Science degrees. These courses are normally for three years full time and students are expected to achieve HSC levels in three-unit maths, physics and sometimes chemistry. The Applied Science courses do not have the same concentration on maths and physics as engineering and are shorter in duration. Most C.A.E.s offer a range of computing options mainly devoted to software programming through their information sciences, business and administration schools. These courses usually have an emphasis on data processing for business applications and are outside the scope of this article.

Undergraduate admission to the universities and C.A.E.s is through the Universities and Colleges Admission Board or Committee in your capital city. Entries are generally required by the first week in October or mid-November, depending on the various states.

At Sydney University it is possible to study electronics as part of a B.E. (Bachelor of Engineering) in Electrical Engineering which is four years full time. Students study the whole range of electrical engineering options and become conversant with electrical, control, electronics, communications and digital and computing systems. Entry requirements are at least three-unit maths and two-unit physics and chemistry or four-unit multistrand science with a 350-400 aggregate mark in the HSC. The first two years offer general engineering subjects with a choice in the third year of various specialisations. Students are required to gain at least twelve weeks of practical work experience during vacations.

It is possible to obtain a combined B.E./B.Sc. degree with an extra year of full time study and this gives a broader scientific basis to the engineering subjects. Majors in computing science subjects are also available in other degree courses such as Science, Arts and Economics.

The University of New South Wales offers a B.E. in Electrical Engineering which includes various computer subjects such as computer hardware and software which may be taken as options. The School of Electrical Engineering and Computer Science enables the student to specialise in communications, electrical power, systems control, electronics or computer science. Students need twelve weeks industrial experience and part time students do three years of appropriate work experience concurrently. There is a B.Sc. with a major in computer science for those who do not wish to pursue the more demanding B.E. Students are able to do a major in computer science as part of a five year programme in Electrical Engineering and Science leading to the combined degree of B.E./B.Sc.

Newcastle University offers a wide range of specialist courses in computing and engineering. Students enrol in a B.E. in either Electrical or Computer Engineering. The Computer Engineering degree was the first of its kind in Australia and is recognised by The Institution of Engineers, Australia. Computer subjects include computer and information

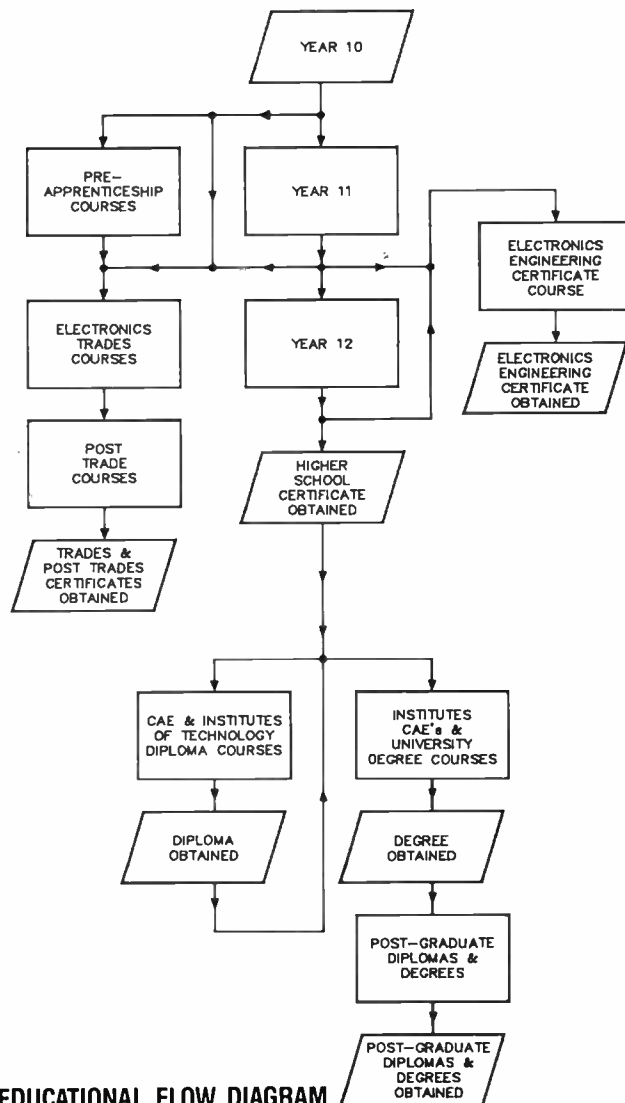

EDUCATIONAL FLOW DIAGRAM

The educational courses you can follow to gain qualifications in electronics. Although this applies for New South Wales, it is applicable to most states.

science, networks, operating systems and microprocessors. These degrees are offered for four years full time, seven years part time or as a sandwich pattern. In the final year students in Electrical Engineering can specialise in options such as computer subjects, switching theory, automatic control systems, electronics and electrical power generation.

Wollongong University also has a B.E. in Computer and Electrical Engineering which is four years full time or six years part time. The Computer Engineering degree is more specific than the electrical engineering course as a knowledge of hardware, software and the design of computers is included. It is possible to gain the combined degree of B.E./B.Sc with an extra year of full time study.

At Canberra College of Advanced Education you can study for the degree of Bachelor of Applied Science in Electronics over four years full time and there is also an Associate Diploma in Engineering which involves two years of full time study. Students can commence their first year of the B.E. at the college and then transfer to the University of N.S.W. to complete their degree. There is also a Graduate Diploma in Computing Studies for graduates who have no prior computing knowledge and a four year course in Communications Engineering offered by the School of Applied Science and Information Sciences.

Melbourne University offers a B.E. in Electrical Engineering specialising in electronics, communications, power

EXCLUSIVE AEM READER OFFER

KIKUSUI OSCILLOSCOPES:

Here is a fabulous opportunity to own a top-quality, high performance oscilloscope from one of the world's leading CRO manufacturers, Kikusui. Save hundreds of dollars on the normal retail price — an offer exclusive to readers of Australian Electronics Monthly.

Emona Instruments of Sydney, in conjunction with the publishers of this magazine, is making these oscilloscopes available as a special offer exclusively to readers of Australian Electronics Monthly. The magazine is acting as a clearing house for orders.

★ Offer closes last post 30th November 1985
Choose from analogue or digital —

● **60 MHz/3-channel delayed-sweep model COS5060A**



● **Digital storage/20 MHz 2-channel model DSS5020**



TWO YEAR WARRANTY!
 Emona offer a two-year warranty on all oscilloscopes, backed up by Kikusui. Full warranty details are available from Emona.

COS5060A Features:

- Dome Mesh CRT. 12 kV Acceleration potential
- 3 Channels
- 1 mV/DIV 20 MHz (at x 5 MAG)
- Maximum sweep speed 5 ns/DIV (x 10 MAG)
- Continuous, Simultaneous Delay Sweep Function (with two time bases)
- Alternate Sweep Function
- Trigger Function in Vert Mode
- Multi-Mode Display
- Built in Delay-line
- 6 inch Rectangular flat faced CRT with internal Graticule
- Dynamic Bias Circuit
- Linear Focus Circuit
- 2 Channel X-Y Operation
- Variable Hold-off function
- ADD Mode
- Trigger level Lock Function
- Newly designed TV
- Synchronisation Circuit
- CH1 Signal Output

DSS5020 Features:

- Digital Storage**
- A high resolution made possible by the 8 bit vertical and 1024 word horizontal axes.
 - maximum sampling speed: 1 megasample/sec.
 - Effective bandwidth: dc-400 kHz.
 - Sine and pulse interpolation functions.
 - Enlargement of stored waveforms.
 - Pretrigger function for observation of the phenomenon preceding triggering.
- Non-storage**
- Roll function for continuous observation of a waveform.
 - A built-in jitter-cancelling circuit.
 - 1024 word reference memory.
 - Store interval function
 - A 2-channel oscilloscope with a dc-20 MHz bandwidth.
 - maximum sweep time: 50 ns/div.
 - maximum sensitivity: 1 mV/div.
 - Trigger function with a level lock.

SPECIAL OFFER PRICES

***COS5060A 60 MHz/3-Channel**

\$1490.00 exc. sales tax

— save \$236!

\$1766.00 inc. sales tax

This instrument's normal retail price is \$1726.00 exc. sales tax, \$2006.16 with tax.

Input probes are included

SPECIAL BONUS!
 The first 30 orders received will get a 3½-digit Escort Multimeter thrown in, totally free of charge!

***DSS Digital Storage/2-Channel**

\$1650.00 exc. sales tax

— save \$283!

\$1952.00 inc. sales tax

This instrument's normal retail price is \$1933.00 exc. sales tax, \$2242.28 with tax.

HOW TO ORDER

Cut out, or photocopy, and complete the coupon. Send it together with your cheque, money order or credit card details to:

'Kikusui CRO Offer'
Australian Electronics Monthly
PO Box 289, WAHROONGA 2076 NSW

*Please make cheques or Money Orders payable to:
 'Australian Electronics Monthly'

Delivery: Please allow up to four (4) weeks from receipt of payment for delivery to be effected.

Name
 Postcode

Please supply:

.....
Sales Tax No (if applicable)

Please add \$20 for packaging, delivery and insurance for delivery anywhere in Australia

TOTAL COST:

I enclose payment by:

Money Order Cheque* Amex
 Bankcard Mastercard Visa

Credit Card No: **Expiry date:**/...../.....

Cheque or Money Order No:
 (Unsigned orders cannot be accepted)

Address
 Signature

*If you would like to inspect either of these oscilloscopes, call into our office any weekday during business hours. We're located at: WB Building, Cnr Fox Valley Rd and Kiogle St, Wahroonga NSW. The entrance is in Kiogle St.

A PC85 Another *Great* offer from microbee



The Personal Communicator

The PC85 is the personal communicator. User friendly, it's packed with innovative features like one touch selection; that enables you to choose from a menu of built-in programs. Word Processing, Basic, a Calculator, Telecommunications and more. These commonly used programs, plus three bonus business programs, are all inclusive in this offer from Microbee.

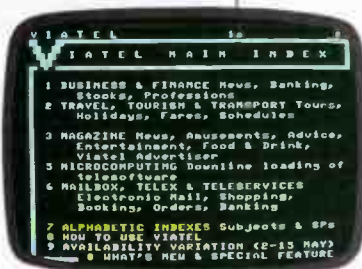

PC85 with Viatel as standard

The exciting news is that Viatel, the Telecom Service which enables you to convert your Microbee into a Videotext terminal, will come as standard with the PC85. Viatel is the easy-to-use, low cost information system. By connecting to the existing telephone network, with the easy to use Telecom approved 1200/75 BAUD Beemodem your Microbee can provide news, weather, telebanking, information, even games. And if you're playing the money or stockmarket, Microbee with the Viatel option is the perfect technology tool to keep you informed and in front.

PC85 with Spreadsheet, Database and Graphics

The personal communicator now offers more with packaged software that includes spreadsheet, database, and simple business graphics. Apart from the built-in software, you'll be impressed with the increased versatility offered by the PC85. — The Personal Communicator.

Look at the simplicity when it comes to selection of programs:— The first letter of the name of the program is all that's required, you type it in and immediately access the appropriate choice on the menu.

New Release

The all important business trio spreadsheet, database and business graphics are now on board in your new Microbee.

Spreadsheet: the electronic ledger for small business and beginners.

Database: an easy to use computer filing system puts all your records (files or address book) in order and keeps them in order while you add more files and retrieve information at will.

Business Graphics: illustrates financial reporting, growth, profit and loss, produce bar charts (Histograms) and line graphs to illustrate the state of the budget or the growth of your pet dog. With this easy to use business graphics package all you do is enter the figures — the Microbee does the rest.

NI-CAD Battery Back-up

Microbee's nickel cadmium battery back-up means you don't lose your data if the power goes down or when you switch off your system for the night.

Offer Number 1

PC85, The Personal Communicator with built-in software and Monitor.—

PC85	\$499.00
Monitor	149.50
Viatel Option	49.50
	<hr/>
You save	\$698.00
You pay only	99.00
	<hr/>
	\$599.00

PLUS you get Spreadsheet, Database and Graphics at no extra cost.

Offer Number 2

'The Complete Communicator Package'

If you take offer No. 1, the PC85 and Monitor, add Viatel compatible Bee Modem priced at \$189.50, together with a Dot Matrix Printer for \$399.00, and you have the lot, the complete package for under \$1,200.

Check the exercise again:—

PC85 with Monitor	\$599.00
DP100 Dot Matrix Printer	399.00
Bee Modem	189.50
Printer Paper	7.50
	<hr/>
	\$1195.00

VIATEL STANDARD

**Take the Lot,
You'd Bee Mad if You Didn't
Programs supplied with PC85
as standard:—**

- MicroWorld BASIC
- Help ROM for help on BASIC STATEMENTS
- Wordbee — Word Processor
- Telcom — Communications Software
- Self Test Program
- Calculator
- Machine Code Monitor
- 24 hour Clock with Alarm

Microbee Technology Centres

New South Wales

1 Pattison Avenue,
Waitara, N.S.W. 2077
Phone (02) 487 2711

2/956 Hunter Street,
Newcastle West, N.S.W 2302
Phone (049) 61 1090

Koala Crescent,
West Gosford, N.S.W. 2250
Phone (043) 24 2711

Queensland

455 Logan Road,
Stones Corner, Qld. 4120
Phone (07) 394 3688

Victoria

50-52 Whitehorse Road,
Deepdene, Vic. 3103
Phone (03) 817 1371

South Australia

117-119 Gouger Street,
Adelaide, S.A. 5000
Phone (08) 212 3299

Western Australia

141 Stirling Highway,
Nedlands, W.A. 6009
Phone (09) 386 8289

Microbee Educational Technology Centre

Unit 2, Eden Park Estate,
31 Waterloo Road,
North Ryde, N.S.W. 2113
Phone (02) 888 9866



microbee computer

Designed and manufactured
in Australia by
Microbee Systems Limited

PHONE
ORDERS ACCEPTED 



ART PROM 2758

SCOPE SPECIALISED TOOLS

PORTABLE SOLDERING STATION



MODEL TC60

MODEL STS 2
SAFETY STAND & SPONGE

- CMOS PROTECTION - FULLY EARTHED
- 60W BACK UP
- 2% TEMP CONTROL 200 - 400 C

THE PENCIL IRON WITH REAL POWER

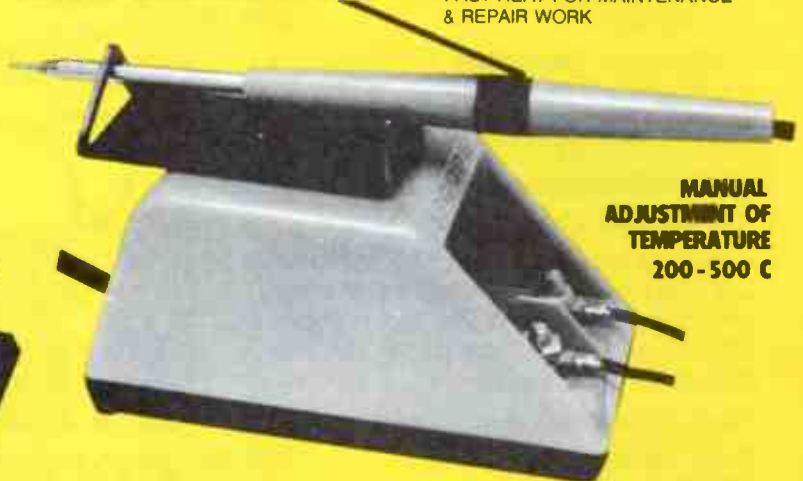

MANUAL
ADJUSTMENT OF
TEMPERATURE
200 - 500 C

- YOUR FINGER ADJUSTS WATTAGE & TEMP. 200 - 500 C
- FAST HEAT FOR MAINTENANCE & REPAIR WORK

INDEXING P.C.B. HOLDER



ROTATES
AND LOCKS
IN 32 POSITIONS

SELF CLEAN TIP METAL BODY

- CRUSH PROOF METAL BODY
- TIP SELF CLEANS EVERY CYCLE



RADICAL SCISSOR ACTION



- SAFETY OFFCUT CATCHER OPTION
- SCISSOR ACTION REDUCES CUTTING EFFORT

FOR A FREE CATALOGUE
SEND YOUR NAME AND ADDRESS TO:
FREEPOST No.2
SCOPE LABORATORIES
P.O. BOX 63, NIDDRIE, VICTORIA, 3042
AUSTRALIA
No Stamp Required

CONTACT
YOUR NEAREST
SCOPE RETAILER

N.S.W.
Promark (02) 439 6477
Selectro Parts (02) 708 3244
D.J. Coulter (049) 67 1455 AA 28650
Geo Brown (02) 519 5855
Sheridan (02) 699 6912
Martin De Launay Pty Ltd (02) 267 1055 AA26679
David Reid (02) 267 1385

S.A.
AJF Electrical (08) 269 1244
Gerard & Goodman Pty Ltd (08) 223 2222 AA 88983

QLD.
L E Boughen (07) 369 1277
ECQ (07) 376 5677
Fred Hoe (07) 277 4311
Delsound (07) 229 6155
Dunlop IBC (07) 392 0011 AA41561
St Lucia Electronics (07) 52 7466 AA42883
Magraths (07) 832 3944

W.A.
Atkins Carlyle Ltd (09) 321 0101 AA93750
Letco Trading Company (09) 387 4966 AA94396

VIC.
Aust School of Electronics (03) 523 5622
Ballarat Electronics Supplies (053) 31 1947 AA37435
Ellistronics Pty Ltd (03) 561 5844 (03) 602 3282
Radio Parts (03) 329 7888 (03) 211 8122 (060) 21 8177
Teleparts Investments Pty Ltd (052) 21 7085
McGraths Electronics (03) 347 1122 AA31001
R D Irving (03) 489 8131
Electrotool (03) 848 1045

TAS.
GHE Electronics (002) 34 2233 (003) 31 6533



(03) 338 1566
TLX 38318

networks, control or computing. In the fourth year students can specialise in their chosen electives. Prospective students are encouraged to achieve D grade or higher in chemistry, physics and pure or applied maths. A B.Sc. degree specialising in Computer Science is offered by the Science Faculty and there is also a one year post graduate diploma in Computer Studies.

Monash University (Vict.) has a B.E. in Electrical and Computer Systems Engineering. In the fourth year the core subjects offered are control systems, electronics, communications, power systems and computer engineering. Students specialise in various options such as optical fibre communications and bio-engineering instrumentation. It is also possible to do a B.E./B.Sc. in consecutive years.

La Trobe University (Vict.) has a B.Sc. course in electronics and computing. It also offers several computing subjects and electives through the School of Mathematics and Information Science. Subjects include software programming, hardware circuits and information systems. A Diploma in Computer Science is also available to graduates who want to further their computing knowledge.

At **Ballarat College of Advanced Education** students can study for a B.E. degree specialising in electronics or electrical engineering for four years full time or the part time equivalent. There is also provision for the conversion of engineering diplomas into degrees. Subjects include electrical power, electronics, communications, automatic control or computing. Ballarat also offers a Bachelor of Applied Science in Computing Science for three years full time. Subjects include computer technology, programming, systems analysis, data structure and processing, and numerical techniques.

Bendigo College of Advanced Education offers a Bachelor of Applied Science in computing for three years full time and the Dept. of Information Science has a two year Associate Diploma in Information Processing for those not wanting to take the longer degree. Students can enrol in the first year of a B.E. in electrical or electronic engineering and then complete their degree at Ballarat C.A.E. A Graduate Diploma in Electronics and Computing is for people wishing to become computer programmers or add to their knowledge in these fields.

The **University of Queensland** offers a B.E. in Electrical Engineering within the areas of electronics, electrical power, communications, control or digital electronics. From 1986, it will offer a new degree in Computer Science Engineering with an emphasis on hardware design. A combined B.E./B.Sc. is also available and the Dept. of Computer Science offers various computer software subjects as part of engineering, science and arts degrees. There is also a Diploma in Computer Science for one year full time or up to three years part time.

Darling Downs Institute of Advanced Education (Qld.) has a B.E. and an external Associate Diploma in Electrical Engineering. The Associate Diploma is a four year part time, para professional course, giving students the training to become technical officers and engineers' assistants in this field. There is also an associate diploma in maths and computing offered by the School of Applied Science.

At **Adelaide University** you may study for a B.E. in Electrical and Electronic Engineering over four years. Entry pre-requisites are a matriculation score of 440 and students must gain sixteen weeks of industrial experience in their holidays. It is possible to specialise in the computer science subjects of assembly language, numerical methods, data structures and digital systems for this degree. Also computer science subjects are available through the Faculty of Mathematical Science.

The **University of Western Australia** has a four year B.E. degree with specialisation in Electrical Engineering from

year three. They require proven ability in maths and physics as well as prior completion of a tertiary course for admission.

Murdoch University (W.A.) offers a B.Sc. in computer science in conjunction with another discipline such as maths or physics. Subjects include information science, computer languages and computers, operating systems, electronics, scientific computing and systems programming.

The **Tasmanian College of Advanced Education** is to be renamed the Tasmanian State Institute of Technology in the near future. It offers an Associate Diploma in Computing and also a three year full time Bachelor of Applied Science which can include computing subjects. Students are able to study for two years of their B.E. and then transfer to Swinburne Institute of Technology (Vict.) for the remainder of the degree.

All the engineering degree courses described above are recognised by both The Institution of Engineers, Australia, and the Institution of Radio and Electronic Engineers, Australia. Most of the computing science courses and diplomas in this subject are accredited by the Australian Computer Society.

PRIVATE COURSES

In addition to courses offered by tertiary institutions, there are a number of private electronic and correspondence schools offering courses in electronics and computing. The courses listed below are respected in the electronics and computing industries, however, you will have to pay for them. A range of courses are available from the beginners level to quite advanced subjects.

The **School of Electronics** located in Milsons Point offers a number of full time courses in electronics. These range from the one year Diploma Course in Electronics for people with no previous experience, to advanced training courses in product engineering and computers. The Electronic Diploma Course includes a number of practical courses many of which can be taken part time at night. This course is divided into seven categories covering basic training, circuit principles, advanced circuits, television and radio, digital electronics including computers and finally revision topics.

There are no pre-requisites for the course, although students with the HSC are usually given first preference. When prospective students apply they are screened for ability and attitude and are given places in the course as a result of their interview. Students are guaranteed a high standard of training and the School claims there is a non-existent dropout level. The cost of the training is \$4800 and students are provided with their own test equipment, books and study material by the School. On completion of their training students gain a certificate and are encouraged to find positions as freelance technicians and technical consultants.

Further Information: The School of Electronics, 54-5 Alfred Street, Milsons Point 2061 N.S.W.; (02) 922 6301.

International Correspondence Schools (I.C.S.) offers a wide range of correspondence courses in electronics and computing which enable people to specialise if they wish. The Electronics Technician Programme is designed for those with little or no electronics experience and requires only basic mathematical ability. Phase 1 is an introduction to electronics with students receiving training in electricity, electronics, amplifiers and radio receivers. It is also possible to take Phase 1 without completing the entire programme.

Phase 2 offers several specialist areas such as audio, radio and hi-fi systems, communication and broadcasting, industrial electronics and computer service. People who have prior experience usually enrol directly into this phase. Other electronics courses include Electronic Instrumentation and Control Systems, the Electronic Technology Certificate and the Electronic Maintenance Certificate.

Several short courses are offered in computing and these include programming in various computer languages such as BASIC, Cobol, Fortran and Assembler. There is also a Computer Programming and Data Processing Diploma Course which covers fundamentals in computing, programming languages and business systems. Prices for the computing courses range from \$600 to \$1400 and the electronic courses are available from \$700 to \$1700. ICS courses are well established and have a good reputation throughout the industry.

Further Information: International Correspondence Schools, 400 Pacific Highway, Crows Nest 2065 N.S.W.; (02) 43 2121 or other capital cities.

Another private school offering correspondence courses is **The Australian School of Electronics (Vict.)**. The two major courses available are the Lernakit Practical Electronics Course and the Microprocessor Course. The Electronics course offers training in the basics of electronics through to digital applications and computers. Emphasis is on practical experience, with students learning to build their own oscilloscope and other test gear. Entry pre-requisites are minimal as only a knowledge of basic maths and English are required. A supplementary maths course is available at no extra charge for people who haven't attained School Certificate level. The price of the Lernakit Practical Electronics Course is \$660 and students normally take twelve to eighteen months to finish the course.

The Microprocessor Fundamentals Course takes six to eight months to complete and prospective students require some prior formal training in electronics, including a knowledge of digital concepts. Material covered includes how a microprocessor functions and various programming subjects. Again the emphasis is on practical rather than theoretical knowledge and the cost of the course is \$550 which includes study material and a microtrainer.

Further Information: The Australian School of Electronics Pty Ltd, PO Box 108, Glen Iris 3146 Vic; (03) 523 5622.

Stott's Correspondence College is one of the oldest private correspondence schools. As well as training in electronics and computing, Stott's offers a wide range of vocational and hobby courses. All study is offered externally and examinations are conducted either by Stott's or the various Institutes. It is possible to sit for admission into the Electronics Technician's Institute of Australia (I.E.T.I.A.) after completion of the Electronics, Radio and TV Servicing Courses.

Electronics courses include the Introduction to Electronics (for people with no prior knowledge of the field), Digital Electronics for Technicians and Servicemen and the Complete Radio and Television Servicing Courses. Prices for the various electronics courses range from \$600 to \$1300.

Several computer courses are also available and these include a course in Data Processing and Computer Programming as well as Automatic Data Processing. There are also short courses on programming and these include languages such as Cobol, Fortran and BASIC. Prices for the computing courses range from \$285 to \$660. There is provision for payment by installments as well as at the time of enrolment and this service is similar to the other private colleges.

Further Information: Stott's Correspondence College, 140 Flinders Street, Melbourne 3000 Vic; (03) 63 6212 or the other capital cities.

EMPLOYMENT OPPORTUNITIES

After years of effort and concentrated study your certificate/diploma degree is hanging proudly on your wall or

hidden safely away in your desk drawer. Now you must leave the sheltered cloisters of your college or university and pursue the rewarding career for which you have prepared yourself.

Commonwealth and State government agencies are the major employers of engineers, technical officers and tradespeople. The Department of Transport (Civil Aviation) employs tradespeople and technical officers working in the fields of radar, air communications, navigational aids and a wide range of computerised equipment. O.T.C. is another large employer of trained personnel who work in the areas of computer control, telephones, telex, data processing and satellite stations. Telecom is currently the largest employer with approximately 10 000 technicians and technical officers working on telephone and telex services and the maintenance of ABC's radio and television transmitters.

Other government departments which employ skilled electronics staff include the Dept. of Communications, the Bureau of Meteorology, the Antarctic Division, the Dept. of Science and the branches of the armed services. Then there are the public utilities such as the Electricity Commission, who employ large numbers of staff. All these departments provide two to four years of in service training after the completion of the relevant certificate courses.

The rapid expansion of the computer industry has opened up many employment opportunities for trained computer specialists in this field. Specialists in computer hardware and software are employed in almost every government department as well as extensively in private industry. Unfortunately, many people choose to specialise in the computer software field and there is now a grave shortage of engineers and computer scientists qualified to design hardware systems.

One of the lesser known aspects of the popularity of the computer boom is that many people who perhaps five years ago would have chosen to work in electronics have entered the more lucrative computer field. This migration to computing has increased the chronic shortage of trained technical people in the electronics industry. Government restriction on staffing levels has also reduced the numbers of traineeships available and this has also contributed to the current shortage in trained electronic personnel.

Public Service positions offer a high degree of job security, but the opportunities for promotion are limited in comparison to the private sector. Often private industry can offer greater salary packages and incentives to their employees and this may account for the fact that fewer than five per cent of public service staff reach the grade of Senior Technical Officer or beyond. The private sector offers more flexibility and greater advancement opportunities as it is not tied to rigid salary scales and promotional grades. As a general rule the salaries offered in private enterprise are around ten to fifteen per cent higher than the public service.

Although employers in both the public service and the private sector are influenced by the tertiary qualifications of their applicants, it is worth remembering that experience remains the most important criteria in gaining a job. Often private employers can afford to be more flexible, and it is not unusual for them to prefer superior work experience to tertiary qualifications.

Many thanks to the people from the various tertiary institutions who wrote letters and sent material on the various courses offered by their colleges. It has not been possible to include material from all the colleges who responded due to time constraints. Special thanks to Jim Wade from the School of Electrical Engineering at North Sydney T.A.F.E. and Jim Athanasou from Blacktown Youth Counselling Service for their help and advice. 📧

Compact disc buyers club to reduce purchasing hassles

A unique concept in compact disc marketing, claimed to reduce the hassles of poor availability and the inability of purchasers to return unwanted, but expensive, discs has been launched by local electronics retailer and mail order house, Jaycar.

Noticing that only around half the record stores actually carry compact disc titles, and those that do only stock a limited range, Jaycar's proprietor, Gary Johnston, decided — as a CD player owner and committed fan — to do something about it. He started a compact disc buyers club.

It works like this: the whole basis hinges on an extensive catalogue of the nearly 3000 titles available here. You can get the catalogue from Jaycar for \$4, or you can ring up and ask if your favourite artist or album is available on CD. If it is, you can order immediately by quoting your credit card details, or you can order by mail, paying by cheque or money order. Incidentally, any purchaser ordering over \$100 worth of discs gets a catalogue for free.

The catalogue is a ripper. It's some 56 pages long, divided into separate sections for pop, jazz and classical titles. (Even Dire Straits is listed!) It is updated

every quarter.

Problem is, what happens if you find a disc disappointing for some reason? Forking out around \$25 for a disc means an expensive disappointment. Jaycar offer to take the disc back, whereupon you get a 50% credit against future disc purchases, provided you return it within 30 days of purchase. As you'd expect, this is conditional on the disc being returned in flawless condition. But, as the 'stylus' in a CD player is a beam of laser light, that should present no problem.

Jaycar aim to keep the returned discs and accumulate them to be offered at discount prices in regular bulletins. This way you could pick up titles you want at below normal retail prices.

It sounds like an innovative idea. More details can be obtained from **Jaycar, PO Box 185, Concord 2137 NSW. (02) 747 1888.**

Keyless car security

Every new device you buy threatens to add yet another key to your collection. If keys were truly a measure of importance you'd have crowds waiting at your doorstep!

Dick Smith Electronics has announced the release of a new car alarm, and you guessed it — no keys! Instead, the alarm is switched remotely with a personal transmitter which, though carried as a keyring, is extremely small, light, and easier to carry than the conventional metal key.

The best news is that the remote switch signals an end to late night keyhole hide and seek. Just push a button and the alarm is activated or deactivated accordingly.

The alarm comes with two personal remote switches, alarm module, siren and mounting hardware. The transmitters are user-encodable for added security and the system has battery backup capability.

The system works as a current sensing device — i.e. activates when any power is drawn. In the case of the system being activated the ignition is auto-



MATSUSHITA MICROCASSETTE WORLD'S SMALLEST?

How much smaller can microcassette recorders get? No one's sure, but August saw the launch of what is claimed to be the world's smallest — the RN-Z36 from Matsushita, marketed under the National Panasonic name. It measures just 54 mm long by 85.7 mm wide — about the size of a credit card, only it's thicker, at 14.3 mm!

To make the RN-Z36 the world's smallest, National supplied the unit with a 1.5 volt drive recording/playback IC, a 1.5 volt drive motor, new surface mounting technology on a flexible printed circuit board, and a low load torque mechanism.

The unit runs off a single 1.5 V AAA cell and weighs just 97 grams (inc. battery). Details from **National, 95-99 Epping Rd, North Ryde 2113 NSW. (02) 887 5354.**

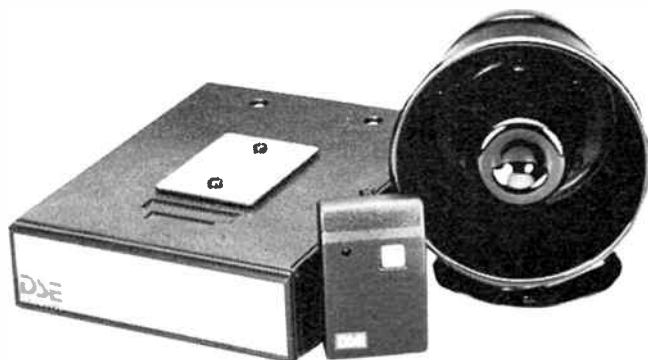

matically cut off as well as the 110 dB SPL siren sounding. The alarm also has a hardwire sensing capability for use on bonnet-boot switches, etc.

The alarm retails for only \$159.00 from Dick Smith stores Australia-wide.

Rank signs deal with Onkyo

Rank Electronics Pty Ltd, a subsidiary of the publicly listed Broadcast and Communications Limited, has signed an

DAVID TILBROOK HAS AROUND \$800 TO GIVE YOU, AND A SUPERLATIVE 2-WAY SPEAKER AS WELL!

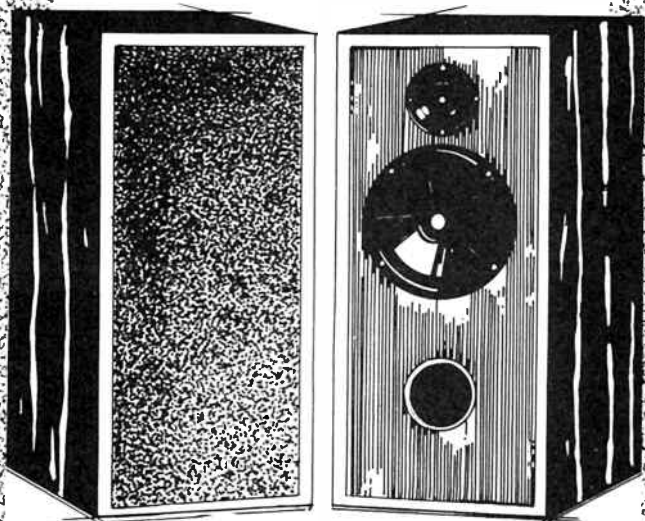

We're talking about the exciting new David Tilbrook designed speaker kit which uses VIFA's high performance drivers from Denmark. His 2-way, digital-ready 100 Watt capable masterpiece.

The name Tilbrook is synonymous with brilliant design and performance characteristics and this new system keeps the legend alive and well. The magazine 'The Australian Electronics Monthly' - where David is Project Manager - published full details of the design in their August issue. Already there has been considerable interest and many speakers have now been built with superb results.

You'll save around \$800 when you hear what you get from this system when compared to something you buy off the shelf with similar characteristics. If you compare its performance to fully imported, high priced, speakers from Mission, Heybrook, Monitor Audio, Bang & Olufsen and many others, you'll see that they too use VIFA speakers.

This kit of 2-P21WO Polycone Woofers and 2-D25TG-55 Ferrofluid Cooled dome tweeters with Polymer Diaphragms, is available for \$350. Cross-overs, cabinets and loudspeaker stands are also available.

For further information and a reprint of the full details of the Tilbrook project, please telephone or write to the Sole Australian Distributors, who can also give you the name and address of your nearest stockist.

Stocked by Jaycar Electronics and leading hi-fi and electronic stores.

vifa

Sole Australian Distributor: SCAN AUDIO PTY. LTD.,
P.O. Box 242, Hawthorn 3122. Telephone (03) 429 2199.
Queensland Distributor: Queensland Stereo Visual Supply.
Telephone (07) 265 7945.

CONSUMER NEWS

agreement with the Japanese Onkyo Corporation to distribute Onkyo audio products in Australia.

The agreement with Onkyo is a major move for Rank, which is a distributor of broadcast equipment, commercial and professional audio and audio-visual technology in Australia.

The addition of Onkyo to Rank's operations represents its first major involvement in marketing of consumer electronic products.

The range of Onkyo products to be introduced in Australia includes the 'Integra' series of sophisticated hi-fi audio components, plus a range of audio systems.

Yamaha enter car sound market



Yamaha, with a well-established presence in hi-fi, musical instruments, synthesisers and pro-sound, is to launch a line of products in the car audio field, as we revealed in our Perth Electronics Show report last issue.

Laurie Ruddock, recently appointed Car Audio product manager at Rose Music, the Yamaha distributor, claims "It is unlikely today that you hear any music recorded or broadcast that somewhere does not have Yamaha involvement, from the instruments to the mixing, to the playback equipment, so it was a natural that car audio be our next step."

The car audio product range features "build-up" convenience in that each radio-cassette combination provides the facility to 'add to' later without having to change the basis of the system.

The units incorporate pre-amp outputs as well as in-built

power amps. You can start with a radio/cassette and speakers, later adding a graphic equaliser or power amp.

Yamaha will offer a broad product range, each with top features, they say. The range will start with four radio/cassettes four power amps, two graphics, eleven sets of speakers and a car CD player.

Yamaha's car CD player, the YCD1000, can be utilised in a Yamaha system as well as with other brands on the market that have pre-out facilities. The YCD1000 is DIN size and can be in-dash mounted.

Pricing will commence around \$400 rrp for a radio cassette player and \$59 rrp for a pair of speakers. Amplifiers will commence at \$99 rrp.

For more information contact: Laurie Ruddock, Car Audio Product Manager, Rose Music, 17-33 Market St, South Melbourne 3205 Vic. (03) 699 2388.

Cycle sentry

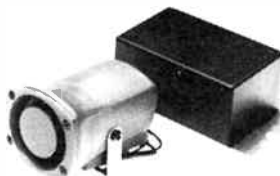

The DSE Cycle Sentry is an alarm system specifically designed for use on a motorcycle and features all the necessary connections for the sensor input and alarm output, ear-splitting piezo electric siren,

protection in either of the normal modes of motorcycle parking, centre or side stand.

It requires one pushbutton to set the alarm and the ignition key to reset and there are only two modules to install along with the mercury switch. The alarm module is only slightly larger than two match boxes and the siren only about half that size.

It suits a large range of motorcycles and is not specific to any brand or type. It can be powered from 6 or 12 volt systems and costs \$69.50 from Dick Smith stores Australia-wide.

WIN THIS FABULOUS ROBOT FROM CAPTAIN COMMUNICATIONS!

PRIZE WORTH \$199!

Captain Communications, of Parramatta NSW, in conjunction with Australian Electronics Monthly, is offering one Elami Jr robot as the prize in this simple contest. Elami Jr features an internal 8-bit microprocessor with 4K ROM for operations and a speech processor with a vocabulary of up to 206 words. It has a liquid crystal 'face' giving four facial expressions. The 25-key 'talking' keyboard permits programming speech and movement. Both 'bump bar' and infrared sensors cause the robot to move away from obstacles it meets during movement. It is battery powered from 4 x AA and 4 x C cells.

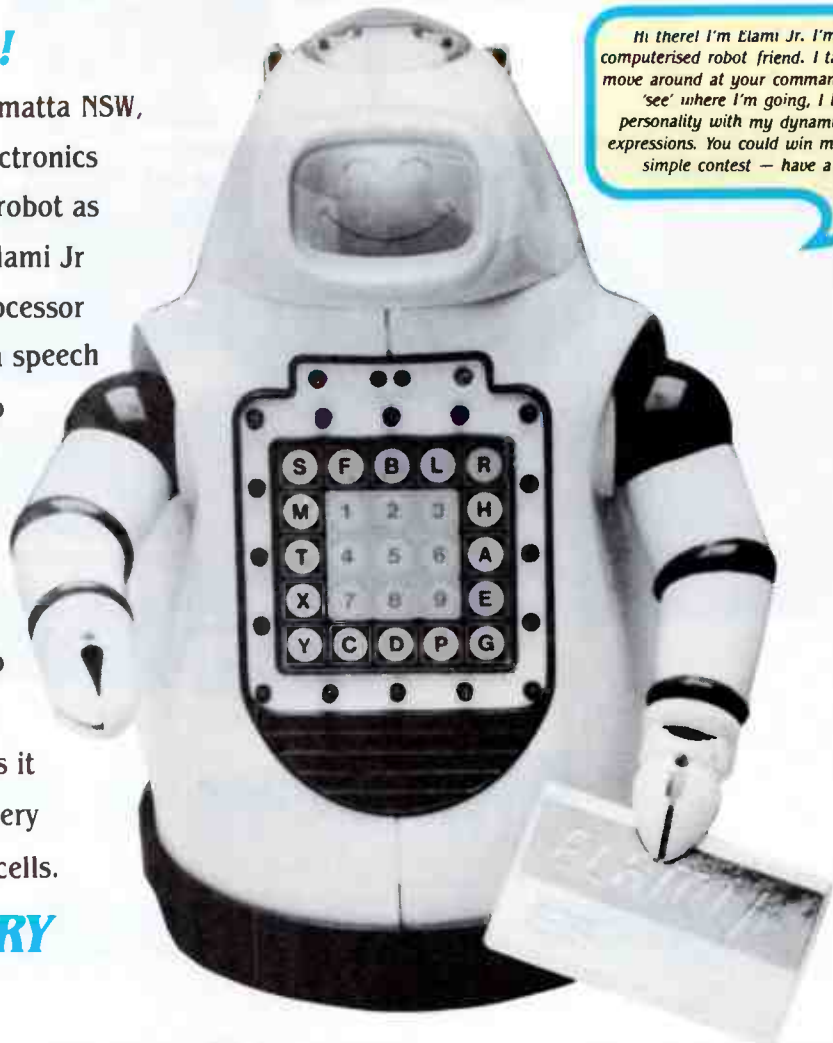

Hi there! I'm Elami Jr. I'm your computerised robot friend. I talk, I can move around at your command, I can 'see' where I'm going, I have personality with my dynamic facial expressions. You could win me in this simple contest — have a go!

FILL OUT THE ENTRY FORM NOW!

You may enter as many times as you wish, but you must use a separate entry form for each entry and include a month and page number cut from the bottom of this page. You must put your name and address on the entry form and sign it where indicated. That is, photocopies are acceptable but an original month/page number from a copy of this month's magazine must accompany each entry form. Please read the contest rules carefully, especially if sending multiple entries. The winning entry will be drawn by the Editor, whose decision is final; no correspondence will be entered into regarding the decision. Winners will be notified by telegram the day the result is declared and the winner's name and contest results published in the next possible issue of the magazine.

RULES: Contestants must enter their names and addresses where indicated on each entry form. Photostats or clearly written copies will be accepted, but if sending copies you must cut out and include with each entry an original page number and month cut from the bottom of the page of the contest. This contest is invalid in states where local laws prohibit entries. Entrants must sign the declaration, accompanying the contest, that they have read the above rules and agree to abide by the conditions.

CLOSING DATE OF THE CONTEST is the last mail of 31 December 1985. Entries received within seven days of that date will be accepted if postmarked prior to and including the closing date.

ENTRY FORM: ELAMI JR ROBOT CONTEST

Send your entry to: "ELAMI JR ROBOT CONTEST"
AUSTRALIAN ELECTRONICS MONTHLY
PO BOX 289, Wahroonga NSW 2076.

- Q1: What is the language of origin and original meaning of the word 'robot'?
A1
- Q2: Which two men built the world's first digital electronic computer?
A2
- Q3: Elami Jr has 16 LEDs around the keyboard. Who invented the first gallium arsenide phosphide LED (in 1962)?
A3
- Q4: How many facial expressions can Elami Jr make?
A4
- Q5: How many LEDs are there on top of Elami Jr's head?
A5

Now tell us in 30 words or less what features of Elami Jr attract you to begin exploring robotics?

.....
.....
.....

Name

Postcode

I have read the rules of the contest and agree to abide by their conditions:

Signed

“V8” —



the new 8 mm video tape technology

Malcolm Goldfinch

The advent of a universally approved, and now supported, magnetic tape cassette format is of great significance to consumers, the trade and manufacturers. This is the first of two articles which will deal with the format itself, its permutations in video, digital and audio imaging. The first article deals with the front runner, Sony, who pioneered the 8 mm format now known as "V8", aiming to be ahead of Beta and VHS: a potential format leader.

Malcolm Goldfinch, who has specialised in consumer video writing for the last five years sets out the format specifications first, then reviews the Sony videocam, which is designed within the format and for use on PAL TV standards. Then he considers and explains the new CCD (charge-coupled device) retina; the

electronic imaging processor replacing the mini, current-guzzling "hot bottle", previously used in all video cameras.

Although it is not an essential part of V8 video, CCD imaging fits like a small hand into the tiny glove of V8. It is a fascinating excursion into new technology, combining light and colour sensing by computer processing techniques in one LSI; yet it has analogue output.

In the second story he will review the record/playback features developed by Sony within the V8 format for their CCD-V8 videocam; just released in PAL version. Malcolm has just returned from Japan where he gained first hand information on the whole imaging scene where most of the excitement is happening.

Figure 1. Construction of 8 mm tapes, top and centre, compared to half-inch Beta tape.

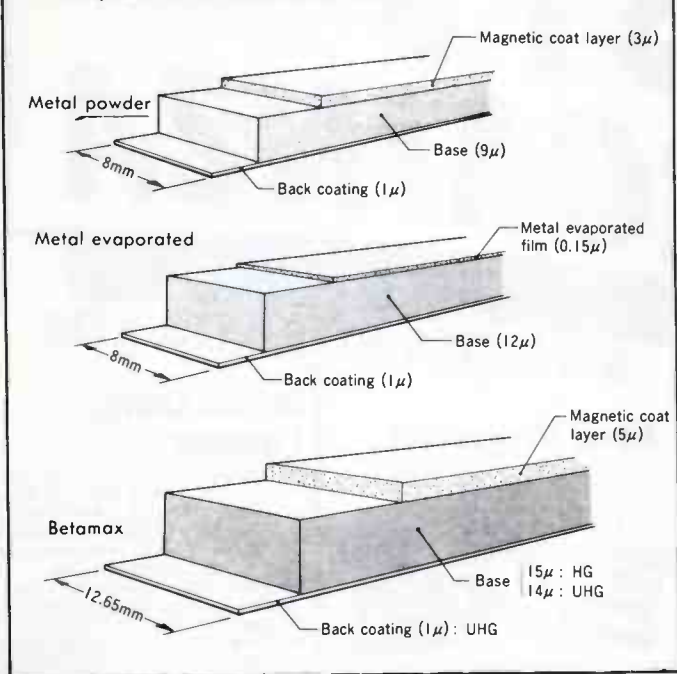

ANY DOUBTS ABOUT THE FUTURE of magnetic recording as an electromagnetic data, acquisition and retrieval medium, were dispelled dramatically by Sony at a press conference in Sydney recently, when they released both their new CCD-V8 camcorder and at the same time spelled out the full ramifications of "V8". This is the new symbol for the 8 mm wide tape and cassette format agreed to by 127 significant companies. Of this total, 102 are in Japan and the other 25 spread around the world

Do not consider V8 just another video or sound tape format like Beta, VHS, or the Philips compact cassette. V8 is the first ever attempt to get the best brains in the world together to consider how the compact cassette and all the video and digital cassette formats could be rolled into one

perfect, but simple unit. All I can do is, like Professor Higgins, cry. "By Jove, I think (they've) done it!"

Sony first showed a prototype form of 8 mm video for industry discussion as far back as 1980. Then, 102 Japanese and 25 foreign companies agreed to form the "8 mm Video Conference". They studied and discussed the permutations for video offered by an 8 mm wide tape for some years (Beta and VHS are 12.65 mm wide). Then, in February 1984, they established the new format by agreement.

In addition to the specs. for video in their handout, Sony gave the press "other use" news which should guarantee that the V8 cassette will be the magnetic imaging medium for the future, in analogue and digital, as well; a great achievement. This is great news for consumers; a universal, magnetic tape cassette! Sony has also managed to double the density of recording on half inch tape using high density recording techniques on V8 format tape.

Has the format wars of the Beta and VHS Shogun ended now V8 has arrived? Will all manufacturers be in harmony now there is an agreement on a new and better format? At least now the consumer is safe to choose any brand of V8 video, knowing everyone else will have a fully compatible V8 video cassette for interchanges.

The tape

Two tape formulations will be available: an evaporated-metal coated tape (a 'super grade' quality tape) and lower quality metal powder-coated tape. The evaporated tape proved difficult to mass produce at first, requiring special, oxygen-free atmospheres as the coating contains pure iron particles.

The basic construction of the V8 tapes is shown in Figure 1, compared with the construction of 'half-inch' video tape. Note the evaporated film tape has a thicker backing layer but the media is only one-twentieth the thickness of the powder-coated tape.

The V8 cassette

The V8 cassette arrangement is shown in Figure 2. The 8 mm tape width allows for quite a small cassette, measuring just 95 x 62.5 x 15 mm (length/width/depth), having a volume of ▶

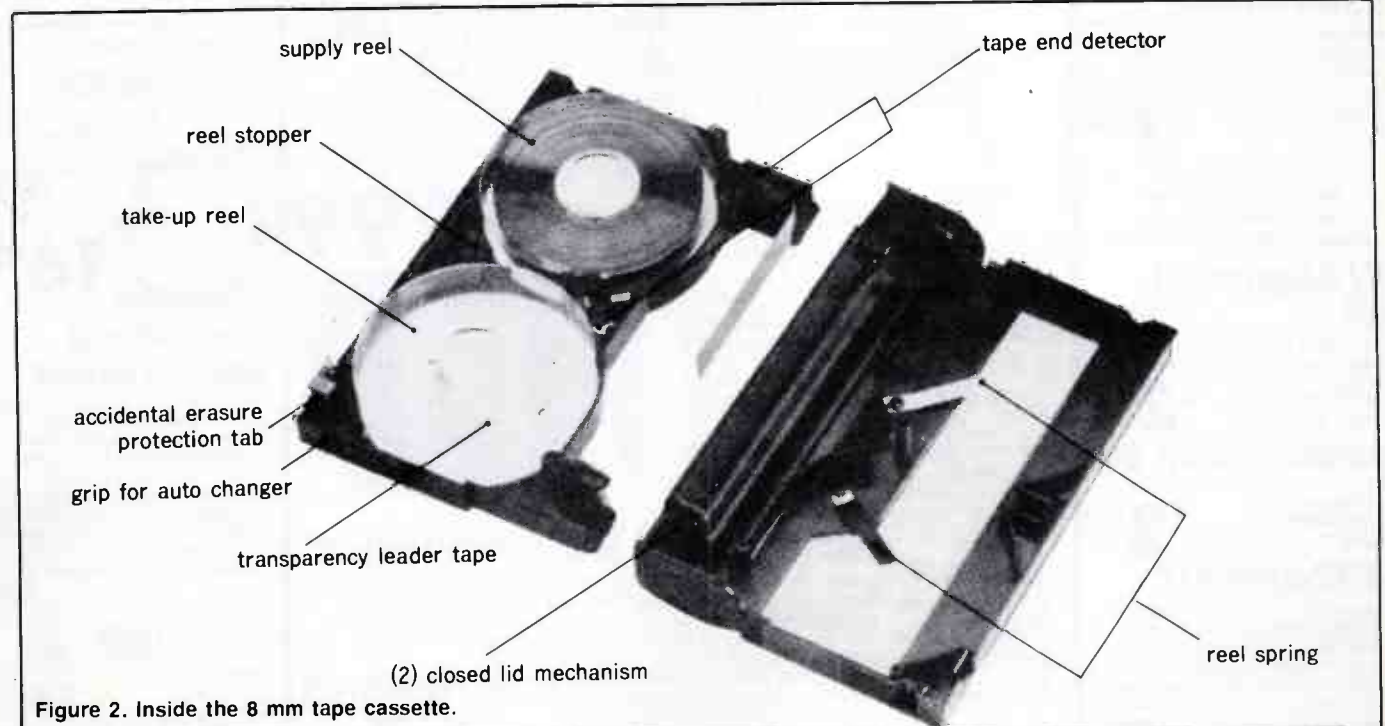

Figure 2. Inside the 8 mm tape cassette.

ALL THOSE BITS AND PIECES YOU'RE ALWAYS LOOKING FOR...

HOBBYIST'S BARGAINZA

TOP TOOLS!

DSE Desoldering Tool

Wow! A fully self contained 240V 30W desoldering station. And it's at a DSE bargain price! It's simple and clean to operate and features quality components and rugged construction. Ideal for home, workshop, lab, etc. Don't miss this incredible value! **\$69**
Cat T-1340

Mini Drivers

This really is a miniature screw-driver! Ideal for small jobs like the magnetic cartridge in your turntable, jewellery etc. Yes they are that small! L-30mm, D-1.6mm, H-25mm X 7mm

Cat T-4010 ... **FLAT BLADE ... 50¢** ~~65¢~~
Cat T-4020 ... **PHILIPS ... 50¢** ~~75¢~~

Pearl Catch

For reaching into awkward places. 3 pronged tweezer with syringe action. A must for small nuts, washers etc. Great for serviceman, jewellers, hobbyists, etc. Cat T-4660 **\$3⁹⁵**

TV Alignment Kit

A versatile four general purpose tools to cover all shapes & sizes of cores. They are made from tough plastic. Cat T-4540 **\$2⁹⁹**

Heatsink Clip Set

Spring loaded, plier grip clips for heat sensitive components and leads. Cat T-2620 **\$2⁹⁹** ~~\$3²⁵~~

ETCHING KIT

Incredible value: a pack consisting of Ferric Chloride, Dalo PC pen, resin (flux), a sample of PC board plus instructions — at less than the price of the etchant and pen on their own! And the Ferric comes in handy 500ml bottle. **\$8⁹⁵**
H-5650

BEST BOOKS!

Transistor Spec. Manual

Tells you how to read specifications then gives you specifications in detail Cat B-4508 **\$12⁵⁰** ~~\$9⁹⁵~~

Transistor Equivalents

This reference book enables the user to find substitutes for approximately 9,500 European, American and Japanese transistors. **\$6⁴⁵** ~~\$5⁹⁵~~

Australian Amateur Callbook

Compiled by the WIA from official DOC lists, together with registered SWL's and Papua New Guinea amateurs. Cat B-2322 **\$6⁴⁵** ~~\$5⁹⁵~~

Foreign Radio 1985 Callbook

WERE **\$32⁵⁰** NOW **\$29⁵⁰**
Cat B-2285

US Radio Amateur Callbook 1985

each **\$32⁵⁰** ~~\$19⁹⁵~~
Cat B-2185

World Radio Handbook

The most thorough and complete listing of international radio and television stations. **\$32⁵⁰** ~~\$19⁹⁵~~
Cat B-2085

KITS KITS KITS KITS KITS

Beat Triggered Strobe



IDEAL FOR XMAS PARTIES
A beat triggered strobe that comes complete with case, reflector, PCB, everything! It's so simple to build and has adjustable sensitivity. Cat K-3153 **\$5⁹⁵**

Want AM Stereo?

Don't throw out your old tuner ... build an AM stereo decoder instead. Save \$\$\$\$ and get the latest sound. Get the latest without spending a motza! Full fitting instructions included. Cat K-3415 **\$39⁹⁵**

Deluxe Car Alarm

Cheap insurance for your vehicle! Cat K-3252 **\$64⁹⁵**

Brake Lamp Flasher

You've seen those snazzy lamps that mount on the parcel shelf and flash when you brake? A great idea for road safety, too: you cannot avoid the flashing! Now you can build your own with this simple kit — and save \$\$\$ on the commercial units. Flashes the lamp three times before holding on. Uses our A-8520 Rear Window Brake Lamps (at extra cost!) Cat K-3245



\$14⁹⁵

COMING SOON! 4 Channel Mixer to Build

Yes, a deluxe four channel mixer — ideal for bands, pa, churches & groups, etc. Coming next month — don't miss out on this one. Easy to build — and you'll save Cat K-3036

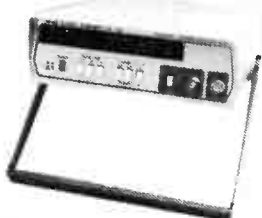

Trio CS1021 20 MHz Dual Trace CRO

Famous brand TRIO — fantastic DSE value. Top quality CRO for all general service work — and for the serious hobbyist. And even better value: we throw in two sets of top quality probes. Amazing value — call in for a test drive. Cat Q-1255 **\$79⁹⁵**



1GHz Frequency Counter

Great value for a superb 8 digit counter with an enormous range of up to 1GHz! A professional device at an affordable price. The robust, functional design make this unit ideal for the lab, technician, workshop or professional hobbyist. The large bright display and logical layout allow the job to be done quickly and efficiently. Cat Q-1315 **\$499**



Hand-Held RC Oscillator

A really worthwhile addition to your test gear: a hand-held oscillator that's small enough to take anywhere. About the same size as a digital multimeter, it gives you 23 ranges of sine & square waves (switchable) between 20Hz and 1.5kHz, plus a x100 range: 46 settings in all. Continuously variable amplitude and a -20dB attenuator built in gives total control. And you can sync the signal if you wish. Output is standard 600 ohms. Complete with clip test leads. **\$89⁵⁰** ~~\$79⁵⁰~~
Cat Q-1220

Shortwave Antenna Kit

Get the best reception from your receiver with this high quality short wave antenna Cat K-3490 **\$16⁹⁵**



Two Great Mosfet Amps

Wow! Now you can have a 60W or 100W Mosfet module amp at a fraction of the cost of a commercially produced unit. These high performance general purpose amp kits are intended for use in a variety of applications and offer performance, reliability and versatility at an incredible price.

60 Watt Mosfet Cat K-3441 **\$49**

100 Watt Mosfet Cat K-3443 **\$69**



AMATEUR BARGAINS

2m Choice:

At last! Total control, total flexibility in a hand-held! That's the new FT-209 series of 2 metre transceivers from Yaesu. Your choice of transceiver/battery combination to give the power — and the features — that you want!

FT-209R Limited Stock
(lower power version) **\$439**
Cat D-3502

FT-209RH
(High Power version) **\$449**
Cat D-3503

FNB-3 10.8V/ 425mAh NiCad. **\$65**

Similar package to above, but containing a 10.8 volt NiCad Battery. Includes provision for charging without removal from hand-held. Instant removal & connection. Cat D-3506 **\$59**

FNB-4 12V/ 500Ah NiCad

Slightly larger to above pack, gives full 12 volts for when highest power is essential (up to 5W out on the FT-209RH!). Also includes charging provision. **\$79**
Cat D-3507 **\$89**



Air Band VHF Radio & AM/FM!

Operates from 4 penlight batteries (supplied), with telescopic whip antenna for aircraft band and internal ferrite rod for broadcast band.

\$29.50 Cat D-2836

• Receives both AM/FM on VHF band.

COAXIAL SWITCH

At last! A really high quality coaxial switch suitable for all HF, VHF & UHF (900MHz) uses.

Made by Welz in Japan. **\$39.50**
Cat D-5208

Amateur Radio and Electronics Study Guide **\$12.95**
Cat B-2319 **\$9.95**



Linear Amplifier

Don't pay \$120 or more! This amp does a better job and will cost you less. This is an all mode, high efficiency linear amplifier for 2 metres. 30 watts output with only 3 watts in. 13.8 volt DC supply makes it perfect for mobile use. Dual time constant for SSB or FM operation. Reverse polarity protection too. Works great with our FT290R and FT208R or any 2M transceiver with up to 3 watts out. The best value in Australia! **\$95**
Cat D-2546 **\$89**

MW/FM/SW 6 BAND

The economic receiver with the deluxe features. Like 6 bands covering standard AM & FM broadcast PLUS 4 shortwave bands: 2.3 - 4.1MHz, 4 - 7.5MHz, 7.5 - 15MHz. And a protective 'soft feel' carry case. Slide switches and controls. And best of all, it comes complete with quality stereo headphones - at **\$69** no extra charge!
Cat D-2835

Regency HX-2000 Hand Held Scanner

At last! A hand-held, go-anywhere scanner that doesn't sacrifice any of the performance of the 'fixed' type. In fact, it does better than many other scanners: up to 525 MHz including aircraft band! and it gives you 20 memory channels! NiCad Batteries included! **\$475**



Cat D-2815

Helical Dipole Scanner Antenna

Designed by a scanner expert especially to suit the bandwidth of today's scanners, it features performance approximately equal to a quarter wave in free space. **\$57.50**
Cat D-4432

Get the most from your scanner

115V Stepdown Transformer

Input 240V AC and secondary voltage 115V AC @60VA with 7% regulation. The unit is fully encased and has fuse protection for the output. Heavy duty carrying handle and socket outlet. Weight 2.9kg. Cat M-1156

NOW ONLY \$59
WAS \$67.50

BARGAIN CORNER

Digitran Keyboard

Get a load of this one: famous US brand keyboard and the manufacturer had to quit the stock. His loss is your gain. Not just a keyboard - the best keyboard we've ever seen. 98 keys (yes, 98!) but that's not all! Also includes decoder board with speaker and buzzer. What a bargain! Cat J-1008



Complete with Instructions **\$39.95**



Computer Flash Innards

A complete "computer flash" insides, ready to build into a case, use as a strobe, etc etc. As used in photographic kiosks - manufacturer's rejects but most work perfectly. And if they don't the fix is pretty easy (circuit supplied). Cat J-1002 **\$9.95**
~~\$14.95~~

PCB with relays

Top value. Brand new computer spare parts pcb's with dozens of resistors, capacitors, etc PLUS six ultra high quality heavy duty relays. About \$9.50 value: Look at our price. Cat J-1007 **\$1.99**
~~\$9.50~~



Philips 2-way Crossover

More bargain buying! How much would a quality crossover normally cost? \$15 or \$20?? Look again. Philips made, ideal for most hi fi use - and they're so simple to fit (goes inside your speaker box). **\$7.50**
Cat J-1022



and that's not all! Buy one ... get one FREE! Perfect for stereo

Power Plant!

Wow! Quality Matsushita brand (ie National Panasonic) 13.2 volt DC motors. With 2.5mm shaft, they're 45mm in diameter and ideal for those larger projects. Talk about torque — you can't stop these beauties with your fingers. You won't find better value! Cat J-1018 **\$1.95**

100 transistors for under ten bucks!

Value: transistors less than 10 cents each. Quality, branded small signal transistors (data available) in a handy pack so you'll have some around. **\$9.90** pack

The Big Guns

The incredible Molon reluctance synchronous 230 volt motors. Heavy duty cast-iron outer casting, they're quality manufactured in the USA. With an 8mm shaft they're ready for the big jobs. Cat J-1016 **\$14.95**



TARZAN FAN

Wow! This is an unprecedented price — stocks are limited so hurry! Genuine Tarzan 17cm Rotary Fans from the USA. The highest quality at this ridiculous price! **\$29.95**
Cat J-1009

Micro Switches

Quality microswitches with positive switching action! These are ideal wherever a limited switching movement is required. Don't miss this great deal! SPDT, 5A 12V or 3A 250V rating. **79¢**
Cat J-1004

Scotchlock

Genuine 3M Scotchlock brand connectors type UG. They're the ones used by Telecom! Now at a BARGAIN price! Cat J-1020 **\$1.99**
PACK OF 10 ONLY

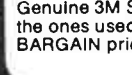

Looking for your nearest Dick Smith Electronics store?

There's an insert in this issue with all store addresses listed ... and don't miss the bargains while you're there!

DICK SMITH ELECTRONICS



the new 8 mm magnetic tape technology

just 89 cubic centimetres. It looks rather like a fat compact audio cassette. It is much simpler in construction than either the video cassette or the compact audio cassette. Only the mini audio cassette is smaller, being 87% the volume of a V8 cassette.

There are no tape guides in a V8 cassette and it has tighter seals to minimise dust entry. A sliding tab prevents accidental recording, there is automatic tape type sensing and an indentation for auto-changer grips. It has transparent leaders.

Tape speed for the V8 is 20 mm/sec. and it only uses about 96 sq. cm/minute (video) compared to about 144 sq. cm/min. for Beta. Half-speed long-play on V8 reduces consumption to a mere 48 sq. cm/min. which compares favourably to VHS long-play consumption of around 89 sq. cm/min. (Beta video does not have a long-play mode as its tape pass speed is too low for it to be reduced further).

The cost saving in V8 allows an upgrading of tape quality without too big a price penalty. V8 video cassettes are presently very expensive compared to VHS/Beta video tapes and the compact audio cassette, but Sony has demonstrated that their small V8 camcorder can double the information density of their half-inch Beta format.

V8 & state-of-the-art video

The best way to update our knowledge of the state of video art, is to take the Sony CCD-V8 camcorder and follow the image along the trail from subject to the replayed image in colour vision and sound. Figure 4 shows the schematic layout of the Sony CCD-V8.

The image enters the camcorder through a power-zoom lens, bottom right. Sony rates the CCD image sensor light sensitivity down to 22 lux (2 ft-candles). Some badge-engineered equivalents — with the identical Sony CCD sensor unit are claiming a sensitivity of 10 lux or better. It all sounds a bit like watts in hi-fi, but the conventional video imaging vacuum tube seems to be the more sensitive at the present time with genuine low lux rating of better than 10, or 1 ft-candle.

Why the charge-coupled device sensor? Because in conventional video cameras the videcon tube filament takes time to heat up and lots of battery power to keep it hot. There are many problems with these tubes, which can cost up to \$800 as a replacement item. If the scanning spot stands still, or the sun shines down the lens, it burns a white hole in the screen forever. Bumps cause picture jitter. Low light scenes makes bright lights flare and leave streamers ("comet tails"). Videographers all know the frustration of waiting for the tube to heat up while a fleeting scene vanishes.

The new Sony CCD comes alive with a rush; the battery life is extended and camera size and weight are reduced. Strong light does not do the same damage. Most video problems are left behind by CCD imaging used in the Sony CCD-V8.

(The V8. format does not require CCD imaging. It as a plus in a V8 videocam or camcorder.)

Charge-coupled devices for image sensing have been under development for over five years and have experienced many problems. Sony's new CCD is close to being the electronic equivalent to the image sensing screen in the human eye, known as the retina.

The Sony CCD-V8 has many plusses. The sensor unit measures only 31 x 20 x 4.5 mm. In an exposed chip of about 3

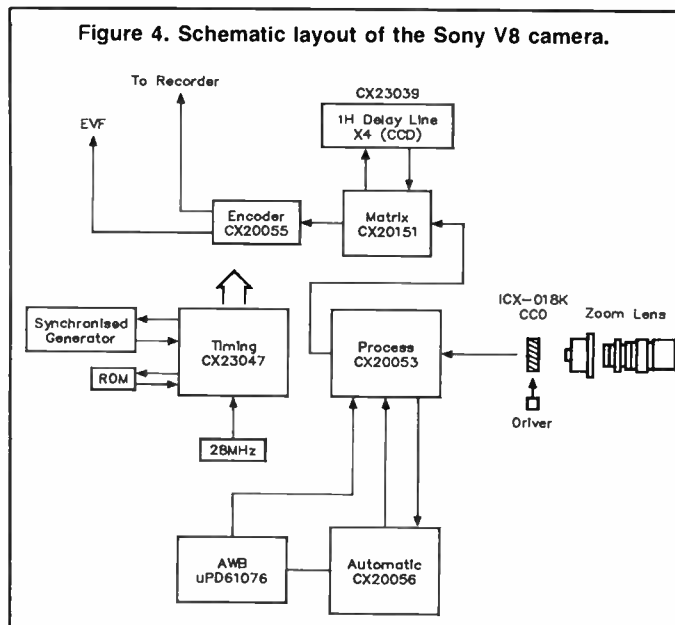

cm² there are 300 000 light and colour sensitive elements like buckets. Figure 5 shows the 'interline transfer' method used to derive the image signal. Considering each receptor as a bucket, the light from the lens excites in each a "charge", according to the brilliance and colour at that part of the image where it is located, arranged into 500 horizontal by 582 vertical elements so that every bucket's content may be measured by transferring its charge horizontally, very rapidly, (9.4 million times/sec.), into a register. Each bucket charge is thereby read, like a TV screen scan, 50 times per second.

The CCD is like a large hybrid IC chip; part computer with analogue output governed by a computer processor. Colour is achieved by having RGB filters over the elements. A sophisticated scan generator switches the output to the correct colour channel before being combined to meet the PAL standard TV signal.

Sophistication of the Sony CCD unit is shown by its ability to diagnose a defect and heal itself. If one of the sensors becomes damaged, the CCD processor detects the fault and cancels the sensor, thereafter substituting a repeat of the contents of the previous sensor; never different enough for the human eye to detect.

A Sony professional camera feature, previously only used in \$40 000 cameras, is included in this CCD. Known as vertical aperture correction, it compares current and previous scans to generate edge correction for sharp pictures of extreme quality.

The camcorder is driven by a synchronised pulse generator that produces sync pulses compatible with broadcast frame offset and ensures no chroma patterning of the image.

Next article I will give full details of the signal processing for both sound and video in the record/playback section of the Sony CCD-V8, but before concluding this story a few remarks about what the Sony CCD-V8 is like as a videocam are pertinent.

The CCD-V8 is a normal modern videocam in many respects. It does not have auto-focus, which would add a lot of weight and bulk. The excellent removable EVF (electronic viewfinder) allows a clear image; so focus is instantly corrected. The problems of auto-focus centre mainly on going onto the wrong subject when a camera angle changes; a major defect that can never be corrected, except by the camera operator alone who knows what is the subject. White balance is automatic, merely a matter of pointing at a white subject and

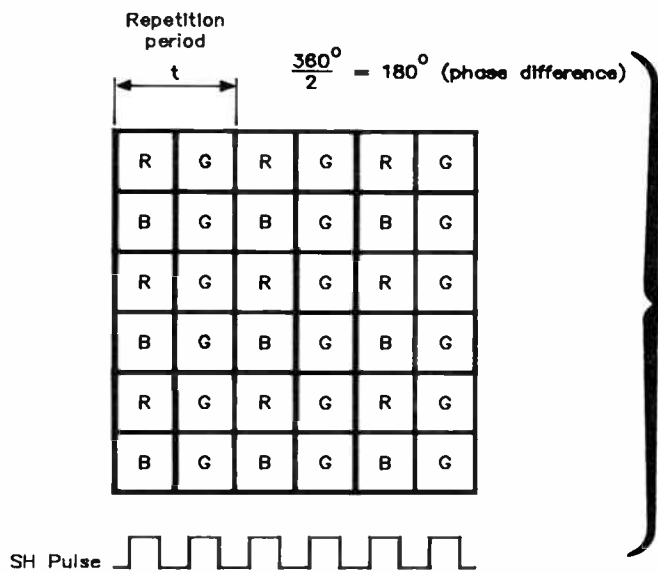
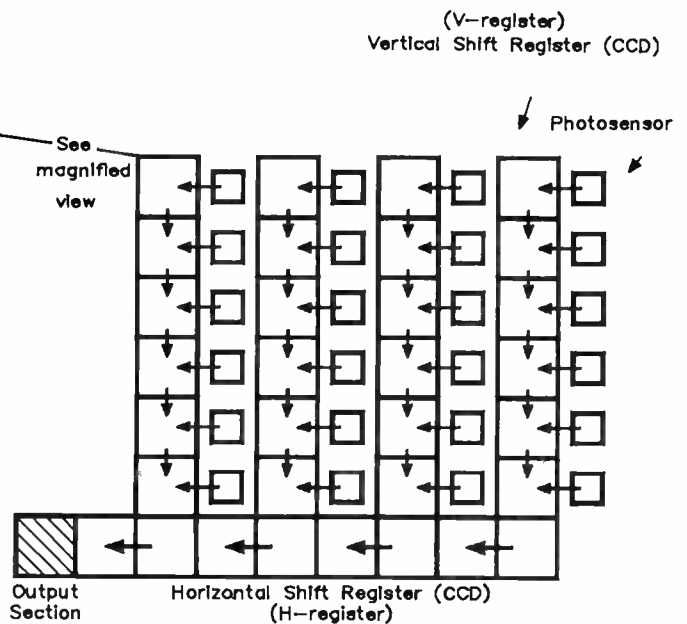

Figure 5. The V8 CCD image sensor uses a digital technique to sense the images.



pushing a button. The lens cover is a white filter that will suffice. I would like to see it with a full auto WB that also adjusts for artificial and outside light, no hands, like the JVC GX-N7E.

The whole CCD V8E unit is very pleasing to the eye and the hands, with a large, clear illuminated LCD at the rear that shows everything that is happening. It is built on a sturdy diecast chassis with gold-plated contact points. The head drum is machined to tolerances allowing headchanges without adjustment. Four motors operate all the functions. Sony's own large scale integration circuits are used to achieve miniaturisation. A typical Sony 'record review' of the last

few seconds on the EVF is a great feature that saves many a flubb. Winding is good for over-the-head-drum in such a small machine. Fast is 11 to 15 times normal speed in both directions, while cue is nine times and review seven times normal speed.

For a retail price around \$2200, the Sony CCD-V8 is a very attractive purchase for the videographer; experienced or a starter. Anyone owning a home VCR can rely on it as a high quality, mobile source of video material that can be edited on the home VCR into high quality half-inch cassettes. The format can be VHS, Beta or whatever.

Of the many fine Sony products I have owned and used, the CCD-V8 must be one of the most brilliant. It represents a great step forward in videography. Personally, I would like to congratulate Sony for their leadership in establishing this exciting new format, as well as leading with such a high standard in their first V8 camcorder.

Figure 3. Comparison of 8 mm video & current home VCR formats

	8mm video SP/LP	Beta	VHS format standard mode
Tape width (mm)	8	12.65	12.65
Cassette dimensions (mm ³)	95 x 62.5 x 15	156 x 96 x 25	188 x 104 x 25
Head drum dimensions (mm)	40	74.5	62
Tape speed (mm/sec)	20.05/10.06	18.7	23.9
Head-to-tape speed (mm/sec)	3.1	5.83	4.85
Recording video signal	2-head azimuth	2-head azimuth	2-head azimuth
Recording system azimuth angle (°)	±10°	±7	±6°
Luminance signal	FM modulation recording	FM modulation recording	FM modulation recording
FM carrier frequency	5.4	5.2	4.8
peak white frequency	4.2	3.8	3.8
Sync tip			
Video track pitch (µm)	34.4/17.2	32.8	49.0
Effective video width (mm)	3.351	10.2	10.07
Video track centre (mm)	4.461	6.01	6.2
Control track range (mm)	—	0.6	0.75
Audio signal recording system	FM recording standard equipment, one channel Video signal & frequency multiplex recording 1.5 MHz PCM recording Option: 2-channel on the extension line of video track about 30° Stationary-head recording Option one- channel 0.6 mm range	Stationary head recording. Track range 1.05 mm Stereo 0.35 mm x 2 Beta Hi-Fi recording Stereo Video signal & frequency multiplex.	Stationary head recording. Track range 1.0 mm Stereo 0.35 mm x 2 VHS Hi-Fi recording Stereo Depth multiplex recording.

Evolution of video tape formats

	1 INCH BROADCAST USE	3/4 INCH INDUSTRIAL USE	1/2 INCH BETAMAX	VIDEO 8
TAPE WIDTH (in mm)	25.4	19.0	12.65	8
TAPE OR CASSETTE SIZE (in mm)	2300DIA.	221 140	156 96	95 62.5
VOLUME RATIO COMPARISON	—	(221x140x32mm) 11.1	(156x96x25mm) 4.2	(95x62.5x15mm) 1
WEIGHT (60° TYPE)	1700g	550g KCA-6D	175g L-500	45g P5-60
HEAD DRUM DIAMETER (in mm)	134.6	110	74.5	40

Dollar Devaluation? Not at Sheridans!!

Electronics Galore! 1001 Stupendous Bargains!

RS232C Connector Sets

25 way RS232 connector sets at massive savings. Complete set with plug, socket and hood. Grab them now at a fraction of the normal price.

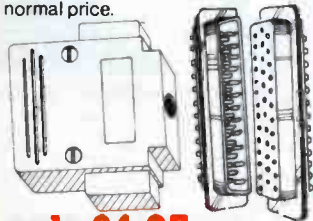

only \$4.95 complete set

Resettable Counters.

Brand new stock! These counters operate on 12V DC 50mA at up to 10cps.



only \$10

DIP Switch sale

Top quality .1" DIL type DIP switches going out at tiny prices.

10 way ... 5 for \$6.00
5 pole ... 5 for \$4.75
3 way ... 5 for \$3.75



I.D.C type D-Submini Connectors

Perfect for the latest 'flat cable' I.D.C. connection cables. 25 way plug and socket. What an incredible bargain!

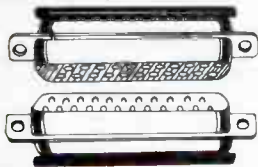

only \$12.00 THE PAIR

Save 66% on Philips & Sprague Electros

Philips and Sprague at crazy prices. All brand new unused stock.

10,000uF/40V..... \$6.00
22,000uF/10V..... \$4.00
47,000uF/10V..... \$5.00
100,000uF/10V... \$6.50

LAST FEW!!

300V/150A Stud Rectifiers below Wholesale!!

Astounding savings. 300V forward voltage only. All brand new stock. Very limited stocks. Be quick.

only \$7.50
5 for \$32.50



"Sizzling Chips" Specials

3764 (4164) Dyn. RAM	\$2.50
2732 4K x 8 EPROM	\$4.50
2764 8K x 8 EPROM	
250ns	\$5.50
27128 16K x 8 EPROM	
250ns	\$19.00
2114 1K x 4 Static RAM	\$1.50
	10 \$1.30 each
6116P3 2048 x 8 Static RAM	\$5.50
8085 CPU	\$7.50
8212 Display Driver	\$3.40
8255 P.P.I. for 808-8085	\$4.80
Z80 PIO	\$5.00
MC1458 D.I.L. Dual Op-amp	70c
MC1458 Can type Dual Op-amp	60c
CA3086 Transistor array	75c
74121 Multistable Multivibrator	50c
4013 Dual type flip-flop	50c
MC1488 RS232 Driver	\$1.00
MC1489 RS232 Receiver	\$1.00
2532 EPROM	\$7.00
7442 BCD to DEC/DEC-Driver	\$1.00
4001A Dual 3 input NOR gate	10 for \$1.25
4020A 14 bit binary counter	10 for \$2.25
4020B Ditto ceramic package	\$1.80

Telephone Plugs and Sockets

Plug **\$2.25**

Socket **\$3.50**

Relays at the Right Price

Type HH62. 24V AC or DC operation. Plug or solder type. 2 pole changeover. Contacts handle 8A/30V DC or 10A/240V AC.

Type HH54. 24V AC or DC. Solder type. 4 pole changeover contacts. Contacts handle 3A/30V DC or 240V AC.

only \$2.00
10 for \$18.00



Triacs and SCRs at massive savings.

We have limited stocks of top quality Teccor brand SCRs and Triacs at massively reduced prices. Order now to avoid disappointment.

Q6025H TRIAC 600V 25A 1/2" stud gated triac **\$3.50**
Q4025H TRIAC 400V 25A 1/2" stud gated triac **\$3.00**
Q4015H SCR 400V 15A 1/2" stud non-sensitive gate **\$2.00**
Q4020L SCR 400V 20A TO220 non-sensitive gate **\$1.50**
T106D1 SCR 200V 4A TO220 sensitive gate **\$1.00**
Q4001L4 TRIAC 400V 1.6A TO220 **\$1.25**



BARGAIN PACKS

1 Fuse Pack 50 assorted 3AG & 2AG glass fuses in both fast acting and slow blow. All useful types. Normally 25c each. Our special price only: **\$6**

2 Disk Ceramic Pack 60 assorted values. From 10pF to .1uF. 100V to 630V. What astounding value. **\$3**

3 Polyester Capacitor Pack 60 assorted types from .001uF to .22uF 100V. **\$6**

4 1% Resistor Pack. High grade Takman 1/4 watt types. 300 mixed types that would normally cost around \$22.00. **\$12**

5 Monolithic Cap Pack. Now here's value. Mini Bypass caps manufactured by Emcon USA. 50 assorted types from 12pF to 270pF 100V. In radial and axial types. Worth at least \$15.00. **\$7**

Heatsinks

Philips 40D3CB heatsinks at bargain prices. Black anodised finish. **5 for \$13.50**

only \$3.00

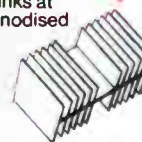

Save a fortune on semis

Enquire for Prices on Larger Quantities

A14A Glass diodes 100V 1A 10 for **\$1.00**
IN914 (IN4148) Diodes 10 for **90c**
100 for **\$2.50**
BC548 Transistors 10 for **\$1.40**
BC549 Transistors 10 for **90c**
BC559 Transistors 10 for **90c**
TIP29B Transistors 10 for **\$3.50**
BC557 Transistors 10 for **90c**
BC332 Transistors 10 for **90c**
BC109/BC337 Transistors 10 of each (20) **\$3.00**
Crystal 6MHz **\$2.50** each
Crystal 32.768 Clock Xtal 1.25
Crystal 4433.619KHz Colorburst 2.00

Handheld Telephone

only \$9.95

We are offering these for component value only. A mine of useful parts. Originally produced for Plessey. Contains miniature speaker, electret microphone, ICs, caps, superb keypad, LED, Xtal etc.



10 ohm Resistors

These 10 ohm/25W power resistors are perfect for dummy loads, attenuators etc.

only \$1.50

20W/8 ohm Horn Speaker

Super efficient reentrant horn speaker. Weather resistant plastic frame.

only \$22.00

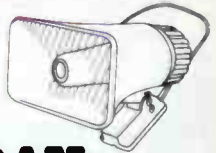

SHERIDAN ELECTRONICS

DEPT AEM8 164-166 Redfern Street, Redfern NSW 2016
Phone (02) 699 5922
699 6912

Mail Orders to: DEPT. AEM8 PO Box 229 Redfern NSW 2016

Mail Charges:
\$5.00-\$9.99 \$3.50
\$10.00-\$24.99 \$4.00
\$25.00-\$49.99 \$6.00
\$50.00-\$99.99 \$7.00
\$100.00 or over ... \$8.00

Trading Hours:
Mon-Fri 9am-5.30pm
Thurs 9am-7pm
★ Saturday 9.30am-1pm (until further notice)

Note: We accept both Bankcard and American Express. However we cannot give quantity discounts on Credit Card purchases or account orders. Minimum for account orders is \$50.00 Minimum order is \$10.00 exclusive of postage and packing

Large and overweight items sent skyroad freight

JAYCAR - UNIQUE PRODUCTS

VIFA SPEAKER SENSATION

**European Style 2-way
Speaker Kit
Sensational NEW
design by
Dave Tillbrook**

SEE AEM
JULY

Tweeter DZ5TG 8 ohm Cat. CT-2020
\$49.95 ea \$99.90 pair
Woofer PZ1WO 8 ohm Cat. CW-2132

\$135 ea \$270 pair

Crossover Network

(Not a kit now - but factory built for precision)
Cat. CX-2630

\$49.95 ea \$99.90 pair
**Total price
\$469.80**

Package Deal price **\$450**

(Price increase due to factory cost increases and
Australian \$ devaluation)
Speaker cabinets for this system. Check with
your store for details!

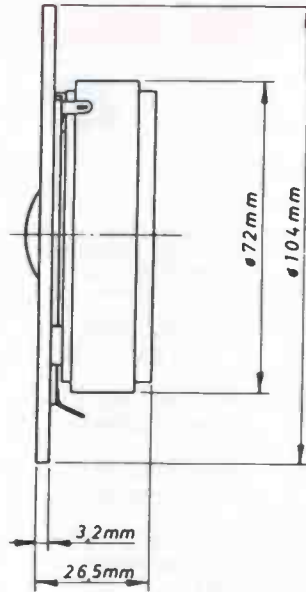

Technical Data - Tweeter

Nominal Impedance	6 ohms
Frequency Range	2 - 24kHz
Free Air Resonance	1500Hz
Operating Power	3.2 watts
Sensitivity (1W @ 1m)	90dB
Nominal Power	90 watts
Voice Coil Diameter	25mm
Voice Coil Height	16mm
Air Gap Height	2.0mm
Voice Coil Resistance	4.7 ohms
Effective Diaphragm Area	7cm ²
Moving Mass	0.3 grams
Weight	0.53kg

We estimate that you will be able to build the cabinets for around \$50 - \$90 (depending on finish). This means that you can end up with a superior 100 watt speaker system for under \$500!!

UNBELIEVABLE!

Technical Data - Woofer

Nominal Impedance	8 ohms
Frequency Range	26 - 4000Hz
Free Air Resonance	33Hz
Operating Power	2.5W
Sensitivity (1W @ 1m)	92dB
Nominal Power	60 watts
Voice Coil Diameter	40mm
Voice Coil Height	12mm
Air Gap Height	6mm
Voice Coil Resistance	5.8 ohms
Effective Diaphragm Area	222cm ²
Moving Mass	20 grams
Thick/Small Parameters	
Qm	2.4
Qe	0.41
Qr	0.35
Vas	80 l
Weight	1.65kg

AT LAST! A low cost 10 Amp Digital Multimeter with transistor test facility

Digital multimeters are very popular these days but good quality ones with 10 amp scales generally cost well over \$100. We think that is too expensive so we've decided to do something about it. Jaycar is pleased to announce a direct import digital multimeter with sensational specifications at an unheard of price! Check the specs:

DC VOLT	0.1mV - 1000V
AC VOLT	0.1mV - 700V
DC CURRENT	1uA - 10A
AC CURRENT	1uA - 10A
RESISTANCE	0.1 - 20 Mohm
CONTINUITY	less than 30 ohm @ 1mA
hFE TEST	0 - 1000 10uA 2.8V NPN/PNP
DIODE TEST	1mV

Basic accuracy of Volts, Current & resistance is between 0.5 - 1.2% depending on range.
DIMENSIONS 170(H) x 90(W) x 35(D)mm

FEATURES

- ★ 0.5 high digits
 - ★ High quality probe set supplied!
 - ★ Vinyl carry case supplied!
 - ★ Built in tilting ball!
 - ★ LED & buzzer continuity test!
 - ★ Precision thin film resistors used for long term accuracy!
 - ★ CMOS logic 1000-2000 hours battery life!
 - ★ Single function range switch
 - ★ Complete with battery spare fuse (2AG) and instruction manual
 - ★ Protected ON/OFF switch!
 - ★ Auto polarity
 - ★ Protected
 - ★ Floating decimal point
- Cat. QM 1530

\$89.95

AT LAST! A low cost 10 Amp Digital Multimeter/ Transistor Tester & Capacitance Meter!

Jaycar is proud to announce a genuine low cost high performance combination Multimeter/Capacitance meter for the enthusiast! This unit is all the most commonly needed test gear rolled into one! Similar units are on the market to sell from around \$150 to over \$200. Why pay more when you can get a Jaycar direct import for less?

DC VOLT	0.1mV - 1000V
AC VOLT	0.1mV - 700V
DC CURRENT	1uA - 10A (20A max 30 secs)
AC CURRENT	1uA - 10A (20A max 30 secs)
RESISTANCE	0.1 - 20M ohms
CAPACITANCE	1pF - 20uF (2%)
CONTINUITY	less than 30 ohms @ 1mA
hFE TEST	0 - 1000 10uA 2.8V
DIODE TEST	1mA (Buzzer & LED)

- ★ 0.5 high digits
 - ★ High quality probes supplied!
 - ★ LED and Buzzer continuity test
 - ★ Precision thin film resistors for long term stability
 - ★ CMOS logic 1000-2000 hours battery life
 - ★ Meter protection Fused
 - ★ Complete with battery quality probes spare fuse
 - ★ Floating decimal point
 - ★ Auto polarity
 - ★ Impact resistant case
- Cat. QM 1540 **\$129.00**



AN ECONOMICAL MAINS FILTER

250V AC @ 3A

250V AC @ 3A insertion loss line to line 20dB @ 0.8 30MHz Line to ground 30dB @ 0.7 - 30MHz Ideal for computers, amps etc. Quick connect lugs DOT approved
Cat. MS 4002

ONLY \$22.50

ULTRASONIC PEST REPELLER

We were staggered by the price increases on the pest repeller we used to sell, so we found a new one at a more realistic price. Will repel mice, blowflies, birds, spiders, bats, rats, cockroaches, flies, moths and fleas. It's cosmetically appealing and is supplied with a 240 volt power adaptor. We are so sure this product works we will give you a 14 day money back guarantee (less postage costs). Power consumption only 1W watts.

**WHAT HAVE YOU GOT TO LOSE
EXCEPT THE BUGS!**

Cat. YS 5510

**MOZZIE SPECIAL
NORMALLY \$55
NOVEMBER SPECIAL
ONLY \$45.00**



These are sophisticated mixers that have excellent specifications. SEE PAGE 86 of our 1985 CATALOGUE for full features and specs.

STEREO AUDIO MIXER

Cat. AM 4200

ONLY \$125.00

PRO-QUALITY CONSOLE

Cat. AM 4202

ONLY \$399.00



Squeaky Clean Mains Filter

Two fantastic low cost models. MS 4010 will supply up to 4 appliances. Each 240V socket is isolated from the other, i.e. interference from disc drives is decoupled from the CPU power supply etc. It will supply up to 4 outlets with a total load of 6 amps (unswitched).
Cat. MS 4010

**ONLY \$125.00
Single 10 amp line
socket type filter.**

(Unswitched)

Cat. MS 4012

ONLY \$34.95

Meet Roger Harrison & Dave Tillbrook!

You can meet Roger Harrison and Dave Tillbrook from Australian Electronics Monthly at our York St. store on the 3rd Saturday in November (16th) from 10.30 - 12 noon.

BE THERE!

JOIN THE JAYCAR COMPACT DISC CLUB

DESK MOUNTED LAMP MAGNIFIER

This unit magnifies any object under a clear cool fluorescent light. The magnification is the maximum obtainable (lens 127mm diameter biconvex 4 Dioptres focal length 254mm) consistent with minimum distortion and eyestrain and good off-angle viewing. It is NOT cheap, but then again it will definitely last a lifetime. It is built like a Rolls Royce. (We doubt whether 20 years continuous use would wear out the German made flexible arms for example). Spare fluoro tubes are available either from us or electrical outlets. If you have trouble with fine PCB work or component identification but still want both hands free, this is for you. We thoroughly recommend this quality Australian made product.

Technical Information

Illumination: 22W Fluorescent
Weight: 8.16kg
Lateral Extension: 254mm
Vertical Extension: 254mm
Fixing: Heavy table base (grey) with two chrome plated flexible arms.
Lens (see text)



Cat. SL 2700

**ONLY
\$169**

**NOTE: This is the GENUINE
'Maggylamp' - don't fall for cheap
substitutes.**

AT LOW, LOW PRICES FOR YOU

IDC DIP PLUGS IDC plug with cover

- 14 pin Cat. PI 6549
- 19 \$1.75 - 10 plus \$1.65
- 16 pin Cat. PI 6550
- 19 \$1.90 - 10 plus \$1.80
- 24 pin Cat. PI 6555
- 19 \$3.20 - 10 plus \$3.00
- 40 pin Cat. PI 6558
- 19 \$3.95 - 10 plus \$3.75

Edge Connector Disc Drives IDC with strain relief

- 34 way Cat. PI 6560
- 19 \$8.50 - 10 plus \$8.00
- 50 way Cat. PI 6562
- 19 \$10.50 - 10 plus \$9.50

'D' type Subminiature IDC with strain relief

- FDE99 9 pin male Cat. PP 0802
- 19 \$6.50 - 10 plus \$5.95
- FDE95 9 pin female Cat. PS 0805
- 19 \$6.50 - 10 plus \$5.95
- FDA15P 15 pin male Cat. PP 0821
- 19 \$8.50 - 10 plus \$8.00
- FDA15S 15 pin female Cat. PS 0825
- 19 \$8.95 - 10 plus \$8.50
- FDB25P 25 pin male Cat. PP 0842
- 19 \$9.95 - 10 plus \$9.50
- FDP25S 25 pin female Cat. PS 0846
- 19 \$9.95 - 10 plus \$9.50

IEEE - 488 CENTRONICS

- 57 30360F 36 way IDC line plug Cat. PP 0892
- 19 \$12.50 - 10 plus \$11.50

Headers - line IDC Sockets PCB protected header with latch

- 16 way Cat. PP 0945
- 19 \$3.50 - 10 plus \$3.25
- 26 way Cat. PP 0947
- 19 \$3.95 - 10 plus \$3.60
- 34 way Cat. PP 0948
- 19 \$4.95 - 10 plus \$4.50
- 50 way Cat. PP 0950
- 19 \$6.50 - 10 plus \$6.00

PCB protected header with latch right angle

- 16 way Cat. PP 0965
- 19 \$3.50 - 10 plus \$3.25
- 26 way Cat. PP 0967
- 19 \$3.95 - 10 plus \$3.60
- 34 way Cat. PP 0968
- 19 \$4.95 - 10 plus \$4.50
- 50 way Cat. PP 0970
- 19 \$6.50 - 10 plus \$6.00

PCB economical unprotected header right angle

- 16 way Cat. PP 0992
- 19 \$2.25 - 10 plus \$2.00
- 26 way Cat. PP 0993
- 19 \$2.95 - 10 plus \$2.70
- 34 way Cat. PP 0994
- 19 \$2.95 - 10 plus \$2.80
- 50 way Cat. PP 0996
- 19 \$3.95 - 10 plus \$3.75

IDC line socket with strain relief

- 16 way Cat. PS 0985
- 19 \$3.50 - 10 plus \$3.20
- 26 way Cat. PS 0987
- 19 \$3.95 - 10 plus \$3.60
- 34 way Cat. PS 0988
- 19 \$4.95 - 10 plus \$4.50
- 50 way Cat. PS 0990
- 19 \$6.50 - 10 plus \$6.00

JAYCAR - No. 1 FOR INSULATION DISPLACEMENT

NOTE! NOTE! We also carry a VERY large range of D-sub in right angle PCB and standard solder as well as any computer interface connector (not to mention power or audio) connector you are ever likely to need.

Machine pin IC sockets By popular demand

(See our catalogue for standard production tin, gold and wire wrap sockets)

Screw M/C pin gold insert

- 8 pin Cat. PI 6452
- 19 \$1.00 - 10 plus 90¢
- 14 pin Cat. PI 6454
- 19 \$1.35 - 10 plus \$1.25
- 16 pin Cat. PI 6456
- 19 \$1.50 - 10 plus \$1.35
- 18 pin Cat. PI 6458
- 19 \$1.65 - 10 plus \$1.50
- 20 pin Cat. PI 6460
- 19 \$1.90 - 10 plus \$1.80
- 22 pin Cat. PI 6462
- 19 \$2.00 - 10 plus \$1.85
- 24 pin Cat. PI 6464
- 19 \$2.30 - 10 plus \$2.00
- 28 pin Cat. PI 6466
- 19 \$2.60 - 10 plus \$2.40
- 40 pin Cat. PI 6468
- 19 \$2.95 - 10 plus \$2.75

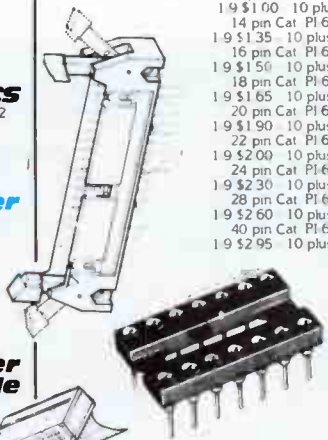

GREAT NEW PRODUCTS RS-232 Connector Products

RS-232 Mini Patch Box

- ★ Patch in to non-standard RS 232
- ★ DB25 male to female connection
- ★ Do it yourself 25 tinned ends on short leads to do your own patch
- ★ Instructions supplied

Cat. PA 0880

ONLY \$25.95



'GENDER BENDERS'

- ★ Got a connector problem? With our Gender Benders you can change sex without pain!
- ★ Overcome non mating RS 232 cables with a Gender Bender adaptor plug!
- ★ All 25 pins wired straight thru



Cat. PA 0882

Male-to-Male

ONLY \$19.95

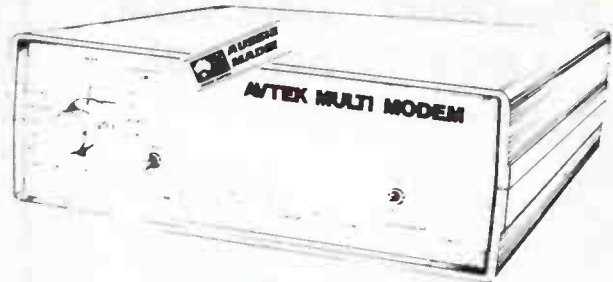

AVTEK MULTIMODEMS

State of the art multimodem has the following data standards CCITT V.21 & V.23 BELL 103 & 202 Data rates 300, 600 & 1200 BPS Backward channel 75 BPS in conjunction with 1200 BPS Computer interface CCITT V.24 - RS232C. Power requirements 240V AC 3 watts. Talk to the world with this fine Multimodem. Cat. XC 4820

AUTO ANSWER VERSION

Cat. XC 4822

INCLUDES PHONE

\$265 \$299

61 Note Wedge Front Keyboards

- ★ Actuators only, no contacts
- ★ Made in Italy - quality
- ★ Ideal for organ builders
- ★ Gold rod, contacts available but you can make your own easily

**Normally \$95.00
This month \$60.00!!**

A FEW ONLY
Cat. HM 3011

HURRY!!!



FM TRANSMITTER MODULE

FEATURES

- ★ Ultra low noise output (-60dB or better attainable with suitable tuner)
- ★ Excellent frequency stability
- ★ NOT a kit - ready for immediate use
- ★ Connections required: (A) Power supply or battery (B) Antenna (C) Audio input
- ★ Full instructions supplied
- ★ Suits any application where a stable low noise FM link is required

SPECIFICATIONS

- Frequency 88 - 108MHz
- Usable range 50 metres
- Supply 6 to 9V @ 20mA
- Input sensitivity - adjustable - max 30mV
- Pre-emphasis 50us standard
- Dimensions 90 x 22 x 15mm (approx)

Cat. DT 5450

ONLY \$59.95



Sheet Metal Bending The Panbrake

Handles up to 16 gauge metal up to 445mm wide. Make your own chassis boxes brackets etc. Unique slotted upper clamping bar allows complex corner bends etc.

Cat. TM 3020

ONLY \$99.50



Standard Mic Inserts

Replacement electrets for tape recorders etc. Includes data sheet and application notes. Operates from a single 1.5V battery. 10mm diameter. 50Hz-15kHz. Cat. AM 4010

ONLY \$1.95 ea



Female-to-Female

Cat. PA 0884

ONLY \$19.95

Jaycar ELECTRONICS

Incorporating ELECTRONIC AGENCIES

NUMBER 1 FOR KITS

MAIL ORDER HOTLINE (02) 747 1888

N.S.W. SHOWROOMS

SYDNEY: 117 Viner Street Tel (02) 267 1614
CARLINGFORD: Cnr Carlingford & Pennant Hills Road Tel (02) 872 4444
CONCORD: 115-117 Parramatta Road Tel (02) 745 3077
HURSTVILLE: 121 Forest Road Tel (02) 570 7000
GORE HILL: 188-192 Pacific Highway (Cnr Bellevue Avenue) Tel (02) 439 4799

QUEENSLAND

BURANDA: 144 Logan Road Tel (07) 393 0777

MAIL ORDERS:

P.O. Box 185, CONCORD 2137

HEAD OFFICE:

115-117 Parramatta Road, CONCORD 2137
Tel (02) 747 2022 Telex 72293

SHOP HOURS

Carlingford, Hurstville
Mon-Fri 9am-5:30pm Thurs 8:30pm Sat 12pm
Sydney
Mon-Fri 8:30am-5:30pm Thurs 8:30pm Sat 12pm
Concord & Gore Hill
Mon-Fri 9am-5:30pm Sat 12pm

POST & PACKING

\$5 \$9.99 \$2.00
\$10 \$24.99 \$3.75
\$25 \$49.99 \$4.50
\$50 \$99.99 \$6.50
\$100 \$198 \$8.00
Over \$199 \$10.00

COMET ROAD FREIGHT ANYWHERE IN AUSTRALIA ONLY \$13.50



**MAIL ORDER VIA
YOUR PHONE**

A HANDHELD LCD 3½-DIGIT DMM FOR LESS THAN \$50

The Parameters 8005 features:

- 3½-digit liquid crystal display
- 5 functions
- 15 ranges
- side pushbutton operation
- 'pocket' size — 130 x 75 x 28 mm
- dc volts to 1 kV in four ranges
- ac volts to 750 V in two ranges
- resistance to 2M in four ranges
- diode test
- basic accuracy, 0.5% (dc V)
- fully overload protected
- safety 'finger guards' on probes
- fully shrouded safety probe plugs
- low battery indicator
- 12 months warranty!

**Special
Offer Price:
\$49.75**
inc. tax, post and packaging



How to order:

COMPLETE THE COUPON AND SEND IT, TOGETHER WITH YOUR CHEQUE, MONEY ORDER OR CREDIT CARD DETAILS, TO:

'Parameters Multimeter Offer'
Australian Electronics Monthly
PO Box 289, WAHROONGA 2076 NSW

Please allow up to four weeks for delivery.

COUPON

PLEASE RUSH ME . . . Parameters 8005 dmm(s).

I enclose payment by:

Money Order Cheque* Credit Card

Bankcard Visa Mastercard

Credit Card No.:

Expiry date:

Cheque or Money Order No:

*Please make cheques or Money Orders payable to
'Australian Electronics Monthly'.

Name

Address

Postcode

Signature

(Unsigned orders cannot be accepted)



Portable solar generator

Designed as a portable power source and/or battery charger, the NV.500M from Solar-Tech is capable of charging nickel-cadmium (Ni-Cad) batteries with capacities from 0.5 amp-hour to 2.0 amp-hour (Ah).

It's just the thing for charging portable video tape and video camera batteries.

With the NV.500M you can also power portable stereos, radio cassettes, AM/FM radios, handheld transceivers, PA systems or portable fluorescent lights — anything that operates on power at 3, 6, 9 or 12 volts dc — using an optional 12 V Ni-Cad battery pack. With this, you can draw up to about 0.45 A at 3 or 12 V, while at 6 and 9 volts, you can draw up to 1 A! The NV.500M will recharge this battery pack from the Sun.

It's great for experimenters, too!



SPECIAL OFFER PRICE:

NV.500M \$189

12 V/1.2 Ah Ni-Cad battery pack \$ 59

plus post & handling, delivered anywhere in Australia by
Certified Post, \$10. Please allow up to four weeks for delivery.

COMPLETE THE COUPON AND SEND IT, TOGETHER WITH YOUR CHEQUE, MONEY ORDER OR CREDIT CARD DETAILS, TO:

'Amtex Solar Generator Offer'

Australian Electronics Monthly

PO Box 289, WAHROONGA 2076 NSW

This offer is being made by Amtex Electronics, a Division of TLE Electrical Pty Ltd. in conjunction with Australian Electronics Monthly who are acting as a clearing house for orders. The NV.500M is offered exclusively to readers of this magazine.

PLEASE SEND ME

..... NV.500M Solar Generator(s)

..... 12 V/1.2 Ah Ni-Cad battery pack(s)

Total Cost:

I enclose payment by:

Money Order Cheque* Amex

Bankcard Mastercard Visa

Credit Card No: Expiry date: .../.../...

Cheque or Money Order No:

*Please make cheques or Money orders payable to Australian Electronics Monthly

Name

Address

Postcode

Signature

If you would like to inspect one of these solar generators, call into our office any weekday during business hours. We're located at: WB Building, Cnr Fox Valley Rd and Kiogle St, Wahroonga NSW. The entrance is in Kiogle St.

Sheridan's hot pot and socket to 'em

Sheridan Electronics in Redfern, Sydney, has a hot special on 25 watt wirewound potentiometers. They're just the thing for power 'rheostats', simple train controllers, light dimmers, etc.

These pots are ruggedly constructed with a moulded ceramic body and an element wound on a ceramic former. They have a standard 9 mm (3/8 in) threaded bush and 6.5 mm shaft with a flat on it. Connections are via solder lugs. Don't pay \$4, don't pay even \$2 — Sheridan's have them for just

half a buck!

In addition, if you're on the lookout for a 44-pin edge connector with 0.156 inch (3.96 mm) pin spacing, then you can pick them up for a song to the tune of \$1.50.

Slip on down to **Sheridan Electronics, 164-166 Redfern St, Redfern 2016 NSW. (02) 699 5922.**

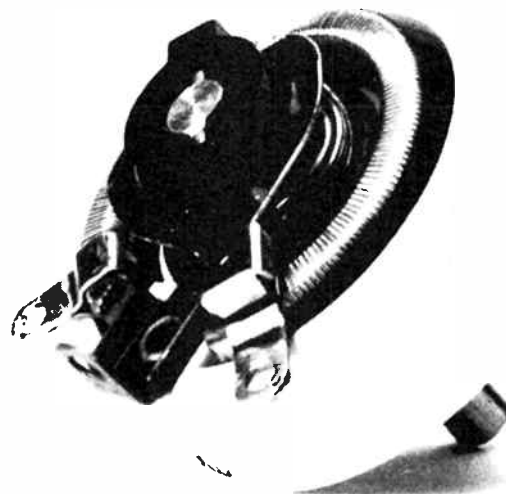

Video RF modulator

Two bucks — two bucks! That's all it costs for Jaycar's bonzer bargain. Just the go for all you digital experimenters who want cheap and easy video display on an old TV set.

It comes in its own tinfoil box complete with three metres of 75 ohm coax with plug attached. You could even throw away the video modulator box and keep the lead!

Jaycar says there's a limit of five per customer, so if you want more then you'll just have to recruit your relatives, give them each ten bucks and send them down to the local Jaycar store. They have stores in York St (city), Carlingford, Con-

cord, Hurstville and Gore Hill in Sydney, and Buranda in Brisbane. Mail order customers should contact **PO Box 185, Concord 2137 NSW. (02) 747 2022.**

Crack onto this crystal filter

For the RF fanatics out there, All Electronic Components in Melbourne has a 10.7 MHz crystal filter available that could be just what you are looking for to use in that 'special' project.

The filter features a bandwidth of 2 MHz and is entirely cased in a soldered and sealed metal case with mounting tabs on each end and connection pins protruding

through the bottom. It could either be chassis mounted or pc board mounted.

And at \$10, how could you go wrong? We're told, by someone who sneaked a peek inside one, that it's got a couple of pot cores inside that would be worth more

than the minging \$10 price tag. And then there's the crystals themselves.

To crack onto this cracker crystal filter, clamber on down to **All Electronic Components, 118-122 Lonsdale St, Melbourne 3000 Vic. (03) 662 3506.**

Kitset Specialists

As our name suggests, we stock a huge range of electronic components; and have access to just about everything electronic. For all your electronic needs, and for some of those "unusual" requirements — contact us first.

STUDENTS — Looking for a practical, functional, interesting Project for your course or own enjoyment? Look no further as we are undoubtedly Australia's largest kitset suppliers. We cater for all tastes.

Call in and browse through our comprehensive list, or write for our FREE kitset list.

SCHOOLS AND UNIVERSITIES — CONTACT US FOR TAX EXEMPT ORDERS; AND CREDIT ACCOUNTS.

MAIL ORDER AVAILABLE.

ALL ELECTRONIC COMPONENTS

118 - 122 LONSDALE STREET, MELBOURNE, VIC. 3000, Australia
Telephone 662 3506

General Radio Microwave Radar Pulse Industrial
Importers • Sales • Equipment • Equipment • Equipment • Techniques • Electronics • Instrumentation

PROJECT BUYERS GUIDE

The AEM 8500 Courtesy Light Timer this month is an ideal project for the beginner. Assembly is simple and all components are widely stocked. For kits, try All Electronic Components and Active Electronics in Melbourne. If you have most components on hand, pc boards can likely be obtained from Geoff Wood Electronics in Sydney, All Electronic Components in Melbourne, Truscott's Electronics World at Croydon (Melb. again) and possibly Protronics in Adelaide. Failing that lot, you can obtain boards through our pc board service (see the card insert in this issue).

The AEM4502 Real Time Clock is another for the Microbee hardware hackers. Assembly of this project could easily be tackled by beginners in electronics construction. Heart of the project is the 58174 real time clock chip. It's stocked by National Semiconductor stockists, like Geoff Wood Electronics in Sydney, in addition to Radio Spares (Perth, Sydney, Brisbane). Note that Radio Spares supplied the on-board NiCad battery for this project, also. The other bits are relatively commonplace. For pc boards, try the above-mentioned firms. Check out All Electronic Components and Active Electronics for kits.

David Tilbrook's 'Ultra-fidelity' preamp will soon be widely stocked as a kit, by all reports. We suggest you pester such notable firms as Dick Smith Electronics (stores all over), Jaycar (Sydney and Brisbane) and All Electronic Components in Melbourne.

The AUSTRALIAN ELECTRONICS Monthly

PC BOARD SERVICE

If your local retailer or board manufacturer is unable to supply you an AEM board, we are carrying a limited number of rolled-tin over copper circuit boards complete with silk screen component over-lay.

Project	Retail Price
1500 Metronome	\$ 4 67
3500 Listening Post	\$ 8 06
6500 Universal Mosfet Amp Module	\$ 9 69
9500 Beat-triggered Strobe	\$11 32
6102 2-Way Speaker	\$21 75
5501 Negative Ion Generator	\$12 35
4500 Microtrainer	\$28 47
6501 4-Input Mixer	\$20 40
6010LL Ultra-Fidelity Pre-amp	\$19 06
4501 8 Channel Computer Relay Interface	\$13 00
6502 Order 6500 and 6501	

NOTE: The boards found in this issue are also available, price on application.

Please rush me the following boards

Project board No.	Price
.....	\$
.....
.....

Allow a minimum of 4 weeks delivery
Price includes postage & packing
New Zealand, add \$1 to these charges

All cheques or money orders should be made payable to
Australian Electronics Monthly

Name

Address

Postcode

I enclose my cheque/money order for

Please tick payment method

Cheque/money order Bankcard Visa

Mastercard American Express

Card No Expiration

Signature

(Note Unsigned credit card orders cannot be accepted)

You can buy the boards at our offices if you wish, at any time during business hours. We're located at WB Building, Cnr Fox Valley Rd and Kiogle St, Wahroonga NSW, the entrance is in Kiogle St.

SUBSCRIBE NOW AND RECEIVE A SPECIAL FREE GIFT

When you subscribe to Australian Electronics Monthly, not only do you receive the brightest, most informative and most useful magazine around, but we'll give you a free gift of your choice!

Fill in the subscription form here, post it to us and we'll start your subscription from the next issue and send you your free gift.

GIFT CHOICE 1 NEW CHOICE



A pack of 23 selected 74LS ICs to the value of approx. \$27. This super pack contains the most common ICs, and are ideal for design, servicing, project construction etc.

GIFT CHOICE 2

A set of C. K. Allen Keys. Top West German quality.

These little beauties are always in need and come in nine different sizes.

They're ideal for

anyone with an interest in electronics.



Not actual size

GIFT CHOICE 3

Best quality West German screwdrivers from C.K.



We use these in our laboratory and consider them excellent as they are specifically designed for electronics requirements.

GIFT CHOICE 4 \$10 Gift Voucher

If you elect to take our Subscribers' Gift Voucher, you can use it to get a \$10 discount when you purchase any item or items by mail order or in-store from any of your favourite electronics or computer retailers honouring the voucher when you make a purchase in excess of \$20. This offer is currently available from Jaycar, All Electronic Components, Applied Technology and Magraths.

Please forward me 12 issues of Australian Electronics Monthly and the gift

GIFT CHOICE 1 GIFT CHOICE 2 GIFT CHOICE 3 GIFT CHOICE 4

All cheques or money orders should be made payable to
Australian Electronics Monthly Price for subscription is \$31 20

Please tick payment method
Cheque/money order Bankcard
Visa Mastercard American Express

Card No Expiration

Signature

(Note Unsigned credit card orders cannot be accepted)

Name

Address

Post Code

Allow a minimum of 4 weeks delivery of your gift

Build this courtesy light extender for your vehicle

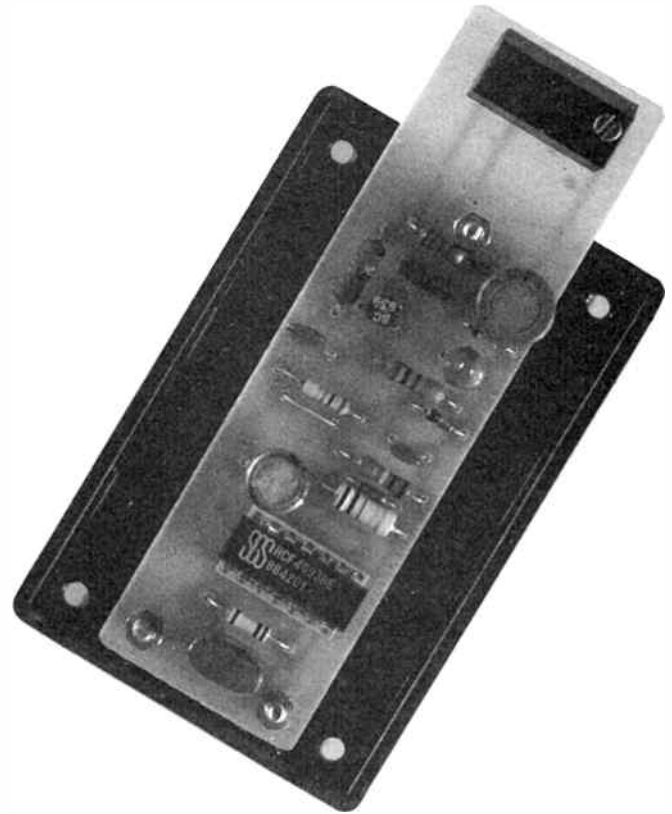

Keith Gooley – design
Roger Harrison – article

This project holds a vehicle's courtesy light on for a time after the doors have all been closed so that you have time to put the ignition key in the lock and get started at night before being plunged into darkness. It also gives you some light at night after you've locked and left your vehicle.

THE INTERIOR 'COURTESY' LIGHTS in vehicles are there to provide light when you're getting in or out in the dark. The problem is, once you're in or once you're out — you're in the dark again, and that can be mighty 'inconvenient'!

The idea of electronically holding the courtesy light on for a time once a door has been opened and then closed again is not new and one or two simple designs for courtesy light 'extenders' have been published over the years. However, such designs have provided limited hold-on periods of only ten seconds or less, which is inadequate under many circumstances — especially when it's raining.

This project provides a hold-on period for the courtesy lights of around 30 seconds. The period can be altered simply by altering the value of either of two components.

Features

The door-mounted switches are wired in the 'ground' lead of the courtesy lamp. When the door is opened, the switch is released, the contacts close and complete the circuit so that the lamp lights.

The general block diagram of the unit is shown here. Let us say the door is open and the light is on. When the door is closed, the switch opens. The trigger circuit senses the switch opening and sends a short pulse to the monostable period timer. This drives the transistor on for the predetermined period. As the transistor is in parallel with the door

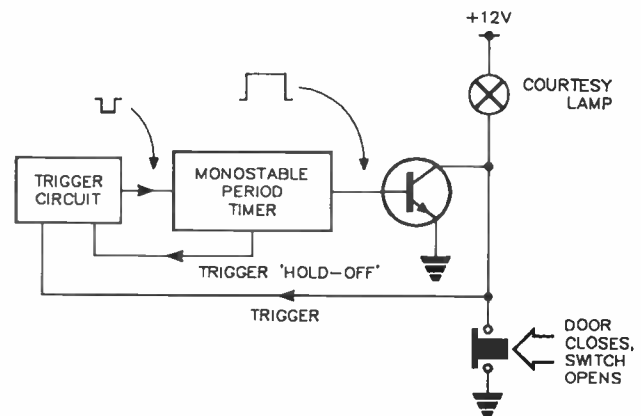

switch, the light is held on for that time. A trigger 'hold-off' signal generated by the monostable prevents the trigger circuit from setting off the period timer once again at the end of the period when the light goes off again.

With the components given in the parts list, the actual period is 26 seconds.

Protection against accidental reverse connection to the supply has been added to the circuit, as well as protection from transient voltage 'spikes' in the vehicle's electrical system damaging the semiconductors or triggering the unit when unwanted ('false-triggering').

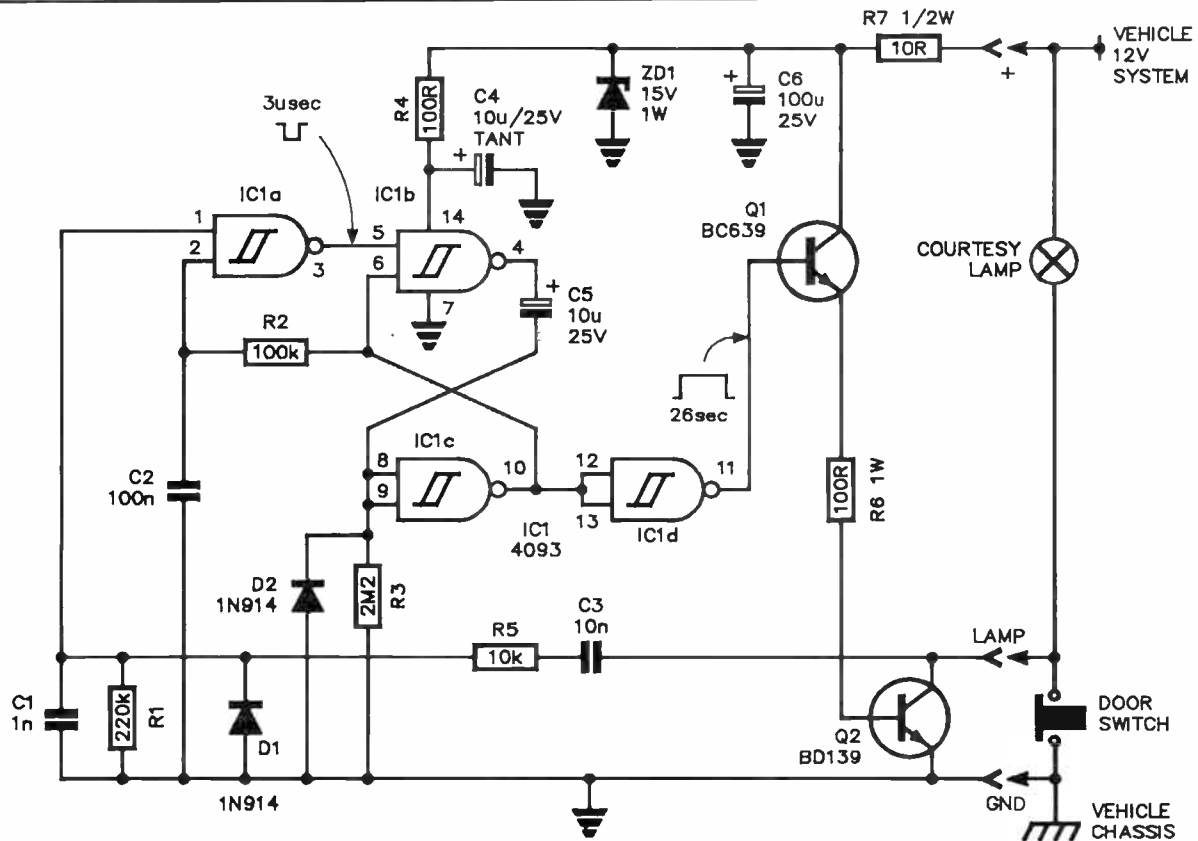

Construction

Although the project could be readily constructed on matrix board, we recommend you use the printed circuit design included here to eliminate the possibility of wiring errors and to ease construction.

The printed circuit board has been laid out to make construction and installation easy. A pc-mounted screw terminal block is positioned at one end of the board for wiring-in the unit to the vehicle. The board may be mounted in a low-cost jiffy box for protection, if you wish, and the box mounted in an out-of-the-way place beneath the dash.

Always visually check a pc board before assembly. Look for possible cracked tracks or smaller copper 'bridges' between close-spaced tracks and see that all the holes are drilled and of the correct diameter.

Assembly can be tackled in pretty well any order, though it's always best to leave the IC till last.

Solder the resistors and capacitors in place first, making sure you get the polarised capacitors the right way round. Then solder the diodes and transistors in place, also checking you get them the right way round. Solder the screw terminal block next, followed by the IC. The 4093 is a CMOS device and the usual precautions are recommended. Only handle the chip by the ends of the package, avoid touching the pins, and solder the common and supply pins first (pins 7 and 14, respectively, here).

The completed board can be mounted in the box, as shown. It's pretty simple. Note that the screw terminal block protrudes from the box to permit access for wiring it in.

CIRCUIT OPERATION

The heart of the circuit is a monostable multivibrator period timer, formed by gates (a) and (b) of IC1, a 4093 quad package NAND Schmitt trigger. The mono output, at pin 10, is inverted by gate (d), which drives the base of Q1. The emitter of Q1 drives the base of Q2, which is in parallel with the door switches. When pin 11 of IC1 is high, Q1 and Q2 are driven on and the light is held on. When the vehicle door closes, opening the switch, a positive-going pulse is applied to pin 1 of gate (a) in IC1 via C3/R5. Diode D1 clips off the negative-going pulse produced here when the door switch closes.

As a result of the door switch opening, a three millisecond long negative-going pulse is generated at the output of gate (a). This triggers the monostable and, after a short delay caused by R2/C2, pin 2 of gate (a) goes low, preventing that trigger pulse which occurs at the end of the timed period from retriggering the monostable. The monostable period is determined by C5/R3. Varying either will vary the the period.

The zener, D3, in conjunction with the resistors and capacitors on the positive supply rail, prevent voltage transients on the vehicle's electrical system from possibly damaging the semiconductors or false-triggering the mono and turning the courtesy light on when you don't want it.

The BD139, Q2, is simply used as a switch and no heatsink is necessary.

LEVEL

We expect that hobbyists who are

BEGINNERS

in electronics construction should be able to successfully complete this project

NOTE: This project is designed for use in NEGATIVE EARTH vehicles only.

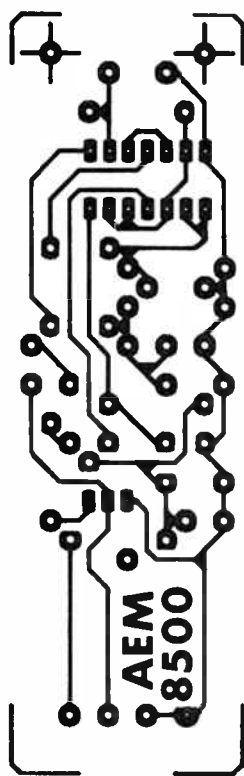

Full-size reproduction of the printed circuit artwork.

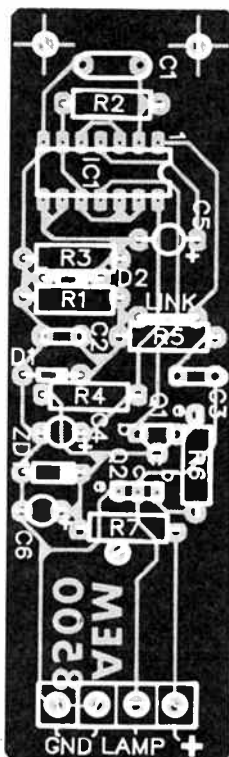

Component overlay.

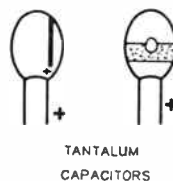

AEM8500 PARTS LIST

Semiconductors

D1, D2	1N914, 1N4148
IC1	4093
Q1	BC639
Q2	BD139
ZD1	15 V, 1 W zener

Resistors

	all 1/2 W, 5% unless noted
R1	220k
R2	100k
R3	2M2
R4	100R
R5	10k
R6	100R, 1 W
R7	10R

Capacitors

C1	1n poly.
C2	100n poly.
C3	10n poly.
C4, C5	10u/25 V tant.
C6	100u/25 V electro.

Miscellaneous

AEM8500 pc board; one 4-way pc mount screw terminal block; jiffy box 83 x 54 x 28 mm; sufficient 14 x 0.2 mm hookup wire to wire-in the unit.

Expected cost: \$13-\$15

SEE 'RETAIL ROUNDUP' FOR A GUIDE TO KIT SUPPLIERS WHO MAY STOCK THIS PROJECT

Wiring it in

It's usually best to temporarily wire-in a unit such as this and try it out before making a more permanent installation so that any problems that might arise can be readily sorted out.

Before commencing, to prevent accidental shorts of the vehicle's electrical system (which can have disastrous effects on the wiring, not to mention being dangerous), disconnect the positive (red) lead at the battery.

Identify where the 'ground' lead from the courtesy light comes through the vehicle's wiring harness to hook up to the leads from the door switches. This point is wired to the terminal marked LAMP. Next find a suitable point to connect the project's GND (ground, or chassis) terminal to the chassis of the vehicle. Last, find a convenient point to wire the terminal marked '+' to the positive side of the vehicle's electrical system.

Close all the doors, reconnect the battery and try out your courtesy light extender. Just get in the car and close the door. The light should stay on for around 26 seconds.

If you have any problems, disconnect the project and check for component or assembly faults. You may also have wired it in improperly. Having corrected any problems, temporarily wire-in the unit and try it again. If, or when, all's well the board can be housed in its box and permanently mounted wherever you've determined it should go.

You can increase or decrease the hold-on period by increasing or decreasing the value of either R3 or C5. Using the next-highest standard value of R3 (2M7) will increase the period a few seconds, dropping it one standard value (to 1M8) will decrease the period some seconds.

The finished product. Assembly is very simple. Note that the end of the board protrudes from the box in which it is housed.

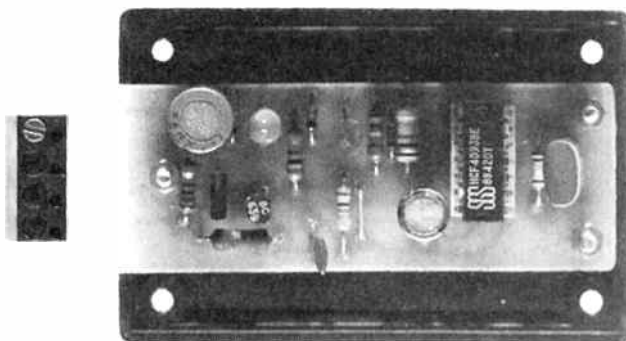
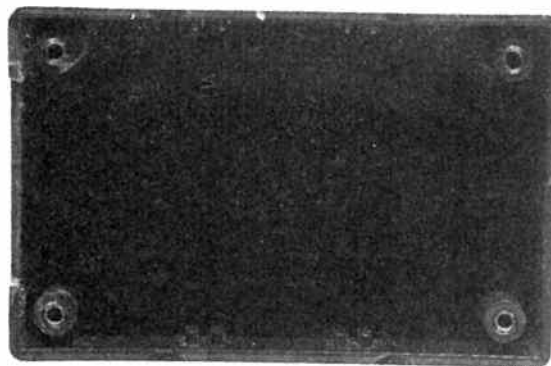

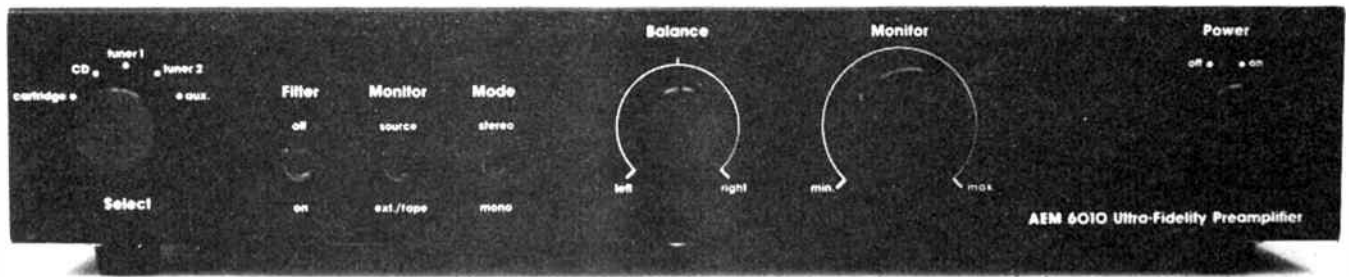

An 'ultra - fidelity' preamplifier

Part 2
David Tilbrook

This article concludes the description of the AEM6010 preamplifier design. In Part 1, published last month (October, 1985) the low level amplifier stages were described in detail. This month we describe the construction of the remaining electronics.

THE COMPLETE PREAMP CIRCUIT diagram is shown here in Figure 7 (Figures 1-6 are included with last month's article) while Figure 8 shows the circuit diagram for the power supply and relay muting circuitry.

The overall gain of the preamplifier is incorporated into two broad stages. The first of these is the low level amplifier stage which was described in detail in last month's article. The second gain stage is the line amplifier which has a flat gain of around 9.3. The line amplifier circuitry is based around the discrete amplifying stage that was developed for use in the AEM6010, which was described in last month's article. This stage provides the gain necessary to ensure the correct nominal output signal voltage (1 V RMS) when the preamp is driven from standard high level sources. The input impedance of this stage is around 470k, which is high enough to prevent excessive loading of the monitor volume control. The input bias current of this stage has been optimised for best possible noise performance when driven from the source impedance formed by the balance and volume potentiometers. The source impedance, of course, will vary depending on the position of the potentiometer wipers so the bias current must be a compromise.

The preamplifier assembly comprises four printed circuit boards. The first of these is the low-level amplifier stage described previously. The bulk of the remaining electronics is mounted on the line preamplifier pc board. The board contains the line amplifier stages, the electronics for the regulated power supplies and the relay muting circuitry. The two remaining circuit boards hold the components for the front and rear panels of the preamp. Some of the interconnections between these pc boards must be made using shielded cable to obviate susceptibility to hum pick-up. No power transformer is included in the preamplifier chassis to minimise any possibility of hum pick-up. The low voltage ac supply required by the preamp must be supplied either by the accompanying power amplifier or by a power transformer mounted in a separate chassis and this technique is a major contributor to the excellent hum and noise figures.

The source selector switch, SW3, is a six-position two-pole Lorlin rotary switch with make-before-break contacts and is in common usage, so availability should present no problems. A more expensive switch, possibly incorporating separate wafers for separate channels, could be used if desired. The switch used, however, was found to give impeccable performance. These switches, manufactured by C&K, are available in two types. The most common seems to be that supplied with solder lugs rather than the pc mount pin types. If you can only obtain the solder-lug type of switch these can be used simply by cutting off the ends of the pins with a pair of sidecutters. There is, however, only just enough pin left to pass through the pc board and leave a sufficient length of pin to solder to, so ensure that the cut is made as closely as possible to the solder eye.

This rotary switch, the power switch and the toggle switches are soldered directly to the front panel pc board. The remaining two front panel controls, the balance and volume control potentiometers are bolted to the pc board. Being dual-gang pots, the set of lugs closest to the board are soldered directly to the pads, the other lugs being wired to their pads using short lengths of hookup wire.

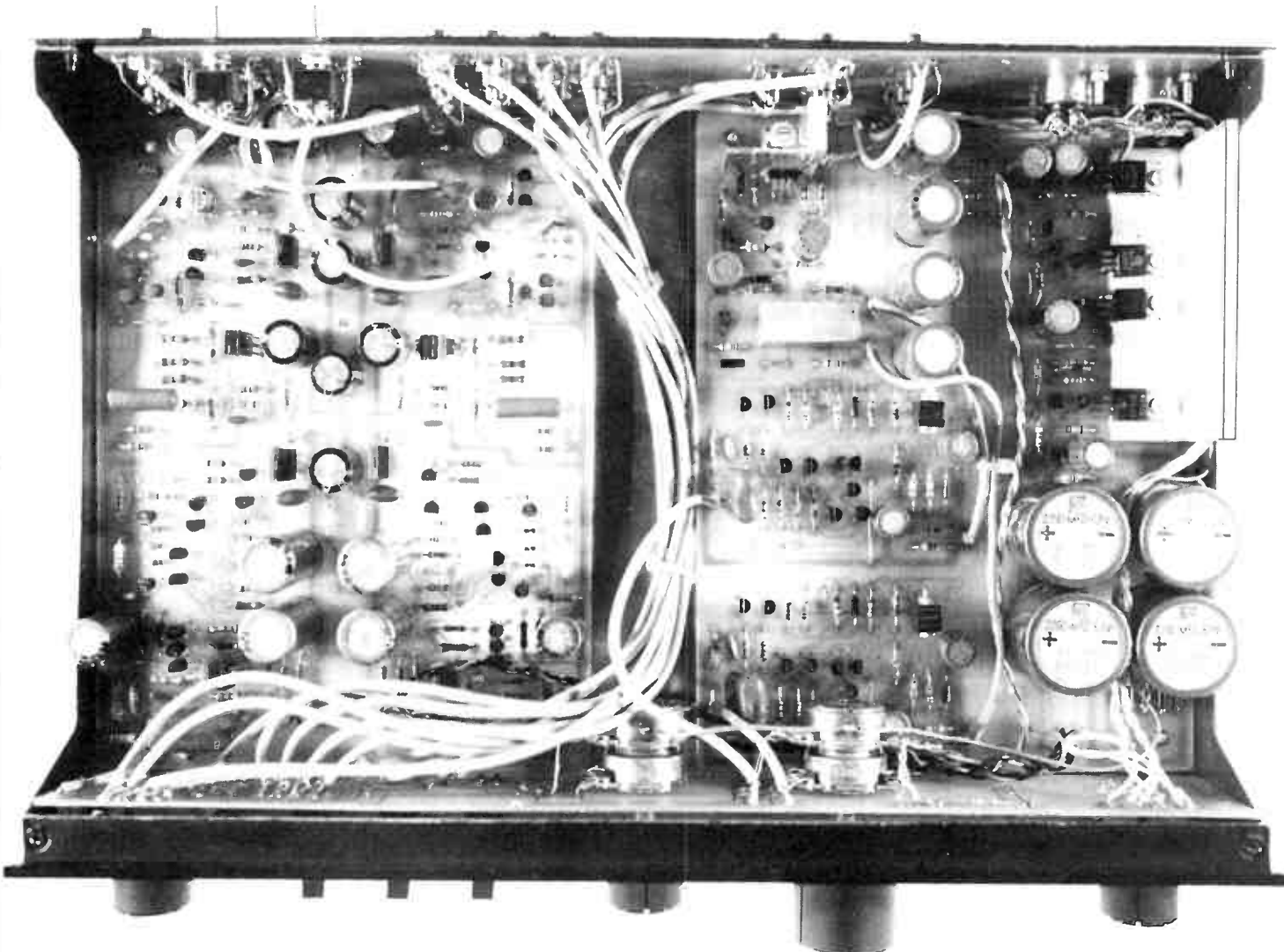

The extensive use of pc boards throughout this design helps to ensure maximum ease of construction and certainly reduces the possibility of incorrect earth wiring, one of the major constructional causes of poor performance in audio circuitry.

All of the inputs are tied to ground with resistors which maintain the dc voltage on these inputs at 0 V. Without these the different inputs can establish themselves at a non-zero dc voltage level. In this case, the preamp will generate a large transient voltage spike when the selector switch is operated which manifest itself as a loud thump in the loudspeakers.

The output of the selector switch is fed to the source/tape monitor switch via 1k resistors R63 and R163. The 1k resistors are also included in series with the tape/extension monitor input. These resistors serve to prevent excessive loading of the inputs when the mode switch is in the "mono" position. The output of the tape/extension monitor is fed to the balance and volume control potentiometers. The balance control consists of 100k linear dual potentiometer wired so that opposite ends of each half of the pot are grounded. This type of balance control was chosen because it enables the signal earths of each channels to remain isolated at this point.

Earthing essentials

This technique of isolating the signal earth points of the channels is essential if good channel separation is to be maintained. Remember that when we speak of a signal voltage we are referring to a potential difference, i.e: a difference in potential between two points. The second reference point

is usually what is referred to as the "earth". The problem is that in the real world there is no such thing as "earth". Every piece of hookupwire or length of copper pc board track has a finite, measurable resistance. Currents flowing in these conductors will generate potential drops across the ends of the conductors. An "earth" track, for example, that returns current to the centre tap of a power transformer from a pair of filter capacitors and bridge rectifier will have 100 Hz current pulses flowing in it when a 50 Hz supply is used. This current causes a 100 Hz voltage to be developed across the ends of the conductor. If any point along this conductor is "defined" to be the point we will call the earth then no other point on that wire will be at the same potential and hence no other point should be called the earth.

It is a recognition of this fact that gives rise to the so called "single-point" earthing schemes so often mentioned. The employment of a single-point earthing scheme, however, is not sufficient on its own to ensure effective earthing to minimise distortion or even to remove hum problems. The essential point to realise is that voltage is a measure of *potential difference*. It is as important to signal quality to ensure the integrity of signal earth line as it is to ensure the integrity of the "active" signal line.

In the AEM6010 this is done by maintaining the signal active and earth lines as a pair throughout the entire gain chain within the preamp. The signal earth lines of the two channels are isolated from each other and from all power supply 0 V lines until the output sockets. At this point the two channels are joined and connected to the power supply ►

NB. LEFT CHANNEL ONLY SHOWN. COMPONENTS FOR THE RIGHT ARE NUMBERED R101, C101, D101, Q101 etc.
 R2, R9, R24, R53 AND C24 ARE MOUNTED EXTERNALLY TO THE PC BOARD
 * DENOTES COMPONENTS USED TO GENERATE THE RIAA EQUALIZATION.
 1% COMPONENTS SHOULD BE USED.
 ⇨ SOLDERED ON THE REAR OF THE PC BOARD

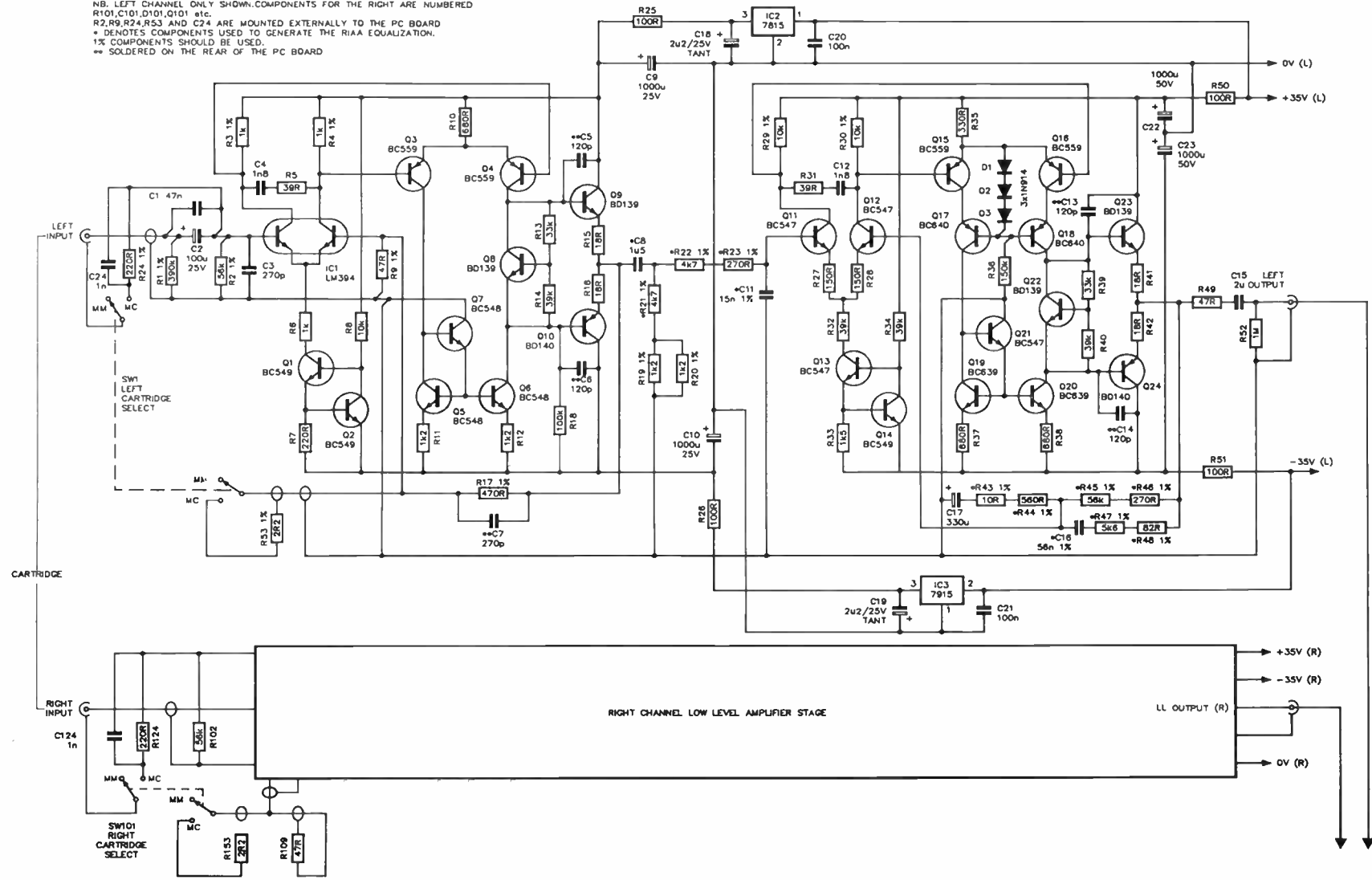

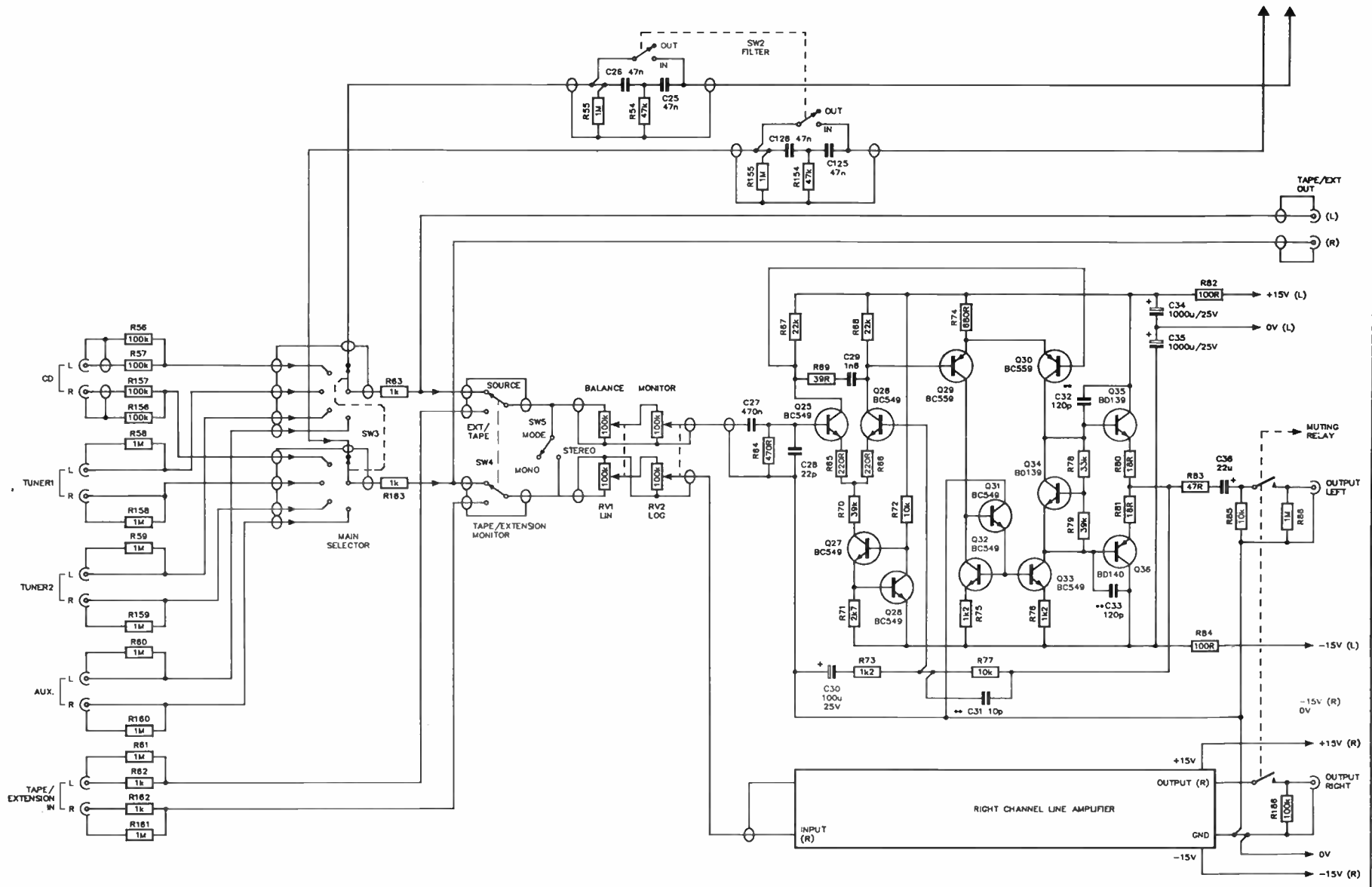
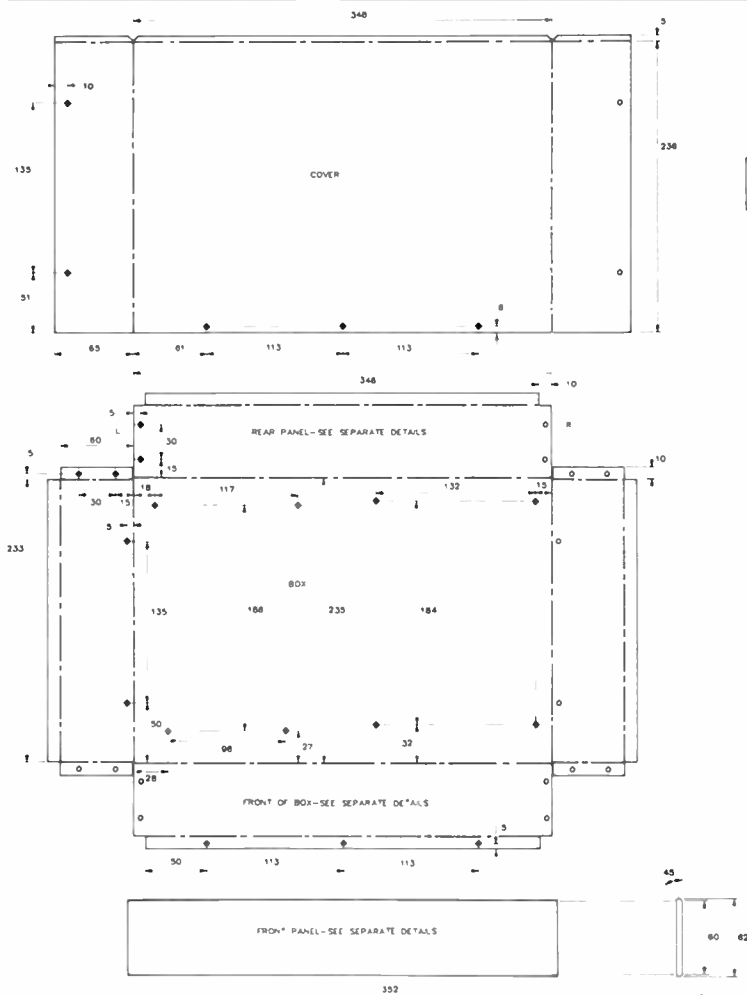
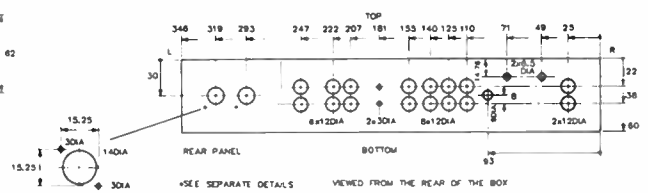
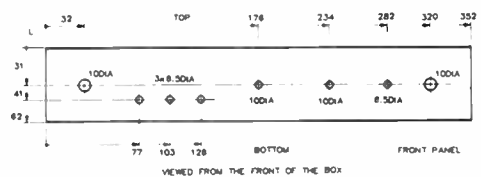
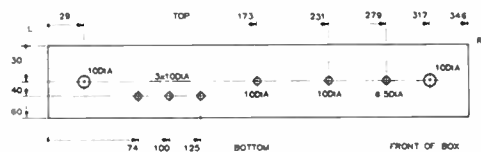
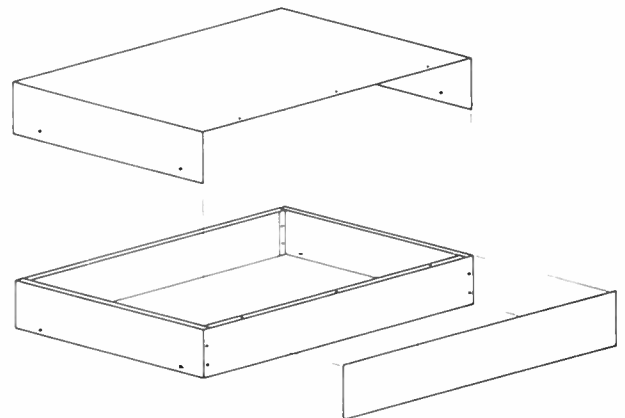

Figure 7.



CASE DRAWINGS, SHOWING ALL DIMENSIONS AND DRILLING DETAILS. THE PROTOTYPE WAS KINDLY SUPPLIED BY DICK SMITH ELECTRONICS.



earth point. This combination of single-point earthing and active/earth pair maintenance ensure that the AEM6010 is free of hum and enables the excellent noise and distortion performance of the active gain stages to be utilised freely.

Muting

As mentioned in Part 1, one of the important parameters in terms of the acoustic performance during the development of this preamp was found to be output impedance. Correspondingly, the active stages were designed with very low output impedance and this provided some problems in relation to the output muting system employed.

Output muting is needed in almost all audio systems to overcome the problem of turn-on and turn-off thump. Some integrated designs tend to provide relay switching for the output of the power amplifier. This is only necessary in discrete preamp-power amp combinations however, if the power amplifier generates a turn-on or turn-off thump. The AEM6500 general purpose power amp modules, for example, are not provided with output relay muting because their topology ensures that they do not generate a turn-on or turn-off thump when connected to any reasonably sized filter capacitors. Usually, it is the preamp which will generate most of the thump due to the large amounts of voltage gain following it in the power amp.

To overcome these problems the 6010 is provided with output muting which disconnects the power amps from the preamplifier output at turn-on until the preamp power supply has had time to settle, and immediately the power switch is turned-off, before the preamp power supply begins to drop.

In past designs I have tended to use active muting transistors which shorted the output of the preamp to prevent it being driven into overload during turn-on or turn-off. The "problem" mentioned before arises due to the very low output impedance of the line amplifier stage. Since any output-shorting transistor has a finite on-resistance the source resistance must be high enough to allow the on-resistance of the transistor to appear as an effective short when the output muting is activated. This is not the case with the 6010 output stage. The very low output impedance prevents this scheme from working effectively. As mentioned above, the output muting in the AEM6010 is achieved by the use of a relay in series with the output. Rather than shorting the output to ground when the muting is activated the relay open-circuits, disconnecting the line amplifier stage from the preamp output terminals.

Construction

Commence the construction by assembling the 6010LL pc board described in last month's issue (October 1985) following the instructions detailed in that article.

Next assemble the line amplifier pc board which contains the two line amplifiers, power supply and relay muting circuitry. This pc board contains two triple-sets of transistors as used on the low-level pc board. Apply the same procedure

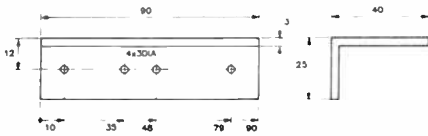

HEATSINK FOR SUPPLY REGULATORS.

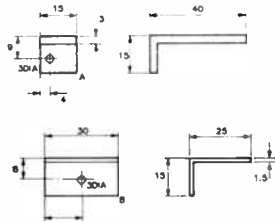

HEATSINK FOR Q37

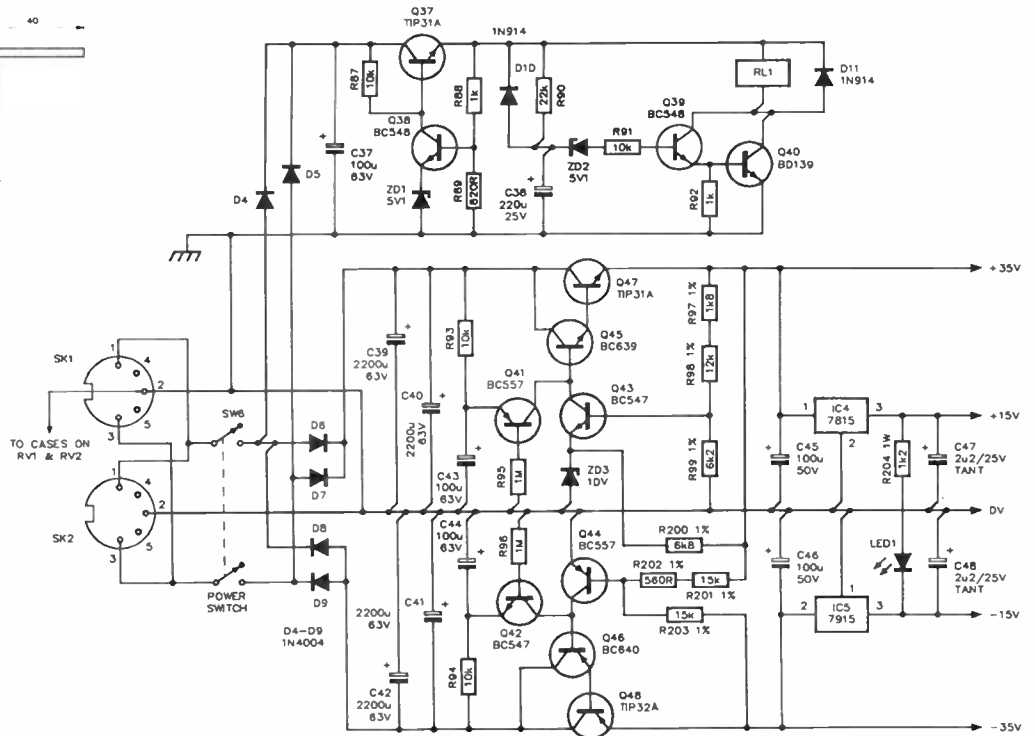

when mounting these sets of transistors as that described in Part 1. This pc board also contains the heatsink for the power supply pass transistors and the positive and negative voltage regulators. The heatsink can be fabricated from a length of aluminium extrusion. A drawing showing the cutting and drilling details has been included with the article.

The centre lead of the two power supply pass transistors and the two voltage regulators is connected internally to the metal base of each transistor. Accordingly, the metal base of each of these devices must be electrically insulated from both the metal heatsink and the mounting screw to prevent shorting of the devices to each other. This is achieved through the use of special insulating washers and mounting bushes. To improve heat conduction across the metal/insulator interface a small amount of heat-sinking compound is applied to all surfaces before bolting the devices in place. The best order in which to mount these devices is to start by measuring the length of lead and bending the leads at the appropriate place. Insert the leads through the pc board but do not solder in place until later. Bolt the devices into place using insulated washers as discussed above. Using a multimeter,

check that no short exists between the centre lead of each device and the heatsink. If all is well, solder the leads in place and trim off the excess with a pair of side cutters.

The usual precautions should be employed when constructing the rest of this board. It is wise to solder the smaller and more robust devices first, such as the resistors and non-polarised capacitors. These devices are less likely to be damaged while subsequently soldering the remaining components in place and are small enough so that they tend not to get in the way during the later stages. As always, be careful with the orientation of the polarised components such as electrolytic capacitors and diodes. These two-legged devices are particularly easy to insert the wrong way around and will often be destroyed if powered up in this condition.

Note that capacitors C31, C32, C33, C131, C132 and C133 are soldered on the track side of the pc board.

The front panel pc board contains the main selection switch as discussed above. The three toggle switches are soldered directly to the pc board as is the 4-pole Lorlin rotary switch used as the power switch. As discussed above, the pots are bolted to the pc board and wired in circuit with short links.

...continued next month.

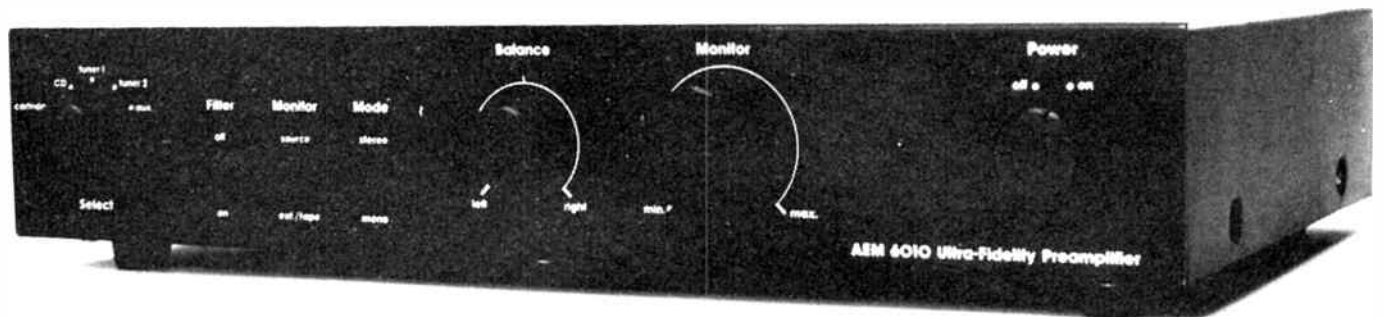

LEVEL
We expect that constructors of an
INTERMEDIATE
level, between beginners and experienced
persons, should be able to successfully
complete this project.

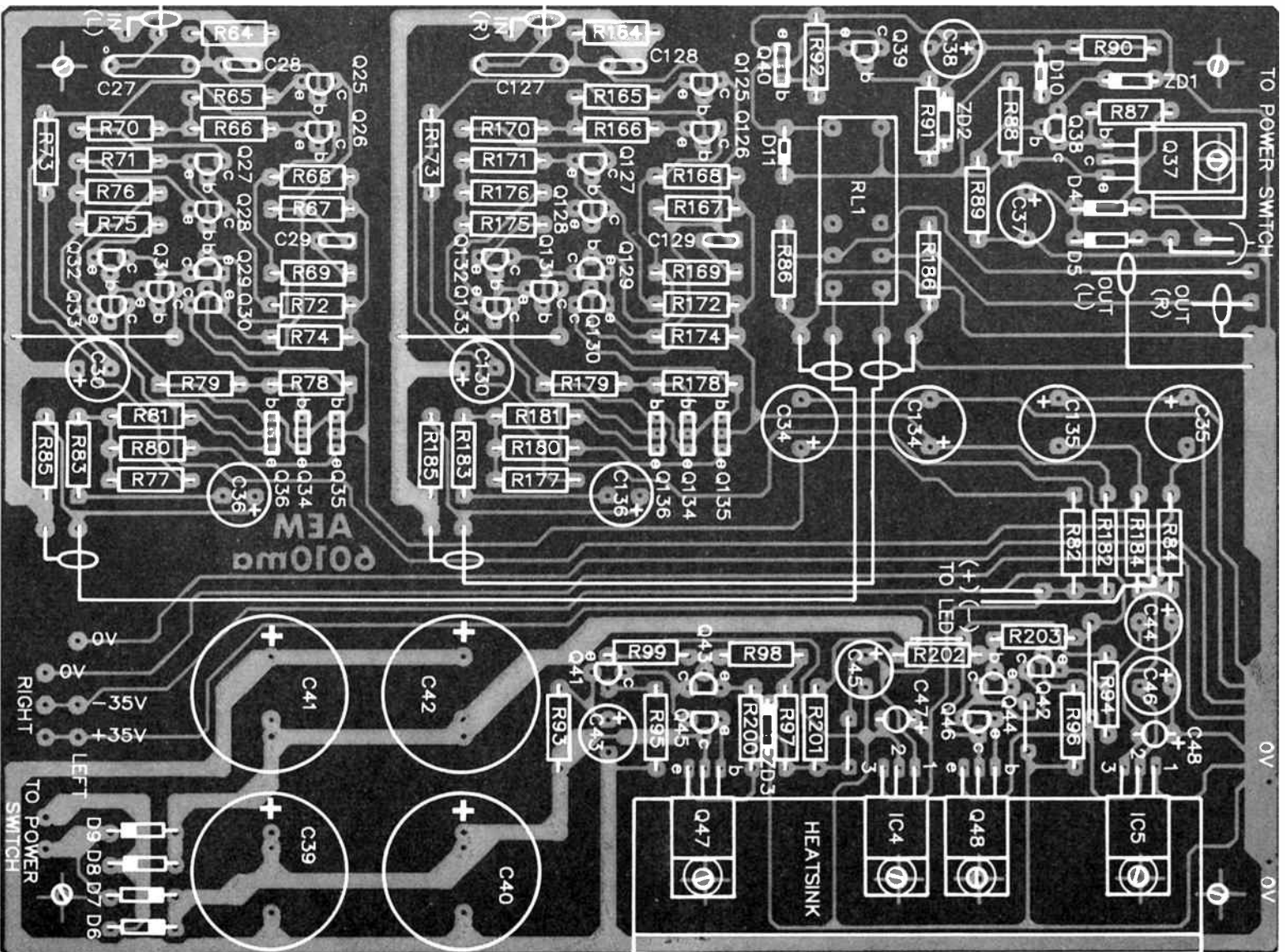

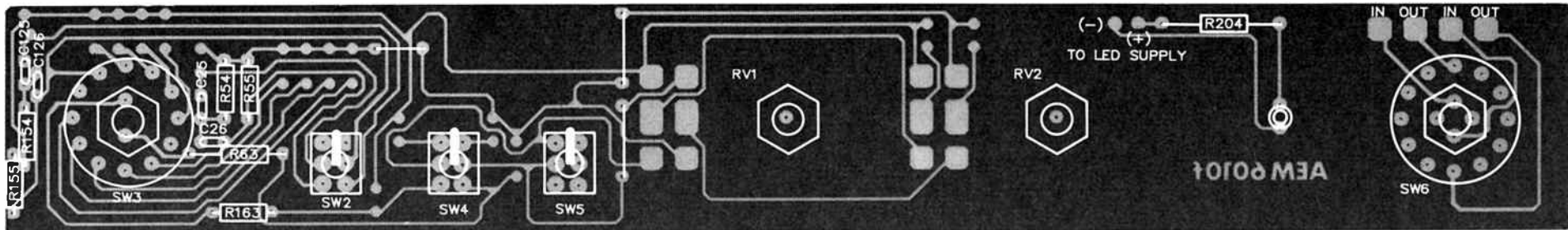

ABOVE: FRONT PANEL BOARD, LOOKING AT THE COMPONENT SIDE

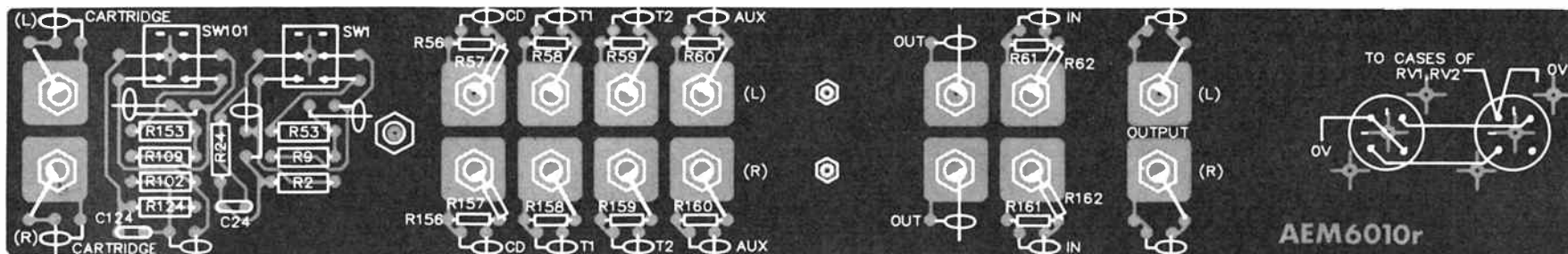

ABOVE: REAR PANEL BOARD, LOOKING AT THE COPPER SIDE.

AEM6010MA F, R PARTS LIST

Semiconductors

Q25, Q125,	
Q26, Q126	BC549C
Q27, Q127,	
Q28, Q128	BC549
Q29, Q129,	
Q30, Q130	BC559C
Q31, Q131, Q32, Q132	
Q33, Q133	BC549
Q34, Q134,	
Q35, Q135	BD139
Q36, Q136	BD140
Q37	TIP31A
Q38, Q39	BC548
Q40	BD139
Q41	BC557
Q42, Q43	BC547
Q44	BC557
Q45	BC639
Q46	BC640
Q47	TIP31A
Q48	TIP32A
IC4	7815
IC5	7915
D4, 5, 6, 7, 8, 9	1N4004

D10, D11	1N914
ZD1, ZD2	5V1, 1 W Zener
ZD3	10 V, 1 W Zener
LED1	TIL220R red LED

Resistors

All 1/4W, 5% unless noted.

R54, R154	47k
R55, R155	1M
R56, R156,	
R57, R157	100k
R58, R158, R59, R159	
R60, R160,	
R61, R161	1M
R62, R162,	
R63, R163	1k
R64, R164	470k
R65, R165,	
R66, R166	220R
R67, R167,	
R68, R168	22k
R69, R169	39R
R70, R170	39k
R71, R171	2k7
R72, R172	10k
R73, R173	1k2
R74, R174	680R
R75, R175,	
R76, R176	1k2

R77, R177	10k
R78, R178	33k
R79, R179	39k
R80, R180,	
R81, R181	18R
R82, R182	100R
R83, R183	47R
R84, R184	100R
R85, R185	10k
R86, R186	1M
R87	10k
R88	1k
R89	820R
R90	22k
R91	10k
R92	1k
R93, R94	10k
R95, R96	1M
R97	1k8, 1%
R98	12k, 1%
R99	6k2, 1%
R200	6k8, 1%
R201	15k, 1%
R202	560R, 1%
R203	15k, 1%
R204	1k2, 1 W
RV1	100k/A dual
RV2	100k/C dual

Capacitors

C25, C125,	
C26, C126	47n greencap.
C27, C127	470n greencap.
C28, C128	22p ceramic.
C29, C129	1n8 greencap.
C30,	
C130	100u/25 V RB electro.
C31, C131	10p ceramic.
C32, C132,	
C33, C133	120p ceramic.
C34, C134, C35,	
C135	1000u/25 V RB electro.
C36,	
C136	22u/25 V RB electro.
C37	100u/63 V RB electro.
C38	220u/25 V RB electro.
C39, C40, C41,	
C42	2200u/63 V RB electro.
C43, C44	100u/63 V RB electro.
C45, C46	100u/50 RB electro.
C47, C48	2u2/25 V tant.

Miscellaneous

SW2, SW4, SW5 . . . DPDT min. toggle, C&K type 7201 L40 with black lever handles part no. 48102 and black dress ring type 7099 blk.

SW3 . 2-pole, 6-pos. Lorlin rotary switch (make before break).
SW6 . 4-pole, 3-pos. Lorlin rotary switch.

RL1 . . . DPDT 'standard relay' (e.g. DSE cat. no. S7130).

SK1, SK2 5-pin DIN sockets.

SK3, SK103, SK9,
SK109 chrome RCA sockets.

SK10, SK110 gold RCA sockets.

AEM6010MA, AEM6010F,
AEM6010R pc boards; two aluminium angle heatsinks (as per drawings); 3 x 22 mm dia. black aluminium knobs; 1 x 30 mm black aluminum knob; length of shielded cable unbraided shield type 4 mm dia.; hookup wire; chassis (as per drawings); 26 sets 12 mm x 6 BA bolts and nuts; 8 x 6 mm spacers; 5 x T0126 transistor insulating sets; 1 x 5-pin DIN plug.

Expected cost:
\$175-\$195.

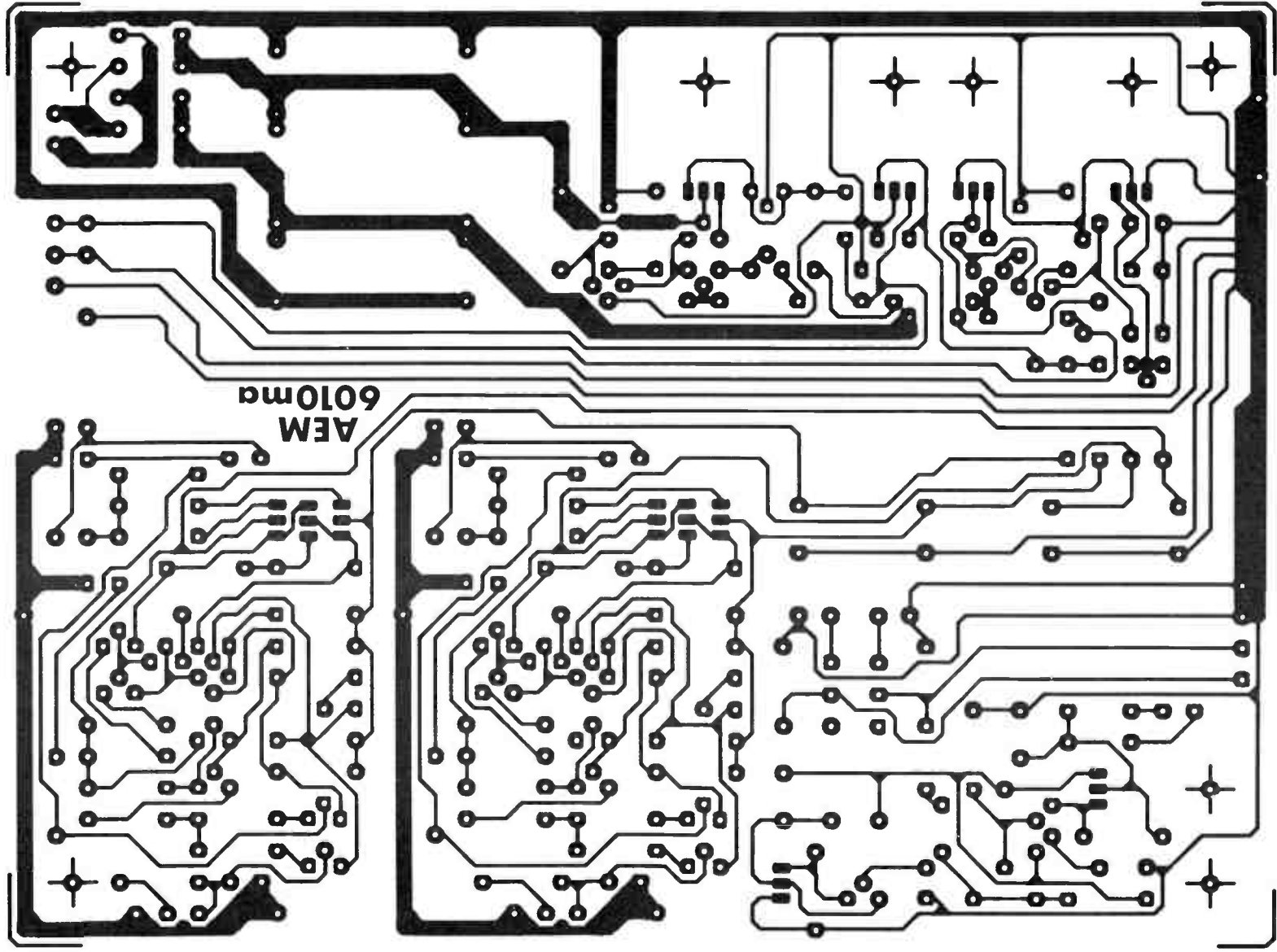

AEM
6010mc

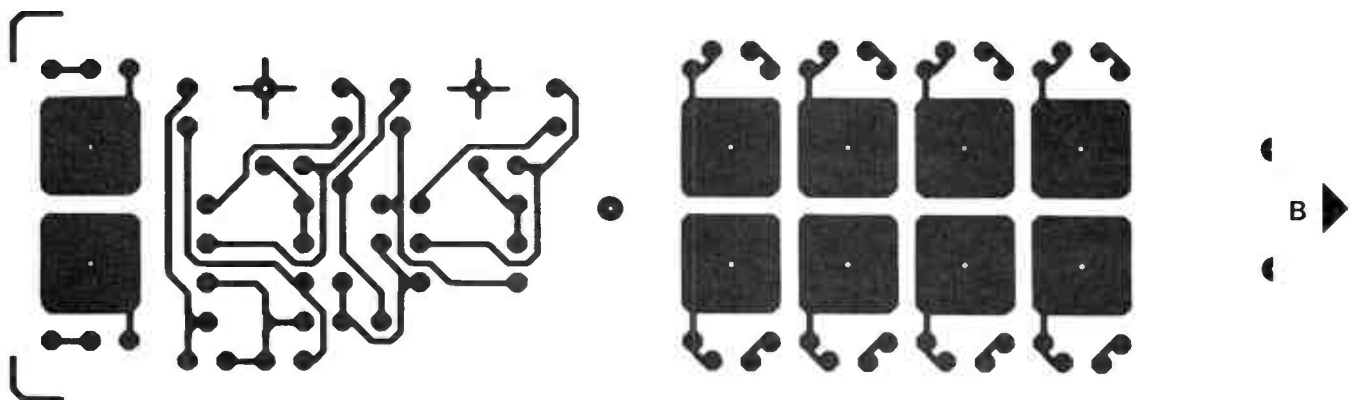
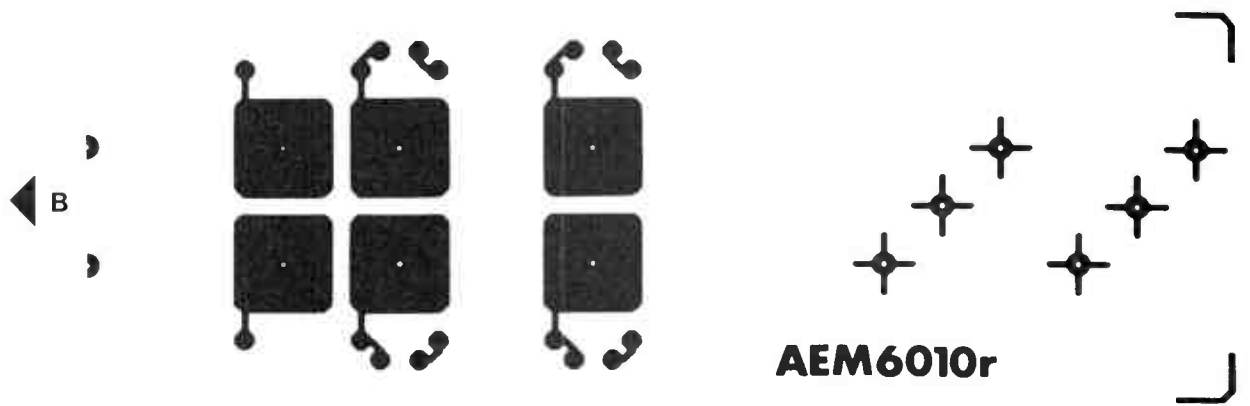
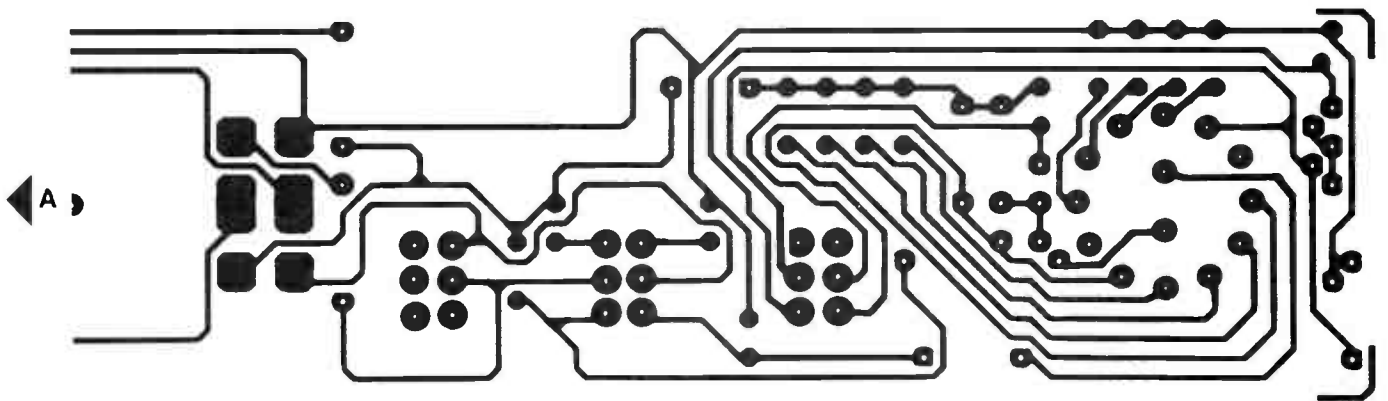
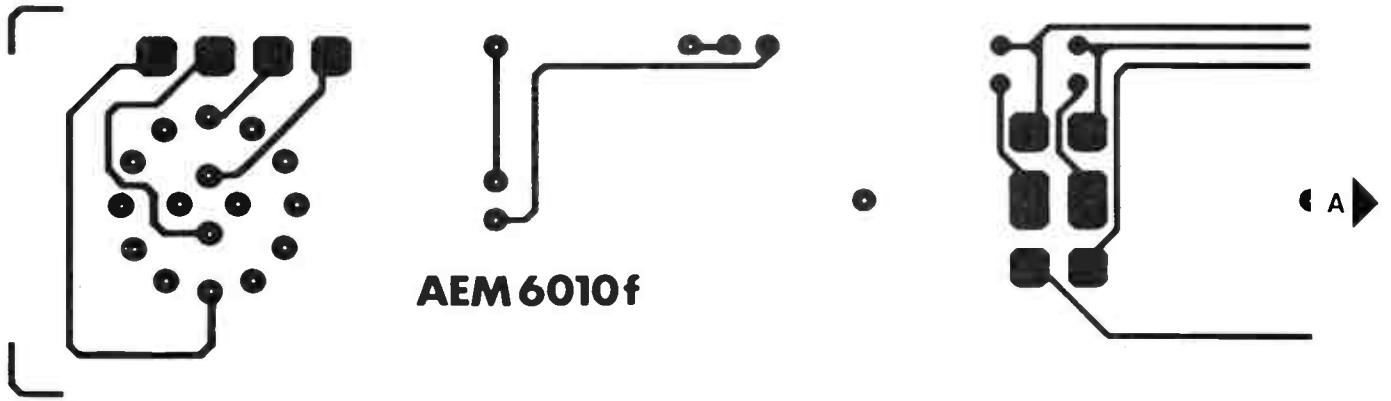



A simple, reliable 30 watt public address amplifier

Giuseppe Iacusso

For Altronics, Perth WA

This economical PA amp features: 100 V balanced line output, provides for input from either balanced or unbalanced low impedance mics, auxiliary channel input for music programmes (e.g: from a cassette player), aux. channel muting when paging and tone controls on the aux. channel. It has ample output to suit use in paging applications for schools, sporting clubs, function centres, etc.

AMPLIFIERS EMPLOYED in public address (PA) systems operate in an environment that is a lot harsher than the average domestic hi-fi amplifier experiences. PA systems commonly comprise multiple speakers located at different points around an installation, driven from a "100 v line output". This provides a pretty-well constant voltage output, up to the output power limit, and ensures each speaker provides the required output, no matter how many may be on-line or off-line at any time.

The problem is, a speaker reticulation system like this can present a widely varying load to the amplifier and the output stage must have a wide safe operating area (SOAR) margin to cope. A good design should cope with shorts on the line or an open-circuit line (no load) without distress. In

addition, the amplifier's feedback circuitry also must be designed to cope with the widely varying conditions it will encounter in order to maintain the equipment's performance.

Looking at the other end of the system, the microphone may be located well away from the amplifier, requiring a long mic lead to the input. This is asking for trouble in big heaps! Hence, low impedance balanced mics and lines are used to obviate hum and noise pickup.

From years of experience in the PA business, a few circuit types have proven their worth in the conditions encountered, hence there are 'favourite' circuit topologies often seen in PA systems. This design maintains the tradition. It features a balanced, low impedance mic input with a 'hum nulling' (common-mode rejection) trim adjustment. The output stage employs a push-pull configuration with balanced, transformer drive to the 100 V line using a pair of high-SOAR 2N3442 bipolar transistors from RCA. Push-pull feedback is employed.

As a built-up unit (the Altronic A2000), this PA has been installed in a wide variety of venues and proved a reliable performer.

LEVEL

We expect that constructors of an **INTERMEDIATE** level, between beginners and experienced persons, should be able to successfully complete this project.

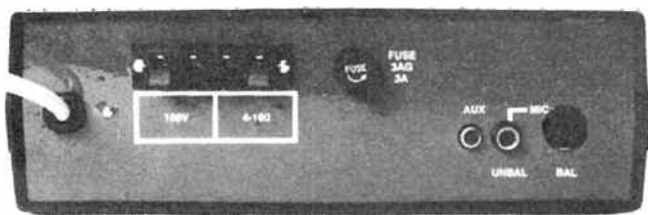
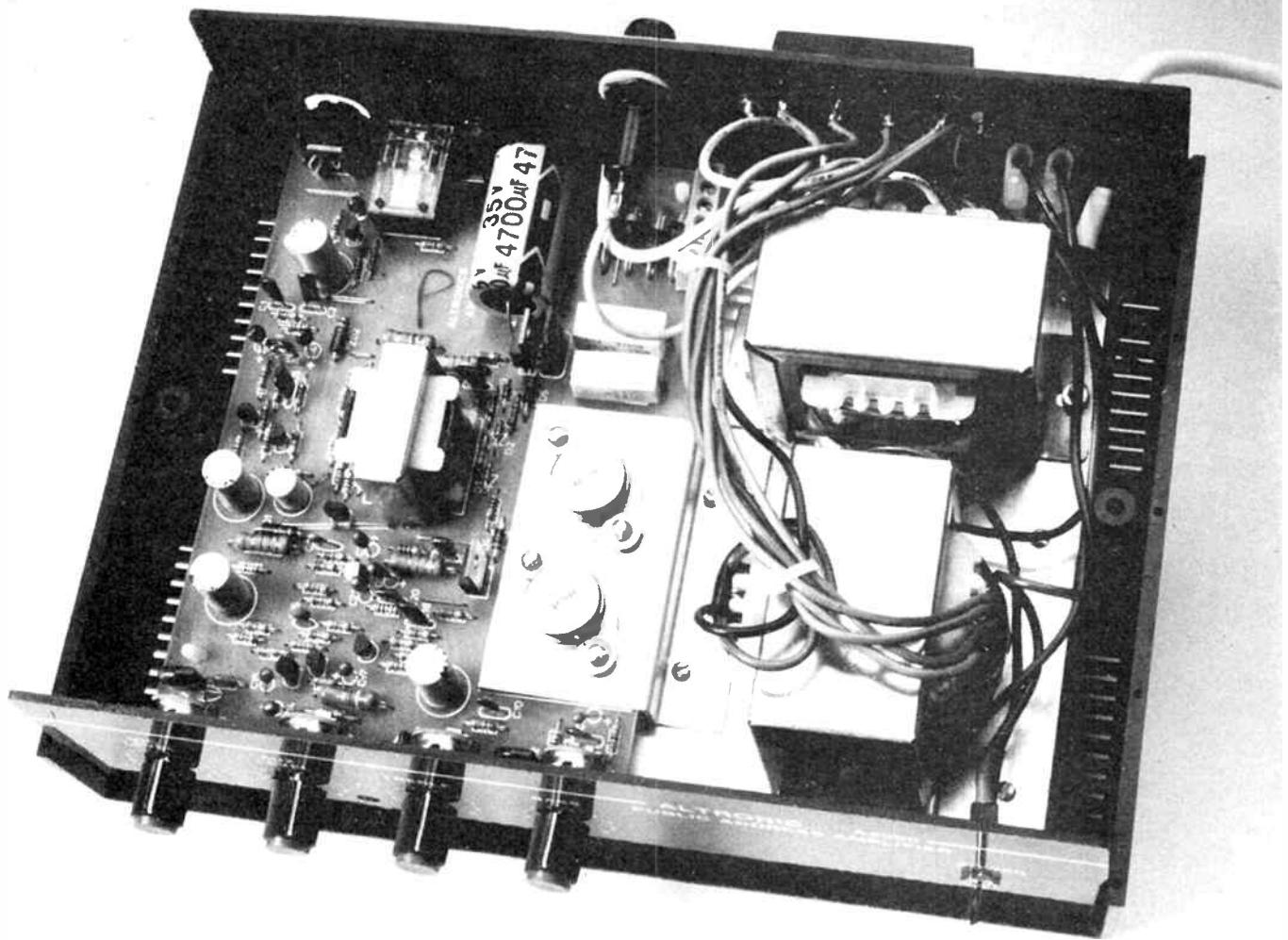

Constructionally, the amplifier has been designed for easy assembly. It is housed in a large size, black plastic (H0482) instrument case. All the electronics is contained on a single pc board, save the output and mains transformers. A baseplate almost the same size as the internal area of the case, having a small bent-up lip along one edge for stiffness, is screwed to the bottom of the case to strengthen it and prevent warping. The mains and output transformers, and the printed circuit board, mount to this baseplate. A small double-bent aluminium plate, bolted beneath the output transistors and also to the baseplate (see the internal picture), is used to thermally couple the output transistors to the baseplate for heatsinking.

The potentiometers and indicator LED mount to the pc board and simply protrude through holes in the front panel, while the input sockets are also pc mounted and protrude through holes in the rear panel. Only the mains on/off switch

SPECIFICATION A2000 PUBLIC ADDRESS AMPLIFIER

Power output	30 W RMS into 4 ohms or 100 V line
Output facilities	Hi-Z: 100 V line, balanced Lo-Z: 4-16 ohms
Mic inputs	50-600 ohms balanced (5-pin DIN, mic — pins 1/3; GND — pin 2: aux channel muting — pins 4/5) 50-600 ohms unbalanced (6.5 mm switched jack)
Auxiliary input	line level, 100k (RCA socket)
Distortion	THD typically less than 1% at rated output
Frequency response	60 Hz to 12 kHz (-3 dB)

This month's ★ Star Project ★ is from Altronics who will be marketing complete kits, available at their store, 105 Stirling St, Perth or mail order to PO Box 8280, Stirling St, Perth 6000 WA. (008) 999 007.

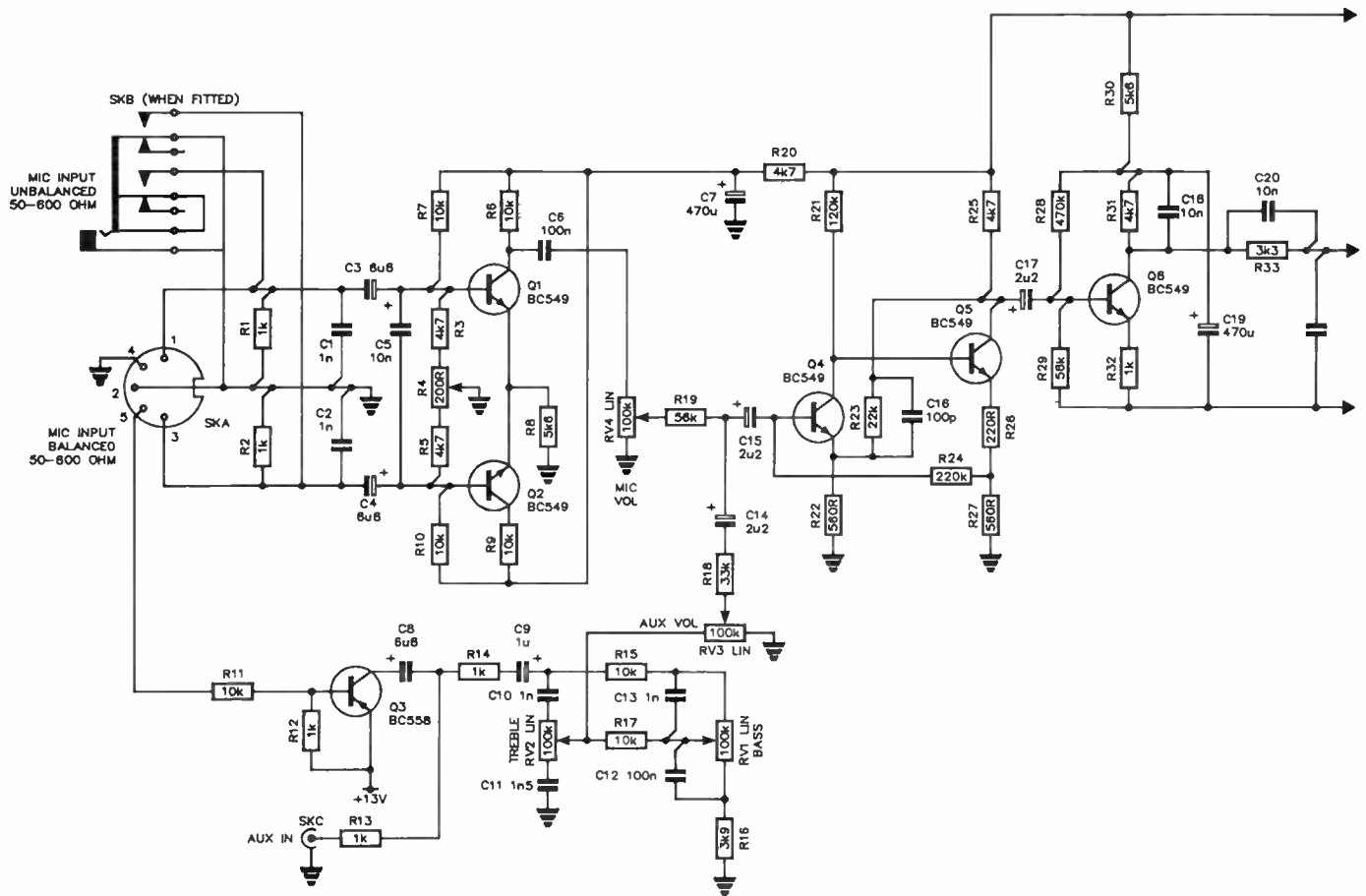

CIRCUIT OPERATION

The mic input stage has a balanced, push-pull input and a single ended output. It comprises Q1, Q2 and surrounding components. The MIC LEVEL control, RV4, is on the output from this stage. The input impedance is essentially determined by R1 and R2. The common-mode rejection can be adjusted via the trimpot R4, which is part of the input biasing network. When an unbalanced mic is used, the switch on the 6.5 mm jack, SKB, shorts the input to Q2 and connects the mic to the input of Q1.

A long-tailed pair, comprising Q4-Q5 and associated components, follows the mic level control, and provides most of the voltage gain. This stage then drives a low gain common emitter stage (Q6), the output of which drives a phase-splitter (Q7). The phase-splitter outputs drive a push-pull penultimate driver stage, comprising Q8-Q9, which is transformer-coupled to the output stage via TR1.

The final stage employs a push-pull Darlington configuration, the collectors of this stage being transformer-coupled to the output via TR2, providing a balanced, 100 V line output. An additional winding on TR2 provides a low impedance output.

Note that Q8-Q9 in the penultimate driver stage are PNP devices. This permits direct-coupled, balanced feedback from the collectors of the output stage. The emitter supply for Q8-Q9 is derived by a 22 V zener, ZD1, from the positive supply rail. Collector supply for this stage is derived by a 13 V zener, ZD2, also from the positive supply rail. Thus, collector-emitter supply for this stage is around 9 V. Resistors R45-R46 provide loading of the driver transformer primary during that part of the in-

put cycle Q8 or Q9 are off, respectively.

Bias for the output stage is derived by three forward-biased silicon diodes, D1-D2-D3, and fed to the base of Q10-Q11 via the secondary centre-tap of TR1. Diodes D4 and D5 provide a signal return path for the output transformer primary for that part of the input cycle when Q10-Q12 and Q11-Q13 are off, respectively. Note that R56/C28 provides a load for the output stage at high frequencies.

The AUX input, which is intended to take music programme input from a tape recorder or tuner line output, comes in via the RCA socket, SKC. R13-R14 and C9 couple this signal to the tone controls, which are followed by the AUX LEVEL control. This couples into the base of Q4 via R18-C14.

The auxiliary input can be muted via a switch on the microphone. This switch should be connected via pins 4 and 5 on the DIN socket (SKA). When operated, it connects R11 to ground, biasing Q3 on, the collector-emitter junction of which shorts the junction of R13-R14 to the +13 V supply, which, being a low impedance at audio, is effectively a signal ground. Thus the auxiliary input is shorted out and effectively muted.

The power supply employs a capacitor-input bridge rectifier from TR3, which delivers a nominal 22 Vac output, providing around a 30 V positive supply rail. One lead of the mains transformer secondary is fused to provide protection in the event of amplifier malfunction or a supply rail short circuit. A mains side fuse was not used for safety's sake. Indication that power is applied comes from the LED, which is forward-biased via R50 from the positive supply rail.

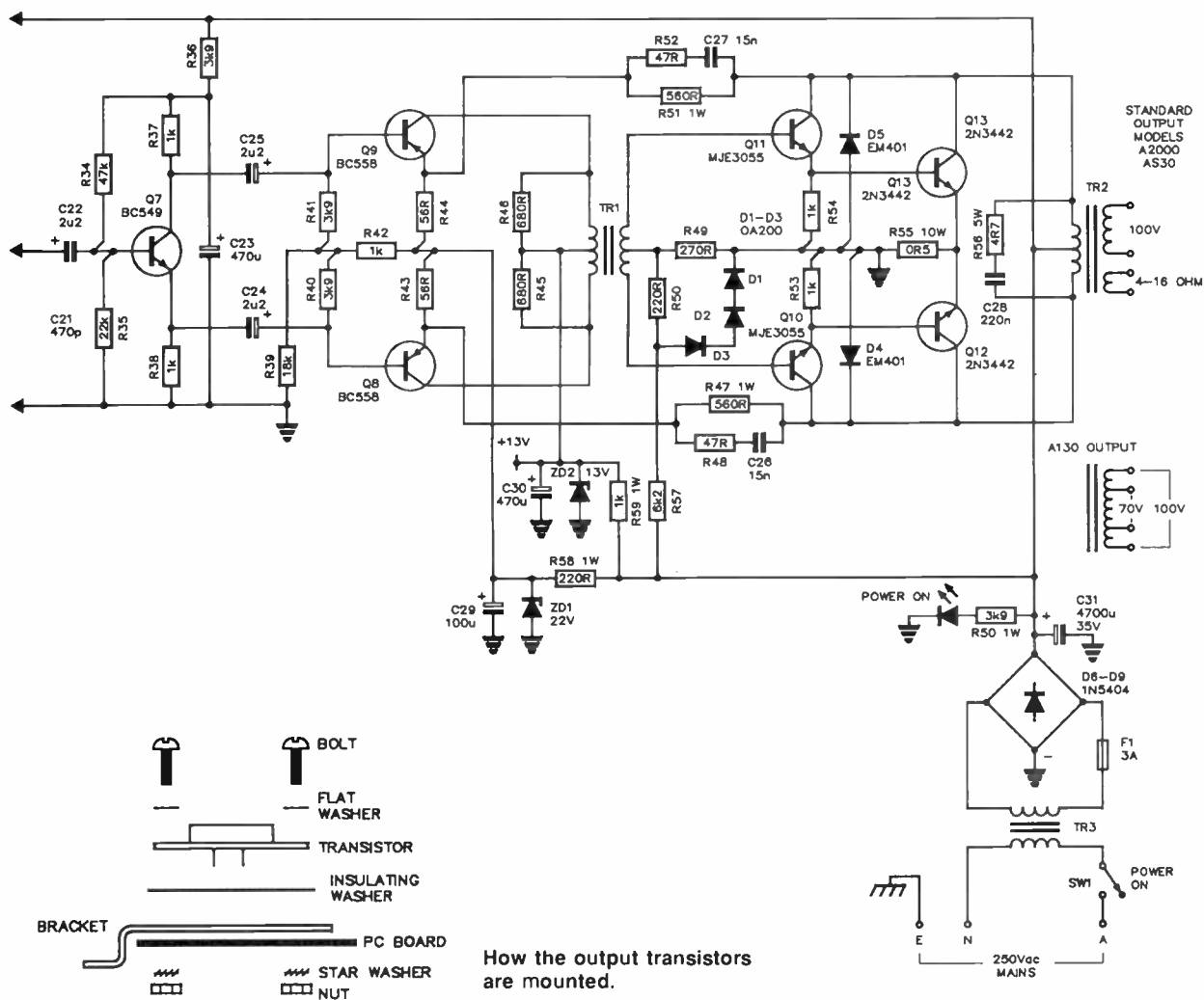

How the output transistors are mounted.

actually mounts to the front panel, while the mains terminal block, power supply fuse and the output terminal strip mount on the rear panel. The mains lead passes through the rear panel via a clamp grommet.

The front and rear panels come ready-punched and with the annotation silk-screened on them. The printed circuit board has a silk-screened component overlay, a solder mask on the rear side with tinned pads for easy soldering.

Construction

There's nothing special about the general order of construction of the project. Give all the major items a visual inspection first to see that all's in order. You wouldn't want to get most of the way through assembling it and find a hole had not been drilled somewhere.

The two transformers mount to the baseplate. First, locate which way round the baseplate sits in the case bottom, then mount the two large transformers to it. The power transformer mounts to the rear, the output transformer to the front (see internal picture). Orientate the mains transformer so that its mains input leads face the front of the case. Orientate the output transformer so its primary leads (red-black-red) face the pc board. An earthing point is positioned at the right rear corner of the baseplate (looking from the front of the unit).

Two solder lugs should be secured by bolt and nut here. Now you can screw the baseplate to the case bottom using four PK screws.

The mains on/off switch is mounted to the front panel, with a solder lug between a washer against the inside of the panel and the inside securing nut. This is later wired to the baseplate earth point. The fuseholder for the power supply fuse and the output connector strip mount to the rear panel from the outside (silk-screened) face. The mains screw terminal block mounts on the inside face, just adjacent to the mains cable clamp. The mains cable is best attached after mounting these components. Strip-back the outer sheath of the mains cable to expose about 100 mm length of the three wires. DO NOT attach the mains plug at this stage.

The printed circuit board comes with a silk-screened overlay identifying the component positions and orientation of the polarised components (semiconductors, electrolytics and tantalums). Best start by soldering-in the ten on-board links using 22 gauge tinned copper wire. Note that a length of shielded cable line links the two points marked 'A' (C9 to R14), but that comes later. The on-board links are identified by just a line joining two pads on the board. Follow with the resistors and capacitors, save for the 4700uF power supply electrolytic. The pc-mount potentiometers will be mounted later, but the trimpot, R4, can be mounted at this stage. Also

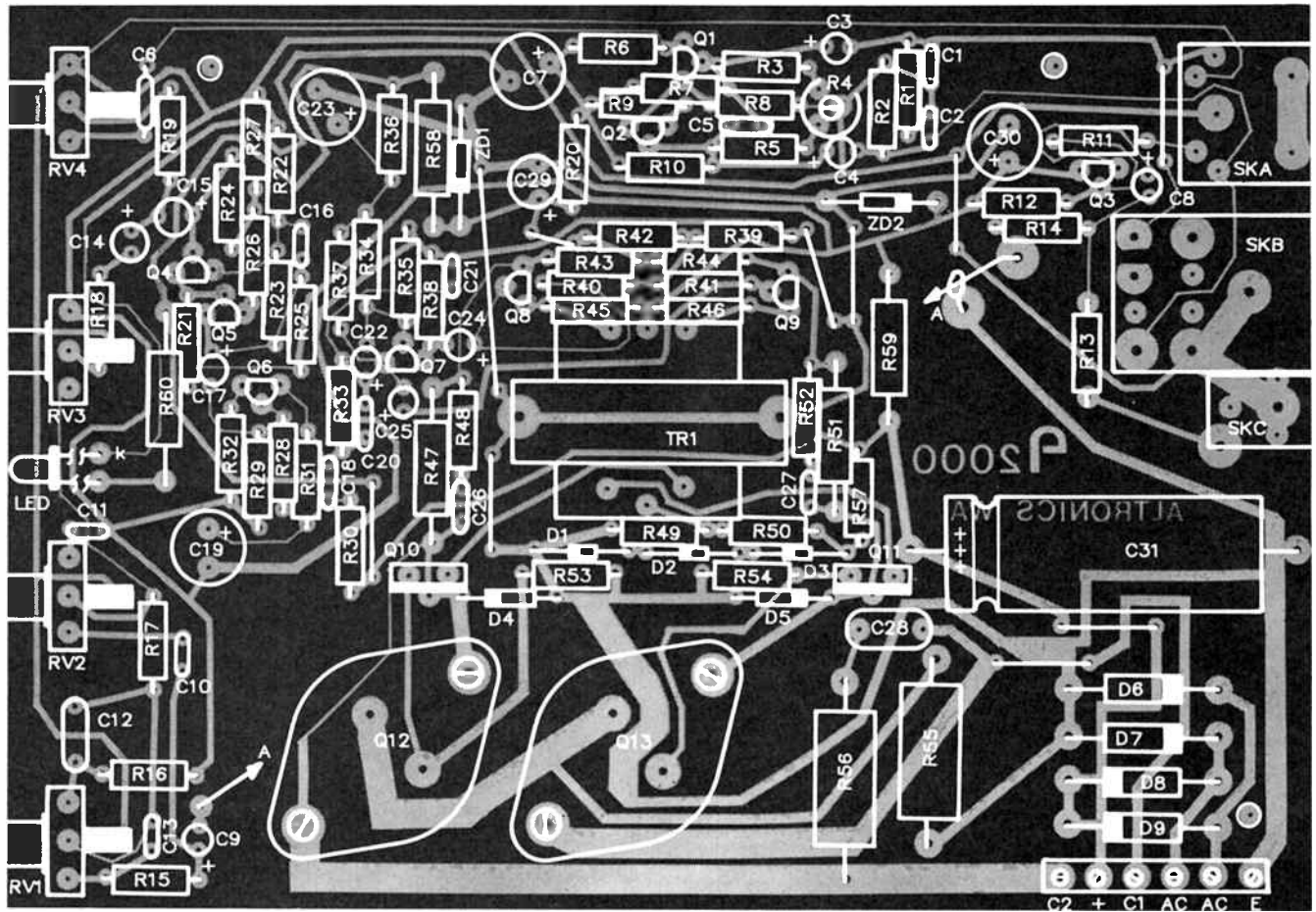

PARTS LIST A2000 30 WATT PA AMP.

Semiconductors

D1-3	1N914, 1N4148
D4, D5	1N4002
D6-9	1N5404
LED1	5 mm red LED
Q1, Q2	BC549
Q3	BC548
Q4-7	BC549
Q8, Q9	BC558
Q10, Q11	MJE3055T
Q12, Q13	2N3442
ZD1	22 V, 3 W zener
ZD2	13 V, 3 W zener

Resistors

all 1/4 W, 5% unless noted.	
R1, R2	1k
R3	4k7
R4	200R, 5 mm trimpot
R5	4k7
R6, R7	10k
R8	5k6
R9-11	10k
R12-14	1k
R15	10k
R16	3k9
R17	10k
R18	33k
R19	56k
R20	4k7

R21	120k
R22	560R
R23	22k
R24	220k
R25	4k7
R26	220R
R27	560R
R28	470k
R29	56k
R30	5k6
R31	4k7
R32	1k
R33	3k3
R34	47k
R35	22k
R36	3k9
R37, R38	1k
R39	18k
R40, R41	3k9
R42	1k
R43, R44	56R
R45, R46	680R
R47	560R, 1 W
R48	47R
R49	270R
R50	220R
R51	560R, 1 W
R52	47R
R53, R54	1k
R55	OR5, 5 W
R56	4R7, 5 W
R57	6k2
R58	220R, 1 W
R59	1k, 1 W

R60	3k9, 1 W
RV1-4	100k pots.

Capacitors

C1, C2	1n/100 V poly.
C3, C4	6u8/35 V tant.
C5	10n/100 V poly.
C6	100n/100 V poly.
C7	470u/25 V RB electro.
C8	6u8/35 V tant.
C9	1u/35 V tant.
C10	1n/100 V poly.
C11	15n/100 V poly.
C12	100n/100 V poly.
C13	1n/100 V poly.
C14, C15	2u2/35 V tant.
C16	100p/50 V ceramic.
C17	2u2/35 V ceramic.
C18	10n/100 V poly.
C19	470u/25 V RB electro.
C20	10n/100 V poly.
C21	470p/50 V ceramic.
C22	2u2/35 V tant.
C23	470u/25 V RB electro.
C24, C25	2u2/35 V tant.
C26, C27	15n/100 V poly.
C28	220n/100 V poly.
C29	100u/25 V RB electro.
C30	470u/25 V RB electro.
C31	4700u/35 V RT electro.

Miscellaneous

F1	3 A, 3AG fuse.
FH1	3AG fuseholder.
SKA	5-pin DIN socket, pc mount type.

SKB	RCA socket, pc mount type.
SKC	6.5 mm jack socket, pc mount type.
SW1	SPDT 240 Vac toggle switch.
TR1	M1126 transistor driver transformer.
TR2	M1128 100 V/70V 4 ohm, 30 W output transformer.
TR3	M1127 power transformer

A2000 pc board; H0483 black instrument case with punched and silk-screened front and rear panels; 175 x 220mm baseplate for case; one 6-way pc mount screw terminal block; bracket for output transformer; insulating kits for output transistors; two-way mains terminal block; 4-way spring-loaded output terminal strip; mains lead with plug; mains cord clamp grommet; four small spined knobs; 22g tinned copper wire for links; 180 mm length of shielded wire; 3 x 6 mm push-in pc board spacers; solder lugs; assorted nuts, bolts and washers; hookup wire.

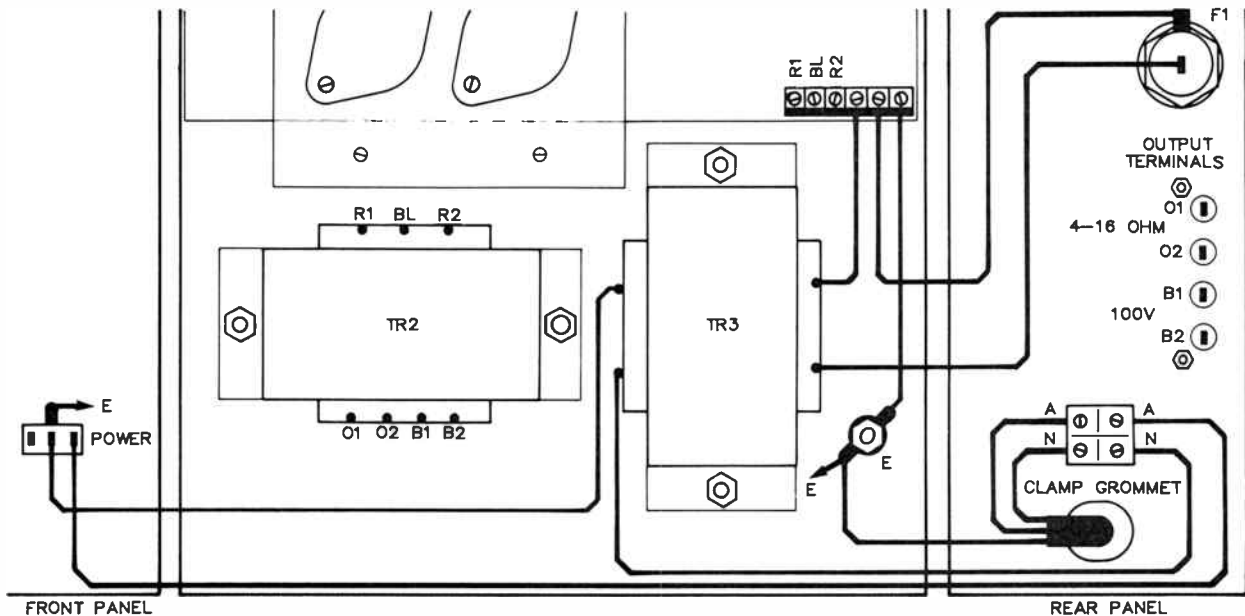

Wiring diagram.

mount the six-way pc-mount terminal block now.

Solder the semiconductors in place next. Leave sufficient leg length on the LED so that it can protrude through the hole in the front panel. Leave the output transistors till last. When you get to them, the double-bent bracket goes against the board, then bolt the transistors to the pc board using an insulating washer between the transistor case and the bracket. The bolt goes through from the transistor side, with nut and star washer beneath the board. Finally, solder the base and emitter pins of each device.

The output stage driver transformer, TR1, can be mounted to the board now. It has solder lugs on the core securing bracket. These are bent over slightly on the underside of the board then soldered using an iron with a large diameter, high heat capacity tip.

Now you can mount the pots, the auxiliary and mic sockets and the 4700u electrolytic. Cut and strip a length of screened lead and wire it between the points marked "A" on the board, putting it on the underside of the board. The shield is grounded via the pad adjacent to point "A" near R14. (This track runs to the negative of the 4700u electrolytic, C31, and the 'E' terminal on the six-way terminal block).

Now, give the board a close visual inspection, checking for missing components, polarised parts the wrong way round, etc. When you're satisfied it's all OK, the board can be mounted to the baseplate. Three plastic push-fit standoff pillars secure the board to the baseplate. The output transistors' bracket is bolted to the baseplate with two PK screws. Wire the power transformer and output transformer to the six-way screw terminal block on the board. The "22 V" lead on the power transformer secondary goes to one "AC" terminal (the other goes to the fuse, but that comes shortly). Wire the "E" terminal to the baseplate earth lug. The output transformer primary leads, identified as "13 V - 0 - 13 V" (red-black-red, respectively) go to the terminal marked "C1", "+" and "C2."

Now wire-in the power supply fuse (it's in series with the 0 V lead from the secondary of TR3), then the mains on/off switch. The active lead (via the terminal block) goes to the contact on the switch, while the lead from the transformer

goes to the switch pole (this is for safety). Sleeve the exposed switch lugs for safety's sake. The other transformer primary lead is wired to the mains terminal block and the mains cable neutral lead wired to the same terminal. Terminate the mains cable to the terminal block, cutting the active (brown) and neutral (blue) leads shorter than the green/yellow lead so that it's the last to break in the event of accident. The mains earth lead is terminated direct to the baseplate earth lug. Also, don't forget to earth the on/off switch mount.

Solder the output transformer leads to the output terminal strip. The low impedance leads (4-16 ohm) are marked "0 . . . 11 V" (colour coded orange), while the line output leads are marked "0 . . . 100 V" and are colour-coded blue.

Now slip the front and rear panels in place in the case bottom. Push the indicator LED through its hole in the front panel. Slip the knobs on the four controls. Leave the top cover off for the present. Last of all, install the mains plug and the power supply fuse (this must be rated at 3 amps).

NOW CHECK EVERYTHING THOROUGHLY.

Power-up

Set R4 to centre position. Set the two level controls fully anti-clockwise and the tone controls to centre position. Attach a speaker to the output (a low impedance type will do for testing). Mentally crossing your fingers, apply power. Quickly see that the LED indicator comes on. If not, switch off immediately, unplug the mains lead and look for wiring faults. Is the fuse in place — is it intact? If, or when, all's well, power-up again.

With the LED lighting cheerfully, measure the voltage across C31, the 4700u capacitor at the rear of the board. There should be somewhere in the vicinity of 30 V or so there. All OK? Now, touch a screwdriver, with your finger on the shaft, to the AUX input socket centre pin and gradually advance the AUX LEVEL. Eventually, you will hear some hum from the speaker. Now you can plug in a mic and try out the system. Also try driving the AUX input from the line level output of a cassette player or tuner. See that the tone controls give some boost and cut.

All working? Now you can put the cover on and you're ready to roll! 🐘

BANKCARD HOLDERS—PHONE ALTRONICS TOLL FREE 008 • 999 • 007 FOR NEXT DAY JETSERVICE DELIVERY

We'll Pay You \$5 Cash!

We promise you ★ Product Quality ★ Speediest Delivery in Australia
 ★ Careful Packaging ★ Friendly, technical advice when you require it.
 If we fail you may return your purchase to us for a full refund ★ Plus \$5 for your trouble.
 ★ Less Transport Costs.

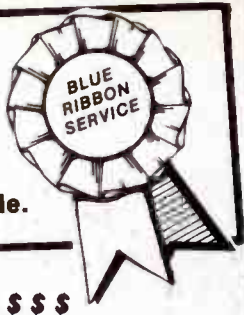

EGAD ★ 2N3055's From 59¢

- | | |
|--------|-----|
| 1—9 | 89¢ |
| 10—24 | 79¢ |
| 25—99 | 69¢ |
| 100 Up | 59¢ |



Premium Quality
Famous PECOR Brand

VHS VIDEO TAPE EXCELLENCE



We've tested the lot - Well how does ME stack up? — in a word superb - Forget all about paying a premium for BASF or TDK—Altronics positively guarantee our new ME Metallic is equal to the very best—and that goes for mechanical construction as well as picture quality!

Were \$12.00 Limited Stocks
NOW \$9.90 Cat
10Up \$8.90 A 9330

240V Mains Power From Your 12V Battery 300 Watt Inverter with Auto Start

Just think how handy it would be to have 240 Volt AC Mains Power when camping, or for your Boat or Caravan—Well this brilliant new design from Leo Simpson and the design Team at Electronics Australia is the answer.



• Auto Start draws power from your battery only when appliance is plugged in and "turned on" i.e. battery can be left permanently connected if desired • Thermal Over Load • Current Regulated • Current Overload

Complete Kit	K 6752	\$199.00
Fully Built and Tested	K 6754	\$249.00

Treat yourself to the Greatest thing to happen to AM in 60 years AM Stereo Sensation

★ Am Stereo ★ FM Stereo ★ Auto Reverse Tape Deck



Delightful AM Stereo is now yours for an unbelievable price. This Top Quality Roadsound RCR 760 Stereo AM and FM Receiver boasts 8 watts per channel and high grade Auto reverse tape deck (Metal Compatibility) C 9122

Amazing Price \$189.00

Look At This Superb Quality Nicad's From an Incredible



\$1.50
 Save Up to 50%
 1—9 \$2.20
 10—99 \$1.80
 100 plus \$1.50ea
 Cat S 5020



1/2 PRICE
DYNAMIC
PHONES
\$5
C 9001

SPEAKER 8 OHM C 0610
 2 1/4 INCH
 1-9 99¢
 10+ 69¢
From 69¢

SAVE \$\$\$ SAVE \$\$\$ Build This Great Little PA Amplifier



K 4990 \$179

This natty little amplifier includes some remarkable features which, until now have only been available on very expensive commercial items. e.g. **Balanced Mic Input** — This enables you to run very long Microphone leads without troublesome interference or hum pickup, **Balanced line output** — This enables you to run the speaker lines right alongside the microphone line without instability. **Constant voltage design** allows you to switch on one speaker circuit or all circuits together without any noticeable variance in output sound level.

Output Power is a genuine 30 watts into either 100V line or 4 Ohms.

Easy to Build uses Single Board Construction

DUAL CONE WIDE RANGE
 200mm (8") 10 watts max. power Input, Public Address. Background Music. Ideal Hi Fi extension speaker. Includes transformer holes at 51mm. Over 60,000 Sold in Australia! Mounting holes 140mm x 140mm
 10 up
C 2000 \$10.95 \$10.00

WITH TRANSFORMER
 Fitted with M 1105 Transformer. Allows Power settings 70V Line 2, 1, .5, .25 watt 100V Line 4, 2, 1, .5 watt
C 2005 \$18.95 10 up \$16.50

CEILING SPEAKER GRILL
 Suits 200mm (8") speaker. Ideal for PA/Background music systems. extension speakers etc. colour: White
C 0800 \$2.95 10 Up \$2.40

SPEAKER TRANSFORMERS
 Primary: 2.5K, 5K Ohms
 Secondary: 2, 4, 8, 16 Ohms
 Frequency Response: 30Hz -12KHz. Mounting hole centres 51mm. Ideal for high quality constant voltage PA systems.
M 1105 \$5.95 10 Up \$5.20

20 WATT
 Primary Power Taps (100V Line) 1.25/2.5/5/10/15/20W (Halve these for 70V line) Secondary Taps 4/8/16 Ohms.
M 1120 \$12.50 10 Up \$11.50

PROFESSIONAL PAGING MIC
 Has tapered low frequency response for articulate speech reproduction. Low Impedance balanced line. PTT switch with lock facility. Additional switch contacts for remote switching, muting etc
C 0372 \$69.50

Polar Pattern Cardioid
 Impedance 600 Ohm

W/PROOF PA SPEAKERS
PVC 5 WATT 8 OHM
C 2010 .. \$10.95 10 Up... \$10.25
PVC 10 WATT 8 OHM
C 2015 .. \$12.95 10 Up... \$10.95

ALUMINIUM 15 WATT 8 OHM
C 2025 \$27.95 10 Up \$25.95

ALUMINIUM 15 AND 30 WATT FITTED WITH LINE TRANSFORMER
 15W Taps 660/15W, 1K/10W, 2K/5W 4K/2.5W
C 2030 \$68.95 4 Up .. \$64.50

30W Taps 330/30W, 660/15W, 1K/10W, 2K/5W 4K/2.5W
C 2033 .. \$79.95 4 Up \$77.95

ALTRONICS EQUIPMENT

008 999 007 Toll Free (09) 328 1599

Perth Metro Area & After Hours Recorded Service
ALL MAIL ORDERS: BOX 8280, STIRLING ST. PERTH W.A. 6000

Toll Free Phone Order - Bankcard Holders can phone order toll free up to 6pm Eastern Standard Time. Remember with our **Overnight Jetservice** we deliver next day.

PACKING AND DELIVERY CHARGES

\$3.00 Delivery Australia Wide - We process your order the day received and despatch via Australia Post. Allow approx. 7 days from day you post order to when you receive goods. Weight limited 10Kgs.
\$5.00 Overnight Jetservice - We process your order the day received and despatch via overnight Jetservice Courier for deliver next day. Country areas please allow additional 24-48 hours. Weight limit 3Kg.
\$10.00 Heavy Heavy Service - All orders of 10Kgs or more must travel express Road - Please allow 7 days for delivery.

A real-time clock add-on for the Microbee

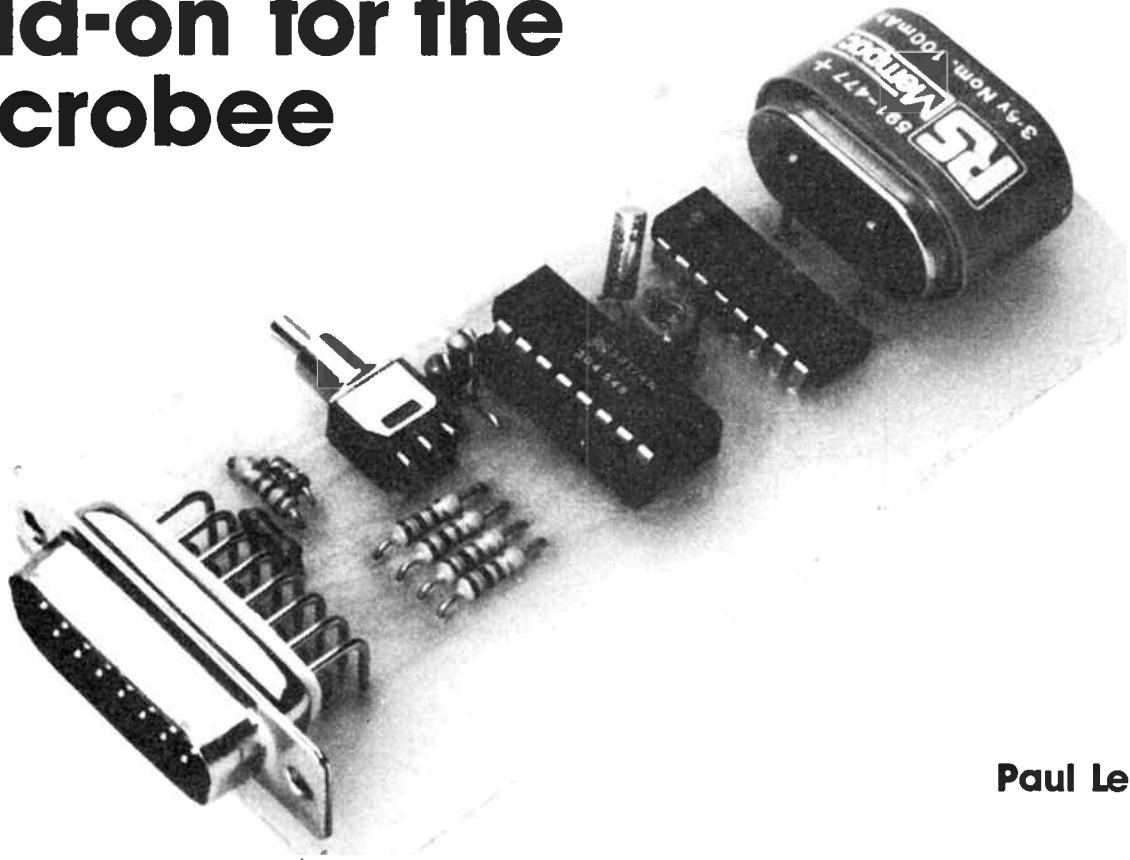

Paul Leonardi

This simple plug-in/pull-out module gives Microbee owners a real-time clock (RTC) with battery backup that 'remembers' the time, day, date, year, etc. even when it's not plugged in. Now you can have *real* RTC facilities whenever you need them.

EVERY REAL TIME COMPUTER needs a real time clock to interface with the real time events in the real world. Ah!, but don't some 'Bees have a real time clock built into the software in the Telcom EPROM? Yes, but it doesn't have battery backup and needs to be reset after a power-down or failure and doesn't have date or day of week facilities. also, what about supporting all those other 'Bees out there?? Wouldn't it be nice to have a real time clock with these features as well as keep time whether it's in the 'Bee or not? Well . . . ta daaaaa . . . here is another plug-in beast for the 'Bee. Oh, but you already have 15 thousand devices to plug into port A on the Bee? Well, this one's different (aren't they all?). This one is likely to be used when developing programs (i.e. want the time and date on the top of the printouts?) or running an important real time program (i.e. wake up the chief at 7 am every day except Saturdays and Sundays) or good plain old experimenting (on Saturdays and Sundays).

This article describes the construction, operation, and software routines for the RTC as well as some application programmes in assembly and BASIC.

Details

The project hinges on one chip — the National Semiconductors MM58174A real time clock device. The same device is distributed by Radio Spares under their 'RS' label as the RS58174N. A data sheet is reproduced elsewhere in this issue. The 58174 is a remarkable chip. In summary, here are the salient features it offers:

- Provides 10ths of seconds, seconds, tens of seconds, minutes, tens of minutes, day of week, days, tens of days, months, tens of months, independent registers.
- Automatic leap year calculation.
- Internal oscillator — just add low-cost 32 kHz 'watch' crystal.
- Low power 'standby' operation from 2.2 V supply.
- Independent interrupt system.
- Protection for read during data changing.

The low-power standby facility enabled me to provide battery backup using a 3.6 V printed circuit mounting rechargeable nickel-cadmium battery. ▶

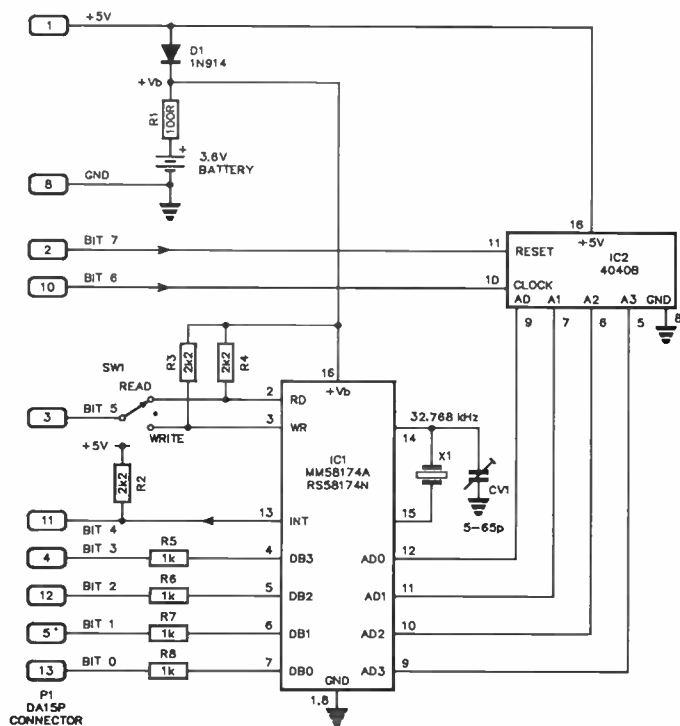

CIRCUIT OPERATION

The Microbee has eight available input/output lines configurable in any combination, plus 5 volts and ground at port A. The 5 V is used to power the 4040 and the 58174 RTC, as well as charge the battery through R1 and D1.

The lower nibble of port A, bits 0 to 3, is configured as input or output depending on whether the RTC is being written to or read from. The next data line, bit 4, is set as an input on the PIO and is used under program control to interrupt the Z80 when it goes low, thus allowing the RTC to interrupt the Z80 for real time events. Bit 5 is used as the strobe for the RD or WR operation depending upon SW1's position. The switch was chosen as you theoretically only write to the RTC once and from then on, only read the RTC.

Bit 6 is set to output and connected to the clock input of the 4040. This clocks the address generator so addresses A0 to A15 can be generated, enabling reading or writing to the RTC registers.

Bit 7 is also set to output, and is connected to the reset pin on the 4040 address generator so as to have a starting address reference point.

To read a particular register you need to reset the address generator, (take Bit 7 high, then low), clock the 4040 (Bit 6 high then low) the desired number of times to access the appropriate register, set Bit 5 low (RD), read Bits 0 to 3 as the BCD value of the register and reset Bit 5 high again.

Routines which automatically do these functions are described in the operational software section.

Very little in the way of 'electronics' is required, as you can see from the circuit. The project simply plugs into the Microbee's parallel I/O port (A). The backup battery is charged from the Microbee's +5 V rail (which is brought out on pin 1 the DB15 I/O connector) each time the unit is plugged in.

The 58174 has sixteen internal registers, each having a unique function. Their purpose is to store all the required date and time data. They're rather like electronic 'pigeon holes' or post-office boxes. Each has a unique function and can be 'written to' or 'read from' by means of a 4-bit (or line) bus. Writing or reading operation is simply selected by means of a switch on-board which connects a 'setting' signal from the computer to the 58174's RD ("read data") or WR ("write data") pins. The 4040B ripple counter is used to address the sixteen registers for reading or writing time and date information. The switch I used is a centre-off type so that accidental writing to the clock could be obviated. After all, you only

really need to write to the clock once in its life (or once in the life of the battery). The rest of the time, the device is either being read or just waiting around.

Table 1 lists the functions and contents of the 58174's sixteen registers. Note that three are 'write-only', three are 'read-only' and the rest are read/write types. Registers 1, 2 and 3 are like the sweep hand on a conventional (analogue) watch. They just 'clock-through' the numbers. To start at zero, you must stop the clock at zero. The other date/time registers can be changed as you wish.

If a register is being updated by the internal timing and the software tries to do a 'read register' operation, the illegal code 1111 will be read, thus allowing detection of changing data. An interrupt system is also available, allowing interrupts every 0.5, 5 or 60 seconds. Leap year calculation is provided by telling the RTC the current status of this year.

REGISTER	FUNCTION	OPERATION	CONTENTS
R0	test mode	write only	0-9
R1	tenths of seconds	read only	0-9
R2	units of seconds	read only	0-9
R3	tens of seconds	read only	0-5
R4	units of minutes	read/write	0-9
R5	tens of minutes	read/write	0-5
R6	units of hours	read/write	0-9
R7	tens of hours	read/write	0-2
R8	units of days	read/write	0-9
R9	tens of days	read/write	0-3
R10	day of week	read/write	0-6
R11	units of months	read/write	0-9
R12	tens of months	read/write	0-1
R13	years	write only	see Table 2
R14	stop/start	write only	0-1
R15	interrupt/status	read/write	see Table 3

TABLE 1. The 58174 registers

YEAR	DB3	DB2	DB1	DB0
leap year	1	0	0	0
leap year + 1	0	1	0	0
leap year + 2	0	0	1	0
leap year + 3	0	0	0	1

TABLE 2. Register 13 (years)

MODE	FUNCTION	HEX CODE
READ MODE	reset	0
	60 sec signal interrupt	C
	5.0 sec interrupt	A
WRITE MODE	0.5 sec interrupt	9
	no interrupt	0
	60 sec interrupt (single)	4
	60 sec interrupt (contin.)	C
	5 sec interrupt (single)	2
	5 sec interrupt (contin.)	A
	0.5 sec interrupt (single)	1
	0.5 sec interrupt (contin.)	9

TABLE 3. The interrupt facilities (register 15).

PARTS LIST AEM4502

Semiconductors
 IC1 . . . MM58174A, RS58174N
 IC2 4040B
 D1 1N914, 1N4148

Resistors all, 1/4W, 5%
 R1 100R
 R2-R4 2k2
 R5-R8 1k

Capacitors
 CV1 5-65 pF trimmer

Miscellaneous
 AEM4502 pc board; P1 - DA15P right-angle pc mount 15-pin D-type plug; SW1 - miniature pc mount, right-angle toggle switch (e.g. C&K T103-A type); 16-pin DIL IC socket; X1 — 32.768 kHz 'watch' crystal 3.6 V NiCad battery (e.g. Radio Spares RS591-477).

Expected cost: \$45-\$53

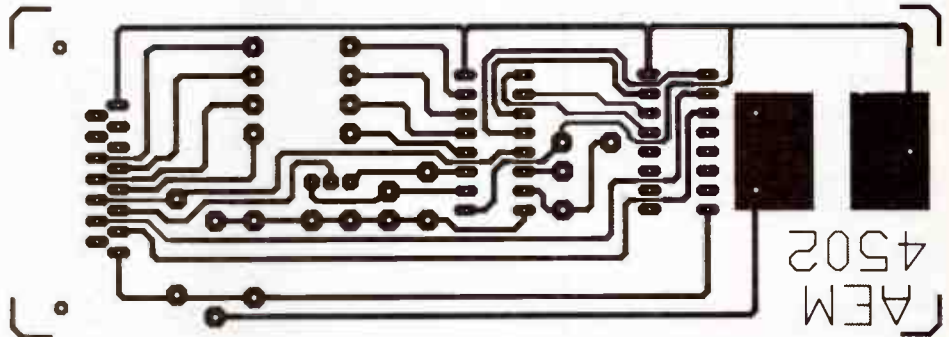
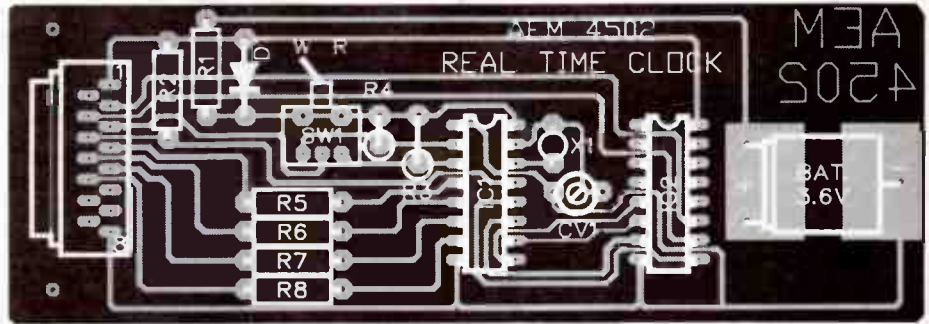

SEE 'RETAIL ROUNDUP' FOR
 A GUIDE TO KIT SUPPLIERS
 WHO MAY STOCK THIS PROJECT

Full-size reproduction of the printed circuit artwork.

Construction

Assembly is easy, but procedure is important — the last item inserted on-board should be the battery otherwise the 58174 may be damaged when inserted. The recommended procedure is: First, carefully check the pc board to see if all holes are drilled correctly and that there are no hairline breaks in tracks or any bridging between close-spaced tracks. Insert the DA15P right-angle connector and solder it in. Next solder in the eight resistors and the diode. Follow with the 32.768 kHz crystal along with the trimmer, the switch and then IC1 (the 4040), taking the usual CMOS care. As the 58174 is relatively expensive, use a 16-pin socket for it. Note that the chip is ESD (electrostatic discharge) sensitive, so take the usual CMOS precautions (the digital control inputs are diode protected).

With the 58174 in place, insert the battery last of all. Do a thorough visual check before trying it out.

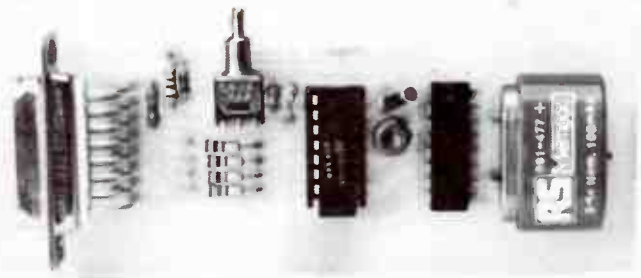

LEVEL

We expect that hobbyists who are **BEGINNERS** in electronics construction should be able to successfully complete this project.

SOFTWARE

A number of programs have been written to complement this project. There are four assembly code programs and a BASIC program to demonstrate setting the clock, reading the clock and using the RTC's interrupt handling routines.

Program 1

This is in two parts, one for reading and one for writing. READC reads the time information from the RTC and puts it in the Microbee's memory. This is a fundamental operation and is used by all the other routines. In this example the READC routine starts at 7100H, and the table where the registers are dumped is at 7000H. By inspecting the code you can see that the routine and table can be inserted wherever

you like, just by modifying lines 280, 290 and 300 and reassembling.

The second routine is WRITEC, used to set the time in the RTC by reading the information YOU put into the TABLER (7000H in this case). As the first thing you will want to do is set the time in the RTC I will firstly describe the WRITEC routine and how to call it.

WRITEC

The time and day information needs firstly to be put into the TABLER area. Let's take an example: we want to set the time and date to 10:45 on Sunday 29 — Sept — 1985. By viewing the data sheet on the RTC you will see there are 16 Registers. These registers have been duplicated in the table area and we need to put the time information into these memory locations so that WRITEC will put them into the RTC Registers for us.

Register 0/Mem 7000H is a test bit. It should be 0 for normal operation.

Register 1/Mem 7001H is the tenths of a second counter. It is read-only so need not be set.

Register 2/Mem 7002H is the units of seconds counter, and again is read-only.

Register 3/Mem 7003H is the tens of seconds counter. This, too, is read only.

Register 4/Mem 7004H is the units of minutes. It is 5 in this example, thus binary 5 needs to be put into this memory location.

Register 5/Mem 7005H is the tens of minutes. This is 4 in the example. Thus, put 4 into 7005H.

Register 6/Mem 7006H is the units of hours. We put 0 into the memory for this example.

Register 7/Mem 7007H is the tens of hours, and we put 1 into the memory.

Register 8/Mem 7008H is the units of days. For the 29th, put 9 into location 7008H.

Register 9/Mem 7009H is the tens of days, so we put 2 in this location.

Register 10/Mem 700AH is the day of the week counter. Use 1 for Sunday.

Register 11/Mem 700BH is the units of months. September is the 9th month, thus, enter 9 into the table.

Register 12/Mem 700CH is tens of months, so we use 0 for this one.

Register 13/Mem 700DH is the leap year calculator and is write-only. i.e: it will automatically generate 29 Feb. every leap year. This is set according to TABLE 2 in the text. For our case it's a leap year + 1 so put 4 into the table.

Register 14/Mem 700EH is the stop-start register. If you want the RTC to run after its registers have been set, put a 1 into this location.

Register 15/Mem 700FH is the interrupt setup register and can be made to interrupt the Z80 at one of the times shown in TABLE 3 in the text. As an example, we later use the five second continuous interrupt mode, so put A (hex), 10 (decimal) or 00001010 (binary) into this location. (The interrupt at this stage only extends to pulling down a line on port A every five seconds so that Port A will really have to be setup to interrupt the Z80).

There are two ways of inserting the values shown into the Table. From MONITOR you can Examine and Modify the 7000H group so that they look like this.

>E 7000

```
7000 00 00 00 00 05 04 00 01 09 02 01 09 00 04 01 0A
```

Or, from BASIC, you can poke the information. i.e.:

```
10 FOR X=28672 TO 28688
20 READ D:POKE X,D
30 NEXT X
40 STOP
50 DATA 0,0,0,0,5,4,0,1,9,2,1,9,0,4,1,10
```

Next, set the switch on the pc board to WRITE, ensure that the project is plugged into the I/O port and execute the WRITEC routine. From BASIC use USR(29184) or from the MONITOR use G 7200.

NOTE: Before removing the board or attempting to read the RTC, put the switch back in the read position or the information may be lost.

READC

Having written to the RTC I'm sure you'll want to read it. The most fundamental routine given here is the READC routine and, as described before, reads the RTC and puts the time/day information into the memory locations at TABLER again. So, ensuring that the switch is in the read position and the project is plugged in, execute the READC routine — BASIC uses USR(28928) or MONITOR G 7100, and then examine the 7000H locations for the information.

```

ROUTINE 1
ADDR  CODE  LINE  LABEL  MNEH  OPERAND
00100  ;
00110  ; 2 routines to write and
00120  ; read from the RTC
00130  ; reading and writing will occur
00140  ; from the same table i.e.
00150  ; if the write program is called
00160  ; the values in the table will be written
00170  ; into the RTC.
00180  ; If the read program is called
00190  ; the values from the RTC will be written
00200  ; into the table.
00210  ;
00220  ;
00230  BRESET EQU 000H ;RESET BIT OF ADDRESS GENERATOR
00240  CLOCK EQU 040H ;CLOCK BIT OF ADDRESS GENERATOR
00250  RWRW EQU 020H ;READ/WRITE BIT OF RTC
00260  INTR EQU 010H ;INTERRUPT BIT OF RTC
00270  ;
00280  WRITER EQU 7200H ;ADDRESS OF WRITE ROUTINE
00290  READER EQU 7100H ;ADDRESS OF READ ROUTINE
00300  TABLER EQU 7000H ;ADDRESS OF RTC TABLE
00310  ;
00320  ;***** RTC TABLE *****
00330  ORG TABLER ;START OF RTC TABLE
00340  TEST DB 0 ;TEST REGISTER
00350  SECT DB 0 ;TENTHS OF SECONDS
00360  SECI DB 0 ;UNITS OF SECONDS
00370  SEC10 DB 0 ;TENS OF SECONDS
00380  MINI DB 0 ;UNITS OF MINS
00390  MIN10 DB 0 ;TENS OF SECONDS
00400  HOUR1 DB 0 ;UNITS OF HOURS
00410  HOUR10 DB 0 ;TENS OF HOURS
00420  DAY1 DB 0 ;UNITS OF DAYS
00430  DAY10 DB 0 ;TENS OF DAYS
00440  QWEEK DB 0 ;DAY OF WEEK
00450  MONTH1 DB 0 ;UNITS OF MONTHS
00460  MONTH10 DB 0 ;TENS OF MONTHS
00470  YEARS DB 0 ;LEAP YEAR CALC
00480  START DB 0 ;STOP/START
00490  INTER DB 0 ;INTERRUPT AND STATUS
00500  ;
00510  ;
00520  ;***** CALL THIS ROUTINE TO READ VALUES FROM
00530  ; THE RTC TO THE RTC TABLE AT TABLER
00540  ;
00550  ;***** SET THE SWITCH TO READ FOR THIS ROUTINE ****
00560  ;
00570  ;
00580  ; call this routine to set up the time
00590  ; in the RTC after entering time values
00700  ; into the RTC table at 3000H
00710  ;
00720  ;***** SET THE SWITCH TO WRITE FOR THIS ROUTINE ***
00730  ;
00740  ORG WRITER
00750  WRITEC OI ;DISABLE INTERRUPTS
00760  CALL INIT2 ;SETUP PIO
00770  LD IX,TEST ;WRITE FROM TABLE
00780  CALL RESET ;RESET ADDRESS GEN.
00790  LD B,16 ;16 TIMES
00800  CALL PUT1 ;FROM TABLE TO RTC
00810  INC IX ;INC TABLE POINTER
00820  CALL CLK ;REG 2
00830  OJNZ LOOP4 ;16 TIMES
00840  LD B,14 ;00 IT 14 TIMES
00850  CALL CLK ;CLOCK 4040
00860  OJNZ LOOP2 ;12 TIMES YET
00870  LD A,01H ;START
00880  CALL PUT2 ;TO RTC
00890  EI ;ENABLE INTERRUPTS
00900  RET
00910  ;

```

ROUTINE 2

```

00920 i*****
00930 i routines for use with
00940 i RTC read and write
00950 i programs.
00960 i*****
00970
00980 i**** pulse the reset bit of the address generator ****
00990
7225 3EE0 01000 RESET LO A,CLOCK+RDWR+BRESET iCLOCK_READ/WRITE
      01010 i AND RESET HIGH
      01020 OUT (0),A iOUTPUT TO PIO
7227 0300 01030 LD A,CLOCK+RDWR iRESET BIT LDW
7228 0300 01040 OUT (0),A iOUT TO PIO
7220 C9 01050 RET
      01060
      01070 i**** pulse the clock bit of the address generator ****
      01080
722E C0B7 01090 CLK RES 5,A iSET BIT 5 LDW
7230 0300 01100 OUT (0),A iOUT TO PIO
7232 C0B7 01110 SET 5,A iSET BIT 5 HIGH
7234 0300 01120 OUT (0),A iOUT TO PIO
7236 C9 01130 RET
      01140
      01150 i**** initialize the PIO for READ RTC ****
      01160
7237 3EFF 01170 INIT LO A,0FFH iDET UP PIO
7239 0301 01180 OUT (1),A iPIO CONTROL
7238 3E1F 01190 LO A,01FH i3 OUT_5 IN
7230 0301 01200 OUT (1),A iPIO CONTROL
723F C9 01210 RET
      01210
      01220
      01230 i**** initialize the PIO for WRITE to RTC ****
      01240
7240 3EFF 01250 INIT2 LO A,0FFH iSET UP PIO
7242 0301 01260 OUT (1),A iPIO CONTROL
7244 3E10 01270 LD A,010H i7 OUT 1 IN
7246 0301 01280 OUT (1),A iPIO CONTROL
7248 C9 01290 RET
      01300
      01310 i**** read the nibble from the RTC at current addr. ****
      01320
7249 3E40 01330 GET1 LD A,CLOCK iSET READ LOW
7248 0300 01340 OUT (0),A iOUT PIO
7240 0B00 01350 IN A,(0) iREAD CHARACTER
724F 0D7700 01360 LO (IX),A iPUT IN TABLE
7252 3E60 01370 LO A,CLOCK+RDWR iREAD HIGH
7254 0300 01380 OUT (0),A iOUT PIO
7256 0D7E00 01390 LO A,(IX) iGET RESULT
7259 E60F 01400 AND 0FH iSELECT DATA ONLY
7258 FE0F 01410 CP 0FH iIS READING 1111
7250 2BEA 01420 JR Z,GET1 iYES DO IT AGAIN
725F 0D7700 01430 LO (IX),A iENTER INTO TABLE
7262 3E60 01440 LD A,RDWR+CLOCK iSET UP A
7264 C02E72 01450 CALL CLK iCLOCK BIT
7267 C9 01460 RET
      01470
      01480 i**** write the nibble to RTC at current addr. ****
      01490
7268 0D7E00 01500 PUT1 LD A,(IX) iGET READING FROM TABLE
726B E60F 01510 PUT2 AND 0FH iSELECT DATA ONLY
726D 57 01520 LO 0,A iHOLD IN 0
726E 3E60 01530 LD A,CLOCK+RDWR iSET WRITE HIGH
7270 B2 01540 OR D iADD DATA TO CONTROL BITS
7271 0300 01550 OUT (0),A iSET ON PIO LINES
7273 CBAF 01560 RES 5,A iWRITE LOW
7275 0300 01570 OUT (0),A iOUT TO PIO
7277 CBEF 01580 SET 5,A iWRITE HIGH AGAIN
7279 0300 01590 OUT (0),A iOUT TO PIO
727B C9 01600 RET
      01610
0000 01640 END

```

```

ADDR CODE LINE LABEL MNEM OPERAND
00100 i*****
00110 i DISPLAY TIME AND DATE ON TOP OF PRINTER PAGE
00120 i*****
7000 00140 TABLE EQU 7000H iSET TO YOUR ACTUAL
7100 00150 READC EQU 7100H iSET TO YOUR ROUTINE
A87F 00160 OUT12 EQU 0A87FH i1200 BAUD OUTPUT VECTOR
A87A 00162 OUT3 EQU 0A87AH i300 BAUD OUT RS232
      00163 iUSER OUTPUT VECTORS
      00170
7600 00190 ORG 7600H
7600 C0B071 00200 OUTPUT CALL READC iREAD TIME INTO TABLE
7603 D0210070 00220 LD IX,TABLE iRTC VALUES
7607 D07E07 00230 LD A,(IX+7) i10 HOURS
760A C07B76 00240 CALL PRINT
7600 D07E06 00250 LD A,(IX+6) i1 HOURS
7610 C07B76 00260 CALL PRINT iOUTPUT IT TO PRINTER
7613 3E0A 00270 LD A, '-30H i : SYMBOL
7615 C07B76 00280 CALL PRINT
7618 D07E05 00290 LD A,(IX+5) i10 MINS
761B C07B76 00300 CALL PRINT
761E D07E04 00310 LD A,(IX+4) i1 MINS
7621 C07B76 00320 CALL PRINT
7624 3E0A 00330 LD A, '-30H i SYMBOL :
7626 C07B76 00340 CALL PRINT
7629 D07E03 00350 LD A,(IX+3) i TENS SECS
762C C07B76 00360 CALL PRINT
762F D07E02 00370 LD A,(IX+2) i UNITS SECONOS
7632 C07B76 00380 CALL PRINT
7635 3EF0 00390 LD A, '/' -30H i SPACE
7637 C07B76 00400 CALL PRINT
763A 3EF0 00405 LD A, '-30H
763C C07B76 00410 CALL PRINT
763F 3EF0 00415 LD A, '-30H
7641 C07B76 00420 CALL PRINT
7644 D07E09 00430 LD A,(IX+9) iTENS OF DAYS
7647 C07B76 00440 CALL PRINT
764A D07E08 00450 LD A,(IX+8) iUNITS OF DAYS
764D C07B76 00460 CALL PRINT
7650 3EFF 00470 LD A, '/' -30H i SYMBOL SLASH
7652 C07B76 00480 CALL PRINT
7655 D07E0C 00490 LD A,(IX+12) iTENS OF MONTHS
7658 C07B76 00500 CALL PRINT
765B D07E0B 00510 LD A,(IX+11) iUNITS OF MONTHS
765E C07B76 00520 CALL PRINT
7661 3EFF 00530 LD A, '/' -30H iSLASH
7663 C07B76 00540 CALL PRINT
7666 3E08 00550 LD A, '0' -30H i TENS OF YEARS
7668 C07B76 00560 CALL PRINT
766B 3E05 00570 LD A, '5' -30H iFILL IN APPROPRIATE YEAR
766D C07B76 00580 CALL PRINT
7670 3E0A 00590 LD A,0AH iLINE FEED CHARACTER
7672 C07076 00600 CALL PRINT iMISS THE ADD 30H
7675 3E0D 00610 LD A,00H iCR CHARACTER
7677 C07076 00620 CALL PRINT
767A C9 00630 RET
767B C630 00650 PRINT ADD A,30H iBIN --> ASCII
767D C07FAB 00660 PRINT! CALL OUT12 iOUTPUTER
7680 C9 00670 RET

```

Program 3

This is a BASIC program to show how the routines and table can be accessed from BASIC. It simply calls the READC routine USR(28928) then, with a series of peeks, multiplications and additions, displays the time and date on the screen with some string manipulation.

ROUTINE 3

```

00100 REM *****
00110 REM READ RTC AND DISPLAY FROM BASIC
00120 REM *****
00130 REM READC=7100H
00140 D=7*4096+1+256*0+16*0+1
00150 REM TABLE=7000H
00160 T=7*4096
00170 I=USR(0):REM READ RTC INTO TABLE AT 7000H
00180 U=PEEK(T+7)+10*PEEK(T+6)
00190 V=PEEK(T+5)+10*PEEK(T+4)
00200 W=PEEK(T+3)+10*PEEK(T+2)
00210 Y=PEEK(T+12)+10*PEEK(T+11)
00220 Z=PEEK(T+9)+10*PEEK(T+8)
00230 T1$=STR(Z)+"/*"STR(Y)+"*/85"
00240 PRINT T1$
00250 D1$=STR(U)+"*"+STR(V)+"*"+STR(W)
00260 PRINT D1$
00270 END

```

The information is stored in the same way as for the write routine (i.e: to find the day of week inspect the 700AH location). Inspection from BASIC is also possible with an example produced later, in Program 3.

This is all very well being able to set and read the clock into registers, but what can you really do with it? Well, that's where Program 2 comes into play.

Program 2

This is a small program which prints the time and date on a printer attached to the 1200 Baud RS232 port. It can be modified to take care of 300 Baud printers but parallel printers will be a problem due to the RTC using the I/O port at the same time.

The program (assembled as it is), requires the READC routine to be in place at 7100H and can be called from BASIC prior to a listing with USR (30208), or from MONITOR with G 7600. The routine is quite simple and basically calls the READC routine to transfer the information into the table then selects the registers it wants, adds 30H to make the number into ASCII and calls a printer output call in the BASIC ROM area.

Program 4

Here is a machine code program which reads the time from the RTC and displays it on the screen in large figures. It's quite long but still requires the READC routine at 7100H. The basic part of the program is quite simple, with the bulk of it used to set up the large characters for the display!

```

ROUTINE 4
ADDR  CODE  LINE  LABEL  MNEM  OPERAND
00100  .....
00110  LARGE DISPLAY CLOCK FROM RTC CHIP
00120  .....
00130  .....
7100   00140  READC  EQU    7100H   ;READ RTC ROUTINE
7800   00150  TABLER EQU    7800H   ;RTC TABLE
00160  .....
0400 00   00170  LSEC  DEFB  00H     ;SPACE FOR PREVIOUS SEC.
00180  .....
7800   00190  ORG    7800H
7800  CDE478 00200  START  CALL  CLEAR   ;CLEAR SCREEN
7803  CDF378 00210  CALL  PCG     ;SET UP A SQUARE
7806  3294F1 00220  LD    (0F194H),A ;SET UP : MARKERS
7809  3295F1 00230  LD    (0F195H),A
780C  3254F2 00240  LD    (0F254H),A
780F  3255F2 00250  LD    (0F255H),A
7812  32AAF1 00260  LD    (0F1AAH),A
7815  32ABF1 00270  LD    (0F1ABH),A
7818  326AF2 00280  LD    (0F25AH),A
781B  326BF2 00290  LD    (0F25BH),A
781E  CD8071 00300  LOOP  CALL  READC ;READ RTC INTO TABLE
7821  3A8270 00310  LD    A,(7802H) ;READ UNIT SECONDM
7824  47     00320  LD    B,A
7825  3A8004 00330  LD    A,(LSEC) ;GET PREVIOUS SECOND
7828  89     00340  CP    B ;NDV - THEN
7829  28F3   00350  JR    Z,LOOP ;NO CHANGE GOTO LOOP
782B  78     00360  LD    A,B ;A = SECONDS
782C  328004 00370  LD    (LSEC),A ;UPDATE LSEC
782F  00210070 00380  OUTPUT LD    IX,TABLER ;ADDRESS OF RTC TABLE
7833  DD7E07 00390  LD    A,(IX+7) ;10 HOURS
7836  1101F1 00400  LD    DE,(0F101H) ;FIRST CHARACTER
7839  CD7E78 00410  CALL  TESTA ;FIND ADDRESS OF CHAR.
783C  CDBB78 00420  CALL  DISP ;DISPLAY AT DE
783F  DD7E06 00430  LD    A,(IX+6) ;1 HOURS
7842  CD7E78 00440  CALL  TESTA
7845  110BF1 00450  LD    DE,(0F10BH)
7848  CDBB78 00460  CALL  DISP ;10 MINS
784B  DD7E05 00470  LD    A,(IX+5)
784E  CD7E78 00480  CALL  TESTA
7851  1117F1 00490  LD    DE,(0F117H) ;POSITION 3
7854  CDBB78 00500  CALL  DISP
7857  DD7E04 00510  LD    A,(IX+4) ;1 MINS
785A  CD7E78 00520  CALL  TESTA
785D  1121F1 00530  LD    DE,(0F121H) ;POS 4
7860  CDBB78 00540  CALL  DISP
7863  DD7E03 00550  LD    A,(IX+3) ;10 S OF SECS
7866  CD7E78 00560  CALL  TESTA
7869  112DF1 00570  LD    DE,(0F12DH)
786C  CDBB78 00580  CALL  DISP ;1 S SECS
786F  DD7E02 00590  LD    A,(IX+2)
7872  CD7E78 00600  CALL  TESTA
7875  1137F1 00610  LD    DE,(0F137H)
7878  CDBB78 00620  CALL  DISP
787B  C31E78 00630  JP    LOOP
00640  .....
00650  .....
00660  ;**** TESTA LOOKS AT A AND SETS HL PAIR TO POINT TO
00670  ; THE ADDRESS OF THE LARGE CHARACTER FOR A *****
00680  .....
787E  210279 00690  TESTA LD    HL,ZERO
7881  FE00   00700  CP    00H
7883  C8     00710  RET  Z
7884  210A79 00720  LD    HL,ONE
7887  FE01   00730  CP    01H
7889  C8     00740  RET  Z
788A  211279 00750  LD    HL,TWO
788D  FE02   00760  CP    02H
788F  C8     00770  RET  Z
7890  211A79 00780  LD    HL,THREE ;POINT HL TO LARGE 3
7893  FE03   00790  CP    03H
7895  C8     00800  RET  Z ;RETURN IF =
7896  212279 00810  LD    HL,FOUR ;RETURN IF =
7899  FE04   00820  CP    04H ;COMPARE A WITH 04H
789B  C8     00830  RET  Z ;RETURN IF =
789C  212A79 00840  LD    HL,FIVE
789F  FE05   00850  CP    05H
78A1  C8     00860  RET  Z
78A2  213279 00870  LD    HL,SIX
78A5  FE06   00880  CP    06H
78A7  C8     00890  RET  Z
78A8  213A79 00900  LD    HL,SEVEN
78AB  FE07   00910  CP    07H
78AD  C8     00920  RET  Z
78AE  214279 00930  LD    HL,EIGHT
78B1  FE08   00940  CP    08H
78B3  C8     00950  RET  Z
78B4  214A79 00960  LD    HL,NINE
78B7  FE09   00970  CP    09H
78B9  C8     00980  RET  Z
78BA  C9     00990  RET  Z

```

```

01000
01010 .....
01020 ; DISPLAY CHARACTER POINTED TO BY HL
01030 ; AT DE ON THE SCREEN (LARGE PRINT)
01040 .....
01050 .....
7888  CDD078 01060  DISP  CALL  WAIT ;WAIT FOR VERT. RETRACE
788E  0608   01070  LD    B,B ;8 CHARS DEEP
78C0  C5     01080  LDP3  PUSH  BC ;SAVE BC
78C1  0608   01090  LD    B,B ;8 CHARACTERS WIDE
78C3  7E     01100  LOP2  LD    A,(HL) ;POINTER TO LARGE CHAR.
78C4  07     01110  LOP1  RLCA ;MOVE LEFT BIT --- CARRY
78C5  F5     01120  PUSH  AF ;SAVE A
78C6  3EFF   01130  LD    A,OFFH ;VALUE FOR DOT
78C8  3802   01140  JR    C,DOT ;DOT IF CARRY ELSE SPACE
78CA  3E20   01150  NDDOT  LD    A,020H ;SPACE
78CC  12     01160  DOT   LD    (DE),A ;OUTPUT TO SCREEN
78CD  13     01170  INC  DE ;INC POINTER
78CE  F1     01180  POP  AF ;RESTORE A
78CF  18F3   01190  DJNZ  LOP1 ;DONE B WIDE
78D1  23     01200  INC  HL ;NEXT PART OF CHARACTER
78D2  7B     01210  LD    A,E ;SET E OF DE
78D3  C638   01220  ADD  A,03BH ;NEXT LINE OF SCREEN
78D5  3801   01230  JR    NC,NOCARY ;NEED TO INC D ALSO
78D7  14     01240  INC  D ;E OVERFLOWED
78D8  5F     01250  NOCARY LD  E,A ;DE=DE+03BH
78D9  C1     01260  POP  BC ;RESTORE B
78DA  18E4   01270  DJNZ  LOP3 ;DONE B LINES ?
78DC  C9     01280  RET
01290  .....
01300 .....
01310 ; WAIT FOR VERTICAL RETRACE BEFORE WRITING TO SCREEN
01320 ; TO STOP SCREEN BREAKUP
01330 .....
01340 .....
78DD  DB0C   01350  WAIT  IN    A,(0CH)
78DF  C8F6   01360  LD    BIT 5,A ;LOOK FOR RETRACE
78E1  28FA   01370  JR    Z,WAIT ;LOOK AGAIN IF NOT
78E3  C9     01380  RET ;RETURN IF SO
01390 .....
78E4  3E20   01400  CLEAR LD  A,020H ;SPACE
78E5  2100F0 01410  LD    HL,(0F000H) ;START OF SCREEN RAM
78E9  77     01420  LD    (HL),A ;CLEAR #1 SPOT
78EA  1101F0 01430  LD    DE,(0F001H) ;NEXT ONE
78ED  010004 01440  LD    BC,(0400H) ;# TO CLEAR
78EF  E0B0   01450  LDIR ;RESTORE B
78F2  C9     01460  RET ;LOAD DIRECT
01470 .....
78F3  3EFF   01480  PCG   LD    A,OFFH ;CODE TO GO IN
78F5  21F0FF 01490  LD    HL,OFFF0H ;PCG RAM
78F8  77     01500  LD    (HL),A ;ENTER #1
78F9  11F1FF 01510  LD    DE,OFFF1H ;ENTER #1
78FC  010F00 01520  LD    BC,0FH ;16 TIMES
78FF  E0B0   01530  LDIR
7901  C9     01540  RET
01550 .....
01560 .....
01570 .....
01580 ; TABLE OF LARGE CHARACTERS FOR DISPLAY
01590 .....
01600 .....
7902  FF     01610  ZERO  DEFB  0FFH
7903  C3     01620  DEFB  0C3H
7904  C3     01630  DEFB  0C3H
7905  C3     01640  DEFB  0C3H
7906  C3     01650  DEFB  0C3H
7907  C3     01660  DEFB  0C3H
7908  C3     01670  DEFB  0C3H
7909  FF     01680  DEFB  0FFH
790A  38     01690  ONE   DEFB  030H
790B  78     01700  DEFB  07BH
790C  18     01710  DEFB  18H
790D  18     01720  DEFB  18H
790E  18     01730  DEFB  18H
790F  18     01740  DEFB  18H
7910  18     01750  DEFB  18H
7911  FF     01760  DEFB  0FFH
7912  FF     01770  TWO   DEFB  0FFH
7913  03     01780  DEFB  03H
7914  03     01790  DEFB  03H
7915  03     01800  DEFB  03H
7916  FF     01810  DEFB  0FFH
7917  C0     01820  DEFB  0C0H
7918  C0     01830  DEFB  0C0H
7919  FF     01840  DEFB  0FFH
791A  FF     01850  THREE DEFB  0FFH
791B  03     01860  DEFB  03H
791C  03     01870  DEFB  03H
791D  03     01880  DEFB  03H
791E  FF     01890  DEFB  0FFH
791F  03     01900  DEFB  03H
7920  03     01910  DEFB  03H
7921  FF     01920  DEFB  0FFH
7922  C0     01930  FOUR  DEFB  0C0H
7923  C0     01940  DEFB  0C0H
7924  CC     01950  DEFB  0CCH
7925  CC     01960  DEFB  0CCH
7926  FF     01970  DEFB  0FFH
7927  0C     01980  DEFB  0CH
7928  0C     01990  DEFB  0CH
7929  0C     02000  DEFB  0CH
792A  FF     02010  FIVE  DEFB  0FFH
792B  C0     02020  DEFB  0C0H
792C  C0     02030  DEFB  0C0H
792D  C0     02040  DEFB  0C0H
792E  FF     02050  DEFB  0FFH
792F  03     02060  DEFB  03H
7930  03     02070  DEFB  03H
7931  FF     02080  DEFB  0FFH

```



```

7932 FF      02090 SIX      DEFB 0FFH
7933 C0      02100        DEFB 0C0H
7934 C0      02110        DEFB 0C0H
7935 C0      02120        DEFB 0C0H
7936 FF      02130        DEFB 0FFH
7937 C3      02140        DEFB 0C3H
7938 C3      02150        DEFB 0C3H
7939 FF      02160        DEFB 0FFH
793A FF      02170 SEUEN   DEFB 0FFH
793B 03      02180        DEFB 03H
793C 03      02190        DEFB 03H
793D 03      02200        DEFB 03H
793E 03      02210        DEFB 03H
793F 03      02220        DEFB 03H
7940 03      02230        DEFB 03H
7941 03      02240        DEFB 03H
7942 FF      02250 EIGHT   DEFB 0FFH
7943 C3      02260        DEFB 0C3H
7944 C3      02270        DEFB 0C3H
7945 C3      02280        DEFB 0C3H
7946 FF      02290        DEFB 0FFH
7947 C3      02300        DEFB 0C3H
7948 C3      02310        DEFB 0C3H
7949 FF      02320        DEFB 0FFH
794A FF      02330 NINE    DEFB 0FFH
794B C3      02340        DEFB 0C3H
794C C3      02350        DEFB 0C3H
794D FF      02360        DEFB 0FFH
794E 03      02370        DEFB 03H
794F 03      02380        DEFB 03H
7950 03      02390        DEFB 03H
7951 FF      02400        DEFB 0FFH
              02410
              02420
0000         02430      END
    
```

Program 5

This is a short, but complex routine used to display the time on the top right hand corner of the screen when running other programs. It uses the interrupt features of the RTC, PIO and Z80 to interrupt whatever program is running and display the time every five seconds (or whatever interrupt interval was initially written into the RTC with WRITEC).

In lines 290, 300 and 310 you may reorganize the positioning of your READC routine and TABLE, And the screen positioning parameters.

There are two routines as part of this program, INTRR1 is used to setup the Z80 interrupt mode and interrupt vectors, setup the PIO to interrupt on certain conditions, read the RTC to allow it to interrupt, and finally, enable interrupts.

The way the circuit board is laid out, the interrupt from the RTC is connected to PIO bit 4, so the PIO needs to be told which bit it needs to monitor for an interrupt, what transition to monitor and the address of the interrupt routine it is to call.

RUPT1 is the routine that is activated every time the RTC interrupts. It firstly exchanges all the registers with the alternative registers to preserve the active registers, so that the program being interrupted will be able to carry on after the RUPT1 routine is finished (for this example the alternative set of registers is assumed not used in most programs — to make it bug proof, these registers would need to be saved as well). The routine then just reads the RTC with READC, displays the appropriate registers on the screen, finally exchanging the registers again and returning to the interrupting program.

To set the interrupt routine in motion you must firstly call the INTRR1 routine with USR(29440) from BASIC, or with G 7300 from MONITOR. Then call RUPT1 to start the first display (i.e: with USR(29696) or G 7400) and the interrupt will do the trick from here on. You may now move around from BASIC to EDASM to MONITOR and the time will continue to be updated every five seconds.

This has been working successfully for some months with my system with BASIC, EDASM and MONITOR programs.

```

ROUTINE 5
00100 *****
00110 ; INTERUPTR ROUTINE FOR SCREEN TIME UPDATE
00120 ; DISPLAY TIME ON SCREEN AT INTERRUPT RATE
00130 *****
00140
00150
00160 ;*** THIS ROUTINE ASSUES YOU HAVE PREVIOUSLY SET
00170 ;THE TIME AND DATE ON THE RTC (WRITER), SET THE
00180 ;START REGISTER TO 01H AND THE INTERRUPT REGISTER
00190 ;TO EITHER - 0CH - 60 SECONO INTERRUPTS
00200 ;           - 0AH - 5 SECONO
00210 ;           or - 09H - .5 SECONO
00220 ;
00230 ;AND THAT THE READ CLOCK ROUTINE IS AT 7100H
00240 ; THE RTC TABLE AT 7000H
00250 ; AS IN PREVIOUS EXAMPLE *****
00260
00270
00280
00290 READC EQU 7100H ;SET TO YOUR OWN ADDRESS
00300 TABLE EQU 7000H
00310 POSITN EQU 0F030H ;SCREEN POSITION FOR TIME
00320
00330 *****
00340 ; THE FIRST ROUTINE INTRR1 SETS UP THE INTERRUPT
00350 ; VECTORS ON THE PIO TO POINT TO THE INTERRUPT
00360 ; ROUTINE THAT IS TO ACCESSED EACH INTERRUPT PULSE
00370 ; AND ENABLES THE IT
00380 *****
00390
00400 ORG 7300H
00410 INTRR1 LD HL, RUPT1 ;ADDRESS OF INTER ROUTINE
00420 LD (08H), HL ;SET ADDRESS OF RUPT1
00430 LD A, 080H ;10001000
00440 OUT (1), A ;SET PIO INTERRUPT VECTOR
00450 LD A, 097H ;10011110
00460 OUT (1), A ;SET PIO INTR. CONTROL
00470 LD A, 0EFH ;11101111 BIT 5 TO INTR.
00480 OUT (1), A ;MASK ALL BUT BIT 5
00490 IM 2 ;CHOOSE 200 INTR MODE 2
00500 LD A, 0
00510 LD I, A ;HIGH INTERRUPT BYTE = 0
00520 CALL READC ;CLEAR INTERRUPTS
00530 CALL READC
00540 CALL READC ; START INTRUPTS ON RTC
00550 EI ;ENABLE INTERRUPTS NOW
00560 RET ;RETURN TO CALLER
00570
00580
00590
00600
00610
00620
00630
00640
00650
00660
00670 *****
00680 ; THIS IS THE INTERRUPT ROUTINE CALLED
00690 ; EACH TIME BIT 5 ON THE PIO GOES LOW
00700 ; IE THE RTC INTERRUPT LINE.
00710 ;
00720 ;
00730 ; IT PRINTS THE CURRENT TIME ON THE SCREEN
00740 *****
00750
00760 ORG 7400H
00770 RUPT1 EXX ;EXCHANGE REGISTER SET
00780 EX AF, AF ;AND AF SET
00790 CALL READC
00800 CALL READC
00810 CALL READC ;OBTAIN TIME AND CLEAR
; INTERRUPT FROM RTC
00820 LD IX, POSITN ;POSITION ON SCREEN
00830 LD A, (TABLE+7) ;10 S OF HOURS
00840 CALL PUTIT ;PUT TO SCREEN AND INC
00850 LD A, (TABLE+6) ;1 S OF HOURS
00860 CALL PUTIT ;SAME AGAIN
00870 LD A, : -30H ; THE : SYMBOL
00880 CALL PUTIT
00890 LD A, (TABLE+5) ;10 S OF MINS
00900 CALL PUTIT
00910 LD A, (TABLE+4) ;1 S OF MINS
00920 CALL PUTIT
00930 LD A, : -30H ; THE : SYMBOL
00940 CALL PUTIT
00950 LD A, (TABLE+3) ;10 S OF SECS
00960 CALL PUTIT
00970 LD A, (TABLE+2) ;1 S OF SECS
00980 CALL PUTIT
00990 EXX ;RESTORE THE REGISTERS
01000 ;SO AS TO CONTINUE
01010 EX AF, AF ;AND AF PAIR
01020 EI ;RE-ENABLE FURTHER INTR. S
01030 RETI ;RETURN FROM INTERRUPT
01040
01050 PUTIT ADD A, 30H ;BIN --> ASCII
01060 LD (IX), A ;PUT IT AT (IX)
01070 INC IX ;INCREMENT IT
01080 RET ;RETURN FROM SUB
01090
01100 END
    
```

The Emtek DLC-400 digital handheld inductance/capacitance meter



HANDHELD DIGITAL MULTIMETERS (DMMs) are now a commonplace item in electronics. The functions and facilities available these days are truly staggering compared to what you got five years ago on even the best analogue bench multimeters. It's all very well, however, to be able to measure, to three decimal places, the common quantities like voltage, current and resistance. So often in electronics work you need to measure the other two fundamental component quantities — inductance and capacitance. But, right from the outset in electronics (or "wireless", as it was first called — so my grandfather said, anyway), inductance and capacitance had to be measured indirectly. You can't simply pass a direct current through inductors and capacitors ('L' and 'C' for short) and measure the voltage drop across them like you can with resistors. For this reason, the L-C 'bridge' was devised.

The bridge

The measuring bridge was an invention of Charles Wheatstone who, along with W.F. Cooke, developed the electric telegraph last

century. The Wheatstone bridge was first used to measure resistance by comparing the ratio of the unknown resistance against a known standard. The circuit is shown here.

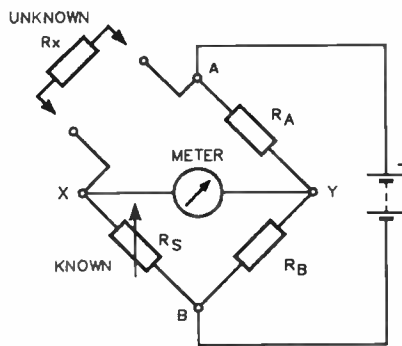

Let us say R_A equals R_B . When the known resistance R_S equals the unknown resistance R_X , no current flows through the meter because the voltage drop A-X to X-B is the same as A-Y to Y-B and there is no voltage difference across X-Y. In this condition, the bridge

is said to be 'balanced'. Thus, if you know the value of R_S , you know the value of R_X .

In practice, R_A - R_B is a potentiometer which is varied to balance the bridge, and the known resistance is selected over a wide range of values by a switch. This switch is varied until the bridge approaches balance, then final balance is achieved by varying the pot. The proportion by which the potentiometer is varied from nominal centre value then indicates the difference between the known and unknown resistances and you can calibrate the pot accordingly. The value of the unknown resistance can then be obtained by adding the range switch value to the pot calibration.

In addition, because the current flowing through the meter when the bridge is unbalanced varies over a huge range, some sensitivity control is provided for the meter.

One of the greatest advantages of the bridge is the accuracy it can provide.

That's great, but what about inductors and capacitors? Well, take a look at this circuit:

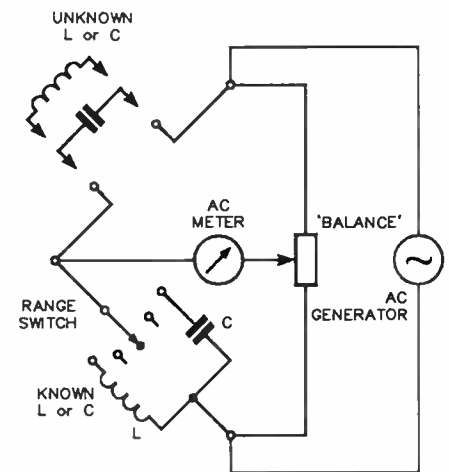

As you can see, it's just a refinement of the first bridge circuit. Here, an ac generator, set at a convenient frequency (usually 1 kHz, 10 kHz and/or 1 MHz) provides the current source instead of a battery. When the impedance of the unknown inductor or capacitor is close to that of the known component selected by the range switch, balancing the bridge permits reading the value in the same way as just described.

It sounds simple enough, but for those who've ever used a bridge regularly, you know that you often get the impression that you need three arms to operate it effectively!

The digital solution

Digital measuring techniques allow tackling L and C measurement in a variety of innovative ways that permit direct readout of the component value under test.

Review unit kindly supplied by Geoff Wood Electronics, 656A Darling St, Rozelle 2039; (02) 810 6845. Emtek instruments are imported and distributed by Emona Instruments, Sydney.

The impedance may be measured, in much the same way as resistance is measured. Or, the component under test may be connected in an oscillator and the frequency or period measured to gain a measure of its value.

Difficulties do arise, however. Where an inductor or capacitor has a low 'Q' (quality factor), it can be difficult to accurately determine the value. A low Q inductor will have high effective series resistance, while a low Q capacitor will have a low effective parallel resistance. This can make impedance measurement quite inaccurate, hence bridges generally include Q compensating circuitry. In addition, test leads and terminals necessary to connect the component under test will add small, but nevertheless real, 'stray' inductance and capacitance which will be significant when measuring small value components.

The DLC-400

The Emtex DLC-400 digital LC meter provides five inductance ranges from 2 mH to 20 Henries and six capacitance ranges from 2 nF (2000 pF) to 200 uF. It will measure both non-polarised and polarised capacitors (tantalums and electrolytics)

Readout is via a 3½-digit liquid crystal display with maximum scale range of 1999. Accuracy on capacitance measurement is quoted as ±1% plus one digit on values from 0.5 uF down, and ±2% plus one digit on values above 0.5 uF. The "plus one digit" simply refers to the uncertainty of the last digit of the display, a factor common to all digital instruments of this type. Over-range is indicated by a "1" on the display.

Digital measuring techniques are never 'instant', and a measuring period is always quoted which indicates how long it takes to display a measurement when a reading is taken. This period is called the "sampling time". For the DLC-400, this is quoted as 0.4 seconds. In applications where you connect an instrument to take a measurement, the sampling time need only be shorter than the time it takes to make a new connection. At less than half a second, the DLC-400 is faster than you'll ever be.

Physically, as you can see from the photograph, the DLC-400 is much like the popular handheld digital multimeters that you commonly see. It has a series of push-in range series down the left hand side of the case, the display in the panel at the top and the connectors down the bottom. Its dimensions are such that it fits neatly in your hand. It measures 180 mm long by 85 mm wide by 35 mm deep and weighs just 320 grams, including the battery. Two alligator test clip-leads are provided. It is powered by a single No. 216 9 V battery.

On the rear of the case is a fold-out stand so you can position the instrument on a bench for better viewing of the display. The photograph shows this quite well.

Operation is very simple. Turn it on, plug-in the test leads, select L or C and select a range, then connect the component to be measured. Quick as wink, you get the result.

The terminals are polarised and the test leads are appropriately red and black. The

handbook supplied recommends polarised capacitors should be connected accordingly, though we could discern no polarising voltage being applied.

So far as could be determined, by comparing DLC-400 readings against those taken on a bridge, the accuracy of the instrument better the specifications. With low Q inductors, it's very difficult to get a stable reading and the result is inaccurate. However, that was determined with a couple of RF chokes which probably have Q values below 'a few'. We couldn't even get reliable results on a bridge with the same components. No trouble was experienced measuring a wide variety of capacitor types. Note, however, that the DLC-400 will not measure Q, which is a function provided on most LC bridge instruments. Then again, one must remember that the DLC-400 is designed for the quick and simple measurement of the value of a component.

General construction of the instrument is well up to the standard you'd expect. It has a tough, impact resistant case and the push-in switches are firm with a positive action. Inside, the electronics is contained on three pc boards; one main board, a display board and a small plug-in 'piggyback' board that seems to have something to do with the range switching. No circuit is provided, so we're unsure of the measurement technique, but judging from what we could discern of the input circuitry and from the handbook — which quotes 'current through inductance under test' and 'voltage across capacitor under test' — it seems likely the DLC-400 measures impedance. The display has easily-read 12.5 mm high digits. A low battery indicator is included on the display which comes on when the battery voltage falls to about 6.5 V. The input is overload protected by a fuse, a spare being provided in the battery compartment.

We only have one curious comment to make. Do you remember, as a kid, when you disassembled your parents' alarm clock and were left with one or two bits when you put it back together? Well, naturally, we opened up the DLC-400 to have a look at the construction. Upon putting it back together, we were left with a narrow strip of plastic of the same material and colour as the case. Try as we might, we've never found where it came from, or where it might go! The instrument still works perfectly, though.

The small handbook provided is adequate, but fails to point out the pitfalls inherent in measuring L and C. Mention is made of the clip lead strays and points to watch when measuring components in-circuit. However, no mention is made of the effect of metals, conductive mats etc in the vicinity of coils or capacitors when making measurements, and such can significantly affect a reading.

At a retail price around \$200, it represents excellent value for money and is far and away much cheaper than an LC bridge of comparable specifications, and significantly easier and quicker to use. Digital LC meters are not common in the marketplace, but we'd not hesitate to recommend you look closely at the DLC-400 if you need the facilities it provides.

— David Tilbrook & Roger Harrison

FLUKE 70 SERIES LOW COST ANALOG/DIGITAL MULTIMETERS —



YOUR FIRST CHOICE FOR FEATURES, QUALITY & VALUE

FLUKE 73	FLUKE 75	FLUKE 77
Analog/digital display	Analog/digital display	Analog/digital display
Volts, ohms, 10A diode test	Volts, ohms, 10A, mA, diode test	Volts, ohms, 10A, mA, diode test
Autorange	Audible continuity	Audible continuity
0.7% basic dc accuracy	Autorange/range hold	"Touch Hold"™ function
2000+ hour battery life	0.5% basic dc accuracy	Autorange/range hold
3-year warranty	2000+ hour battery life	0.3% basic dc accuracy
	3-year warranty	2000+ hour battery life
		3-year warranty
		Multipurpose holster

FROM THE WORLD LEADER
IN DIGITAL MULTIMETERS.



See the 70 Series at leading electronics stores or contact us for data

ELMEASCO Instruments Pty. Ltd.

NEW SOUTH WALES	VICTORIA	QUEENSLAND
15 McDonald Street	12 Maroondah Highway	Tel (07) 369 8688
MORTLAKE	RINGWOOD	S AUSTRALIA
P.O. Box 30 CONCORD	P.O. Box 623 RINGWOOD	Tel (08) 344 9080
NSW 2137	VIC 3134	W AUSTRALIA
Tel (02) 736 2888	Tel (03) 879 2322	Tel (08) 181 1500
Telex AA25887	Telex AA3018 ELTENT	

New RF power capacitors from IRH

For frustrated RF power amp designers/constructors who find capacitors hard to get, the Murata-Erie glass encapsulated miniature RF power multilayer UFP capacitor series are specifically designed for high voltage and high RF current applications up to microwave frequencies.

They are said to be ideally suited to commercial mobile and fixed communication equipment. The glass encapsulation protects these capacitors against corona, contaminants and other environmental factors. Wide, fine silver lead terminations assure minimum inductance and high RF current capabilities. They can withstand temperatures far in excess of soldered units due to solderless lead attachment.

Electrical characteristics include:

- Current rating of 8A at 25°C (derated for higher temperatures)
- Q of 5000 min. at 1 MHz and 25°C for values 1000 pF and smaller
- Power typically 12KVAR at 20°C with a temperature coefficient of P90 (+90 ± 20 ppm/°C) at 1 MHz over temperature range of -55°C to +125°C.

For further technical information contact **IRH Components, 32 Parramatta Rd, Lidcombe, 2141 NSW. (02) 648 5455.**

The bits that byte can talk all night

For those interested in getting their computers communicating on air, **GFS Electronic Imports of PO Box 97 Mitcham, Vic. (03) 873 3777**, has announced the new version of their intelligent radio data modem, model CPU-100. Known as the SDX-PKT 1.2, it is designed to provide error-free data communications over a standard voice band simplex radio link on HF, VHF, UHF, or two-wire land line.

The device simply connects between a terminal, computer remote sensing device via

RS232, and the radio transceiver. It is claimed that full error correction means that, even under loss of signal conditions, absolutely no data is lost or corrupted, the system merely being held up until the signal is recovered. Data rate on the link is nominally 1200 baud, depending on the link quality.

The secret of error free transmission is of course "redundant" check characters, and the retransmission of a faulty block of information as many times as necessary to achieve success.

Exchange of data between the two communicating units is in blocks and takes the form of an asynchronous byte-oriented

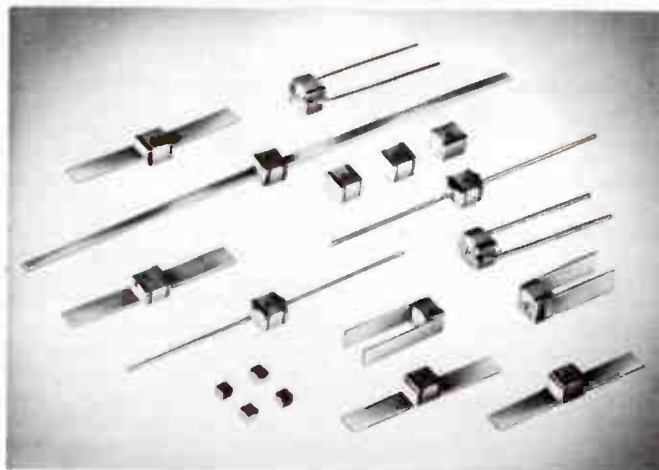

protocol. Automatic block re-sends are initiated for all detected errors. The radio equipment automatically switches from transmit to receive as each block of data is sent.

For every received block each byte is checked for correct parity and framing or overrun errors. A further check sequence then calculates block validation data on the receive block which must agree with the received check data contained in that block. Only when all checks verify is the data accepted and output to the DTE.

Other versions of the CPU-100 Intelligent Data Modem are available too.

More amateur activity from Shuttle flight this month

The D-1 European Spacelab mission due to fly on the 61-A Shuttle mission this month (liftoff Nov. 7) will feature amateur activity from several mission specialists on-board.

Using the callsign DP0SL, some three amateurs will be active, listening (uplink) on 437.125, .175, .225, .275, .325 and .375 MHz FM, with downlink frequencies of 145.450, .475, .550 and .575 MHz. We understand Prof. Reinhard Furrer DD6CF, Ernst Messerschmitt DG2KM and Dr Wubbo Ockles PE1LFO will be operating.

When busy with experiments, all calls will be recorded and there will be a low power beacon in the 435 MHz band operating as a tracking aid.

Mission coverage on HF will be from GB2RS on 3650 kHz and WA3NAN on 14 295 kHz.



The quarterly magazine dedicated to amateurs interested in the VHF/UHF bands, six metres and up. Vol. 5 (1985-86) now commencing.

SUBSCRIBE NOW!

GUP is dedicated to publishing solid, practical information, news and reviews for radio amateurs who frequent the VHF and UHF bands. Vol. 4 (1984-85) included articles on — Component Considerations at VHF/UHF, Meteor Scatter, Experimental 2m converter Using GaAsFETs, Sporadic-E Propagation, Packet Radio Experiments on Six Metres, Care & Feeding of RF Power Transistors, Coaxial Collinear Antennas, the EME Path, Working the Shuttle, a 5-Over-5 for Six, etc. Vol. 5 promises more of the same!

It costs just \$20 per year for four issues packed with info.

Compiled and published by Roger Harrison VK2ZTB and Andrew Kay VK2YLA.

Send subscriptions to:

**Teknidata Pty Ltd
PO Box 844
North Sydney 2060 NSW**

**PROGRAMMABLE
POCKET
SCANNER**

**—MICROCOMM—
SX-155**

**PROFESSIONAL
POCKET SCANNER
WITH OVER 16,000
CHANNELS & 160
MEMORIES**

**26
to
32,
68
to
88,
138
to
176
and
380
to
514
MHz**



The Microcomm SX 155 represents the latest developments in State-of-the-art LSI CMOS technology as applied to scanning monitor receivers. It incorporates many features, a lot of which are not even found in today's larger base scanners.

For example the SX 155 has 160 memory channels which can be programmed in either of two modes. The first allows you to manually program the entire 160 channels. The second mode provides for manual programming of the first 40 channels with the top 120 reserved for use by the SX 155 while in its SEARCH mode. It uses these channels to automatically store frequencies on which it has found signals during the search phase.

The SX 155 also features a Priority Channel (for that important frequency). An LCD display providing readout of all receiver functions including an accurate crystal controlled 24 hour clock.

Supplied complete with rechargeable Nicad batteries, charger, and rubber duck antenna, the SX 155 is a must for anybody with an interest in monitoring.

**PRICE \$449
+ \$14 P & P**

**AUSTRALIAN DISTRIBUTOR
GFS ELECTRONIC IMPORTS
Division of DERIBAR PTY LTD**

**17 McKeon Road, Mitcham, Vic. 3132
PO Box 97, Mitcham, Vic. 3132
Telex: AA 38053 GFS
Phone: (03) 873 3777 3 Lines**

**WIRELESS
INSTITUTE
OF
AUSTRALIA
FOUNDED 1910**



Get with the strength of the W.I.A., which represents the Radio Amateur at Local, National and International level and offers the following services:

- ★ Monthly "AMATEUR RADIO" Magazine, included in membership fee.
- ★ World-wide QSL service.
- ★ Assistance to members with legal problems arising out of the pursuit of their hobby.
- ★ A Weekly Sunday Broadcast to Amateurs and Short Wave Listeners.
- ★ Novice and full call courses
- ★ Trial Novice and AOCPS theory exam papers
- ★ Advice on Radio Mast approvals
- ★ The ONLY representation of the RADIO AMATEUR in legislative matters.

**Join the 8,600 Amateur members
in the W.I.A. by forwarding this
coupon to
W.I.A., P.O. BOX 300,
CAULFIELD SOUTH,
VIC. 3162**

Please forward a membership application form and further details to:

Mr, Mrs
Miss
Ms
Address
.....
.....
Callsign
Postcode

**FLUKE 20 SERIES
ANALOG/DIGITAL
MULTIMETERS FOR
THE TOUGHEST
ENVIRONMENTS**



FLUKE 21 & 23

Yellow case colour
Analog/Digital display
Touch Hold™ function (23)
0°C to 50°C operation
0.5% & 0.3% basic accuracy
100 µV to 1000V dc
1mV to 750Vac
10 µA to 10A (23), all fused
10 µA to 320 mA (21) fused
Three-year warranty

FLUKE 25 & 27

Charcoal or yellow case colour
Analog/Digital display
Touch Hold™ function
-15°C to 55°C operation
0.1% basic accuracy
100 µV to 1000V ac and dc
0.1 µA to 10A all fused
Relative (difference) mode (27)
MIN/MAX recording mode (27)
Ruggedized waterproof case
Two-year warranty

FROM THE WORLD LEADER
IN DIGITAL MULTIMETERS.



See the Fluke 20 series at leading electronics stores or contact us for data

**ELMEASCO
Instruments Pty. Ltd.**

NEW SOUTH WALES 15 McDonald Street MORTLAKE P.O. Box 30 CONCORD NSW 2137 Tel: (02) 736 2888 Telex: AA25867	VICTORIA 12 Maroondah Highway RINGWOOD P.O. Box 623 RINGWOOD VIC 3134 Tel: 1031 879 2322 Telex: AA30418 ELTEL	QUEENSLAND Tel: 1071 369 8688 S AUSTRALIA Tel: 08 344 9000 W AUSTRALIA Tel: 08 941 9100
---	--	---

GaAs HALL ELEMENT FROM NATIONAL PANASONIC

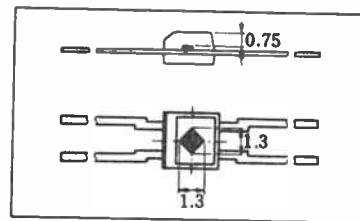
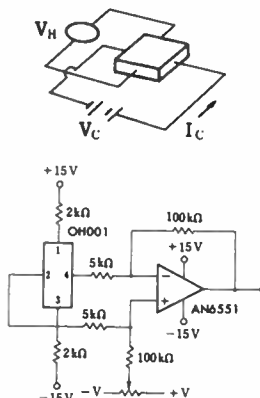
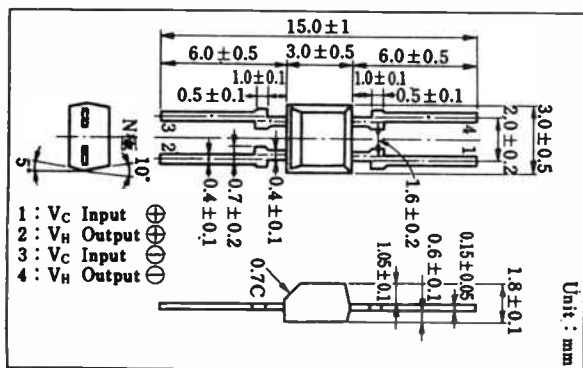

The location of the chip

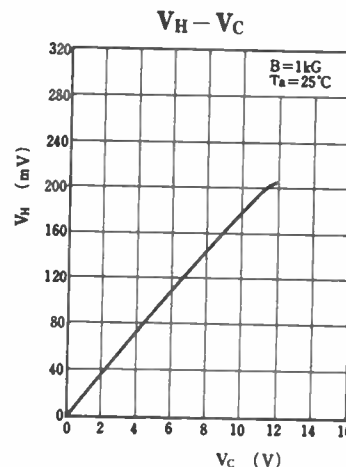
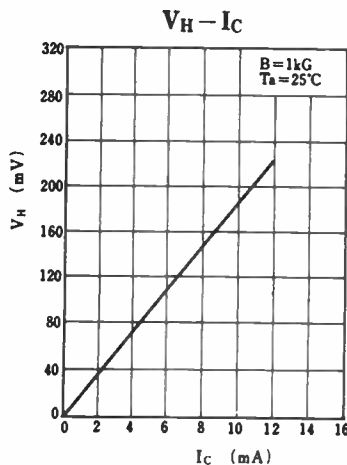
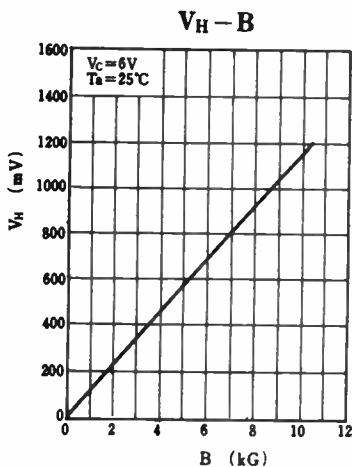

Absolute Maximum Ratings (Ta = 25 °C)

Symbol	Value	Unit
V _c	12	V
P _d	150	mW
T _{opr}	-55 ~ +125	°C
T _{stg}	-55 ~ +150	°C

FEATURES:

- Small temperature coefficient of Hall voltage.
- Good linearity coefficient or magnetic field dependence of Hall voltage.
- High Product sensitivity.
- 1k input resistance, DC voltage directly applicable.

APPLICATION:

- Brushless DC motors
- Micro switches
- Rotation detectors
- Magnetic detectors
- Proximity switch
- Gauss meters

STOP PRESS NOW AVAILABLE

MN6631A 5 Channel CMOS Electronic Switch

The MN6631A is a 5-channel CMOS electronic switch for Hi-Fi audio signals. This switch has large input capability up to 40V_{PP} and very low total harmonic distortion. This switch can conduct current in either direction in the ON condition. Control voltage level is compatible with TTL.

MN6632A 2 Channel CMOS Electronic Volume Control LSI

The MN6632A is a 2-channel CMOS electronic volume control LSI for Hi-Fi audio signals. This device can attenuate audio signals of 40V_{PP} with low distortion at a supply voltage of 5V. Display out, oscillator, back-up and reset circuits are included.

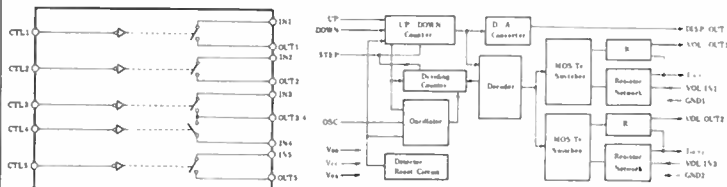

Also contact us about our extensive new range of I.C.s, Semiconductors and Opto Devices

ELECTRONIC FACILITIES Pty Ltd

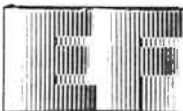

Wholesale & Retail Component Suppliers

TOLL FREE (008) 22 6385
Telex AA177084

67 Dickson Avenue, Artarmon
Sydney N.S.W. 2064 Australia
Telephone: 439 3786

Address for Correspondence:
PO Box 351
Artarmon N.S.W. 2064

Power meter features frequency counter

Vicom has announced the release of the new Fujisoku range of termination power meters which feature a built-in frequency counter. How handy!

The frequency counter has been designed for low power consumption and operates from internally mounted batteries. A 7-digit LCD is used for frequency readout, with a claimed stability of 2×10^{-7} per week, whilst power is read from the more appropriate analogue meter.

The instrument is said to be ideal for servicing applications due to the wide frequency range, the compact rugged construction, and light weight.

Three models are available to cover the frequency ranges 0-150 MHz, 30-500 MHz, and 330-960 MHz. This implies an expensive purchasing exercise



if a wide frequency range is required. However, we are pleased to see that the three power ranges of 1.5, 7 and 15 watts are switchable on the front panel. Other models for higher RF power can be obtained.

Further details from Michael Bonacci, National Sales Manager, Vicom Australia Pty Ltd on (03) 62 6931.

Multi-purpose antenna kit

From Britain comes news of a versatile HF antenna kit which might be of interest to amateur field-day and emergency service groups.

Obviously designed primarily for military applications, this kit, made by C & S Antennas Ltd of Knight Road, Rochester, Kent, England, contains all the components that are necessary to permit any of nine different antennas covering the HF band to be erected by one man in as little as ten minutes.

The MTA (multipurpose tactical antenna) kit covers the frequency range 1.6 MHz to 30 MHz, and is said to be far more versatile than other antenna kits of similar design. Components

can be selected to provide omnidirectional or directional characteristics for short-, medium-, or long-range communications, and everything is contained in a small canvas bag.

By using trees or available buildings, dipole, delta, base-fed vee, inverted-"L" or sloping-vee configurations can be rigged and the dipole arrangement can be made directional by using one element as a reflector.

We assume the MTA's usefulness is limited in the Simpson or the Nullabor, but then that's a long way from the cricket green at Rochester in the good old UK...

Transmitter powers up to 500 W can be used, and an antennatuning unit will soon be available for use with the kit, the company says.



TELEFUNKEN TOPICS



NEW PRODUCTS FROM TELEFUNKEN

HI POWER IRLEDS

The TSHA series from TFK offer radiant intensities to 900mW/SR, suitable for pulse applications in communications, light barriers etc. We also have a full range of PIN diodes, phototransistors and photo-IC's for detectors. EX-STOCK.

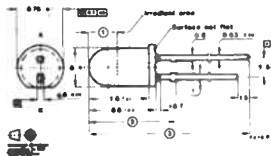

DATA COUPLERS

The K8000 series couplers are used where high voltage isolation is needed in high speed (500Kbit/Sec) data links. CMOS/TTL compatible. EX-STOCK.

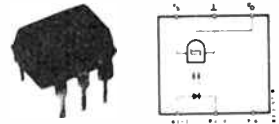

MULTI-CHANNEL COUPLERS

These are in addition to our very wide range of standard (4N...) series devices, triac couplers, A/C input types and EXTRA HIGH VOLTAGE 10kV-15kV models.



30 LED DRIVER

The 1096B can drive 30 LEDs in moving spot mode by a clever current steering technique. Input sensitivity is wide range adjustable and 5 can be cascaded for 150 leds. EX-STOCK.

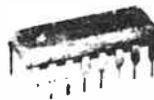
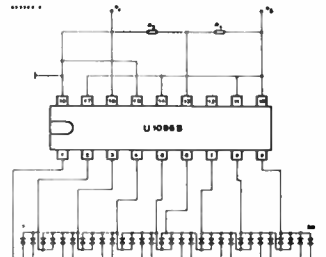
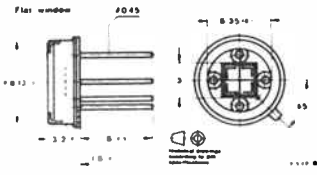

PHOTO-QUADRANT DETECTOR

The S239 is used for laser alignment, optical surveying, robotics and guidance systems. High output, high speed, linearity and broad response are the main features. EX-STOCK.



LIGHT BAR DISPLAYS

The TDA4100/8100 use 4 or 8 hi-efficiency LEDs in red, yellow and green to form large light emitting surfaces for backlighting and making up large displays. EX-STOCK.

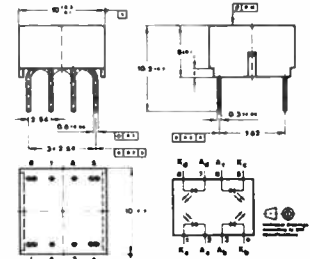

JUMBO LEDES

The 10mm diameter TLH040 series are available in red, yellow and green high output selection for use as large indicators for display panels etc. EX-STOCK.

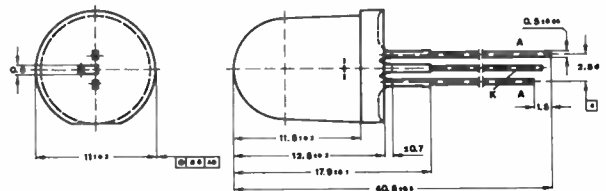

Promark Electronics PTY. LTD.

SYDNEY
02-439 6477

MELBOURNE
03-878 1255

TOLL FREE
008-22 6226

A keyboard in the ham shack

Neil Duncan VK3AVK

Do computers and amateur radio go together? If you're vexed by this question, or pondering the problem, Neil has the answers.

WHY TAKE ON A HOBBY like ham radio in the first place? For more than twenty years I have asked myself that question! I mean, it is an expensive hobby, doesn't achieve greatness or fitness (not unless you are a real antenna freak) and it doesn't really impress the neighbours. Yet, the challenges and thrills this hobby continues to provide for me make it worthwhile.

When I was a teenager, I aimed at a technical career in electronics and saw my hobby as a rather nice link to that aspiration. Alas, my career took a different path and thus ham radio did not justify itself in that way. Over the years, I have gradually come to the conclusion that my particular inclination to the hobby is largely derived from the 'talking to people' aspect it provides.

Enthusiastic groups

Without any doubt, there is a wide enough range of activities that ham radio offers as a challenge for the enthusiast. I have the distinct impression sometimes that those who enthuse in one area often rubbish the activities of those devotees of another! Take for example those do-it-yourself UHF people. They carry around beam antennas which resemble medieval toothbrushes, communicate over comparatively short distances (or aim at transitory objects in the sky) and delight in "plumbing" and the like.

Their 'opponents' seem to be the HF freaks. Now, an HF freak usually has an antenna system which provides summer shade to an entire suburban block, owns a linear amplifier which is *probably* legal and is able to hold several QSOs (conversations) in one minute. Chasing elusive overseas DX and the ability to blast holes in the upper atmosphere in Star Wars fashion are the joy of this group.

Note that groups such as these two co-exist quite happily. There are no punch-ups or verbal battles. After all, one group tends to avoid the other! Perhaps the challenges within one of those realms is sufficient to keep that 'spare hobby time' fully occupied. I suspect the need for further hobby stimulation is avoided (my theory, anyway.)

Other 'in-groups' of the hobby include the 40 metre rag-chewer, the two metre repeater fanatic, the TV transmitter critter, those in the packet racket, the home-brew crew, the morse code load, the RTTY (ritty) nit and the microprocessor professor. Sometimes an exceptional character comes along who actually indulges in more than one of these activities. This is to be frowned upon, really, as it detracts from a prime area of conversation — that of having a go at one of the other groups! Don't believe it? Have a listen on the bands. It's all good fun. I must point out!

In my own case, I cannot speak TV, do not know how to break into one of the VHF/UHF FM cliques without seeming to be a room-clearer and have all but given up homebrew because of the laughter which ensues when people look at my efforts. I do, however, love DX chasing and bashing out CW on forty or twenty metres.

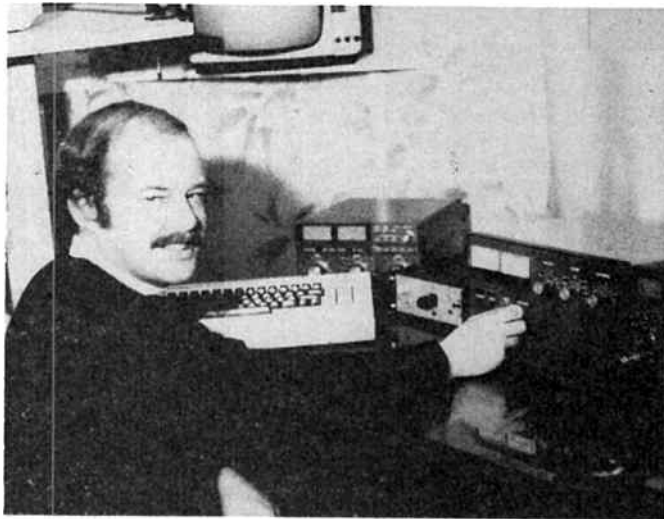

Recent equipment

Since I have the floor, I will sketch some of my activities over the past while. Home-brewing of SSB equipment once gave me lots of pleasure. I have built battleship type 'phasing rigs' (gee they sound nice), small transceivers and not so long ago, an all-bells-and-whistles multiband effort. The back shed now looks like one of those good old-fashioned disposals stores. I am not willing to go out there because of the memories and old glories I see.

You see, I became one of the many, oft maligned, 'black box' operators. I no longer drift, I sound nice (the tones that is) and hold onto resale value of my equipment very nicely. Actually, one of my old rigs could transmit on two bands at once. I didn't know about that until someone told me! The same rig filled all of 80 metres at one stage, I am told! All that is in the past. My new gear cannot do any of those things.

My first commercial rig was a Yaesu FT101ZD. With this rig, I quickly became bored with people telling me that my audio 'was the best they had ever heard'. Lovely rig and lots of knobs to twiddle when changing bands and tuning up; and you can't beat valves in the final for quality transmission. But why settle for extreme quality when there are new rigs on the market? My first mistake was selling that delightful rig.

One old timer once told me that the best way to overcome the 'I own a black box blues' is to select your main radio item and to remove the front panel and knobs. A false panel is added (cruddy aluminium is necessary) and knobs taken from an old valve BC radio are added. Presto, a homebrew rig which actually works well!

WARC bands

The new WARC bands on 10, 18 and 24 MHz came along and guess who had to be one of the first on them? Yes, the FT101ZD had a QSO on 10.1 MHz within one minute of that band being available. The antenna tuner loaded the lump of wire outside like a beauty and history at the '3AVK location was made. Next thing was the antenna, I decided.

Now, I have hot and cold periods in the hobby. The times when I am on heat (ham radio, you know) usually involves deprivation for the rest of the family. Such luxuries as food, petrol and clothing expenses must take second place to new possessions in the ham shack — this hobby requires capital.

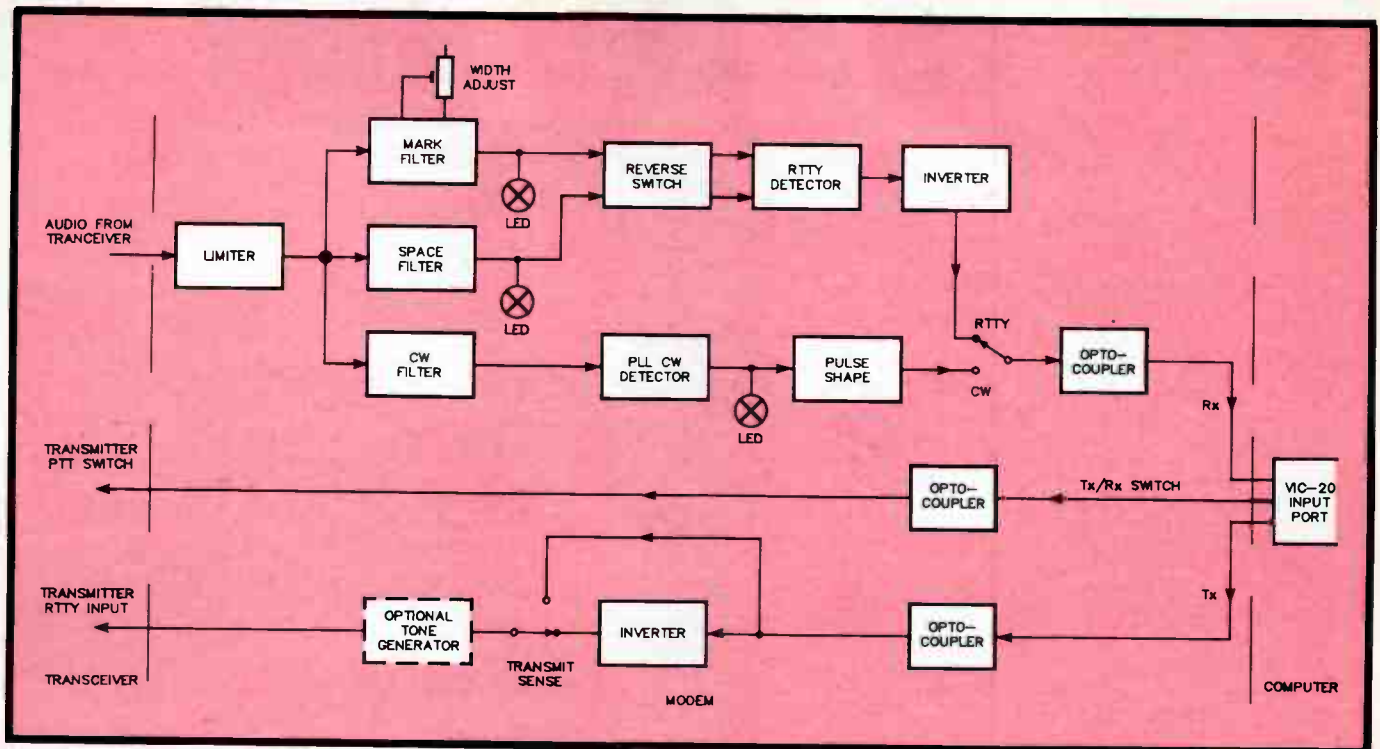

I had two aims — a new FT980 computer-controlled HF rig and a log-periodic antenna for the new bands. They arrived and worked well. All bands, no tune-up and SWR flat everywhere.

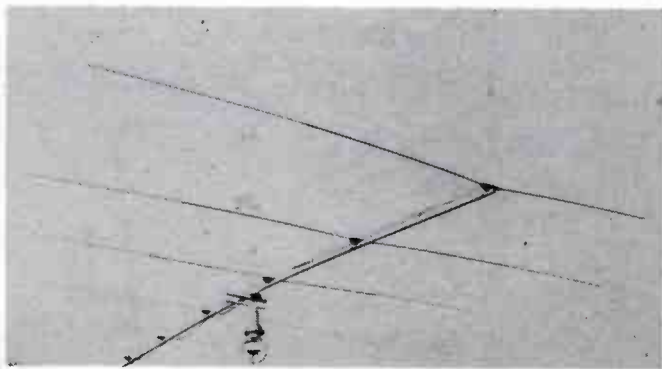

The latest 'hobby-bug' thus arrived with yours truly a little broke: Computer CW and RTTY. There were so many adverts in the various journals for stand-alone units to be plugged into ham gear that I couldn't bear to read them. The economy drive and the need for glass RTTY/CW combined to produce the current set-up.

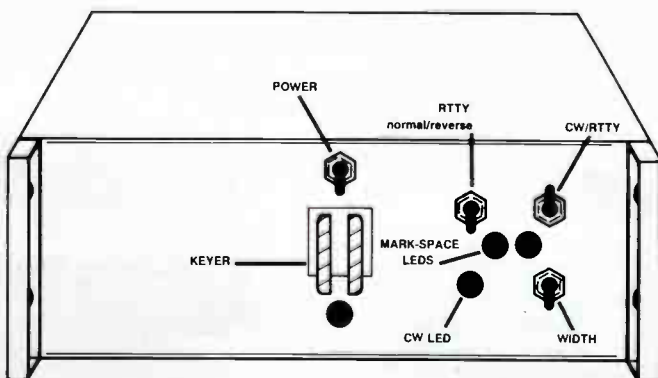

The VIC-20 system

I was able to buy a VIC-20 computer for less than \$200 and, thanks to High Technology Computer Systems Pty Ltd in Melbourne, a plug-in RTTY module for \$59 was purchased. I think this module has increased in price since, but not by much. I cannot understand why rave reviews have not been written all over the place for it! Certainly, some reviews have appeared, but nothing in line with the credit I think it deserves.

The combination which I have operating here consists of these two items, a home-brew modem based on Tom-Moffat's (VK7TM) RTTY decoder published quite some time ago and an opto-coupler module to plug into the computer.

There is also a module available for the Commodore 64 computer but I decided the piggy-bank did not have sufficient resource for that combination. There is no doubt that this version has some advantages over the smaller one I have due to the wider facilities of the '64 computer. Nevertheless, my new gear looked very nice indeed considering the low capital outlay.

Why the lower than expected interest in the computer module? It would seem that software alone isn't sufficient. One must sell the appropriate hardware interface to complete the package. Bearing in mind my earlier comments about the quality of homebrew gear at this shack, one weekend's effort was all it took to throw together a modem — and it goes like a ripper. No-one sells such a device. This is a shame really as I feel many others would derive great pleasure from this aspect of ham radio if they did:

The only difficulties I found were (a) finding a suitable plug for the back of the VIC-20 and (b) discovering the hard way that opto-couplers are essential for hooking the outside world to the computer if internal smoke bombs are to be avoided.

What can I do with my \$300 or so of investment? Transmit RTTY and receive it at various speeds; Transmit and receive CW from 1 to 99 words per minute (and boy, does it work!!). Transmit and receive ASCII (I have not tried it yet); In both modes I have a type-while-listening facility and I can pre-record such things as call signs, names and crass conversation.

KITS, KITS AND MORE KITS

AEM500 Courtesy Light Extender

Ref. AEM November 1985
This great little project keeps the interior light of your car ON for a specified period enabling you to find your keys etc in light. Compact and inexpensive.
Cat. KM-3025

ONLY \$8.95

AEM6010 Ultra Fidelity Preamp

Ref. AEM November 1985
Jaycar will be doing a full version of this kit in the near future. Please order in our shops - call head office for details.

SPECIAL NOTE REGARDING KIT PRICES.

It has been brought to our attention that one of our major competitors appears to be selling similar kits to Jaycar at what **APPEARS** to be much lower prices. The inference of course, is that we are expensive! The problem is, however, that the so called cheaper kit is actually a 'short form' version of some of the kits we advertise! Their cheaper kits are **missing essential items** which were originally specified in the magazine project. Usually the same kit supplier offers them as options - which you generally must buy to get the project going! After you add the price of the options in, you may be surprised to learn that the genuine Jaycar kit is cheaper.
PLEASE BE CAREFUL

DWELL/TACHOMETER

Ref. EA Sept. 1985
Tune up your car quickly and easily with this handy piece of gear. The Jaycar kit includes case, large meter and Scotchal meterscale.
Cat. KA-1612

ONLY \$34.95
Suits 4-6 or 8 cylinder cars



ETI 698 Microbee Dialler

Ref. ETI July 1985
Complete set of parts.
Cat. KE-4696

ONLY \$19.95

40 WATT DC INVERTER

Ref. EA August 1985
An upgrade of a previous design featuring a smart new ABS case.
Cat. KA-1598

\$79.95



300 WATT INVERTER

Ref. EA Sept. 1985
This totally new design is a vast improvement over the EA June 1982 project. It features a modern all plastic case, easier assembly toroidal type inverter transformer, auto start up and double switched power outlets.
And it's cheaper than the old model!!
The Jaycar kit contains all specified parts to enable you to complete the project in one go.
Cat. KA-1610

ONLY \$199.00



The Listening Post

Ref. AEM July 1985
This device attaches between audio output of a short wave receiver and the input port of a computer. It allows decoding and printing of Morse Code, Radioteletype (RTTY), AND radio facsimile (FAX) pictures! You can, for example, watch weather maps from the Met and dump them on to your printer!
Specific software for the Microbee is in the first article. Programs for other popular computers will be printed in later issues of AEM.
Complete set of specified components (inc. IDC plug).
Cat. KM-3015



ONLY \$29.50

Meet Roger Harrison & Dave Tillbrook!

You can meet Roger Harrison and Dave Tillbrook from Australian Electronics Monthly at our York St. store on the 3rd Saturday in November (16th) from 10.30 - 12 noon.
BE THERE!

HEBOT II FULL KIT BELOW COST! WAS \$299

Cat. XR-1020
ONLY \$99.00

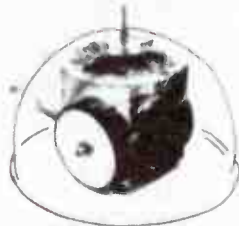

8 SECTOR BURGLAR ALARM

Ref. EA Jan/Feb 1985
Why buy a commercially made up unit for more when you can buy this kit and SAVE money! A unique feature of this kit is the fact that you can wire N/O and N/C alarm sensors ON THE SAME LINE.
★ 8 SECTORS
★ 2 delayed entry sectors
★ Steel box
★ Includes battery and siren driver in the price
★ Variable exit and entry delays
Cat. KA-1580

\$149.00

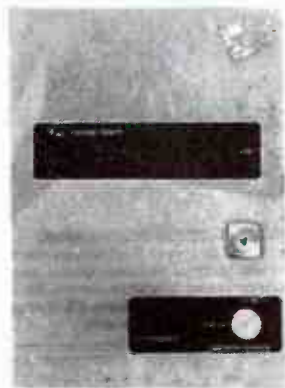

Digital Bench Type Capacitance Meter

Ref. EA August 1985
★ Easy to assemble
★ 4 digit LED readout
★ Measures from 1pF to 99.9uF
★ 3 ranges
★ Bench type mains powered
Cat. KA-1595

ONLY \$79.95

DON'T buy a speaker kit until you check our **GREAT NEW 1986** Models of low cost Jaycar "Euro-Style" speaker system kits. **CALL US** or you **WILL** be sorry!!!

"PEST OFF" Ultrasonic Pest Repeller

Ref. EA November 1985
Why pay up to \$150 when you can build a pest repeller yourself and save a fortune? The Pest Off works on a similar principle to the expensive commercial designs.
The Jaycar kit contains all specified components including the special piezo electric transducer.
Cat. KA-1620

ONLY \$39.95



ETI 1401 DIRECT INJECT BOX

Ref. ETI Sept. 1985
This unit accepts unbalanced audio inputs (line or mic level) and produces a line level balanced signal to drive mixers or balanced input equipment. The Jaycar kit includes die-cast box, specified push button switch bank and all other parts.
Cat. KE-4708

'SONICS' D.I. BOX

After some field experience it has been decided to replace the push bank of switches with a set of toggle switches. There are two reasons for this: (1) The push button switch bank is fairly fragile and a good kicking will destroy the bank.
(2) Constructors have had difficulty filing the slot in the die cast box to accommodate the switch bank. The toggle switches only require a 4mm drill hole (Incidentally we could not punch the slot in the side of the box - it's virtually impossible).
(3) The new kit is cheaper!
Cat. KE-4708

ONLY \$29.95



Electronic Jumper Leads - ETI 341

Ref. ETI August 1985
This project enables you to charge up a car battery via the cigarette lighter plugs in each car. A small inverter boosts the battery voltage from car No 1 to charge the flat battery in car No 2 via its cigarette lighter socket.
It's amazing how quickly you can put enough charge in a flat battery to start the car!
Complete set of parts including 2 x cigarette lighter plugs.
Cat. KE-4703

\$39.95

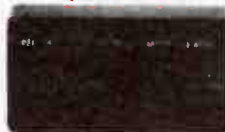

MAIL ORDER HOTLINE (02) 747 1888

DRUM SYNTHESISER

Original design from the UK magazine 'Electronics and Music Maker' April 1981. This self-contained unit can produce a variety of fixed and falling pitch effects triggered either by tapping the unit or striking an existing drum to which the unit is attached! The Jaycar SYNTOM Drum Synthesiser comes complete with a high quality pre drilled moulded all ABS box measuring 152 x 80 x 47mm with professional silk screened front panel.

FEATURES
Decay from less than 0.1 second to several seconds
pitch control - sweep control and volume on/off
Cat. KJ-6502

ONLY \$36.50



Ignition Killer

Ref. EA Feb 1984
This little project is cheap, easy to fit and is effective. It basically is a timer circuit that disables your ignition system a few seconds after it is activated. A would-be thief starts the car, it goes a few metres and stops, he immediately cranks the engine and it fires but it stops again moments later. This could continue indefinitely. Frustrated, the thief looks for easier 'game' elsewhere. The Jaycar kit contains specified original components, instructions and two BONUS alarm stickers.
Cat. KA-1535

ONLY \$14.95

8 CHANNEL MIXER Model 8002

Balanced input 8 channel stereo mixer with features only found in units costing \$1,500 or more!

- MAIN FEATURES**
- Balanced (600 ohm) mic inputs/line inputs
 - Input attenuators
 - Cannon connectors included in the price
 - Bass, mid and treble equalisation on each input
 - Effects (re-echo etc) capability
 - Foldback on all 8 inputs
 - Stereo pan on all 8 inputs
 - 60mm slide faders used throughout
 - 19 rack mount capability (or console mount)
 - Professional black front panel with format borders and multicoloured knobs to assist function identification
 - Designed for quick and easy service
 - VU metering
 - Only high quality components used
 - 5534A OP amps used for low noise and very low distortion
- TECHNICAL**
- Signal to noise microphone input -75dB with ref to +4dBm
 - Signal to noise line input -60dB with ref to +4dBm
 - Line level +4dBm (0VU)
 - Distortion less than 0.003%
 - Power requirements 240V AC 50Hz 25 watts

8002 MIXER

Ref. EA April/May 1983
8002 RACK KIT This is the basic mixer. This kit gives you virtually all the electronics. Provided front panel VU meters, 11 PCB's, all pots (rotary and slider), knobs, components for PCB's, hook up wire etc. All Cannon XC chassis connectors are included as well. It is ideal for rack mount and all that is necessary is a ±15V 1A power supply.
Cat. KJ-6504

\$535.00



**MAIL ORDER HOTLINE
(02) 747 1888**

FROM JAYCAR NO 1 IN KITS

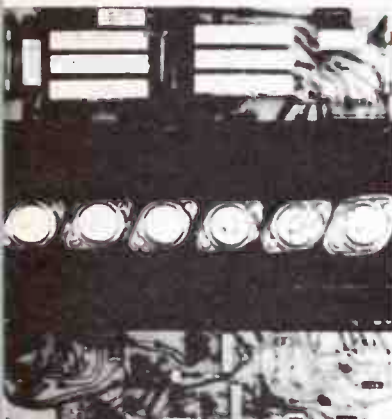

ARM 6500 - 60/120 WATT UTILITY MOSFET AMP MODULES

Ref. EA July 1985
This is a low cost high performance design using proven MOSFET technology. A single pair of (2S)49/25K134 Mosfets will deliver up to 60 watts output. Another pair may be added for 120 watt performance. The module has been designed to fit into a large variety of commonly stocked instrument cases and rack boxes. It features VERY LOW distortion and impeccable transient performance. It is unconditionally stable and virtually blow-up proof. It can be powered from common transformer/rectifier/capacitor combinations. A Winner!
As usual, the Jaycar kit reflects a quality approach. All specified components for each version are included.

60 WATT MODULE Cat. KM 3010

\$49.50

120 WATT MODULE Cat. KM 3012

\$65.00

300W PLAYMASTER AMPLIFIER

Ref. EA June 1980
This rugged design provides 200W rms into 8 ohms and 300W rms into 4 ohm loads. All parts fit onto a single PCB. It also features comprehensive protection circuitry and will even withstand short circuits for short durations without adverse affect. Unlike other high powered amps, it is unconditionally stable. It will not therefore break into supersonic oscillations, overheat and fail.
The Jaycar kit of this project provides a quality roller tinned fibreglass PCB and other quality components down to the heatsink compound.
Cat. KA 1115

ONLY \$99.95
300W AMP POWER SUPPLY KIT

This basically consists of a 300VA power transformer (PF4363), rectifier and filter capacitors. It also has 15VAC power for the speaker protector.
Cat. KA 1116

ONLY \$79.95
Speaker Protector for Playmaster 300W amp

Ref. EA July 1980
This device is designed to mate with the Jaycar KA 1115 Playmaster 300W amp module. It also provides the handy facility of switch on mute. This disconnects the speakers for the first few seconds when the amp is switched on, avoiding the horrifying thump in the speakers. If you have expensive speakers (whether you have the EA 300W amp or not) this speaker protector is cheap insurance. The Jaycar kit provides all PCB parts including the relay.
Cat. KA 1117

ONLY \$14.95

Electronic Crossover

Ref. EA November 1984
NEW SHORT FORM KIT!
You can NOW build this desirable project for a lot less! There have been requests for a version of this kit that can be built into other equipment. This is it! The kit contains PCB and all board components etc. The box (including front panel) and selector switches are not supplied but everything else!
Cat. KA 1571

ONLY \$79.00

Car Booster Amp

Ref. EA August 1985
This project enables you to have 2 x 50 watts **BOOST** of power for your car sound system. In order to do this, a special high voltage power supply forms part of the system. Absolutely stunning value for money. Around half the price of inferior commercial units.
The Jaycar kit is, as usual, absolutely complete.
Cat. KA 1600



20 WATT UTILITY AMPLIFIER

Ref. EA November 1984
This is a low cost general purpose amplifier which is easy to build and gives Hi Fi performance. All components mount on the printed circuit board which is provided. Capable of up to 19 watts rms from a 35 volt supply. Note that 35V is the maximum permitted supply voltage.
See the Jaycar 1985 catalogue for specs.
Cat. KA 1567

ONLY \$17.50

ETI 467 MIXER/PREAMP

Ref. ETI July 1980
The ideal companion to the Utility Amp (KA 1567). Mixes up to 4 inputs (high and low level) with individual level controls. Includes high performance 3 band tone controls making it ideal for musical instrument use. Kit comes without a case so that you can build it in with a power amplifier if you wish. Operates from 2 x 15V AC (usually available from power amp supply, or use Cat. MM 2008 transformer).
Cat. KE 4014

ONLY \$29.50



ONLY \$179

Cat. KA 1500

ONLY \$429.00

BUSKER AMPLIFIER

Ref. EA Feb 1985
Fantastic, portable amplifier kit for low-level PA. Buskers or for practice.
★ Battery or mains operation
★ Full control - bass, treble and volume
★ 17 WATTS RMS output
★ Gel battery automatically recharged when mains used.

★ INTRODUCTION PRICE ★

ONLY \$125.00

All electronics including Gel battery, 8" speaker, metal chassis etc.

Cat. KA 1592

PRE-CUT WOODEN CABINET to suit

Cat. KA 1593

ONLY \$30.00

SAVE 20%

this month and pay

ONLY \$124.00

You must buy both!



BASIC AMP

Ref. ETI 061
Teaches the basics of transistor amplifiers and builds a useful low power amp at the same time. Amp can be used to amplify microphones or crystal radios so they they can be heard through a small loudspeaker.
Cat. KE 4001

ONLY \$5.90

ETI 499 150 watt MOSFET Amp Module

Ref. ETI March 1982
A high power amplifier with the stability and reliability of MOSFET's. Genuine 150 watts rms with power supply components on board. You only need to connect a power transformer (Cat. MM 2015) and heatsink. The Jaycar kit includes a magnificent jig drilled extruded heatsink bracket for greater thermal efficiency.
Cat. KE 4220

ONLY \$79.50 ea

ETI 480 SERIES AMPLIFIER MODULES

Ref. ETI December 1976 & ETI's 30 Audio Projects
ETI 480/100 A complete audio amp on a single board. Just add a power supply and you have a 100 watt Hi Fi musical instrument or PA amplifier. Use it with the KE 4014 mixer/preamp for instrument or PA. Kit contains metal bracket, all PCB items and instructions. Legendary performance at a modest price.
Cat. KE 4052

ONLY \$27.00

ETI 480/50 Same circuit as the 480/100 except 2 less output transistors. Half the power and a little cheaper. Great if you don't need 100 watts. All parts supplied.
cat. KE 4050

ONLY \$23.00

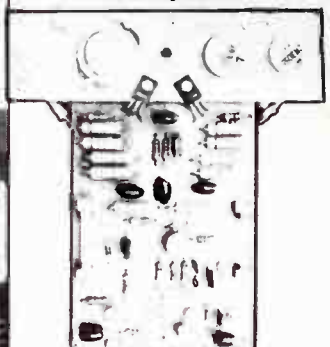

ETI 477 MOSFET AMP MODULE

Ref. ETI Jan/Feb 1981
Two 477 amp modules form the basis of the 5000 power amp. You can buy the modules (mono) individually to make your own custom MOSFET amp! For performance specifications refer to the Black Monolith amplifier in the Jaycar catalogue.
Power supply extra.
Cat. KE 4210

ONLY \$59.00 ea

BENCH AMPLIFIER

Hobby Electronics Project
If you ever need to test whether a preamp is functioning correctly this is the ideal project to test it with. It can amplify signals as low as a few millivolts to an audible level.
Cat. KS 8105

ONLY \$9.75

PLAYMASTER SERIES II MOSFET AMP KIT

Ref. EA Jan/Feb/March 1985
"... s stereo amplifier that will equal or better just about any integrated commercial amplifier, regardless of price". Leo Simpson, Editor of EA, February 1985.

MAIN FEATURES

- Switchable phono input for MM and MC cartridges
- Electronic signal switching
- Full facilities for dubbing between two cassette decks
- Monitor loop for either of two cassette decks or a signal processor
- Click-action pushbutton switches for selection of sources, dubbing and tape monitor with LED status indicators
- Centre detents on bass, treble and balance controls, multiple detents on volume control
- Heavy duty heatsinks
- Power transformer for low hum and noise
- Easy to build - all parts except power supply mount directly on the two printed circuit boards, wiring has been kept to an absolute minimum
- 100 watts RMS per channel into 8 ohm load
- Less than 0.01% total harmonic distortion

Jaycar ELECTRONICS

Incorporating ELECTRONIC AGENCIES
NUMBER 1 FOR KITS

MAIL ORDER HOTLINE (02) 747 1888

N.S.W. SHOWROOMS
SYDNEY: 117 York Street Tel (02) 267 1614
CARLINGFORD: Cnr Carlingford & Pennant Hills Road, Tel (02) 872 4444
CONCORD: 115/117 Parramatta Road, Tel (02) 745 3077
HURSTVILLE: 121 Forest Road, Tel (02) 570 7000
GORE HILL: 188/192 Pacific Highway (Cnr Bellevue Avenue) Tel (02) 439 4799

QUEENSLAND
BURANDA: 144 Logan Road, Tel (07) 393 0777

MAIL ORDERS: P.O. Box 185, CONCORD 2137
HEAD OFFICE: 115-117 Parramatta Road, CONCORD 2137
Tel: (02) 747 2022 Telex: 72293

SHOP HOURS
Carlingford, Hurstville
Mon-Fri 9am - 5:30pm, Thurs 8:30pm, Sat 12pm
Sydney
Mon-Fri 8:30am - 5:30pm, Thurs 8:30pm, Sat 12pm
Concord & Gore Hill
Mon-Fri 9am - 5:30pm, Sat 12pm

POST & PACKING
\$5 \$9.99 \$20.00
\$10 \$24.99 \$37.75
\$25 \$49.99 \$45.50
\$50 \$99.99 \$65.50
\$100 \$198 \$80.00
Over \$199 \$10.00

COMET ROAD FREIGHT ANYWHERE IN AUSTRALIA ONLY \$13.50



MAIL ORDER VIA YOUR PHONE

A keyboard in the ham shack



OK, you have seen a few items in magazines for RTTY decoders and FAX printers; where does my black box differ from these? Simple — I can talk and listen. I can work CW as well as RTTY. I wish I had greater dexterity with my equipment construction. For every few hours of on-air use of the computer, I receive one letter of enquiry! How do you answer when you have to co-exist with a decoder looking like the one I built!!

Operating the gear

With the VIC-20 system, the first thing to do is to switch on and to type your own call sign. The various 'magic key' combinations are best written on a card and pinned to the wall. One forgets! Having done that, either select CW or RTTY mode and tune over the bands. If a CW signal is found, the modem is switched to the CW filter and the computer is instructed to decode CW. You guess the speed of the CW and type that in. This guess can be miles (oops, km) off without ill effect.

Tune in the signal until the CW LED on the modem glows and whoopee, the CW is decoded and appears on the TV screen! I still boggle at the magic of this. I have used CW for ages and cannot really accept this shortcut. On noisy and weak signals, I find that my ability to decode plus the computer's ability to record leads to a winning combination.

Of course, CW buffs do such things as vary speed, use abbreviations ad-nauseum and send 'C' as daaaaaa-did-dah-dit instead of da-did-dah-dit. None of this helps the computer really, you find. Ahhh yes, then there is sending CW. You may detect from the photograph that I have an electronic keyer built into the modem. I sometimes use this when conscience strikes. What do I mean? Believe it or not, there have been CW operators who have literally *switched off* when I told them I was talking with a keyboard.

Having a keyer lets me revert to my old style. By the way, way back in the old days when I first built an electronic keyer, guess who learnt to operate the thing back to front? What a dill! Press to the right and dashes come out on my machine — that is not the way it is supposed to be! When I visit other shacks (would you believe) I have to turn their CW bug upside down in order to operate it!

The built-in keyer is really lovely for CW practice. I send to the computer and see what sort of % accuracy the screen picks up. Good fun — and the computer doesn't switch off when I tell it about the equipment being used! Then of course, I can get the computer to send me random groups for aural testing.

RTTY?

Now the main bit — RTTY. Yes I can operate, and operate very well, provided things are in good condition. I have one problem. The computer generates noise, and I think the optocouplers contribute. This noise can often confuse the system. It is a matter of tuning-in to a signal and seeing whether the computer is also transmitting there. Yes, computers do transmit and do it well. Is there a magic paint for the computer cabinet to quieten their brains (see Bee Buzz, September issue)? One well-informed editor has hinted at such a product. Is there also one for teenage kids, Roger? By the way, would you believe, my Apple slim-line disk drive generates TVI!

On the air, and if things are in good shape (clear channel, low noise, good signal), switch the modem to RTTY, type the 'RTTY-please' command to the computer, select the correct baud rate on the keyboard and tune the signal until the two LEDs glow at about the same intensity. On the screen, you either see text or garbage. If there is garbage, invert the signal, either on the modem or the computer. The former is better since this will bring along with it, the correct sense for transmission.

The technique for transmitting in either mode is identical. Once you can hear, you can simply switch to transmit and talk (type?). It is as simple as that. No fuss and no error. You have to watch the power level that your transmitter emits on RTTY. Remember that the carrier is continuous and that can test an SSB-only rig.

How useful?

I cannot use the CW facility in a contest because I get flustered too easily. Maybe I am slow or lack dexterity but there are simply too many things to do. Vox controlled CW with a keyer is easier. For a rag-chew, the system is brilliant. AND, you can get on with other things while you QSO. There is progress! Nothing really fools the system. It is sheer pleasure sending CW without error, with perfect spacing and with the knowledge that the other person will throw a complement if he or she doesn't twig to the fact that you are using a computer.

RTTY on a computer is great fun. The wretched thing sends faster than I can type, however! You fill up the screen and, when it is your turn to send, you let it rip. Then you type even more and watch the thing catch up. It is like a bad dream. The computer gobbles all you have typed and sends at professional speed. Then it catches up; the other person suddenly detects that you are a hunt-and-peck typist, which is rather a let-down after the rapid transmission to that point. I usually break into a cold sweat at this stage. My wife usually laughs (the typing fury brings her into the shack).

Both facilities are great and work very well. Yet I sometimes let the system gather dust a bit. Perhaps the microphone and keyer are a more simple and straightforward combination to operate for standard QSOs. Look at the philosophy of the hobby. We are radio communications experimenters, yet the computer is here to stay. It is rather nice to combine the two and thus to extend the frontiers of the hobby for yourself. I have had hundreds of QSOs in both modes with the computer and have 'had my money's worth' for sure.

Conclusion? Give it a go if you have the chance. I am not convinced I could justify for myself a kilobuck commercial unit (I note they are quieter RF-wise) for RTTY and CW over my cobbled-together system. I get to use my VIC-20 for other purposes (i.e. it is not a dedicated system) and thus find wider justification. The money I paid for the software was well spent and I recommend it to anyone who is willing to build a modem. Maybe I will save for a full commercial system one day. I doubt it, though — my current setup quells my thirst for typing at people quite well. ♣

3 84 240 1545

Radio Communicators guide to the ionosphere

Part 3

Leo McNamara and Roger Harrison

Introduction to the ionosphere

MOST OF US have at some time turned to the broadcast (or MF) band on our radios for company at night or to keep ourselves awake on long dark trips through the country. There is no trouble finding a station to listen to — they are usually spread from one end of the dial to the other. The real trick is to find a station which does not slowly disappear, to be followed by frustrated twiddling of knobs as we go searching for another to take its place. The elusive station is usually a distant one, as we eventually discover when there is a station break giving the local time or an advertisement for a local business.

Now let's ask ourselves what is going on. What facts do we have to help us? We know that:

- (1) We can hear distant radio stations, not just the ones nearby.
- (2) We can hear these distant stations only at night, not during the day.
- (3) The stations come and go, apparently at random.

Consider the first point. How can we possibly hear the distant radio stations, a 1000 km or so away? Put another way, the question we want answered is how do the radio waves transmitted from the radio station manage to travel so far? If we were playing cricket or baseball and wanted the ball to travel a long way (preferably over the fence), we would hit it up into the air as hard as we could. Gravity would then bring it down on the other side of the fence, or what is more likely, into a fielder's hands. The harder the ball is hit, the higher it goes and the further it goes.

We can consider the propagation, or travel, of radio waves in a similar fashion — we hit them up into the air in the right direction (with an antenna) as hard as we can (using a powerful transmitter) and catch them if we are clever enough (with a receiving antenna).

The only thing missing from this analogy is some way of getting the radio waves down to earth again. We all know that gravity does not affect radio waves — otherwise we would be knee-deep in radio sludge. What we need is some sort of mirror to reflect the radio waves back to ground. So let us just assume that there is in fact some sort of mirror in the sky which will do the job for us. We could work out how high up it has to be, but we will not do that. When this height is worked out, it turns out to be about 300 km.

So far, we have a picture, or model, in which the radio waves we receive at night are reflected down to us from some sort of mirror at about 300 km. This is illustrated in Figure 3.1. We can now ask ourselves why there is a difference between day and night, and what might cause that difference.

The big difference between day and night, of course, is that the sun is around during the day, so it is odds on that the sun does something during the day which is detrimental to (fouls up) the propagation of radio waves. Since the radio signals do not arrive at the receiver, we must assume that either (a) they have not been reflected by our mirror at 300 km altitude and are still travelling off into space, or (b) they were absorbed by something on the way. How do we work out which of these explanations is the correct one?

We can reject (a) immediately because our experience with HF (rather than MF) tells us that the mirror is there all day. We can therefore deduce that there is an absorbing region between the ground and our reflecting mirror which affects the MF signals during the day, but that this region does not exist at night. Broadcasting stations rely on this absorption to protect themselves and their local audience from interference from distant transmitters during the day.

The third thing we have to explain is why the signals from the distant radio stations come and go. The explanation of

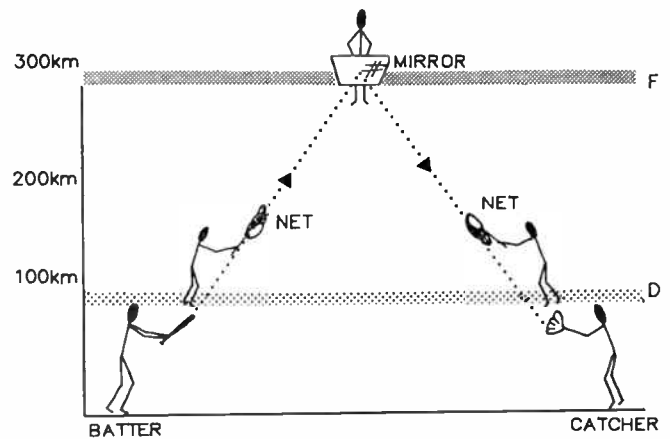

Figure 3.1. Sketch illustrating the reflection of radio waves sent upwards by a batter (transmitter), to be caught by a fielder (receiver) after reflection to the ground by a mirror at 300 km altitude. During the day, some energy is lost as the waves travel through an absorbing layer at around 100 km altitude.

this is a bit messy, but basically it is a matter of too many cooks spoiling the broth. We get not just one bundle of radio waves arriving at our receiver, but two or more, and these bundles get in each other's way (we say that they interfere with each other), at times working together, giving a good strong signal, and at times working against each other, giving a signal which is too weak to be detected by our receiver. The rise and fall in signal strength is called *fading* of the signal, and it is this fading which causes the distant stations to come and go as the signal reaching the receiver rises and falls in intensity.

So far, we have been able to deduce several important points about HF radio propagation:-

- (1) There is something situated at a height of about 300 km which acts as a mirror, reflecting radio waves back to the ground.
- (2) There is also something situated at a height less than that of this mirror which absorbs or attenuates the radio signals passing through it.
- (3) Several sets of radio signals arrive at our receiver at night, interfering with each other and causing fading of the received signal.

With these three points in mind, we can move on to a little more detail of what is going on, so that we can talk about the problems we encounter when trying to use HF radio both effectively (choosing the right thing to do) and efficiently (doing the right thing well). Obviously the situation is not as simple as we have made it appear so far — otherwise we would not encounter the exasperating problems so conveniently called "conditions".

Before we move on, however, it is worthwhile to set up a few catch phrases to help us remember the basic facts. We can introduce a few phrases which will remind us of our simple picture when we move on to a more complicated and correct picture of what is going on.

The mirror in the sky corresponds (more or less) to what is known in the business as the *F* layer. We can remember this by noting that the *F* layer is a good guy, or friendly fellow, so that the "F" can stand for "friendly".

The region below the *F* layer which absorbs the radio signals, both on the way up to the *F* layer and down, is known

SAVE \$\$\$

ROCKWELL INTEGRATED CIRCUITS FROM THE AUSTRALIAN DISTRIBUTOR.

R68000 CPU DIL QUIP, CERAMIC PLASTIC: MILL 885 6, 8, 10, 12 MHZ
R6502, R6503, R6504, R6507 CPU
R65020 PIA, R6572 VIA, R6532 RIOT;
R6545, R6545-1CRT; R6551 ACIA;

Single Chip

R6511Q 64 Pin Quip 2 x ctr 31 I/O 192 RAM Com Port.
R6541Q 64 Pin Quip, letr, Bus I/F, 23 I/O 64 RAM.
R65F11 P 40 Pin FORTH Kernel. I/O Coms RAM.
R65F12 Q 64 Pin FORTH Kernel. I/O Coms RAM.
R65C29 64 Pin Quip. RAM. Dual CPU. MPY. CMOS Com Port. Call for latest prices.

Many new 65 CXX parts now available in Low Power CMOS.
1984 Data Book 1300 pages available now.



PRINTERS. By CTI of Japan.

All with tractor/friction feed. Graphics True descenders. Provision for 4K Buffer. Square Pin Head Technology gives solid vert. and hor. lines. (P) for centronics I/F (S) for RS232 with X on X off.

CPA-80 25cm 100 cps
CPB-80 25cm 130cps 2K Buffer IBM compatible.

NEW release.

CPB-136 38cm 130cps 2K Buffer. IBM compatible, Linear tractor, 2 position ribbon. Call and save.

energy CONTROL

ENERGY CONTROL PTY. LTD.
P.O. Box 8502 Goodna Qld 4300
Brisbane AUSTRALIA
Phone: (07) 538 2455
Telex: AA43778 ENECON
P.O. Box 12133 Wellington North
NEW ZEALAND
Phone: 4-72 6482 Telex: NZ30135

AUTHOR! AUTHOR! AUTHOR!

So you've written this great article.

Tell us all about it then!

Maybe you've developed a project you think others might be interested in?

We'd like to hear from you!

Write to:

Roger Harrison
Australian Electronics
Monthly
PO Box 289
WAHROONGA 2076 NSW

Cop This!

I.C. SPECIALS FROM Promark

EPROMS

(T) 2716-450NS	\$3.60
(T) 2764-250NS	\$4.10
(T) 27128-450NS	\$5.05
(T) 27128-300NS	\$5.50

CMOS-EPROMS

(T) 27C16	\$8.60
(T) 27C32	\$10.24

C-RAMS

(H) HM6264LP-15	\$7.95
(H) HM6116P3	\$3.85

MICROPROCESSORS

(S) 8085A	\$5.00
(N) 8748HD	\$8.00
(N) 8749HD	\$10.00
(T) 68000P-8	\$29.50
(T) 68000P-10	\$44.50
(S) 8086	\$13.50
(N) UPD8087-8MHZ	\$300.00

D-RAMS

(H) HM50256-15	\$6.85
(S) HYB4164-P2	\$1.50

V, REG TO3 STEEL

(T) LM338K	\$5.50
(T) LM323K	\$2.45

QUAD BI-FET OP-AMPS, ETC.

(T) TL064DP	\$1.10
(T) TL074DP	\$1.30
(T) TL084DP	\$1.15
(T) TL494DP	\$1.45

UNIVERSAL MODEM

(T) 7910CP	\$25.90
------------	---------

BRANDS OFFERED:

(T) THOMSON, (H) HITACHI,
(N) NEC, (S) SIEMENS

All prices + 20% tax \$4.00 freight, minimum order \$50.00 before tax and freight.

If you use big bags of this stuff - call Clive Barry or Vivian in Sydney, or Ian, David or Lena in Melbourne, and we will fix you up with even better prices!



Promark Electronics PTY. LTD.

SYDNEY 02-439 6477 MELBOURNE 03-878 1255 TOLL FREE 008-22 6226

FOR QUALITY AND VALUE TALK TO THESE PEOPLE ABOUT FLUKE MULTIMETERS

A.C.T.

Actec Pty Ltd
34 Geelong St Fyshwick
(062) 80 6576

N.S.W.

Ames Agency Pty Ltd
605 Elizabeth St Redfern
699 4524

George Brown & Co Pty Ltd
174 Parramatta Rd
Camperdown - 519 5855
Newcastle - 69 6399
Canberra - 80 4355

Bryan Catt Industries Pty Ltd
10/59-61 Gympie Bay Rd
Gymea
526 2222

Collier Tools (Aust) Pty Ltd
185 Parramatta Rd
Homebush
763 1888

D G E Systems Pty Ltd
103 Broadmeadow Rd
Broadmeadow
(049) 69 1625

Davred Electronics Pty Ltd
127 York St Sydney
267 1385

W F Dixon & Co Pty Ltd
P.O. Box 42 Wickham
(049) 61 5628

Macelec Pty Ltd
99 Kenny St Wollongong
(042) 29 1455

Paul's (Merchants) Pty Ltd
22 Canterbury Rg
Bankstown
709 2311

Radio Despatch Service
869 George St Sydney
211 0291

Electro Parts Pty Ltd
482 Hume Hwy Yagoona
708 3244

Standard Communications Pty Ltd
6 Frank St Gladesville
896 1755

Geoff Wood Electronics Pty Ltd
656A Darling St Rozelle
810 6845

WESTERN AUSTRALIA

Atkins Carlyle Ltd
1 Milligan St Perth
321 0101

Dobbie Instruments (Aust) Pty Ltd
9 Boag Rd Morley
276 8888

Cairns Instrument Services
32 Wickham St East Perth
325 3144

Willis Trading Co Pty Ltd
165 Albany Hwy
Victoria Park
470 1118

VICTORIA

Radio Parts Pty Ltd
562 Spencer St
West Melbourne
329 7888

G B Telespares Pty Ltd
504 Queensbury Rd
North Melbourne
328 3371

Browntronics Pty Ltd
93 Sackville St Collingwood
419 3986

R K B Agency
20 Council St Hawthorn
82 7704

A J Ferguson & Co Pty Ltd
558-568 Swanston St Carlton
347 6688

SIRS Sales Pty Ltd
4 Edols Pl North Geelong
(052) 78 1251

TASMANIA

George Harvey Electrics
Head Office
76 York St Launceston
(003) 31 6533
Hobart - (002) 34 2233

SOUTH AUSTRALIA

Prottronics Pty Ltd
174 Wright St Adelaide
212 3111

Trio Electrix Pty Ltd
177 Gilbert St Adelaide
212 6235

Redarc Electronics
253 Main Rd Blackwood
278 7488

QUEENSLAND

L E Boughen & Co
33 Railway Tce Milton
369 1277

Colourview Wholesale
5 Commerce St Salisbury

Fred Hoe & Sons Pty Ltd
246 Evans Rd Salisbury Nth
277 4311

Nortek
36 Punari St Townsville
(077) 79 8600

St Lucia Electronics
71-77 Brunswick St
Fortitude Valley
52 7466

Selectro Parts (Qld)
44 Esher St Ekibin
394 2422

NORTHERN TERRITORY

Thew & McCann (NT) Pty Ltd
Menmuir St Winnellie Darwin
(089) 84 4999



ELMEASCO Instruments Pty. Ltd.

NEW SOUTH WALES VICTORIA

15 McDonald Street
MORTLAKE
P.O. Box 30 CONCORD
NSW 2137
Tel: (02) 736 2888
Telex: AA25887

12 Maroonah Highway
RINGWOOD
P.O. Box 623 RINGWOOD
VIC 3134
Tel: (03) 879 2322
Telex: AA30418 ELTENT

QUEENSLAND

Tel: (07) 359 8688
S AUSTRALIA
Tel: (08) 344 9000
W AUSTRALIA
Tel: (09) 481 1500

HYPEC FOR RS232 HARDWARE

GENDER CHANGERS

A quick, inexpensive way to avoid modifying or replacing incompatible RS-232 cables. Our gender changers are shielded to meet new FCC emissions regulations. All 25 pins are live, our gender changer works on any shielded EIA cables.
 Model GC-25MM Male-Male
 Model GC-24FF Female-Female
 \$14.00

DATA TRACKERS

The most economical method to diagnose EIA RS-232 interface problems. Our RS-232 Mini Tester is pocket sized and no battery is required. Twenty-five pins are connected directly on PC board. LEDs indicate the status of pins: pin 2 transmit data (TD), pin 3 receive data (RD), pin 4 request to send (RTS), pin 5 clear to send (CTS), pin 6 data set ready (DSR), pin 8 carrier detect (CD), and pin 20 data terminal ready (DTR).
 Model MT-25MF Male to Female \$25.00

NULL MODEM

Replaces two modems when connecting two DTE or two DCE devices together over short distances. The unit operates within EIA RS-232C specification. Install directly to equipment ports or insert in between two cables.
 Model NM-25MM Male to Male
 Model NM-25MF Male to Female
 Model NM-25FF Female to Female
 \$14.00

SPIKE SUPPRESSOR

This protector has built-in MOV (metal-oxide varistor) to protect pins 2, 3 and 7. Plug the surge protector into RS-232 ports to prevent costly equipment damage and data loss from large voltage surges caused by lightning, electrical interference, static electricity etc.
 Model SP-25MF Male to Female \$20.00

MINI PATCH KIT

The fastest way to reconfigure mismatched EIA RS-232 connectors. Allows you to make your own cross-over cable, null modem and cable matcher. Each kit includes 2 covers, 2 RS-232 connectors, mounting hardware, 10 M-F jumpers, 2 F-M/F "Y" jumpers and 2 M-M/F "Y" jumpers.
 Model HH-10MF Male-Female
 Model HH-10MM Male-Male
 \$20.00

Convert What You Have To What You Want!



- RS-232 Serial
- Centronics Parallel
- 3 Baud Rates
- Handshake Signals
- Latched Outputs

No longer will your peripheral choices be limited by the type of port you have available! Our new High Performance Converter provide the missing link. Based on CMC's technology, these units feature full baud rate selection to 19.2K with handshake signals to maximize transfer efficiency. Detailed documentation allows simplified installation.

\$150 PLUS TAX

DB 25s

CRIMP TYPE
 MALE (Pins) \$6.95
 FEMALE (Socket) \$6.95
SOLDER TYPE
 MALE \$1.80
 FEMALE \$1.90

IDC CONNECTORS SOCKETS

 16 \$1.94
 20 \$2.00
 26 \$2.71
 34 \$3.30
 40 \$3.38
 50 \$4.75

CARD EDGE CONNECTORS

 20 \$4.00
 26 \$4.40
 34 \$4.58
 40 \$5.56
 50 \$6.30

BITS & PIECES

CABLE TIES

LENGTH	PER 10	PER 100
75M	1.65	13.50
100	1.83	15.30
120	2.65	22.10
150	3.50	29.20
180	4.71	39.30
200	6.26	52.20
250	9.80	82.40
280	14.13	117.80
300	20.72	172.70
380	23.80	198.40

CROCODILE CLIPS

SIZE	10	100
SIZE 1A	2.88	18.40
SIZE 2A	2.74	24.09

MIXED COLOUR INSULATION COVERS

NYLON STAND OFFS

LENGTH	PER 10	PER 100
8	2.80	23.60
10	3.00	28.50
12	3.30	30.60
15	4.20	36.60

FANS

 4" 240V \$16.95
 3 1/2" 240V \$15.95
 3" 240V \$15.50

ALL BRAND NEW
 ALL EX-STOCK
 CALL FOR QUANTITY DISCOUNTS

COVER THOSE EXPOSED CONNECTORS VINYL BOOTS

 6 COLOURS AVAILABLE

	10	100
1.25mm dia.	0.62	5.40
2.00	0.70	5.50
3.5	0.85	6.00
5.5	0.98	6.40
8	1.05	6.95
14	1.20	10.50
22	1.34	11.85
38	1.65	13.79
60	2.70	22.34

2AMP TRANSFORMERS

PRIMARY 240V
 SECONDARY 6, 9, 12, 15
 SOLDER LUGS
 \$11.50 each

INSULATION SPAGHETTI
TEFLON
 MANY SIZES
 CUT LENGTH

IN-LINE POWER PAK WITH 240V POWER CORD

 +5 @ 0.8
 +12 @ 0.25
 -12 @ 0.25
\$65.00

DISC DRIVE POWER CONNECTORS

5 1/4" \$1.40
 8" \$2.50
 INCLUDES PINS

SHORTING BLOCKS

4/\$1.00

SWITCHING POWER SUPPLIES

CPI-604 +5 e 7
 160 x 120 x 50 +12 e 2.5
 -12 e 0.5
\$85
CPI-107 +5 e 7
 250 x 90 x 55 +12 e 2.5
 -12 e 0.5
\$95
CPI-4203 +5 e 2.0
 148 x 98 x 42 +12 e 2.0
 -12 e 0.2
\$45

CPI-622 +5 e 3
 160 x 120 x 50 +12 e 2
 -12 e 0.5
\$72

CPI-625 +5 e 4
 160 x 120 x 50 +12 e 2
\$75.60

PSA-523 -12 e 0.1
 145 x 80 x 50 +5 e 5
 + e 2.5
\$140-
 - e 0.5

HYPEC FOR COMPUTER PARTS

COMPLETE PC



256K 1 Serial Port
2 x 360 Drive A Clock Calender
1 Parallel Port 1 Games Port

MONITOR
EXTRA **\$1950**

PC ADD — ON BOARDS

PART NO	DESCRIPTION	PRICE
CBC 001	MULTIFUNCTION CARD VER 1	199.37
CBC 002	256K MULTIFUNCTION CARD VER II	238.56
CBC 002 S	STACK ORG ROM VER II MULTIFUNCTION CARD	128.84
CBC 003 B	384 MULTIFUNCTION CARD — 1 SERIAL PORT	238.56
CBC 004	COLOR GRAPHICS MONO CARD	248.40
CBC 006	MIDRESOLUTION CARD	160.19
CBC 007	MIDRESOLUTION GRAPHIC CARD	212.43
CBC 008	FDD CARD	107.94
CBC 009	GAME ADAPTOR	66.15
CBC 010	8MHz 256K FDC CARD	113.17
CBC 011	MULTIFUNC CARD	356.11
CBC 012	HARD DISK CONTROLLER	447.54
CBC 012 II	HARD DISK CONTROLLER II	395.29
CBC 012 III	HARD DISK CONTROLLER III 2 INT FDD	421.42
CBC 013	256K ROM CARD	113.17
CBC 013 0	OPTION CARD	66.15
CBC 014	384K ROM CARD	113.17
CBC 014 II	384K ROM CARD WITH SERIAL PORT	160.19
CBC 015	512K RAM CARD	107.94
CBC 016	10 PLUS 4 & 8 MB	194.14
CBC 018	MULTIFUNC CARD	275.13
CBC 019	ASYNCHRONOUS COMMUNICATION ADAPTER	107.94
CBC 020	PARALLEL PRINTER CARD	71.37
CBC 021	FIRMWARE CARD	60.92
CBC 022	BUFFER PRINT CARD	186.31
CBC 023	ADAPTER CARD	207.21
CBC 024	PC SUPER WHEEL	853.87
CBC 025	PC BUFFER BOARD	131.45
CBC 026	L TIPS MANIPULATOR	268.15
CBC 027	SUPER WHEELBOARD	459.27
CBC 027 B	SUPER WHEELBOARD (K)	367.00
CBC 028	SUPER TONER WHEELBOARD (K)	400.00
CBC 029	COLOR GRAPHIC PRINTER CARD	228.56
CBC 030	MIDRESOLUTION COLOR CARD	488.35
CBC 031	DIAGONAL BOARD	238.56
CBC 032	512K MULTIFUNCTION CARD	343.05
CBC 033	576K RAM CARD	141.98
CBC 034	B/S COMMUNICATION CARD	173.25
CBC 035	8085 CPU CARD	187.12
CBC 036	SUPER WHEEL CARD	343.05
CBC 037	NETWORK ADAPTER	335.29
CBC 038	EPROM BOARD	251.62
CBC 039	TELETYPE BOARD	343.05
CDH 001	EMPIRE BOARD	100.00
CDH 004	EMPIRE BOARD	100.00
CDK 001	IBM PC & PCXT KEYBOARD	302.53
CD4 002	IBM PC KEYBOARD	224.16
CD4 003	IBM PC KEYBOARD	171.01
CD4 004	IBM PC KEYBOARD	175.71
CP 1130	PC 1130 POWER SUPPLY SWITCH ON BACK	160.00
CP 1138M	IBM POWER SUPPLY SWITCH ON SIDE	195.00

PLUS TAX

PC RELATED BOOKS

C Programming Tutor	\$37.95
Graphics Made Easy for the IBM/PC XT	35.95
C Programming Guidelines	52.00
Lotus 123 Self Taught	29.50
Illustrated MS/PC DOS Book	32.50
C Programmers Hand Book	22.95
From Basic to 8086/8088 Assembler	32.95
Lotus 123 At Work	32.50
MS/PC DOS Users Guide	33.95
Software Solutions for the IBM/PC	27.95
Assembler IBM PC/PCXT	32.50
Inside the IBM PC	42.50
IBM PC/XT Assembly Language	37.95
8087 Applications Programming	47.50
Assembly Language Programming for the PC	33.95
Accounting On Your IBM PC	17.95
MS/DOS Handbook	20.00
Basic A Handbook	20.00

MEMORY

4164	\$1.90
41264	\$8.50

PC PARALLEL PRINTER
CABLE \$30.00

**3 FOR THE PRICE OF 1
TVM MD-3
COLOUR MONITORS**

GREEN/AMBER/
COLOUR AT THE
TWIST OF A
SWITCH

\$750 TAX PAID



**14", 90 DEGREE,
0.39MM DOT PITCH,
DARK TINT**

IMPORTANT FEATURES:

- * Multi-Display Amber/Green/Full Colour versatility available with multidisplay control knob
- * Direct compatibility with almost any PC using R.G.B.I. TTL level
- * Wide Bandwidth
- * High resolution with 2,000 characters on 8 x 8 dot matrix
- * Full UL/FCC, CSA, TUV and VDE/PTB approval

NOVEMBER'S SPECIALS

MITSUBISHI 4851

40 TRACKS

\$195.00

TAX INC.

\$25- OFF LIST \$25-

**20 MEGABYTE
HARD DISK UPGRADE
FOR THE PC & CLONES
INCLUDES DTC &
CONTROLLER CABLES**

\$1400.00 TAX INC.

E. & O.E.

DEALER ENQUIRY WELCOME

MAIL ORDER HOTLINE (02) 808 3050

HYPEC ELECTRONICS PTY. LTD.

21 Ryedale Road, West Ryde NSW 2114.
Ph: (02) 808 3666, 808 3050

PO Box 438 Ryde, NSW 2112. Telex: AA71551

MAIL ORDER

POSTAGE RATES

\$1-\$9.99	\$2.00
\$10-\$24.99	\$3.00
\$25-\$49.99	\$3.50
\$50-\$99.99	\$5.00
\$100-\$199	\$7.50
\$200-\$499	\$10



WIN WIN WIN

this fabulous Yaesu scanner from Dick Smith Electronics

Don't miss this opportunity to win a really top-line scanner — this Yaesu FRG-9600 scanner from Dick Smith Electronics. It has many functions and features not seen on other scanners — especially the ability to receive single sideband (SSB) signals. In reviewing the FRG-9600 in the September '85 issue of AEM, Roger Harrison said:

“The FRG-9600 is a well-thought-out unit, easy to use and with facilities and features that will appeal to many — whether newcomers to scanning on the VHF/UHF spectrum or ‘old hands’.”

Dick Smith Electronics, in conjunction with Australian Electronics Monthly, is offering a Yaesu FRG-9600 scanner as the prize in this simple contest. The unit provides continuous coverage from 60 through 905 MHz and features 100 memory channels. Five reception modes are provided — FM narrow and wide, AM narrow and wide, plus SSB (unique to

the Yaesu.) The unit can scan over the full frequency range, preset frequency limits or across the memory channels. Provision is made for 'priority' channel selection, which is momentarily tested every three seconds, when activated, while listening to other channels. Selectable tuning steps are provided on the different reception modes. A 24-hour clock/timer is incorporated. The large display shows frequency or time on a 7-segment fluorescent readout along with a channel and mode display, plus a digital signal strength meter. A special feature is the tuning knob, which is an index switch, but the unit can also be tuned using UP and DOWN channel-step keys. The FRG-9600 can be optionally computer controlled via Yaesu's CAT interface system. It operates from a nominal 13.8 V supply and may be bench (base) or vehicle (mobile) mounted.

All you have to do is complete the questions below and tell us in 30 words or less what it is about the Yaesu FRG-9600 scanner that attracts you.

☆ **PRIZE WORTH \$729** ☆



Send your entry to:
YAESU FRG-9600 SCANNER CONTEST
Australian Electronics Monthly
PO Box 289, Wahroonga NSW 2076

You may enter as many times as you wish, but you must use a separate entry form for each entry and include a month and page number cut from the bottom of this page. You must put your name and address on the entry form and sign it where indicated. That is, photocopies are acceptable but an original month/page number from a copy of this month's magazine must accompany each entry form. Please read the contest rules carefully, especially if sending multiple entries.

The winning entry will be drawn by the Editor, whose decision is final, no correspondence will be entered into regarding the decision.

Winners will be notified by telegram the day the results is declared and the winner's name and contest results published in the next possible issue of the magazine.

RULES Contestants must enter their names and addresses where indicated on each entry form. Photostats or clearly written copies will be accepted, but if sending copies you must cut out and include with each entry an original page number and month cut from the bottom of the page of the contest. This contest is invalid in states where local laws prohibit entries. Entrants must sign the declaration accompanying the contest, that they have read the above rules and agree to abide by their conditions.

CLOSING DATE OF THE CONTEST is the last mail of January 31, 1986. Entries received within seven days of that date will be accepted if postmarked prior to and including the date.

Q1: What reception facility is unique to the Yaesu FRG-9600?

A1:

Q2: Does the FRG-9600 employ triple or double conversion, or both?

A2:

Q3: Who first imported Yaesu equipment into Australia in the early 1960s?

A3:

Q4: About how long has Dick Smith Electronics been selling Yaesu equipment?

A4:

Q5: What is the minimum tuning step of the FRG-9600 and in what mode?

A5:

Now tell us in 30 words or less what it is about the FRG-9600 that attracts you:

.....

Name

Address

Postcode

I have read the rules of the contest and agree to abide by their conditions:
 Signed

as the D layer. Just think of Dastardly Dan the D layer.

The D and F layers form part of what is known as the ionosphere, and it is the ionosphere which does all the work when we communicate over long distances using HF radio.

FORMATION OF THE IONOSPHERE

The ionosphere is formed when extreme ultra-violet (EUV) light from the sun strips electrons from the neutral atoms of the earth's atmosphere. Ultra-violet light has a shorter wavelength and is more energetic than visible light. Extreme ultra-violet light is even more energetic. Ultra-violet or UV light is perhaps more familiar in the context of sunburn.

When a bundle of EUV light (called a photon) hits a neutral atom such as an oxygen atom, its energy is transferred to an electron in the neutral atom which can then escape from the atom and dart freely around. The neutral atom thereby becomes positively charged (because it has lost a negatively charged electron) and is known as a positive ion. The process in which the photon strips an electron from a neutral atom, thus creating a positively charged ion, is known as *photoionization*, and is illustrated in Figure 3.2. That part of the atmosphere in which the ions are created is called the *ionosphere*. Actually this is not a terribly good name from our point of view because it is the *free electrons which reflect radio waves*. The ions are over 20 000 times as heavy as the electrons and are just too massive to respond to the rapid oscillations of a radio wave.

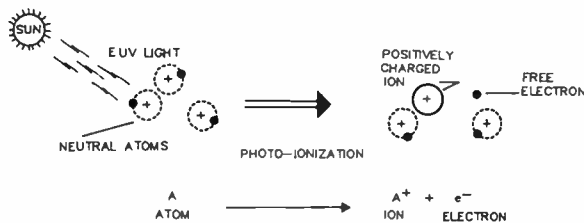

Figure 3.2. Photoionization of a neutral atom, A, by ultra-violet light from the sun, yielding a positively charged ion, A⁺, and a free electron, e⁻.

Recombination is the reverse of photoionization, negatively charged electrons and positively charged ions combining together again to give back neutral atoms. This is the main process by which electrons are "lost" in the higher parts of the ionosphere. In the lower levels of the ionosphere, electrons are lost by the process of *attachment*, in which they are "attached" to neutral atoms which thus become negatively charged ions. Like the positively charged ions, the negative ions are much heavier than electrons and do not respond to the radio wave.

There are two types of recombination, *radiative* and *dissociative*, which are illustrated in Figure 3.3. In radiative recombination, the electrons combine directly with positively charged ions, converting them into neutral atoms and losing their own freedom. This process is not as important as dissociative recombination which occurs by a two-stage process and is much more efficient. In the first stage, positive ions, X⁺ (formed by photoionization) interact with the numerous neutral molecules, A (such as oxygen and nitrogen), replacing one of the atoms in the molecule:-

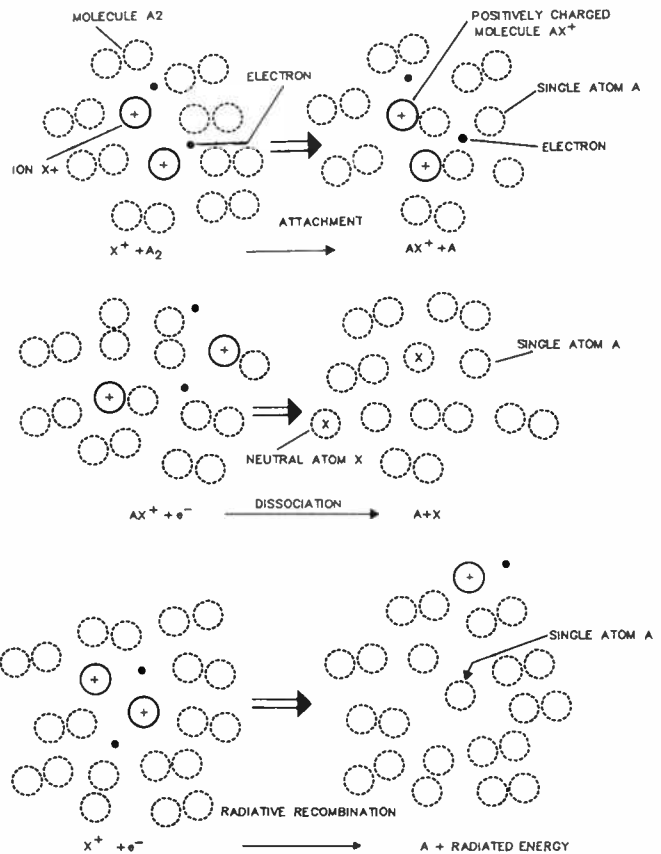
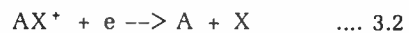

Figure 3.3. Recombination of an electron, e⁻, with a positively charged ion, by dissociative recombination (top) and radiative recombination (bottom). In dissociative recombination, a positively charged ion (X⁺) attaches itself to a neutral molecule (A₂), replacing one of the neutral atoms in the molecule, and giving rise to the positively charged molecule AX⁺. In due course, an electron splits AX⁺ apart (in other words, dissociates AX⁺), yielding two neutral atoms A and X. The previously free electron thus becomes part of the atom X, and is lost from the ionosphere. In radiative recombination, the free electron combines directly with any positively charged ion, giving a neutral atom, A, and radiating away any excess energy.

In the second stage, electrons combine with the positively charged molecule AX⁺, giving two neutral atoms and again losing their freedom:-



In practice, it is found that attachment is the more important phenomenon at low altitudes (in the D layer), while dissociative recombination is the more important at higher altitudes (the F layer).

An important thing to note is that the rate at which the electron density is decreased by attachment and dissociative recombination will depend on how many neutral molecules are present at the altitude considered.

Recombination and attachment are always taking place, at all levels of the ionosphere. Photoionization, on the other hand, can occur only during the day when the sun is above the horizon. The net density of electrons in the ionosphere is the result of the imbalance between the two processes. It is thus greatest in the middle of the day when photoionization is at its greatest and only a small fraction of the electrons created by photoionization is lost by recombination (or attachment). ▶

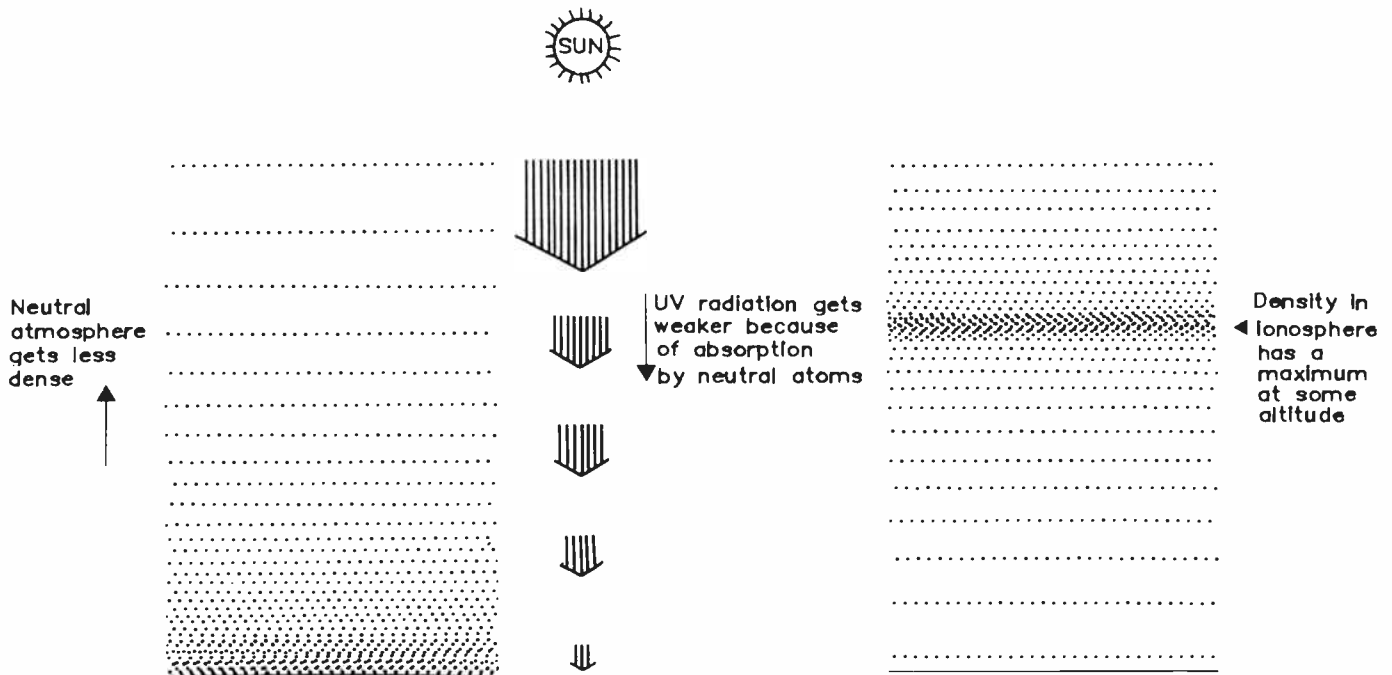

Figure 3.4. The fact that the electron density in the ionosphere forms a layer at some altitude, with the density decreasing as we move away from that height, is the result of two opposing phenomena — the density of the neutral atmosphere decreases as altitude increases, while the amount of UV light increases as altitude increases. Thus,

as we go to lower altitudes, even though there is more matter which could potentially be photoionized by the UV light, there is less UV light to do the job because it has been progressively absorbed more and more as it penetrates to lower altitudes.

When photoionization ceases at sunset, recombination eats away at the free electrons unimpeded and the density of electrons drops steadily as the night wears on. Recombination is not completely effective throughout the whole ionosphere, some free electrons surviving until dawn when their numbers are rapidly replenished by the rising sun. We know that recombination is not completely effective because we can still use HF at night.

The chances of the electrons in the F layer remaining free, and not recombining with positively charged ions are also increased by the fact that after sunset the whole F layer rises (or drifts) vertically to higher altitudes. The density of the neutral atmosphere decreases rapidly with height, so there are fewer neutral atoms around at the greater altitudes. Consequently, recombination is not very effective.

The structure of the ionosphere at any particular spot is not simple — if it were you would not be reading this! The strength or intensity of the UV and EUV (extreme ultra-violet) light from the sun is not constant at all wavelengths but is much stronger at some particular wavelengths which correspond to the type of atom (for example, hydrogen) which is emitting it. The neutral atmosphere is also complex, with a wide range of atoms and molecules such as oxygen, nitrogen and nitric oxide which can be photoionized. The situation is further complicated by the facts that the density of atoms which can be photoionized decreases as the altitude increases (recall the problems that climbers have on Mt Everest), while the intensity of the UV light which does the photoionizing decreases at lower altitudes because the light has been partially absorbed (attenuated) on its way down through the upper levels of the atmosphere.

The net result of these opposing effects, as illustrated in

Figure 3.4, is to produce a layer of electrons with a maximum electron density at some particular altitude and lower electron densities above and below this altitude. In fact, because the intensity of the EUV radiation varies with wavelength and because the neutral atmosphere contains as many different types of atoms and molecules as it does, the ionosphere may contain up to four different layers at different altitudes. We have already met two of these, the D and F layers. The D layer covers the altitude range of about 50 to 90 km and the F layer covers the range of about 200 to 600 km.

Historically, the first layer of the ionosphere discovered was at around 100 km altitude and was called the E layer, with the "E" denoting electric field. During the daytime in summer, the F layer splits into two separate layers known as the F1 and F2 layers, giving four layers D, E, F1 and F2. At night, recombination (and attachment) wins out over photoionization and the D, E and F1 layers almost completely disappear. The F2 layer, on the other hand, survives throughout the night, albeit in a somewhat depleted fashion. This is one reason why it is the most important layer as far as HF is concerned.

In general, the density of electrons increases as we move up from the D to the F2 layer. In the D layer, typical electron densities are 1000 per cubic centimetre (cc), while at the peak of the F2 layer during the day the electron density is about 10^6 (1 000 000) per cc. The corresponding densities of the neutral atmosphere are approximately 10^{14} per cc and 10^8 per cc, telling us that the ionosphere is a very wispy thing indeed in relation to the neutral atmosphere. This means that the ionosphere will be blown to and fro whenever the atmosphere chooses to move, for example when there are

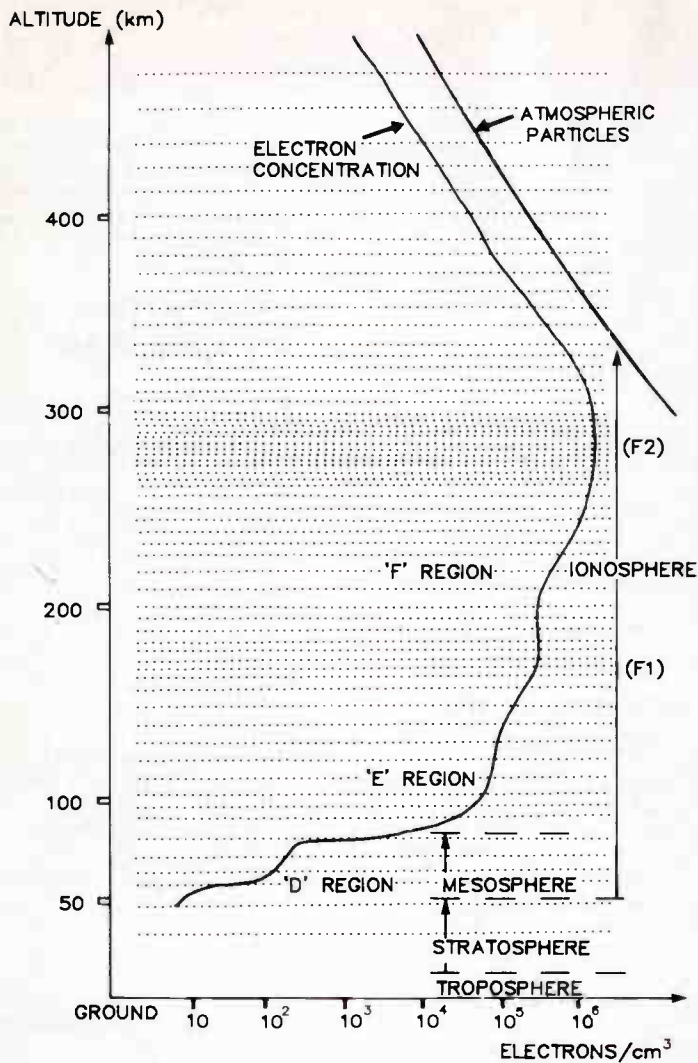

Figure 3.5. Typical daytime variation with altitude of the electron density of the ionosphere, illustrating the four possible layers. The ionosphere covers the height range from about 50 km to about 1000 km. (In fact there is no clearly defined upper limit, the electron density just decreasing continuously as the altitude increases.) The density of the neutral atmosphere is also shown. Note that at no time does the density of electrons exceed about 1% of the density of the neutral atmosphere.

Figure 3.6. Sketches of the variation with altitude of the electron density of the ionosphere under different conditions. The electron density profiles shown illustrate

winds blowing at ionospheric heights. However, it is not a wispy thing as far as radio waves are concerned.

Figure 3.5 summarises the properties of the electron density of the ionosphere on a typical day in relation to the neutral atmosphere.

Figure 3.6 illustrates how the electron density of the ionosphere varies under different conditions. We shall discuss the variations in more detail later.

Talking in terms of electron densities is not going to get us very far because we do not have any real feeling for what an electron density means. What does a density of 10^6 per cc, or even worse 10^{12} per m^3 mean? What does it tell us about the frequencies we can use for HF communications?

We can make the relation between the ionosphere and our use of it for communications somewhat more comprehensible by introducing the term *critical frequency* for a layer of the ionosphere. The critical frequency of a layer, f_c , is related to the maximum electron density in that layer, N , by the formula

$$f_c = 9 \times 10^{-3} N^{1/2} \quad \dots 3.3$$

where f_c is in MHz, N is electrons per cc, and the "1/2" tells us to take the square root of N .

For example, if the electron density has the typical value of 10^6 electrons per cc, the corresponding critical frequency is 9 MHz. The usefulness of the concept of critical frequency is that the critical frequency of a layer is equal to the maximum frequency which can be reflected from it at vertical incidence. (Note that we have ignored the effect of the earth's magnetic field here.) Waves at higher frequencies will simply pass right through the layer. The concept of critical frequency is found to be so useful in practice that very few people think or work in terms of electron density. Thus the above equation can now be forgotten!

The critical frequencies for the E, F1 and F2 layers of the ionosphere are denoted by f_oE , f_oF1 and f_oF2 . These terms will be used very often in the remainder of this series.

the variation of the ionosphere with season, and from day to night. The bottom right hand panel illustrates a sporadic E layer.

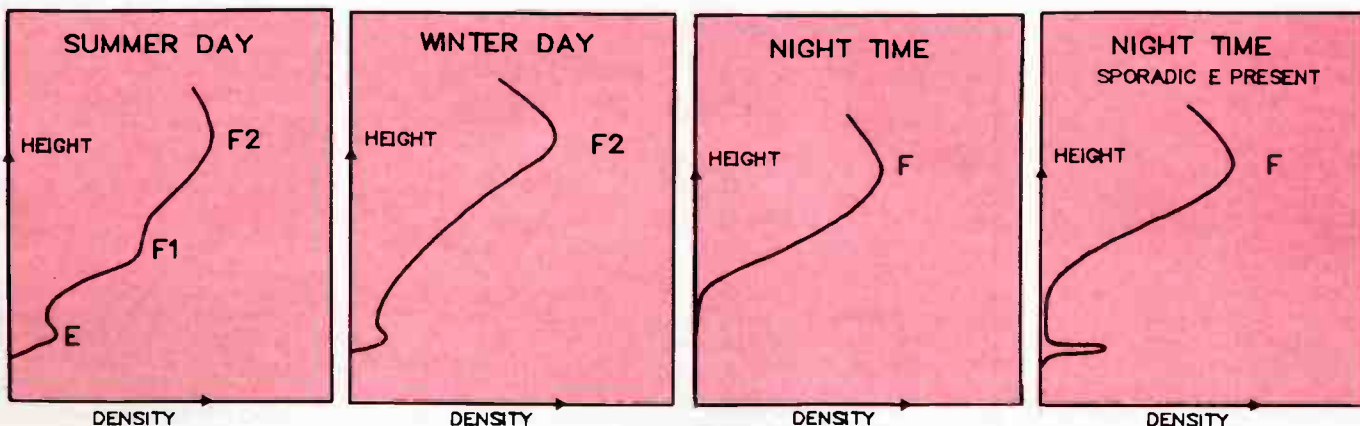



IBM tackles low-end market with JX release

Mid-September saw the release of IBM's new 'baby', the JX, described as a "low-cost desktop business computer", which is clearly designed to take on customers in that area of the market who don't require or won't pay for a PC — the smaller business users, educational establishments and the well-heeled home user.

Employing a compact, modular design, the JX Features a "wire-less" keyboard that communicates with the processor unit via an infrared link, freeing you from trailing curly cords.

Both disk and cartridge software entry are offered, the disk system now being the erstwhile industry 'standard' 3.5" disks, though an optional expansion unit for 5.25" disks is offered, allowing existing IBM PC software use.

A wide range of options can get you such goodies as: colour graphics, clustering (for multi-user applications), communications (just add serial card and modem), joy stick, light pen, mouse and up to half a meg of RAM. A parallel printer port comes as standard equipment.

A choice of two keyboards is offered: a 79-key compact keyboard or a 98-key full keyboard which includes a numeric keypad. Three different printers are also available, designed for either graphics-and-text, high speed text or letter quality printing.

The JX is to be offered in three packages, known appropriately

as the JX1, JX2, and JX3. The JX1, aimed at classroom use, comprises a 64K RAM system unit, two cartridge slots, a 12" colour display and a keyboard with a cable. The list price, including compact keyboard and colour display, is \$2115.

The IBM JX2 is appropriate for the home and small business user, says IBM. It offers additional features to the JX1 including a 128K RAM System unit and one 3.5" drive. The list price of the JX2, including full keyboard and colour display, is \$2861.

For business applications requiring dual drives, the IBM JX3 is available with two 3.5" drive units and 256K RAM system unit. The list price, including full keyboard and colour display, is \$3365.

Over 100 software packages are already available for the IBM JX, including the highly popular IBM Assistant series and the IBM Displaywrite series, with many more being developed. In addition, because the IBM JX offers a high degree of compatibility with other IBM Personal Computer products, many IBM PC software pack-

ages can also be run on the IBM JX either through the optional 5.25" drive or by converting them to 3.5" format, subject to any copyright conditions, IBM say.

All three JX models are now available from IBM Australia or from authorised dealers.

At the same time, IBM Australia announced major changes to the IBM PC family of products, including new introductions and price revisions. These included two new PC XT models, a 12% price reduction on the exiting IBM PC XT Model 486 system unit, a 7.5% price reduction on both the monochrome and colour display screens, plus a 10% price increase on the IBM PC.

Software-only Viatel for the Microbee

We hear from Phil Gleeson, once seen in the Waitara area, that Avtek Electronics, manufacturers of the Mini and Multi-modem, has released another interesting product on an unsuspecting marketplace. It should make them very popular with Microbee owners.

The Microbee, say Avtek, is a great little computer, but until now it hasn't had a proper Viatel facility. "Hardware/software modifications carried out to date have been a time-consuming solution," says Phil, "in particular, they slow down graphics presentations to a painful degree".

The answer, according to Phil, is really good software. And that's exactly what Avtek are offering to provide. Brilliant Microbee software writer Conal Walsh (so that's how you spell it: we though he was in the Army) was commissioned. The brief: "Write the best and fastest Viatel software possible for the 'Bee'".

The result "really has to be seen to be believed" says Phil. Importantly, it requires no hardware modifications — no hacking into your 'Bee' required!

Some of the features not found in other Viatel software include: ● Immediate printing of any Viatel frame ● Ability to save any frame to disc for later viewing and printing

● Downloading of selected software from a database ● Support of most Viatel display modes

All this and the Microbee

Viatel software costs only \$49.50! It is available on 3.5 and 5.25 inch discs. For further information contact: Avtek Electronics, PO Box 651, Lane Cove, 2066 NSW. (02) 427 6688.

Imagineering, fun & the C 64

Sorry — your scribe has a bias against games. When we think of all the exciting money you can make using a computer it always strikes us as a terrible waste to be zapping Martians or wandering through caves holding lamps that have just been put out! Our son is trying to convert us, but as we always say to him, Space Invaders won't pay the mortgage (except for the authors of Space Invaders ... Ha, he may have a point there ...)

Anyway, Imagineering has released three new games which they say are aimed at making Christmas a fun time for Commodore 64 home computer users. Called Rescue on Fractalus, The Great American Cross-Country Road Race and Tour de France, they have all been produced by Activision, described as one of America's leading lights on the home computer software front.

Combining strategy, action, and flight simulation, "Rescue on Fractalus" can make you a hero ... if you're good enough! Your fellow pilots have all been shot down over the hostile planet Fractalus, and unless you save them they're goners.

The game sells for \$19.95 on cassette and \$34.95 on disc.

"The Great American Cross-Country Road Race" is said to offer far more challenge than the average program calling for fast driving reflexes. You are at the wheel in true-to-life driving conditions for the most challenging, hair-raising sprint from coast to coast across the US

First you consult your detailed map (presumably not driving at the time) deciding which of 25 cities you will drive through. You have to consider terrain, time of day, distance between cities and recent weather reports.

This program is available either on cassette or disk at the same price as Rescue on Fractalus.

"Tour de France" is much the same sort of game, except you

VZ-300 NOW ONLY \$99!!



And It Gives You So Much More!

It's unbelievable! The amazing VZ-300 colour computer is at its lowest price ever!! Whether you're a computer expert or a first-timer, the VZ-300 has plenty to offer.

Now, for under \$100 there's a computer that will expand to meet your needs. With 18K RAM memory — expandable to an amazing 32K, high resolution graphics, and optional disk drive, printer and a host of extras available: the VZ-300 is unbeatable value!

Because it uses the most popular computer language in the world, 'Microsoft Basic', there's an incredible range of software available; games, business/management, education . . . there's dozens to choose from!

Look at these fantastic specifications!:

CPU. — Z80A running at 3.5MHz

Memory. — 16K Basic ROM

RAM — 18K expandable to 32K

Keyboard — 46 key full stroke with automatic repeat key.



Graphics — 32 columns x 16 lines. 128 x 64 dot (8 colour)/64 x 32 dots (9 colour) selectable colours.

With an unbelievable range of add-ons available your VZ-300 will give you years of service! When good value isn't good enough — DSE makes it even better! Cat X-7300

Dick Smith Electronics Pty Ltd

COMPUTERSTOP



do it on the other side of the Atlantic, and swap petrol for push bike.

Tour de France is available only on cassette, price \$19.95

Further information from **Imagineering at 77 Dunning Ave, Rosebery 2018 NSW. (02) 662 4499.**

Breakout box and activity tester

Most computer enthusiasts and engineers who have ventured into the hardware side know only too well the utter frustration of trying to connect together devices of the so called RS232-C standard.

With DB25 Sellotaped to the desk and trembling fingers guiding a soldering iron to rewire the ribbon cable yet again. Yes, we know the numbering is alternate and starts backwards and upside down, and pin 5 has to be strapped to pin 3, and pin 11 in this case has to be cut off . . .

Now, in answer to a person's prayer (maidens being discriminatory) Elmeasco has announced the Datacom Northwest Four-State Model 1000 Breakout and Activity tester which they describe as "the ultimate in handheld multifunction interface testing".

Both ends of any RS232 cable are simply plugged in to the connectors on the Model 1000 and with its built-in battery you can quickly and accurately analyse any cable configuration.

Full line definition for the RS232 interface is provided with 100 LEDs, 50 red and 50 green. Every line on both the

DTE and DCE side (if you don't know what these mean please don't try to use the box!) is monitored with a pair of LEDs. All four states of the line: mark, space, clocking, and off are visible at a glance.

Also, because of the ever increasing number of devices transmitting parallel data over serial connectors (is nothing sacred?) many users will find the following feature very useful: the signal ground for line 7 can be disabled (a feature not available in most RS232 breakout boxes), and reassigned via the signal ground post with a jumper. Thus, you can select any line to be signal ground, allowing, for example, the testing of the IBM PC parallel output on their serial connector.

In addition, the remote monitor from Datacom's Model 250 cable tester works with the Model 1000, allowing the testing of installed cables up to 1000 feet long.

Sounds fantastic — what about a sample, Elmeasco?

More information from **Elmeasco Instruments, PO Box 30, Concord, 2137 NSW (02) 736 2888.**

Imagine! JX software, already

Imagineering, claiming to be Australia's largest micro-computer software and peripherals distributor, has announced the release of a range of software products to support the just-released IBM JX computer.

This IBM JX was specially de-

veloped for the South East Asian and Australian educational and home hobbyist markets we are told by IBM's Asia Pacific Group, based in Tokyo. A need for a low cost, innovative machine for schools and the home was identified by the Group, and two versions of the IBM JX were built, an English model and a Japanese model.

One of the first wordprocessing software packages to be announced for the IBM JX is Micropro's Wordstar, distributed by Imagineering.

Wordstar for the JX was developed by Micropro Japan in association with IBM and has been given IBM's seal of approval. It was written with the special consideration that it was to be used in educational markets and so must be easy to learn and use.

The program is a shorter version of the traditional Wordstar package. It has all the features of Wordstar but has been reorganised to support the system requirements of the JX. Very importantly it is file compatible with all other Wordstar programs, including Wordstar 2000 and 2000 plus.

Priced at \$149, the program is said to feature touch-typing design that allows users to reach commands quickly from the home row of the keyboard, and supports the ten function keys on top of the JX's infra-red keyboard. It also features dynamic page break display which shows the user exactly where the next page begins.

The program can also be customised, allowing users to tailor it for their particular needs.

Imagineering tell us that the JX will also run Lotus 1-2-3 and right now Imagineering is "searching the world for the best games software suited to the JX".

More information from: **Alan Bowman, Imagineering's Consumer Products Manager, on (02) 212 1411.**

Microbee educational software catalogue

PRIMUG, the New South Wales Primary School Microbee Users Group, has published their first catalogue of educational software for use in primary schools. For just \$2.00 readers are presented with an extremely clear and informative

catalogue of a wide range of software.

As Barry Manefield says in the Foreword: "The NSW Primary School Microbee Users Group is pleased to present its first catalogue of educational software for use in primary schools. What a long way we have come in just three and a half years since the first 'Bees' appeared on the market!"

"What an enormous improvement there has been in the quality and quantity of software available! As well, all the software written has been for Australian curricula and has been heavily influenced by Australian teachers.

"We are proud to present this catalogue to you and we thank the suppliers who have contributed pages outlining their programs. We hope that the catalogue will be a service to the thousands of teachers in the schools who are constantly searching for software relevant to the needs of their pupils."

Seventeen suppliers portray their wares with interesting descriptions and, in most cases, very reasonable prices. Reading between the lines it seems that having had to develop software for their own classrooms in the early days, many teachers have branched out into software development as an extra activity.

We believe that the way computing, or any other subject for that matter, is presented in primary school is fundamental to the student's attitude to that subject throughout life. For this reason we are particularly pleased to see a notice on copyright.

"PRIMUG urges all members to strictly observe copyright laws. Only through such observance will programmers and companies be encouraged to continue to produce high quality programs."

Software in the catalogue ranges from the inevitable games of little educational value, through games of educational value, to straightforward hard work! This catalogue will, we believe, markedly increase the effectiveness of the 'Bee in schools.

Which brings us to confession time: Some years ago when your scribe was asked to assist with investigation into possible computing facilities at his son's own school, he confesses to not taking the Microbee very seriously. As Barry Manefield says, a lot has happened in three and a half years . . .



New Avtek MultiModem II

Australia's top selling modem is now 5 ways better

1. Fully Viatel compatible. Multimodem provides the 1200/75 baud rate necessary for Viatel and the new generation of high speed databases.

With Multimodem you won't be left out in the cold.

2. Fully integrated baud rate convertor (optional). Multimodem II provides 1200/75 baud communications for computers such as Commodore, IBM, Osborne, Kaypro and Microbee which do not support split baud rate as they stand.

Note: in order to operate on Viatel you will need special software. Avtek can supply software for a number of machines. For other machines, please contact your dealer directly.

3. Internal expansion buss. A Multimodem first. As developments come along, Multimodem will handle them.

4. Auto answer facility is a true 'ring detect' circuit. Multimodem II can actually sense an incoming call and respond immediately.

It is completely independent of the strength of the ring voltage.

5. Interfacing is easy. Multimodem now provides front and back channels that are fully integrated.

No need for special cables when using 1200/75 and other split baud rates.

And Multimodem II still incorporates all the features that have made it Australia's first choice.

1. Advanced digital filtering and signal processing.

Multimodem II provides the highest standards of data integrity. You will get reliable data transfer on lines where other modems simply cannot function.

2. Multimodem never requires adjustment. Complex

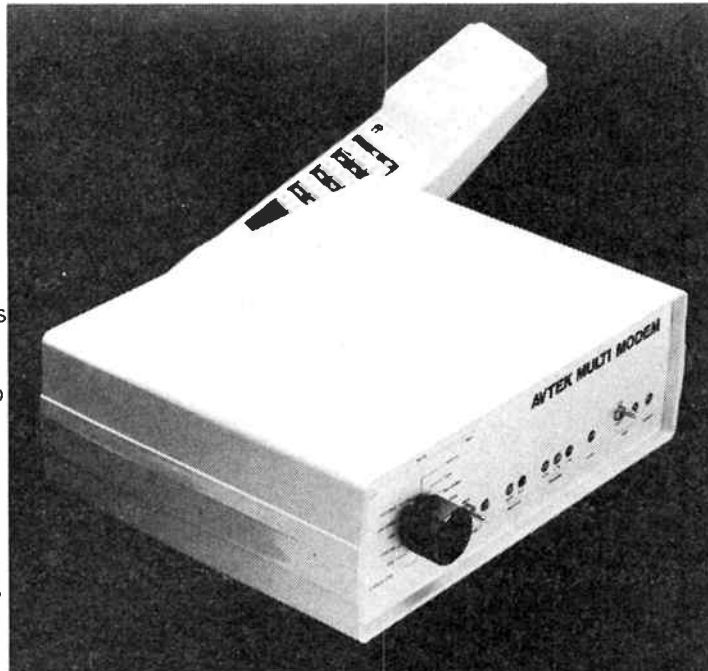

modulation, demodulation and filtering are performed by crystal locked filters. Critical analogue adjustments give way to crystal locked precision.

3. Australian and US standards at the flick of a switch. CCITT and Bell standards let you talk to any database or other computer in the world.

4. Full Analog and digital loopback facilities. Fast testing of line, computer, cabling and modem.

Multimodem II **\$365.00**

Multimodem II inc. auto answer **\$399.00**

Multimodem II inc. auto answer plus baud rate **\$485.00**

convertor **\$485.00**

Minimodem II.
New improved version of the famous Minimodem provides the reliability and digital filtering of the

Multimodem. Features include:
 Now provides Viatel (1200/75 baud rate) and 300/300 full duplex as standard.



Commodore VIC 20 and 64 version now available. These plug directly into the user port. No need to buy expensive RS232 adaptors.

Can be powered by the computer directly (for example MicroBee and Commodore).

On 1200 baud (e.g. Viatel) special equalisation is available for improved results on poor phone lines.

Minimodem inc. power supply **\$199.00**

Minimodem (suit Commodore user port) **\$235.00**

Brilliant New Software for Viatel

Avtek brings you brilliant software at reasonable prices:

For IBM PC (and compatibles), NEC III, Apricot, Sanyo MB550 and 555, Wang PC and TI Professional.

Black and White **\$169**
Colour **\$275**

Better Viatel for the MicroBee

There are other Viatel modifications for the Bee, but they are hardware/software modifications and they are a compromise.

Our software is undoubtedly the fastest and easiest way to put your MicroBee on Viatel. Written by Conal Walsh, famous MicroBee software developer, it provides superb, fast, Viatel access on your MicroBee without the need for messy hardware modifications.

MicroBee Viatel Software **\$49.50**
3.5" or 5 1/4" format, please specify

Modem Cables

1.8 metre male to male **\$35.00**

1.8 metre male to female (suit IBM etc) **\$35.00**

Cables are also available to suit most other non standard RS232 ports (e.g. Macintosh) ring for details **\$45.00**

AVTEK

Electronics Pty Ltd
Phone (02) 427 6688
for the name of our dealer nearest you.
Or write to us for further details at: **PO Box 651 Lane Cove NSW 2066**

Learn 8088 computing with the MPF-1/88

To hand is a nice glossy leaflet put out by Multitech Industrial Corp of Taiwan, and bearing Emona Instruments stamp. This well produced sheet reminds us that "To understand the computer is to understand many of the changes our world is undergoing, and to really understand the computer you must first understand the microprocessor — the heart of today's microcomputers."

In an effort to convert mere button pushers to microprocessor engineers, the MicroProfessor MPF-1/88 sets out to teach how it all works. And not just any microprocessor, it says, but the Intel 8088 — the same one that powers the IBM PC and other popular 16-bit microcomputers.

The instrument is claimed to be a complete learning kit with everything you need to grasp the fundamentals of computer operation. The special design al-

lows you to open the case and look at the system board's components. (Most hackers we know would open the case in any case even if it was permanently welded, but at least this saves the mess . . .)

The MPF-1/88 is not just a crude PCB with hex pad, however. In fact it is very similar to the current crop of lap portables, except for the rather small liquid crystal display, 20 characters x 2 lines. There is a full QWERTY keyboard, and the unit has cassette interface, Centronics printer interface, and 4K RAM expandable to 24K.

An EPROM programming option is also available, and software options include a BASIC interpreter, Forth language, and a two-pass assembler and editor.

The unit comes with three informative manuals: user's guide, monitor source listing, and, to the delight of software hackers, an experiment manual.

More information from: **Emona Instruments, 720 George Street, Sydney 2000 NSW. (02) 212 4599.**



Apple stalks in and gives critics the pip

Apple has announced the considerable re-vamping of the Apple II, originally marketed in 1977 and one of the beginnings of the micro revolution.

The re-vamps include a memory expansion PCB increasing RAM capacity to one megabyte, a 3.5 inch double density double-sided disk drive of 800K capacity, and a "Mouse Desk" program using the icon style as on the Macintosh.

A high resolution colour monitor is also announced, switchable between monochrome and colour.

On the printer side comes a much improved ImageWriter which, although dot-matrix, produces near letter quality hard copy quite difficult to distinguish from the industry-standard daisywheel, they say. The printer has a sheet feeder and an optional 32K buffer, useful if you want to get on with some other programming task while the printer does its job.

Hearing all this, readers may be forgiven for thinking that the Macintosh might fade away, but we hear that the Mac is to have a 20 megabyte hard disc and a new software package called The Switcher which will allow

near simultaneous use of several programs at the same time without waiting for them to load off disc.

Thomson-CSF get Motorola micros

Promark Electronics of Crows Nest in New South Wales and Nunawading in Victoria announce that Thomson semiconductors has been licensed by Motorola to produce the 6800 and 68000 series microprocessors, derivatives and peripherals.

The range includes approximately 60 devices in NMOS and CMOS including 8-bit 6800, 6802, 6803, 6804, 6808, 6809, 16- and 8-bit 68000, 68008, 68010 and most recently Motorola has licensed only Thomson to produce the 32 bit 68020.

These ICs represent an approved second source to Motorola and price, delivery, and breadth of range means that Thomson offers a very attractive business package for these products.

Thomson also second source the National Semiconductors Inc COP-400 series of economical 4-bit NMOS and CMOS controllers and the Advanced Micro Devices Inc AM2900 series fast 4-bit bit-slice processors. Call Promark, toll free, on (008) 22 6226.

Another job done

Are there still typewriters out there? Having wrapped up *Bytewide* for another issue we really cannot imagine what we did without word-processing. All that correcting, polishing and retyping . . . Now, all we have to do is press CTRL B and the column writes itself . . . well, not quite.

It is said that one's first word-processing system is like one's first love, or the car you learned to drive on (can't keep up this "one" business — sorry, Charles) — you always have a soft spot for it.

Your scribe first used Michael Shroyer's pioneering "Electric Pencil" on a Tandy Model I cassette version with inbuilt keyboard, random cassette level, and later self-booting mains millivolt fluctuation detector disk drive with accelerated tarnishing edge connectors and Bluetak attached fully sliding VDU.

Copy was first produced on a Teletype 33, and later, for some reason, we downgraded to the Lineprinter II with automatic arcing mains switch for additional random reboot, and fully hand inking replaceable ribbons, although Tandy did supply plastic gloves in the pack.

In case all this seems a side-swipe at our friends in Mount Druitt, we should add that thou-

sands of words pour weekly (or is it weakly) out of your scribe's present system, with consistent reliability and surprising ease, not to say brilliance. (No, not to say — Ed.)

Our wordprocessing workhorse is a Tandy Model II, not to be confused with the Model I level II, but a full business machine with 8" floppy, although somewhat long in the tooth. Copy is produced on a Daisywheel II, built like a tank, sounds like one, and goes on forever with near typeset quality.

The wordprocessing system itself is *Scriptit 2.0*, and we wouldn't be without it. Easy to learn, and logical, screen not cluttered with commands and options, and fast. So it's the second love, but nonetheless polarised. We know it's not the very latest, old, but it works.

But last night, just after the Editor threatened dire consequences if his copy didn't arrive two days ago as promised, the F1 key (insert) got stuck. Now that's inconvenient, to say the least.

The practical writer probably uses insert and closeup more than any other commands. Ahah! CTRL A is the same ASCII code, and we'll fix the F1 key tomorrow.

And to think, ten years ago we thought ASCII was a comedian.

— Alan Ford

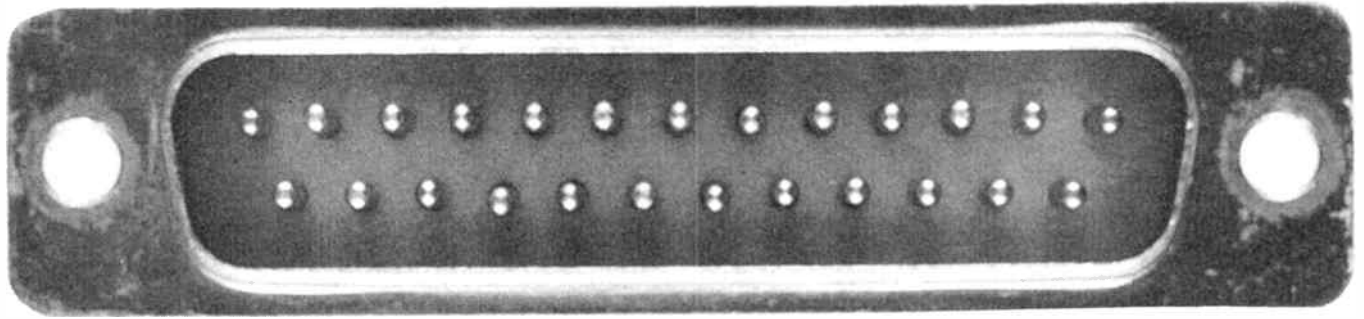

The ins and outs of RS232

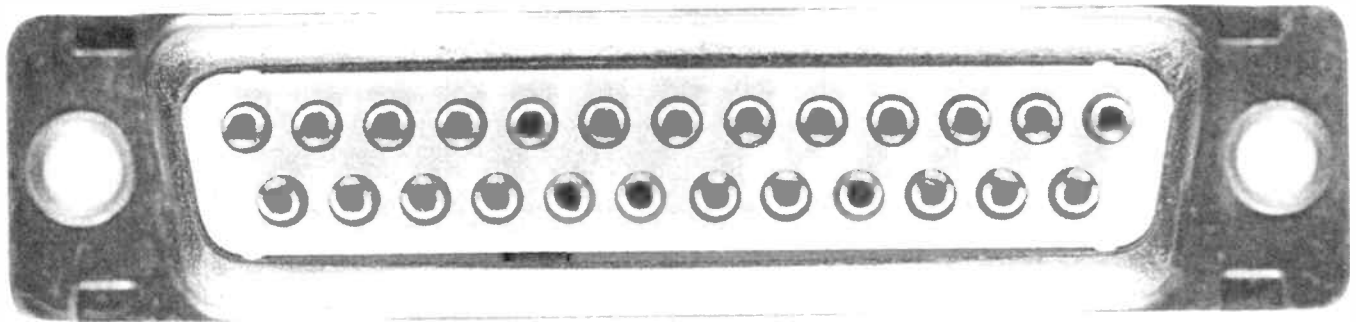

Roger Harrison

The ubiquitous RS232 computer equipment serial interface is probably the most praised and abused 'standard' in the computing industry. Praised on hand because of its wide acceptance, abused on the other hand because it's not well understood. Here's a basic guide to the ins and out of RS232.

THE RS232C STANDARD is an ancient and venerable document. Set down by the US Electronic Industries Association (EIA) in 1969, it was originally intended to describe the interface between 'data terminal equipment' (DTE for short — a 'dumb' computer terminal) and 'data communications equipment' (DCE for short — a modem, for example). For the record, it's document S.90120EIA. It seems that, probably due to its age, this 30-page document speaks a language people no longer understand. It specifies, in voluminous detail, the electrical characteristics of the interface signals, along with the physical characteristics of the connectors to be used. The European-based Consultative Committee on International Telegraphy and Telephony (CCITT) also put their spoke in during the 60s, when all this was drafted and there is close congruence between EIA and CCITT interface standards, which shall come due for mention later.

Because the computer industry grew up using teletype machines for data input and display (on paper!), then 'glass teletypes' (video display units, or VDUs) later, with ever-advancing features and functions, the signalling requirements that grew out of this equipment were incorporated in the RS232C standard. When printers, plotters and the like came along, manufacturers adopted/adapted the RS232C interface for them as it was broad in scope and depth and probably seemed fit the bill at the time. This has subsequently resulted in not a little confusion about what's a DTE and what's a DCE. In fact, the assignment of equipment 'sex' (by which we mean 'is it a DTE or a DCE?'), where it's not obvious, has seemingly become more or less arbitrary.

Sending it serially

You can send data signals over a two-wire line by sending signal 'bits' — as represented by a high or low voltage — one after the other. This is serial communications. Computers employ a standard signalling code for serial communications, called the American Standard Code for Information Interchange, or ASCII code. This uses a string of seven bits to signify a total of 128 characters, which includes all the numerals, all the letters of the alphabet in upper and lower case, plus special characters.

Each of the 128 7-bit character codes comprises a unique string of binary 'ones' and 'zeros' which can be represented as voltage levels. In the familiar TTL IC logic, a voltage over 2.8 V is regarded as 'high' or logic 1, while a voltage below 0.4 V is 'low' or logic 0. Because TTL signals do not do well when sent down long lengths of cable, the RS232C interface does things a little differently.

The highs and lows

When teletypes were all the go for computer I/O, they spoke of signals as comprising 'mark' and 'space' bits. The convention was have the low voltage represent mark (referred to in an older parlance as 'mark low'), the high voltage being the space. In the RS232C standard, a high (space) is represented by a voltage between +3 V and +12 V while a low is represented by a voltage between -3 V and -12 V. The range between +3 and -3 volts is undefined.

The right connections

In essence, the RS232C standard specifies the recommended control functions and signal paths of a 25-wire signal line interconnecting terminals (DTE) and modems (DCE), or equipment designed to act as a DTE or a DCE. The 25-pin connector employed is a 'D' type, after its shape, with two rows of pins with the centres interleaved between rows.

Twenty of the pins are specified for routine system operation. Of the remaining five pins, two (9 and 10) are reserved for test voltages, while the other three (11, 18 and 25) are unassigned. The D-type connector arrangement is shown in Figure 1, while Table 1 lists each pin's 'name' and function, along with the EIA and CCITT circuit designations.

Because the interface standard is for inter-equipment communications, certain other conventions attach to the standard, such as data rates and signal formats in common use. The RS232 interface may be used for both synchronous and asynchronous communications, though the latter seems its most popular use these days. The 'nominal' upper baud rate limit specified is 20 000 bits per second (say, 19K baud) but that doesn't seem to have put the damper on some users.

Talking to each other

When sending ASCII signals down a line, a number of conventions are observed about the order and timing of the signal so that the 'sender' and 'receiver' understand one another. Each character comprises a unique code of 1s and 0s and the characters are sent *least significant bit first*.

To illustrate, say you're talking about money (a popular topic!) and you've just sent the \$ character. In ASCII, this is 010 0100 binary or 24 hexadecimal. Here's what the signal looks like:

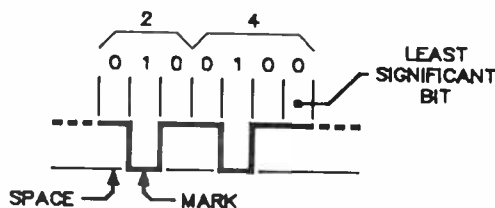

Now, the device receiving such a signal must 'know' when the character starts and stops. We shall assume, for the moment that both the sender and receiver agree on the length of the mark and space.

Conventionally, the line sits at low, or the 'mark' condition. Along comes the first bit of our \$ character, which is a space (high) and right away the receiver knows a character is coming in. But what if 'a' was sent prior to that? The zero character is 61 hex, or 110 0001 binary, looking like this:

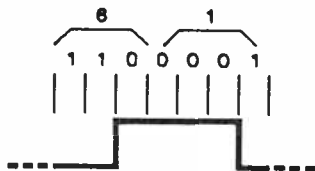

In this case, your receiver won't know a character has been sent until the second bit rolls by. Very awkward!

This problem is cured by prefacing each character with a 'start' bit, which is *always high*.

Because the real world isn't perfect, keeping the sender and receiver in step over the period when hundreds or thousands of characters may be sent can be a sticky task. Thus, to identify the finish of each character, one or two 'stop' bits are added, and these are *always low*. Hence, there is a mark-space transi-

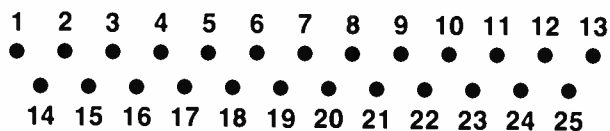

Figure 1. The RS232 'D' connector pinout, looking at the pins of a plug or the connections to a socket.

TABLE 1.

RS232C INTERFACE PIN ASSIGNMENTS

Pin	Name	Function	Circuit CCITT (EIA)
1	FG	Frame Ground	101 (AA)
2	TXD	Transmitted Data	103 (BA)
3	RXD	Received Data	104 (BB)
4	RTS	Request to Send	105 (CA)
5	CTS	Clear to Send	106 (CB)
6	DSR	Data Set Ready	107 (CC)
7	SG	Signal Ground	102 (AB)
8	DCD	Data Carrier Detect	109 (CF)
9		Positive dc test voltage	
10		Negative dc test voltage	
11	QM	Equalizer Mode	Bell 208A
12	(S)DCD	Sec. Data Carrier Detect	122 (SCF)
13	(S)CTS	Sec. Clear to Send	121 (SCB)
14	(S)TD	Sec. Transmitted Data	118 (SBA)
15	NS	New Sync	Bell 208A
16	TC	Transmitter Clock	114 (DB)
17	(S)RD	Sec. Received Data	119 (SSB)
18	DCT	Divided Clock Transmitter	Bell 208A
19	RC	Receiver Clock	115 (DD)
20	DCR	Divided Clock, Receiver	Bell 208A
21	(S)RTS	Sec. Request to Send	120 (SCA)
22	DTR	Data Terminal Ready	108.2 (CD)
23	SQ	Signal Quality Detect	110 (CG)
24	RI	Ring Indicator	125 (CE)
25		Data Rate Selector	111 (CH)
		Data Rate Selector	112 (CI)
	(TC)	Ext. Transmitter Clock	113 (DA)
		Busy	

Positive voltage equals binary zero, signal *space*, control ON.
Negative voltage equals binary one, signal *mark*, control OFF.

The RS232C standard specifies the recommended control functions and signal paths of 25 signal lines interconnecting modems and terminals. An RS232C connector contains 25 pins, of which 20 are specified for routine system operation. Of the remaining five pins, two (pins 9 and 10) are reserved for test voltages, and three (pins 11, 18, and 25) are unassigned.

tion following each character which keeps the sender and receiver in step with each other.

Having got this far, you would realise that the sender and receiver would have to be operating at the same nominal 'speed'. The speed is measured in "bits-per-second", or "bauds". In binary signalling, as we have here, one bit per second is one baud — not to be confused with characters per second. Commonly used baud rates these days are 300, 600, 1200, 2400 and 9600 baud, though speeds up to 76 800 baud are encountered.

Odds and evens

A simple error-checking technique is sometimes employed in serial signalling over an RS232 line. An extra bit is added at the end of each character, before the stop bit, which enables the receiving equipment to check the validity of the data sent by counting the 1s. It's called 'parity checking' and works in either of two ways:

- 1) **Even parity.** The transmitting terminal counts the number of 1s in each character, and if there's an even number, it sets the parity bit to 1, if an odd number it sets the parity bit to 0.
- 2) **Odd parity.** If the transmitting terminal counts an odd number of 1s in a character, it sets the parity bit to 1, or to 0 if there's an even number.

The receiving terminal also counts the 1s in each character and compares the result to the parity bit sent. If there's agreement, the character's been correctly received, if not then there's been an error. Let's take our 7-bit ASCII character 'a' (61 hex) and add-in even and odd parity check bits:

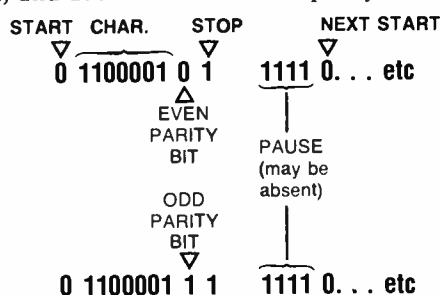

If one of the character or parity bits got changed along the way, or an extra one got added in (through noise) between being transmitted and being received, there would be one more or one less 1 and the parity would not add up. It's clear that if double-bit errors occurred, the parity check would not signal a fault. However, the scheme has the advantage of simplicity.

Parity checking is not always used and, anyway, equipment may not have the circuitry to request the faulty data be re-sent. Some equipment is set up to expect the parity, but actually makes no use of it.

The RS232 'circuits'

The EIA RS232 standard provides for four different 'interchange circuit' categories, listed here in order of importance:

- Ground** (category A)
- Data** (category B)
- Control** (category C)
- Timing** (category D)

Table 2 lists all the interchange circuit categories, along with their CCITT equivalents, and the 'direction' of each signal (where applicable). Note the set of 'secondary' interchange circuits which, when implemented, have essentially equivalent functions to the primary circuits. They may be used coincidentally with the primary circuits.

The circuit descriptions are largely self-explanatory, so I won't go into them in detail here. Table 1 should be read in conjunction with Table 2.

Shake on it

Probably one of the most confusing areas of RS232 communications is "handshaking." This involves the equipment at each of a line 'talking' to one another about their status ('ready,' or not), signal timing and other things. The category

Interchange Circuit	CCITT Equivalent	Description	Gnd		Data		Control		Timing	
			From DCE	To DCE	From DCE	To DCE	From DCE	To DCE	From DCE	To DCE
AA	101	Protective Ground (Frame Ground)	•							
AB	102	Signal Ground/Common Return	•							
BA	103	Transmitted Data			•					
BB	104	Received Data		•						
CA	105	Request to Send					•			
CB	106	Clear to Send					•			
CC	107	Data Set Ready					•			
CD	108.2	Data Terminal Ready					•			
CE	125	Ring Indicator					•			
CF	109	Received Line Signal Detector					•			
CG	110	Sign Quality Detector					•			
CH	111	Data Signal Rate Selector (DTE)					•			
CI	112	Data Signal Rate Selector (DCE)					•			
DA	113	Transmitter Signal Element Timing (DTE)							•	
DB	114	Transmitter Signal Element Timing (DCE)							•	
DD	115	Receiver Signal Element Timing (DCE)							•	
SBA	118	Secondary Transmitted Data			•					
SBB	119	Secondary Received Data		•						
SCA	120	Secondary Request to Send					•			
SCB	121	Secondary Clear to Send					•			
SCF	122	Secondary Rec'd Line Signal Detector					•			

TABLE 2.

C interchange circuit pins are used for this function. Handshaking is commonly used for printer or modem control of the terminal equipment, and often for two-way control between equipment.

For example, some slower, unidirectional letter-quality printers may overflow their buffer (which temporarily stores a limited number of characters) during the time it takes the carriage to travel from right to left ('carriage return') and roll the paper up ('linefeed'), in which time characters will be lost. To overcome this, the printer will send a 'halt' signal to the computer or terminal, telling it to wait until carriage return and linefeed have finished.

Typically, such a handshake line will be high when the equipment's able to take data, going low when a pause is required. Some printers may only send a 'halt' handshake when advancing to the next page, but others don't require it at all because they have a buffer with sufficient capacity to store the characters sent during such non-printing periods.

I'll have more to say on handshaking shortly.

Connectors

The 25-pin D connector is available in a variety of types to suit differing applications. Those attaching to equipment are generally arranged to bolt to a panel and may have solder-type pins to which wires are individually soldered. Some are designed for direct printed-circuit mounting, while others have insulation displacement connections ('IDC') on the rear for simple crimp-on attachment or ribbon cable.

D-type connectors designed for attachment to flexible cables may also be of the IDC type or have solder pins for individual wire attachment. The latter generally come with a 'back shell' which provides for strain relief of the wiring and securing screws which firmly attach the plug to its mating connector on the equipment via threaded nuts. ▶

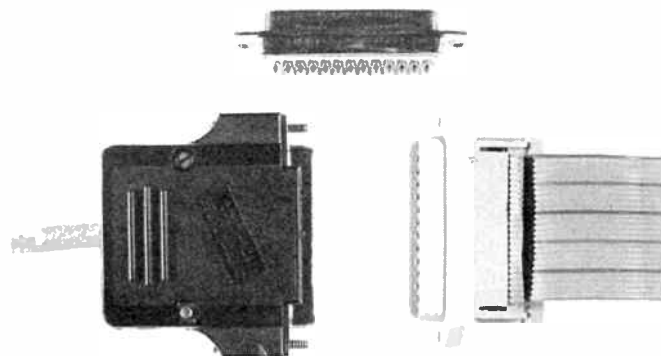

UNIQUE OPPORTUNITY!

Only for readers of Australian Electronics Monthly — here's a unique opportunity to obtain a **6-PEN, A3 'PERSONAL PLOTTER'** at under half cost!

These plotters, made by Iwatsu (model SR6602), were part of a shipment brought into the country for a client who subsequently ceased business before completion of the purchase order. They are brand new and come complete with a handbook, a set of 10 pens and a three-month warranty.

LIMITED NUMBER ONLY

This is a strictly limited opportunity, as only 30 plotters are available.

Features:

- 240 V ac operation
- standard RS232 interface (protocol selectable)
- plot area of 270 x 365 mm (A3 sheet)
- plot step of 0.1 mm
- takes commonly available plotter pens
- variable plot speeds — 2 x switch selectable — 6 x software selectable
- ten pens supplied, 0.3 mm diameter tip, four black ink types, six different coloured-ink types.

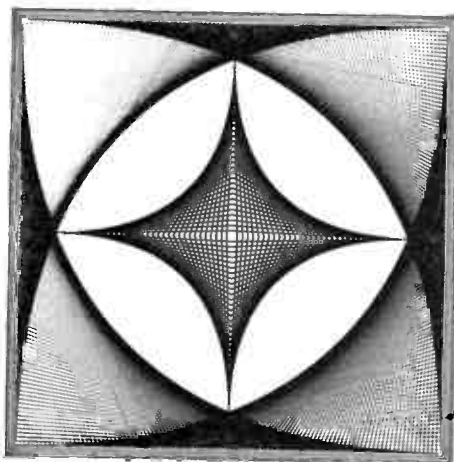
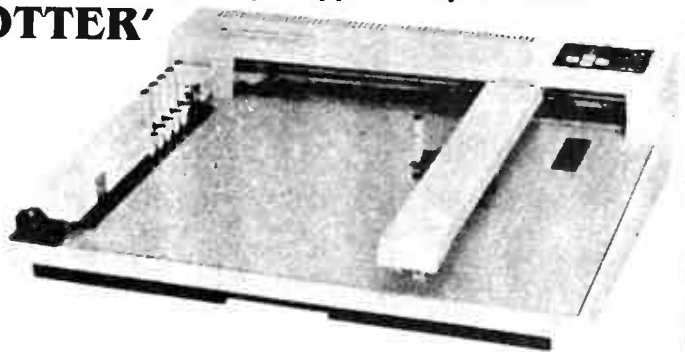

Simple command parameters permit driving the SR6602 from a terminal or from ASCII strings sent to the serial port of your computer.

UNBELIEVABLE OFFER:

\$1299.00! (sales tax free)*

\$1454.00 inc. sales tax

Delivery to your door, including insurance, is \$20.00.

This offer is made available exclusive to readers of Australian Electronics Monthly through Electronic Facilities of Artarmon NSW and A.E.M. is acting as a clearing house for orders.

SEND YOUR ORDER NOW!

Only 30 units are available, so hurry before they're all snapped up.

* All orders claiming sales tax exemption must be accompanied by an appropriate sales tax exemption certificate.

HOW TO ORDER: Complete the coupon and send it, together with your cheque, Money Order, or Credit Card details to:

PLOTTER SPECIAL OFFER

Australian Electronics Monthly PO Box 289, WAHROONGA 2076 NSW

COUPON Cut out, or photocopy, and complete this coupon. Send it, together with your cheque, Money Order or Credit Card details to the address above.

- Please make cheques or Money Orders payable to "Australian Electronics Monthly"

Name

Address

Signature

(unsigned orders cannot be accepted)

PLEASE DELIVER: SR6602 Iwatsu plotter(s)

Total cost \$

I enclose payment by:

Money Order Cheque* Amex

Bankcard Mastercard Visa

Credit Card No:

Expiry Date: .../.../...

Cheque or Money Order No:

- If you would like to inspect one of these units, call into our office any weekday during business hours. We're located at: WB Building, Cnr Fox Valley Rd and Kiogle St, Wahroonga NSW. The entrance is in Kiogle St.

LISTENING POST SOFTWARE

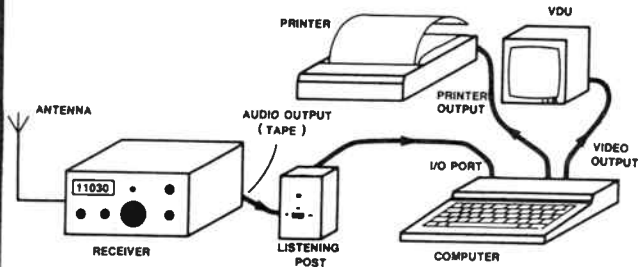

Decode — MORSE/RADIOTELETYPE/RADIO FACSIMILE PICTURES using your Microbee and the AEM3500 Listening Post project.

Software for our very popular AEM3500 Listening Post project, from the first issue (July '85) is available on either cassette or disk to suit any model Microbee.

You can specify the software to suit its use with either the C.Itoh 8510 or Epson FX80 printers, or their equivalents. All it costs is just:

\$17.00

plus \$2.50 post & handling

All you have to do is: ● send us a blank C10 cassette, or a formatted 3.5" or 5.25" diskette (to suit your machine). ● Fill out the address label below and firmly attach it to your tape or diskette. ● Complete the COUPON and send it to us, together with your labelled tape or diskette, enclosing payment by cheque or Money Order or you Credit Card details

Enclose your blank tape or diskette in a jiffy bag for protection. Put 5 25" diskettes between stiff cardboard

All mail orders will be despatched by certified mail

Please allow for normal turnaround post delays prevailing at time of sending order

We will gladly re-record any software that does not run

Fill in and cut out this coupon, cut off and attach the return-address label to you tape or diskette and send it to

LISTENING POST SOFTWARE
Australian Electronics Monthly
PO Box 289, WAHROONGA 2076 NSW

COUPON

Yes please! Rush me software for the Listening Post. I require the software to suit the:

- ... C.Itoh 8510-type
- ... Epson FX80-type

printer (tick appropriate one).

Cost: \$17.00 plus \$2.50 post & handling

TOTAL: \$19.50

I enclose payment by:

Credit Card No.:

Expiry Date: / /

Signed: _____
 (Unsigned orders cannot be accepted)

Cheque or Money Order No. _____
 (* Please make cheques or Money Orders payable to 'Australian Electronics Monthly')

RETURN-ADDRESS LABEL

RUSH ME TO: _____ (name)

Address _____

Postcode _____



Figure 2. Numbering of the individual lines in a ribbon cable attached to an RS232 IDC connector.

There's a trap to watch out for with IDC connectors. As flat 'ribbon' cable is used with this type of connector, the alternate lines will be consecutive, not the adjacent ones. Figure 2 illustrates.

It is pretty well standard practice (though not actually a 'standard') to use female connectors on all equipment chassis or panels and male connectors on cables. There are, however, exceptions. DEC, for example, do it the other way round — males on chassis, females on cables.

It is not possible to tell an equipment's sex (i.e. whether it's a DTE or a DCE) from looking at its connector. For example, I have a dot matrix printer which thinks it's a DTE, while a colleague has a daisywheel printer which is configured as a DCE (much more sensible).

If you encounter an item of equipment with a male connector to which your 'standard' cable will not attach, you can simply solve the problem with a 'gender bender' which is nothing more than two female connectors mounted 'back-to-back' with pin 1 connected to pin 1, pin 2 to pin 2, etc.

Note that the 25-pin connector may not always be found on RS232 hookups as only as few as three lines need be connected. You may find 3-pin or 5-pin DIN plugs (commonly seen on audio equipment), pc board edge connectors etc, on some computers where the cost of a 25-pin D socket is not warranted. Special cables are required in such cases to interface to equipment which employs the 25-pin connector.

AUSTRALIAN ELECTRONICS MONTHLY — RS232 INTERFACE CHART

EQUIPMENT		SEX: DTE DCE		DATE			
PIN	SIGNAL	FUNCTION	IN	OUT	OPEN?	TO?	REMARKS
1							
2							
3							
4							
5							
6							
7							
8							
9							
10							
11							
12							
13							
14							
15							
16							
17							
18							
19							
20							
21							
22							
23							
24							
25							

Reducing the confusion

There are NINE MAIN PINS on the RS232 connector and familiarity with them will help you solve most RS232 interfacing problems. Figure 3 shows these nine pins and their general uses.

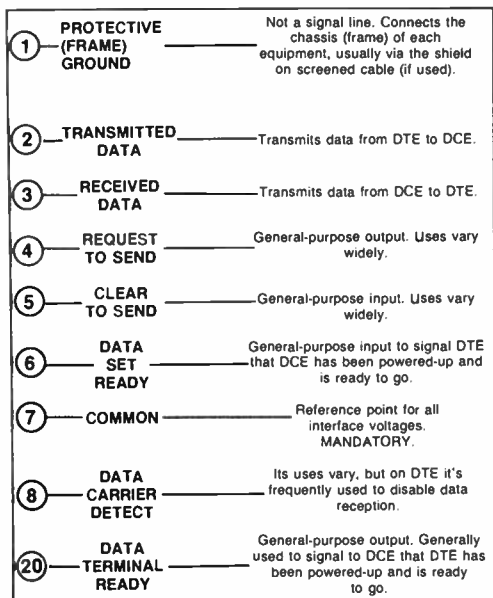

Figure 3. The NINE MAIN PINS and their general uses. You should remember when hooking up one unit to another that pin 7 on one unit always connects to pin 7 on the other.

Only one pin is MANDATORY in any interconnection of equipment — pin 7. This is the signal common line, the reference point for all interface signals.

If a shielded interconnecting cable is used, the shield connects the chassis of each unit either directly via a 'strap' and lug at each end (which bolts to a screw terminal on each chassis near the connector), or via pin 1 — the Protective Ground or Frame Ground. Shielded cables are generally used where a cable run in excess of six metres or so is necessary, to protect against hum and noise pickup. Note that, occasionally you may find the signal common and chassis connected internally on some equipment. Even so, in such event the cable connections should be kept separate.

BEFORE attempting to hookup any RS232 interface, first determine from any equipment documentation all the pin assignments and, if possible, the equipment sex — whether it's DTE or DCE. The thing is, when the RS232 standard was devised, most have joined the ranks of the unemployed and are NOT used. Because of this, some equipment makers employ the 'spare' pins on the DB25 for other uses! Grrr.

To help you out, we have made up an 'AEM RS232 Interface Chart,' reproduced elsewhere in this article. Photostat it, fill it out and keep it with any other equipment documentation — or sticky-tape it inside your equipment.

If handshaking lines are provided, you'll need to know if they actually do anything. Some gear simply provides 'dummy' handshake signals by tying the relevant pins high or low. There's a trap here, too. Handshake signals are sometimes indicated as inverted (a bar over the name. e.g. RTS). Thus, as a data 1 is low (by convention), the handshake will signal with a high, which corresponds to zero. Hence the inverted (bar) annotation. It is, however, the identical signal. Watch it, though, because occasional equipment actually signals 'not ready' with a high! If the documentation is unclear, then you'll have to determine what's happening either by trial and error or with a signal tester (and we'll get around to those later. 🐉

...continued next month.



WORDSTAR PRINTER PROBLEMS SOLVED

MODERN PRINTERS have dozens of printer commands. Until now it has been impossible to send all of these codes to your printer from a Wordstar file. Most printer demonstrations are written in computer code, not Wordstar.

FLASHPRINT!! changes the world of Wordstar and printers. Now you can print anything — even your own special characters or color on a printer with a multi-color ribbon.

And here are special characters which we designed for an Epson and other printers



YOU can print compressed proportional elite pica expanded italics quality or any combination your printer allows. Single-key commands control ^{SUPER} and ^{SUBSCRIPT} as well as true underline. It's clever.

FLASHPRINT!! is supplied with commands for several popular printers. But you can chose the command and the coding your printer needs. FLASHPRINT!! does the rest. A single command can send hundreds of codes to the printer (Wordstar allows only four or five).

We include notes on designing your own characters such as boats, cars and graphic symbols.

FLASHPRINT!! requires no special knowledge and Wordstar requires absolutely no installation. You simply copy FLASHPRINT!! and a printer table on to your normal Wordstar disk and run FLASHPRINT!! instead of Wordstar. It loads your table and runs Wordstar.

NOW WITH FLASHKEY!!

There's more. FLASHPRINT!! now includes FLASHKEY!! This allows any Wordstar character (including control characters) to be a function. That's 127 function keys on your computer. Functions can contain hundreds of bytes. FLASHKEY!! also allows key translation. You can create a Dvorak keyboard or change Wordstar's clumsy commands.

Don't take just our word for it. Here are some genuine unsolicited comments from FLASHPRINT!! users:

● If you need any kind of enhancement to Wordstar this is the one. The ads don't do it justice. *First Osborne Group, USA (Foghorn July 1985).* ● Excellent value for such a useful piece of software. *John P. Carney.* ● FLASHPRINT!! is everything you said it would be. *Terry Bibo.* ● I had been going to buy Smartkey, but FLASHKEY!! will do all the changes I want. *Peter Carnell.*

● It represents the best value for money of any software I have purchased. *Gordon Woolf.* ● Every Wordstar user should have this one. *Kaypro User Group of Victoria.* ● The manual was a pleasant change from many computer-related manuals. *Peter Barker.*

\$57

Includes postage and a comprehensive user guide. We can supply almost any CP/M-80 disk format including Apple, Microbee 3.5 inch and 8-inch SSSD.

FLASHPRINT!! with FLASHKEY!! runs Wordstar versions 2.26, 3.0 and 3.3. An MS-DOS version for Wordstar V3.3 which includes enhancements for the IBM PC and clones is now available at \$88.

JRT SOFTWARE
42 TURNERS AVENUE
COROMANDEL VALLEY

SOUTH AUSTRALIA 5051 (08) 278-7076

We believe FLASHPRINT!! with FLASHKEY!! will completely change the way you use Wordstar.

Shaping-up with VIC-20 graphics

Neil Duncan

MY SERIES OF SHORT ARTICLES on Apple graphics prompted a good response from readers. It is interesting to extract pictures and animation from ones computer and the concept is appealing to most hackers. Not everyone has an Apple computer, so I thought perhaps a comparison with another computer would be in order. And, as requests for Commodore coverage were legion, here we go.

Now, the VIC-20 may not be in a high state of production any more, but the very large numbers of that machine sold in Australia has prompted the thought that there are still a lot of VIC-20 programmers! The mechanism for generating graphics on that machine (and, for that matter on the '64) makes an interesting comparison with the Apple. With each new Commodore personal computer since the VIC-20, the graphics and sound facilities improved considerably.

The most awkward feature in writing for the VIC-20 is the fact that various configurations are available. By purchasing and plugging in extra memory boxes, the machine effectively changes in "personality". I will assume that the minimum memory arrangement is present (in the computer, that is). Others may feel the need to unplug their extra Ks for this article.

The memory map

Let us begin with a peek at the memory map of the VIC-20 (pardon the pun). This map changes when the extra memory modules are plugged in.

Note that the memory space used for graphics is above the place for programs. That means, amongst other things, that a large program could creep into the video area and be clobbered when anything is displayed on the screen (of course, the operating system protects against this). The gap in the map is simply due to the fact that there isn't any memory there, a feature which can be remedied with the application of money.

In the expanded VIC, the video area is below the program area (4096-4607 decimal for video, 4608 onward for programs). This is a strange switch over (in my humble opinion!) since no apparent benefit is derived by this and the programmer has to allow for it. By typing the command:

```
PRINT PEEK(648)
```

(there is a 16 there on the unexpanded VIC), you can detect how much memory is present and thus change any necessary pointers. That location is the "screen memory page" pointer. On the other hand, you could take a look at the back of the machine and see what is plugged in!

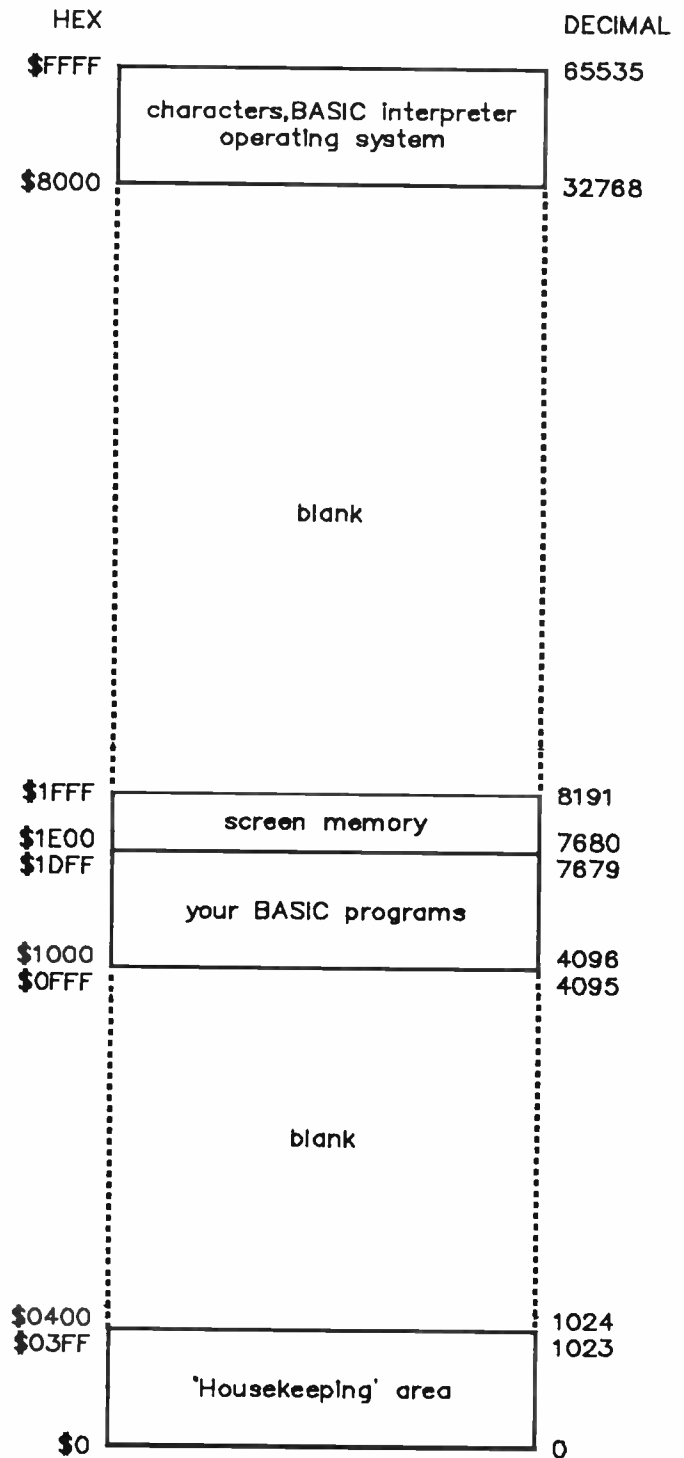

For those who waded through the Apple graphics notes, you may recall that \$2000 Apple memories are set aside for a hi-res graphics 'page'. Each one of those \$2000 bytes controls the "on-off'd-ness" (I have coined a new word!) of seven consecutive screen 'dots' or pixels. The remaining bit is for colour information which isn't a lot really. By some clever footwork, each of the 53,760 pixels on the hi-res screen can be carefully controlled by a single command.

Commodore Codex

procedure will allow us 32 characters which should be sufficient.

Before this task can go ahead however, BASIC must be told to think twice before using the high area of memory. If you run a BASIC program then poof! (pardon the expression), your shapes are clobbered by BASIC. The pointers to top of memory can be altered with:

```
POKE 52, 28 : POKE 56, 28
```

This lowers the upper memory requirement of BASIC and thus allows the shapes we build to be left alone. Once having made some shapes and then having installed them into memory (along with these changed pointers) we can still use some of the original VIC shapes. A print statement with a 'reverse on' followed by the usual stuff will achieve that.

Let's illustrate

So, here is a program which will make shapes and illustrate them after the event. We will dissect it afterwards to gain ideas on how to use it!

```
PROGRAM 1
10 GOSUB 1000
20 GOSUB 2000
30 GOSUB 4000
40 GOSUB 9000
50 PRINT "MORE? (PRESS F1)"
60 PRINT "EXIT? (ANOTHER KEY)";
70 GET A$:IF LEN(A$)=0 THEN 70
80 IF A$=CHR$(133) THEN 10
90 END

1000 S=7680:C1=38400:S1=36878:S2=36876
1010 PRINT "<clear>"
1020 FOR I = 1 TO 17:PRINT"<down>":NEXT I
1030 PRINT TAB(11);"I"
1040 PRINT "SPACE BAR J*K OR F1"
1050 PRINT TAB(11);"M"
1060 FOR I=1 TO 8:X(I)=0:NEXTI
1070 RETURN

2000 REM BOX
2010 J=4:M=240:GOSUB 3000:POKES1,15
2020 FOR J = 5 TO 12:POKE S2,M:M=M-15:GOSUB 3030:
NEXT J:GOSUB 3000
2030 POKE S1,0
2040 RETURN

3000 REM LINES
3010 FOR I=6 TO 15:K=22*J+I:POKE S+K,102:
POKE C1+K,6:NEXTI
3020 RETURN
3030 FOR I = 6 TO 15:K=22*J+I
3040 IF I = 6 OR I = 15 THEN POKE S+K,102:
POKE C1+K,6:GOTO 3060
3050 POKE S+K,87:POKE C1+K,7
3060 NEXT I:RETURN

4000 REM SHAPE
4010 R=1:C=1
4020 GET A$:IF LEN(A$)=0 THEN GOSUB6000:GOTO 4020
4030 IF A$=CHR$(133) THEN RETURN
4040 IF A$ = "I" THEN R=R-1 :IF R=0 THEN R=1
4050 IF A$ = "M" THEN R=R+1: IF R=9 THEN R=8
4060 IF A$ = "J" THEN C=C-1: IF C=0 THEN C=1
4070 IF A$ = "K" THEN C=C+1: IF C=9 THEN C=8
4080 IF A$<>" " THEN 4020
4090 K=S+22*(R+4)+C+6
4100 IF PEEK(K)=87 THEN 4120
4110 POKE K,87:POKE K+C1-S,7:Y=255-2*(8-C):
X(R)=X(R) AND Y:GOTO 4130
4120 POKE K,81:POKE K+C1-S,0:X(R)=X(R) OR (2*(A-C))
4130 GOTO 4020
```

```
6000 REM FLASH
6010 K=C1+22*(R+4)+C+6:X=PEEK(K)
6020 IF X=0 THEN POKE K,7:GOTO 6040
6030 POKE K,0
6040 FORI=1 TO 10:NEXT I
6050 POKE K,X
6060 RETURN
```

```
9000 REM PRINT
9010 PRINT "<clear>";
9020 POKE 52,28:POKE 56,28:POKE 36869,255
9030 FORI=1 TO 8: PRINT"<reverse on>BYTE";I;" =";X(I)
9040 POKE 7167+I,X(I):NEXT I
9050 PRINT "<down twice><reverse on>YOUR SHAPE = <reverse off>"
9060 PRINT "<down twice><reverse on>PRESS RETURN";:INPUT A$
9070 PRINT "<clear>"
9080 POKE 36869,240
9090 PRINT "<clear><home>":RETURN
```

Thanks to Andrew (my son) for the basic floorplan for this program. (No, I can't see an increase in your allowance, Andrew!) Rather than use Commodore graphics symbols in a listing, I have chosen to put special characters in text form enclosed in <these symbols> in an attempt to speed up interpretation and typing time.

The style of programming used in that program is (as far as the language allows) 'modular'. Thus, the first nine lines form the 'mainline' which supervises the major blocks of the program. Modules at lines 1000, 2000 and 3000 set up an 8 x 8 box on the screen ready for the shape design. Module 4000 allows you to set a shape with the I-J-K-M keys (for movement), the space bar (for plot/unplot) and the F1 key (for escaping). Module 9000 prints the results.

To digress, this style of programming has real appeal. Too often in hobby magazines (even specialist computing journals) we see programs which are real 'spaghetti bowl' efforts. Languages such as PASCAL and PL/1 superbly 'force' modules to be constructed. BASIC is rather lenient in this respect but the technique can certainly be used. Some define good programming in terms of 'how few GOTO's are used'. I rather like a definition based on how easily read and thus how easily serviced or modified, the program is.

Dissecting the technique

A subroutine (i.e. a section of code called by a GOSUB) should be written to perform one particular task only, should not occupy more than one page of paper and should have (preferably) one point of entry. Another reason for using a subroutine is that a section of code may have to be repeated several times. I find it somewhat distressing to see programs with a particular line or group of lines repeated over and over. There has to be a better way!

Now to clarify some lines in Program Line 1000;

```
1000 S = 7680:C1 = 38400
```

This sets memory S and C1 to point to the start of the shape table and colour table respectively. Note that a line of code like POKE S, 10 is much faster than POKE 7680, 10 since the computer would have to convert 7680 into binary in the latter case. In the former case, it is already stored in binary. Line 1000 need to be changed in a VIC-20 with extra memory plugged in, incidently.

Part of line 3010 looks like this;

```
K = 22 * J + 1 : POKE S + K,102 : POKE C1 + K,6
```

Refer to the shape and colour table diagrams given earlier in the article.

Assume that we wish to draw a shape on the screen 'I' columns across and 'J' lines down. Since each line has 22

places, the number $22 * J + 1$ will be how many places from the start of the table that screen co-ordinates (I, J) will occupy. Thus S + K will be the memory location needed for a shape to be POKE'd into and C1 + K will be the one for the matching colour.

Line 3010 will place shape 102 in colour 6 at those co-ordinates. If you wish to find what that is, look up the "screen codes" at page 141 in the VIC-20 guide. You can have colours 0 through 7 and shapes 0 through 127. Shapes 128 to 255 are the 'reverse on' partners to the first 128. There are another 255 characters sitting there, the so-called lower-case set, but that is a horse of a different colour.

One of the beauties of VIC graphics system is that you can very easily see what shape or colour is at a particular place on the screen. The module at line 6000 is set up to make the shape under the current cursor position flash. Line 6010;

```
6010 K = C1 + 22*(R + 4) + C + 6:X = PEEK(K)
```

The memory K once again contains the address of the screen position in the colour table of interest to us. R + 4 is the row within our clever boxing ring (constructed by the program) on the screen. C + 6 is the column. PEEK(K) will tell us what colour is there. It is all very simple to see what is already on the VIC-20 screen. Try that on an Apple, I dare you!

AND umm, OR but . . .

Another nice Commodore feature is the presence of *real live* AND and OR statements. Consider the OR statement. What is 45 OR 200? (Try PRINTing 45 OR 200 on the computer). In binary 45 and 200 are 101101 and 11001000. Now the process of ORing two binary digits means 'if one digit OR the other is a 1, then the result is a 1'. check this one;

```
00101101   (45)
11001000   (200) OR
11101101   (237, the result)
```

An AND works like this — 'only if one digit is a '1' AND the other is also a '1' will the result be a '1'. Again, check this;

```
00101101   (45)
11001000   (200) AND
00001000   (8)
```

these have been used in lines 4110 and 4120 in order to build up our shapes in binary form. An AND to remove a bit, and OR to add it in. The real core of the program is in the statements:

```
X(R) = X(R) AND Y
X(R) = X(R) OR (2 (A-C))
```

Finally, the pointers to the new character table are set in line 9020;

```
9020 POKE 52,28:POKE 56,28:POKE 36869,255
```

The first two POKES change BASIC's ideas on where it can operate and the third one points to our table. Line 9080 restores the character set pointer but leaves BASIC alone so that it does not become schizophrenic.

Using the program

Try the program and design a shape with it. The 'X' given earlier may be good to try since the eight bytes it generates

have been given and this will confirm that your program is working. Here is another shape stated in 8-byte form.

```
BYTE 1 = 0
BYTE 2 = 127
BYTE 3 = 64
BYTE 4 = 64
BYTE 5 = 192
BYTE 6 = 64
BYTE 7 = 64
BYTE 8 = 127
```

Now to see it drawn on the screen!

PROGRAM 2

```
10 GOSUB 1000
20 GOSUB 2000
30 PRINT:PRINT"<reverse on>PRESS RETURN";:INPUT A$
40 POKE 36869,240:PRINT"<clear>"
50 END
```

```
1000 POKE 52,28:POKE 56,28:POKE 36869,255
1010 FOR I=7168 TO 7199:READ D:POKE I,D:NEXT I
1020 DATA 0,127,64,64,192,64,64,127
1030 DATA 0,254,2,2,3,2,2,254
1040 DATA 0,8,8,10,250,10,8,8
1050 DATA 0,128,128,160,191,160,128,128
1060 RETURN
```

```
2000 REM DRAW IT
2010 PRINT "<clear><5 down><8 right><reverse on>3 OHMS"
2020 PRINT TAB(9)"<reverse on><commodore a><reverse off>
    @A<reverse on><commodore s>"
2030 PRINT TAB(9)"<reverse on><shift -> <shift ->"
2040 PRINT TAB(9)"<reverse on><commodore z><reverse off>
    BC<reverse on><commodore x>"
2050 RETURN
```

A few points to note. Line 1020 contains the eight bytes referred to. Three more shapes were added, thus we require $4 \times 8 = 32$ bytes of memory space. Line 1010 sets locations 7168 onwards to contain our shapes. Note that $7168 + 32 = 7200$ but the old 'inclusive number' trick means that the second memory number in the loop counter is one less than this (see line 1010).

The four shapes are drawn by lines 2020 and 2040. You see, the numbers 0 through 31 poked into the shape table would normally draw these shapes:-

@, A to Z, left square bracket, pound,
right square, up arrow, left arrow.

Here, however, the @, the A, B and the C in those lines will draw our shapes. Note also that ordinary text made up of the rest of those first 32 characters will produce garbage on the screen, depending on (randomly) what was in the memory at the time. The '<reverse on>' commands will allow normal text.

I hope readers may be encouraged to develop programs using the idea of home-made shapes which fit together to form good graphics ideas. Such things as alternative character sets and electronics symbols are quite possible.

Two for the price of one

I can't resist one more tip! The Apple (and other computers) allows you to place text anywhere on the screen. Thus, the program line:

```
HTAB(14):VTAB(10):PRINT "HI THERE"
```

would produce a message at co-ordinates (14,10). This isn't possible in the VIC since HTAB and VTAB aren't present.

— to page 109 ▶

The Fingerpicken' BeeBuzz Rag Blues

THIS MONTH we're going to discuss something that's been grinding around in my head for some time: a problem, an opportunity to develop a really snazzy application for the Microbee. I don't intend to tell you how to do it, just sow some seeds for thought.

Point number One: There has been a lot of action in the overseas computer magazines involving the coupling together of computers and video laser-disk players, so that the computer is in control. In the midst of some game, or training program, the computer can call up and display on its screen "real" pictures, either still or moving, from the laser-disk player. This produces a massive library of full colour, broadcast quality pictures, which the computer can use instead of trying to generate its own graphics in software.

Now I'm not saying we should be trying this on the Microbee. Laser disk players aren't all that common in this country, or anywhere for that matter, and the whole scheme seems a quick way to spend a lot of money on something that could become boring once the newness has worn off. So let's scale our target down a bit, with . . .

Point number Two: I have lately spent many, many hours trying to learn to play ragtime and finger-style guitar. My teacher is an American fellow named Stephan Grossman, who imparts his somewhat formidable knowledge and skill to me via a series of audio cassettes and some printed sheets. He apparently makes quite a reasonable living sitting in front of his tape recorder and lecturing his students all over the world by remote control. He must make a lot of money; those six cassettes cost me a bloody fortune, but I'd say they're proving worth it.

This is the way the lessons work: Stephan starts off a session playing a piece all the way through, as the students sits there going "Gaaahh! I'll never play that in a million years!" Then Stephan breaks the tune apart into little chunks, or phrases, which are fed to the student bit by bit. The student listens to the phrase being played slowly, and then tries to reproduce the phrase by following the music on a "tablature sheet" which shows the required fingerings in a form similar to standard musical notation.

Learning this way isn't particularly easy if (1) you can't read music, and (2) if the music is ragtime in which the melody is played on the up-beats and you're trying to play a bass and treble line at the same time only with the parts 90 degrees out of phase with each other. Confusing? Yup.

Eventually, the student wins out and the tune emerges, recognizable and in one piece. It's a satisfying end to a long hard slog, and you can't help thinking that there must be an easier way. Aha! The mighty Microbee!

Now, the problem with the above scheme is mostly one of timing. The tablature sheet tells you which notes you must play, but where? How fast? How long? Well, if your tablature sheets were somehow transferred to the screen of the

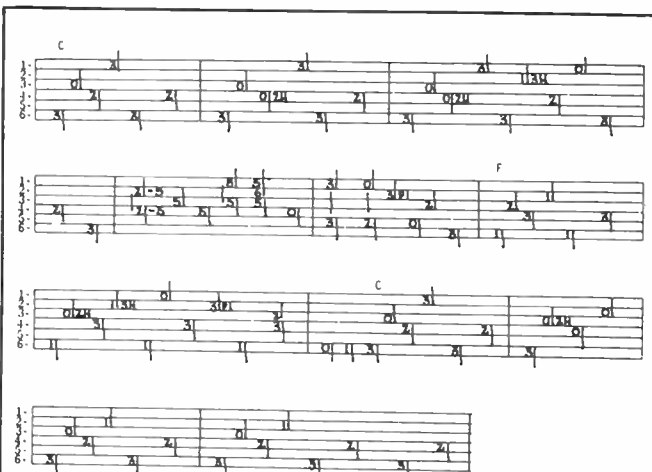

ABOVE: This is what a tablature sheet looks like. The song is "Cocaine Blues" or "All My Friends Are Gone" by Rev. 'Blind' Gary Davis (pictured above). Getting the tablature to appear on-screen as you listen/play looks like a job for a graphics package such as Exitek's "BeeArtistik".

computer, your teacher could then arrange the lesson so that a pointer or cursor indicated the right note, as the teacher played the phrases. End of timing problems, end of confusion. But how to do it?

It seems the same old cassette system would be the answer, only with the teacher's audio recorded on only one channel. Grossman's tapes are much like that anyhow, the stereo balance is just about non-existent. On the second channel the teacher could then arrange for computer data to be recorded in the normal 1200 baud audio format. Then, as the student listened to the teacher first playing the tune all the way through, certain information would be loaded into the computer at the same time. It would probably consist of a small

program to load further information off the tape, and, in the case of a Microbee, programmable character generator data to generate the tablature symbols on the screen.

As the cassette then played on, the Microbee would be waiting for more bytes from the cassette, which would be provided to it in time with the music. Each byte would contain information to display each new tablature symbol on the screen as it was played on the teacher's guitar.

The student's hardware requirements wouldn't be more than a stereo cassette player. The teacher would need a computer program to put the information onto the cassette in the first place. This would probably be laid down on one track first, and then the teacher would play that back into the computer, watching the screen as he recorded the music and commentary on the other audio track.

This idea isn't just restricted to guitar lessons. You could use it for any instruction procedure that required synchronizing audio information with what appears on the screen, such as touch typing. Now here's the coincidence: as I'm writing this, ABC-FM is playing a Scott Joplin piano rag, and I can just about visualize the notes popping onto the 'Bee's screen. That would really be magic if someone pulled it off! And don't say it can't be done, you can do anything on one of these beasts if you set your mind to it!

Listening Post teaser

Now to completely change the subject to the Listening Post (oh no, you say), I've received an interesting letter from Michael Laba of 22 Garden Place, Dunedin, New Zealand. He's got a facsimile program going on a ZX Spectrum computer,

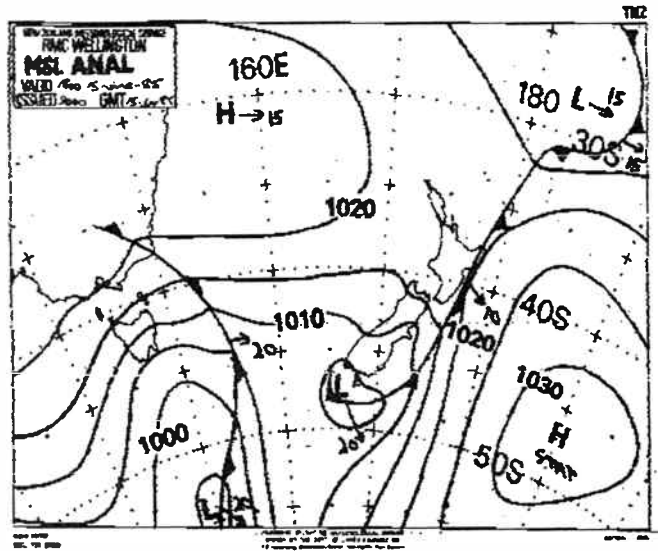

using the general plan of attack used in the Listening Post. Michael is using a Sony ICF2001D attached to an OUTSIDE ANTENNA (oh yes, oh yes!). His system is producing lovely pictures, one of which is reproduced here.

Now, I'll probably get murdered for dobbing him in, but I'd suggest any Spectrum owner who's been lusting for a facsimile receiver might profit from a quick letter to Michael at the above address. 📧

Want to know more about your microbee?

Online — the first magazine devoted entirely to you — the microbee owner.

'ONLINE' is the microbee owners journal full of information and features about your favourite personal computer. It is available from your local microbee technology centre at a cost of \$2.50 OR you can subscribe to 'ONLINE' which is published monthly for \$25.00 annually. Why not fill out the coupon now and subscribe? That way you're sure to be informed of all the latest microbee developments, new products and computing information.

If paying by cheque or money order please make payable to Applied Technology Pty. Ltd.

Post completed form to:
The Subscriptions Officer
P.O. Box 41, West Gosford,
N.S.W. 2250

SUBSCRIBE TODAY AND SAVE!

YES Please include me on your mailing to receive 12 issues of 'ONLINE'.
I would like my subscription to commence with the 19 issue.
(insert month)

NAME _____
ADDRESS _____

POSTCODE _____
I enclose (cheque/money order) for \$25.00 which includes postage and packing. OR Please charge my Bankcard.
No. _____
Expiry Date _____
Signature _____



DSE - THE LARGEST DISTRIBUTOR OF SCOPE PRODUCTS IN AUSTRALIA

WE HAVE MORE SCOPE!

SCOPE Cordless!!

It's here! Now you can take your work anywhere — outside, inside, in the field . . . it doesn't matter! With the incredible Scope Cordless 60W Soldering Gun there's no need to be near a power outlet.

If you're a serviceman, auto electrician, technician, hobbyist: in fact any one who needs a powerful, reliable soldering tool then the new Scope is ideal!

FREE

With every Scope Cordless Soldering Iron we're giving away an AC Battery Charger . . . absolutely free! You won't find better value anywhere! Cat T-1600

Don't pay \$99 elsewhere!

Includes BONUS Charger

\$85



Spares Pack!
Spare tip and element to suit your T-1600 Scope Cordless. Keep some spares just in case!
Cat T-1601

\$5.10

NiCad Replacement
Spare NiCads so you've always got power!
Cat T-1602

\$14.50

SUPERSCOPE!

The Scope superspeed mini-iron is ideal when you need to get things done . . .

Fast! A massive 150W capacity and features you'd only expect in the big ones. Thumb operated switch delivers just the right heat — at the right time.

Operates from 30 amps AC or DC. Quality non-corrosive stainless steel barrel and comes with spare tip and element!

\$38.50

GENUINE SCOPE COPPER TIPS: \$1.15 EA
Standard 1A: T-1610 Instrument: T-1618
Spare Element T-1618 \$1.15



MINISCOPE!

When you're cramped for space you wouldn't want to cramp your style. The amazing Mini-Scope has all the advantages of bigger irons and it's easy to handle!

Fantastic for servicing PC boards, etc!

Finger tip control gives tip temperature equivalent of irons 10-70W. Comes complete with spare tip and element.

\$33.95

SPARE TIP: T-1662 SPARE ELEMENT: T-1666
EACH: ONLY \$1.15

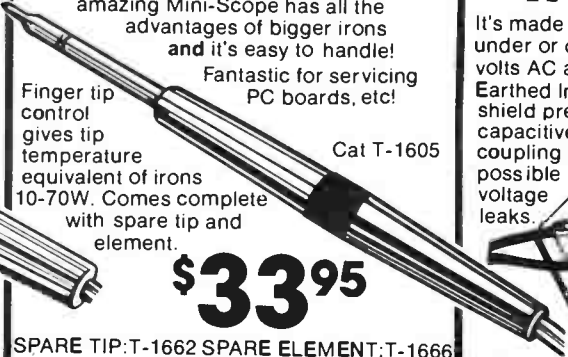

Scope Transformer

It's made for your Scope iron! Mounts under or on the bench. Delivers 3-4 volts AC and it's completely safe!

Earthed Insulation shield prevents capacitive coupling and possible voltage leaks.



\$39.95

Suits T-1605 & T-1660
Cat T-1692

SEE ADDRESSES ON MAILER

DICK SMITH ELECTRONICS

PTY LTD

New technical workstations from HP

Hewlett-Packard Australia has expanded its HP 9000 technical-computer family with the addition of a series of medium to high performance technical workstations that, through modular design, allow users to tailor their own system.

Designated the Series 300, the workstations feature a choice of central-processing units (CPUs), displays, systems software, programming language and peripherals. The systems are aimed primarily at the instrument-control and engineering/technical-design environments, but can be used in other applications as well.

Said John Ewins of HP's Design Systems Group, "The fear of product obsolescence or out-growing a computer system's capabilities is something all computer users and purchasers experience".

"The Series 300 solves this dilemma through its advanced modularity," Ewins said. "Users can purchase an entry-level system now, and upgrade it as their needs change by simply adding the faster CPU or changing the display.

"All of the software remains compatible and the mass-

storage devices, memory and interfaces retain their value within the system, thereby protecting the user's original investment," he said.

Two different CPUs are offered with the Series 300. For use in an entry-level to mid-range system configuration, a 10-MHz Motorola 68010 is available, while a 32-bit, 16.6-MHz 68020 is available where high-speed processor performance is required. One megabyte of RAM is standard with both CPU configurations, and is expandable up to 7.5 megabytes.

Users may choose from four bit-mapped displays with low- or high-resolution monochrome and colour facilities. Two low-resolution monitors feature 512 x 400 pixels with a tilt-and-swivel 12-inch screen. The 19-inch colour and 17-inch mono high-res monitors have 1024 x 768 pixel display and are



intended for engineering graphics applications.

Series 300 will run most Series 200 applications software including word-processing, spreadsheet, database, project management and graphics programs. An integrated word-processing/spreadsheet/database package is available as well as electrical and mechanical engineering programs.

Integrated programming languages/operating systems available with the Series 300 include BASIC 4.0 and Pascal 3.1 HP-UX, derived from a UNIX operating system, is also available.

A selection of input devices

includes digitizer tablets and mice. Mass-storage subsystems, printers and plotters are available, allowing user flexibility in the design of the system.

As a member of the HP 9000 computer family, the Series 300 can be networked with the Series 200 and 500 systems over a high-speed, 10-megabit-per-second, local-area network (LAN). Series 300 also can be networked with the HP 3000 computer family.

Full details from Hewlett-Packard Australia, 31-41 Joseph St, Blackburn 3130 Vic. (03) 895 2895.



Low-cost hobbyist's CRO

A new, low-cost oscilloscope has been released by Dick Smith Electronics. The DSE 6.5 MHz oscilloscope (cat. no. Q 1280) is aimed at the hobbyist or first-time buyer.

For general audio and radio use, or for the hobbyist, this unit represents excellent value for money, DSE claim.

Equipment of this nature has long been out of the amateur's reach because of its prohibitive price tag. But the Q 1280 costs less than \$300!

It's the ideal introduction to CROs, DSE says, offering such features as: retract blanking for clear display, 10 mV per division vertical sensitivity, 500 mV per division horizontal sensitivity, 10 Hz to 100 kHz timebase

(in four sections), internal and external sync and usable response above 6.5 MHz.

The simplicity of the unit makes it suitable for classroom applications and brings sophistication into the price range of the beginner, says DSE.

Further information from Dick Smith Electronics, PO Box 321, North Ryde 2113 NSW. (02) 888 3200.

Auto-routing PCB design package

It's a bit like being able to solve crossword puzzles — some can and some can't! A friend of ours who was once in the printed circuit board business seemed to really enjoy himself laying down strips of tape and creating circuit board designs from schematics. ▶

NEW PRODUCTS NEWS

"This looks very therapeutic", said we, "and furthermore it looks as though it might be an easy way to make money", we thought.

Many hours of eye straining later we discovered the truth, and many sore metres of walking later we found that there were no books available which taught the principles of designing circuit boards from schematic diagrams. It just needed some weird sense of three dimensional logic, and an inexhaustible supply of patience when you found that you had to start all over again for the fifth time.

But the suspicion that there are definite logical rules and therefore learnable principles applicable to the task is proved by the fact that it can now be performed by computer.

We hear from **Lamron Pty Ltd, PO Box 438 Ryde NSW, (02) 808 3666**, of Fastwire. This consists of four graphics-orientated programs designed to run on IBM-PC personal computers and close compatibles. The programs are designed to lay out and auto-route printed circuit boards.

A symbolic graphics editor defines each board module functionally and physically, either from the system library or from a user-defined library. Using the editor, the user prepares a netlist (one or more net names can be define per component terminal) as well as component layout on the board. With a single command, each module can be moved, copied, rotated, or deleted. A wire-density map can be concurrently computed from a ranked wire list with the same layout program.

The board-routing program is completely re-entrant and supports manual, automatic, and semi-automatic wire routing. The plotter program allows double-sided layout plotting on paper, vellum, or mylar with any a Houston Instruments Inc plotter using DM/PL protocols or a Hewlett Packard plotter.

Fastwire can be used for small and large layouts, allowing fast and efficient routing and one- or two-sided boards up to the maximum of 163 square inches.

The high-performance routing algorithm, which uses combinatorial (pardon?) alternative-path searches, typically routes a 20-module layout in 30 minutes, with 99% automatic routing performance, it is claimed.

For Fastwire to run, the PC needs 256K bytes of RAM, a disk drive, a colour-graphics adapter card, and a serial-to-parallel adapter.

For things that go bump in the night

IRH components has sent us details of the Murata PKS series shock sensor, which is a useful addition to burglar systems as a sensor of mechanical shock, vibration, or acceleration.

The PKS Series sensor can be set on desks, filing cabinets, doors, windows, or automobiles, and will transform any



mechanical shock or vibration into an electrical output.

It occurs to us that its use may have a wider scope, for example in industrial control and automation, robotics, and laboratory testing.

The device is 4.5 mm high and 24 mm in diameter, and is ideal for security applications, says IRH. You can get more details from **IRH Components, 32 Paramatta Road, Lidcombe, 2141 NSW. (02) 648 5455**.

Audio transmission test system

A truly mouth-watering photograph arrived on our desk this week from the **Dindima Group Pty Ltd of PO Box 106, Vermont 3133 Vic**. This refers to the release of Sound Technology's 3000 Series of audio and test transmission systems, designed for benchtop, field service, production line and remote testing.

Maximum flexibility is provided by a separate generator and analyser which communicate through the audio line being tested. As can be seen from the photograph, both units have extensive front panel programmability, allowing storage of entire automated test sequences such as proof of per-

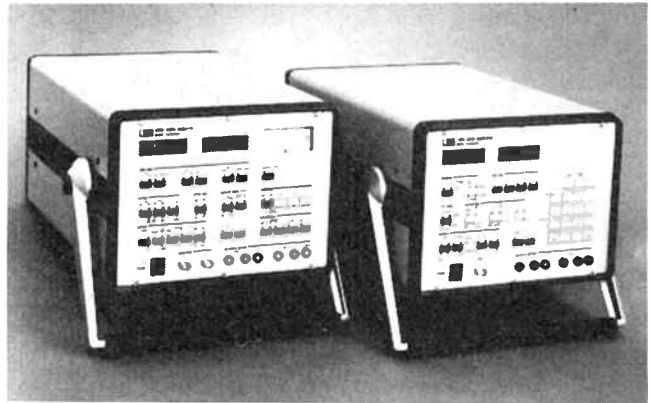

formance results.

This unique approach allows unmanned automated remote transmission line testing to be performed through any audio "line" being tested (i.e: microwave, satellite, or telephone transmissions) in typically less than 60 seconds, without usage of modems or external computers.

Test results can be graphed on a standard printer or plotter. The 3000 Series can also be programmed with RS232C or GPIB interface.

The 3100A Audio Generator

produces sinewaves, squarewaves, IMD signals, toneburst, and sine-step waveforms. Output is two channel, electronically balanced, and completely floating, as no doubt would be the technician using it.

The 3200A Analyser measures level, noise, frequency, harmonic distortion, quantizing noise, intermodulation distortion, phase error and channel separation. Other features include sine-step tests, squarewaves up to 50 kHz and 10, 25, 50 and 75 microsecond de-emphasis.

The answers to last month's Weller Crossword

B	O	O	T	S	T	R	A	P	C	I	R	C	U	I	T				
I									R										
N			D	Y	N	A	M	I	C	P	I	C	K	U	P				
A								T							S				
R				D				I							I				
Y				Q	U	E	N	C	H	F	R	E	Q	U	E	N	C	Y	
C				P				A	L						G				
O	S			L				L	I	J	A	M	M	I	N	G			
U	J			E				D	C						N				
N	D			X				A	K	H					G				
T	I	B		E				M	E	H	O	T	S	P	O	T			
E	R	O		O				P	R	P					O				
R	E	N		H				Z	E	M					H	I	S	S	
				C				D	T	N	F	E			N				
				T				I	E	G	F	S			T				
				Z				N	N		E	S							
				O				G	A	S	D	I	S	C	H	A	R	G	E
				N				I							T	G	A		
				B				A	C	K	P	O	R	C	H		E	I	
				L				N										N	



MM58174A Microprocessor-Compatible Real-Time Clock

General Description

The MM58174A is a low-threshold metal-gate CMOS circuit that functions as a real-time clock and calendar in bus-oriented microprocessor systems. The device includes an interrupt timer which may be programmed to one of three times. Time-keeping is maintained down to 2.2V to allow low power standby battery operation. The timebase is generated from a 32768Hz crystal-controlled oscillator.

Features

- Microprocessor compatible
- Tenths of seconds, seconds, tens of seconds, minutes, tens of minutes, day of week, days, tens of days, months, tens of months, independent registers
- Automatic leap year calculation
- Internal pull-ups to safeguard data
- Protection for read during data changing
- Independent interrupt system with open drain output
- TTL compatible
- Low power standby operation (2.2V, 10 μ A)
- Low cost internally biased oscillator
- Low cost 16-pin dual-in-line package
- Available for commercial and military temperature ranges

Applications

- Point-of-sale terminals
- Word processors
- Teller terminals
- Event recorders
- Micro-controlled instrumentation
- Microprocessor time clock
- TV/VCR reprogramming
- Intelligent telephone

Connection Diagram

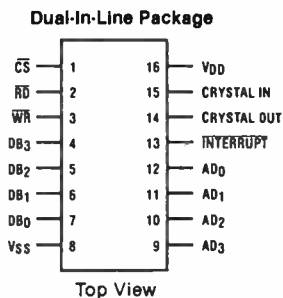

Functional Description

The MM58174 is a microprocessor bus-oriented real-time clock. The circuit includes addressable real-time counters for tenths of seconds through months and a write only register for leap year calculation. The counters are arranged as bytes of four bits each. When addressed a byte will appear on the data I/O bus so that each word can be accessed independently. If any byte does not contain four bits (e.g. days of the week uses only 3 bits), the unused bits will be unrecognized during a write operation and tied to V_{SS} during a read operation.

The addressable reset latch causes the pre-scaler, tenths of seconds, seconds, and tens of seconds to be held in a reset condition. If a register is updated during a read operation the I/O data is prevented from updating and a subsequent read will return the illegal b.c.d. code '1111'. The interrupt timer may be programmed for intervals of 0.5 second, 5 seconds, or 60 seconds and may be coded as a single or repeated operation. The open drain interrupt output is pulled to V_{SS} when the timer times out and reading the interrupt register provides the internal selected information.

Circuit Description

The block diagram shown in Figure 1 shows the structure of the CMOS clock chip. A 16-pin DIL package is used.

Crystal Oscillator

This consists of a CMOS inverter/amplifier with on-chip bias resistor and capacitors. A single 6-36 pF trimmer is all that is required to fine tune the crystal (see Figure 2). However, for improved stability, some crystals may require a capacitor of typical value 20pF to be added between pin 14 and ground. The output of the oscillator is blocked by the start/stop F/F.

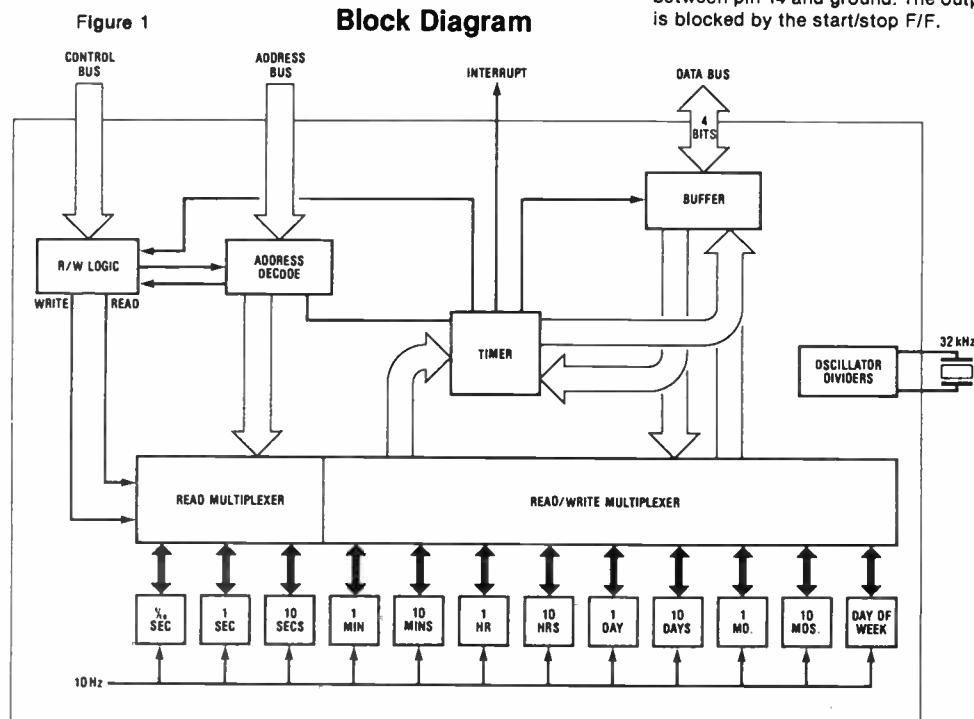

Non-Integer Divider

This counter divides the incoming 32,768Hz frequency by 15/16 down to 30,720Hz.

Fixed Divider (512)

This is a standard 9-stage binary ripple counter. Output frequency is 60Hz. This counter is reset to zero by start/stop F/F.

Fixed Divider (6)

This is a 3-stage Johnson counter with a 10Hz output signal. This counter is reset to zero state by the start/stop F/F.

Synchronization Stage

Both 10Hz and 32,768Hz clocks are fed into this section. It is used to generate a pulse of 15.25µs width on the rising edge of each 10Hz pulse.

This pulse is used to increment all the seconds, minutes, hours, days, months, and year counter and also to set the data changed F/F.

Data Changed F/F

This is set by the rising edge of each 10Hz pulse to indicate that the clock value has changed since the last read operation. It is reset by any clock read command. The flip-flop sets all data bus bits to a "1" during RD time indicating that a register has been updated. This transient condition may occur at the end of the Read Data strobe. Hence, invalid data may still be read from the clock, if the strobe width was less than 3µs.

The possibility may be overcome by implementing a further read of the tenths of seconds register at the end of every series of reads (starting with a read at the tenths of seconds register) and checking for unchanged data.

Seconds Counters

There are three counters for Seconds:

- tenths of seconds
- units of seconds
- tens of seconds

The outputs of all three counters can be separately multiplexed on to the command 4-bit output bus. Table I shows the address decoding for each counter. All three counters are reset to zero by the start/stop F/F.

Minutes Counters

There are two Minutes counters:

- units of minutes
- tens of minutes

Both counters are parallel loaded with data from the 4-bit input bus when addressed by the microprocessor and a Write Data Strobe pulse given. Similarly, the output of both counters can be read separately onto the common 4-bit output bus (Table I).

Hours Counters

There are two Hours counters which will count in a 24-hour mode:

- units of hours
- tens of hours

Both counters have identical parallel load and read multiplex features to the Minutes counters.

Seven Day Counter

There is a 7-state counter which increments every 24 hours. It will have identical parallel load and read multiplex capabilities to the Minutes and Hours counters. The counter counts cyclically from 1-7.

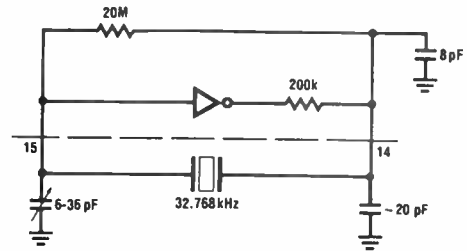

Figure 2. Crystal Oscillator

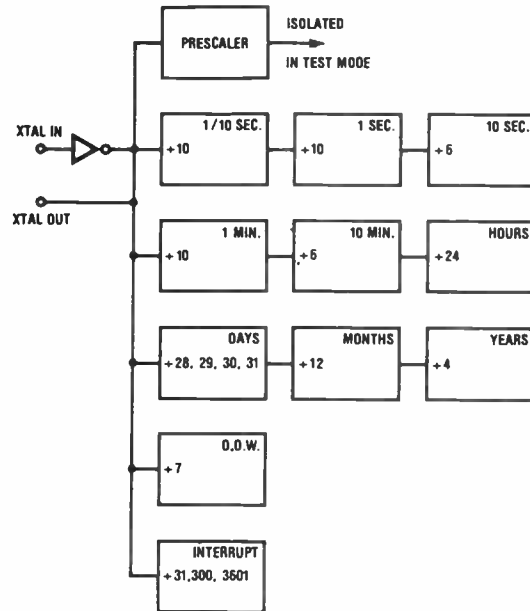

Figure 3. Test Mode Organization

Days Counter

There are two Days counters:

- units of days
- tens of days

The Days counters will count up to 28, 29, 30, or 31 days depending on the state of the Months counters and the Years Status Register. Days counters have parallel load and read multiplex capabilities.

Months Counters

There are two Months counters:

- units of months
- tens of months

The Months counters have parallel load and read multiplex capabilities.

Years Status Register

The Years Status register is a shift register of 4 bits. It will be shifted every year on December 31st. The status register must be set in accordance with Table III. No readout capability is provided.

Chip Select (\overline{CS})

An external chip select is provided. The chip enable is active low.

Table I. Address Decoding for Internal Registers

Selected Counter	Address Bits				Mode
	AD ₃	AD ₂	AD ₁	AD ₀	
0 Test Only	0	0	0	0	Write Only
1 Tenths of secs.	0	0	0	1	Read Only
2 Units of secs.	0	0	1	0	Read Only
3 Tens of secs.	0	0	1	1	Read Only
4 Units of mins.	0	1	0	0	Read or Write
5 Tens of mins.	0	1	0	1	Read or Write
6 Units of hours	0	1	1	0	Read or Write
7 Tens of hours	0	1	1	1	Read or Write
8 Units of days	1	0	0	0	Read or Write
9 Tens of days	1	0	0	1	Read or Write
10 Day of week	1	0	1	0	Read or Write
11 Units of months	1	0	1	1	Read or Write
12 Tens of months	1	1	0	0	Read or Write
13 Years	1	1	0	1	Write Only
14 Stop/Start	1	1	1	0	Write Only
15 Interrupt	1	1	1	1	Read or Write

Table IIa. Interrupt Selection Data

Mode: Address 15, Write Mode

Function	DB ₃	DB ₂	DB ₁	DB ₀
No Interrupt	X	0	0	0
Int. at 60 sec. intervals*	0/1	1	0	0
Int. at 5.0 sec. intervals*	0/1	0	1	0
Int. at 0.5 sec. intervals*	0/1	0	0	1

* + 16.6 ms

DB₃ = 0, single interrupt DB₃ = 1, repeated interrupt

Table IIb. Interrupt Read Back (Status)

Mode: Address 15, Read Mode

Interrupt Status	DB ₃	DB ₂	DB ₁	DB ₀
Reset	X	0	0	0
60 sec. signal	X	1	0	0
5.0 sec. signal	X	0	1	0
0.5 sec. signal	X	0	0	1

X = don't care state

Table III. Years Status Register

Mode: Address 13, Write Mode

	DB ₃	DB ₂	DB ₁	DB ₀
Leap year	1	0	0	0
Leap year - 1	0	1	0	0
Leap year - 2	0	0	1	0
Leap year - 3	0	0	0	1

Note: Leap year counter rolls over on Dec. 31 @23:59:59

Counter and Register Selection

Table 1 shows the coding on the address lines AD₀-AD₃ which select the registers in the circuit to be either parallel loaded or read on to the output bus.

Start/Stop (Reset) Latch

A logic "1" on DB₀ at chip address 14 (E) will start the clock running, a logic "0" will stop the clock. This function allows the loading of time data into the clock and its precise starting. The clock starts at 0.1 seconds.

Test Mode

This mode is incorporated to facilitate production testing of the circuit. In this mode, the 32,768 Hz clock is fed forward as shown in Figure 3. For normal operation, the circuit must be set to the non-test mode as part of the system initialization. This is accomplished by writing a logic "0" to DB₃ at AD₀.

Interrupt System

The interrupt output and its frequency of operation is enabled by writing to address 15 (see Table IIa). To ensure correct operation, the interrupt should be serviced within 16.6ms.

The interrupt is initialized by writing "0" to address 15 and reading the interrupt, i.e., reading at address 15 three times. Initialization must be performed at power on and also if the interrupt is not serviced correctly within 16.6ms.

Servicing the Interrupt

In a typical system the open drain interrupt output is wired to the processor interrupt system. Hence, when the interrupt timer times out, the interrupt output is pulled low and the processor is interrupted.

The processor may then reset the interrupt by utilizing the following procedure:

Read Address 15 three times.

This resets the interrupt output and restarts the interrupt timer when in the repeat mode.

It is recommended that the interrupt output is connected to a unique processor port.

Crystal Parameters

Figure 4 is an electrical representation of the crystal along with some typical values. The 32.768 kHz crystal is an NT CUT (tuning fork type) or XY BAR for use in a parallel resonant Pierce oscillator.

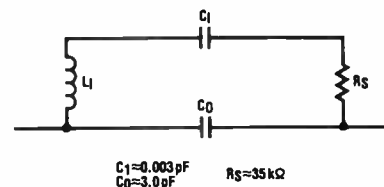
Figure 4. Typical Crystal Parameters

Device Initialization and Oscillator Setting

When first installed or if the battery back-up has failed, the MM58174A will require to be properly initialized. The following sequence is a suggested flow of operations to achieve this.

Action	Result
1) Apply power.	
2) Write '0' to address 15.	Clears interrupt timer chain.
3) Read 3 times from address 15.	Clears interrupt output logic.
4) Write '0' on DB3 to address 0.	Clears test mode.
5) Write '0' on DB0 to address 14.	Stops clock running.
6) Set up time-keeping registers.	Load real-time into device time registers, minutes to leap years.
7) Write '1' on DB0 to address 14.	Starts time-keeping synchronized to an external time source.
8) Program and start interrupts.	Commence interrupt timing, if so required.

Oscillator Setting

Directly connecting a frequency meter to the Crystal Out pin (14) will not allow correct frequency setting because of the extra capacitive loading of the meter. One possibility for setting is to use a high impedance probe or a CMOS buffer to keep the loading as low as possible (e.g., 100 x 2 pF probe). Alternatively, a buffered output of 16.384 kHz (OSC/2) can be produced on DB0 by applying the following procedure:

- | Action | Result |
|---|--------------------------------|
| 1) Write a '1' on DB3 to address 0. | Selects test mode. |
| 2) Write a '1' on DB0 to address 14. | Starts clock timing. |
| 3) Read at address 1 (tenths of secs). | 'Data Changed' signal is read. |
| 4) Read at address 1 and HOLD the strobe LOW. | 16.384 kHz appears on DB0. |
| 5) Adjust trimmer capacitor. | |

There must be no extra activity on the RD line between steps 3 and 4 or only the normal 'Data Changed' signal will be observed on the data bus. Thus if the normal host processor system is being used to generate the chip waveforms, proper care must be taken.

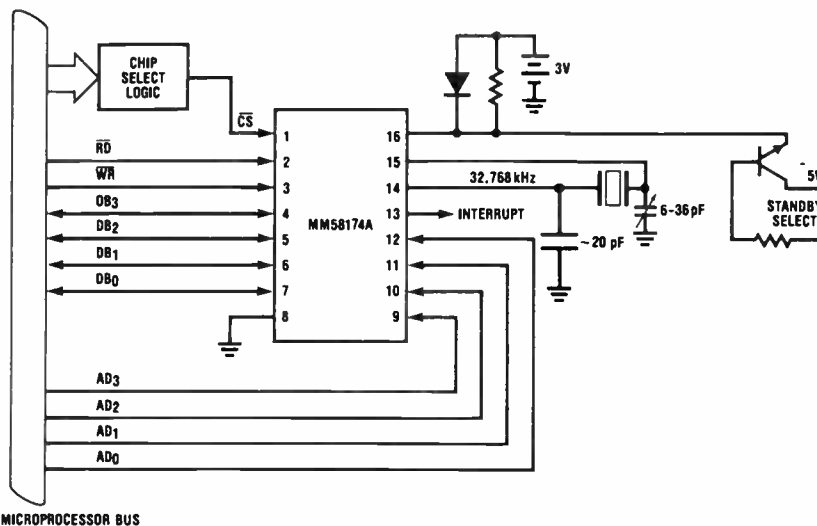
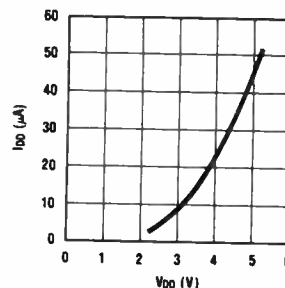

Figure 5. Typical Microprocessor Interface

Typical Supply Current vs Supply Voltage During Power Down



Electrical Characteristics

Symbol	Parameter	Conditions	Min	Typ	Max	Units
V _{DD}	Supply Voltage	Standby mode (no READ or WRITE instructions)	2.2		5.5	V
		Operational mode	4.5		5.5	V
I _{DD}	Supply Current	V _{DD} = 2.2V (Standby) MM58174AN V _{DD} = 5V (Operating)			10 1	μA mA
	Input Logic Levels For Signals: AD ₀ - AD ₃ , DB ₀ - DB ₃ , WR, RD, CS Logic "1" Logic "0"	V _{DD} = 5V	2		0.8	V V
	Input Capacitance				10	pF
	Input Current Levels	V _{DD} = 5V				
	Current to V _{SS} For Signals: AD ₀ - AD ₃ , DB ₀ - DB ₃ , RD	V _{IN} = V _{DD}			30	μA
	Internal Resistor to V _{DD} For Signals: WR CS		30 30	100 100		kΩ kΩ
	Output Logic Levels For Signals: DB ₀ - DB ₃ Logic "1" Logic "0" INTERRUPT (Open Drain) Logic "0" Off Leakage	V _{DD} = 5V I _{OH} = 0.1 mA I _{OL} = 1.6 mA For I _{DS} = -1.6 mA V _{OUT} = 5V	2.4		0.4 0.4 5	V V V μA

MM58174A

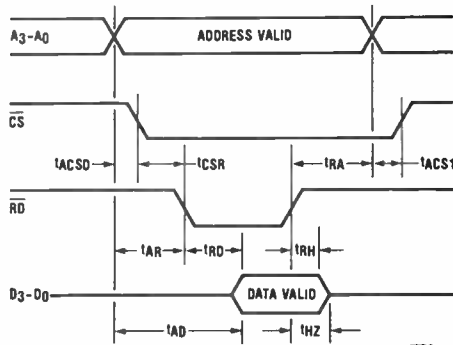

Figure 6. Read Cycle Waveforms

Timing Waveforms

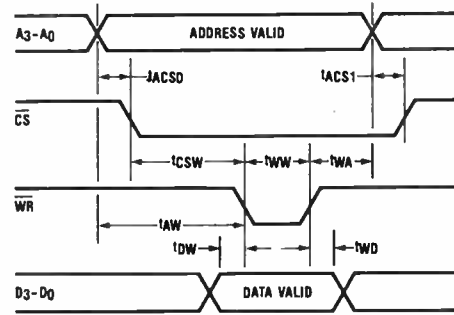

Figure 7. Write Cycle Waveforms

Read Mode

Figure 6 gives detailed timing for the transfer of data from peripheral to microprocessor. See Table IV. All times are measured from (or to) valid logic "0" level = 0.8V or valid logic "1" level = 2.0V.

Write Mode

Figure 7 gives detailed timing for the transfer of data from microprocessor to peripheral. See Table V.

Table IV. Read Timing: Data from Peripheral to Microprocessor

Symbol	Parameter	MM58174AN		Typ	Units	Comments
		Min	Max			
t _{ACS0}	Address Bus Valid to Chip Select ON ($\overline{CS} = 0$)	0			ns	
t _{CSR}	Chip Select ON to Read Strobe	0			ns	
t _{RD}	Read Cycle Access Time from Read Strobe to Data Bus Valid		900	450	ns	CL = 100 pF
t _{RH}	Data Hold Time from Trailing Edge of Read Strobe	0	330		ns	
t _{RA}	Address Bus Hold Time from Trailing Edge of Read Strobe	70		500	ns	
t _{ACS1}	Address Change to Chip Select OFF	0		40	ns	
t _{AD}	Address Bus Valid to Data Valid	~	1850	850	ns	CL = 100 pF
t _{HZ}	Time from Trailing Edge of Read Strobe until Interface Device Bus Drivers are in TRI-STATE® Mode	0	330		ns	
t _{RW}	Read Strobe Width		14		µs	
t _{AR}	Address Bus Valid to Read Strobe	500			ns	

Note 1: In order not to degrade timekeeping accuracy, the number of Read strobes in any one second should be less than 10,000.

Table V. Write Timing: Data from Microprocessor to Peripheral

Symbol	Parameter	MM58174AN		Typ	Units	Comments
		Min	Max			
t _{ACS0}	Address Bus Valid to Chip Select ON ($\overline{CS} = 0$)	0			ns	
t _{CSW}	Chip Select ON to Write Strobe	0		450	ns	
t _{AW}	Address Bus Valid to Write Strobe	725			ns	
t _{WW}	Write Strobe Width	670			ns	
t _{DW}	Data Bus Valid Before Write Strobe	70			ns	
t _{WA}	Address Bus Hold Time Following Write Strobe	165			ns	
t _{WD}	Data Bus Hold Time Following Write Strobe	185			ns	
t _{ACS1}	Address Change to Chip Select OFF ($\overline{CS} = 1$)	0			ns	

Note 1: If address and write occur simultaneously, then they must exist for t_{AW} and t_{WW}.

Commodore Codex

— from page 97.

That explains why so many 'up cursor' (etc) commands are present in VIC programs. I wrote a short machine code routine to achieve this for the VIC which is relatively useful. The problem is 'where to put the machine code?'

The solution was to bury it in a BASIC program. Pardon the 'recipe' approach, but here is how to put it into an unexpanded VIC-20.

Step 1. NEW

Step 2. 10 REMXXXXXXXXXXXXXXX (type 21 or more Xs)

Step 3. type this line eighteen times —

POKE 4102,#

Start with 4102 and increase it each time by 1, up to 4119

Replace, in turn, the # with these numbers;

8, 72, 24, 174, 79, 3, 172, 80, 3, 32, 240, 255, 104, 40, 96, 88, 88, 119

Step 3. Save the one line program to tape.

You now have a one line BASIC program with some buried machine code. This is neat, since you recall two languages when the program is retrieved from tape. Two for the price of one, sort of thing.

Here is an example of its use. Note how X and Y coordinates are poked into the memory:

```
10 REM (THE MESSY LINE JUST CONSTRUCTED)
20 PRINT "<clear>"
30 POKE 848, 10: POKE 847, 12: SYS(4102)
40 PRINT "HELLO"
50 END
```

This will allow another method of animation. Note that POKE 848 sets the X value and the POKE 847 sets the Y value. SYS(4102) calls the machine code buried in the BASIC.

So what do you have? A means of producing characters of your own and a quick method of placing them anywhere on the screen. This could lead to some interesting animation programs! 🐘

HI FI SPEAKER KITS

HAVE FUN. SAVE MONEY BUILDING THE LATEST HI FI SPEAKER KITS. RAW DRIVERS, X-OVERS, PLANS, REPLACEMENT SPEAKERS AND ACCESSORIES FROM THE WORLD'S FINEST MANUFACTURERS. FOR AUDIOPHILES AND BEGINNERS.

DYNAUDIO-FOSTER-KEF- MAGNAVOX- PEERLESS-PHILIPS- SCANSPEAK-VIFA and MORE. KEF CONSTRUCTOR KITS FROM \$399.00 — SCAN SPEAK SERIES 200 KIT FROM \$650.00 — VIFA AEM6102 KIT FROM \$399.00 — DYNAUDIO DAK2 120 KIT FROM \$469.00.

AUDIOCRAFT
AUSTRALIA'S MAIL ORDER
SPECIALISTS HI FI KIT

SEND \$2.00 FOR OUR LATEST CATALOGUE TO AUDIOCRAFT DEPT AE PO BOX 725 TOOWONG BRISBANE 4066. ENQUIRIES MON-FRI 9AM-4PM PH 07-870 8785. CREDIT CARD PHONE ORDERS AVAILABLE. WE SHIP ANYWHERE IN AUSTRALIA AND EXPORT TO NEW ZEALAND AND PACIFIC. MAIL ORDER DISTRIBUTORS OF FINE SPEAKER COMPONENTS AND ACCESSORIES FROM AROUND THE WORLD FOR THE DIY. (DO IT YOURSELF) HOME CONSTRUCTOR MARKET.

PO BOX 725 TOOWONG BRISBANE AUSTRALIA 4066. PH 07 — 870 8785

TAMIYA RC CARS

AEM - SPECIAL PRICES!

HORNET \$119
FROG \$189
HOTSHOT \$229

Famous Futaba brand remotes
ONLY \$149 complete with servos (FP-2NL)

FOR MAILORDER & STORE LOCATIONS ring

(02) 858 2288

AE ELECTRONICS
WHOLESALE
ENQUIRIES WELCOME

THE RADIOMAN PACK

for Commodore 64 as well as VZ200/300 and VIC-20

Gives you a Typing Tutor, Log Book, Morse Code and Beam Heading — all on a single cassette.

\$12

inc. post and handling.

John Hirst
Hi-Com Programs, RSD 170,
PO Exeter, Tas. 7251

AUSTRALIAN ELECTRONICS MONTHLY

Small Spaces.

Great Advertising potential for very little cost. Reaching around 40,000 readers for just \$190.00



ARE YOUR SPEAKERS SOUNDING A LITTLE TIRED AND LAZY?

PERHAPS YOU WOULD LIKE TO UPDATE SOME DRIVER OR MAYBE YOU'RE A BIT OF A WIZZ AT BUILDING THEM.

WE HAVE THE COMPLETE RANGE OF DYNAUDIO SCANSPEAK AND VIFA DRIVERS PLUS SOME IDEAS ON BUILDING ENCLOSURES

● DANISH EXCELLENCE THESE SPEAKERS ARE USED BY MANY MANUFACTURERS AROUND THE WORLD



SEND NOW FOR INFORMATION REGARDING THESE WORLD FAMOUS DRIVERS.



Queensland Stereovisual Supplies
P.O. BOX 227, ZILLMERE, QLD. 4034. PH: (07) 265 7945

Contact
John Whalen
(02) 487 2700

for further details, or send in your copy* with your cheque for \$190 to PO Box 289 Wahroonga 2076

Proof supplied before publication

Here's our fourth monthly crossword with a prize of the marvellous Weller WTCPN Controlled Output Soldering Station for the winner.

This month we move back to the subject of inventors and discoverers this time the people who made their discoveries during the 1940s to the 1970s. We've filled in a few blanks to make it easier, so lose no time in sending in your entry you never know you might join our other happy winners in owning a magnificent Weller soldering station. This is a fairly hard crossword, so if you get it all out, except for one or two, send in your entry anyway as you may well still win!

As with the last time we ran a similar crossword, some of the inventions mentioned in the clues could be open to dispute as to who was the inventor, so only our set of answers are considered correct and no correspondence will be entered into on the subject.

Entries close December 17.

Our crosswords are prepared on an Apple 11e using 'Crossword Magic' supplied by Edsoft Pty Ltd, 20 Blackburn Rd, Blackburn, Vic. 'Crossword Magic' is just one of a vast range of educational software they stock.

The winner of the September 1985 crossword was J. R. Kleeman of Kenmore, Qld. The answers appeared in our October issue on page 112

WELLER CROSSWORD COMPETITION NO. 4

CooperTools

THE PRIZE

A transformer powered soldering station complete with a low voltage temperature controlled soldering pencil. The special Weller closed loop method of controlling maximum tip temperature is employed, thereby protecting temperature sensitive components, while the grounded tip and non inductive heater protects voltage and current sensitive components. The soldering pencil features stainless steel heater construction, a non-burning silicon rubber cord and a large selection of iron plated tips in sizes from 8 mm diameter to 6 mm diameter with a choice of tip temperature of 315°C/600°F, 370°C/700°F and 430°C/800°F. The transformer case features impact resistant nylon for durability and protection against accidental damage, a quick connect/disconnect plug for the soldering iron, extra large wiping sponge tip tray to store extra tips, plus an improved off/on switch with a long-life iron indicator light, a non-heat sinking soldering pencil holder, and a 2 m flexible 3 wire c...



ACROSS

5. Developed the Planar process which led to Fairchild marketing planar transistors.
6. Worked with K.C. Kao to produce a paper which led to the development of fibre optics. (U.K. 1966).
7. In 1960 this man developed the ruby actioned laser.
10. With J. O'Connell developed the semiconductor diode junction capacitor (1956).
11. Famous author who developed the theory of stationary communication satellites.
14. Developed the first practical LED (1962).
16. The company that developed the video tape recorder.
19. With R.A. Logan at Bell Labs developed the integrated optical circuit.
21. Nicknamed Buck he brought to fruition the Dual-in-line package at Fairchild (1964).
22. Helped develop the solar battery with Chaplin and Pearson (1954).
23. Developed the integrated circuit concept in the U.K. (1952).

DOWN

1. Part of the 1969 American team to develop magnetic bubbles.
2. The company generally credited with the development of the minicomputer.
3. Developer who along with G.H. Townes produced the Laser in 1958.
4. One of the two developers of the UNIVAC in 1947.
8. The other developer of UNIVAC.
9. The developer of the basic design theory of modern computers (1948).
12. Inventor of the electronic clock (1961).
13. The company considered to be the developers of the 16 bit single chip microprocessor.
15. Company that developed the X-Ray Scanner.
17. Considered the inventor of holography (U.K. 1948).

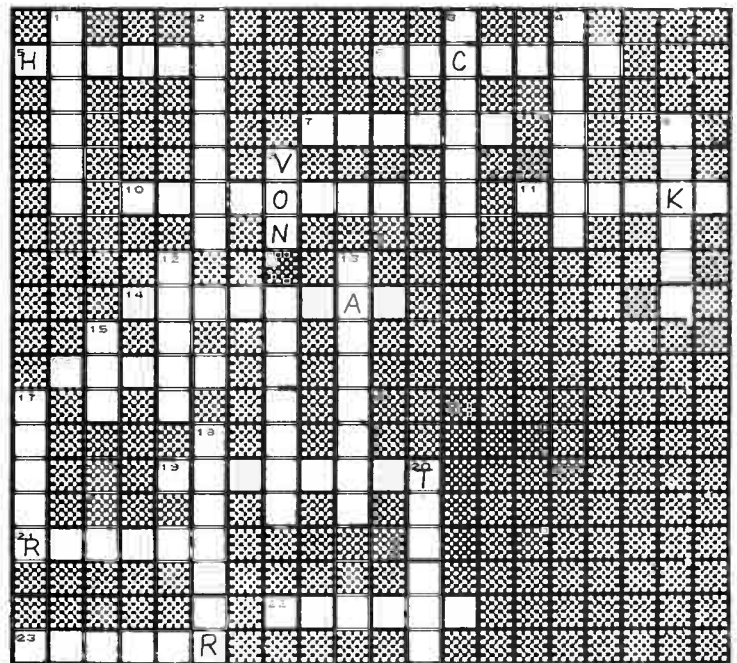

18. The first communication satellite to transmit TV pictures across the Atlantic (July 1962).
19. Worked with 3 on the Laser and worked with the team that developed the Mas...

SEND YOUR ENTRY IN BY LAST MAIL DECEMBER 17.

The competition is open to all persons normally resident in Australia or New Zealand, with the exception of members of the staff of Australian Electronics Monthly, the printers, Oriset Alpine, and/or associated companies. The winning entry will be drawn by the Editor, whose decision is final; no correspondence will be entered into regarding the decision. Winners will be notified by telegram the day the result is declared and the winner's name and contest results published in the next possible issue of the magazine.

Cut out or photocopy the entry form, complete it and send to:

"Weller Crossword"
Australian Electronics Monthly
PO Box 289,
Wahroonga NSW 2076

We will accept entries postmarked no later than December 18

In case two or more entrants correctly complete the crossword, we'll have to judge who's best at waxing lyrically, in 30 words or less, over: **"Why I think the Weller WTCPN is the soldering station for me".**

.....

.....

.....

.....

.....

Name

Address

..... Postcode

Numbers large and small

IN ELECTRONICS, YOU'LL FIND that many of the quantities encountered are either very large or very small. For example, resistance as encountered in electronics is a small quantity so the units used are large — thousands of ohms, millions of ohms, etc. Capacitance, on the other hand, is a naturally large quantity so electronics tends to employ very small units of capacitance — thousandths of a Farad, millionths of a Farad, etc. As a contrast, voltage seems to be naturally a 'unitary' thing — common batteries deliver 1.5 V, 9 V etc — though the range of voltages encountered in electronics varies over a truly enormous range. Signals commonly picked up on your shortwave receiver are measured in millionths of a volt, while the high voltage required by the picture tube in a colour TV is measured in tens-of-thousands of volts.

Very large and very small numbers are often conveniently represented in 'scientific notation', using powers of ten to express the size of a quantity. e.g: two million is written — 2×10^6 . The 10^6 stands for "10 multiplied by itself six times", which can also be thought of as "1 followed by six noughts". Thus, 10^4 is "1 followed by four noughts" or — 10 000! Very small quantities are expressed in a similar way, but a "-" (minus) precedes the power. e.g: one millionth, or $1/1\ 000\ 000$ as a fraction, is written — 1×10^{-6} . The minus preceding the power indicates it comes from the bottom of the fraction (the divisor).

The "x 10^n " is also referred to as the "multiplier", for obvious reasons.

Now, because quantities are never conveniently straight units, decimal notation is used in conjunction with scientific notation. Thus, two-and-a-half million may be written — 2.5×10^6 . Four thousand and seventy volts would be written — 4.07×10^3 volts.

Naming the units

The common multiplier quantities have been given names for ease of use. Everyone's familiar with "kilo", meaning "thousands" as in kilograms, kilometres etc. A thousand grams is 1×10^3 grams. Thus, kilo stands for 10^3 . There are seven such names for the common multipliers. In use, they're abbreviated, the first letter being used to symbolise the name except for 'micro', where the Greek letter 'mu' (μ) is substituted to avoid confusion with milli, though often the lower case letter 'u' is employed instead. In descending order, the multiplier names and symbols are:

Giga	G		
Mega	M		
kilo	k	micro	μ or u
milli	m	nano	n
		pico	p

Table 1 here shows them with the related quantities and multipliers.

Thus, one microvolt is one-millionth of a volt, one Megohm is one million (1 000 000) ohms, one Gigahertz is one thousand Megahertz, or a thousand million Hertz. Reiterating some of the earlier examples, 2.5×10^6 ohms is 2.5 million ohms or 2.5 megohms (generally written as 2.5M, or 2M5 to avoid confusion about placement of the decimal point — see "Resistors", July issue). Again, 4070 volts would be written 4.07 kilovolts (or kV).

NOTE: The terms 'Mega' and 'Kilo' used in computer parlance have different meanings to that given here. In binary notation Kilo means 1024 times (2^{10}), while Mega means 1 048 576 times (2^{20}). as you can see, the "digitologists" talk in powers of two.

Converting between units

There often arises the need to convert a quantity's units to something more convenient for the purposes of calculation, comparison or clarity of expression. The multiplier name indicates the size of the quantity and thus, the action you need to take when converting — either multiplication or division.

Thus, one ohm is one-millionth of a megohm, one volt is one million microvolts, and so on. Where fractional quantities are involved (1.23, 11.57 etc), the decimal point is shifted left or right according to the size of the quantity and the conversion involved. e.g: 4.07 kilovolts is 4.07×10^3 expressed in volts, we move the decimal point three places to the right, and we get — 4070 volts. Simple, isn't it? Table 2 here shows how to convert between the common units.

TABLE 1. The Units

Multiplier	10^n	Size	Name	Symbol
1 000 000 000	10^9	thousand-millions	Giga	G
1 000 000	10^6	millions	Mega	M
1000	10^3	thousands	kilo	k
1/1000	10^{-3}	thousandths	milli	m
1/1 000 000	10^{-6}	millionths	micro	μ (or u)
1/1 000 000 000	10^{-9}	thousand-millionths	nano	n
1/1 000 000 000 000	10^{-12}	million-millionths	pico	p

TABLE 2. Converting the units

Change from	To	Divide by	Multiply by
Units	nano-units		10^{12}
	micro-units		10^6
	milli-units		10^3
	kilo-units	10^3	10^{-3}
	mega-units	10^6	10^{-6}
	giga-units	10^9	10^{-9}
	Nano-units	micro-units	10^3
units		10^9	10^{-9}
Micro-units		nano-units	
	milli-units	10^3	10^{-3}
	units	10^6	10^{-6}
Milli-units	micro-units		10^3
	units	10^3	10^{-3}
	Kilo-units	units	
mega-units		10^3	10^{-3}
Mega-units		units	
	kilo-units		10^3
	Giga-units	units	
mega-units		10^9	10^{-9}

Speech compressor

This simple audio compressor circuit is ideal for use on a transceiver, particularly the SSB mode, to provide improved speech 'punch'. Subjectively, your signal sounds louder because of the compression provided.

The circuit will take an audio input ranging between 10 mV and 10 V and provide a nearly-constant level output of 8 V peak-to-peak.

The op-amp is a TL081 biFET input type. The output is peak rectified by two 1N914s arranged as a voltage doubler. The output of this rectifier drives the gate of a FET which is part of an input attenuator. More input produces more output, which produces more attenuation, tending to hold the output level constant.

The 1u capacitors could be either tantalum types or low voltage polyester or polycarbonate plastic caps. The 10u output capacitor could either be a tantalum or an electrolytic. The circuit has been arranged to operate from a single supply rail. Anything from 10 to 15 volts is fine, although 12 V is suggested on the circuit.

— L. Richardson
Contarf, Qld

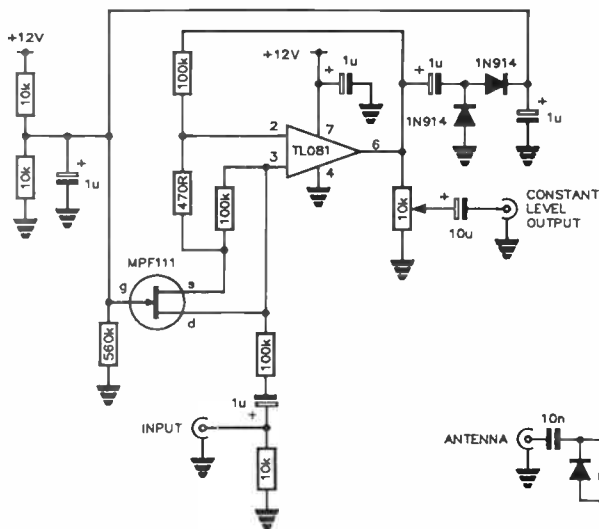

Benchbook is a column for circuit designs and ideas, workshop hints and tips from technical sources of the staff or you — the reader. If you've found a certain circuit useful or devised an interesting circuit, most likely other readers would be interested in knowing about it. If you've got a new technique for cutting elliptical holes in zippy boxes or a different use for used solder, undoubtedly there's someone — or some hundreds — out there who could benefit from your knowledge.

We'll pay from \$10 to \$100 for each item published. Send your gems to 'Benchbook', Australian Electronics Monthly, PO Box 289, Wahroonga NSW 2076. Please include your postal address for publication with your item(s).

As far as reasonably possible, material published in Benchbook has been checked for accuracy and feasibility etc, but has not necessarily been built and tested in our laboratory. We cannot provide constructional details or conduct correspondence or technical enquiries.

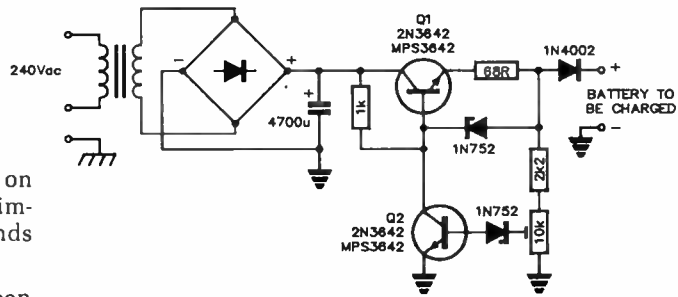

Quick-charge for 12 V NiCads

By using a combination of constant-current and constant-voltage drive, 12 V NiCads rated at under 500 mAh, as used in many handheld scanners and transceivers, can be charged a lot more quickly using this circuit. Conventional 'trickle'-type chargers take overnight, or longer, to fully charge these batteries, I found.

This circuit provides around 70-80 mA charging current constantly until the battery is close to fully charged, when the current reduces to a trickle of a few milliamps as the output then reverts to constant-voltage drive. This will charge a 200 mAh 12 V battery in something like four hours.

The 10k trimpot is there to adjust the upper voltage shutoff point. To do this, just connect a 250 ohm, or 270 ohm, 5 W resistor across the charging terminals while measuring the output voltage, then set the trimpot for 15.5 V output. You'll need a small heatsink on Q1.

— E. Moore,
Clayton, Vic.

RF-actuated Morse monitor

If your (amateur) transceiver does not have sidetone facilities for monitoring your Morse (CW) transmissions, this straightforward RF-actuated circuit will do the job. It requires no tuned circuits and will work well in many instances with just a short length of hookup wire as a pickup antenna.

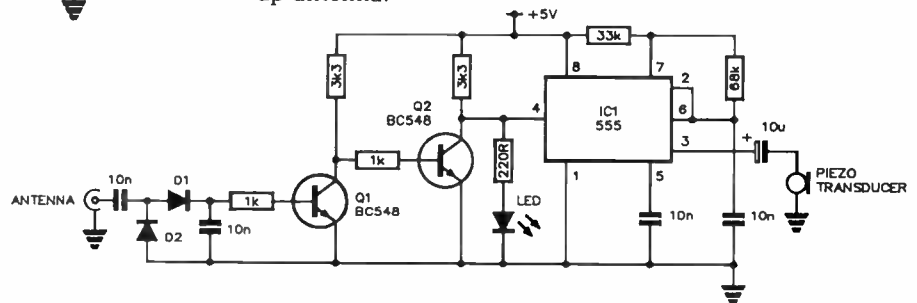

It works like this. The signal picked up at the antenna is rectified with a voltage doubler (D1-D2). The dc output from this drives the base of Q1 which is normally off with no signal. Q2 turns off, the LED lights and the 555 is triggered. It bursts into oscillation so long as it is triggered, the output being heard via the piezo transducer.

The input diodes may be germanium (OA91s) or silicon signal types (1N914s or 1N4148s), though the germanium types give better sensitivity, as you'd expect. It should work right up to 432 MHz.

I originally saw the circuit in Pat Hawker's informative Technical Topics column in the September 1980 issue of Radio Communication (the RSGB journal).

— F. Douglas
Mt. Druitt, NSW

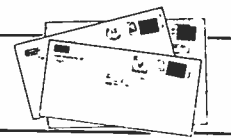

Listening Post

Dear Sir,

Having read the first three issues of your magazine I think I'll be with you for a long time.

I was very interested in the Listening Post project but hope that you will provide the appropriate software to use it with a variety of computers and not just the Microbee as in issue No. 1.

Thanks for a fine magazine.

Wenlock Burton VK3YWB
Thomastown, Vic.

Dear Sir,

I have been searching in vain for a FAX converter and software for the Commodore 64 computer. When making enquiries I find that most people do not know what I am talking about, and those who do cannot help.

Would it not be possible for Australian Electronics Monthly to publish the appropriate circuit and software program?

If you were able to help me in adding FAX receiving capabilities to my radio room you sure would have one very satisfied reader.

By the way, the magazine looks promising. Keep up the good work and all the best with the future editions.

Grant Booth
Newtown South, NSW

Dear Sir,

I'm writing to you in reference to your July issue of AEM, as I am interested in Project 3500, the "Listening Post". However, I noticed that the project is for the Microbee computer. Is it possible to convert the program to suit a C-64 Commodore computer as I own one and haven't fully mastered it yet?

I'm very keen to build this kit but if the program can't be modified to suit my C-64 I'm afraid I'll still be in the dark.

Mr C. Marchitto
Northland Centre, Vic.

Dear Roger,

Congratulations, I have been waiting for your name to turn up in a magazine and got a pleasant surprise when I went to the newsagents.

A new business is like a sponge until filled and dripping wet. It's going to be hard work to keep up the whole operation, but I know you'll do well.

As always, I enjoyed Tom's work (Listening Post) which I would like to translate to the Tandy MC10 even though I don't have a suitable receiver, but the best part (program) was hardest to read. I'm tired of polishing glasses and getting a strong light out with magnifier to read photo-reduced print. If it had been like the hex dump of the program it would have been OK. Many a mag. just goes back on the rack as too difficult to read. AEM will join them if programs are to be treated in same fashion, as nowadays computer contents is the most important part to me.

All the best for the future.

Frank Rees
Bort Vic.

Alright, we give in! A kind and diligent correspondent has developed Listening Post RTTY and FAX software for the Commodore 64 which will be published at the earliest opportunity, along with details on connecting up the project to your C-64.

To dispel any misconceived notions, the AEM3500 Listening Post project does not itself need any modification. Only the software has to be rewritten to suit different computers.

We have received numerous requests for Listening Post software to suit computers such as the Apple, among a variety of others. We are currently having a look at Apple software. Are there any takers for other current machines? Has anyone adapted the software for a computer other than the C-64? Other readers might well be interested.

Roger Harrison
Editor

Quality and content

Dear Editor,

First of all, congratulations on AEM. I am a pretty critical character but I have nothing but praise for what I have seen of the first three issues. It may seem a small point but I like the style of binding used, it gives the magazine a quality that ordinary staple binding cannot. No one will convince me that ETI looks better for returning to staples — now it just looks like any other magazine. Obviously the important thing is content, but looks count too.

Geoff Wilson VK3AMK
Frankston, Vic.

Don't forget amateurs

Dear Editor,

Many thanks for the new magazine, I have been waiting eagerly for over six months for the first edition.

Also, now you have control of the latest magazine I hope you don't forget the radio amateurs of Australia as you progress through your various projects, circuits etc.

Roger, great to see you at the helm again. Best of luck.

Spero Davies VK2YHX
Newcastle, NSW

I think you can see, Spero, from our Communications Scene section, that I have not forgotten the amateurs and the many others interested in various aspects of communications.

Roger Harrison VK2ZTB

Phone patch

Dear Sir,

Telecom Australia, not satisfied with its massive profits and super monopoly, is now using muscle power against one of Australia's most diplomatic, law abiding, and best international ambassadors, a group which has neither the political power nor the finance with which to protect itself or its interests, I refer to the Amateur Radio Service.

Telecom's answer to a request from the Amateur Service for "phone patch" privileges is contained in their document, "Interconnection of Mobile, Amateur and Citizen Band Radiocommunications with the Public Switched Telephone Network, Policy and Conditions, issue 2, June 1985."

This document is so restrictive that it makes the use of the telephone system by the Amateur Radio Service unbelievably difficult. In addition, Telecom want us to pay a surcharge (in addition to the regular telephone charges) for no more facilities than normal use of the telephone. The Department of Communications makes no extra charge for third party privileges!

The Amateur Service cannot, by DOC regulation, make any form of profit whatsoever, and cannot recover any costs whatsoever, not even the standard telephone charges.

Please help us to encourage Telecom to modify their unreasonable and unnecessary rules and regulations, and remove their demands for unreasonable and unwarranted surcharges on the Amateur Radio Service.

A. D. Tregale VK3QQ
Watsonia, Vic.

The Last Laugh



I'M ALWAYS AMUSED at the computer industry's ability to satirise itself. I believed for years that it was a deliberate conspiracy by members of the 'the club' (i.e.: those 'in' the industry) to gain vocabularic ascendancy over those 'on the outside', thus gaining a distinct marketing advantage; nobody would know what they were talking about. Conversely, everybody would talk about them for they didn't understand what was being said. The computer industry's penchant for acronyms being a case in point.

However, I am now thoroughly convinced that such self-satirisation is the random ramblings of fertile minds ignorant of the consanguineous connotations of their conjunctive conglomerations. How was I convinced of this? Well, it happened like so:

A colleague of our acquaintance, at the time only recently arrived from his British Isles homeland, decided he would register his own computing business here. Wishing to 'integrate' with his new surroundings, said colleague decided it would be best to choose a name which would particularly identify itself as Australian.

He duly obtained the appropriate forms, in triplicate, from the Corporate Affairs office and carefully filled them out.

He was surprised and, dare I say, a little miffed, when the good fellows behind the counter at Corporate Affairs all fell about in great guffaws when he handed them in. As he stood there, crest falling all the while, the forms were passed from hand to hand around the staff who all fell about in great amusement.

"I say chaps," he pleaded. "If there's something amiss I should like to correct it, if you don't mind."

"Oh no," replied public-servant-behind-counter between gasps for breath. "The form's correctly filled out. But I don't think you'll do very well with a name like Galah Computing!"

This is not a galah, but a kookaburra — famous predator of snakes in the grass and rats in the underbrush!





You can come on an incredible journey, not to the future, but to a technology available today for innovative electronics users. Philips, custom design and manufacture right here in Australia, both hybrid circuits or custom I.C. chips, to suit your budget and product concept.

Access to reliable hi-technology at very competitive cost even in modest production quantities.

Tell the Philips Elcoma designers what you are trying to achieve and they will create for you a unique microcircuit solution. Perhaps you already have a design. That's where Philips 50 years of continuous production experience in Australia will ensure an efficient result. Naturally, your product design security is always assured and the resulting microcircuit is exclusively your own property.

Philips years of practical experience in computer aided design (CAD/CAM) will get you off to a good start. Your new electronics package will require little space, will improve reliability and the performance of your "new product." At the same time it will provide you with more features and added benefits for your customer, and protect your design against "copycats"!

Imagine the new business opportunities with Philips custom microcircuits

The time it takes, from engineers briefing to delivery of your first electronic microcircuit or micro sub-assembly, will pleasantly surprise you. Design sampling and testing may be as little as 8 to 10 weeks for hybrid circuits. More advanced custom "monolithic chip" designs will take longer, depending on the size of the chip and complexity of the design.

Send off the coupon today or call Philips Electronic Components & Materials to get the ball rolling on the improvements you'd like to make to your product.

Sydney (02) 439 3322
Melbourne (03) 542 3333
Adelaide (08) 243 0155
Perth (09) 277 4199
Brisbane (07) 44 0191

We make electronics in Australia

I'd like to explore the benefits of Philips microcircuits in my products. AEM

My area of interest is _____

Name: _____

Organisation: _____

Address: _____

Postcode: _____ Phone: _____

Send to: Philips Elcoma, 11 Waltham Street, ARTARMON, N.S.W. 2064.

The UNITEC



Electronic Components & Materials

PHILIPS

GW TEST INSTRUMENTS

Time and Experience in the market
proves they simply work better.

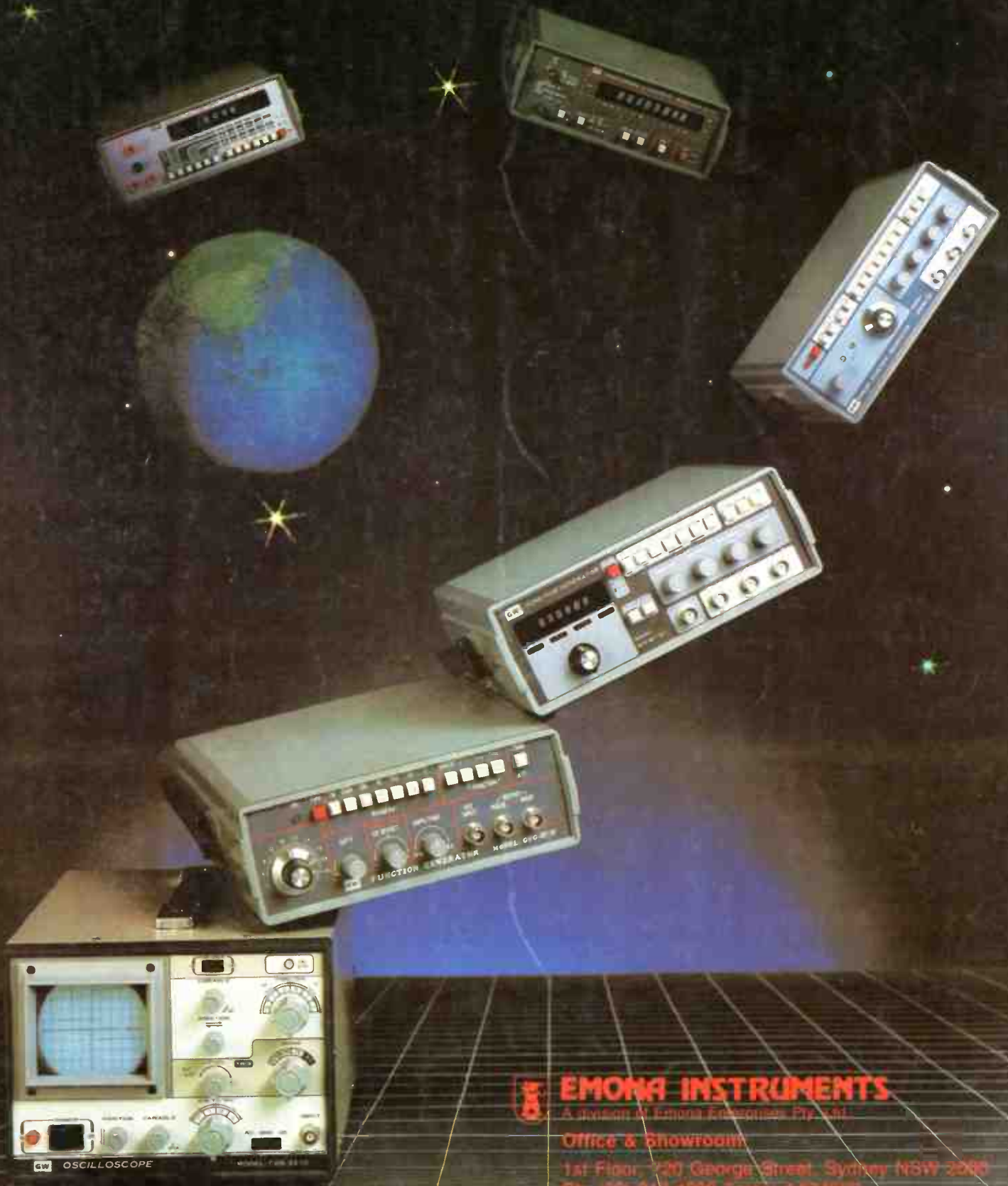

EMONA INSTRUMENTS

A Division of Emona Electronics Pty Ltd

Office & Showroom

1st Floor, 220 George Street, Sydney NSW 2000
Ph: (02) 213 4599 Telex: A074500