

Complete Broadcasting Programmes a Week in Advance

# Wireless Weekly 3<sup>d</sup>

INCORPORATING "RADIO IN AUSTRALIA & NEW ZEALAND"

VOL. 15, NO. 1

FRIDAY, DECEMBER 27, 1929

(Registered at the G.P.O. Sydney, for transmission by post as a newspaper.)



Send your  
**NEW YEAR GREETINGS**  
**ABROAD THE MODERN WAY—**  
**"via BEAM"**

**SPECIAL GREETING RATES**

To Great Britain, 10 words for 4/-  
To the United States and Canada, Fiji,  
and New Guinea.

RATES ON APPLICATION  
Lodge your messages at all Post Offices, or at

**THE BEAM WIRELESS OFFICES**

SYDNEY AND MELBOURNE

*Examining the*  
**NEW TARIFF**  
**on Radio Sets and**  
**Component Parts**

Building  
**EXPONENTIAL HORN**  
**Loud Speakers**

*THE "PRE-SELECTOR"*  
**PRINCIPLE FOR**  
**3 VALVES**

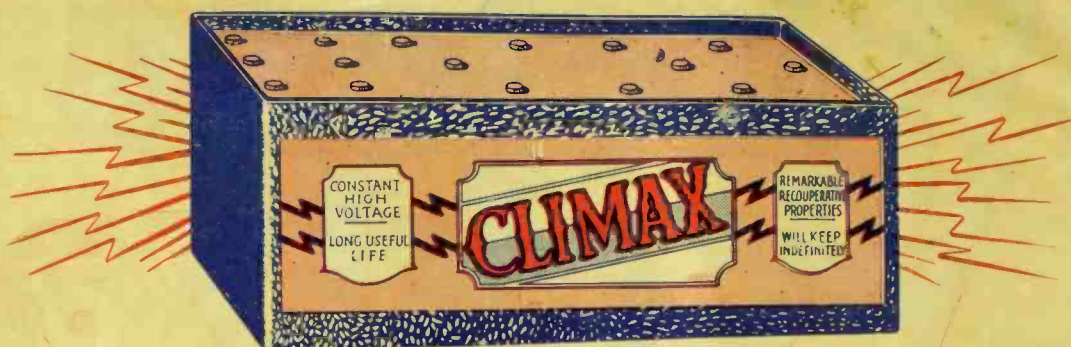

**Distributors  
for  
CLIMAX  
BATTERIES**

Wholesale Distributors for the following well-known Radio lines:—

- PHILIPS PRODUCTS
- CLIMAX BATTERIES
- EVER-READY BATTERIES
- COLUMBIA BATTERIES
- BURGESS BATTERIES
- DIAMOND BATTERIES
- RADIOTRON VALVES
- MULLARD VALVES
- COSSER VALVES
- RAYTHEON VALVES
- AMPLION SPEAKERS
- AIRZONE PRODUCTS
- RADIOKES PRODUCTS
- WETLESS PRODUCTS
- FERRANTI PRODUCTS
- POLLOCK PRODUCTS
- T.C.C. CONDENSERS
- A.W.A. PRODUCTS
- BLUE SPOT PRODUCTS
- PILOT PRODUCTS
- FORMO PRODUCTS
- MAGNAVOX PRODUCTS
- JACKSON CONDENSERS
- EMMCO PRODUCTS
- ESSANAY PRODUCTS
- JANSEN DYNAMIC SPEAKERS
- ALL OTHER STANDARD RADIO LINES
- WINDING WIRES FLEXES.

# CLIMAX

*The Battery that Lasts LONGER*

You won't know what you are missing in Radio enjoyment, and just how much of your Battery Money you can save by their longer life, until you install Climax.

30 Volts, 8/-.  
45 Volts, 12/-.  
All sizes for Torches:

45-V. Heavy Duty  
25/- Now here.  
Climax "C" Batteries—  
9 Volts, 4/-.  
15 Volts, 6/-

60 Volts, 16/-.  
90 Volts, 24/-.  
Give your set more power with a CLIMAX.

Radio Dealers, Write for Attractive Proposition and Special Discounts.

## CLIMAX BATTERIES FOR YOUR TORCH

The next time you order torch batteries, see they are "CLIMAX." You will be rewarded with a steadier, brighter, and never-failing light, plus longer life and service, than you have ever had before. Mono Cells, 8d.

Double Cells, 3 volts, 1/4; Triple Cells, 4½ volts, 2/-; Flat Cells, 4½ Volts, 1/-.

Distributors for Magnavox Speakers and Units, with the Realism that cannot be copied!

For Quick Service, Ring B2409, B2410.



Wholesale Radio Dealers,  
MERINO HOUSE, 57 YORK STREET, SYDNEY, N.S.W.

**BONUS ENDS 31st. DEC.**

ELECTRIC SOLDERING IRONS, 18/6

T  
I  
M  
M  
O  
N  
S  
S  
P  
E  
A  
K  
E  
R  
S  
63/-

SIEMENS 100v. "B" BATTERIES, 15/9  
BLUE SPOT PICK-UP, 47/6

2 MF HYDRA CONDENSERS, 3/-

**LESS  
10%**

1 AMP. BATTERY CHARGER, 50/-

TEFAG PHONES, 12/6

4 MF, 650v. Test CONDENSERS, 5/-

"KODEL" One-valve, complete, 65/-

CLOCK, 30 HENRY CHOKES, 15/-

"SWAN" NEUTRODYNE KIT, Space Wound, 10/6

L  
E  
W  
C  
O  
S  
W  
A  
V  
E  
T  
R  
A  
P  
22/6

FIRST QUALITY  
MANUFACTURERS  
TRANSFORMERS  
SHIELDED 7/6

SPERO 0005  
S.L.F.  
CONDENSERS  
6/-

**PRICE'S RADIO SERVICE**

WINGELLO HOUSE, ANGEL PLACE

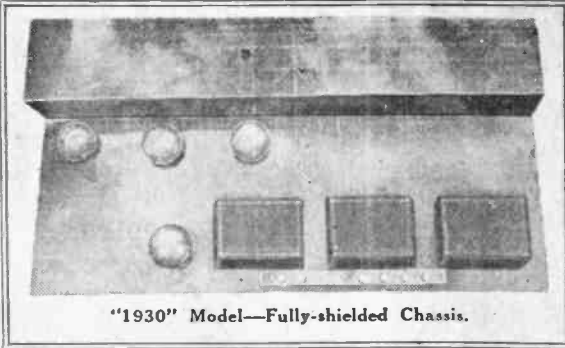

"1930" Model—Fully-shielded Chassis.

# 1930 SALONOLA

(Fully Shielded)

All-Electric 3 Valve

Table Model



£3/10/0

Deposit—8/1 Weekly  
Cash Price, 30 Gns.

Country Orders:  
Case and Freight Extra.

**JUST PLUG IN!**

1. **EACH SET** is adjusted to suit the prevailing conditions of the locality for which it is required.
2. **NO SERVICE NECESSARY.**
3. **GUARANTEED TWELVE MONTHS.**
4. **NO EXTRAS TO BUY.** Amplion Cone Speaker included. Any other make supplied by arrangement.
5. **EASY TO INSTAL, OPERATE,** and care for. Full instructions that anyone can easily and efficiently carry out accompany each set.

**FREE** *Home Demonstration*  
Without Obligation.

"Salonola" 1930 Models are second to none for **POWER, RANGE, REALISTIC REPRODUCTION, SENSITIVITY, SELECTIVITY, SUPERB TONE, and SIMPLICITY OF CONTROL.**

**FREE** installation within 20 miles of G.P.O., Sydney.

## BARGAINS in RADIO PARTS

We are offering a useful assortment at Give-away Prices to clear quickly. Do not miss this opportunity—Call to-day.

EVERYTHING FOR THE RADIO USER

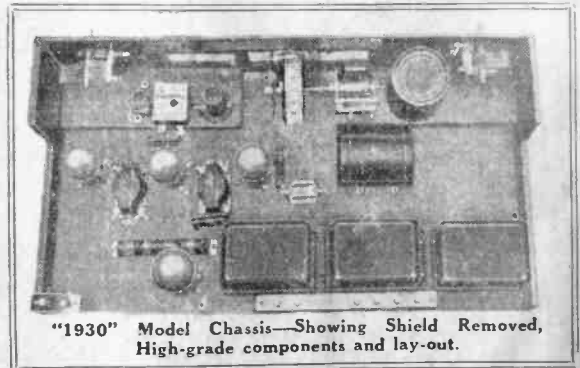

"1930" Model Chassis—Showing Shield Removed, High-grade components and lay-out.

Write or Call for Prices and Full Particulars of Salonola "1930" THREES, FIVES, and SEVENS

## HOME RECREATIONS (Aust.) LTD.

Head Office: 388 George Street (opp. Beard Watson's), Sydney.

BRISBANE: 297 Queen Street.

NEWCASTLE: 88 Hunter St.

PARRAMATTA: 232 Church St.

## The MAKING of a RADIO SET

STAGES OF MANUFACTURE AT A MODERN RADIO PLANT

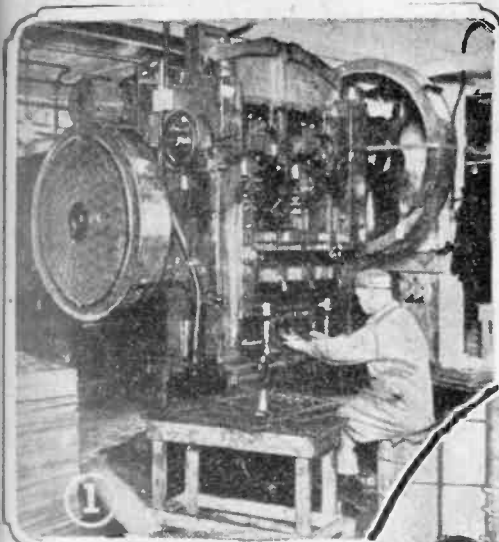

(1) Although you would not think so from their appearance, 90-ton punch presses are used in making radio sets. Over 3000 chassis bases an hour can be stamped by the presses shown above.

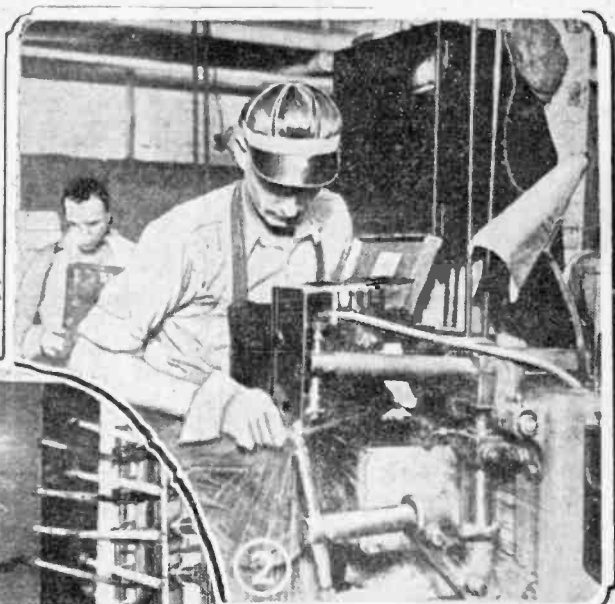

(2) The coil winding machine. Specially treated paper is used in the making of the paper core to ensure protection from acids which are found in ordinary paper and cardboard. The hair-like copper strands are wound on the coil by machines which automatically place specially prepared paraffin paper over each layer of wire on the coil. After the coil has been wound with the correct number of windings it is then baked under tremendous dry heat to exclude all moisture and then subjected to a vacuum tank, where hot paraffin completely seals the coil and protects it for ever from dampness.

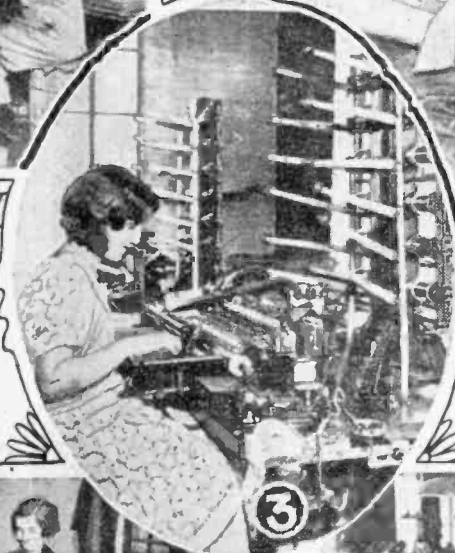

(3) Spot welding of the chassis. One of the most important parts in the construction of the chassis base is the welding of the two-sided pieces. For this operation spot welding machines are used instead of screws or rivets in the case of this manufactured receiver.



(4) Assembling automatic tuning devices. Automatic tuning is an unusual feature in radio sets. Great skill is maintained in the manufacture of these automatic tuning devices, which consist of many intricate parts.



(5) Chassis assembly. One of the most interesting operations in the manufacture of a radio receiver are the chassis assembly lines. Here the metal chassis base is secured to a wooden frame on rollers and

moves from operation to operation down the line until it is turned out at the end a completed chassis with every part installed. In its assembly in this factory the chassis passes up one side and down the other side of a 100-foot table, where each worker has his or her own particular operation to perform as the chassis passes down the line. Inspectors stationed between every fifth operation ensure proper workmanship and perfect working parts.

# BETWEEN YOU & ME & THE MICROPHONE

## New Year

**T**HE New Year begins on January 1, so we feel we ought to write something about it—it is a Milestone on the Progress of Individual and National misery. like Birth, Becoming Twenty-one, Marriage, Divorce, Success, and Death. Why one should feel obliged to write of miserable milestones we don't know; however, this ridiculous fact, that we have no reason for writing on a subject, has never in the past prevented us from writing on any subject whatever, as has been amply demonstrated, nor will it prevent us in the future. We touch wood devoutly with crossed fingers. We are not feeling very cheerful to-night. Probably the restaurant rump-steak disagreed with us, or it may have been the fruit salad with ice cream, or the beer, or the black coffee, or even the oyster soup; or perhaps the last chap we talked with before beginning this page was a little down in the dumps. Whatever did it, we are downright melancholy, like Cleopatra brooding over Anthony's defeat in the battle of whatever it was, or Dido sorrowing over the desertion of Aeneas; but please do not look so hopeful, because we really haven't got the courage or the asp to apply to our bosom, or enough money to buy a decent funeral pyre.

Or perhaps it's because the Old Year is going out. The Old Year is going out—a year of dead flesh and blood, a year of faces we shall never see again, a year of ideas that will never be real again, a year of lovelinesses that are faded and gone, lost, dead—a dead year.

Which is very funny when you see it on paper and think how silly the whole business is—how the year is only an arbitrary division, how life is really a connected affair, how man is a comic, and not a tragic, animal, and how beer still sells by the gallon. The last is a very comforting

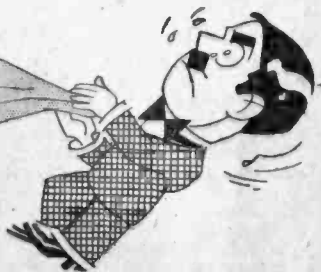

thought, dear brethren, a very comforting thought.

Besides, it has been too much of a dull farce of a year to be tragic over; from a broadcasting point of view, at any rate. It appeared to Mr. Bruce's Government, the Listeners, and Mr. H. P. Brown that Something Ought to be Done.

To Improve the Programmes.

*Curtain falls on Act 1.*

*Curtain rises on Act 2.*

Enter Mr. Stuart F. Doyle, attended by Mr. Frank Albert and Sir Benjamin Fuller. They confer together.

Mr. STUART F. DOYLE: We shall raise broadcasting to a national plane.

We shall raise broadcasting to a higher level.

We shall place broadcasting on it's feet.

*Curtain falls on Act 2. (Loud applause.)*

*Curtain rises on Act 3.*



Five months have passed since the last act.

The Scene is a broadcast programme.

And if you own a Wireless Set you will know how funny it sounds; that is what they call cumulative irony, or the Unexpected Ending; when the Russians do it they call it realist tragedy; when Australians do it, they either don't notice anything unusual about it, or they call it a New Era in Broadcasting; but the fact is, it is a farce, and the sad fact is, that the actors don't know it; which means more than we would care to say for our skin's sake; so you can put that in your pipe and smoke it.

And, besides, in the Old Days,

Ages Ago.

When No one knew anything about Broadcasting, And cats wore pyjamas (This was before the New Era in Broadcasting), There used to be Announcers And Control Operators At 2BL. 2FC, also, Was suspected of harboring announcers And control operators, We loved them, and called them fondly By name, reciting weekly Their virtues, humors, and peculiarities. But now there are no more announcers nor any control operators; The announcers and other members of the studio staffs Have become Servants of a National Institution; And the 2BL Control Operators, once almost human, have become Civil Servants. Broadcasting Has no flesh and blood other than that of

It's National Institution, and that is dead, or under the supervising eye Of the Government, which Is the same thing. Our friends Or what is left of them, Are nameless. So if the New Year Brings more developments Along these progressive lines, we suppose Australian broadcasting will become Anonymous that no one Will ever have heard of it, which we said

Some time ago in the dead year, in which

We would like to have lived much longer. However, We suppose we Must move with The times. They are very bad Company.

**BY** the way, as we have all this space to fill in, we notice that the A.E.C. wants everyone to make this a radio Christmas, of course this is not our Christmas issue; but we thought perhaps you might still be curious to know what a radio Christmas is; well, Christmas is a season of cheer and goodwill (see "Wireless Weekly's" Christmas editorial and forget all about a place called Rothbury), and therefore a radio Christmas is a Radio Season of Cheerfulness and Goodwill.

So thank heavens Christmas is over, and we can be natural again.



# THE AMENDED TARIFF

## on Radio Receivers and Parts

A brief review of the new tariff on radio apparatus, with representative comment on the question from two points of view.

THE new tariff on wireless receivers and parts will give more protection to Australian manufacturers of complete receivers, increase the selling prices of imported complete receivers, and render the importation of inferior, cheap parts unprofitable.

The former duty on wireless parts and receivers was ad valorem, 35 per cent. British Preferential, 50 per cent. Intermediate, and 55 per cent. General (foreign). The amended tariff specifies a set rate for each (specified) part, and for each valve socket of a receiver; except where the former duty, 35, 50, or 55 per cent., returns a higher duty, when that ad valorem rate will apply.

It is obvious that the new duty on parts is not aimed at the higher qualities. The new General Tariff on audio transformers, for instance, is 2/6 each. Hence, if the invoice price of an audio transformer were over 4/2, plus the statutory 10 per cent. provided for by the Customs Act, the ad valorem duty of 55 per cent., and not the fixed rate of 2/6, would apply; and certainly an audio transformer which can be invoiced at under 4/2 is not of very high quality. Similarly, the invoice price of a "B" battery eliminator would have to be below £3/6, plus the statutory 10 per cent., before the new fixed rate of 40/- General Tariff would apply.

With complete wireless receivers ("wholly or partly assembled, excluding valves, loud-speakers, batteries, and headphones") the case is different, and it is claimed that the new fixed rate duty of 20/- Preferential, 25/- Intermediate, and 30/- General Tariff, PER VALVE SOCKET, will enable local manufacturers to compete on a very satisfactory footing with imported receiving sets. At the General Tariff rate of 30/- per valve socket, the invoice price, plus the statutory 10 per cent., of receivers will have to be below the following prices before the new fixed rate duty will apply:—1 valve, £2/14/6; 2 valves, £5/9/1; 3 valves, £8/3/8; 4 valves, £10/18/2; 5 valves, £13/12/9; 6 valves, £16/7/3; 7 valves, £19/1/10; 8 valves, £21/16/4; and the duty will be—1 valve, 30/-; 2 valves, £3; 3 valves, £4/10/-; 4 valves, £6; 5 valves, £7/10/-; 6 valves, £9; 7 valves, £10/10/-; 8 valves, £12.

The British Preferential Tariff is a fixed rate of 20/- per valve socket, or ad valorem 35 per cent., if that return a higher duty. Hence, the invoice price, plus the statutory 10 per cent., of a British 4-valve receiver must be below £11/5/6 if the new duty is

Tariff Items.	British Preferential Tariff.	Intermediate Tariff.	General Tariff.
180. By omitting the whole of sub-item (e) and inserting in its stead the following sub-item:—			
(c) Wireless receivers and parts, viz:—			
(1) Condensers, fixed mica	each 2/3	7/6	7/6
(2) Variable condensers, .001 to .0001	each 1/2	1/5	1/6
(3) Midjet variable condensers	each 1/10	1/1	1/8
(4) Vernier dials	each 4 1/2	3 1/2	7/6
(5) Grid leaks	each 2/8	7/4	4/
(6) Headphones	each 3/6	7/8	7/8
(7) Jocks	each 3/4	7/4	7/4 1/2
(8) Plugs	each 3/4	7/4	7/4 1/2
(9) Valve sockets	each 7/5	7/6	7/6
(10) Lightning arresters	each 1/1 1/2	7/2	7/2
(11) Rheostats or potentiometers	each 1/2	2/3	2/6
(12) Dials and knobs and bakelite dials, n.e.l.	each 3/6	4/6	5/
(13) Audio transformers	each 27/6	35/	40/
(14) Power transformers	each 40/	50/	60/
(15) "B" battery eliminators	each 35/	40/	47/6
(16) "ABC" battery eliminators	each 20/	25/	30/
(17) "B and C" battery eliminators	each 7/	9/	10/
(18) "A" battery eliminators			
(19) Battery chargers—4 to 1 ampere, both inclusive, each including 3 amperes	each 21/	27/	30/
(20) Battery chargers—wholly or partly assembled, excluding valves, loud-speakers, batteries, and headphones			
(21) Wireless receivers—4 to 1 ampere, both inclusive, each including 3 amperes	ad. val. 35 per cent.	50 per cent.	55 per cent.
Or as to the goods covered by paragraphs (1) to (21) of sub-item (e) the following rates if same return a higher duty, viz:	20/	25/	30/

The following letter, from the president of the Australian Radio Manufacturers' Association, sets out the position from the point of view of the local manufacturer:

Dear Sir.—While the new radio tariff only gives the radio manufacturers approximately 60 per cent. of what they requested in their application, the new tariff will have a powerful effect in reviving the Australian radio industry, which, under the policy of the last Government, had been

allowed to reach a point where it was in danger of complete extinction.

The new tariff will shut out completely all that mass of cheap and inefficient American radio sets, which were not only driving the Australian manufacturers into bankruptcy, but which were also creating a bad impression of the quality and operation of radio among the general public.

For some time it has been the policy of American radio manufacturers to ship to Australia and elsewhere all their out-of-date and imperfect sets and parts, so as not to foul the home market in U.S.A.

Australia has borne the brunt of this flood of cheap and nasty radio equipment. It is an astounding fact that America exports TEN TIMES more radio equipment to "protected" Australia than she does to free-trade Britain, in spite of Britain's greater population and closer proximity.

Britain's immunity is due to the fact that for two years she shut out completely all foreign radio sets and parts.

The new tariff will shut out the worst of foreign competition, but the tariff will have to be increased if the Commonwealth Government and the people really desire to build up a self-supporting radio industry that can operate independent of foreign supplies.

Nevertheless, the radio manufacturers of the Commonwealth appreciate the quick action of the present Government in granting increased protection, and so saving the industry from extinction. We secured from the present Government in two weeks what we could not secure from the previous Government in two and a half years of consistent and strenuous effort. It is expected that the new tariff will lead to the employment of over 1000 additional workers in the coming radio season.

The radio manufacturers have given an undertaking that the new tariff will not

to apply. This means that a British 4-valve receiver invoiced at not more than £10/5/ can pass the Customs for £4 duty, while an American or Dutch or German 4-valve receiver invoiced at not more than £9/18/6 must pay £6 duty, which is a good whack of preference for British made.

Supposing that American and English production costs and invoice prices of 4-valve receivers are equal at, say, £9/10/, the £6 General Tariff makes the price of an American 4-valve receiver £15/10/, while the £4 Preferential Tariff brings the British 4-valve receiver to £13/10/. With freight, landing charges, and insurance added on, the result must be to put the Australian manufacturer in a strong position.

### Shrewdly Calculated

We know nothing of the actual invoice prices or manufacturing costs of 4-valve receivers, the figures simply approximate the maximum amounts on which the new duty can apply, and these must have been very shrewdly calculated and argued about by the interested parties before they were provided for. Yet the actual manufacturing costs and invoiced prices must be very much lower than the figures stated; otherwise the new duty would have little significance.

It seems, therefore, that our local manufacturers are out to secure the Australian market against the competition of overseas mass production in all parts of the industry where they are attempting large-scale manufacture. High-grade parts are let off lightly (if 55 per cent. may be called lightly), because they are not yet manufactured in Australia, while parts of inferior quality will find it harder to get sales. There is no doubt that importers of complete receivers, especially of American, Dutch, and German receivers, will dislike the new tariff, which will almost as certainly find its way into the selling price of their sets.

mean increased prices for standard equipment to the public. The trade is convinced that the new tariff will enable mass production methods to be employed in Australia that will actually lead to a decrease in the prices to the public and an increase in technical efficiency. Yours, etc.,

E. R. VOIGT.

(President, Australian Radio Manufacturers' Association.) Sydney.

**IMPORTER'S VIEW**

The other side of the question is outlined below by a well-known importer of American receivers:—

Dear Sir.—I wish to voice disapproval to the enormous Customs duty which the public are now forced to pay on imported radio sets and parts.

These new duties mean that the retail prices of good imported radio sets are forced up high in price, which naturally automatically curtails the sales of these, whereas the whole idea behind the national broadcasting scheme is to bring radio sets within the reach of the masses, and not confine them to the elite.

With these duties on American sets of 30/ per valve socket per set, it means, in some instances, we are paying duty at approximately 240 per cent., which is absolutely extortionate, and which prevents us from selling good high-class radio sets to the public at a low price.

Radio sets are essentially a mass-production article, and, this being so, it is im-

possible to turn them out in sufficient quantities in Australia to bring the price down to reason.

In addition to this, I might say that radio is continually being improved from time to time, and only through the importation of sets can the public get the benefit of these improvements quickly and without any added expense.

Naturally, if an Australian manufacturer tools up to turn out a certain quantity of a certain set, it is impossible for him to stop production because there is some new developments, whereas the large factories, like the Crosley Radio Corporation of America, have continually a big research staff, who spend all of their time on bringing out all of the latest improvements and developments, and these are immediately passed on to the ultimate users, namely, the public.

We feel that a big public petition should be signed and presented to our Prime Minister, and point out clearly to him that this action on his part has immediately taken the radio sets out of the hands of those who should really have them.

Broadcasting and selling good quality radio sets at the lowest possible price originated in U.S.A., and Australia, like other countries, followed suit, and some companies down here decided to assemble, and others to make, radio sets in Australia, and at that time they had a Customs duty of over 60 per cent. as protection, and surely the public must realise

that, if a factory here cannot make their factory successful when they have an import duty to protect them of 60 per cent., that to ask any Government to give them greater protection than this is absolutely suicidal to the public at large.

Why should six million (6,000,000) people in Australia be penalised and have to pay high prices for good-quality radio sets because a few Australian factories desire to make them in Australia?

There is no radio set, in our opinion, made in Australia that has a factory behind it with a real staff of engineers who are continually seeking to improve these sets (excepting by copying the imported models), whereas the imported models could be landed down here at a price to bring them within the reach of every working man in Australia.

Naturally, the working man in Australia should demand that any products which he requires should be available to him at the lowest possible prices, but with this crazy, suicidal idea of tremendous tariff, it just means that the working man is tremendously penalised when he comes to buy good products which are imported, and embody the latest developments.

Trusting that you will publish this in the columns of your excellent journal for the benefit of listeners generally.

Yours, etc.,

INTERNATIONAL RADIO COMPANY.  
CHAS. E. FORREST.  
Sydney.

**::: Trader Produces Portable Set :::**

**M**ESSRS. LEVENSON'S Radio have prepared a kit for a three-valve portable set for the home builder, details of which are published below.

If you decide to build this cheap set commence by assembling the three sockets, the two transformers, and grid leak and condenser on the sub-panel in their relative positions to each other, as shown on the chart. Also mount the reaction condenser .0001 on the dead centre of the panel, and the rheostat and tuning condenser, .00035, at equal distances on either side, having due regard to the fact that the tuning condenser must be in such a position that its moving plates will not touch the side or top of the cabinet when they are being turned in tuning.

**WIRING.**

The wiring of this simple set is so clearly indicated on the chart that no detailed description should be necessary. Note that there are eleven flexible wires connected to various points in the set; these should be labelled as indicated for convenience when connecting up batteries, speaker, and loop aerial. Make each of these wires about 13 inches long. Note that the speaker leads connect into the porcelain connector marked "speaker"; all these wires, except Nos. 12 and 3, should be passed down through holes in the baseboard. Nos. 1, 2, and 3 are led out through three holes near the end of the

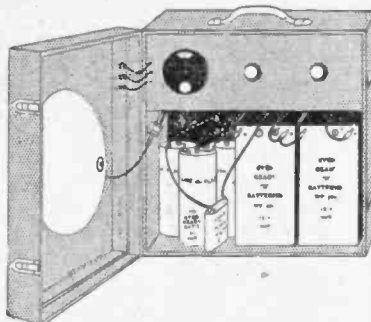

connect the terminal No. 2; now wind on a further 9 turns in the same direction as the others, cut the wire, and connect the end to terminal No. 3. Now cut some small pieces of card and slide them under the turns of wire so as to prevent the cotton insulation on the wire rubbing off and allowing the turns to short on the terminal screws.

Replace the loop in the lid of the cabinet and the set in its compartment, assemble the batteries as illustrated, wiring same up according to labels on wires, connect the wires numbered 12 and 3 to their respective terminals on the loop, and connect the loud speaker wires to the porcelain connector (try reversing speaker leads to give better results).

panel, these wires connect to the loop aerial. The loud speaker is screwed on to the inside centre of the lid by means of the screws provided, and so that the adjusting knob extends through to the outside of the lid.

**MAKING THE LOOP.**

Take out the loop frame and drill in one side three holes for the three terminals marked on chart 12 and 3, connect the end of a reel of 22 D.C.C. wire on to terminal No. 1 on the inside of the frame, now wind on twelve turns side by side, at the twelfth turn bare the insulation off the wire and

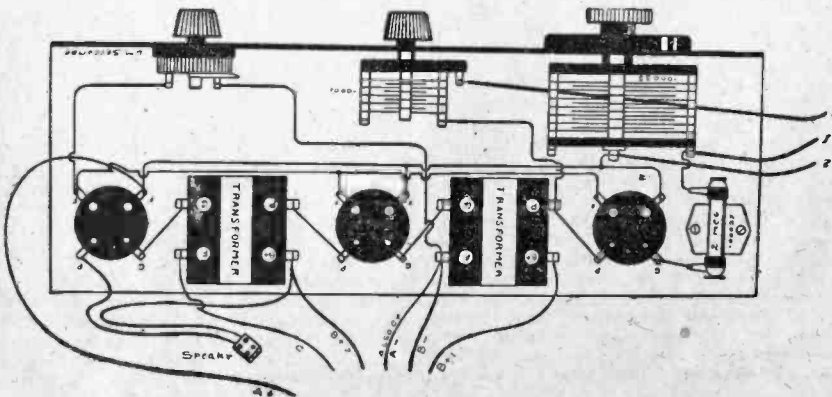

**PARTS REQUIRED**

- 1 Like a Flash Tom Thumb beautifully finished Imitation Leather Cabinet, with nickel fittings and locks, complete with loop frame, panel, etc. . . . . £1 19 6
- 1 Variable condenser, .00035 . . . . . 0 4 9
- 1 Variable condenser, .0001 . . . . . 0 5 6
- 1 Knob . . . . . 0 0 6
- 1 Vernier dial, "Diora" . . . . . 0 3 6
- 2 Transformers at 10/6 . . . . . 1 1 0
- 1 Magnus rheostat . . . . . 0 2 6
- 3 De Jur Sockets, U.X., at 1/3 . . . . . 0 3 9
- 1 De Jur grid leak and condenser . . . . . 0 2 9
- 1 Porcelain connector . . . . . 0 0 3
- 3 Nickel terminals, at 3d . . . . . 0 0 9
- 1-lb. 22 D.C.C. wire . . . . . 0 1 2
- 9ft. Hook-up flex . . . . . 0 0 6
- 15ft. flex battery wire . . . . . 0 1 8
- 3 Valves to suit, from 8/6 each.
- 1 Lissen or Continental cone speaker unit, from 13/6 each. Many other makes to choose from . . . . . 0 13 6
- 1 Paper cone . . . . .
- 2 WP40 Ever Ready "B" Batteries, 12/6 each . . . . . 1 5 0
- 1 Ever Ready "C" battery (small size) . . . . . 0 1 0
- 3 Ever Ready "A" Batteries, 3/- each . . . . . 0 9 0



# Building EXPONENTIAL HORN Speakers

Mr. Tremloth shows us his unusually fine speaker built of pitch on a wire frame.



*There is a particular fascination about building one's own loud speaker — especially when the work is rewarded by unusually fine operation. In this article, several "Wireless Weekly" readers tell of novel constructional methods applied in building their own speakers, and come forward with many practical suggestions.*

**W**IDE interest in new methods of constructing and operating the exponential type of horn is indicated by the quantity and variety of correspondence which has been received from "Wireless Weekly" readers. In many instances novel and thoroughly practical ideas were described—ideas which might well be of value to other enthusiasts similarly engaged in endeavoring to improve the performance of their radio sets with the aid of the exponential horn speaker.

Judging from his letter, Mr. John Tremloth, State mine, via Stanthorpe, has an interest in the subject and an enthusiasm which are quite without limits. Mr. Tremloth's most successful horn has been built up in an unusual manner. First, the entire horn was made up in skeleton form, with heavy galvanized iron wire with all joints soldered. Then this wire frame was covered with "bandages" of cloth heavily impregnated with pitch. Finally, the whole affair was covered with paper and then painted. The finished product was highly successful from a musical reproduction point of view, one important reason being the excellent solidity of the walls of the horn. Mr. Tremloth's novel method would not present many difficulties for anyone used to working with wire, but the work would require considerable care in any case. For the benefit of those who plan to build a speaker in this manner, we will quote some portions of Mr. Tremloth's carefully detailed letter.

"The parts necessary," he states, "are 14lb. of quick and hard setting pitch of which 'Royal Australia' is a particularly suitable brand. The ordinary pitch is far too soft and too prone to let go in hot weather. Failing this 'marine glue' can be used. It can be obtained from any ship's chandlers.

In addition to the pitch, about 2lb. of sheet glue, 12lb. of good strong brown paper, a 1in.

galvanized pipe socket, 200 to 250 feet of galvanized iron wire, about 1/4 in. in diameter, and a small reel of tinned copper wire will be necessary. Half a dozen yards of unbleached calico and enough paint to cover the speaker are the other essentials."

Concerning the constructional work, Mr. Tremloth says:—"If the builder is making the 64-cycle horn, first measure the exact size of the connecting link between the speaker diaphragm and the horn, it will be 1/4 in., or, as in my case, 1in. diameter. The horn doubles its diameter for every foot in length. The bell diameter of my horn is 64 inches, thus making length 6ft. Lay out on the floor the actual length (6ft.) in the form of sketch with chalk or blue pencil, as shown in figure 1. Then measure from the 1in. end (small end) 1ft. along, and mark, then the next foot out and so on up to 64in. (5ft. 4in.).

"The diameter measurements, viz., 1, 2, 4, 8, 16, 32, 64 in. are then marked out.

"You must get the gradual slope from base to bell, uniform right through the entire length, as this line drawn connecting each end of the diameter lines are used as a template in forming the wire shape.

"Next form the different size wire rings, and be sure to either solder their joints or, as I did, flatten the wire, drill it, and then rivet them. Having formed the rings, lay the big one (5ft. 4in.) on the floor, get a box exactly two feet high, but not bigger in the end of it than the 16-inch ring. Now get a length of wire and lay it on the floor over your chalked-out sketch. Shape the wire exactly the same as the chalk marked on the floor, and then cut it a little longer than the actual chalk mark, to allow for two turned-over ends, to catch the big ring and the 16-inch ring; then, after being sure that your wire for template (or pattern) is O.K. you can put it on the two rings, the big one

on the floor and the 16-inch on the upturned box 2ft. high in the centre).

"Now cut enough wires to go right around, spacing them about four inches apart; then connect them to the two rings and solder them.

"After you have the wires all on and soldered get the 32-inch ring and place it over the smaller one. If your pattern wire was O.K. you will find the 32-inch ring will be a foot off the floor all around. Anyhow, secure it to the wires at that distance all around. When fastening the 32-inch ring use the tinned copper wire (about 30-gauge) for tying, and then solder the ties.

At this stage of the proceedings the frame of the bell portion of the horn is somewhat in the form of an enormous flower-pot, to which we must add the remaining trunk portion. It is unfortunate that space forbids the publication of Mr. Tremloth's carefully worded instructions concerning the correct procedure, but at least we will outline his method.

First, he ties two strings across the 64-in. ring in the form of a cross, so as to give a centre-point and four equally-spaced points around the circumference of the 64-in. ring. Then the assembly is hung on two nails in the wall, so that the 64-in. ring is flat on the wall, with the bell of the horn skeleton projecting away from it. At this time a piece of wire is placed along the centre-line of the chalk drawing on the floor, and the intersections of the various rings are marked on it. This wire is then bent to the shape shown in the second diagram, and is used to provide the centre-line for a new full-size chalk drawing on the floor, similar to this second diagram. Wires are now cut and shaped to the form of the outer and inner lines connecting the 16-in. and 8-in. hoop, and these are used to support the 8-in. loop from the frame hanging on the wall. Other

wires are then added to join the two hoops, all joints being well soldered.

The same procedure is adopted with the wiring from the 8-in. hoop back to the end, wires first being cut and shaped to the full-size diagram, and then being used to attach each loop. In each case it is very important to see that the outer wire and the inner wire are exactly opposite. The attachment of the 1-in. pipe socket can be made with four strips of galvanised iron, soldered to the socket, and also to the wire frame.

From here we will again take up Mr. Trem-lath's description of the covering of the wire frame. "Get a cast-iron ladle," he states, "like plumbers use for melting lead: put some pitch in it and melt it. It should be used just at the melting-point, and not boiling.

"Cut strips from the calico 1in. wide at first, and start from socket end.

"Lay the strips out on a board, and paint on the hot pitch. You will find 2ft. lengths of calico plenty long enough to handle. After painting on the pitch, hold the strip over the fire to get hot (the pitch sets quickly), then wrap around the wire frame. If the pitch sets before you fasten it to the wire, have a piece of hot iron, and hold it to the pitched strip (don't burn it though), and before it sets, quickly secure it around, making a 1in. lap over each turn. This seems hard, but after a little while, you become expert at it.

"Continue this bandaging business right through. When starting on the small end, do the bandaging 3in. at a time outside, then look through inside, and if there is any protuberance, smooth it out, making the surface smooth and level with the inside of wire frame. After you work out to the 6in. diameter, you needn't worry, as you will reach the inside easily from the bell-end of the horn inside, and won't have to smooth out from between the wires like you will have to do where the diameter is small. This is important, too, as you must have the inside perfectly smooth, or your results won't be much better than the old type of horn.

"The next step I found the hardest to do, and that is covering the pitched surface with the brown paper. Starting again from the socket end, cut the paper into strips like the calico previously referred to, and have a hot iron in one hand, apply to the pitch on the horn, and quickly slap on the end of the paper strip. Press it on, then, warming the pitch a little at a time, and quickly pressing the paper strip to the hot pitch. Above all, make sure each inch you do is securely fastened to the pitch: it has to be done very quickly, as the pitch sets practically instantaneously.

"Now, melt the glue, and add to it a cup

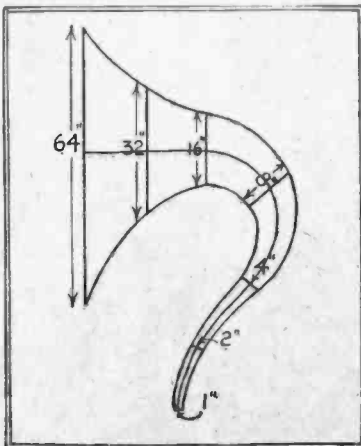

A further full-size drawing is made during the construction of the horn from which the shape of the curved outer and inner wires is obtained.

**SOME COMING FEATURES**

*Readers who have been waiting patiently for some details of a modern crystal receiver will be interested to know that we are soon to publish the description of such a set—and it doesn't use screen-grid valves, either! Also, in the near future we are to have a five-valve battery set designed to give the biggest results for the smallest outlay.*

of flour, made into a boiled paste. Put the flour in with 1lb. glue to one cup of flour paste. Then paint on the paper strips with glue, outside and inside as far as you can reach. The final job may be painted in any way to suit the builder.

"Static was awful when I first tried it on the set, but I know I had succeeded by the roar each blast of static gave out next morning. I tried it on 4QG at 11 a.m. session, and they were giving us a band record. Well, I don't want to appear as a braggart, but that band was transplanted into my front garden. The results are not like radio reception at all. It is the real thing, and is positively uncanny.

"Of course, I have a good audio side to my set, an output filter consisted of a 50 Henry choke and two 2 mfd. cond. I can only say I am more than pleased with results I have got, but you must use ample H.T. and a good power valve."

Mr. H. Nottingham, of North Ryde, has built his speakers of wood. He has some interesting comments and suggestions to

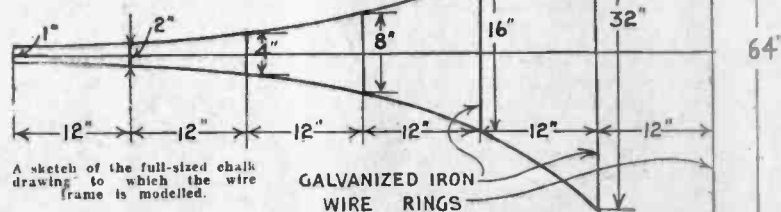

make concerning them. "I have built two exponential horns recently," he says. "The first one I built (which I am now using) was originally 12 feet long, and doubled its area every foot. After building it, much to my dismay, I found that I would have to take the side out of the house to get it outside, as it was far too big to take through the ordinary doorway. I reduced the length by about one foot, and made it just large enough to shift through the ordinary doorway. The results were not impaired to any noticeable degree to that of the original design. The speaker gave excellent reproduction, even an earpiece giving plenty of volume.

I made the second one on an exponential curve that tripled its area every foot, and it was nearly 7ft. in length; the results were excellent, and a Baldwin Concert Model unit, used with a Ferranti AF5 transformer audio combination, gave results which, in my own opinion, were only equalled by the best of moving coil speakers.

The two speakers were tried out together off the same set, the larger speaker using an Amplion AUI unit, after hearing the smaller speaker it would seem as if perfection in quality was obtained, but on changing over to the larger horn it was marvel-

lous the decided difference. Both were distinctly clear and true in tone, but as one lady who came and heard it said, "It is just like listening-in to my crystal set, only it is ever so much louder."

A few remarks about construction. The two speakers were both built in two sections, the first half is built of 1in. cedar, and the second half of heavy 3-ply, the two sections being butt-jointed. As an alternative, the four sides of the cedar section can be tapered about four inches from the end, planed off to nothing, and fixed inside with 3-ply section. To fasten the plywood together after cutting out the four sides (two sides being a little wider than the other two), I cut out four strips of wood 1/4 in. wide, 1/4 in. thick, and the length of the plywood, the strips being cut on the exponential curve, so as to simplify fastening on to the ply sheets, and to minimise strain. The sheets were first drilled with small holes to take a very fine counter-sunk screw, about every 3 inches along the edge, then the four strips were fastened by means of these fine screws to the edge of the ply sheets, making it flush. After fixing the strips on, it is simple to join the two blank sheets of ply to the two sheets, with the strips fastened to their edges, it is best to drill all of the holes along the edges first before joining up, and when joining the larger section start at the mouth of the horn. After joining the speaker up, I used wood 3in. wide by 1/4 in. or 1in. thick, to square the mouth of the speaker and keep the ply from sagging.

To anyone who wishes to build an exponential horn I can thoroughly recommend a speaker of this type as being second to none. It is not nearly as hard to build as it looks and when used with a really

good amplifier I have found it ideal. Quality is the first and foremost item in radio, and we have it here.

Further comment on this interesting subject is provided in a letter from Mr. R. Fourro, of Narrandera. He says, in part:—"I have just completed and tested the exponential horn, as published in 'Wireless Weekly' of October 25. There is no doubt it is a great success, volume and clarity, combined with tone, is there—almost 100 per cent. I had a speaker, which I thought was pretty good; but when the unit went into the exponential there was no comparison.

"I am using a six-valve set, with three-stage resistance coupled audio, with home-made eliminator. There used to be too much volume for the old horn to carry, but now I can let the set go full out, with wonderful volume and clarity.

"A few words on the material I used which might come in handy to others:—Five sheets 1in. x 25in. x 30in. cardboard, cost 3/4 (should be cheaper in the city), and 6d gummed paper; total, 3/10. Another thing, I found it was necessary to have a mate to give me a hand. It is rather awkward on one's own."

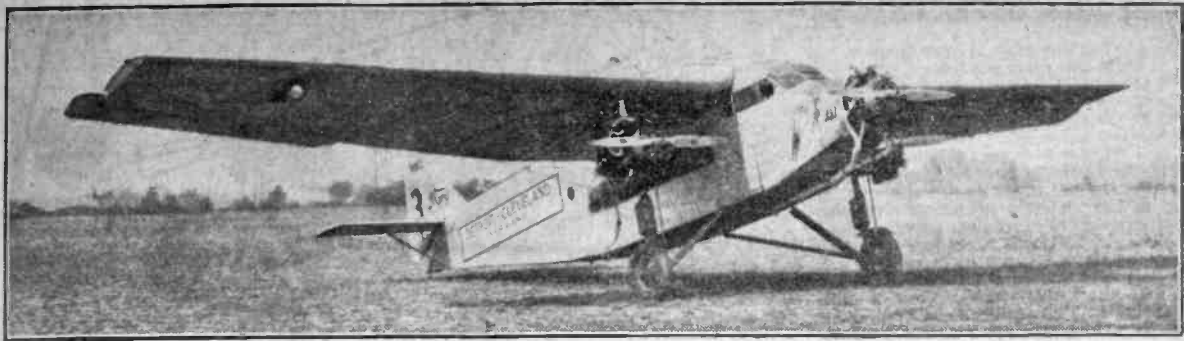

# MODEL THIS GIANT FORD *Tri-Motor Air Transport*

*Plans and details of another 'plane for aeroplane modellers, published in conjunction with the Model Aero Club of Australia, whose sessions are broadcast by Mr. Norman Lyons every Monday Night.*

**A** GIANT three-motor, 12-passenger, all-metal ship—that's the original of the scale model that readers can learn to build from this article. The 'plane is about as different from the Curtiss Hawk described recently as day is from night; but, like the Hawk, it stands out in its field.

Building scale models is not at all times the same thing as building flying models. The "flying sticks" you have learned to make, if you have followed the "Wireless Weekly" series, are designed to stay in the air the longest possible time. Scale models, on the other hand, should be exact copies on a small scale of man-carrying ships. They don't have to fly a foot!

Since the two types are so unlike, the things you have learned in constructing flying models won't help you very much when you try your hand at scale models. You don't have to bend every thought toward keeping your 'plane light; you don't have to worry about balance; you don't have to follow a definite detailed process step by step. Instead, you will sacrifice everything to appearance; you will concentrate on dimensions to get them exactly to scale; you will rack your brain for ways to make your model a tiny image of the original.

Your own ingenuity will be your greatest asset in scale model building, for this article

attempts to give you little more than the dimensions you need to build a 24-inch wing-spread model of the Stout all-metal 'plane. A few hints are included to start you thinking, but the greater part of the problem is left for you to solve. You are "on your own" in building scale models, and that's why they are fun to make.

Aside from the fun, you're going to learn a good deal about aeroplanes. You're going to get a new understanding of the theory of designing ships. You're going to get better knowledge of wing shapes, of streamlining, of the "why" of struts and braces. You're going to be able to start at the propeller and name every part of a big ship all the way back to the rudder.

Take one of your flying models and compare it to the picture of the Tri-motor accompanying the article. They aren't very much alike, are they? The fuselage of the flying model, you notice, is a single slim stick of balsa that runs from propeller to tail, while the fuselage of the big transport is deep and wide. Now look at the position of the Tri-motor's wing. It is far forward, right up near the nose of the 'plane, while the wing of your flying model probably is nearer to the tail than the propeller. Those are the chief differences, although you will see others as you look—differences in respect to motors,

landing gears, wing shapes, and so on.

While you have been examining your model and the picture you have seen (possibly without knowing it) why scale models don't fly. The wing of your flying model must be far back to balance the ship. The wing of a man-carrying ship must be far forward to support the motors. You might move the wing of your scale model back, of course, but as soon as you do that your model no longer looks like the original.

Now that you have your task well in mind, put aside your flying model and concentrate on the picture and the drawing. From them you can learn all you need to know to enable you to build an accurate copy of the Tri-motor.

Exact cross-sections of the wing, at several points along its span, are also shown in the drawings—a very valuable aid, because the Tri-motor's wing tapers down, both in chord (front to rear dimension) and thickness, toward the tips. Two photographs, together with a printed explanation of several details, are added helps. Moreover, all measurements are given in inches—you can make your parts the same size as the drawings, which show the whole 'plane reduced down to fit the 24-inch wing.

Whether you use the printed drawing or not, you're going to have fun building a scale model of the Tri-motor. It is a great ship, modern in every detail. Every part of it is made of metal, from landing gear to wing-tip, with the exception of one or two that have little to do with the structure of the 'plane. The framework for the fuselage, the ribs for the wings, the frames for the elevators, stabiliser, fin, and rudders, even the "skin" which covers the whole—all are made from duralumin. The propellers are steel, the motor parts are made from several different alloys, the controls operate by means of steel wire cables. Yet this metal 'plane can carry 14 persons through the air at 120 miles an hour, and its cruising rate is 100 miles an hour!

Before you begin reproducing it, get every detail clearly in your mind. Examine the drawings, look at the picture, find other pictures of the 'plane in magazines and rotogravure sections. Then start.

You can start anywhere you like, because there is no set way to construct a scale model. If you decide on the fuselage, check with your drawing to get the exact length—the side drawing gives that to you. The top view gives you the width of the fuselage, and the picture shows the general shape.

As for materials, take your choice. White pine, balsa, or any easily-carved wood will do



Members of the Model Aeroplane League of America, inspecting one of the Ford all-metal 'planes.

for the fuselage; or you can build it up from flat wood, steaming so you can bend it as you wish.

Tools? Use any that fit your purpose. A sharp knife will carve your wood, pliers will bend your metal (if you use metal), a small block plane will smooth the surface, and some fine sandpaper will finish the job.

While you are working, remember the skin of the Tri-motor is corrugated metal, with the corrugations parallel to the flying direction. You'll get the idea if you look carefully at the wing in the picture. Remember that this metal covering is burnished, so your 'plane will have to be bright silver in color when you've finished it.

It isn't necessary to go into too much detail with the inside construction of this 'plane, but it is interesting to know that the cabin is divided into five separate compartments. Farthest forward, just behind the centre propeller, is the control cabin, containing two seats for the pilots and two sets of controls. You enter this cabin through a door from the observation compartment, just behind. This is a small walled-off part of

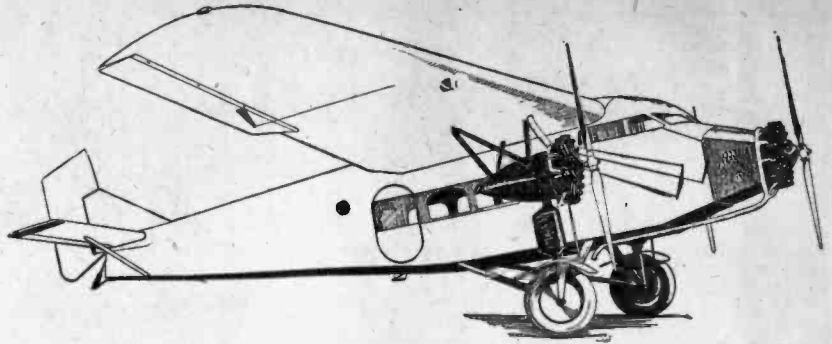

Detail sketch of the 'plane.

the fuselage, with windows in the upper half of it. Farther back is the main cabin, equipped with wicker chairs for the passengers. Behind the main cabin is a washroom, and still farther back is space for luggage.

The door, as the picture shows, is at the rear of the main cabin and on the right side of the ship. There are five windows on the left side of the 'plane and four on the right.

Notice, in the photographs and drawings, that the landing gear struts are streamlined, like the shock-absorbers, the motor sup-

ports, and the nose of the ship. The fairings behind the two wing motors are also designed to cut down wind resistance. You'll be interested to know that the shock-absorbers attached to the wheels are oleo cylinders, while the tail-skid shock-absorber is a compression rubber spring.

It's a good idea to work with other builders when making scale models. Sometimes one builder will hit on a way of reproducing a part that will be the despair of everyone else. That's why it is worth while to join a club.

Plans of the Ford Transport.

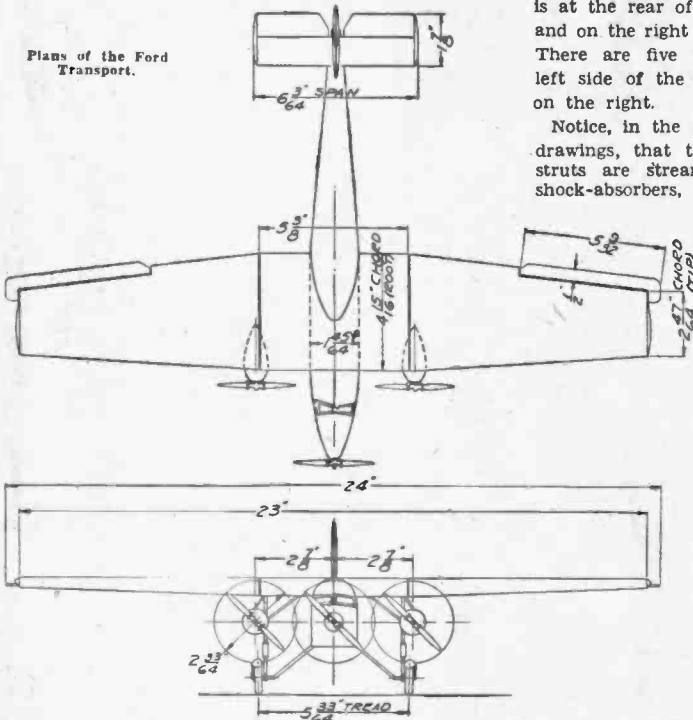

FORD TRIMOTOR

SCALE

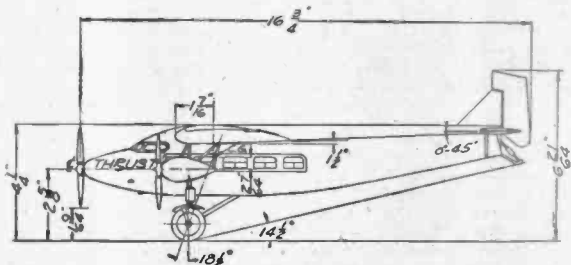
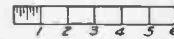

## PESTS AND CURES



MANY of the following remedies I have advised over the air for various troubles in the garden, and so as to enable amateurs to have a printed copy of the directions, etc., as to how to use these remedies, I have written what follows:—

**CLIFT'S MANURIAL INSECTICIDE:** This is a powder for destroying destructive soil insects, at the same time sterilising and cleansing the soil. This insecticide is a reliable and effective soil fumigant, with a certain amount of manurial and fertilising value. When mixed with the soil the powder, actuated by the natural dampness and heat of the earth, gives off heavy fumes, which penetrate through the soil and destroy all insect life on contact. The effects are lasting, not only for a month, but for a very lengthy period. It will destroy wireworms, cockchafer grubs, pear mites, mill-

(By G. W. COOPER, who speaks on gardening from 2BL every Saturday morning at 10.40.)

pedes, potato moth grubs, white ants, woolly aphid (on the roots of apple and pear trees), and all underground insects. Before sowing seeds of vegetables, flowers, etc., or planting seedlings or young plants of any description, no matter what they are, Clift's Manurial Insecticide, mixed thoroughly with soil to a depth of three or four inches, is worth while about seven days before. For general use, about two ounces of the insecticide to the square yard will be found quite effective. The preparation is non-injurious to plant life if used as I have recommended above.

"PEEPI": This preparation kills all weeds on lawns, that is, all plants that gardeners

term weeds. It also improves the grass a few weeks after it has been applied. "Peepi" is specially prepared for the destruction of clover, trefoil, daisies, dandelion, and other weeds on grass tennis courts, golf courses, cricket and croquet grounds, bowling greens, and ordinary couch and buffalo grass lawns. For bowling greens, the proper time to apply "Peepi" is at the end of the bowling season. Lawns can be treated all the year round, but from the beginning of September to the end of May is the best period. The same applies to croquet lawns, tennis courts, golf courses, buffalo and couch lawns. Tennis courts may be used ten days after treatment with "Peepi." The strength to use it is at the rate of 14 pounds to 40 square yards, or a strip 3 feet wide and 120 feet long of surface. Large leaves of docks and dandelions require a little more "Peepi" than is recommended for weeds like clover, etc.

# FAREWELL TO 1929

*A sad note for the passing year and a joyous note of welcome for the coming year will be the key of the New Year's Eve Programmes . . . "Rio Rita" on the Air . . . "The Magic Carpet."*

THE spirit of rivalry will be abroad in 2FC Studio on New Year's Eve. Philosophers have gathered, and during the course of the evening C. N. Baeyertz will contribute a philosophic thought, Scott Alexander reflects "From a Park Bench," while H. W. Varna also speeds the parting guest—1929—and Francis Jackson looks at the future. Brunton Gibb will make some random remarks.

Part of the programme will be supplied from the Manly Rotunda, where an excellent band recital will be held. Another feature of the programme will be the community singing, led by Mr. H. P. Williams. "New Year Resolutions at the Zoo," should prove entertaining.

The New Super Ideal Broadcasting Receiver will be introduced by James Donnelly, the "Four Black Troubadours" the "Ahad Duo," the A.B.C. Male Quartette will render harmony numbers, and W. E. Lewis and Dorrie Ward, Harry Croot, and Norman Francis will sing duets. Vocal numbers will be given also by Nea Hallet, Raymond Beatty, Oliver King, Mabel Batchelor, Miss Le Brun Brown, Peggy Dunbar, Rae Foster, R. A. Bartleman, Virginia Bassetti, Clement Q. Williams, and Vladimir Elin, the Russian baritone. The Two Old Cronies will supply an interlude, and Goodie Reeve will do "Something Different," assisted by Bert Gilbert. The A.B.C. Quintet will render several instrumental items, and solos will be provided by Dulcie Blair (violinist), Al Hammet (saxophonist), Carl Oberdorf (cornet), Lidgey Evans (pianist), Lionel Bennett (xylophone), Madam Evelyn Grieg (dulcitone), Gladstone Bell (cellist), Harrison White (banjolist), Carlton Fay and Maggie Foster will also render novelty numbers.

You will find on the programme the names of Charles Lawrence, Dismal Desmond, Lew James and Dodie Wolfe, John Stuart and others of their ilk, while Walter George gives an amusing interlude. Later in the evening also a dance band will be broadcast from the Hotel Australia. When "Big Ben" chimes, cross for a few minutes to the Manly Beach to hear the roar of cheers that greet the happy New Year of 1930.

FROM 2FC on January 1 the broadcast of the musical comedy, "Rio Rita," has been arranged. By arrangement with Florenz Ziegfeld, Sir Benjamin and Mr. John Fuller are producing this musical comedy from the Majestic Theatre, Newtown, for a return season. It will be relayed to 3LO, Melbourne. All the luring melodies that made "Rio Rita" famous will be heard again. "When You're in Love You'll Waltz," "The Kinkajou," "Rio Rita," "Was it a Dream," "Following the Sun Around," and others.

Gladys Moncrieff has the leading role as the fiery, beautiful Mexican girl. Miss Janette Gilmore, comedienne, will be Dolly Bean, whilst other artists to be heard include Phil Smith, Eric Bush, Fred Moore, Phyllis du Barry, Queenie Ashton.



Gladys Moncrieff.

## LISTENERS' LICENCES FOR NOVEMBER.

	Increase.	Decrease.
N.S.W. ....	108,071	755
Victoria ....	143,284	—
Queensland ...	23,133	—
South Aust. ...	25,103	429
West Aust. ...	4,618	305
Tasmania ....	5,555	134
COMMON-WEALTH	309,764	493

The continued decrease in Queensland is rather alarming; perhaps it is due to the difficulty of reception during the hot months in that very hot State. The drop in Victoria, after October's increase of 3,986, has little significance; probably Victorian licences will continue to fluctuate about the 144,000 mark. The continued small increases in South Australia, West Australia, and Tasmania are most encouraging. We shall be interested to see how the New South Wales licences stand at the end of December.

A PROGRAMME of Australian music will be arranged by Madame Emily Marks from 2FC on December 30. "We are trying to find some new, worth-while music, which would otherwise not be heard," said Madame Marks. "We don't want songs about kookaburras and flannel flowers, because that kind of local color has been largely overworked. Musical settings to the lyrics of classic poets are the type of material we have been seeking. The programme has been constructed with a view to including all the best music available, and we have found that there are many really beautiful songs lacking a publisher."

SOME little sketches of everyday life will be presented by Lew James, Dodi Wolfe, Sadie Anderson, Doris Lascelles, and May Fouldes through 2BL on January 2.

SCHUBERT'S "Ave Maria" and "The Slumber Song" by Gretchaninoff will be played by Miss Dulcie Blair, violinist, on January 1 from 2BL.

AN organ recital will be broadcast through 2BL from the Christian Science Church on December 29 by G. Vern Barnett. By special request he will play the March in D of which he is part composer. Mr. Barnett has been asked to prepare a studio production of Rossini's "Stabat Mater," and will undertake the arrangement of a series of classical programmes in the near future, which will occupy certain evenings specially set apart for them. The programmes relayed periodically from 2BL to 3AR will also be under his direction.

DOUGLAS GRAHAM, Scottish entertainer, whose songs are both humorous and tuneful, will give some numbers of a seasonable nature from 2BL on New Year's Day. Among them will be: "New Year's Day," "Just Let Off the Chain," "The Centenarian," and "Married Tae the Wife."

COLIN CAMPBELL, of the Campbell Boys, concertina players and entertainers, will be heard on the New Year's Day programme from 2BL in English concertina solos.

A PROGRAMME of Old French and Italian music, dating from the 17th century, has been arranged by Madame Evelyn Grieg for December 29 from 2FC, with Veta Wareham (violin) and Norman Martin (cellist).

Minna Weiddele, a German contralto who has made her name throughout Europe as a leader singer, will render some Old Italian folk songs. She will accompany herself on the lute, a curious old instrument, which is of the same period as the songs. "Quando Rosa Tourna dal Village" is one of her ballads, which has a specially haunting tune. Norman Martin will contribute cello solos, one of which, the "Macello Sonata," was composed about 1642. Veta Wareham will play as violin solos "Rigadon" (Rameau, 1683-1764) and the Chanson Louis XIII. et Pavane (Couperin, 1668-1733).

THE first four scenes of James Donnelly's new play, "The Magic Carpet," will be given from 2BL on January 2. The story concerns one Hafiz, who, brought up in the deserts of Arabia, finds that he has inherited the learning of the East plus a million pounds and an aeroplane. In the first scene, wherein a Moroccan story teller is repeating the tale of the magic carpet to Hafiz in the Garden of Baa, the plot is subtly foreshadowed. The entry of the dancing girls is followed by the arrival of the aeroplane salesman, the Bargain and the Feast.

In the second scene Hafiz sets out, and the action changes from the bazaar to the aerodrome and the Festival of Minnah. The third is in the desert at the Oasis of Seven Palms, where Hafiz meets the Three Wise Men.

In the fourth Hafiz falls in love with a beautiful archaeologist in the Valley of Tombs in Upper Egypt.

A POPULAR dance and variety programme will be broadcast by 3LO on Boxing Night, including Paul Jeacle and his Band; Jack Kearns, comedian; Phyllis Dickenson, soprano; Newstead Rush, bass-baritone; and Etts Bernard, contralto.



John Stuart.

JOHN STUART will broadcast a short comedy, "Punishment," from 2FC on January 2. He wrote it specially for broadcast. Margot Morton, who will play opposite him, is the daughter of one of Australia's most brilliant journalists, the late Frank Morton, of "The Triad."

PIPE-MAJOR MACKAY has been asked to broadcast bagpipe music from 2BL on January 1. Each New Year sees him in the van of the pipers, and in 1924 and 1927 he won the championship of Australia. He began his musical career as a boy of eleven in his native Renfrewshire; later joined the 6th Battalion Argyll and Sutherland Highlanders as a piper.

# Wireless Weekly

Incorporating "Radio in Australia and New Zealand."

FRIDAY, DECEMBER 27, 1929.

## ACCURATE PROGRAMMES

**T**HE most welcome evidence of the hand of the new Superintendent of Broadcasting Stations in the management of the New South Wales stations is the announcement that henceforth the advance programmes of 2FC and 2BL will be closely adhered to.

It has always been the grievance of N.S.W. listeners that the advance programmes both under the new and the old regime were never reliable. This, of course, was not due to lack of attention to detail on the part of the stations' officials but their established policy.

"N.S.W. broadcasting programmes differ from the usually accepted plan of English, Continental, American, and most Australian stations. Practically all these fix definite programmes, and no matter what subsequently comes along, they will not alter their booked items. The Sydney stations, however, feel that to give the best service to their listeners they must be prepared, even if it does mean wrecking their originally arranged programmes and additional work to the staff, to absorb every topical event that may be available for broadcasting."

Which was an admirable policy for listeners-in and worthy of the highest regard had not experience shown that dozens of minor alterations, transferred and substitute items, absentee artists, new pieces, and other changes which had all the markings of a lack of strict supervision crept in under this guise. Listeners may be pardoned, therefore, for believing that the policy itself was merely the sidestepping of a difficult problem.

Accurate programmes are essential to a successful broadcasting entrepreneur, and the goodwill they bring worth their trouble. No listener objects to the occasional jettisoning of an announced programme for another of wider importance and interest, but he has every right to protest against the minor inaccuracies which confuse him, and present him from exercising a choice between the items on the local programmes and the Interstate programmes.

Co-ordination and the wider outlook necessitated by a Nation-wide service is responsible for the adoption of the new policy of strict and accurate timing of the programmes. As one of the first moves in the larger plan for better service, it will be welcomed by listeners-in.

# SHORT WAVE NOTES

By R. N. SHAW

**R**EALLY good reception of the various stations controlled by the Phillips' organisations has been obtained during the week. The 'phone service between Holland and Java is most consistent, and can be heard at good strength as a rule after 9 p.m.

Honors are, however, with PHI, which is coming through with wonderful punch. Some excellent musical programmes are also transmitted by PHI, in addition to the usual tests on speech. PHI works on a wave length of 16.88, and can generally be heard between 11 p.m. and 2 a.m. (S.M.T.). The management of Phillips inform me that the station is now on the air regularly on at least four nights a week. Its best strength is usually around 11.30 p.m.

PCJ is still rather weak, but can be heard in the early mornings. Saturday's transmission is still unreliable. I could not hear even the carrier wave last Saturday after noon.

### LONDON TRANSMISSIONS.

Interest is unabated in the tests between GBX and 2ME, and it is anticipated that ere long the public will be permitted to share in the service. Strength between 6 and 7 p.m. is still fair speaker, whilst the tests after midnight are speaker strength.

5SW cannot be "read" in the early morning session, but is good speaker strength at night. The station now comes on the air at the more convenient hour of 10 p.m. and closes down at 11.30 p.m.

### THE AMERICANS.

KGO still maintains his tri-weekly transmissions on Tuesday, Friday and Sunday, but is comparatively weak until after 4 p.m. I noticed that, on Sunday last, reception weakened around 6 p.m.

KDKA tests at irregular intervals and it is difficult to say when he may be heard. Announcements are usually made during tests, which are often heard during the early morning; usually on a wave length of 25.4.

W2XAF is still too weak to be worth bothering with during the day, but on several occasions he has tested on 31 metres around 8 or 9 at night, with fair strength.

### RADIO MANILLA.

The Philippine station still maintains its superior position on the same wave length. On Sunday afternoon between 5 and 6 a good band programme was broadcast. A change was made in the usual programme on Sunday night, when the nation broadcast a Phillipino church service, conducted by the Bishop of Manilla, speaking in the native tongue. The singing of the native congregation was most interesting. The American announcer broke in at intervals with explanations of the service. On Tuesday night the station re-broadcast a programme of Hawaiian music from Java.

### OTHER STATIONS.

RA97 has been considerably interfered with by static, although maintaining its strength.

TLO (Nairobi) was only fair phone strength at 4.30 a.m. on Friday.

The Bangkok station was heard at fair strength on about 17 metres on Monday morning between 5.30 and 7.

A station has been heard very close to the one-time wave length of KZRM, 49 metres, between 5 and 6 p.m. The station is apparently an American, but his call sign was not clear. He can be heard almost any Friday afternoon between the hours mentioned.

# DOMESTIC INTERFERENCE



## What Length of Life Has the Popular Dance Tune?

Dear Sir,—I saw in the "Safety Valve" page the other day an excerpt from a letter by a man who had much to say concerning the present-day clash between the lovers of modern dance music and the followers of the classics. He stated that modern music does not live as long as do the masterpieces of another day. If the gentleman meant life in terms of years, he is correct. If he meant it in the number of times a musical composition actually is rendered, he certainly is not.

When a modern piece of music is released from the publishers copies are distributed to more orchestras and singers than we care to mention. Each orchestra, if it likes the piece, will proceed to play it to a natural death.

The radio is merely one method of publicising a number. Think of the theatres all over the country! All have their vaudeville acts and their orchestras; all play the composition until it has grown familiar—so familiar in fact that the public grows weary of listening to it. When this time comes, the song may be three, six months' old, or maybe a year. But it is relegated to the category of the has-beens.

Classical compositions, however, are played almost exclusively by philharmonic orchestras and string ensembles. These units may run into large numbers when the total in the entire world is taken, but when we compare them, numerically, with the dance orchestras, etc., their number fades into insignificance.

Inasmuch as the life of a musical number is reckoned not in the number of years as in the number of times it has been rendered, the modern dance numbers live as long as do the jaded compositions of the musicians of the past.

Yours, etc.,

CHARLES MANTE,

Brooklyn, December 8.

## Surely He's Wrong

Dear Sir,—As several readers are taking the opportunity of criticising the new Broadcasting Company, I wish to have a few words to say, also. While listening-in to-night to 4QG I heard the minister of St. Barnabas' Church of Engand say that after the Federal Government had taken over 4QG there would be no more church services broadcast from that station. What are the Federal Government thinking of? Do they think of us poor people outback? If so, they wouldn't stop that for us; or do they only think of themselves? They who are always only a stone-throw from church or else have a high-powered set so that they can listen-in from Sydney. Anyhow, what else is Sunday for? Do they not recognise it as the Sabbath? Seems they don't otherwise they would not be thinking of doing such a thing.

Trusting some other reader will carry this on a bit further, and hoping there will be no alteration in the programme of 4QG.—Yours, etc.,

FOR THE SAME OLD PROGRAMMES.  
ROSEDALE (December 9, 1929).

# The Safety Valve

Readers are urged to express their opinions on matters pertaining to broadcasting. If you have some grievance, if you have some constructive criticism to offer, here is your chance of expression—your safety valve. The editor assumes no responsibility for statements made by readers and published on this page. Anonymous letters are not considered.

## More of the Masters

Dear Sir,—I notice sometimes letters re musical selections, and as one fond of good music, not jazz, I should be very glad to hear more of Chopin, Beethoven, and Handel on Sundays. My sister, with whom I reside, is 81½, and I used to enjoy a few nice musical items on a Sabbath. I am not fond of long church services. I enjoyed a melody by Franz Liszt the other morning. There is one announcer with a charming voice.—I am, yours, etc.,

OFTEN PLEASED.

ASHFIELD (November 27, 1929).

## Country Interference

Dear Sir.—The complaints re the bad transmission, and the bad programmes the A.B.C. are putting over are amusing to me. If those that don't get enough jazz, too much church, or not enough classical music only had a bit of what I have been putting up with for the last four months (since I purchased my set), they would be glad to listen to anything they could get. Because there is very little of that which I get that is not ruined by interference from electric wires, etc.

I, like Q.R.M. and Q.W.M. ("W.W.", 15/11/29), think that it is about time that there was something done to overcome this trouble. As I said before, I would be mighty pleased to be able to listen to any kind of programme, but as it is I am seldom able to listen at all!—Yours, etc.,

"S.B."

SOUTH GRAFTON (November 17, 1929).

## ACCURATE PROGRAMMES AT LAST

"Wireless Weekly" readers will be glad to hear the announcement of the A.B.C. to the effect that co-ordination of programmes will necessitate a strict adherence to the advance programmes as published in "Wireless Weekly."

"The chief difficulty with advance programmes to date," the announcement reads, "has been with the organisers of outside concerts and functions getting their information from artists sufficiently in advance so that these details can be included in the programmes. In future, however, the published programme will be strictly adhered to, and unless organisers and others desirous of having broadcasting carried out in respect of their various efforts get in touch with the A.B.C. earlier than formerly, they will find it too late to make satisfactory broadcasting arrangements."

## B Stations' Transmission

Dear Sir,—I read the second criticism of 2KY this time by A. L. S., Rozelle. He says he has only a "home-made" set; that is where his trouble is. If he invested a few pounds on a good set he would receive all the stations quite O.K.

Mine is a three-valve set, and I never have any trouble with 2KY, and there are only five degrees between 2KY and 2UE; and there is not the slightest interference, nor with 2UW either. I don't know what he would do if he lived in Mosman, where 2GB (the worst offender of them all for interference) would wipe him right out on his "home-made" set. The only fault I have with 2KY is that the announcer does not speak very distinctly, but their transmission is perfect. At any rate, why doesn't "A.L.S.," write to 2KY; they may alter their service to suit his set. 2UE is the station to cry about. I once heard them described as being too "tinny," and it is true they are very weak. Also 2FC transmission is very thick lately, but I have no fault to find with their programmes.—Yours, etc.,

J. TOOVEY.

Mosman (December 6, 1929).

## Plea for Tolerance

Dear Sir,—During the past weeks I have constantly read letters published in the "Safety Valve" regarding the programmes put over by the Australian Broadcasting Company. The majority of letters have been voicing their opinions with disfavor. We must take into consideration the difficult task the programme arranger for the A.B.C. is confronted with. To please all is impossible; but in my opinion he effects the compilation in such a way that in all programmes there are some items to suit every individual liking.

On perusing the weekly schedules published in "Wireless Weekly" one will see that the programmes are of a very varied type, consisting of classical music, humorous sketches, excellent dance orchestras, plays, and interesting lectures. I think that a programme of this type should surely contain something of interest for all.

In other letters some listeners are of the opinion that the records broadcast by 2FC and 2BL are such as the "B" stations would not play. I should think that these records are supplied by various manufacturers to the Broadcasting Company, and are naturally the best obtainable, as they are broadcast to thousands of listeners-in, thus being an excellent advertising medium for them.

I wonder if some of these dissatisfied listeners ever take time to think when writing their letters to the "Safety Valve": "Could I fill the position of programme arranger with more ability myself?" To meet with approval from all.—Yours, etc.,

SATISFIED.

DOUBLE BAY (December 3, 1929).

# THE SILVER BELL

OPERATES WITH OR WITHOUT AERIAL

## THE Silver Bell

WILL REPRODUCE YOUR GRAMOPHONE RECORDS WITH PURITY AND VOLUME UNDREAMED OF.

THE PRICE IS £18/2/6



Selectivity goes 60% towards making a set perfect

You cannot possibly tune in with pleasure to any station if you get interference from the neighboring transmission.

### THE SILVER BELL ELECTRIC RADIO

is guaranteed to give you 100 per cent. selectivity, beside ample volume and clarity.

£18/2/6

3 valves (excluding rectifier). Write or call for free particulars. TWELVE MONTHS' GUARANTEE.

SUITABLE SPEAKERS FROM 37/6.

POSITIVELY NO BATTERIES



# THE SILVER BELL

IS DESIGNED ON THE

## FAMOUS RENOWN PRINCIPLE

### THE Silver Bell

WILL BANISH THOSE LONELY HOURS AS NO OTHER INSTRUMENT CAN DO.

THE PRICE IS £18/2/6

50 Per Cent. Reduction in Operating Cost Guaranteed When you use one of our **ECONOMIC "B" BATTERY ELIMINATORS**

Complete Home Assembly Kit  
£3/13/0 £3/3/0

PROVED TO BE AUSTRALIA'S FINEST 3 VALVE SET **THE RENOWN 3** (with 5 valve performance) Kit of Highest Grade Parts  
£6/13/5

FOR QUALITY FAR SUPERIOR TO ANYTHING YET PRODUCED

See and Hear **THE SUPER RENOWN 4**

OUR LATEST PRODUCT IS A NEW **"B" & "C" BATTERY ELIMINATOR** (Full wave) 136 Volts at 36 milli amps. 4 "B" Battery Tappings and 10 "C" Battery Tappings  
£6/15/0

**Economic Radio Stores**  
25 ROYAL ARCADE, SYDNEY

And at  
126A PIT STREET,  
UNION STREET,  
NEWCASTLE,  
PARRAMATTA.

Please mail more details re your advt. 27/12/29.  
NAME .....  
ADDRESS .....



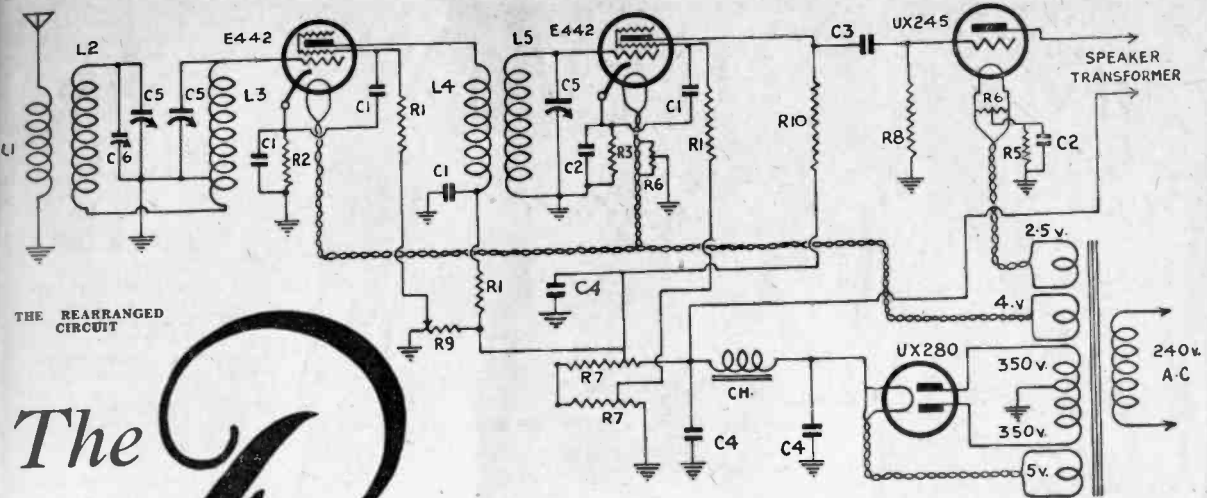

# The Pre-Selector

## a.c. 3

This week the Pre-Selector principle is applied to three valves, instead of four, and enables musical reproduction to be further improved. This modification, because of the saving in expense, is likely to be popular.

By ROSS A. HULL

PROVIDING the receiver is to be used for reception over distances no greater than a couple of hundred miles, it can be said that the splendid reproduction of the "Pre-Selector Four" can actually be made more brilliant still by the elimination of one valve.

This statement may seem inconsistent in view of our frequently expressed contention that the average Australian receiver has an insufficient number of valves for the work it is supposed to do. It is not, however.

When reception is limited to nearby stations and when a reasonable aerial is available, three well-operated valves are ample even for the high-quality reception in which we are exclusively interested. The "Pre-Selector Four," with its first audio valve removed—in other words, a good radio frequency stage, a screen-grid "plate" detector and a high-powered output valve—is a combination which will permit mighty fine musical reproduction. As a set built purely for the reproduction of programmes as music, we do not quite know how it could be improved at the present state of the art.

An alternative type of three-valve rig could be built by leaving off the radio frequency valve. This would be a splendid receiver for locations not in the immediate vicinity of a broadcast station, but it would not be quite up to the standard of the first-mentioned arrangement.

### OBVIOUS ADVANTAGES.

The advantages of the "Pre-Selector Four" from a musical reproduction point of view are not hard to appreciate. In the first place, almost all the necessary amplification is accomplished at radio frequency. Whereas the ordinary radio frequency amplifier is responsible for the reduction of the high musical frequencies, this one provides just as much (possibly slightly more) amplifica-

tion for the high frequencies as well as the low, even though its selectivity is actually greater. The reason for this, of course, is found in the use of the double-tuned input circuit to the radio frequency valve.

In addition to this feature, the set has an almost distortionless detector so operated that it can feed the audio valve to its full capacity without overloading. The coupling between the detector and the one audio valve is a resistance which undoubtedly permits better musical reproduction under these particular conditions than any other coup-

ling device. Finally, the set has a high-powered output valve—a valve which will fill the largest room with music before it will start to contribute any distortion of its own.

### DIFFERENCES IN CIRCUIT.

Since we have described the four-valve receiver in such great detail in the last two issues of "Wireless Weekly," we will not duplicate our instructions for the construction and operation of the apparatus. Instead we will deal exclusively with those features which distinguish the three-valve model from the four. We will assume that the prospective builder of the set has thoroughly studied the two preceding articles.

The circuit printed with this article should first be compared to that of the "Pre-Selector Four." The important difference is in the elimination of the first audio valve and its associate components. The tuned input circuits to the radio frequency valve and the coupling between this valve and the detector remain the same and require no further mention. From the plate of the detector, however, the two circuits start to differ.

In the three-valve circuit, resistance coupling is used from the detector instead of the high inductance choke specified in the original set. The choke method could still be used, of course, though the resistance will be less expensive, will occupy less space, and will be about as effective as the choke. The particular reason for the use of the choke in the four-valve model was the simplification of the pick-up connection by using the primary winding of an audio transformer for the pick-up and the secondary as the coupling choke.

No pick-up connection is provided in the circuit of the three-valve model, though it could be arranged in the grid circuit of the detector, as described in last week's article. On account of the voltage drop in the

### List of Parts Used in the "Pre Selector Three"

- Two E-442 Philips Valves.
- One UX-245 Radiotron Valve.
- One UX-280 Radiotron Valve.
- L to L5, Three Unit coil kit, with three Radiokes Coil Shields.
- C5, Three-Gang Stromberg-Carlson variable condenser.
- C6, Five-plate Radiokes Midget variable condenser.
- R10, .5 megohm Carborundum Resistor.
- C1, Four 5 mfd. fixed condensers.
- C2, Four 1 mfd. fixed condensers.
- C3, One .1 mfd. fixed condenser.
- C4, Three 4 mfd. fixed condensers.
- All "Chanex" 1000-volt rating.
- R1, Three 10,000 ohm resistors, No. 953.
- R2, One 900 ohm No. 959.
- R5, One 1200 ohm, No. 958.
- R7, Two Power pack resistors, No. 953.
- R6, Two centre-tapped 50 ohm, No. 358.
- R9, One Volumgrad 50,000 ohm resistor, No. 940. All of these are "Fliot."
- R3, One Ferranti 40,000 ohm resistor.
- One Southern Radio Power Pack Unit—comprising transformer with 350 volts, each side of centre-tap, and filament windings for 5 volts, 4 volts, and 2.5 volts. Also including filter choke.
- Two UX sockets.
- Two UX sockets.
- Folded Aluminum Base 12in. x 19½in., with space at least 1in. deep underneath.
- Note.—The Standard Radiokes AC 3-32 Cabinet, but with aluminum base, is suitable.

coupling resistor R10, which is very much greater than in the choke used originally, a higher voltage is used for the detector tapping from the voltage divider. In all models of the receiver the two voltage dividers are connected in series, so that one of the 4000 ohm sections is at the grounded end, and one of the 2800 sections at the positive end. In the four-valve set the r.f. valve and the first audio are fed from the tapping, which is 2800 ohms from the positive end. The detector is fed from the junction of the two divider resistors, while its screen is supplied from the tapping 4000 ohms from the grounded end.

#### PLATE SUPPLY CONNECTIONS

In the case of the three-valve arrangement, the detector and r.f. valves are both fed from the tap 2800 ohms from the positive end, while the detector screen is connected as in the previous instance. The r.f. amplifier screen, of course, is supplied from the volume control R9.

The filter condenser C4 is still connected across the detector positive tapping and ground as before, though the connections are changed on account of the different tapping used.

Aside from these features, the connections are exactly as detailed before. The centre-tapped resistor across the detector filament supply, mentioned before but not shown, is indicated as R6.

The adjustment of the receiver should be carried out in the manner which has already been treated. It will be simplified somewhat by the fact that the elimination of the first audio stage will carry off with it the hum problem. The Pre-Selector Three should be so quiet in operation that no hum should be audible from a good moving-coil speaker at distances greater than a few feet. Considerable hum is sometimes generated

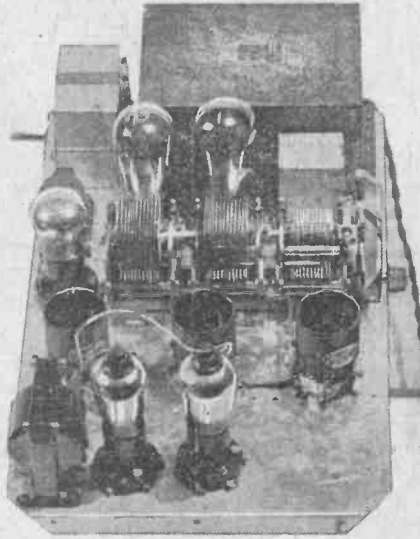

The Pre-Selector Four, the first audio valve of which has been eliminated.

by the field supply system of the speaker itself, and in listening for hum from the receiver it is as well first to short circuit the input terminals to the speaker, in order to see just how much hum exists when the speaker is not excited from the set. In our own particular case it was found that the hum being generated by the speaker itself was actually reduced when the set was connected to it.

One detail which we fear was not mentioned in the previous descriptions is the shield over the lower part of the radio frequency valve. This shield is provided to isolate the grid wiring and the grid end of the valve from the plate end. It consists of nothing more elaborate than a "Capstan" cigarette tin, with a hole cut in its end large enough to accommodate the valve. The hole is made of such a size that the valve fits in it tightly, and thus holds the tin in position. This shield, in common with all others, is lined inside with thick paper, to prevent the possibility of any short-circuits should the shield be displaced.

We have been asked by a number of prospective builders of the set whether any other type of "B" eliminator could be used. Obviously, any other type may be incorporated, providing it is capable of supplying at least 300 volts of d.c., together with 2.5 and 4 volts of filament current. Two types which may well be used are Stromberg-Carlson and the Pilot K-112. Where the voltage divider is contained in the power pack the resistors, R7, are unnecessary. All other resistors, however, should be retained.

The amendment of the receiver to operate as a detector and two audio frequency valves is another matter in which there is some interest. This change would simply mean the elimination of the r.f. valve from the four-valve circuit, together with all the apparatus preceding it, and associated with its plate circuit. The aerial coil (of 25 turns wound in a hank) would be placed at the ground end of L5, and the detector would be operated without reaction as before. The receiver has been operated in this manner and ample signal strength has been obtained from the local stations, notwithstanding the use of a "plate" detector without reaction of any sort.

## ∞ FLYING THE GLIDER ∞

**H**AVING our machine built, we naturally turn to our first flight or glide.

Do not be in too much of a hurry to get into the air. First of all, make sure that the glider is complete in every detail. See that the controls are working perfectly, and with crisp freedom. Draw the stick back and forth, and note whether each control surface moves as it should. Go over all cables again, and see that they are well lubricated where they run over the pulleys or through guides. Test every guide-wire and turnbuckle, and see that they are taut. Check up on measurements again, and, above all, make sure that all important nuts, bolts, and screws, are in place and fast.

#### In Open Country

All woodwork should be varnished or shelled to withstand the weather. It is advisable to keep an eye on the condition of the plywood on the miscellaneous joints. The fabric of the planes, rudder, elevator, and fin should be evenly spread, and no dry spots should be left on the material.

Select a suitable day, and if possible select a ridge that offers a slope of about one in eight or ten for the preliminary attempts. If possible, I suggest a spot somewhere out in the country, or an open park. A gently-sloping hill that is about 300 feet long is ideal. The next consideration, of course, is the wind, which should not be too strong for a beginner. A light, even breeze will help a lot, and under no consideration try gliding from any abrupt cliff or steep hill until you have mastered the art of gliding.

Take your glider out, and mount the wings at the point of flight, and again go over every joint to assure yourself that the glider is structurally and aerodynamically O.K.

*The machine, now assembled and with controls operation is flown for the first time.*

By J. BALL

Get your friends to assist in clearing the way, in case you have interested spectators. Place the glider on its skid, and take your place in the seat. Have a man at each wing tip, to help in the getaway, and have your launching crew ready at the launching rope. A set of signals should be arranged in advance, and a captain of the launching crew should be selected, who should be on the rope nearest to the nose of the machine.

When everything is ready, the signal should be given the rope crew. They should start away at a walk until the machine begins to slide easily over the ground. Once the friction has been lessened, the order "Run!" should be given, and the crew should respond with increased speed, which will draw the machine forward with a sure, even movement. As the speed increases, the pilot should begin to feel the lift of the air current under his wings, and he can begin to try his elevator. He will soon find himself free of the ground, and actually flying, or gliding. At this point the rope will release itself, and it is up to the pilot to keep the glider in the air. As he gains experience the pilot will be able to control his glider and keep it into the wind, gain altitude, and adapt the strength of the rising air flow to keep his machine in the air, for short periods.

#### Practice Necessary

A skilful pilot will allow himself to be

taken a little above the highest point of his hill, and remain at that point until he is ready to land. Do not attempt turns until several hours have been spent, in straight glides.

To land, depress the nose gently, and allow the glider to coast down easily. There should be little trouble in making a successful landing. A little difficulty may be noted at first, and minor accidents in the way of bent wingtips or skids may be experienced, but these are all parts of the game. Keep at it as much as possible, and the knack of natural flying will come suddenly, and you will wonder why it is so easy and graceful.

Later on you will want to attempt a few turns. Under no circumstances attempt this feat until you really begin to feel the air. "Feel" is everything in gliding, for you have no motor to pull you out of your mistakes.

No turn should be attempted near the ground. Under ideal conditions—that is to say, with strong, steady winds, one may attempt turns at about 100ft. It will be found that a turn must be made by first depressing the nose and then feeling the way around with the ailerons and rudder until the circuit or part thereof has been accomplished, then the nose may be drawn back to the horizon line again.

#### Forward Speed

Once the machine is turned around, with its tail to the wind, a new sensation will be noted from the prevailing current. Here a new forward speed will be available, and it is here that the pilot must take care in turning again back into the wind to make his eventual landing. As the pilot gains in this experience he will become more familiar with the tricks of the air currents, and will be able to make them do just as he bids.

# ANOTHER DX MAIL

## Bright Log

Dear Sir.—I see a S.W. fan wants to know if there was such a station as WCMR. No—but there is WENR-W9XF. Voice of Service, Chicago, owned and operated by the Meat Export Company. I am listening to it to-night at loud-speaker strength, R8, fairly clear. We get them in from 6 p.m. till 8 p.m. every night except Monday, when they close down at 7 p.m. My short-wave notes are as follow:—

PLE: On 15.74 metres' tests on Wednesday night, with PLF on 17 metres at 9 p.m. on New Zealand time Strength, R8, and puts over records.

W2XAD: Schenectady, N.Y., on 19.56 metres, received on Saturdays, Monday, Wednesday, and Friday. This station can be picked up in the morning at about R4. Afternoons till 3 o'clock at R5-6, when it fades.

VPD: Suva, on 21 metres, usually tests with VK2ME from 5 p.m. till 6 p.m., N.Z. time. Strength, R8.

AMERICAN STATION: On 23 metres. Telephony to England most mornings from 9 p.m., on usually R5-6.

KGO and W6XN: California, received here at R7-8 from 5 p.m. on, but fades towards finish, 8 p.m.

G5SW: On 25.5 metres. Received here at 7 a.m., strength about R7. but seldom come up to the mark now for clearness. Generally mushy. Was received last Wednesday from 12.30 a.m. till 1 a.m. on luncheon music at good loud-speaker strength, and very clear.

KDKA: Pittsburg, received here from 4.30 p.m. on till 5 p.m. at R8, but atmospherics have been bad lately.

KZRM: Manila, received here from 8 p.m. till 9 p.m.; strength, R6-7 at 10 p.m., R7-8 very clear, on 26 metres.

GBX: London, on 27 metres, on tests with VK2ME most evenings from 6 o'clock till 8.30 o'clock. Strength, R6-7.

BANGKOK, SIAM: Usually received from 11 p.m. on at R5-7 on records and native music.

VK2MR: Sydney, received here at good strength, R9, on tests, with VPD and GBX, on 28.5 metres.

TLO: Nairobi, Central Africa, on 31 metres, received here from 5.30 a.m. till 7 a.m.; usually R4-5. On 31-5 metres.

PCJ: Holland, comes in on Saturdays at R7-8 from 4 p.m. till 6 p.m.

GERMAN STATION: Wessen, on 31-5 metres at 5.30 a.m. till 7 a.m.; R7-8. On 32 and 33 metres, trans-atlantic telephony between New York and England. Throughout the day conversation picked up on several occasions, strength R6-8.

WLW and W8XAL: On about 49 metres, received here occasionally from 5 p.m. till 6 p.m. at R4 to 5; also W2XAL, New Jersey, N.Y., on 49.7 metres testing from 6 p.m. till 7 p.m., at R6-7.

WENR and W9XF: Chicago, on 49.80 metres, received every night from 6 o'clock till 8 o'clock; Monday, close down at 7 p.m. Strength varies from R6-8.

RA97: Khabarousk, Siberia. On 70.2 metres every night at 9 o'clock, except Wednesdays; usually spoilt by static; strength, R6-8, was on 34 metres for two nights this other week, when they came through at a good R8. A lady gave out new items from 11 p.m. till 11.20 p.m. in English.

Set used: Circuit Schnell, short-wave three.

Yours, etc.,

S. SAUNDERS.

Wellington, N.Z. (November 29, 1929).

## Canadian Station

Dear Sir.—I have received verification of reception from CJRX, Winnipeg, Manitoba. The transmitting apparatus is located at Middlechurch, a few miles north of the city, and is of Canadian Marconi design and manufacture. The owners are James Richardson and Sons, Ltd., 1018 Grain Exchange Building, Winnipeg, Manitoba. Their schedule is as follows:—

Daily (except Sunday), 5 p.m. to 7 p.m. Music, news, markets, etc.

Sunday, 10.30 a.m. to 1.30 p.m.: Sacred and classical music and church service.

Monday, 7 to 8 p.m.: Re-broadcasting (receiving conditions permitting).

Tuesday, 7 to 8 p.m.: French concert; 8 to 9.15 p.m., music, talks, etc.; 9.15 p.m., "Profitable Investment."

Thursday, 7 to 8 p.m.: Re-broadcasting; 8 to 9.15 p.m., music, talks, etc.

Saturday, 7 to 8 p.m.: Re-broadcasting. French lessons, Tuesday and Friday, 6.49 p.m. to 7 p.m.

News: Daily (except Sunday), 5.25 p.m. Investment talks, Tuesday, 9.15 p.m. Markets, daily (except Sunday), 5.30 p.m. Uncle Peter, daily (except Sunday), 6 p.m. to 6.40 p.m.

All times are central time

Power, 2000 watts.

Wavelength, 25.6 metres.

Stations re-broadcast are KDKA, 5SW, and PCJ.

The receiver used for re-broadcasts operates with seventeen tubes, and is equipped with meters, which enables the operator to maintain a high state of efficiency. I have also received verification of reception from TLO, Nairobi, Kenya Colony, British East Africa. They transmit on a wavelength of approximately 31.4 metres, with a power of 2 kilowatts, and their times of transmissions are from 4 to 7 p.m., GMT, daily, including Sundays.

I have also received a verification of reception from 6XN, General Electric Company, Oakland, California.

Schedule:—

Tuesdays, Wednesdays, and Fridays. 9.30 a.m. to 1 p.m.

Tuesdays, 6 p.m. to midnight.

Wavelength, 23.35 metres

Power, 5 K.W.

I am using an adaptor (Schnell) on short-waves. Thinking this might interest other fans.

Yours, etc.,

H. N. KEENE.

Girraween (November 17, 1929).

## Mystery Foreigners

Dear Sir.—Short-wave notes herewith. During the week the following have been received very well on speaker:—

G5SW: 10-11.30 p.m. using phonograph records, too!

RA97: After 7 p.m., English session.

PHI: 11 p.m., as usual, very clear.

KZRM: On about 26 metres, like a local Bangkok, Siam, on about 16 metres, in conversation with Berlin. The speaker was Prince Purachata (my spelling is phonetic).

Can anyone say who the two foreigners are on about 15 metres, and the other quite near Bangkok. They were certainly not transmitting programmes, and there was a good deal of "alo" and "ya" from both stations, but no English.

Yours, etc.,

WILBUR BROOKE.

Jerry's Plains (Nov. 22, 1929).

## "Dope" for S.W. Listeners

Dear Sir.—Being an ardent short-wave fan. I think the following "dope" will prove useful to fellow listeners:—

RA97: 75 metres every evening, except Wednesday. Music perfect, R8-9. Static bad at present.

KGO/W6XN (23.35 m.): Tuesdays, Thursdays, and Sundays, from 11.30 p.m. onwards. At my end reception is very unreliable. KGO has lost its punch.

5SW: England (25.53 m.), 5 a.m.-8 a.m., but very weak and inconsistent at present.

GBX: Rugby, England (28.86 m.). Constantly carrying on Duplex telephony with 2ME. 4 p.m.-6 p.m. mostly, also from 7 a.m.-8 a.m.

KZRM/KIXR: Radio, Manila, now on 24.5 metres. KIXR uses three wave-lengths, viz., 49, 31.3, and 24.5. Recently he was on 49. Music from here is excellent, loud-speaker strength at times. KIXR works nightly from about 9 p.m. on. Of course, he can be heard earlier, but his night session commences at 9 p.m., S.M.T.

VPD: Suva Radio (20.79 metres). Duplex telephone with 2ME. Mostly early evenings. Have not heard him of late.

2XG: Rocky Point. Variable wave-lengths, usually carrying out field tests. He can be heard to call, "Write down on matrimony," etc.

TLO: Nairobi, E. Africa (31-4 metres). Working early morning, 3-6 a.m.

2XAF: Schenectady (31.48 metres). Working from 9 a.m.-3 p.m., Mondays, Tuesdays, Thursdays, Saturdays. Can also be heard working Saturday evening from 1 p.m. onwards. This is a special transmission to Australia.

W8XK: Pittsburg (25.24 metres). Saturday, 4 a.m.-6 a.m., and 10 a.m.-4 p.m. Relays KDKA. Can also be heard working to the Byrd Expedition. Reception is fair, though unreliable.

PCK: Kootwyk, Holland (18.4 metres), Saturday, 12.40 a.m.-3 a.m. Some very fine music, worth listening to.

PCT: Kootwyk, Holland (28.8 metres). Programmes variable, mostly late at night.

DHC: Germany (26.02 metres). Works early evening, but of late I have not heard him. Reception is very good.

CJRX: Winnipeg, Canada (25.60). Works Sundays, 10.30-1.30 p.m.; Mondays, Tuesdays, Thursdays, and Saturdays, 7 p.m.-8 p.m.; also 8-9.15 p.m. on Tuesdays and Thursdays. French lessons are given on Fridays and Tuesdays, 6.40 p.m.-7 p.m.

The above are only the main short-wave broadcasters I have received. There are two or three foreigners on the 75-80 metres, but so far I've not got their call or QRA. I have received stations from all over the globe, totalling so far over 700. I should welcome letters from short-wave fans in any State other than New South Wales or Victoria.

Yours, etc.,

L. SCHNITZERLING.

Warwick, Qld. (November 16, 1929).

## What Station?

Dear Sir.—On Thursday night, 5th Inst., I logged a station between 3UZ, Melbourne, and 1YA, Auckland, N.Z. I heard the music and singing fairly plainly, but the announcing was faint, so I couldn't catch it. Could any reader inform me, through your valuable paper, what station this is, please?

Yours, etc.,

ERN. MARSTELLA.

New Lambton (December 5, 1929).

**THE WEEK'S TALKS**

**DAY SESSIONS.**

**FRIDAY, December 27.—2BL:** 9.0, A. C. C. Stevens; 2.30, Half an Hour with Silent Friends; 3.45, Claire E. Byrne, "What Happened on Christmas Morn." "Sporting": 11.0, Miss Furst, "Cooking"; 12.0, Rosalie Wilson, "Sentimental Treasures of Antiques"; 3.0, Dr. Harold Norrie, "Outstanding Personalities in Australian History—Charles Sturt"; 4.0, "Red-gum," "Gardening."

**SATURDAY, —2BL:** 9.0, Wilfrid Thomas, a Reading; 10.40, Mr. Cooper, "Gardening." 2FC: 10.32, Mr. Ferry, "Racing"; 11.0, Miss Furst, "Week-end Suggestions."

**SUNDAY, —2BL:** 5.10, W. F. Kay. **MONDAY, —2BL:** 9.0, A. C. C. Stevens; 2.30, Business Efficiency; 3.45, Brunton Gibb. 2FC: 10.32, Mr. Ferry, "Racing"; 11.0, Miss Furst, "Cooking"; 12.0, V. C. Bell, "The Public Forum"; 2.0, Museum Talk; 4.0, Norah Alexander, "Technique of Poetry—The Ode and Ballad."

**TUESDAY, —2BL:** 9.0, A. C. C. Stevens; 2.30, Half an Hour with Silent Friends; 3.45, Price Conkrove, "Gregory on the Victoria River." 2FC: 10.32, Mr. Ferry, "Racing"; 11.0, Miss Furst, "Hints to Housewives"; 12.0, Mrs. Burrows, "Outposts of the Empire"; 3.0, Rev. F. H. Raward, "The Barbary States"; 4.0, "The Storyteller," "A Window in Suburbia."

**WEDNESDAY, —2BL:** 9.0, A. C. C. Stevens; 2.0, Half an Hour with Silent Friends. 2FC: 10.32, Oscar Lind, "Sporting"; 11.0, Miss Furst, "Cooking."

**THURSDAY, —2BL:** 9.0, A. C. C. Stevens; 2.0, Half an Hour with Silent Friends; 3.15, Captain L. Roberts, "The Trouble in China"; 4.15, Rose Antill de Warren. 2FC: 10.32, Mr. Ferry, "Racing"; 11.0, Miss Furst, "Domestic Notes"; 12.0, Annie Hughes, "King George V. In Comparison"; 3.0, C. N. Baeyeritz; 4.0, A. S. Cochrane, A Reading."

**NIGHT SESSIONS.**

**FRIDAY, —2BL:** 9.30, Claude Corbett, Sporting. 2FC: 9.0, Tom Gurr, "The Islands of the South Seas."

**SUNDAY, —2FC:** 6.40, W. J. O'LEARY, Chief Commissioner, N.S.W.G.R. 7.40, "The Storyteller"; 9.15, Brunton Gibb.

**MONDAY, —2FC:** 9.0, Wilfred Blackett, "Old Time Politicians."

**TUESDAY, —2BL:** 9.30, V. C. Bell, "Are You Bored by Your Job?"

**THURSDAY, —2BL:** 9.30, Wilfred Blackett, "Reminiscences of the Bar."

# Howard Carr



A PROGRAMME consisting of selections from Howard Carr's works, and conducted by him personally, will be given from 2FC on December 30, commencing at 8.30, following on his half-hour appearance from 2BL. Howard Carr, who is at present on a visit to Australia, is one of England's musical authorities. He has conducted every type of music, from light opera to symphony, but his own music is recognised as worthy to rank with that of any contemporary composer. "Three Heroes," his best-known orchestral suite, was inspired by three war V.C.'s. The first number is suggestive of the gay recklessness of O'Leary; the second, which is also considered the best, is a description in tones of the waste of Polar ice, where Captain Oates met his death. A fight in mid-air, and the sudden crash of a flaming aeroplane is depicted in the third.

Dearsley, accompanied by the composer, "Ben Backstay," which will be sung by Raymond Beatty, and two chancies, "A Jug of This" and "High Barbaree," especially the latter, have a swing which it is hard to resist.

Howard Carr is especially fond of sea songs, and his Nautical Suite is a gem, particularly one number, "The Sentimental Bo'sun," which is interrupted by three saucy cabin boy "tootling" on his tin whistle. Howard Carr conducted the London production of "The Lilac Domino," and contributed several numbers to it. One of these, "For Your Love I am Waiting," will be included in the broadcast programme.

A complete contrast to this is "The Chiffon Frock," a light, dainty interlude, after which follows "The Carnival of the Elements," an ambitious work, consisting of four numbers. "Air" is a light rhythmic scherzo, and "Earth" a valse lente movement. "Water," a peaceful stream that wends its way in terms of melody; but "Fire" demands the best from any orchestra, not so much for the notation as for the time, which is 9/8 presto furioso. Perhaps of all his orchestral and vocal music Mr. Carr's settings of quaint old traditional songs are best known to the general public. One of these, "Oh, for a Husband," will be rendered by Vera

He held the position of musical director to the Harrogate Municipal Orchestra for some years, besides conducting numerous West End productions, for which he wrote orchestral numbers. He was the youngest conductor at any West End theatre when he was first appointed to the Empire Theatre, and he began his musical career at 18 years of age. During a long and brilliant career Mr. Carr has been instrumental in fostering public interest in good modern music. He is hon. secretary and treasurer of the Musical Conductors' Association, and honorary director of the Philharmonic Society.

## The A.B.C. Women's Association

**A.B.C. WOMEN'S ACTIVITIES.**

SUMMER vacation not only affects the school children, but grown-ups, too. Many of the A.B.C. women's tennis clubs have closed down for a few weeks during the Christmas and New Year holidays. Seasonal festivities and the hot days have been the reason for this.

Ashfield Club, however, are true Spartans. For one week only at Christmas time did they close, and are now once again in full swing. They want several new members who have played some tennis before. Here is an opportunity for any woman living near Ashfield to join up with an excellent club on Tuesdays and Thursdays.

The members meet at 12 o'clock, play and have lunch, and continue throughout the afternoon. Challenge matches against other A.B.C. women's clubs are constantly arranged, and the club is recognised as a "live-wire" branch of the A.B.C. Women's Association.

Other clubs are held at Coogee, Maroubra, Strathfield, Mosman, Chatswood, Manly, Balgowlah, Waverley, and Rockdale. Coaches are supplied in most of the clubs, and the approximate cost per month is 6/6 each.

**SWIMMING CLUBS.**

SWIMMING clubs revel in the heat, and A.B.C. women's swimming clubs are established at Coogee, Balmoral, and Laverder Bay. Coaches are in attendance, so that members not only enjoy the happy social club life, but are learning to swim and to improve their strokes. Some are learning to dive and life-save.

**YOUNGER SET.**

THE younger set tennis clubs are not deterred by the hot days, but meet every Saturday morning at Lakemba, Vaucluse, Wollstonecraft, and Rockdale. Coogee has turned its club into an evening club, and consequently has increased its membership. They meet every Monday night at the Car-

## Association (Conducted by Gwen Varley)

den courts. The weekly fee is 1/ each, and arrangements have been made that the courts are available to club members throughout the week by paying an additional 6d per week.

Strathfield Club has closed down for a few weeks.

**HORSE-RIDING CLUB.**

APPLICATIONS are steadily being received by Miss Varley as an outcome of Miss Molly M'Williams's sporting offer to teach members of the younger set clubs to ride during the holidays. The fee will be at a minimum cost, and young would-be riders will learn from one of Sydney's best horsewomen.

**SWIMMING CLUB.**

A SCHOOL holidays Swimming Club is suggested. Names have been registered, but not sufficient to start a school. Would anyone like to learn to swim or improve their swimming so that they can race and dive? The fee is 7/6 for six lessons, and one of the best teachers in Sydney will take the class.

**WOMEN'S TALKS FOR THE WEEK.**

Programme for week commencing Friday, December 27, to Thursday, January 2. Time: 10.40 to 11.0 a.m.

**FRIDAY, December 27:** 10.40 a.m.: "Madame, do you know?" by Miss G. Varley.

Many suggestions are given by Miss Varley for the school holiday vacation days—how to fill them happily is the problem of many mothers. Miss Varley is brimful of suggestions, and can also offer to employ the members of the Radio Younger Set Club for boys and girls in swimming, tennis, and riding clubs.

10.50 a.m.: "The Last Page of the Sweetest Story Ever Told," by "Priscilla." Mrs. L. C. North, best known as "Priscilla" over the air, will close her "Sweetest Story Ever Told" on the last Friday of the old year, before she departs for holidays. We sincerely hope that "Priscilla" will be free to come back to her many radio friends later. Hundreds of pounds of sweets have been made by busy housewives during the year.

**MONDAY, December 30:** 10.40 a.m.: An Introduction to an Outstanding Personality, by Miss G. Varley.

Miss Varley hopes to have the pleasure of introducing a much-travelled woman to speak to her listeners, who love travel talks.

10.50 a.m.: "Croquet for Women," by Miss G. Varley.

Miss Varley will tell of the steady growth of croquet throughout N.S.W., and entuse her women listeners to consider playing in the new year. She believes that it is every woman's right to play some sport, and urges croquet as one of the most suitable games for young and old, especially for the matron.

**TUESDAY, December 31:**

10.40 a.m.: "Good-bye, 1929," by Miss G. Varley. The last day of the year will be said good-bye to, and Miss Varley, the enthusiastic secretary of the A.B.C. Women's Association, will make a review of the year's work, and invite many women to join for 1930.

10.50 a.m.: "Persia, the Land of Romance, Rugs, and Roses," by Gladys Edith Glanville.

This will be the last of a most popular series of talks by Mrs. Edith Glanville. She has taken her listeners into countries little known to the Western world, Constantinople, Greece, Bethlehem, and Persia will have all been visited with Mrs. Glanville, and the women of those countries made known to us. There will be sincere regret when Mrs. Glanville says good-bye to us.

**WEDNESDAY, January 1:**

New Year Greetings by Miss G. Varley. New Year's Day cannot come without Miss Varley wishing all her listeners every happiness and good wish for the coming year. They will talk together of the past year, and plan big things for 1930. New Year's Day is a great one for new resolutions, and together they will make them.

**THURSDAY, January 2:**

10.40 a.m.: "Diet an Important Factor in Your Good Health," by Miss G. Varley.

As a result of the remarkable interest shown by hundreds of women in Miss Varley's advice re diet two weeks ago, she will give another helpful talk to women, showing how one may be literally starved with three good meals a day if the correct and balanced diet is not being observed.

10.50 a.m.: Further Hints on Tennis, by Miss G. Varley.

New Year's Day interferes with the regular tennis coaching talks, so Miss Varley has programmed it Thursday. She would not dare miss a Tennis Talk, knowing the keenness of her tennis enthusiasts, especially found among the 500 members of the A.B.C. Women's Association.

**YOUNGER SET SESSION.**

**TUESDAY, December 31:**

8.45 p.m.: Girl Guides' Session. "Birding," by Lady David.

Lady David, president of the Girl Guides' Association of N.S.W. is one of the most beloved women in the movement, and hundreds of Guides will listen eagerly for her talk on "Birding," a subject she knows well and is most enthusiastic on.

**THURSDAY, January 2:**

Girls' Radio Club, by Miss G. Varley. Miss Varley will open the new year of the Girls' Radio Club on the first Thursday of the new year, and many further plans will be made together.

## What Determines The Accuracy of Fixed Condensers

**H**OW accurate are commercial fixed condensers? The question is often asked and seldom answered. Hence, at this time let us analyse the elements that determine the accuracy of a fixed condenser.

Of course, the accuracy applies to the electrical function known as capacity, and the capacity is generally referred to a physically determined national standard in the possession of some bureau.

It is, however, little known that this standard in itself is liable to variation, and that in determining the magnitude of this standard, possible mathematical and physical errors enter in. Moreover, the comparison of this standard to the sub-standards involves errors of such magnitude that a measurement to less than 2 micro-microfarads is not usually possible, in other words, 2 per cent. for a condenser measuring .0001 microfarads. Thus, right at the beginning of our consideration, we have an arbitrary limitation on the accuracy.

The manufacturing methods of measuring capacity have been developed to a high degree of precision. Meters have been constructed which will measure capacity, always referring to a standard with an accuracy as great as that of any other electrical quantity. The development of the art necessary for such accuracy has been slow, and the instrument itself can be maintained at this great precision only by constant vigilance. In addition to the meters, laboratory methods have been developed which make it possible to compare capacities to a much greater degree of accuracy than can be done on a large scale. Thus, comparisons of two capacities can be carried out to an accuracy of about 1 in 25,000, or .004 per cent. However, it must be realised that such high precision involves considerable labor and consequent expense.

A fixed condenser, as is well known, consists of intervening layers of metal and dielectric. It is the thickness of the dielectric, together with the surface of metal in contact, that determines the resultant capacity. This thickness, however, is of the same order of magnitude as that of a sheet of paper, and in the case of a paper condenser, is subject to exactly the same variations. In the case of mica condensers, the hardness and the unchanging character of the material are assured, but the small thickness still remains. It is this small thickness that makes it difficult to measure the thickness accurately. Thus, on a sheet of mica .002 of an inch, a variation of one-half thousandth, which is about the practical limit of measurement with ordinary thickness gauges, would be equivalent to 25 per cent. accuracy. It will be seen, therefore, that the resulting product manufactured from elements of an accuracy of 25 per cent. can hardly aim at an accuracy greater than 5 or 10 per cent. However, by combining two, three, or more sheets of mica in one condenser, the law of averages enters in, and most of the condensers manufactured in this manner will fall very close to the specified magnitude. It is possible by mathematical calculation to predict what percentage from the total manufactured will come within a specified accuracy limit. Thus, out of 1,000,000 condensers manufactured from sheets gauged as above, we may get 500,000

# Curves Ahead

within 5 per cent. of the specified value; 400,000 within 10 per cent. limit, and the remaining 100,000 within 20 per cent. limit.

It is evident that if every condenser demanded a condenser with 5 per cent. limit, there would be a large number of condensers discarded as defective. It is fortunate, therefore, that some of the radio sets and some of the circuits do not require an accuracy smaller than 10 per cent. This opens out a large avenue for condensers that would otherwise have to be discarded and raise the cost of manufacture of the article as a whole. As it stands, it is possible to adjust the prices in such a way that the customer requiring a greater accuracy will pay a proportionately higher price for this greater accuracy. It will readily be seen that this arrangement is not only fair to the manufacturer, but also to the customer. The same thing holds true in any other line.

### The Resistance Coupled Audio Amplifier Coming Back?

**T**HE screen-grid tube was designed primarily for radio-frequency amplification; in which function it has proved a much needed boon. Like many other radically improved devices, however, this tube has other uses than the one for which it was designed.

Resistance-coupled audio amplification, which had fallen into the discard, is coming back. The new tube, with its high impedance and high amplification, changes the picture entirely, as between transformer and resistance coupling.

These are not our own words, but the thoughts expressed by two American authorities, Messrs. James Millen and Graddon Smith, in a recent issue of "Radio News." As they say, the old type resistance coupled amplifier, with three element valves, was satisfactory in some respects, but very weak in others. In the first place, the gain per stage was low, and then, on account of poor resistors, it usually was noisy. The screen-grid valve, together with resistors of higher quality, have overcome both of these troubles, and there would appear to be every reason why we should expect the resistance coupled audio amplifier soon to become quite general in its application. One obvious reason why the resistance is to come back, of course, is the general introduction of the "plate" detector with its high plate impedance. The ordinary transformer is quite unsuited for the work of coupling such a detector to the amplifier, and a high inductance choke or a resistance are all that we have to fall back on at the present time. Fortunately, both of them can be used to great advantage, as we have pointed out in connection with the 1930 Super-Het and more recently the Pre-Selector Four.

### What About the Pentode?

**A** GREAT deal has been said and written both in Europe and the United States about the possibilities of the Pentode. The valve has been widely applied in England and on the Continent during the last year or so, but as yet it has not appeared on the American market. Controversy over the

merits and disadvantages of the valve have been waging "hot and strong." The American laboratories would appear to be uncertain over the practical value of the valve, and have not yet gone into production with them. They are influenced, too, by the radio traders, who fear that the new valve would upset a now rather stable condition of affairs. As the editor of "Radio" says in a recent issue of that magazine:—

"Vacuum tube manufacturers hesitate to introduce the pentode into the 1930 market for fear that it will cause an upset like that introduced by the a.c. and screen-grid tubes. Notwithstanding the hesitation of some of the tube makers, it will probably be available for experimental purposes in America during the next year."

Many English writers acclaim the valve as an invaluable development, but its unqualified acceptance is by no means general. Mr. W. T. Cocking, an English authority writing in the American "Radio Broadcast," treats the technicalities in a level manner, and has many things to say in favor of the pentode. Even so, he ends up by stating:—

"It is the writer's opinion, therefore, that there is little advantage to be gained by using a pentode in place of a really good triode power tube, the only thing in which it scores is in stage gain; and its superiority here is not sufficient to make its use worth while, except in receivers where quality is only a secondary consideration, such as lightweight portable sets. This latter type of set is very popular in England, and the pentode is becoming very common in them, due solely to its high stage gain, for the high plate current does not make for economical operation from small dry batteries, which have nearly always to be used in these sets."

This searching summary of the valve and its possibilities would appear to us to be well worth taking to heart.

### How the Cone Works

**U**NTIL recently it was supposed that the paper cone of a loud-speaker acts as a unit, like the piston of an engine moving at high speed and generating standing waves in the air. To reproduce this function, a stiff, non-stretching, light material is required, hence the use of paper as cone material. Research into the matter, however, has disclosed the fact that, except under very special conditions, the behaviour of cones is very different. Instead of acting as a unit, the cone can set up air waves by at least five different motions and combinations of motions. On the low frequencies, trough-like waves are formed from the apex outward, the ends of the curves tending to become sine curves. To execute this motion properly, the cone must expand and contract its diameter. For higher frequencies, the action of the cone is such that it must be able to bend readily. Raising the frequency still higher, the cone must be able to increase and decrease in length from edge to apex.

Experiment into these phenomena has shown that paper is not necessarily the ideal material for the speaker cone, since it falls down rather badly in performing these gyrations. Attempts are being made to evolve some composition cone which will be more nearly perfect.

The  
Experimenters'  
Department  
of Technical  
Progress . . .  
Conducted by  
Ross A. Hull  
M.I.R.E.

# A PECULIAR WIRELESS SET

By John Wirth

(Acknowledgments to S.T.C., John  
Masefield, and Alfred Noyes.)

The skipper of the Maribel  
Was skipping on the quay,  
The Wireless salesman touched his arm--  
"O, hearken unto me!"

"You see this finely carpentered  
And handsome cabinet?  
With seven valves complete it is  
The world's best wireless set.

"It brings in stations A and B,  
And brings them all in well;  
But chief of its attractions is  
A most peculiar spell!"

Then straightway for that wireless set  
The simple skipper fell--  
"I'll buy that handsome wireless set  
For its peculiar Spell!"

The wireless set is put aboard,  
The mooring ropes fall free;  
And soon the steamer Maribel  
Is steaming out to sea.

She sails beyond the harbour heads  
A full day and a night,  
And when the sunny morning breaks  
There is no land in sight.

The skipper whistles at the wheel  
The engine pulses strong,  
And suddenly the wireless set  
Begins to sing this song:

Do you want to go down where the mermaid sighs,  
Lonely for lovers that never come?  
She has cupid lips and her passionate eyes  
Are weeping away in her watery home;  
And she watches the fishes' loving play  
As she lies in the bed of her long black hair  
And waits for a lover to pass her way  
Sailorman, say: Do you want to go there?

"I'd burn in Hell," the skipper swore,  
"To kiss a maid so fair!"

"Then, hearken," said the wireless set,  
"And I shall guide you there!"

The skipper gaily spins the wheel  
Between his mighty hands--  
For seven days and seven nights  
The wireless set commands;

For seven days and seven nights  
The Maribel speeds on,  
And land is on the starboard bow  
With the eighth rising sun.

And soon they passed the rocky cliffs  
And anchored in the bay,  
Where, floating in her glossy hair,  
The lonely mermaid lay.

She saw the Maribel, and swam  
In rapture to the side,  
The skipper gave an anourous hail  
And softly she replied.

He took her hands within his hands  
And drew her to the deck,  
And that she might not fall she flung  
Her arms about his neck!

And quick he kissed her cupid's mouth--  
But as their warm lips met  
A coarse laugh and a wicked laugh  
Escaped the wireless set.

The wireless set laughed loud and long  
With awful jollity;  
The skipper swore a dreadful oath  
And flung it in the sea!

The skipper swore a dreadful oath  
And flung it in the sea!  
And loud it splashed, and a ripple ran  
And rolled upon the sea.

And still grew greater as it rolled  
For leagues across the sea,  
And still it rolled around the earth  
Upon the circling sea . . .

But on the steamer Maribel  
The skipper loved his love;  
The sea blew kisses from below,  
The sun from heaven above.

'Twas kisses, kisses, everywhere,  
And kisses of delight,  
And kisses passed the languorous day  
And kisses filled the night.

He almost kissed her mouth away,  
Her passionate eyes, her hair;;  
He almost kissed herself away  
With kisses everywhere . . .

"What breaks the wide horizon's line  
Upon the silent sea?  
O Lord, deliver us from harm  
Whatever it may be!

"It rolls upon us mountains high--  
A vengeful Deity!  
O Lord, deliver us from harm  
Whatever it may be!

"It is the ripple has returned  
Upon the circling sea!  
It is the ripple has returned  
In God's Immensity!

"It towers above! It crashes on  
And strikes against the bow!"  
O Lord, have mercy on their souls,  
For naught can save them now!

The Maribel is lifted high  
And splintered on the rock!  
A loud shout and a wild scream  
Sound shrill above the shock!

The morning bathed the sands in light  
And the dead in death were fair,  
And he held her close in his wan white  
arms,  
Wrapped in her wild black hair.

"'Twill do," remarked the Editor  
Over the morning mail,  
"But don't you think you ought to put  
A moral to the tale?"

"For at the end of fairy tales  
Whatever they're about,  
Good radio Aunts and Uncles pause  
And point the moral out."

So, Children, stop and firmly vow  
When this sad tale is read,  
No more to take your whisky neat  
Before you go to bed.

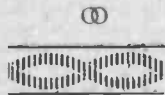

Ⓞ



Ⓞ

## Practical Hints on Stamp Collecting for the Younger Set

# The Hobbies Session

Conducted by  
Norman  
Lyons in  
conjunction  
with the  
Younger Set  
Sessions of  
the Australian  
Broadcasting  
Company.

STAMP collecting as a hobby has, during the last fifty years, grown in popularity to an extraordinary extent. Immediately upon its introduction from France it took a hold upon the public fancy, and from that day keenness in philately on the part of both juveniles and grown-ups has not abated; indeed, it may be safely assumed, as year succeeds year, that the number of devotees to a hobby as interesting as it is instructive, as profitable as it is pleasant, will go on increasing.

Stamp collecting is a hobby above the ordinary. It is definite and helpful, and from which can be gained much that is beneficial.

Let me briefly outline one or two of the pleasant results that may be obtained from taking up this fascinating pastime. To begin with, every collector will agree that there is, above his hobby as a means of supplying him with pocket-money, an extraneous interest—an attraction due very much to the general idea suggested by works of art, and a desire, developing gradually as he proceeds in his pursuit, to obtain specimens of every kind and class to help towards completion.

Were this alone all that could be said in favor of stamp collecting, to the most inappreciative it would indicate that importance and value are attached to it, but a practical acquaintance with the science quickly brings to light other facts, which must serve to raise it above the ordinary level.

At the start the beginner realises, perhaps for the first time, how incomplete and faulty is his knowledge of both history and geography; then before long he finds that his new hobby has given a very remarkable stimulus to the study of these subjects, so invariably presented in a dry form, and he gains in a pleasant manner a deal of information concerning foreign countries, as well as enlightenment concerning countries of whose very existence he was, perhaps, not previously aware.

Besides this, and probably of far greater importance, is the amount of general knowledge and information to be gathered. Affording, as it does, acquaintance with variety of color and design, together with portraiture of eminent people, philately also gives, in the natural course of events, instruction in the various processes of printing and engraving. The different kinds of paper used in the manufacture of stamps are brought under notice, and a deal can be learnt concerning water-marks and other methods employed for the prevention of forgery or imitation.

A glance through any fairly comprehensive collection will show that there are lessons without number to be learned from the pictures of fauna, of flora, and of physical and natural features illustrated in the postal productions of the respective countries to which the stamps belong. The desire to collect stamps of beautiful designs may safely be fostered even among those most scantily blessed with this world's goods, for, as it happens, it is not, as a rule, the elaborate typographical specimen which costs the most; on the contrary, the great rarities are frequently noteworthy for crudeness and lack of artistic merit.

All this and more may be justifiably claimed for stamp collecting. In all cases it should

lead to a cultivation of the powers of observation, the faculty of arrangement, and a general inculcation of neatness and method. Another inducement which may naturally appeal to many boys is the prospect of adding materially to their supplies of pocket money, for with very little trouble and expenditure of time the hobby can speedily be established on a paying and lucrative basis. Sale and exchange become, quite naturally, duties of even amateur collectors, and unlucky indeed must be the one who fails to make fair and legitimate profit on his transactions.

The fortunate possessors of old collections ought especially to be in a position for making a grand start, for the value of many specimens issued thirty or forty years ago is now so great that large sums are offered for them every day.

No hard-and-fast rule can be laid down for starting a collection. The generally accepted methods are purchasing and judicious requests from stamp collectors and other interested friends.

With regard to purchase, a glance through the advertisement columns of any paper will reveal ample particulars of reputable firms dealing in every philatelic accessory, from gummed paper mounts to entire collections.

The young collector must from the start understand how important it is not only that

---

*Readers who have been listening  
to Mr. Lyons' talks over the air will  
be interested in this article. Further  
hints will be given next week.*

---

his stamps should be properly and decently arranged, but that in the manner of choice of album, management of specimens, etc., he should be guided in the right direction.

The value of a very large number of old collections is spoiled by the manner in which the specimens have been put into the book; many, perhaps valuable stamps, having been securely fastened down on the original pieces of paper. The query naturally arises, "Should stamps always be taken from the paper on which they were at first stuck?" The answer requires some amount of careful consideration.

Individually, a stamp is never lessened in value by its being kept on the original envelope. In this condition the whole is called an "entire." The disadvantage is, of course, that these "entires" take up much more space than do the ordinary adhesives—space which the average collector can ill afford; but when we take into consideration the fact that, particularly in the case of the octagonal embossed of Great Britain (1847), and the earlier stamps of some of the European States, the value of "entires" is generally considerably more than when the stamps have been cut out, we shall feel that the disadvantage ac-

cruing from "entires" is hardly one of much weight.

Having then decided upon what we shall keep on the original paper and what we shall remove, the next question that arises is, "What is the best manner in which to clean them?"

To the youngest enthusiast it must be apparent that a stamp on the back of which is an irregularly-shaped piece of paper torn from the original envelope would not increase the artistic appearance of the collection, and this means that in almost all cases the superfluous paper must be removed, although this will not apply to rarities or stamps of doubtful origin. This subject may be briefly dealt with under the heading of cleaning.

By "cleaning" it is not meant the employment of certain acids to bring back the faded color of a stamp or the removal of old-age signs. These tasks fall more to the lot of the experienced philatelist and the dealer; but it is necessary for the amateur to know the best and easiest method of getting his specimens into a condition fit for placing in the album.

Perhaps the commonest method of removing paper from the back of stamps is to immerse them in water. Now, experiment and experience only will show what stamps may and may not be treated in this way. For example, it is not advisable to adopt this method with the bi-colored stamps of Russia, as the colors run very easily. It is quicker to clean large quantities of common stamps by simply placing the specimens face upwards in a shallow vessel containing tepid water. This will gradually soften the "back paper," so that it may be removed without trouble by a pocket-knife. Thus drawn off by the action of the water, the back of the stamp is quite moist and sticky on account of the loosening of the gum. Leave the stamp to dry in this condition, and what follows?

The gum hardens as the paper becomes dry, and the stamp curls up, resolutely refusing, with the pertinacity of a bulldog, to unroll and lie flat. To overcome this trouble, except when a rarity is being dealt with, the moist paper should be placed downwards on a piece of clean, dry blotting-paper, a similar piece being put on the top. Now, by pressing on the paper and frequently removing the stamp as the gum dries, the adhesive may be entirely taken off, leaving the specimen in a beautifully clean condition. Careful treatment in this way ensures a neat and nice-looking collection.

Not infrequently it happens that, by the careless application of a stamp to the envelope when it was originally stuck on, some part of the specimen has become creased. In such a state it does not present a very attractive appearance, and if sale or exchange be attempted under this condition the amount obtainable is certain to be diminished. Should you find, then, that some among your collection are like this, the above method of cleaning is particularly useful. Once the back paper has been removed, and while the stamp is thoroughly damp, pressure of the fingers on the upper sheet of blotting-paper will quickly straighten out all obnoxious creases, and the stamp may then be put in the book in a perfect state.

# Local Programmes, Friday, December 27

## 2FC

Australian Broadcasting Company, Ltd., Market St., Sydney (Wavelength, 451 Metres).

### EARLY SESSION—7 to 8.15 a.m.

- 7.0: "Big Ben" and Meteorological information for the man on the land.  
7.3: This morning's news from the "Sydney Morning Herald."  
7.8: Austradio Musical Reproduction.  
7.45: Mails and shipping.  
7.48: What's on to-day?  
7.50: Children's Birthday Calls.  
8.0: Music from the Studio.  
8.15: CLOSE.

### MORNING SESSION—10.30 a.m. to 12.30 p.m.

- 10.30: Announcements.  
10.32: To-morrow's Sporting Events, by Oscar Lind.  
10.45: HORACE WEBER at the GRAND ORGANS.  
11.0: HOUSEHOLD HELPS—Cooking, by Miss Ruth Furst.  
11.10: CABLES (Copyright), A.P.A. and Sun-Herald News Service.  
11.15: MORNING DEVOTION.  
11.30: Austradio Musical Reproduction.  
11.53: British Official Wireless Press.  
12.0: "Big Ben" Stock Exchange, and Metal Quotations.  
12.5: DR. HAROLD NORRIE will speak on "Outstanding Personalities—Charles Sturt."  
12.20: Midday weather forecast and weather synopsis. Special produce market session for the man on the land, supplied by the State Marketing Board.  
12.30: CLOSE. NOTE—Cricket results of the matches, South Australia v. Queensland, at Adelaide; Victoria v. N.S.W., at Melbourne, will be transmitted as received.

### THE LUNCH HOUR—1 to 2.30 p.m.

- 1.0: Lunch Hour Music.  
2.0: Stock Exchange, second call.  
2.2: A Glance at the afternoon "Sun" and "News."  
2.7: Studio Music.  
2.27: Announcements.

### THE RADIO MATINEE—2.30 to 4.30 p.m.

- 2.30: THE LIGHT ORCHESTRA.  
2.40: DORIS ROBINSON, Soprano—  
(a) "A Palace of Dreams" (Waller).  
(b) "The Winds in the South" (Scott).  
2.47: MURIEL LANG, Cellist—  
(a) "Melody" (Gluck).  
(b) "Andante" (Goltermann).  
2.54: INSTRUMENTAL TRIO—  
Fred, Whalfe, Piano.  
Dulcie Blair, Violin.  
Muriel Lang, Cello.  
3.0: ROSALIE WILSON will speak on "Interior Decorating—Antiques and Furnishings."  
3.15: THE LIGHT ORCHESTRA.  
3.30: DORIS ROBINSON, Soprano—  
Group of Songs from "The Cycle of Life" (Landon Ronald).  
(a) "Prelude."  
(b) "Love, I Have Won You."  
(c) "Drift Down, Drift Down."  
3.37: THE LIGHT ORCHESTRA.  
4.0: "REDGUM" will speak on "Gardening."  
4.15: RADIO RHYTHM.  
4.28: Stock Exchange, third call.  
4.30: Close.

### EARLY EVENING SESSION—5.45 to 7.55 p.m.

- 5.45: Children's "Good-night" Stories, told by the "Hello Man," assisted by the Farmyard Five.  
6.45: Dinner Hour Music by Farmer's Dance Band.  
7.20: A.B.C. Sporting Service.  
7.30: Special Country Session. Stock Exchange Resume. Markets. Weather Forecast. Late news service from the "Sun" and "News." Truck Bookings.  
7.58: To-night's Programme.

### THE EVENING PRESENTATION—8 to 11.30 p.m.

The National Broadcasting Orchestra is contributing to our programme to-night, and our listeners are privileged in hearing Madame Irene Ainsley, the noted New Zealand contralto, who makes her first

## INDEX

### To Local Programmes

FRIDAY, DECEMBER 27—	
2FC, 2BL	22
2UW, 2UE, 2KY, 2UE	23
SATURDAY, DECEMBER 28—	
2FC, 2BL, 2GB, 2UW, 2UE	26
SUNDAY, DECEMBER 29—	
2FC, 2BL	28
2UW, 2UE, 2GB	29
MONDAY, DECEMBER 30—	
2FC, 2BL	30
2GB, 2UW, 2KY, 2UE	31
TUESDAY, DECEMBER 31 (New Year's Eve)—	
2FC, 2BL	34
2UE, 2GB, 2UW	35
2KY	44
WEDNESDAY, JANUARY 1 (New Year's Day)—	
2FC, 2BL, 2GB, 2UW	38
2UE	44
THURSDAY, JANUARY 2—	
2FC, 2BL, 2GB	42
2UW, 2UE	44

### To Interstate Programmes

FRIDAY, DECEMBER 27—	
3LO, 3AR, 3DB, 4QJ, 5CL, 6WF, 7ZL	24
SATURDAY, DECEMBER 28—	
3LO, 3AR, 3DB, 4QG, 5CL, 6WF, 7ZL	27
SUNDAY, DECEMBER 29—	
3LO, 3AR, 3DB, 4QG, 5CL, 6WF, 7ZL	29
MONDAY, DECEMBER 30—	
3LC, 3AR, 4QG, 5CL	32
6WF	29
7ZL	31
TUESDAY, DECEMBER 31 (New Year's Eve)—	
3LO, 3AR, 4QG, 5CL, 6WF	36
WEDNESDAY, JANUARY 1 (New Year's Day)—	
3LO, 3AR, 4QG, 5CL	40
6WF	29
THURSDAY, JANUARY 2—	
3LO, 3AR, 4QG, 5CL, 6WF	44

broadcast appearance in Australia. In addition to her solos she will sing duets with Oscar Lansbury, who is also making his bow to Australian listeners.

- 8.0: THE NATIONAL BROADCASTING ORCHESTRA.  
8.12: MADAME IRENE AINSLEY, Contralto.  
8.20: THE NATIONAL BROADCASTING ORCHESTRA.  
8.25: MADAME IRENE AINSLEY and OSCAR LANSBURY, Duets.  
8.33: DULCIE BLAIR, Violinist—"Danse Espagnole" (Granados-Kreisler).  
8.40: OSCAR LANSBURY, Bass-Baritone.  
8.47: SONGS, SENSE, and NONSENSE with WALTER GEORGE, MARK ERICKSEN, and LEONORE DAYNE.  
9.13: THE COUNTRY MAN'S WEATHER SESSION—(a) New South Wales Forecasts, (b) Interstate Weather Synopsis, Yachtsman's and Fisherman's Forecast.  
9.15: RELAY FROM 3LO, MELBOURNE.  
9.54: RELAY FROM 3AR, MELBOURNE—COMMUNITY SINGING.  
10.15: FROM THE STUDIO—Announcements; Late Official Weather Forecast.  
10.20: CEC. MORRISON AND HIS BAND.  
11.30: CLOSE. NATIONAL ANTHEM.

## 2BL

Australian Broadcasting Company, Ltd., Market St., Sydney (Wavelength, 353 Metres).

### OPENING SESSION—8.15 to 11 a.m.

- 8.15: G.P.O. Chimes and Announcements.  
8.16: Music for every Mood.  
8.40: Meteorological data for the country.  
8.45: Mails and Shipping Information.  
8.50: Memory Melodies.  
9.0: This Morning's Story.  
9.30: A Musical Interlude.  
9.40: British Official Wireless Press.  
9.45: New Music.  
10.5: News from the "Sydney Morning Herald."  
10.10: Austradio Musical Reproduction.  
10.40: THE AUSTRALIAN BROADCASTING COMPANY'S WOMEN'S ASSOCIATION, conducted by Miss Gwen Varley.  
11.0: G.P.O. Chimes. Close down.

### MIDDAY SESSION—12 Noon to 2.30 p.m.

- 12.0: G.P.O. Chimes and Announcements.  
12.2: A Pianoforte Recital

### 12.30: LUNCH MUSIC.

- 1.0: Afternoon news from the "Sun" and "News."

### 1.5: Austradio Musical Reproduction.

- 1.30: Memory Melodies.

### 1.45: Studio Music.

- 2.0: Half an hour with silent friends.

### AFTERNOON ENTERTAINMENT—2.30 to 5.45 p.m.

- 2.30: A Musical Interlude.

### 3.0: FROM THE BALLROOM OF THE ORIENTAL— Sydney Simpson's Syncopaters in Dance Music.

- 3.12: FROM THE STUDIO. BASIL RYE, Baritone—  
(a) "Messmates" (Lohr).  
(b) "Fortune Hunter" (Willeby).

### 3.19: FROM THE BALLROOM OF THE ORIENTAL— Sydney Simpson's Syncopaters in Dance Music.

- 3.30: FROM THE STUDIO—Music grave and gay.

- 3.45: CLAIRE E. BYRNE will speak on "What Happened on Christmas Morning."

### 4.0: FROM THE BALLROOM OF THE ORIENTAL— Sydney Simpson's Syncopaters in Dance Music.

- 4.12: FROM THE STUDIO. BASIL RYE, Baritone—  
(a) "Stock Rider's Song" (James).  
(b) "Home Along" (Sanderson).

### 4.19: FROM THE BALLROOM OF THE ORIENTAL— Sydney Simpson's Syncopaters in Dance Music.

- 4.30: FROM THE STUDIO—Radio Rhythm.

- 4.45: The Trade Hour—Demonstration Music.

- 5.45: Weather Information. Close Down.

### THE DINNER HOUR—6.15 to 7.55 p.m.

- 6.15: DINNER MUSIC by FARMER'S DANCE BAND.

- 6.45: THE BOY SCOUTS' CLUB, conducted by Mr. Norman Lyons.

- 7.5: The Country Man's Market Session—Wool, Wheat, Stock, Farm Produce, Fruit and Vegetable Markets.

- 7.20: DINNER MUSIC by FARMER'S DANCE BAND.

- 7.45: Austradio Musical Reproduction.

- 7.55: What's on the air to-night?

### TO-NIGHT'S PRESENTATION—8 to 10.30 p.m.

We are introducing a feature into our programme to-night in Lynwood Roberts' portrayal of "The Dream Scene" from "The Bells." Carlyle Kenny is giving a pianoforte recital, there are songs by Jack Kinison (basso), and Tom Gurr's talk at 8.54 will prove of wide interest. In lighter vein we turn to Linn Smith and Guy Kidd, who have a number of instrumental novelties to offer, and it is hoped we will be able to arrange a transmission from the Grand Opera House.

- 8.0: JACK KINSON, Basso—(a) "The Banderolo" (Stuart), (b) "Star of Eve" (Wagner).

- 8.7: E. CARLYLE KENNY, Pianist—(a) "Waltz in E Minor, Op. Posth" (Chopin), (b) "Waltz in G Flat Major, Op. 70, No. 1" (Chopin), (c) "Waltz in D Flat Major, Op. 64, No. 1" (Chopin), (d) "Grande Waltz in A Flat Major, Op. 42" (Chopin).

- 8.19: "THE DREAM SCENE" from "THE BELLS." Adaptation for radio of the dramatic scene, "The Dream," in Lewis's drama, "The Bells," made famous by Sir Henry Irvine. LYNWOOD ROBERTS as "Mathias."

- 8.44: LINN SMITH and GUY KIDD, in instrumental novelties.

- 8.54: TOM GURR will give a travelogue.

- 9.14: E. CARLYLE KENNY, Pianist—(a) "Impromptu A Flat Major, Op. 142, No. 2" (Schubert), (b) "Moment Musical No. 3"



(Schubert), (c) "March Militaire" (Schubert-Tausig).  
 9.23: JACK KINSON, Basso—(a) "Up from Somerset" (Sanderson), (b) "Father O'Flynn" (Stanford).  
 9.29: Weather information for the man on the land.  
 9.31: LYNN SMITH and GUY KIDD, in instrumental novelties.  
 9.35: FROM THE GRAND OPERA HOUSE—BY COURTESY OF THE MANAGEMENT—Second act of the Comedy Farce, "Money from Home," featuring the well-known Australian comedian, Alfred Frith.  
 10.10: FROM THE STUDIO—CLAUDE CORBETT will give a sporting talk.  
 10.25: Late news from the "Sun" and "News." Late weather forecast.  
 10.30: NATIONAL ANTHEM. CLOSE.

**2GB**

Theosophical Broadcasting Station, 29 Bligh St., Sydney (Wavelength, 316 Metres).  
 10.0: Music. 10.10: Happiness talk by A. E. Bennett. 10.20: Music. 10.30: Women's session by Mrs. W. J. Stelzer. 11.30: Talk by Mrs. Jordan. 11.45: Close down. 2.0: Music 2.5: Women's Radio Service, by Mrs. Dorothy Jordan. 2.50: Movie Know All. 3.0: Music 3.30: Close down. 5.15: Children's session, by Uncle George. 6.50: M.-G.-M. Radio Movie Club session. 7.0: Music. 7.45: Feature story. 8.0: FOLK SONGS OF ALL NATIONS. Miss Bunty Stuart (Scotland), contralto. 8.7: Violin solos (American). 8.15: Mr. Barend Harris (Russia), basso. 8.22: Symphony Orchestra (Maori). 8.30: Mr. Jack Win and Mr. Heath Burdock, humor. 8.35: Miss Gwen Selva (France), soprano. 8.42: Band selections (Ireland). 8.50: Miss Bunty Stuart (Hebrides), contralto. 9.0: Weather report. 9.3: Madame Betts-Vincent, in an illustrated talk on Folk-music of All Nations. 9.20: Symphony Orchestra (England). 9.30: Mr. Barend Harris (Palestine), basso. 9.40: Mr. Jack Win and Mr. Heath Burdock humor. 9.45: Band selections (Scotland). 9.50: Miss Gwen Selva (Italy), soprano. 10.0: Instrumental music. 10.30: Close down.

**2UW**

Radio Broadcasting, Ltd., Pallings' Building, Ash St., Sydney (Wavelength, 267 Metres).  
**MIDDAY SESSION.**  
 12.30: Request numbers.  
 1.0: Chimes. Music.  
 1.15: Talk on Homecraft, by Pandora.  
 1.40: Music and request numbers.  
 2.30: Close down.  
 4.30: Musical programme.  
**EVENING SESSION.**  
 5.30: Children's Hour, conducted by Uncle Jack.  
 6.30: Close.  
 7.0: Chimes. Request numbers.  
 8.0: Popular music.  
 9.0: Chimes. Comments on Foreign Affairs, by Mr. J. M. Prentice.  
 9.10: Music and request numbers.  
 10.30: Close.

**2KY**

Trades and Labor Council, Goulburn St., Sydney (Wavelength, 280 Metres).  
**MORNING SESSION.**  
 10.0 (from Trades Hall): Tune-in to the ticking of the clock.  
 10.3: Popular fox trots.  
 10.15: Calls and announcements.  
 10.30 (from Beharfaid's new studio): Women's session. Home hints and information, conducted by Mrs. GRAY.  
 11.0: A few laughs.  
 11.5: Pianoforte selections.  
 11.15: Calls and announcements.  
 11.20: Musical interlude.  
 11.30: Request numbers.  
 11.40: Music and vocal items.  
 11.55: Where to go to-night.  
 12.0 noon: Closing announcements.

**CHILDREN'S SESSION.**

6.0: (from Trades Hall): Birthday calls, request numbers, and kiddies' entertainment, UNCLE BERT.

**EVENING SESSION.**

7.0: Musical interlude.  
 7.5: Birthday calls.

7.15: SPORTING FEATURE. Turf topics. Review of candidates and their prospects for to-morrow, Mr. GEO. A. DAVIS.  
 7.40: Request numbers.  
 8.0: (from Beharfaid's new studio): Hawaiian steel guitar selections.  
 8.10: Women's information service, MRS. GRAY.  
 8.30: Music and vocal items from the studio.  
 9.10: Full description of main 15-round event from SYDNEY STADIUM.  
 10.0: Closing announcements.  
 2KY Broadcasting Station will be closed on Saturday, December 28, 1929.

**2UE**

Broadcasting Station 2UE, Everett Street, Maroubra, Sydney (Wavelength, 298 Metres).  
**EARLY MORNING SESSION.**—7.15: Breakfast time hour orchestral music. 8.0: Clock and chimes. 8.1: Orchestral music. 8.30: Weather forecast; close down.  
**MIDDAY SESSION.**—10.0: Women's session, arranged by Miss Dorothea Vautier. 11.35: Musical selections. 12.0 noon: Close down.  
**AFTERNOON SESSION:** 1.0: Orchestral and vocal items. 1.45: Organ recital. 2.0: Close down.  
**EVENING SESSION.**—6.30: Wendy's hour with the children and birthday greetings. 7.15: Music. 7.18: Health talk by T. Gordon Marsden. 7.28: Music. 7.32: Talk on "Sheep" by Mr. B. J. Fallon. 7.50: Music. 7.55: Programme announcements and news from the "Sun." 8.0: Clock and chimes. 8.1: Overture, "Orpheus in Hades." 8.10: Orchestral and vocal concert. 10.15: Close down.

**METAL CABINETS**  
 Finished in Attractive Designs.

Made by  
**HARRY CRABB, LTD.,**  
 261 Riley Street, City.  
 'Phone, FL1887.

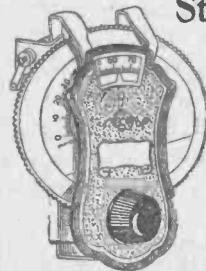

**Stromberg-Carlson**  
**Gear Drive**

THE Stromberg-Carlson Gear Drive is primarily for use with ganged condensers. It is positive in action with truly meshed gears.

The Scale is of heavy celluloid, which is efficiently illuminated from the back by means of a standard 6-volt Lamp, which operates satisfactorily on either 4 or 6 volt circuits. The Escutcheon Plate is of handsome design, finished in old gold, with a Knob of pure brown bakelite. One of the main features of the Stromberg-Carlson gear drive is its sturdy construction, which, together with the fact that it has a precision made gear drive, makes it far more satisfactory for driving ganged condensers than any other type of dial.

Type A. 623, Gear Drive. Complete with Escutcheon, Knob, and Lamp — Dimensions, 4 7/8 x 3 7/8 x 2 in. Price. Weight, 8oz. 15/6

Made in Australia by  
**Stromberg-Carlson (A/sia.), Ltd.,**  
 72-76 WILLIAM ST., SYDNEY.

**Home Set Builders!**

**ELECTRIFY YOUR PRESENT SET FOR £9/10/-**

OR—

**Build your own Electric Set by the SIMPLICITY "3" method for £14/3/9.**

Wiring diagram, subpanel layout diagram, and full particulars simply expressed may be obtained from any Radio store for the asking

**4 GANG CONDENSER**

Each section fitted with trimmer.

**57/6**

**DRESNER SHORT-WAVE KIT**

with world-wide reputation, complete with tuning and reaction condenser and choke.

**32/6**

**SUBURBAN RADIO DEALERS**

We have now arranged to finance our radio sets for you. We take all risk of bad debts and collection. Ask for our representative to call and explain details.

Wholesale Only.

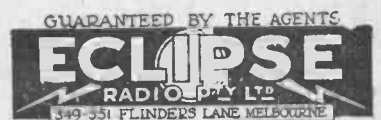

**32 Clarence St., Sydney**  
 'PHONE, B2002.

# Interstate Programmes, Friday, December 27

## 3LO

Australian Broadcasting Co., 129A Russell St., Melbourne (Wavelength, 371 Metres).

### MORNING SESSION.

10.30: Current happenings in Sport, by Mel. Morris. 10.45: Musical reproduction. 11.0: Fish market reports. 11.3: Musical reproduction. 11.30: Description of Sheffield Shield cricket match, Victoria versus New South Wales, at the Melbourne Cricket Ground. 12.0: Time signal. 12.1: Musical reproduction. 12.15: News service. Newmarket stock sales. Associated Stock and Station Agents' official report. 12.30: Close down.

### MIDDAY SESSION.

1.0: Melbourne Observatory time signal. Meteorological information. Weather forecast for Victoria, New South Wales, South Australia, and Tasmania. Ocean forecast. River reports. Rainfall data. 1.15: Comments on the day's news. 1.30: Musical interlude.

### AFTERNOON SESSION.

2.0: Description of Sheffield Shield cricket match—Victoria versus New South Wales—at the Melbourne Cricket Ground. 4.0: By and G. the Confidential Two—"Mean to Me." A Little Syncope. "My Bouquet of Memories." 4.7: Harold Collier, the Mouth-Organ Man, will entertain. 4.12: Tom Masters, tenor "All the World" (Woodford-Pinden). 4.20: The Studio Light Orchestra—Selection from "Wildflower" (Youmans). 4.30: Close Down. During the afternoon reports of Wodonga and Ballarat Miners' Races will be broadcast as they come to hand, also progress scores. Cricket Match, S.A. versus Queensland, at Adelaide Oval, and Victoria v. Tasmania, at Hobart.

### THE CHILDREN'S CORNER.

5.45: Opening Chorus, by "Plain Peter" and "Rolling Rita." A Story for the Little Ones, by "Billy Bunny." The Children's News Bulletin. 6.0: Time Chimes. Paul Jeacle and his Band will play some novelty numbers. A Story for the "Somewhat Older" Ones, by "Billy Bunny." "Plain Peter" and "Rolling Rita" will entertain. 6.25: Birthday Greetings by "Billy Bunny." 6.35: Musical interlude.

### EVENING SESSION.

6.40: Miss Patricia Dawson—Tennis Topics: The Service and Foot-work. 6.55: Musical interlude. 7.0: Melbourne Observatory time signal. 7.1: Countryman's Session—Associated Stock and Station Agents' official report. Fish and rabbit prices. Farm and dairy produce report, supplied by the Interstate Dairy Produce Committee. Wholesale fruit prices, supplied by the Wholesale Fruit Merchants' Association. Retail fruit prices, supplied by the Victorian Fruitgrowers' Association. Citrus fruit prices, supplied by the Victorian Central Citrus Association. Weather synopsis. River reports. Rainfall data. 7.25: H. A. Brown—Gardening: Mulching. 7.40: News service. 7.45: Eric Akin—Motordrome events. 8.0: Time signal.

### NIGHT SESSION.

8.0: The Brunswick City Band—(Conductor: Hugh Niven)—Overture, "Tancred" (Rossini). 8.10: James Riley, tenor—"Eleanore" (Coleridge-Taylor). "The Star" (Rogers). 8.17: Horace Perkins, Mus. Bac—"Colonial Song" (Percy Grainger). "Hungarian Rhapsody No. 12" (Liszt). 8.22: Linda Wald, soprano—"Over the Mountains" (Quilter). "An Eskislay Love Lilt" (Fraser). 8.40: "The Monkey's Love"—A Story in Three Scenes, by W. W. Jacobs, dramatised by Louis N. Parker. Characters: Mr. White, Maurice Dudley, Mrs. White, Mrs. Maurice Dudley; Herbert, Frank Hathery; Sergeant-Major Morris, H. M. Hill; Mr. Sampson, Chas. R. Dyson. Scene: The living-room of an old-fashioned cottage in Fulham. Produced by Maurice Dudley. 9.15: Brunswick City Band—Selection of Plantation Songs (Bourne). 9.25: James Riley, tenor—Two Songs by Easthope Martin—"Wayfarer's Night Song." "The Tune of Open Country." 9.35: Brunswick City Band—Trombone solo, "The Fire-Flly" (Moss). 9.45: Val, soprano—Two Irish Songs, (a) "Has Sorrow Thy Young Days Shaded," (b) "The Lass to Ballybree." 9.55: Brunswick City Band—Fantasia, "Operatic Gems" (arr. Rimmer). 10.0: Anton Mullner—and his Zither. 10.9: Brunswick City Band—Scotch Medley, "Sandy's Prolie" (Sutton); March, "Grove House" (Hume). 10.12: Mel. Morris—will speak on "To-morrow's Remotest at Aspendale Park." 10.22: Anton Mullner—Zither Melodies. 10.30: British Official Wireless News. Meteorological information. Items of interest. 10.40: Paul Jeacle and His Band—Latest Dance Numbers. 11.30: God Save the King.

## 3AR

Australian Broadcasting Co., 129A Russell St., Melbourne (Wavelength, 481 Metres).

### MORNING SESSION

8.15: "Austradio" musical reproduction. 8.45: Weather data. 9.0: G.P.O. chimes. 9.1: News. 9.5: Musical reproduction. 10.0: G.P.O. chimes. 10.1: British official wireless news. 10.10: Announcements. 10.30: Arnold Coleman at the Wuriltzer. 10.50: The daily broadcast service. 11.0: Close down.

### MIDDAY SESSION

12.0: G.P.O. chimes. 12.1: Description of Sheffield Shield cricket match, Victoria v. New South Wales at the Melbourne Cricket Ground. 1.15: Luncheon music, supplied by the Studio Light Orchestra.

### AFTERNOON SESSION

2.30: A chat by a prominent woman. 2.45: Topical chatter—The Flapper and Aunt. 3.0: Studio Light Orchestra—Overture, "The Barber of Seville" (Rossini). 3.3: Phyllis Dickenson, soprano—"Golden

Dancing Days" (Clarke). "The Lass with the Delicate Air." 3.15: J. and G. the Confidential Two—"Song of the Nile"; piano novelty, "Sing a Little Song." 3.22: Studio Light Orchestra—"La Cinq-quantine" (Maxie); song, "Macushla" (McMurragh). 3.30: Tom Masters, tenor—"Love is Waiting" (Squire). "Requiem" (Homer). 3.37: Harold Collier, The Mouth Organ Man, will entertain. 3.3: Phyllis Dickenson, soprano—"Two Brown Eyes" (Grieg). "With a Water Lily" (Grieg). 3.38: Studio Light Orchestra—"A Moorish Serenade" (Chapi). "Andalouse" (Chapi). 4.0: A Woman's Wanderings Through the Empire. Memisahib. 4.15: Description of Sheffield Shield cricket match, Victoria v. New South Wales, at the Melbourne Cricket Ground. 5.30: Weather. 5.40: From the M.C.C.—Description of cricket match resumed. 6.0: Close down.

### EVENING SESSION

6.15: Dinner music, supplied by Paul Jeacle and his Band. 7.30: What's on the air to-night? 7.32: Sporting results. 7.35: Road notes. 7.40: Latest musical releases. 8.0: G.P.O. chimes.

### NIGHT SESSION

8.1: A.I.F. Recollections—Digger Crusaders, Mr. C. Ellis. 8.15: Community singing—Transmission from Geelong, conductor, W. Sampson. 10.20: Weather and news. 10.30: God Save the King.

## 3DB

The "Herald" Broadcasting Station, Flinders Street, Melbourne (Wavelength, 255 Metres).

### MORNING SESSION

11.0: Women's Radio Service—Special Holiday Session, conducted by Miss Iris Turnbull. 12.0: Light Opera Company—"Gems from Maritana." C1693. 12.30: Community Singing, under the auspices of the Prahran Traders' Association—Conductor, Mr. G. J. Mackay; accompanist, Mr. Reg. Brown.

### AFTERNOON SESSION

2.30: London Symphony Orchestra—"Wand of Youth Suite" (Elgar). D 1636. 1637. 1638. 3.0: Peter Dawson, baritone—"Boots" (McCall). B 3072. 3.30: Sousa's Band—"Golden Jubilee." EA 603. 4.0: Close down.

### EARLY EVENING SESSION.

5.0: Philadelphia Symphony Orchestra—"Prelude A Flat Minor" (Bach). D 1464. 5.30: Leviathan Session. 6.30: Joseph Hislop—"My Love is Like a Red Rose." DA 901. 7.0: D'Alba, L. Robin, and Hood—"Of Susanna." EA 309. 7.15: Market reports—John McNamara and Co. Pty., Ltd. 7.20: Lurescia Bori and Lawrence Tibbett—"Calm as the Night." DA 912.

### EVENING SESSION.

8.0: Bridge—Radio Game No. 5. In the "South" is G. H. Levy, K.C. of Hamilton, Ontario; Spades, A Q 5 3 2, Hearts A 10 9, Diamonds 10 8, Clubs J 10 7. On the left of Mr. Levy, in the "West," is Mrs. L. A. Dodsworth, of Charlotte, North Carolina; Spades J 10 8 spot, Hearts 8 spot 4, Diamonds A K Q J 8 spot 6, Clubs A 5. In the "North" opposite Mr. Levy, is his partner, Ralph C. Blessing, of Almont, New York; Spades K 9 7, Hearts K Q J, Diamonds 7 5 2, Clubs K Q 9 2. In the "East," is Mrs. Helen M. Hubbard, of San Francisco, California; Spades 6 4, Hearts 7 6 5 3 2, Diamonds 4 3, Clubs 8 spot 6 4 3. 8.39: Coldstream Guards' Band—"Three D.G.'s." B 1433. 9.0: Franklyn Bauer—"Little Mother." EA 338. 9.30: Shannon Quartette—"Sweet Elaine." Zono. EE 101. 10.0: Jascha Helfetz, violin—"Hebrew Melody." DB 1048. 10.30: Rudy Valle and His Yankees—"My Tune is Your Tune." EA 549. 10.45: News. 11.0: God Save the King.

## 4QG

Queensland Government Radio Service, Brisbane (Wavelength, 385 Metres).

### EARLY MORNING SESSION

7.30 a.m.: News. 7.50: Time. 8.0: Music. 8.15: News. 8.30: Close.

### MORNING SESSION

11.0: Music. 11.5: Social News. 11.15: A cookery talk. 11.30: Music. 11.35: More social news. 11.45: Music. 12.0 (noon): Close down.

### MIDDAY SESSION

1.0: Markets and weather. 1.15: Music. 2.0: Close down.

### AFTERNOON SESSION

3.0: Music. 3.30: Mail train running times. 3.31: Music. 4.15: This afternoon's news. 4.30: Close down.

### EARLY EVENING SESSION

6.0: Mail train running times; mail information; shipping news. 6.5: Music. 6.25: Commercial announcements. 6.30: Bedtime stories, conducted by the "Sandman." 7.0: News in brief. 7.5: Stock Exchange news. 7.6: Metal quotations. 7.7: Market reports. 7.25: Fenwick's Stock report. 7.30: Weather information. 7.40: Announcements. 7.43: Standard time signals. 7.45: To-morrow's sporting fixtures reviewed.

### NIGHT SESSION

A programme by the Brisbane Municipal Concert Band (conductor: E. Jackson). 8.0: Municipal Concert Band—Overture, "Dramatique" (Keler-Bela). The Co-ee Quartet Party—"Southern Memories" (Berquist). E. Drouyn—Saxophone Solo, "Valse Erica" (Wiedoeft). Eileen McLennan, soprano—"Carmena" (Lane Wilson). E. Selby—Trombone solo, "Home Sweet Home." The Band—Fantasia, "Fuletide" (Kappely). S. Yorston, vocalist—"Mate o Mine" (Elliot). W. Dougherty, cornetist—"The Water Witch" (Clay Smith). 9.0: Weather. 9.1: Week-end road information for motorists, officially supplied by the R.A.O.C.

9.10: The Band—Czardas, "Dernier Amour" (Keler-Bela). The Band—"Sweet Thought" (Brooks). Co-ee Quartet Party—"Comrades in Arms" (Adams). Eileen McLennan, soprano—Selected. The Band—Descriptive, "The Belis" (Thurban). The Band—Valse, "Maid of the Mill" (Liddell). C. T. Birbeck, tenor—"Bonnie Mary of Argyle." The Band—Descriptive, "Chinese Temple Bells" (Ketelbey). A. Rickwood, cornetist—"Cavatina, La Regina Di Golconda." The Band—Selection, from "The Orchid" (Caryl and Monckton). 10.0: News. 10.15: The Rhythm Rascals—Entertainers. 11.0: Close.

## 5CL

Central Broadcasters, Ltd., 114 Hindmarsh Square, Adelaide (Wavelength, 409 Metres).

### MORNING SESSION.

During the day descriptions of the interstate cricket—South Australia—will be given. 11.0: Chimes. 11.1: Recordings. 11.45: Kitchen craft and menu talk. 12.1: Recordings. 12.15: News. 12.2: Recordings. 12.52: Railways and weather. 1.1: Piano. 1.15: Recordings. 2.0: Chimes and close.

### AFTERNOON SESSION.

3.0: Chimes. 3.1: Programme review and announcements. 3.4: Recordings. 4.1: Player piano session. 4.45: An educational talk. 4.55: Stock Exchange. 5.0: Close.

### EVENING SESSION.

5.45: Port Adelaide acceptances. 6.0: Chimes. 6.1: Children's happy moments. 6.30: Dinner session. 7.0: Chimes. 7.1: Senior Birthday League greetings. Sporting service—Review of the Port Adelaide Cup and other events to be decided at Cheltenham and Aspendale Park to-morrow. Stock Exchange and market reports. 7.20: "Mo" Manning will give a resume of the cricket. 7.35: Sir David Gordon will give a talk of interest on everybody. 7.45: A talk sponsored by the Australian Dental Association.

### NIGHT SESSION.

8.0: Chimes. 8.1: Programme review and announcements. 8.10: Richard Smith and partner, xylophonist and trombonist (selected). 8.20: The Apollo Radio Mass Choir will entertain. 9.0: Chimes. 9.1: Meteorological information, including semaphore times. 9.2: Overseas grain report. 9.3: Announcements. 9.5: The Apollo Radio Mass Choir will entertain you again. 9.20: Richard Smith and partner, xylophonist and trombonist (selected). 9.30: W. Eckerman, elocutionist, "Aunt Maria Getting Ready for Xmas." "The Sea." 9.40: Pianoforte recital, by Tom King. 9.55: Harold Tidemann, baritone. 10.2: W. Eckerman, elocutionist, "Ladle." 10.9: Harold Tidemann, baritone. 10.15: "The Advertiser" general news service; British Official Wireless news; meteorological information; sporting service. Port Adelaide acceptances. 10.30: Recordings. 11.15: Close down.

## 6WF

Australian Broadcasting Company, Ltd., Wellington Street, Perth (Wavelength, 435 Metres).

EARLY MORNING SESSION.—7.30: Chimes. 7.31: Meteorological report. 7.35: Musical reproduction. 7.55: Mails and shipping intelligence. 8.5: Worldwide cables. 8.10: Musical reproduction. 8.27: Features of to-day's programme. 8.30: Close down.

MORNING SESSION.—10.0: Chimes. 10.1: Musical reproduction. 10.40: Women's interest talk by Dorothy Graham. 10.30: Organ recital from Ambassador's Theatre. 11.0: Close.

MID-DAY SESSION.—12.30: Chimes. 12.31: Musical reproduction. 12.35: Market reports. 12.45: A.B.C. news service. 12.55: Item of interest. 1.0: Weather. 1.1: Luncheon music by the National Broadcasting Orchestra. 2.30: Close.

THE RADIO MATINEE.—3.30: Chimes. 3.31: Musical reproduction. 3.45: A message from the Country Women's Association. 4.0: Special recital of reproduced music. 4.55: What's on the air. 5.0: Close.

EARLY EVENING SESSION.—5.45: Chimes. 5.46: Children's goodnight stories by Uncle Bas and Auntie Maxine. 6.15: A.B.C. Younger Set Session. 6.30: Dinner music. 7.30: Weather. 7.31: News. 7.35: Market reports. 7.40: Stock Exchange. 7.48: Review of to-morrow's sporting fixtures. 7.57: Features of to-morrow's presentation.

EVENING SESSION.—8.0: Chimes. 8.1: "The Optimists broadcast from Coliseum Gardens, Subiaco. 8.50: Sporting anticipations by Russell Sandeman. 9.5: Announcements. 9.10: Description of wrestling contest broadcast from Olympia Gardens. 10.10: Programme of dance music, including the famous Strauss waltz: (reproduced). 11.0: Close down.

## 7ZL

Tasmanian Broadcasters Pty., Bursary Bldg., Elizabeth Street, Hobart (Wavelength, 616 Metres).

During the day descriptions will be given of the interstate cricket match, Victoria v. Tasmania, 11.30 a.m. Columbia broadcasts. 11.34: Midlands weather forecast. 11.55: Tasmanian stations 9 a.m. weather report. 12.01: Shipping information; mail notices; housewives' guide. 12.08: Columbia broadcasts. 12.30: News service; announcements. 12.40: Columbia broadcasts. 1.05: Railway auction sales. 1.10: Columbia broadcasts. 1.30: Close down. 3.01: Columbia broadcasts. 3.4: Weather information. 3.5: Columbia broadcasts. 4.15: Readings. 4.30: Close down. 6.15: Children's corner with "Uncle David." 7.10: Recorded music. 7.30: News session. 7.40: An hour with Joseph Hislop, tenor, and Geraldine Farrar, soprano (interspersed with instrumental numbers). 8.45: James Counsel, "The History and Development of Music." 8.45: News. 10.01: Close down.



## Local Programmes, Saturday, December 28

### 2FC

Australian Broadcasting Company, Ltd., Market St., Sydney (Wavelength, 457 Metres).

#### EARLY SESSION—7 to 8.15 a.m.

- 7.0: "Big Ben" and Meteorological information for the man on the land.
- 7.3: This morning's news from the "Sydney Morning Herald."
- 7.8: Austradio Musical Reproduction.
- 7.45: Mails and shipping.
- 7.48: What's on to-day?
- 7.50: Children's Birthday Calls.
- 8.0: Music from the Studio.
- 8.10: Condition of the Roads, supplied by the Main Roads Board.
- 8.15: CLOSE.

#### MORNING SESSION—AFTERNOON SESSION.

- 10.30: Announcements.
  - 10.32: A.B.C. Racing Observer.
  - 10.45: Studio Music.
  - 11.0: HOUSEHOLD HELPS—Week-end suggestions, by Miss Ruth Furst.
  - 11.10: CABLES (Copyright). A.P.A. and Sun-Herald News Service.
  - 11.15: Austradio Musical Reproduction.
  - 11.53: British Official Wireless Press.
  - 12.0: "Big Ben," Stock Exchange, and Metal Quotations.
  - 12.5: Studio Music.
  - 12.20: Midday weather forecast and weather synopsis.
  - 12.30: Austradio Musical Reproduction.
  - 12.50: FROM RANDWICK—Description of the Tattersall's Club Meeting in the running.
- NOTE.—Progress Results of the Cricket Matches, South Australia v. Queensland, at Adelaide, and Victoria v. N.S.W., at Melbourne, will be transmitted as received. During the intervals between races a programme of musical items will be broadcast from the Studio.

- 4.35: FROM THE STUDIO—Late Sporting Results.
- 4.45: CLOSE.

#### EARLY EVENING SESSION—5.45 to 7.55 p.m.

- 5.45: Children's "Good-night" Stories, told by the "Hello Man," assisted by Aunt Willa and Cousin Gwen.
- 6.45: Dinner Hour Music by the Light Orchestra.
- 7.20: A.B.C. Sporting Service.
- 7.30: Special Country Session. Stock Exchange Resume. Weather Forecast. Late news from the "Sun" and "News."
- 7.58: To-night's Programme.

#### THE EVENING PRESENTATION—8.0 to 11.30 p.m.

- 2FC's programme to-night will find favor with many holiday makers, who, after a day on the beaches, turn with real pleasure to a bright evening's entertainment on the air which is easy to listen to. The Mirthquakers are here to-night, in sparkling revue; Peter and Priscilla have something entirely new to offer; and the Mellow Fellows in song and story, will create fresh interest. A short description from the Speedway will prove yet another interesting feature of our evening's presentation.
- 8.0: THE MIRTHQUAKERS in a new Revue.
  - 8.15: CARLTON FAY, Novelty Pianist—(a) "Marilyn" (b) "Fire Crackers."
  - 8.22: PETER AND PRISCILLA, in Unusual Humor.
  - 8.32: TOM WILLIAMS, Violinist.
  - 8.39: THE MELLOW FELLOWS, IN SONG AND STORY.
  - 8.49: FROM THE SPEEDWAY: Description of the races.
  - 9.4: FROM THE STUDIO: THE COUNTRY MAN'S WEATHER SESSION—(a) New South Wales Forecasts. (b) Inter-State Weather Synopsis. Yachtsman's and Fisherman's Forecast.
  - 9.6: THE MIRTHQUAKERS continue their fun.
  - 9.21: CARLTON FAY, Novelty Pianist. (a) "The Toymaker's Dream." (b) "Kewpie."
  - 9.29: THE MELLOW FELLOWS—FURTHER BRIGHT CAPTIONS.
  - 9.39: TOM WILLIAMS, Violinist.
  - 9.46: FROM THE SPEEDWAY: Description of the races.
  - 10.1: FROM THE BALLROOM OF THE ORIENTAL—Sydney Simpson's Syncopaters in Dance Music.
  - 10.15: FROM THE STUDIO—Announcements. Late official weather forecast.
  - 10.20: FROM THE BALLROOM OF THE ORIENTAL—Sydney Simpson's Syncopaters in Dance Music.
  - 11.30: CLOSE. NATIONAL ANTHEM.

### 2BL

Australian Broadcasting Company, Ltd., Market St., Sydney (Wavelength, 353 Metres).

#### OPENING SESSION—8.15 to 11 a.m.

- 8.15: G.P.O. Chimes and Announcements.
  - 8.16: Music for every Mood.
  - 8.40: Meteorological data for the country.
  - 8.45: Mails and Shipping Information.
  - 8.50: Memory Melodies.
  - 9.0: This Morning's Story.
  - 9.30: A Musical Interlude.
  - 9.40: British Official Wireless Press.
  - 9.45: New Music.
  - 10.5: News from the "Sydney Morning Herald."
  - 10.10: Austradio Musical Reproduction.
  - 10.40: MR. G. COOPER, Park Superintendent of City Parks, will speak on "GARDENING."
  - 11.0: G.P.O. Chimes. Close Down.
- #### MIDDAY AND AFTERNOON SESSIONS—12 Noon to 5.15 p.m.
- 12.0: G.P.O. Chimes and Announcements.
  - 12.2: A Pianoforte Recital.
  - 12.30: LUNCH MUSIC
  - 1.0: Afternoon news from the "Sun" and

#### "News."

- 1.5: Austradio Musical Reproduction.
  - 1.30: A Pianoforte Recital.
  - 2.0: Music grave and gay.
- NOTE.—During the afternoon sporting descriptions will be given, and in the intervals, from the Studio, music by the Light Orchestra.
- 5.0: Complete Racing and Sporting Resume.
  - 5.15: G.P.O. Chimes. Close Down.

#### THE DINNER HOUR—6.15 to 7.55 p.m.

- 6.15: DINNER MUSIC by the LIGHT ORCHESTRA.
- 6.45: "THE CAPTAIN" to his Comrades.
- 7.0: The A.B.C. Sporting Service.
- 7.20: Dinner Music, by the LIGHT ORCHESTRA.
- 7.45: Austradio Musical Reproduction.
- 7.55: What's on the air to-night?

#### TO-NIGHT'S PRESENTATION—8 to 12 midnight.

- While we are awaiting to cross to the Sydney Stadium to-night for the description of the fight, Con Moreni and Dolly Varni are here to entertain us, and "New Lamps for Old" will provide an unusual and interesting feature. There are solos by the Janetski Trio, princes of the Xylophone, and comedy songs by Charles Sadler. Later in the evening, Cec. Morrison and his Band, will please dancing enthusiasts.
- 8.0: THE JANETSKI TRIO—Princes of the Xylophone.
  - 8.10: CON MORENI AND DOLLY VARNI, Entertainers—(a) "Sunshine" (Berlin). (b) "Days Gone By."
  - 8.20: NEW LAMPS FOR OLD.
  - 8.30: CHARLES SADLER, Comedy Songs—(a) "Hello Prosperity" (Bratton). (b) "Broadway Babies" (Swanstrom and Morgan).
  - 8.37: FROM THE SYDNEY STADIUM: Description of the fighting contest.
  - 9.37: FROM THE STUDIO—Weather information for the man on the land.
  - 9.39: CON MORENI AND DOLLY VARNI, Entertainers—"Oh, Amelia" (Croft).
  - 9.49: THE JANETSKI TRIO—Princes of the Xylophone.
  - 9.59: CEC. MORRISON AND HIS BAND.
  - 10.9: CHARLES SADLER, Comedy Songs—(a) "Flappers" (Clifford). (b) "Old King Tut" (Von Tilzer).
  - 10.16: CEC. MORRISON AND HIS BAND.
  - 10.25: Late news from the "Sun" and "News." Late weather forecast.
  - 10.30: CEC. MORRISON AND HIS BAND.
  - 12.0: CLOSE. NATIONAL ANTHEM.

### 2GB

Theosophical Broadcasting Station, 29 Bligh St., Sydney (Wavelength, 316 Metres).

- 3.0: Musical session.
- 5.15: Children's session by Uncle George.
- 6.50: M.-G.-M. Radio Movie Club session.
- 7.0: Musical's request hour.
- 8.0: Sutton's musical session.
- 10.30: Close down.

### 2UW

Radio Broadcasting, Ltd., Pallings Building, Ash St., Sydney (Wavelength, 267 Metres).

- 5.30 p.m.: Children's Hour, conducted by Uncle Jack.
- 6.30: Close.
- 7.0: Musical Programme.
- 10.30: Close.

### 2UE

Broadcasting Station 2UE, Everett Street, Maroubra, Sydney (Wavelength, 293 Metres).

- EARLY MORNING SESSION.—As usual.
- AFTERNOON SESSION.—12.0: Broadcast description of races, with musical selections.
- 5.0: Close down.
- EVENING SESSION.—6.30: Wendy's hour with the children, and birthday greetings.
- 7.15: Music.
  - 7.19: Turf talk by Mr. T. Hopkins, turf expert.
  - 7.45: Music.
  - 7.55: Announcements and news from the "Sun."
  - 8.0: Clock and chimes.
  - 8.1: Overture, "La Traviata" selections.
  - 8.11: Vocal and instrumental items.
  - 8.30: Greetings.
  - 10.15: Close down.



Mica Moulded and  
Genuine Mansbridge

## CONDENSERS



The most dependable Condensers in the World. Known and used everywhere because of their Reliability and Efficiency.



All T.C.C. Condensers are subjected to a "Per-iod" Test instead of the mere "Flash" Test frequently used.

Permanent, Accurate,  
Calibrated, Guaranteed.

ALL RADIO DEALERS

(W—McF.)

# Interstate Programmes, Saturday, December 28

## 3LO

Australian Broadcasting Co., 120A Russell St., Melbourne (Wavelength, 371 Metres).

### EARLY MORNING SESSION.

7.0 to 8.5: As usual (see Friday).

### MORNING SESSION.

10.30 to 12.30: As usual. 10.30: Cricket.

### MIDDAY SESSION.

1.0 to 1.30: As usual.

### AFTERNOON SESSION.

2.0: Description of Sheffield Shield Cricket Match—Victoria v. New South Wales—at the Melbourne Cricket Ground. 2.13: Description of Hurdle Race, 2.20 miles, Ascendale Park Races, by Mel. Morris. 2.20: Description of Sheffield Shield Cricket Match—Victoria v. New South Wales—at the Melbourne Cricket Ground. 2.43: Description of Two-year-old Handicap, five furlongs, Ascendale Park Races. 2.50: Description of Sheffield Shield Cricket Match—Victoria v. New South Wales—at the Melbourne Cricket Ground. 3.13: Description of Ascendale Plate, six furlongs, Ascendale Park Races. 3.20: Description of Sheffield Shield Cricket Match—Victoria v. New South Wales—at the Melbourne Cricket Ground. 3.43: Description of Ascendale Park Handicap, one mile and a quarter, Ascendale Park Races. 3.50: Description of Sheffield Shield Cricket Match—Victoria v. New South Wales—at the Melbourne Cricket Ground. 4.0: Melbourne Observatory time signal. Sporting results to hand. 4.5: Musical interlude. 4.13: Description of Ascendale Horse, six furlongs, Ascendale Park Races. 4.20: Description of Sheffield Shield Cricket Match—Victoria v. New South Wales—at the Melbourne Cricket Ground. 4.43: Description of Trial Welter, seven furlongs, Ascendale Park Races. 4.50: Description of Sheffield Shield Cricket Match—Victoria v. New South Wales—at the Melbourne Cricket Ground. 5.0: Sporting results to hand, from the Studio. 5.10: Description of Cricket Match (continued). 6.0: Stumps scores. During the afternoon progress scores of cricket matches in South Australia v. Queensland, at Adelaide, and Victoria v. Tasmania, at Hobart, will be broadcast as they come to hand.

### THE CHILDREN'S CORNER.

6.5: "Little Miss Kookaburra" opens proceedings with some hearty laughter. The story to-night is "New Year Fairy Story." 6.20: Birthday Greetings by "Little Miss Kookaburra."

### EVENING SESSION.

6.40: Sporting results. 7.0: Melbourne Observatory time signal. 7.1: Countryman's Session. 7.25: Mr. Earl Cooper—Aviation. Life-saving in the Air with the Parachute. 7.45: Mr. E. J. G. Esmond—Adventuring Round the World: Episodes of the R.N.W.M.P. 8.0: Melbourne Observatory time signal.

### NIGHT SESSION.

8.0: "Little Bo Peep." Specially written and compiled for broadcasting by George English and Hugh Huxham. (Produced by Hugh Huxham.) A merry mixture of jokes, songs, topicalities. Act I. 8.0: National Broadcasting Orchestra—Overture, "Morning, Noon, and Night" (Surine). Scene I, "The Demon King's Lair." Scene II, "The Market Place." Scene III, "In Toyland." A description of to-night's events at the Grand Theatre. From the Studio—Act II. Scene IV, "The Village." Scene V, "The Dame's Cottage." Scene VI, "At the Fancy Dress Ball. More Sport: A description of to-night's events at the Exhibition Oval. From the Studio—News Session. 10.30: British Official Wireless News. Items of Interest. Meteorology. Information. 10.40: From the Plaza Ball-room. St. Kilda—Paul Jarrold and His Band—Latest Dance Music. 11.30: God Save the King.

## 3AR

Australian Broadcasting Co., 120A Russell St., Melbourne (Wavelength, 481 Metres).

### MORNING SESSION

8.15 to 11: As usual (see Friday).

### MIDDAY SESSION

12.0: G.P.O. chimes. 12.1: Description of Sheffield Shield cricket match—Victoria v. New South Wales, at the Melbourne Cricket Ground. 1.18: Luncheon music supplied by the Studio Light Orchestra. 2.30: Wonder Cities of the Past. Dr. E. Sweetman, M.A., Litt.D.

### AFTERNOON SESSION

2.40: Tribes and Castes of Bengal. Mr. A. A. Downs. Radio Matinee—3. Paul Jeacle and his Band—"I Love You, I Hate You" (Bryan), "Dawning" (Silver). 3.0: Ruby Davidson, soprano—"At D'awning" (Cadmam). "Big Lady" (Coleridge Taylor). 3.13: Paul Jeacle, saxophone—"Saxony" (own composition). 3.17: The Two Dales—Stop Press Topicalities. 3.27: Paul Jeacle and his Band—"F. Schmette" (King), "I'm More than Satisfied" (Walker). 3.33: Roy Simpson, bass—"Friend of Mine" (Sanderson), "Maire My Girl" 3.41: Comedy sketch "The Lunatics." Characters: He, Brandon Cremer; She, Gertie Cremer. Scene: Ante-room in a Lunatic Asylum. 4.0: Paul Jeacle and his Band—"In the Middle of the Night" (Rose), "Telling the World We're in Love" (Whiting). 4.5: Jack Kearns, comedian, will agitate, cogitate, and ruminate. 4.53: Paul Jeacle and his Band—"Painting the Clouds with Sunshine" (Burke), "Piccolo Pete" (Baxter), "Pa's Old Hat" (Guy). 5.0: Chimes. 5.1: Musical reproduction. 6.30: Weather. 5.45: Close.

4.45: Jack Kearns, comedian, will agitate, cogitate, and ruminate. 4.53: Paul Jeacle and his Band—"Painting the Clouds with Sunshine" (Burke), "Piccolo Pete" (Baxter), "Pa's Old Hat" (Guy). 5.0: Chimes. 5.1: Musical reproduction. 6.30: Weather. 5.45: Close.

### EVENING SESSION

6.15: Dinner music, supplied by the Studio Light Orchestra. 7.30: What's on the air to-night? 7.32: Sporting results. 7.40: Latest musical releases. 8.0: Chimes.

### NIGHT SESSION

8.0: Transmission from St. Paul's Cathedral—Special carol service. 9.20: Coburg City Band—Waltz, "Waves of the Danube." 9.30: Etta Bernard, contralto—"O, Night of Stars and Splendor" (Thompson), "Gospling" (Dodge). 9.37: Coburg City Band—Cornet solo, "A Perfect Day" (Bond). 9.40: One-act play, "Deceivers," produced by Frank Hatherley. Characters—Amos Little, Frank Hatherley, Flora Little, Irene Burke; Phil "The Mink," Archibald Leslie. 9.55: Coburg City Band—Intermezzo, "Handel Wakes" (Morrissey). 10.0: Weather; news. 10.10: Shirley Cook, songs at the piano—"Do I Like Love," "Little Pal." 10.17: Coburg City Band—Selection. "Convivial Songs" (Le Duc). 10.27: Etta Bernard, contralto—"By the Waters of Minnetonka" (Lieurance), "The Silver Ring" (Chaminade). 10.34: Coburg City Band—Euphonium solo, "Land of Hope and Glory" (Eagar). 10.40: Shirley Cook, songs at the piano—"Oh, the Waltz," "That's a Good Girl." 10.50: Coburg City Brass Band—Selection. "Community Land." 11.0: Rex Dance Band. 12.0: God Save the King.

## 3DB

The "Herald" Broadcasting Station, Flinders Street, Melbourne (Wavelength, 355 Metres).

### AFTERNOON SESSION.

2.0: Philadelphia Symphony Orchestra—"Carmen. Prelude, Act I." E 531. 2.30: Paul Robeson—"Rock Me, Julie." B 3033. 3.0: Ignacio Jan Paderewski—"Valse Caprice." DB 1273. 3.30: Grand Opera Company—"Tales of Hoffman." C 1641. 4.0: Jesse Crawford—"Why Can't You?" EA 584. 4.30: Wain's Pennsylvanians—"When My Dreams Come True." EA 322. 5.0: Berlin State Opera Orchestra—"Polonaise No. 2." D 1625.

### EARLY EVENING SESSION.

5.30: Leviathan Session. 6.30: Niesha Lewitski—"Organ Prelude, D. 1919." Nat. Shikler and His Orchestra—"Lady Divine." EA 531. 7.15: Market Reports—John McNamara and Co., Pty., Ltd. 7.20: De Groot, David Bor, and H. M. Calve—"Londonderry Air." B 2943.

### EVENING SESSION.

8.0: Creator's Band—"Semiramide Overture." C 1420. 8.30: Eddie Cantor—"Makin' Whoonee." EA 538. 9.0: Royal Opera Chorus and Orchestra—"Opening Chorus Boris Godunov." C 1567. 9.30: Nat. Shikler and His Orchestra—"One for All." EA 524. 10.0: Ivar Andresen, bass—"O Isis and Osiris." C 1625. 10.30: Chick Endors—"When the World is at Rest." EA 408. 10.45: News. 11.0: God Save the King.

## 4QG

Queensland Government Radio Service, Brisbane (Wavelength, 383 Metres).

Early Morning Session: As usual. No. morning session. No mid-day transmission. Afternoon session, as usual. Early Evening session, as usual.

### NIGHT SESSION

8.0: The Studio Orchestra—Dance music. Two Sad Sunbeams, entertainers. Millicent Nagel—At the piano, in popular numbers. Phyllis Verner, soprano—"June Music" (Trent). The Aloha Novelty Trio—Hawaiian melodies. The Studio Orchestra. 9.0: Weather. The Studio Orchestra—Dance music. Phyllis Verner, soprano—"The Bitterness of Love" (Dunn). Millicent Nagel—At the piano. The Aloha Novelty Trio—Hawaiian music. The Studio Orchestra—Dance music. 10.0: News, weather. Close.

## 5CL

Central Broadcasters, Ltd., 714 Hindmarsh Square, Adelaide (Wavelength, 409 Metres).

### AFTERNOON SESSION.

A description of the cricket—South Australia v. Queensland—will be given. 12.0: Chimes. 12.1: Special late selections for races at Ascendale Park. 12.5: Probable starters and selections for to-day's races at Cheltenham. 12.15: News. 12.35: Cheltenham—Riders and positions for Alberton Hurdle Race, about 2 1/2 miles. 12.40: News. 12.50: Running description of the Alberton Hurdle Race by

of Ascendale Park and Cheltenham race results. 1.15: Riders and positions for the Port Adelaide Cup. 1.30: Running description of Oaklands Plate. 1.55: Riders and positions for the Port Adelaide Cup. 1 mile 6 furlongs and 74 yards. 2.0: Resume of Ascendale Park and Cheltenham race results. 2.10: Running description of Port Adelaide Cup. 2.35: Riders and positions for Steeplechasers' Flat Race. 1 1/4 m. 2.50: Running description of Steeplechasers' Flat Race. 3.1: Resume of Ascendale Park and Cheltenham race results. 3.15: Riders and positions for the Bonson Quality Stakes, 6 1/2 furlongs. 3.30: Running description of Woodville Handicap. 4.55: Resume of Ascendale Park and Cheltenham race results. 5.0: Close down.

### EVENING SESSION.

6.0: Chimes. 6.1: Resume of Port Adelaide and Ascendale Park race results. 6.2: Children's happy moments. 6.15: Children's request numbers. 6.30: Dinner session. 7.1: Senior Birthday League greetings. 7.2: Announcements. 7.10: Rev. G. E. Hale, B.A., will speak on "Let Bygones be Bygones." 7.25: Mr. C. G. Riley will speak on "Items of Interest." 7.40: Sporting advice, including a resume of Port Adelaide and Ascendale Park race results; yachting, cricket, tennis, athletics, and other sporting results.

### NIGHT SESSION.

8.0: Chimes. 8.10: A special programme has been arranged. 10.20: Sporting service. 10.30: Recordings. 11.15: Close down.

## 6WF

Australian Broadcasting Company, Ltd., Wellington Street, Perth (Wavelength, 435 Metres).

Day sessions as usual. See Friday.

EVENING SESSION.—Results of Perth trotting meeting will be broadcast immediately received. 8.0: Chimes. 8.1: Musical reproduction. 8.2: Description of motor cycle events broadcast from Speedway meeting, Claremont. 8.22: Musical reproduction. 8.32: Description of motor cycle events from Speedway. 8.42: Musical reproduction. 8.52: Description of motor cycle events broadcast from Speedway. 9.0: Announcements. 9.5: Trotting results resume. 9.8: Musical reproduction. 9.15: Description of motor cycle events from Speedway. 9.25: Musical reproduction. 9.35: Description of motor cycle events broadcast from Speedway. 9.45: Musical reproduction. 9.55: Description of motor cycle events, broadcast from Speedway. 10.0: What's on the air to-morrow. 10.5: Temple Court Dance Band, conducted by Merv. Lyons. 10.59: Weather. 11.0: Close down.

## 7ZL

Tasmanian Broadcasters Pty., Bursary Bldg., Elizabeth Street, Hobart (Wavelength, 516 Metres).

During the morning descriptions will be given of the interstate cricket match, Victoria v. Tasmania. 11.20 a.m.: Record recital. 11.34: Midlands weather forecast. 11.35: Record recital. 11.55: Tasmanian stations 9 a.m. weather report. 12.1: Shipping information; mail notices; housewives' guide. 12.08: Record recital. 12.30: News service; announcements. 12.40: Record recital. 1.6: Railway auction sales. 1.10: Record recital. 1.30: Close down. 3.15: Transmission from T.O.A. Ground, interstate cricket match, Victoria v. Tasmania, described by Syd. Jones. 5.10: All sporting results to hand. 5.15: Close down. 6.10: All sporting results. 6.25: Children's corner, with "Uncle David." 7.10: Recorded music. 7.40: Roy Johnson will speak on "Manual Trainings." 7.50: J. M. Gounsel will speak on "European Affairs." Record recital. 8.15: Request numbers. 10.30: Close down.

## 7ZL

### Wednesday, January 1

Tasmanian Broadcasters Pty., Bursary Bldg., Elizabeth Street, Hobart (Wavelength, 516 Metres).

11.30: Recital. 11.34: Midlands weather forecast. 11.35: Adeline Eager will speak on "Household Hints." 11.50: Sonora recital. 11.55: Weather report. 12.1: Shipping information; mail notices; housewives' guide. 12.8: Sonora recital. 12.30: News service; announcements. 12.40: Sonora recital. 1.5: Railway auction sales. 1.10: Recital. 1.30: Close down. 3.1: Recital. 3.4: Weather. 3.5: Sonora recital. 3.45: Mrs. G. Rycroft will speak on "Some Topics." 4.0: Recital. 4.15: An educational talk on "Chemicals—Synthetic Nitrogen." 4.30: Close down. 6.15: Children's corner with "Uncle David" and "The Story Lady." 7.10: Recorded music. 7.30: News session. 7.40: Belle St. Lawrence will continue her "Travel Talks." 7.50: W. E. Fuller will speak on "Literary Lapses and Library Lists." 8.1: Sonora recital. 8.15: Transmission from the City of Hobart; dance numbers by Theo. Pipkin and his orchestra. 12.1: New Year greetings. 12.5: Close

## Local Programmes, Sunday, December 29

### 2FC

Australian Broadcasting Company, Ltd., Market St., Sydney (Wavelength, 451 Metres).

**THE CHURCH HOUR—10 a.m. to 12.30 p.m.**  
10.0: Announcements.

10.5: Studio Music.

10.30: This Morning's News from the "Sunday News," "Sunday Times," and "Truth." British Official Wireless Press.

10.45: Musical Items.

11.0: **FROM BALMAIN METHODIST MISSION—Morning Service.**

Minister: Rev. S. W. McKibben.

Conductor: Mr. A. H. May.

Organist: Mrs. Denham.

Organ Solo, "Largo" (Handel).

Hymn.

Prayer.

Solo. Mr. A. H. May. "Throne of Grace" (Bonheur).

Psalm.

Hymn.

Lesson.

Children's Choir.

Children's Talk.

Announcements—Collection.

Anthem. "I Waited Patiently" (Jarman).

Hymn.

Address—Rev. S. W. McKibben.

Hymn.

Benediction.

Organ.

12.15: **FROM THE STUDIO—Studio Music**

12.30: **CLOSE.**

**AFTERNOON CONCERT—3 p.m. to 4.30 p.m.**

3.0: **FROM THE CENTRAL METHODIST MISSION, LYCEUM HALL—Pleasant Sunday Afternoon Programme.**

Doxology.

Prayer.

Remarks.

Baritone Solo—Norman Williams.

Contralto Solo—Florence Smith.

Floccutionist—Bessie Wrigley.

Soprano Solo—Amy Firth.

Offertory.

Organ Solo—Constance Bardsley, L.T.C.L.

Address—"A Bird's Eye View of World Progress During 1929," Mr. C. Brunson Fletcher (Editor-in-Chief, "Sydney Morning Herald").

Acknowledgments.

Anthem. Benediction.

4.30: **CLOSE.**

**EVENING PROGRAMME—6 to 10.30 p.m.**

6.0: **A PROGRAMME OF OLD ITALIAN and FRENCH MUSIC**, arranged by Madame Evelyn Grieg, in association with Minna Weidele. Contralto: Veta Wareham, Violinist; and Norman Martin, Cellist.

**VIOLIN SOLO—VETA WAREHAM—**"Concerto in A Minor" (Vivaldi) (1660-1743).

**OLD SONGS IN ITALIAN—MINNA WEIDELLE—**

(a) "O del mio dolce ardor" (O Thou My Sweet Love) (Gluck).

(b) "Per la gloria d'adorati" (With Glorine Adoring Thee) (Buononcini) (1672-1760).

(c) "Ogni sabbato arrete" (Every Sabbath Thou Shalt Have a Lighted Candle) (Geordiniani).

**PIANOFORTE—MADAME EVELYN GRIEG—**

"Minuet" (Boccherini).

**VIOLONCELLO—NORMAN MARTIN—**"Sonata" (Marcello) (1642-1720) (1st Movement Andante and Allegro).

6.40: **AN ADDRESS BY W. J. CLEARY.**

7.0: **CONTINUATION OF THE OLD ITALIAN PROGRAMME**, arranged by Madame Evelyn Grieg. Special Feature—Old Italian Folk Songs, accompanied by the Lute.

**VIOLONCELLO—NORMAN MARTIN—**"Sonata" 2nd and 3rd Movements. "Largo and Allegro" (Marcello).

**ITALIAN FOLK SONGS with LUTE ACCOMPANIMENT—MINNA WEIDELLE—**

(a) "Avattro cavaj che trothano" (Four Horses Trotting).

(b) "Quando Rosa torno dal village" (As Rosa Returned from the Village).

(c) "Ti Cuccu" (The Cuckoo).

**PIANOFORTE—MADAME EVELYN GRIEG—**

"A Study" (Scarlatini).

**VIOLIN—VETA WAREHAM—**

(a) "Rigaudon" (Rameau) (1683-1764).

(b) "Chanson Louis XIII. and Pavane" (Couperin) (1668-1733).

7.40: **THE STORYTELLER tells a Tale.**

8.0: **A CLASSIC PROGRAMME**, arranged by HOWARD CARR, Guest Conductor of the National Broadcasting Orchestra, featuring his own compositions—

Intermezzo, "The Crystal Gazer."

Idyll, "The Singing Stream."

Song, "Dorothy's a Buxom Lass" (Traditional air, arr. by Howard Carr).

Raymond Beatty. Howard Carr at the piano.

Reverie, "Bygone Days" (Hawkes).

Intermezzo, "The Crimson Fan."

Traditional Song, "My Johnny Was a Shoemaker" (Arr. Howard Carr), sung by Vera Dearsley.

Selections from Carr's Cinemusic (Designed for fitting screen situations).

1. Two Humorous Fragments—"Pranks" and "Chuckles"

2. Two Dramatic Episodes—"The Hungry Heart," "Hell Hath No Fury."

8.30: **THE ASHFIELD DISTRICT BAND—**

(a) Cornet Duet. "Sandy and Jock" (Sulton).

Soloists: Messrs. A. Herron and E. Mijler.

(b) Selection, "Zampa" (Herold).

8.45: **BRUNTON GIBB—**

"A Few Bars in the Key of G" (Osborne).

9.0: **THE ASHFIELD DISTRICT BAND—**

(a) Overture, "La Militaire" (Raymond).

(b) Love Lyrics—

(a) "Temple Bells" (Amy Woodforde Flinden).

(b) "Less Than the Dust" (Amy Woodforde Flinden).

(c) "The Kashmiri Song" (Amy Woodforde Flinden).

(d) "Till I Wake" (Amy Woodforde Flinden).

9.15: **SENIA CHOSTIAKOFF, Russian Baritone.**

9.22: **THE ASHFIELD DISTRICT BAND—**

(a) Zylphone Solo, "Two Little Imps" (Alford).

Soloist, Mr. G. Jackson.

(b) Selection, "The Bohemian Girl" (Balfe).

9.37: **SENIA CHOSTIAKOFF, Russian Baritone.**

9.45: **THE ASHFIELD DISTRICT BAND—**

(a) March, "Simplicity" (Hume).

(b) Fantasia, "Scottish Beauties" (Greenwood).

(c) March, "The Australasian" (Rimmer).

9.50: **MEDITATION MUSIC.**

10.30: **CLOSE.**

"NATIONAL ANTHEM."

### 2BL

Australian Broadcasting Company, Ltd., Market St., Sydney (Wavelength, 353 Metres).

**MIDDAY SESSION—10.55 to 3 p.m.**

10.55: Announcements.

11.0: **FROM THE UNITARIAN CHURCH, HYDE PARK—**

Organ Voluntary: MR. S. V. CLUTSAM.

Hymn 37: "Father of World and Soul."

Short Prayer and Lord's Prayer.

Duet: "Love Divine" (Stainer), MISS A. B. HARRIS (Soprano) and MR. J. SCOTT ROSS (Tenor).

Lesson.

Hymn 98, "Father, Let Thy Kingdom Come."

Lesson.

Announcements.

Hymn 55: "Ring Out the Want, the Care Therein."

Sermon: IS AUSTRALIA DRIFTING? Hymn 56: "To Thee, Great Lord, Our Country."

Benediction.

12.15: **FROM THE STUDIO—Musical Items.**

12.30: News from "The Sunday Sun," "The Sunday Times," and "Truth."

12.38: A specially arranged programme of instrumental music.

2.15: "Cheer-up" Session conducted by Uncle Frank.

2.45: Austradio Musical Reproduction.

3.0: Close down.

**LATE AFTERNOON—4.30 to 6 p.m.**

4.30: **FROM THE CHRISTIAN SCIENCE CHURCH—**

Organ Recital by G. VERN BARNETT.

(a) "Canzona" (Wolstenholme).

(b) "Allgro Pomposo" (West).

(c) "Walter's Priesled" (Wagner).

4.45: **FROM THE STUDIO—MISS LE BRUN BROWN, Soprano.**

(a) "A Sea Lullaby" (German).

(b) "Hindu Slumber Song" (Ware).

4.52: **FROM THE CHRISTIAN SCIENCE CHURCH**

Organ Recital by G. VERN BARNETT—

"Messiah" Excerpts (Handel).

(a) Chorus, "Lift Up Your Heads."

(b) "Pastoral Symphony."

(c) "Hallelujah Chorus."

5.12: W. F. KAY will speak

5.27: **FROM THE CHRISTIAN SCIENCE CHURCH.**

Organ Recital by G. VERN BARNETT—

(a) "Romance in A Flat" (Arensky).

(b) "Prelude in C Sharp Minor" (Rachmaninoff).

(c) "Intermezzo in D Flat" (Hollins).

5.43: **FROM THE STUDIO. MISS LE BRUN BROWN, Soprano—**

(a) "The Reed Player" (Bantock).

(b) "Home Thoughts" (Bantock).

5.49: **FROM THE CHRISTIAN SCIENCE CHURCH.**

Organ Recital by G. VERN BARNETT—

(a) "Prayer and Cradle Song" (Guilmant).

(b) "Cathedral Music" (Wareing).

(c) "March in D" (Croft-Vern Barnett), by request.

**EVENING SESSION—6 to 10 p.m.**

6.0: For Children in Hospital. Session conducted by Uncle Steven, and assisted by Aunt Goodie and Cousin Marjorie.

6.50: Organ Music.

7.0: **FROM ST. STEPHEN'S CHURCH.**

Evening Service, conducted by Rev. Hugh Paton—

Doxology.

Invocation.

Hymn 88.

Lesson: 1 Samuel, 7.

Prayer.

Hymn 365.

Lesson: 2 Timothy, 4.

Anthem.

Prayer.

Hymn 71.

Sermon: "LOOKING BACK." Preacher, Rev. Hugh Paton.

Prayer.

Hymn 191.

Benediction.

8.30: **FROM THE STUDIO—**HOWARD CARR, Guest Conductor, in the National Broadcasting Orchestra, in a programme of his own compositions.

**NAUTICAL SUITE, "On the Briny"—**

1. A Last Step with Polly and Sal.

2. The Chantey Man's Song.

3. The Sentimental Bo'sun.

4. Jolly Sea Dogs.

**PRELUDE, "The Shrine in the Wood." SONG, "Oh, for a Husband"**

(Traditional Air, arranged by Howard Carr) Sung by VERA DEARSLEY, with HOWARD CARR at the piano.

**REVERIE FOR STRING ORCHESTRA—"A Bedtime Tale."**

**TRADITIONAL SEA SONG** (arr. by Howard Carr)—

"Ben Backstay," Sung by RAYMOND BEATTY.

**MOORISH DANCE.**

9.0: A Talk by MICHAEL SAWTELL.

9.15: **PROGRAMME ARRANGED BY HOWARD CARR—**

**BALLET SUITE, "The Carnival of the Elements":**

1. Air.

2. Earth.

3. Water.

4. Fire.

**SONG FROM "THE LILAC DOMINO"—**

"For Your Love I Am Waiting." Sung by VERA DEARSLEY, accompanied by the Composer.

**YORKSHIRE PATROL, "Bah Goom" (If that does owt for nowt, do it for the sea).**

ROMANCE, "The Trysting Tree."  
 TRADITIONAL SONGS (arr. Howard Carr)—  
 "A Jug of This."  
 "High Barbaree."  
 Sung by **RAYMOND BEATTY**.  
 GRACEFUL DANCE, "The Chiffon Frock."  
 SKETCHES FOR ORCHESTRA. "Three Heroes"—  
 1. O'Leary, V.C.  
 2. Captain Oates.  
 3. Warneford, V.C.  
 10.0: "NATIONAL ANTHEM."  
 CLOSE.

**2GB**

Theosophical Broadcasting Station, 29 Bligh St., Sydney (Wavelength, 316 Metres).  
 9.0: Address by Miss Mary Rivet. "H. G. Wells—A Modern Utopia." 9.30: Address by Mr. Victor E. Cromer, "To Him that Overcometh." 10.0: Music from studio. 10.15: Organ music from St. Alban's Church, Regent Street, Sydney. 10.30: Morning service from St. Alban's Church, Regent Street, Sydney. 12 noon: Music from studio. 12.30: Close down. 3.0: Musical session. 5.30: Children's session, by Uncle George. 7.0: Lecture from St. Alban's Church. 7.35: Lecture from Adyar House. 8.15: Concert from Adyar House, by courtesy of Suttons, Ltd. Miss Ada Brook, pianiste. 8.25: Miss Beatrice Kendrick, contralto. 8.30: Mr. Cecil Chaseling, baritone. 8.37: Mr. Gregory Valentini, violinist. 8.45: Miss Elsie Brown, soprano. 8.52: Miss Ada Brook, pianiste. 9.0: Weather report. 9.1: Miss Beatrice Kendrick, contralto. 9.8: Mr. Cecil Chaseling, baritone. 9.15: Mr. Gregory Valentini, violinist. 9.25: Miss Elsie Brown, soprano. 9.30: Address by Mr. Victor E. Cromer. "The Kingdom of God." 9.45: Close down.

**2UW**

Radio Broadcasting, Ltd., Faling's Building, Ash St., Sydney (Wavelength, 267 Metres).  
 10.30 a.m.: Music and request numbers.  
 1 p.m.: Close.  
 5.30: Children's Hour, conducted by Uncle Jack.  
 6.30: Close.  
 7.0: Musical Programme.  
 8.0: Story and music of an opera.  
 9.0: Request items.  
 10.30: Close.

**2UE**

Broadcasting Station 2UE, Everett Street, Maroubra, Sydney (Wavelength, 293 Metres).  
 11.0 a.m.: Mass from St. Mary's Cathedral.  
 12.20 p.m.: Musical items. 1.0: Close down.  
 EVENING SESSION—6.15: Music. 6.20: Instruction by Rev. Father T. Walsh, S.J. 6.40: Music. 7.0: Evening devotions from St. Mary's Cathedral. 8.10: Music. 8.15: Overture, "Barber of Seville." 8.25: Orchestral and vocal concert. 10.15: Close down.

**"EXCELTRON"**

B ELIMINATORS . . . . £3 15 0  
 A CHARGERS . . . . . £3 0 0  
 A.B.C. POWER PACKS . £5 10 0

Usually sold £6 to £12—sold direct from factory to you, hence these low prices. Fully guaranteed, 12 months. Installed free. Easy Terms. Mail Order, add carriage. EXCELTRON ELECTRICS, 54 Oxford Street, Sydney.

**INSPECT OUR LARGE STOCK WHILST IN SYDNEY.**

House Lighting Plants, 52 volt and 110 volt. Electric Motors for Pumping, Shearing, Driving Saws and General Machinery. All powers and voltages, direct and alternating current.

Radio Transformers for "B" Eliminators A.B.C. 22/6 each. Choke Coils, 30 Henries, 70 mils., single air gap type, high quality, 5/- each. "Don" Power Transformers and Battery Chargers, all sizes to 50 kilowatts.

**F. T. S. O'Donnell, Griffin & Co., Ltd.**  
 M2991—51-53 Druitt Street, City.

**Interstate Programmes, Sun., Dec. 29**

**3LO**

Australian Broadcasting Co., 120A Russell St., Melbourne (Wavelength, 371 Metres).  
 MORNING SESSION.  
 10.0: Time signal. 10.1: Musical reproduction. 10.20: Express train information. British Official Wireless news. Items of information. 10.30: Bells of St. Paul's Cathedral. 10.45: Preacher, His Grace the Archbishop of Melbourne. Te Deum and Benedictus—Stanford in C. Carols at the close of the service. 12.30: Close down.

**AFTERNOON SESSION.**

3.0: Pleasant Sunday Afternoon, from Wesley Church Central Mission, conducted by Rev. J. H. Cain. Soloist, J. Alexander Browne. 4.30: Close down.

**THE CHILDREN'S CORNER.**

6.0: "Brother Bill," "Harry and Bob."

**EVENING SESSION.**

7.0: Reg. Bradley, violin, and Mabel Nelson, piano—First and Second Movements of Sonata in G Major—Op. 13 (Op. 13) (Op. 13). 7.10: Through Persia with Dunsterforce—The Trek to Hamadan—and a Persian Dinner, Captain N. Carter. 7.25: Mabel Nelson, piano—A Short Recital from the works of Schumann—"Pomphe Bird," "Warum," "Aufschwung." 7.35: Universal Safety—Fire Precautions for Safety, J. T. Wilkins. Chief Officer Metropolitan Fire Brigade. 7.50: Reg. Bradley, violin—"Spanish Dance" (Granados-Kreislter), "Minuetto" (Pugnani-Kreislter).

**NIGHT SESSION.**

8.0: Musical Ensemble, presented by Hamilton Webster, Mus.Bac., and his All-Australian Orchestra.  
 10.15: News Session.  
 10.30: God Save the King.

**3AR**

Australian Broadcasting Co., 120A Russell St., Melbourne (Wavelength, 484 Metres).

**MORNING SESSION**

11.0: Divine service from Wesley Church, Lonsdale Street, Melbourne. Sermon, Rev. J. H. Cain.

**MIDDAY SESSION**

12.20: A studio programme of specially selected reproduced music. 2.0: Frank Lanterman at the Wurlitzer, with assisting Artists. 3.0: Close down.

**AFTERNOON SESSION**

4.30: "Hungarian Rhapsody" (Liszt), Vaselli's Italian Band. 4.35: "Sigmund's Love Song" (Wagner), Laurits Melchior, tenor. 4.42: "Chant Sans Paroles" (Willeke), Willem Willeke, cello. 4.46: "Aria" from "Faust" (Gounod), Edith Mason, soprano. 4.50: "Chimes of Normandy." Brunswick Light Opera Company. 4.54: "Souvenir de Moscow" (Wieniawski), Michel Piastro. 4.58: "When the King Went Forth to War" (sung in French), Giuseppe Danise, baritone. 5.2: Enigma Variations, Op. 36, Royal Albert Hall Orchestra, conducted by Sir Ed. Elgar, O.M. 5.35: The Week's Good Cause—Goodwill Towards Animals, Mr. A. T. Latham, secretary V.S.P.A. 5.49: "Songs My Mother Taught Me" (MacFadden-Dvorak), "Kathleen Melnie, contralto, with orchestral accompaniment. 5.53: "Flower Song" (Lange), Willem Willeke, cello. 5.57: "On Yonder Rock Reclining," from "Fra Diavolo" (Auber). 6.1: Request numbers. 6.45: What's on the air to-night? 6.47: St. Paul's Cathedral bells.

**EVENING SESSION**

7.0: Service from the Baptist Church, Melbourne—Sermon, Rev. H. J. Haekworthy, M.C. M.A. Subject, "Victorious Personality." Choir direction, Madame Ella Kingston.

**NIGHT SESSION**

8.30: Transmission from Sydney, relayed from 2FC.  
 9.58: Weather.  
 10.0: God Save the King.

**3DB**

The "Herald" Broadcasting Station, Flinders Street, Melbourne (Wavelength, 255 Metres).

**AFTERNOON SESSION.**

3.0: London Symphony Orchestra—"Petroushka" (Stravinski), D 1521-1524. 4.30: Close down.

**EVENING SESSION.**

6.30: Philharmonic Choir—"Mass in G Major" (Schubert), D 1478, 1479, 1480.  
 7.30: Band, H.M. Coldstream Guards—"Nalla" (De-liber), B 9798.  
 8.0: Requests.  
 10.0: God Save the King.

**4QG**

Queensland Government Radio Service, Brisbane (Wavelength, 385 Metres).

**MORNING SESSION.**

11.0: Morning service from the City Congregational Church. 12.15: Close.

**AFTERNOON SESSION**

3.15: Band concert from the Botanic Gardens. 4.30: Close.

**EARLY EVENING SESSION**

6.0: A session for little listeners.

**NIGHT SESSION**

7.0: Children's service from the City Congregational Church. 7.30: Evening service. Concert by Brisbane Municipal Concert Band.  
 9.30: Close down.

**5CL**

Central Broadcasters, Ltd., 114 Hindmarsh Square, Adelaide (Wavelength, 409 Metres).

**MORNING SESSION.**

10.45: Carillon of bells from the Adelaide Town Hall. 11.0: Service from Rose Park Congregational Church. Minister, Rev. Watts Grimmer; organist, Mr. Stanley Brand. 12.10: British Official Wireless news. 12.15: Close down.

**AFTERNOON SESSION.**

3.0: Chimes. 3.1: A pleasant Sunday afternoon service from the Glenelg Congregational Church. 4.0: Chimes. Close down.

**EVENING SESSION.**

6.0: Chimes. 6.1: Birthday greetings. 7.0: Chimes. 7.1: Senior Birthday League greetings. 7.2: Service from St. Peter's Cathedral. Minister, Rev. H. P. Finnis, M.A.; organist, Mr. John Dunn.

**NIGHT SESSION.**

8.20: From 5CL Studio; announcements. 8.30: From the Regent Theatre, Malcolm Reid and Co.'s special concert. Frank Roberts, Wurlitzer organ, "Rose of My Heart," "O, Star of Eve." 8.38: Beryl Counter, mezzo-soprano, "An Old Garden" (Temple), "A Cuckoo Clock," 8.45: Harry Berry, cornetist (selected), 8.53: The Lyric Male Quartette, "Absent Face" (Davey), "Steal Away to Jesus" (Parks). 9.0: Frank Roberts, Wurlitzer organ, "First Valse" (Durand). 9.4: Beryl Counter, mezzo-soprano, "A Wild Rose" (Scaubert), "Cradle Song" (Schubert). 9.11: Harry Berry, cornetist (selected). 9.15: The Lyric Male Quartette, "Silent Night" (Thomas), "In Absence" (Buck). 9.23: Frank Roberts, Wurlitzer organist, "Brise D'Ete" (Sanderson). 9.27: The Lyric Male Quartette, "Holy Night" (Beethoven), "At Even" (Davey). 9.35: Harry Berry, cornetist (selected). 9.39: Beryl Counter, mezzo-soprano, "Angels Guard Thee" (Godard). 9.43: Orchestral number (selected). 9.55: News. 10.0: Close down.

**6WF**

Australian Broadcasting Company, Ltd., Wellington Street, Perth (Wavelength, 435 Metres).

MORNING SESSION.—10.40: Sporting resume. 10.50: Sunday news service. 11.0: Church service, Baptist Church. 12.30: Musical reproduction. 1.0: Close.  
 AFTERNOON SESSION.—3.0: Chimes. 3.1: Musical reproduction. 4.55: Features of to-night's programme. 5.0: Close down.

EVENING SESSION.—5.30: Children's session. 7.15: Temperance talk to Younger Set by Mr. Dent. 7.30: Church service, Seventh Day Adventists. 8.45: Special music arranged by Bert Howell broadcast from Ambassador's Theatre, including assisting artists:—Ambassadorian Orchestra, Les Waldron at the console of the grand organ, Charles Stephens (tenor), Irene Stancliffe (soprano). 10.30: Close down.

**7ZL**

Tasmanian Broadcasters Pty., Brewery Bldg., Elizabeth Street, Hobart (Wavelength, 516 Metres).

11.0 a.m.: Morning service from Holy Trinity Church, Hobart. 12.15: Close down. 3.30: A band concert by the Derwent Concert Band; conductor, T. W. Hopkins. 4.30: Close down. 6.15: Children's chorus singing; conductor, Trevor M. Morris. 6.45: Bertha Southey Bramall, P.O. Evening service from Chalmers Presbyterian Church, Hobart. 8.30: From the studio, a programme of sacred and classical music, arranged by James Counsel. 9.45: News session. 9.50: Close down.

**6WF**

Monday, December 30

Australian Broadcasting Company, Ltd., Wellington Street, Perth (Wavelength, 435 Metres).

Day sessions as usual. See Friday.  
 EVENING SESSION.—8.0: Chimes. 8.1: Instrumental ensemble. 8.16: One-act play by the Radio Players. 8.35: Beryl Ardill, mezzo soprano. 8.43: Instrumental ensemble. 8.53: Gladys Thomas, entertainer, at piano. 9.0: One-act play by the Radio Players. 9.20: Instrumental ensemble. 9.30: Beryl Ardill, mezzo soprano. 9.37: Instrumental ensemble. 9.44: Gladys Thomas, entertainer, at piano. 9.51: What's on the air. 9.55: Temple Court Dance Band, conducted by Merv. Lyons. 10.59: Weather. 11.0: Close.

**6WF**

Wednesday, January 1

Australian Broadcasting Company, Ltd., Wellington Street, Perth (Wavelength, 435 Metres).

Day sessions as usual.  
 EVENING SESSION.—8.0: Chimes. 8.1: Radio production of famous Christmas pantomime, produced and presented by Harry Graham; artists—Harry Graham (entertainer), Dorothy Manning (soprano), David Lyle (tenor), Reuben Betts (crooning baritone), Cissie Thompson (sketch artist), Gladys Thomas (pianist). 10.0: Musical reproduction. 10.59: Weather. 11.0: Close down.

## Local Programmes, Monday, December 30

### 2FC

Australian Broadcasting Company, Ltd., Market St., Sydney (Wavelength, 451 Metres).

#### EARLY SESSION—7 to 8.15 a.m.

- 7.0: "Big Ben" and Programme Announcements.  
 7.2: Meteorological information for the man on the land.  
 7.5: This morning's news, from the "Daily Telegraph Pictorial."  
 7.10: Austradio Musical Reproduction.  
 7.45: Mails and Shipping.  
 7.48: What is on to-day?  
 7.56: Children's Birthday Calls.  
 7.55: Music from the Studio.  
 8.15: CLOSE.

#### MORNING SESSION—10.30 a.m. to 12.30 p.m.

- 10.30: Announcements.  
 10.32: A.B.C. Racing Observer.  
 10.45: HORACE WEBER at the GRAND ORGAN.  
 11.0: HOUSEHOLD HELPS—Cooking, by Miss Ruth Furst.  
 11.10: CABLES (Copyright), Sun-Herald and A.P.A. News Service.  
 11.15: MORNING DEVOTION  
 11.30: Austradio Musical Reproduction.  
 11.53: British Official Wireless Press.  
 12.0: "Big Ben," Stock Exchange, and Metal Quotations.  
 12.5: V. C. BELL will speak from the Public Forum.  
 12.20: Midday weather forecast and weather synopsis. Special produce market session for the man on the land, supplied by the State Marketing Board.  
 12.30: CLOSE.

#### THE LUNCH HOUR—1 to 2.30 p.m.

NOTE.—Progress Results of the Matches. South Australia v. Queensland, played at Adelaide, and Victoria v. N.S.W., at Melbourne.

- 1.0: LUNCH HOUR MUSIC.  
 2.0: Stock Exchange, second call  
 2.2: A Glance at the afternoon "Sun."  
 2.7: Austradio Musical Reproduction  
 2.27: Announcements.  
 THE RADIO MATINEE—2.30 to 4.30 p.m.  
 2.30: A GROUP OF NEW SONGS.  
 2.45: GEMS FROM THE GREAT MAS-TERS.  
 3.0: J. R. KINGHORNE will give a talk on "Nature's Wonders—Queer Creatures."  
 3.15: BERSFORD HALLETT, Popular Vocalist—  
 (a) "My Sin Is Loving You" (Henderson).  
 (b) "Take This Rose" (Kahn).  
 3.22: FARMER'S DANCE ORCHESTRA.  
 3.42: FROM THE STUDIO. BERSFORD HALLETT, Popular Vocalist—  
 (a) "When My Dreams Come True" (Berlin).  
 (b) "Broadway Melody" (Brown).  
 3.49: FARMER'S DANCE ORCHESTRA.  
 4.0: FROM THE STUDIO. NORA ALEXANDER will speak on "The Technique of Poetry—Ode and Ballade."  
 4.15: FARMER'S DANCE ORCHESTRA  
 4.28: FROM THE STUDIO—Stock Exchange third call.  
 4.30: CLOSE.

#### EARLY EVENING SESSION—5.45 to 7.55 p.m.

- 5.45: Children's "Good-night" Stories, told by the "Hello Man," assisted by Aunt Eily.  
 6.45: DINNER HOUR MUSIC by Cec. Morrison and His Band.  
 7.20: A.B.C. Sporting Service.  
 7.25: Special Country Session. Stock Exchange Resume. Markets. Weather Forecast. Late news from the "Sun." Truck Bookings.  
 7.58: To-night's Programme.

#### THE EVENING PRESENTATION—8 to 11.30 p.m.

- Our programme of Classic Music is contributed by Madame Emily Marks, soprano, and Enid Hynes, pianist, who have arranged a special recital of Australian contemporary Composers. There are songs by Vladimir Elin, noted Russian Baritone, Selections by the National Broadcasting Orchestra, and the talk by Wilfred Blacket, K.C., on "Old Time Politicians" will

provide a fund of Humor for the Older Generation. Through 2BL Service Humphrey Bisnop's Revue, relayed through 3LO, Melbourne, will hold the interest of many who prefer a lighter form of entertainment.

#### 8.0: THE NATIONAL BROADCASTING ORCHESTRA—

- "Tancredi" (Rossini).  
 8.12: VLADIMIR ELIN, Russian Baritone—  
 (a) Three Songs from "Winter Journey" (Schubert).  
 1. "The Watercourse."  
 2. "Looking Backward."  
 3. "Courage."  
 (b) "No Sleeping, No Repose" (Borodin) Orchestral Accompaniment.  
 (c) "I Love Thee" (Grieg)—Orchestral Accompaniment.  
 (d) "And Wouldst Thou Thus Have Sullied" (Verdi). Orchestral Accompaniment.

#### 8.22: MURIEL LANG, Cellist—

- (a) "Sarabande."  
 (b) "Bouree," 1 and 2 (Bach).  
 8.29: MADAME EMILY MARKS and ENID HYNES in a Recital of Australian Contemporary Composers.

#### 8.41: THE NATIONAL BROADCASTING ORCHESTRA—

- "Four Ways" Suite (Coates).  
 8.53: WILFRED BLACKET, K.C., will speak on "Old Time Politicians."  
 9.8: THE COUNTRY MAN'S WEATHER SESSION—  
 (a) New South Wales Forecasts.  
 (b) Interstate Weather Synopsis.  
 9.10: VLADIMIR ELIN, Russian Baritone—  
 (a) "Song of the Flea" (Moussorgsky)—Orchestral Accompaniment.  
 (b) "Devotion" (Strauss).  
 (c) "The Birch in the Meadow" (Folk Song).  
 (d) "O. Could I But Express in Song" (Malashkin).

#### 9.20: INSTRUMENTAL TRIO.

- 9.37: MADAME EMILY MARKS and ENID HYNES in a Recital of Australian Contemporary Composers.

#### 9.44: THE NATIONAL BROADCASTING ORCHESTRA—

- (a) "Sons of Italy" (Lohr).  
 (b) "Fourteen Fathoms Deep" (Lake).  
 (c) "Divermen Tissimo" (Bendix).  
 10.0: CEC. MORRISON and HIS BAND.  
 10.15: Announcements.  
 Late Official Weather Forecast.  
 10.20: CEC. MORRISON and HIS BAND.  
 11.30: CLOSE.  
 "NATIONAL ANTHEM."

### 2BL

Australian Broadcasting Company, Ltd., Market St., Sydney (Wavelength, 358 Metres).

#### OPENING SESSION—8.15 to 11 a.m.

- 8.15: G.P.O. Chimes and Announcements.  
 8.16: Music for every Mood.  
 8.40: Meteorological data for the country.  
 8.45: Mails and Shipping Information.  
 8.50: Memory Melodies.  
 9.0: This Morning's Story.  
 9.30: A Musical Interlude.  
 9.40: British Official Wireless Press.  
 9.45: New Music.  
 10.5: News from "The Daily Telegraph."  
 10.10: Austradio Musical Reproduction.  
 10.40: THE AUSTRALIAN BROADCASTING COMPANY'S WOMEN'S ASSOCIATION, conducted by Miss Gwen Varley.  
 11.0: G.P.O. Chimes. Close down.

#### MIDDAY SESSION—12 Noon to 2.30 p.m.

- 12.0: G.P.O. Chimes and Announcements.  
 12.2: A Pianoforte Recital.  
 12.30: LUNCH MUSIC.  
 1.0: Afternoon news from "The Sun."  
 1.5: Memory Melodies.  
 1.30: Austradio Musical Reproduction.  
 1.45: A Pianoforte Recital.  
 2.15: Dance Music.

#### AFTERNOON ENTERTAINMENT—2.30 to 5.45 p.m.

- 2.30: Business Efficiency Talk.  
 2.45: Memory Melodies.  
 3.0: FRANK BOTHAM, Baritone—  
 (a) "The Jester" (Cooper-Lissenden).

(b) "Oh! Could I But Express in Song" (Malashkin).

- 3.7: A Pianoforte Recital.  
 3.27: Modern Ballads.  
 3.37: An Old Dance Number.  
 3.45: BRUNTON GIBB in "RANDOM REMARKS."  
 4.0: Radio Rhythm.  
 4.10: FRANK HOTHAM Baritone—  
 (a) "The Old Superb" (Villiers-Stanford).  
 (b) "The Broken Cut" (Lohr).  
 4.17: A Pianoforte Recital.  
 4.35: Music grave and gay.  
 4.45: The Trade Hour—Demonstration Music.  
 5.45: Weather Information. Close Down.

#### THE DINNER HOUR—6.15 to 7.55 p.m.

- 6.15: DINNER MUSIC BY CEC. MORRISON AND HIS BAND.  
 6.45: THE BOYS' AERO CLUB.  
 7.5: The Country Man's Market Session—Wool, Wheat, Stock, Farm Produce, Fruit, and Vegetable Markets.  
 7.20: DINNER MUSIC BY CEC. MORRISON AND HIS BAND.  
 7.45: Austradio Musical Reproduction.  
 7.55: What's on the air to-night?

#### TO-NIGHT'S PRESENTATION—8 to 10.30 p.m.

Humphrey Bishop sparkling Revue, relayed from 3LO Melbourne, will please the ear of many listeners this summer night. Through 2FC Service a programme of classical music will provide pleasing contrast, and listeners will hear the National Broadcasting Orchestra, Vladimir Elin, the Russian baritone; a recital of Australian Composition by Madame Emily Marks and Enid Hynes, Pianist, and a talk by Wilfred Blacket, K.C., will be enjoyed by many to whom these reminiscences are a source of keen enjoyment.

#### 8.0: RELAY FROM 3LO, MELBOURNE: THE HUMPHREY BISHOP MUSICAL COMEDY COMPANY.

OVERTURE by THE HUMPHREY BISHOP and A.B.C. ORCHESTRAS. HUMPHREY BISHOP addresses his audience. RAGTIME ENSEMBLE by THE COMPANY.

DENIS SHEARD and MAURICE JAFFEY sing "Quivering Lyre." GEORGE (Scratcher) ROSS and MAURICE JAFFEY in a flash of Comedy. SYDNEY MONTIGUE and THE GIRLS warble—"The Wabby Walk." THELMA TROTT and ARTHUR HEMSLEY in a Cockney Characterisation. "Before and After."

CECILIE AUDIBERT and DENIS SHEARD sing—"Someday, Somewhere." NICK MORTON, MARIE LONDON, and ELAINE MAYE, in an interlude entitled "The Mean Man."

ARTHUR HEMSLEY, whimsical Lancashire Comedian. THELMA TROTT singing "Pale Moon." GEORGE (Scratcher) ROSS, assisted by Sydney Montigue.

NICK MORTON with his—"That's a Good Girl" and "Just Like a Fool." MDLLE NANETTE and THE GENTLEMEN.

GEORGE (Scratcher) ROSS in further Scratcherisms.

OPERATIC EXCERPT—"Il Trovatore." "Miserere Duet," THELMA SCOTT and MAURICE JAFFEY.

"Anvil Chorus," THE COMPANY.  
 9.15: FROM THE STUDIO—Weather Information for the man on the land. Announcements.

9.25: FROM 3LO MELBOURNE. THE HUMPHREY BISHOP MUSICAL COMEDY COMPANY.

ENTR'ACTE by the HUMPHREY BISHOP and A.B.C. ORCHESTRAS. DENIS SHEARD will sing "Schubert's Serenade." NICK MORTON, RUBY OWEN, and SYDNEY MONTIGUE in a Dramatic Sketch. THELMA TROTT and MAURICE JAFFEY singing—



"Someday you will miss me."  
**MARIE LANDON** and **ARTHUR HEMSLEY** in a lover's episode—"Courting."  
**CECILIE AUDIBERT**—"Where is the Song of Songs."  
**GEORGE (Scratcher) ROSS** and **ELAINE MAYE** in a fantasy inspired by "The Doll Dance."  
**SYDNEY MONTIGUE**—"Walking With Susie."  
**MARIE LANDON**, **GWEN WESTON**, and **CECILIE AUDIBERT** turn "feminine" into "feline" at an afternoon tea.  
**NICK MORTON** and **MAURICE JAFFEY** in a Nautical Episode.  
**GEORGE (Scratcher) ROSS** and **THE COMPANY** in "The Denunciation of Ragtime."  
 10.30: "NATIONAL ANTHEM."  
 CLOSE.

**2GB**

Theosophical Broadcasting Station, 29 Bligh St., Sydney (Wavelength, 316 Metres).

Day sessions as usual. 8.0: Miss Heather Kinnaird, contralto. 8.7: Instrumental trio. 8.15: Mr. Guy McAlister, baritone. 8.22: Symphony Orchestra. 8.30: Mr. Jack Win and Mr. Heath Burdock, humor. 8.35: Miss Dorothy Rudder, soprano. 8.42: Violin solos. 8.45: Address. 9.0: Weather report. 9.1: Miss Heather Kinnaird, contralto. 9.10: Instrumental trio. 9.20: Mr. Guy McAlister, baritone. 9.30: Mr. Jack Win and Mr. Heath Burdock, humor. 9.35: Symphony Orchestra. 9.45: Miss Dorothy Rudder, soprano. 9.55: Violin solos. 10.0: Instrumental music. 10.30: Close down.

**2UW**

Radio Broadcasting, Ltd., Pallin's Building, Ash St., Sydney (Wavelength, 267 Metres).

**MIDDAY SESSION** (as usual). **EVENING SESSION**.—5.30: Children's Hour. 6.30: Meccano Club. 6.45: Close. 7.0: Chimes Request numbers. 7.45: Radio talk, by Mr. E. Homfray. 8.0: Wagnerian Concert. 9.0: Chimes. Music and request numbers. 10.30: Close.

**2KY**

Trades and Labor Council, Goulburn St., Sydney (Wavelength, 280 Metres).

**MORNING SESSION.**

As usual (see Friday).

**EVENING SESSION.**

7.0: Musical interlude.  
 7.15: Dance music.  
 7.30: Request numbers.  
 7.45: Musical numbers.  
 8.0 (from Bebarfald's new studio): Overture  
 8.8: Tenor solos.  
 8.15: Dance music.  
 8.30: Request numbers.  
 8.45: Soprano solos, **MISS WRIGHT**.  
 9.0: Novelty interlude.  
 9.10: Concert programme from Bebarfald's.  
 10.0: Closing announcements.

**2UE**

Broadcasting Station 2UE, Everett Street, Maroubra, Sydney (Wavelength, 293 Metres).

**EARLY MORNING SESSION.**—As usual.  
 No evening session.

**7ZL**

Monday, December 30

Tasmanian Broadcasters Pty., Bursary Bldg., Elizabeth Street, Hobart (Wavelength, 516 Metres).

11.30 a.m.: Record recital. 11.34: Midlands weather forecast. 11.35: Record recital. 11.55: Tasmanian stations' 9 a.m. weather report. 12.1: Shipping information; mail notices; housewives' guide. 12.08: Record recital. 12.30: News service; announcements. 12.40: Record recital. 1.05: Railway auction sales. 1.10: Record recital. 1.30: Close down. 3.01: Record recital. 3.4: Weather information. 3.5: Record recital. 4.15: "Aunt Edna" will speak on "Ribbons and Laces." 4.30: Close down. 6.15: Children's corner, with "Uncle David." 7.10: Recorded music. 7.30: News session. 7.40: Belle St. Lawrence will continue her talk on "Poets—Past and Present." 7.50: Roger Doherty will speak on "Southern Tasmanian Tennis Championships." 8.1: Record recital. 8.15: Transmission from Memorial Congregational Church, Hobart, a programme arranged by James March. 9.30: News session. 9.40: Record recital. 10.0: G.P.O. clock chimes the hour. 10.01: Close down.

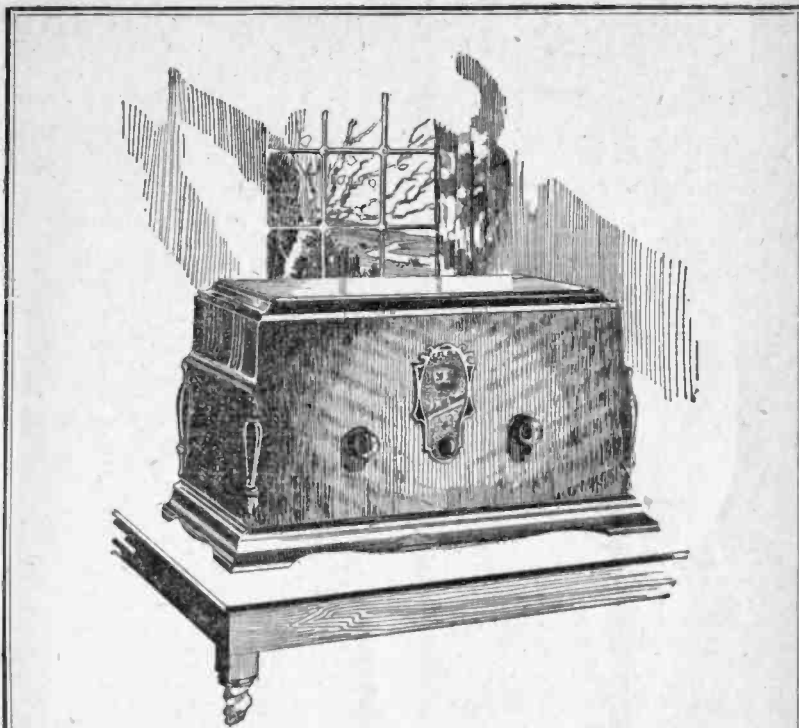

**Colville-Moore AC Three Receiver**

A Triumph in Tone and Mechanical Perfection

100 p.c. All-Electric

Right off your Power or Electric Light Socket

PLUG IN—TUNE IN.

No Aerial or other loose wires. Solves your Entertainment Problem

**SOME POINTS OF COLVILLE-MOORE SUPERIORITY**

Duoced Maple Cabinet, of unique and pleasing design. Power equipment and Valves totally Philips. Super selectivity obtained with special wave-trap. Tonal reproduction unequalled by any other Receiver. Twelve Months' Guarantee and Service. Imposing and binding Warranty issued with every Receiver.

Let us show you all our latest models at  
**No. 4 Rowe Street**

- AC THREE, Table Model, complete with Speaker. CASH PRICE, £29. Dep. £6. Monthly £2/2/9.
- AC THREE, Console Model, complete with Speaker. CASH PRICE, £34. Dep. £7. Monthly £2/10/1.
- AC SIX, Console Model, complete with Speaker. CASH PRICE, £56. Dep. £12. Monthly £4/1/5.

**Demonstrations in Your Home Without Obligation**

**Colville-Moore Wireless Supplies Limited**

'Phones, B2261, B4594. 4 and 10 Rowe Street, Sydney

Interstate Programmes, Mon. Dec. 30



BRITISH MADE

VARIABLE

CONDENSER

is the SMALLEST, LIGHTEST, MOST EFFICIENT Obtainable

SPAN FULLY OPEN

3 1/2"

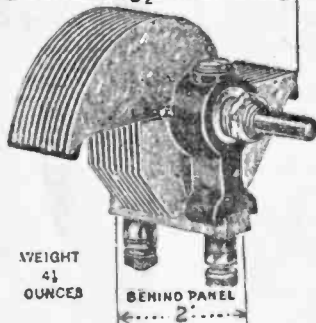

Construction and Performance SECOND TO NONE.

THE PRICE IS RIGHT.

.0005—9/-, .00035—8/6; .00025—8/-



COMBINATION L.F. UNITS

"TRUE SCALE" ..... 45/- (Dual Impedance).

"TWO STAGE" ..... 52/6 (Resistance-Transformer).

"TRANSFORMER Output Filter CHOKE" .. 45/-

ASK YOUR DEALER FOR CATALOGUE.

DISTRIBUTORS for New South Wales, O. H. O'BRIEN, 37-39 Pitt Street;

MURDOCH'S, LTD., Park Street;

ELECTRIC UTILITY SUPPLY CO., 617 George Street

Factory Representative

WHITELAW AND WOOD PTY., LTD., CATHCART HOUSE, 11c Castlereagh St., Sydney 312 Flinders St., MELBOURNE.

3LO

Australian Broadcasting Co., 120A Russell St., Melbourne (Wavelength, 371 Metres).

MIDDAY SESSION

1.0 to 1.30: As usual. 1.30: Transmission from the Constitutional Club Luncheon.

AFTERNOON SESSION.

2.0: Description of the Sheffield Shield Cricket Match—Victoria versus New South Wales—at the Melbourne Cricket Ground. 4.0: Paul Jeacle and His Band—"I'm Just in the Mood To-night" (Leslie). "The Hollow of the Hill" (Plong). 4.7: Norman Leslie and Partner, in a musical sketch. 4.15: Jessie Smith, contralto—"The Little Grey Church on the Hill." "Babe of Mine" (Jessie Smith). 4.22: Paul Jeacle and His Band—"It's You" (Silverstein). "Ever So Goosy" (Butler). 4.26: Acceptances and barrier positions for the V.R.C. New Year's Day Meeting at Flemington. During the afternoon progress scores of the Cricket Match—South Australia versus Queensland—at Adelaide Oval, will be broadcast as they come to hand. 4.30: Close down.

THE CHILDREN'S CORNER.

5.45: Opening Chorus by "Humpty and Dumpty." 5.48: "Humpty and Dumpty." 5.56: The Children's News Bulletin. 6.0: Chimes Times. 6.1: The Studio Light Orchestra. 6.10: "Billy Bunny." 6.18: Humpty and Dumpty. 6.26: Birthday Greetings. 6.35: Musical Interlude.

EVENING SESSION.

6.40: Public School Life and Sport. Mr. E. C. H. Taylor. 6.53: Musical Interlude. 7.0: Time signal. 7.1: Countryman's Session. 7.25: The Latest in Patent Life-Saving and Swimming Appliances. Mr. G. F. Thomas. 7.40: News service. 7.45: Hints and information for the Camping Motorist—The 3LO Motorists' Service Station. Mr. C. J. P. Hodges, secretary. Royal Automobile Club of Victoria. 8.0: Time signal.

NIGHT SESSION.

8.0: Overture by the Humphrey Bishop and National Broadcasting Orchestras. Humphrey Bishop addresses his audience. Retime Ensemble, by the Company Denis Sheard and Maurice Jaffey sing "Quivering Lyre." George "Scratcher" Ross and Maurice Jaffey in a flash of comedy. Sydney Montague and The Girls warble "The Wabby Walk." Thelma Trott and Arthur Hemsley in a Cockney Characterisation, "Before and After." Cecile Audibert and Denis Sheard sing "Somebody Somewhere." Nick Morton, Marie Landon, and Elaine Maye, in an interlude entitled "The Mean Man" Arthur Hemsley, the Whimsical Lancashire Comedian. Thelma Trott, singing "Pale Moon." George "Scratcher" Ross, assisted by Sydney Montague. Nick Morton, with his "That's a Good Girl" and "Just Like a Fox." Melina Nanette and The Gentlemen. George "Scratcher" Ross in further "Scratcherisms." Operatic Excerpt, "Il Trovatore." "Miserere" Duet. Thelma Trott and Maurice Jaffey. Anvil Chorus. The Company.

9.15: An Orchestral Interlude. 9.25: Entr'acte—By the Humphrey Bishop and National Broadcasting Orchestras. Denis Sheard will sing Schubert's "Serenade." Nick Morton, Ruby Owen, and Sydney Montague, in a Domestic Sketch. Thelma Trott and Maurice Jaffey, singing "Somebody You Will Miss Me." Marie Landon and Arthur Hemsley in a lovers' episode, "Caring." Cecile Audibert, "Where is the Song of Songs?" George "Scratcher" Ross and Elaine Maye, in a Fantasy inspired by "The Doll Dance." Sydney Montague, "Walking With Susie." Marie Landon, Gwen Weston, and Cecile Audibert turn "Feminine" into "Felling" at an afternoon session. Morton and Maurice Jaffey, in a Nautical Episode. George "Scratcher" Ross and the Company, in "The Denunciation of Retime."

10.30: News Session. 10.40: Paul Jeacle and His Band—Latest and Brightest Dance Numbers. 11.30: God Save the King.

3AR

Australian Broadcasting Co., 120A Russell St., Melbourne (Wavelength, 484 Metres).

NOISSAS DINNOR

8.15 to 11.0 As usual (see Friday).

MIDDAY SESSION

12.0 to 1.15: As usual. 12.1: Cricket.

AFTERNOON SESSION

2.30: Art in Modern Life—Beauty and the Beach. Miss Stephanie Taylor. 2.45: Your Garden—Seasonable Hints for Lady Gardeners. Mr. A. Antonio. 3.0: Paul Jeacle and his Band—"Kalamazoo" (Gumble). "Sposin'" (Denniker). 3.6: Thomas George, bass—"Away in Aithlon" (Lohr). "I Heard You Go Bye" (Wood). 3.13: Josie Keen, songs at the piano. 3.20: Jaul Jeacle and his Band—"Piccolo Pete" (Baxter). "Fashionette" (Glogan). 3.24: Norman Leslie, comedian, will entertain. 3.32: Paul Jeacle and his Band—"Piccolo Pete" (Baxter). "Fashionette" (Glogan). 3.40: Jessie Smith, contralto—"In the Dark Silence." "Listen" (Haydn Wood). 3.47: Guy Stavoralle, banjo—"Bernard March" (Ellis). 3.54: Thomas George, bass—"When I Was a Bachelor" (Gregory). "The Star" (Rogers). 4.0: A Woman's Wandering Through the Empire—A Real Scottish New Year. Miss Doreen Barry. 4.15: Description of Sheffield Shield cricket match, Victoria v. New South Wales, at the Melbourne Cricket Ground. 5.30: Weather data. 5.40: Description of cricket match re-med. 6.0: Close down.

EVENING SESSION

6.15: Dinner music. 7.30: What's on the air to-night? 7.32: Sporting results: acceptances and barrier positions for the V.R.C. New Year's Day meeting at Flemington. 7.35: Latest musical releases. 8.0: G.P.O. chimes.

NIGHT SESSION

8.1: Strange Things in Strange Places—The Port George IV. Mission. Mr. H. L. Richardson. 8.15: Neapolitan Quartette—"Der Wellen Spiel"

(Huber). "Hawaiian Lullaby" (Bridge). "Humor-eque" (Dvorak). 8.25: Herold Kyng, baritone—"Serenade" (Schubert). "Impatience" (Schubert). 8.32: Piano recital by Horace Perkins, Mus.Bac.—"Romance, F sharp" (Schumann). "Novelette in E" (Schumann). "Songs of a Grandmother," No. 1 (Velkmann). "La Campanella" (Liszt-Busoni). 8.48: Merna Stewart, soprano—"Prelude" (Landon Ronald). "On the Day I Go to Heaven" (Lehmann). 8.55: Neapolitan Quartette—"Medley of Old-time Melodies" (arr. Gibson); duc, mandolin and Spanish guitar, "Drifting and Dreaming" (Levine). 9.5: Dorothy White, comedienne—A little Cockney study. "A sedtime Story." 9.13: Jean Lewis, contralto—"I Be Hopin'" (Coningsby Clarke). "My Girl and I" (Coningsby Clarke). "Love's Rhapsody" (d'Hardelo). 9.22: Pierrot and Pierrette—Pierrot with his piano. Pierrette with her saxophone. 9.32: Herald Kyng, baritone—"The Last Hour" (Kramer). "The Old Road" (Scott). 9.39: Len Gibson, mandolin—"Souvenir" (Drdia); Chinese novelty "Ah Sun" (Rolf). 9.43: Meina Stewart, soprano—"The Answer" (Terry). 9.50: Neapolitan Quartette—"Traumeret" (Schumann). "Lily of Laguna" (Stuart). "Aloha Oe" (Lillickaului). 9.59: Jean Lewis, contralto—"Only the River Running By" (Hopkins). "Don't You Mind the Sorrows" (Cowles). 10.6: Weather, news. 10.16: Dorothy White, comedienne—"Er Upstairs"; selected. 10.24: Pierrot and Pierrette—Pierrot with his piano. Pierrette with her saxophone. 10.30: God Save the King.

4QG

Queensland Government Radio Service. Brisbane (Wavelength, 385 Metres).

Day sessions, as usual.

NIGHT SESSION

8.0: The Rhythm Rascals (conductor: Raffy Grunden)—Ten Minutes' Melody. 8.10: Two Sad Sunbeams—Entertainers. 8.20: Jill Manners, soprano—"Dream Boat" (Novello). "Il Bacio" (Arditi). 8.28: J. W. Bergemeister, cornetist—"O Sole Mio" (Capua). 8.32: Monument and Harrow—The Argumentative Pair. 8.47: The Rhythm Rascals—Syncopeation. 9.0: Weather. 9.1: Mrs. R. G. Allen, soprano—"I Wonder if Love is a Dream" (Foster). "Canterbury Bells" (Carew). 9.9: J. W. Bergemeister, cornetist—"Sunshine of Your Smile" (Ray). 9.15: The Rhythm Rascals—Entertainers. 9.30: A recital of electric records. 10.0: News; weather; close down.

5CL

Central Broadcasters, Ltd., 114 Hindmarsh Square, Adelaide (Wavelength, 40 Metres).

MORNING SESSION.

During the day descriptions of the cricket match—South Australia, Queensland—will be given. 11.0: Chimes. 11.1: Recordings. 11.45: Miss Laurie McLeod, of Weber, Shorthose, and Rice, will speak on "Physical Culture." 12.1: Recordings. 12.15: News. British Official Wireless news. 12.40: Recordings. 12.52: Railway, Stock Exchange, and meteorological information. 1.1: Player piano session. 1.59: Meteorological information. 2.0: Close down.

AFTERNOON SESSION.

3.0: Chimes. 3.1: Programme review and announcements. 4.0: Chimes. 4.1: Wertheim's player piano session. 4.45: An educational talk. 4.55: Stock Exchange. 5.0: Chimes. Close down.

EVENING SESSION.

5.45: Morphettville acceptances. 6.1: Children's happy moments; birthday greetings; correspondence; songs by "Auntie Peggy." 6.15: Children's request numbers. 6.30: Dinner session. 7.1: Senior Birthday League greetings. 7.2: Market reports; sporting service; billiard notes. 7.35: The 5CL Twinkler Boys' Club.

NIGHT SESSION.

8.0: Chimes. 8.1: Programme review and announcements. 8.10: Walter Barratt and his Maison Masters of Melody (selected). 8.20: Charles Manthorpe, baritone, "Honour and Arms." 8.24: Walter Barratt and his Maison Masters of Melody. 8.34: Rebie Saunders, monologist, "When you call for a girl." 8.38: Walter Barratt and his Maison Masters of Melody (selected). 8.48: Charles Manthorpe, baritone, "An Old English Love Song." 8.52: Walter Barratt and his Maison Masters of Melody. 8.54: Rebie Saunders, ological information, including Semaphore tides. 9.2: Overseas grain report. 9.3: Announcements. 9.5: Walter Barratt and his Maison Masters of Melody. 9.15: Rebie Saunders, monologist, "Obsession." 9.19: Walter Barratt and his Maison Masters of Melody. 9.29: Charles Manthorpe, baritone, "Vulcan Song" (Gounod). 9.33: Walter Barratt and his Maison Masters of Melody. 9.43: Rebie Saunders, monologist, "Little Girl." 9.47: Walter Barratt and his Maison Masters of Melody. 9.57: Charles Manthorpe, baritone, "What am I, Love, without Thee?" (Adams). 10.1: Walter Barratt and his Maison Masters of Melody. 10.11: Rebie Saunders, monologist. 10.15: News; British Official Wireless news; meteorological information; sporting service. 10.30: On with the dance. Walter Barratt and his Maison Masters of Melody, request numbers. 11.0: Close down.

**F109**

**F209**

**C603**

**F704**

**1560**

**1562**

**LONG LIFE  
PHILIPS TUBES  
FOR YOUR  
AMERICAN**

**F**OR your American A.C. Radio (any make, any model) there's a complete set of Philips Valves only put into production after a year of research and a thousand exacting tests.

**AE  
SET**

The tubes we talk of are the Philips American Replacement Series, sturdy dependable "Miniwatts" which are kith and kin to the famous Philips Penthodes and Screen Grid Valves.

**PHILIPS**  
*for better radio*

(Advt. of Philips Lamps (Australasia) Ltd. (Radio Dept.) Head Office and Showrooms: Corner Clarence and Margaret Streets, Sydney, N.S.W.) 9R85

**MAKE YOUR OLD SET NEW, WITH A PHILIPS POWER UNIT AND TRICKLE CHARGER**

## Local Programmes, New Year's Eve

### 2FC

Australian Broadcasting Company, Ltd., Market St., Sydney (Wavelength, 451 Metres).

#### EARLY SESSION—7 to 8.15 a.m.

- 7.0: "Big Ben" and programme announcements.  
 7.2: Meteorological information for the man on the land.  
 7.5: This morning's news from the "Daily Telegraph Pictorial."  
 7.10: Austradio Musical Reproduction.  
 7.45: Mails and shipping.  
 7.48: What is on to-day?  
 7.50: Children's Birthday Calls.  
 7.55: Music from the Studio.  
 8.15: CLOSE.

#### MORNING SESSION—10.30 a.m. to 12.30 p.m.

- 10.30: Announcements.  
 10.32: A.B.C. Racing Observer.  
 10.45: HORACE WEBER at the GRAND ORGAN.  
 11.0: HOUSEHOLD HELPS—Hints to Housewives, by Miss Ruth Furst.  
 11.10: CABLES (Copyright), "Sun"—"Herald" and A.P.A. News Service.  
 11.15: MORNING DEVOTION.  
 11.30: Austradio Musical Reproduction.  
 11.53: British Official Wireless Press.  
 12.0: "Big Ben"; Stock Exchange and Metal Quotations.  
 12.5: Mrs. E. M. BURROWS, speaking on "Outposts of the Empire."  
 12.20: Midday weather forecast and weather synopsis. Special produce market session for the man on the land, supplied by the State Marketing Board.  
 12.30: CLOSE.

NOTE.—Progress results of the cricket match, Victoria v. N.S.W., played at Melbourne.

#### THE LUNCH HOUR—1 to 2.30 p.m.

- 1.0: LUNCH HOUR MUSIC.  
 2.0: Stock Exchange, second call.  
 2.2: A glance at the afternoon "Sun."  
 2.7: Austradio Musical Reproduction.  
 2.27: Announcements.

#### THE RADIO MATINEE—2.30 to 4.30 p.m.

- 2.30: THE LIGHT ORCHESTRA.  
 2.42: PAT CROSBY, Popular Vocalist—  
 (a) "Big City Blues" (Conrad, Mitchell, and Cottler).  
 (b) "Tired Hands" (Plantadosi).  
 2.49: THE LIGHT ORCHESTRA.  
 3.0: REV. F. H. RAWARD will speak on "The Barbary States."  
 3.15: DULCIE BLAIR, Violinist—  
 (a) "Ave Maria" (Schubert-Wilhelmj).  
 (b) "Schon Rosmarin" (Kreisler).  
 3.22: WAGNER LECTURE RECITAL by Sydney Francis Hoben—  
 "O Star of Eve."  
 "Tannhauser March."  
 Spinning Chorus from "The Flying Dutchman."  
 "Prize Song" (Bendel arrangement).  
 3.42: PAT CROSBY, Popular Vocalist—  
 (a) "My Sin is Loving You" (De Sylva, Brown, Henderson).  
 (b) "Chanson de Florian" (Song of Florian) (Godard).  
 3.49: THE LIGHT ORCHESTRA.  
 4.0: THE STOPYTELLER—A Window in Suburbia—The Merry Widow.  
 4.05: THE LIGHT ORCHESTRA.  
 4.08: Stock Exchange, third call.  
 4.30: CLOSE.

#### EARLY EVENING SESSION—5.45 to 7.55 p.m.

- 5.45: Children's "Good-night" Stories, told by Aunt Willa, assisted by Cousins Gwen and Clarice.  
 6.45: DINNER HOUR MUSIC by the Light Orchestra.  
 7.20: A.B.C. Sporting Service.  
 7.25: Special Country Session. Stock Exchange Resume, Markets, Weather Forecast. Late news service from the "Sun" Truck Bookings.  
 7.58: To-night's Programme.

#### THE EVENING PRESENTATION—8 to 11.30 p.m.

A NIGHT OF STARS AND SPLENDOR. And the Studio is brilliant with stars in the radio firmament. New Year's Eve, and the spirit of revelry is abroad. It is the night of our Studio Reunion, and over a hundred personalities well known to listen-

ers will foregather to cheer the Old Year on his way and to welcome Young 1930.

- 8.0: "Big Ben."  
 8.1: THE NATIONAL BROADCASTING ORCHESTRA.  
 8.10: VLADIMIR ELIN, noted Russian baritone.  
 8.13: DULCIE BLAIR, Violinist—  
 "The Swan" (Saint-Saens).  
 8.16: INTRODUCING THE NEW SUPER-IDEAL BROADCASTING RECEIVER, by James Donnelly.  
 8.20: CARL OBERDOFF, Cornet Solo—  
 "In the Garden of To-morrow."  
 8.23: W. E. LEWIS and DORRIE WARD Vocal Duet—  
 "At Love's Beginning" (Lehman).  
 8.26: "FROM A SEAT IN THE PARK"—a reflection, by SCOTT ALEXANDER.  
 8.29: THE A.B.C. QUINTET—  
 Dulcie Blair, violinist.  
 Muriel Lang, cellist.  
 Clive Amadio, clarinet.  
 Neville Amadio, flute.  
 Fred. White, pianist.  
 8.33: VIRGINIA BASSETTI, Contralto—  
 "A Summer Night" (Thomas).  
 8.36: A PHILOSOPHIC THOUGHT from C. N. BAEYERTZ.  
 8.39: NEA HALLETT, Popular Vocalist—  
 "Ah, Sweet Mystery of Life" (Herbert).  
 8.42: THE TWO OLD CRONIES in reminiscent mood.  
 8.46: CLEMENT Q. WILLIAMS, Baritone—  
 "The Ballad Singer" (Easthope Martin).  
 Accompanist, G. VERN BARNETT.  
 8.49: GOODIE REEVE and BERT GILBERT—  
 "Something Different."  
 8.53: AL HAMMETT and his Saxophone—  
 "Valse Erica" (Wiedoff).  
 8.56: A.B.C. MALE QUARTET—  
 "Drifting and Dreaming" (Van Alstyne).  
 9.0: THE COUNTRY MAN'S WEATHER SESSION—  
 New South Wales Forecast.  
 Interstate Weather Synopsis.  
 9.2: GREETINGS TO OUR LISTENERS.  
 9.8: LINDLEY EVANS, Pianist—  
 "Capriceuse" (Schutt).  
 9.11: H. W. VARNA SPEEDS OUR PARTING GUEST—1929.  
 9.13: RAYMOND BEATTY, Basso—  
 "The Horn" (Felegier).  
 9.16: A MERRY MOMENT WITH JOHN STUART.  
 9.19: LIONEL BENNET and xylophone step out.  
 9.22: JOE CAHILL, the Irish Wit.  
 9.23: MABEL BATCHELOR, Soprano—  
 "One Spring Morning" (Ethelbert Nevin).  
 9.28: MAGGIE FOSTER and CARLTON FAY say it with music.  
 9.31: STUDIO PERSONALITIES as Ron McCuaig sees them.  
 9.39: HARRISON WHITE and friend banjo.  
 9.42: LEW JAMES and DODI WOLFE in amicable argument.  
 9.46: OLIVER KING, Basso—  
 "Rolling Down to Rio."  
 Accompanist, EWART CHAPPLE.  
 9.49: FRANCIS JACKSON LOOKS INTO THE FUTURE.  
 9.51: THE FAIRY DULCITONE MUSIC, by MADAME EVELYN GRIEG.  
 9.54: CHARLES LAWRENCE asks: "Have you heard this one?"  
 9.58: PEGGY DUNBAR, Contralto—  
 "Name of Mine" (Davies).  
 10.1: THE AHAD DUO—a novelty instrumental item.  
 10.4: "RANDOM REMARKS," by BRUNTON GIBB.  
 10.7: NORMAN FRANCIS and HARRY CROOT—  
 "Watchman, What of the Night" (Sarjeant).  
 10.10: GLADSTONE BELL, Cellist—  
 "An Old Italian Love Song" (Sammartini).  
 10.15: Late Weather Announcement.  
 10.17: DISMAL DESMOND, the Lugubrious Wit.  
 10.20: THE FOUR BLACK TROUBADOURS in mysterious murmurings.  
 10.25: NEW YEAR RESOLUTIONS AT THE ZOO.  
 10.30: FROM THE MANLY BAND ROTUNDA, MANLY BEACH—  
 THE MANLY BAND, conducted by James Pheloung—Christmas Hymns and Carols.  
 10.42: FROM THE STUDIO—COMMUNITY SINGING, lead by H. P. WILLIAMS.

10.50: COME NOW, LET'S HAVE A DANCE.

11.0: FROM THE MANLY BAND ROTUNDA, MANLY BEACH—

A description of the scene, where thousands of people have been listening to our concert programme broadcast through 2BL earlier in the evening, interspersed with items from the Manly Band, through loud-speakers, which the Manly Council courteously arranged for.

11.10: FROM THE STUDIO—the late-comers participate in our merrymaking—

A SONG BY MISS LE BRUN BROWN, accompanied by HORACE KEATS.

11.14: MORE DANCE MUSIC.

11.18: FROM THE MANLY BAND ROTUNDA—The Manly Municipal Band.

11.22: FROM THE STUDIO—WALTER GEORGE in an amusing interlude.

11.26: THE HOTEL AUSTRALIA DANCE BAND.

11.34: FROM THE STUDIO—R. A. BARTLEMAN, Baritone—

"Why Shouldn't I?" (Kennedy Russell).

11.37: FROM THE MANLY BAND ROTUNDA—The Manly Municipal Band.

11.44: FROM THE STUDIO—RAE FOSTER, Popular Vocalist—

"When My Dreams Come True"

11.47: THE HOTEL AUSTRALIA DANCE BAND.

11.56: THE OLD YEAR IS NEARLY GONE! ANOTHER MILESTONE PASSED IN THE MARCH OF PROGRESS.

12.0: "BIG BEN" USHERS IN 1930! THE AUSTRALIAN BROADCASTING COMPANY GREET'S YOU WITH THE WISH FOR YOUR CONTINUED HAPPINESS AND PROSPERITY.

RETURN WITH US FOR A MOMENT TO MANLY BEACH TO HEAR THE ROAR OF CHEERING WHICH HERALDS THE BIRTH OF THE LUSTY YOUNG INFANT, 1930.

12.15: NATIONAL ANTHEM.

### 2BL

Australian Broadcasting Company, Ltd., Market St., Sydney (Wavelength, 353 Metres).

#### OPENING SESSION—8.15 to 11 a.m.

- 8.15: G.P.O. chimes and announcements.  
 8.16: Music for every mood.  
 8.40: Meteorological data for the country.  
 8.45: Mails and shipping information.  
 8.50: Memory melodies.  
 9.0: This morning's story.  
 9.30: A musical interlude.  
 9.40: British Official Wireless Press.  
 9.45: New music.  
 10.2: News from the "Labor Daily."  
 10.5: News from the "Daily Telegraph."  
 10.10: Austradio musical reproduction.  
 10.40: THE AUSTRALIAN BROADCASTING COMPANY'S WOMEN'S ASSOCIATION, conducted by Miss Gwen Varley.  
 11.0: G.P.O. chimes. Close down.  
 MIDDAY SESSION—12 Noon to 2.30 p.m.  
 12.0: G.P.O. chimes and announcements.  
 12.2: A pianoforte recital.  
 12.30: LUNCH MUSIC BY CEC. MORRISON AND HIS BAND.  
 1.0: Afternoon news from "The Sun."  
 1.5: Memory melodies.  
 1.15: Austradio musical reproduction.  
 2.0: A pianoforte recital.

#### AFTERNOON ENTERTAINMENT—2.30 to 5.45 p.m.

- 2.30: Half an hour with silent friends.  
 3.0: ROMANO'S DANCE ORCHESTRA under the direction of Bennie Abrahams.  
 3.12: FROM THE STUDIO: A group of old songs.  
 3.22: ROMANO'S DANCE ORCHESTRA under the direction of Bennie Abrahams.  
 3.32: FROM THE STUDIO: Music—grave and gay.  
 3.45: C. PRICE CONIGRAVE will speak on "Gregory on the Victoria River."  
 4.0: ROMANO'S DANCE ORCHESTRA under the direction of Bennie Abrahams.  
 4.12: FROM THE STUDIO: New songs of modern composers.  
 4.22: ROMANO'S DANCE ORCHESTRA under the direction of Bennie Abrahams.  
 4.32: FROM THE STUDIO: A pianoforte recital.

- 4.45: The Trade Hour—Demonstration music.  
5.45: Weather information. Close down.

**THE DINNER HOUR—6.15 to 7.55 p.m.**

- 6.15: DINNER MUSIC BY THE LIGHT ORCHESTRA.  
6.45: THE GIRL GUIDES' CLUB, conducted by Lady David. Talk on "Birding."  
7.5: The Country Man's Market Session—wool, wheat, stock, farm produce, fruit, vegetable, and pig markets.  
7.20: DINNER MUSIC BY THE LIGHT ORCHESTRA.  
7.45: Austradio musical reproduction.  
7.55: What's on the air to-night?

**TO-NIGHT'S PRESENTATION—8 to 10.30 p.m.**

The last of the Old Year. Good-bye to 1929, with its hopes and fears! Come to Manly Beach with us to-night, and make merry with Walter George and His Mirth-quakers on Manly Beach.

Through 2FC service, James Donnelly has put into practice one of the most intriguing of radio fantasies, "A Listener's Dream." Wait until New Year's Eve—it's worth while. We are not going to tell you any more about it now.

8.0: FROM THE BAND ROTUNDA, MANLY BEACH: By courtesy of the Manly Council. A concert programme, arranged by Walter George, with selections by the Manly Band, conducted by J. Pheloung. The council has arranged for loud speakers to be installed, and this will enable the huge crowd which assembles on Manly Beach on New Year's Eve to hear our entertainment in comfort.

2BL CONCERT PARTY, IN ODDS AND ENDS—MOSTLY ODDS, which include Nat Hanley, Grace Quine, Driscoll and Allan (Dopy and Shrewdy), R. A. Bartleman, Laurel Mather.

- 10.0: FROM THE STUDIO: V. C. BELL will speak on "The New Year, Yet Another Milestone, not a Tombstone."  
10.15: Music—grave and gay.  
10.25: Late news from "The Sun." Late weather forecast.  
10.30: NATIONAL ANTHEM. CLOSE.

**2UE**

Broadcasting Station 2UE, Everett Street, Maroubra, Sydney (Wavelength, 293 Metres).

Day sessions as usual.

**EVENING SESSION.—6.30:** Wendy's hour with the children, and birthday greetings.  
7.15: Orchestra dinner music. 7.55: Announcements and news from the "Sun." 8.0: Clock and chimes. 8.1: Overture, "La Tosca." 8.10: Vocal and instrumental music. 10.15: Close down.

**2GB**

Theosophical Broadcasting Station, 29 Bligh St., Sydney (Wavelength, 316 Metres).

Day sessions as usual. 8.0: Mr. Laurence Macaulay, baritone. 8.7: Symphony orchestra. 8.15: Miss Bunty Stuart, contralto. 8.22: Bard selections. 8.30: Mr. Tommy Clyde, Scottish comedian. 8.37: Violin solos. 8.45: Miss Elsie Peerless, soprano. 8.52: Symphony orchestra. 9.0: Weather report. 9.3: Mr. Laurence Macaulay, baritone. 9.13: Band selections. 9.23: Miss Bunty Stuart, contralto. 9.33: Violin solos. 9.38: Mr. Tommy Clyde, comedian. 9.46: Symphony orchestra. 9.53: Miss Elsie Peerless, soprano. 10.0: Instrumental music. 10.30: Close down.

**2UW**

Radio Broadcasting, Ltd., Palling's Building, Ash St., Sydney (Wavelength, 267 Metres).

**MIDDAY SESSION** (as usual). **EVENING SESSION.—6.30:** Children's Hour. 6.30 Close. 7.0: Chimes. Request numbers. 8.0: A New Year's Eve programme. 9.0: Chimes. Comments on Foreign Affairs, by Mr. J. M. Prentice. 9.10: Music and request numbers. 10.30: Close.



## Giving **SERVICE** unexcelled by any other make of Battery of equal size and capacity

You've probably often spent much thought about your radio batteries—comparing the efficiency of their service with the price you pay for them. There's a virtue in always seeking value and economy. No pleasure merits a continuous and costly drain on your patience and your finances.

Here are some features you will like about the famous "Ever-Ready" SUPER SERVICE 45 Volt H.T. "B" Battery. Consider its advantages carefully, and you will realise how much more in power, efficiency, and economy an "Ever-Ready" offers you.

1. Specially designed for use with multi-valve sets, of 4 or more valves.
2. Made up of 30 large cells in moisture-proof containers. Positive screw terminal taps at 18, 24, 30, and 45 volts.
3. Heavy gauge zinc containers, high grade chemicals perfectly balanced; efficient insulation.
4. Cells are larger and have 25 per cent. greater output capacity than those in most other Heavy Duty "B" Batteries selling at a higher price.
5. AUSTRALIAN MADE—FRESH FROM THE FACTORY TO YOU.
6. Used in conjunction with the "Ever-Ready" No. 126 C Battery, it represents the most economical radio battery service obtainable in Australia.
7. Noted for its long life, complete reliability, and noiseless flow of power.
8. Guaranteed by the largest manufacturers of dry batteries in the Empire.
9. Obtainable from all good radio dealers.

WHOLESALE DISTRIBUTORS:

THE EVER-READY CO. (Gt. Britain), LTD  
163 Pitt Street, SYDNEY.

**EVER-READY**  
**DRY BATTERIES**



HERE'S A THREE VALVE ALL ELECTRIC RECEIVER COMPLETE WITH VALVES FOR

£15-10-0

Imagine this low price for a three-valve receiver! THE ALPINE is all-electric, operating direct from your light socket without batteries. You tune by simply turning one full-vision graduated dial—and bring your volume to any desired pitch with a small knob. You will be surprised at the life-like reproduction of this handsomely finished receiver.

But, remember! This remarkably low price lasts only while there are existing stocks. THE NEW TARIFF WILL MEAN AN INCREASE IN PRICE. GET YOUR ALPINE RECEIVER NOW!

WHAT THIS SATISFIED USER SAYS

"For simplicity, volume, and clearness, nothing more could be desired. I am highly satisfied."

# ALPINE ALL-ELECTRIC THREE

DEALERS.—We shall be glad to have your inquiries concerning our radio products. In addition to the ALPINE ALL-ELECTRIC THREE, we are exclusive distributors for AIR-MASTER, BRANDES, and the new ALPINE SCREENED GRID ALL-ELECTRIC RECEIVER.

See our display at the Radio Exhibition, State Shopping Block.

**S. E. TATHAM & CO.,**

160 Castlereagh Street, SYDNEY.  
Phones, M4151-2.

## Interstate Programmes New Year's Eve

### 3LO

Australian Broadcasting Co., 120A Russell St., Melbourne (Wavelength, 371 Metres).

**EARLY MORNING SESSION.**  
7.0 to 8.15: As usual.

**MORNING SESSION.**  
10.30 to 12.30: As usual. 11.3: Cricket.

**MIDDAY SESSION.**  
1.0 to 1.30: As usual.

**THE EDUCATIONAL SESSION.**  
2.0: Through the Himalayas, Mrs. Chas. King. 2.15: Musical interlude. 2.20: The Romance of an Oil-field, Mr. A. A. Downs. 2.35: Musical interlude. 2.40: A Talk in French, Mons. Th. Rouel. 2.45: Musical interlude.

**BRASS BAND MATINEE.**  
3.0: Royal Brass Band—March, "Salute the Brave"; Fox-trot, "Louise"; 3.8: Les. Rohmer, "The Prince of Variety," will entertain. 3.15: Freda Trewick, mezzo-soprano—"Thank God for a Garden" (Del Riego); "Gingham Gown" (Penn). 3.22: Royal Brass Band—Waltz, From "Eugene Onegin"; Gavotte, "Castle Chimes"; 3.30: Jack Kearns, comedian, will entertain. 3.38: Victor Harding, bass-baritone—"Four Jolly Sallormen" (German), "A Retreat" (Loughborough). 3.45: Royal Brass Band—Request Number. 3.52: Les. Rohmer, "Prince of Variety," will entertain. 4.0: Royal Brass Band—Trombone Solo, Ave Maria" (Gounod). 4.4: Freda Trewick, mezzo-soprano—"Love's Coronation" (Alyward); Selected. 4.11: Jack Kearns, comedian, will entertain. 4.18: Victor Harding, bass-baritone—Request Numbers. 4.24: Royal Brass Band—Selection, "Daughter of the Regiment," 4.30: Acceptances and barrier positions for the Mentone Races, to be held on Thursday, January 2. 4.35: Close down. During the afternoon results of the Yarra Glen Races will be broadcast as they come to hand; also progress scores in the Cricket Match, Tasmania versus Victoria, at Launceston.

**THE CHILDREN'S CORNER.**  
5.45: Opening Chorus, with "Bobbie Bluegum" and "Clever Clarice." "Bobbie Bluegum" discusses "New Year Resolutions with Echo" and "Grace. The Children's News Bulletin. 6.0: Time Chimes. The Studio Light Orchestra—Popular Tunes for Little People. "Clever Clarice" sings a little song, and "Bobbie Bluegum" sings one a little longer. 6.25: Birthday Greetings by "Bobbie Bluegum." 6.35: Musical interlude.

**EVENING SESSION.**  
6.40: The Boy Scouts and Girl Guides' Associations—Representatives from both Associations will discuss "The Activities of the Closing Year and a Few Prospects for the New." 6.55: Musical interlude. 7.0: Melbourne Observatory time signal. 7.1: Countryman's Session. 7.20: Musical interlude. 7.25: Travel Sketches in Europe—Geneva in History and Literature. Miss Frances Fraser. 7.40: News service. 7.45: The World's Kaleidoscope. Prof. K. H. Bailev. 8.0: Time signal.

**NIGHT SESSION.**  
8.0: National Broadcasting Orchestra—Overture, "The Beautiful Galatea" (Suppe). 8.10: Allan Mitchell, tenor—"The Minstrel Boy" (Cvrlil Scott). 8.17: Eric Welch will speak on "To-morrow's Races at Flemington." 8.30: Paul Jeacle and His Band—Dance Music. 8.40: Merna Stewart, soprano—"A Heart That's Free" (Robyn), with Orchestra.

8.50: Nora O'Malley, at the piano. 8.53: Paul Jeacle and His Band—Dance Music. 9.0: Allan Mitchell, tenor—"Myrrha" (Clutsum). 9.3: Paul Jeacle and His Band—Dance Music. 9.12: Mark Makeham, "The Whispering Wag." 9.16: Paul Jeacle and His Band—Dance Music. 9.26: Nora O'Malley, at the piano. 9.30: Paul Jeacle and His Band—Dance Music. 9.40: Merna Stewart, soprano—"Land of My Dreams" (Stewart), with Orchestra. 9.43: Paul Jeacle and His Band—Dance Music. 9.53: Allan Mitchell, tenor—"Mandalay" (Hedgerly).

9.56: Paul Jeacle and His Band—Dance Music. 10.6: New Year Greetings. 10.15: Paul Jeacle and His Band—Dance Music. 10.25: Nora O'Malley, at the piano. 10.28: Paul Jeacle and His Band—Dance Music. 10.38: Mark Makeham, "The Whispering Wag." 10.41: Paul Jeacle and His Band—Dance Music. 10.50: Nora O'Malley and Mark Makeham—A Radio Sketch. 11.0: Paul Jeacle and His Band—Dance Music. 11.10: Merna Stewart, soprano—"My Heart is Light" (Klein). 11.12: Paul Jeacle and His Band—Dance Music. 11.30: A Song Scene—New Year's Eve at the Bachelors' Club, produced by F. Clarke Cottrell. 11.55: Bells from St. Paul's Cathedral. 12.0: "Auld Lang Syne." 12.5: New Year Greetings. 12.10: God Save the King.

### 3AR

Australian Broadcasting Co., 120A Russell St., Melbourne (Wavelength, 484 Metres).

**MORNING SESSION**  
8.15 to 11.0: As usual.

**MIDDAY SESSION**  
12.0 to 1.30: As usual. 12.1: Cricket.

**AFTERNOON SESSION**

The artistic reproduction of absent artists. 2.30: Bands, massed Military Bands. 2.33: Whispering tenor, Fred Williamson. 2.38: Trumpet, Tom Dorsey. 2.39: Entertainers, The Six Nite Lites. 2.43: Monologues, North and South. 2.46: Bands, massed Military Bands. 2.49: Soubrette, Sophie Tucker. 2.52: Violin, Tossy Spivakovsky. 2.55: Whispering tenor,

Fred Williamson. 2.58: Trumpet, Tom Dorsey. 3.1: Request numbers. 3.20: The Baby—Summer Hints for Mothers, Matron Moreland, of the Twiddle Baby. 3.35: Musical interlude. 3.40: The Lure of the Red-lined Map, Miss M. Punshon. 3.55: Musical interlude. 4.15: Musical reproduction. 5.0: Chimes. 5.1: Musical reproduction. 5.30: Weather. 5.45: Close down.

**EVENING SESSION**

6.15 to 8.0 As usual.

**NIGHT SESSION**

8.1: Tricks and Tricksters, Dr. Loftus Hills, D.Sc. 8.15: National Broadcasting Orchestra—Overture, "Euryanthe" (Weber). 8.25: Winifred Mitchell, soprano—"The Almond Tree" (Schumann), "The Loreley" (Liszt). 9.2: Sisserman, cellist—"Kol Nidrei" (Bruch), with piano and organ accompaniment; "Romance Sans Paroles" (Davidoff), "Tarantella" (Popper). 8.47: Gertrude Hutton, contralto—"Margaret at the Spinning Wheel" (Schubert), "The Wild Rose" (Schubert). 8.54: National Broadcasting Orchestra—"Andantino," from "Fourth Symphony" (Tschalkowsky). 9.4: The Two Jesters—Scene from the "Merchant of Venice" (Shakespeare). 9.14: National Broadcasting Orchestra—Descriptive fantasy, "In a Chinese Temple Garden" (Ketelby). 9.22: Les. Hansen, comedian, will entertain. 9.30: Cecil Steele, piano—Syncope. 9.35: Winifred Mitchell, soprano—"Blackbird's Song" (Scott), "Cradle Song" (Kreiser). 9.42: A.B.C. String Quartette—Quartette No. 1 (Beethoven). 9.52: Gertrude Hutton, contralto—"A Necklace of Love" (Nevin), "The Sands of Dee" (Clay). 10.0: Weather. 10.10: The Two Jesters in song and comedy. 10.18: National Broadcasting Orchestra—"March of the Marionettes" (Savino). 10.23: Les. Hansen, comedian, will again entertain. 10.30: God Save the King.

### 4QG

Queensland Government Radio Service, Brisbane (Wavelength, 385 Metres).

Day sessions, as usual.

**NIGHT SESSION**

8.0: An entertainment from the Wynnum Bowl House. 9.0: Weather. 4QG Concert Orchestra (conducted by Eric John)—"Carnival Overture" (Dvorak). Monument and Harrow—A New Year's Eve Meeting. 4QG Concert Orchestra—"Turkish March" (from "Ruins of Athens"—Beethoven). "Rubinstein's Melody in F." Pete—entertainer. 4QG Concert Orchestra—"Slumber Song" (Schumann), "Moment Musical" (Schubert). Shirley Radford (soubrette)—popular numbers. 4QG Concert Orchestra—Ballet Suite, "Masquerade" (Laconne), "Carnival Match," "Harlequin and Columbine," "Antics of the Clowns." E. Harper, baritone—"When the Sergeant Major's on Parade." 4QG Concert Orchestra—Ballet Suite—"Masquerade" (Laconne), "The Mandolin Serenaders." "Grand Parade." E. Harper, baritone—"The Trumpeter" (Dix). 4QG Concert Orchestra—Waltz, "Mon Reve" (Waldeufel). 10.45: News; weather. 11.0: Roy Baird and his Trocadero Orchestra. 12.0 (midnight): "A Happy New Year to All."

### 5CL

Central Broadcasters, Ltd., 114 Hindmarsh Square, Adelaide (Wavelength, 409 Metres).

Day sessions as usual. See Friday.

**NIGHT SESSION.**

8.0: Chimes. 8.1: Programme review and announcements. 8.10: Potpourri of grand opera, including scenes from "The Barber of Seville," "The Daughter of the Regiment," "The Bohemian Girl," in which the following artists will take part.—Marcelle Bernard, Vincent McMurray, Fred Guster, Gwen Collett, Bert Woolley; explanatory remarks by Bessie Francis; music by the Steimer Trio. 9.0: Chimes. 9.1: Meteorological information, including Semaphore tides. 9.2: Overseas grain report. 9.3. Announcements. 9.5: Continuation of potpourri of operas. 10.15: News; weather. 10.30: Recordings. 12.1: Rev. G. E. Hale, B.A., will speak to you. 12.5: Close down.

### 6WF

Australian Broadcasting Company, Ltd., Wellington Street, Perth (Wavelength, 435 Metres).

**EVENING SESSION.—8.0:** Chimes. 8.1: Ambassador's Theatre Symphony Orchestra. 8.7: Les. Waldron at the console of the Wurliizer organ. 8.12: Archie and Wattie, "Playing at the Game of Golf." 8.22: Thomas Foley, tenor. 8.29: Marie Will-Godwin, popular vocalist. 8.36: Thomas Foley, tenor. 8.43: Marie Will-Godwin, popular vocalist. 8.50: Request violin recital. "Kreiser" (reproduced). 9.10: Stage presentation from Ambassador's Theatre. 9.30: Uncanny tales by Basil Kirke. 9.45: Bert Howell and his Ambassador's Stage Band. 10.15: Temple Court Dance Band. 10.59: Weather. 11.0: Temple Court Dance Band. 11.45: Scottish programme (reproduced). 11.55: New Year greetings to the people of Western Australia; "Auld Lang Syne." Close down.

RAISE THE STANDARD OF RECEPTION

fit a  
D.E.L  
410



# Osram Valve

## Low Power Consumption

Here is a general purpose valve which consumes only one-tenth of an ampere. It is ideal for strong reception of weak signals and better reception of good ones.

Osram D.E.L. 410 is equally useful for R.F. amplification, sensitive detection, and first stage audio.

Put it in your set for better results.

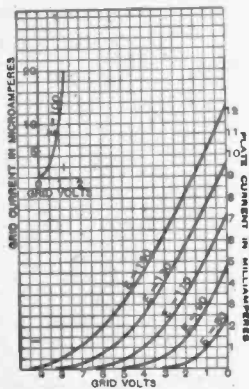

Filament Volts .. 4.0 max.  
 " Current 0.1 amp.  
 Plate Volts .. 150 max.  
 Amplification Factor 15  
 Impedance .. 8,500 ohms.  
 Normal Slope .. 1.77 ma/volt.

Ask for it by number—  
 and say **OSRAM**  
 Made in England

Your "B" Batteries last longer,  
 when used with "Osram Valves."  
 Ask your dealer for the Osram  
 Valve Guide, free on request.

**BRITISH GENERAL ELECTRIC CO., LTD.**

Head Office and Public Showrooms: 104-114 Clarence Street, Sydney.

Branches at Newcastle, Melbourne, Adelaide, Perth, Christchurch, Wellington, Auckland.

Sole Agents at Brisbane and Hobart.

# Local Programmes, New Year's Day

## 2FC

Australian Broadcasting Company, Ltd., Market St., Sydney (Wavelength, 451 Metres).

### MORNING SESSION—AFTERNOON SESSION.

- 10.30: Announcements.  
 10.32: General Sporting Talk by Oscar Lind.  
 10.45: Austradio Musical Reproduction.  
 11.10: CABLES (Copyright), Sun-Herald and A.P.A. News Service.  
 11.15: MORNING DEVOTION.  
 11.30: Austradio Musical Reproduction.  
 11.53: British Official Wireless Press.  
 12.0: "Big Ben." Studio Music.  
 12.20: Midday weather forecast and weather synopsis.  
 12.30: Studio Music.  
 12.50: FROM RANDWICK—Description of the Tattersall's Club Meeting in the running. Note.—Between 1 and 2 p.m. Cec. Morrison and His Band will play Lunch Hour Music.  
 CRICKET.—Progress Results of the Match, Victoria v. N.S.W., played at Adelaide, will be broadcast as received.  
 During intervals between race descriptions a programme of music will be broadcast from the Studio. At 2 o'clock a glance at the afternoon "Sun" will be given.  
 4.35: FROM THE STUDIO—Late Sporting Results.  
 4.45: CLOSE.  
 EARLY EVENING SESSION—5.45 to 7.55  
 5.45: Children's "Good-night" Stories, told by the "Hello Man," assisted by Uncle Ted and "Sandy."  
 6.45: DINNER HOUR MUSIC by the Light Orchestra.  
 7.20: A.B.C. Sporting Service.  
 7.30: Special Country Session. Stock Exchange Resume. Weather Forecast. Late news from the "Sun."  
 7.58: To-night's Programme.

### THE EVENING PRESENTATION—8 to 11.30 p.m.

2FC are featuring to-night the first broadcast of that sparkling Musical Comedy, "Rio Rita," from the Newtown Majestic Theatre. Through 2BL Service a real Scotch Programme, to appeal to Natives of the Highlands, contributed by Piper McKay, Colin Campbell in Novelty Concertina Numbers, the Harmony Four Scotch Quartet, and Scott Alexander in Personality Radio Sketches. Popular Selections will be contributed by the National Broadcasting Orchestra.

- 8.0: FROM THE NEWTOWN MAJESTIC THEATRE—  
 Sir Benjamin and John Fuller present Florenz Zeigfeld's Triumph. "RIO RITA."

Headed by Australia's Idol, Miss Gladys Moncrieff.  
 A Musical Comedy, in Two Acts. Music and Lyrics by Harry Tierney and Joseph McCarth. Book by Guy Bolton and Fred Thompson.

CHARACTERS (in order of appearance)—  
 Padrone ..... Phil Smith  
 Reporter ..... Eric Bush  
 Robert Ferguson (Rita's Brother),  
 Garnet Carroll

Carmen ..... Queenie Ashton  
 Ed. Lovett (a lawyer) ..... Charles Norman  
 Davolas (a bandit) ..... Harry Burgess  
 General Enrique Joselito Esteban,  
 Ian Iredale

Lolita ..... Flo. Flint  
 His Friends.

Rio Rita ..... Gladys Moncrieff  
 Chic Bean ..... Charles Megan  
 Dolly (a cabaret girl) ..... Janette Gilmore  
 Jim ..... Fred. Moore  
 Sgt. McGinn (of the Texas Rangers),  
 Graham Mitchell

Sgt. Joe Wilkins ..... Jack Settle  
 Gonzalez ..... Eric Bush  
 Katie Bean (Chic's First Wife),  
 Phyllis Du Barry

Hermine ..... Minnie Goldberg  
 Montezuma's Daughter ..... Eileen Hembure  
 Synopsis of Scenes—Act 1—  
 Scene 1 ..... Mesca Francesco  
 Scene 2 ..... A Mexican Rendezvous  
 Scene 3 ..... General Esteban's Patio  
 Act 2—  
 Scene 1 ..... A Floating Cabaret on the Rio  
 Scene 2 ..... On the Texas Side

Scene 3 (Three Weeks Later), A Triple Moonlight Wedding.

Musical Programme—Act 1—Scene 1—

Opening: Siesta Time—  
 (a) "The Jungle Dance."  
 (b) "The Tambourine Dance, Ballet."

The Best Little Lover in Town—Charles Norman.

Four Little Gringoes—Dorothy Evans, Minnie Goldberg, Irene Stone, A. Brown.

(a) Sweetheart.  
 (b) River Song.

Gladys Moncrieff and Ensemble.

Are You There?—Janette Gilmore and Charles Megan.

Rio Rita—Gladys Moncrieff and Fred. Moore.

March of the Rangers—Fred. Moore, Jack Settle, Graham Mitchell, and Rangers.

Act 1—Scene 2—

The Spanish Shawl—Nellie Strong and Serenaders.

The Charra Dance—The Rio Rita Girls.

The Kinkajou—Janette Gilmore and Ballet.

If You're in Love You'll Waltz—Gladys Moncrieff and Fred. Moore.

Moonlight Ballet—Rio Rita Dancers. Solos by Irene Stone and Minnie Goldberg.

Out on the Loose—Charles Megan, Glorified Girls, Gringo Dancing Girls, and Rio Rita Dancers.

Finale, Act 1—Entire Ensemble.

Act 2—Scene 1—

The Floating Cabaret—

(a) The Pirates—Rio Rita Dancers.

(b) Dance—Minnie Goldberg.

(c) Skating Dance—Janette Gilmore.

(d) Black and White—Rio Rita Ballet Girls.

I Can't Speak Espagnol—Janette Gilmore and Charles Norman.

Was It a Dream?—Gladys Moncrieff.

Following the Sun Around—Fred. Moore.

The Jumping Bean—Janette Gilmore and Ballet.

Montezuma's Daughter—Gladys Moncrieff.

Moonshine—Charles Megan.

The Triple Moonlight Wedding at Jim's Home—Phyllis Du Barry, Charles Norman.

Janette Gilmore, Charles Megan, Gladys Moncrieff, and Fred. Moore.

10.55: FROM THE STUDIO—

Announcements.  
 Late Official Weather Forecast.

11.0: CEC. MORRISON and HIS BAND.

11.30: CLOSE.  
 "NATIONAL ANTHEM."

## 2BL

Australian Broadcasting Company, Ltd., Market St., Sydney (Wavelength, 353 Metres).

### OPENING SESSION—9.0 to 11 a.m.

9.0: This Morning's Story.

9.20: A Musical Interlude.

9.40: British Official Wireless Press.

9.45: New Music.

10.5: News from the "Daily Telegraph Picture."

10.10: Austradio Musical Reproduction.

10.40: THE AUSTRALIAN BROADCASTING COMPANY'S WOMEN'S ASSOCIATION, conducted by Miss Gwen Varley.

11.0: G.P.O. Chimes; close down.

MIDDAY SESSION—12 Noon to 2.30 p.m.

12.0: G.P.O. Chimes and Announcements.

12.2: A Pianoforte Recital.

12.30: CEC. MORRISON and HIS BAND

1.0: Afternoon news from the "Sun."

NOTE: Cricket results, VICTORIA v. SOUTH AUSTRALIA, will be transmitted as received.

1.5: Memory Melodies.

1.20: Austradio Musical Reproduction.

1.45: A Pianoforte Recital.

2.15: Dance Music.

AFTERNOON ENTERTAINMENT—2.30 to 5.15 p.m.

2.30: FROM TARONGA PARK—A Concert Programme, arranged by the Professional Musicians' Band. At intervals in the afternoon, sporting descriptions will be given.

5.0: Complete Sporting and Racing Resume.

5.15: Close Down.

THE DINNER HOUR—6.15 to 7.55 p.m.

6.15: DINNER MUSIC BY THE LIGHT ORCHESTRA.

6.45: BOYS' RADIO CLUB.

7.5: The A.B.C. Sporting Service.

7.20: DINNER MUSIC BY THE LIGHT ORCHESTRA.

7.45: Austradio Musical Reproduction.

7.55: What's on the air to-night?

TO-NIGHT'S PRESENTATION—8 to 10.30

New Year's Night! A night devoted particularly to Scottish Celebrations, and our programme is replete with the atmosphere of the Highlands. The Harmony Four will sing ballads of the border, Piper Mackay to pipe our programme in, Douglas Graham, Scottish Humor; Colin Campbell in novel concertina items, and Scott Alexander in radio sketches specially written for broadcasting by Codrington Ball. The National Broadcasting Orchestra will also contribute popular Selections.

8.0: PIPER MACKAY, Bagpipes—

(a) "Balmoral Highlanders" (Mackay).

(b) "Blair Drummond Strathspey" (McLennan).

(c) "The Man from Glengarry Reel" (Mather).

8.7: THE HARMONY FOUR, Vocalists.

8.17: THE NATIONAL BROADCASTING ORCHESTRA—

"The Rose" (English Fantasia), Middleton.

8.27: DOUGLAS GRAHAM, Scottish Comedian—

(a) "New Year's Day" (Fyffe).

(b) "Just Let Off the Chain" (Lauder).

8.35: COLIN CAMPBELL, Concertina Solos—

"Scotch Medley."

8.42: SCOTT ALEXANDER will present Codrington Ball's dramatic comedy—

NEW YEAR RESOLUTIONS.

The Scene is laid at Mrs. Macquarie's Chair, Farm Cove.

8.52: THE NATIONAL BROADCASTING ORCHESTRA—

"Melodious Melodies" (Finit).

9.7: THE HARMONY FOUR, Vocalists.

9.17: DULCIE BLAIR, Violinist—

(a) "Ave Maria" (Schubert-Wilhelmj).

(b) "Slumber Song" (Gretchaninoff).

9.24: DOUGLAS GRAHAM, Scottish Comedian—

(a) "Centenerian" (Fyffe).

(b) "Married Tae the Wife" (Fyffe).

9.31: Weather information for the man on the land.

9.33: THE NATIONAL BROADCASTING ORCHESTRA—

"The Star Dreamer" (Oriental Phantasy), Bendix.

9.43: SCOTT ALEXANDER will give the quaint Radio Farce, entitled—

A BRASS RAZOO.

Specially written for Broadcasting by Codrington Ball.

Scene: An Actor's Flat at Darlinghurst.

9.53: COLIN CAMPBELL, Concertina Solo—

"Songs of the Highlands."

10.0: Vocal Duet.

10.7: THE NATIONAL BROADCASTING ORCHESTRA—

(a) "Rosemary" (Barton).

(b) "Summer Nights" (Roberts).

10.25: Late News from the "Sun."  
 Late Weather Forecast.

10.30: "NATIONAL ANTHEM."  
 CLOSE.

## 2GB

Theosophical Broadcasting Station, 29 Rigg St., Sydney (Wavelength, 316 Metres).

Day sessions as usual. 8.0: Miss Mary Neal, contralto. 8.7: Instrumental music.

8.15: Mr. Cecil Houghton, tenor. 8.22: Band selections. 8.30: Mr. Jack Win and Mr. Heath Burdock, humor. 8.35: Miss Gladys Verona, soprano. 8.43: Cello solos. 8.50: Miss Mary Neal, contralto. 9.0: Weather report. 9.3: Address. 9.15: Instrumental trio. 9.25: Mr. Cecil Houghton, tenor. 9.35: Mr. Jack Win and Mr. Heath Burdock, humor. 9.40: Band selections. 9.50: Miss Gladys Verona, soprano. 10.0: Instrumental music. 10.30: Close down.

## 2UW

Radio Broadcasting, Ltd., Paling's Building, Ash St., Sydney (Wavelength, 267 Metres).

MIDDAY SESSION (as usual). EVENING SESSION.—5.30: Children's Hour. 8.30: Close. 7.0: Chimes. Request numbers. 8.0: A New Year's Night programme. 9.0: Chimes. Comments on Foreign Affairs, by Mr. J. M. Prentice. 9.10: Music and request numbers. 10.30: Close.



# Wireless Weekly

**52 ISSUES  
DELIVERED POST FREE  
FOR ONE YEAR**

**13/-**

"WIRELESS WEEKLY" gives you the complete broadcasting programmes from every important Station in Australia a week in advance, in addition to topical news and articles and a technical constructive article by a qualified radio man.

## SUBSCRIPTION FORM

To the Editor, "Wireless Weekly,"  
Box 3366PP, G.P.O., Sydney

Please forward "Wireless Weekly" for a period  
of ..... for which I enclose .....  
for .....

(Add Exchange to Country Cheques.)

NAME .....

ADDRESS .....

Subscription Rates: 12 months (52 issues), 13/- post free; 6 months (26 issues), 6/6 post free

1930 Power Resistors by

## RADIOKES

At Pre-tariff Prices

These Resistors are produced in three types—Light, medium, heavy duty resistors. Ask for information contained in Radiokes New Pamphlets, at your dealers, or direct from factory. We can solve your resistor problems and supply the proper resistor for your job.



Radiokes new 12,000 ohm Resistor for your voltage dividing jobs, as used by leading manufacturers and home constructors. Quite small, being only 4 1-16in. total length and approx. 1 1/2in. high. Tapped for 180v., 135v., 90v., and 45v. Runs cool in use, and will not burn out with normal work. Price, 8/6 each.



Radiokes Vitreous Type Resistors in three duties, and all resistance values, from 100 ohms to 10,000. For all uses with Electric Radios, Gramophones, Power Packs, Public Address Systems, and Talkies. High current carrying capacity, and small and compact in size, and reliable in use. Supported on insulated mounting brackets, beautifully finished, and moderately priced from 3/3 to 6/6 each.



Filament Tubes operating on A.C. require a centre tap for the grid return. The centre tapped transformer is costly, and fails to provide for circuit or filament unbalance. Adjustable centre taps have heretofore been bulky, costly, and by no means fool-proof. But now you have the Radiokes adjustable centre tapped resistor, simple to install, fool proof, highly efficient, and inexpensive. Priced at 3/3 each. Sizes from 10 to 50 ohms.

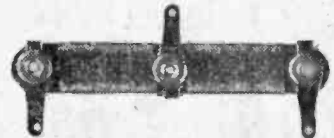

Radiokes Centre Tapped Strip Resistors are made in sizes from 10 to 75 ohms, with adjustable solder lugs for mounting direct to your socket terminals, ruggedly and accurately constructed, and reasonably priced at 2/6 each.

From your dealer or direct from  
**METROPOLITAN ELECTRIC CO., LTD.,**

Sussex Street, Sydney.

# Mr. Crystal Set User

## ELIMINATE THAT IRRITATING INTERRUPTION!

of lost or poor reception caused through that faulty and inferior Crystal Detector.



Instal the modern famous LION MICRO PERMANENT DETECTOR, and enjoy real and continuous reception. Not only will the reception be continuous, but Volume and Clarity will be doubled.

LION MICRO, glass enclosed, 6/6 each.

LION TRON, for panel mounting, 7/6 each.

LION MAXTONE, as illustrated, 8/6 each.

**No Catswhiskers—  
No Trouble  
Dust and Moisture  
Proof!**

Australian Agents:

## W. Harry Wiles

Electrical, Radio, and Meccano Supplier,

**Pitt & Goulburn Streets  
Sydney**

The Home of Wiles' Wonderful Wireless.

# Interstate Programmes New Year's Day

## 3LO

Australian Broadcasting Co., 120A Russell St., Melbourne (Wavelength, 371 Metres).

### MORNING SESSION.

10.30 to 12.30: As usual. 11.30: Cricket. 12.55: Description of New Year Hurdle Race, two miles, V.R.C. races at Flemington, by Eric Welch. 1.5: Weather. 1.20: Comments on the day's news. 1.35: Description of Standish Handicap, six furlongs, V.R.C. races, at Flemington, by Eric Welch. 1.45: Musical interlude from the Studio.

### AFTERNOON SESSION.

2.0: Description of Sheffield Shield Cricket Match, Victoria versus South Australia, at M.C.C. 2.30: Description of January Steeplechase, two miles half a furlong, V.R.C. Races at Flemington, by Eric Welch. 2.40: Description of Sheffield Shield Cricket Match, Victoria versus South Australia, at M.C.C. 3.10: Description of Bagot Handicap, one mile and a half, V.R.C. Races at Flemington, by Eric Welch. 3.20: Description of Sheffield Shield Cricket Match, Victoria versus South Australia, at M.C.C. 3.50: Description of Criterion Handicap, five furlongs, V.R.C. races at Flemington, by Eric Welch. 4.0: Melbourne Observatory time signals; sporting results to hand. 4.5: Description of Sheffield Shield Cricket Match, Victoria versus South Australia, at M.C.C. 4.25: Description of January Handicap, one mile, V.R.C. races at Flemington, by Eric Welch. 4.35: Description of Sheffield Shield Match, Victoria v. South Australia, at M.C.C. 5.0: Melbourne Observatory time signal. Sporting results to hand. 5.5: Description of Sheffield Shield Cricket Match, continued. 6.0: Stump scores.

### THE CHILDREN'S CORNER.

6.5: "Little Miss Kookaburra" starts with a peal of laughter. "Old Mr. 1929" has gone right away for ever, and tiny Baby "1930" is with us. "Little Miss Kookaburra" will give him a hearty welcome on behalf of the Little Kookaburres. He is a wee bit shy at first. The Children's News Bulletin. 6.25: Birthday Greetings by "Little Miss Kookaburra." 6.35: Musical interlude.

### EVENING SESSION.

6.40: Sporting results. 6.55: Musical interlude. 7.0: Melbourne Observatory time signal. 7.1: Musical interlude. 7.15: Captain Donald MacLean—Tales of the Spanish Main. 7.20: Musical interlude. 7.25: Hattie Knight—Those New Year Resolutions. 7.40: The "Herald" News Service. Cable news service (copyright, Australian Press Association and "Sun"-"Herald" News Service, Ltd.). 7.45: Chas. Nuttall—Why We Commemorate New Year's Day.

### NIGHT SESSION.

8.0: Transmission from Station 2FC Sydney—The Popular Musical Comedy, "Rio Rita," headed by Australia's Idol, Miss Gladys Moncrieff (See 2FC programme). 10.30: News Session. 10.45: Paul Jeacle and His Band—Dance Music. 11.30: God Save the King.

## 3AR

Australian Broadcasting Co., 120A Russell St., Melbourne (Wavelength, 484 Metres).

### MORNING SESSION

9.0: Chimes. 9.1: Weather data. 9.15: News. 9.20: Musical reproduction. 10.0: Chimes. 10.1: British official wireless news. 10.10: Announcements. 10.30: Arnold Coleman at the Wurlitzer. 10.50: The daily broadcast service. 11.0: Close down.

### MIDDAY SESSION

12.0: Chimes. 12.1: Description of Sheffield Shield cricket match, Victoria v. South Australia, at the Melbourne Cricket Ground. 1.15: Luncheon music.

### AFTERNOON SESSION

2.30: Wurlitzer organ, Leslie James—"Lily of Laguna," "Just Imagine." 2.36: Comedian, Frank Crumple—"The Road to Vicksburg." 2.39: Orchestral—Jack Hilton and his Orchestra. 2.45: Homes Throughout the Ages, Dr. Loftus Hills, D.S.S. New Year's Day Matinee.—3.0: Paul Jeacle and his band—"Pa's Old Hat" (Guy). "The Toymaker's Dream" (Golden). 3.6: R. Nicholson, bass—"Land of Delight" (Sanderson). "The Little Ships" (Sanderson). 3.13: Claude Jeacle, tenor saxophone—Selected. 3.17: J and G., the Confidential Two—Something novel and new. 3.25: Paul Jeacle and his Band—"Love is a Dreamer" (Green). "Laughing Marionette" (Collins). 3.31: The Two Daleys in Stop-press Topicalities. 3.41: Bruce Wite, piano—Selected. 3.45: A comedy sketch—"The Dyspentic" by Robert Hizzinbotham. Characters: Mrs. Daniel Stokes, Mrs. Dudley; Mr. Fairfax, Maurice Dudley. 4.0: Paul Jeacle and his Band—"Sweetheart of All My Dreams" (Fitch). "Lila" (Gottler). 4.6: Gaby Du Valle, soprano—"Love's Torment" (Berthelem). "Bree" Mexican song. 4.13: Horrie Sheehan, trumpet—"Queen of the Earth" (Pinsuti). 4.17: R. Nicholson, bass—"The Song of the Homeward Bound" (Coningsby-Clarke). "Sylvia" (Speaks). 4.24: Paul Jeacle and his Band—Dance numbers. 4.30: The Two Daleys in Stop-press Topicalities. 4.38: Claude Jeacle, baritone—"Destiny" (Bayres). 4.42: J. and G., the Confidential Two—"Dream Mother," piano novelty. 4.46: Bruce Wite, piano—"Sollou" (Broom). 4.50: Gaby Du Valle, soprano—"Bird Song at Eventide" (Coates), selected. 4.57: Paul Jeacle and his Band—"Goodness Gracious Grace" (Abbott). 5.0: G.P.O. Chimes. 5.1: Musical reproduction. 5.30: Weather. 5.45: Close down.

### EVENING SESSION

6.15: Dinner music. 7.30: What's in the air tonight? 7.32: Sporting results. 7.55: Latest musical releases. 8.0: G.P.O. chimes.

### NIGHT SESSION

8.0: New Year's Day in Strange Countries—Mr. H. J. G. Esmond. 8.15: National Broadcasting Orchestra—Overture, "Poet and Peasant" (Suppe), "Serenade" (Herbert). 8.25: James Riley, tenor—"Lord Randal" (Scott), "Inter Nos" (MacFadyen). 8.32: Cecil Fraser, piano—"Concerto in G Minor" (Saint-Saens), 1st Movement, accompanied by the National Broadcasting Orchestra. 8.42: Linda Wald, soprano—"Caro Mio Ben" (Gloriani). "O, That It Were So" (Bridge). 8.49: Anlon Mulliner will entertain with his zither. 8.57: Kate Cornell, entertainer—"Let Her Go to Jericho." 9.7: National Broadcasting Orchestra—Descriptive fantasia, "A Day in Naples" (Byng). 9.15: James Riley, tenor—"Mother Macree" (Ball), "A Thrush at Eye" (Cadman). 9.22: Edouard Lambert, violin—"Polonaise" (Wentawski). 9.30: Linda Wald, soprano—"Mah Lindy Lou" (Strickland), "All in the April Evening" (Diack). 9.37: Anlon Mulliner will again entertain with his zither. 9.45: A mystery story—"The Room of Fear," Mr. J. Howlett Ross. 10.0: Weather information and "Herald" news. Cable news service (copyright Australian Press Association and Sun-Herald News Service, Ltd.). 10.10: National Broadcasting Orchestra—Selections from "Les Cloches D'Corneville" (Planquette). 10.18: Kate Cornell, entertainer—"How to Live to be Two Hundred." 10.25: National Broadcasting Orchestra—"March Militaire" (Schubert). 10.30: God Save the King.

## 4QG

Queensland Government Radio Service, Brisbane (Wavelength, 385 Metres).

Early morning session, as usual. No morning transmission. No midday transmission. Afternoon session, as usual. Early evening session, as usual.

### NIGHT SESSION

8.0: Grace and Nat Gould—Piano and Banjo. 8.10: Harry Humphreys—A Dame sketch, Mrs. Odson and Mrs. Ackett. 8.25: B. F. Kelly, flautist—"Graceful Dance" (Lemon). 8.30: Roy Baird and his Trocadero Orchestra—Ten Minutes' dance music. 8.40: Two Sad Sunbeams—Entertainers. 8.50: W. H. Davis, cornet solo—"Memories of the Past" (Smith). 9.0: Metropolitan weather forecast. 9.1: Roy Baird and his Trocadero Orchestra—Dance music. 9.10: W. H. Davis, cornet solo—"Polka Brilliant" (Osbourne). 9.15: B. F. Kelly, flautist—"Saltarello" (German). 9.20: A short recital of electric records. 9.45: Roy Baird and his Trocadero Orchestra. 10.0: News; weather. Close.

## 5CL

Central Broadcasters, Ltd., 114 Hindmarsh Square, Adelaide (Wavelength, 469 Metres).

### AFTERNOON SESSION

12.0: G.P.O. Chimes. 12.1: Special late selections for races at Flemington. 12.3: Probable starters and selections for races at Morphettville to-day. 12.15: News. 12.45: Recordings. 1.0: G.P.O. Chimes. 1.1: During the afternoon a running description of the races at Morphettville will be given, interspersed with musical numbers from the Studio. 5.0: Close down.

### EVENING SESSION

5.45: Morphettville acceptances. 6.1: Children's Happy Moments. 6.15: Children's request numbers. 6.30: Dinner session. 7.0: Chimes. 7.1: Senior Birthday League greetings. 7.2: Sporting service. Resume of Flemington and Cheltenham race results. 7.20: Recordings. 7.45: Boy Scout Corner.

### NIGHT SESSION

8.0: Programme review and announcements. 8.10: The Madrigal Singers. 8.18: Luigi Patrucco, harmonica. 8.25: Phyllis Everett, contralto. 8.32: Dave Howard, comedian. 8.42: The Madrigal Singers. 8.50: Guido Giacchino, cellist. 8.55: Gordon Hele, baritone. 9.0: Chimes. 9.1: Meteorological information, including Semaphore tides. 9.2: Overseas grain report. 9.3: Announcements. 9.5: Luigi Patrucco, harmonica. 9.9: One-act play (produced by Beryl Alford), in which Beryl Alford and Frank Johnstone will take part. 9.29: The Madrigal Singers. 9.35: Guido Giacchino, cellist. 9.39: Linda Wald, soprano—"Sing, Sing, Blackbird" (Phillips). "The Night Has a Thousand Eyes" (Del Riego). 9.46: Dave Howard, comedian. 9.55: The Madrigal Singers. 10.1: Norman Morphet, tenor. 10.7: Luigi Patrucco, harmonica. 10.15: News service. 10.30: Recordings. 11.15: Close down.

# LEVENSON'S RADIO

The *Leading Australasian Wireless Goods House,*

OFFER SOME MORE UNBEATABLE VALUES

Muter 5-stage Resistance Coupled Amplifiers, 3 stage 10/6, 2 stage 8/6.	Gramophone Pick-ups. Lissen Adjustable, 15/-; Blue Spot, 55/-; De Jur, £2/12/6; Loewe, 21/6.	.0001 Reaction Variable Condensers, Midget, English, 1-hole mount, 5/6.	Silver Knight Short-wave Coil Kit, now 27/6.	Valve Sockets, De Jur UX, 1/3; De Jur UY, 1/9. Alpha Spring with Terminals, 1/9.
---	--	---	--	---

1—Electron 100ft, Aerials, Insulated . . . 2/-, 2/6	5—Single or Double Jacks . . . . . 1/-
2—De Jur Switch and Rheostat (30 ohm combined) . . . . . 3/6	6—200,000 Wire Wound Variable Resistances . . . . . 8/-
3—7-way Battery Cable . . . . . 1/3 yd,	7—S.C.O. Continental Audio Transformers 12/6
4—Bremer Tully Short Wave Kit, £4, NOW £2/-	8—Magnus Headphones, 35/-, . . . . NOW 17/6

Bremer Tully Vernier Dials, 15/-. Now 4/-. Perfect in detail—wonderful in action.

---

Like a Flash ABC Eliminator Transformer. Heavy duty—no hum. Chart supplied. 35/-.

Double Heavy Duty Chokes, 25/-, Chokes, 50 Henry, for small eliminators, 8/6.

---

Build your own "A" Battery Charger. Chargers, 2, 4, or 6 volt Accumulators, 50/-. Not a trickle charger. Anyone can build it in 15 minutes. Chart supplied.

---

Renown Coil Kits, 10/6.  
De Jur Interstate 3-coil Tuner, 15/-.

Like a Flash Reinartz Coils, 4/9.  
De Jur 1930 B.D. Coil Kit, 22/6.

---

Make your own coils. Just landed. English Adjustable Coil Winders, 32/6.

---

Ready-cut Radlon Panels, 4d square inch.

Bakelite Tubing, 1, 1 1/2, 2, 2 1/2 and 3 inch, 3d per inch.

Dilecto Tubing, 2 1/2, 3, 3 1/2, 4 inch, 6d inch.

Anyone can now build their own

## Electric 3 Radio Set

Levenson's simply-explained Illustrated Booklet shows any novice how to construct it. Price 1/-. Free with parts.

**Everything supplied, including only Best Quality Components.**

# £15

**NO HUM. NO WORRY.**

See it built in skeleton form in our window.

---

Sterling "Popular" Loudspeaker, £3. Now	30/-
Continental Cone Speaker Units . . . . .	13/6
Paper Cones, ready made, 1/3. Six-sixty Cone Paper, 1/9, 2/9.	
Marco Shielded 30 ohms. Rheostats . . . . .	2/9
Marco Multi Phone or Speaker Plugs . . . . .	2/9
Duo Phone Plugs, 2/-. De Jur Phone Plugs	1/3
Amico De Luxe Battery Strip, 7/9. Now	3/6
Par's Multi Stranded Phosphor Bronze 100ft. Aerials . . . . .	2/6

Tefag Adjustable Headphones, 4000 ohms, 12/6.

---

B.T.H. British Valves, UX Tape Base, 2, 4, and 6 volt series, 13/6, 22/6. Now 6/6.

Cleartron Special Detector, 6-volt valves, 32/6. Now 10/-.

---

Radio Frequency Midget Basket Coil Kit for any 5-valve set, 13/6. Now 5/-.

---

German Frame Aerial, collapsible swivel, nickel-plated compass, base. Worth £10. Now £2.

---

Build Levenson's 3-valve Midget Portable Radio. Everything needed costs £7/17/6. Booklet 1/-, free with parts.

---

Good-bye "B" Batteries. Make your own "B" Battery Eliminator. A child could. Everything needed cost £2/8/6. Chart supplied. Build it in 25 minutes.

Like a Flash Heavy Duty 45-volt B Batteries, 21/-. Worth 28/6.	Amplion AR 38 Loud Speakers, 90/. Now half-price, 45/.	Amplion AR 19 Loud Speakers, £6/10/-. My price, 50/-.	Lissen Loud Speaker Units, 13/6. Reeds for making same into cone Speaker, 1/-.	Like a Flash Wave Trap. Cut out that interfering station, 15/-.	Lissen English Super-audio Transformers. The world's best, 24/-.
Compact .00035 Brass Plate Variable Condensers, 10/6 Value. 4/9.	High Grade 4-volt 1-unit Hard Rubber Cased Accumulators, 50/-. Now 30/-.	De Jur .00014 Short Wave Variable Condensers, one hole mount. Best made, 10/6.	Wates 3 in 1 Volt-amp. Meter. Best made British. Now 10/6.	Like a Flash High Grade Valves. UX 199, 4 volts, 8/6; UX 201, 6 volts, 6/6. Special Detector or Power Valve, 10/6.	"Quam" High Grade Variable Condensers, .00025, .00055, .0005, 35/-. Now 6/6.

**SEND NOW FOR CATALOGUE, FREE.**

ALSO,  
To be issued early in New Year, Levenson's Handbook and Catalog, 160 pages, 1/-. coupon enclosed worth 4/-. Send stamps now, and we will mail you yours when ready.

## LEVENSON'S RADIO

THE PALACE OF WIRELESS.

### 226 PITT STREET, SYDNEY

Branch: 86A Pitt Street, between Hunter Street and Martin Place.

Special attention to Mail Orders. Satisfaction assured. Your wants forwarded V.P.P. System. You pay your local Post Office on receipt of goods.

# Local Programmes, Thursday, January 2

## 2FC

Australian Broadcasting Company, Ltd., Market St., Sydney (Wavelength, 451 Metres).

### EARLY MORNING SESSION—7 to 8.15 a.m.

- 7.0: "Big Ben" and Programme Announcements.
- 7.2: Meteorological information for the man on the land.
- 7.5: This morning's news from the "Daily Telegraph Pictorial."
- 7.10: Austradio Musical Reproduction.
- 7.45: Mails and shipping.
- 7.48: What is on to-day?
- 7.50: Children's Birthday Calls.
- 7.55: Music from the Studio.
- 8.15: CLOSE.

### MORNING SESSION—10.30 a.m. to 12.30

- 10.30: Announcements.
- 10.32: A.B.C. Racing Observer.
- 10.45: HORACE WEBER at the GRAND ORGAN.
- 11.0: HOUSEHOLD HELPS—Domestic Notes, by Miss Ruth Furst.
- 11.10: CABLES (Copyright), Sun-Herald and A.P.A. News Service.
- 11.15: MORNING DEVOTION.
- 11.30: Austradio Musical Reproduction.
- 11.53: British Official Wireless Press.
- 12.0: "Big Ben." Stock Exchange, and Metal Quotations.
- 12.5: ANNIE HUGHES, speaking on "King George V.—In Comparison."
- 12.20: Midday weather forecast and weather synopsis. Special produce market session for the man on the land, supplied by the State Marketing Board.
- 12.30: CLOSE.

### THE LUNCH HOUR—1 to 2.30 p.m.

- 1.0: LUNCH HOUR MUSIC by Cec. Morrison and His Band.
- 2.0: Stock Exchange, second call.
- 2.2: A Glance at the afternoon "Sun."
- 2.7: To-day's acceptances, by the A.B.C. Racing Observer.
- 2.17: Studio Music.
- 2.27: Announcements.

### THE RADIO MATINEE—2.30 to 4.30 p.m.

- 2.30: A PIANOFORTE RECITAL.
- 3.0: C. N. BAEYERTZ will speak on "Spoken English."
- 3.15: NEA HALLETT, Popular Vocalist—(a) "Heart O' Mine" (Silvers). (b) "Little Town Called Home, Sweet Home" (Donaldson).
- 3.22: FARMER'S DANCE ORCHESTRA.
- 3.23: FROM THE STUDIO—MODERN BALLET DADS.
- 3.22: FARMER'S DANCE ORCHESTRA.
- 3.52: FROM THE STUDIO. NEA HALLETT, Popular Vocalist—(a) "Avalon Town" (Brown). (b) "What Wouldn't I Do For That Man?" (Gorney).
- 4.0: AN AFTERNOON STORY.
- 4.15: FARMER'S DANCE ORCHESTRA.
- 4.28: FROM THE STUDIO—Stock Exchange, third call.
- 4.30: CLOSE.

### EARLY EVENING SESSION—5.45 to 7.55 p.m.

- 5.45: Children's "Good-night" Stories, told by Aunt Goodie.
- 6.45: DINNER HOUR MUSIC—Cec. Morrison and His Band.
- 7.20: A.B.C. Sporting Service.
- 7.25: Special Country Session. Stock Exchange Resume, Markets, Weather Forecast, Late news from the "Sun." Truck Bookings.
- 7.58: To-night's Programme.

### THE EVENING PRESENTATION—8 to 11.30 p.m.

A play night for 2FC always offers something a little different, and the factory-made Magic Carpet woven by James Donnelly is going to transport our Listeners to-night in imagination to far-distant countries. We will take you for a trip in the air "on the air"—by Radio Aeroplane. At 9 o'clock we return home to a scene in everyday life at the home of the Kenney's, later in the evening there is Dance Music by the Hotel Australia Dance Band, Comedy Numbers by John Stuart, popular songs by Margaret Grimshaw. Through 2BL the Overture and Presentation from the State Theatre, a Comedy Interlude by the Mirth Quakers, Reminiscences by Wilfred Blacket, K.C., which are creating wide inter-

est, Songs from Rowell Bryden, and Fred Gooch, entertainer at the piano, complete the evening's popular entertainment.

8.0: THE FACTORY-MADE MAGIC CARPET—Will you come with us to the other side of the world? We will show you a dazzling snow scene, and in a moment we will transport you to a vividly colorful Eastern Bazaar. We will take you to the Dark Continent, and, lest this prove too much, the mellow climate of the South of France will provide an effective anodine.

### 9.0: WE ARE HOME AGAIN—THE COUNTRY MAN'S WEATHER SESSION—

(a) New South Wales Forecasts.  
(b) Interstate Weather Synopsis.  
Yachtsman's and Fisherman's Forecast.

9.2: Cameos of Suburbia—"The Kenney's At Home"—A Scene in Everyday Life.

9.30: THE HOTEL AUSTRALIA DANCE BAND.

9.42: FROM THE STUDIO—JOHN STUART in a Comedy Sketch, entitled, "Punishment." Specially written for the Radio by John Stuart.

Characters—  
The Father..... John Stuart  
The Daughter..... Margot Morton

9.50: MARGARET GRIMSHAW. Popular Vocalist—  
(a) "Heart O' Mine" (Silvers).  
(b) "Do Something" (Green and Stept).

9.57: THE HOTEL AUSTRALIA DANCE BAND.

10.7: FROM THE STUDIO. JOHN STUART, Comedian—  
(a) Song, "Don't Hang the Washing on the Aerial."  
(b) Song, "Youngest Old Man in the Village."

(c) Humorous Chat, "Present Day Life."

10.15: Announcements. Late Official Weather Forecast.

10.20: THE HOTEL AUSTRALIA DANCE BAND.

11.30: CLOSE. "NATIONAL ANTHEM."

## 2BL

Australian Broadcasting Company, Ltd., Market St., Sydney (Wavelength, 333 Metres).

### OPENING SESSION—8.15 to 11 a.m.

- 8.15: G.P.O. chimes and announcements
- 8.16: Music for every mood.
- 8.40: Meteorological data for the country
- 8.45: Mails and shipping information.
- 8.50: Memory Melodies.
- 9.0: This morning's story.
- 9.30: A musical interlude.
- 9.40: British official wireless press.
- 9.45: New music.
- 10.2: News from the "Labor Daily."
- 10.5: News from the "Daily Telegraph Pictorial."
- 10.10: Austradio musical reproduction.
- 10.40: THE AUSTRALIAN BROADCASTING COMPANY'S WOMEN'S ASSOCIATION, conducted by Miss Gwen Varley

11.0: G.P.O. chimes. Close down.

### MIDDAY SESSION—12 noon to 2.30 p.m.

- 12.9: G.P.O. chimes and announcements.
- 12.2: A pianoforte recital.
- 12.30: LUNCH MUSIC, BY CEC. MORRISON AND HIS BAND.
- 1.0: Afternoon news from the "Sun."
- 1.5: Austradio musical reproduction.
- 1.30: A pianoforte recital.
- 2.0: Memory melodies.
- 2.15: Music—grave and gay.

### AFTERNOON ENTERTAINMENT—2.30 to 5.45 p.m.

- 2.30: Half an hour with silent friends.
- 3.0: A pianoforte recital.
- 3.15: CAPTAIN LYNWOOD ROBERTS will speak on the trouble in China.
- 3.30: SONGS OF TO-DAY.
- 3.45: NEW DANCE MUSIC.
- 4.0: IN SERIOUS MOOD—A moment with the old masters.
- 4.15: ROSE ANTILL DE WARREN will talk.
- 4.30: RADIO RHYTHM.
- 4.45: The Trade Hour—Demonstration Music.
- 5.45: Weather information. Close down.
- THE DINNER HOUR—6.15 to 7.55 p.m.
- 6.15: DINNER MUSIC BY CEC. MORRISON AND HIS BAND.
- 6.45: The Girls' Radio Club, conducted by Miss Gwen Varley.

7.5: The Country Man's Market Session—Wool, wheat, stock, Farm produce, fruit, and vegetable markets.

7.20: DINNER MUSIC.

7.45: Austradio musical reproduction.

7.55: What's on the air to-night?

**TO-NIGHT'S PRESENTATION—8 to 10.30**  
2BL offers listeners to-night the Overture from the State Theatre. There are xylophone solos by Lionel Bennett. The talk by Wilfrid Blacket, K.C., will prove of wide interest, and Walter George's Mirthmakers are with us to-night, to laugh the New Year in.

Through 2FC service a unique radio novelty, "The Factory Made Magic Car pet," woven by James Donnelly, when listeners will travel in imagination to far distant countries—one moment we are shivering in the grip of England's winter, and the next the langorous beauties of the mystic East enthral us. At 9 p.m. we return home, and in the "Cameo of Suburbia" we will see "The Kenney Family" in a typical home setting. Later in the evening we turn in lighter vein to popular songs by Margaret Grimshaw, John Stuart, comedian.

8.0: FROM THE STATE THEATRE—Overture by Will Prior and the State Orchestra, with Price Dunlavy at the Grand Organ.

8.7: FROM THE STUDIO—ROWELL BRYDEN, baritone—  
(a) Negro Spiritual, "Deep River."  
(b) Old English Folk Song, "The Pretty Creature."

8.14: VIGNETTES OF EVERYDAY HAPPENINGS AND DOINGS, sketched by—Sadie Anderson.  
Doris Lascelles.

Lew James and Dodi Wolfe, and May Foulds.

8.35: G. VERN BARNETT, piano solos—  
(a) "Romance" (Schumann).  
(b) "Arabesque" (Schumann).

8.42: FRED GOOCH, entertainer—  
"Jim Steps Out" (Gooch).

8.52: LIONEL BENNETT, xylophone solo—  
Fantasie, "William Tell" (Kruker).

9.0: WILFRID BLACKET, K.C., in "Reminiscences."

9.15: ROWELL BRYDEN, baritone—  
(a) "Long Through the Silent Night" (Rachmaninoff).  
(b) "Night and the Curtains Drawn."

9.22: G. VERN BARNETT, pianist—  
(a) "Whither" (Schumann).  
(b) "Novlette in F" (Schumann).

9.28: FURTHER VIGNETTES OF EVERYDAY HAPPENINGS AND DOINGS, sketched by—  
Sadie Anderson,  
Doris Lascelles,  
Lew James and Dodi Wolfe, and  
May Foulds.

9.45: THE NATIONAL BROADCASTING ORCHESTRA—  
(a) "Il Trovatore" Selection (Verdi).  
(b) "Dance of the Tea Dolls" (Schmidt-Hagen).

9.57: FRED GOOCH, entertainer—  
"Musical Philosophy" (Gooch).

10.7: THE NATIONAL BROADCASTING ORCHESTRA—  
(a) "Merry Widow" Selection (Lehar).  
(b) "Nola" Intermezzo (Zamenick).

10.25: Late news from the "Sun."  
Late weather forecast.

10.30: NATIONAL ANTHEM.  
CLOSE.

## 2GB

Theosophical Broadcasting Station, 29 Bligh St., Sydney (Wavelength, 316 Metres).

Day session as usual. 8.0: Ailsa Lewis trio. 8.8: Miss Edna Lister, contralto. 8.15: Ailsa Lewis trio. 8.22: Mr. Jack Win and Miss Nora Windle in a humorous sketch. 8.32: Mr. Austin Punch, baritone. 8.40: Ailsa Lewis trio. 8.48: Miss Gwladys Edwards, soprano. 8.55: Ailsa Lewis trio. 9.0: Weather report. 9.3: Miss Edna Lister, contralto. 9.13: Symphony orchestra. 9.25: Mr. Austin Punch, baritone. 9.35: Mr. Jack Win and Miss Nora Windle, in a humorous sketch. 9.45: Symphony orchestra. 9.50: Miss Gwladys Edwards, soprano. 10.0: Instrumental music. 10.30: Close down.

USE ONLY--

# Emmco

AUSTRALIAN MADE

GUARANTEED RADIO PRODUCTS

THE LATEST

POWER AMPLIFIER

PUBLIC  
SPEECH

PICTURE  
THEATRES

MUSIC  
DISTRIBUTION  
SYSTEMS

CAFES

DANCE  
HALLS

HOTELS

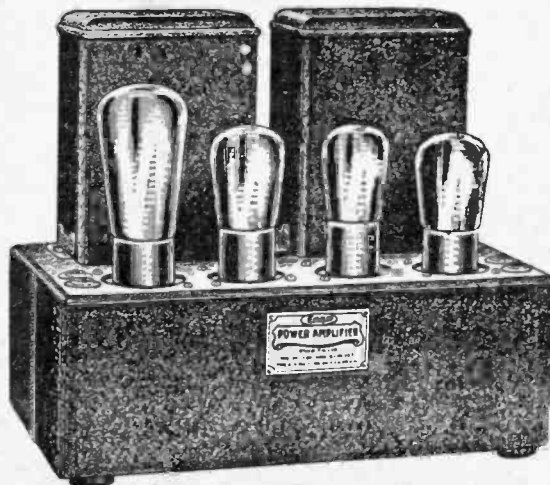

WILL OPERATE  
A MULTIPLICITY  
OF SPEAKERS

Home Amplifier £18'10'---Concert Model £30

Manufactured by ELECTRICITY METER MFG. CO. LTD., Sydney

Sole Factory Representatives:—

MANUFACTURERS PRODUCTS PTY., LTD.,

137 Clarence St., Sydney

Sugden Place, Melbourne

Interstate Programmes, Thursday, January 2

3LO

Australian Broadcasting Co., 129A Russell St., Melbourne (Wavelength, 371 Metres).

EARLY MORNING SESSION.

7.0 to 8.15: As usual.

MORNING SESSION.

10.30 to 12.30: As usual. 11.30: Cricket.

MIDDAY SESSION.

1.0: Time signal. 1.15: Luncheon Music, supplied by the Studio Light Orchestra.

AFTERNOON SESSION.

2.0: Description of Sheffield Shield Cricket Match, Victoria versus South Australia, at the Melbourne Cricket Ground. 2.10: Description of Novice Handicap, one mile, Mentone Races, by Eric Welch. 2.40: Description of Sheffield Shield Cricket Match. 2.40: Description of Mentone Plate, six furlongs. 2.50: Sheffield Shield Cricket Match. 3.10: Description of Mentone Purse, six furlongs. 3.20: Sheffield Shield Cricket Match. 3.40: Description of Brush Steeplechase, two miles and one furlong, Mentone Races. 3.50: Sheffield Shield Cricket Match. 4.0: Time signal. Sporting results to hand. 4.10: Description of January Handicap, one mile, Mentone Races. 4.20: Sheffield Shield Cricket Match. 4.30: Acceptances and barrier positions for the Aspendale Park Races on Saturday. 4.40: Description of Welter Handicap, seven furlongs, Mentone Races. 4.50: Sheffield Shield Cricket Match. 5.0: Time signal. Sporting results to hand. 5.10: Sheffield Shield Cricket Match. 6.0: Stump scores. During the afternoon results of the Chiltern Races will be broadcast as they come to hand.

THE CHILDREN'S CORNER.

6.5: Opening Chorus by "Bobbie Bluezug" and "Clever Clarice." "Bobby Bluezug" tells a New Year Story. "The Children's News Bulletin," "Bobby Bluezug" and "Clever Clarice" sing in a little harmony. 6.25: Birthday Greetings by "Bobbie Bluezug." 6.35: Musical Interlude.

EVENING SESSION.

6.40: Swimming—Advance Crawl Swimming, Mr. Les. Uren. 6.55: Musical Interlude. 7.0: Melbourne Observatory time signal. 7.1: Countryman's Session. 7.20: Musical Interlude. 7.25: A New Year's Resolution—Bull Strome Treat for Four Children. Mr. F. R. Byrne. 7.40: News service. 7.45: Our Radio Service, Mr. H. K. Love. 8.0: Time signal.

NIGHT SESSION.

8.0: National Broadcasting Orchestra—"Invitation to the Dance" (Weber). 8.8: Jessie Smith, contralto—"Silent Noon" (Vaughan Williams). "The Blackbird's Song" (Cyril Scott). 8.15: You Will Hear the Outstanding Personality of Subject of the week. 8.30: Paul Jeacle and His Band—Dance Music. 8.40: Jack Kearns, comedian—New Year Notions. 8.48: Paul Jeacle and His Band—Dance Music. 8.53: Pat MacLenn will entertain. 8.56: Paul Jeacle and His Band—Dance Music. 9.6: John D. Fraser, baritone—"A Brown Bird Sings" (Wood). 9.9: Paul Jeacle and His Band—Dance Music. 9.20: Jessie Smith, contralto—"I Love You More." 9.23: Paul Jeacle and His Band—Dance Music. 9.33: Jack Kearns, comedian—"Comicallities." 9.36: Paul Jeacle and His Band—Dance Music. 9.46: Pat MacLenn and his ukulele. 9.50: Paul Jeacle and His Band—Dance Music. 10.0: John D. Fraser, baritone—"The Hills of Donegal" (Sanderson). 10.3: Paul Jeacle and His Band—Dance Music. 10.13: Jessie Smith, contralto—"When We Are Old." 10.18: Paul Jeacle and His Band—Dance Music. 10.30: John D. Fraser, baritone—"Ay! Ay! Ay!" (Pavane). 10.30: News Session. 10.40: Pat MacLenn will entertain. 10.48: Paul Jeacle and His Band—Dance Music. 10.55: Jack Kearns, comedian—"Laughter for Sale." 11.0: Paul Jeacle and His Band—Song and Syncope. 11.30: God Save the King.

3AR

Australian Broadcasting Co., 129A Russell St., Melbourne (Wavelength, 381 Metres).

MORNING SESSION

8.15 to 11.0: As usual.

MIDDAY SESSION.

12.0: G.P.O. Chimes. 12.1: Community singing from the Melbourne Town Hall; conductor, Frank Hatherley. 2.0: G.P.O. chimes.

AFTERNOON SESSION

2.1: Orchestral, Edith Lorand Orchestra. 2.3: Contralto, Phyllis Hudson. 2.6: Comedy, Vincent Conway. 2.9: Bands, massed Military Bands. 2.12: Tenor, Richard Tauber. 2.15: Orchestral—Edith Lorand Orchestra. 2.18: Contralto, Phyllis Hudson. 2.21: Violin, Tossy Spivakovsky. 2.24: Entertainers, The Three Australian Boys. 2.27: A request number. 2.30: Ladies' tonics—Beauty Hints, Mrs. Chas. King. 2.45: Recollections of a Traveller—The Lebanon Mountains, Miss Milli Meyer. 3.0: Regal Brass Band—March, "Ragtime" overture, "Semiramide." 3.10: Stella Dredge, soprano—Irish folk song (Footle). 3.17: Irene Galloway, violin—"Romance" (Wieniawski). "Spanish Dance" (Sarasate). 3.24: The Two Busy Bees will entertain. 3.32: Regal Brass Band—Selection, "Gems of the Masters." 3.40: J. Alexander Brown, baritone—"Just John" (Gibson-Smythe). "Little Blue Peter" (Gibson-Smythe). 3.47: Irene Galloway, violin—"Serenata" (Toselli). "Liebersfreud" (Kreisler). 3.54: Stella Dredge, soprano—"Hushean" (Neederham). "There are Fairies at the Bottom of our Garden" (Lehmann). 4.0: Regal Brass Band—Fox-trot, "Follow a Big Cigar" march, "The Tall

Cedars." 4.8: The Two Busy Bees will entertain. 4.18: J. Alexander Brown, baritone—"Thick is the Darkness" (Mallinson). "Pleading" (Elgar). 4.23: Regal Brass Band—Two old ballads, "Love's Old Sweet Song." "The Mill Wheel." 4.30: Musical reproduction. 5.0: G.P.O. chimes. 5.1: Musical reproduction. 5.30: Weather data. 5.45: Close down.

EVENING SESSION

6.15: Dinner music. 7.30: What's on the air to-night? 7.32: Sporting results; acceptances and barrier positions for the Aspendale Park races on Saturday, 4th January. 7.35: Latest musical releases. 8.0: G.P.O. chimes.

NIGHT SESSION

8.1: Youth Faces the World, by the Odd Men Out. Three special studio reproductions.—8.15: Quintette in F Minor, Op. 34 (Brahms), played by the Pionzaley Quartette and Harold Bayer, pianist—Allegro, Andante, Scherzo, Finale. The Pionzaley Quartette is an organisation devoted exclusively to chamber music. It was formed in 1903 by E. J. De Coppet, an American millionaire, and named after his Swiss villa on Lake Geneva. The quartette, however, has long maintained an independent existence, and is famous in American musical circles for its devotion to its artistic ideals and the perfection of its achievements. The players who form the quartette are: Adolfo Betti (first violin), Alfred Pochon (second), Louis Bailly (viola), and Ivan d'Archembeaux (cello). The quartette binds its members not to play in orchestras, or even solo so as to preserve the perfect unity of effect for which it is famous. 8.55: Songs from "The Winter Journey" (Schubert), with piano accompaniment by Coenraad V. Bos. Sung by Elena Gerhardt, mezzo-soprano—"Good Night." "The Linden Tree." "The Water-course." "A Dream of Spring." "The Organ Player." "The Guide Post." "The Post." "The Raven." "Fisherways." "The Fisher-Maidens." "The Secret." "The Departure." "Slumber Song." "The Poet." "The Rosegag." "In Spring." "Rosamunde." "Litanei." 9.55: Symphony No. 5 in C Minor, Op. 87 (Beethoven), played by the Royal Albert Hall Orchestra—Allegro Con Brío, Andante Con Moto, Allegro, Finale. 10.20: Weather, news. 10.30: God Save the King.

4QG

Queensland Government Radio Service, Brisbane (Wavelength, 385 Metres).

Day sessions as usual.

NIGHT SESSION

To-night's programme will comprise the third of a series of "Old Time" nights, which have been arranged in response to numerous requests. 8.0: The Studio Orchestra—"Blue Danube Waltz" (Strauss). 8.5: Double Male Quartette—"Massa in de Cold Ground" (Poster). 8.10: J. P. Cornwell, bass—"Here's Health unto His Majesty." 8.14: R. Tate, pianist—Valse, "Il Baccio" (Arditti). 8.19: Double Male Quartette—"The Old Log Cabin in the Dell." "When There's Love at Home." 8.27: Francis Lane, contralto—"Robin Adair." 8.32: The Studio Orchestra—"After the Ball" (Bernard). 8.37: George Williamson, tenor—"My Pretty Jane" (Bishop). 8.41: A Duo Art Selection—"Home Minstrels." 8.47: Double Male Quartette—A group of Nigger Melodies, "Swanee Ribber." "Old Kentucky Home." "The Gwine Back to Dixie." 9.0: Metropolitan weather forecast. 9.1: Ernest Harper, baritone—"The Vicar of Bray." 9.8: The Studio Orchestra—"Firelight Waltz" (Napier). 9.11: Francis Lane, contralto—"Killarney" (Balfe). 9.15: George Williamson, tenor—"I'll be with you in the Springtime" (accompanied by Double Male Quartette). 9.20: Duo Art Selection—More "Home Minstrels." 9.25: Double Male Quartette—"The Harp that Once" (Moore). "The Old Rustic Bridge by the Mill" (Skelly). 9.35: From the Band Room—A short programme of Band music by the Brisbane Municipal Concert Band (conductor: E. Jackson). 10.0: News; weather. Close down.

5CL

Central Broadcasters, Ltd., 114 Hindmarsh Square, Adelaide (Wavelength, 409 Metres).

MORNING SESSION

Day sessions as usual: See Friday.

NIGHT SESSION

8.0: Programme review and announcements. 8.10: The Steiner Trio—"Petite Suite" (Masson). 8.20: The Haydn Male Quartette 8.27: Guido Giacchino, celloist. 8.34: Linda Wald, soprano—"If I Were a Bird" (Lehmann). "Thoughts Have Wings." 8.41: The Hawaiian Trio. 8.49: Vocal number. 8.55: The Steiner Trio. 9.0: G.P.O. chimes. 9.1: Meteorological information, including Semaphore tide. 9.2: Overseas grain report. 9.3: Announcements. 9.5: Pianoforte recital by Tom King. 9.30: Linda Wald, soprano—"Heart's Desire." "My Sweet" (Batt). 9.37: The Hawaiian Trio. 9.45: The Haydn Male Quartette. 9.53: The Steiner Trio—"In My Dream Garden"

(Rayners), "Cavotte" (Fletcher). 10.3: Vocal number. 10.10: The Steiner Trio—"Andante" (Reissiger). 10.15: "The Advertiser" general news service. British official wireless news. 10.29: Our Good-night Thought. 10.30: Recordings. 11.15: Close down.

6WF

Australian Broadcasting Company, Ltd., Wellington Street, Perth (Wavelength, 435 Metres).

Day sessions as usual. See Friday.

EVENING SESSION.—8.0: Chimes. 8.1: Perth City Band. 8.16: Reuben Betts, crooning baritone. 8.19: Perth City Band. 8.34: Reuben Betts, crooning baritone. 8.37: Perth City Band. 8.52: G. Murphy (dryblower), "The Poet of the West." 9.39: Perth City Band. 9.14: G. Murphy (dryblower). 9.21: Reuben Betts, crooning baritone. 9.24: Perth City Band. 9.49: Reuben Betts, crooning baritone. 9.52: Strange tales of adventure by A. J. Dry. 10.10: Reproduced classical programme. 10.59: Weather. 11.0: Close.

LOCAL PROGRAMMES CONTINUED.

2KY

Trades and Labor Council, Goulburn St., Sydney (Wavelength, 280 Metres).

Tuesday, December 31

MORNING SESSION.

As usual (see Friday).

EVENING SESSION.

7.0: Musical interlude. 7.15: SPORTING FEATURE. Turf topics. How they should run to-morrow, MR. GEO. DAVIS. 7.45: Request numbers. 8.0 (from Beharfeld's new studio): Special NEW YEAR'S EVE PROGRAMME. 9.0: SPORTING FEATURE, presented by TOOTH and CO., LTD., KENT BREWERY from the ringside of McHugh's Leichhardt Stadium. Results of early events and full description of 15-round event. 9.50: Dance music from the studio. 10.0: Closing announcements. On Wednesday, January 1, 1930, 2KY Broadcasting Station will be closed.

2UE

Broadcasting Station 2UE, Everett Street, Maroubra, Sydney (Wavelength, 293 Metres).

Wednesday, January 1

EARLY MORNING SESSION.—7.15: Orchestral and vocal breakfast time music. 8.0: Clock and chimes. 8.1: Music. 8.30: Weather forecast; close.

AFTERNOON SESSION.—12.0: Broadcast description of the races by Mr. T. Hopkins, turf expert. 5.0: Close down.

EVENING SESSION.—7.15: Turf talk by Mr. T. Hopkins, turf expert. 7.45: Music, 7.55: Programme announcements and news from the "Sun." 8.0: Overture, "Light Cavalry." 8.10: Vocal and instrumental selections. 10.15: Close down.

2UE

Broadcasting Station 2UE, Everett Street, Maroubra, Sydney (Wavelength, 293 Metres).

Thursday, January 2

Day sessions as usual.

EVENING SESSION.—6.30: Wendy's Hour with the children, and birthday greetings. 7.15: Dinner music. 7.55: Announcements and news from the "Sun." 8.0: Overture, "Morning, Noon, and Night." 8.10: Vocal and orchestral music. 10.15: Close down.

2UW

Radio Broadcasting, Ltd., Paling's Building, Ash St., Sydney (Wavelength, 267 Metres).

Thursday, January 2

MIDDAY SESSION (as usual). EVENING SESSION.—5.30: Children's Hour. 6.30: The Meccano Club. 6.45: Close. 7.0: Chimes. Request numbers. 7.45: Garden talk, by Mr. S. H. Hunt. 8.0: Operatic vocal scenes. 9.0: Chimes. Comments on Foreign Affairs, by Mr. J. M. Prentice. 9.10: Music and request numbers. 10.30: Close.

SHORT  
WAVE  
COILS  
NOW  
AVAILABLE,  
13/6  
PAIR.

THE WONDERFUL  
NEW

# COSSOR Melody Maker

COSSOR  
PENTODE  
VALVES  
NOW  
ARRIVED  
FOR  
COSSOR  
MELODY  
MAKER,  
25/-  
Each

The Best Resolution You Can Make!  
"BUY A COSSOR MELODY MAKER"  
—Real Enjoyment for the Coming Year

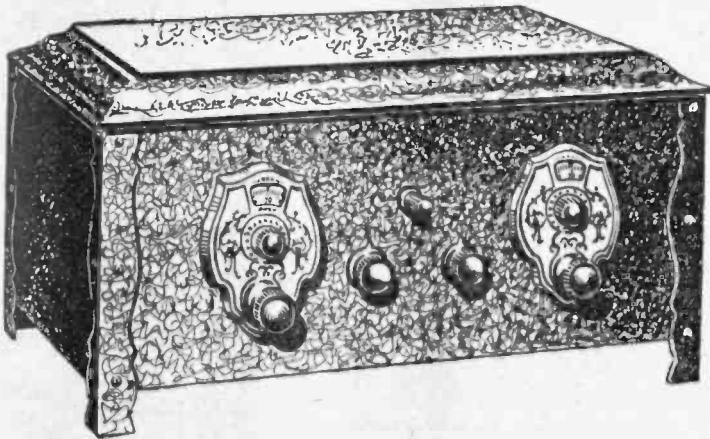

£11'12'6

Price includes 3 Cossor Valves (including one Screened Grid Type), Cabinet, and all necessary parts. Batteries and Speaker only extra.

—and it's 100 p.c. British

HERE'S the most remarkable Radio Set ever produced—the Cossor Melody Maker. It has 1000 miles range, it has "knife-edge" selectivity. It will cut out local stations like magic, and bring you the programme you want to hear. Never before has such a powerful and efficient Receiver been obtainable at anything like its modest price. The Cossor Melody Maker is so simple that you can build it yourself. No wireless knowledge is necessary—no sawing—no drilling—no soldering—it's as simple as Meccano. Get to know all about this amazing new Receiver—mail the coupon.

World's Lowest Priced Screen-Grid  
Receiver of Advanced Design

NAMES OF DISTRIBUTORS;

Harringtons, Ltd., George Street.	W. G. Watson, Ltd., Clarence Street.
Manufacturers Products, Clarence Street.	Martin De Launey, Ltd., Clarence Street.
Bloch and Gerber, York Street.	Humphreys, Ltd., York Street.
Fox and MacGillcuddy, York Street.	

Agents for Australia and New Zealand

Lyall Willis and Co., Ltd., Billiter House, London (Eng.).

SYDNEY REPRESENTATIVES:

JONES and JOSEPH, LTD., 235 CLARENCE ST., SYDNEY

Please send me free of charge one of your Cossor Melody Makers, which will be built in 48 minutes.  
Name: JONES & JOSEPH, LTD.  
Address: 235 Clarence Street, Sydney.

# Convenience---Simplicity---Tone---Power They Mean All-Electric Operation!

## You can have them all in 1930!—by building a **WALLACE ELIMINATOR**

For Three Valves, B only, 59/6.  
 For Four and Five Valves. B only, 67/6; B and C, 75/-.  
 For Six, Seven, and Eight Valves (or less), B and C, Special 280 Full Wave Rectifier, £6/17/6.  
 A.B.C. PACKS.—Four and Five Valve Sets, £4; Six, Seven, and Eight Valves, £7/2/6.  
 Ten pages of instructions and illustrations in "Electrified Radio"—making your set All-Electric, with Eliminator Circuits, 1/-.  
 Posted 1/3.  
 Power Transformers.—300 volt, with filament winding for 4 or 5 volt rectifiers, 25/-; Same Transformers, with additional A.C. 4-volt, centre-tapped winding, 27/6. UX280 type, 600 volt, centre-tapped full-wave, with 5-volt centre-tapped filament winding, 30/-. Same, with additional A.C. 4-volt, centre-tapped filament winding, 35/-.  
 Resistors.—Sliding Resistors, for grid bias, wire-wound, 3/6. Pilot Wire-wound Resistors, for grid bias, 4/-. 100,000 ohms. Variable Resistors, for detector or radio tap, 4/6. Centralab power Rheostats, 2 and 3 ohm., 3 amp. 1/-. And all other Resistances.  
 Chokes.—30 henry power chokes low D.C. resistance, 10/6. 50 henry chokes, 10/6.  
 Condensers.—4 mfd., 5/-; 2 mfd., 3/-; 1 mfd., 2/-; .5, .25 mfd., 2/-. All 650-volt test.  
 Rectifying Valves.—UX280, full-wave, guaranteed (will supply over 200 volts, 35 mls. to any set), 25/-. Mullard Half-wave Rectifiers, 17/6. Philip's Half-wave, 373 Rectifiers, 17/6.

SAME DAY SERVICE  
FOR  
COUNTRY CLIENTS.

### THE WIRELESS SHOP

Miss F. V. Wallace, 6 Royal Arcade, Sydney.  
THE OLDEST RADIO FIRM IN TOWN.

MONEY BACK  
GUARANTEE.

ESTABLISHED 8 YEARS. PHONE. MA5543.

Two Doors from George Street, opp. Q.V. Markets.

# New **RADIO PLEASURE**

With the **HARLIE WAVE SELECTOR**

—Cut Out Interfering Stations!



Introduced to Australia only in August last—the Harlie Wave Selector has already proved to be a sensation. If you can't get rid of local stations—get a Harlie—and increase the selectivity of your set almost magically. And here is another important feature—because the Harlie increases selectivity it also increases volume. Easy to fit, strong and handsome, inexpensive, the Harlie really means rejuvenation to an old set or improvement in a new one.

PRICE,  
**25/-**

'Phone:  
MA 6001

*Harringtons Ltd*

Established 40 Years.  
Radio, Photo and Cine Merchants.

386 GEORGE ST.  
SYDNEY

Branches All States and  
New Zealand



## Erecting an Aerial In A Country Location

Under the direction of  
ROSS A. HULL, M.I.R.E.

# Information Service

"G.R." Teraba, asks for approximate dimensions of the most suitable aerial for his three-valve set.

**Answer:** The considerations involved in putting up an aerial have been greatly exaggerated, and a great deal of rot has been written concerning the ability of some sorts of aerials in eliminating static, and the advantages to be gained by arranging the aerial to face the station most desired. At the same time, the aerial cannot be passed over as something inconsequential. The general idea is that the larger the aerial is the broader will be the tuning of the set. At the same time, particularly in the case of sets with but a few valves, the larger aerial will give greater signal strength. In order to preserve selectivity in the simple set, it is, therefore, desirable to put up the largest aerial consistent with good selectivity. In your own case, and in most instances where the receiver is in the country, the aerial can well be a single wire of a total length (including lead-in), of between 100 and 150 feet. The wire should preferably be enamelled, and can be either of the multi-strand or the single strand type. In the latter case, 16 or 14 gauge usually is strong enough for a span of at least 100 feet. In city locations an aerial such as this, operated with a set of, say, three valves, would not permit sufficient selectivity. Lengths of the order of 50 to 75 feet are then usually more desirable. The height influences the effectiveness of the aerial, but it is rarely necessary to erect it higher than 20 or 30 feet above the ground. No, there will be no harm done by having a length of rope between the end of the aerial and the mast, though, in your case you might as well carry the aerial over the entire span.

**ELECTRO-FOR-US (Lakemba).**—"Would you kindly supply me with the addresses of the following stations:—VK2PS, VK2JG, VK2ME, VK2AM, VK2NK, VK2NM."

**Answer:** VK2PS is P. O. Stephen, 126 Good Street, Queensland, N.S.W.; VK2JG, C. J. Hawthorne, "Coota," View Street, Concord, N.S.W.; VK2ME, Amalgamated Wireless ("Asia"), Ltd., 47 York Street, Sydney, N.S.W.; VK2AM, probably mistaken for VK2AN, since there is no VK2AM on our list. VK2AN is W. Gardner, Central Mine, Piner Street, Broken Hill, VK2NK, not on our list, either. It may have been VK2MK, Mocker Bros., Howick Street, Balhurst, though this is a "B" class station, working on 275 metres, 250 watts, and having, I believe, been off the air for some time. VK2NM, no record of this call. There is no VK2MN either.

(2) "What was the name of the station working with 2ME, Friday, 22nd ult.?" I think it was an aeroplane, whose call sounded like 4L."

**Answer:** Sorry, we can't assist here, since we were not listening. Some reader may be able to advise. Keep your eyes on this column and on Safety Valve.

(3) "Do you think these stations would appreciate reports?"

**Answer:** Yes, if the reports are genuine, and if they are not over-gilded. Thanks for your kind remarks.

**E.A. (Lakemba).**—"Probably a faulty valve or transformer. Try taking the F terminal of the transformer to the negative terminal of a 4½-volt 'C' battery, and the positive terminal of this battery to a minus."

**F.M. (Kempsey).**—"Please advise size of wire, number of turns, etc., on secondaries of Radiokes' Nentrodynic coils, as used in the 1930 super-heterodyne."

**Answer:** Two-inch diameter former, 75 turns 24 gauge d.s.c.

(2) "What gauge wire shall I use for the primaries on these coils?"

**Answer:** 30 gauge d.s.c.

(3) "By hank would do you mean the coils are wound roughly on a former, or without former altogether?"

**Answer:** The coils are wound roughly on a former but slipped off it on completion. The bunched turns are held together with wiread. Winding should be as rough as possible.

(4) "For a battery-operated receiver for operation in the country, whose selectivity is not so important as sensitivity, would aerial coil 30 turns and

r.f. coil 80 turns be satisfactory as primaries?"

**Answer:** Yes.

**A.F. (North Coast).**—"I understand that some method of earthing the shield is essential in a screen grid receiver. The circuit diagram of the Screen Grid Marconi Five gives no indication of these connections. What connections are to be made to the shield?"

**Answer:** The shields are connected direct to the earth terminal. They are also connected to the components that make contact with any part of the earthed circuit, such as the rotor plates of the variable condensers, some of the coil connections, etc.

**A.W. (Victoria).**—"As a result of reading each week the column devoted to short waves published in 'Wireless Weekly,' I intend building a short wave set. Before doing so, I would like your opinion per Information Service as to whether a short-wave adaptor or a straight-out short wave set would be more efficient; also how many valves would be required in a short-wave set to pick up European and American stations."

**Answer:** A straight-out short-wave set would be a better proposition. One valve would receive short-wave signals from all over the world under normal conditions. Two stages of audio allow loud-speaker reception of signals that are fair headphone strength on one valve. A stage of screen grid r.f. placed before the detector is a great improvement.

**J.B. (Hornaby).**—"Would you be good enough to supply through 'Wireless Weekly' a crystal circuit that would be likely to receive the local stations from this district? Several well-known circuits have been tried, but only 2FC is received."

**Answer:** It would be difficult to cut out 2FC in your location, but the circuit published in these columns December 6, 1929, was an unusual one, and may give you reasonably good results.

**R.M. (Willoughby).**—"I have appreciated Mr. Hull's articles very much, and hope he gives us many more of them. He has not yet described an up-to-the-minute a.c. three-valve set for local reception—one of the type now largely sold. I myself would be very interested in such a set, and I am sure many others would be too."

**Answer:** Mr. Hull tells me to refer you to this, the Christmas issue. The four-valve receiver is later to be described with one less valve. It will then constitute a splendid three-valve set.

**"L.B.R." (Strathfield).**—"Yes, it is quite possible that the interference would be more marked under those conditions. Rain would make the possibility of power leak greater. In some instances an wind would be prone to blow wires about, and thus accentuate the interference, which would be caused by any faulty contact. However, it is still possible that your interference is merely from atmospheric though it does seem extraordinary that it should be so severe. We strongly advise you to compare notes with some other listener, either in your own neighborhood or elsewhere, preferably taking your set to his location for a comparative test."

**M.C. (Alberton East).**—"L1 should have about 40 turns. One of the 00035 mfd. condensers can be used in place of the midset to tune reaction. The coil should have about 25 turns."

**GENERAL.**—Can any reader please supply Mr. J. Boger, 75 Penshurst Road, Dumbarton, with copy of 'Wireless Weekly,' Vol. 13, No. 12, containing the Renown Three. Inquirer is willing to pay post and postage. He also wishes to advise that readers may have any of the following back numbers on forwarding postage: February 22, February 15, March 15, March 8, March.

**W.B. (Poole Point).**—"Could you please oblige me with a practical drawing of wiring another stage of . . . Do you think you could oblige by private letter as soon as possible?"

**Answer:** Firstly, you have omitted to mention whether you refer to a stage of audio or radio (note space in above query). Secondly, you did not enclose your coupon, and I have no reply to queries by letter. Please read conditions on query coupon appearing each issue.

**S.U. (Murray Bridge).**—"I have just recently constructed the Marneck Five S.G. receiver, which appeared in your journal some months ago. When it came to hooking up the 120-volt radio frequency B plus lead to the whole unit, I became a little puzzled over the circuit time and time again. I have the blueprint that came with the Radiokes coils, and also the circuit that appeared in 'Wireless Weekly,' and both are identical. I can't find a wire end in either, but I am using Celestite rubber bushes where passing through the metal. Also have bushed rotors of the condensers with celluloid, and have ½-inch holes drilled for clearance. I have tested all the various parts with a millimeter and screw driver, and found the trouble. Do you think there could be any chance of a mistake in the letters placed on the coils? Trusting you can fathom this mystery."

**Answer:** There is no mystery about it. The fact that the shield is connected through the "A" battery to B minus explains why you feel a shock when touching the B battery 120 volt lead and the shield. This is quite as it should be, and you have no need for alarm. You would not have noticed the fact if you had adhered to one of the general rules of radio, that is, do not leave the set switched on when making adjustments or alterations.

**J.B. (Queensland).**—"I wish to thank you for answering my query. I got the items mentioned by you, and reception is now pretty good. However, there is a terrible lot of whistling as soon as I shift any of the dials. Please tell me what is wrong, and how I can remedy this."

**Answer:** You should have mentioned the type receiver you are using, as you surely do not expect us to memorize the hundreds of queries received. Generally, however, we can advise that as you have replaced the old "B" batteries with new, it will now probably be necessary to reduce the voltage on the plate of the detector valve. Try also a .002 fixed condenser across the secondary of the transformer. If these do not help you, write again, advising type of receiver used, and voltage supplied to plate of each valve.

**H.S. (Surry Hills).**—"How can I find the resistances offered by three resistances in parallel?"

**Answer:** The formula for finding the total resistance when three are placed in parallel is "Reciprocal of R1, plus reciprocal of R2, plus reciprocal of R3." The reciprocal of any number is merely unity divided by that number. In your diagram you show resistances of 6, 10, and 30 ohms in parallel. The reciprocals would be 1/6, 1/10, and 1/30. These added give 9/30. Reverse, equals 30/9, equals 3 2/3, equals 3 1-3/3 ohms.

**GENERAL.**—Mr. T. K. Amoor, sixth Avenue, Glen Keddson, Brisbane, writes: "I have a two-valve short-wave set, and have been listening to a concert on about 10 metres, all in English—music and speech. I could not get the call sign. I was listening between 10 p.m. and 11 p.m., 1/12/29."

**Answer:** Afraid we cannot place the station accurately, though it may have been PH1, the new Philip's S.W. station. Some reader may be able to help. Glad you like the short-wave page.

**H.M. (Wilcannia).**—"Static as referred to in radio is merely the sound (heard from the radio set) of a high voltage discharge in the atmosphere. It is this discharge that causes the crackle in our radio sets. The louder the crackle the greater was the discharge, or the nearer was the discharge. You can imitate static by getting a 2 mfd. bypass condenser, tested 500 volts, and connecting it across the mains for a moment. With an insulated handled screwdriver, short the two terminals of the condenser after it has been charged, and at the moment the spark occurs, you will hear a loud crack in your speaker. Write to Messrs. Angus and Robertson regarding the books. They have a good selection. Thanks for kind remarks. Your suggestion has been passed on, though we must mention that the programmes are published as submitted, and it might be awkward for the broadcasting companies to alter as you suggest. Your kind wishes for Xmas and the coming year are reciprocated. See elsewhere in queries under your initials and address."

**R.A.L. (via Blayney).**—"How would — set compare with — set?"

**Answer:** It has been repeatedly said that comparisons cannot be made through these columns, for reasons which should be very apparent. Your best plan is to send for data on both sets, asking the selection. I have in mind which set would better suit your requirements.

**DARGO (Randwick).**—"I have a 1926 model set. All valves seem to be the same, as when I change them about there is no difference in reception. Should I use a power valve?"

**Answer:** Yes, a power valve should be used, and the correct voltages provided.

(2) "I have an A battery, (six volts), and it is just about worn out. My valves take about ¼ amp. each. I was thinking of purchasing an Exide accumulator. Will you advise if this is a good make, and what ampere hour capacity I should require?"

**Answer:** The Exide accumulator should be perfectly satisfactory. You should procure one of about 60 actual ampere hour capacity.

(3) "My B batteries are about done (two 45-volts). Would it be advisable to replace them with a B eliminator? If so, what market price?"

**Answer:** Yes, a B eliminator would be a good investment. The prices vary from a couple of pounds upwards. Your best plan would be to get some catalogues and make your choice, including output, neatness, and compactness in favorable points for selection. If possible, get one that gives 200 volts or more. This will permit the use of a rest output valve.

**R.L. (Victoria).**—The old slider type crystal set is hopelessly out of date, and you cannot expect to receive stations without interference in your location. You might improve matters, however, by shortening your aerial or placing a .0001 mfd. fixed condenser in series with the aerial.

**C.M. (Muntley Point).**—The circuit is a very poor one. It cannot be used on short waves with the condenser mentioned. It would be necessary to use smaller condensers and coils and a larger grid leak.

**H.J. (Stanmore).**—Regret we cannot publish readers' addresses without their permission. Your request, however, will be printed below.

(2) "Please tell me if a transformer with the primary gone can be permanently repaired with a resistor, and, if so, the value of the resistor."

**Answer:** The use of a resistor in place of the primary is only intended as a makeshift, and you should replace the transformer as soon as possible. The value of the resistor should be 170,000 ohms.

**"HAYSEED" (Barrington, H.J. (Stanmore),** wishes to get in touch with you. Will you kindly forward your address for publication?

**"POMMY" (Cooma).**—Sorry, there's no room here for all the information and circuits required. All have been published very recently. You can get details of the coils from those treated with the Go-Getter S.W. receiver. Circuits for adding audio stages have appeared countless times during this year. A suitable grid leak for S.W. and broadcast bands would be about 5 megohms.

**"ESSEX" (Brisbane).**—Probably a faulty component in the eliminator. The other eliminator circuit referred to is no more dangerous than the one you are using. The idea is that the mains are connected directly to the filter in both cases. If you wish to use a mains transformer, connect the secondary to the present input terminals of your eliminator, and the primary terminals to the mains.

**MAX (Adavale).**—Probably a faulty resistor.

**M.J.O. (Gunnedah).**—A matter of coils. You will depart from specifications, so you must bear the consequences. The original receiver was tested, and found perfectly satisfactory.

**N.E.C. (Gurley).**—May be faulty valve or wrong battery connections. The circuit mentioned was not pinned to your letter, and there were no pinholes.

**T.H.C. (Enfield).**—A simple one-valve set was published in "Wireless Weekly," August 30, 1929. Sorry, do not know the characteristics of this valve, which, however, we believe is a very old type.

**DIZZY (Murwillumbah).**—See recent article by Mr. Hull on choice of valves for such receivers.

**W.A.P. (Brisbane).**—Strictly advise you against building the transformer yourself, since it is evident (by your letter) you have not the necessary knowledge, or you would have mentioned current and secondary has to carry. Without this factor cannot advise further. These power transformers are very cheap to buy, and are hardly worth building unless you have a thorough knowledge of the subject and the necessary apparatus.

**W.B. (Jerry's Plains).**—Your query has already been answered. As previously advised, 19 ohm coil and 14 minutes would represent 7.14 p.m.

**K.W.R. (Eastwood).**—The changes you mention should be quite O.K., so that the trouble is either a faulty component or wrong wiring.

**PEP PUNCH (Waverley).**—Sorry, we cannot give you the coil data of this receiver, which was published in our contemporary, "The Listener In," Melbourne.

**C.J. (North Sydney).**—The 1929 Neurodyne would suit your requirements.

**C.A.B. (Bathurst).**—Sounds like open grid circuit.

**A.E.B. (Pymont).**—You have got the wrong idea of things, making an error which quite a number of other constructors fall into. Because the r.f. dial reads higher than the detector dial this does not infer that there is too much capacity in the r.f., but not enough turns on the r.f. coil. By adding more turns a lower reading on the r.f. dial will result, and sufficient number of turns should be added, so that the r.f. and detector dials read alike when the setting is about 50 degrees.

**M.W.O.D. (Five Dock).**—Your extremely long letter passed on to Mr. Calvin Walters.

**H.P. (Queensland).**—This is a commercial product which has never been submitted to us for test, and on which we have no data. Advise you to write to your local dealer for the information required. Sorry we cannot help you here.

**A.H.B. (Annandale).**—This is quite correct. You may have a faulty component. Impossible to say where wiring may be wrong as you give no symptoms, merely saying you have not been successful.

**F.C. (Burwood).**—The secondaries of audio transformers in which the primary is burned out can be used as audio chokes, but they are a poor substitute for the real thing. Suggest you build up chokes as described in the A.R.R.L. Handbook, a copy of which (according to your letter) is in your possession.

**A.B. (Rockhampton).**—Glad to hear the valve base coils treated in queries columns suited the All-Empire so well. See reply to W.G.J.S. (Casino) in queries columns dated December 6, 1929.

**H.M. (Willeanna).**—"Could suggest an improvement for the paper. It really is one for us country folk who would be the only ones to benefit. In the programmes section, which now concludes with Thursday's programme, if that was extended to Friday it would mean a lot of difference for us. You see, the majority of places this far out receive mails on Saturdays, hence Friday's radio movements are a blank, and we often regret having missed something we had no idea was on the air. Could this alteration be made?"

**Answer:** Elsewhere in these columns you were advised that this part of your letter had been handed

on. It was received back later, advising that it should be possible to arrange the programmes as you suggest, and steps will be taken immediately to ascertain if this is so.

**F.B. (Maroubra).**—Thanks for kind remarks. You are in an unfortunate position as regards interference and a wavetrapp would probably be your only definite solution to the problem.

**R.A.H. (via Blayney).**—Yes, the Cosor is (judging by a number of letters received) quite a success on the short waves. Probably the speaker was placed facing or too near the set, the valves of which are microphonic.

**F.H. (Petersham).**—Open circuit in primary of first transformer will probably be found to be the cause.

**W. McD. (Parramatta).**—Put name and address in correct place, way of telling the correct placing of leads for the transformer unless you advise gauge of wires. Request published below.

**GENERAL.**—W. McDonald, 1 Dixon Street, Parramatta, wishes to know if any reader can supply him with copies of "Wireless Weekly" containing the "Countryman's One" and the "Improved Countryman's One," for which inquirer is willing to pay cost and postage.

**J.H. (Gungah).**—Adjust coils so that dials read same at detector. See remarks to A.E.B. (Pymont) this issue. Look in corner of this week's queries for query coupon, and digest information given in fourth line, commencing fourth word, finishing fifth line and fifth word.

**"Troup" (Taillima).**—Yes, there are such variable condensers as "Mica Dielectric." They are used in some receivers. The idea of using r.f. transformers with a core is very antiquated, as are the type of condensers mentioned. Suggest you read Mr. Hull's remarks on the 1930 Superhet in his recent articles. The use of condensers with mica dielectrics may eventually lead to noisy tuning. The usual .0001 mfd. variable condenser can be used in place of these.

**A.H.B. (Woollabra).**—These output ratings are conservative, and the transformer can be used for a much higher draw. The valves are obtainable in Sydney. It is not absolutely necessary to shield the S.G. valves if the coils and leads are shielded in such a manner that the plate and grid circuits are isolated. This procedure has been adopted in receivers treated recently.

**C.S.C.W.f. (No address).**—It will not be necessary to alter the Cosor Melody Maker in order to use it on short waves. Coils are available for this receiver so that it can be used on the lower wavebands.

**B.G.S. (Hawthorn).**—There is always a very slight hum from an a.c. set. Yes, this is from the a.c. transformer. The humming and banging are caused through making or breaking contact with the same a.c. circuit. The fact that you seem to think that the dynamic speakers reproduce the bass notes at a greater volume than the higher notes is probably because the average ordinary speaker, such as the type you are now using (the cone, not the dynamic), does not reproduce the lower notes efficiently, and consequently you are not used to hearing these register through your speaker. There are, however, a few types of dynamics which reproduce the lower notes to a greater extent than the higher notes, but this condition may be improved by using a good amplifier, and removing the by-pass condenser from the transformer inside the speaker unit.

**K.A. (South Australia).**—Please write on one side of the paper only.

(1) "Which are the best values to use — or —?"  
**Answer:** See reply to R.A.H. (via Blayney). (2) The circuit is a Reinartz.

**W.D. (Deniliquin).**—The station that transmits on the same wavelength as 2BL is JOKF, Japan (353 metres, 10,000 watts). Mr. Robinson is announcer for 4QG. There are probably other announcers, too, but as we have no details suggest you write this station. The address is Queensland Government Radio Service, Brisbane, Queensland.

**A.E.F. (Fairfield).**—Increase the primary coil by five turns.

**C.R. (Bargo).**—Use A435 valves. Yes, selectivity will be improved.

**G.H.K. (Newtown).**—Space between L1 and L2 1/4 inch. Between L4 and L5, no spacing. Wind on a single coil and take tapping. The R.F. stage shown in your diagram is incorrect. The circuit does not require neutralising. Here is correct wiring in words: Aerial through a .0001 fixed condenser (this latter not necessary unless you are liable to suffer from interference), to first turn of aerial coil, end of which connects to earth and to one end secondary coil (i.e., the filament terminal), thence to rotor plates of R.F. condenser and to one of the filament terminals of the valve socket. Other end of secondary to fixed plates of R.F. condenser, thence to grid terminal of valve socket. Plate terminal of valve socket to one end of plate coil. Other side of plate coil to one side of a by-pass condenser .002 mfd., to B plus. The other side of the by-pass condenser should connect to the remaining filament terminal of the valve socket and thence to A plus. A Marco Four circuit was published in query columns January 4, 1929.

**E.P. Wallsend.**—There are not many bell transformers with one amp output. Usually the rating is considerably lower. Seldom either are the voltages as marked, since the transformers are not made for such accurate work. Your best plan would be to procure a filament transformer of the type made for transmitting valves. This will give you a fairly high output, and if the voltage is too high it can be brought down by means of a suitable resistor, after rectification.

**E.S. (No Address).**—Crystal circuits have been published in these columns numerous times. A circuit was published last week, and another was published the week previous. Yes, we still have a few copies left.

**J.C. (Honeysuckle).**—A stamped addressed envelope in your name has been found. Please note,

we do not reply to queries by post. So far have not struck the query to which the envelope belongs.

**F.C.G. (Campsie).**—Thanks for the list, which will be checked, and probably published at a later date.

**A.D. (N.S.W.).**—First socket, last amplifier; second socket, first amplifier; third socket, detector; fourth socket, second R.F.; fifth socket, first R.F. The A415 is the detector, the B406 first amplifier, and the B405 last amplifier. The other two valves are for the R.F. sockets. Glad our recent assistance through queries proved of benefit.

**R.H.L. (Canterbury).**—"Please supply full details for winding the coils of the Marco Four."

**Answer:** Aerial coil 12 turns 24 gauge D.C.C. wire on a 3-inch diameter former. First turn connects to aerial. Last turn connects to earth. Space 1/4 inch, and wind 47 turns of same wire for second primary. First turn connects to grid of R.F. valve and fixed plates of tuning condenser. Other end connects to filament, rotor plates of condenser, and earth. On a separate former of equal diameter wind 30 turns. This is the R.F. plate coil. First turn to plate of valve, other end to coil to B plus. This coil is coupled up to the next coil, which consists of 75 turns of the same wire on a 3-inch diameter former. This coil is tapped at the 47th turn. The first turn connects to the fixed plates of the detector tuning condenser, through the grid leak and the condenser to the grid of the detector valve. The tapping connects to earth, and to one of the filament terminals of the valve socket, also to rotor plates of the tuning condenser. The end of the coil connects to the plate of the detector valve through the reaction condenser.

**"ONE LUNGER" (Carlton).**—Would give good results in a portable providing a number of them are used. This type valve is called a Tetrode. It has an extra element, and the valve requires only a very low plate voltage (about 12 volts).

**E.G. (Stockingbal).**—It is just a matter of adjusting the coils so that the tuned circuits match up. A list is supplied with the Radiokes' S.W. coils showing the bands covered with various capacity condensers. Do not think you will find the broadcast coil covers the whole range from 200 to 600 metres with a .0014 mfd. condenser. There is little difference in the two capacities mentioned, as a matter of fact it only amounts to .00001 of a microfarad, and this would not affect tuning except on low waves. The transformer substituted is O.K. The power valve mentioned is quite suitable.

**H.W. (Victoria).**—"I noticed a circuit of the Renown Three in 'Wireless Weekly,' but no details of coils were given. Please explain how these coils are wound."

**Answer:** The wave-trap coil consists of 70 turns 26-gauge D.C.C. wire on a two-inch diameter former. Tap every tenth turn. This is the wave-trap coil. The primary consists of ten turns of 20-gauge D.C.C. tapped every second turn. The secondary and reaction coils are wound as one. Use the 26-gauge wire, and wind on 110 turns, taking a tap at the 75th turn. The first turn is the grid lead. The tap is the filament lead, and the end of the coil connects to the rotor plates of the reaction condenser. The wave-trap coil is wound on a separate former. The other coils are wound on one former. The space between the ten-turn coil and the 110-turn coil should be about 3/4 in. If you wish to obtain a copy of "Wireless Weekly" dated March 22, no doubt some reader could supply you, if you cared to inquire through these columns.

**C.D. (Bellevue Hill).**—The Countryman's One-valve receiver was originally published January 25, 1929, and the circuit has been published several times since. Regret we have not the complete set of "Proving Radio" articles from 1-19, but we have some of them. You may be able to obtain the missing numbers by inquiring through these columns. No; the articles are not obtainable in book form.

**G.C.R. (Queensland).**—This type "Umaki" is very much out of date. Besides that fact, it is probable that some of the components are just about on their last legs. Advise you to have all parts tested, and use the good parts to make up a more modern receiver.

## Radiair

Have Your  
OLD SET CONVERTED  
Into a  
GENUINE ALL-ELECTRIC  
MACHINE.

No Batteries or Accumulator  
required any longer. Converting  
is your last expense.

WE DO THE CONVERTING FOR  
3-valve, 4-valve, 5-valve,  
£10 £11 £12

NOTE THE ONLY ADDRESS—  
The RADI AIR WIRELESS CO.,  
114 Castlereagh Street,  
NEAR MARKET STREET,  
Phone, M2037.

# Three New Radiotrons



Radiotrons have an enviable reputation in Australia for long life and consistent performance.

This reputation has been built up over a long period of years, and the addition of three new types complete a range of Broadcast Receiving Valves which will meet all requirements.

## RCA. 221

For battery operated sets  
General Purpose.

Fil. Volts ..... 5.5 to 6

**FIL. CURRENT .06 AMPS**

Plate Volts ..... 45 to 150

## UY. 224

**A.C. SCREEN GRID**

General Purpose.

Heater Volts ..... 2.5

Heater Cur., 1.75 amps

Plate Volts ..... 180

## UX. 245

**FOR A.C. OR D.C. SETS**

Power Amplifier.

Fil. Volts ..... 2.5

Fil. Current ..... 1.5 amps

Plate Volts ..... 180-250

Obtainable from all Radio Dealers

**Amalgamated Wireless**  
*(Australasia) Ltd.*

"Wireless House,"  
47 York Street, Sydney

Queensland Distributors:  
J. B. CHANDLER & CO.,  
45 Adelaide Street, Brisbane.

*Genuine*

# Radiotron

# Why own a "Half-time" Radio?

that denies you daylight reception of races . . . news . . . community singing . . . and all the wealth of entertainment that's on the air. Hundreds are changing over to the luxury of the new super powered "full-time" radio that definitely GUARANTEES DAYLIGHT reception, at full speaker strength—to every country resident, no matter how remote.

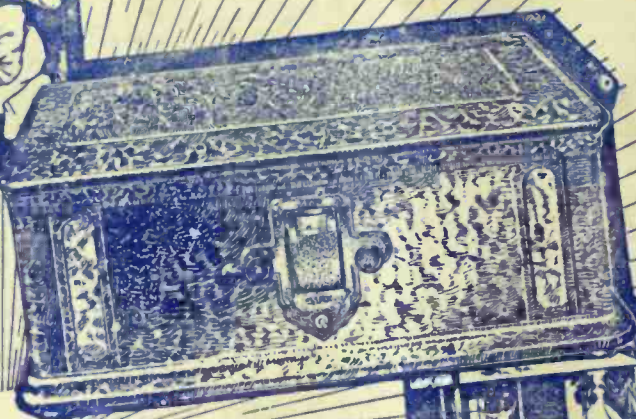

D.S.G./Z/D



The New

## ASTOR RADIO

DOUBLE SCREEN GRID

Table Model, in Two-tone Duco, complete with heavy-duty accessories and Amplion Speaker. Price, £48.  
 Console Model, £53.  
 Terms. Deposit from . . . . . **£10/11/-**

BY employing a new radio principle the Astor Double Screen Grid radio revolutionises long range daylight reception. Two giant amplifiers are incorporated, which give 18 times the amplification of two normal valves.

Full Particulars and Demonstration from Local Distributors, or

**AMPLION A/SIA LTD., 53-55 York Street, SYDNEY**

NO OBLIGATION.

**SEND THE COUPON NOW!**

Messrs. AMPLION (A/sia) LTD., 53 York Street, Sydney.

Dear Sirs.—Please forward, without obligation, your Illustrated Folder on the New Astor Double-Screened Grid Receiver.

Name \_\_\_\_\_

Address \_\_\_\_\_