

MITCHELL LIBRARY,
5 MAR 1929
SYDNEY

Wireless Weekly 3^d

INCORPORATING "RADIO IN AUSTRALIA & NEW ZEALAND"

VOL. 13. NO. 11.

FRIDAY, MARCH 8, 1929

(Registered at the G.P.O., Sydney, for transmission by post as a newspaper).

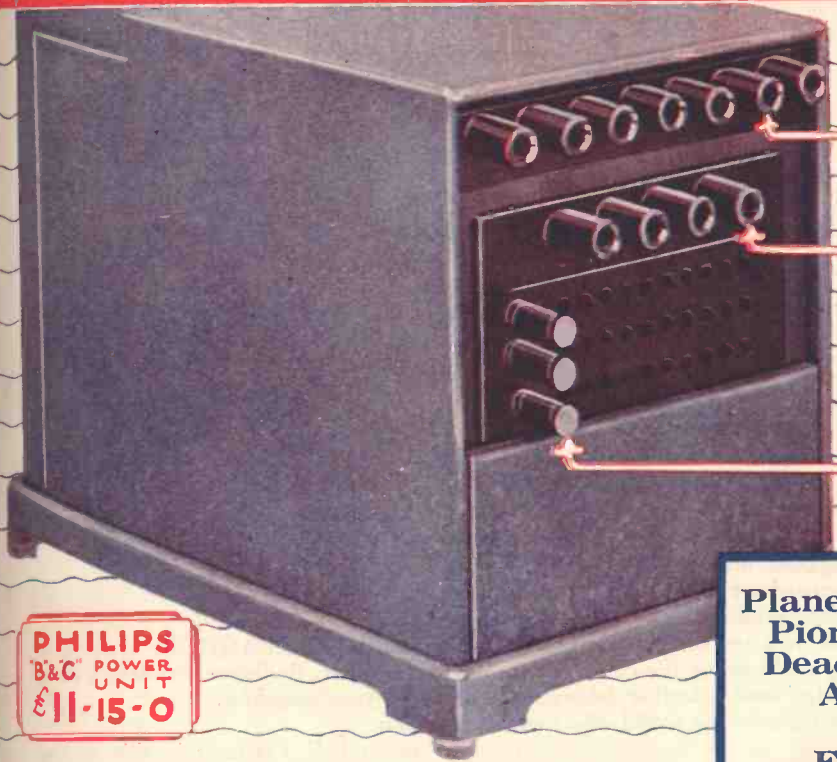

6 B VOLTAGES
GIVING
FROM
60 - 200
VOLTS

CONNECT
C LEADS
FROM
RECEIVER
HERE

3 STAGES
OF C BIAS
UP TO 40 VOLTS
ADJUSTED BY
THESE TAPS?

PHILIPS
B&C POWER
UNIT
£11-15-0

Planes and Radio
Pioneer Great
Dead Heart of
Australia

Electrical
Amplification
By Ray Allsop

A New Wave Trap
By Don B. Knock

The Aberdonian
Three Valve Receiver

PHILIPS POWER UNITS



No Need to Worry

About Your Construction

If You Build With Radiokes Components

All are Sold with this Familiar Tag attached

Radiokes Guarantee



Here is illustrated one of the very popular products of Radiokes Factory. Used and specified throughout the Commonwealth by Radio Editors, manufacturers and experimenters alike. An excellent coil kit wound on highest grade Bakelite formers, accurately machined, highly polished and carefully tested. This Marco Four Kit sells for 30/- complete as illustrated.



All Radiokes Products are not only covered with this now well-known PERPETUAL GUARANTEE, but you are also protected against any possible litigation, because Radiokes have secured a HAZELTINE LICENSE for the manufacture of their products as an additional protection. Not only this, but you are further assured of COMPLETE SATISFACTION, because, if you do strike any problems in the construction of your receiver, Radiokes maintain a competent advisory staff and a testing laboratory, and invite your enquiries. No other manufacturer in the world offers such protection.

Radiokes are the Premier R.F. Products in this or any other market, and, remember, they COST NO MORE. Insist on Genuine Radiokes and refuse any substitutes.

OBTAINABLE FROM ALL RADIO DEALERS,

OR DIRECT FROM

Metropolitan Electric Co. Ltd.

"RADIOKES HOUSE,"

126-130 SUSSEX STREET, SYDNEY
YORK HOUSE,

294 Lt. Collins St., Melbourne.



LICENSED UNDER
AUST PATENTS OF HAZELTINE CORP. (U.S.A.)

NEUTRODYNE

REG. TRADE MARK

REG. PAT. NO. 19,999 FEB. 20, 1924 NO. 20,000 APRIL 7, 1924
NO. 24,469 SEPT. 22, 1924 NO. 23,508 FEB. 27, 1925
NO. 23,802 APRIL 3, 1925
OTHER PATENTS PENDING

Install these Accessories and have perfect Radio reception

Everything for the Radio Enthusiast

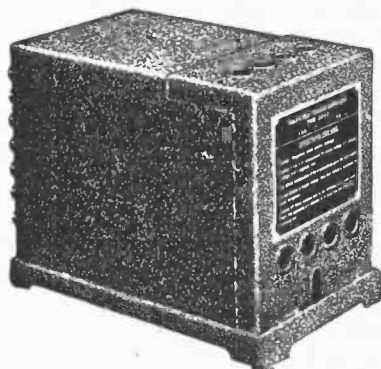

The following Philips lines are also stocked.
Philips Trickle Charger
" A & B Charger
" B & C Eliminator
" Valves



The Philips Eliminator does away completely with your "B" Battery, and is used by simply plugging into the ordinary electric light socket.
PRICE £9/15/-

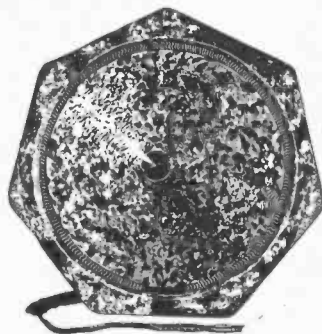

PHILIPS STANDARD 1 "B" ELIMINATOR, 372.

Here is the most popular power unit in Australia, which, owing to a price reduction, is now actually a cheaper proposition than "B" Batteries.

At its new price of £7/15/- there are none who need suffer the inconveniences of the dry battery.

Price £7/15/-

Easy Terms can be arranged if preferred.

PHILIPS BABY GRAND LOUD SPEAKER.

This is a particularly fine baby model with an exceptionally clear tone and pleasing appearance. Splendid value at

£3/15/-

OPEN UNTIL 9 p.m. FRIDAY

Home Recreations (Australia) Ltd.

388 George Street, Opp. Beard, Watson's, SYDNEY



Big Money Made In Spare Time With Radio

Both Men and Women Increase Their Incomes



RIGHT now there is an opportunity in your locality to profitably devote your spare time or all your time to a pleasant, easy and profitable business—one that does not require any training or capital. A unique and original scheme inaugurated by the largest Radio Distributors in Australia provides an opportunity for you—whether you be a man or woman—young or old (in fact, boys and girls can benefit by it), to profitably devote your spare time, in your own locality or elsewhere, to pleasant, easy business with good money—no training or capital being required; in fact, you are not asked to put down a single penny.

IN every street there are homes galore which have not installed a Radio Set, and the people in these homes appreciate Radio—they realise its advantages and enjoy it, but just haven't bothered. As time goes on these people will certainly purchase Sets, but under ordinary conditions you and others who have aided them with advice will not be compensated.

A SPLENDID system has been evolved by Harringtons Ltd. to recognise the efforts of those who are instrumental in interesting their friends in quality Radio. There are no difficult conditions—no long drawn out Agreements—everything is on a simple basis, and the work can be done in your spare time.

IN other parts of the world men and women have made very handsome incomes in this way—many young men previously on small salaries are to-day in a good financial position—more independent—more self-reliant—as a result of devoting a little of their spare time to remunerative and interesting work. Think of the opportunities in

this State—there are in N.S.W. alone over 150,000 homes without Radio. Here is a great fertile field waiting to be tapped—some bright people are going to benefit by linking up with Harringtons Ltd., and during 1929 increase their banking account considerably.

HERE is a real tip. Think it over—are you satisfied? Are you making enough money at work that you like? No matter what your plans are, no matter how much or how little you know about Radio—clip the Coupon below and post to us as soon as possible. This may be the turning point in your career, but in any case you will place yourself under no obligation.

Address your communication to:

Harringtons LTD

386 GEORGE STREET, SYDNEY
Branches at Katoomba, Newcastle, Melbourne, Brisbane, Adelaide, Hobart, Auckland (N.Z.), Wellington (N.Z.).

HARRINGTONS LTD., Box 141CC, G.P.O., Sydney.

Will you please forward me all information about the opportunities offering in Radio, and how I can quickly and easily take advantage of them? I understand this request places me under no obligation whatsoever.

Name
(State whether Mr., Mrs., or Miss)

Address

Date

Wireless Weekly

Incorporating "Radio in Australia & New Zealand"

Address:
 51 Castle-
 reagh St.,
 Sydney.
 'Phones:
 B7148-9.

RADIO NEWS OF THE WORLD IN PICTURE



KEITH HARRIS, of the Young Australia League, at KGO, during a recent tour through the United States. Marguerite King introduced him to local listeners. Was the broadcast heard in Australia?

LIONEL COHEN and **KEITH HARRIS**, both of the Young Australia League, before the KGO microphone. Howard Mulholland is introducing them. The flags of the respective countries are seen in the picture.



MAJOR RAYMOND PHILLIPS, O.M.E., demonstrating his well-known invention of wireless controlled model railways, at the recent British exhibition of better things for the home.

Centre Top: No camping party is complete without a radio. Here is seen a happy group around the loud-speaker at a recent holiday camp.



Emotional qualities in students' voices are measured by a new scientific instrument and "pictured" on a movie film at the University of Southern California. The device is called "tono-phonograph," and is the invention of Dr. Arnold Wagner.



The new 2UW studio, at Paling's Buildings, which is equipped with every instrument for musical reproduction. Mr. J. M. Prentice is seen announcing, and Mr. Leighton Bailly is standing in the background.

BETWEEN YOU AND ME AND THE MICROPHONE

The Announcer's Findings

A MAN was lost the other day, and at two minutes to eight in the evening a message was broadcast. At three minutes after eight in the same evening he was found. Although we don't want to startle the Husbands - who - have - to - work - in - the - office - to - night - dear.

"Big Phella Bunny"

FROM a station outback comes an excellent story of the interest taken by the aborigines in the Children's Hour at 3LO, which seems to appeal to their native simplicity. One evening the head rouseabout was required urgently, but he was not difficult to find, for, as usual, he was not far away from the loud speaker. However, he could not be coaxed away until the close of the Children's Hour, and then smilingly he went about his work with the remark, "im big phella Bunny plurry good yabba."



The Prince

"HOW I just adore you, my Prince! How I enjoy your wonderful entertainments, and how I just worship that well-known, loved voice which never fails to drive an unknown force through my whole being! I just love every bit of you, my wonderful Radio Prince!" This is an extract from a letter sent to Mr. Charles Lawrence, who felt so proud of it that he thought it ought to be published to all the world. As Mr. Lawrence remarked, it proves that radio, in certain instances, can be more romantic than life itself. Mr. Lawrence also told us very confidentially that he hoped television would not arrive too soon.

Discrimination of Dogs

A HARD-HEADED, but eccentric, old bachelor lawyer in a Victorian country town was known to have a pet aversion, and that was music. It came as a shock, therefore, when his friends learned that he had installed a wireless set. It came as a greater shock when it was known that his loud speaker could be heard all day long whilst he was at his office, and there was no one else in his house. Asked about this, he explained that he had the set installed solely for the benefit of his dogs, who found



endless enjoyment listening in, and even had their likes and dislikes. For instance, his big Gordon setter disliked sopranos and violins, but enjoyed male voices; whilst his terrier always set up a doleful howl at the voices of all singers, but was happy and contented with the music of bands. This is proof that even dogs have discrimination, and would write to the press if they only could.

Childishness

AT 6.15 in the evening station 2RN (Dublin) announces its "Uair i dTir na n-og"; although we are quite satisfied out here with the old practice of calling it the "Children's Hour." We seem to understand it better.

Infant Digression

REPORTED reception from 2FC by a Victorian listener-in, "The station came in very loud with 'My Melancholy Baby.'" Investigation has failed to give any definite reason for the baby's excursions at 11 p.m.; and we cannot see why babies should go about rooting up stations, even if they are melancholy. Of course, this is a question for the Victorian listener-in. He has to er-carry the baby.

Art, Criticism, and Gramophones

THE only thing Allan Wilkie's broadcast "scenes" and addresses from Shakespeare brought forth in New Zealand was an article by a critic whom Mr. Wilkie had criticised. After reading the article, which contains Mr. Wilkie's criticisms, and the angry critic's rebuttals, we are under the impression that neither Mr. Wilkie nor the critic can possibly have survived—only Shakespeare. Somehow, we wish that Shakespeare might produce a play or so over the air. We feel that he could do it with a minimum of critical puff-jabber, and a maximum of effect. We were told only the other day of some gramophone renderings by Barrymore from "Hamlet" and "Macbeth." We were told they were most effective, even powerful. Surely radio can express as much dramatic power as a gramophone.

Radio Tragedy, No. 7

"My love!" she sang, "You're all to me—
My heart, my soul, my very life,
I cannot leave weeth-how-howt thee—
And so I won't become your wife."
The lady sang with all her might,
For he was listening-in that night.

A thousand million speakers shrieked;
Ten thousand million people winced
As higher and higher the thin voice squeaked;
And frogs were everywhere evinced.
Next morn they found her lover dead,
With headphones draped about his head.

O lady fair, by death betrayed,
You who would die without his love!
Poor, suffering heart, we straightway move
That you should keep the promise made!

Am I My Brother's Keeper?

A PROFESSOR ESAU, of Jena, claims to have invented yet another "death ray." It works on the principle of radiation of ultra-short waves, is effective up to 250 miles, and the set fits into a cigar box. And if the invention prove successful, Professor Esau will not lack the filial attentions of the War Offices.

Little Brown Jug

MANY times we have noticed a large stone jar being brought into the control room, and we have waited near the control room door in a subtly insinuating manner. But we have never been offered anything. So we protested the other day against the operator's meanness, only to find that the jar contained distilled water for the batteries. Imagine that! All the time we had thought it was—milk. We do like our morning glass of milk.



Returned to Owner

BEFORE Mr. Vincent Aspey left New Zealand a friend gave him a short violin composition, written specially for him. So Mr. Aspey played it the other night, while his friend listened-in from somewhere on the leg-and-boot.

Hallelujah

ON the night of the day when the Salvation Army took unto itself a brand new General, a Salvation Army band played from 2BL. The band presented a united front, and it was quite evident that the Army was keeping its discords out of its instruments, although it has not been ascertained whether the general joyousness of the programme was a sign or merely a matter of routine.



The Clock Put Back

A NOTHER story comes from a one-horse town—in this case, a one-hotel town—in South Australia. The hotelkeeper was also the local bookmaker, and many were the complaints that he made his book with unreasonable odds against the punters, who vowed vengeance. Accordingly, one important race day, whilst the hotelkeeper was out of his bar, they put his wireless set out of action, and turned his clock back. Then one of them went to a house nearby, and listened to Eric Welch describe a race, with the winner well in mind, he hurried to the hotel, and laid all he had on it, and the other lads of the village did the same. The unsuspecting bookmaker wondered why an outsider had suddenly become favorite, but paid in good spirit. The joke, however, fell flat, to some extent, because he never found out, and the lads who got a little of their own back were forced into silence.



PLANES & RADIO PIONEER DEAD HEART OF AUSTRALIA

By E. GOLLAN

The Rev. Scott and A.I.M. Car.

NOT many descriptions of Australia are truer than that which labels it "the great hollow Continent." However pleasant, easy, and temperate. Look at the map. Railway lines do not penetrate far, telegraph lines little farther.

The centre of Australia is bare of markings denoting either cities, fauna, flora, or geological variation. One has only to travel a few hundred miles inland to prove that the geographer is right. Australia is indeed a hollow continent.

But there are people in this great hollow continent. What do they do? They are employed in ways strange to city people, ways which expose them to many risks the city man seldom dreams of. There is fever, starvation, thirst, accident, and sudden death. All these things are experienced in their everyday life, and they have borne them stoically, for they are beyond reach of doctor, medicine, or assistance of any kind. Hundreds of miles separate their primitive settlements; there is no means of communication or conveying assistance.

That is until recently. The Australian Inland Mission built hospitals and nursing homes, and there has now been established through the development of radio and aeroplane a means of rendering assistance.

Radio transmitters are installed in nearly all the settlements and stations, and a call brings the "Flying Doctor" to them.

I have just returned from a sojourn in the Northern Territory and far western Queensland, installing these transmitters. I left as a country-bred man, but one whose home was within a few miles of the sea coast, I did not realise fully the difference of life in the "great dead heart of Australia."

It was not until leaving Bourke as radio officer with the Australian Inland Mission's expedition that I fully realised the truth of the description.

As far as Bourke the journey was always interesting. There was, even after leaving Byrock, something of variety in the landscape, but this was soon toned down to an impression of dead monotony that made one recall Paterson's description: "The everlasting sameness of the never-ending plains."

From Bourke to Baringun, on the Queens-

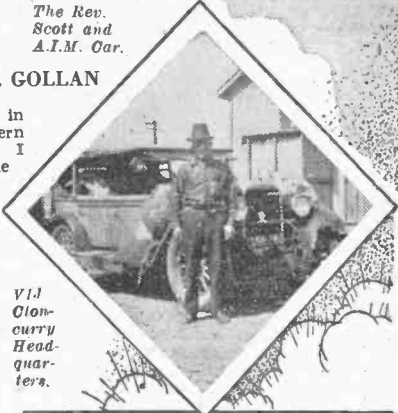

V.I.J. Cloncurry Headquarters.

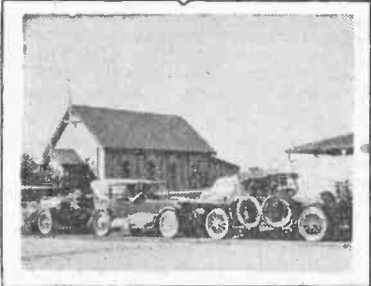

ORDINARY MEDICAL AID	
Bush Nurse Doctor or Complete Dist Hospital	●
Nil	○
TELEGRAPH & C	
Wire lines	—
Wireless Stations	★
RAILWAYS	
Gauges 5' 6"	—
2' 6"	—
3' 6"	—
AERIAL MAIL ROUTES	
Operating	—
Authorised	—
LIMIT OF "CLOSE" SETTLEMENT (ie more than ONE PERSON per 50 MILE)	—
AERIAL MEDICAL SERVICE	
Normal zones of 100 mile radius (as shown) are practicable, with special provision - in places - for longer flights.	
A.I.M. EXPERIMENT... Heavy Circle Possible Extensions... Double Circles	
A.I.M. NURSING HOMES Represented by... RED STARS A white dot in centre indicates	
NO DOCTOR in settlement.	



Left: The A.I.M. Service car bogger in the Diamantina "River," not far from where Bourke and Wills perished. Such bogs are common in the billabong country

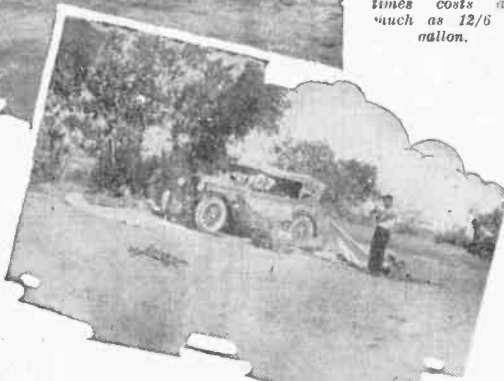

Right: A night camp at an "oasis." Petrol is life in these great spaces, and sometimes costs as much as 12/6 a gallon.

THE GULF COUNTRY

The most difficult part of our task was not the installation of the sets, but the discovery of the remote parts where they were to be placed. To find these places we went sometimes by plane, but usually in the A.I.M. big Dodge car, and it was on some of these expeditions, accompanied by the Rev. Scott, that we made an acquaintance with the Gulf country, which I do not wish to renege.

In the real Gulf country (i.e., Arnhem Land and the Peninsula), the only inhabitants for the most part are crocodiles and abos.

The heat, especially in the summer months is something to be wondered at. One has to fly at a height of about five thousand feet to reach even a temperate climate. On the barren plains it was almost unbearable. Malaria or Gulf fever, is rife over the whole of the Gulf country, and one is almost certain to contract this disease if any length of time is to be spent in these areas. But this illness did not constitute the majority of calls upon the doctor, for all the white inhabitants supply themselves plentifully with quinine, with which to combat the dread invader. We travelled many thousands of miles through malaria-infested country, installing the sets.

ABOS AND 'GATORS

At night we camped beside salt-water streams, and it took us some time to accustom ourselves to the roaring of the 'gators, which throng these rivers. The aboriginals near the Gulf, and especially around the Roper River, are almost as savage as they were in the days of Kennedy and Jacky-Jacky. Some acquaintance with the whites, however, has imbued them with a wholesome respect for fire-arms, and a keen desire for tobacco. We always carried at least one automatic pistol apiece to guard against possible attack.

On one occasion a laughable incident occurred. Both the Rev. Scott and I had gone to bed with thoughts of the natives in our minds. In the night I awoke with a roar and clatter in my ears, and heard Scott's voice shouting, "The blacks, the blacks!" I grabbed the rifle which lay beside me, and stared intently into the darkness, but all was silent. So far as we could tell there were no niggers within a hundred miles of us. Then we discovered that the heavy weight which had fallen on Scott's head, and so startled him,

(Continued on Page 23.)

land border, the only variety afforded was by the increasing viciousness of the sandflies, and the growing density of the dust storms. One drove, ate, and slept in an atmosphere of dust, until, on arrival at Baringun, we were probably the filthiest assortment of mortals in Australia. Even the Warrego River afforded us no relief, for the muddy trickle which passed muster for a river was too uninviting to arouse our enthusiasm sufficiently for us to indulge in a mud bath.

Passing through Cunnamulla to Charleville, we found little to amuse us. The only variety afforded was the expectation of finding a good hotel at each of the tiny villages through which we passed. Our hopes, however, were never realised.

Usually we camped at night in the open air, with the sky for a roof. By means of a five-valve neodydne we were enabled to keep in touch with the world, which we seemed to be leaving behind.

The next stage of the journey was from Charleville to Longreach. During this phase, over perfectly flat country, we traversed at a speed of 40 miles per hour, the vast silence of the deserted plains being broken occasionally by the roar of a service plane overhead. The final stage of the journey, about 560 miles, we compassed in one day.

BILLABONG COUNTRY

As we approached Cloncurry the scenery changed, and we found ourselves among billabongs and dry water courses, while the trees were a welcome change from the deadly monotony of the scorching plains. At about 7 o'clock in the evening we reached our destination—"the city of the Gulf"—after 12 days' continuous travelling. This was to be our home, and the centre of our operations for the next six months.

Most Australians are acquainted with the work, which is being done in the never-never country by the Australian Inland Mission, but few perhaps realise the immensity of the work, and the nature of the difficulties that are likely to occur.

PARISH OF 250,000 SQUARE MILES

The parish of the Rev. G. McLaren Scott, who was in charge of the religious aspect of the work, was about 250,000 square miles. Over this vast area the "flying doctor" exercised a general control, and was likely to be called at any time to the most distant part. My work was to organise radio for the area.

The scheme was to erect a central station

at Cloncurry and transmitters at various places, usually some large cattle station which is the recognised centre of a district. Thus a call for help could be sent to Cloncurry from a distance of a thousand miles. On receipt of such a message the doctor was to set out in the plane driven by Air Pilot Affleck to the scene of the illness or accident. There was also a radio outfit installed on the plane, by means of which we could pick up messages as we flew, and also send calls for help in times of a forced landing.

During the periods when not accompanying the Padre and doctor on the expeditions into the wilds, I was engaged upon building the transmitters, which are small five watt machines, on a wave-length of 32.5 metres. This does not include the central station, whose call sign is VIJ, and has a transmitting power of 250 watts; our calls on this machine have been heard in Sweden.



(Left): Until the advent of the car, and now the plane, transport in central and northern Australia was mainly by camel. The picture shows a familiar "caravan."

(Right): A typical stretch of country showing another "river" in the foreground. Cars speed constantly at 50 or 60 miles an hour over virgin plains with little trouble.

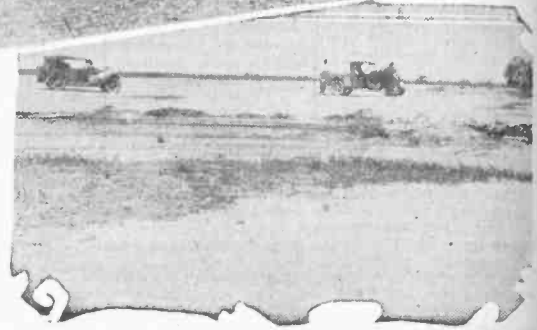

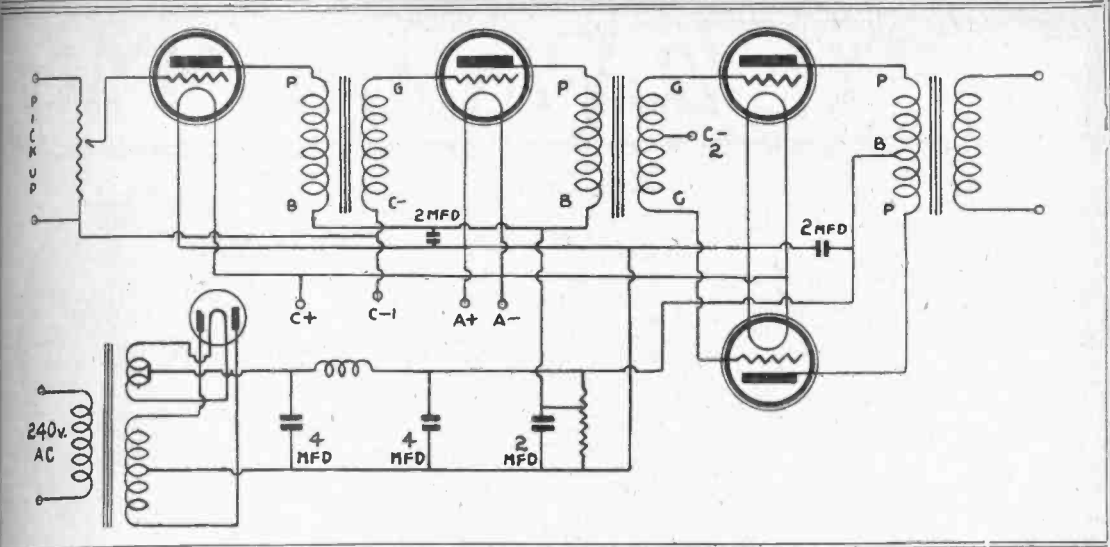

ELECTRICAL AMPLIFICATION

The first article of an important series on large scale Amplification and Reproduction by Mr. Allsop, who is at present conducting a number of experiments in that direction.

**By
Ray
Allsop**
*(Associate
Technical
Editor)*

In any system for the electrical amplification and reproduction of sound, there are three general requirements which it is desirable that the reproduced sounds should meet. First, that they be at about the same loudness as people are accustomed to hearing the original sounds; second, that they be free from appreciable distortion, that is, that the character of the reproduced sounds be so close to that of the original sounds that the ear cannot distinguish between them; and, third, that they be free from extraneous noises. The degree to which these requirements of loudness, freedom from distortion, and noise are met is the measure of the quality of the system.

The sounds which comprise speech and music involve complicated pressure variations. For any small interval of time these pressure variations may be resolved into a series of component waves. As the speech or music proceeds, the amplitude, the frequency, and the phase of these components change. The amplification and reproduction of such sounds may be considered as a matter of amplifying and reproducing the several component waves.

The requirements then for no noticeable distortion in a sound reproducing device will be as follow:—

1. The reproduced sounds shall have the relative intensities of the component frequencies the same as the original sound.
2. The reproduced sound shall not contain any components of frequencies not present in the original sound.

Another important factor in the reproduction of sound which is not generally appreciated is that apparent distortion is obtained if the intensity of the reproduced

sounds is materially outside of the range in which the listeners are accustomed to hearing the original sounds.

With these requirements in mind, consideration will now be given to a circuit for the amplification and reproduction of gramophone records.

This circuit is to employ 4 valves, the last two being power valves, and in push-pull. The Audio Transformer feeding these two valves has one end of its grid winding connected to the grid of one of the valves, and the other end to the grid of the other valve. The midpoint is connected via a suitable grid bias battery to the negative end of the filament. In a similar manner the two plates of the valves are connected to the opposite ends of the primary winding of the output transformer. The midpoint provided in this transformer is connected to the "B" supply giving 300 volts or more. The secondary side of the output transformer is connected to the loud speaker in the ordinary way. The advantages of this power stage are numerous, and as follow:—

The division of the signal from the first stages of amplification—one-half going to each of the two valves in parallel—provides the equivalent of double the normal grid swing permissible when using only one valve, without distortion, that is, a much louder signal may be handled without distortion and no valve overloading.

The output transformer is more effective, because there is no direct current magnetisation of its iron circuit, thus keeping the inductance high, and leaving the iron fully operative under the best conditions for the signal.

As we are considering an amplifier for reproducing sounds at a natural intensity, we must be prepared to use large valves, and expend a good amount of power.

In the following issue I will deal with the complete building instruction for this amplifier.

PEOPLE in the PROGRAMMES

Moore MacMahon

WE do not say that Mr. Moore MacMahon was born with a violin in his mouth, because this would not be true; and, at any rate, it would exaggerate the capacity of the mouth of Mr. Moore MacMahon. Mr. Moore MacMahon's is only an ordinary mouth, after all. Besides, Mr. Moore MacMahon is nothing if not original. So that when his father presented him with a violin on his fifth birthday, the now Mr. Moore MacMahon calmly waited until his father had left the room, and then, just as calmly, put his foot through the violin, which his father had given him. He said it gave him more fun than practising scales. Such was his introduction to music.

However, a new violin was procured, and he studied for some time under his father, then under Mr. J. Coad and M. Henri Verbruggen. In 1918, when the really-truly-last war was simmering in it's own ashes, he went to Geneva, which, at that exciting time, was the cross roads of all Europe. He studied there under Szigeti.

Eggs were at two shillings per egg, and Mr. MacMahon committed the indiscretion of having a hot bath every morning and every night for the first week. At the end of the first week, the bath-water bill worked out at three shillings per bath. Someone explained to an exasperated Moore MacMahon that this was quite the usual charge for a quite unusual service. Passing lightly over the tale of Zlatopolski, a Russian Jew student, who invited all his friends to a restaurant for dinner, and then began to wait on tables in an endeavor to get enough tips to pay for the dinner, we find that Mr. MacMahon gave several successful concerts in Geneva, went to Paris, returned to Geneva, and arrived back in Australia full of honors and beans.

He hasn't found musical life out here a compensation for the loss. "Wireless and the gramophone," says Mr. Moore MacMahon, "have come too soon. In Europe, at the better-class restaurants, Mozart and Beethoven are popular composers. Here, their compositions have been heard through the gramophone, always played in the same way. Australians have no method of making comparisons; and therefore no real desire to appreciate good music."

Which hasn't deterred Mr. MacMahon from giving as many recitals of modern music as he can. He is one of the few in Sydney who keep a spotlight on new compositions. He calls this "Playing what no one wants to hear." Which is very pessimistic. Perhaps he is even now creating the sympathetic Australian audience of the future.



J. Howlett Ross

ELOCUTIONIST, journalist, and student—there are few things Mr. J. Howlett Ross has not done.

He was born in Melbourne, whence he went to London to study under Creswick the tragedian, and under Brandram, the elocutionist. He followed the silvery voice through England, Scotland, and France; and, while in London, became editor of the "Australian Handbook" of Gordon and Gotch, a position he held both in England and Australia during twenty years. His "Laureate and the Centaurs" was the first biography written of Adam Lindsay Gordon; and it was Howlett Ross, incidentally, who inaugurated the annual pilgrimage to that poet's grave.



J. HOWLETT ROSS.

For the past 14 years Mr. Howlett Ross has been lecturer in voice production at the School of Education, Melbourne University, and also at many colleges. He is also a lecturer in diction at the University Conservatorium of Music. And just to prove that he is a man who counts, he is a member of the London Royal Statistical Society.

It is only to be expected that his many years' experience as artist and lecturer have given Mr. Howlett Ross a precise knowledge of what the public wants. His favorite pastime is reading, and his long lines of shelves hold many rare publications.

The Girl at the Piano

THOSE who enjoy the comedy side of the programme will be glad to know that witty and versatile Rita Hilton will be heard from 3AR on March 14 in a budget of old and new favorites. As an entertainer, Miss Hilton has few equals—she is a really brilliant pianist, and, once upon a time, trained very seriously as a vocalist. It was her original intention to be an operatic artist, but the war opened quite a different



RITA HILTON.

channel. She was singing at a camp concert where both the comedian and comedienne failed to put in an appearance, the boys were getting restive, and demanding something with "pep" in it. Rita was called upon to fill the bill. She made an attempt, and was so successful that she has stuck to comedy ever since.

Madame Emily Marks

A TALENTED soprano left Australia for England, where she studied for some time; ultimately touring England and America with a string quartets of the King's Hall Orchestra players. In America, Madame Marks continued her studies under Henri Zay, broadcasting from WJZ (Newark), in



MME. EMILY MARKS.

conjunction with her master, who was lecturing on his famous vocalisation method.

Returning to Australia in 1923, after eleven years' absence, Madame Marks began teaching in the method of Henri Zay. Her early broadcasting experience made her appearance on the air very welcome; and it was not long before she was a regular performer from 2FC.

Madame Marks was quick to perceive that, since the advent of radio, a microphone technique has become most necessary to all aspiring singers, and fitted out her little studio on top of the Strand Arcade as an exact replica of a broadcasting studio and control room. On one side of the sawdust-filled partition the student sings into the microphone. On the other side Madame Marks controls the amplifier and the loud-speaker while she demonstrates to a class. Most interesting.

Of late, Madame Marks and her students have been associated in the production of light operas from 2FC, which have been very well received throughout New South Wales. We understand that more are to follow; but whether the next production will be a repetition of "Maritana" or "Il Trovatore" is uncertain.

Madame Marks is also to arrange a classical programme, in continuation of 2FC's series, for March 27.

Eight-hour Day Speeches

ARRANGEMENTS have now been completed by 3LO to broadcast the speeches in connection with the annual Eight Hours Day Banquet and Celebrations, from the Trades Hall, on March 16, and those interested are asked to make a note of this date.

Radio Fans—Take Notice

THE attention of listeners is drawn to the fact that the address of the New South Wales Broadcasting Company is now Box 3834V, G.P.O., Sydney, and it will expedite delivery of correspondence if thus addressed, instead of the city location of the company's offices.

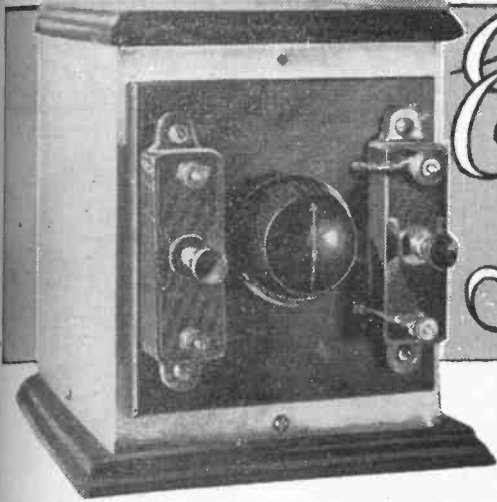

Eliminating Interference

By DON B. KNOCK (Associate Technical Editor)

A few details explaining how selectivity may be obtained in the simplest manner, with special attention to wave-traps.

THE subject of this article is one which will need more and more attention as the science of wireless broadcasting continued its steady progress. Three years ago we were not so concerned with this problem, not only because in New South Wales there were only three broadcasting stations occupying the regular band of wavelengths reserved for the purpose, but also because receivers as we knew them were not to be classed in sensitivity with the average set of to-day.

Another reason was that one of these stations, namely 2FC, was operating on a wavelength of 1100 metres, and thus there was no question of interference with those transmissions. When a change to the lower waveband from 250 to 500 metres took place, 3LO in Victoria and 2FC in New South Wales were added to those few stations already operating in this more restricted channel, and with the advent in another two years of a great number of other stations in all States, the steadily increasing wireless public began its great outcry for selectivity. They had sensitivity, plenty of it, and they found on the average that there was nearly always a background on 3LO from 2BL, and occasionally on 4QG from 2FC, owing to the fact that the receiver invariably tuned very broadly.

SIMPLE ELIMINATOR.

Although radio engineers have been working very hard since then, and there is practically no excuse for lack of selectivity when designing a modern receiver, yet all cannot be expected to go to the expense and trouble of a metal chassis with totally enclosed RF amplifiers, and the consequence is that there are still a great number of people who suffer from interference, and probably an equal number who do not realise how simple it is to make a really efficient Interference Eliminator.

The interference I am referring to is that of an unwanted station. The other problems coming under the same heading have been well dealt with also by engineers, and no longer does the radio expert look astounded when he is faced with interference from a nearby powerful broadcasting station, or power line buzzes and noises.

The only unconquerable source of undesirable interruptions is static, and it is hardly possible to deal with the elimination of this until its source is known. Totally shielded receivers, with carefully designed RF amplifying stages, and wavetraps are helping in the securing of complete selectivity, and are doing their best to hold the transmission of a powerful station in close proximity within just one or two degrees of the tuning dials of a receiver.

Even a low-power station (taking the rating in watts) will assume very powerful proportions on a receiver situated very closely, if that receiver is of the ordinary unshielded RF type.

NATURAL CAUSES.

Did it ever occur to those who suffer in this way that a good step forward may be taken by paying attention to a very natural cause of the interference? It is often traced to the fact that the aerial itself used with the receiver is, apart from the tuned circuits, probably in tune with the aerial of the transmitting stations. By this I mean that the wavelength of the receiving aerial corresponds fundamentally, or through a sub-multiple, with that of the transmitting station.

This will be found more so when the transmitting station is one of those using the higher frequency or lower end of the broadcasting channel around 250 metres. It is quite easy for many listeners to be in possession of an aerial system with a fundamental of 250 metres or more. This state of affairs then gives what we call "shock excitation" in its worst form, as the aerial will oscillate continuously at the frequency of the transmitting station, owing to the energy dissipated at such close range.

REMEDY.

The obvious remedy is to change the natural wavelength of the receiving aerial, and this is a very simple matter, without having to haul down the aerial and lengthen or shorten it. A coil or a fixed condenser placed

in series with the aerial will throw the receiving circuit sufficiently off the frequency of the transmitting station to overcome the annoying broadness of tuning. If you choose to use the coil method of doing this, a suitable coil will be one consisting of about 50 turns of 24 gauge DCC copper wire, wound on a two-inch diameter former. It depends on exactly how close you are to the offending station, as to what capacity of condenser should be used for the series condenser method. A capacity as high as .0005 mfd. may be needed, but this may be determined by experiment.

Supposing you have one or the other ready for use in the circuit. Take the aerial lead-in off the aerial terminal of the set, and attach one end of the coil, or the condenser, to the lead-in wire. Next connect the other end of the coil or condenser to the aerial terminal which previously had the aerial directly connected. Do this with as short a length of wire as possible.

That is all there is to the job, and the circuit diagram shows the two methods. A shows the coil method and B the condenser. The dotted lines drawn round illustrate the independence of these two units from the receiver itself.

HIGH POWER INTERFERENCE.

Interference from a high power station calls for more attention than just changing the wavelength of the receiving aerial, and it is here that the wavetraps are pressed into service. Sometimes it is sufficient to connect a .0005 mfd. variable condenser in series with the aerial, but this will have very little

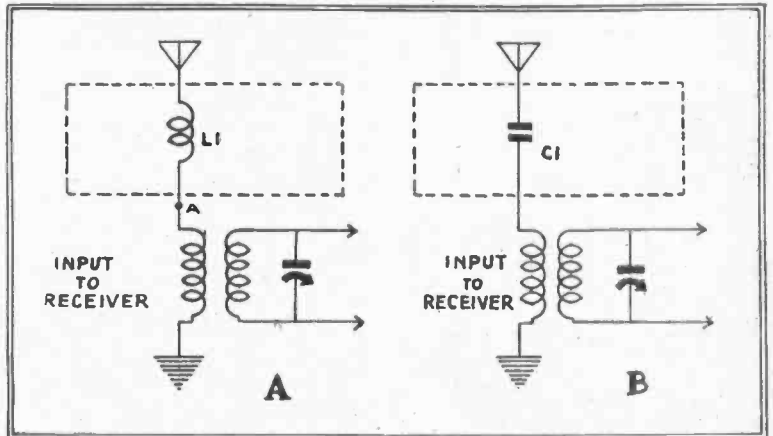

Loading the aerial at A and reducing it at B will effectively alter the fundamental.

ADVANTAGES AND DISADVANTAGES OF VARIOUS WAVETRAPS

effect unless the receiver is a reasonable distance from the transmitting station. In any case, you will need a variable condenser with a wavetraps, so that there is no harm in trying this method first.

There are really only two types of wavetraps in use; these being either of the conductive or inductively coupled kind, and any others described can but be elaborations on these two types. The simplest is the conductive, consisting merely of an inductance shunted in the usual way by a variable condenser, so that the tuning range covers the broadcast band or at least that part of it occupied by the station causing interference. You will see from the diagram that the wavetraps is shown surrounded by a dotted line to distinguish it from the rest of the receiving circuit.

WAVETRAP EFFICIENT.

There is no doubt but that this method is highly efficient, but it has one serious disadvantage, particularly if used with a straight-out detector circuit, such as a Reinartz. The disadvantage is that it seriously upsets the tuning or calibration of the receiver. In some cases I have found that not only is the tuning thrown right off, but it becomes quite different.

Nevertheless, there is no doubt about this form of wavetraps doing its work. Recently I tested one of this type with a Reinartz receiver in Belmore Road, Coogee, right underneath Station 2BL, except for an intervening hill, and, much to my surprise, I had to look for 2BL's carrier wave, whereas 2FC was extremely strong.

The inductively coupled wavetraps only varies the tuning of the receiver very slightly, and is for this reason to be preferred. It consists of two coils used together with the variable condenser. The large coil, wound for the broadcast range, is tuned by this variable condenser, and the other coil consists only of a few turns of wire. This coil is connected in series with the aerial before the set.

CONSTRUCTION EASY.

There is no difficulty in constructing either of these two wavetraps. To make the conductively coupled trap, obtain a .0005 mfd. variable condenser, a piece of tubing three inches long and two inches in diameter, and 1 lb. of No. 24 DCC copper wire. Pierce two

any chance of it slipping. Wind about 46 turns of the wire on, and at the other end of the tube make two similar holes, and fasten the end of the wire in the same manner. Both the ends of this completed coil are connected to the terminals of the variable condenser, and with a little ingenuity you can mount the coil direct on the condenser itself.

One side of the condenser and coil goes to the aerial and the other side to the set. To construct the inductively coupled trap you will need the same items with the addition of a piece of waxed paper about 11 inches long and 1 inch wide.

There are two ways in which it may be made. The small winding consists of eight turns of wire, which may be wound on the tubing first, fastening the ends as described in the conductive trap. Next wrap the waxed paper around the tube over this small coil, and fasten the ends by secotine or some other adhesive. The large coil, which consists again of 46 turns, is wound over the top of this.

ALTERNATIVE METHOD.

The other way of constructing this trap is to wind the two coils side by side on the

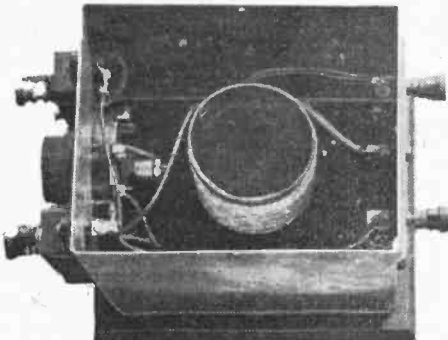

The interior of the special double trap

former, with a space of about 1/4 inch between the two. In the case of this inductively coupled trap, the 46-turn coil is shunted by the .0005 mfd. variable condenser. One of the ends of the eight-turn coil connects directly to the receiving aerial, and the other to the aerial terminal of the receiver. This is also indicated by a circuit diagram.

The operation of a wavetraps is quite simple once the user has grasped the idea of its functioning. Assuming you have the trap connected and ready for operation, turn the dial controlling the variable condenser so that the condenser is at minimum capacity. Set your receiver tuning to the station interfering, and whose signals you wish to eliminate, and then turn the dial of the wavetraps condenser until the signals from the station are at their weakest.

OPERATION SIMPLE.

Leave the trap set in this position, and then tune your receiver for the other station or stations which have previously suffered from interference, and note the effect. What actually happens is that when the coil and condenser of the wavetraps are in resonance with the station you wish to cut out, they are absorbing the most energy at that particular frequency, and will therefore pass through all signals from other stations operating on frequencies higher or lower than this. The reason you had to locate the inter-

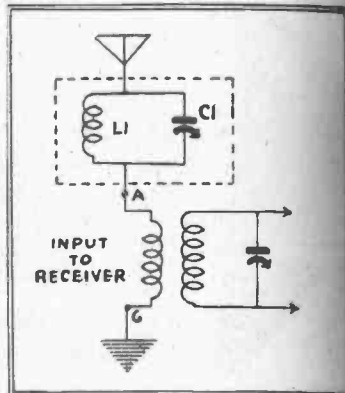

The conductively coupled wavetraps.

fering station first with your receiver was to make sure that when turning the dial of the trap was properly in tune with the station. The photographs illustrate a unique and compact wavetraps made in an entirely new form.

LOCAL DESIGNER.

This trap is designed by Mr. Furness, who was responsible for the Australian version of the 1924 Solodyne, as described in "Wireless Weekly." It is enclosed in an aluminium cabinet or box. On the front of the panel are two of the small "variometers." They have a capacity of from .0001 to .0005 mfd., and the capacity is changed by the rotation of the small knob on top. The bakelite knob in between these two "fixed-variable" condensers does not control any variable condenser, but a two-way switch. Mounted on a small wooden base-board inside is a coil consisting of 66 turns of Litz wire, wound on a 2-inch diameter former. This coil is tapped at 15 and 22 turns from one end, and is mounted vertically, as may be seen from the photo, showing the inside.

CIRCUIT SIMILAR.

The circuit is the same as any other absorption wavetraps, except that the two-way switch brings either condenser in shunt across the coil. The idea will be apparent. The trap is used with one condenser set on 2BL and the other on 2FC or 2GB, as required. Thus all that is necessary when covering the broadcast band in search of distant stations is to flip the switch as required. The two little condensers are provided with locknuts so that the spindles may be firmly locked in position. Mr. Furness uses this wavetraps with his 1928 Solodynes, and reports that it is indeed a valuable asset.

This concludes my brief chat on simple devices for eliminating interference from unwanted stations, and I am sure that it will be well worth the while to those readers who inundate us with flocks of queries asking how to overcome their trouble, to spend the cash on the few parts necessary for such a valuable accessory.

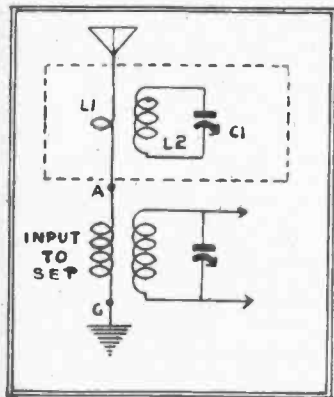

The inductively coupled wavetraps.

holes through one end of the tubing, close together, and about half an inch from the end, and thread the start of the wire through the holes, looping it back on itself to avoid



Cec Morrison's Dance Band, which has been the chief provider of jazz and popular syncopated numbers from 2FO and 2BL of recent months. Cec Morrison is seen seated at the piano.

JAZZ—Melody of Youth and Age

We Jazz It Up

CEC MORRISON. Not Mister. Conducting jazz band twelve years—Wentworth Hotel, Bondi Casino, Hotel Australia, Marine Hotel. Musical director, Pavillon Cafe. Numerous arms. Studied with Henry Penn at Conservatorium. Yes, yes. Sit down. Plenty of time before next item.

Started with 2BL on top of Smith's building—funny then—rain dripped in—played on blackboards—like trenches.

Played with 2BL three and a half years.

Some time ago, 2BL used to play request numbers—funny experience. Headphones clamped on head while playing—people rang up—asked for special numbers—played them immediately from memory. Got cables from all over world asking for numbers—all late-night stuff—memory test.

New South Wales Broadcasting Company—Studio Dance Band—Combination 4 saxophones—toodleoodeo—trombone—blahrst—kousaphone—oom pa oom pa—trumpet—tara-tara—two pianos—kicked tinkles—banjo—tiddley om pom—MIXED MELODY!

Opinions—long experience.

Good rhythm not enough—no—Jazz must sound sweet—nowadays. Over-air waltzes more popular than faster numbers—old-time sentiment stuff—Old House among Trees—Dearest, growing Bolder—funny—Jazz 'em up—make old folk remember, and young folk dance.

Musicians without grounding in elements music—no chance now—too many special numbers unrehearsed—wait five minutes—on now—back soon. . . .

Where were we—oh, yes—Musicians—not much scope for specialised Jazz musicians

in Sydney—not enough places—look at Melbourne—Sydney centralised—also so much sport—grows animated—makes gestures—becomes explanatory.

Besides—Sydney people don't take dancing seriously—just think it's got to be done—so get it over quickly—don't take any pleasure in dancing—something the matter somewhere.

Public quick to realise that right sort of numbers—well played—make all the difference.

Rhythm not everything—good feeling in band—no one must bring troubles into studio—If man thinks about quarrel with his mother-in-law while playing—gets into his music—spills everything.

Beethoven—Song of the Soul—Song of the Old Soul—Song of Heroes. Jazz—Song of Us—Song of the Unheroic—Song of Release—Song of Oblivion—Song of Brain-sick Humanity. Beethoven mocks us—Jazz puts the brain to sleep. Which is better? Give us Jazz.

Always see the people—make 'em dance—make 'em dance to old tunes—make the old folk remember and the young folk dance.

Raymond Ellis

RAYMOND ELLIS, the English baritone, who, during his stay in Australia for two years, gave so much pleasure with his wonderful broadcasting voice, is now in London, after a season in South Africa. He has written to the manager of the New South Wales Broadcasting Company, Limited, sending his greetings to all in Sydney, and states that he looks back with intense pleasure on his association with broadcasting in New South Wales, and is hoping to return to Australia as soon as possible. Mr. Ellis intended returning to England after his theatrical contract was finished, but was given sufficient work by 2FC to spend another eighteen months in Australia. This led to appearances in Queensland, Victoria, Adelaide, and West Australia, so he has probably sung to more listeners in the Commonwealth than any other artist. It is understood that Mr. Ellis will marry in England, and journey back to Australia with his wife as soon as his arrangements can be made.

The Red Shadow at 3LO

LANCE FAIRFAX, whose popularity never seems to wane, will be included in the programme from 3LO on March 10, in a recital of classical and operatic ballads. It is generally agreed that his voice is ideal for the broadcasting studio, and his perfect diction and artistic interpretation are evidence of many years spent under the Gilbert and Sullivan banner, the school where so many of our famous artists served their apprenticeship.

"Dolly's Little Bills"

AN amusing trifle, "Dolly's Little Bills," by Henry Arthur Jones, will be given from 3LO on March 10 by Miss Winifred Moverley and J. Alexander Browne. Miss Moverley is a past mistress in the delicate art of choosing suitable plays for the wireless, and suitable people to act in them, and believes in selecting a playlet with pithy dialogue that will tell its own tale.



The Microphone Presents—

2FC—2BL

Better-class Music

BETWEEN November and February, the inclination of listeners, probably fostered by the holiday spirit, tends towards a popular type of programme. The concert season is finished and teacher and student alike enjoy a well-earned rest after their winter activities.

Now the vacation is over and the musical life of Sydney is becoming active, the New South Wales Broadcasting Company, Limited, is sketching out programmes in anticipation of the trend of public opinion in favor of the better class of music, and listeners will have a definite opportunity of hearing Sydney's better artists. Iris de Calros Rego, Laurence Godfrey Smith, Frank Hutchens, and Lindley Evans are preparing recitals which 2FC listeners may anticipate with pleasure. Lionel Lawson, Gladstone Bell, and Jules Van der Klei have also been approached regarding studio appearances.

Very complete broadcasting facilities were offered in connection with the Music Teachers' Conference. Mr. Faunce Alman, president of the conference, gave an address at 2FC on the evening of March 1, and Mr. Roland Foster spoke on March 8. Mr. Frank Hutchens has intimated his willingness to give a short address regarding the activities of the conference on March 14, at 7.45 p.m. Lindley Evans on March 21, at 7.45, and, it is hoped Mr. Laurence Godfrey Smith, will be available for Wednesday, March 27.

Negotiations are being entered into for authority to broadcast the first violin session of the conference, conducted by Mr. Lionel Lawson, on the afternoon of April 2, through 2FC; the morning of April 3, when the elocutionary session will be given, conducted by Mr. Lawrence Campbell, 2BL; the morning of April 4, through 2BL, when Mr. Spencer Thomas, who will be remembered in Sydney as principal tenor of the Quinlan Opera Company, on its second visit to Australia, will take the vocal session. Mr. Spencer Thomas has been engaged by the Goulburn Choral Society for their annual concert on May 7. The afternoon of April 4, 2FC—when Mr. Lindley Evans will conduct the school music session; the morning of April 5—second violin session—lecturer, Mr. Cyril Monk. It is also hoped that the concert from the Conservatorium, on Tuesday evening, April 2, and the "At Home," held at David Jones', on Friday evening, April 26, will be broadcast.

Spivakovsky Season

SPÉCHES at the reception to Jacha Spivakovsky, and Spencer Thomas, by the New South Wales Musical Association, recently, were broadcast through 2FC, and it is hoped listeners will have an opportunity of hearing the great Russian pianist at his final recital, on March 16.

Conservatorium String Quartet

THROUGH 2BL, in April, May, and June, a semi-classical programme will be given each Tuesday night, and the Conservatorium String Quartet, leader Mr. Gerald Walenn, Lloyd Davies (violin), Alfred Hill (viola), and Gladstone Bell (cello), are arranging programmes for those to whom the better class music appeals, on April 16, May 14, and June 11.

Merriva Buckjumping Championship

THE New South Wales Broadcasting Company, Limited, has now finalised arrangements for broadcasting the Australian Buckjumping Championship and Rodeo, to be held at Merriva on Wednesday, March 13. The programme is being carried out in the arena of the Merriva Agricultural and Pastoral Showground, and will be judged by Mr. M. A. Ferry, 2FC Racing Commissioner.

Mr. Ferry has had very considerable experience in this type of thing, both here and in the Old-country, and the conditions applying to these contests have been drawn up after a consultation with him. The morning programme from 10 to 12.45, will cover a number of riding contests. The big buckjumping championship will commence at 1.45, and will carry prizes totalling £125. At 2.45 the Steer Riding Championship of Australia will be contested, with prizes totalling £22. At 3.45, a stockwhip exhibition will be given, while at 4 p.m. the local championship for buckjumping and steer riding will be proceeded with. These events carry over £40 in prize money.

The broadcast will cover all the events from 1.45 until 5 p.m., and should make a thrilling afternoon's entertainment.

3LO—3AR

"Castles in the Air"

BROTHER BILL, who by his Sunday talks from 3LO has endeared himself to thousands of young people, in addition to reaping the heartfelt thanks of their parents, has much sympathy and understanding with the minds and outlook of the lads and lasses of the present day, and for March 10 has chosen for his subject, "Castles in the Air."

Tobacco Curing

MANY country listeners, especially those in the north-east of Victoria, will appreciate the talk programmed from 3LO on March 11, when, under the auspices of the Department of Agriculture, Mr. G. E. Marks, Assistant Tobacco Expert, will give advice on "Tobacco Curing." As tobacco growers will tell you, "everything depends on the curing," a shade too little or too much, or too little heat in the kiln, may mean the loss of hundreds of pounds, and a few words of expert advice will be greatly valued by the many young men on the land, who have recently taken up the culture of "My Lady Nicotine."

Two and a Piano at 3LO

NEWCOMERS to 3LO are Spencer Ward and Gertrude Long, who, under the title of "Just a Piano and I's" will present their bright turn at 3LO on March 11. Both artists are experienced and versatile entertainers. Spence Ward uses his fine baritone voice to great advantage in some rousing numbers, and also, in ditties of the more popular type, a number of which have been composed by his vivacious partner, Gertrude Long, who also proves a brilliant solo pianist and expert accompanist.

The Return of Miss Fortune

AGNES FORTUNE, who has been enjoying her annual vacation in the mountains,



Agnes Fortune

will be welcomed back to 3LO this week, and will be heard in a short Chopin recital on March 12. This popular artist has become so much "part and parcel" of the musical side of the studio, that she is greatly missed from her accustomed place when holidaying. Everything is fish that comes to her artistic net; she is at home with popular melodies, the classics are her intimate friends, and, as an accompanist, the artists fervently and unanimously declare she is "one in a thousand."

Guildford Bishop at 3AR

GUILDFORD BISHOP, whose well-rendered violin solos are often a feature of the 3AR programme, will be on the air again on March 12 in some specially requested items. Mr. Bishop, who is most popular with Adelaide audiences, commenced to train at the Adelaide Conservatorium at the age of seven, under Professor Heinecke, and, when the professor finally returned to Germany, he appointed Mr. Bishop to take his place at the Conservatorium. On leaving the Conservatorium he was offered an appointment in a leading theatre orchestra, and finally the Station Broadcasting Orchestra offered an opportunity whereby many thousands of people could enjoy the music so artistically played by this gifted young instrumentalist.

Ormonde Exhibitionist at 3AR

THE opportunities of hearing the clever young Queensland pianist, Victor Stephenson, are gradually drawing to a close, as he is beginning to make active preparations for his trip to Europe in a few months' time. It will be remembered that he is a double Ormonde Exhibitionist, securing first-class honors for solo playing on each occasion.

Jessie Shmith Returns to 3LO

AFTER a brief absence from the studio, Jessie Shmith, the popular contralto, will be on the air from 3LO on March 14, and will include some songs of her own composition in her programme. This favorite artist is well known to listeners throughout Australia and New Zealand, for she has broadcast from all the leading stations and, whilst singing at 6CL, was invited to make a series of gramophone records which were released



Jessie Shmith

some little time ago. She was one of the leading vocalists in the atmospheric proglogue "Four Sons," and substantial "royalty" cheques to hand from America and England indicate that her songs are equally successful overseas.

St. Patrick's Day at 3AR

TO commemorate St. Patrick's Day, a special programme of the world's best Irish records has been arranged at 3AR, and will be broadcast on St. Patrick's Eve, March 16. A good deal of work has been put into the arrangement of this programme, which will include orchestral selections of the songs of Ireland, and vocal solos by such world-famous artists as John McCormack, Alfred O'Shea, and Tom Burke.

"The Runaway Girl" at 3LO

IN response to many requests, there will be a further performance of "The Runaway Girl," from 3LO, on Monday, March 11, under the direction of Madame Ethel Ashton. It will be remembered that Madame Ashton was responsible for the first musical ensemble ever put over the air, "A Pageant of Empire," which was a replica of the famous pageant at the Wembley Exhibition, in England, and since that time has produced many successful musical plays, among which may be mentioned "Mamie Rosette" and "Floradora." Associated with Madame Ashton will be Florence Blitz as Winifred Grey, John Donovan as Leonello, Allan Bell as Flipper, who will supply the necessary comedy element, while the entire production will be in the capable hands of Maurice Dudley.

Personality—Is It Right?

A continuation of last week's dissertation on announcers and announcing. What kind of announcing personality do you prefer—the cheerful, doleful, charming, dynamic, or the magnetic?

PERSONALITY is something you have to have if you want to sell anything, from silk hosiery to elephants' tusks; otherwise your goods must be really worth buying. Personality is what politicians and all other public men have to have; otherwise you cannot put them on the back or kick them into the gutter. There is an old Chinese proverb. The man without a nickname is to be feared.

Personality is what politicians and all other things you are Not, which Makes You What You Are. Therefore, we should all have personalities; because if we all seemed to be what we are, we should all remain as we are; whereas we all want to be something we are not. Don't we?

Don't you? Moreover, we all wish other people to be exactly as we would like them to be. We like to say of this man that he is SUCH a clever chap; and of that man that he has SUCH a beautiful mind; and of the other man that he is always SO funny and amusing. We do.

Don't YOU? For this reason all radio announcers should have personalities; because they cannot possibly be what are—think of the scandal!—and because we all wish them to be always what we would like them to be.

Nowadays, announcers haven't got personalities for the same reason that a dictionary has no personality. In the early days, personality was rampant among announcers. But, as we hinted in our issue of last week, people began to write in about pronunciation and all that kind of Tommy-stick, with the result that announcers have spent valuable time in the study of the dead English language, which should have been spent in observation and construction. Perfect English is no more necessary to an announcer than an easy-flowing voice is to a grammarian.

A pure mind may be necessary. We have met people who have never seen an announcer and artists, and who have been able to describe their characters and mannerisms perfectly. Their souls. It all comes out in the airing, these people say; but we take it with several grains of salt. You can fool all the people some of the time; and the announcer doesn't work for more than six to eight hours together during the day. If he watches himself during that time he will be able to do it quite easily.

So it only remains for announcers to get those personalities which will please the public.

There are not many.

There is the Cheerful Personality. This is a good personality for all occasions except when a Test match is lost, or when the news of a wreck at sea with no survivors is to be broadcast, or when the announcer himself is in low spirits. The Cheerful Personality is of no use nowadays.

There is the Doleful Personality. We have seen this used on many occasions by various performers. The only thing wrong with it is that it cannot be sustained for long without resignation on the part of the listener.

There is the Charming Personality. This is very effective with women listeners-in; but, unfortunately, women do not make good listeners.

Then there are the Dynamic and the Magnetic Personalities. We read about these

in several novels. They are most interesting. In fact, we think they are about the only kinds of personalities worth having nowadays. If an announcer can't be dynamic, he should be magnetic. If he can't be magnetic, he should be dynamic. If possible, he should be both.

A dynamic announcer is, as one of our contemporaries said of Helfetz, a dynamo. He is energy. He is driving force. His words, disentangling themselves from the whirling armatures of his brain, smack the microphone with typhonic intensity, shoot across the ether waves, rush down the aerial, and through the loud speaker, catching the listener-in full in the face, and leaving him a job of quivering credulity. Announcers wishing to get patterns of this Personality should communicate with Mr. Bruce, and ask him when the next election will be held. The reply will

(a) Illustrate what we have been saying; and

(b) Give the approximate date of more illustrations.

Announcers should note, with relief, that it is quite unnecessary for a man with a dynamic personality to believe in what he is saying, or even to think about what he is going to say. This personality will put anything over.

The magnetic announcer is, as might be guessed, a magnet. He draws attention. He holds attention. He makes people come to attention. He is something between a sergeant-major on parade and the village barmaid.

It would be very hard to be a magnetic announcer. People with magnetic personalities must really believe in what they are saying; and they must understand what they are saying; and they must say it intelligibly. They must be interesting. They must be able to make the most uninteresting subjects interesting. Announcers who wish to qualify as magnets should read this article, because—

(a) We really believe what we are saying.

(b) We say it intelligibly.

(c) We make announcers interesting; and, finally, because

(d) We have held your interest for all this time.

But Personality alone does not make the Complete Announcer. It will carry him

through; but even an announcer with personality is capable of improvement. One must remember Alexander Pope's daring old assertion—"A Little Knowledge is No Dangerous Thing." No announcer should be afraid of knowing a thing or two. No announcer should be ashamed of knowing anything.

Of what wonderful benefit it would be both to the announcer and to the public if, when the programme were running a little late, he could utter a few noble words on Kant's "Critique of the Sublime and Beautiful," or Burke's "Essay on Pure Treason!" How charmed the listening public would be with a softly-spoken meditation of Marcus Aurelius sandwiched in between news reports! How instructed would the public be, after a report of a murder in faraway Chicago, to hear the impassioned Macbeth, soliloquy; or to hear a discourse on the "Ars Poetica" of Bacon after the reports on the state of the pig market! It would be to merge the present with eternity; and thus add infinite time to a universal medium. Yes; we think all announcers should study; and we think it would be no bad plan for them to start learning their alphabet as soon as possible.

The question has several times been asked: Should announcers be married? Our only answer to this question is—that the announcers are best able to judge—afterwards. We were. Weren't YOU? And our Safety Valve Page has been disturbed lately by a controversy over Egotism in announcing. Now, we are either all Egotists, or we are not all egotists. Egotism is the window through which one looks into a man's soul. There is only one reason which should prompt a man to pull the blinds down. We think so. Don't YOU?

Note: The Editor sent this article back to us, saying: Where are the conclusions you promised to give us on "The Whole Trouble with Announcers"? We suddenly remembered that we had promised to draw some conclusions; but on looking through what we have written we found the conclusions sticking out a mile high. Besides, we were very tired. Therefore we have resolved to let an intelligent public draw its own conclusions. Our only prayer is, that the aforesaid public will not repeat them.

Marjorie Prichard's impression of the Light Music: Four—Bruce Carter at the 'cello, Horace Keats, Dulcie Blair, and Vincent Aspey.

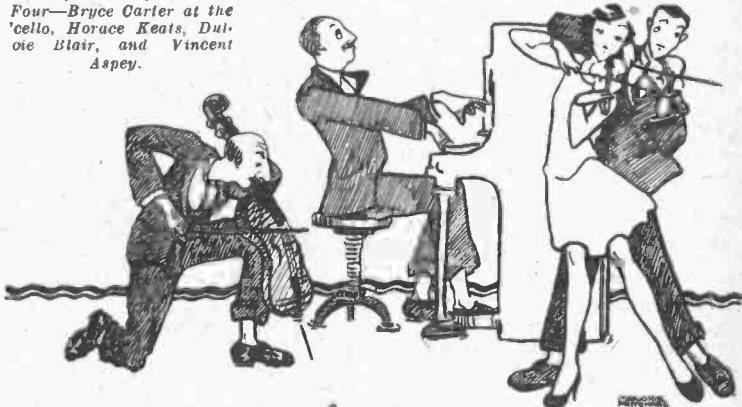

Wireless Weekly

Incorporating "Radio in Australia and New Zealand."

FRIDAY, MARCH 8, 1929.

20,000 Studio Auditions at 2FC

A FEW years ago "auditions" implied, to most of those who had personal experience of them, uncomfortable quarters of an hour in cold, empty rooms, where bored men thumped worn-out pianos, whilst hard-eyed managers looked scornfully on. Now an increasing number of people have quite a different experience.

The New South Wales Broadcasting Company, Limited, gives incomparably more auditions than any single producing organisation of this side of the world, and it has acquired a technique of giving them that provides the candidate who has "got the goods" with a fair chance of delivering them, whilst sparing the feelings of the failures as far as may be. Every week a stream of aspirants passes through the audition studios at Market Street. At one time the music department alone gave 120 auditions a week. That number has been cut down by two-thirds, but the stream, if reduced, shows no sign of drying up, and talks, dramatic, and variety auditions add to the total. Obviously some members of the staff must have acquired a considerable practical experience of handling the artistic temperament with tact.

The actual procedure to be followed by those who want to have their talents tried out, does not vary much, whether it is a musical, dramatic, or variety audition, or a speaking voice test. The applicant turns up at Market Street at the appointed time, duly armed, as the case may be with his or her roll of music, trombone, or script, and is ushered into a studio where a red light over the door signifies to the initiate that the microphone is "alive," though a closed circuit only is being used. This means that sounds from the studio pass through the microphone and so to the control room, but instead of being broadcast they are merely

passed back on the wires to a pair of headphones in the control room itself.

It is on these headphones that a tactful member of the staff listens to the test, for the microphone has its own exigencies, and a voice or an instrument that might be beautiful in a hall only too often fails to pass the microphone test. A second hearing is sometimes allowed, for nervousness can play havoc with ability, and even hardened performers are often unable to face the microphone without a qualm. Talkers particularly can be enormously helped by a few words of expert advice on inflection and the pitch of the voice, and a special list of hints is sent to all of them who pass the test.

Some, of course, in particular those with a taste for novelty, thoroughly enjoy the whole affair; in fact, in early days there was reason to believe that many people without the faintest hope of ever bursting into the broadcast programmes, came for auditions for the fun of the thing and nothing more. But the "auditor" who had spent weary hours listening to their efforts would at least reap his reward now and again when someone possessing real talent, even to himself or herself unknown, came into his net, or when he got a letter such as that of the gentleman who said: "I must also thank you for the kind way you received me; you must make many friends there."

When the licenses now held by the New South Wales Broadcasting Company, Limited, expire in July next, there will be stored in the archives of the company reports dealing with 20,000 individual tests. This should prove to the public that whatever shortcomings there may be in the provision of fresh talent in broadcasting, the charge cannot be made against the management in New South Wales of failure on its part to try to find new artists.

RADIO to-day is a matter of calibrated components assembled into a complete circuit, with mathematical certainty based on good engineering. There is an absolute minimum of guess work, and the engineer can specify exactly what is required, with the assurance that there will be no variable or unknown quantities to upset his well-laid plans."

That is, according to a commercial expert, intent on producing the same type of receiver over and over again. But if this were really so, radio would have lost all the fascination which it now holds for thousands of listeners.

The pleasure of experimenting with the mysterious ether waves has never diminished; indeed, if the popularity of our "Proving Radio" series is considered, it is increasing. Far from being a stable science, based on certain knowledge, radio is fluctuating, ever changing, ever developing. And that is what makes it so interesting.

No expert has yet succeeded in reducing radio to a simple formula. The truth of this is well demonstrated when a new component first appears. Not until the radio enthusiast has experimented with it in a hundred different ways, and finally arrived at the most efficient method of its employment, does the expert step in and make use of this knowledge.

Almost every listener is tempted to explore the vitals of a new piece of apparatus receiver, but his curiosity and interest in radio does not end with the acquirement of practical knowledge; rather that is its beginning. The most skilful operation of a receiver does not explain it. There is something else mysterious and hidden which induces investigation with something like the provoking insistence of a cross-word puzzle.

It is at this stage that the listener is impelled towards the study of the theoretical principles of radio—seemingly so dry to the layman. It is also here that the listener embarks upon pure knowledge, and becomes in an amateur fashion a scientist.

The scientific bent is the most typical of our age, and the most healthy. If everyone in the world could possess the radio enthusiast's understanding of the fundamentals of the Universe, we would be much happier than we are. Perhaps, in some future era, we will all be radio fans!

Domestic Interference - - No. 2



THE SAFETY VALVE



Readers are urged to express their opinions on matters pertaining to broadcasting. If you have some grievance, if you have some constructive criticism to offer, here is your chance for expression—your safety valve. The

editor assumes no responsibility for statements made by readers and published on this page as opinions of correspondents do not represent our editorial policies or beliefs. Anonymous letters are not considered.

Banjos and Chess

Dear Sir,—I would like to say a few words regarding programmes. Firstly give the banjoists quarter-time, and stick the rest on to something decent, such as organ items, or vocal items. Banjos remind me of beating kerosene tins with sticks; where is the music in them? I say it is poison to other music. J.O. seems to be dance mad. They must trot to keep themselves warm these summer days and nights. Why not more waltzes and schottisches? They are more respectable to listen to.

Could I offer a tip? Why not put in "Wireless Weekly" a chess problem, say, once a month, and competitors send the results to your paper. You could have the correct solution broadcast, together with the name of the sender. You could give the key move and, perhaps, a small prize could be offered. I think chess players would like this very much, so why not try it?

Yours, etc.,
LEWIS HAZELL.

Gympie.

Bouquets for "B" Stations

Dear Sir,—Some time ago I wrote to the "Safety Valve" with reference to the broadcasts from the Arcadia Theatre, Chatswood. These organ broadcasts must be heard by new listeners in general; they must be heard to be appreciated, and Mr. Robins is certainly a virtuoso. There is no doubt about the fact that these recitals have been improved upon as far as the broadcasting side of the affair is concerned, and I must congratulate 2BL on its enterprise.

Not very much is said in these columns about the "B" class stations. In fact very little is said, now I come to think of it, and when one considers the enormous number of listeners to these stations this is to be wondered at. The three stations, 2GB, 2KY, and 2UE, are giving us a service which is certainly up to the standards of the "A" class stations, more especially 2GB, which station is almost an "A" station in itself. The morning music and Sunday evening music from 2UE is always looked forward to, because of its variety, and the amount of extra entertainment derived from this station makes us want to scrap our phonographs for ever. The same statement applies to 2KY, but there is one thing wrong here—the station lacks a good announcer. The chap at this station would almost make you cry. I am afraid his English has been sadly neglected. This is the opinion of many fans, and not merely my own.

In conclusion I want to tell you that tests are now being held at Marrickville between the "Marco" and Browning Drake Four. Results of the tests and performance will most surely be published in these columns, that is, if the Technical Editor consents.

Yours, etc.,
BO BUER.

Alexandria.

Marco Selectrex Best

Dear Sir,—For some time I have been experimenting with four-valve sets, and have thought that my experiences might perhaps be helpful to other readers. Using ordinary valves, I have tried the Marco, Browning Drake, Selectrex, and others, that have appeared from time to time in "Wireless Weekly" and other papers. Comparing them with reference to tone, distance, volume, selectivity, and ease of tuning, I obtained best results with the "Selectrex."

A couple of months ago I bought a Philips A442 S.G. valve, and altered the "Selectrex" circuit to suit the new valve, with the result that my reception improved. I then made up the B.D. circuit as described in the B.D. S.G.5 in "Wireless Weekly," and tested it thoroughly. Following upon this experiment, I built the Marco, with slight alterations, to suit the Screen Grid valve, and have had the set in use for the last fortnight. I find that the "Marco" and "Selectrex" are equally good, and each is better than the Browning Drake.

It may interest "Marco" enthusiasts to know that the circuit was published in an American paper. The writer stated of the set: "That the volume was ample, and equal to that of any set he had heard."

Yours etc.,
E. G. GEE.

Rockhampton.

Dinkum—No

Dear Sir,—With amusement I read in "Wireless Weekly," 15/2/29, the prating of an Australian (?) travelling under the signature of "Fedup 2."

Goodness! Surely he does not seriously think that his views (as expressed) are those of dinkum Australians? If so I fear there must be some typographical error in putting his address down as Belmore. Are you sure it is not GLADESVILLE? I am not a wowsler, but, thank goodness, I can appreciate the religious services which are broadcast from our "A" class stations, and, even if such were not the case, I would not begrudge the religious-minded one day out of the seven—especially as the other six are more or less swamped in jazz.

Another phase; Does "Fedup 2" ever stop to think of the enormous amount of people (many infirm and aged) who only have the humble crystal set, and can only get one "A" class station?

Would he really wish to take from these people their one day of religious service? Shame to him! It is men of that type who bring (or attempt to bring) discredit to the character trait of Australians.—Yours, etc.,

FAIR-GO.

Oatley.

Why Jazz?

Dear Sir,—"Fedup 2" ("Wireless Weekly," 15/2/29), makes statements that should not go unchallenged. There are many, not wowslers, who are debarred by circumstances from attending church regularly or at all and who do enjoy the services broadcast each Sunday. As "Fedup 2" says he goes to church in the morning, why does he want jazz put on the air? I am as Australian as "Fedup 2" can possibly be, but do not see the necessity for dance music on Sunday, and would like to see the "A" stations keep it off the air.—Yours, etc.,

BROADMINDED

Belmore.

Where to Enjoy Broadcast Music

Dear Sir,—The solution of "J.C.B.'s" complaint in a recent issue can be found by tuning in to the "B" class station 2UW any afternoon or evening.

He will discover, as I did, that this young station is putting over the air daily a wonderful programme of diversified music. As music is said to soothe the savage breast, so will 2UW's evening programme soothe the tired man after his day's labors, because it is providing the type of music for which your correspondent and hundreds of other listeners are yearning.

Yours, etc.,

YELIAB.

Waverley.

No Thought of Future

Dear Sir,—I think "Fedup's" letter in this week's issue of "Wireless Weekly" casts a slur, and almost an insult, on the broadcasting stations, 2FC and 2BL, and also on the ministers who broadcast their services on Sunday, which give great pleasure and help to many. I think "Fedup" forgets many who are unable to go to church through illness, age, tending the sick and the children, who look forward to the services broadcast on Sunday.

If "Fedup" and a few Australians like to dance through life with no thought for the future, I think they represent a very small percentage, for I believe the greater number of Australian men are fighting the battle of life bravely, and with a desire to help others. Surely all honor is due to those who are striving after the best things. Perhaps the day may come when "Fedup" may wish for helpful words in some dark hour of his life.

I desire to thank the broadcasting stations, 2FC and 2BL, and all our ministers, for their very helpful and inspiring services, and trust they may long be continued to supply words of hope and comfort to many.

Yours etc.,
(Miss) H. M. KING.

Bexley.

£3/19/6 **"The Amplo"** £3/19/6
"B" Battery Eliminator

AGAIN AVAILABLE----HAVE YOU BOUGHT YOURS ?

Due to the unprecedented demand for our new
AMPLO "B" ELIMINATOR

We were forced to disappoint many enquirers. Production is now well in hand and further supplies are now available.

Supplies ample milliamps at voltages to 150, 4 plug tappings—no bother— no hum.

GENUINE EMMCO
 BACK OF PANEL
 VERNIER DIALS
 3/-

Price **£3/19/6**

Complete and ready for operation

**ASSEMBLE YOUR OWN
 ECONOMIC B'ELIMINATOR**

Complete set of parts include valve
 and Diagram

No Failures—Results Sure

Price, 59/6

Wire Wound Resistors
"PILOT"
 For "B" Eliminators
 Suitably Tapped
 8/6

LET US REBUILD IT
 THAT OLD SET
 You'll Save Money

THE ABERDONIAN
 THREE VALVE RECEIVER IS FEATURED IN
 THIS ISSUE

Some Guaranteed Parts.

2 Continental .0005 Condensers	at	8/6
2 Diura Midget Dials	at	4/6
3 Eco Antivibration Sockets	at	2/6
1 Bakelite Former, 3in. Diam., 5in. Long	at	1/8
1 8oz. Reel 24 D.S.C. Wire	at	3/6
3 Fixed 100,000 Ohm Resistors	at	2/-
1 Gridleak, 1 Megohm	at	1/-
1 do. 1/2 do.	at	1/6
1 do. 1/4 do.	at	1/6
1 Terminal Board	at	2/3
3 Braclstats	at	4/9
1 Carborundum Fixed Detector	at	8/6
3 Fixed Condensers, .006	at	3/6
1 do. do. .0005	at	1/6
1 do. do. .002	at	1/6
1 do. do. .0001	at	1/6
1 Doz. Sq. Buswire	at	1/10

WHY DO WITHOUT?
 The ECON Box Cone
SPEAKER, 10/-

KARAS DIALS
 HAVE ARRIVED
 The Super Micrometer
 63 to 1 Vernier
 17/6

For That
**CRYSTAL SET
 THE CANNONBALL
 HEADSET,**
 4000 ohm. 12/6

"Yours for Lower Prices and Service that Satisfies"

THE ECONOMIC RADIO STORES,

Address Mail Orders, 492 George Street, Sydney

COUNTRY CLIENTS.—Our parts are absolutely guaranteed to give satisfaction. Send your orders to us conditionally that your money is refunded if you are not satisfied with the goods upon receipt of same. Goods must be returned to us within ten days. We Pay Carriage on All Orders of 10/- and over. Valves and goods specially procured cannot be exchanged. Terms Cash. No discounts.

SYDNEY
 25 New Royal Arcade,
 near
 Palace Theatre.
 'Phone, M6138.

NEWCASTLE
 13 Union Street, . .
 off
 Hunter Street West.
 'Phone, New. 1622.

PARRAMATTA
 Corner Church and
 Macquarie Streets.
 'Phone, UW 9601.

ORANGE
 120A Summer Street.
 'Phone, Orange 735.

The ABERDONIAN

Three Valve Receiver



WHAT'S in a name? Well, in this case there's quite a lot! We have all, at some time or another, laughed at the jokes against the unfortunate Aberdonian who, according to all accounts, should have an immense banking account.

Who has ever heard of an Aberdonian who did not appreciate good value for small expense? And who does not agree with the Aberdonian in this respect?

The receiver here described is made up especially for those who desire a good receiver at very little expense. Immense volume on all stations is assured, because it incorporates three stages of audio-frequency amplification.

However, perhaps the most important point about this receiver is the fact that it delivers a very mellow, pure, undistorted tone. This is because a crystal detector is used for rectification, and because the audio stages are resistance coupled, instead of transformer coupled, as is usual. Resistance stages consist merely of two grid-leaks and a fixed condenser, infinitely cheaper than a transformer, and results are superior to transformer amplification, except, of course, where the very best of transformers are used.

We have, however, not nearly exhausted the good points about the Aberdonian three-valve receiver. Only one tuning control is necessary. The front panel view shows simply a vernier dial, a battery switch, and a jack—and the panel looks very neat, indeed.

There are no disfiguring rheostat knobs, and rotor knobs, etc. This receiver might well have been called the "Futurist Three-Valver," because it is an example of the ultimate goal of radio. The goal of radio, as most of us will know, is volume, clarity, and simplicity of control.

The Aberdonian incorporates all these points.

Only two coils are used. These can be wound by the constructor at very little cost. The primary is wound on the same coil as the secondary, as shown in the circuit diagram.

The receiver may be made in an hour. Let us follow the procedure.

CONSTRUCTION

Commence by giving the baseboard a coating of black Ezywurk. This substance dries in a few minutes, and the result is a black, glossy surface, which at a short distance resembles bakelite.

Whilst this is drying, mount the variable condenser (C1) of .0005 mfd. in the centre of the bakelite panel, allowing plenty of clearance for the spindle. Then mount the battery switch (preferably on the "push-pull" type, for neatness) three and a half inches to the left of the outer edge of the vernier dial, and the jack three and a half inches to the right of the vernier dial. The switch and jack should be two inches above the level of the baseboard. (See Fig. 2.)

Drill a hole 3/4 in. from the bottom of the panel, at a distance 2 in. from the left end, and another at the right end, then drill another hole in the centre of the panel. The panel should now be mounted to the baseboard by means of these holes, using counter-sunk wood screws. If the screws are of the bright type, they may be blackened over with a little Ezywurk.

Mount the battery-strip at the back of the baseboard, and the crystal anywhere on the baseboard, so long as it is very near to the tuning condenser.

WINDING THE COILS

Wind the secondary coil first. This consists of 47 turns of 24-gauge D.C.C. wire, wound on the 3 in. former. Leave about 12 in. of wire at each end for connecting purposes. When commencing the coil, start 3 in. from one end of the former, as this will then leave plenty of room for mounting purposes.

The primary consists of 15 turns of the same wire, and is wound directly over the secondary coil, in the centre of the latter. The coil should then be mounted on the panel in an upright position, by means of two Meccano brackets. The valve sockets and coupling stages are next mounted in order.

WIRING

Take care to keep plate and grid leads as short as possible, and also to see that these leads do not run parallel to each other. If you find it necessary to bring these leads fairly close to one another, see that they cross at right angles.

Commence by connecting the aerial terminal to one side of C6 (a fixed condenser, of .0001 mfd.), and the other side of this condenser to the first turn of the primary coil (i.e., the coil which is wound over the secondary). The other end of the primary should then be connected to the earth terminal.

Connect the first turn of the secondary coil to the fixed plates of the variable condenser, and also to one side of the crystal detector. The other side of the secondary coil should then be connected to the moving plates of the variable condenser, C1, then on to one side of C7 (a fixed condenser of .002 mfd.), and thence to one side of the 100,000-ohm resistance in the first stage of A.F. amplification. The other side of this resistance should be connected to the remaining side of the fixed condenser C7, and thence to the other side of the crystal.

Connect this lead also to one side of C2 (.006 mfd.), and the other side of this condenser to one side of the 1-megohm grid-leak, which is also connected to the grid terminal of the first valve socket. Take a lead from the other side of the 1-meg. grid-leak to one side of the 4-meg. grid-leak, and also to the 4-meg. leak, and thence to the C negative terminal on the battery strip.

WHAT YOU WILL REQUIRE.

- Three resistance-coupled valves.
- Three valve sockets.
- One dozen lengths bus-bar.
- Fixed condensers—three of .006 mfd., one of .0005 mfd., one of .002 mfd., and one of .0001 mfd.
- Variable condenser, S.L.F., .0005 mfd.
- 8oz. 24-gauge D.S.C. wire.
- One three-inch former, five inches long.
- Two Meccano angle brackets.
- Three resistances (fixed), 100,000 ohms.
- One grid leak, 1 megohm; one ditto, 4 meg., and one ditto, 1 meg.
- One battery strip.
- Three Brachistats.
- One fixed crystal detector.

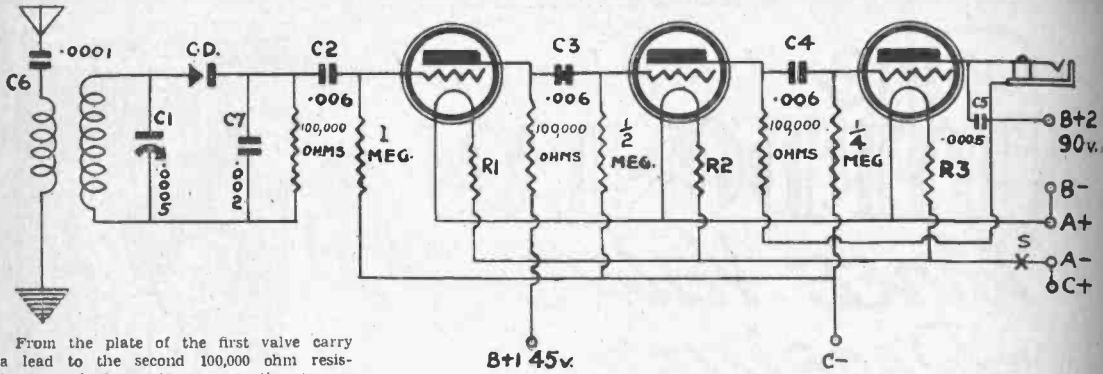

From the plate of the first valve carry a lead to the second 100,000 ohm resistance, and also make a connection to one side of C3 (.006 mfd.). The other side of this condenser is connected to the remaining side of the 1-meg. leak, and also to the grid terminal of the second valve socket. Take a lead from the remaining side of the second 100,000-ohm resistance to one of the B post-

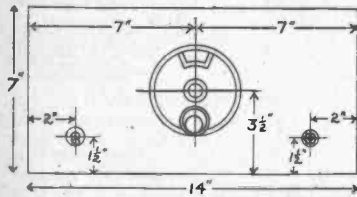

terminal terminals on the battery strip. Call this B plus one. We shall refer to it later.

From the plate of the second valve connect a wire to one side of the third 100,000-ohm resistor, and also to one side of C4 (.006 mfd.). The other side of this condenser should then be connected to one side of the 1meg. leak, and also to the grid of the third (last) valve. The remaining side of the 100,000-ohm resistance should be connected to one side of the jack, and also to the second B plus terminal (we shall call it B plus 2, for future reference).

From the plate of the last valve, connect a lead to the remaining side of the jack.

Connect the filament plus terminals of each valve socket all together, and take a common lead to the A plus terminal on the battery strip. This terminal should be connected to the B negative terminal on the strip.

Now connect the remaining filament ter-

minial of each valve to one side of a Brachstat, i.e., one Brachstat for each valve. The remaining sides of each Brachstat should be connected together, and a lead taken from here to one side of the battery switch. The other side of the switch should then be connected to the A negative terminal, and also the C positive terminal on the battery strip. Carry a lead from one terminal of the jack to one side of C5 (.0005 mfd.), and the other side of this condenser to the remaining side of the jack.

You have now finished the wiring. A cone speaker is recommended for best results on this receiver. Marconi valves gave

exceedingly good results. Use the DEL 410 in each stage of amplification.

To operate the receiver, merely connect up the 4-volt accumulator, the B battery (two in series), and the C battery, connecting B plus 1 to the 45-volt tapping on the first B battery (this terminal also connects to the B negative tapping on the second B battery, and the B plus 2 terminal to the 45-volt tapping on the second B battery. Next, pull out the switch, and tune slowly with the condenser.

You will be surprised at the volume and clarity delivered if you have used the parts recommended.

Now connect the remaining filament ter-

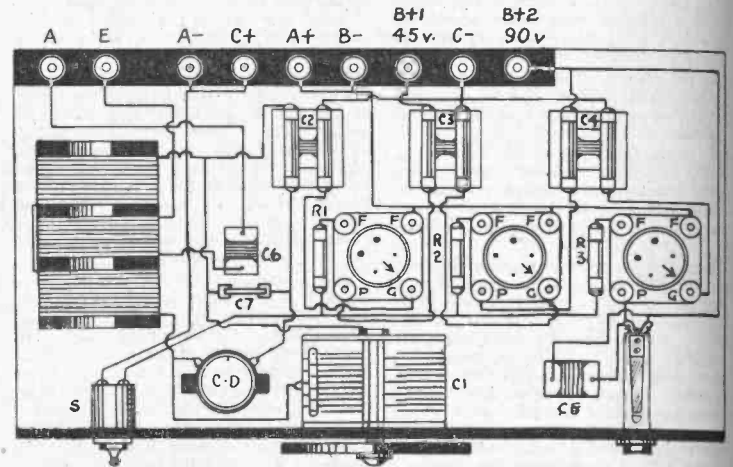

New Device Designed to Overcome Unstable Reception

TO many home-set builders the problems of neutralisation offer considerable difficulties. To meet these, Amalgamated Wireless now have available a very compact and interesting device known as the Electrad Phasatrol, which goes a long way towards overcoming one of the chief difficulties of the home constructor.

In the usual form of radio frequency amplifier, the radio frequency energy, passing through the primary winding of the radio frequency inter-stage transformer, has to travel via the high tension battery or eliminator back to the filament of the valve to complete its circuit. When more than one stage of radio amplification is used, this common circuit through the high tension battery forms an auto coupling which frequently causes uncontrollable oscillation to set in.

The Phasatrol has been designed to over-

come this, and from the accompanying illustration it can be seen that the high tension direct current is fed through the high resistance element of the Phasatrol, while the radio frequency component travels directly through the condenser and primary of the radio frequency transformer to the valve filament. This eliminates the above-mentioned

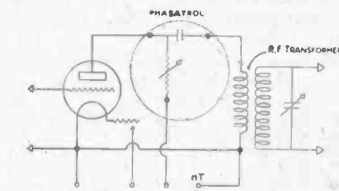

auto coupling, and, in addition, provides a means of damping the tendency of a multi stage radio frequency amplifier to oscillate by reason of self regeneration. The resistance element of the Phasatrol can be brought to a sufficiently low value to damp the radio frequency circuit to a degree sufficient to stop these oscillations.

The Phasatrol has the valuable property of causing the greatest damping at the higher frequencies or shorter wavelengths, where the regeneration causes most trouble. The reason for this is that the impedance of the primary winding increases with the frequency, and a greater percentage of the voltage rise due to the regeneration is shunted by the resistance element. An opposite effect takes place at the lower frequencies, thereby keeping a uniform level of radio frequency amplification throughout the entire tuning range of the receiver.

Sporting and Musical Features for EASTER 1929

Notes by Our Melbourne Correspondent

Victorian Licenses Increase

IN spite of seasonal fluctuations and unemployment there has been an increase in wireless licenses in Victoria during the last six months of 3521. Because there was a decrease in the months of December and January—which, by the way, was very slight compared with the huge total—much was written and said about the programmes from 3LO being the cause, but the directors of that station were not perturbed because they know that these seasonal fluctuations are inevitable, and, after all, it is the net result over a period that counts.

This net result of over 3500 for the last six months is regarded as entirely satisfactory, especially in view of the widespread unemployment caused by industrial troubles during the last three months, and the fact that the licenses in Victoria have reached what may be regarded as saturation point.

Victoria still has nearly one-half of the total licenses in Australia, and by far the largest quota to population in the world. Than this no better proof can be cited as to the excellence of the services of 3LO, Melbourne, the supremacy of which is beyond question.

Special Easter Music

EASTER this year will be ushered in by 3LO, and celebrated with special music appropriate to the sacred occasion, to be rendered by the choir of Scots Church, Colindale Street, under the conductorship of Mr. E. Mansley Greer.

On Tuesday night, March 19, the beautiful Church cantata, "The Last Night at Bethany," by Mr. C. Lee Williams, will be produced. This was composed by the request of the stewards of the Gloucester Musical Festival in 1889, and has always been regarded as one of the most beautiful of the Easterlike Church cantatas.

The production selected by Mr. Mansley Greer for the Tuesday evening before Easter is the successful Passion cantata, "The Darkest Hour," by Harold Moore, which depicts the trial of Christ before Pilate and the Crucifixion, whilst the final composition for the series will be the Biblical scene by Dr. Herbert Brewer.

Mr. Mansley Greer will also act as organist, and his playing of the famous organ at Scots Church will be a special feature of the productions. Broadcasting from Scots Church is always a success on account of its acoustic properties, which are very suitable for microphone transmissions of big choral and organ productions such as these, and a delightful feature of the broadcasting from there is the intermixing with the music, of the inspiring beauty of holiness and atmosphere of sanctity of Scots Church.

Holiday Racing at Moonee Valley

MOONEE Valley Racing Club always has a racing date on Eight-hour Day, and this year the meeting will be held on Monday, March 18, which is a little earlier than usual. As the meeting falls on the Monday following a meeting at Caulfield it would seem that that fact has spoiled the chance of the club getting a good field for the Eight Hours Handicap, which always carries a stake of £1000. However, the club has made provision for that, and the Eight Hours Handicap has been altered for the meeting this year. The majority of the middle distance horses in training in Melbourne this year will either be visiting Sydney at that time or will have raced at Caulfield on the Saturday, so the club framed a programme in which was substituted a mile and a quarter welter handicap in place of the mile and a half Eight Hours Handicap. So as not to disappoint owners the club has extended the distance of the Moonee Ponds Handicap, which will be run on Saturday, March 23, to a mile and a half. All of the races at Moonee Valley on the Monday and Saturday of that week will be described for 3LO, Melbourne, by Eric Welch, and as steeplechasing will be resumed at the Saturday meeting after a spell during the summer racegoers will follow the racing with great interest. Selections for the Monday meeting will be broadcast by Eric Welch in a talk from the studio on the morning of the races. Selections for the races on the Saturday will be the subject of two talks, one on the Friday and the other on the Saturday morning.

Kyeton Races

IN connection with the meeting to be held at Kyneton on Wednesday, March 20, 3LO, Melbourne, has arranged to have descriptions of all of the races broadcast, the descriptions being in the hands of Eric Welch. The Kyneton Turf Club always has its cup meeting on the nearest Wednesday to March 17, St. Patrick's Day, and the meeting always attracts many good horses from Melbourne. The cup will be run over 8½ furlongs, and diversification will be lent to the programme by the inclusion of an event for trotting horses. Listeners will find a great deal to interest them in the description of a trotting race.

Good-bye to English Cricketers

ON Thursday, March 21, the English cricketers will commence their last game in Australia, the match being against a team selected by the Western Australian Cricket Association. It is possible that a number of players from the eastern States will be asked to play with Western Australia, so that the match should be full of interest. Especial interest will be taken in the performance of the former South Australian bowler, Halcumbe, who will be in the Western Australian team, as he is regarded as probably the best fast bowler in Australia at the present time. 3LO, Melbourne, is making arrangements to have the tea adjournment and stumps scores telegraphed, and they will be broadcast as soon as they come to hand. The match will extend over three days, and the team will leave for home on the Ormonde on March 25.



ERIC WELCH, 3LO's Sporting Commissioner.

Arrangements for Flemington

DURING the week ending Saturday, March 9, the V.R.C. autumn meeting will be held at Flemington, and, as usual, 3LO has made arrangements to cover every aspect of the racing. On Tuesday night, March 5, the acceptances and barrier positions for the third day on Thursday, March 7, will be available, and they will be broadcast as soon as possible that night. Similarly on the Thursday night the acceptances for the last day on Saturday, March 9, will be broadcast. Eric Welch will speak on the prospects of the runners each day of the meeting at 10.50 a.m., before going on to the races to broadcast descriptions.

Weight-for-age Races at Flemington

ON the last two days of the V.R.C. autumn meeting at Flemington, Thursday, March 7, and Saturday, March 9, racegoers will follow with great interest three very important weight-for-age races. They are the C. M. Lloyd Stakes and Governor's Plate, on the Thursday, and the King's Plate, on the Saturday. Practically all the best horses in Australia will be brought together for those races, and 3LO will have descriptions of all of the races broadcast. The descriptions will be in the hands of Eric Welch.

Modern French Songs

GERTRUDE HUTTON, whose vocal work is of such a consistently high standard, is once again broadcasting from 3LO on March 11, and will be heard in a group of modern French songs. Miss Hutton is a well-known concert and broadcasting artist, and has appeared on many occasions with the Oriana Madrigal Society and the Melbourne Choral Union. She sustained leading contralto roles with the Postal Institute Choir, on the production of "Martha" and "Faust," and was one of the leading artists with the Riga Opera Company. She was selected as supporting vocalist to the well-known Continental tenor, Maxim Brodi, with whom she successfully toured Victoria. Apart from her many concert engagements, it should be mentioned that Miss Hutton has achieved much popularity as soloist of the Australian Church.



MANSLEY GREER.

Clearance Sale Bargains

To make way for new Merchandise and Models for the Coming Season, we are sacrificing the below at prices never heard of before in the History of Australian "RADIO."

B Eliminator Bargains

G. R. Step-up Transformers, 500 Volts,	
Sec. Centre Tapped	25/-
G. R. Double Filter Chokes, 30 Henry	25/-
Pilot Resistograds, 0 to 30 Megs	5/6
Bradleyohms, 25 to 250,000 Ohms..	4/6

Tobe 4 M.F.D. 1000 V Test Condens-	
ers	5/11
Hydra 1 M.F.D. 500	2/11
Power Plus 4 M.F.D. 1000 V Test ..	9/4
Power Plus 2 M.F.D. 1000 V Test ,	5/6

Short Wave Kits, 20 to 600 Metres	13/6	Kurz-Kasch Dials (Verniet)	2/6
" " Adapters, 20 to 600 Metres	56/-	Frost Jack Switches	/6
Pilot Drum Dials (Single and Double) from	20/-	Hegra Cone Speakers	22/6
" Back Panel Dials	5/3	" Units and Cone	12/6
" 2 Gang Condensers	10/6	Magnavox Cone Units	39/6
" Centraline .0005 Cond.	8/-	German Cabinet Speakers	8/6
" " .00025 "	8/-	Cabinets (of Maple)	35/-
" " .00015 "	7/6	Reinartz Coils	3/9
" Neutralising Condensers	3/6	Cosmos 2 Volt Valves	1/6
" Midget Condensers (7 plate)	3/6	Philips 4 Volt Valves, A306-A310	5/6
" Transformers (small type)	9/11	Remler Infradyne Amplifiers	35/-
" " (large type)	18/6	Resistance Coupled "	19/11
" 400 ohm. Potentiometers'	2/9	General Radio Super Het Kits	27/6
Centralab Volume Controls	3/6	Precise 30 ohm Rheos	2/3
Muter 3½ and 5 to 1 Transformers	5/11	Compact Condensers, .0005	4/11
" Grid Condensers and Clips	1/-	" " .00025	4/11
" Fixed Condensers, .001, .002, .006, from ..	1/-	" " .00035	4/11
Headphones	from 6/8	T.A.B. 45V. B Batteries	14/9
Electric Irons	from 12/6	T.A.B. 1½V. A Batteries	1/9

There are a number of marvellous bargains in Receiving Sets of all sizes. Including Battery and Electric Models; Locally made and imported.

DO NOT MISS THIS OPPORTUNITY

If what you require is not listed here, ask for it at

UNITED DISTRIBUTORS Ltd.,

151 Castlereagh Street, SYDNEY.

(LATE LATIMERS WIRELESS SUPPLIES LIMITED.)

'Phone. M3004

PROVING RADIO!

No. 11 We construct this week an electro-magnet, which is used in the manufacture of electric bells, buzzers, headphones, speakers, electric bells, and so on. Sound waves, cycles, kilocycles, wavelength, amplitude, zero, line of time, and other important points in connection with this subject are discussed.

p

THE PRINCIPLES of electro-magnetism and electro-magnets themselves are used in almost every conceivable form of electrical apparatus. Later, when we make our own headphones, we shall see how important is the electro-magnet to the operation of this component. This week we shall construct an electro-magnet which may be used in conjunction with two or three dry cells (or other source of supply as outlined in previous issues), and which may be used for a goodly number of interesting experiments.

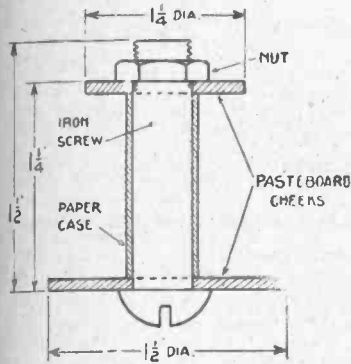

Fig. 1.

You will first require an iron machine screw 1 inch in diameter and 1 1/2 inches long, with a nut to fit. Next get a piece of cardboard tubing, 1 1/2 inches long, and just wide enough to slip over the screw. Now cut two discs of heavy cardboard, one of which is 1 inch in diameter and the other 1 1/2 inches in diameter, and make a hole in the centre of each one 1 inch in diameter, or a little larger, so that they will fit over the ends of the cardboard tube. Glue the discs on the ends of the tube to form a spool, and slip it over the screw, and down to the head, as shown in Fig. 1.

When it is dry, place the screw into the former, and wind on a layer of No. 22 or 24

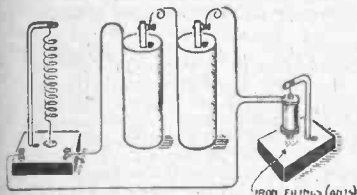

Fig. 2.

D.C.C. (double cotton covered) wire. Leave about six inches of wire spare before you start winding. When you come to the end of the former, paste a strip of paper over it, and continue winding. Next put on another strip of paper, and continue this procedure until the spool is full of wire. Make sure the windings are even. This is important. Screw on the nut, and your electro-magnet is complete.

The electro-magnet itself should need no explanation by now. You all know what a permanent magnet is, so you have probably guessed that an electro-magnet is one which obtains its magnetism by means of electricity. If you have carefully followed previous issues you will see how the electro-magnet operates. When a current of electricity is passed through the wire, magnetic lines of force are set up. The core then acts as an object which is being held by the magnet. If, when the current is on, you remove the nut from the electro-magnet, and try to withdraw the screw, you will find there is a sucking tension on it, caused by the lines of force emanating from the coil through which the current is passing.

We shall first prove that the electro-magnet is capable of attracting other bodies. Cut out a piece of wood about four inches square, and drill a one-eighth inch hole near one edge. (See Fig. 2.) Make a support from a piece of brass wire five inches long, set one end of this into the hole in the base, and bend the other end of the wire over for a distance of 1 1/2 inches. The diagram will show this clearly. Support the magnet to this rod, then connect one of the wires from the electro-magnet to one of the terminals of the jumping spring, and the other side of this instrument to one side of your battery. Then take a lead from the other side of the battery to the remaining wire on the electro-magnet.

Now, place a little heap of filings directly under the polar projection of the magnet, start the spring going, and the magnet will attract the iron filings to it every time the spring makes contact with the mercury, and they will drop when the spring contracts and the circuit is broken. At a little distance, the filings look like jumping ants.

If you connect one of the terminal wires of the magnet with the positive terminal of the battery, and then hold one lead from the electro-magnet in one hand, and the other lead from the battery (i.e. the negative lead), and touch the two together, you will see a spark. This spark is strong enough to light an ordinary gas jet. The correct way to get the spark is to place the two leads together, then pull them gently apart.

The reason for this spark is that when a current is broken there is a heavy surge of current. This may be compared to a tap. If you suddenly (while the tap is running) place your finger across the outlet, stopping the water from flowing, there will be a heavy pressure of current, which in most cases will be quite strong enough to pass the water through the tap.

A dead-beat pendulum, which is the principle used in many types of electrically driven clocks, is simply made. Place a small bunch of iron washers on an iron screw, and twist one end of a very thin piece of wire to the latter. Mount your apparatus as shown in Fig. 3. Connect one lead from the electro-magnet to the negative terminal of the battery, and the positive terminal of the battery to one side of a morse key or bell push. The other side of this component should be connected to the remaining lead of the electro-magnet. Mount the screw and washers on the arm as shown. Give the pendulum a slight swing, and by closing the key the pen-

dulum will be caused to stop almost immediately, depending on the power of the electro-magnet. If the key is opened and closed at properly-timed intervals, the pendulum can be kept swinging. In electrical clocks this regular opening and closing of the circuit is done by means of cog-wheels.

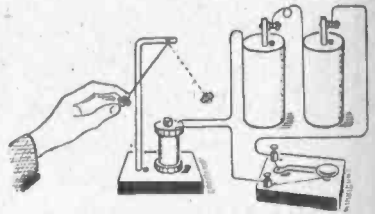

Fig. 3.

It is the attraction of the electro-magnet that casts its lines of force round the screw and washers that exerts a pull toward the centre.

If you connect up the apparatus as shown in Fig. 4, and start the jumping spring, the inductive action of the magnet will give the current an additional "kick," and if you hold the two carbon rods in your hands, you will get a fair shock. If a continuous shock (which is not so strong) is desired, an electric buzzer or electric bell may be placed in the circuit in lieu of the jumping spring. The electric bell and buzzer both work on the electro-magnet principle. If you have a look inside one of these components, you will see this for yourself.

Next week we shall make a strap morse key, a sounder (on the principle used in post offices) and some other interesting apparatus with which we can transmit messages, and from which we can get a better idea of the principle underlying certain effects.

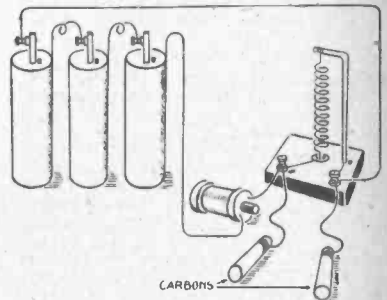

Fig. 4.

Now let us learn a few points about waves. First of all, let us treat sound waves. These waves are caused to move by sound. They can be diverted by any interfering matter, and travel at the rate of 13 miles per minute. That is, if you were to shout "Proving Radio!"—and your voice was strong enough to carry for a mile—and there were

Clubs Formed to Prove Radio

New Movement for Increased Knowledge



TO PROVE RADIO. That quite simply is what hundreds of listeners would like to do, but cannot. Beyond doubt radio does exist, but how could a listener-in show that radio and associated phenomena is not a delusion of the senses. If someone, say a being from an age long past, asked him to put forward his evidence, what radio fan could prove conclusively that radio was what he claimed it to be?

That is the trouble with most modern developments. They come and are accepted by everyone without a doubt, although not one in a thousand knows how they come. Radio is a particular case, for, though there are thousands of enthusiastic followers, few know the origin, history, and cause of the mysterious force they find so fascinating.

Even one who sets out to find out about radio meets with difficulty. We do not know of one text-book which sets out interestingly and simply the facts of radio for the lay man. Nearly all books dealing with the subject employ complicated technical names, and seldom explore the small by-ways of radio, which are full of interest.

It is for this reason that "Wireless Weekly" set out to prove radio for the new radio enthusiast. A series of articles were begun some time ago, and have proved immensely popular. So much so that numbers of "Proving Radio" clubs are springing up all over the city and suburbs. A group of enthusiastic readers meeting together carry out the simple experiments mentioned in the articles with mutual profit. "Wireless Weekly" now sets out to unite these clubs, which have all been working separately. The idea of the movement is to demonstrate in a practical manner, at a very low cost to each member, exactly how and why certain laws in relation to electricity and radio come about. The "Proving Radio" series is the club member's text-book. The ultimate goal of "Proving Radio" is the Amateur's Proficiency Certificate—for each member. However, the series is made interesting enough to warrant the attentions of any reader, whether he is interested in the amateur side of radio or no.

Members pay their club secretaries 1/- per week. All of this goes towards cost of apparatus. If you desire to join a local club, get in touch with one of the secretaries mentioned below as soon as possible. Certi-

(Continued from previous page.)

no interfering objects, and wind and weather conditions were normal, your voice would take exactly one minute to reach a point one mile away.

Your voice is carried by means of sound waves, which are sometimes (particularly where radio is concerned) termed audio waves. This simply means that the waves are audible—that is, they can be heard. Not every sound can be heard by the average human being. The usual audible range is from 16 to 30,000 cycles per second. A cycle (as has already been explained) is simply a unit, and when measured, is termed the frequency. Thus, if your voice sings the note C (or as tonic solfa singers will have it—the note Doh), your voice will be giving out sound waves of a frequency of 256 cycles per second. This means that 256 cycles will reach a given spot in one second.

The concluding remarks on this absorbing part of radio and sound waves will appear next week.

Now take a look at the above page, and let us know what you think of it.

icates now being printed will be issued to all members, and periodically test papers will be available for all who are seriously pursuing knowledge.

On behalf of country club members who have difficulty in procuring material for their experiments, etc., "Wireless Weekly" offers its assistance. Where the price of material is required, this will be published on the "Club Page," which will be used also for answering members' queries in connection with "Proving Radio." Members desiring matter must forward a query coupon, together with remittance covering cost of material and postage. When money forwarded is insufficient to cover costs applicant will be advised through the "Club Page." If there is a balance, this will be forwarded to the applicant, less postage.

Unfortunately, we are sold out of all copies containing first numbers of the "Proving Radio" series, but readers will benefit by joining a club, which keeps a copy of each series issued. Several well-known electricians and transmitting amateurs are preparing interesting lectures.

PROVING RADIO CLUBS.
DULWICH HILL GROUP.—(Meets every evening at 7.30 p.m.)

Secretary:

C. Y. Hook, 29 Blairgowrie Street,
DULWICH HILL.

- | | |
|----------------------------------|-------------------------------|
| Dick Worswick,
CONCORD WEST. | H. Archer,
DULWICH HILL. |
| Ron Patterson,
CONCORD WEST. | H. Bester,
CROYDON PARK. |
| George Randle,
MARRICKVILLE. | Eric Hook,
DULWICH HILL. |
| Harold Rankine,
DULWICH HILL. | Hugh Flynn,
PETERSHAM. |
| Stanley Clarke,
ARNCLIFFE. | William Carlton,
STANMORE. |
| S. C. Thomas,
BURWOOD. | |

CITY GROUP.—(At present meeting at St. Andrew's Place on various days between 1 and 2 p.m.)

Secretary: George Manual,
c/o "The Worker" Office,
St. Andrew's Place, SYDNEY.

- | | |
|---------------------------------|-------------------------------------|
| J. O'Dea,
STANMORE. | C. Y. Hook,
DULWICH HILL. |
| A. Sox,
CITY. | Miss Joy Morgan,
MAROUBRA JUNC. |
| L. R. Barker,
BONDI. | Arthur C. Morgan,
MAROUBRA JUNC. |
| William Tregilgas,
RANDWICK. | |

BONDI GROUP.—(Meeting place and secretary not yet chosen. Intending members please get into touch with the organising

secretary, Mr. C. Y. Hook, 29 Blairgowrie Street, Dulwich Hill.)
M. Wright,
PADDDINGTON.

William S. Fleming,
WAVERLEY.
Beresford Hallett,
WOOLLAHRA.

WAHROONGA GROUP.—(Meeting place not yet chosen. Readers who can assist by procuring a suitable local club room are asked to get in touch with the secretary.)

Secretary: J. G. Burgess,
Marshall Avenue, TURRAMURRA.
J. Flemmett,
TURRAMURRA. W. H. Matthews,
TURRAMURRA.

SUMMER HILL GROUP.
Secretary: Mr. Beeby,
1 Dover Street, SUMMER HILL.
W. H. Matthews,
LEICHHARDT.

(Note.—As Dulwich Hill Club rooms are not large enough to hold all members, it has been decided to break the club into two groups, one remaining the Dulwich Hill Group, under Mr. Hook, and the other coming under the Summer Hill Group, with Mr. Beeby.)

WILLOUGHBY GROUP.—This club has only just been formed, and the first meeting will be held at Mr. Meadow's residence, 111 Willoughby Road, Crow's Nest, North Sydney, on the 8th March, 1929, at 7.30, when the club's secretary will be chosen, and other preliminary matters discussed. Roll up, North Sydney!
William Loughland, E. Richards,
WILLOUGHBY. WILLOUGHBY.
L. Sharpe,
WILLOUGHBY. Mr. Bondy,
James Macquarie, WILLOUGHBY.
WILLOUGHBY. V. Murphy,
Jack Richards, WILLOUGHBY.

Certificates will be forwarded to these members as soon as possible.

CLUB NEWS City Group

THE experiments with magnetic induction were a great success. The nail being placed between the poles of the magnet was temporarily magnetised, and the iron filings were attracted to it by the magnetism induced into the nail by the magnet. Experiment on transfer of electric power was demonstrated by placing the two ends of a coil to the opposite poles of a battery, and also placing the galvanometer across a second coil not in any way connected with the first coil. It was noticed that the galvanometer showed that some of the current had been induced into the second coil.

Experiments on magnetism. In the experiments with the bar magnet, the iron and brass filings were mixed, and it was definitely observed that the iron filings only were attracted to one of the poles of the magnet, leaving the brass filings unattracted. It was also observed that the curved end of the horseshoe magnet had far less attracting power than the pole ends. The experiment with the magnet under a sheet of glass moving the needle, on account of the glass being a non-conductor, was demonstrated. The needle upon a sheet of iron made no movement, but, quite by accident, the needle was placed upon a piece of 14-gauge zinc, and it behaved exactly in the same manner as when the glass was used. We then tried the experiment, using brass and copper, with the same result. The magnetic lines of force were beautifully de-

Planes and Radio Pioneer Great Dead Heart of Australia

(Continued from Page 6.)

was a camp pie, which had been placed on the hood of the car, and had rolled off.

TREACHEROUS COUNTRY.

During about seven weeks which we spent in this country I installed about six transmitting sets, many miles apart. The difficulties of travel were often very great. On one occasion we were bogged in the treacherous sand of the Flinders River, and from time to time found ourselves facing precipitous rises in the billabongs, that almost barred our progress.

We never actually saw the "grey Gulf Waters," for there are several miles of mangroves thickly studded along the shores.

Then we made several expeditions into the sterile west, where there had been no rain for seven years. At Birdsville, on the South Australian border, there was a shower while we were in the town, and the youngsters under ten were struck dumb with amazement, and in one case at least with terror. This was a small girl of nine years old, who was so scared at the appearance of water from above that she became hysterical.

NO RAIN FOR SEVEN YEARS.

Even the desert regions of New South Wales do not approach this for colossal dryness. No rain for seven years! It was said that when the rain came at Boulia, the local frogs had lost the art of swimming, and were drowned. This may be true, as I heard many vouch for it, but as they were all hard-bitten bushmen we accepted it with a grain of salt.

The whole of our installation of sets was completed in about four months, and for the remaining portion of my sojourn I was engaged chiefly on work in Cloncurry, interspersed with occasional expeditions with Rev. Scott and the "flying doctor" to emergency cases in the wilds.

Once, during an expedition into the Northern Territory, we came to Elsey Station, well known to readers of Mrs. Gunn's "We of the Never-Never," and saw the grave of at least one of the characters. The old homestead is now deserted, but we recognised it without difficulty from Mrs. Gunn's description.

It is interesting to note the tremendous part played by wireless in the work of the A.I.M. Not only does it add tremendously to the speed with which medical aid could be summoned (in some cases help can be obtained in 12 hours which, without radio, would take a fortnight), but in some of the more distant places no doctor could be obtained under any circumstances. It is impossible even to conjecture the tremendous debt that these isolated people owe, and will owe, to radio.

As the organisation develops, many hundreds of people who still are beyond medical aid will be able to secure help within a few hours.

HELL'S KITCHEN IN SUMMER.

After six months, the latter part during the summer of this Hell's Kitchen, we set out on our return journey, and arrived in Sydney after four weeks' travelling over the worst country in Australia—sandhills and gibber ridges for hundreds of miles. It was a great relief for me to know that unless I wish it I will never see Cloncurry again.

I could write for hours of the interesting and the unusual incidents which occurred, but let me close by glancing at the tremendous work which could not be done without radio.

It is pioneering these vast places in Australia, making life safer and a little less unpleasant. But this is only a beginning. Within the next decade we may hope for many such services and the complete penetration of "the great dead heart of Australia," which should be made to pulse with life.

HITTING BELOW the BROADCAST BELT



Short-wave and Amateur Notes by VK2NO

SPASMODIC nights of good reception, with an occasional groan from a threatening power leak, has been my lot for the last few days. When the night has been good I think how well I was justified in hammering it into the Australian experimental transmitter a year or so ago, that the much maligned 20-metre band was our "land of milk and honey." Now we are well into the hang of things with the 1929 business, and the gang have found that when the 20-metre band has simply GOT to be used that it is not so bad as they thought it was.

The most remarkable things have been happening down there, as my last notes showed; in fact, it is most intriguing, and quite enough to keep one away from the latest "talkie." A few months ago, in September, 1928, the only possible time to hear any real long-distance stations seemed to be from 4 in the afternoon, Sydney time, until 6 o'clock, at which time they faded out with a sudden silence which left one wondering if the other fellow had had a breakdown in the middle of the contact.

In those afternoons one could hear our old friends, English 5MS in Lytham, 5LS in South London, and 5BY in Croydon, at a consistent R6 to 8 on 23 metres, and for four weeks it was worth a quick rush to the operating shack at 2NO for a good yarn every afternoon. 5LS used to ask me if I could smell the bacon and eggs his good lady was preparing for breakfast before his morning rush to the Metropolls. . . . and the world seemed very small, especially as I used to be second operator at that station in 1924. Then, just as quickly came the great debacle, and all the screen-grid valves and high-power transmitters in the world could elicit nothing but silence from Europe. Interest flagged again, and here and there a hopeful Australian "ham" would take a look down at 23 from 32 metres and spread the news—a terse "ND." It seemed as if this 20-metre band of ours, with its peculiarities, simply HAD to wait until 1929 to show the gang that it was after all really a faithful old frequency, and had a lot of things up its sleeve, for no sooner had we gone over the stile of the years than it woke up again.

It woke up again in the reverse way, however, and contrary to all we had known before, the long-distance European stations started to come in at such an unheard-of time as 10 p.m. Sydney time. This last few weeks flocks of Englishmen and Frenchmen, not forgetting Finlander 2NM, have been worked by all and sundry, and while all this has been going on reliable Inter-State working is going on through the whole evening. Inter-State working on 20 metres has previously failed after about 6 p.m., and, although in one or two remote cases it was tried, it was always the same result—excellent in daylight but a deathly silence at nightfall.

The new prefixes are causing a little trouble, for, although the list is as complete as apparently possible, there seem to be some weird and wonderful countries on the air who are not listed. I had an experience of this on Friday afternoon, February 22. At 4.30 o'clock I decided to see if European signals were audible at this time as they had been before a few months ago, and, accordingly, put my 1929 tuned-plate tuned-grid transmitter on the air and launched a "CQ DX" call.

A station answered me with a very wishy-washy, almost unreadable, ICW note, and signed VRIAH. I deciphered his report as R6 in our old strength code, and that he could not stay as he was just having breakfast before going to work. Just when I wanted his location he disappeared, and I was left in the air without knowing what country and who I had been in touch with. An annoying state of affairs, and I cannot find "VR" in the list. It seems certain he was a European, but very probably low-powered. Probably he was the only enthusiastic European "ham" to turn to on the key that morning!

Every evening about 10 o'clock I hear K1CM at QSA5 with an excellent RAC note, who invariably reports VK2NO maximum strength up there. This is very interesting for the reason that the doublet aerial in use at VK2NO is miles out of resonance owing to incorrect feeders, and the meters in both feeders are only registering 4 TC ampere. Rather a waste of energy with a splendid Mullard VO 150 valve in the transmitter, but a day or two and a little wire clipping will tell.

Another station heard practically every evening is K6EHA, in Hawaii. He spends most of his time yarning with Australians, and has a nearly pure DC note with a slight filter kick. This station seems to be a good one for the beginners to pick on, for he sends very slowly and deliberately. Up in Java PK4AZ may be heard nightly ready for a yarn with anyone.

Very little interference is being occasioned between our own stations on the 20-metre band, but up on 42 it is not quite the same story. In Victoria a few are starting up on the re-granted 80-metre band, which seems futile until the "last rose of summer has gone." In Sydney reception on 80 metres is so full of static and power leaks that the only place to hear a signal there would be in a submarine or a coalmine, and it seems certain in my own case that there is a very decided static peak on 80 metres, whereas 120 and 60 metres seem fairly free.

International broadcasting has taken on a new aspect with the advent of the great European station PH1, at Hulzen. Mr. Russell Crane reports unparalleled short-wave telephone reception from this station at 10 p.m., February 25, and that it was so powerful as to be compared with a local transmission on the usual broadcast band.

Advice has been received here that PH1 will be transmitting on greatly increased power on a wave-length of 16.88 metres at the following Sydney times: February 27, 10 p.m. to 2 a.m. on the 28th; March 1, midnight to 4 a.m., Sydney time. The well-known Phillips station, PCJ, is working on 30.2 metres from 2 to 4 p.m. each Saturday, especially for Australian and New Zealand listeners.

More Wall-paper

QSL CARDS are now held for 3AR, 7EH.

2HL, 2LI, 3JK, 6AG, 2NS, 2MF, 2ZY, 2HM, 2LG, 2RX, 2EK, 4AB, 5JH, 4CM, 2EK, 7CH, 2GW, 5HG, 5HH, 5MC, 5HG, 2YJ, 2RB, 3DY, 2KD, 5JA, 2EK, 2KD, 3DY, 3YX, 5FA, and 3LK. All these cards are for Australian amateurs. The following are N.Z. amateurs: —3AC, 1AX, 2GO, 3IR. Will owners please send stamped addressed envelope or call?

monstrated by placing a bar magnet under a sheet of glass, under which was a sheet of paper. Iron filings were then slowly sprinkled over the glass. The iron definitely arranged itself around the poles of the magnet, and after tapping the glass the lines of force were graphically observed. The magnetic compass was made by first magnetising a needle with a bar magnet; then placing it on a piece of tissue paper, which floated in a glass of water, and behaved identically as an ordinary compass.

REMARKS: A better plan would have been to use a cigarette paper on which to place the needle. The cigarette paper would have sunk to the bottom of the glass, leaving the needle floating, and the needle would point to the magnetic north and south poles. By moving the poles of a magnet near the glass, the needle could be deflected. The lines of force in a magnet will travel (as is the case with electro-magnetic waves) round a conducting body, but will not pass through it. Thus is why the metallic objects failed to upset the action of the magnet. If the magnet has been made to actually touch the metallic substance, the lines of force would have been shorted, and no action would have been noted.

Dulwich Hill Group.

ALL members were present at the meeting held on February 22nd, at 7.30 p.m. Four new members arrived, viz., Messrs. Thomas. Burwood; Uesper, Archer, and Hook, jun., from Dulwich Hill. The meeting room is too small to accommodate such a large group (there are thirteen members in this one group now), and it will probably divide itself into two groups at next meeting, making one half a "Summer Hill Group." The first experiment to be carried out was the decomposition of water. This was done successfully. Next we started on magnetic experiments. We observed that the magnet picked up the iron filings from the mixed iron and brass filings. Taking the horseshoe magnet and needle, we observed the magnet had a greater attracting energy at the poles than was so in the centre. With the bar magnet underneath a glass plate, and the needle on top, the magnet attracted as stated in the article. We demonstrated for ourselves that the lines of force would not pass through iron, as when the iron was placed between the magnet and the needle, no action took place. We should like to know why the needle follows the magnet when brass, copper, or zinc sheets are substituted for glass. The experiment with magnetic induction was then carried out, and it was found by putting the point of the nail between the two poles of the horseshoe magnet, very few filings were attracted, but, placing the head of the nail between the two poles, the point was well demonstrated, for as soon as the nail was moved the iron filings began to fall, which not only proved the presence of magnetic induction, but proved the nail only remains a magnet so long as it is in the magnetic field. The making of a magnetic compass with needle and glass of water was successfully demonstrated. Mr. J. G. Burgess, of Turramurra, was present with the idea of forming a North Shore Group, and he was very interested in the evening's work.

REMARKS: Copper, zinc, and brass cannot be made into permanent magnets. The magnetic lines of force would (if blocked by the matter referred to) travel round the substance. If the magnet was made to touch the substance, the magnetic lines of force would be shorted. The experiment was merely given in the first place to demonstrate that magnetic lines of force would TRAVEL AROUND A BODY. It is unreasonable to suppose that the magnetic lines of force would travel THROUGH glass, which is an insulator, and the only possible manner in which the lines of force can act upon the object is to travel AROUND the insulator.

As the field is stronger in between the two poles than in any other part of the circuit, the needle (which is of steel, and steel objects can be magnetised), is held in the centre of the magnetic field. Probably the reason why the magnetic induction experiment was not successful until the needle was pushed in between the two poles was because the nail had been previously used in magnetic experiments, and had taken on a magnetic effect.

The lines of force would, of course, have greater effect on the centre of the nail, which would become more or less a bar magnet, with the strong fields at the poles. Either this, or the magnet is weak. Remember, too, that whereas a magnet will attract iron (this is why the iron stopped the lines of force from flowing round it), the magnet (try for yourself) will not attract zinc, copper, or brass.

New Apparatus Tested & Approved



Screen-grid Valve Holders

"WIRELESS WEEKLY" readers will recollect the 1928 Solodyne, as described in this journal last year. The Australian version which was kindly submitted to us by the designer, Mr. W. Furness, was a receiver in which the utmost care was taken in the mechanical design to ensure electrical effi-

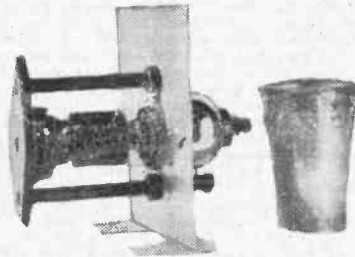

ciency of the highest order, and to obtain the maximum performance from the screen-grid valves, which were then being introduced to Australia.

Mr. Furness has designed some very neat and unique valve-holders for both types of screen grid valves, in which the screening partition itself is utilised as the support for the holder, thus keeping all wiring as short as possible, and the metallic screening complete.

One form is designed for the well-known Osram and Marconi S625 types of valves, and the other for those of the Philips and Mullard types, to fit a standard UX socket. In either case, the valve is supported at one end by a base of Bakelite, carrying the socket, with two rigid Bakelite pillars attached by

locknuts to the metal partition. At the point where the screening grid passes through the metal a projecting flange is provided to entirely cover this, and in the case of the UX socket type valve, a conical canister is made to push into the hole and project outward, thus entirely covering the plate end of the valve. These holders, with or without the metal partitions, may be obtained from the manufacturer, Mr. W. Furness, King's Cross Chambers, King's Cross, Sydney, and are to be recommended as a very useful component.

Wirelessecret

THERE is music at the Pelican Cafe, but no one knows whence it comes. Except the engineers of Philips Radio, who installed the loud speaker. Some people think it comes through the ceiling, others from interstices in the walls; others, from the floor. Personally, we should prefer to think that it comes from the ceiling; but if the music happens to be jazz, we are positive that it must come from the floor.

Business Growth

MR. R. W. PATTERSON, the well-known set constructor, who formerly carried on business at 90 Pitt Street, has now moved to 22a Bond Street. His telephone number will remain the same.

Radio in the Class Room

THE Department of Education in the State of Ohio, United States of America, is taking a very practical interest in developing education by broadcasting. The department decided that every school shall be equipped with a radio receiving set, and a definite schedule of subjects to be taught by broadcasting has been set up as follows:—

Monday.—Current events talk by a leading newspaper man or student of world affairs (15 minutes, for upper grades and high school).

History dramalogues—great moments in history, presented by a selected group of players (20 minutes, for upper grades). Talks on "achievement" by great men and women, not only worthy residents of Ohio, but all others that can be secured (25 minutes, for high school).

Tuesday.—Stories and playlets by selected story-tellers and casts of players (15 minutes, for lower grades).

Literary masterpieces by selected readers (20 minutes, for upper grades). Literary masterpieces by selected readers (25 minutes, for high school).

Wednesday.—Health talks by physicians and athletes (15 minutes, for upper grades). Travelogues, geography, with emphasis on music and sound (20 minutes, for upper grades).

Civil government by State and national Government officials (25 minutes, for upper grades and high school).

The Literary Gent

MR. ALDOUS HUXLEY has let it be known that, "so far as literary art is concerned, the broadcasting of short stories is as irrelevant as the publication of short stories in popular magazines. The thing may be done and may even prove a popular attraction, but that it can in any way either assist or harm literature," he greatly doubts.

THREE VALVE SET---£10/10/- COMPLETE YOU BUILD IT YOURSELF

Without Technical Knowledge, Soldering, Circuits, Tools, or Trouble
Wallace Booklet on "The Community Three" Tells You How. Price 10d; posted 1/-.

CUT RATE SPECIALS

Star-way Battery Cables, with lugs	£0 1 9
Four-gang Condensers, ready mounted ..	1 10 0
De Forest DL3 Valves (3 volt, .06 amp.) ..	0 6 9
Return Jacks (all types)	0 1 6
Langrid Double-capacity 46 volt B Batteries	0 17 6
Ormes A.P. Transformers	0 9 6
Wood Headphones, dependable	0 12 6
Short-wave Plugs and Sockets, per pair ..	0 5 0
Mat Stand-off Insulators	0 0 4
Electric Soldering Irons	0 15 0
Carlhone Headphones, 4000 ohms	0 13 6

USING THESE PARTS.

Bakelite Panel, 7 by 14 in.	0 4 0
Two Wallace .00035 Condensers at 5/11 ..	0 11 10
30 ohm Rheostat	0 3 6
Baseboard Rheostat, 30 Ohms	0 2 6
Filament Switch	0 0 9
Ready-wound Coil	0 5 6
Wallace Slow-motion Dial	0 6 6
Radio Frequency Choke	0 3 9
Three Empire UX Valve Sockets at 1/8 ..	0 5 0
Two Pival Transformers at 10/3	1 0 6
Electrolyne Condenser and Grid Leak ..	0 3 0
No-solder Jack and Plug	0 2 6
Knob for Volume Control	0 1 0
Sundries, Flex, etc.	0 5 11
"Stripped" Set	£3 16 3
Two Eveready 45 volt B. Batteries at 12/6	£1 5 0
Exide 4 volt Accumulator	0 15 6
Eveready O Battery	0 2 9
Three Philips' Valves	2 0 6
M.P.A. Cone Speaker	2 10 0
	£10 10 0

OTHER DEPENDABLE PARTS.

Dry Rectifiers for A Charge or Elimina-	
tors, 2½ amp.	£1 12 6
Dry Rectifiers to replace Tungar Bulbs ...	1 9 6
(These are guaranteed for 1000 hours, and	
have none of the risks of bulb recti-	
fers.)	
13,000 ohm Vitreous Enamelled B Elimina-	
tor Resistors	0 14 9
Mesco Morse Keys	0 9 6
Pilot 3000 ohm B Eliminator Resistances ..	0 6 6
Formo Single-hole Mounting Condensers.	
.00025, 7/6; .00035, 8/-; .0005, 8/6.	
Spltdorf 30 Henry Chokes	0 10 6
Quaker Condensers, .0005	0 7 6

WRITE FOR THIS BOOKLET—NOW

Same day service for country clients.
Unqualified money back guarantee.

"The Wireless Shop"

Miss. F. V. WALLACE

Postage paid on all goods except batteries and speakers.

THE OLDEST WIRELESS FIRM IN TOWN

Established 8 Years.

6 Royal Arcade, Sydney

'Phone, MA5543

Two doors from George Street, Opp. Q.V. Building.

Wireless Weekly

52 ISSUES DELIVERED POST FREE FOR ONE YEAR

"WIRELESS WEEKLY" gives you the complete broadcasting programmes from every important station in Australia a week in advance in addition to topical news and articles and a technical constructive article by a qualified radio man.

13/-

SUBSCRIPTION FORM

To the Editor, "Wireless Weekly," 51 Castlereagh Street, Sydney.

Please forward "Wireless Weekly" for a period of
for which I enclose for
(Add Exchange to Country Cheques.)

NAME
ADDRESS

Subscription Rates: 12 months (52 issues), 13/- post free; 6 months (26 issues), 6/6 post free.

List of World's Broadcasting Stations Which can be Received in Australia on Long and Short Waves

AUSTRALIA.		Metres. Watts.		Metres. Watts.		Metres. Watts.									
New South Wales.															
1FC—N.S.W. B'casting Co., Ltd. Market St., Sydney. 010-2230	443	6000	2102. Silent Tues.	208	500	JAPAN.									
1BL—N.S.W. B'casting Co., Ltd. Market St., Sydney. 0400-2230	453	5000	4YA—Radio B'casting Co. of New Zealand. Dunedin. 1700-2200. Silent days Mon. and Thurs.	463	750	JOAK—Tokio Central B'casting Co., Tokio. Japan. Jap. stations received best about midnight on Sunday.	875	1000							
1GB—Theosophical B'casting Station, 29 High St., Sydney. 1000-2200	318	8000	FOREIGN		GREAT BRITAIN.		JOBK—Osaka Central B'casting Co., Osaka	356	1000						
2KY—Trades and Labour Council, Goulburn St., Sydney. 0900-2200	180	1500	GREAT BRITAIN.		2LO—British B'casting Co. Savoy Hill, London. 1900-0850	861.4	3000	JOCK—Nagoya Central B'casting Co., Nagoya	360	1000					
1UW—Radio B'casting Ltd., Paling's Building, Ash St., Sydney. 1230-2230	246	600	WEST AUSTRALIA.		5XX—British B'casting Co., Davenport, 1900-0860	1604.3	6000	10000	DUTCH EAST INDIES.						
1UR—Electrical Utili-ties, Ltd., 513 George St., Sydney. 0730-2330	493	250	WEST AUSTRALIA.		UNITED STATES.		JPC—Batavia's Radio. Batavia	220	40	PHILIPPINE ISLANDS.					
1MK—Mockler Bros., Ltd., Hawick St., Bathurst	276	250	WEST AUSTRALIA.		KDKA—Westinghouse Electric and Manufacturing Co., E. Pittsburg, Pa.	316.6	60000	KZRM—Radio Corp. of the Philippines, Manila	413	1000	KZKZ—Radio Corp. of the Philippines, Manila	270	500		
1HD—H. A. Douglas, King St. Newcastle	288	100	WEST AUSTRALIA.		KFI—Earle C. Anthony Inc., 1009 St., Hope St., Los Angeles	468.5	6000	KZIB—Radio Corp. of the Philippines, Manila	260	500	INDIA.				
1BR—Burgin Electric Co., 340 Kent St., Sydney. At present off the air	316	100	WEST AUSTRALIA.		KGO—General Electric Co., Ltd., Oakland, California	354.4	6000	7CA—Indian B'casting Co., Calcutta. Indian stations received best about 1.30 a.m. Monday.	870.4	3000	7BY—Indian B'casting Co., Bombay	367.1	3000		
1LO—Dominions B'casting Co., 120A Russell St., Melbourne. 2230	371	6000	TASMANIA.		KOA—General Electric Co., Ltd., 1370 Krameria St., Denver Colorado	325.9	6000-10000	SOUTH AFRICA.		WAMG—Africa n B'casting Assn., Capetown	875	1500	JB—Africa B'casting Assn., Johannesburg	450	500
1AR—Dominions B'casting Co., 120A Russell St., Melbourne. 1000-2200	484	6000	TASMANIA.		WPAF—National B'casting Co., 1250 Broadway, New York	491.6	60000	EUROPE.		ET—Eiffel Tower, Paris, France	2650	5000			
1LZ—C. J. Wilson, 81 Co. Bourke St., Melbourne	319	100	TASMANIA.		WGY—General Electric Co., Schenectady, N.Y.	378.5	60000								
1DB—Deutsche Busi-			TASMANIA.		WJZ—National B'casting Co., 192 Broadway, New York	454.3	30000								

International Short Wave Stations: Times Stated are S.M.T.

AUSTRALIA.		Metres.	Metres.		Metres.	Metres.
1ME—A.W.A. (Syd.), relays			from 0930	65.04	2400 Sat.; 0100-0400 Sun.	21
2FC, times irregular, usually Mon. from 0430-0600	31.23		WBZ—Springfield. Relays WBK	70	PCP—Kootwijk, Wed. and Fri., 0300-0800; Sat., 0900-2400; Sun., 0100-0400	27
1YQ—Rag Allston, relays 2BL, times various	32.6		2XAP—Schenectady, Tues. 0900-1430; Fri., 0900-1500; Sat., 0900-1500	82.4	PCU—The Hague, 0500-0600, Wed. and Fri.; 0900-2400, Sat.; 0100-0400, Sun.	42
1ME—A.W.A. (Melb.), relays 1LO, times various. Usually heard about 0430-0630	32		WLW—Ohio, 0900, except Sat. and Mon.	52.02	UNION OF SOVIET SOCIALIST REPUBLICS.	
1ACQ—W. E. Coxon (Perth), relays 6WP, Times various. Usually 2130-0200 daily	32.3		KKA—East Pittsburg. Daily, from 0800	43.35, 44	RPN—U.S.S.R. Moscow	29.60, 30
GREAT BRITAIN.			WIZ—New Brunswick. Irregular, usually after 0900	43.35, 61.00	RFB—U.S.S.R. Siberia	60, 30
18P—Marconi Co. (London), relays 1LO, 0400-0800, daily, except Sun. and Mon. From 0330 on alternate Saturdays, and 2100-2230 daily	26		7XAO—Portland, Oregon. Daily from 0900-2300	53.54	ITALY.	
1YF—Marconi Radio, Poldhu, Times various 25, 33, 12M—Gerald Marconi, Carterham, Surrey, 1700-0400-0600 (Sun), 1900, Thurs. and Sat.	32.5, 28		2XO—Rocky Point, from 1400 Mon. and Fri.	16.02	RMI—Milan	45
1LW—Beam Station, all times (Dorchester)	15.7		2XB—Richmond Hill. Relays WABC daily, from 0900	16.02	IDO—Italy	33.5
1LQ—Beam Station, all times throughout day (Onkap)	24.6		WOWO—Fort Wayne, Indiana. Relays Columbian stations daily, 0800	22.1	IAK—Rome	45
1GR—Beam Station, Grimshy (Beam Station) All times	25.9		8XK—E. Pittsburg. Relays KDKA, 0300-0600, Tues. and Wed.	26.8	IMA—Rome, 0700 Sun.; 0300-0530, Mon.	34.5
UNITED STATES.			2XAG—New York. Telephony, irregular	26.92	SOUTH AFRICA.	
2XAD—G.E.C. Schenectady Relays WGY, 0430-1300 Mon., 0400-1400 Tues. and Fri., 0800-1300 Thurs. and Sat.	21.96		2XAL—New York. Relays WNY, 0900-1400 Tues., 1100-1200 Wed.; 1200-1300 Sat.	30.31	JB—Johannesburg	20, 25
1XU—Columbian, Relays Columbian B'casting stations	61.05		8XN—Detroit, Mich. Relays WJR daily	32	JAPAN.	
1XBA—Newark, N.J., Relays WAAI, 1000-1500 Wed., Fri. and Sun.	65.18		WCVG—Brooklyn, Daily, 0500	64	JRBB—Yokohama, nightly	37.8
1XP—Cleveland, daily from 1600	64.04		2XW—New York. Relays WABC and WBOQ daily, 0900	66.8	JJP—Tokyo	70
1XAT—Inglewood, daily			2XAG—New York. Transatlantic telephony	22.93	JIA—Yokohama	79
			INDO-CHINA.		JKBZ—Tokyo	20
			HVA—Hanoi, Daily 1900-2000 and 2200-2300	30.56	GERMANY.	
			HOLLAND.		AGJ—Nauen, Daily, 0.500	56.7
			PCJ—Kootwijk, 2240-2400 Wed.; and from 0200 Thurs., 0300	21.98	POX—Nauen	70
			PCM—The Hague, Irregular	26	POZ—Nauen. Press and news reports to ships 19, 20	64
			PCY—Eindhoven, 0300-0600, Wed. and Fri.; 0900-2400 Sat., 0100-0400 Sun.	31.4	AGA—Nauen. Press and news, daily	26.3
			PCZ—Kootwijk, 0400 Wed. and Fri.; 0900		AGC—Nauen. Throughout day	17.1
					APK—Dneberitz, Tues. Thurs., Sat., 0500-0600 (Call sounds like "AR-ER-Call")	37.85, 67.66
					NORWAY.	
					LGN—Bergen, 0900. Irregular	30, 31.25
					STANZ—Stanger, News bulletins, 0400	12.14
					DENMARK.	
					7MK—Copenhagen, Irregular	39.4, 32.8
					7RL—Copenhagen	42.12
					Motala Tests Irregularly after midnight	41
					EDTR—Copenhagen, 2130-	

2300, Mon.; 0820-0700, Wed.; 0900-0930, Sun. Future transmissions 0800-1100, Tues. and Sat. 62.12

AUSTRIA.
OKK1—Vienna, 70
OKK2—Vienna, Mon., 0400-1100 70

SPAIN.
Casablanca 63

FRANCE.
GC—Paris 61
TR—Lyon, Daily, 0230-0330 40, 20
FL—Paris, Time signals, 1750-0555 24.46
FW—Ste. Arelle. At odd times throughout day, 14.28
Radio Vitis, Paris, 0700-0900 37
Radio Agen, France, Wed. and Sat., 0300-0915 39.74

SWITZERLAND.
RHSD—Zurich, Relay work, Tues., Thurs., and Sun. 35, 33
RH30—Berne, 0500-0600, 32

MALAY STRAITS.
CXW—Singapore, 1200-1400 28.5

JAVA.
ANE—Bandoneg, 31.80 16.33
ANH—Malabar, 2240-2440, Sat. 17.

INDIA.
VWZ—Poona, Beam station 14.1

FINLAND.
SPM—Helsingfors, 1930-0630 47, 31.8

BELGIUM.
10G—Brussels, Almost daily, 0600-0900 34.7
10U—Brussels, Almost nightly, 0800-0900 45.0

TUNIS.
SKR—Constantine, Sun. only, 0800-1000 42.7

MOROCCO.
AIN—Casablanca, 1930-0630, Weather report 57

Local Programmes, Friday, March 8

2FC

EARLY EVENING SESSION.

10. "Big Ben" and announcements. 7.2: Official weather forecast, rainfall, river reports, temperatures, astronomical memoranda. 7.7: "Sydney Morning Herald" summary. 11.2: Shipping intelligence, mail services. 11.5: Studio music. 7.25: Investment market, mining sharemarkets, metal quotations, wool sales, breadstuffs markets, inter-bank markets, produce markets. 7.40: Studio music. 8.0: "Big Ben" Close.

MORNING SESSION.

Announcer: A. S. Cochrane. 10.0: "Big Ben" and announcements. 10.3: Quarterforte reproduction. 10.10: "Sydney Morning Herald" news service. 10.25: Studio music. 10.45: A talk on "Home Cooking and Recipes" by Miss Ruth Furst. 11.0: "Big Ben" A.P.A. and Reuter's cable services. 11.5: Close down.

MIDDAY SESSION.

Announcers: A. S. Cochrane, Eric Bessemer. 12.0: "Big Ben" and announcements. 12.1: Stock Exchange, first call. 12.3: Official weather forecast, rainfall. 12.5: Scores of the 5th Test match, England v. Australia, played at Melbourne. 12.7: Studio music. 12.8: Summary of news, "Sydney Morning Herald". 12.15: Rugby wireless news. 12.18: A reading. 12.20: Scores of the 5th Test match. 12.22: A reading, continued. 12.30: Studio music. 12.35: Scores of the 5th Test match. 12.37: Studio music. 12.50: Scores of the 5th Test match. 12.52: Studio music. 1.0: "Big Ben" Weather intelligence. 1.3: "Evening News" midday news service. 1.5: Scores of the 5th Test match. 1.7: "Evening News" service continued. Producers' Distributing Society's report. 1.20: Scores of the 5th Test match. 1.22: Studio music. 1.28: Stock Exchange, second call. 1.30: Studio music. 1.35: Scores of the 5th Test match. 1.37: Studio music. 2.0: "Big Ben" Close.

AFTERNOON SESSION.

Announcer: Laurence Halbert. Accompanist: Ewart Chapple. 2.30: Programme announcements. 2.32: Musical session for the schools. Short musical recital. A talk by Freda Sternberg "Of the beaten track, for Australians about to go to London." 3.0: Studio music. 3.15: Cricket scores of the 5th Test match, England v. Australia, played at Melbourne. 3.1: Studio music. 3.20: Cricket scores of the 5th Test match. 3.22: Popular records. 3.35: Scores of the 5th Test match. 3.37: Herbert Hinton, baritone—(a) "When My Wife Came Sailing Home" (Dorel), (b) "A Home Song" (Homer), (c) "Uncle Rome" (Bomer). 3.45: A reading. 4.0: Scores of the 5th Test match. 4.2: Romano's Cafe Dance Orchestra, conducted by Bennie Abrahams. 4.10: From the studio, Herbert Hinton, baritone—(a) "The Serenade" (Schubert), (b) "Glorious Devon" (German). 4.28: Studio music. 4.21: Romano's Cafe Dance Orchestra, conducted by Bennie Abrahams. 4.0: From the studio, studio music. 4.50: Scores of the 5th Test match. 4.52: Stock Exchange, third call. 4.54: Studio music. 4.58: "Big Ben" Close.

EARLY EVENING SESSION.

Announcer: A. S. Cochrane. 5.40: The chimes of 2FC. 5.45: The children's session, conducted by the "Hello Man." Letters and stories. Music and entertainment. 6.15: The Farmyard Fife, from Kookaburra Gully. 6.30: Dalgety's market reports (wheat, wheat, and stock). 6.40: Fruit and vegetable markets. 6.43: Stock Exchange information. 6.45: Weather and shipping news. 6.48: Rugby wireless news. 6.50: Last minute sporting information, by the 2FC Machine Commissioner. 7.0: "Big Ben." Late news service. 7.10: Special dinner music.

EVENING SESSION.

Announcer: Laurence Halbert. Accompanist: Ewart Chapple. 7.40: Studio music. 7.45: Programme announcements. 7.47: Studio music. 8.0: Castle Palais Dance Band. 8.15: George Jennings, entertainer. 8.23: Castle Palais Dance Band. 8.32: Gwladys Flimster, soprano. 8.40: Horace Keats, pianoforte solos. 8.48: George Jennings, entertainer. 8.58: Castle Palais Dance Band.

9.6: Late weather forecast. 9.7: Nea Hallett, popular vocalist. 9.15: Horace Keats, pianoforte solos. 9.23: Gwladys Flimster, soprano. 9.30: Castle Palais Dance Band. 9.40: George Jennings, entertainer. 9.48: Castle Palais Dance Band. 9.58: Nea Hallett, popular vocalist. 10.6: Castle Palais Dance Band. 10.20: Late weather and to-morrow's programme. 10.21: Castle Palais Dance Band. 10.30: National anthem. Close.

2BL

MORNING SESSION.

Announcer: A. C. C. Stevens. 8 a.m.: G.P.O. chimes. Metropolitan weather report. 8.2: State weather report. 8.15: G.P.O. chimes. News from the "Daily Telegraph Pictorial." 8.30: G.P.O. chimes. News service continued. 8.40: Information, mails, shipping, arrivals, departures, and sailings. 8.45: Studio music. 9.15: Half an hour with silent friends. 9.45: Studio music. 10.0: G.P.O. chimes. Close down.

MIDDAY SESSION.

Announcer: A. C. C. Stevens. 11.0: G.P.O. chimes. 2BL Women's Sports Association session, conducted by Miss Gwen Varley. 11.30: Advertising hints. Talk on "Diet and Health," by Miss Dorothy de Cleghorne. 11.40: Women's session, conducted by Mrs. Cranfield. 12.0: G.P.O. chimes. Special ocean forecast and weather report. 12.3: Pianoforte reproduction. 12.5: Scores of the 5th Test match, England v. Australia, played at Melbourne. 12.7: Studio music. 12.20: Scores of the 5th Test match. 12.22: Studio music. 12.30: Shipping and mails. 12.35: Scores of the 5th Test match. 12.37: Market reports. 12.48: "Sun" midday news service. 1.0: G.P.O. chimes. Studio music. 1.5: Scores of the 5th Test match. 1.7: Studio music. 1.20: Scores of the 5th Test match. 1.30: Talk to children and special entertainment for children in hospital. 1.35: Scores of the 5th Test match. 1.37: Talk to children, etc., continued. 2.0: G.P.O. chimes. Close.

AFTERNOON SESSION.

Announcer: A. C. C. Stevens. Accompanist: Kathleen Roe. 3.45: Programme announcements. 3.47: Studio music. 3.50: Scores of the 5th Test match, England v. Australia, played at Melbourne. 3.52: Studio music. 4.0: G.P.O. chimes. A talk by Captain Stevens. "Following the Drum in Many Lands." 4.15: Studio music. 4.20: Molly James, pianoforte solo. "Waldstein Sonata" (Beethoven), Op. 53, first movement. 4.28: Studio music. 4.35: Scores of the 5th Test match. 4.47: Popular music. 4.50: Scores of the 5th Test match. 4.52: Molly James, pianoforte solo. "Andante and Rondo Capriccioso" (Mendelssohn), Opus 14. 5.0: Studio music. 5.5: Scores of the 5th Test match. 5.7: Studio music. 5.20: "Sun" news service. 5.25: Studio music. 5.32: Producers' Distributing Society's poultry report. 5.34: Studio music. 5.37: Features of the evening's programme.

EARLY EVENING SESSION.

Announcer: Basil Kirke. 5.40: Children's session. Music and entertainment. Letters and stories. 5.50: Scores of the 5th Test match. 5.52: Children's session, continued. 6.5: Stumps drawn and scores of the 5th Test match. 6.7: Children's session, continued. 6.30: "Sun" news and late sporting. 6.40: Special dinner music recital. 7.7: Australian Mercantile Land and Finance Co.'s report. Weather report and forecast, by courtesy of the Govt. Meteorologist. Producers' Distributing Society's fruit and vegetable market report. Grain and fodder report ("Sun"). Dairy produce report ("Sun"). 7.25: Mr. Pim and Miss Pam in advertising talks and nonsense. 7.55: Programme and other announcements.

EVENING SESSION.

Announcer: Basil Kirke. Accompanist: G. Vern Barnett. 8.0: G.P.O. chimes. From Her Majesty's Theatre, the first act of "Hit the Deck" (by permission of J. C. Williamson, Ltd.). Cast: Characters in order of appearance—

A Marine Jack Grant
Battling Smith Gus Bluett
Magnolia (a colored servant) May Beatty
Looloo Martin (owner of the Sailors' Coffee House) Annie Croft
Charlotte Payne Mary Rigby
Flag Lieutenant Alan Clark, Frank Leighton

Pamela Carr Ivy Parker
Bill Smith, Mat, Bunny, sailors in H.M. Navy, Leyland Hodgson, Leo Franklyn, Leslie Donaghey.
Captain Roberts, R.N. Jack Dunne
Quartermaster James Hughes
Middy Lauri Beatty
Sergeant of Marines Ray Carey
Chinese Singing Girl Ellen Starr
Wing Fang (a Chinese Mandarin), Frank Hawthorne

First Chinese Coolie Len Gotting
Second Chinese Coolie James Patterson
Choo Fang Maa Ting Fu
Rita Billie Lockwood

Musical Numbers:

Overture.
"Join the Navy" Ladies and Gentlemen
Looloo, Annie Croft and Chorus Gentlemen.

"Harbor of My Heart," Annie Croft and Leyland Hodgson.
"Shore Leave," Ladies of the Ballet and Chorus Gentlemen.
"Lucky Bird" May Beatty

"Sailor Boy Blues," Annie Croft and Chorus Ladies and Gentlemen.
"Sometimes I'm Happy," Annie Croft and Leyland Hodgson.

"Forty-seven Ginger-headed Sailors," Gus Bluett and Chorus Gentlemen.
Finale Annie Croft and Company
Synopsis of Scenery:

Scene 1.—Looloo Martin's Ship Coffee House (near the Docks at Plymouth).
Scene 2.—Six months later—the Quay Steps.
Scene 3.—Quarter-deck of H.M.S. Inscrutable—three days later.

9.50: From the studio, last minute sporting information, by G. R. Dexter.
10.5: Charles Lawrence and Rae Foster, popular vocal duets.

10.15: "Archie airs his views."
10.20: Charles Lawrence and Rae Foster, popular vocal duets.

10.30: Late weather report.
10.31: Romano's Dance Orchestra, conducted by Bennie Abrahams.

10.57: From the studio, resume of following day's programme.
11.0: Romano's Dance Orchestra, conducted by Bennie Abrahams. During the intervals between dance items "Sun" news will be broadcast.

11.30: National Anthem. Close down.

2GB

10.0: Music. 10.10: Happiness Talk by A. E. Bennett. 10.20: Music. 10.30: Women's session, by Miss Helen J. Beerling. 11.30: Close down. 2.0: Music. 2.5: Women's Radio Service, by Mrs. Dorothy Jordan. 2.50: Music. 3.15: Close down. 5.30: Children's session, by Uncle George. Radio Movie Club. 7.0: Stock and market reports by New Zealand Loan and Mercantile Agency, Ltd. 7.15: Music. 8.0: Mr. Leonard Brewer (violinist). 8.10: Miss Lorraine Lincey (contralto). 8.20: Miss Jean Read (pianiste). 8.30: Mr. Jack Win and Mr. Heath Burdock (humor). 8.35: Mr. Gerald Cashman (tenor). 8.45: Instrumental music. 8.50: Miss Marjorie Cole (soprano). 9.0: Weather report. 9.3: Address. 9.15: Mr. Leonard Brewer (violinist). 9.25: Miss Lorraine Lincey (contralto). 9.35: Mr. Jack Win and Mr. Heath Burdock (humor). 9.40: Miss Jean Read (pianiste). 9.50: Mr. Gerald Cashman (tenor). 10.0: Miss Marjorie Cole (soprano). 10.10: Dance music. 10.30: Close down.

2UW

10.0: Music. 10.10: Happiness Talk by A. E. Bennett. 10.20: Music. 10.30: Women's session, by Miss Helen J. Beerling. 11.30: Close down. 2.0: Music. 2.5: Women's Radio Service, by Mrs. Dorothy Jordan. 2.50: Music. 3.15: Close down. 5.30: Children's session, by Uncle George. Radio Movie Club. 7.0: Stock and market reports by New Zealand Loan and Mercantile Agency, Ltd. 7.15: Music. 8.0: Mr. Leonard Brewer (violinist). 8.10: Miss Lorraine Lincey (contralto). 8.20: Miss Jean Read (pianiste). 8.30: Mr. Jack Win and Mr. Heath Burdock (humor). 8.35: Mr. Gerald Cashman (tenor). 8.45: Instrumental music. 8.50: Miss Marjorie Cole (soprano). 9.0: Weather report. 9.3: Address. 9.15: Mr. Leonard Brewer (violinist). 9.25: Miss Lorraine Lincey (contralto). 9.35: Mr. Jack Win and Mr. Heath Burdock (humor). 9.40: Miss Jean Read (pianiste). 9.50: Mr. Gerald Cashman (tenor). 10.0: Miss Marjorie Cole (soprano). 10.10: Dance music. 10.30: Close down.

2UW

5.30: Children's hour, conducted by Uncle Jack. 6.30: Close down. 7.0: G.P.O. clock and chimes. Music. 8.0: To-day's anniversary. Music. 9.0: G.P.O. clock and chimes. Comments on foreign affairs by Mr. J. M. Prentice. 9.10: Music and request numbers. 10.0: Close down.



IT'S THE SLOPE THAT MAKES PHILIPS VALVES SO GOOD!

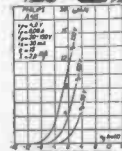
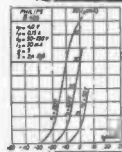
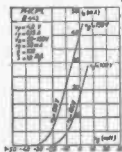

SLOPE, or as it is called, Mutual Conductance, tells just how good a radio valve is. The steeper the slope the larger the changeable current for a given grid voltage.

Look at the slope Philips "Mini-watts." Some of you will see are as high as 2.4 mA/Beer; that's the only word that describes them!

POPULAR SIX VOLT TYPES

Type.	Purpose.	Fil. Amps.	Price.
A609	General Purpose.	.06	13/6
A635	H.F.	.06	13/6
A615	Det.-1st Audio.	.08	15/-
B605	Power.	.1	13/6
C603	Super Power.	.3	18/-

POPULAR FOUR VOLT TYPES

Type.	Purpose.	Fil. Amps.	Price.
A409	General Purpose.	.06	13/6
A435	H.F.	.06	13/6
A415	Det.-1st Audio.	.08	15/-
A442	Screen Grid.	.06	30/-
B405	Super Power.	.15	20/-
B409	High Gain.	.15	18/-
B443	Penthode.	.15	37/6

PHILIPS "MINIWATTS"

Overseas (fifth Test match). 7.45: Leo Thistleton, soloist of "The Varsity Drag."

NIGHT SESSION.

Announcer: J. L. Norris.—8.0: G.P.O. chimes. 8.1: Holden's Silver Band (conductor, Mr. O. Summer-... "Song of Australia," selection "Musical Switch," march "On the Quarter Deck" (Alford). 8.15: Rev. Ezra Corman and Sadie M'Donald. 8.22: Don... comedian. 8.28: Marion Davey, contralto—... Mary's Song" (Elgar), "A Memory" (Davey). 8.30: Holden's Silver Band—Intermezzo, "After Sun-... (Wood), march, "Charge of Battalions" (Hall). 8.35: Helen Jackson, soprano—"The Second Minute" march, "The Elf Man" (Wells). 8.48: Cyril Reid and partner, instrumentalists, in enchanting Ha-... music. 8.50: Holden's Silver Band, selection, "The... 9.0: G.P.O. chimes. 9.1: Meteorological... 9.2: Overseas grain report. 9.3: Inter-... cricket scores. 9.4: Results of Inter-State... matches and annual tournament. 9.5: P. H... march, assisted by Bessie Francis, "Julius Caesar." 9.55: Marion Davey, contralto—"Caller Herrin" (old... "A sprit Flower" (Tipton). 9.31: Don... comedian, in a humorous interlude. 9.37: Holden's Silver Band—Dance, "Hanky Panky" (Hollis), waltz, "Scotch" (Raymond). 9.46: Rev. Ezra Corman and Sadie M'Donald. 9.55: Cyril Reid and partner, instrumentalists. 10.4: Violet Jackson, soprano—"Creole Cradle Song" (Clutsam), "Persian... of Spring" (M'Burney). 10.15: Holden's Silver... Characteristic, "March of Manikins" (Wheeler); intermezzo, "After Sunset" (Wood); mor-... "White Heather" (Philliam). 10.15: General... service, meteorological information; 5GL's... service by "Slightly" including a review of... and Murray Bridge racing. 10.31: Modern... numbers by the Radio Revellers. 11.0: God... the King.

6WF

Progress results of the 5th Test match will be broadcast each half hour until stumps.) 12. Tune in. 12.35: Markets, news, etc. 1.0: News report. 1.1: Weather bulletin, supplied by Meteorological Bureau of West Australia. 1.3: Music selection by the Studio Trio; vocal numbers from the studio. 2.0: Close down. 3.30: Tune in. 3.45: Afternoon tea concert, relayed from the Carlton Cafe, vocal numbers from the studio. 4.30: Close down. 6.45: Tune in. 6.48: Bedtime stories by the Kiddles by Uncles Percy and Duffy. 7.5: Music made by the Studio Trio. 7.50: Commercial and general information. 7.45: "Racing Anticipations" by the Sporting Editor of the "Truth" News-... Co. Ltd. 8.0: Time signal. 8.1: First... weather bulletin. 8.3: Items by the "Katoomba... Instrumental; vocal items from the studio. 8.45: Late news items by courtesy of "The Daily... Newspaper Co.; ships within range announce-... nation announcements; late weather bulletin. 8.55: Description of wrestling match by the Sporting... of "Truth" Newspaper Co., relayed from... the Minto Oval. 10.30: Close down.

104.5 METRE TRANSMISSION.

Simultaneous broadcast on 104.5 metres of pro-... gram given on 1250 metres, commencing at 6.45

7ZL

MIDDAY SESSION.

Announcer: Jack Broadbent.—11.30: Selections. 11.45: Midlands weather forecast. 11.35: Selections. 11.50: Tasmanian stations 9 a.m. weather report. 12.0: G.P.O. clock chimes the hour. 12.1: Shipping... mail notices, housewives' guide, com-... news, ships within wireless range. 12.8: Se-... 12.11: British official wireless news. 12.20:... 12.25: Announcements. 12.33: Selections. 12.35: News service; railway auction produce sales... at railway. 1.0: Description of the fifth Test... England v. Australia, played at Melbourne... Ground, Victoria. 1.30: Close down.

AFTERNOON SESSION.

Announcer: Jack Broadbent.—2.15: Description of the fifth Test match, English XI v. Australia, played at Melbourne C.G., Victoria. 4.0: An educational talk on "General Exports to Norway." 4.15: Description of the fifth Test match, English XI v. Australia, played at Melbourne C.G., Victoria. 4.30: Close down. 5.0: Description of the fifth Test match, English XI v. Australia, played at Melbourne C.G., Victoria. 5.30: Close down.

EARLY EVENING SESSION

Announcer: Jack Broadbent.—6.15: Selections. 6.30: "The Story Lady" will tell a story to the wee folk; "William III." 6.40: Selections. 6.45: Birthday... by "Uncle David" and "The Story Lady." 6.55: Answers to letters. 7.5: Selections.

EVENING SESSION.

Announcer: Lella Read. Announcer: Jack Broadbent.—7.15: A. M. O'Leary will speak on "Cricket... and 7ZL Artists:—Lella Read, piano solo. 7.30: Ruby Wallace, soprano, "Danny Boy" (Weather-... "Little Red House on the Hill" (La Vouche). 7.35: Ruby Wallace's Concert Orchestra. "In a Persian... Paris I and 2 (Ketelby). 7.49: J. Blair, violin. 7.54: Ketelby's Concert Orchestra, "Three... Kings, Paris 3 and 4 (Ketelby). 8.3: Ruby Wallace, soprano, "The Wood... (Lohmann), "Laugh and Sing" (Drummond). 8.5: Goodies Silverton Quartet, "Under the Clover... World Serenade" (Helmund). 8.10: Ketelby's... Orchestra, "Bells across the Meadows" (Ke-... 8.11: Ruby Wallace, soprano, "The Wood... (Lohmann), "Laugh and Sing" (Drummond). 8.15: Goodies Silverton Quartet, "Under the Clover... World Serenade" (Helmund). 8.22: J. Blair, baritone. 8.30: Spencer Shaw, violin solo, "Pinaudina" (Sibelius). 8.33: Rene Dyer, violin. 8.35: Lella Read, soprano, "Tha's... (Bates). 8.40: Cernilovsky Trio, violin, cello, and... "Baccarile," Tales of Hoffmann (Offenbach). 8.45: J. M. Counsel. "A Musical Hour with the Old... 8.45: News. 10.0: G.P.O. clock chimes the... 11.0: Close down.



AUTO LITE

ELECTRICAL EQUIPMENT SALES and SERVICE

World-famed for its hardy construction and trouble-free service, this system is standard equipment on the following cars:—

- DURANT
- ESSEX
- FALCON KNIGHT
- GARFORD TRUCK
- HUDSON
- HUPMOBILE
- JORDAN
- NASH
- OVERLAND
- REPUBLIC TRUCK
- RUGBY
- STAR
- STEARNS KNIGHT
- WILLYS KNIGHT

We invite you to pay a visit to our Service Station where all car electrical repairs are carried out, quickly and efficiently, and only genuine parts are supplied and used.

Exide

LONG LIFE CAR AND WIRELESS BATTERIES

Service Station:—

GIBSON, BATTLE & Co. Ltd.,

HUNT AND COMMONWEALTH STREETS, (off Wentworth Avenue) SYDNEY. 'Phone, M2771 (Three Lines)

Exide Batteries, Delco-Remy, North East, Autolite, Owen Dyneto Electrical Equipment.

Local Programmes, Saturday, March 9

2FC

EARLY MORNING SESSION.

Announcer: A. S. Cochrane.
 7.0: "Big Ben" and announcements. 7.2: Official weather forecast, rainfall, river reports, temperatures, astronomical memoranda. 7.7: "Sydney Morning Herald" summary. 7.12: Shipping intelligence, mail services. 7.15: Investment market, mining sharemarkets, metal quotations, wool sales, breadstuffs markets, Inter-State markets, produce markets. 7.40: Studio music. 8.0: "Eig Ben." Close.

MORNING SESSION.

Announcer: Eric Bessemer.
 10.0: "Big Ben" and announcements. 10.2: Pianoforte reproduction. 10.10: "Sydney Morning Herald" news service. 10.25: Studio music. 10.30: Last minute sporting information, by the 2FC Racing Commissioner. 10.40: Studio music. 10.45: A gardening talk, by "Redgum" (J. G. Lockley). 11.0: "Big Ben." A.P.A. and Reuter's cable services.

MIDDAY AND AFTERNOON SESSIONS.

Announcers: Laurence Halbert, Ewart Chapple.
 12.0: "Big Ben" and programme announcements. 12.2: Stock Exchange information. 12.4: Studio music. 12.10: "Sydney Morning Herald" news service. 12.15: Rugby wireless news. 12.20: Scores of the 5th Test match, England v. Australia, played at Melbourne. 12.22: Studio music. Note.—Races: Description of the events in the running of the meeting at Rosehill will be given by the 2FC Racing Commissioner. Cricket: Throughout the afternoon at intervals scores of the 5th Test match, England v. Australia, played at Melbourne, will be given. 1.0: "Big Ben." Weather intelligence. 1.3: "Evening News" midday news service. Rugby wireless news. 1.15: Stock Exchange and sporting events. Note.—During sporting intervals the 2FC Studio Dance Band, conducted by Cec. Morrison, will be heard in popular numbers. 4.45: Complete sporting resume. 5.0: "Big Ben." Close.

EARLY EVENING SESSION.

Announcer: A. S. Cochrane.
 5.40: The chimes of 2FC. 5.45: The children's session, conducted by the "Hello Man." Letters and stories. 5.50: Cricket scores, 5th Test match, England v. Australia, played at Melbourne. 5.52: Letters and stories, continued. 6.5: Cricket scores and stumps drawn. 5th Test match. 6.7: Letters and stories, continued. 6.30: Music and entertainment. 6.40: Weather intelligence, shipping, Stock Exchange. 6.45: Rugby wireless news. 6.50: Sporting news, late news, and studio music. 7.10: The 2FC Dinner Quartette, conducted by Horace Keats—(a) "Russian Peasant Dance" (Lehar), (b) "Intermezzo Francaise" (Hosmer), (c) "In a Chinese Temple Garden" (Kettelbey), (d) "Serenade Espagnole" (Bizet), (e) "Three English Dances" (Quilter), (f) "The Londonderry Air" (arr. Kreisler), (g) "Norwegian Dance" (Grieg).

EVENING SESSION.

Announcer: Laurence Halbert.
 Accompanist: Ewart Chapple.
 7.40: Studio music.
 7.45: Programme announcements.
 7.47: Studio music.
 8.0: From the Empire Theatre, Camden, programme arranged by 2FC's Hospital Concert Party, in aid of the District Hospital, under the direction of Charles Lawrence. Assisting artists: Ad Cree, Scottish comedian; Margaret Grimshaw, popular vocalist; John Warren, tenor; Arthur Prince, banjo and uke; Peg Dunbar, contralto; Uncle Ted and Sandy, ventriloquist act.
 9.0: From the studio, late weather forecast.
 9.1: Studio Dance Band, conducted by Cec. Morrison.
 9.10: From the Empire Theatre, Camden, second part of the programme arranged by the 2FC Concert Party, under the direction of Charles Lawrence.
 9.40: From the studio, Studio Dance Band, conducted by Cec. Morrison.
 9.50: From the Speedway, description of the racing.
 10.0: From the studio, Studio Dance Band, conducted by Cec. Morrison.

INDEX

To Local Programmes

FRIDAY, March 8—	
2FC, 2BL, 2GB, 2UW	27
SATURDAY, March 9—	
2FC, 2BL, 2GB, 2UW	32
SUNDAY, March 10—	
2FC, 2BL, 2GB, 2UW	36
MONDAY, March 11—	
2FC, 2BL, 2GB, 2UW	38
TUESDAY, March 12—	
2FC, 2BL, 2UW	42
WEDNESDAY, March 13—	
2FC, 2BL, 2GB, 2UW	45
THURSDAY, March 14—	
2FC, 2BL, 2UW	48

10.10: The Speedway, description of the racing.
 10.20: From the studio, Studio Dance Band, conducted by Cec. Morrison.
 10.26: Bernice Patterson, popular vocalist.
 10.33: Studio Dance Band, conducted by Cec. Morrison.
 10.40: Bernice Patterson, popular vocalist.
 10.47: Studio Dance Band, conducted by Cec. Morrison. z z z z z
 10.59: To-morrow's programme.
 11.0: Studio Dance Band, conducted by Cec. Morrison.
 11.30: National Anthem. Close down.

2BL

MORNING SESSION

Announcer: A. S. Cochrane.
 8.0: G.P.O. chimes; metropolitan weather report. 8.1: State weather report. 8.2: Studio music. 8.15: G.P.O. chimes; news from the "Daily Telegraph Pictorial." 8.30: G.P.O. chimes; news service continued. 8.40: Information; mails, shipping, arrivals, departures, and sailings. 8.45: Studio music. 9.15: Half an hour with silent friends. 9.45:



"The Temple of the Winds," at the Melbourne Botanic Gardens, designed and erected by W. E. Guilfoyle, Director 1873 to 1904, and dedicated to the memory of Charles Joseph Latrobe, first Governor, who selected the site of the Botanic Gardens, established 1846. Mr. G. Cooper, in his gardening talk from 2BL to-day, will have some interesting and little known facts to say about this memorial.

Studio music. 10.0: G.P.O. chimes; close down.

MIDDAY SESSION

Announcer: A. S. Cochrane.
 11.0: G.P.O. chimes; women's session, conducted by Mrs. Cranfield; what's on in the pictures and theatres. 11.30: Advertising hints. 11.40: Women's session continued. 12.0: G.P.O. chimes; special ocean forecast and weather report. 12.3: Pianoforte reproduction. 12.20: Scores of the fifth Test match, England v. Australia, played at Melbourne. 12.22: Pianoforte reproduction. 12.30: "Sun" news service. 12.35: Scores of the fifth Test match. 12.37: Studio music. 12.50: Scores of the fifth Test match. 12.52: Studio music. 1.5: Scores of the fifth Test match. 1.7: Studio music. 1.20: Scores of the fifth Test match. 1.22: Studio music. 1.30: "Sun" midday news service. 1.35: Scores of the fifth Test match. 1.37: "Sun" midday news continued. 1.40: Studio music. 2.0: G.P.O. chimes; close. Note.—Race results will be given from Rosehill of the race meeting at regular intervals during the afternoon by courtesy of the "Sun" Newspapers.

AFTERNOON SESSION

Announcer: Basil Kirke.
 3.45: Programme announcements. 3.47: Studio music. 3.50: Scores of the fifth Test match, England v. Australia, played at Melbourne. 3.52: Studio music. 4.0: Romano's Cafe Dance Orchestra, conducted by Bennie Abrahams. 4.10: Scores of the fifth Test match, England v. Australia, played at Melbourne. 4.12: Studio music. 4.15: Romano's Cafe Dance Orchestra, conducted by Bennie Abrahams. 4.30: Studio music. 4.35: Scores of the fifth Test match, England v. Australia, played at Melbourne. 4.37: The Idlers. 4.50: Studio music. 5.5: Scores of the fifth Test match, England v. Australia, played at Melbourne. 5.7: The Idlers. 5.20: Studio music. 5.25: The Idlers. 5.30: Racing resume. 5.33: Studio music. 5.37: Features of the evening programme.

EARLY EVENING SESSION

Announcer: Basil Kirke.
 5.40: Children's session, music and entertainment; letters and stories. 6.30: "Sun" news and late sporting. 6.40: 2BL Dinner Quartette—(a) "Valse des Fleurs" (Tschakowsky); (b) "Chero" (Finck); (c) "Low Song" (Flegler); (d) "Mississippi Mud" (Garris); (f) "Little Lady of the Moon" (Coster). 7.7: Complete sporting and racing resume. 7.30: Mr. Pim and Miss Pam in advertising talks and nonsense. 7.55: Programme and other announcements.

EVENING SESSION

Announcer: Jack Barnett.
 Accompanist: Jack Barnett.
 8.0: G.P.O. chimes.
 "Ye Merrie Trio."
 8.15: "Archie Ails his Views."
 8.20: Tom King, novelty pianist—
 (a) Selection "Good News" (Henderson).
 (b) "That Certain Feeling" (Gershwin).
 8.28: Popular Studio programme.
 9.37: Tom King, novelty pianist—
 (a) "Hallelujah" (Cummings).
 (b) "Some Old Favorites Renewed" (arr. King).
 9.45: "Ye Merrie Trio."
 10.0: Romano's Dance Orchestra, conducted by Bennie Abrahams.
 10.10: From the studio—
 "Ye Merrie Trio."
 10.25: Romano's Dance Orchestra, conducted by Bennie Abrahams.
 10.35: From the studio—
 Weather report and announcements.
 10.37: Romano's Dance Orchestra, conducted by Bennie Abrahams.
 10.57: From the studio—
 Resume of following day's programme.
 11.0: Romano's Dance Orchestra, conducted by Bennie Abrahams.
 During intervals between dance items "Sun" news will be given.
 11.30: National Anthem; close down.

2GB

3.0: Musical session. 5.30: Children's session. 7.0: Dance music. 8.0: Request night. 9.0: Grown-up bedtime stories. 10.0: Close down.



SIEMENS RADIO BATTERIES

Stand the test
of TIME

PRICE.



Time is the Great Leveller. The value of a Radio Battery is measured by the time of its usefulness and efficiency during that time.

By efficiency it is understood that nothing less than 100 per cent. is worth while. It must deliver all that is called upon it to do to make your set function with precision and clarity. It is the most vital part of your radio equipment.

With a "SIEMENS" Battery you get long life, plus 100% efficiency. A "Siemens" is constructed to deliver these two vital essentials. A specially prepared Electrolyte is employed to overcome rapid deterioration.

The moment you install "SIEMENS" as part of your radio equipment you will begin to know what efficiency really is, and after months of heavy duty you will discover how economical, too! Cut out Battery troubles—hook up to Siemens.

BE SURE TO INSIST ON

SIEMENS RADIO BATTERIES

British Built Throughout

ON SALE
AT ALL
RADIO
DEALERS

ACCREDITED
RADIO
DEALERS
APPLY
FOR
TRADE
TERMS.

SIEMENS (Australia) Pty. Ltd.,

257 Clarence Street, Sydney; 45 Watt Street, Newcastle; Melbourne, Adelaide, Brisbane, Hobart.

Interstate Programmes, Saturday, March 9

3LO

EARLY MORNING SESSION.

7.15 to 8.15, see Friday.

MORNING SESSION.

Announcer: John Stuart.—11.0: The Radio Revelers.—"The Duke Dearest" (Fisher); "It Goes Like This" (Whitting); "Roses of Yesterday" (Beilke). 11.20: Syd. Hollister, comedian, "Jocularity". 11.25: Eric Welch will speak on to-day's V.R.C. races at Flemington. 11.35: The Radio Revelers—"Forever More" (Runnelt); "Nebraska" (Alken); "That's my Weakness Now" (Stept). 11.44: Syd. Hollister, comedian, "A Few Minutes' Fun". 11.51: The Radio Revelers—"Get Out and Get Under the Moon" (Tobias); "In a Bamboo Garden" (Donaldson); "Anything You Say" (Donaldson). 12.0: Description of the fifth Test match, England v. Australia, at M.C.C., by Rod M'Gregor. 12.58: Description of Gibson Carmichael Stakes, seven furlongs, by Eric Welch. 1.5: Description of King's Plate, two miles, V.R.C. races, at Flemington. 1.45: The Imperial Russian Trio (Arved Norio, violin; Ivan Bersinsky, cello; Vassili Ilster, piano)—Arved Norio, violin, "Indian Lullaby" (Dvorak-Kreisler); the Trio, selected. 2.0: Close down.

AFTERNOON SESSION.

Announcer: John Stuart.—2.15: Description of fifth Test match, England v. Australia, at M.C.C., by Rod M'Gregor. 2.38: Description of Leonard Stakes, V.R.C. races at Flemington, by Eric Welch. 2.45: Description of fifth Test match resumed. 3.28: Description of Autumn Steeplechase, three miles, on turf, V.R.C. races at Flemington. 3.35: Description of fifth Test match continued. 4.0: Sonora recital of the world's most famous records. 4.05: Description of Northcote Handicap, 1 1/4 miles, V.R.C. races, at Flemington, by Eric Welch. 4.26: Description of fifth Test match continued. 4.58: Description of Farewell Handicap, one mile, V.R.C. races, at Flemington. 5.5: "Herald" news service. 5.12: Description of fifth Test match continued. 6.0: Stumps drawn.

6.5: Answers to letters and birthday greetings by "Little Miss Kookaburra." 8.30: Musical interlude. 8.35: "Miss Kookaburra" will tell more about Nellie and Billy in Moonland. The Prince presses Billy into his service when waking the sleeping Beauty. Bill's disgust. The Man in the Moon and the Queen of Dreamland help explain matters. Nellie and Billy return to earth, and hear the jolly laugh of the Test match continued. 6.0: Stumps scores.

NIGHT SESSION.

Announcer: Renn Miller. Accompanist: Agnes Fortune. 6.50: Stock Exchange information. 7.0: Market reports. 7.20: News session; stumps scores, fifth Test match, England v. Australia. 7.30: Birthday greetings. 7.33: "On the Past." 7.34: Edna Lee. Edna Lee will speak on "Wattles-Trees." 7.45: A Maker of History. 7.46: Dr. J. A. Leach will speak on "Quail Thrushes." 7.51: The Station Orchestra, overture, "Ika" (Doppler). 8.10: Millie M' Cormack, mezzo-soprano—"Bush, My Little One" (Bewignani); "Butterflies and Lilies" (Gibson). 8.17: The Station Orchestra, suite, "From the South" (Nicole). 8.25: J. Alexander Browne, baritone—"The Blue Dragons" (Keeney-Rundell); "An Interlude." 8.30: "Strike Martin." 8.32: Percy Code, trumpet, "For You Alone" (Geehl). 8.37: Hugh Huxham's Serenade Quartette—"The Quartette," "The Lantern and the Moth"; Madeline Knight, contralto, selected. Orchestral interlude, first movement of "Sonatina" (Hill); The Quartette, "Just Like a Melody," "Smile, Smile, Smile"; Orchestral interlude, second movement of "Sonatina" (Hill); The Quartette, "A Heart that's Free." 9.0: The Song Feature of the Week. 9.3: The Station Orchestra, selection, "Sylbi" (Jacobi). 9.13: Eric Welch will describe to-night's events at the Stadium. 9.30: The Station Orchestra, "Serenade and Pierrette" (Chaminade). 9.35: Millie M' Cormack, mezzo-soprano—"Last of the Minstrel" (Barnes); "How Delightful the Morning" (Reynolds). 9.42: The Station Orchestra, "Selection from Cycle" (Goddard). 9.52: J. Alexander Browne, baritone—"The Crown of the West" (Sanderson); "The Crown of the Year" (Easthope-Martin). 10.0: Eric Welch will again describe the night's events at the Stadium. 10.05: The Station Orchestra, "I selection." "Il Trovatore" (Verdi). 10.28: Syd. Hollister, comedian, will amuse you for a while. 10.35: The Station Orchestra—Intermezzo, "Aminu" (Lanka); "As the Breeze" (de Bouter). 10.42: Spencer Ward and Gertrude Long, "Just a Piano and Us." 10.50: Late sporting. 10.55: The Radio Revelers—"Forever More" (Burdette-Geebraska) (Revel); "Mexican Serenade" (Terese); "I Love to Dunk a Hunk of Sponge Cake" (Castill). "Because my dear Mother" (The Station Orchestra). "Beloved" (Kahn). 11.0: Our Great Thought for to-day is—"That which is everybody's business is nobody's business."—Jaac Walton. 11.1: The Radio Revelers—"Beloved" (Kahn). "That Which You Mean to Me" (Davis). "There's a Ricketty-Racketty Shack" (Turk). "Japanese Mammy" (Donaldson). "Lena" (Gilbert). "The Station Orchestra" (Fisher). "Guess Who's in Town" (Razall). "My Dream Sweetheart" (Hall). "Old Man Sunshine" (Dixon). 11.30: God Save the King.

3AR

MORNING NEWS SESSION

10.0: G.P.O. clock says "Ten." 10.1: "Age" stock Exchange reports; London metal market. 10.2: "Age" market reports; farm and station produce, fruit, fish, vegetables, etc. 10.25: "Age" shipping

reports; ocean forecast. 10.30: Mail notices; express train information. 10.35: "Age" news service. 10.59: Weather forecast.

MORNING MUSICAL SESSION

11.0: A bravura of beautiful ballads. 11.50: News service; rates of exchange. 12.0: Close down.

AFTERNOON SESSION

Announcer: Maurice Dudley, Accompanist: Agnes Fortune. 3.0: The Station Orchestra—selection, "Gerswini" ("Butterfly" (Denmore). 3.15: Marcelle Berard, soprano—"Sylvain" (Sinding), selected. 3.22: The Station Orchestra—Irish selection, "Musically" (Bernard Manning, biter) and Gertrude Long—"A Piano and Just Us." 3.49: The Station Orchestra—selection, "The Bushing Brice" (Romberg). 4.0: Announcements. 4.4: Bernard Manning, bass-baritone—"Tny Sentinel An T" (Watson); "At Sunrise" (Ronald). 4.11: The Station Orchestra—Suite, "Dance Revel" (A. Phillips). 4.16: Spencer Ward and Gertrude Long—"A Piano and Just Us." 4.23: The Station Orchestra—selection, "Sally" (Kern). Bernard Manning, biter, "Serenade"—"Onward Awake, Beaved" (Covey). "The Silent Night" (Rachmaninoff). 4.40: Announcements. 4.45: The Station Orchestra—"Children's Suite" (Ansel), selected. 5.0: Close down.

EVENING SESSION

Announcer: Frank Hatherley. 6.0: Gramophone recital. 7.10: News service; announcements; results of cricket, England v. Australia. 7.29: Gramophone recital continued.

NIGHT SESSION

Announcer: Frank Hatherley. Accompanist: Agnes Fortune. 8.0: 11 sporting results. 8.30: Prahran City Band—March, "Murcette" (Heber); "La Paloma" (Yradier). 8.40: Chas. Treways, baritone—"Home-ward Bound" (Gieson). "Song of the Bow" (Ayrward) 8.47: Prahran City Band—"March of the Mannikins" (Pletcher); cornet solo, "At Dawn." 8.55: Ivan Head—Bernard Manning, biter Tongue, produced by Betty Rae. Cast: Patty Janslop, Ruby May; Minnie Bracey, Betty Rae; Walter Scotland, W. J. Bracey; Terence Clisp, waitress, Nancy Hardenach. Scene: Varley's Private Hotel, Southampton. 9.20: Prahran City Band—"Chanson Indou" (Rimsley-Korsko). 9.27: Chas. Treways—"Home-ward Bound" (Gieson). "Time Was I Roved the Mountains" (Lohr). 9.34: Imperial Russian Trio—Brahms' Trio in E flat Major, Adagio Mesto, Albanic corn trio, "Spanish Dance" (Moszkowsky), selected. 10.4: Organ recital by C. E. Monteth—transmission from St. Peter's Church, Eastern Hill—"Chora No. 3 in A Minor" (Geat Franck). "Morning" and "Aase's Death" from "Peer Gynt" (Moriag), "Minuet" from "Samson" (Haeckel); "Triumphal March" (Liszt). 10.55: News service; announcements; results of cricket match, England v. Australia. "God Save the King"

40G

EARLY MORNING SESSION

Announcer: J. Tyson. 7.43: Time signals. 7.48: News service. 7.51: Some musical records. 8.15: News service. 8.30: Close down.

AFTERNOON SESSION

E.A.T.O. Race meeting: The race meeting will be described direct from the Albion Park Racecourse. Transmission will commence with the start of the first race. Between races music from the studio will be relayed.

EVENING SESSION

6.30: Bedtime stories, conducted by "Uncle Ben." 7.15: To-day's race results in brief. 7.20: General sporting notes. 7.30: Sailing notes by Mr. Fred. Smith.

NIGHT SESSION

8.0: From the Studio—Orverture by Savoy Orchestra. 8.10: From the Studio—Fee Todd (elocutionist)—"A Gentleman of France" (Walsh). 8.15: Mrs. F. North (pianiste)—"Noivette in D" (Schumann). 8.20: Phyllis Vermer (soprano)—piano numbers—"Jeannine." "The Blue Room"—8.30: From the Speedway—motor cycle races. 8.45: From the Speedway—"The Station Orchestra" (M'Gee). 8.55: From the studio—Fee Todd (elocutionist)—"Soliloquy on an Old Shoe" (Nichols); Mrs. Funnell (soprano), "Waddle Song"—Brahms' "Sing Merrily To-day" (Phillips); Mrs. F. North (pianiste)—"Mendelssohn." 9.15: From the Speedway—motor cycle races. 10.0: From the Studio—"The Sunday Mail" news; weather; close down.

5CL

MORNING SESSION.

Announcer: J. L. Norris.—12.0: G.P.O. chimes. 12.1: Late sporting. 12.15: "Age" news service. Eric Welch, 3LO's Sporting Commissioner. 12.2: Description of the fifth Test match, England v. Australia, by Mr. Rod M'Gregor, of M.L.C. Melbourne. 1.0: From Murray Bridge—discussions and positions for the Handicap Hurdle race, 2 miles and 13 furlongs. 1.5: General news service; British official wireless news, description of the fifth Test match, England v. Hurdles by Mr. Arnold Treloar. 1.20: Twenty minutes with Parlophone artists. 1.40: Riders and positions for the second division of the Handicap Trial Stakes, 2 miles. 1.47: Musical interlude continued. 1.55: Running description of Novice Race. 2.0: Resume of previous race results and dividends, and scores of College v. Country cricket match. 2.5: Musical numbers. 2.20: Riders and positions for the Autumn Handicap, 1 1/4 miles. 2.25: Musical interlude. 2.30: Description of play in the fifth Test match. 2.35: Running description of the Autumn Handicap. 2.40: Description of play in the fifth Test match. 3.10: Riders and positions for Handicap Brush Steeplechase, about 3 miles and 3 furlongs. 3.15: Running description of the Handicap Brush Steeplechase. 3.20: Description of play in the fifth Test match. 3.30: Resume of previous race results and

College v. Country Colts cricket match scores. Description of Inter-State cricket match and announcement by Mr. F. J. Mills. 3.40: Riders and positions for first div. of Handicap Trial Stakes. 3.45: Description of Handicap tennis match, 1st annual tournament. 3.55: Running description of first division of Handicap Trial Stakes. 4.0: Description of race results at Flemington and Bridge; scores of College v. Country cricket match. 4.5: Description of Inter-State tennis annual tournament. 4.20: Riders and positions for division of Handicap Trial Stakes. 4.35: Description of Inter-State tennis and annual tournament. Description of fifth Test. 4.35: Running description of second division of Handicap Trial Stakes. 4.40: Description of the fifth Test. 5.1: Positions for the Welter Handicap, 1 mile. 5.15: Running description of Welter Handicap. 5.20: Run of the closing minutes' play in the fifth Test. 5.30: Resume of race results and close down.

EVENING SESSION.

Announcer: C. J. O'Connor.—6.0: G.P.O. 6.1: Resume of late sporting. 6.3: Birding news. 6.45: Sporting service by G.P.O. 6.50: Wattle Lullaby. 6.50: Captain Donald MacIntyre. An interlude of dinner music. 7.0: G.P.O. 7.1: C. Ward. 7.2: Stock Exchange information. 7.5: International cricket match, College v. Country Colts cricket match, and tennis matches and annual tournament. 7.5: Rev. G. E. E. "Willow" on "Cricket" (Cricket Test match). 7.55: C. G. Riley, talk on "The History of Cricket." 7.55: Sporting service by G.P.O. including Murray Bridge and Flemington suits.

NEIGHBOURHOOD SESSION.

Accompanist: Jean Fiddler.—6.0: G.P.O. 6.1: Marcus Tozer and Bondi Randall, violin. 6.2: Violet Jackson, soprano—"A Brown and a Blue" (Wood). "Lair de Salome" (L. Delibes). 6.3: A pianoforte recital by Lillian L.A.B. and Lillian Keen. L.A.B., Lillian Keen, pianiste, "Rhapsodie Hongroise" (Liszt); "Selling the Butter" (Hubay); Lillian Keen, pianiste, "Bird Song" (Chopin). "Butterfly Study" (Chopin). 6.4: Norman Sellick, violinist, "The Minute" by Kreisler; Lillian Keen, pianiste, "Evenson" by Easthope-Martin; Lillian Keen, violinist, "Paraphrase of Kreisler"; Lillian Keen, violinist, "Rondo" by Weber.

6WF

(Progress results of 5th Test match will call each hour until stumps.)

12.0: Time in. 12.5: Football news. 1.0: The Meteorological Bureau of West Australia. Close down. 2.30: Tune in. 2.33: Braconidae and other sports. 2.35: News service. 15 minutes. 5.30 (approx): Close down. Tune in. 6.48: Bedtime stories for the children. 7.12: Sports results. 7.15: News and general information. 7.20: Tune in. 8.1: First weather bulletin. Reuben Bell, songs at the piano. 8.15: Tune in. 8.0: Late news items. "Daily News" Newspaper Co.; ships announcement; station announcements; late bulletin.

104.5 METRE TRANSMISSION. Simultaneous broadcast on 104.5 metres given on 1250 metres, domestic p.m.

7ZL

MIDDAY SESSION

Announcer: Jack Broadbent.—11.30 to 11.45: Friday. 12.30: Anticipation.—31. Mr. Commissioner's last-minute selections for the races; also selections for the Sydney race meeting. 1.0: News service. 1.15: Running description of 5th Test Match. 12.50: News service. 1.15: Running description of Gibson Carmichael Stakes, seven furlongs, at Flemington. 1.25: Pennington, Melbourne, Victoria. 1.5: Description of the 5th Test Match. 1.40: Running description of King's Plate, two miles, Flemington. 1.43: Close down. Description of 5th Test Match. 1.45: Running description of Pillard Stakes, six furlongs, at Flemington. 2.45: Description of the 5th Test Match.

AFTERNOON SESSION

Announcer: Jack Broadbent. 3.30: Running description of Steeplechase, about 3 miles, at Flemington. 3.35: Description of the 5th Test Match. 4.0: Music. 4.20: Running description of the 5th Test Match. 4.30: Running description of the 5th Test Match. 4.30: Running description of Farewell Handicap, one mile, at Flemington. 5.5: Description of 5th Test Match.

EARLY EVENING SESSION

Announcer: Jack Broadbent. 5.0: Anticipation. 5.5: Music. 6.30: "The Minute" by Kreisler. 6.35: News items and birthday greetings by "Uncle Dan" Music. 7.15: News service.

Announcer: Jack Broadbent. 7.30: 8.0: A holds will speak on "Preservation of Bush." J. M. Counsel will speak on "European G.P.O. clock says Ten." 8.5: News items from the City Hall, Macquarie Street, Hobart. 9.15: News items from the City Hall, Macquarie Street, Hobart. 10.20: News items from the City Hall, Macquarie Street, Hobart. 10.50: Close down.

BRING 'EM IN, BOY!!!

LOCAL AND INTER-STATE LEAVE YOU COLD!!!

SHORT WAVES---They're saying something that'll thrill you

The English, the Dutch, the Yanks are putting it over—get in with a Short Waver !!!

	s	d
1 Bakelite Panel, 15 x 6	3	9
1 Lewcos 20-45 Meter Kit	18	6
2 Diora Bakelite Vernier Dials	12	0
1 Pilot 00015 S.L.F. Condenser	9	6
1 Pilot 00025 S.L.F. Condenser	11	6
1 Bakelite UX Socket	1	3
1 Centralab 30 Ohms Rheostat	3	6
1 R.F. Choke	5	3
1 Sangamo Grid and Leak	4	0
1 Terminal Strip with Terminals	2	6
1 Philips Special Detector	15	0
1 Ever-Ready 30v. B Battery	9	6
3 Columbia Dry Cells	8	3

(Guaranteed 1st Class Parts.)

Complete, £5/4/6

(ADD 10/- AND WE WILL BUILD IT.)

SEE IT MADE UP—IN ONE OF OUR WINDOWS

PRICE'S RADIO SERVICE, Wingello House, Angel Place, SYDNEY. B4146.

WIN £150

- 1st Prize £150 Cash
 - 2nd ,, £100 ,,
 - 3rd ,, £45 ,,
 - 4th ,, £20 ,,
- and hundreds of other prizes
YOU CAN WIN!



FIND THE FACES

Alman Bey, Magician of the East, is working in his magic way. He thinks he is alone, but there are four people watching him. If you turn the picture this way and that you will find them hidden in different parts. Mark each face as you find it with an X and send your answer AT ONCE.

As soon as your solution of the Magician Puzzle is received I will send you a copy of the simple, novel and thrilling Picture Game Competition in which over £600 is offered in 500 Big Prizes, First Prize, £150 Cash. The object of this Great Competition is to advertise my new series of books on character analysis through Graphology. Surely you can win one of these splendid prizes in this great test of skill! If there is a tie for any prize the full amount of the prize will be paid to each person. The prizes will be forwarded immediately after the judging.

Cut the Magician Puzzle out now, mark the hidden faces with an X, and send to me TO-DAY with your name and address clearly written. Here's your opportunity to win a small fortune. A simple test of skill which all may try. Enclose 3d. in stamps for postage, etc., on the particulars and simple rules of the Puzzle Game Contest, which will be sent at once. Address your solution to:—

A. HENRY SILVER, Author and Publisher
284 Castlereagh Street, Sydney

£50

Extra for Correct Solution and Early Entry.

£50 will be added to any prize won by you if you are successful in finding the four hidden faces and if yours is the earliest winning entry received in my Picture Game Competition. So send your answer to the Magician Puzzle AT ONCE.

A LONG FILAMENT

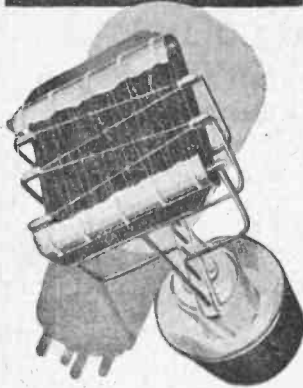

A long filament with a long life — that's the Mullard P.M. The great length of this filament gives it a gigantic emission surface, ensuring powerful yet pure reproduction.

Further, it consumes only .075 amps., and is easy on your batteries.

This wonderful Mullard filament is found only in Mullard P.M. Valves. They will improve any radio set—ask your dealer, he stocks them.

Mullard
THE MASTER VALVE

"Ask your dealer to demonstrate the Mullard Speaker, the only speaker with a Tone Control Switch."

B

Local Programmes, Sun., March 10

2FC

MORNING SESSION

Announcer: A. S. Cochrane.

- 10.0: "Big Ben" and announcements.
- 10.2: Studio music.
- 10.15: News service.
- 10.30: Studio music.
- 11.0: St. Mark's, Darling Point, morning service, conducted by Rev. Canon E. Howard Lea.
- 12.15: Close.

AFTERNOON SESSION

Announcer: C. R. Hall.

- 2.30: Programme announcements.
- 2.32: A chat about the "Cheer-up" Society by Uncle Frank.
- 3.0: From the Lyceum Hall, Pitt Street, pleasant Sunday afternoon programme, items by the Randwick Presbyterian choir, and an address by Rev. Maurice Young.
- 4.30: From the studio—W. F. Kay will give a talk on "Life on the Early Goldfields."
- 4.45: Studio music.
- 5.0: "Big Ben"; close.

EVENING SESSION

Announcer: Laurence Halbert.

- 6.0: "Big Ben" and programme announcements.
- 6.2: A talk by C. R. Hall.
- 6.20: From the Pitt Street Congregational Church—organ recital by Lilian Frost, (a) "Carillons of Dunkirk" (Carter), (b) "Priere et Berceuse" (Goullimant), (c) "Intermezzo" (Hollins), (d) "Festival Prelude" (Faulkes), (e) "Even Song" (Martin).
- 7.0: From the Pitt Street Congregational Church—Evening service, conducted by Rev. T. E. Ruth.
- 8.30: From the studio—The Empire Trio, in association with Miss le Brun Brown—Trio, "Opus 77 in E Flat" (Reissiger). Songs—"Down in the Forest" (Ronald), "Feast of the Lanterns" (Bantock).

- Miss le Brun Brown.
- Sonata for violin, cello, and piano (Maccello), Erve Carter and Horace Keats.
- "Ave Maria" (Bruch).
- Miss le Brun Brown.
- Trio—No. 4 in F (Rheinberger).
- Two request numbers—
- (a) "A Sprig of Boronia" (Hull)
- (b) "Forget-me-not" (Hull).
- Miss le Brun Brown.
- Trio, Opus 34 in G (Kiel).
- 10.0: Recital of selected records of world-famous artists.
- 10.27: To-morrow's programme.
- 10.30: National Anthem; close.

2BL

MORNING SESSION.

Announcer: A. C. C. Stevens.

- 11.0: G.P.O. clock and chimes.
- Morning service—broadcast from the Bourke Street Congregational Church, conducted by Rev. Sydney Herbert Cox.
- Organ Prelude.
- Call to Worship.
- Doxology.
- Prayer of Invocation.
- Hymn 585, "Awake, My Soul" (Verses 1, 4, 6).
- Responsive Readings, 785, Matt., 5: 3-9.
- Offertory.
- Organ Interlude and Offertory Prayer.
- Solo, Miss Varra Latham.
- Pastoral Prayer and Lord's Prayer (chanted).
- Notices.
- Anthem, "I am Alpha and Omega."
- Scripture Lesson.
- Boys and Girls' Story.
- Hymn 725: "There is a Green Hill Far Away."
- Sermon, "Facing what Seems Impossible."
- Hymn 487: "Take my Life—to Thee."
- Benediction.
- Organ Postlude. Organist, Mr. Penn Hughes.

- 12.15: approx. From the Studio; "Sun" service.
- 12.30: Studio Music.
- 2.0: G.P.O. clock and chimes, close down.

AFTERNOON SESSION.

Announcer: Basil Kirke.

- 3.0: G.P.O. clock and chimes. Recital of Records.
- 3.30: From the Band Rotunda, Manly Beach—The Manly Municipal Military Band, conducted by James Pheloung.
- 5.0: G.P.O. clock and chimes; close down.

EVENING SESSION.

Announcers: Basil Kirke, Vern Barnett.

- 6.0: G.P.O. clock and chimes. Children's session, conducted by Ursula Bas.
- 6.20: Letters and Stories.
- 6.30: Studio music.
- 7.0: From Petersham Baptist Church—Evening service, conducted by Mr. G. A. Craike.
- 46th Sunday School Anniversary. Choir of over 200 voices. Conducted by Mr. A. Shaw.
- Organ Prelude.
- Musical item, Choir.
- Prayer.
- Musical item, Choir.
- Reading.
- Musical item, Choir.
- Solo.
- Offertory.
- Duet.
- Prayer.
- Hymn, Congregation and Choir.
- Sermon, Rev. G. A. Craike.
- Musical item, Choir.
- Benediction and Vesper.
- 8.30: From the Band Rotunda, Manly Beach—The Manly Municipal Military Band, conducted by James Pheloung.
- 9.30: From the Studio—Stanley Catlett, tenor.
- 9.37: Gerald Walenn, violinist.
- 9.44: Stanley Catlett, tenor.
- 9.51: Gerald Walenn, violinist.
- 9.58: Late weather and announcements.
- 10.0: National Anthem; close down.

2GB

- 10.15: Organ music from St. Albans Church, Redfern.
- 10.30: Morning session.
- 12 noon: Close down.
- 6.30: Children's session by Uncle George.
- 7.0: Music from studio.
- 8.0: Evening programme, Miss Gladys Aubin (soprano), 8.23: Miss Gladys Aubin (soprano), 8.30: Mr. Reginald Duncan (violinist), 8.38: Mr. Cecil Houghton (tenor), 8.45: Miss Mary Neal (mezzo-soprano), 8.52: Rosenkranz piano solos, Miss Gladys Aubin, 9.7: Mr. Reginald Duncan (violinist), 8.15: Mr. Cecil Houghton (tenor), 9.22: Miss Mary Neal (mezzo-soprano), 9.29: Rosenkranz piano solos, 9.35: Close down.

2UW

- 10.30 a.m.: Music.
- 1 p.m.: Close down.
- 5 p.m.: Children's Hour, conducted by Uncle Jack.
- 6.30: Close down.
- 7.0: Musical programme.
- 10.0: Close down.

2UW

MONDAY, MARCH 11

MIDDAY SESSION.

- 12.30: Music.
- 1.0: G.P.O. clock and chimes.
- Music.
- 2.30: Close down.
- 4.30: Musical programme.

EVENING SESSION.

- 5.20: Children's hour, conducted by Uncle Jack.
- 6.30: Close down.
- 7.0: G.P.O. clock and chimes.
- Music.
- 8.0: To-day's anniversary.
- Music.
- 9.0: G.P.O. clock and chimes.
- Comments on foreign affairs by Mr. J. W. Prentice.
- 9.10: Music and request numbers.
- 10.0: Close down.

Inter-State Programmes, Sun., Mar. 10

3LO

MORNING SERVICE

Announcer: Frank Hatherley. 10.30: Bells from St. Paul's Cathedral. 10.45: Express train information from the British official wireless news from Rugby; news from yesterday's papers. 11.0: Morning service from the Ross Church, Collins Street, Melbourne; organist, Rev. Dr. W. Borland, M.A. Psalm (modern version), 90, 14-17, "O with Thy Tender Mercies, Lord"; tune 116; prayer; prose Psalm 42. 11.15: "The Part Partech"; Old Testament lesson, "The Rock"; hymn No. 191, "Rock of Ages"; "The Rock of Ages"; New Testament lesson, St. Luke 23, 18; prayer; intimations; offering; hymn No. 197, "My Faith Looks Up to Thee"; Benediction. 12.15: Close down.

AFTERNOON SERVICE

Announcer: Frank Hatherley. 8.0: Sonora recording of the world's most famous records. 8.15: Pleasant Sunday afternoon, Wesley Church Mission, Lonsdale Street, Melbourne; chairman, Rev. J. H. Cain; hymn No. 112, "Ye Separated"; prayer; choicest selection. Mr. J. L. Williams, conductor; hymn No. 61, "O Save Us from the Rock"; solo, Mr. Cecil Gribble, M.A. (London Island Mission); orchestra; solo, Mr. Cecil Gribble, M.A.; notices; offering; orchestra; National Anthem; Benediction; organist, Mr. L. P. Forster will speak on "The Battle of Lepanto"; 4.40: Close down.

EVENING SERVICE

Shipping information. 5.47: Answers to letters and birthday greetings by "Bobby Bluegum." 5.55: "Brother Bill" will tell the children about "Cavendish in the Air." 6.45: Adult greetings and notices; announcements. 6.47: Bells from St. Paul's Cathedral.

NIGHT SERVICE

Evening service from Wesley Church, Lonsdale Street, Melbourne, conducted by Rev. O. Irvine. 7.0: "The Holy Temple"; hymn, "The Quiet Gate"; hymn, "At Even Ere the Sun was Set"; prayer, "The Inner Court"; Scripture reading; intimations and offering; hymn, "Give to the Winds Thy Greetings"; hymn book sermon; hymn, "Our Day of Praise"; Benediction; sevenfold Amen. 8.30: "The Sacred Trio"—Trio, Op. 86, No. 7 (Hummel); solo, soprano; Andante; Rondo alla russa. 8.45: "The Sacred Trio" (by permission J. O. Williams, M.A.), selections from his repertoire. 8.56: "Paderewski—Kreutzer"; "Siguenerveles"; "The Moorish Maid" (Parker); "The Lillac Tree" (Graham). 9.15: May Broderick, piano—"Organ and Fugue in the Minor" (Bach-Taubig); "Lance Parfax, harp"—Selections from his repertoire. 9.30: Frank Johnson, cello—"Litanie" (Scherzo) (van Goens). 9.35: Lalie (dramatic soprano)—"With All My Heart"; "Song of Threshing" (Allittsen). 9.55: "The Sacred Trio"—"Drink to me Only" (arr. by "Strienné" (Lavater), "Scherzo" (Rels). 9.57: "Argus" news service; announcements. 10.3: "God Save the King."

3AR

Announcer: Maurice Dudley. 10.48: Morning service from St. Paul's Cathedral, Melbourne. Sermon: Exhortation—General Confession. Absolution. Lord's Prayer. Versicles and Responses. Psalm 119, verses 146-176. First Lesson. Epistle (Macpherson). Second Lesson. Benediction. Collect. "Everyone" (Mendelssohn). Hymns (A. and M.), 3, "Awake, My Soul." The Dean. Hymn 197, "King of Love." The Benediction. 12.10: British official wireless news; 12.10: Close down.

AFTERNOON SERVICE

Announcer: Maurice Dudley. 3.0: Special Gramophone Recital. Sir Henry J. Wood, conducting the Queen's Hall Orchestra. Symphony No. 3, "Pastorale" (Beethoven), in fourteen parts. The King's Hall. 3.15: "The Queen's Hall." Edna (Mrs. John Harrison) and Robert Radcliffe. "Gladstone Light" (Sullivan). "O Hush My Babe." Theodore Challaupine (bass). "The King's Hall." Op. 11, No. 2 (Albanes). "Nightingale" (Schubert). "Tocatta Seidel" (violin). "Requiem" (Wagner). "Air for G String" (Bach). 4.0: Close down.

EVENING SERVICE

Announcer: Maurice Dudley. 8.30: Close down.

NIGHT SERVICE

Announcer: Maurice Dudley. 7.0: A special programme recital of vocal and orchestral chefs d'oeuvre. 8.0: Brunswick City Band. Selection, "The Knight Errant" (Trussell). 8.15: Collin Crane (bass). "The Knight Errant." 8.20: Brunswick City Band. Selection, "The Knight Errant." 8.32: The Radio Society. Part song, "Carry Me Back to My Native Land." Tenor solo, "King, Ever Glorious." Solo and chorus, "In a Monastery Garden." Solo and chorus, "Sweet Ye." Recitatives, "Listening In." Part songs, "Go Down, Moses." "Swing Low, Sweet Chariot." Duet, from the "Crucifixion." Part song, "In This Hour of Softened Splendour." 8.52: The Radio Society. Piano recital, "Gavotte in A Major" (Brahms). "Rhapsody in G Minor" (Brahms). "Intermezzo in E Flat Major" (Brahms). 9.7: Brunswick City Band. Request items. 9.17: Rosalind Hartung (soprano). "The Sapphic Ode" (Brahms).

"In Questa Tomba" (Beethoven). 9.24: Brunswick City Band. Selection. 9.29: Collin Crane (bass). Selection. 9.36: Brunswick City Band. Selection. grand opera. 9.43: Rosalind Hartung (contralto). "Omnia mai" (Handel). "The Lillac Tree" (Gartlan). 9.50: News service. Announcements. God Save the King.

4QG

MORNING SERVICE

11.0: Morning service from Albert Street Methodist Church. 11.15: Close down.

AFTERNOON SERVICE

3.15: Federal Band concert from the Botanic Gardens. 4.30: Close down.

EARLY EVENING SERVICE

6.30: Greetings from little listeners and replies to letters.

NIGHT SERVICE

The complete evening service will be relayed from the Albert Street Methodist Church. 7.0: Children's service from Albert Street Methodist Church. 7.30: Evening service. At the conclusion of the church service the concert by the Brisbane Municipal Concert Band will be relayed from Wickham Park. 9.30: Close down.

5CL

MORNING SERVICE

Announcer: J. L. Norris. 11.0: G.P.O. chimes from Adelaide Town Hall. 11.0: G.P.O. chimes. 11.1: Divine service from St. Bartholomew's Church of England, Norwood. Services for Mothering Sunday. 12.15: General news service. Wireless news. 12.30: Close down.

AFTERNOON SERVICE

Announcer: J. L. Norris. 3.0: G.P.O. chimes. 3.1: A Pleasant Sunday Afternoon Service from Maughan Church. 4.0: G.P.O. chimes and close down.

EVENING SERVICE

Announcer: J. L. Norris. 6.0: G.P.O. chimes. 6.1: S.A. railway information. 6.3: Birthday greetings. Correspondence. Songs and stories by "Miss Wireless." 6.30: "The Bird Lady" and "The Junior Songsters" will entertain the children. 7.0: G.P.O. chimes. 7.1: A religious service from Stow Memorial Congregational Church.

NIGHT SERVICE

Announcer: J. L. Norris. Accompanist: Jean Finlay. 8.25: Venetian Trio, instrumentalists. "Opera Gems" (Verdi). 8.30: Jean Sinclair (contralto). "When All Was Young" (Gounod). "Summer Rain" (Wiley). 8.35: Angelo Demodena (mandolinist) in fascinating melodies. 8.42: Stanley Gare (baritone). "The Sands of Dee" (Clay). "Salsam" (Lang). 8.43: Venetian Trio (Instrumentalists) will play three Spanish songs. "La Paloma," "Marquita" (Juanita). 8.55: A pianoforte recital by Irene Kemp, L.A.B. "Prelude and Fugue in E Minor" (Mendelssohn). "Toccata" (Paradies). "Two Spanish Dances" (a) "Playera" (Granados). (b) "Seguidillas" (Albeniz). "Prelude in D Flat" ("Raindrop") (Chopin). 9.15: Man Sinclair (contralto). "Little Brown Cottage" (Dickson). "Mell-sande in the Wood" (Gost). 9.25: Angelo Demodena (mandolinist), haunting tunes on the mandolin. 9.30: Stanley Gare (baritone). "The Earl King" (Schubert). "The Lark in the Clear Air" (Lehmann). 9.36: Venetian Trio (Instrumentalists). 9.45: Mr. P. H. Nicholls in one of his interesting talks, "The Law of Compensation." 9.55: Meteorological information, including Semaphore tide. 10.0: G.P.O. chimes and close down.

6WF

10.25: Tune in. 10.30: Half hour for the enthusiastic listener. 11.0: Morning service, relayed from the Baptist Church, Museum Street, Perth. 12.15: Close down. 3.30: Tune in. 3.35: Musical programme from the studio, including vocal and instrumental features. 4.30: Tune in. 4.40: Tune in. 7.5: Bedtime stories for the children. 7.30: Evening service, relayed from St. George's Cathedral, Perth. 8.45: Concert by the Perth City Band, conducted by Mr. Les Price, relayed from the Government Gardens, Perth. 10.5. Close down. 10.4.5: METRE TRANSMISSION. Simultaneous broadcast on 104.5 metres of programme given at 1250 metres, commencing at 7 p.m.

7ZL

MORNING SERVICE

Announcer: J. M. Counsel. 10.45: Transmission from the Trinity Church, Hobart. 11.0: Transmission from the Memorial Congregational Church, Hobart. 12.30: Close down.

AFTERNOON SERVICE

3.30: A band concert by the Municipal Band (L. M. Barnett, conductor). 4.30: Close down.

EARLY EVENING SERVICE

Announcer: J. M. Counsel. 7.0: Transmission from conductor, Godfrey Lewis of the Children's Spectacular Service Mission). 6.45: Bertha Southey Bramhall will tell a story.

EVENING SERVICE

Announcer: J. M. Counsel. 7.0: Transmission from the Chalmers Presbyterian Church, Bathurst Street, Hobart. 8.25: From the studio—a sacred and classical programme, arranged by J. M. Counsel, L.A.B. 9.40: News session. 9.50: Close down.

Clear Natural Tone and Great Volume SONOCHORDE LOUD SPEAKERS

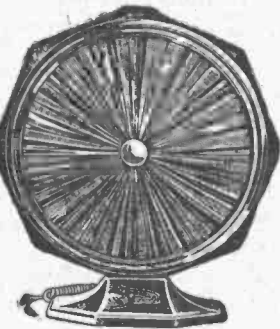

That is the greatest and most pleasing feature of this new Speaker. We could use many words to tell you about this Sonochorde, but if you will come and hear it, it will convince you that, at last, you have heard the Speaker you want for your set.

BELLING-LEE TERMINALS

These terminals really are efficient—much more efficient than any other on the market—as you will agree if you ask your radio man to show them to you.

W. G. WATSON & CO., LTD.,

279 Clarence Street, Sydney.

29 Hunter Street, Newcastle.

200 Queen Street, Melbourne.

28 Coromandel Place, Adelaide

933 Hay Street, Perth.

53 Charlotte Street, Brisbane.

33 Argyle Street, Hobart.

Local Programmes, Monday, March 11

2FC

EARLY MORNING SESSION

Announcer: A. S. Cochrane.
7.0: "Big Ben" and announcements. 7.2: Official weather forecast; rainfall, river reports; temperature; astronomical memoranda. 7.7: "Sydney Morning Herald" summary. 7.12: Shipping intelligence; mail services. 7.15: Studio music. 7.25: Investment market; mining sharemarkets; metal quotations; wool sales; breadstuffs markets; inter-State markets; produce markets. 7.40: Studio music. 8.0: "Big Ben"; close.

MORNING SESSION

Announcer: A. S. Cochrane.
10.0: "Big Ben" and announcements. 10.3: Pianoforte reproduction. 10.10: "Sydney Morning Herald" news service. 10.25: Studio music. 10.30: The 2FC Racing Commissioner, late sporting news. 10.45: A talk on home cooking and recipes by Miss Ruth Furst. 11.0: "Big Ben". A. F. A. and Reuters' cable services. 11.5: Close.

MIDDAY SESSION

Announcer: A. S. Cochrane.
12.0: "Big Ben" and announcements. 12.1: Stock Exchange, first call. 12.3: Official weather forecast; rainfall. 12.5: Studio music. 12.10: Summary of news, "Sydney Morning Herald". 12.15: Rugby wireless news. 12.20: Scores of the fifth Test match, England v. Australia, played at Melbourne. 12.25: A reading. 12.35: Scores of the fifth Test match. 12.40: Studio music. 12.50: Scores of the fifth Test match. 12.55: Studio music. 1.0: "Big Ben"; weather intelligence. 1.2: Studio music. 1.5: Scores of the fifth Test match. 1.10: "Evening News" mid-day news service; Producers' Distributing Society's report. 1.20: Scores of the fifth Test match. 1.25: "Evening News," etc. continued. 1.33: Stock Exchange, second call. 1.35: Scores of the fifth Test match. 1.45: Popular studio music. 2.0: "Big Ben"; close.

AFTERNOON SESSION

Announcer: Laurence Halbert.
Accompanist: Ewart Chapple.
2.30: Programme announcements. 2.32: Educational session—Musical recital, a reading. 2.35: Cricket scores, fifth Test match, played at Melbourne. 2.40: Education session, continued. 2.50: Scores, fifth Test match, played at Melbourne. 2.55: Educational sessions, continued. 3.5: Scores, fifth Test match, played at Melbourne. 3.10: Popular music. 3.20: Scores, fifth Test match, played at Melbourne. 3.25: Popular music. 3.35: Scores, fifth Test match, played at Melbourne. 3.40: A reading. 3.50: Scores, fifth Test match, played at Melbourne. 3.55: Betty Armstrong, soprano—(a) Selected; (b) "Pleading" (Elgar). 4.2: Popular music. 4.5: Scores, fifth Test match, played at Melbourne. 4.15: Una Cavill, pianist. 4.20: Scores, fifth Test match, played at Melbourne. 4.25: Betty Armstrong, soprano—(a) "Elegie" (Massenet); (b) "When Smiling Fortune" (Gounod). 4.32: Studio music. 4.35: Scores, fifth Test match, played at Melbourne. 4.40: Una Cavill, pianist. 4.47: Third call of the Stock Exchange. 4.50: Scores, fifth Test match, played at Melbourne. 4.55: Studio music. 5.5: Scores, fifth Test match, played at Melbourne. 5.10: Close down. Note: Cricket scores will be transmitted at 5.20.

EARLY EVENING SESSION

Announcer: A. S. Cochrane.
5.35: Scores, fifth Test match, played at Melbourne. 5.40: The chimes of 2FC. 5.45: The Hello Man talks to the children, assisted by "Mara." Letters and stories. Music and entertainment. 5.50: Scores, fifth Test match, played at Melbourne. 5.55: Children's Session continued. 6.5: Scores, fifth Test match, played at Melbourne. 6.10: Children's Session continued. 6.30: Dalgety's market reports (wool, wheat, and stock). 6.40: Fruit and vegetable markets. 6.43: Stock Exchange information. 6.45: Weather and shipping news. 6.48: Rugby Wireless news. 6.50: Late sporting news. 7.0: "Big Ben." Late news service. 7.10: The 2FC Dinner Quartette, conducted by Horace Keats—(a) "Serenade

Coquette" (Barthelemy). (b) "Rozeska" (Roberts). (c) "Popular Songs" (Eric Coates). (d) Prelude, "The Deluge" (Saint-Saens). (do) "When Love Comes Stealing" (Rapee).

EVENING SESSION

Announcer: Laurence Halbert.
Accompanist: Ewart Chapple.
7.40: Popular music.
7.45: Programme announcements.
7.47: Cricket resume—fifth Test, played at Melbourne.
7.57: Popular music.
8.0: From the Haymarket Theatre: The Haymarket Theatre Orchestra, under the baton on Stanley Porter.
8.20: From the Studio: Randwick Presbyterian Choir.
8.30: The Light Music Four—
(a) "Air de Ballet" (Massenet).
(b) "The Gondoliers" (Sullivan).
8.46: Tales by a Traveller—Rev. S. H. Raward.
9.0: "Big Ben" Weather report.
9.1: Norman Frances, tenor.
9.8: The Light Music Four—
(a) "Princes Charming" (arr. Higgs).
(b) Suite, "Russet and Gold" (Sander-son).
9.26: Randwick Presbyterian Choir.
9.36: From the Haymarket Theatre: The Haymarket Theatre Orchestra, under the baton of Stanley Porter.
9.56: From the Studio: Norman Frances, tenor.
10.3: The Light Music Four—
(a) Rokoko-Liebsteid" (Helmund).
(b) "Irish pictures" (Ansell).
10.14: Randwick Presbyterian Choir.
10.24: Late weather and announcements. To-morrow's programme.
10.30: National Anthem. Close down.

2BL

MORNING SESSION

Announcer: A. C. C. Stevens.
8.0: G.P.O. Chimes. Metropolitan weather report. 8.1: State weather report. 8.2: Studio music. 8.15: G.P.O. chimes. News from the "Daily Telegraph Pictorial." 8.30: G.P.O. chimes. News service continued. 8.40: Information, mails, shipping, arrivals, departures, and sailings. 8.45: Studio music. 9.15: Half an hour with silent friends. 9.45: Studio music. 10.0: G.P.O. chimes. Close down.

MIDDAY SESSION

Announcer: A. C. C. Stevens.
11.0: G.P.O. chimes. 2BL Women's Sports Association Session, conducted by Miss Gwen Varley. 11.30: Advertising hints. A talk by Miss Dorothea de Clegghorne. 11.40: Women's Session, conducted by Mrs. Cranfield. 12.0: G.P.O. chimes. Special ocean forecast, and weather report. 12.3: Studio music. 12.20: Scores of the fifth Test match, England v. Australia, played at Melbourne. 12.25: Studio music. 12.30: Shipping and mails. 12.35: Scores of the fifth Test match. 12.40: Market reports. 12.50: Scores of the fifth Test match. 12.55: "Sun" midday news service. 1.5: Scores of the fifth Test match. 1.10: Studio music. 1.20: Scores of the fifth Test match. 1.25: Studio music. 1.30: Talk to children and special entertainment for children in hospital. 1.35: Scores of the fifth Test match. 1.45: Talk to children continued. 2.0: G.P.O. chimes. Close down.

AFTERNOON SESSION

Announcer: A. C. C. Stevens.
Accompanist: Kathleen Roe.
2.35: Scores, fifth Test match, played at Melbourne. 2.40: Close down. 2.50: Scores, fifth Test match, played at Melbourne. 2.55: Close down. 3.5: Scores, fifth Test match, played at Melbourne. 3.10: Close down. 3.20: Scores, fifth Test match, played at Melbourne. 3.25: Close down. 3.35: Scores, fifth Test match, played at Melbourne. 3.40: Studio music. 3.50: Scores, fifth Test match, played at Melbourne. 3.55: Studio music. 4.5: Scores, fifth Test match, played at Melbourne. 4.15: Herbert Hunt, pianist—(a) "Prelude in A Flat" (Chopin). (b) "Prelude in B Minor" (Chopin). (c) "Prelude in B Flat" (Chopin). 4.20: Scores, fifth Test match, played at Melbourne. 4.25: Studio music. 4.35: Scores, fifth Test match, played at Melbourne. 4.40: A talk by Captain

Fred Aarons: "Allest." 4.50: Scores, fifth Test match, played at Melbourne. 4.55: Herbert Hunt, pianist—(a) "Second Movement of G. Major Sonata" (Beethoven). (b) "The Movement of G. Major Sonata" (Beethoven). 5.5: Scores, fifth Test match, played at Melbourne. 5.10: Studio music. 5.20: Scores, fifth Test match, played at Melbourne. 5.25: Studio music. 5.31: Racing resume. 5.35: Features of the evening's programme. 5.40: Scores, fifth Test match, played at Melbourne.

EARLY EVENING SESSION

Announcer: Basil Kirke.
5.40: Children's Session, conducted by Uncle Bas. Music and entertainment, letters and stories. 5.50: Scores, fifth Test match, played at Melbourne. 5.55: Children's Session continued. 6.5: Scores, fifth Test match, played at Melbourne. 6.10: Children's Session continued. 6.30: "Sun" news and late sporting. 6.40: 2BL Dinner Quartette—(a) "Petite Mazurka" (Sapellnikoff). (b) "Spring Morn" (Gazabon). (c) "Querida" (Sapellnikoff). (d) "The Pirates of Penzance" (Gilbert and Sullivan). (e) "Serenade" (Herbert). 7.7: Australian Mercantile, Land, and Finance Report. Weather report and forecast, courtesy of Government Meteorologist. Producers' Distributing Society's fruit and vegetable market report. Grain and fodder report ("Sun"). Dairy produce report ("Sun"). 7.25: Mr. Pam and Miss Pam in advertising talks and nonsense. 7.55: Programme and other announcements.

EVENING SESSION

Announcer: Basil Kirke.
Accompanist: G. Vern Barnett.
8.0: G.P.O. chimes. Topical Chorus. From the King's Cross Theatre: Joseph Wayne at the Wuriltzer Organ.
8.20: From the Studio: Margaret Madden and Frances Lea, vocal and instrumental—(a) "My Blackbirds are Bluebirds Now" (Rapee). (b) "Someday, Somewhere" (Rapee). (c) "Among My Souvenirs."
8.30: Frank Ryan, comedian.
8.40: Studio Dance Band, conducted by Cec Morrison.
8.52: David Graham, baritone.
8.59: Weather report.
9.0: G.P.O. chimes. Edith Cowley and Ian Maxwell.
9.10: Studio Dance Band, conducted by Cec Morrison.
9.22: Margaret Madden and Frances Lea, vocal and instrumental—
(a) "Czardas" (Monti).
(b) "Sally of My Dreams" (Kernell).
(c) "Just a Little Tear."
9.32: Frank Ryan, comedian.
9.42: Boyle, xylophonist.
9.50: David Graham.
9.57: Edith Cowley and Ian Maxwell.
10.7: From the King's Cross Theatre: Joseph Wayne at the Wuriltzer Organ.
10.27: From the Studio: Late weather and announcements.
10.32: The Savoyans Dance Band.
10.57: Features of the Evening's programme.
10.59: The Savoyans Dance Band.
11.30: National Anthem. Close down.

2GB

10.0: Music. 10.10: Happiness Talk, by A. E. Bennett. 10.20: Music. 10.30: Women's Session, by Miss Helen Beesling. 11.30: Close down. 2.0: Music. 2.5: Women's Radio Service. 2.30: Music. 2.45: Talk. 3.0: Close down. 5.30: Children's session, by Uncle George. 7.0: Stock and market reports by New Zealand Loan and Mercantile Agency Ltd. 7.15: Music. 7.30: Feature story in Songs by Mr. C. G. Watson. 8.10: Mr. Phil Couchman (cornet solos). 8.20: Miss Heather Kinnaird (contralto). 8.30: Mr. Jack Win and Mr. Heath Burdock (humor). 8.35: Instrumental music. 8.40: Mr. Maurice Helsen (tenor). 8.50: Mr. John Benson (pianist). 9.0: Weather report. 9.3: Address. 9.15: Mr. C. G. Watson (baritone). 9.25: Mr. Phil Couchman (cornet solos). 9.36: Mr. Jack Win and Mr. Heath Burdock (humor). 9.40: Miss Heather Kinnaird (contralto). 9.50: Mr. John Benson (pianist). 10.0: Mr. Maurice Helsen (tenor). 10.10: Dance music. 10.30: Close down.

FURNESS COMBINATION WAVE TRAP

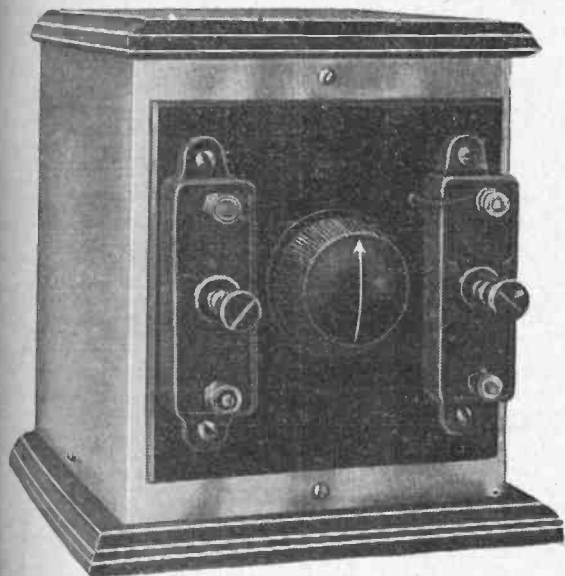

FURNESS COMBINATION WAVE TRAP.

The trap is first tuned in to any two stations you want cut out, say, 2BL for the lower band, and 2FC for the upper band, and left permanently on this station, and in using set you simply turn a switch to tune out one or the other. Once tuned, you only have to turn switch for results. The whole of the parts to make same£1/10/-

The above parts drilled and aluminium box, all drilled ready for use£1/17/6

The Set complete £2/5/-

FURNESS PATENT SCREEN GRID VALVE HOLDERS

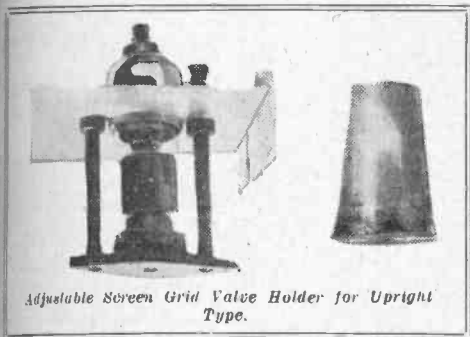

Adjustable Screen Grid Valve Holder for Upright Type.

Furness Patent Adjustable Screened Grid Valve Holder, for both upright and S625 types. This Holder saves time and temper in fixing and changing valves, and can be fixed in any position in set, either on baseboard or screen, enabling set builder to get a much better layout, and when fixed is perfectly screened. Valves easily changed, and both types being made of insulating lessens danger of shorts or set.

S625 Type 6/6

Type for Upright Valve .. 8/-, 9/-

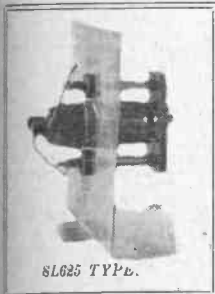

S625 TYPE.

We cut, bend, and drill any shape of shielding, and will cut any baseboard and panel to size. If there is any virtue in shielding, and there is, why not have effective shielding?

W. FURNESS,

1st FLOOR, FURNESS CHAMBERS, KING'S CROSS,

Top of William Street,

DARLINGHURST

Interstate Programmes, Monday, March 11

3LO

EARLY MORNING SESSION.
7.15 to 8.15: See Friday.

MORNING SESSION.
Announcer: Frank Hatherley. 11.0: 3LO's Different Dainties for the Daily Dinner. Today's Radio Recipe, Cheese Straws. 11.8: Olga Parker will speak on "What Some Famous Poets have Written for Children." 11.30: Musical Interlude. 11.35: Under the auspices of the Boy Scouts' Association, E. V. Neill will speak on "Our Birthday Year." 12.0: Description of fifth Test match, England v. Australia, at M.C.C., by Rod McGregor. 1.30: Meteorological information. Weather forecast for Victoria, New South Wales, South Australia, and Tasmania. Ocean forecasts. River reports. Rainfall. Newsweek stock sales. Entries for the market, Tuesday, Wednesday, and Thursday, the Associated Stock and Station Agents, Bourke Street, Melbourne. Stock Exchange information. 1.40: Close down.

AFTERNOON SESSION.
Announcer: Frank Hatherley. 2.15: Description of fifth Test match, England v. Australia, at M.C.C. by Rod McGregor. 4.0: Spencer Ward and Gertrude Long. "Just a Piano and Us." 4.5: Further description of the fifth Test match, England v. Australia, at M.C.C., by Rod McGregor. 4.55: Special weather report for the benefit of listeners in the Red Cliffs district. "Herald's" news service. Stock Exchange information. Acceptances and barrier positions for Sandown Park Races, March 13. 4.55: Description of the fifth Test match resumed. 6.0: Stumps scores.

EVENING SESSION.
6.5: Answers to letters and birthday greetings by "Billy Bunny." 6.30: Musical Interlude. 6.35: William C. Groves will tell the children about "The Peter Pan of the Pacific." 6.50: "Billy Bunny" will entertain the kiddies.

NIGHT SESSION.
Announcer: John Stuart. Accompanist: Agnes Fortune. 7.5: Stock Exchange information. 7.15: Market reports. 7.30: News session. Stumps scores. Fifth Test match at M.C.C. 7.43: Birthday greetings. 7.45: Out of the Past. 7.48: Under the auspices of the Department of Agriculture, Mr. G. E. Marks, assistant tobacco expert, will speak on "Tobacco Curing." 8.0: Maker of History. 8.1: The station orchestra. Overture. "Maid of Artois" (Balfe). 8.10: Adele

Crane, soprano (by permission of J. C. Williamson, Ltd.). "I Wonder If Love is a Dream" (Forster). "The Robin's Song" (White). 8.17: Imperial Russian Trio (Arved Norit, violin; Ivan Berzinsky, 'cello; Vassili Ilster, piano). "Trio in A Minor" (Tschakowsky). (a) Thema con variazioni. (b) Variations on a waltz. 8.42: Gertrude Hutton, mezzo-contralto. A group of French songs. 8.49: The station orchestra. "Adagio Lamento" from Sixth Symphony (Tschakowsky). 8.55: Adele Crane, soprano. "Is Only a Tiny Garden" (Haydn Wood). "The Pipes of Pan" (Monckton). 9.3: Joseph Barrile, flute, "Mazurka" (Popp). 8: Gertrude Hutton, contralto. "Woe My Heart Should Break" (Tschakowsky). "The Forge" (Brahms). 9.15: Studio presentation of "A Runaway Girl." Musical directress, Madame Ethel Ashton. Producers by Maurice Dudley. Jessie, Brother Tamarind, Edgar Chapple; Guy Stanley, James Lloyd; Signor Paloni and Mr. Creel, Frank Conrad; Lord Coodie, Albert Harford; Sir William Hake, James Harford; Leopoldo, John Donovan; Picca Pascara, James Russell; Flipper, Allan Bell; Alice, Jean Kelly; Dorothy Stanley, Rose Clayden; Carmentia, Meric Griffin; Lady Coodie, Elsie Lang; Fraulein von der Rube, Lillian Gray; Winifred Grey, Florence Blitz. 10.40: "Argus" news service. Meteorological information. British official wireless news from Rugby. 10.55: The Radio Revellers. "Just Jog Along." "I Care No More About You" (Gardner). "Mississippi Mud" (Harris). 11.1: The Radio Revellers. "Tin Pan Parade" (Whiting). "My Heaven is Home" (Collin). "Gangster" (Gilbert). "Dream House" (Foxe). "Mother, I Still Have You" (Jolson). "Out of the Dawn" (Donaidson). "Get Out and Get Under the Moon" (Toledo). "Jenny's Beauty" (Theatre). "The Fringe Song" (Crumli). "Sincerely I Do" (Davis).

3AR

Announcer: Maurice Dudley. 10.0: G.P.O. clock says "Ten." 10.1: Market reports, farm and station produce, fruit, fish, vegetables, etc. 10.25: "Age" shipping reports; ocean forecast. 10.30: Mail notices; express information. 10.35: "Age" news service, exclusive to 3AR. 10.40: "Age" news service, exclusive to 3AR. 12.10: British Official Wireless news; announcements. 12.20: Transmission from His Majesty's Theatre. Announcer: Frank Hatherley. "Little Irish Girl" (Lohr). "With Mother a-Smiling on Me" (Alysteyne). "I Heard You Go By" (Wood). "Come to the Fair" (Marfisi). 1.48: Close down.

AFTERNOON SESSION
Announcer: Frank Hatherley. 2.15: The Station Orchestra, overture. "Siciliana" (Verdi). "Dance d'Amore" (Soro). 2.30: Syd. Hollister, comedian. "Jolly Jingles." 2.37: The Station Orchestra. "Scenes From the Past." 2.40: Mary King, soprano. "The Story of Pearl's" (Phillips). "Carnegie" (Penn). 2.49: The Station Orchestra, selection. "The Student Prince" (Romberg). 3.59: Diana Belmont, contralto. "The Schubert Song." "Down in the Quiet Hills" (Carne). 3.6: The Station Orchestra, suite. "Silhouettes" (Hadley). 3.16: Announcements. 3.19: The Imperial Russian Trio (Arved Norit, violin, Ivan Berzinsky, 'cello, Vassili Ilster piano). "Ivana Berzinsky, 'cello, 'Chant Triste" (Tschakowsky). "Madrigal." "Arved Norit, violin, Sharp Minor" (Rachmaninoff). "Arved Norit, violin. "Valse" (Chopin). "Trio, from 'Orpheus'" (Gluck). "Trio" (Farwell to Cucullini) (Kreiser). 3.40: Syd. Hollister, comedian. "A Hilarity at the Station Orchestra, selection. "Cairo" (Norion). 3.57: Mary King, soprano. "Poppies for Forgetting" (Clark). "Bach" (Schmidt). 4.4: Iris Rothstadt, piano. "Scherzo" (de Bock). 4.11: The Station Orchestra. "Mendelssohn Melodies" (arr. Roberts). 4.21: Diana Belmont, contralto. "Lovers in the Lane" (Lehmann). "Summer Storm" (Lehmann). 4.28: The Station Orchestra. "Three Songs" (Brahms). "Gondoliera" (Moszkowski). 4.40: Iris Rothstadt, piano. "Etude in E Major" (Chopin). "Minuet" (Paderewski). 4.48: Announcements. 4.50: The Station Orchestra, overture. "Maid of Artois" (Balfe). 5.0: Close down.

EVENING SESSION
Announcer: Renn Millar. 6.0: Sweet solace from the Seraphina. 7.10: News service; results of fifth Test match; acceptances and barrier positions for Sandown Park races on Wednesday. 7.30: Encore solace.

NIGHT SESSION
Announcer: Renn Millar. 8.0: E. C. H. Taylor will speak on "School Life and School Sport." 8.18: Under the auspices of the League of Nations Association, Hon. Fred Easton, will speak on "The British Foreign Policy To-day." 8.30: H. Webb, Tasmania Government Tourist Officer, a talk on Tasmania. "Fort Arthur and the Peninsula." 8.40: The Radio Revellers. "Chiquita" (Wayne). "I Dreamed You Kissed Me" (Kahn). "Tin Pan Parade" (Gillespie). 8.50: Spencer Ward and Gertrude Long. "A Piano and Just Us." 8.57: The Radio Revellers. "Little Long Cabin of Dreams" (Harley). "Who Knows?" (Dixon). "Someday, Somewhere" (Rapee). 9.3: Marcelle Berardi, soprano, Chanson Arabe (Bemberg). 9.8: The Radio Revellers. "Who Love Comes Stealing" (Rapee). "To-day, To-morrow, for Ever" (Nichols). "High Up On a Hill Top" (Beyer). 9.18: Syd. Hollister, comedian. "I'll Tell Me." 9.19: The Radio Revellers. "Mississippi Mud" (Harris). "Anything You Say" (Harris). "That Melody of Love" (Davidson). 9.29: Spencer Ward and Gertrude Long. "A Piano and Just Us." 9.30: The Radio Revellers. "Constantinople" (Carlton). "Maybe I'm Wrong" (Harris). "Hum and Strum" (Keyser). 9.42: Marcelle Berardi, soprano. "The Cuckoo Clock" (Schaefer). 9.45: The Radio Revellers. "Lady of Love" (Nausbaum). "Mexican Serenades" (Teresese). "In My Bouquet of Memories" (Lewis). 9.55: Syd. Hollister, comedian. "Let's

to You." 9.58: The Radio Revellers. "Pansie" (Nichols). "Get Out and Get Under the Moon" (Toledo). "Jeannine" (Gilbert). 10.8: Spencer Ward and Gertrude Long. "A Piano and Just Us." 10.15: The Radio Revellers. "My Blackbirds are Blushing Now" (Friend). "Tin Pan Parade" (Kahn). "News You Know Me" (Bader). 10.20: "Age" news service exclusive to 3AR; cricket, results of fifth Test match; acceptances and barrier positions for Sandown Park races on Wednesday. "God Save the King."

4QG

EARLY MORNING SESSION.
Announcer: J. Tyson. 7.43: Time signals. 7.45: News service. 8.0: Some electric records. 8.15: News service. 8.30: Close down.

MORNING SESSION.
Announcer: Rita M'auliffe. 11.0: Music. 11.2: Social news. 11.15: Lecture. 11.30: Music. 11.45: More social news. 11.45: Wurliizer organ. 12.0 (noon): Close down.

MID-DAY SESSION.
Announcer: R. Wight. 1.0: Market reports and weather information. 1.30: Lunch-hour music. 1.45: Close down.

AFTERNOON SESSION.
Announcer: H. Humphreys. 3.0: A programme of electrically-reproduced records. 3.30: Mail train running times. 3.31: Radio Revellers. 3.35: P.R.C.O. (City Organist). 4.15: This afternoon's news. 4.30: Close down.

EARLY EVENING SESSION.
Announcer: R. Wight and H. Humphreys. 6.0: Mail train running times; mail information; tipping news. 6.5: Dinner music. 6.25: Commercial announcements. 6.30: Bedtime stories conducted by "The Sandman." 6.45: News in brief. 7.2: Stock Exchange news. 7.6: Metal quotations. 7.7: Market reports. 7.25: Penwick's stock report. 7.30: Weather information. 7.40: Announcements. 7.45: Standard time signals. 7.45: Lecture. "The Children's Music Corner" conducted by "The Music Man."

NIGHT SESSION.
Announcer: H. Humphreys. 8.0: The Studio Orchestra (Conductor, A. R. Featherstone): Overture "A May Day" (Haydn Wood). 8.8: The Anglo-Melba Quartet. "Rocky Road" (Bader). "The Deep" (Farks). 8.13: Will H. Lister: "A Thought for the Night." "Who Would Be A Friend?" 8.17: J. W. Beaumeister (cornist). "Somewhere a Voice is Calling" (Tate). 8.21: Dorothy Sanders (soprano). "Love Love Call" (Trimi). 8.26: The Anglo-Melba Quartet. "Nelle Was a Lady" (Farks). 8.31: The Studio Orchestra: Dance. "Daddy Shepherd" (Beaumeister). "Rocky Road" (Bader). "My Country" (W. Frank Warbrick (pianist). A ten-minute recital, including: "Lament in G" (Rachmaninoff). "Etude in E" (Scriabin). "Ernest Burdy" (Goossens). "The Mary M'Neas" (soprano). "Happy Summer Song" (Kahn). 8.55: Dick Pike (bass). "The Vagrant" (Mullinar). 9.0: Metropolitan weather forecast. 9.1: The Anglo-Melba Quartet. "The Return of the Prodigal" (Hankin). A synopsis of the play and the fourth act. Cast: Mr. Jackson, Ernest Barry; Eustace and Curry (his sons), Ernest Barry; Gladys (his daughter), Jean Trundle. The Citizens Band. 9.30: An impromptu programme by the Brisbane Citizens Band (Conductor, Mr. Gaezer). 10.0: The "Daily Mail" news, the "Courier" news, weather news. Close down.

5CL

MORNING SESSION.
Announcer: J. L. Morris. 11.0: G.P.O. chimes. 11.1: A recital on the Sonora (with and without lists). 11.1: H. Rieder, Wurliizer organist. "Old Kentucky Home" (Foster). 11.4: Peter Dawson (bass-baritone). "The Auld Roose" (traditional). 11.7: Mische Eiman (violinist). "Where Art Thou?" (Ascher). 11.11: The band of H.M. Coldstream Guards. "Evening Hymn and Last Post" (Regan). 11.15: Kitchie Craft and Maudie Talk. 11.30: A recital on the Sonora. 11.35: The Diamond Band. "The Mary and Dorothy." "Country Dance Tunes" (arr. C. J. Sharp). 11.36: Peter Dawson (bass-baritone). "The Forest" (Tschakowsky). 11.38: Mische Eiman (violinist). "Hymn to the Sun" (Korsakov). 11.42: Evan Wo Williams (tenor). "The Song that Reached My Heart" (Jordan). 11.45: The Associated Black and White America. 1000 Male voices. "Prayer of Thanksgiving" (arr. by Kremser). 11.50: Sousa's Military Band. "Round and Round the Village" (Helen). 11.53: Gerald Farrar (soprano). "The Wings of a Dove" (Mendelssohn). 11.58: Mische Eiman (violinist). "Ruins of Athens" (March). (Beethoven). 12.0: G.P.O. chimes. 12.1: From Melbourne Cricket Ground. Description of the fifth Test match, England v. Australia by 3LO's special commissioner, Mr. Rod McGregor. From the studio. 1.0: G.P.O. chimes. 1.1: General news service. 1.18: British official wireless news. 1.20: S.A. railway information. S. C. Ward and Co's Stock Exchange information. Meteorological information. 1.30: Close down.

AFTERNOON SESSION.
Announcer: J. L. Norris. Accompanist: Jess Pinlay. 3.0: G.P.O. chimes. 2.31: Description of the fifth Test match. 3.0: News service. 3.31: Station quartette. Overture. "Triumphal" (King). "Jumping Jack" (Bloom). 3.38: Intruding Alys Watson (soprano). "My Prayer" (Kahn). "Now Sleeps the Crimson Petal" (Gautier). 3.44: E. Ryberg (holder of S.A. mouth organ championship). "Winning Flight March." "Aloha Song." 3.53: Rev. F. Macnamara and Sadie M'Donald. 3.54: Station quartette. "Passion" (Edwards).

Do You Know:

That Resco Sets carry an Unconditional Guarantee against Defect in Material or Manufacture, and are installed in your Home without any extra charge whatever?
That Resco Sets are the Cheapest High-grade Sets on the market in Sydney, and you may obtain a demonstration in your own Home without any obligation whatever?

A Resco Model for Every Purse.

'Phone us to call when in trouble with your Set. 'Phone, B1817.

The Resco Radio Supply Co.,
38A PITT STREET,
Near Quay,
SYDNEY.

The March of the Priests" (Mendelssohn). 4.6: An Watson (soprano). "Sing, Joyous Bird" (Phillips). "Three Fishers" (Hullah). 4.12: E. Ryberg. "Tropic Band." "Sing Me to Sleep." ("Sing Me to Sleep" was the number played when Mr. Ryberg was the Tanunda competitors.) 4.18: Rinaldo (soprano). "Titella" (Cattaneo). "Inferno" (Mendelssohn). 4.24: Station quartette. "Third Movement Concerto" (Mendelssohn). 4.30: Description of 8th Test match. From S.C.L. studio, scores of inter-State tennis matches and annual tournament. 4.30: Close down.

EVENING SESSION.
 Announcer: G. J. O'Connor. 6.0: G.P.O. chimes. Notes, inter-State tennis matches and annual tournament. 6.2: Birthday greetings, correspondence, songs and stories by "Aunty Peggy." "Buckingham Palace" (de Sylva). 6.30: Captain Donald Maclean tells you about buccannery of every race and description. 6.45: An interlude of dinner music. G.P.O. chimes. 7.1: S. C. Ward and Co.'s Stock Exchange information. 7.5: General market reports. News and Co's wool and grain report. South Wales and Adelaide Stock Salesmen's Association's 1st cattle sales. International cricket scores, England v. Australia, at Melbourne. 7.15: Under the auspices of the South Australian Agricultural Department, Mr. H. B. Barlow (chief dairy inspector) will speak on "Dairy Legislation." 7.30: The K.M. Twinkler Boys' Club. Entertainment by "The Twinkler" (Mr. F. J. Mills).

- NIGHT SESSION.
 Accompanist: Jean Finlay. Announcer: G. J. O'Connor. 8.0: G.P.O. chimes. 8.1: Boake Smith's band. "High Upon a Hilltop" (Baer). "Without You Sweetheart" (de Sylva). "Just Like a Melody Out of the Sky" (Donatoni). 8.3: Alys Watson (soprano). "The Star" (Lummins). "The Lattice in the Wood" (McGeoch). 8.15: One-act play. An original comedy. "He Should Have Thought of that Before" (Alec Symons). "Old" Badman (Clerk). Mrs. Taylor, Joan Maudie, Miriam Ralph; Mr. Ford-Reynold, Malcolm Symons, Mr. Maudie, Jack Burston. Time: Evening. Scene: The living-room of 5, Manly. 8.35: Boake Smith's Band. "The Rag" (Brown). "Together" (Berlin). 8.42: Rev. Gordon and Sadie McDonald, selections from pop. repertoires. 8.48: Tom O'Dea (comedian) in headlines. 8.54: Rinaldo Toree (baritone). "Mon Vie" (Maitte). "Toreador's Song" (Bizet). 9.0: G.P.O. chimes. 9.1: Meteorological information. News of Semaphore tides. 9.2: Overseas grain report. 9.3: Boake Smith's Band. "Adore" (West). "That's My Weakness Now." "Dream Sweetheart" (Maudie). 9.10: Alys Watson (soprano). "O Mio Bambino" (Donatoni). "Birth of Morn" (Leon). Bill Young and Burgess (entertainers) in bright, happy numbers. 9.24: A thrilling story interlude by Captain Donald Maclean. 9.35: Boake Smith's Band. "Tollix the Cat" (Kortlander). "Congo" (de Sylva). "Two Lips." 9.45: Rinaldo Toree (baritone). "The Last Watch" (Pinsuti). "The Mio Ben" (Gloriani). 9.50: Tom O'Dea (comedian) will entertain you. 9.58: Young and Burgess (entertainers), more vaudevillities. 10.4: Boake Smith's Band. "Old-fashioned Locket" (Kort). Selected numbers. 10.15: "The Advertiser" special news service. Meteorological information. News of inter-State tennis matches and annual tournament. 10.31: Modern dance numbers by "The Radio Revelers." 11.0: God Save the King.

6WF

Progress reports of 8th Test match will be broadcast each half hour until stumps.
 12.30: Tune in. 12.35: Markets, news, etc. 1.0: Special. 1.1: Weather bulletin supplied by the Meteorological Bureau of West Australia. 1.3: Programme Hour, relayed from Messrs. Musgrove's, 1st. Eric House, Perth. 2.0: Close down. 3.30: Tune in. 3.35: Musical selections from the Carlton Club vocal items from the studio. 4.30: Close down. 6.0: Tune in. 6.48: Bedtime stories for the Kiddies, by Douglas Percy and Duffy. 7.5: Light music by the Station Trio. 7.30: Commercial and general news. 7.45: Talk by Lieut.-Colonel Le Souef, Director Zoological Gardens, South Perth. 8.0: Time signal. 8.1: First weather bulletin. 8.3: Vocal and instrumental items from the studio. 9.0: Late news items by courtesy of the "Daily News" Newspaper. Station announcements; ships within range announcements; late weather bulletin. 9.15: Programme continued from the studio. 10.30: Close down.

104.5 METRE TRANSMISSION.
 Simultaneous broadcast on 104.5 metres of programme given on 1250 metres, commencing at 6.45.

7ZL

MIDDAY SESSION
 Announcer: Jack Broadbent. 11.30 to 1.30: See page 39.

AFTERNOON SESSION
 Announcer: Jack Broadbent. 2.15: Description of 8th Test Match, English XI. v. Australia, played at Melbourne. Cricket Ground, Melbourne, Victoria. "Aunt Edna" will speak on "Autumn Millinery." Description of the 1st Test Match. 3.30: Close down. 4.0: Description of the 5th Test Match. Close down.

EARLY EVENING SESSION
 Announcer: Jack Broadbent. 6.15: "His Masters' Voices" Moments Merry and Musical. 6.30: "Clark David" will entertain the wee folk. 7.0: "F. Masters" will talk to the children—"Animal Farm" by G. Orwell. 7.10: Answers to letters. Birthday greetings by "Uncle David." 7.10: Close down.

EVENING SESSION
 7.15: G. Colles, Tasmanian's Champion wicket-keeper will speak on "Physical Culture." 7.45: R. W. Mackenzie will speak on "The Future of Motion Pictures." 8.0: G.P.O. clock chimes the hour. 8.15: News. 8.15: Transmission of the Memorial Cup at the Memorial Hall, Brisbane Street, Hobart—a concert arranged by James Marsh, a well-known Tasmanian singer. 9.50: News session. 10.0: G.P.O. clock chimes the hour. 10.1: Close down.

25% GREATER OUTPUT AT LESS COST!

"THIS IS WHAT 'SUPER-SERVICE' MEANS TO YOU"

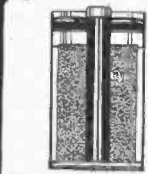

This is the size cell found in most Heavy Duty "B" Batteries, selling at 25% or more.



This is the size cell used in the "Ever-Ready" SUPER SERVICE Battery. Note the great difference in size.



EVER seen the inside of an "Ever-Ready" SUPER SERVICE "B" Battery? Ever noticed the construction of the 30 powerful cells inside the case—the heavy-gauge zinc containers—the high quality of all materials used in the manufacture?

If you haven't, then you've missed finding out why this Battery is so popular. It's in the cells! The illustration on the left shows you graphically how much larger a SUPER SERVICE cell is than the average Heavy Duty cell. By using an "Ever-Ready" SUPER SERVICE "B" Battery for your radio you can obtain 25% greater output, longer life, greater reliability, and unexcelled economy—all this at a price actually lower than many of the small-cell Heavy Duty "B" Batteries on the market.

Enjoy to-night's radio programme to the full. Get your SUPER SERVICE to-day from any good radio dealer.



See that this Trade-mark is on each Battery. It guarantees the genuine British article.

Wholesale Distributors:

THE EVER-READY CO. (Gt. BRITAIN), LTD.,
163 PITT STREET, SYDNEY.

W.E.S.



Local Programmes, Tuesday, March 12

2FC

EARLY MORNING SESSION

Announcer: A. S. Cochrane.
7.0: "Big Ben" and announcements. 7.2: Official weather forecast, rainfall, river reports, temperature, astronomical memoranda. 7.7: "Sydney Morning Herald" summary. 7.12: Shipping intelligence, mail services. 7.15: Studio music. 7.25: Investment market, mining sharemarkets, metal quotations, wool sales, breadstuffs markets, inter-State markets, produce markets. 7.40: Studio music. 8.0: "Big Ben." Close.

MORNING SESSION

Announcer: A. S. Cochrane.
10.0: "Big Ben" and announcements. 10.3: Pianoforte reproduction. 10.10: "Sydney Morning Herald" news service. 10.25: Studio music. 10.30: Last minute sporting information by the 2FC Racing Commissioner. 10.40: Studio music. 10.50: Pianoforte reproduction. 11.0: "Big Ben." A.P.A. and Reuter's Cable Services. 11.5: Close.

MIDDAY SESSION

Announcer: A. S. Cochrane.
12.0: "Big Ben" and announcements. 12.1: Stock Exchange, first call. 12.3: Official weather forecast, rainfall. 12.5: Studio music. 12.10: Summary of news. "Sydney Morning Herald." 12.15: Rugby Wireless news. 12.20: Scores of the fifth Test match, England v. Australia, played at Melbourne. 12.25: A reading. 12.35: Scores of the fifth Test match. 12.40: Studio music. 12.50: Scores of the fifth Test match. 12.55: Studio music. 1.0: "Big Ben." weather intelligence. 1.2: Studio music. 1.5: News of the fifth Test match. 1.10: "Evening News" midday news service, Producers' Distributing Society's report. 1.20: Scores of the fifth Test match. 1.25: "Evening News" etc., continued. 1.33: Stock Exchange, second call. 1.35: Scores of the fifth Test match. 1.45: Popular studio music. 2.0: "Big Ben." Close.

AFTERNOON SESSION

Announcer: Laurence Halbert.
Accompanist: Ewart Chapple.
2.30: Programme announcements. 2.32: Educational Session—Musical recital, a reading. 2.35: Scores, fifth Test match, played at Melbourne. 2.40: Educational Session continued. 2.50: Scores, fifth Test match, played at Melbourne. 2.55: Educational Session continued. 3.0: Studio music. 3.20: Scores, fifth Test match, played at Melbourne. 3.25: Gertrude Grey, soprano. 3.32: Popular music. 3.35: Scores, fifth Test match, played at Melbourne. 3.40: "Where to Wander in Paris," by Freda Steinberg. 3.50: Scores, fifth Test match, played at Melbourne. 3.55: Edith Harrison, pianist—(a) "Sonata in E Flat Minor" (Bach), (b) "Le Bavolet Fleuri" (Gouperin). 4.5: Scores, fifth Test match, played at Melbourne. 4.15: Gertrude Grey, soprano. 4.20: Scores, fifth Test match, played at Melbourne. 4.25: Edith Harrison, pianist: (a) "Papillons" (Lavallee), (b) "Nocturne" (Grieg), (c) "Cavotte" (Balfour-Cardiner). 4.35: Scores, fifth Test match, played at Melbourne. 4.40: Studio music. 4.47: Third call of the Stock Exchange. 4.50: Scores, fifth Test match, played at Melbourne. 4.55: Studio music. 5.5: Scores, fifth Test match, played at Melbourne. 5.10: Close down. Note: Cricket scores will be transmitted at 5.20.

EARLY EVENING SESSION

Announcer: A. S. Cochrane.
5.35: Scores, fifth Test match, played at Melbourne. 5.40: The chimes of 2FC. 5.45: The Hello Man talks to the children, assisted by "Aunt Eily." Letters and stories, music and entertainment. 5.50: Scores, fifth Test match, played at Melbourne. 5.55: Children's Session, continued. 6.5: Scores, fifth Test match, played at Melbourne. 6.10: Children's Session, continued. 6.30: Dalgety's market reports (wool, wheat, and stock). 6.40: Fruit and vegetable markets. 6.43: Stock Exchange information. 6.45: Weather and shipping news. 6.48: Rugby Wireless news. 6.50:

Late sporting news. 7.0: "Big Ben," late news service. 7.10: The 2FC Dinner Quartette, conducted by Horace Keats—(a) "Forty-seven Ginger-headed Sailors" (Sarony), (b) "Prelude in C Sharp Minor" (Rachmaninoff), (c) "The Count of Luxemburg" (Lehar), (d) "The Fiddler of June" (Elliott), (e) "Blue Night" (Rollins).

EVENING SESSION

Announcer: Laurence Halbert.
Accompanist: Ewart Chapple.
7.40: Popular music.
7.45: Programme announcements.
7.47: Resume of the fifth Test, played at Melbourne.
7.57: Popular music.
8.0: Metropolitan Band, conducted by John Palmer—
(a) March, "Duty's Call" (Selbourne).
(b) Selection, "Songs of Squire" (arr. Hume).
8.20: Olive Godwin, soprano—Farewell appearance before Miss Godwin sails for America.
8.30: Sketch by Gwen Sherwood.
8.38: Metropolitan Band, conducted by John Palmer—
(a) Selection, "Emilia" (Donizetti).
8.53: Stanley Clarkson, basso—
(a) "Within These Sacred Bowers" ("Magie Flute" (Mozart).
(b) "The Wanderer" (Schubert).
9.0: "Big Ben." Weather report.
9.1: Sketch by Gwen Sherwood.
9.8: Metropolitan Band, conducted by John Palmer—
Frotrot, "Sunshine" (Berlin).
9.13: Olive Godwin, soprano.
9.23: Metropolitan Band, conducted by John Palmer—
Selection, "Patience" (Sullivan).
9.33: Stanley Clarkson, basso—
(a) "Sapphic Ode" (Brahms).
(b) "The Vain Swif" (Brahms).
(c) "The Sergeant's Song" (Holst).
(d) "Break, Break, Break" (Lavater).
9.40: Metropolitan Band, conducted by John Palmer—
Overture, "Crown of Honor" (Richards).
9.55: Announcements.
10.0: "Big Ben." Studio Dance Band, conducted by Cec Morrison.
10.12: Announcements.
10.17: Studio Dance Band, conducted by Cec Morrison.
10.27: Late weather report.
10.30: Studio Dance Band, conducted by Cec Morrison.
10.57: To-morrow's programme.
10.59: Studio Dance Band, conducted by Cec Morrison.
11.30: National Anthem. Close down.

2BL

MORNING SESSION

Announcer: A. C. C. Stevens.
8.0: G.P.O. chimes. Metropolitan weather report. 8.1: State weather report. 8.2: Studio music. 8.15: G.P.O. chimes. News service from the Daily Telegraph "Fictorial" vice from the Daily Telegraph "Fictorial".
8.30: G.P.O. chimes. News service continued.
8.40: Information, mails shipping, arrivals, departures, and sailings. 8.45: Studio music.
9.15: Half an hour with silent friends. 9.45: Studio music. 10.0: G.P.O. chimes. Close down.

MIDDAY SESSION

Announcer: A. C. C. Stevens.
11.0: G.P.O. chimes. 2BL Women's Sports Association Session, conducted by Miss Gwen Varley. 11.30: Advertising hints. 11.40: Women's Session, conducted by Mrs. Cranfield. 12.0: G.P.O. chimes. Special ocean forecast and weather report. 12.3: Studio music. 12.30: Scores of the fifth Test match, England v. Australia, played at Melbourne. 12.35: Studio music. 12.30: Shipping and mails. 12.35: Scores of the fifth Test match. 12.40: Market reports. 12.50: Scores of the fifth Test match. 12.55: Sun" midday news service. 1.5: Scores of the fifth Test match. 1.10: Studio music. 1.20: Scores of the fifth Test match. 1.25: Studio music. 1.30: Talk to children and special entertainment for children in hospital. 1.35: Scores of the fifth

Test match. 1.45: Talk to children continued. 2.0: G.P.O. chimes. Close down.

AFTERNOON SESSION

Announcer: A. C. C. Stevens.
Accompanist: Kathleen Roe.
2.35: Scores, fifth Test match, played at Melbourne. 2.40: Close down. 2.50: Scores, fifth Test match, played at Melbourne. 2.55: Close down. 3.5: Scores, fifth Test match, played at Melbourne. 3.10: Close down. 3.15: Scores, fifth Test match, played at Melbourne. 3.25: Close down. 3.35: Scores, fifth Test match, played at Melbourne. 3.40: Studio music. 3.50: Scores, fifth Test match, played at Melbourne. 3.55: Studio music. 4.5: Scores, fifth Test match, played at Melbourne. 4.15: Nancye Rouse, violinist—"Slumber Song" (Von Carse). 4.20: Scores, fifth Test match, played at Melbourne. 4.25: James Peden, pianist. 4.35: Scores, fifth Test match, played at Melbourne. 4.40: Nancy Rouse, violinist: "Serenade Espagnola" (Chaminade). 4.47: "Sun" news service. 4.50: Scores, fifth Test match, played at Melbourne. 4.55: James Peden, pianist. 5.5: Scores, fifth Test match, played at Melbourne. 5.10: Popular music. 5.20: Scores, fifth Test match, played at Melbourne. 5.25: Studio music. 5.29: Producers' Distributing Society's poultry report. 5.31: Racing results. 5.33: Features of the evening's programme. 5.35: Scores, fifth Test match, played at Melbourne.

EARLY EVENING SESSION

Announcer: Basil Kirke.
5.40: Children's Session, conducted by Uncle Bas. Music and entertainment, letters and stories. 5.50: Scores, fifth Test match, played at Melbourne. 5.55: Children's Session continued. 6.5: Scores, fifth Test match, played at Melbourne. 6.10: Children's Session continued. 6.20: Mr. Norman will talk to the bigger boys. 6.30: "Sun" news and late sporting. 6.40: 2BL Dinner Quartette—(a) "Cheero" (Finck), (b) "A Song Remembered" (Coates), (c) "Scenes from the South" (Hode), (d) "Full Moon" (Woolmer), (e) "In Bamboo Garden" (Donaldson), (f) "Everywhere I Look" (Molly Carew). 7.7: Australia Mercantile, Land, and Finance Co.'s report. Weather report and forecast, by courtesy of Government Meteorologist. Producers' Distributing Society's fruit and vegetable market report. Grain and fodder report ("Sun"). Dairy produce report ("Sun"). Mr. Pim and Miss Pam in advertising talk and nonsense. 7.55: Programme and other announcements.

EVENING SESSION

Announcer: Basil Kirke.
Accompanist: G. Vern Barnett.
8.0: From the Rose Bay Wintergarden Theatre: The Rose Bay Wintergarden Theatre Orchestra, conducted by Lionel Hine.
8.20: From the Studio: Ray Simmons, boy soprano—
(a) "Boat Song" (Ware).
(b) "Afton Waters" (Hume).
8.27: The Music Makers.
8.42: Monologues by Charles Lawrence.
8.52: Ethel Daw, contralto—
(a) "O Del Mio Dolce Ardor" (Gluck).
(b) "Lilles" (Barry).
8.59: Weather report.
9.0: The Music Makers.
9.15: Talk by S. H. Bowden, "Weet by Week."
9.30: Ray Simmons, boy soprano—
(a) "The Meeting of the Waters" (Cran Melody).
(b) "Wild Rose" (Schubert).
9.37: Charles Lawrence's monologues.
9.47: The Music Makers.
9.57: Ethel Daw, contralto—
(a) "Love, Could I Only Tell Thee" (C. pel).
(b) "One Who Has Yearned Alone" (Tschakowsky).
10.4: From the Rose Bay Wintergarden Theatre: The Rose Bay Wintergarden Theatre Orchestra, conducted by Lionel Hine.
10.25: From the Studio: Late weather. Features of to-morrow's programme.
10.30: National Anthem. Close down.

Interstate Programmes, Tuesday, March 12

3LO

EARLY MORNING SESSION

10.0 to 8.15: Set Friday.
MORNING SESSION
 Announcer, Maurice Dudley. 11.0: 3LO's Daily Dinner for the Daily Dinner—8 passionfruit (for filling) 8 passionfruit, 3 eggs, juice of one large lemon, 2 tablespoons water, 1lb. sugar. 11.5: E. Noble will speak on "Gas Cookery." 11.55: Musical interlude. 11.55: Mrs. Sills will speak on "Homemakers." 11.40: Musical interlude. 11.45: Miss Doreen Berry will speak on "Windmills and Baggy Breeches."

MIDDAY SESSION

Announcer, Frank Hatherley. 12.0: Description of 5th Test match, England v. Australia, at M.C.C. v. Red M'Gregor. 1.30: Meteorological information forecast for Victoria, New South Wales, South Australia, and Tasmania; ocean forecast; river reports; rainfall; Stock Exchange information. Newmarket stock sales; official report of the sheep market by the Associated Stock and Sheep Agents, Bourke Street, Melbourne. 1.45: To 6.0.

AFTERNOON SESSION

1.45: Description of the fifth Test match, England v. Australia, at M.C.C., by Rod M'Gregor. 2.0: The Imperial Russian Trio (Arved Nordt Vlohin, Ivan Berinsky, cello, Vassili Ister piano)—Arved Nordt Vlohin, "Savonia Dance" (Dvorak-Kreisler); Ivan Berinsky, cello, "Chanson XIII. et Valse" (Franz-Kreisler); the trio, "Romance d'Autant" (Frederic Hall), "Berceuse" (Grieg). 4.15: Description of the fifth Test match resumed. 4.45: Further description of the fifth Test match. 4.55: Further description of the fifth Test match. 5.0: Stumps scores.

EVENING SESSION

5.15: Birthday greetings by "Bobby Bluegum." Story—"Little Miss Kookaburra." 6.5: Answers to questions and birthday greetings by "Bobby Bluegum." "Little Miss Kookaburra" knows some more. "Nellie and Billie in Moonland." Nellie and Billie are mysteriously invited to a picnic in Butterfly Land. Song of the Queen of Dreamland. Mother and her long-lost dog comes to life again. A little girl named Migsy Migsy. 6.50: "Bobby Bluegum" has also a story for the children.

NIGHT SESSION

Announcer, John Stuart. Accompanist, Agnes Gorman. 7.15: Stock Exchange information. 7.15: Stumps reports. 7.30: News session; stumps scores.

4QC

EARLY MORNING SESSION

Announcer: J. Tyson. 7.43: Time signals. 7.45: News service. 8.0: Electric records. 8.15: News service. 8.30: Close down.
MORNING SESSION.
 Announcer: Rita M'Auliffe. 11.0: Music. 11.5: Social news. 11.15: Lecture: Talk on "Home Crafts," by Mrs. R. L. Reid. 11.30: Music. 11.35: More social news. 12.0 (noon): Close down.

MID-DAY SESSION

Announcer: R. Wight. 1.0: Market reports and weather information. 1.20: Wurlitzer organ. 2.0: Close down.

AFTERNOON SESSION

Announcer: H. Humphreys. 3.0: A programme of electrically-reproduced records. 3.30: Mail train running times. 4.15: This afternoon's news. 4.30: Close down.

EARLY EVENING SESSION

Announcers: R. Wight and H. Humphreys. 6.0: Mail train running times; mail information; shipping news. 6.15: A Law talk: "Negligence by a Barrister-at-Law." 6.25: Commercial announcements. 6.30: Bedtime stories conducted by "Uncle Ben." 7.0: News in brief. 7.5: Stock Exchange news. 7.6: Metal quotations. 7.7: Market report. 7.8: Perth's Stock report. 7.30: Weather information. 7.40: Announcements. 7.43: Standard time signals. 7.45: Lecture on "Photography," by Mr. F. L. South (Kodak).

NIGHT SESSION

Announcer: H. Humphreys. A programme by Mr. Sydney May's party—8.0: Double Quartette: "O Come Everyone That Thirsteth" (Mendelssohn), "Lou Lambert (baritone); "Ases Fewer" (Clarke) Pat M'Onigly (soprano) and Vera Parker (contralto); Vocal duet, "The Sweetest Story Ever Told" (Stuils), Jack Land (tenor); "Love is Forever" (Newton), Women's Voices; "Near an Ancient Hostelry" (Richardson), Lou Lambert (baritone); "A Thousand Mothers' Eyes" (Drummond), John Steele (tenor) and W. L. Burch (bass); Vocal duet, "I Wish to Tune My Qu'ring Lyre" (Walton); Agnes Kerr (contralto); "My Ships" (Barratt), Men's voices; "Sabbath Gail" (Kreutzer), Jill Manners (soprano); "Una Voce Poco fa" (Rossini), John Steele (tenor); "In Native Worth" (Haydn), Part-songs; "O Peaceful Night" (German), W. L. Burch (bass); "Up From Somerset" (Sanderson), Will H. Lister; "A Thousand To-night, The Hope and Now," Pat M'Onigly (soprano); "The String of Pearls" (Phillips), Part-song; "Alice, Where Art Thou" (Archer), Jack Land (tenor); "I Heard You Singing" (Gosset), Vera Parker (contralto); "Like as the Heart Desireth" (Allison), Part-song; "Dream, Baby, Dream" (Baynon), Ernest Hyde (violinist); "Liebesfreud" (Kreisler), Jill Manners (soprano) and Pat M'Onigly (soprano); Vocal duet, "Oberon in Fairyland" (Newton), Jack Land (tenor); "Believe Me, If All Those Endearing Young Charms" (Moore), Lou Lambert (baritone); "Night-fall at Sea" (Phillips), Ernest Hyde (violinist); "Each of a Day" (Drummond), John Steele (contralto); "That's All" (Brabe), Part-song; "The Bonnie Banks of Loch Lomond," John Steele (tenor); "Intermezzo" (Kahn), Jill Manners (soprano); "The Net Mender" (Clarke), Agnes Kerr (contralto); "My Ain Folk" (Lemon), W. L. Burch (bass); "The Mountains of Mourne" (Collinson), Pat M'Onigly (soprano); "Dear Little Jammy Face" (Russell), Vera Parker (contralto); "The Sweetest Flower That Grows" (Howley), Men's voices; "Song of the Pedlar" (Le Williams), 10.0: "The Daily Mail" news, the "Courier" news, "Queenslander" bi-weekly news for country listeners. Close down.

3AR

Announcer: Maurice Dudley. 10.0: G.P.O. clock says, "Ten." 10.1: "Age" market reports, farm and station produce, fruits, fish, vegetables, etc. 10.23: "Age" shipping reports. Ocean forecast. 10.30: Mail notices, express train information. 10.35: "Age" news service, exclusive to 3AR. 10.42: Weather forecast. 11.0: The Radio Revelers, "The Desert Song" (Romberg), "One Alone" (Romberg), "Meet Me To-day" (Dean), "Mexican Serenade" (Teres), "It Goes Like This" (Friedel). 11.20: Beautiful Ballads. 11.30: The Radio Revelers, "Too Busy" (Miller), "Sweet Sue, Just You" (Tobias), "In a Bamboo Garden" (Donaldson), "Ankling You Say" (Donaldson). 11.50: Beautiful Ballads. 12.8: The Radio Revelers, "Lonely Acres" (Robinson), "Shake It Down" (Williams), "Next to You I Like Me Next to You" (Blitz), "What Was I To Do?" (Reid). 12.20: British official wireless news. Announcements. 12.30: Close down.

AFTERNOON SESSION

Announcer: Frank Hatherley. Accompanist: Mabel Nelson. 2.15: The station orchestra. Overture, "Eunuyade" (Erkel). 2.30: Mary King (soprano), Adagio Lamento from Sixth Symphony (Tschai-kowsky). "Dawn" (Pearl Curran), "Last Night" (Kjerulf). 2.37: The station orchestra. Selection, "Dream Girl" (Herbert). 2.47: Spencer Ward and Gertrude Long, "A Piano and Just Us." 2.54: The station orchestra. "Air Ship" (Herbert), "Andante (Grieg). 3.4: Syd. Hollister (comedian). "Listen To Me." 3.11: The station orchestra. "Songs of Italy" (Lohr), 3.21: Rosalind Hartung (contralto), "Barbara Allan" (Scottish air), "My Ain Folk" (Lemon). 3.25: Mona Nugent (piano), "Romance in D Flat" (Sibelius), "March of the Dwarfs" (Grieg). "Moment Musical in A Flat" (Schubert). "Dance of Spring" (Chaminade). 3.43: Mary King (soprano), "Lackaday" (Edgerton), "Last Night," Song of Creole" (M'Burney). 4.0: The station orchestra. Selected. 4.15: Spencer Ward and Gertrude Long, "A Piano and Just Us." 4.22: Guildford, Bishop, "Serenata" (Toselli). 4.27: Syd. Hollister (comedian). "Cheer Up." 4.34: Schuber-tiana. The station orchestra. Selection, "Lark Time" (Schubert), 4.44: Rosalind Hartung (contralto), "The Linden Tree" (Schubert). "To Music" (Schubert). 4.51: The station orchestra. "Two Favorite Classics" (Schubert). 5.0: Close down.

EVENING SESSION

Announcer: Renn Millar. 6.0: Gramophone recital. 7.10: News service. Announcements. Cricket. Results of fifth Test. 7.20: Gramophone recital continued.

NIGHT SESSION

Announcer: Renn Millar. 8.0: Mme. Soward. "A French Talk." 8.15: A. W. Jackson. "Golf." 8.30: The station orchestra. Overture, "Robespierre" (Tiot). 8.45: Adele Crane (soprano), "Villa." "The Merry Widow" (Glinka). 9.15: Fred Hall. Selected. 9.25: The station orchestra. "Adieu" (Harganoff). 9.30: Transmission from the Victory Theatre. The orchestra, under the baton of Henri Perak. 10.20: News session. Announcements. Results of fifth Test match. "God Save the King."



Radio Tube Checker

Pattern 107: Junior Tube Checker for testing tubes at home. Equipped with plug and cord so that necessary voltages may be taken direct from any radio set. Adapters supplied so checker may be used with any set equipped with standard sockets.

Baton furnished to charge grid bias on tubes, thus giving definite measure of value of tube.

Write for Radio Instrument Catalogue No. 15c.

STROMBERG CARLSON

Australasia Limited, 76 William Street, Sydney. Phone: F4184.

Telegrams: "Strom."

Information. 7.6: General market reports—S.A. Farmers' Union, Dairy Produce; A. W. Sandford and Co., produce and poultry; A. E. Hall and Co., dairy produce and poultry; Daigety and Co., wool and grain; Retail Grocers' Association, dairy produce. International cricket scores, England v. Australia, at Melbourne; scores of inter-State tennis matches and annual tournament. 7.10: SCL's sporting service by "Silvius." 7.18: Miss Laurie M'Leod will speak on "The Art of Dancing." 7.35: Dr. Herbert Basedow in another of his interesting Australian talks.

NIGHT SESSION

Accompanist: Jean Finlay. Announcer: J. L. Norris. 8.0: G.P.O. chimes. 8.1: Hindmarsh Municipal Band (conductor, Mr. J. Radcliffe)—Overture, "Poet and Peasant" (Suppe); March, "B.B. and C.F." (Ord Hume). 8.14: Alys Watson, soprano—"One Lone Star" (MacCunn); "Jeunesse" (Barry). 8.20: A pianoforte recital by Tom King (original compositions)—"The Sea," "Nocturne in D Flat," "Capriccio in E," "Serenade Egyptian," "Music Box," "The Enock," "Rhapsodie African." 8.45: Rev. Frank Gorman and Sadie M'Donald—selections from their repertoire. 8.51: Hindmarsh Municipal Band—"The Gondoliers" (Sullivan), by request. 9.0: G.P.O. chimes. 9.1: Meteorological information, including semaphore tides; overseas grain report. 9.3: William and Florence Davey, xylophonists—"We'll Meet Again" (Greenberg); "Last Night I dreamed" (Kahn). 9.9: Rinaldo Torre, baritone—"Sancta Lucia Luntana" (Mario); "Dreams That Are Sweet and True" (Mona). 9.15: A. Ellis, trumpeter—"The North Star" (Greenwood). 9.22: Hindmarsh Municipal Band—"Maritana" (Wallace). 9.37: Alys Watson, soprano—"String of Pearls" (Phillips). "They Say" (Evans). 9.43: A. Radcliffe, trombone soloist—"The Tyrolenne" (Sutton). 9.48: Rinaldo Torre, baritone—"Possente" (Gounod); "Love Sends a Little Gift of Roses" (Openshaw). 9.54: William and Florence Davey, xylophonists—"Giri of the Southern Sea" (Heaghey); "Just a Memory" (Henderson). 10.0: Hindmarsh Municipal Band—Serenade, "A Night in June" (Radcliffe); "March, "Brilliant" (Ord Hume). 10.1: General news service; meteorological information; SCL's sporting service by "Silvius"; international cricket scores, England v. Australia; Melbourne scores of inter-State tennis matches and annual tournament. 10.30: Modern dance numbers by the famous "Radio Revelers." 11.0: "God Save the King." Close down.

6WF

(Progress results of 5th Test match will be broadcast each half hour until stumps.)

12.30: Tune in. 12.35: Market news, etc. 1.0: Time signal. 1.1: Weather bulletin supplied by the Meteorological Bureau of West Australia. 1.3: Music by the Studio String Trio. 2.0: Close down. 3.30: Tune in. 3.35: Musical programme, including pianoforte solos by Miss Audrey Dean; vocal items. 4.30: Close down. 6.45: Tune in. 6.48: Bedtime stories for the kiddies, by Uncle Dury. 7.5: Light music by the String Trio. 7.30: Commercial and general information. 7.48: Talk by Dr. Battye, B.A., LL.B. 8.0: Time signal. 8.1: First weather bulletin. Items by 6WF's Station Orchestra, conducted by Mr. W. Wilkins (pianist, Miss Audrey Dean). 8.0: Late news items by courtesy of the "Daily News" Newspaper Co.; ships within range announcements; station announcements; late weather bulletin. 9.15: Orchestra programme continued from studio. 10.30: Close down.

104.5 METRE TRANSMISSION.
Simultaneous broadcast on 104.5 metres of programme given on 1250 metres, commencing at 6.45 p.m.

7ZL

MIDDAY SESSION

Announcer Jack Broadbent. 11.30: to 1.30: See Friday.

AFTERNOON SESSION

Announcer: Jack Broadbent. 2.15: Description of the 5th Test Match, English XI. v. Australia, played at the Melbourne Cricket Ground, Melbourne, Victoria. 4.0: An educational talk on "Asbestos—Production in Canada in 1927." 4.15: Description of 5th Test Match. 4.30: Close down. 6.0: Close down.

EARLY EVENING SESSION

Announcer: Jack Broadbent. 6.15: Broadcasts. 6.30: Doreen Elsey will play the piano for the wee folk—"Eruba," "Prince of Smiles." 6.45: Broadcasts. 7.0: Answers to letters and birthday greetings by "Uncle David." 7.5: Broadcasts. 7.18: News Session.

EVENING SESSION

Announcer: Jack Broadbent. 7.30: Geo. Lewis, of the Hobart Savings Bank, will speak on "Thrift." 7.45: W. E. Fuller will speak on "Literary Lists and Library Lists." 8.6: Transmission from the Derwent Rowing Club symposium—description of Southern Tasmanian boxing contests, described by "Olympus." 8.48: News session. 10.0: G.P.O. clock chimes the hour. 10.1: Close down.

2UW

MIDDAY SESSION.

12.30: Music. 1.0: G.P.O. clock and chimes. Music. 2.30: Close down. 4.30: Musical programme.

EVENING SESSION.

5.30: Children's hour, conducted by Uncle Jack. 6.30: Close down. 7.0: G.P.O. clock and chimes. Music. 8.0: To-day's anniversary. Music. 8.15: Film talk by Miss E. Baumberg. 8.30: Music. 9.0: G.P.O. clock and chimes. Comments on foreign affairs by Mr. J. M. Prentice. 9.10: Music and request numbers. 10.0: Close down.

Brown

LOUD SPEAKERS

Every Speaker of the world-famed BROWN Pedigree is indicative of that unrivalled Standard of production which has made the name BROWN famous wherever Radio is known.

A BROWN Speaker—any one of the famous Range, will give reproduction of a kind that makes Radio reception the faithful echo of the original Broadcast.

FROM TWO POUNDS TO TWENTY GUINEAS

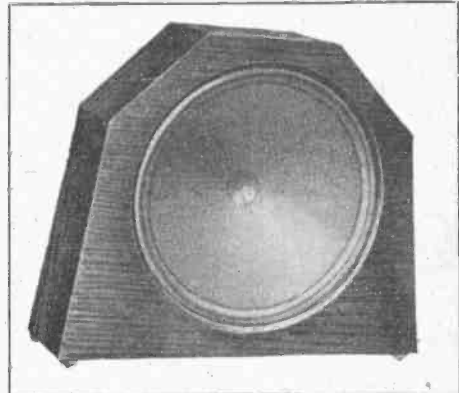

THE "DUCKLING."

A new addition to the Brown Pedigree—an advanced improvement on the "Junior" type, to meet the growing demand for a reliable and moderately-priced Cone Speaker.

This model is proving as popular and as efficient in the Cone Type as the H 4 did in the Horn Type.

May be had in Mahogany or Oak, 9 1/2 in. high x 11 in. wide x 3 1/2 in. deep.

Ask to Hear the "DUCKLING" Demonstrated
--AT ALL RADIO DEALERS--

NOYES BROS.

(SYDNEY), LTD.

(MELBOURNE), PTY., LTD.

Sydney: 115 Clarence Street.

Melbourne: 495 Bourke Street.

Newcastle: 11 Watt Street.

Adelaide: 119 Pirie Street.

Brisbane: Perry House, Elizabeth Street.

Hobart: 36 Argyle Street.

Bath Street.

Launceston: 59 George Street.

PERTH: J. R. W. Gardam and Co.



The New H4.

Write for Pamphlet "B.W.W."

Local Programmes, Wednesday, March 13

2FC

EARLY MORNING SESSION.

Announcer: A. S. Cochrane.
 10. "Big Ben" and announcements. 7.2:
 Official weather forecast, rainfall, river
 reports, temperature, astronomical memoranda.
 11. "Sydney Morning Herald" summary.
 12. Shipping intelligence, mails services
 13. Studio music. 7.25: Investment market,
 mining share markets, metal quotations, wool
 and breadstuffs markets, inter-State mar-
 produce markets. 7.40: Studio music.
 7.45: "Big Ben," close.

MORNING SESSION.

Announcer: A. S. Cochrane.
 10. "Big Ben" and announcements. 10.2:
 Pandorite reproduction. 10.10: "Sydney
 Morning Herald" news service. 10.25: Studio
 music. 10.45: A talk on home cooking and
 recipes by Miss Ruth Furst. 11.0: "Big Ben,"
 A.P.A. and Reuter's cable services. 1.5:
 Close down.

MIDDAY SESSION.

Announcer: A. S. Cochrane.
 12. "Big Ben" and announcements. 12.1:
 Stock Exchange, first call. 12.3: Official
 weather forecast, rainfall. 12.5: Studio music.
 12.11: Summary of news, "Sydney Morning
 Herald" 12.15: Fifth wireless news. 12.20:
 Scores of the fifth Test match, England v.
 Australia, played at Melbourne. 12.25: A
 Reading. 12.35: Scores of the fifth Test
 match. 12.40: Studio music. 12.50: Scores of
 the fifth Test match. 12.55: Studio music.
 1. "Big Ben," weather intelligence. 1.2:
 Studio music. 1.5: Scores of the fifth Test
 match. 1.10: "Evening News" mid-day news
 service. Producers' Distributing Society's re-
 1.20: Scores of the fifth Test match.
 "Evening News," etc., continued. 1.33:
 Stock Exchange, second call. 1.35: Scores of
 the fifth Test match. 1.45: Popular studio
 music. 2. "Big Ben," close.

AFTERNOON SESSION.

Announcer: Laurence Halbert.
 Accompanist: Ewart Chapple.
 11. Programme announcements. 2.15
 Mr. Merriwa: Gigantic Rodeo—the first
 Rodeo in Australia to be broadcast. Buck-
 brennie, Cattle Drafting, Bullock Riding,
 Throwing, Tyne. During the afternoon
 market scores of the fifth Test match, played
 at Melbourne, will be given at 2.35, 2.50, 3.5,
 3.15, 3.30, 3.45, 4.20, 4.35, 4.50, and 5.15.
 During intervals in the description from the
 Laurence Mather, soprano: (a) "A Song
 remembered" (Coates). (b) "Vainka's Song"
 The Swainson (c) "The Cuckoo" (Leh-
 man). (d) "A Spirit Flower" (Tipton). Race
 results from Kensington will be transmitted
 received. 5.10: Close down. Note.—
 Market scores will be transmitted at 5.20.

EARLY EVENING SESSION.

Announcer: A. S. Cochrane.
 13. Scores fifth Test match, played at
 Melbourne. 5.40: The Chimes of 2FC. 5.45:
 The Hello Man talks to the children, assisted
 by Uncle Ted and "Sandy," music and enter-
 tainment, letters and stories. 5.50: Scores,
 fifth Test match, played at Melbourne. 5.55:
 Children's session continued. 6.5: Scores,
 fifth Test match, played at Melbourne. 6.10:
 Children's session continued. 6.30: A chat
 about the Cheer-Up Society by Uncle Frank.
 6.45: Daley's market reports (wool, wheat,
 etc., stock). 6.40: Fruit and vegetable mar-
 6.45: Stock Exchange information. 6.45:
 Weather and shipping news. 6.48: Rugby
 6.50: Late sporting news. 7.0:
 "Big Ben," late news service. 7.10: The 2FC
 Chamber Quartette, conducted by Horace
 (a) Waltz, "Eugene Onegin" (Tschai-
 (b) "A Spring Dav" (Haines). (c)
 (d) "You Were in My Garden" (Benyon). (d)
 "Three Mask Dances" (Pierrot), (e) "On Pen
 11. "Amour" (Slesiu), (f) "Pierrette" (Chami-
 11.10: Close down.

EVENING SESSION.

Announcer: Laurence Halbert.
 Accompanist: Ewart Chapple.
 11.0: Popular music.
 11.15: Programme announcements.
 11.45: Resume of the fifth Test match,
 played at Melbourne.
 11.50: Classical programme arranged by
 Roland Foster.
 11.55: Weather report.
 12.1: A Talk by Francis Jackson.
 12.15: Second half of the classical pro-

gramme arranged by Roland Foster.

10.30: National Anthem.
 Close down.

2BL

MORNING SESSION.

Announcer: A. C. C. Stevens.
 8 a.m.: G.P.O. chimes; metropolitan
 weather report. 8.1: State weather report.
 8.2: Studio music. 8.15: G.P.O. chimes; news
 service from the "Daily Telegraph Pictorial."
 8.30: G.P.O. chimes; news service continued.
 8.40: Information, mails, shipping, arrivals,
 departures, and sailings. 8.45: Studio music.
 9.15: Half an hour with silent friends. 9.45:
 Studio music. 10.0: G.P.O. chimes; close
 down.

MIDDAY SESSION.

Announcer: A. C. C. Stevens.
 11.0: G.P.O. chimes; 2BL Women's Sports
 Association session, conducted by Miss Gwen
 Varley. 11.30: Advertising hints. 11.40:
 Women's session, conducted by Mrs. Cran-
 field. 12.0: G.P.O. chimes; special ocean
 forecast and weather report. 12.3: Studio
 music. 12.20: Scores of the fifth Test match,
 England v. Australia, played at Melbourne.
 12.25: Studio music. 12.30: Shipping and
 mails. 12.35: Scores of the fifth Test match.
 12.40: Market reports. 12.50: Scores of the
 fifth Test match. 12.55: "Sun" midday news
 service. 1.5: Scores of the fifth Test match.
 1.10: Studio music. 1.20: Scores of the fifth
 Test match. 1.25: Studio music. 1.30: Talk
 to children and special entertainment for
 children in hospital. 1.35: Scores of the fifth
 Test match. 1.45: Talk to children con-
 tinued. 2.0: G.P.O. chimes; close down.

AFTERNOON SESSION.

Announcer: A. C. C. Stevens.
 Accompanist: Kathleen Roe.
 2.35: Scores, fifth Test match, played at
 Melbourne. 2.40: Close down. 2.50: Scores,
 fifth Test match, played at Melbourne. 2.55:
 Close down. 3.5: Scores, fifth Test match,
 played at Melbourne. 3.10: Close down. 3.20:
 Scores, fifth Test match, played at Mel-
 bourne. 3.25: Close down. 3.35: Scores, fifth
 Test match, played at Melbourne. 3.40:
 Studio music. 3.50: Scores, fifth Test match,
 played at Melbourne. 3.55: Studio music.
 4.5: Scores, fifth Test match, played at Mel-
 bourne. 4.15: Frank Martin, baritone—(a)
 "You're a Real Sweetheart" (Friend). (b)
 "Dirty Hands, Dirty Face" (Jolson). 4.20:
 Scores, fifth Test match, played at Mel-
 bourne. 4.25: Talk by Basil Kirke, "The
 Romance of Don Mendoza and Donna Isa-
 belle." 4.35: Scores, fifth Test match, played
 at Melbourne. 4.40: Frank Martin, baritone—
 (a) "After my Laughter Came Tears" (Turk).
 (b) "When I Met Sally" (Wade). 4.47:
 "Suns" news service. 4.50: Scores, fifth Test
 match, played at Melbourne. 4.55: Studio
 music. 5.5: Scores, fifth Test match, played
 at Melbourne. 5.10: Studio music. 5.20:
 Scores, fifth Test match, played at Mel-
 bourne. 5.25: Racing resume. 5.35: Features
 of the evening's programme. 5.55: Scores,
 fifth Test match, played at Melbourne.

EARLY EVENING SESSION.

Announcer: Basil Kirke.
 5.40: Children's session, conducted by
 Uncle Bas; music and entertainment; letters
 and stories. 5.50: Scores, fifth Test match,
 played at Melbourne. 5.55: Children's ses-
 sion continued. 6.5: Scores, fifth Test match,
 played at Melbourne. 6.10: Children's session
 continued. 6.30: "Sun" news and late sport-
 ing. 6.40: 2BL Dinner Quartette—(a) "Red
 Poppies" (Elliott). (b) "Waltz" (Carreno),
 (c) "Three Dream Dances" (Coleridge-
 Taylor). (d) "The South Pacific" (Travers).
 (e) "Meditation" (Thais) (Massenet). (f)
 "Hallelujah" (Youmans). 7.7: Australian
 Mercantile, Land, and Finance Co.'s report;
 weather report and forecast by courtesy of
 Government Meteorologist; Producers' Dis-
 tributing Society's fruit and vegetable market
 report; grain and fodder report ("Sun").
 dairy produce report ("Sun"). 7.25: Mr.
 Pim and Miss Pam in advertising talks and
 nonsense. 7.55: Programme and other any-
 8.0: G.P.O. chimes and Topical Chorus.

EVENING SESSION.

Announcer: Basil Kirke.
 Accompanist: G. Vern Barnett.
 8.0: G.P.O. chimes and Topical Chorus.

H. W. Varna and Company will produce

"The Thief"—
 Richard Chelford H. W. Varna
 Raymond Leyton (his friend)—
 William Hume
 Harry Leyton (Leyton's son)—
 Gordon Stilling,
 Mr. Protheroe (Detective) H. J. Salier
 Isabel Leyton Miss Bornewton
 Marise Chelford Meg Service
 Act I.—Leyton's House.
 Act II.—Mr. and Mrs. Chelford's bedroom.
 Act III.—The Library, Leyton's House.

9.0: Weather report.
 9.1: The Savoyans' Dance Band.
 9.13: Frederick Todd, basso.
 9.20: The Savoyans Dance Band.
 9.32: Nellie Ferguson, monologues at the
 piano—
 (a) "When Sister Mary Tried to Broad-
 cast" (Gourley).
 (b) "Earthenware" (Weston).
 9.39: The Savoyans Dance Band.
 9.49: Douglas Graham, Scottish comedian.
 9.56: Frederick Todd, basso.
 10.3: Nellie Ferguson, monologues at the
 piano—
 (a) "Handy Little Thing to Have about
 You" (Montague).
 (b) "Laugh and the World Laughs with
 You" (Barnard).
 10.10: The Savoyans Dance Band.
 10.27: Late weather and announcements.
 10.32: The Savoyans Dance Band.
 10.57: To-morrow's programme.
 10.50: The Savoyans Dance Band.
 11.30: National Anthem; close.

2GB

10.0: Music. 10.10: Happiness Talk, by A.
 E. Bennett. 10.20: Music. 10.30: Women's
 session, by Miss Helen J. Beegling. 11.30: Close
 down. 2.0: Music. 2.5: Women's Radio Ser-
 vice, by Mrs. Dorothy Jordan. 2.50: Music.
 3.0: Labor-saving demonstration from Nock
 and Kirbv. 4.0: Close down. 5.30: Child-
 ren's session, by Uncle George. 7.0: Stock
 and market reports by New Zealand Loan
 and Mercantile Agency. Ltd. 7.15: Music.
 7.30: Feature story. 7.40: Short talk by Miss
 Beegling. 8.0: Miss Ruth Pearce Jones
 (pianiste). 8.10: Mr. Austin Punch (bari-
 tone). 8.20: Mr. Leonard Brewer (violini-
 8.30: Mr. Jack Win and Mr. Heath
 Burdock (humor). 8.35: Miss Elsie Brown
 (soprano). 8.45: Instrumental music. 8.50:
 Mr. William Green (tenor). 9.0: Weather
 report. 9.3: Address. 9.15: Miss Ruth
 Pearce Jones (pianiste). 9.25: Mr. Austin
 Punch (baritone). 9.35: Mr. Heath Bur-
 dock (dramatic recital). 9.45: Mr. Leonard
 Brewer (violinist). 9.55: Miss Elsie Brown
 (soprano). 10.5: Mr. William Green (tenor).
 10.15: Dance music. 10.30: Close down.

2UW

MIDDAY SESSION.

12.30: Music. 1.0: G.P.O. clock and chimes.
 Music. 2.30: Close down. 4.30: Musical pro-
 gramme.

EVENING SESSION.

5.30: Children's hour, conducted by Uncle
 Jack. 6.30: Close down. 7.0: G.P.O. clock
 and chimes. Music. 8.0: To-day's anniver-
 sary. Music. 9.0: G.P.O. clock and chimes.
 Comments on foreign affairs by Mr. J. M.
 Prentice. 9.10: Music and request numbers.
 10.0: Close down.

2UW

THURSDAY, MARCH 14

MIDDAY SESSION.

12.30: Music. 1.0: G.P.O. clock and chimes.
 Music. 2.30: Close down. 4.30: Musical pro-
 gramme.

EVENING SESSION.

5.30: Children's hour, conducted by Uncle
 Jack. 6.30: Close down. 7.0: G.P.O. clock
 and chimes. Music. 8.0: To-day's anniver-
 sary. Music. 8.15: Gardening talk by Mr. S.
 H. Hunt. 8.30: Music. 9.0: G.P.O. clock and
 chimes. Comments on foreign affairs by Mr.
 J. M. Prentice. 9.10: Music and request num-
 bers. 10.0: Close down.

Interstate Programmes, Wednesday, March 13

3LO

EARLY MORNING SESSION.
7.15 to 8.15: See 3AR.

MORNING SESSION.
Announcer: Frank Hatherley. 10.50: Eric Welch will speak on to-day's races at Sandown Park. 11.0: SLO's Different Dainties for the Daily Dinner. 70-day's Radio Recipe. Salmi V. Duck. 11.5: Miss L. D. Deavan will speak on, "Home-made Confectionery." 11.20: Musical interlude. 11.25: Mrs. M. Callaway Mahoon will speak on, "The Art of Decoration." 11.40: Musical interlude. 11.45: Mrs. Clarence Weber, physical culture expert, will speak on "Physical Culture for Women." "Stiffness is a Sign of Old Age."

MIDDAY SESSION.

12.0: Description of the fifth Test match, England v. Australia, at M.C.G., by Rod McGregor. 1.30: Stock Exchange Information. Meteorological Information. Weather forecast for Victoria, New South Wales, South Australia, and Tasmania. Ocean forecasts. River reports. Rainfall. Newmarket stock sales. cattle sales report, bullocks and calves, by the Associated Stock and Station Agents, Bourke Street, Melbourne. Metal prices received by the Australian Mines and Metals Association from the London Stock Exchange this day. 1.45: Close down.

AFTERNOON SESSION.

Announcer: J. L. Norris. 2.15: Description of Two-year-old Handicap, 4 furlongs, Sandown Park Races, by Eric Welch. 2.20: Description of Fifth Test match, England v. Australia, at M.C.G., by Rod McGregor. 2.45: Description of Sandown Park, 8 furlongs, Sandown Park Races. 2.50: Description of fifth Test match continued. 3.15: Description of Brush Steeple, 1 mile, Sandown Park Races. 3.20: Description of fifth Test match continued. 3.45: Description of Sandown Park Handicap, 1 mile, Sandown Park Races. 3.50: Description of fifth Test match continued. 4.15: Sonora recital of the world's most famous records. 4.13: Description of Sandown Purse, 1 mile, Sandown Park Races. 4.20: Description of fifth Test match continued. 4.35: Description of Trial Handicap, 1/2 mile, Sandown Park Races. 4.50: Description of fifth Test match continued. 5.0: "Herald" news service. Stock Exchange Information. Special weather report for the benefit of listeners in the Redcliffs district. During the afternoon results of the Omeo and Swan Hill Races will be broadcast as they come to hand. 5.10: Description of the fifth Test match resumed. 6.0: Stumps scores.

EVENING SESSION.

6.5: Answers to evening and birthday greetings by "John, the Piper's Son." 6.30: Musical interlude. 6.35: "John, the Piper's Son," will entertain the kiddies.

NIGHT SESSION.

7.5: Stock Exchange information. 7.15: Market reports. Jute, dairy produce, potatoes, and onions. Market reports of the Victorian Fruit and Vegetable Growers' Association. Retail prices. Wholesale prices of fruit by the Wholesale Fruit Merchants' Association. Citrus fruits. 7.30: News service. Stumps scores. Fifth Test match, England v. Australia, at M.C.G. 7.43: Birthday greetings. 7.45: Out of the Past. 7.46: Under the auspices of the Department of Agriculture, L. C. Bartels, senior irrigation officer, will speak on "Irrigation Agriculture: Sowing Lucerne and Pastures." 8.0: The station orchestra. Overture, "French Comedy" (Hein. Belz). 8.10: Adele Crane (soprano), "Philosophy" (Emmell). 8.17: The station orchestra, "Witching Hour" (Felix). 8.20: Gertrude Hutton (contralto), "Mindful of the Roses" (Coldridge Taylor). "Easter Carol" (Shaw). 8.31: The Imperial Russian Trio (Arved Norit, violin; Ivan Berzinsky, cello; Vassili Ister, piano). 8.35: Ivan Berzinsky (cello), "Chant Triste" (Tcharkovsky). Vassili Ister (piano), "Prelude in C Sharp Minor" (Rachmaninoff). "Arlingford" (Grieg). 8.40: Gertrude Hutton (contralto), "The Trio, Trio from 'Orpheus' (Gluck). "Farewell to Cucullian" (Kreutzer). Selected. 9.0: The Victorian Postal Institute Chorus. Part songs, "King Arthur" (Edwards). "The Three Little Williams" (Davies). part song, "Cargoes" (Balfour Gardiner). Ladies chorus, "Morning" (Bull). Part song, "Sweet and low" (Wagner). Madrigal, "silver Swan" (Gibbons). Madrigal, "All Hail" (Byrd). Chorus, "Bring Us in Good Ale" (Hoist), Anthem, "Into the Woods" (Noble). Chorus from Mass in B, E. Bach. "Gloria" (Bach). "Gloria" (Bach). "Gratias Agimus" (Bach). 9.30: Donald Mackintosh will speak on, "The Gun for Defence." 9.45: The station orchestra. Suite, "Othello" (Curtiz). 9.55: Adele Crane (soprano), "Bird of Love Divine" (Haydn Dunc). "The Star" (Rogers). 10.3: "Argus" news service. Meteorological information. British official news news from Rugby. Announcements. 10.32: Spencer Ward and Gertrude Long, "Just a Piano and a Chair" (Grieg). 10.30: Gertrude Hutton (contralto), "Little Lady of the Moon" (Coates). "Ladde Wit the April Eys" (Willeby). 10.37: The Station Orchestra. Suite, "A Day in May" (Frim). 10.40: Announcements. 10.42: The Radio Revelers. "Old Man Sunshine" (Dixon). "My Dream Sweetheart" (Hall). "Guess Who's in Town?" (Hart). "That Stolen Melody" (Fisher). "Lona" (Gilbert). "Japanese Mammy" (Donaldson). "There's a Ricketty Rackety Shack" (Turk). "That's What You Mean to Me" (Davis). "All By Yourself" (The Right) (Walls). "Hail Like a Melody Out of the Sky" (Donaldson). "Querida" (Simon). Selected and request numbers. 11.30: God Save the King.

3AR

Announcer: Maurice Dudley. 10.0: G.P.O. clock song. "Ten, 10.1: Musical reports; farm and station produce, fruit, fish, vegetables, etc. 10.25: "Age" shipping reports; ocean forecast. 10.30: Mail notices; express train information. 10.35: "Age" news service, exclusive to 3AR. 10.45: Weather forecast. 11.0: The Radio Revelers (conductor, Ern Hall). "Ohm-lown" (Yvain). "The Riff Song" (Romberg). "The Dance of the Blue Danube" (Fisher). "A Lonesome Boy's Rosary" (Tobias). 11.20: Beautiful ballads. 11.28: The Radio Revelers, "High Up on a Hill Top" (Baer). "Tell Me Again" (Clark). "Can't Do Without You" (Rubeus). "Up and Down" (Rose). 11.48: Beautiful ballads. 11.56: The Radio Revelers, "Mississippi Mud" (Harris). "Tin Pan Parade" (Whitney). "Lotta" (Stanhelm). "Without You, Sweetheart" (de Sylva). 12.16: Beautiful ballads. 12.20: British Official Wireless news; announcements. 12.30: 9.50: Announcements from the Rotary Club luncheon, transmitted from the Freemasons' Hall, Collins Street, Melbourne. 2.0: Close down.

AFTERNOON SESSION.

2.15: The Station Orchestra, overture, "Peter Schmitt" (Weber). "Witching Hour" (Felix). 2.30: Spencer Ward and Gertrude Long in "A Piano and Just Us." 2.37: The Station Orchestra, selection, "Clinging Vine" (Levy) suite "Sigurd" (Sorsford). (Grieg). 2.47: Syd. Hollister, comedian, "Barks and Breezy." 2.54: The Station Orchestra, deuxième, "Petite Suite" (Micheil). 3.4: Adele Crane, soprano, "The Wonderful" (Grieg). 3.5: The Imperial Russian Trio (Simon). 3.11: The Imperial Russian Trio (Arved Norit violin, Ivan Berzinsky cello, and Vassili Ister piano). "Trio in B Sharp Minor" (Haydn). 3.15: Minuetto. Request items. 3.40: Tom Semple, tenor, "In Summer-time on Bredon Hill" (The Devo). 3.45: The Station Orchestra, "Modern Songs" (Tschalkovsky, Debussy, and Grieg). "Tender Question" (Felix). 4.2: Spencer Ward and Gertrude Long in "A Piano and Just Us." 4.25: The Station Orchestra, "Adieu" (Karganoff). "By the Waters of Minnetonka" (Leifurvang). 4.21: Syd. Hollister, comedian, "The Children of the Regiment" Orchestra, selected. 4.38: Adele Crane, soprano, request item. 4.45: The Station Orchestra, "Blumenluster" (von Blon). 4.50: Tom Semple, tenor, "The Yeoman's Warning" (Poniatowski). "I Heard You Singing" (Coates). 4.37: The Station Orchestra, "Sleeping Beauty" (Begnorn). 5.0: Close down.

EVENING SESSION.

Announcer: Renn Millar. 6.0: Gramophone recital of the orchestra and vocalists. 7.10: News service; announcements; cricket; results of fifth Test. 7.20: Gramophone recital continued.

NIGHT SESSION.

Announcer: Renn Millar. 8.0 Captain G. H. Peters, "Books: Wise and Otherwise." 8.15: Commissioner W. D. Kennedy, of the Boy Scouts Association, on "Why Scout? Why Patrols Have Nature Names." 8.30: Prahran City Band, march "The Vedette" (Alford) selection, "Gems of the Masters" (Rimmer). 8.45: Syd. Hollister, Come, list 40: "Prahran City Band, overture, "Morning, Noon, and Night" (Suppe), Chiquita" (Wayne). 8.52: Marcelle Berardi, soprano, "Fretful Mocking Bird" (Bishop) with Suite obligato by a member of the Prahran Band, "Rain in the Night" (Vesell). 9.9: J. J. Dear, selected. 9.24: Prahran City Band, march "Children of the Regiment" (Feric). romance "Love and Duty" (Rimmer). 9.34: Syd. Hollister, comedian, "Words, Idle Words." 9.4: P. G. Bourne, "Silver Threads Among the Gold" (Danks). 9.51: Marcelle Berardi, soprano, request items. 10.0: Prahran City Band, selection, "Lila Time" (Clutzam). 10.20: News service; announcements; cricket; results of fifth Test match "God Save the King."

40C

EARLY MORNING SESSION.
Announcer: J. Tyson. 7.43: Time signals. 7.45: News service. 8.0: Electric records. 8.15: News service. 8.30: Close down.

MORNING SESSION.

Announcer: Rita M'Autiff. 11.0: Music. 11.5: Stock news. 11.55: Talk on "Artistic Uses of Sealing Wax and Crepe Paper," by "Denise." 11.30: Music. 11.35: More social news. 11.45: Wurliizer organ. 12.0 (noon): Close down.

MIDDAY SESSION.

Announcer: R. Wight. 10.0: Market reports and weather information. 1.15: From the G.P.O.: The Postal Institute. Orchestra. 2.0: Close down.

AFTERNOON SESSION.

Announcer: H. Humphreys. 3.0: A programme of electrically-reproduced records. 3.30: Mail train announcements. 6.30: 4.0: Announcements. 7.43: P.R.O.C. (City Organist). 4.0: Afternoon news. 4.30: Close down.

EARLY EVENING SESSION.

Announcers: R. Wight and H. Humphreys. 6.0: Mail train running times; mail information; shipping news. 6.5: Dinner music. 6.25: Commercial announcements. 7.0: News stories conducted by "Little Miss Brisbane." 7.0: News in brief. 7.5: Stock Exchange news. 7.5: Metal quotations. 7.7: Market reports. 7.35: Fenwick's stock report. 7.30: Weather information. 7.40: Announcements. 7.43: Standard time signals. 7.45: Lecture arranged by the Queensland Agricultural High School and College.

NIGHT SESSION.

Announcer: H. Humphreys. 8.0: Alf Featherstone and his Orchestra: Rhythmic paraphrase, "Faust"

(arr. Lange); fox-trot, "High Hat Harry" (Le South). 8.10: Mrs. Charles Wilby (contralto), "My Baby Will Know" (H. Harelod), "Saint Valentine" (Linton). 8.20: Alf Featherstone and his Orchestra: Fox-trot, "Rain" (Ford); fox-trot, "Is It Gonna Be Long" (Covian). 8.30: 9.0: Listeners: Throughout the night, "The Big Things." 8.35: Phyllis Verner (soprano); "Poor Buttery!" Alf Featherstone and his Orchestra: Jazz-waltz, "Paradise Isle" (Dovings). 8.40: Mary L. Spanier and Mrs. Dehnam: Vocal duet, "Twelve, Sang the Clock"; vocal duet, "Lars Meant to Make Us Glad" (German). 8.50: Alf Featherstone and his Orchestra: One-step, "One Step Up" (Kaufman); one-step, "Wild Cats" (Cobb). Metropolitan weather forecast; movement of light-house steamers. 9.5: Betty Chambers (soprano); "Brown Is My Love" (Quilter). "I'll Sing to You" (Thompson). 9.10: Alf Featherstone and his Orchestra: Fox-trot, "Get Out and Get Under the Moon" (Tobias); fox-trot, "That's My Weakness Now" (Green). 9.20: The Albert Trio: A quarter of hour's melody and mirth. 9.35: Alf Featherstone and his Orchestra: Jazz-waltz, "Charmaine" (Raper). 9.40: Phyllis Verner (soprano); "A Japanese Love Song" (S. S. Stoddart and Miss Daisy McDonald); Vocal duet, "Awake" (Fellister). 9.50: Alf Featherstone and his Orchestra: Fox-trot, "My Blackbird" (H. Harelod). 9.55: "High Up on a Hilltop" (Baer). 10.0: The Daily Mail news, the "Courier" news, weather news. 10.15: Alf Featherstone and his Orchestra: Three-quarter of an hour's dance music. 11.0: Close down.

5CL

MORNING SESSION.
Announcer: J. L. Norris. 11.0: G.P.O. chimera. 11.1: A Sonora concert. 11.15: Kitchen craft and menu talk. 11.30: Popular melodies. 12.0: G.P.O. chimera. 12.1: Description of the fifth Test Match. 12.15: G.P.O. chimera. 12.20: General news. 1.15: British official wireless news. 1.20: 8.0: Railway information; S. O. Ward and Co.'s Stock Exchange information. Martindale race results. 1.30: Close down.

AFTERNOON SESSION.

Announcer: J. L. Norris. Accompanist: Jean Field. 2.30: Description of the fifth Test Match. 2.35: From SCL Studio—resume of previous race results at Martindale and Sandown Park. 3.25: Station Quartette—selection, "Cannary Cottage" (Carpenter). 3.30: Alys Watson (soprano), "One Little Flower" (H. E. "Ease" (Willeby). 3.40: 4.48: Original compositions by Dorothea Angus, pianist—"Reveries," "Birds in the Wood," "Song of the Bush," "Sandwiches," "Bird's Dance," "Musical Moments." Sandown Park race results—"The Purse." 3.54: Station Quartette—Suite, "The Fairy Realm" (Kestey). 4.0: G.P.O. chimera and resume of race results at Martindale and Sandown Park. 4.43: Rev. Frank Gorman and Sadie M'Donald. 4.5: Vern Rogers, tenor, "Happy Day" (D. J. O'Connell). "The Song is Sweet" (Sims Semp). 4.14: Rinaldo Trio, baritone—"Mi Piaci Semp" (Dianello), "Alla Via Che L'Arride" (Sersol). Dorothea Angus, pianist—"Glude in C Minor" (Rachmaninoff). 4.25: Sandown Park results—The Trial Handicap; Martindale Race results. 4.30: Description of the fifth Test Match. 4.5: From SCL Studio—resume of Martindale and Sandown Park race results. 5.0: Martindale and Sandown matches and annual tournament. 5.30: Close down.

EVENING SESSION.

Announcer: J. L. Norris. 6.0: G.P.O. chimera. 6.1: England v. Australia score. 6.2: Sandown Park and Martindale race results. 6.4: Scores Inter-State tennis matches and annual tournament. 6.5: Birthday greetings, correspondence, song stories by "Miss Wireless." 6.20: a playlet, "The Top Shop." Characters: Daddy Tackhammer, Rosemary, Fred, Donnie, Thea, and the boys. 6.30: Tackhammer's shop; toys are arranged about the shop, and Daddy Tackhammer is discovered pushing the children towards the door. 6.35: "The Top Shop." "Westward Ho" with Captain Donald Maclean. 6.35: Martindale and Sandown Park race results. 7.0: Scores Inter-State tennis matches and annual tournament. 7.3: S. O. Ward and Co.'s Stock Exchange information. 7.40: general market report. Dupleys and O'Connell, tenor, South Australian and Adelaide Salesmen's Association—sheep, lamb, pig, and cattle. 7.45: "The Top Shop." 7.50: Corner—an address to Boy Scouts. 8.0: SCL Studio. G.P.O. chimera—an entertainment by "The Bird Lady."

NIGHT SESSION.

Accompanist: J. L. Norris. 8.0: G.P.O. chimera. 8.1: Unley Orchestra (conducted by Norman Sellick)—"The Magnificent Seven" (Walls). "The Bird Lady" (Alford). "Break O' Day" (Sanderson). "Absentmentals" (8.16: Cyril Reid and partner, instrumental. 8.18: Gorman and Sadie M'Donald. 8.22: Rev. Frank Gorman and Sadie M'Donald. 8.25: Rev. Frank Gorman and Sadie M'Donald. 8.30: Rev. Frank Gorman and Sadie M'Donald. 8.35: Rev. Frank Gorman and Sadie M'Donald. 8.40: Rev. Frank Gorman and Sadie M'Donald. 8.45: Rev. Frank Gorman and Sadie M'Donald. 8.50: Rev. Frank Gorman and Sadie M'Donald. 8.55: Rev. Frank Gorman and Sadie M'Donald. 9.0: G.P.O. chimera. 9.05: Meteorological information. 9.10: News. 9.15: News. 9.2: Overseas race results. 9.3: International cricket scores, England v. Australia.

8.45: Rev. Frank Oorman and Sadie
9.12: Cyril Reid and partner, Instru-
mentals will entertain you for a few minutes.
9.24: Alys Watson, soprano—"Waist a Pol" (Hill),
"The Top Were Mine" (Sans Souci). 9.34: Unley
orchestra—"Unfinished Symphony" (second move-
ment, Schubert). 9.40: Rinaldo Torre, baritone—
"In Provenza" (Verdi), "The Last Watch" (Pisutti).
10. Arnold Blaylock, clarinet soloist—selected.
10.15: Beryl Alford, elocutionist—selected numbers.
10.15: Dally Orchestra—"Pirates of Penzance" (Bul-
lock). 10.15: General news service; meteorological
information: Martindale and Sandown Park race re-
sults; England v. Australia at Melbourne; scores of
Inter-State tennis matches and annual tournament.
10.15: By courtesy of 3LO, Melbourne—modern dance
numbers by the famous Radio Revellers. 11.0:
"God Save the King"; and close down.

6WF

Progress results of 5th Test match will be broad-
cast each half hour until stumps.
12.15: Tune in. 12.35: Markets, news, etc. 1.0:
Tune signal. 1.1: Weather bulletin, supplied by
the Meteorological Bureau of W. Australia. 1.13: Talk
by Eugene, by Dr. Winifred Holloway, of London.
1.35: Music. 1.30: Close down. 3.30: Tune in.
3.45: Afternoon tea concert, relayed from the Car-
lisle Cafe; social items from the studio. 4.30: Close
down. 6.45: Tune in. 6.48: Bedtime stories
by the Kiddies by Uncles Percy and Duffy. 7.5:
Light music by the String Trio. 7.30: Commercial
and general information. 7.45: Talk. 8.0: Time
signal. 8.1: First weather bulletin. 8.3: Vocal
and instrumental artists from the studio (Miss
Lucy Dean, pianist). 9.0: Late news items, by
courtesy of the "Daily News" Newspaper Co.; ships
and range announcement; station announcements;
the weather bulletin. 9.15: Programme continued
from the studio. 10.30: Close down.

104.5 METRE TRANSMISSION.

Simultaneous broadcast on 104.5 metres of pro-
gramme given on 1250 metres, commencing at 6.45
p.m.

7ZL

MIDDAY SESSION.

12.30 to 1.30, see Friday.
AFTERNOON SESSION.
1.30: Running description of Hurdle Race, 2 miles,
at Sandown Park racecourse, Victoria. 2.35: Close
down. 2.15: Description of the fifth Test match,
England XI v. Australia, played at Melbourne Cricket
Ground. 2.30: Running description of the Two-year-
old Stakes, 5 furlongs, run at Sandown. 2.35:
Description of the fifth Test match.

AFTERNOON SESSION.

3.30: Running description of
Sandown Plate, 6 furlongs. 3.35: Description
of the fifth Test match. 3.30: Running description
of Sandown Park Handicap, 1 mile. 3.35: Description
of the fifth Test match. 4.0: Readings from the
"Observer Mail". 4.15: Description of the fifth Test
match. 4.30: Running description of Trial Welter
Stakes Race, 6 furlongs, run at Sandown Park. 4.35:
Close down.

EARLY EVENING SESSION.

6.10: All sporting re-
sults to hand. 6.15: Music. 6.30: Bertha Southey
(Dumell) will tell a Tasmanian fairy tale to the wee
ones. 6.45: Music. 7.0: Answers to letters and birth-
day greetings by Bertha Southey Brammell. 7.15:
Close down.

EVENING SESSION.

7.30: George Nation
will give a talk on "Trees and Shrubs." 7.45: A tal-
k by the "Tamar Farmers and Fruitgrowers" Association
here. 8.0: By E. O. Lucas, secretary. 8.0: G.P.O.
time chimes the hour. 8.6: Recital of instrumental
and vocal items by leading international artists,
arranged by Paton's Music Warehouse. 9.45:
Close down. 10.0: G.P.O. clock, chimes the hour.
10.15: "God Save the King"; close down.

"Farmer's Three"—£21

Ask about easy terms!

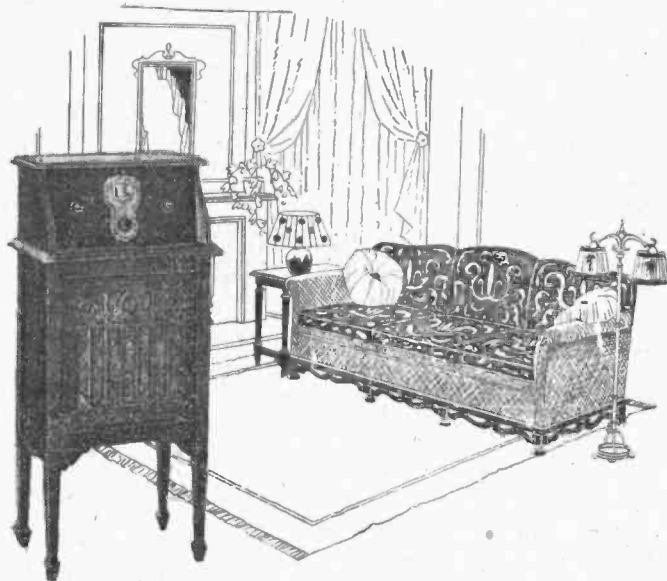

**They go away to compare
—but come back to buy!**

These are the people who've once heard and seen
"Farmer's Three." Naturally, having had a
demonstration, they go away and hear other sets,
they compare; and, *just as naturally* they come
back to "Farmer's Three" and **buy it**. This is a
fact in nine out of ten cases! Just as nine out of
ten sets, sent freely to homes for demonstrations are
never returned! Come and hear it yourself! Take
that elevator at the Market Street entrance to the
Men's Hat section—to the First Floor and the
Wireless Department. You'll be glad you came!

*Deferred payments may be arranged. Ask about them
in the Wireless Department, First Floor, Market Street.*

FARMER'S

Pitt, Market and George Streets, Sydney

VAR-LAC

Multi-way Battery Cable
is Sold by the Yard.

Seven different color-
ed leads under one
water, acid and flame
proof covering. No
matter how far your batteries
may be from your set, VAR-
LAC will reach them.
Scrap those untidy wires and
use VAR-LAC Battery Cable.
For Neatness, Convenience and
Efficiency. Supplied in any length.
If dealer is out of stock write
direct.

1/8 Per Yard.

BEAL PRITCHETT (AUST.) LTD.,
17 PARKER STREET, SYDNEY.

The WIRELESS WEEKLY RADIO INFORMATION

Under the direction of

Ray Allsop

and

Don B. Knock

Associate Technical Editor

Service

Correspondence Answered only through these Columns (See Coupon Below)

N.S.R. (Krawarree).—“What would I require to be able to pick up shortwave stations with my N.S.R. Six? Would it be better to build a short-wave set? What would you recommend? What headphones would be most suitable for my set? What would be the best length of aerial?”

Answer: A short-wave adaptor would be necessary. Yes; a separate short-wave receiver would be better. Suggest the Midget Screen Grid Short-wave Four. Any good 2000 ohm headphones will be O.K. Use an aerial about 50 feet long.

G.P.P. (Arthurville).—“I wish you would help me to locate the trouble with my set. It is a five-valve, three-dial control. Set when tuned in seems O.K. but when you put your hand near the left-hand dial the set howls, and tuning is very hard, and has a slight loss of volume. I will await your answer before interfering with the set. The funny part of it is that previously the set was working O.K.”

Answer: This is probably due to either run-down ‘B’ batteries or a faulty R.F. valve.

“Fantom” (Ryde).—“I have an 80 volt ‘B’ battery accumulator made from ‘Wireless Weekly,’ December, 1926, and find it works wonderfully. I have practically every circuit printed in ‘W.W.’ since September 1, 1926, and find they come in very handy. Could you publish a small diagram of a rectifier, using electric globes that would need little attention? Would it be safe to use two jars without injuring the accumulator?”

Answer: As I have had numerous inquiries for an accumulator ‘B’ charger, an article was published dealing with a suitable charger, using one lamp globe, on 22/2/29. Two jars may be used if desired.

J. E. McP. (Drummoyle).—“Could you give me the information and constructional data for the making of a rectifier for the recharging of a 90 volt Philco battery (‘B’) from the house current? I asked this question a few weeks ago without any reply, but I did not send in a coupon. I will deem it a great pleasure if you can accede to my request, and I wish to thank you in anticipation. I think the ‘Wireless Weekly’ invaluable for radio information.”

Answer: See ‘Wireless Weekly,’ February 22, 1929, when a special article was published.

R.F. (Rose Bay).—“Can you tell me if television is being carried out in N.S.W., and if so, by whom?”

Answer: There is no television transmitter in Australia as yet, though Mr. Allsop is hoping to make early experiments and J.C. Melbourne has announced their intention of taking up television at the first opportunity. There are a goodly number of amateurs experimenting with television transmitters. Mr. W. G. Nicholas, c/o L. F. Style, M.U.L.O.O.F. Building, Castlereagh Street, Sydney, has been carrying out some extensive experiments in television reception.

R.F. (Rose Bay).—“Could any reader supply me with copies of ‘Wireless Weekly’ for January 15 and 25, 1929?”

Answer: Your request is published above. (Address: Robt. J. Frankl, ‘Undoons,’ Rawson Road, Rose Bay.)

W.J.M. (Waratah).—“Re your answer to H.E. (West Ryde) in connection with the Screen Grid Marco Four, 8/2/29. I am in the same position re building the Marco Four with a stage of S.C. R.F. amplification instead of with a three element valve.

and would be pleased to have same, as promised to H.E. (West Ryde).”

Answer: Very sorry, but H.E.’s requirements were exceptional, and we do not make reply by post except under very exceptional cases. So that you will not be disappointed, I have published the circuit for you in this issue.

J.P. (Neutral Bay).—“I have two .0005 and one 11-plate midget variable condensers on hand, and I would like you to publish in your query columns a short-wave circuit, utilising these condensers. Would you also publish particulars of coils. I wish, of course, or other necessary parts, such as variable grid leak, grid condenser, valve, rheostat, etc.”

Answer: A suitable circuit appeared in last week’s issue. Build the set minus the stage of audio. The .0005 variable condensers are of no use. They will have to be reduced to seven plates, or a variable condenser of .00015 used in place of this. Suggest Radiocos S.W. coil kit, which is far more efficient than home-made a.w. coils. If you would like further data, however, let us know. In this case, suggest Airzone material, which can be cut to number of turns desired.

(2) “I have a three-valve Reinartz set (1 detector and two audios), which is giving fairly good results, but if I turn the rheostat on more than three-quarters the set howls. Could you tell me why this is? Valve used is the Marconi, D.E. 410, A.W.A. 95X, Philips A308. Is this combination O.K.?”

Answer: The cause of howl may be due to the conflicting requirements of the valves as regards filament current. Suggest you use all Marconi or all Philips’ valves (or any other make). It is not advisable to use valves of different characteristics. Your reaction coil may be too large, or you may be using too much voltage on the plate of the detector valve.

W.W. (Gladesville).—“On trying out the Sampson Two which I built from ‘Radio’ some time ago, I found that the set works well with the ‘C’ battery omitted, and the ‘G’ terminals connected together, but when the ‘G’ battery is connected up it won’t work at all.”

Answer: Perhaps you were connecting C plus to A plus, instead of to A minus. On the other hand the ‘G’ battery may have been faulty, or the ‘B’ battery dead.

(2) “Is there any chance of your publishing a two-valve short-wave set?”

Answer: One was published in these columns two weeks ago.

R.F. (Kogarah).—“Please send me a circuit of the Screen Grid Marco Four.”

Answer: We do not reply to letters by post. The circuit appears in this issue.

W.W. (Gladesville).—“Congratulations to your ‘Proving Radio.’”

Answer: Thank you, very much.

J.P. (Kogarah).—“I have recently constructed the One-valve Loud-speaker Reflex described in ‘Wireless Weekly,’ 13/7/28. I wish you to advise me how to make this set more selective on the Inter-State stations without loss of volume. I have heard 2LO and 4QG on ‘phones, but suffer interference from 2BL and 2FC respectively. I have a Pilot ‘Micrograd’ substitute for the 0001 fixed condenser at present in the aerial lead? I am using 100 feet aerial overall, 85 volts ‘B’ battery, 4½ volt ‘C’ battery.”

Answer: Reduce the length of your aerial to 80 feet overall. The Micrograd may be used in place

of the fixed condenser. Suggest you add a stage or two stages of audio.

U.R.E. (Thangood).—“I usually have awfully bad luck making things. I’ve never been able to get a crystal set that will work so far, but I had smacked at some of the experiments in ‘Proving Radio’ and they were a great success; so now I have begun to improve. I am trying to form a ‘Proving Radio Club’ here, and will let you know how I get on. I am only 12 years old, so I haven’t much money, but Dad’s going to stand expenses for ‘Proving Radio’ one week, and Mum says she’ll stand expenses the other week if I’m good—so of course she’ll be there.”

Answer: That’s the style! Let’s know how you progress, and always write in when you are sure of any point.

A.D.W. (Lidcombe).—“I am just trying to get apart a variable grid leak which is in my possession, but as I am afraid of ruining it, will you please tell me what is inside it?”

Answer: Inside the variable grid leak is a coil which gets wider and wider (of Indian ink), contact arm makes pressure with this.

Mac (Rockdale).—“Having made up accompanying Neurodyne circuit, using Circoloid coils, I find when tuning there is reaction caused through the thickness of the lead grid, or in the wet ‘B’ described in ‘Radio,’ vol. 1, No. 47. My dry ‘B’ batteries are starting to drop in voltage, so my question now becomes urgent. Hope to soon receive your valuable advice.”

Answer: 3/4 of an inch. This is not critical.

W.A. (Merrylands).—“Could you please give me details of making fixed condensers, the number of plates, and size of plates, for each capacity. I think your ‘Radio Information Service’ is a fine class idea, and that many people benefit by it.”

Answer: We have no room in queries. Consult our technical or constructional articles. Your comments will be dealt with in ‘Proving Radio’ shortly.

J.R.W. (Bondi).—“Would be obliged if you could kindly inform me as follows: Can you suggest a type of paper for the making of cones for the speaker reproduction which is equal to the Engstrom paper known as ‘Kraft,’ and weighs approx. 120 lbs to the ream? We have no room in queries anywhere in Australia, any one of the good quality English supplies, such as the Blue Spot?”

Answer: N. Segal and Company, Fort Street, supply the proper cone paper on stiffener, cones for boards to save creasing, and marked out ready to use, and with screws for 2/6. The paper is specially prepared for this purpose. Use a ‘Listen’ cone set. This is a British production.

A.W. (Lutwyche).—“Would you please send me a diagram of a crystal receiver that I have been published in your ‘Wireless Weekly’ of February 15, 1929. I am in the same position as in Para. 53. I propose you know that we in Queensland have a 4QG to hear at night on a crystal set. You can get clear music from a crystal set. I was really about the R.C.G. Crystal Receiver, published in last week’s ‘Wireless Weekly,’ and it looks good to me. Do not think that it would do in Brisbane, do you? Do not reply to queries by post. The R.C.G. Crystal receiver would suit your requirements admirably. The other circuit mentioned appeared in these columns last week.”

E.W. (Redfern).—“I have an eight-valve superheterodyne which has been in use for 12 months. Late last year I had a new transformer in it. Since it has been in use I can only receive stations situated in Sydney, but cannot receive 2FC at all. (2) I have had the set overhauled at the above address. Can you advise me a capable man? Let me know the approximate cost of overhauling it.”

Answer: Colville Moore charges 5/- per hour for overhauling receivers. Trouble may be in the intermediate stage, or the transformer may be faulty.

E.J.P. (Strathfield).—“Have been a subscriber to ‘Wireless Weekly’ since 1924, and I am now writing

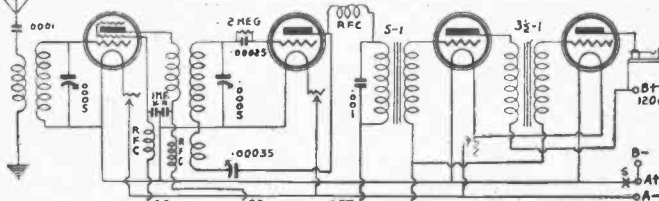

The circuit diagram of the screen-grid Marco Four, requested by W.J.M. (Waratah). This circuit will be the subject of an article in a later issue.

for a little advice. My set is a five-valve Neutrodyne, and I cannot get Melbourne or Queensland-only local stations. I have now changed the set to all electric, but cannot get any better results. I was wondering if a six-valve set would be any better? My valves are Marathon ordinary valves. Acme transformer instead of 'A' battery, and Philips eliminator instead of 'B' battery. If you think a six-valve set would be better than a five-valve Neutrodyne I would be glad if you would let me know. If you think a six-valve would be better, have you a sketch of same, as I could alter my set. I have a good aerial."

Answer: We do not reply by post. It seems that your set is not neutralised. Five valves should be used for inter-State work. Follow out neutralisation instructions, which appeared in these columns.

Regular" (Badington).—"I have a five-valve set which works wonderfully well, but there is a chap who has an eight-valve Super-het. in a flat directly above me, and when he tunes in he gets a sort of a buzz from him. He works off a 'B' eliminator instead of an indoor aerial. Could you please suggest any way of overcoming this squeal? I may state that I can't always get it, and when I do it's only on the station which I am tuned-in to. I have been a reader of 'Wireless Weekly' practically since its commencement, and appreciate your different articles on wireless each week, and especially the recent 'Proving Radio'."

Answer: There is no remedy. Neighbor should be evicted. The P.M.G.'s Department is very busy about oscillating receivers.

PAT. (Bingara).—"I have built the S. G. Drake receiver, which I mentioned in a previous letter, and I really think it is an improvement on the old one. I find that it is not so sharp in the tuning as I anticipated. I am using 'B' condensers, which I thought should be right for this distance. Had a Jap. coming from the States, and asked him whether the set would be in English or their own tongue? He got out the condenser in the Radiokos box, and said not having enough space; would you also advise whether this would affect the tuning at this distance?"

Answer: The Japs. announce the call signs in their own tongue, and sometimes also in English. The set would alter tuning.

AS (Mascot).—"I have a two-valve Reinartz set, and I wonder how I can get 2KV very well and 2UV very well, but now I can't get 2UV at all, while I can only fair. Do you think if I put a .0001 fixed condenser across the aerial lead would it help at all? I might say that ever since I have had a two-valve set I have never been without 'Wireless Weekly'. It is a great help to me, and I am sure it is a great many others."

Answer: Place a .0005 variable condenser in series with the aerial lead. Test batteries and valves.

W.E. (Three).—"I must congratulate you on your improvement since last year, especially on the Sydney A station programmes. No doubt the worst point is the inaccuracy of the programmes are very reliable, but Sydney programmes play 'ducks and drakes' with their original programmes. This is a bad fault."

Answer: Late arrivals of articles and other unimportant notices etc. are the cause of the delay in your queries. Please repeat them. Thanks to your kind remarks.

W.M. (Oranville).—"Having taken a great interest in your Radio Information Service, I would be pleased if you could explain the following: I have a five-valve Neutrodyne set. Every time I touch the electric light I hear a click from the set. I would be thankful if you could explain this. I wish your paper every success in the future."

Answer: When a contact is made or broken a surge of current is set up. As one side of the set is connected to earth and one side of the set is also earthed, the surge is heard as a click by the motor. You will also hear a click when the set is switched off.

W. (Granville).—"From which firm can I procure all valves?"

Answer: From Messrs. Lawrence and Hansen of the British General Electric Co., Ltd.

W.M. (Drummoyle).—"Why are screen grid receivers scarce in spring?"

Answer: It's the reaction, we suppose. I should say a millionth of a millionth of a farad.

G.P. (Burrville).—"What is a micro-micro-farad?"

W.M. (Adcombe).—"I am writing to ask you if you would be so good as to send me full instructions for the building of an all-electric three-valve set."

Answer: Sorry, we cannot oblige. However, the British General Electric Co. have circuits and books with full instructions for building a three-valve all-electric set, using the type K1 valves. An all-electric receiver may shortly be published in these pages.

W.M. (Shannon).—"I have been a reader of 'Wireless Weekly' since June last year, but as it has ceased to be published I am a reader of 'Wireless Weekly', and I am a reader of the 'Proving Radio'. Could you kindly send me through your information columns the names of the Sydney group of the 'Proving Radio' and full particulars of meeting times. I have missed your first issue of 'Wireless Weekly', and the issue dated January 18, 1929. Please advise me how I can obtain a copy. What can I do to have a receiver would you advise me to construct—the All Empire or the Midget All-wave?"

Answer: Advise you to get in touch with the secretary, Mr. C. Y. Hook, 29 Blairgowrie

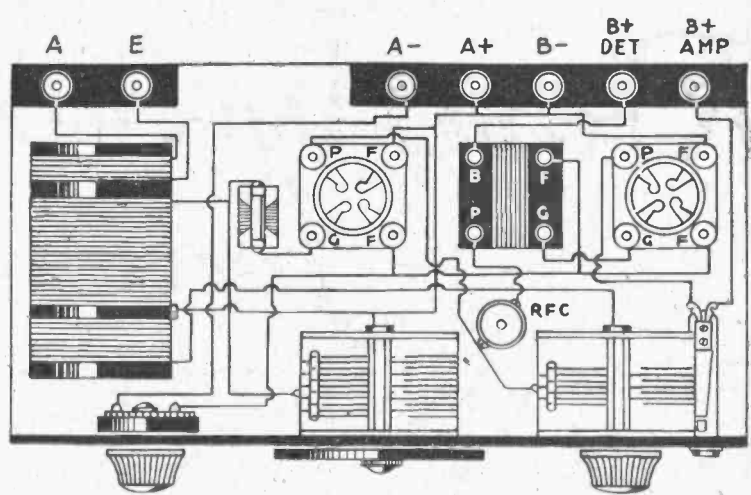

A three-valve Reinartz circuit, requested by J.H. (Waverley), E.P.W. (Auburn), and other readers.

Street, Dulwich Hill. I have given him your address, and he will probably write to you within a couple of days. We have a few copies left of the issues you require. Shall we forward them? Suggest the All-Empire S.W. receiver.

J.L.S. (Chatawood).—"I have a Jefferson transformer, the ratio of which is 3.75-1. I want to build one of the same type with a ratio 3-1. Could you give me the number of turns for primary and secondary coils, and where the iron can be procured to make the core? If a shield were placed over transformer and then earthed would it make any difference to the tuning of set? 'Proving Radio' is very helpful to me. I made the battery described, and by connecting three of them in series there was enough power to work my Marco Four for two weeks without having to refill battery."

Answer: Unless you have had considerable experience with armature windings or transformer windings, and have the necessary apparatus, it would be impossible for you to construct the transformer mentioned. It is difficult enough to construct a power transformer, but an audio transformer makes this former job insignificant. I think you would agree with me a few minutes after you had commenced construction. However, if you still intend to carry out your proposition, drop us another line. O'Donnell, Grims can supply transformer cores to specification. The shield would have no effect on tuning. Glad you like 'Proving Radio'. A club is being formed out your way. Why not join it?"

F.R.D. (Rose Bay).—"What do the letters G.M.T. and S.M.T. represent?"

Answer: G.M.T. is "Greenwich Mean Time," which is used as a standard all over the world. S.M.T. is "Sydney Mean Time," which is ten hours ahead of G.M.T.

E.A.S. (Arncliffe).—"Being very interested in 'Proving Radio,' I should like to know how (part 4) the lamp glows when the current is passed through the circuit in fig. 4."

Answer: The principle is the same as the household lighting service. The current flows right through the circuit, and but for the lamp this current would be short-circuited, and if the current was high enough, the connecting wires would get red hot. As the filament of the lamp is of very fine wire, and is very short, it acts almost as a fuse, i.e., whereas the fuse would get red hot and part, thus breaking the circuit, the filament (which is enclosed in a vacuum) gets white hot, and does not short, thereby giving out a bright light.

W.E.G. (Wahroonga).—"Is there any 'Proving Radio' Club running out at Wahroonga or district? What are the weekly fees?"

Answer: The nearest club is the North Shore club, which is now in process of formation. Suggest you form a local club. Write to Mr. Hook for particulars. His address will be found in several of the 'Proving Radio' articles. (Also below.)

Mr. T. (Randwick).—"Where are meetings held for the City 'Proving Radio' Club? How do I go about joining?"

Answer: The meetings are held at St. Andrew's Place. Get in touch with Mr. C. Y. Hook, 29 Blairgowrie Street, Dulwich Hill.

J.H.P. (Waverley).—"Thanks for your prompt reply to my queries. I should be pleased if you would forward me a circuit or a modern three-valver you so kindly offered to send."

Answer: Sorry; but when we said "If you would like a circuit, write again," we meant that we would be pleased to publish it for you. A three-valve Reinartz circuit, as requested, is therefore published in these columns.

T.E. (Rockdale).—"Please publish circuit of what-ever is needed to add to my crystal set to increase the volume, and give list of parts required."

Answer: The circuit of a one-valve amplifier is shown in these columns. You will require a valve, 5-1 transformer, .001 fixed condenser, valve socket, and terminals.

F.S. (Darlinghurst).—"Where are 'Proving Radio' Clubs now running?"

Answer: Eastern Suburbs, Sydney, North Shore, Bondi Beach, Dulwich Hill, Hurlstone Park, Lismore, and Leichhardt.

E.R.W. (Auburn).—"I built up a three-valve Reinartz, and cannot get it to work at all. The circuit is attached."

Answer: The circuit is incorrect. Remove the fixed condenser from the plate circuit of the detector, and place this condenser across the two primary terminals of the first transformer, or leave it out altogether. The correct circuit is published in these columns.

U.R. (Carlton).—"If it is 5 p.m. in Sydney, what time would it be at Hampstead, London, England?"

Answer: It would be 7 a.m. in London.

S.E.W. (Forbes).—"What is the QRA of 8ORM? I have heard him consistently, and desire to find out what ckt. he is using. He certainly has a fine sig."

Answer: 8ORM can be found by addressing your letter to 8ORM, c/o R. E. F. Larcher, E.P. II Boulogne-Billancourt (Seine), France. According to one of his QSL cards he is using a Meisner circuit with an input of 80 watts. Plate voltage 1000 volts.

Mr. McKenzie (Macleay River).—Mr. Howlett, of Lakemba, has advised us that he is forwarding you the one-valve Filadene circuit, for which you expressed through these columns. Thanks, Mr. Howlett.

A.J.G. (Newcastle).—"I have a five valve set with eliminator, and get good results from 2BL, but reception from 2FC and inter-State stations is absolutely marred by static and impossible to listen to."

QUERY COUPON

If you are in difficulties about reception or set-construction, let us know, and we will endeavor to set you right. Make your questions brief to the point, and, where possible, show lay-out and wiring design. Under no circumstances will answers to queries be made by letter or by telephone. All answers will appear in the columns of this department in the ordinary way in which they are received.

The Radio Information Service, WIRELESS WEEKLY, Please answer the accompanying queries in the most concise manner. Enclose this coupon in order to indicate that I am a bona-fide reader.

to. I know enough about static to know that it cannot be entirely eliminated, but can you give me some information enabling me to remedy it as much as possible.

Answer: If you set is sufficiently sensitive, it may be an advantage to try a small aerial. You do not give any details of your aerial. A counterpoise will often help, but only slightly. Possibly your best solution will be an underground aerial, but this must be laid out with care. If you have the room available, dig a trench about two feet deep and 80 to 100 feet long. Use heavy lightning cable for the aerial itself, and lay it in the trench, or earthenware drappling, sealing the end of the aerial in a glass bottle filled with bitumen or any insulating compound. The aerial must come straight up, as short as possible, to the receiving set. If you have a length of lead-in trailing up the wall, the effect of the underground aerial is nullified, as the lead-in itself will act as an aerial.

G.C.H. (Haberfeld).—The circuit diagram you have submitted is quite correct, except that the centre tapped coil in the detector circuit would be more efficient with the return to A negative instead of A positive. Try this yourself and note results. It will be easy enough to neutralise your R.F. amplifier by connecting a three-plate midget neutralising condenser between the grid of the R.F. valve and the stator plates of the second variable condenser in your diagram.

M.H. (Double Bay).—The Philips A442 sg. valve may be used in the Uni-International short wave receiver, in place of the UX222, with only a little alteration. The terminal on top of the A442 is the plate instead of the control grid, as in the UX222. The literature accompanying the valves is self-explanatory. The new Mullard PM12 SG valve may also be used. This valve is similar physically to the Philips A442. A Penthode in the audio amplifier would not necessarily increase the range of the set, but would certainly increase the volume for loud-speaker work.

J.J.G. (Woy Woy).—Healthy criticism is always welcome, but that contradiction of established technical facts is simply a waste of the paper and ink you used. Your reference to the Penthode valve made by certain internationally-known manufacturers being useless is as ridiculous a statement as would be one that aeroplanes don't fly in 1929!

W.O. (Auburn).—There is, we believe, a bounty of 20,000 dollars offered by the United States Government for a definite solution to the elimination of static problem. If you think you have hit upon anything worth while, there is no reason why you should not develop the idea.

F.W. (Richmond, Melbourne).—Sorry to keep you waiting, but I did not see your previous letter. Yidjet SG short-wave receiver could be used very nicely as a very compact and highly efficient adaptor for use with the audio amplifier of an existing broadcast receiver. You apparently have an existing amplifier in your 1927 Solodyne.

KIWI (Lithgow).—Your assumption regarding the continuity test for the windings of a transformer is correct. The resistance of the windings must be taken into consideration. That is why the meter shows such a low reading. The "Proving Radio" series will be dealt with by the author in such a manner as to cover every phase introductory to Radio.

W. FURNESS,
1st Floor, Furness Chambers,
KING'S CROSS, DARLINGHURST.
Shields, Coils, and all Component Parts
as used in the Tested 1928 Solodyne.
Coils are guaranteed to proper specifications.
Shields assembled if desired.
Terms may be arranged.

TRANSFORMERS.
Built up to a specification and wound
lamination iron cut to any size from stock
Prices and estimates on application.
O'DONNELL, GRIFFIN & Co., Ltd.,
53 Druitt Street, Sydney.
'Phones: M 2991 (3 lines).

"SIMPLEX"
A FIXED
CONDENSER
FOR EVERY
PURPOSE.
ALL
RADIO
DEALERS.

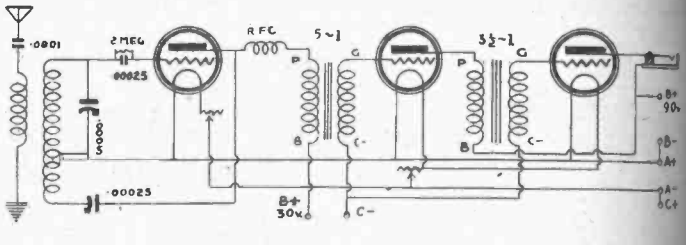

A Reinartz two-valve back-of-panel wiring diagram, requested by a number of readers.

A.G.S. (Arcliffe).—If you are using the correct capacities, the grid leak of the All-Empire receiver to cover the broadcast band will be about 100 turns of 28 D.S.O. copper wire on a 3-inch former. You must take into consideration stray capacity in wiring, etc. Little differences in construction will make great differences in the L/C ratio.

L.T. (Neutral Bay).—You are quite correct, Mr. Thompson. Your query unfortunately got mixed up with another for some untraceable reason. You will find the Screen Grid Browning Drake far superior to the old reliable bearing the famous name of Browning-Dake. Your trouble seems to be entirely one of valves. No harm can be done by using the valves as you have been doing. Tuned Anodes offering the most efficient coupling for the screen grid valve, owing to the high impedance, although the primary of the regenerator may be used in the same manner as in the Screen Grid Peridyne. For a primary coupling, it is really necessary to design it with a higher resistance as in the 1928 Solodyne.

GYMPIE SUBSCRIBER (Gympie).—You're a location trouble. Your letter tells me that at a glance. The improved Reinartz Three is a very good all-round set for general work, but is apparently not suitable in your geographical position. It will not be a difficult matter for you to make a neutralised RF amplifier and connect this to the present circuit. Three, thus making it a sensitive distance getter.

R.E.K. (Taree).—The Countryman's one-valve receiver will be more trouble for you out there than any crystal receiver ever devised.

L.N.M. (R.A.N. College, Jervis Bay).—Have been unable to trace the first letter. However, I got this one O.K. You have apparently got some stray capacity probably introduced by the wiring of your All-Empire, which is upsetting the balance of the circuits. There seems to be a big difference in your coils in the RF and detector circuits. If the first dial is reading high you need more turns on the RF coil. Eventually I found that for short-wave work the RF coil needed to be one turn in advance of the detector coil, owing to the very low inductance capacity of the S.C. valve. The Gram DE410 is a good detector for this receiver. I had a little trouble with matching the circuits in one All-Empire set I made, but soon got over it by altering the coils until the circuits (not the coils) were synchronised.

Coils (Ashfield).—Recently I built up the Improved Reinartz Wireless Weekly, 10/8/28), and followed your instructions exactly. The set worked O.K., bringing in all the Sydney stations at great speaker volume, also 4QG and 3LO on the 'phone coil. Will you please let me know how to wind a coil on a 2-inch former, using 28 or 30 gauge wire, to tune from 200 to 600 metres. I have a plenty of above articles. I am using a 0.0035 for reaction, but would like to use a 14-plate Midget condenser.

Answer: Wind 58 turns of 28 or 30 gauge wire on the 2-inch former for the secondary, and 48 turns spaced 1/4 inch for reaction. The 0.0035 or the Midget condenser may be used as desired. The parts mentioned in your letter are O.K. Thanks for your kind remarks.

A.M. (Maroubra).—Would you kindly let me have a circuit for a crystal set? I have tried the last two sets in your last two issues of Wireless Weekly, and found them no good. I am a constant reader of your helpful paper. Thanking you in advance. Will you tell me what is a good crystal?

Answer: The crystal circuits recently published should have been O.K. You must have erred somewhere. Did you see the circuit published in queries last week? This was published after I received your letter. The circuit referred to is very simple and efficient. Suggest the Harle crystal or the Lion Micro.

A.B. (Lithgow).—Could you send me by return mail full particulars concerning Morse code sets?

Answer: Your letter was passed on to us by Messrs. Deaton and Spencer, printers. Afraid we cannot publish full details as requested; there is not enough space. May do so in an article later.

(2) "What things would I have to learn before I could transmit?"

Answer: The fundamentals of electricity and magnetism, theory of the action and operation of receivers and transmitters, radio-telegram reception and transmission, Morse code reception and transmission at the rate of 12 words per minute, etc.

(3) "What license would I have to get?"

Answer: An experimental transmitter's license.

(4) "Where are the exams held?"

Answer: P.M.G. Radio Department, Castlereagh Street.

(5) "Would I have to be fully learned on the Morse code?"

Answer: Yes. You would have to know the Q signals and abbreviations also.

(6) "Wishing to own a Morse code transmitter set (I have a circuit of one), and knowing I must sit for an exam, I should be pleased to receive the above information."

Answer: Follow the "Proving Radio" articles which are leading up to the amateur operator's proficiency course.

L.R.B. (Bondi Beach).—"This is my second request within a couple of weeks, but possibly my first letter went astray. Please let me know through queries columns of a reliable circuit which will give me daylight reception (phone strength sufficient) of 3LO and 4QG. We get strong interference from 2BL here."

Answer: Your letter did not go astray. You probably find it in these columns. However, a circuit you cannot find this or next week. I suggest the Martin Screen-grid Five, which I suggest my own eyes, pulled in New Zealand on the RF speaker during daylight at Randwick. There was no interference.

G.C. (Peakhurst).—"Will you please complete dress on enclosed envelope and forward?"

Answer: This has been done.

Mr. F.W. McKenzie, c/o Tait and Co., Bellingen, writes: "I notice that there is an enquiry from W.C.F. (Armidale) with reference to daylight reception from an Atwater Kent Six-valve receiver, 12 am situated at Bellingen, which is about 100 miles distant from the various stations. It is close to the coast, whereas Armidale is about 120 miles inland, and is on the tablelands. In this locality, where one is away from interference caused by town current, etc., we get the following results: There are two models of six-valve A.K. receiver the 35, which has three tuning condensers, and the 33, which has four tuning condensers, and a small balancing condenser to compensate for different length aerials. With the 35 we get fair daylight reception, rather weak at midday, but good from about 3 pm onwards, and with the 33 we can get good daylight reception all day on 2BL, and 4QG. Of course, you have to have reasonably efficient aerial, and, more important still, a good earth. I do not know how long W.C.F. has had a set, but some of the following suggestions may help him, and also other owners of such sets. If there are six 201A valves in the set, replace these with the following combination (from aerial terminal end of set), Philips AR Radiotone 201A, Philips A609, A609, or A615, ARB 609, Mullard PM 609. These also perform well in the R.F. sockets (first three valves). With valves, as the last valve is a power valve, 135 W.B. battery should be used, with a grid bias of 12 volts. The grid bias may be determined by experiment. The radio valves (white wire) operate on about 87%, and the detector 22% to 45% (yellow wire). Also it is possible that the condenser designers' relationship is not correct, and a belt drive, the belt being pinned to a weak pulley on each condenser, each of which is fixed to the condenser shafts with two set screws. One screw in each is readily accessible by reaching the middle of the tuning range, while the other is inaccessible in that position. The proper procedure is to loosen the inaccessible screws first, then turn the receiver to a station. Loosen the remaining screws and carefully adjust the condensers, then turn them with a small stick, until the best results are obtained. Grid bias must be exercised in connection with, as very little movement of the screws will make these adjustments on the 35 it is necessary to remove the bottom of the set, which is attached with small screws. This is done by first necessary to remove the screws from the front panel, and draw the set out of the cabinet about 1 inch, when the screws in the condensers are readily accessible. I would advise W.C.F. to get in touch with his local dealer, as I am sure he would be only too pleased to assist him in the matter. If any of the above adjustments are necessary he could do them for him. I have published the whole of your letter, which will be of interest to many of our readers."

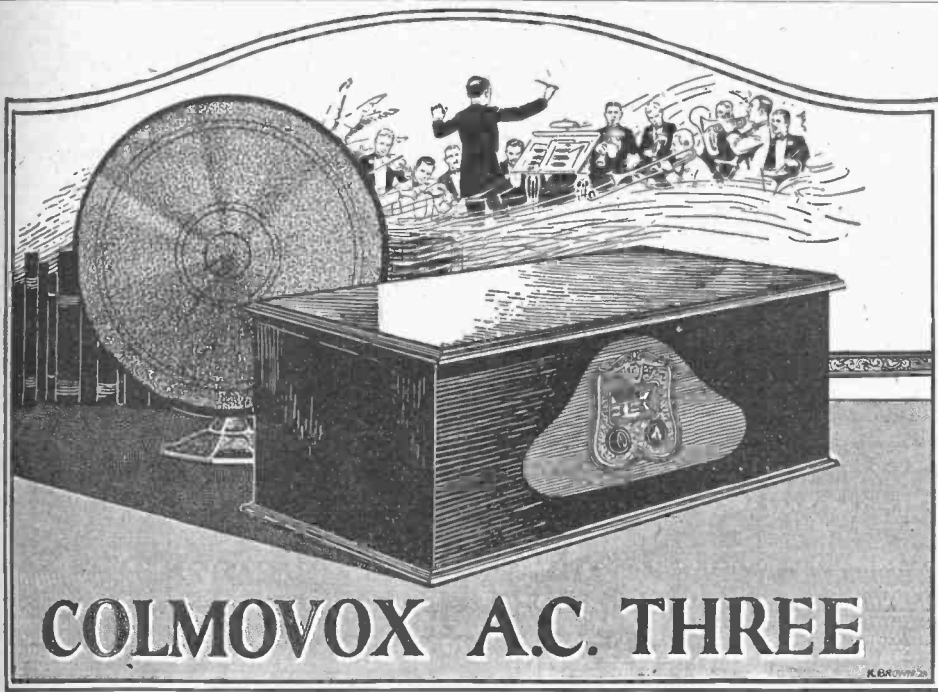

COLMOVOK A.C. THREE

“COLMOVOK” RECEIVERS

Practically the oldest Receiver manufacturers in New South Wales! “Colmovox” Receivers have stood the test of time and are still in demand from those who buy recommended goods. “Colmovox” Receivers are guaranteed for twelve Months, and are built to suit Australian conditions, being selective to a high degree, giving good, faithful reproduction, and they are moderately priced.

Our new Model AC3 Batteryless Receiver is the latest addition to our large range of Receivers, and intending purchasers should see this wonderful Receiver before they buy elsewhere.

	Cash Price.			Deposit.			Weekly.
	£	s.	d.	£	s.	d.	s. d.
“Colmovox” All-Electric Three	29	0	0	5	0	0	9 8
“Colmovox” All-Electric Five	48	10	0	11	0	0	15 11
“Colmovox” Three-valve Receiver	17	10	0	3	0	0	6 2
“Colmovox” Four-valve Receiver	28	0	0	4	0	0	9 8
“Colmovox” Five-valve Receiver	33	10	0	6	0	0	11 8
“Colmovox” One-valve Receiver	5	10	0	0	10	0	5 0
“Colmovox” Crystal Receiver	3	10	0	0	7	0	3 6

ALL SETS ARE COMPLETE WITH LOUD SPEAKER, BATTERIES, ETC. AND INSTALLED FREE OF CHARGE

Demonstrations given in your own home without any obligation.

THE ABERDONIAN THREE-VALVE RECEIVER

featured in this issue—for list of parts and prices see our advertisement in last issue “W.W.,” March 1st

Colville-Moore Wireless Supplies Ltd.,

10 ROWE STREET (Next Hotel Australia) SYDNEY.

Phone B2261

Phone B2261

EMMCO'S NEW RADIO PRODUCTS INCLUDE ALL A.C. PARTS

A.C. POWER PACK

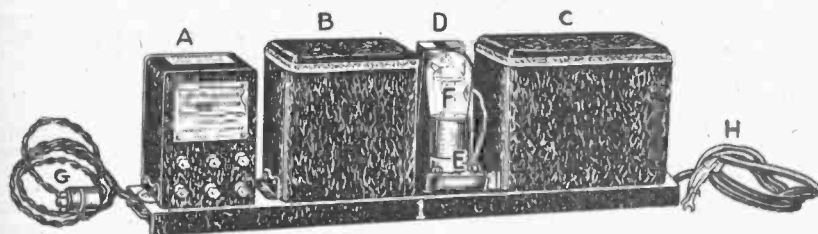

A—An A.C. Filament Transformer.
B—Transformer and chokes.
C—Condenser pack.

D—Resistance bars voltage divider.
E—Balanced socket.
F—Raytheon B.H. tube.

G—Cord and socket.
H—Connection to set, 7 cord B supply.
I—Chassis.

A long felt want is now being supplied by Emmco in a complete A.C. Power Pack, which is made up as detailed above, and can be used with any A.C. set up to and including seven valves, giving quiet, smooth power.

The standard set is equipped for Radiotron valves, but is also made for Arcturus, Philips, Osram or any other type of A.C. Valve.

The Pack has an output of 135 volts, 40 milliamps, and is mounted complete on a chassis 19 x 3 1/4 inches to go in the rear of the cabinet.

Full instructions, wiring and circuit diagrams supplied with each Pack.

PRICE £12

A.C. TRANSFORMERS

Type "A," for Radiotron or similar A.C. valves.
1 1/2, 2 1/2, and 5 volt Tappings. Price 35/-
Type "B," for Arcturus 15 volt A.C. valves.
Price 30/-
Type "C," for Philips A.C. Valves. Two Tappings.
Price 30/-

CONDENSER PACK

Made up in Crystalline finish Metal case, 6 1/2 x 3 x 5 inches.
8 Tappings. Price of Standard Pack 60/-

CHOKES

Medium Duty Chokes, maximum current 45 milliamps.
Price, Single Choke 22/6
" Pair of Chokes 40/-
Power Chokes for maximum current 100 milliamps.
Price, Single Choke 32/6
" Pair of Chokes 60/-

A.C. SOCKET.

Five prong balanced Socket. Price 5/-

Write for Illustrated Catalogue, containing over thirty new lines.

ALL EMMCO PRODUCTS ARE FULLY GUARANTEED

MADE BY ELECTRICITY METER MFG. CO., LTD.

EXCLUSIVE FACTORY REPRESENTATIVES

139 Clarence St. Sydney
TELE. 9W 1328

*Manufacturers
Products Pty Ltd.*

Sudgen Place off Little Collins St.
MELBOURNE

Unstintingly acclaimed!

... by leaders in the radio field, the radio technical press, musical critics, and radio "fans" as the perfect speaker.



Belvedere
(Firescreen)
Model

For "A" Battery
Operation

£11/10/-

For A.C. Power
Point Operation

£14/10/-

Other Models
from

£10

MAGNAVOX DYNAMIC POWER LOUD SPEAKER

Rich, undistorted reproduction, with great volume

First place in realism . . . flawless re-creation
is accorded Magnavox Dynamic Speaker by everyone who
hears it.

Magnavox made the first Radio Loud Speaker . . . cre-
ated and sponsored the wonderful Dynamic . . . Magna-
vox Speakers are used as built-in equipment by leading Set
makers in England and America. Let these facts guide you.

Wholesale and Retail Distributors of Magnavox.

MICK SIMMONS LTD.

Haymarket, Sydney

AND AT BRISBANE

Radio Underground

FROM Wynyard Square to Market Street, staggering along slippery planks and over slimy, clayey mud. Concrete overhead, moulded in long strips by the wooden battens that held it, and lit by dull, yellow electric light. At last the sight of radiators in the form of insulated microphone cables and an amplifier box. We followed the way to Mr. Burberry and his staff, whom we found standing in overalls near a dripping tunnel under a piece of naked, unconsolidated rock, listening to the boom of some infernal machine working overhead. Dr. Bradfield was there, and Mr. Keith Frazer, the resident engineer. In the dim distance we saw Mr. Oswald Anderson, a photographer, and Mr. C. R. Hall. We made for the dim distance over some more perilous planks. Mr. Anderson's trousers were as clayey as anything there. So were his sandshoes. And on his face was an expression of childish delight. "See that engine up there?" he inquired. "That's the cement gun. It throws some six hundred feet along and rams it down hard and fast!"

If there is anything to be said of Mr. Hall's trousers it is that they were even more clayey than those of Mr. Oswald Anderson. So were his sandshoes. His army tunic still bore the badge of the Australian Wireless Squadron, and his army cap sat rakishly over his right ear. Mr. Hall sat on a pile of rocks, and talked softly, as his wont, into the microphone.

Unfortunately we were late, and we missed the fifty-five explosions (which blew the top of the microphone box open), and the winning drills, and the triumphal entry of Mr. Hall on a dirt cart drawn by a pit pony (he had to hop off because the wires became tangled). Mr. Hall waxed sentimental over the soles of a pair of child's shoes, which were found during the excavating work. "The sole survived," said Mr. Hall, "and this was most fitting." We were pleased to hear Mr. Shoe leather is so dear nowadays; and Mr. Hall's, we are sure, is a most deserving one. Mr. Burberry told us that two telephone lines had been tapped for the relay. They were taken from Holt House, in York Street, and run down an air hole into the tunnel. Six operating points and four microphones were used, and seven hundred feet of flex.

A fleeting memory of Mr. Anderson and Mr. Hall asking Mr. Frazer, like eager children, "Can we go up the big shaft, please," and of Mr. Frazer carefully shepherding them away from the dangerous experience.

Should Announcers . . .

UNCLE BAS has gone away for a fortnight's holiday. We believe he is going to do a little fishing; although we wish announcers would keep well away from sport, which tend to undermine veracity and to foster creative imagery with such disregard for proportion and symmetry as to point the truth the finger of the grotesque. Yes, indeed, we think it may be bad for our children.

Archie

"ARCHIE" AIRS HIS VIEWS for the benefit of 2BL listeners, and this informal little innovation is finding decided favor. Broadcasting administration struggles continually to get away from stereotyped routine, which is not the easy matter many enthusiasts think, but "Archie" seems to have struck the keynote, in his broadcast chats, which are creating wide interest.

Radio Frequency Oscillations NOW CONTROLLED!

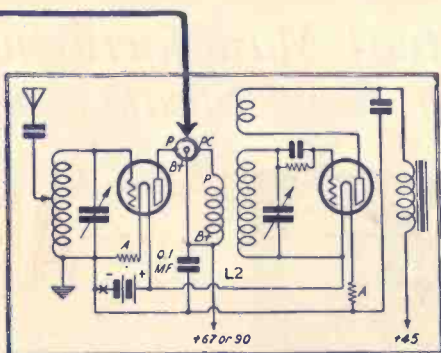

THE ELECTRAD PAHSATROL

is a true balancing device for radio frequency amplifiers, and will effectively stabilise oscillatory tendencies in circuits using radio frequency.

Use it in the
Browning Drake
Circuit,
Neutrodyne Circuit,
etc.

PRICE
17/6

Dealers

Electrad Products are obtainable at All Radio

Other Electrad Products:

SWITCHES AND JACKS.

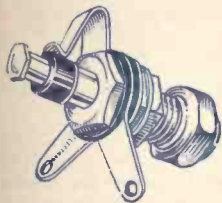

A neat, small, positive acting Mid-get Jack, which requires less than an inch behind the panel.

Sterling silver contact points, hard rubber insulation, phosphor bronze spring.

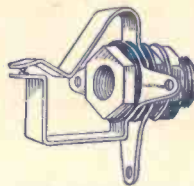

Closed

In two types—

Closed Circuit 1/9

Open Circuit 1/6



Open

The Filament Switch is Mechanically and Electrically Perfect. Positive action at all times. The same material is used as in Jacks, with push-pull knob of genuine Bakelite. 2/.

Amalgamated WORLDWIDE WIRELESS **Wireless**
(Australasia) Ltd.

Sydney, Melbourne, Adelaide and Wellington (N.Z.).

Over Forty Years

Actual Manufacturing Experience is built into every Speaker bearing the name of—



The Amplion "Junior Cabinet" Cone

A popular priced model possessing the "natural tone" characteristic of the Cone Range.

MODEL AC4
in well finished oak.

Old Price, £5/5/-

New Price £1/7/0.

Mahogany.

Old Price £5/10/-

New Price £1/12/0.

Your dealer will be pleased to demonstrate any model. Meanwhile, may we send you interesting Literature post free? The Coupon is for your convenience. Use it.

AMPLION

The models illustrated and described here represent the very highest expression of Loud Speaker manufacture. There is a comprehensive range to choose from at 50/- Upwards



Amplion "Senior Chippendale" Cone

MODEL AC9. A masterpiece of faultless design and workmanship in beautifully finished mahogany. Capable of handling considerable volume with crystal-clear purity.

Old Price £9/10/-.

New Price £7/10/-.



The Amplion "Junior" Cone

MODEL AC2. This "Hanging Type" model is one of the Lowest Priced of the Amplion Range, and in volume and tone is more than equal to many other makes of Speakers priced much higher

Old Price £3/5/-.

New Price £2/15/-.

Make "The World's Standard"
Your Choice

Messrs. Amplion A/SIA Ltd.
Please forward me illustrated literature describing
Name _____
Address _____
Amplion Cone Speakers.

AMPLION A/SIA LTD.

BRADBURY HOUSE

53-55 YORK STREET :: SYDNEY