

# WIRELESS WEEKLY

Registered at the G.P.O., Sydney, for

Transmission by post as a newspaper.

VOL. 2. No. 9.

FRIDAY, JUNE 25, 1926.

## 3D

# MAGNAVOX

Obtainable from:  
Anthony Hordern  
& Sons Ltd.,  
Mick Simmons Ltd.,  
Sydney.



Obtainable from:  
The Myer  
Emporium Ltd.,  
The Leviathan Pty.  
Ltd., Melbourne.

MODEL M75.

Built in Loud Speaker, and enclosed A and B Batteries, in hand rubbed Mahogany Cabinet.

A Radio Receiving Set so simple, yet so efficient, that it is greeted with equal enthusiasm by experts and amateurs—the turn of a single dial makes you master of the air.

"In Harmony with the Home and Air—Magnavox"

Charging  
Radio  
Batteries  
from the  
Car



3.A.R. MELBOURNE



2.K.Y. SYDNEY



2.F.C. SYDNEY



3.L.O. MELBOURNE



4.Q.G. BRISBANE



2.B.L. SYDNEY

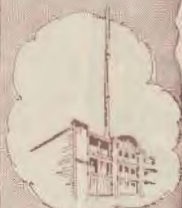

6.W.F. PERTH



7.Z.L. HOBART



5.C.L. ADELAIDE

*Distance no longer a bar!*  
**UDISCO**  
**RADIO RECEIVERS**  
*Lay Australia at your finger-tips.*

Matthew Flinders in his trail craft could never have dreamed that his feat of seamanship in circumnavigating Australia would be duplicated nightly but a short century later.

Yet this is so. Nightly, owners of "UDISCO" Radio Receivers—without stirring from comfortable homes—are accomplishing what to Flinders entailed many weary days of hunger and privation.

All "UDISCO" Sets, whether "Eights," "Sixes," "Fives," or "Threes," are built to a standard of excellence in efficiency and design never before equalled in the world.

Only the best components—assembled with scientific precision by a specially trained corps of radio Engineers—are incorporated.

The "Capacdyne" circuit employed ensures reception of Stations operating on any wavelength between 20 and 2000 metres. This circuit—a purely Australian invention—gives selectivity, volume without distortion, superlative tone quality and ease of control.

Tuning dials synchronise—wavelengths are controlled with one switch—volume by another.

Housed in full polished cabinets of pleasing design, "UDISCO" Receivers are masterpieces of craftsmanship.

"UDISCO" Eight  
 on Stand with Quam  
 Loud Speaker, Clyde  
 United Wet Accumulator,  
 Ray-O-Vac B Batteries,  
 Valves, and Aerial Equipment... 110 gns.  
 "UDISCO" Five,  
 with Hawley Speaker,  
 and requisite Batteries. No Stand.  
 . . . . . 245

"UDISCO" Special  
 Five on Stand with  
 Quam Loud Speaker,  
 Clyde United Wet Accumulator,  
 Ray-O-Vac B Batteries,  
 Valves and Aerial Equipment... 275.  
 "UDISCO" Three,  
 with similar equipment  
 to Five, but with Hawley Junior  
 Speaker . . . 229/10/-

**United Distributors Ltd.**

72 CLARENCE ST., SYDNEY.  
 MELBOURNE, BRISBANE, ADELAIDE,  
 PERTH, WELLINGTON, LAUNCESTON, N.E.

SEND FOR Illustrated catalogue, folders and literature.

Demonstrations arranged at your own home without any obligation whatever on your part to purchase.

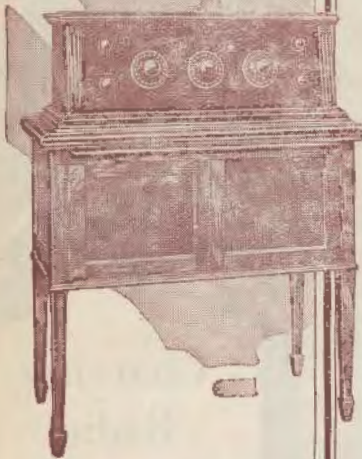

# DE FOREST - The Quality Valve

## Now 13/6 Each

Everywhere



Filament, 3 Volts .06 Amp.  
 Detector, 16 to 45 Volts.  
 Amplifier, 45 Volts to 150 Volts.  
 Fits Standard American Socket.

De Forest Valves were the first made.

Lee De Forest invented the valve, so you can rest assured that De Forest Valves are the best.

**DON'T BE MISLED.**

DE FOREST is the "QUALITY TUBE," and is correct in design and manufacture.



Filament, 5 Volts  $\frac{1}{2}$  Amp.  
 Detector, 12 to 22 $\frac{1}{2}$  Volts.  
 Amplifier, 45 to 180 Volts.  
 Fits Standard American Socket.

## International Radio Co. Limited

200 Castlereagh Street, Sydney.

91-93 Courtenay Place, Wellington, N.Z.

STATE DISTRIBUTORS:

VICTORIA: Alexander Mair & Co., Elizabeth Street, Melbourne.

TASMANIA: W. & G. Genders Pty. Ltd., 69 Liverpool Street, Hobart.

QUEENSLAND: Home Radio Service Ltd., Courier Buildings, Queen Street, Brisbane.

WEST AUSTRALIA: A. C. McCallum Ltd., 95 Murray Street, Perth.

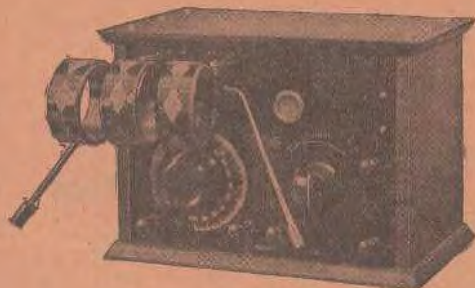

**ONE VALVE SET.**

With Polished Maple Cabinet and all panel equipment, wiring diagram, wire, solder, flux, etc., but without coils . . . . .	£	s.	d.
	3	15	0
Accessories required to fully equip this set are as follows:—			
1 Valve, Radiotron, Phillips, Geco or De Forest . . . . .	0	13	6
5 Mounted Coils covering 200—1300 meters . . . . .	1	1	0
2 1.5 Columbia Dry Cells . . . . .	0	5	8
1 Pair Headphones . . . . .	0	15	0
1 32-Volt High Tension Battery . . . . .	0	0	0
100 ft. Aerial Wire . . . . .	0	2	6
15 ft. Lead-in Wire and 4 Insulators . . . . .	0	1	7

This Set completely wired and tested, with all Accessories as shown . . . . . 26 6 0



**FOUR VALVE SET.**

With Polished Maple Cabinet and all panel equipment, wiring diagram, wire, solder, flux, etc., but without coils . . . . .	£	s.	d.
	8	0	0
Accessories required to fully equip this set are as follows:—			
4 Valves, Radiotron, Phillips, Geco or De Forest . . . . .	2	14	0
7 Mounted Coils covering 200—1300 meters . . . . .	1	9	8
3 1.5 Columbia Dry Cells . . . . .	0	8	8
1 Pair Headphones . . . . .	0	15	0
1 60-Volt High Tension Battery . . . . .	0	18	0
100 ft. Aerial Wire . . . . .	0	2	6
15 ft. Lead-in Wire and 4 Insulators . . . . .	0	1	7

This Set completely wired and tested, with all Accessories as shown . . . . . £17 5 0

Loud Speakers from 35/-.

Building a Radio Receiver is a happy event in any boy's life; there is nothing so satisfies the natural creative ability of boys YOUNG AND OLD as the building of these Radio Set; for when a Radio is finished it brings the world's best entertainment and education from far and near.

Many of the achievements of modern Radio Reception have been made by young men who a few years ago built their own Radio Sets.



**Colville - Moore  
Wireless  
Supplies Ltd.**

**10 ROWE STREET.  
SYDNEY**

Next Hotel Australia

## Clarke's "ATLAS" Filament Control



This instrument gives an infinite control over the flow of Electrons through the Valve, and perfect adjustment of the Valve Filament is obtained from dull red to necessary brightness, consequently a longer life is obtained from the Valves, as there is no sudden rush of current.

This rheostat, which is smooth and noiseless, will carry two Amps. without over-heating, which means that three ordinary valves taking .75 Amps. could be controlled with the same.

If Dull Emitter Valves are used, a correspondingly larger number could be controlled dependent on the amperage the valves take.

Not Carbon Powder but specially-prepared resistance Discs, which are practically unbreakable.

It is impossible for this Resistance to "Pack."

Highly-glazed Porcelain Casing; Nickel plated Fittings, and complete with a metal dial, and surmounted by a first-class Ebonite Knob. One-hole fixing. Ask your Licensed Radio Dealer for "Atlas" Component Parts.

THE GENERAL TRADING COMPANY

70 PITT STREET—SYDNEY

Sole Australian Distributors.

Telephones: BW 6938 and B 4917

## Columbia 45 Volt

*Vertical "B" Battery No. 4772*



**D**ESIGNED for all sets having not more than four tubes using 90 volts. Occupies less than half the table space of the horizontal 45 volt battery, yet contains the same large, powerful cells. Three Fahnestock spring clips—negative, plus 22½, and plus 45 volts.

FACTORY REPRESENTATIVE  
**ELLIS & CO. (AUSTRALIA) LTD.**  
 516 KENT STREET, SYDNEY, N.S.W.

## Columbia Radio Batteries

*Made by the manufacturers of the Famous Columbia Dry Cell*



## DEPENDABLE ALWAYS

The popularity of Ever-Ready Batteries is due to their dependable qualities. They are always fresh and give maximum service.



### EVER-READY RADIO "B" BATTERY

These batteries are unsurpassed for radio service. Made in Australia from the finest selected materials—quality ensures the best results to users.

Positive tappings are arranged to suit all required voltages.

Note the very moderate pricings:—

For 1 to 2 Valve Sets.		For 2 to 5 Valve Sets.	
WP 30 Volt . . . . .	9/6	XP 30 Volt . . . . .	16/-
WP 40 Volt . . . . .	12/6	XP 40 Volt . . . . .	21/-
WP 60 Volt . . . . .	18/-	XP 60 Volt . . . . .	31/6

Prices quoted apply only in N.S.W.

Obtainable from all up-to-date dealers.

If unprocureable locally, write for address of nearest source of supply.

## EVER-READY CO. (Gt. Britain) LTD.

163 PITT STREET - - SYDNEY



## The Crystal with Valve Power

NEUTRON CRYSTALS operate a loud speaker.

Many owners of crystal sets are now operating loud speakers with NEUTRON CRYSTALS. Next month 2BL promises to increase their volume. This will enable the owner of a crystal set to operate a loud speaker with sufficient volume to fill the house, provided he uses a NEUTRON. THE CRYSTAL IN THE BLACK AND GOLD BOX WITH THE SILVER CATS WHISKER.

FOR SALE AT ALL DEALERS at . . . . . 2/3

AUSTRALIAN DISTRIBUTORS: Louis Coen Pty. Ltd., Melbourne.

SOLE AGENTS FOR N.S.W.:

**Manufacturers' Products Sales Company**

Challis House, 4 Martin Place, SYDNEY (Tel.: B.W. 6753).

PROMPT SHIPMENTS OF NEUTRONS FROM SYDNEY STOCK.

## Slingsby & Coles Ltd.

482 Pitt St. (opposite Marcus Clark's)

THE RELIABLE  
RADIO HOUSE

On Terms.  
Loud Speakers,  
and Headphones,  
etc.

Any Radio Goods  
on TERMS or  
Lay-By.



## SALE of Surplus Stock

	s.	d.
Bakelite Bases, 4 1/2 in. x 2 in. x 3/16 in. . . . .	1	0 doz.
Drilled . . . . .	0	0 "
Bakelite Bases, 3 1/2 in. x 2 in. x 3/16 in. . . . .	0	0 "
Drilled . . . . .	0	0 "
Bakelite Bases, 2 1/2 in. x 2 in. x 3/16 in. . . . .	0	6 "
Drilled . . . . .	0	6 "
Ebonite Bases, 4 1/2 in. x 1 in. x 2 in. . . . .	0	3 each
Drilled . . . . .	0	6 "
.0015 and .001 Fixed Condensers . . . . .	0	6 "
Bakelite Strips, mounted with 3 5BA Studs and Nuts . . . . .	0	2 "
Variab's Grid Condensers, max. cap. .000105; min. cap. .00002 . . . . .	1	6 "
N.P. Crystal Cups . . . . .	0	6 "
Brass Switch Stops . . . . .	0	6 "
Telephone Transformers . . . . .	5	0 "
A.W.A. Telephone Plugs and Jacks . . . . .	1	6 "
Etc., etc.		

On View, 2 p.m. to 5 p.m.  
Saturdays, 9 a.m. to Noon.

**Basement**

**Amalgamated Wireless (A/sia) Ltd.**  
97 Clarence Street, Sydney

Country Readers write to "Dept. F," for full  
Particulars

# BRANDES

*The Name to Know in Radio*

BRANDES  
Table  
Talker



NOW  
45/-  
each

## THE TABLE TALKER

The new goose-neck design is the result of research in radio acoustics, which definitely establishes its value in relation to the diaphragm fitted. One feature is the potent material used in the construction of the horn, which eliminates any suggestion of harshness. It is now possible to control volume and sensitivity with the small lever located at the rear of the base. Elegantly shaped, it still has that tasteful neutral brown finish and felt-padded bass. Height, 18 in.; bell, 10 in.

45/- each Retail

The  
Brandola



NOW  
£6:10:0  
each

## THE BRANDOLA

Specially built to bring greater volume with minimum current input and exceptional clarity over the full frequency range. A large diaphragm gives new rounded fulness to the low registers and new clarified lightness to the high. The semi-goose-neck horn is constructed of material which eliminates harshness or metallic resonance. Reproduction is controlled by a thumbscrew on the bass. Polished walnut plinth with electroplate fittings. Height, 26 in.; bell, 12 in.

£6/10/- each Retail

FACTORY REPRESENTATIVES:

**INTERNATIONAL RADIO CO. LTD.**

200 Castlereagh St., Sydney.

91-93 Courtenay Place, Wellington, N.Z.

STATE DISTRIBUTORS FOR BRANDES:

VICTORIA: Alexander Mair & Co., Elizabeth Street, Melbourne.

TASMANIA: W. & G. Genders Pty. Ltd., 69 Liverpool Street, Hobart.

QUEENSLAND: Home Radio Service Limited, Courier Buildings, Queen Street, Brisbane.

WEST AUSTRALIA: A. C. McCallum Ltd., 96 Murray Street, Perth.





Published by Publicity Press Ltd., 71-75 Regent St., Sydney, Australia.  
 Phones: Redfern 864 and 930.

Managing Editor: E. C. MUMFORD.

Editor: A. W. WATT.

Technical Editor: C. W. SLADE.

Advertising Manager: J. T. REEDIE.

The Editor will be glad to consider Technical and Topical Articles of interest to Australian Experimenters. All Manuscripts and Illustrations are sent at the author's risk, and although the greatest care will be taken to return unsuitable matter (if accompanied by stamps), the Editor cannot accept responsibility for its safe return.

Subscription Rates.—Twelve months (52 issues), 13/-. post free. Six months (26 issues) 6/6. post free. Single Copies 3d. each, or post free 4d.

Advertising. Copy must be in the hands of the Managing Editor by the Friday preceding each issue. If copy is not received in time, the previous week's advertisement will be repeated.

"Questions and Answers." All requests by non-subscribers calling for technical advice or drawings MUST be accompanied by postal note or stamps to the value of 1/-. A maximum of four questions is allowed.

Agents in Great Britain.—The Colonial Technical Press Ltd., Dudley House, Southampton Street, Strand, W.C. 2.

All accounts should be made payable to Publicity Press Ltd., 71-75 Regent Street, Sydney.

"Wireless Weekly" is fully protected by copyright, and nothing that appears in it may be reprinted, wholly or in part, without special permission. The use of our articles or quotations from them for any purpose whatsoever is never authorised.

CONTENTS

	Page
Is Your Receiver Giving Maximum Efficiency .	7
Queries Met by Every Beginner . . . . .	11
On the Air. . . . .	19
Broadcasting Notes. . .	23
Amongst the Traders .	35
Broadcasting . . . . .	37

IS A RECEIVER WORTH WHILE?

Saturday night's programme from 2FC, when Signorina Toti Dal Monte was broadcast from the Town Hall, must have forever settled the vexed question as to whether broadcasting is worth while in the minds of critics of this new and wonderful form of entertainment. The voice of this famous Italian prima donna, borne from the Town Hall platform across the whole of Australia and New Zealand—into the homes of the vast interior—carried perhaps the finest message ever scattered far and wide by an Australian broadcasting station. Those who listened to that wonderful voice, whose every cadence was perfectly clear, must have registered a silent vote of thanks to 2FC.

We have little to quarrel with in the quality of the broadcasts from our Sydney stations, but it is on occasions such as this that the true wonder and value of broadcasting becomes apparent and the real measure of success in Australian broadcasting may be checked up. The congratulatory messages that have already poured in upon 2FC from far and near are ample evidence of the scope covered by the station, and that the efforts of the management to provide the highest available talent in the musical world to the listening-in public are appreciated. Even those who chafe at operatic music and pine for the lighter

variety offered by jazz items were silent under the spell of the magic voice, but the spell was wrought not alone by the human voice, but by the perfection of the mechanical and technical arrangements of the station itself, which made it possible for the voice of Dal Monte to be brought into thousands of homes.

There is another and particularly important point which may be stressed when summing up the value of broadcasting, and that is the moral and psychological effect upon the young ones, whose joy it is to listen to those delightful bedtime stories from 2BL and 2FC. At the former station hundreds of letters are on file from parents and guardians all over the country, expressing nothing but the highest appreciation. The names Uncle George and Uncle Jack are familiar on the lips of many a tiny tot who has come to love and to be impressed by these two invisible "relatives" who deliver so much that is good for children to hear. The knowledge that "Hector" sees all, hears all, and knows all has been proved in many cases to be actually a deterrent to children whose tendencies are apt to be somewhat precocious. These bedtime stories are a real force for good in dozens of homes.

Summing up the foregoing, therefore, the question, "Is a receiver worth while?" scarcely requires an answer.

A. W. WATT.

# Important Notice

## TRANSFER OF BUSINESS

THE General Public are invited to inspect our new premises which are regarded as one of the World's finest Radio Stores

---

WE STOCK EVERYTHING  
IN RADIO

## The Australian Wireless Company

140 Castlereagh Street, Sydney

*(Between Market and Park Streets)*

---

PHONES — M 2037, M 2038

Manufacturers of the well-known "RADI AIR" Radio Sets

# Is Your Receiver Giving Maximum Efficiency?

A NON-TECHNICAL ARTICLE FOR THE B.O.L.

It is really extraordinary how a pair of straight out valve receiving sets, constructed by two broadcast listeners from almost identical components but rather on different lines, can vary in their performances. Readers are requested to carefully study Figs. 1 and 2. Each is a two-valve receiver consisting of a regenerative detecting valve and a stage of audio frequency amplification. Which of the two would you say is the most efficient, supposing, of course, that valves, components and batteries of exactly the same make were used in each? Do not read further until you have made your choice.

the more selective will the tuner be, though there is some loss in signal strength if the reduction is carried too far. The secondary is tuned to the desired wavelength by means of the variable condenser, and in this manner it selects the desired signal from the primary. Very careful adjustment of the coupling of the coils is, however, very necessary to even obtain a moderately low percentage of selectivity.

Let us now see why the Fig. 1 hook-up is superior to Fig. 2; In the first place, both primary and secondary coils are tuned to the desired wavelength by means of variable condensers and plug-in coils. Hence

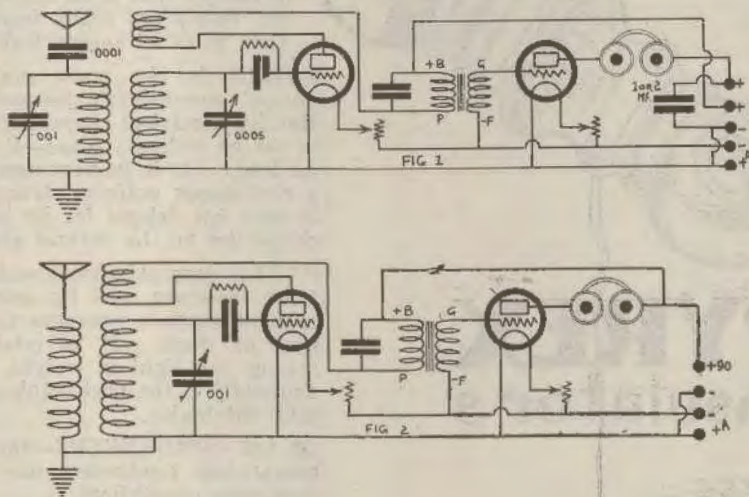

There cannot be any doubt about it that the Fig. 1 hook up is by far the better of the two, in spite of the fact that there are two tuning controls as compared with Fig. 1, which has only one. It must, however, be definitely pointed out that Fig. 2 has advantages for the home constructor whose conditions are such that maximum selectivity is not essential.

Aperiodic tuning is used, which means that the primary and aerial is not definitely tuned to any one wavelength. It passes equally well all frequencies within certain limits, providing the tuner is of the plug-in coil type (for all the lower wave broadcast stations a 25 turn coil, and for 2FC a 100 turn coil, will be found O.K.) A very good tip, worth remembering when using aperiodic aerial tuning, is the fact that the fewer the number of turns in the primary,

increased selectivity. A glance at Fig. 1 also shows that .0001 fixed condenser is joined in series with the aerial circuit. This is a further refinement which again increases the selectivity. Almost every reader is familiar with the fact that a small low aerial is considerably more selective than a large high aerial. By using the fixed series condenser as shown, however, the fundamental wavelength of the big aerial is reduced to that of the small one, thereby increasing selectivity, without lowering the increased pickup properties of the large high aerial.

There is one drawback to the Fig. 2, in that there is one extra control which makes searching (or tuning) more difficult. This difficulty can, however, be overcome by using a good type of double-pole double-throw switch, which enables quick change from

# THE IMPORTANCE OF PERFECT INSULATION EMPHASISED

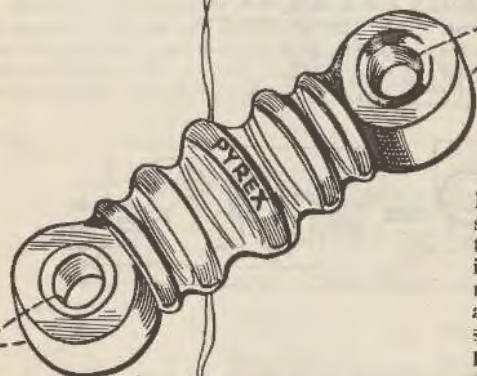

## PYREX Insulators

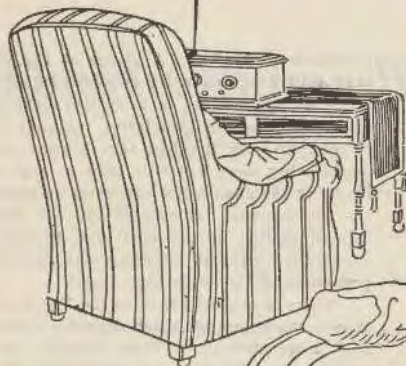

PYREX INSULATORS have improved his radio reception a hundred fold. Now he gets every bit of energy that is on the air. Pyrex Insulators really insulate—they don't let energy leak away.

PYREX is the trade mark of a special composition possessing distinctive electrical characteristics. It is not an ordinary glass—it contains no lead. It is homogeneous and of a continuous uniform structure, and so does not depend for its insulating properties on the surface glaze.

PYREX does not absorb water or attract moisture, and its smooth permanent surface prevents the collection of dust. It is mechanically strong and light in weight, and undoubtedly is the best insulating material obtainable.

QUAM CONDENSERS—the world's lowest loss condensers use PYREX insulation throughout.

PYREX Broadcast Insulators, 3/6 at all Dealers.

### United Distributors Ltd.

73 Clarence St., Sydney 343 Queen St., Brisbane  
 G. Jervis Quay & Har- 864 Bourke St., Melb.  
 ris St., Wellington, N.Z. 26 Queen St., Perth

27 Chesser St., Adelaide  
 68 Charles St., Lancaster

The transmitting and receiving antennae of the McMillan Arctic Expedition are PYREX insulated. 34 Broadcasting Stations in the U.S.A. have recently replaced other insulators with PYREX. The U.S.A. Navy and Coast Guard Lighthouse and Air Mail Service specify and use genuine PYREX.

single to double circuit tuning. Home constructors who wish to have a simply controlled receiver, for other members of the family to tune, will be very wise to add this refinement. (See Fig. 3.)

#### A Word About the Tuning Coils.

It is a well-known fact that, to obtain the largest

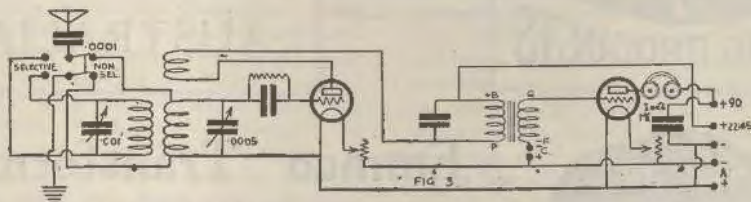

possible high frequency potential difference across an inductance, the self-capacity of the coils must be kept as low as possible. This we can keep low by using good quality coils, which are so designed that minimum capacity is obtained. We have explained in previous articles how and why the large size variable condenser joined in parallel with the primary coil is most suitable for Australian conditions, where maximum selectivity is desired on a large band of wavelengths, so that this will not be dealt with again here.

There is another bad fault in Fig. 2 which, unfortunately, is made by many home constructors. That is that both valves receive the same high tension voltage as the plates. Let us see why this is wrong.

In the first place we must not overlook the fact that both valves are carrying out two different duties; one is the detector, and the other purely and simply amplifies what the first valve detects. Now, if the plate potential is high, the flow of grid current will be cut down, because electrons, on leaving the filament, will be so strongly attracted by the highly positive plate, that very few of them are caught by the grid. The grid of the valve should control the amount of current the anode receives, but it cannot carry out this duty satisfactorily if too high a plate voltage is used. Hence the receiver which employs common H.T. voltages for detector and audio valves will usually be very unstable. The majority of valve makers recommend various plate voltages to be used on their valves, when used for detector or audio amplifiers. These instructions should be rigidly carried out.

It is not unusual in some home-made sets to find that one or both of two important condensers are omitted. These are (1) the transformer condenser which bridges the primary terminals of the first audio

transformer, and (2) the high tension condenser.

The reason why these condensers are required is simply this: The primary windings of the iron-cored audio transformer has a very big inductance, which forms an effective barrier to the passage of high frequency current in the plate circuit of the detector. If the transformer is badly designed and has a very

high self-capacity, the condenser may not be absolutely necessary, since the capacity of the windings may give a sufficient path to these currents. For a good quality transformer, however, a .001 fixed condenser will usually be found most suitable for bye-passing these radio frequency currents.

The same action applies to the high tension battery condenser. When the dry battery is new there is no appreciable resistance and the bye-pass condenser, on actual test, will probably give no increased results. But try it on a battery which is a few months old, and you will be astounded at the improved results you will obtain, both in tone and volume.

Can any further improvements be made? Yes, the addition of a "C" battery as shown in Fig. 3 will again improve the efficiency and also reduce the drain on the "B" battery. If B.C.L.'s with multi-valve sets who are constantly grumbling about the short time their expensive "B" batteries last would only add this refinement, they would be more pleased with the tone of their receivers and better off in the pocket. It is often said that in a small set, such as a two-valve, a "C" battery is unnecessary. So it may be, as far as the sound produced is concerned, but the drain on the "B" battery should not be overlooked even with one audio amplifier.

Most of the noisy sets in use to-day owe their defect to the fact that they are drawing too much current from the high tension battery. The ordinary small-sized high tension battery should never be called upon to give more than 5 milliamperes of current, and the more you can reduce this amount the longer will be the silent working life of the battery. Hence the advice that a grid battery should be used even in a two-valve set. Large "B" batteries are advisable where more than two valves are used.

(Continued on Page 16, Column 1.)

**Emmco**  
RADIO PRODUCTS

—MADE—  
IN  
AUSTRALIA

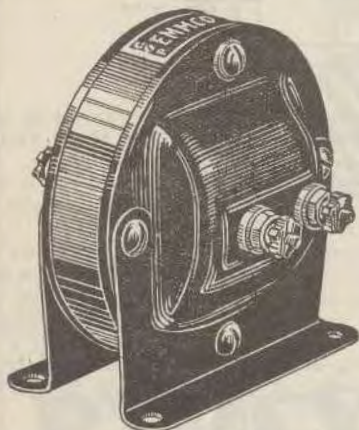

Ratios  $3\frac{1}{2}$  to 1 and 5 to 1.  
Also made in 2 to 1 and  $7\frac{1}{2}$  to 1.

## Emmco Transformer

THE BEST INSTRUMENT THAT MODERN  
ENGINEERING METHODS CAN PRODUCE.

The New Emmco Transformer fulfils the very highest demands of Radio Engineering Standards to-day. Constructed throughout on sound engineering principles, backed up by the prestige of one of the largest engineering concerns in Australia, it deserves its reputation as the King of Transformers.

Ruggedly built and of handsome appearance.

PRICE . . . . . 21/-

EMMCO PUSH-PULL TRANSFORMERS,  
63/- PAIR

## Emmco Condenser

Absolute insulation—grounded rotor  
end plates—straight line wavelength—  
most minute adjustment.

These are some of the features contributing to the efficiency of EMMCO Vernier Condensers.

Prices:

VERNIER TYPE.

.00025 . . . . . 20/-  
.0005 . . . . . 21/-

PLAIN TYPE.

.00025 . . . . . 13/6  
.0005 . . . . . 15/-

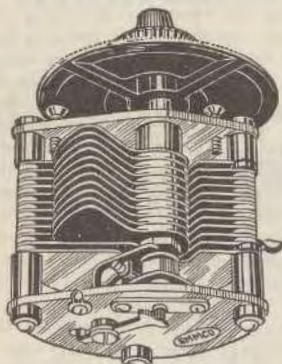

See Emmco Products at Your Dealers

Manufactured by

Electricity Meter Manufacturing Company Limited, Sydney

## Queries Met by Every Beginner

A Coogoo reader's query: "In a current issue of 'Wireless Weekly' you showed a one-valve amplifier hook-up in a non-technical illustration. Could you please show the hook-up for a one-valve detector without regeneration? I have been getting your paper since its inception and can find no trace of this. At present I am using crystal detecting and two L.F. amplifiers, but I wish to substitute the valve for the crystal without losing the purity. I don't want reaction, as I only listen to local stations. I am using two tuned coils inductively coupled. Please show how to add the valve to the leads coming at present from crystal detector and secondary condenser."

A.: The back of panel view shows clearly the wiring of a valve detecting unit. Both secondary and primary are tuned. The valve when used as a straight-out detector without regeneration will give excellent purity, with the added advantage that it is far more stable than the average crystal detector, which constantly requires adjustment. (Country readers should, however, understand that this is not a long distance receiver.)

A Neverfire reader writes: "I have had a lot of trouble lately with getting my wireless batteries charged and returned to me, on account of being 30 miles from the service station. Owing to the wet weather a creek in between has been impassable for the last three months. Is it possible to charge my A battery from primary cells? In a book I have, called 'A Practical Guide to Wireless,' by Bernard E. Jones, of 'Amateur Wireless,' the author explains how it can be done. Failing the above method, is it possible to charge the accumulators from a motor car? I have a Standard Model Studebaker car (1925), with a six volt starting and lighting set. Could I connect my accumulator up somehow so that it could be charging at the same time as the car battery? If I could, would you please draw me a diagram showing me how and where to connect it up? Would it be doing my car battery any harm charging another battery up at the same time, and would it be taking too much of the charge from the battery?"

A.: It is not possible to recharge large accumulators with primary cells. The car generator can, how-

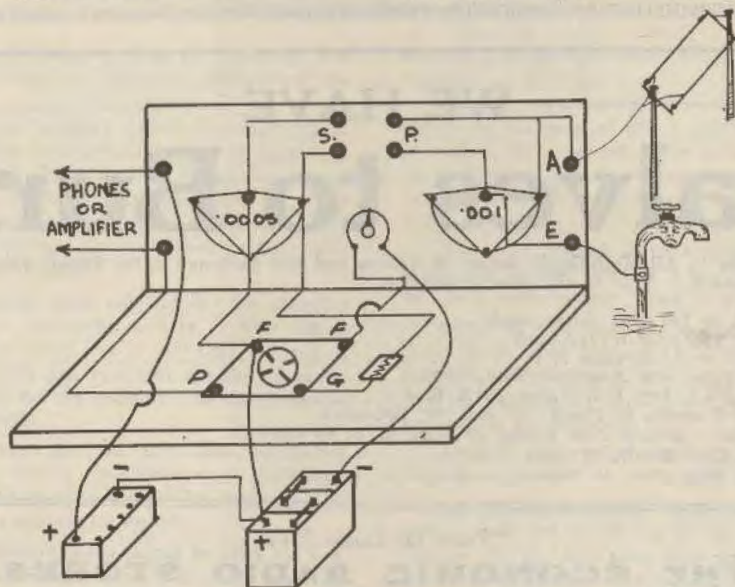

One Valve Detector Without Regeneration.



## FURTHER REDUCTIONS OF IGRANIC HONEYCOMB COILS

You can now obtain the finest coils that the world produces at prices within the reach of every pocket. Due to the ever-increasing world-wide demand for famous IGRANIC Coils, we are able to announce substantial price reductions which will make an instant appeal to all lovers of fine quality apparatus. Here are the new prices:—

Coil No.	Old Price.	New Price.
25	8 s. d.	5 s. d.
30	6 6	5 0
35	6 6	5 0
40	6 6	5 0
50	6 9	5 6
60	6 9	5 6
75	7 3	6 0
100	7 3	6 0
150	9 6	8 0
150	10 6	9 0
200	12 0	10 0

Igranitic Dualateral Honeycomb Coil, recognised as the finest and most efficient coil produced. Now available at greatly reduced prices.

Write for Booklet No. 3. Contains full particulars of the famous Igranitic range, Brown's Loud Speakers and Oldham's Batteries. Post free on request.

Larger sizes proportionately reduced.  
ALL DEALERS SELL THEM.

### NOYES BROS.

(Sydney) Ltd. Melbourne (Pty.) Ltd.

SYDNEY: 115 Clarence Street.  
NEWCASTLE: 11 Watt Street.  
BRISBANE: Perry House.

MELBOURNE: 495 Bourke Street.  
ADELAIDE: Darling Buildings,  
Franklin Street.

HOBART: 145 Macquarie Street.  
And at LAUNCESTON; also from J. W. R. Gardam, PERTH.  
Sole Agents for BROWN'S Loud Speakers.  
Distributors of PHILIPS Valves.

WE HAVE

# Valves to Burn

We specialise in All High-Grade makes of Valves and test each one in the Jewell Tube Checker before despatch. This is for your protection.

Radex 201A or 199 type valves, each	s. d.
Radiotron UX201A or UV199, each	7 6
Philips B406 or A110, each	13 6
Ediswan R type with American Base, each	13 6
De Forest DV.3, Dry Cell Valve, 201A Base	3 0
We carry full stocks of Fresh "A" and "B" Batteries.	13 6
"B" Batteries. British Ever Ready, 42 volts, 12/6; 60 volts	18 0
Large Size Ever Ready, 42 volts	21 0
Winchester, large size, 45 volts	24 0

"Yours for Lower Prices"

## THE ECONOMIC RADIO STORES

28 ROYAL ARCADE, SYDNEY.

(3 doors from Pitt Street, left side)  
Phone: M 3049.

569 HUNTER ST. WEST, NEWCASTLE.

Phone: New. 1622.



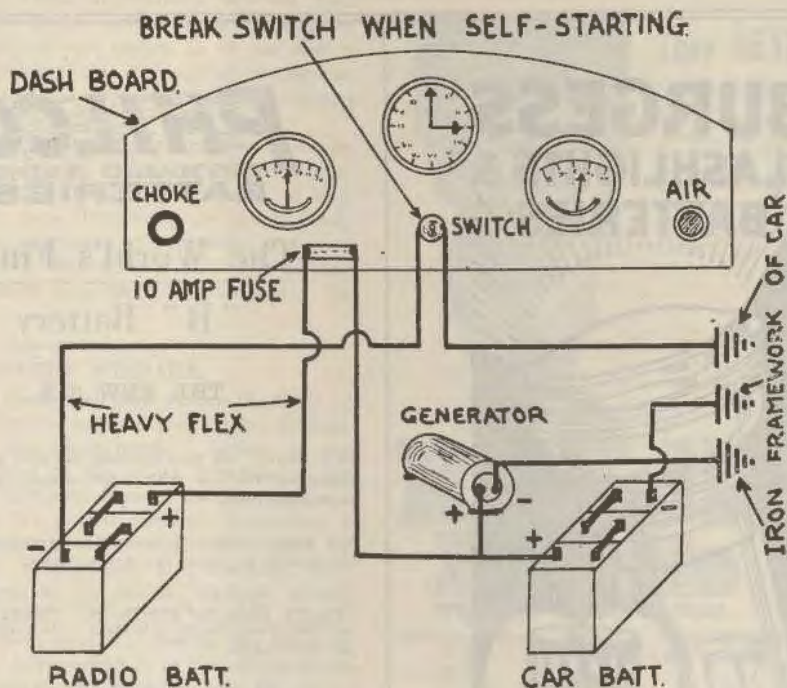

*Charging a Radio Battery on the Car.*

ever, be very satisfactorily used for charging the A battery, providing the following precautions are taken:—

(1) Place the negative (green terminal) of A battery to one side of the switch shown on dashboard in drawing. From the other side of switch a connection is taken to the iron framework of car. The positive A of both car and radio batteries should next be joined together via a terminal or fuse—also shown on the dashboard.

(2) The charge must not exceed the charging rate suitable for the radio battery. This means that if the car is taken out on the road a speed of from 10 to 20 miles per hour will run the generator quite fast enough for the charge to suit the averaged sized radio batteries.

(3) Never start the car with the self-starter when the radio battery is connected. Remember, the switch on the dashboard must be broken before you tread on the self-starter switch.

(4) Heavy flexible leads should be used for connecting up the A battery, in order that the vibration of the car will not chafe through the insulation and short circuit the battery. If the above precautions

are taken no damage whatever can be done to either radio or car batteries.

Country readers who are continually worried about the charging of the A batteries will be wise to replace their present radio battery with another car battery of exactly the same capacity. The two batteries can then be alternately changed for car or radio duties.

Numerous readers have the wrong impression that a car battery (because it is large) is too powerful for a radio battery. This is absolutely wrong.

Note: If both your car and radio batteries are made up of three distinct accumulators joined together (viz., 6 volts), you may safely use the car battery for lighting the filaments of the valves, without any fear of burning them out.

Another city reader's query: "Are slow-motion dials worth while?"

A: Yes; a thousand times, yes. Good slow-motion dials are invaluable to the city or country listener. In the first place they make accurate tuning somewhat simple. Quite a number of them are fitted with a small window which can be marked at the correct setting for each station's adjustment.

# BURGESS FLASHLIGHTS & BATTERIES



The life of your flashlight, or any flashlight, depends upon the electrical, chemical and mechanical efficiency of the battery and case. That's why you can always depend upon Burgess Flashlights and Batteries. They will give you strong white light when and where you want it, and as long as you want it.

Obtainable at

**HARRINGTONS LTD.,**  
**GEORGE STREET,**

Also MELBOURNE, ADELAIDE, BRISBANE.

**New System Telephones Pty. Ltd.**

280 CASTLEREAGH STREET,

Also MELBOURNE & ADELAIDE.

# PHILCO

DRY-DYNAMIC RADIO  
BATTERIES

The World's Finest

"B" Battery

THE NEW 83X.

This Battery has been specially designed by "Philco" Engineers for use with super-heterodyne and other multi-valve sets.

The current drain of the many valves on these sets has proved too heavy for dry batteries.

The new 83X is therefore most economical, besides has fool-proof charge indicators. Its capacity is simply tremendous.

Its a quality job through and through. No set has reached maximum efficiency without one.

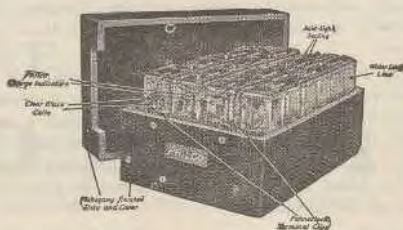

248DXO, 48 volt, 3000 M.A.H. . . . .	26	4	0
248DHO, 48 volt, 6000 M.A.H. . . . .	28	5	0
83X, replaces 90 v. Dry Battery, 3000 M.A.H. . . . .	28	15	0
88H, replaces 90 v. Dry Battery, 6000 M.A.H. . . . .	£10	10	0

**New System Telephones Pty. Ltd.**

280 CASTLEREAGH STREET,  
Also MELBOURNE & ADELAIDE.

So that once the tuning adjustments have all been found it is a very simple matter for any member of the family to receive the station he or she desires by turning the dial until the call sign or distinguishing mark of that station appears in the little window device attached to the dial.

Another very big advantage of these vernier dials is, without a doubt, due to the fact that they prevent a wonderful amount of interference, as they stop the beginner from deliberately or unconsciously twirling the dials backwards and forwards. If every city reader used a slow-moving dial the howling valve menace would undoubtedly be reduced. 'Sa fact.

**SPEEDY MESSAGE.**

Telegraphic records all fade before the feats of radio, which conquers distance and brings furthestmost Australia into close touch. Acting on the request of relations of Mr. A. D. Freeman, a lay delegate to the Methodist General Conference meeting at Brisbane, an urgent message concerning a family bereavement was recently broadcasted by 3LO, Melbourne, asking that Mr. Freeman, who had left Melbourne by the Sydney Express, should return home at once. A private wireless experimenter in a Brisbane suburb picked up the message and immediately telegraphed it to the Government station, which relayed the message, and Mr. Freeman was found. The message had been broadcasted by 3LO at 9.26 p.m. but at 10.15 p.m. the studio was able to announce that its message sent 36 minutes earlier had been delivered. Mr. Freeman was on his way home next day.

(Continued from Page 9.)

So much for points of design. Now let me mention a few of the things which make or mar the performances of the valve set. In the first place you should choose your valves with care. The old idea that any valve will do in any position in the set often leads to very poor results. Though valves are now turned out so well standardised that there is very little difference in their characteristics, there is still, as a rule, some tiny difference between any two of the makes.

You may find when you come to try them out that one, for example, is a better detector than the other. Therefore, you should never fail to try each valve that you have in various positions, and to note where each valve operates best. Don't buy the cheapest grid condenser and leak you can find. Good ones cost very little more and they are well worth the extra money.

**WANTED.**—All kinds Secondhand Wireless Sets, Parts, Speakers, etc. Best prices given. JACK RAPKEN, 16 George Street West. MA 1198.



**They NEVER Vary!**

Not so much the gloriously pure tone or their astonishing range nor the valve-power volume, but it is by their day-in and day-out consistently—the absolute certainty of getting perfect and uninterrupted programmes—that these super crystals have made a new pleasure in Radio. They NEVER vary!

Beware of imitations. Look for the label



**GENUINE**  
**Russell's**  
**Hertzite**  
**PURPLE LABEL**

Price 1/6 per box.

Obtainable from all Wireless Dealers, or from: The L. G. Russell Laboratories, 1-7 Hill Street, BIRMINGHAM.

AGENTS:—Messrs. MOREY'S PROPRIETARY LTD., 99 QUEEN STREET, MELBOURNE.

86 W.W.1

**AN INDISPENSABLE COMPANION OF EVERY WIRELESS ENTHUSIAST**

**THE WORLD STANDARD TIME INDICATOR**

Will tell you at a glance when to listen in to America, England, and any other part of the world.

No Calculation. No confusion of Date or Night Periods. All clearly shown at one setting.

PRICE . . . . 1/- Each  
BY MAIL . . . . 1/3.

**R. H. YOUNG, Newsagent**  
Wholesale and Retail Distributor,  
20 Royal Arcade, SYDNEY.

All Wireless Shops and Newsagents.

# BAKELITE PANELS

Cut to any desired size

3/16in. . . . .  $\frac{3}{4}$ d. PER SQUARE INCH.

This Price is the Lowest in Sydney

## Manhattan Junior Adjustable Loud Speaker

Not merely a headphone attached to a horn, but a specially designed Speaker with large diaphragm. Height, 21 $\frac{1}{2}$  inches with 10 inch Bell, black crystalline finish . . . . . **37/6**  
(Postage anywhere in Australia, 2/-).

**5 VALVE NEUTRODYNE KITS**, panel drilled, complete with everything ready to build, 250 to 2000 meters **£11**

**NEUTRON CRYSTAL.** The World's Greatest Crystal. "The Crystal with Valve Power." New stocks just to hand . . . **2/3**

**ALL MAKES OF VALVES STOCKED.**

All valves are tested in our Jewell Tube Checker and carefully packed for dispatch.

All Wireless Sets can be purchased for Cash or Terms.

# Mick Simmons Ltd.

"The World's Greatest Sports Store"

Headquarters: HAYMARKET, SYDNEY

Before you  
Expend  
Money on  
Radio  
Equipment  
Consult  
Anthony  
Hordern's  
Wireless  
Experts.

Your inspection of the big display of everything that is new in the world of Wireless, is invited.

(Wireless -- Second Floor)

Anthony Hordern & Sons Limited,

Brickfield Hill, Sydney

Phone City 94

Box 2712 G.P.O.

## POPULAR SONG HEADS LIST.

The most noteworthy feature of the 10,000 entries received was the unanimity with which competitors included an Australian composition for various items. "After the Dawn," composed by Mr. Jack O'Hagan, of Melbourne, was included in 2240 of the programmes, the nearest popular rival being "The Blue Danube Waltz," by Straus, which was mentioned by 1902 competitors. Other popular items were well up in the list, a fact which seems to indicate that the youthful listener-in had not been very much interested in the recent wireless plebiscites which placed classical items in an unassailable position, and gave popular numbers a place down low in the scale of approval. The figures of song popularity demonstrated most of all that 3LO, Melbourne, has two distinct classes to please, and each is not too fond of the items fancied by the other.

Naturally, Mr. O'Hagan was delighted that his composition "After the Dawn" should head the poll of popularity, and he states that the result will be welcomed by all writers of popular numbers, as the public is beginning to realise that because a number has rhythm and a haunting melody it should be regarded as having no status in the music world. "Even the most prominent musicians and orchestral conductors of to-day have realised the musical worth of popular numbers, and are including such works in their repertoire," said Mr. O'Hagan.

## THE ONE VALVE REFLEX.

"WIRELESS WEEKLY," MAY 28th, 1926.

Quite a number of readers are meeting with great success with this receiver. W. Waldron, 680 Willoughby Road, Willoughby, writes: "I connected up the set about half past six, and before seven had 2FC, 2BL, 2KY, 4QG, and 3LO on a small speaker."

W. H. Rewley, 1 Skipton Street, Ballarat, receives 3LO, 3AR, 5CL, 4QG, and 2BL on the speaker, according to a letter from him last week.

## UNCERTAIN REPORTS OF RECEPTION OF KTAB.

An operator of one of Brisbane's most popular amateur stations has been in touch with the Manager of KTAB recently, on the low waves, and was requested by the latter to send all reports of the reception of the transmission of this station sent out on the 21st May. The local operator states that he has received many reports of probable reception of the station, but the call sign was not on any of these occasions distinctly heard, so there is really nothing definite to go by.

## POPULAR? YES!

The outstanding popularity of Uncles George and Jack, of 2BL, has been demonstrated in a remarkable way in connection with their Saturday morning entertainments at Anthony Hordern & Sons Limited, Sydney. By courtesy of this firm, the Picture Gallery has been placed at their disposal to meet and entertain the large family of radio nephews and nieces, the size of which was out of all proportion to the accommodation at the Studio. For many weeks they have been regularly meeting and entertaining this vast body of little ones, the audience ranging from 500 to over 2,000. A regular programme is presented, including songs by members of the radio family who regularly assist the Uncles by broadcasting and by periodical appearances of Bringa, the authority on the Australian Aborigines. Every Saturday morning the children are entertained and the audience of adults has also been steadily increasing.

## A VAUDEVILLE SKETCH.

In one of the successful "perfect programmes" in the 3LO "Sun" competition, the comic songs have been assigned to Mr. Bert Hopping, an entertainer who appeared two or three months ago with success. His capabilities in this direction are only to be expected considering that he has been in the atmosphere of the theatre most of his life. As a member of the staff of the Tivoli Theatre, Mr. Hopping has seen the methods of the world's finest artists and benefited accordingly. As a lightning sketch artist he is quite up to a professional standard, his services being much in demand for concert work. Mr. Hopping may soon present a vaudeville act, incorporating songs, stories, elocution and sketching.

## TELLING AMERICA—CALIFORNIAN AMATEURS AND 3LO.

It is safe to say that in California listeners-in are just as familiar with 3LO Melbourne as they are with their own stations. The Melbourne studio has been occupying considerable space in the Californian press through the competitive efforts of two or three amateurs who listen-in every morning to pick up 3LO's programmes. Each one rushes to the newspapers with tidings of his successes, and the American press is ever ready to devote space to the accomplishment of experimenters.

Donald Wright, of Terminal Island, California, who was one of the first Californian amateurs to pick up 3LO, writes: "Hallo, folks. I have had a fine write-up in the 'Los Angeles Examiner,' so I sent the card you sent me to the 'Radio Digest' of Chicago. Mr. Jack Moskovita, of San Pedro, also got newspaper stories."

# Lowest Prices in RADIO History!

Harringtons Ltd. are:—

MANUFACTURERS AND SUPPLIERS OF

"IMPERIA" RADIO SETS.  
"IMPERIA" HEADPHONES.

"POPULAR" RADIO SETS.  
"IMPERIA" RADIO PRODUCTS.

SOLE AUSTRALASIAN AGENTS FOR

GILFILLAN NEUTRODYNES.  
GILFILLAN RADIO PRODUCTS.  
HERCULES RADIO PRODUCTS.  
CLEARTRON VALVES.  
KWIKLITE TORCHES AND BATTERIES.  
HOYT POCKET AND PANEL METERS, Etc.

MARS AERIAL.  
MAR-CO RADIO PRODUCTS.  
THOROLA RADIO PRODUCTS.  
THOROLA SPEAKERS.  
HARLIE DETECTORS.  
"INSULINE" PANELS, Etc.  
TIMMONS PRODUCTS.

DISTRIBUTORS OF

AMPLION SPEAKERS.  
EXIDE ACCUMULATORS.  
BURGESS BATTERIES.  
ACCUMULATORS.  
BATTERY CHARGERS.  
EVER-READY BATTERIES.  
JEWELL METERS.  
RADIOKES COILS, Etc.  
RED SEAL BATTERIES.  
DAVEN RADIO PRODUCTS.  
RADIOTRON VALVES.

PRECISE RADIO PRODUCTS.  
COLUMBIA BATTERIES.  
BRADLEY RADIO PRODUCTS.  
PHILIPS VALVES.  
A.W.A. VALVES.  
MULLARD VALVES.  
PHILCO BATTERIES.  
CELERON, BAKELITE, Etc.  
ALL-AMERICAN RADIO PRODUCTS.  
DURHAM RADIO PRODUCTS.  
ETC.

RADIO DEALERS will find it to their advantage to link up with the "HARRINGTONS" ORGANISATION and see us re the printing of their catalogues, leaflets and circulars at greatly reduced rates. Remember you are dealing with a House of 37 years' trading reputation.

COUNTRY CLIENTS. Our excellent MAIL ORDER SERVICE is yours to command.

CUT THIS OUT AND POST TO-DAY.

Please send me Post Free—New Illustrated Radio Catalogue.

Name .....

Address .....

# Harringtons LTD

Wholesalers and Retailers  
Photo. and Radio Warehouses

Sydney . . . . 366 George Street  
Katumba . . . . Katumba Street  
Melbourne . . . . 266 Collins Street  
Brisbane . . . . 98 Queen Street  
Adelaide . . . . 19 Rundle Street  
Wellington, N.Z. . . 42 Willis St.  
Auckland, N.Z. . . 140 Queen St.

# ON THE AIR

## SUNDAY PROGRAMME.

On Sunday, 27th June, Station 2BL will broadcast in the morning the Chalmers Presbyterian Church Service, the sermon on this occasion being preached by the Rev. D. F. Brandt. At 3.30 in the afternoon, Mr. W. "Cairo" Bradley will continue to conduct his Bible Class, which is very greatly appreciated by the listeners-in. Associated with Mr. Bradley are Mr. Will White and Mr. Arthur Smith as soloists. At 4 p.m. an Organ Recital from the Petersham Baptist Church and at 7 p.m. the Anglican Service from St. Jude's Church, Randwick. At 8.30, the Manly Municipal Military Band, under the direction of Mr. J. Pheloung will be broadcast from the Bialto Theatre, and Broadcasters Instrumental Trio will provide a programme from the Studio.

## NEWTOWN BAND.

On Monday, June 28th, Station 2BL announce a programme of exceptional merit. During the Afternoon Session, David Jones' Instrumental Trio will be broadcast together with a talk on "Philosophic Thought" by Mr. J. M. Prentice. In the evening

the Newtown Band will be heard in a specially selected programme; Miss Anna Burke will sing a series of Irish Songs and Mr. Ward L. Havard will lecture on Australia's Scenic Treasures: Caves and Caverns. The Ambassadors Dance Orchestra directed by Mr. Al. Hammett will provide music at 9 p.m., and during intervals in the dance programme, social notes and a description of the frocks being worn will be broadcast by Mrs. Potts. Mr. C. F. Laseron will continue his talks on "Old English Pottery and Porcelain," and from 10.30 until midnight, the dance programme of the Ambassadors will be put on the air. Mr. Hammett's excellent Dance Orchestra is keenly appreciated by the listeners-in and provides an excellent medium for dancing at home.

## HOYT'S ORCHESTRA.

2BL's programme for Tuesday, June 29th, includes during the afternoon session, Hillier's Instrumental Quartette in selected numbers, and Miss Ruby Michael, soprano, in solos from the Studio. During the Evening Session, Hoyt's Imperial Orchestra, under the direction of Mr. Lionel Hart, will be



Haymarket Theatre Orchestra, under the baton of Mr. Stanley Porter, which is one of the regular features from 2FC.

# Jazz and Jollity

brought to  
your home  
via wireless



**PHILIPS**  
**B406**

Only perfect reception will give you the uninterrupted dance and Philips valves will give you perfect reception. The B406 is the new wonder valve, designed for use with a 4-volt accumulator, and controlled by a rheostat of at least 12 ohms resistance.

The unique purity of tone and wonderful volume given with this valve combined with its low filament consumption of one-tenth amp. make this valve perhaps the most economical, considering its accomplishments, on the market.

The main characteristics are as follows :

Filament voltage, 3.4-4.0 volts.

Filament current, 0.1 amp.

Saturation current, 30 m.a.

Plate voltage, 20-120 volts.

13/6 each.

Let your next valve  
be a PHILIPS



# PHILIPS



broadcast from Hoyt's Theatre de Luxe. An eye talk by the President of the Institute of Optometrists on "Moving Pictures and Vision," a matter of great importance at the present time. Mr. Norman Janson, a favourite baritone will sing and Mr. Crosby Browne will present clarinet solos; Miss Pauline Harford-Foster singing soprano songs will also be heard, and Mr. A. G. Huie will deliver a talk on "Henry George, the founder of Single Tax."

#### OPERATIC SESSION.

During Station 2BL's Wednesday afternoon programme there will be a special Operatic Session illustrated by gramophone records and music from



Mr. Robert Harper, Sydney's brilliant tenor, as Count Almaviva in Rossini's famous opera, "The Barber of Seville." Mr. Harper is a regular singer from the Studio of 2BL.

the Studio. In the evening the Sydney Orpheus Society will present a varied programme of choral numbers sung by a male choir of 40 voices. The City of Sydney Band will also be heard in a series of brackets and Mr. Frank Marshall, B.Sc., will deliver the second of his talks on Cancer, dealing with types of the disease and their characteristics. Mr. J. M. Prentice will also talk on Foreign Affairs, replying to any written questions. The Paragon Dance Orchestra under the direction of Mr. Bennett, will provide a dance programme. Also selections by Hillier's Instrumental Quartette.

#### WAR SERVICE HOMES.

Thursday Afternoon Session from the Studio of 2BL will include the David Jones' Trio, music from the Studio and Serial Story. At 7.30 Mr. J. C. Morrell, the Deputy Commissioner of the War Service Homes Commission will talk on War Service



## Ever Cracked Walnuts?

The shell looked all right; big, brown, inviting. In fact, you picked it out on size. It *looked* good. But when you cracked it—nothing.

There are batteries like that. To look at 'em, you'd think they housed a power station. But give them a clock-and-ammeter discharge test. That is—crack them . . . nothing.

Get a P. & R., though, and you get *capacity*, you get *service*; plates sturdied to work and keep working; terminals petroleum-jelly packed to stop creep; a "Dagenite" cell case which is leak and acid-proof; wood interplate separators tested and re-tested; a battery with a guarantee; which costs no more than the ordinary kind: the battery which is standard to Rolls Royce cars.

Ask your dealer about

# P AND R

PETO & RADFORD

## ACCUMULATORS

*The beginning and the end in*

### POWER

Direct Factory Representative  
John Arnold, Degraives Buildings,  
Degraives Street, Melbourne.

# We Serve You Right

We stock Radio Parts and Accessories of most reliable construction, and more, we sell them for less. See these and decide for yourself.

	£ s. d.		£ s. d.
Sets of eight engraved terminals on cards . . . . .	1 9	Valve Sockets: Basemounting English, each . . . . .	1 3
Engraved terminals sold separately, each . . . . .	4	Valve Sockets: American, 2/7 and Valve Sockets, 201A, H & H Porcelain . . . . .	4 0
Plain Bakelite top Binding Posts, each . . . . .	3	Valve Sockets for 199 valves, Porcelain 3/3; Metal Shell . . . . .	1 6
Nickel plated non-removable top Binding posts, each . . . . .	2 1	Rheostats: High grade, 6 or 30 ohms	2 1
Nickel plated phone terminals, double, 5d.; single, . . . . .	2	Potentiometers, 400 ohms, Ajax . . . . .	3 0
Contact Studs or Contact Stops, per dozen . . . . .	4	Columbia inside mounting 3-coil holders . . . . .	11 6
Terminal Boards, complete with 7 posts, each . . . . .	2 6	Jacks: High grade fantail connection, Single circuit . . . . .	1 9
Rubber Ear Cushions for headphone comfort, pair . . . . .	2 7	Jacks: High grade fantail connection, Double circuit . . . . .	2 4
Spring Aerials for indoor use, each	5 9	Phone Plugs: Automatic or Double	1 9
Adaptors to adapt your headphones to gramophone, each . . . . .	4 3	Phone Cords: For American phones, Double, 5ft. . . . .	2 3
Earthing switches, Porcelain SPDT, each . . . . .	1 11	Speaker Cords: 20ft. extension, 5/9; 5ft. . . . .	1 9
Emmeo Vernier Dials, no backlash, each . . . . .	9 6	Wood Rotors: 3 1/2 in. 9d.; 3 in. . . . .	7
Dials, black or mahogany, 4 in., each	2 4	Radio Frequency Kit, including 3 Low Loss Condensers and 3 R.F. tuned transformers, complete in box with drawings and instructions for building an extremely efficient 5 valve Set for distance work . . . . .	2 12 6
Dials, black 2 in., 1/-; 3 in. . . . .	1 5	World Standard Time Indicator Cards . . . . .	1 0
Dials, Beautiful genuine bakelite, 4 in., each . . . . .	3 9	Buswire: Square in straight 2ft. lengths, dozen . . . . .	10
Vernier Adjusters for condensers, each . . . . .	1 2	Buswire: Round, in straight 2ft. lengths, dozen . . . . .	11
Low Loss Condensers, "The Aircraft" all brass, .0005, each . . . . .	12 6	Resin Solder: Bilden, per length, 18 in. . . . .	3
Crescent Audio Transformers, guaranteed. Ratios 6 to 1 or 3 1/2 to 1, each . . . . .	13 6	Kester Solder: High grade, per tin	2 0
Pival Audio Transformers, 5 to 1 or 3 1/2 to 1, each . . . . .	12 6		

"Yours for Lower Prices."

## The ECONOMIC RADIO STORES

28 Royal Arcade

(3 doors from Pitt Street, left side)

SYDNEY

Phone M 3049

569 Hunter St. West

NEWCASTLE

Phone, Newcastle 1622

Homes. The Ambassadors Salon Quartette under the direction of Mr. Claude McGlynn; Mr. W. E. Lewis, baritone, and Miss Dorrie Ward, mezzo soprano, in duets and solo numbers; Miss Dulcie Blair, violinist; Mr. Reg. Harrison, comedian; Mr. Lance Jeffree, tenor; Mr. Bryce Carter, cello solos, together with Dr. Donald Luker, speaking on "China," make up a remarkably entertaining programme. The Ambassadors Dance Orchestra will be heard until midnight.

#### MODERN ENGLISH POETRY.

On Friday, July 2nd, 2BL will broadcast their usual Afternoon Session which includes a talk on Modern English Poetry, by Mr. J. M. Prentice, and



Mr. W. E. Fuller, whose "Literary Lapses and Library Lists" are a feature of 7ZL programmes. Mr. Fuller gives his reviews on Tuesday evenings at 8.10. Since broadcasting from 7ZL, Mr. Fuller has received an offer of an engagement to give reviews from a well-known mainland station.

music from the Studio, together with Hillier's Instrumental Quartette. A Sporting Talk will be delivered by the Senior Sporting Expert of "The Sun," and the Travelogue will continue to describe the Spell of Egypt. Mr. Clem Williams, baritone, and Broadcasters Instrumental Brass Quartette.

#### SPORTING RESULTS.

On Saturday, July 3, Station 2BL will broadcast its usual Sporting Session in the afternoon, when various football games will be described and racing information supplied from the office of "The Sun" Newspaper. A Forestry Talk will be delivered by Mr. D. G. Stead on, "Tree Planting and the Science of Forestry," and a Scottish Concert from Rockdale will also be broadcast.

## H. & H. Grid Leak Resistance

Fixed resistance or grid leaks are steadily increasing in popularity. H. & H. resistances are composed of a permanent impregnated material which is not affected by change in temperature or atmospheric conditions. Made in 50,000, 70,000, 100,000 ohms, 1/4, 1/2, 1, 2, 3 and 5 megohms.

### Variable Grid Leak Resistances

The W-261 is variable from 100,000 ohms (0.1 megohm) to 5 megohms. Use with UV-200, C-300, DV-6, or any soft detector tube. In fact, use where a grid leak up to 5 megohms only is required.

The W-262 is variable from 2 to 10 megohms, and works wonderfully well with WD-11, WD-12, UV-201-A, UV-199, C-301-A and C-239.

### Grid Leak Resistance Mounting



Fig. W-263 shows the handy leak holder. It's small, yet affords good, stiff contacts, and permits instant interchangeability of leaks.

The cleverest, handiest "leak" holder made; adjustable in an inconceivable number of ways; particularly useful in resistance coupled amplification hook-ups.

Dielectric insulation material is moisture proof. Metal portions are spring brass, nickel-plated.

H. & H. RADIO GOODS ARE OBTAINABLE AT ALL LEADING STORES, AND INCLUDE:—

Sockets (see No-Loss Porcelain Socket)  
Rheostats  
Variable Condensers (Low Loss Type)  
Mica Condensers  
Transformers (Audio)  
Push-Pull Transformers  
Jacks and Plugs  
Potentiometers  
Dials and Knobs  
Battery Switches  
Lever Switches  
Etc., Etc.

Send for complete catalogue to the  
Australian Representatives:

## BOSWELL & CO.

51 YORK STREET, SYDNEY, and  
403 BOURKE STREET, MELBOURNE.

# C.A.V. ACCUMULATORS

C.A.V. Accumulators are British manufacture. Strong and Durable and will give efficient service for a number of years; each cell is fitted in Ebonite container, and are absolutely acid proof.

2c. 18 ampere Hour	.. 22/-
4c. 20 ampere Hour	.. 28/6
4c. 30 ampere Hour	.. 35/-
4c. 44 ampere Hour	.. 47/6
4c. 60 ampere Hour	.. 60/-
4c. 80 ampere Hour	.. 80/-

Charged ready for immediate use.



EBONITE CONSTRUCTION.  
EL. RANGE, 2, 4, and 6-VOLT

ACCUMULATORS CHARGED AND REPAIRED BY EXPERTS.

OUR GUARANTEE. We guarantee every article you buy from us to be satisfactory in every detail. If, for any reason whatever, you are dissatisfied with any article purchased from us, return same with all transportation charges you have paid; we will then exchange for exactly what you want, or will refund your money.

## WILES' WONDERFUL WIRELESS and ELECTRICAL STORE

(W. Harry Wiles)

Branch: 294 Pitt Street, (near Goulburn Street).

Head Office and Shop: Col. Pitt and Goulburn Streets, SYDNEY.

Branch: 23 Pitt Street, (near Circular Quay).

# Michrometer Tuning

WITH THE

## Emmco Velvet Vernier Dial

Besides converting your Variable condenser to a Vernier movement, it provides the necessary Vernier Control so essential for long distance tuning. It is easily fitted in any type of condenser using 180° dial. It vastly improves the appearance of your set.

PRICE.  
All Bakelite 9/6  
Dull Metal Finish 6/9



PRICE.  
All Bakelite 9/6  
Dull Metal Finish 6/9

Eliminates use of geared type of condensers; runs true parallel to panel. Absolutely no back-lash.

QUIET — NO FRICTION NOISES

OUR MAIL ORDER DEPARTMENT, 60 Goulburn Street, is under supervision of a Mail Order Expert which ensures prompt despatch, careful attention to packing, and all details necessary for an efficient Mail Order Service. We despatch within 24 hours. May we have your order? Open Friday Nights until 9 p.m. Complete Parts for all circuits. Advice Gratis. Your own set rewired by experts. Satisfaction guaranteed. Established over 20 years.

**Manufacturing Products Sales Co. (M.P.)**

(H. J. HAPGOOD).

CHALLIS HOUSE, MARTIN PLACE,  
SYDNEY.

Tel.: BW 6753.

Agents for all Styles of Radio Products.

Agents for Clyde Batteries.

Elec. Meter Mfg. Co., "Emmco."

Benrade Condensers, Leaks and Fixed  
Rheos.Airzone Rheos, Pots, Special Coils and  
Loops.Radiokes, Honeycomb, Circloid and Special  
Coils.Neutron Crystals, Prompt Shipments from  
Sydney.In New South Wales for Louis Coen Pty.,  
Ltd., Melbourne.The most complete line of Radio Products in  
Australia.

Write for Special Catalogues.

Write for Indent List.

We Represent 34 Foreign Radio Manufac-  
turers.**WANTED**

Quite a number of youths and men who possess some knowledge of how to construct a Radio Set.

We are in need of over a dozen men from 17 years and upwards to learn how to manufacture our "Popular" and "Imperia" Radio Sets.

There surely must be a number of readers of "Wireless Weekly" who, having experimented with the many circuits and ideas, are capable of wiring up according to instruction, direction, or drawing, and soldering the joints correctly on Radio receivers.

The Radio Broadcasting industry is here to stay, and any person could well make it their profession. There is always a demand for good men to manufacture or install or sell Radio equipment and our activities embrace all those processes.

The public demand for our Broadcast receivers is so great, that we have had to enlarge our factory and take on more staff.

Only those willing to learn and adapt themselves to our requirements need apply. There are no vacancies for any person simply wishing to experiment.

Good Prospects for Good Men

Apply personally or by letter and supply copies of references.

RADIO MANAGER,

**Harringtons** LTD

386 George St., Sydney.

**WIRELESS  
BARGAINS**

Never have there been such drastic reductions in Radio goods before. Consider these values immediately. Also note that we are offering a Standard £55 five Valve set for £35 less the discount.

*Radio Department 22 York Street*Peto and Radford Accumulator, P.D., 11R.,  
60 amp., actual extra heavy service battery.

Usually .. .. . £7/2/6

Sale Price .. .. . £5/7/1

"Walnut" Variable condenser, "K and C," also

"Master" 43 plate. Usually .. .. 21/-

Sale Price .. .. . 15/-

Detector Units. Usually, 32/6. Sale, 7/6

Extension Handles. Usually .. .. 1/6

Sale Price .. .. . 6d.

Jacks, Frost. Usually, 5/6. Sale Price, 2/3

Slider Bars. Usually, 2/3. Sale Price, 1/-

S.P.D.T. Switches. Usually .. .. 2/6

Sale Price .. .. . 1/-

D.P.D.T. Switches. Usually .. .. 4/-

Sale Price .. .. . 1/6

Ivory Scales. Usually .. .. 8d.

Sale Price .. .. . 1d.

'Phones (French). Usually .. .. 13/-

Sale Price .. .. . 10/6

*All Less 2/- in the £ for Cash.***DAVID JONES'  
SALE**

**WENTWORTH CAFE.**

On Friday, 25th, the Sydney Instrumental Trio will join with Mr. Livingstone Mote in presenting a vocal and choral and instrumental programme of Scandinavian music from 2FC. A one-act play by Mr. Walter Hunt and Eve Warhurst, and Mr. Lawrence Halbert, baritone, from the Studio. Dance music from the Wentworth Cafe; and from Farmer's Oak Hall, Sir Hugh Denison's farewell speech prior to his departure from Australia.



"Aunt Stella," a real "find." An authoress in the "cat world," whose cat talks from 7ZL are eagerly looked forward to on Tuesday and Thursday evenings. The stories are true to life, and are worked round "George." "The Adventures of George, the Bookshelf Cat." Many visitors from the mainland call in at the Bookshelf Shop, Collins Street, Hobart, especially to see "George." "Aunt Stella" is the Bookshelf Librarian. Would you like a copy of one or two of her stories? "Aunt Stella" has quite a family of cats:—Boadicea, the mother, silver grey, half Persian; Ginger Joe, the father; George, the son and hero, black and white; The Prince of Wales, white and black, mostly white—an adoption. George is called a "Katten." He is too big to be called a kitten, and too small to be called a cat!

**THE CONSERVATORIUM.**

The whole of the evening's programme on Saturday, 26th, will be taken from the Chappell concert at the Conservatorium by 2FC. The 2FC Dance Band will also be heard in the Studio.

**PRINCE EDWARD ORGAN.**

The morning service on Sunday, 27th, from St. Mark's, Darling Point. The afternoon session will be taken from the Sydney Town Hall from the Metropolitan Band concert. In the evening arrangements have been made whereby Mr. Leslie



The  
**Greatest**  
 Success

Start Your Subscription Now

10/- PER ANNUM

**Radio Press Limited**

Bush House — Strand, London

Gives you more programmes



## The REAL Long Distance Valve

**D**ESIGNED specially for powerful long-distance radio reception. Gives you the means to pick up those weak and elusive signals and amplify them to reality.

Secure the valves that are associated with all the great trans-world records.

**MULLARD Double Red Ring VALVES**

Type D.3 for 2 volt accumulator  
EACH 13/6

Type D.06 for 2 or 3 dry cells or  
4-volt Accumulator EACH 13/6

**GET ONE FROM YOUR RADIO DEALER**

# Mullard

## THE · MASTER · VALVE

(ARKS. B1)

MULLARD VALVES CAN BE OBTAINED FROM ALL RADIO AND ELECTRICAL DEALERS.

Advertisement of the Mullard Wireless Service Co. Ltd., Ballham, London, S.W. 12, ENGLAND.

## BROADCASTING NOTES

### MONOTONY BROKEN.

It is rumoured that 7ZL is to have the monotony of the gramophone records which have hitherto been broadcast in the afternoons broken by items played by their own pianist (says Hobart "Mercury"). An accompanist is to be appointed shortly, it is understood, for these afternoon programmes, and also to assist with the musical items to be broadcast at night. It is intended also to allow listeners to ask for request items in the afternoon programmes.

It is noted that considerable interest is being taken in the use of the Big Brother instead of the traditional uncle at 7ZL in the mainland wireless papers.

A letter was received recently from Humbolt, California, stating that the bedtime stories had been received there on a four tube Browning Drake set. The reception has been confirmed by the station's log. It seems that 7ZL is not having any trouble in getting DX reports. Many letters are being received from the mainland congratulating the station on the transmission.

### TRAVELLING RADIO ENGINEER.

The Associated Radio Company of Australia Ltd. have equipped an expert (Mr. T. King), who will travel throughout Victoria in a specially constructed car. He will be furnished with an up-to-date equipment, comprising every tool necessary to radio engineering. The idea is that he will be in a position to deal with any possible emergency which can occur to sets installed in the country stations.



*Signorina Toti Dal Monte, who thrilled thousands in her broadcast from the Town Hall, through 2FC, on Saturday night, June 19.*

V. Harvey, by arrangements with the Directors of the Prince Edward Theatre, will give a programme from 6 till 7 o'clock on the orchestral grand organ. In the evening a service from the Petersham Congregational Church, and at 8.30 a band concert from the Strand Theatre, Leichhardt, by the Leichhardt District Band. Cricket scores will be given every morning at 8 o'clock, with the exception of Monday, 21st, and on Saturday, 27th, the scores of the Second Test Match will be transmitted at 7 a.m. and repeated hourly until 11 o'clock.

Through the courtesy of the Directors of the Prince Edward Theatre, and special arrangements with Mr. Leslie V. Harvey, listeners to 2FC will hear an organ recital on the Prince Edward Theatre orchestral organ on Sunday night, June 27, from 6 to 7. Mr. Harvey is selecting a special programme for the occasion.

### A NOVELTY FOR BRIDGE PLAYERS.

Auction Bridge has a remarkable hold on the community, and listeners to 2FC will be interested to know that arrangements are being completed to present novel bridge broadcasts weekly from the Studio. Four chosen players will play a rubber of bridge. Their play will be called in detail, and at the close of the game listeners can immediately ring Farmer's Studio and ask for information concerning the hands just played. Details of the hands to be played will be available some days before the actual game takes place. Queries by listeners on the telephone and the replies by players at the Studio will be heard "on the air" simultaneously.



*Miss Florence Grant, soprano, who is often heard from 2FC.*





Why not have "Wireless Weekly" mailed direct to your home regularly every week?

The subscription rate is 13/- the year post free.

Mail your subscription TO-DAY to The Editor, "Wireless Weekly," 71/75 Regent St., Sydney.



# HOWELL'S SALE & EXCHANGE

Large Variety Loud Speakers from 35/- to £8.  
Hear them on music.

	£	s.	d.		£	s.	d.
3 Plate Condenser . . . . .	3	0		Polymet Phone Plugs . . . . .	2	3	
Spitfire Loud Speaker . . . . .	1	17	6	Automatic Phone Plugs . . . . .	1	6	
"Jefferson" 41 Transformers . . . . .	1	9	0	4 inch Dials, 2/3; 3 inch Dials	1	3	
"Ediswan" Transformers . . . . .	15	0		2 inch Dials . . . . .	1	0	
12 Point Inductance Switches . . . . .	2	6		201A Socket . . . . .	1	6	
Single Jack, 1/9; Double . . . . .	2	0		Bakelite 198 Sockets . . . . .	2	6	
Standard 201A Sockets . . . . .	1	6		.0095 Condensers . . . . .	8	0	
.0005 Straight Line Frequency				7 Marked Mounted Terminals	3	0	
Low Loss Condensers . . . . .	13	6		Bakelite Rhco., 30 ohm. . . . .	3	0	
.00025 Straight Line Frequency				Spaghetti . . . . .	6		
Low Loss Condensers . . . . .	11	6		Hydrometers . . . . .	3	0	
Ediswan Valves . . . . .	3	0		Lightning Arresters . . . . .	2	6	

Cash with order. Over 10/-, post free (Batteries excepted)

HAVE YOU TRIED THE HOWELL REINARTZ? Blue Prints, Full Size Back Panel, 1, 2, or 3 valve, 2/- each, Post Free.

There's Nothing Better — Let us Rewire your Set WE GUARANTEE RESULTS.

**19 BARLOW STREET, SYDNEY**  
Open till 9.30 Friday Night

Phone MA 1133

## No More Distorted Music!

Even the poorest Receiver with its harsh reproduction can be converted into a mellow-toned musical instrument with the new

# MACLURCAN

TONE PURIFIER AND STATIC REDUCER

(Patent app. 26131)

NOW READY FOR SALE

PRICE, 21/-

WITH A MONEY BACK GUARANTEE

AN EMMCO PRODUCT



Particulars from—

**CHAS. D. MACLURCAN**, Pratten Building, Jamieson St., Sydney

Manufactured by Electricity Meter Manufacturing Co. Ltd, Sydney



MR. H. C. SLOCOMBE.

Mr. H. C. Slocombe, who will broadcast talks on photography for 3LO Melbourne, commencing June 23, needs little introduction.

Mr. Slocombe, an Englishman, is manager of the Victorian branch of Kodak Pty. Ltd., and was one of the first to broadcast from 3LO. For 35 years he has been associated with photography, both as a hobby and a business, and is thoroughly wrapped up in his work.

Talks broadcasted by Mr. Slocombe will deal with photography as a hobby, in the home, the practical side, and useful hints on printing and developing. Also, he will speak of the future of photography. In a few years he believes it will be a thing of the past and motion picture cameras will be instead.



MR. FRITZ HART.

Mr. Fritz Hart, F.R.C.M., is a Londoner, and first came out to Australia as a musical director for J. C. Williamson Ltd. He was persuaded to join the staff of the Albert Street Conservatorium. Four years later he was appointed director, and has occupied the position ever since.

Mr. Hart is a vice-president of the Melbourne Music Club, and is well known as a composer. Since commencing broadcasting he has become very popular, and has been congratulated by people of all classes.

Future lectures per 3LO Melbourne will deal with such great composers as Schumann, Brahms, Gluck, Stanford, and modern English composers.

Mr. King is qualified to instal new sets at practically a moment's notice. These sets will be adjusted to local conditions, and will be a distinct improvement on the risk which country buyers take in buying sets in town without an adequate knowledge of local and district conditions, thereby saving our country friends much disappointment and expense.

Mr. King will also be able to give expert advice and is sufficiently equipped with tools and knowledge to deal with any breakdown which may occur. In fact, he will act as a travelling radio expert ready for any emergency.

To country and outback listeners, therefore, the monthly visit of the 3AR expert will be a great convenience.

Mr. King will be around about once each month, and in the event of a serious breakdown a telephone call to 3AR Melbourne will locate him and will ensure his immediate attention. Thus it is that 3AR is endeavouring to meet all the demands of listeners-in.

#### THE RUGBY PRESS NEWS FROM 3AR.

One of the most interesting and informative items in any day's broadcast is the transmission from 3AR studio of the Wireless Press News from Rugby, England.

The service which is broadest daily from the Government Station at Rugby is received by the operators at 3AR Station, Essendon, at 6 o'clock each morning (8 p.m. English time), and is the last news broadcast in the day from England and thus conveys the latest news from the Old Country.

The news is received by Morse Code, and after translation at Essendon is sent by telephone to the 3AR Studio, and then broadcast twice daily at 11.30 a.m. and 8 p.m.

This service is, of course, not exclusive to 3AR or to any other station, but the fact remains that the Associated Radio Company of Australia were the pioneers of this service, and it was by their enterprise and the good work by the station operators that such early and reliable news from the other side of the world was placed at the disposal of Victorian listeners.

**BURGESS—"They're on the Leviathan"—BATTERIES**

# RADIO DISTRIBUTORS

## PRICES CUT IN HALVES

201A type Valves . . . . .	8/9	Filco Resistors, 5,000-25,000 ohms . . . . .	10/6
200 ohm Potentiometer, bakelite, complete with dial . . . . .	6/-	Acme Low Loss Condensers	39/6
35 ohm Rheostat, bakelite, complete with dial. . . . .	5/6	Acme Audio Transformers	29/9
Bakelite Shock Absorber Sockets . . . . .	3/3	Acme Radio Frequency ..	29/9
Jacks, Single Circuit . . . . .	2/3	Acme Pot Rheos. . . . .	17/9
Jacks, Double Circuit . . . . .	2/6	Fleron lead-in Insulators ..	5/6
Condensers, low loss .0005	17/10	Fleron Porcelain . . . . .	3/-
Condensers, low loss vernier	23/6	HILCO Fixed Condensers, from . . . . .	2/3
Condensers, plain type ..	9/6	Loose Coupler Crystal Sets	25/-
Filco Arresters . . . . .	6/8	Crystals from . . . . .	6d.
		All Guaranteed	
		Insulators from . . . . .	1d.

The First Shop  
in Royal Arcade  
from Pitt Street  
entrance

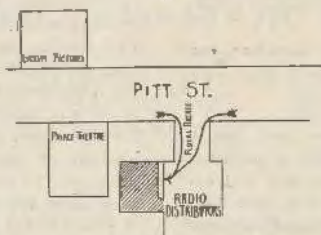

29 Royal Arcade,  
SYDNEY.

All Country Orders  
Postage Free.

The Press News is received on quite an ordinary set, and the reception is always clear and uninterrupted.

Some little idea of the power required to transmit this service is shown by a study of some facts about the super radio station at Rugby. The station covers an area of 900 acres, and is installed on a plateau in Warwickshire which has a height of 340 ft. above sea level. There are on one side as many as eight masts each 20 ft. high, and so placed at distances of 440 yds. apart that they form the corners of a hexagon. On the other side are four similar masts, so placed that at any future time four others may be erected and so form another hexagon if necessary.

This will give listeners some idea of the enormous station which provides them with their daily ration of English and world news, translated and transmitted by 3AR Studio, Melbourne.

#### VERSATILE VICTORIAN RAILWAYS.

Right down from the Chief Commissioner to the members of the general rank and file, the staff of the Victorian Railways Department seem to be a versatile body. Mr. Clapp's various activities confront us almost daily from the columns of the press or the hoardings of his railway stations, but it is through the medium of broadcasting that the talents of his staff are most strikingly revealed. Already 3LO, Melbourne, has broadcasted a Victorian Railways Band, an orchestral society, a musical society and other entertainments produced by railway members.

#### BROADCASTING FOR AMERICANS.

If the American mail received by 3LO, Melbourne, keeps on increasing at its present rate, a special staff will soon have to be set aside to deal with it. Mr. Donald Wright, of Terminal Island, near San Pedro, California, has attracted world-wide attention to 3LO, Melbourne, by his newspaper stories of his splendid reception. "Thousands of radio fans in Los Angeles, and San Francisco are sitting up early in the morning to pick up your station," he says, and if they all write for verification cards a busy time is ahead of the 3LO staff. "From the picture you sent me I see you have a fine radio station," he continues, "and from what I can see, you are further in advance in radio progress than these broadcasters here."

#### A CAT RANCH.

A proposal for a money making scheme was broadcasted from 3LO, Melbourne, by Mr. Keith Desmond during last week. It was quite ingenious and sounded all right, but there was only one response. The elocutionist told the public of a scheme whereby a cat ranch in the Northern Territory could

be made to earn nearly £2000 a week, and be entirely self supporting. The investors merely had to start off with 1000 cats which would in time increase. The skins could be sold from 6d. to 1/3, according to quality. Food supply was easily solved. Adjoining the cat ranch the same proprietors would build a rat ranch. The cats would eat the rats, and the rats would eat the carcases of the skinned cats, and so the whole business would be self supporting. However, only one responded to the wonderful opportunity. The next day, Mr. Desmond received a letter from Hampton in these terms: "Applications for shares in cat ranch." Dear Sir, Referring to your broadcasted prospectus of above, would like to take up 100 shares in it provided that the initial outlay is not too great and that the payments may be extended over a considerable period. We suggest that as the scheme is in its infancy, payment may be made in stock. We have a cat whose five kittens are available for the first instalment. When the next calls are due we feel confident she will again rise to the occasion. As a further addition to the herd we think (from nocturnal sounds) that a drag net in this neighbourhood would produce good results. We heard of many wild cat schemes for developing the Northern Territory but nothing has appealed to us as this one." The applicant gave his name as "I. Skinner."

#### A BOUQUET FROM BRISBANE.

Mr. H. Gee writes: "I have built up the 'Wireless Weekly' Reflex circuit in your issue of May 28, and I am pleased to be able to say that it is the best circuit I have ever yet tried, and I have tried numerous Reflex circuits. It works our local station, 4QG, at full loud speaker strength, and when it closes down I am able to bring in 3LO, 2BL, and 5CL on the phones at exceptionally good strength."

#### FIRE BRIGADE DEMONSTRATION.

On Wednesday afternoon, June 30, at Fire Brigade Headquarters, a very interesting ceremony will take place, at which his Excellency the Governor will present to representatives of the various hospitals the proceeds of the Fire Brigades' Hospital Carnival 1926. The proceedings will be broadcast by 2FC, including items by the Fire Brigade Band, and also a description of the activities of the Fire Brigade, including a display of physical drill and description of the "turnout" which will be arranged for the occasion.

#### LONG DISTANCE ON CRYSTAL.

With a simple crystal receiver tuned by a tapped coil and variable condenser, L. J. Bourne, of Mittagong, N.S.W., receives 2FC, 3LO, 4QG, 5CL, and 2BL. The crystal used is a Hertzite, which has given 18 months' service.

PHILCO—"Ask the man who has one"—BATTERIES

# Supertran "Mica Insulated"

## Audio Transformers

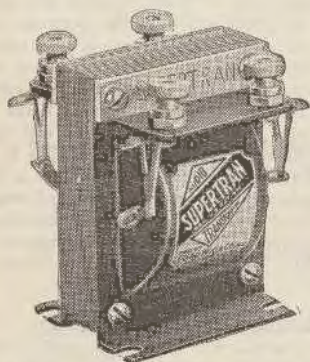

Supertran 25/- each

Ratios  $3\frac{1}{2}$ -1  
5-1



FMC 18/6 each

Ratios  $3\frac{1}{2}$ -1  
5-1

These Transformers  
give Clear Reception  
and stand Higher volt-  
age than any other  
Transformers

*Constructed for Longevity  
and Maximum Performance*

### INTERNATIONAL RADIO CO. LTD.

(Wholesale)

200 Castlereagh St.,  
SYDNEY, N.S.W.

91-93 Courtenay Place  
WELLINGTON, N.Z.

## AMONGST THE TRADERS

### GARAGES AND BATTERIES.

#### UX ADAPTOR, TYPE UR.556.

The Radiotron UX120 valve being fitted with a UX base, which can only be fitted into a standard UX socket, it was found necessary to produce a special adaptor for the purpose of adapting this valve to the standard UV199 socket. The Radio Corporation of America have, therefore, produced the UR.556 Adaptor as illustrated.



By means of this adaptor, the Radiotron UX.120 can be used in conjunction with UV.199 valves in receiver fitted only with UV.199 sockets. Special terminals are arranged to take the extra bias and high tension battery tapings which are necessary with this type of valve.

The Adaptor is a high-grade and compact piece of apparatus and should prove a boon to set owners who have receivers fitted with UV.199 sockets only. Full details of the Radiotron UX.120 were given in the issue of "Wireless Weekly," dated 11/6/26.

Agents: Amalgamated Wireless (A/sia) Ltd.

#### MURDOCH'S SALE.

To have the opportunity of buying in a low market knowing that prices must immediately rise again—is a welcome experience that comes but seldom to most folk.

An opportunity of this kind, looked forward to each year by thousands upon thousands of thrifty shoppers in every state of the Commonwealth, will again take place from 18th June until 10th July, when Murdoch's Red Spot Clearance Sale will be in operation. Huge stocks of men's and boys' wear to the extent of £150,000 must be swept out in three short weeks, and to achieve this, prices have been cut regardless of cost; in fact huge stocks are clearing at half price.

Apart from the immense cash saving such an opportunity presents for buying present needs, thrifty buyers will seize the chance to stock up for months ahead, and thus save practically on the year's shopping. The Red Spot Bargain Catalogue (from which we have noted these reductions) is quite free and will be sent immediately to any of our readers who write to Murdoch's in Park Street, Ltd., Sydney, mentioning this paper.

(To the Editor.)

Sir,—I have noticed your remarks in the last issue of "Wireless Weekly," with regard to the rough treatment which radio batteries receive in the great majority of garages, and as a garage proprietor I must admit that you are quite right.

However, this is mainly due to the fact that most garages are equipped with a plant for charging car batteries only in series, and it is very difficult to adapt this system to charge smaller batteries at the same time as the car batteries are getting their proper charging rate. If this rate is reduced to the amount required by the radio battery the time taken to charge the others becomes too long.

If you instruct your readers to take their batteries to a garage or service station which uses the constant potential method of charging, they need have no fear that their battery, even that of the smallest amperage, will be charged at too high a rate. With this system the generator is kept at a constant potential of about 7½ volts, and a busbar extends from the positive and negative terminals over the charging bench, all batteries being hooked on in parallel.

Now, if a battery showing a voltage of, say, 5½ is put on the line, a fairly heavy current, properly proportioned to the plate area of the battery, will flow, due to the difference of 2 volts. As the battery charges, the voltage of same will rise, which will cause the amperage flowing into the battery to drop proportionally. When the battery is fully charged practically no current will flow, as the voltage of battery and generator will be about the same. This system gives the theoretically perfect taper charge, and does it automatically.

To take care of 4 and 2 volt batteries a variable resistance is used, and is adjusted till the safe maximum for the battery on charge is flowing, the amperage will then drop as the voltage rises.

This system is giving excellent service in the garage here, and is being used in some service stations in Sydney. I know that Messrs. Hipsley Ltd., of Palmer Street, Woolloomooloo, have a fine plant of this type.—Yours truly,

R. J. TURNER (A.2RI).

Verner Street, Goulburn.

June 16, 1926.

#### AN ERROR.

On Page 33 of "Wireless Weekly," June 18, in describing the UX.112 Valve, we published the filament voltage as 6 amps, and the filament terminal voltage as 5 amps. The word amps. should have read "volts."

# FOUR SENSATIONAL OFFERS!

Payment of **£1** will secure immediate delivery in the Metropolitan area of any of our Special Offers.

**£1** DOWN  
and  
**5/-**  
WEEKLY

**WONDERFUL COMBINED OFFER.**

Do you realize that for **£4** down and **£1** a week we will deliver to your home a Super Cabinet Tonophone a Valve Wireless Set, a Pathé Home Cinema and one of Heiron & Smith's Lift-on Billiard Tables?



**OFFER NO. 1**

**SUPERB CABINET TONOPHONE**

Noted for its remarkable reproduction of its faint valves and exclusive Non-Sound features. A gem of workmanship in a handsome highly polished cabinet. **£1** down secures immediate delivery balance 5/- weekly.



**OFFER NO. 2**

**VALVE WIRELESS**

SET on an exclusive unit system. This set is built in a handsome foundation cabinet and has a valve set with headphones and a loud speaker permanently built in. Applicable to all classes of reception. Extra valves can be added to a full strength 7 valve set without reconstruction.

**£1** down secures immediate delivery balance 5/- weekly.



**OFFER NO. 3**

Pathé Home Cinema at £18-18-0 or a Perfect Pathé Cinema Camera at £12-12-0, enabling you to photograph your friends in living pictures that become permanent records. Show these with a programme of Pathé Educational, Dramatic and Comic films in your own home. Thousands of films to select from which can be screened up to 8 ft x 6 ft. **£1** down secures immediate delivery. Balance 5/- weekly.



**OFFER NO. 4**

Heiron & Smith's Lift-on Billiard Table. Complete for the game of Billiards with cues, balls and marking board. **£1** down secures immediate delivery. Balance 5/- weekly.

Call at once with a Pound Note and we will deliver immediately to your Home.

**HOME RECREATIONS LTD.**

**388 GEORGE STREET (Opp. Beard Watson's)**



# Broadcasting

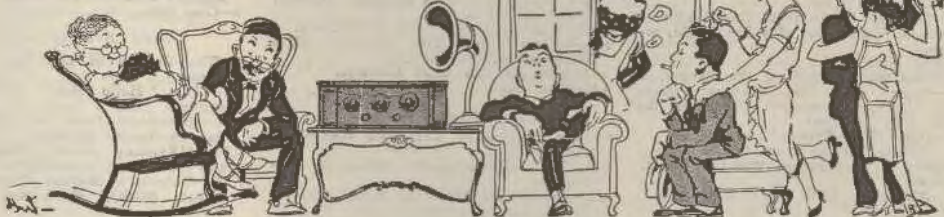

## 2FC

### FARMER'S BROADCASTING SERVICE.

Call Sign: 2FC. Wave Length: 1100 Metres.  
Power: 5 Kilowatts.

#### FRIDAY, JUNE 25.

##### Morning Session.

- 8—Cricket Scores, Australia versus Derby, held at Sheffield. Scores to be repeated at 9 and 10 a.m.  
10—The Chimes of 2FC and Announcements.  
10.10—Weather Information, Commercial News, Shipping Intelligence, Market and News Session.  
11—Cables.  
11.15—Details of cricket scores.  
11.20—Cooking Talk and Recipes by Miss Ruth Fursell.  
11.30—Close down.

##### Midday Session.

- 12.30—The Chimes of 2FC and Announcements.  
12.35—Morning Call Stock Exchange.  
12.40—Musical Items.  
1—Time Signals.  
1.3—“Evening News” News Service, Weather Information, Commercial News, Musical Items.  
1.30—Noon Call Stock Exchange, Musical Items.  
2—Close down.

##### Afternoon Session.

- 3—The Chimes of 2FC and Announcements.  
3.5—Vocal Recital by the Pupils of Mr. Andrew MacCunn.  
3.10—From the Tea Rooms—Miss Eileen Crowley, soprano.  
3.15—Oak Hall Trio.  
3.35—Musical Items from the Studio.  
4—From the Tea Rooms—Miss Gladys Briggs, contralto; “Beloved it is Morn” (Aylward).  
4.5—Oak Hall Trio.  
4.15—Musical Items.  
4.20—From the Tea Rooms—Miss Eileen Crowley, soprano.  
4.35—Music from the Studio.  
4.40—From the Tea Rooms—Miss Gladys Briggs, contralto; “For a Dream’s Sake” (Coven).  
4.44—Afternoon Call Stock Exchange.  
4.45—Close down.

##### Early Evening Session.

- 6—The Chimes of 2FC and Announcements.  
6.5—The “Hello Man” talks to the Children.  
6.45—Broadcast from Farmer’s Oak Dining Hall, Instrumental and Vocal Items.  
7.15—“Evening News” News Service, and Sporting Information.  
7.30—A Racing Talk.  
7.40—A Talk on “Hamlet” by Mr. Walter Hunt.

##### Night Session.

- 7.55—The Chimes of 2FC and Announcements.  
8—From the Studio—Instrumental Trio—Mr. Lionel Lawson, violinist, Mr. Gladstone Bell, cellist, Mr. Lindley Evans, pianist.  
8.15—A Programme of Scandinavian music arranged by Livingstone Mote, consisting of

vocal and instrumental numbers.

- 8.45—Broadcast from Farmer’s Dining Room—A speech by Sir Hugh Denison, at the dinner tendered to him by the English Speaking Union, prior to his departure for America as Commissioner for N.S.W.  
9—Mr. Lindley Evans, piano solos.  
9.10—Mr. Walter Hunt and Miss Eve Warhurst in a One Act Play.  
9.20—Mr. Gladstone Bell, vocal solos.  
9.30—Mr. Laurence Halbert, baritone.  
9.35—Instrumental Trio.  
9.45—Soprano solos.  
9.55—Mr. Walter Hunt, dramatist.  
10.6—Mr. Laurence Halbert, baritone.  
10.14—A Film Talk.  
10.20—Broadcast from the Westworth Hotel, Sydney Westworth Cafe Dance Orchestra, under the baton of Mr. Sydney Simpson.  
11—National Anthem—Close down.

#### SATURDAY, JUNE 26.

##### Morning Session.

- 10—The Chimes of 2FC.  
10.10—Weather Information, Commercial News, Shipping Intelligence, Market and News Session.  
11—Cables.  
11.5—Details of the Cricket Scores.  
11.15—Gardening Talk.  
11.30—Close down.

##### Midday Session.

- 12.55—The Chimes of 2FC and Announcements.  
1—Time Signals.  
1.3—“Evening News” News Service, Weather Information, Commercial News, Musical Items.  
Race results will be given at regular intervals.

##### Afternoon Session.

- 3—The Chimes of 2FC and Announcements.  
3.5—Musical items, interspersed with race results.  
4.30—Complete resume of the afternoon’s sporting events. Musical Items.  
5—Close down.

##### Early Evening Session.

- 6—The Chimes of 2FC and Announcements.  
6.5—The “Hello Man” talks to the Children.  
6.45—Broadcast from the Hotel Australia: Orchestral Items.  
7.15—“Evening News” News Service and Sporting Information. Close down.  
7.30—Dulgey’s Market Reports (wool, wheat, stock), fruit and vegetable markets.

##### Night Session.

- 7.55—The Chimes of 2FC and Announcements.  
8—Broadcast from the Conservatorium Hall. The 5th Popular Chappell Ballad Concert: At the conclusion of the concert, approx. 10.15 p.m., the 2FC Dance Band, conducted

by Mr. Eric Pearce, will play Dance Music in the Studio till 11.15 p.m.  
11.15—National Anthem—Close down.

#### SUNDAY, JUNE 27.

##### Morning Session.

- 7—The Chimes of 2FC and Announcements; Cricket Scores, Second Test Match—England versus Australia—Full scores to the drawing of stumps at the first day’s play. These scores will be repeated at 8, 9, and 10 a.m.  
10.55—The Chimes of 2FC and Announcements.  
11—Broadcast from St. Mark’s Church of England, Darling Point: Morning Service; preacher, Rev. E. Howard Lee.  
12.20—From the Studio: News Session.  
12.30—Close down.

##### Afternoon Session.

- 2.55—The Chimes of 2FC and Announcements.  
3—Broadcast from the Sydney Town Hall: A Band and Vocal Recital arranged by the Metropolitan Band, conducted by Mr. John Palmer.  
3.30—Close down.

##### Evening Session.

- 6—The Chimes of 2FC and Announcements.  
6.5—Broadcast from the Prince Edward Theatre Beautiful (by courtesy of the management), a special Organ Recital by Mr. Leslie V. Harvey, on the Grand Organ.  
7—Broadcast from the Petersham Congregational Church, the evening service, conducted by Rev. A. P. Doran.  
8.50—Broadcast from the Strand Theatre, Leichhardt: Sunday Evening Concert by the Leichhardt District Band, conducted by Mr. E. F. Kerry.  
10—National Anthem. Close down.

#### MONDAY, JUNE 28.

##### Morning Session.

- 10—The Chimes of 2FC and Announcements.  
10.10—Weather Information, Commercial News, Shipping Intelligence, Market and News Session.  
11—Cables.  
11.5—Details of Cricket Scores.  
11.15—Musical Items from the Studio.  
11.30—Close down.

##### Midday Session.

- 12.30—The Chimes of 2FC and Announcements.  
12.35—Morning Call Stock Exchange.  
12.40—Musical Items.  
1—Time Signals.  
1.5—“Evening News” News Service, Weather Information, Commercial News, Musical Items.  
1.30—Noon Call Stock Exchange, Musical Items.  
2—Close Down.

##### Afternoon Session.

- 3—The Chimes of 2FC and Announcements.

PHILCO—“For less worry and better results”—BATTERIES



3.5—Vocal Recitals by the pupils of Mr. James Beach.

3.4—From the Tea Rooms: Miss Alicia Hayward, contralto: "My Dear" (Cadmans).

3.45—Oak Hall Trio.

3.55—Musical Items from the Studio.  
4—From the Tea Rooms: Miss Ilka Knight, soprano.

3.5—Oak Hall Trio.

4.15—Musical Items from the Studio.  
4.20—From the Tea Rooms: Miss Alicia Hayward, contralto: "Song of the Little Folk" (Coates).

4.25—Oak Hall Trio.

4.35—Musical Items from the Studio.  
4.40—From the Tea Rooms, Miss Ilka Knight, soprano.

4.44—Afternoon Call Stock Exchange.

4.45—Close down.

Early Evening Session.

6—The Chimes of 2FC and Announcements.  
6.5—The "Hello Man" talks to the children.

6.45—Broadcast from the Hotel Australia: Orchestral Items.

7.15—"Evening News" News Service and Sporting Information.

7.30—Dalgaty's Market Reports (wool, wheat, stock), Fruit and Vegetable Markets.

7.40—Close down.

Night Session.

7.55—The Chimes of 2FC and Announcements.

8—Broadcast from the Haymarket Theatre, Sydney: Operatic Orchestra, under the baton of Mr. Stanley Porter.

8.25—Broadcast from the Rose Bay Picture Theatre, Items from the Farwell Recital of Mr. Oliver King, basso.

9—Broadcast from the Haymarket Theatre, Sydney: Vocal Act.

9.20—From the Rose Bay Picture Theatre, further items from Mr. Oliver King Concert.

10—Broadcast from the Haymarket Theatre: Orchestral Items.

10.15—From the Studio: The 2FC Dance Band will play Dance Music until 11 p.m.

11—National Anthem. Close down.

TUESDAY, JUNE 29.

Morning Session.

7—The Chimes of 2FC and Announcements; Cricket Scores, Second Test Match—England versus Australia—Full scores to the drawing of stumps at the second day's play. These scores will be repeated at 8, 9, and 10 a.m.

10—The Chimes of 2FC and Announcements.

10.10—Weather Information, Commercial News, Shipping Intelligence, Market and News Session.

11—Cables.

11.5—Details of Cricket Scores.

11.15—Cooking Talk and Recipes by Miss Ruth Furst.

11.30—Close down.

Midday Session.

12.30—The Chimes of 2FC and Announcements.  
12.35—Morning Call Stock Exchange.

12.40—Musical Items.

1—Time Signals.  
1.3—"Evening News" News Service, Weather Information, Commercial News, Musical Items.

1.40—Broadcast from Farmer's Smoke Room, speeches of welcome given by the Musical Association of N.S.W. to the famous pianist, Mr. William Baukhaus.  
2—Close down.

Afternoon Session.

3—The Chimes of 2FC and Announcements.  
3.5—Violin Recital by the pupils of Mr. Herman Willis.  
3.40—From the Tea Rooms: Miss Chris Hawkeford, soprano, "Annie Laurie" (Lichmans).  
3.45—Oak Hall Trio.  
3.55—Musical Items from the Studio.

4—From the Tea Rooms, Miss Naomi Mercer, contralto.

4.5—Oak Hall Trio.

4.15—Musical Items from the Studio.  
4.20—From the Tea Rooms, Miss Chris Hawkeford, soprano, "Love's a Merchant" (Carew).  
4.25—Oak Hall Trio.

4.35—Musical Items from the Studio.  
4.40—From the Tea Rooms: Miss Naomi Mercer, contralto.

4.44—Afternoon Call Stock Exchange.

4.45—Close down.

Early Evening Session.

6—The Chimes of 2FC and Announcements.  
6.5—The "Hello Man" talks to the children.

6.45—Broadcast from the Hotel Australia: Orchestral Items.

7.15—"Evening News" News Service and Sporting Information.

7.30—Dalgaty's Market Reports (wool, wheat, stock), Fruit and Vegetable Markets. Close down.

7.40—Close down.

Night Session.

8—The Chimes of 2FC and Announcements.  
8.5—Broadcast from the Ashfield Town Hall. A Concert organised to obtain funds for the Returned Soldier's League, Ashfield Branch.

9.12—Violin solo: "Tarantelle (Wieniswaki), Miss Doris Woods.  
8.20—Humour: Rae, Cealng and Jerry.  
8.40—Soprano solo: "Laughing Song" (from Mignon), Miss Lurline Hammond.

8.48—Baritone solo: "Elegie" (Messenet), Rod Newman.  
8.56—Recitation: Miss Eileen Hogan.  
9.5—Tenor solo: Aria from "Carmen", R. M. Baxter.

9.14—Humour: Mr. Frank Ryan.  
9.25—Duet: "As I went strolling" (Bralic), Rod Newman and Lurline Hammond.

9.40—Monologue: Miss Eileen Hogan.  
9.44—Piano solo: "Impromptu" (Schubert), Mr. H. S. Cellin.

9.52—Tenor solo: R. M. Baxter.  
10—Humour: Mr. Frank Ryan.  
10.4—Violin solo: Doris Woods.

10.15—Soprano solo: "La Caprieta (Beboduct), Miss Lurline Hammond.  
10.22—Musical Tramp: Duu Rus.  
10.30—Broadcast from the Wentworth Cafe—Dance Music.

11—National Anthem. Close down.

WEDNESDAY, JUNE 30.

Morning Session.

7—The Chimes of 2FC and Announcements; Cricket Scores, Second Test Match—England versus Australia—Full scores to the drawing of stumps at the third day's play. These scores will be repeated at 8, 9, and 10 a.m.

10—The Chimes of 2FC and Announcements.

10.10—Weather Information, Commercial News, Shipping Intelligence, Market and News Session.

11—Cables.

11.5—Details of Cricket Scores.  
11.15—Cooking Talk and Recipes by Miss Ruth Furst.

11.30—Close down.

Midday Session.

12.30—The Chimes of 2FC and Announcements.  
12.35—Morning Call Stock Exchange.

12.40—Musical Items.

1—Time Signals.  
1.3—"Evening News" News Service, Weather Information, Commercial News, Musical Items.

1.40—Broadcast from the Pit Street Congregational Church; Noon Call Stock Exchange.  
2—Close down.

Afternoon Session.

2.5—The Chimes of 2FC and Announcements. Broadcast from the Headquarters of the

N.S.W. Fire Brigade, for the first time a full description of His Excellency, the Governor's visit of inspection. Drill by the firemen, also a full turn-out by the Brigade, will be broadcast. The N.S.W. Fire Brigade's Band will play during the function.  
5—Close down.

Early Evening Session.

6—The Chimes of 2FC and Announcements.  
6.5—The "Hello Man" talks to the children.

6.45—Broadcast from the Hotel Australia: Orchestral Items.

7.15—"Evening News" News Service and Sporting Information.

7.30—Dalgaty's Market Reports (wool, wheat, stock), Fruit and Vegetable Markets.

7.40—Details of the Radio Photo Competition—explained by Mr. E. J. Vandeveldt.

Night Session.

7.55—The Chimes of 2FC and Announcements.  
8—Broadcast from the Lyric Wintergarden—Orchestra under the baton of Mr. Alfred Moulton.

8.30—From the Studio: Madame Emily Marks, soprano.  
8.35—Mr. Ewart Chapple: Piano solos

8.45—Broadcast from the Tivoli Theatre, Sydney "The Street Singer."  
8.55—From the Studio: Mr. Lionel Lawson, violin solos.

9.5—Miss Goodie Reeve: entertainer.  
9.13—Madame Emily Marks, soprano.  
9.22—Mr. Lionel Lawson, violin solo.

9.25—Broadcast from the Lyric Wintergarden: Orchestral Items.

10—Miss Goodie Reeve: entertainer.  
10.10—2FC Dance Band.  
10.22—Announcements.

10.25—2FC Dance Band.  
11—National Anthem. Close down.

THURSDAY, JULY 1.

Morning Session.

8—The Chimes of 2FC and Announcements; Cricket Scores, Australia versus West Indians—These scores will be repeated at 9 and 10 a.m.

10—The Chimes of 2FC and Announcements.

10.10—Weather Information, Commercial News, Shipping Intelligence, Market and News Session.

11—Cables.

11.5—Details of cricket scores.  
11.15—Musical Items from the Studio.  
11.30—Close down.

Midday Session.

12.30—The Chimes of 2FC and Announcements.  
12.35—Morning Call Stock Exchange.

12.40—Musical Items.

1—Time Signals.

1.3—"Evening News" News Service, Weather Information, Commercial News, Musical Items.

1.30—Noon Call Stock Exchange. Musical Items.  
2—Close down.

Afternoon Session.

3—The Chimes of 2FC and Announcements.  
3.5—Pianoforte Recital by the Pupils of Miss C. D. Barton.

3.40—From the Tea Rooms: Miss Winifred Woodcock, soprano.  
3.45—Oak Hall Trio.

3.55—Musical Items from the Studio.  
4—From the Tea Rooms, Miss Maryl Holiday, Contralto.  
4.5—Oak Hall Trio.  
4.15—Musical Items from the Studio.

- 4.20—From the Tea Rooms; Miss Winifred Woodcock, soprano.  
4.25—Oak Hall Trio.  
4.35—Musical Items from the Studio.  
4.40—From the Tea Rooms; Miss Meryl Holliday, contralto.  
4.44—Afternoon Call Stock Exchange.  
4.45—Close down.

## Early Evening Session.

- 6—The Chimes of 2FC and Announcements.  
6.5—The "Hello Man" talks to the children.  
6.45—Broadcast from the Hotel Australia; Orchestral Items.  
7.15—"Evening News" News Service and Sporting Information.  
7.30—Dalgety's Market Reports (wheat, wheat, stock), Fruit and Vegetable Markets.  
7.32—Talk on Richard 2nd. One of the Shakespearean subjects set down this year by the Department of Education.  
7.43—Talk on Roses, by "Red Gum."

## Night Session.

- 7.55—The Chimes of 2FC and Announcements.  
8—Announcement of the "Old Time Night." The whole of the evening will be devoted to an Old Time Programme going so far back as 40 years, giving listeners many almost forgotten melodies. The Bandwick Municipal Band will play a selection of Old Numbers. A play has been written by Mr. James Donnelly. He will have the assistance of the following artists: Miss Virginia Beasetti, contralto, will sing: (a) Out on the Rocks (Dolly); (b) Silver threads among the Gold; (c) Till we meet Again (Temple); (d) Ben Bolt. Mr. Alex. Whitson, baritone, will sing (a) Down the Vale; (b) True till Death; (c) My Old Shako; (d) Good Company. Miss Lucy Wise, soprano, Mr. Ernest Archer, tenor: (a) Island of Dreams; (b) Come into the Garden Maud; (c) Alice where art Thou; (d) Let me like a Soldier Fall. Miss Kitty Elliott, Souhrette.  
11—National Anthem. Close down.

## 2BL

**BROADCASTER (SYDNEY) LTD.**  
Call Sign, 2BL. Wavelength, 363 metres.

## FRIDAY, JUNE 25.

- 10.55—Special Cricket Session, with music from the Studio.

## Afternoon Session.

- 9—G.P.O. Clock and Chimes; Weather Report and Social Notes from the "Sun."  
9.15—Music from the Studio.  
9.30—G.P.O. Clock and Chimes; a talk on Philosophical Thought, by Mr. J. M. Prentice.  
9.45—Music from the Studio.  
4—G.P.O. Clock and Chimes; Music from the Studio.  
4.30—G.P.O. Clock and Chimes; Serial Story entitled The Seventh Hunch.  
4.45—Music from the Studio.  
5—G.P.O. Clock and Chimes; the "Sun" News Service.  
5.15—G.P.O. Clock and Chimes. Close down.

## Early Evening Session.

- 6—G.P.O. Clock and Chimes; Sporting Resume from the "Sun" Newspapers; the pupils of Miss Monica Scully will entertain the kiddies.  
6.45—Broadcasters' Dinner Orchestra.  
7.45—Late Stock, Hides and Market Reports by courtesy of Australian Mercantile Land and Finance Co.  
7.50—Close down.

## Evening Session.

- 9—G.P.O. Clock and Chimes; Cec. Morrison and His Glomchasers; Resume of following day's programme; Weather Report and Forecast, by courtesy of Mr. C. J. Mares, Govt. Meteorologist; Senior Sporting Expert Cost. Meteorologist will speak on "The Prospects of to-morrow's Races"; Round the World Travogue, by Mr. J. M. Prentice; News Reports by courtesy of "Sun" Newspapers.

## SATURDAY, JUNE 26.

- 10.55—Special 20-minute Cricket Session, with music from the Studio.

## Afternoon Session.

- 2—G.P.O. Clock and Chimes; Special Sporting Information broadcast direct from "Sun" Office.  
5.15—G.P.O. Clock and Chimes. Close down.

## Early Evening Session.

- 6—G.P.O. Clock and Chimes, Pavilion Dinner Orchestra, under the direction of Mr. Cec. Morrison.  
6.30—Sporting Resume from "Sun" Newspapers; Uncle Jack and the Kiddies.  
7—A Talk to the Kiddies by Brings.  
7.45—Late Stock, Hides and Market Reports by courtesy of Australian Mercantile Land and Finance Co.

## Evening Session.

- 8—G.P.O. Clock and Chimes; Euboe Theatre Symphony Orchestra, conductor, Mr. F. Watkins; Mr. D. C. Strad will speak on "Australian Trees for Streets and Parks"; Mr. Alfred Cunningham; Resume of following day's programme; Miss Molly Raynor, comedienne; Miss Freda Gilda (contralto); Miss Dulcine Clark, violinist; Mr. E. J. Macpherson will speak on "Gold Mining—The Outlook"; News Reports by courtesy of "Sun" Newspapers; Al. Hammett and The Ambassadors Dance Orchestra, broadcast from the Ambassadors Ballroom; National Anthem.

## SUNDAY, JUNE 27.

- 10.55—Special Cricket Session.  
11—Chalmers Street Presbyterian Church, Minister: Rev. D. F. Brandt.

## Afternoon Session.

- 3.30—Bible Class conducted by Mr. W. "Cairo" Bradley.  
4—Organ Recital broadcast from Baptist Church, Petersham.  
7—St. Jude's, Randwick.  
8.30—Manly Municipal Military Band, broadcast from Rialto Theatre, Manly; Resume of following day's programme; Weather Report and Forecast by courtesy of Mr. C. J. Mares, Govt. Meteorologist; Broadcasters' Instrumental Trio; National Anthem.

## MONDAY, JUNE 28.

- 10.55—Special Cricket Session with Music from the Studio.  
2—G.P.O. Clock and Chimes; Weather Report and Social Notes from "The Sun."  
3.15—David Jones' Tea Room Trio.  
3.30—G.P.O. Clock and Chimes; Philosophical Talk, by Mr. J. M. Prentice.  
3.45—Music from the Studio.  
4—G.P.O. Clock and Chimes; David Jones' Tea Room Trio.  
4.15—Music from the Studio.  
4.30—G.P.O. Clock and Chimes; Serial Story entitled The Seventh Hunch.  
4.45—Music from the Studio.  
4.55—Late Market Reports from The Sun.  
5—G.P.O. Clock and Chimes; Sun News Service.  
5.15—G.P.O. Clock and Chimes; Close down.

## Early Evening Session.

- 6—G.P.O. Clock and Chimes; Pavilion Dinner Orchestra under the direction of Mr. Cec. Morrison.  
6.30—Sporting Resume from Sun Newspapers; Uncle George and the Kiddies.  
7.30—"What's On," a guide to the visitors and citizens of Sydney.  
7.45—Late Stock, Hides and Market Reports by courtesy of Australian Mercantile Land & Finance Company.  
7.50—Close down.

## Evening Session.

- 8—G.P.O. Clock and Chimes; Newtown Band, broadcast from Industrial Hall, Newtown; Miss Anna Burke in Irish Songs; Mr. Ward L. Hayward will speak on Australia's Scenic Treasures; Caves and Caverns No. 1; Al. Hammett and the Ambassadors Dance Orchestra; the intervals between dances there will be tra, broadcast from the Ambassadors. During Social Notes and a description of the frocks by Mrs. Post; Resume of following day's programme; Weather Report and Forecast by courtesy of Mr. C. J. Mares, Govt. Meteorologist; Mr. C. F. Lascron will speak on Old English Pottery and Porcelain; News Report by courtesy of "Sun" Newspapers.

## TUESDAY, JUNE 29.

- 10.55—Special 20 minute Cricket Session with Music from the Studio.

## Afternoon Session.

- 3—G.P.O. Clock and Chimes; Weather Report and Social Notes from The Sun.  
3.15—Music from the Studio.  
3.30—G.P.O. Clock and Chimes.  
3.45—Music from the Studio.  
4—G.P.O. Clock and Chimes; Music from the Studio.  
4.30—G.P.O. Clock and Chimes; Serial Story entitled The Seventh Hunch.  
4.45—Music from the Studio.  
4.55—Late Market Reports from The Sun.  
5—G.P.O. Clock and Chimes; Sun News Service.  
5.15—G.P.O. Clock and Chimes; Close down.

## Early Evening Session.

- 6—G.P.O. Clock and Chimes; Sporting Resume from "Sun" Newspapers; Uncle Jack and the Kiddies.  
6.45—Broadcasters' Dinner Orchestra.  
7.45—Late Stock, Hides and Market Reports by courtesy of Australian Mercantile Land & Finance Company.  
7.50—Close down.

## Evening Session.

- 8—G.P.O. Clock and Chimes; Hoyt's Imperial Orchestra, under the direction of Mr. Lionel Hart, broadcast from Hoyt's Theatre; The President of the Institute of Optometrists of N.S.W. will speak on Moving Pictures and Vision; Miss Pauline Harford Foster, soprano; Resume of following day's programme; Weather Report and Forecast by courtesy of Mr. C. J. Mares, Govt. Meteorologist; Broadcasters' Trio; Mr. Norman Janson, baritone; Mr. A. G. Hale will speak on: Henry George, Founder of the Single Tax; Mr. Crosby Browne, clarinet solo; News Reports by courtesy of "Sun" Newspapers.

## WEDNESDAY, JUNE 30.

- 10.55—Special 20 minute Cricket Session with Music from the Studio.

## Afternoon Session.

- 3—G.P.O. Clock and Chimes; Weather Report and Social Notes from The Sun.  
3.15—Broadcasters' Trio.  
3.30—G.P.O. Clock and Chimes; Special Operatic Talk by Mr. J. M. Prentice.  
4—G.P.O. Clock and Chimes; Broadcasters' Trio.  
4.30—G.P.O. Clock and Chimes; Serial Story entitled The Seventh Hunch.  
4.45—Broadcasters' Trio.  
4.55—Late Market Reports from The Sun.

5—G.P.O. Clock and Chimes; Sun News Service.  
 3.15—G.P.O. Clock and Chimes; Close down.

## Early Evening Session.

1—G.P.O. Clock and Chimes; and Dinner Orchestra under the direction of Mr. Cec. Morrison.  
 6.30—Sporting Resume from Sun Newspapers; Uncle George and Uncle Jack with the Kiddies.  
 7.45—Late Stock, Hides and Market Reports by courtesy of Australian Mercantile Land and Finance Company.  
 7.50—Close down.

8—G.P.O. Clock and Chimes; Sydney Orphans Society; City of Sydney Band broadcast from Review Chamber; Mr. Frank Marshall, B.Sc., will speak on No. 2, Types of Cancer and their characteristics; Mr. J. M. Proutie will speak on Foreign Affairs, and reply to any telephone question on the subject; Pagan Jazz Orchestra under the direction of Mr. S. Bennett; News Reports by courtesy of "Sun" Newspapers.

## THURSDAY, JULY 1.

10.55—Special 20 minute Cricket Session with music from the Studio.  
 3—G.P.O. Clock and Chimes; Weather Report and Social Notes from "The Sun."  
 3.15—David Jones' Tea Room Trio.  
 3.30—Music from the Studio.  
 4—G.P.O. Clock and Chimes; David Jones' Tea Room Trio.  
 4.15—Music from the Studio.  
 4.30—Serial Story entitled The Seventh Hunch.  
 4.45—Music from the Studio.  
 4.55—Late Market Reports from "The Sun."  
 5—G.P.O. Clock and Chimes; "Sun" News Service.  
 5.15—G.P.O. Clock and Chimes; Close down.

## Early Evening Session.

6—G.P.O. Clock and Chimes; Sporting Resume from "Sun" Newspapers; Uncle Jack and the Kiddies.  
 6.45—Broadcasters Dinner Orchestra.  
 7.30—Close down.  
 7.45—Australian Mercantile Land & Finance Co. Ltd. Stock Report.  
 7.50—Close down.

## Evening Session.

8—G.P.O. Clock and Chimes; Ambassadors Instrumental Salon Quartette under the direction Mr. Claude McClyan (Mr. W. E. Lewis (baritone); Miss Dolcie Blair (violinist); Miss Dorrie Ward (soprano); Mr. Reg. Harrison (comedian); Weather Report and Forecast by courtesy of Mr. C. J. Mars, Govt. Meteorologist; Resume of following day's programme; Mr. Lance Jeffrey (tenor); Mr. Bryce Carter (cello solo); Dr. Donald Laker will speak on "China"; Broadcasters Trio; News Reports by courtesy of "Sun" Newspapers.

## 2BE

BERGIN ELECTRIC COMPANY LTD.

Wave-length, 316 metres. Power 100 watts.  
 Every Monday and Thursday evening, from 6.30 p.m. to 9 p.m.

6.30 to 7.30—Medicine Music, consisting of vocal and orchestral items.  
 7.30 to 9—Lectures, orchestral and vocal items.

2BE will be glad to get into touch with artists willing to give their services to this station.

## 4QG

## QUEENSLAND RADIO SERVICE.

Wave-length, 385 metres.

## FRIDAY, JUNE 25.

## Midday Session.

12.45—Tune-in.  
 12.58—Time Signal.  
 1—Market Reports, Stock Exchange, Weather, "The Daily Mail" News, The "Daily Standard" News.  
 1.20—Close down.

## Afternoon Session.

3.30—A Musical Programme from the Studio including Bang Numbers by Mr. N. Gould.  
 4.15—"The Telegraph" News.  
 4.30—Close Down.

## Early Evening Session.

6.25—Tune-in.  
 6.30—"The Children's Session. Stories by "The Sealdman."  
 7—"The Farmers' Session; Market Reports; Lectures—"The Suppression of Tuberculosis in Farm Animals," by Mr. C. J. Pound (Government Bacteriologist).  
 7.20—"The Telegraph" News.  
 7.30—Close Down.

## Night Session.

7.45—Lecture Session—A Talk arranged by the Workers' Educational Association.  
 8—A Miscellaneous Musical Programme from the Studio.  
 8.50—Weather Information officially supplied by The Commonwealth Weather Bureau.  
 8.55—Announcements.  
 9—Overture, The Savoy Orchestra; bass solo, Mr. Stanley Tamblin; cornet solo, Mr. J. W. Burgemeister; waltz, The Savoy Orchestra; vocal duet, Mrs. B. G. Allen and Miss Jessie McDonald; soprano solo, Miss Winnie Danon; fantasia, The Savoy Orchestra; mezzo-contralto solo, Miss Margaret Lloyd; orchestral, The Savoy Orchestra; cornet solo, Mr. J. W. Burgemeister; march, The Savoy Orchestra.  
 10—"The Daily Mail" News Service; Close Down.

## SATURDAY, JUNE 26.

## Afternoon Session.

3.25—Tune-in.  
 3.30—A Matinee Entertainment for Little Listeners.  
 4.30—Close down.

## Early Evening Session.

6.25—Tune-in.  
 6.30—"The Children's Session; Bedtime Stories by "Uncle Ben," assisted by "Mabel Sunshine."  
 7.15—Sporting News.  
 7.30—Close Down.

## Night Session.

7.45—Lecture Session—A Sporting Talk, by Rugby League Officials.  
 8—A One Act Play: "When the wheels Run Down," by Maud M. Rogers. Play produced by Miss Nell Douglas Graham.  
 8.20—A Concert from the Studio.  
 8.50—Weather Information officially supplied by The Commonwealth Weather Bureau.  
 8.55—Announcements.

9—From Lennon's Ballroom—by courtesy of the Proprietors of Lennon's Hotel, dance music played by Miss May Dobbyn's Victrola Orchestra will be relayed from Lennon's Ballroom.  
 From the Studio: Baritone solo; Mr. N. Brown; soprano solo, Miss Blanche Richardson.  
 From Lennon's Ballroom—Dance Music.  
 Tenor solo, Mr. J. Trzaska; contralto solo, Miss Doris Vera.  
 From Lennon's Ballroom—Dance Music.  
 From the Studio: Baritone solo, Mr. N.

Brown; soprano solo, Miss Blanche Richardson.

10—From the Studio—"The Sunday Mail" News Service. Close down.

## SUNDAY, JUNE 27.

## Morning Session.

The complete Morning Service will be relayed from All Saints Church of England.  
 10.55—Tune-in.  
 11—Church Service.  
 12.30—Close down.

## Afternoon Session.

The concert provided in the Brisbane Botanical Gardens by the Federal Band (under the leadership of Mr. W. H. Davis) will be relayed.  
 3.15—Band Concert.  
 4.30—Close down.

## Night Session.

The complete Evening Service will be relayed from All Saints' Church of England.  
 7.10—Tune-in.  
 7.15—Organ Voluntary.  
 7.30—Evening Commencement. Sermon by the Rector.  
 At the conclusion of the Service the Band Concert provided by the Greater Brisbane Municipal Concert Band (under the leadership of Mr. E. Jackson) will be relayed from the Wickham Park Bandstand.  
 9.30—Close down.

## MONDAY, JUNE 28.

## Midday Session.

12.55—"Tune-in" Signal.  
 1—Market Reports supplied by the Council of Agriculture; Stock Exchange Information supplied by the Committee of the Brisbane Stock Exchange; Weather Information supplied by the Commonwealth Weather Bureau; "Daily Standard" News Service; Close down.  
 2—Close down.

## Afternoon Session.

3.30—A Musical Programme from the Studio.  
 4.15—News service supplied by The Telegraph.  
 4.30—Close down.

## Early Evening Session.

6.25—Tune-in.  
 6.30—"The Children's Session—Stories by The Sealdman."  
 7—"The Farmers' Session—Market Reports supplied by the Council of Agriculture, Lecturette—Eat More Pig Products, by Mr. F. J. Shelton (Pig Instructor).  
 7.20—News Service supplied by The Standard.  
 7.30—Close down.

## Night Session.

7.45—Lecture Session—Motorists—Correct Lubrication, Talk No. 11, by "Gargyle."  
 The First portion of to-night's programme will be provided by the Brisbane Austral Choir (under the conductors of Mr. E. R. E. Jordan), in the Ann Street Presbyterian Church, will be relayed.  
 8.30—Programme from the Studio.  
 8.50—Weather Information officially supplied by the Commonwealth Weather Bureau.  
 8.55—Announcements.  
 9—From the Band Room: A programme of music by the South Brisbane City Orchestra under the leadership of Mr. J. W. Ferguson.  
 10—From the Studio The Daily Mail News Service. Close down.

## TUESDAY, JUNE 29.

## Midday Session.

12.55—Tune-In Signal.  
 12.58—Time Signal.  
 1—Market Reports, Stock Exchange, Weather, "The Daily Mail" News, The Daily Standard News.  
 Afternoon Session.

3.30—Programme from the Studio.  
 4.15—"The Telegraph" News.  
 4.30—Close down.

BURGESS—"Constant satisfaction assured"—BATTERIES

## Early Evening Session.

- 6.25—Tune-in.  
6.30—The Children's Session; Stories by Uncle Ben and Uncle Jim.  
7—The Farmers Session; Lecture—What the Sun Is, paper supplied by Mr. Ingo Jones.  
7.20—News Service supplied by The Standard.  
7.30—Close down.

## Night Session.

- 7.45—Lecture: Photography, by Mr. F. L. South (Manager, Kodak Ltd.)  
8—A Miscellaneous Programme, including the St. James' R.C. Church Choir.  
8.50—Weather Information officially supplied by the Commonwealth Weather Bureau.  
9.5—Announcements.  
9.55—Concert continued.  
9.30—From the Centennial Hall—By courtesy of the Lessee, a programme of dance music by the Centennial Hall Dance Orchestra, will be relayed from the Hall.  
10—From the Studio The Daily Mail News Service. Close down.

## WEDNESDAY, JUNE 30.

## Midday Session.

- 12.55—Tune-in.  
12.56—Time Signal.  
1—Market Reports, Stock Exchange, Weather, The Daily Mail News, The Daily Standard News.  
1.20—Close down.  
Afternoon Session.  
3.30—A musical programme from the Studio.  
4.15—News service supplied by The Telegraph.  
4.30—Close down.

## Early Evening Session:

- 6.25—Tune-in.  
6.30—The Children's Session—Stories by Little Miss Brisbane.  
7—The Farmers' Session; Market Reports; Lecture—Value of Organisation, by Mr. N. N. Bentley (Secretary, Council of Agriculture).  
7.20—"The Standard" News.  
7.30—Close down.

## Night Session.

- 7.45—Lecture Session.  
8—The first part of Programme by The Federal Band.  
8.50—Weather Information officially supplied by the Commonwealth Weather Bureau.  
9.5—Announcements.  
9—The second part of Programme supplied by the Ithaca Orchestral Society.  
10—The Daily Mail News Service; Close down.

## THURSDAY, JULY 1.

## Midday Session.

- 12.55—Tune-in signal.  
12.56—Time Signal.  
1—Market Reports, Stock Exchange information, weather information, "The Daily Mail" News, the "Daily Standard" News.  
1.20—Close down.  
Afternoon Session.  
3.25—Tune-in.  
3.30—A programme of Music from the Studio.  
4.15—"The Telegraph" News.  
4.30—Close down

## Early Evening Session:

- 6.25—Tune-in.  
6.30—The Children's Session—Stories by "The Sandman"  
7—The Farmers Session; Market Reports; Lecture—Building up a Rural Civilisation, by J. F. Reid (Editor, "Agricultural Journal").  
7.20—"The Standard" News.  
7.30—Close down.

## Night Session.

- 7.45—Lecture Session. A talk on Books, by Mr. W. A. Braiden (McLeod's Book Store).  
8—A Vocal and Instrumental Programme from the Studio.  
8.50—Weather Information officially supplied by the Commonwealth Weather Bureau.  
9.5—Announcements.  
9—From the Band Room—An impromptu programme of Music by the Greater Brisbane Municipal Concert Band (under the leadership of Mr. E. Jackson).  
10—"The Daily Mail" News Service. Close down.

## 5CL

## CENTRAL BROADCASTERS LTD.

Call Sign, 5CL. Wavelength, 395 metres. Input, 6 K.W.

## FRIDAY, JUNE 25.

Morning Session (11.30 a.m. to 2 p.m.)

- 11.36—G.P.O. Chimes.  
11.31—Featuring a Steek Duo Art number.  
11.40—"Advertiser" News Service.  
12—G.P.O. Chimes.  
12.1—News and Cable Service.  
12.16—Featuring a Steek Duo Art number; The 5CL Studio Orchestras Selection; cornet solo; Fox Trot.  
1—G.P.O. Chimes.  
1.1—Relay from Aldeide Towd Hall, Community Singing.  
1.55—S. C. Ward & Co.'s Stock Exchange Intelligence and Official Weather Synopsis and Station Announcements.  
2—G.P.O. Chimes.

## Afternoon Session (3 to 5).

- 3—G.P.O. Chimes.  
3.1—Relay from Maple Leaf Cafe; Orchestral numbers.  
3.45—Broadcast from Studio; Serial Story.  
4—G.P.O. Chimes.  
4.1—Broadcast from Arcadia Cafe; Orchestral numbers.  
4.55—Stock Exchange Reports, General Information and Station Announcements.  
5—G.P.O. Chimes.

## Evening Session (6.30 to 10.30).

- 6.30—G.P.O. Chimes.  
6.31—Bedtime Stories for the Children.  
7.30—Stock Exchange, Market Reports and Station Announcements.  
7.40—Sporting Talk by "Old Times."  
8—G.P.O. Chimes.  
8—A Special Programme from the 5CL Studio at the Radio Exhibition; Musical Prologue to "The White Sister," relayed from the Wondorgraph Theatre by kind permission of the management; The Studio Orchestra in a series of classical numbers; Campfire Songs by members of the Boy Scout's Association; The Havana Syncopators will entertain with 20 minutes of Real Jazz; Miss Elsie Woolley in selected numbers; Miss Lucette Foglia, violin solo; Mr. Broadland Hook will render popular tenor songs.  
9—G.P.O. Chimes.  
9.1—Weather Reports.  
10.15—Advertiser News Service; International Cricket; and Ships within wireless range.  
10.36—The Studio Orchestra, continued.  
11—G.P.O. Chimes; National Anthem.

## SATURDAY, JUNE 26.

## Morning Session.

- 10.30—G.P.O. Chimes.  
10.31—The 5CL Studio Orchestra will play—Selection; violin solo; fox trot; waltz; conjurers' dance; suite; cornet solo; dance Tenor; and finale.  
11.45—Station Announcements.

## Afternoon Session.

- 1 to 5.30 (Approx.)—Relay from the Morphetville Racecourse. A running description of Tattersall's Race Meeting. Mr. Arnold Treloor will describe the races.

## Evening Session.

- 6.30—G.P.O. Chimes.  
6.31—Bedtime Stories for the Children.  
7.30—Racing Resume; Football Results and

## General Sporting Information.

- 8—Relay from the Radio Exhibition, a programme of Orchestral, vocal, and Band Music by Holden's Silver Band.  
9—G.P.O. Chimes.  
11—G.P.O. Chimes; National Anthem; Close down.

## SUNDAY, JUNE 27.

## Morning Session:

- 11—Relay from Parkside Baptist Church—Divine Service (Preacher, Rev. Bernard Tuok, B.A.)

## Afternoon Session.

- 3.45—Relay from Black Forest Baptist Church—A pleasant Sunday afternoon service.

## Evening Session:

- 6.30—G.P.O. Chimes.  
6.31—Sunday Story for the Children by Uncle Radio.  
7—Relay from Rose Park Congregational Church 8.30 (approx.)—Musical items from the Studio.  
8.45—Relay from Parkside Baptist Church—Sacred Concert of vocal and instrumental numbers.  
9.5—Holden's Silver Band, continued. Station Announcements; National Anthem.

## MONDAY, JUNE 28.

## Morning Session (11.30 a.m. to 2 p.m.)

- 11.30—G.P.O. Chimes.  
11.31—Featuring a Steek Duo Art number.  
12—G.P.O. Chimes.  
12.1—News and Cable Service.  
12.16—Featuring a Steek Duo Art number; 5CL Studio Orchestra will play; Selection; cornet solo; fox trot; waltz; Beau vivant; reverie; "Men of Sparta"; cornet solo; finale.  
1.55—S. C. Ward & Co.'s Stock Exchange Intelligence and Official Weather Synopsis and Station Announcements.  
2—G.P.O. Chimes.

## Afternoon Session. (3 to 5).

- 3—G.P.O. Chimes.  
3.1—Relay from Maple Leaf Cafe; Orchestral numbers.  
3.45—Broadcast from Studio; Serial Story.  
4—G.P.O. Chimes.  
4.1—Broadcast from Arcadia Cafe; Orchestral numbers.  
4.55—Stock Exchange Reports, General Information and Station Announcements.  
5—G.P.O. Chimes.

## Evening Session (6.30 to 10.30).

- 6.30—G.P.O. Chimes.  
6.31—Bedtime Stories for the Children.  
7.50—"The History of Leather," given by Mr. J. Alexander.  
8—Humorous Interludes by Mr. Athol Lykke, from the Studio; tenor songs by Mr. Howard Banoroche; soprano songs by Miss Elizabeth Wylie.  
8.20—Twinkler's Original Humorous Talk (Mr. F. J. Mills).  
9.1—Weather Reports.  
10.15 (Approx.)—Advertiser News Service; International Cricket; ships within wireless range.  
During the evening Ross Kelton's Club Royal Dance Band from the Grosvenor Palais will be heard in a programme of dance music.  
10.45—Station Announcements; To-morrow's Programme; National Anthem.

## TUESDAY, JUNE 29.

## Morning Session (11.30 a.m. to 2 p.m.)

- 11.30—G.P.O. Chimes.  
11.31—Featuring a Steek Duo Art number.  
12—G.P.O. Chimes.  
12.1—News and Cable Service.  
12.16—Featuring a Steek Duo Art number; 5CL Studio Orchestra will play; Overture; cornet solo; fox trot; serenade;

"Nepopolitan nights"; dance passion; reverse; instrumental trio; finale.  
 1.55—S. L. Ward & Co.'s Stock Exchange Intelligence, Official Weather Synopsis and Station Announcements.  
 2—G.P.O. Chimes.

Afternoon Session. (3 to 5).

3—G.P.O. Chimes.  
 5.1—Relay from Maple Leaf Cafe; Orchestral Numbers.  
 5.45—Broadcast from Studio; Serial Story.  
 4—G.P.O. Chimes.  
 4.1—Broadcast from Arcadia Cafe; Orchestral Numbers.  
 4.55—Stock Exchange Reports, General Information and Station Announcements.  
 6—G.P.O. Chimes.

Evening Session (6.30 to 10.30).

6.30—G.P.O. Chimes.  
 6.31—Bedtime Stories.  
 7.15—Cookery Talk by Miss Sharman, arranged by S. A. Gas Co.  
 7.30—Stock Exchange, Market Reports and Station Announcements.  
 7.40—Talk on Milling by Mr. Jacket.  
 8—G.P.O. Chimes.  
 8—Special Musical Festival Service relayed from St. Peter's Cathedral.  
 9.15 (approx.)—The Weather Reports.  
 9.16—The Cadenzza Quartette in a series of popular numbers, vocal items by Mr. Gerald Healy and Miss Lorna Kerrison.  
 10.15—Studio Concert, continued.  
 10.30—"Advertiser" News Service.  
 10.50—Station Announcements; National Anthem.

WEDNESDAY, JUNE 30.

Morning Session (11.30 a.m. to 2 p.m.)

11.30—G.P.O. Chimes.  
 11.31—Stock Duo Art and Acolian Vocalion Recitals.  
 12—G.P.O. Chimes.  
 12.1—News and Cable Service.  
 12.15—Featuring a Stock Duo Art number; 5CL Studio Orchestra will play; Overture; violin solo; fox trot; waltz; novelty; instrumental trio; andante symphony; mazurka; finale.  
 1.55—S. L. Ward & Co.'s Stock Exchange Intelligence, Official Weather Synopsis and Station Announcements.  
 2—G.P.O. Chimes.

Afternoon Session. (3 to 5).

3—G.P.O. Chimes.  
 3.1—Broadcast from Maple Leaf Cafe; Orchestral Numbers.  
 3.45—Serial Story from the Studio.  
 4—G.P.O. Chimes.  
 4.1—Relay from Arcadia Cafe; Orchestral Numbers.  
 4.55—Stock Exchange Reports, General Information and Station Announcements.  
 5—G.P.O. Chimes.

Evening Session (6.30 to 10.30).

6.30—G.P.O. Chimes.  
 6.31—Bedtime Stories for the Children.  
 7.20—Copec Lecture, Mrs. M. Mounstar.  
 8—G.P.O. Chimes.  
 8.1—Fred Caventis's Havana Syncopters in a Special Dance Programme. Vocal numbers by Misses Jean Sinclair and Grace Cussion, A.I.C.L.; and Messrs. Broadland Rock and Mostyn Skinner.  
 8.30—Science lecture arranged by Messrs. F. H. Faulding & Co.  
 8.40—Clec Club Concert, continued.  
 9.1—Weather Reports.  
 9.5—Jazz Band, continued.  
 10.15—News Service.  
 10.30—Jazz Band, continued.  
 11—G.P.O. Chimes; National Anthem; Good Night.

THURSDAY, JULY 1.

Morning Session.

11.30—G.P.O. Chimes.  
 11.31—Featuring a Stock Duo Art number.  
 11.40—"Advertiser" News Service.  
 11.55—Vocalion Number.  
 12—G.P.O. Chimes.  
 12.1—"Advertiser" News Service.  
 12.10—Featuring a Stock Duo Art number; 5CL Studio Orchestra will play; Selection; cornet solo; fox trot; "Solveig's Song"; instrumental trio; waltz; selection; gavotte; finale.  
 1.55—Ward & Co.'s Stock Exchange Intelligence, Official weather synopsis, and station announcements.  
 2—G.P.O. Chimes.

Afternoon Session.

3—G.P.O. Chimes.  
 3.1—Relay from Maple Leaf Cafe, orchestral numbers.  
 3.45—Broadcast from Studio, Serial Story.  
 4—G.P.O. Chimes.  
 4.1—Broadcast from Arcadia Cafe, orchestral numbers.  
 4.55—Stock Exchange Reports, general information, and station announcements.  
 5—G.P.O. Chimes.

Evening Session.

6.30—G.P.O. Chimes.  
 6.31—Bedtime Stories.  
 7.15—Health Talk, given by School for Mothers, arranged by Mr. A. M. Whitesbury.  
 7.30—Market Reports.  
 7.40—Poultry Talk by Mr. A. M. Whitesbury.  
 8—G.P.O. Chimes.  
 8.1—The Studio Orchestra in a classical instrumental programme, assisted by the following artists: Moses H. W. Durbin, bass songs; and Keith Clarke, tenor; and Miss Gwen Collett, contralto.  
 9.2—Studio Concert, continued.  
 10.21—"Advertiser" News Service.  
 10.30—Studio Concert, continued.  
 11—G.P.O. Chimes; National Anthem; Good Night.

7ZL

HOBART.

Wave Length, 535 metres. Temporary Power, 250 watts.

SUNDAY, JUNE 27.

Evening Session.

7—Service from St. David's Cathedral, Hobart; Preacher: The Bishop; Psalms 22, 23; Hymns, 193, 26.  
 8.45—Concert from the Studio. Miss Amy Butterworth, pianist; Mr. J. Blight, sax soloist; Mr. Ralph Lyons, baritone; Mr. G. C. Tennant, baritone; Mr. Audley Jones, baritone.  
 9.45—"The Mercury" Special Interstate News Service; Weather Synopsis; Station Announcements. National Anthem.

MONDAY, JUNE 28.

Morning Session.

11—"The Mercury" News; Stock Market; Ship-

ping; Commercial Intelligence; Weather Information; Records from the Studio.  
 12—Time Signal.

Afternoon Session.

3—Musical Items from the Studio; Weather Information.  
 3.30—Hobart Stock Exchange Quotations.  
 4—Time Signal.

Early Evening Session.

7—Children's Corner by "Big Brother."

Evening Session.

8—"The Mercury" Special Tasmanian News Service; Railway Auction Produce Sales; Weather Forecasts.  
 8.5—Hobart Stock Exchange Quotations.  
 8.10—Mr. L. F. Giblin, Deputy Commonwealth Statistician, Per Capita Payments.  
 8.30—Miss Dorothy Newton, contralto; Miss Dorcas Glover, mezzo contralto; Mrs. E. W. Bailey, contralto; Miss Elsie Lamkin, soprano; Miss Amy Butterworth, pianist; Miss Gretta Wilson, soprano; Miss Bevil Scobie, soprano; Mr. Geo. Muir, tenor; Mr. Edgar Taylor, violinist; Mr. Ralph Lyons, baritone; Mr. De-la-Bere, bass.  
 9.50—"The Mercury" Special Interstate News Service; Weather Synopsis; Station Announcements. National Anthem.

TUESDAY, JUNE 29.

Morning Session.

11—"The Mercury" News; Stock Market; Shipping; Commercial Intelligence; Weather Information; Records from the Studio.  
 12—Time Signal.

Afternoon Session.

3—Musical Items from the Studio; Weather Information.  
 3.30—Hobart Stock Exchange Quotations.  
 4—Time Signal.

Early Evening Session.

7—Children's Corner by "Big Brother."  
 7.15—The Adventures of George the Bookahol Cat. "George Waggles a Whisker," by Aunt Sheila.

Evening Session.

8—"The Mercury" Special Tasmanian News Service; Railway Auction Produce Sales; Weather Information.  
 8.5—Hobart Stock Exchange Quotations.  
 8.10—Literary Lapses and Library Lists, by Mr. W. E. Fuller.  
 8.30—Miss Prudentia Hutchens, pianoforte solos; Miss Maureen Jones, contralto; Mr. G. T. Lows, tenor.  
 9—Photographic Talk, by Mr. C. H. Sims, of Kodak Ltd., Hobart; Development, continued.  
 9.20—Musical Items from the Studio.  
 9.50—"The Mercury" Special Interstate News Service; Weather Synopsis; Station Announcements. National Anthem.

WEDNESDAY, JUNE 30.

Morning Session.

11—"The Mercury" News; Stock Market; Shipping; Commercial Intelligence; Weather Information; Records from the Studio.  
 12—Time Signal.

Afternoon Session.

3—Musical Items from the Studio; Weather Information.  
 3.30—Hobart Stock Exchange Quotations.  
 4—Time Signal.

Early Evening Session.

7—Children's Corner by "Big Brother."  
 7.15—Story from Illustrated Tasmanian Mail.

Evening Session.

8—"The Mercury" Special Tasmanian News Service; Railway Auction Produce Sales; Weather Information.  
 8.5—Hobart Stock Exchange Quotations.

8.15—Palais de Dance Band, City Hall.  
9.56—"The Mercury" Special Interstate News Service; Weather Synopsis; Station Announcements. National Anthem.

## THURSDAY, JULY 1.

## Morning Session.

11—"The Mercury" News; Stock Market; Shipping; Commercial Intelligence; Weather Information; Records from the Studio.  
12—Time Signal.

## Afternoon Session.

3—Musical Items from the Studio; Weather Information.  
3.30—Hobart Stock Exchange Quotations.  
4—Time Signal.

## Early Evening Session.

7—Children's Corner by "Big Brother."  
7.15—"The Adventurers of George the Bookshelf Cat." "George Through the Looking Glass," by Aunt Stella.

## Evening Session.

9—"The Mercury" Special Tasmanian News Service; Railway Auction Produce Sales; Weather Information.  
9.5—Hobart Stock Exchange Quotations.  
9.16—Selections from Jones' I.X.L. Band, Conductor, Mr. L. M. Barnett.  
9—Physical Culture Talk by Mr. George Collins.  
9.15—Jones' I.X.L. Band.  
9.56—"The Mercury" Special Interstate News Service; Weather Synopsis; Station Announcements. National Anthem.

## 3LO

BROADCASTING CO. OF AUSTRALIA, PROP.  
LTD.

Call Sign, 3LO. Power, 5 kilowatts.  
Wavelength, 371 metres.

## FRIDAY, JUNE 25.

## Midday Session.

12—Time Signal. Latest Australian Cricket Eleven scores, by courtesy of Reuters Ltd. British Official Wireless News from Rugby. Reuter and the Australian Press Association Cables. "Argus" and "Herald" News Services. Shipping Intelligence.  
12.45—Stock Exchange information.  
12.50—Meteorological information. Weather Forecasts for Victoria, Tasmania, South Australia, and N.S.W. Ocean forecast. River Reports.

## 1—Time Signal.

1.1—Studio Orchestra.  
1.10—C. Melvin, bass.  
1.17—Stanley Adams, violin solo.  
1.24—Studio Orchestra.  
1.34—C. Melvin, bass.  
1.41—Stanley Adams, violin solo.  
1.48—Studio Orchestra.  
2—Close down.

## Afternoon Session.

Latest Australian Cricket Eleven scores, by courtesy of Reuters Ltd.  
2.30—First half of programme transmitted from the Troli Theatre.  
3.30—Studio Orchestra.  
3.40—Miss Frances Fraser.  
3.55—Studio Orchestra.  
4.5—Yetty Landau, elocutionist.  
4.12—Au Fait, Fashion Talk.  
4.27—Station Trio.  
4.37—Yetty Landau, elocutionist.  
4.45—Latest Australian Cricket Eleven scores, by courtesy of Reuters Ltd. "Herald" News Service. Stock Exchange information.  
6—Close down.

## Evening Session.

5.45—Children's Hour. Answers to letters and birthday greetings.  
6—Stories by Billy Bunny; Littlest's Fairy Story.

The Lost Princess; Black Beauty.

6.40—Latest Australian Cricket Eleven scores, by courtesy of Reuters Ltd. "Argus" and "Herald" News Service. Reuters and the Australian Press Association Cables.

6.52—Weather Synopsis. Shipping Movements.

6.57—Stock Exchange information.

7.3—Fish Market Reports by J. R. Borrett Ltd.

7.4—Market Reports by the Victorian Producers' Co-operative Co. Ltd. Hay-market Sales. Poultry, grain, chaff, hay, straw, fute, dairy produce, potatoes and onions.

## Night Session.

7.26—Under the auspices of the Agricultural Department—Mr. W. J. Yull, Senior Dairy Supervisor, Herd Testing.

7.40—Miss Dorothy Lenz, of the "Leave it to Jane" company at the Theatre Royal will speak from her dressing-room by permission of J. C. Williamson Ltd.

8—Studio Orchestra.

8.10—The Captain—School Life and School Sport.

8.30—Mortimer J. Pettigrove, tenor.

8.37—Studio Orchestra.

8.42—Mortimer J. Pettigrove, tenor.

8.54—Studio Orchestra.

9.10—Mr. Leslie Brunning, The Home Orchard.

9.30—Bert Howell and his Concert Orchestra, transmitted from the Victory Theatre, St. Kilda.

10.45—Latest Australian Cricket Eleven scores, by courtesy of Reuters Ltd. "Argus" News Service. British Official Wireless News from Rugby. Meteorological information.

11—God Save the King.

## SATURDAY, JUNE 26.

## Morning Session.

11—Sonora Recital.

11.7—Oliver Peacock, baritone.

11.14—Harold Rodgers, organ recital.

11.21—Sonora Recital.

11.42—Harold Rodgers, organ recital.

12—Time Signal. Latest Australian Cricket Eleven scores, by courtesy of Reuters Ltd. British Official Wireless News from Rugby. Reuters and the Australian Press Association Cables.

"Argus" and "Herald" News Services. Shipping Intelligence.

12.45—Stock Exchange information.

12.50—Meteorological information. Weather Forecast for Victoria, Tasmania, South Australia, and N.S.W. Ocean Forecast. River Reports.

## 1—Time Signal.

1.1—Studio Orchestra.  
1.10—C. Melvin, bass.  
1.17—Studio Orchestra and piano.  
1.23—Walter Smith, cornet solo.  
1.30—Studio Orchestra.  
1.37—C. Melvin, bass.  
1.44—Studio Orchestra.

2—Result of Maiden Hurdle—Williamstown Races; Close down.

2.35—Result of Trial Welter—Williamstown Races.

## Afternoon Session.

3—Broadway Jazz Orchestra.

3.10—Result of Port Phillip Hurdle—Williamstown Races.

3.11—Broadway Jazz Orchestra.

3.40—Result of Williamstown Steeple Chase—Williamstown Races.

3.41—Broadway Jazz Orchestra.

4.10—Result of Point Cook Handicap—Williamstown Races.

4.11—Broadway Jazz Orchestra.

4.45—Latest Australian Cricket Eleven scores, by courtesy of Reuters Ltd. Sporting Results. "Herald" and "Argus" News Services.

Result of Esplanade Welter—Williamstown Races.

5—Close down.

## Evening Session.

5.45—Sporting Results.

6—Children's Hour; Mary Gumleaf; Poems; The Engine; All Tickets Ready Please; Boys and Girls—another little play; "School's In."

6.40—Latest Australian Cricket Eleven scores, by courtesy of Reuters Ltd. "Argus" and "Herald" News Services. Sporting Results. Reuters and the Australian Press Association Cables.

6.52—Weather Synopsis; Shipping Movements.

6.57—Stock Exchange information.

7.2—Fish Market Reports by J. R. Borrett Ltd.

7.4—Market Reports by the Victorian Producers' Co-operative Co. Ltd.: Grain, chaff, hay, straw, fute, dairy produce, potatoes and onions.

## Night Session.

7.20—Mr. Alf Peters—Cromation.

7.45—Dr. J. A. Leach—Songs and Calls of Birds.

8—Collingwood Citizens' Band.

8.10—Roy Warren, bass.

8.17—Archie Borthwick, xylophone selections.

8.25—J. Harcourt Bailey, entertainer.

8.32—Collingwood Citizens' Band.

8.37—Roy Warren, bass.

8.44—Archie Borthwick, xylophone selections.

8.54—J. Harcourt Bailey, entertainer.

9—Collingwood Citizens' Band.

9.10—Mr. E. J. Farnam, President of Shire Seymour, "Seymour."

9.25—Latest Australian Cricket Eleven scores, by courtesy of Reuters Ltd. "Argus" News Service. Meteorological information. British Official Wireless News from Rugby. Sporting Results—Races, Football, Metropolitan Soccer League, Metropolitan Amateur Association, Lacross.

9.40—"Leave it to Jane"—Act 2, transmitted from the Theatre Royal, by permission of J. C. Williamson.

11—God Save the King.

## SUNDAY, JUNE 27.

## Morning Session.

10.50—Express Train information.

11—Service from Scots Church, Collins Street, Melbourne, conducted by the Rev. Dr. W. Borland; organist, Mr. Mansley Groer.

12.15—British Official Wireless News.

## Afternoon Session.

3—Pleasant Sunday Afternoon Service, Central Mission Wesley Church, conducted by Rev. J. H. Olin.

4.30—Close down.

## Evening Session.

5.45—Children's Hour. Billy Bunny and his Brer Rabbit Trio. Music by the Trio. Stories: The Lost Garden, Loveliest Life and the Unfinished Tower.

6.30—Close down.

## Night Session.

7—Service from St. Paul's Cathedral, Evening (Choral).

From the Studio.

8.40—Messrs. Ramsey and Robertson, (by permission of J. C. Williamson Ltd.), duet.

8.45—Studio Orchestra.

8.55—Tom Bruderick (by permission of J. C. Williamson Ltd.), tenor.

9.2—Reginald Bradley and Agnes Fortune, organ and violin.

9.10—John Byrne (by permission of J.

- C. Williamson Ltd.), bass.  
 9.17—Studio String Orchestra.  
 9.24—Gordon Ramsay (by permission of J. C. Williamson Ltd.), tenor.  
 9.31—"Argus" News Service.  
 9.41—Vernon Robertson (by permission of J. C. Williamson Ltd.), baritone.  
 9.48—Gilbert and Sullivan Co. Double Quartette (by permission of J. C. Williamson Ltd.).  
 10—God Save The King.

## MONDAY, JUNE 28.

## Midday Session.

- 12 Noon—Time Signal. Latest Australian Cricket Eleven scores, by courtesy of Reuters Ltd. British Official Wireless News from Rugby. Reuters and the Australian Press Association Cables. "Argus" and "Herald" news services. Shipping Intelligence.  
 12.45—Stock Exchange Information.  
 12.50—Meteorological Information. Weather Forecasts for Victoria, Tasmania, South Australia and New South Wales. Ocean Forecast. River Reports.  
 1—Time Signal.  
 1.1—Studio Orchestra.  
 1.10—Edgar Harris, tenor.  
 1.17—Tasmania Tiernan, 'cello solo.  
 1.22—Studio Orchestra.  
 1.30—Community Singing, by the Students of the University of Melbourne, transmitted from the Club House, University Grounds, Carlton.  
 2—Close down.

## Afternoon Session.

- 3—Latest Australian Cricket Eleven scores, by courtesy of Reuters Ltd.  
 3.1—Studio Orchestra.  
 3.20—Mr. J. B. Locke: Travel and Adventure during Sojourn in Persia.  
 3.25—E. Mason Wood, baritone.  
 3.32—Studio Orchestra.  
 3.42—Lillian Crisp, soprano.  
 3.50—Miss Flora Pell, Supervisor of Domestic Arts, Education Department.  
 3.55—Domestic Economy.  
 4.10—Walter Smith, cornet solo.  
 4.18—E. Mason Wood, baritone.  
 4.25—Studio Orchestra.  
 4.30—Lillian Crisp, soprano.  
 4.37—Studio Orchestra.  
 4.45—"Herald" News Service. Stock Exchange Information. Latest Australian Cricket Eleven scores, by courtesy of Reuters Ltd.  
 5—Close down.

## Evening Session.

- 5.45—Children's Hour. Little Miss Koobaburr will tell a bushranger story of Black Thursday in Victoria during the middle of last century, the story of Little Miss Muffet, and the tale of Mrs. Tittlemouse; also answers to letters and birthday greetings.  
 6.40—Latest Australian Eleven Scores, by courtesy of Reuters Ltd. "Argus" and "Herald" News Services. Reuters and the Australian Press Association Cables.  
 6.53—Weather Synopsis; Shipping Movements.  
 6.57—Stock Exchange Information.  
 7.2—Fish Market Report by J. B. Borrett Ltd.  
 7.4—River Reports.  
 7.6—Market Reports by the Victorian Producers Co-operative Co. Ltd.; Haymarket Sales; Poultry, Grain, Chaff, Hay, Straw, Jute, Dairy Produce, Potatoes and Onions. Market prices of Oranges and Lemons by the Victorian Central Citrus Association Pty. Ltd.

## Night Session.

- 7.20—Under the auspices of the New Settlers' League: Mr. Vincent Ellingworth—How Big Brother Movement appealed to the British Parent at Wembley.

- 7.40—Under the auspices of the Department of Agriculture: Mr. H. W. Davey, Chief Orchard Supervisor—Planting and Pruning Fruit Trees.  
 8—Mr. C. J. Tatham: Talk—Seymour.  
 8.15—"Belle of New York," a musical comedy in two acts.  
 10.45—Latest Australian Cricket Eleven scores, by courtesy of Reuters Ltd. "Argus" News Service. Meteorological information. British Official Wireless News from Rugby.  
 11—God Save the King.

## TUESDAY, JUNE 29.

## Midday Session.

- 12 noon—Time Signal. Latest Australian Cricket Eleven scores, by courtesy of Reuters Ltd. British Official Wireless News from Rugby. Reuters and the Australian Press Association cables. "Argus" and "Herald" News Services. Shipping Intelligence.  
 12.45—Stock Exchange Information.  
 12.50—Meteorological Information; Weather Forecasts for Victoria, Tasmania, South Australia, and New South Wales; Ocean Forecast; River Reports.  
 1—Time Signal.  
 1.1—Studio Orchestra.  
 1.10—Joe Delaney, tenor.  
 1.17—Studio Orchestra.  
 1.27—Yetta Landau, a reading from W. M. Thackeray.  
 1.37—Joe Delaney, tenor.  
 1.44—Reginald Bradley, violin.  
 1.50—Studio Orchestra.  
 2—Close down.

## Afternoon Session.

- 3—Latest Australian Cricket Eleven scores, by courtesy of Reuters Ltd.  
 3.1—Will Page and his Popular Players of Carlton.  
 3.10—Billie Jones, soprano.  
 3.17—Matron Moreland: Infant Welfare.  
 3.32—Jack O'Hagan, baritone.  
 3.39—Will Page and his Popular Players of Carlton.  
 3.49—Tasmania Tiernan, 'cello solo.  
 3.54—Billie Jones, soprano.  
 4.1—Will Page of Fashion Talk.  
 4.18—Jack O'Hagan, baritone.  
 4.23—Walter Smith, cornet solo.  
 4.31—Will Page and his Popular Players of Carlton.  
 4.45—Latest Australian Cricket Eleven scores, by courtesy of Reuters Ltd. "Herald" News Service. Stock Exchange Information.  
 5—Close down.

## Evening Session.

- 5.45—Children's Hour. Answers to Letters and Birthday Greetings; Stories by Mary Gurnea; Little Red Ridinghood in Verse. Story for the little ones: A Tiny Robber. A talk to girls on Class Types and to boys on Flags. Mr. Jack Stewart will tell the children an easy way to become a ventriloquist.  
 6.40—Latest Australian Cricket Eleven scores, by courtesy of Reuters Ltd. "Argus" and "Herald" news services. Reuters and the Australian Press Association Cables.  
 6.53—Weather Synopsis; Shipping Movements.  
 6.58—Stock Exchange Information.  
 7.2—Fish Market Reports by J. B. Borrett Ltd.  
 7.4—River Reports.  
 7.6—Market Reports by the Victorian Producers Co-operative Co. Ltd.; Haymarket Sheep Sales, Poultry, Grain, Chaff, Hay, Straw, Jute, Dairy Produce, Potatoes and Onions.

## Night Session.

- 7.20—Mrs. Soward: French Talk—L'Oiseau Blue.

- 7.40—Under the Auspices of the University Extension Board: Mr. J. T. Sutcliffe—Trades Unionism To-day.  
 8—Grand Concert, transmitted from the Yarra St. Methodist Church, Geelong.  
 10.45—Latest Australian Cricket Eleven scores, by courtesy of Reuters Ltd. "Argus" News Service. British Official Wireless News from Rugby. Meteorological Information.  
 11—God Save the King.

## WEDNESDAY, JUNE 30.

## Midday Session.

- 12 noon—Time Signal. Latest Australian Cricket Eleven scores, by courtesy of Reuters Ltd. British Official Wireless News from Rugby. Reuters News Service. Shipping Intelligence.  
 12.45—Stock Exchange information.  
 12.50—Meteorological information. Weather forecasts for Victoria, Tasmania, S.A. and N.S.W. Ocean forecast. River reports.  
 1—Time Signal.  
 1.1—Le Gassick's Quartette.  
 1.15—Jack O'Hagan, baritone.  
 1.22—Le Gassick's Quartette.  
 1.40—Jack O'Hagan, baritone.  
 1.47—Le Gassick's Quartette.  
 2—Result of Glendewar Trial Hurdle Race. Oaklands Hunt Club Races.  
 2.30—Result of Glendewar second race.

## Afternoon Session.

- 2—"Leaves it to Jane," a musical comedy in two acts.  
 3.35—Public Schools Football, by "The Captain." Xavier v. Geelong Grammar.  
 4.45—Studio Orchestra.  
 3.55—Public Schools Football, by "The Captain."  
 3.57—Miss S. V. Parker: Miss Amy Wilson Carmichael and the Miracle of Dohnavier.  
 4.12—Joe Delaney, tenor.  
 4.20—Public Schools Football, by "The Captain."  
 4.25—Studio Orchestra.  
 4.35—Sister Peck: Mothercraft.  
 4.45—Joe Delaney, tenor.  
 4.50—Public Schools Football, by "The Captain."  
 4.55—"Herald" News Service. Stock Exchange information. Latest Australian Cricket Eleven scores, by courtesy of Reuters Ltd.  
 5—Close down.  
 Note: The results of the Oakland Hunt Club Races will be given at the following times:—  
 3.30—Result of the Gworie Handicap, Woodlands Hunt Steeplechase, Bolinda Steeplechase.  
 4.17—Result of the Springbank Corinthian Handicap.  
 4.45—Result of the Arundel Handicap.

## Evening Session 6 to 7.15

- 5.45—Children's Hour. Billy Bluegram will answer letters and give birthday greetings.  
 6—Musical programme for children arranged by Mr. Fritz Hart.  
 6.40—Latest Australian Cricket Eleven Scores, by courtesy of Reuters Ltd. "Argus" and "Herald" News Services. Reuters and the Australian Press Association Cables.  
 6.53—Weather Synopsis. Shipping movements.  
 6.58—Stock Exchange information.  
 7.2—Fish Market Reports by J. B. Borrett Ltd.  
 7.4—River Reports.  
 7.6—Market Reports by the Victorian Producers Co-operative Co. Ltd.; Haymarket Sheep Sales, Poultry, Grain, Chaff, Hay, Straw, Jute, Dairy Produce, Potatoes and Onions. Market prices of Oranges and Lemons by

the Victorian Central Citrus Association Pty. Ltd.

## Night Session.

- 7.20—Under the Auspices of the Department of Agriculture: Mr. R. Crowe, Exports Supt.—Market Reports and Comments.  
7.40—Mr. P. W. Pearce: Physical Culture Talk.  
8—Choral Association of Victoria Annual Choirs' Contest, transmitted from the Auditorium.  
10.30—Capt. Peters: Books, Wise and Otherwise.  
10.45—Latest Australian Cricket Eleven scores, by courtesy of Reuters Ltd. "Argus" News Service. Meteorological Information. British Official Wireless News from Rugby.  
11—God Save the King.

## THURSDAY, JUNE 1.

## Midday Session.

- 12 Noon—Time Signal. Latest Australian Cricket Eleven scores, by courtesy of Reuters Ltd. British Official Wireless News from Rugby. Reuters and the Australian Press Association Cables. "Argus" and "Herald" News Services.  
12.15—Community Singing under the auspices of Community Singers and Concert Goers' Association, transmitted from Assembly Hall, Collins St., Melbourne.

- 1.45—Stock Exchange Information; Meteorological information; Weather Forecast for Victoria, Tasmania, South Australia, and New South Wales.  
2—Close down.

- 2.40—"The Captain": Public Schools Football, Scotch v. Wesley.  
2.45—Close down.

## Afternoon Session.

- 3—Latest Australian Cricket Eleven scores, by courtesy of Reuters Ltd.  
3.1—Station Trio: Bessie Gunnson, violin; Gusma Tiernan, cello; Agnes Fortune, piano.  
3.10—"The Captain": Public Schools Football, Scotch v. Wesley.  
3.15—Marie Lethbridge, soprano.  
3.22—"Mary Gumleaf": A talk on—What does "The Home" Mean? and humorous sketch.  
3.40—"The Captain": Public Schools Football, Scotch v. Wesley.  
3.45—"The Station Trio."  
3.52—Vera Patterson, contralto.  
3.55—"The Captain": Public Schools Football, Scotch v. Wesley.  
4—Marie Lethbridge, soprano.  
4.7—Bessie Gunnson, violin.  
4.12—Vera Patterson, contralto.  
4.20—"The Captain": Public Schools Football, Scotch v. Wesley.  
4.25—Dorothy Ruxburgh, viola solo.  
4.30—Latest Australian Cricket Eleven scores, by courtesy of Reuters Ltd. "Herald" News Service. Stock Exchange information.  
4.45—Evensong, transmitted from St. Paul's Cathedral.  
5.30—"The Captain": Public Schools Football, Scotch v. Wesley, final scores. Close down.

## Evening Session.

- 5.45—Children's Hour. Answers to letters and birthday greetings. Stories by Mary Gumleaf. Poems: "When Mother is Tired; Mary, the Children's Friend. Story for the littlest ones: The Blackbirds. For the girls: The Tree that Wanted to Die. Boys: Hokey Pokey's Magic.  
6.40—Latest Australian Cricket Eleven scores, by courtesy of Reuters Ltd. "Argus" and "Herald" News Ser-

vices. Reuters and the Australian Press Association Cables.

- 6.53—Weather synopsis. Shipping movements.  
6.58—Stock Exchange information.  
7.2—Fish Market Reports by J. R. Borrett Ltd.  
7.4—River Reports.  
7.6—Market Reports by the Victorian market Sales, Poultry, Grain, Chaff, Producers' Co-operative Co. Ltd. Hay, Straw, Jute, Dairy Produce, Potatoes and Onions.

## Night Session.

- 7.20—Tramways: Mr. C. H. Wickham, Works Manager, Melbourne and Metropolitan Tramway Board—The Building and Maintenance of a Tram Car.  
7.49—Under the auspices of the Health Association: Mr. W. Adam—Oral Hygiene.  
8—Agnes Fortune, piano solo.  
8.10—Tod Collins: Football Talk.  
8.30—Leo O'Donnell and the Embassy Band. (During the intervals—Jack O'Hagan, baritone, and Lawson Graham, tenor.)  
10.10—Latest Australian Cricket Eleven scores, by courtesy of Reuters Ltd. "Argus" News Service. British Official Wireless News from Rugby. Meteorological Information.  
11—God Save the King.

## 3AR

Wavelength, 484 metres. Power, 1600 watts.

## SATURDAY, JUNE 26.

## Morning Session.

- 11.30—The British Official Government Press, received by 3AR's operator from Rugby Super Wireless Station, England; The Age News Bulletin.  
12—Time Signal Chimes from the tower of the General Post Office, Melbourne; 1st Weather Forecast; Events of the Day.  
12.30—Stock Exchange News; Foreign Exchanges, supplied by Messrs. Thos. Cook & Son.  
12.35—Market Reports.  
12.40—Musical Selections.  
12.55—Mail Notices; Shipping Movements.  
1—Close down.

## Afternoon Session.

- Williamstown Races: Results immediately after each Race and at half-hourly intervals.  
2—Result of Maiden Hurdle.  
2.25—Result of Trial Weight.  
2.40—Hoyt's Premier Orchestra.  
3.10—Result of Post Philip Hurdle.  
3.15—Hoyt's Premier Orchestra.  
3.40—Description while racing of Williamstown Steeple.  
3.50—Hoyt's Premier Orchestra.  
4—Time Signal Chimes from the tower of the G.P.O., Elizabeth St. Studio barometer and thermometer readings.  
4.10—Result of Point Cook Handicap.  
4.15—Hoyt's Premier Orchestra.  
4.45—Result of Explanade Welter.  
4.55—The Evening Amusement Guide.  
5—Time Signal Chime from the G.P.O., Elizabeth St. Studio barometer and thermometer readings; Close down.

## Early Evening Session.

- 6.45 to 7.30—The Children's Corner by Uncle Peter.

## Evening Session:

- 6—Time Signal Chime from the G.P.O., Elizabeth Street. Studio barometer and thermometer readings; the British Official Wireless Press, received by 3AR's operator from Rugby Super Wireless Station, England; Sporting News; Local News.

8.15—Dance Night. The Rhythmic Dance Orchestra under the direction of Mr. George Lewis, relayed from the Maison De Luxe, Broadway, St. Kilda.

9.30—Week-End Traveller's Information: Supplied by the Victorian Railway's Department and Tramways Board.

9.50—The Maison De Luxe Dance Orchestra.

10—Time Signal Chime from the G.P.O., Elizabeth St. Studio barometer and thermometer readings; Result of Billiard Tournament, Tattersall's Club.

10.5—The Maison De Luxe Rhythmic Dance Orchestra.

11—National Anthem and Close down.

## SUNDAY, JUNE 27.

## Morning Session.

10.30—The Bells from St James' Old Cathedral.

11—Service from the Collins Street Independent Church, preacher, The Rev. J. Ernest James, B.D.

## Afternoon Session.

Transmission from the South Melbourne, St. Vincent De Paul's Orphanage, Selections by the St. Vincent De Paul's Boys Brass Band.

4—Close down.

## Evening Session.

7—Service from the Collins St. Independent Church, preacher, Rev. J. Ernest James, B.D.

8.00—From the Studio: Misses Macfie, MacGregor and Mercer, Instrumental Trio.

8.35—Miss Gladys MacDowell, contralto.

8.42—Miss Sheila Macfie, cello.

8.49—Mr. R. F. Parsons, baritone.

3.50—Miss Margaret Mercer, violinist.

9—Mr. G. Yorke Ray, Literary Talk, The Boy Carlyle.

9.10—Miss Gladys MacDowell, contralto.

9.14—Miss Sheila Macfie, cello.

9.12—Mr. Leo Szaman, baritone.

9.25—Misses Macfie, MacGregor and Mercer, Instrumental Trio.

9.30—The Eclipse Grand Orchestra, relayed from the Eclipse Theatre, Port Melbourne.

9.50—The "Age" News Bulletin, exclusive to 3AR.

9.55—National Anthem and close down.

## MONDAY, JUNE 28.

## Morning Session.

11.30—The British Government Wireless Press, received by 3AR's operator from Rugby Super Station, England; The Age News Bulletin.

12—Time Signal Chimes from the tower of the General Post Office, Melbourne; 1st Weather Forecast; Events of the Day.

12.3—Musical Selections from Hoyt's De Luxe, relayed from Bourke Street.

12.30—Stock Exchange News.

12.35—Market Reports.

12.40—Musical Selections.

12.55—Mail Notices; Shipping News.

1—Close down.

## Afternoon Session.

Riebownd Poulis. Results immediately after each Race and at half-hourly intervals.

2.30—Hoyt's Premier Orchestra, under the direction of Miss Ella Brien, relayed from Hoyt's De Luxe, Bourke Street.

3—Mr. Claude Kette, will give Piano-Player Interpretations.

3.15—Hoyt's Premier Orchestra.

4—Time Signal chimes from the tower of the G.P.O. Studio barometer and outdoor thermometer readings; 2nd Weather Forecast.

4.5—Hoyt's Premier Orchestra, relayed from the De Luxe, Bourke Street.

4.55—The Evening Amusement Guide.

5—Time Signal Chime from the G.P.O., Elizabeth St. Studio barometer and thermometer readings. Close down.



## Early Evening Session.

6.45 to 7.30—The Children's Corner by Uncle Ned.

8—Time Signal chimes from the tower of the G.P.O., Elizabeth St.; Studio Barometer and outdoor thermometer readings; The British Official Wireless Press; Result of the Billiard Tournament at Tattersall's Club.

8.8—Mr. Eddie Graham, undefeated Light Weight Champion of Australia, will talk on "Jujitsu."

8.35—Transmission from Sutton's Music Warehouse, Bourke Street; Spry's Dance Orchestra.

8.46—Mr. Harcourt French, tenor.  
8.54—Spry's Dance Orchestra.

9.12—Piano solos.  
9.21—Mr. Harcourt French, tenor.  
9.29—Spry's Dance Orchestra.

9.40—Piano solo.  
9.46—Melogram Phonograph.  
9.56—Spry's Dance Orchestra.

10—Time Signal Chimes from the G.P.O., Elizabeth St.; Studio Barometer and outdoor Thermometer readings; The Age News Bulletin, exclusive to 3AR.

10.10—Hoyt's Premier Orchestra, relayed from Hoyt's De Luxe, Bourke Street.  
10.40 Approx.—National Anthem.

## TUESDAY, JUNE 29.

## Morning Session.

11.30—The British Government Wireless Press, received by 3AR's operator from Rugby Super Station, England; The Age News Bulletin; Express Train Information.

12—Time Signal, Chimes from the tower of the G.P.O., Elizabeth St., Studio barometer and thermometer readings. In Weather Forecast, Events of the Day.

12.30—Stock Exchange News.  
12.35—Market Reports.  
12.40—Musical Selections.

12.55—Mail Notices; Shipping Movements.  
1—Close down.

## Afternoon Session.

2.30—The Parma Trio.  
2.37—Mr. Jarace C. Croft (humorous entertainer).

2.44—Miss Marjorie Vince (violinist).  
2.51—Mr. Jarace C. Croft (humorous entertainer).

2.59—The Parma Trio.  
3.9—Miss Ettie Bernard (contralto).  
3.15—Mr. Arthur Kempton.

3.22—Miss Dolly Haines (cello solo).  
3.29—Mr. Arthur Kempton (baritone).  
3.36—Miss Marjorie Vince (violin).  
3.43—Miss Ettie Bernard (contralto).

3.50—Madame Sartoria (humorous monologue).  
3.57—The Parma Trio.

4—Time Signal Chime from the G.P.O., Elizabeth St., Studio barometer and thermometer readings. 2nd Weather Forecast.

4.55—The Evening Amusement Guide.  
5—Time Signal Chimes from the tower of the General Post Office.

## Early Evening Session.

6.45 to 7.30—The Children's Corner by Uncle Peter.

8—Time Signal chimes from the tower of the G.P.O., Elizabeth St.; Studio Barometer and outdoor Thermometer Readings; Result of Billiard Tournament, Tattersall's Club; The British Official Wireless Press.

8.11—Mr. Evan Mackinnon, B.A., B.Sc., of the Institute of Science and Industry, will speak on "Textile" Care and Selection.

8.29—Miss Margaret Groom (contralto).  
8.36—Miss Margaret Stewardson (violinist).  
8.43—Mr. Vere Williams (baritone).  
8.50—The Debung String Quartette.

9.1—Mr. Francis Drake will speak on Symbols, The Eye of Hoop.

9.25—Miss Margaret Groom (contralto).  
9.32—Miss Margaret Stewardson (violinist).  
9.39—Mr. Vere Williams (baritone).  
9.46—The Debung String Quartette.

10—Time Signal chimes from the tower of the G.P.O., Elizabeth St.; Studio Barometer and Thermometer Readings; Result of Billiard Tournament, Tattersall's Club.

10.1—The Age News Bulletin, exclusive to 3AR.  
10.10—Hoyt's Premier Orchestra, relayed from Hoyt's De Luxe, Bourke Street.

10.40 Approx.—National Anthem.

## WEDNESDAY, JUNE 30.

## Morning Session.

11.30—The British Government Wireless Press, received by 3AR's operator from Rugby Super Station, England; The Age News Bulletin; Express Train Information.

12—Time Signal, Chimes from the tower of the General Post Office, Melbourne; In Weather Forecast; Events of the Day.

12.5—Musical Selections; Result of Billiard Tournament, Tattersall's Club.  
12.30—Stock Exchange News.  
12.35—Market Reports.  
12.40—Musical Selections.

12.55—Mail Notices, Shipping Movements.  
1—Close down.

## Afternoon Session.

Oaklands Hunt Club at Moonee Valley.  
2—Result of Trial Hurdle.  
2.30—Result of Gowrie Handicap.  
2.35—Hoyt's Premier Orchestra.

3—Description while racing of Hunt Steeple.  
3.5—The Melbourne Piano Trio.  
3.22—Miss Vera Buck (songs at the piano).  
3.30—Description while racing of Belinda Steeple.

2.35—Mr. Ronald Brearley (colliet).  
3.45—Miss Vera Buck (songs at the piano).  
3.47—Mr. Pettifer (violinist).  
3.54—The Melbourne Piano Trio.

4—Time Signal, chimes from Clock Tower, Elizabeth Street; Studio Barometer and outdoor Thermometer Readings; 2nd Weather Forecast.

4.10—Result of Corinthian Handicap.  
4.35—Hoyt's Premier Orchestra.  
4.40—Result of Arundel Handicap.

5—Time Signal Chime from the G.P.O., Elizabeth St., Melbourne; Studio barometer and thermometer readings; close down.

6.45 to 7.30—The Children's Corner by Uncle Ned. (1) The Bedtime Story; (2) Talk on Hobbies.

8—Time Signal Chime from the G.P.O., Elizabeth St., Melbourne; Studio barometer and

outdoor thermometer readings; The British Official Wireless Press; Result of Billiard Tournament at Tattersall's Club.

8.5—Transmission from the North Melbourne Methodist Church, Organ Recital and Concert.

Approx. at 10 p.m. The Age News Bulletin, exclusive to 3AR; Result of Billiard Tournament at Tattersall's Club.

## THURSDAY, JULY 1.

## Morning Session.

11.30—The British Government Wireless Press, received by 3AR's operator from Rugby Super Station, England; The Age News Bulletin; Express Train Information.

12—Time Signal, Chimes from the tower of the General Post Office, Melbourne; In Weather Forecast; Events of the Day.

12.30—Stock Exchange News.  
12.35—Market Reports.  
12.40—Musical Selections.

12.55—Mail Notices; Shipping Movements.  
1—Close down.

## Afternoon Session.

2.30—Hoyt's Premier Orchestra, under the direction of Miss Ella Erlson, relayed from Hoyt's De Luxe, Bourke Street.

4—Time Signal Chimes from G.P.O., Elizabeth St., Melbourne; Studio Barometer and Thermometer Readings; 2nd Weather Forecast.

4.55—The Evening Amusement Guide.  
5—Time Signal Chime from the G.P.O., Elizabeth St., Melbourne; Studio barometer and thermometer readings. Close down.

## Early Evening Session.

6.45 to 7.30—The Children's Corner by Uncle Peter.

## Evening Session.

8—Time Signal Chime from the G.P.O., Elizabeth St., Melbourne; Studio barometer and outdoor thermometer readings; Result of Billiard Tournament, Tattersall's Club; The British Official Wireless Press.

8.1—Special Pig and Calf Report, supplied by Messrs. McPhail, Anderson & Co.

8.8—Captain Dentman, V.D. will speak on "Stamps," (King George Period) 5th Series.

8.29—Miss Ada Smith (mezzo-contralto).  
8.36—Mr. James Simpson (cornetist).  
8.43—Mr. William Chapman (baritone).

8.50—Mr. Albert Thompson (violinist).  
8.57—Mr. Fred Dennis (bass).  
9.4—Dr. William Maloney, M.P., will speak on "The Florida Hedges Fund."

9.25—Miss Ada Smith (mezzo-contralto).  
9.32—Mr. James Simpson (cornetist).  
9.39—Mr. William Chapman (baritone).

9.46—Mr. Albert Thompson (violinist).  
9.53—Mr. Fred Dennis (bass).

10—Time Signal, chime from Clock Tower, G.P.O., Elizabeth St.; Studio barometer and outdoor thermometer readings; Result of Billiard Tournament, Tattersall's Club.

10.1—The Age News Bulletin, exclusive to 3AR.  
10.5—Hoyt's Premier Orchestra.  
1.40 approx.—National Anthem and Close down.

## FIRST WOMAN PIRATE.

The doubtful honour of being the first woman wireless pirate in Britain goes to Mrs. Jane Phillips, of Shirley, Warwickshire, who was fined £1 for working a set without a license. Leave it to Janet!

## BROADCASTING NEW STYLE.

From a Belgian contemporary: "The station at Dorchester (England), is actually one of the most powerful broadcasting installations; it has at present 800 transmitters."

Doubtless the ideal arrangement would be to provide one transmitter for each listener.

# HERE AND THERE

## RADIO FILLS THE GAP.

Broadcasting station 2BL, Sydney, has agreed to a request by the Federal Government to give permission for the Administrator of the Island of Nauru to use for the information of the inhabitants of the Island, the news which is broadcast nightly by 2BL. The Island of Nauru is over 2,000 miles from Sydney. It was taken from the Germans during the war, and as the population is too scanty to support a newspaper the information sent out by wireless is of great value to the inhabitants.

Only two months ago, the Administrator of Norfolk Island, which is 500 miles from Sydney, obtained a radio set, by means of which, news broadcast from Sydney is picked up and published for the information of the Islanders.

## RADIO FROM AEROPLANE.

Broadcasting station 2FC (Farmer's) is making arrangements for a broadcasting demonstration from a flying aeroplane. The date of the event has not been fixed.

There have been many difficulties to overcome, the principal being to find an aeroplane in Australia large enough to carry a transmitting set together with an engineer and an announcer in addition to the pilot. The machine will have a load of nearly half a ton and the only plane available for the purpose belongs to the Civil Aviation Department in Melbourne.

Through the good offices of the President of the Aero Club in Sydney (Captain Geoffrey Hughes, M.C.), the officer in charge of civil aviation (Colonel Brinsmead) has agreed to lend the machine as soon as an opportunity affords for a pilot to fly it across from Melbourne to Sydney. The intention of station 2FC is to take the air for a couple of hours on a Sunday afternoon and while the plane is flying over the metropolitan area the announcer will describe all he can see and talk to his listening-in audience about radio in general.

Only once before in Australia has a stunt of this kind been attempted. The feat will involve transmitting from the aeroplane on a short wavelength. The messages will be picked up at 2FC, Pennant Hills, and sent out with increased power on the station's usual wavelength, 1100 metres. The aeroplane stunt is of interest as Farmer's have already broadcast from the floor of Sydney Harbour and from the bowels of the earth at Jenolan, have transmitted an account of the beauties of the limestone caves.

## LOUD SPEAKERS ON SHIPS.

A new field for the loud-speaker reproduction of music has been found in the requirements of British passenger ships for music and entertainment. In order to cater for the pleasure of passengers and to supplement the usual musical arrangements, a number of ships are now being equipped with Marconi orchestra repeater installations. Music from the ship's orchestra or from a gramophone, or received by wireless, can be reproduced in any part of the ship by means of this installation.

## TROTSKI'S RADIO PREDICTION.

A prophecy involving the seizure of the Eiffel Tower wireless station by revolutionaries was made by Leon Trotski, in addressing the society known as the "Friends of Radio," in Moscow, on March 2nd.

After emphasising the importance of radio as a means of binding together Russian cities and villages, M. Trotski said: "We must be prepared for the moment when the French proletariat will seize the Eiffel Tower and proclaim itself master in all civilised languages. Then we must answer: 'We hear you and are ready to help you!'".

## NEW PROBLEM FOR INDIAN AMATEURS.

The pending arrival of a general scheme of broadcasting in India has prompted an investigation of amateur transmitting licenses. At present, several radio clubs hold licenses to broadcast, but whether this privilege will remain in their hands is open to doubt. Many individual amateurs hold licenses for experimental transmission, whilst being forbidden to transmit anything in the nature of a broadcast programme.

In connection with the above, a well known British business man, recently arrived in Australia from India, blames the amateur for killing broadcasting in India. The Marconi Company installed at great expense, two stations, each of 1500 watts, one at Bombay and the other at Calcutta, and commenced broadcasting. At once amateur radio clubs demanded and obtained permission to broadcast. In a very short time, dozens of clubs, using anything from 5 to 100 watts, and mostly very badly modulated, were putting out second and third rate matter in active opposition to the Marconi Company. The resultant fiasco forced the Company to close down its stations and by the tone of the announcement above it seems that the amateurs are shortly to be shown where to get off.

The GRODAN  
NEW  
**Hinged Spider Former** 1/9

6<sup>D</sup> 1/3

9<sup>D</sup> PAIR

The utility of our new hinged Spider Plug in Formers will appeal to those desiring the best results from their sets. Easy to wind. Fits all Standard Sockets.

The Grodan Folding  
**LOOP AERIAL**

Takes up no more room than an umbrella. Most attractively finished. Can be used anywhere. When open the loop stands 33in. high; closed, 19in.

39/6 each.

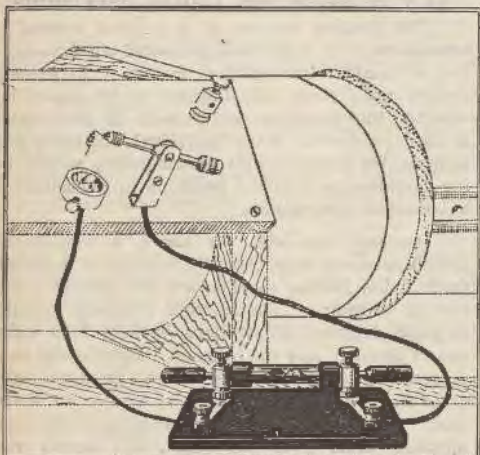

GRODAN PERICON DETECTORS.

Carefully tested on actual Broadcasting before leaving our factory. The crystals being the very best obtainable are enclosed in a dust and moisture-proof glass tube. Can be attached to any existing crystal set in a few minutes. Guaranteed to give service and satisfaction .. 8/9 each



There's a use for "ECS" in every set.  
Plug and Socket. 9d.  
The latest Terminal and Wonder Plug.

## Raytron Crystals

Better than the best of the rest.

- Special Galena . . . . . 2/- each
- Selected Bornite . . . . . 2/- each
- Synthetic Zincite . . . . . 2/- each

Pericon Redls. 1/6.

ASK YOUR DEALER FOR THE BOX WITH THE WINDOW.

Should any difficulty be experienced in obtaining these lines, communicate direct with

## Grose & Daniell

HOLDEN STREET (off Eveleigh St.)  
REDFERN, SYDNEY

'Phone: Red. 373

## To Users of Dry Cell Valves

### Who want to know about the "Power Plus" True Blue.

An answer to your questions:

The True Blue "Power Plus" is a small True Blue made to fit and function in small Sockets.

It is a full power Valve, taking up to 6 volts on the filament, and 30 or more on plate, as in the well-known Standard True Blue.

The "Power Plus" True Blue has been placed on the market to meet the demand of the users of Dry Cell Valves, who wish to change to full power Valves without the expense of rewiring and new sockets.

Dry Cell Valves are a poor substitute, and are only satisfactory in Midget Valve Sets.

The "Power Plus," like the big True Blue, is the only non-microphonic Valve in the world, has 3 to 4 times the hfa, and much greater volume and purer tone than any Dry Cell Valve. True Blues will improve your Set.

**PARSONS & WHITTEMORE LTD.**  
30 MARKET STREET, SYDNEY

## EVERYTHING GOOD IN RADIO

TRUE BLUE VALVES  
HEATH LOW LOSS CONDENSERS  
REACTONE LOW LOSS COILS  
TUNGSTALITE CRYSTALS  
HEATH RESISTANCE COUPLED UNITS  
• HEATH RESISTANCE COUPLED KITS  
ULTRA HANDY BATTERY CHARGERS  
TWIN BULB BATTERY CHARGERS  
MEGGIT GRID LEAKS AND RESISTANCES  
SUPER HETERODYNE KITS  
CROSLBY SETS  
DYNAC RHEOSTATS AND POTENTIOMETERS  
CARDWELL AUDIO TRANSFORMERS  
FIXED CONDENSERS, DIALS, PLUGS, SWITCHES

Dealers: Write for Price List.

**PARSONS & WHITTEMORE Ltd.,**  
30 Market Street Sydney.

## EFFICIENT SERVICE

is assured when you place your order for  
replacement parts or accessories with us

Full range of all well known  
:: parts always in stock. ::



We have a special Mail Order  
Department at your service.

**BURGIN ELECTRIC CO. LTD.**

WIRELESS MANUFACTURERS, IMPORTERS, AND DISTRIBUTORS

340 KENT STREET, SYDNEY

Telegrams: "BURGINECO," Sydney

Box 734, G.P.O.

Phones: City 141; City 9886; M 3069.



# Genuine

## R.C.A. RADIOTRONS

bear the above seal



### RADIOTRON UX 199

Equally serviceable as a detector or as a high efficiency radio or audio frequency amplifier. Extremely economical in operation. Adaptable to dry battery operated sets.

Filament voltage 3. Current .06 amps. Price 13/6

### RADIOTRON UX 201A

The standard all round flexible storage battery valve—good in any detector or amplifier circuit—sure to give the best results at the lowest operating cost.

Filament voltage 5. Current .25 amps. Price 13/6

### RADIOTRON UX 120

New dry cell Radiotron for use in the last stage of audio amplification only. Exceedingly high filament emission. Volume equal to that of two UV199's.

Filament voltage 3. Current .125 amps. Price 17/6

### RADIOTRON UX 112

A new power valve similar to the familiar UV201A, but several times as powerful. Designed for use as last valve in accumulator operated sets, when it will deliver far more energy than the average loud speaker requires. Two of these valves will give exceptional results. Filament voltage 5. Current .5 amps.

AT ALL DEALERS

Price £2/5/0

Amalgamated  Wireless  
(Australasia) Ltd.

97 Clarence St., Sydney

167/9 Queen St., Melbourne

King and King Chambers, Queen St., Brisbane



# Radiotron

# MURDOCH'S RED SPOT SALE

As a basis—all lines of Merchandise throughout the Great Store (except a few Proprietary lines) have been reduced

**10%**

In over-stocked lines, however, immense stocks have been sacrificed to ensure quick despatch, many lines clearing as low as

**Half Price**

*Genuine Reductions in Radio Equipment*

## VALVE SETS

**SPECIAL 1 VALVE SET**—noted for its remarkable efficiency. Will bring in Interstate Broadcasting. Complete with Valve and Batteries—ready for installation.

Usually ... .. £7/7/-

**Red Spot Price £5 8s.**

**MURDOCH'S WONDER 3 VALVE**—a set of the highest order both in workmanship and efficiency. Receives all Interstate Broadcasting. Supplied with Valves, B Batteries, Accumulator, Loud Speaker and Aerial.

Usually ... .. £27/-

**Red Spot Price £24 6s.**

## Usually

**27/6** Murdoch's Headphones, 2000 and 3000 ohms. Fox pair.

**59/6** Western Electric Loud Speaker.

**22/6** Marconi D.E.R. Valves. Reduced 33 per cent.

**20/-** B.T.H. B5 on U.V.198 type base.

## ORMOND SQUARE LAW CONDENSERS.

	R.S.P.	Usually.	R.S.P.
<b>14/9</b> .001	<b>12/6</b>	12/6	.0003 Plain
<b>13/4</b> .0003 (Vernier)	<b>11/6</b>	12/-	.00025 Plain

**14/9** .001 ... **12/6** 12/6

**13/4** .0003 (Vernier) **11/6** 12/-

## Red Spot Price

**16/6**

**35/-**

**15/-**

**13/6**

**10/6**

**10/6**

## THE "BRUNO" CONDENSER

Just arrived, and in time for Sale! The famous "Bruno" Low Loss Condenser, as used by Australia's leading Experimenters. These Condensers can be used for several different capacities. Limited quantity only.

.0005 Size. Usually 42/-.

**Red Spot Price 37/10**

.001. Usually 49/-.

**Red Spot Price ... 44/2**

Hundreds of similar reductions. See the Wireless Window Displays, in Park Street!

**POSTAGE PAID TO YOUR DOOR.**

When ordering by Post kindly mention "Wireless Weekly."

# MURDOCHS

**In Park Street 1<sup>st</sup> Sydney.**

"Specialists in all Radio Equipments."

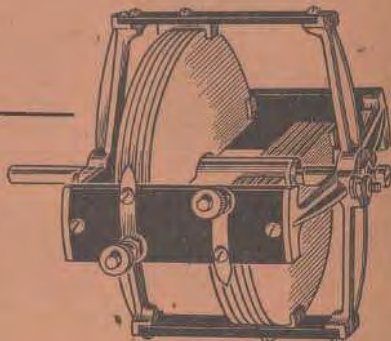

Greater Volume  
Increased Power



with

# RADIOTECHNIQUE

## Scientific Super Valves

Without Any Extra Cost

### RADIO MICRO.

LOW CONSUMPTION, DETECTOR, OR AMPLIFIER, FILAMENT  
3-3.5 VOLTS; .00 AMPS.; PLATE 40-80 VOLTS . . . . .

PRICE . . . . . 13/6

### SUPER AMPLI.

DETECTOR, HIGH AND LOW FREQUENCY AMPLIFIER.  
TYPE R46 (201A) 5 VOLTS, .25 AMPS. PLATE 40-80 VOLTS . . . . .  
TYPE R41, 3.8 VOLTS, .4 AMPS., PLATE 40-80 VOLTS . . . . .

PRICE . . . . . 13/6

OBTAINABLE WITH ENGLISH OR AMERICAN BASE.

If difficulty is experienced in obtaining supplies, communicate with Australasian Representatives.

**BROWN & DUREAU**, BROUGHTON HOUSE, CLARENCE STREET, SYDNEY;

and at Melbourne, Perth, Wellington and Auckland, N.Z.



# Genuine

## R.C.A. RADIOTRONS

bear the above seal

### RADIOTRON UX 199

Equally serviceable as a detector or as a high efficiency radio or audio frequency amplifier. Extremely economical in operation. Adaptable to dry battery operated sets.

Filament voltage 3. Current .06 amps. **Price 13/6**

### RADIOTRON UX 201A

The standard all round flexible storage battery—good in any detector or amplifier circuit—sure to give the best results at the lowest operating cost.

Filament voltage 5. Current 25 amps. **Price 13/6**

### RADIOTRON UX 120

New dry cell Radiotron for use in the last stage of audio amplification only. Exceedingly high filament emission. Volume equal to that of two UV199's.

Filament voltage 3. Current .125 amps. **Price 17/6**

### RADIOTRON UX 112

A new power valve similar to the familiar UV201A, but several times as powerful. Designed for use as last valve in accumulator operated sets, when it will deliver far more energy than the average loud speaker requires. Two of these valves will give exceptional results. Filament voltage 5. Current .5 amps.

**AT ALL DEALERS**

**Price 22/5/0**

Amalgamated  Wireless  
*Australasia Ltd.*

97 Clarence St., Sydney  
King and King Chambers, Queen St., Brisbane

167/9 Queen St., Melbourne



# Radiotron





Type RS1, Metal Case.

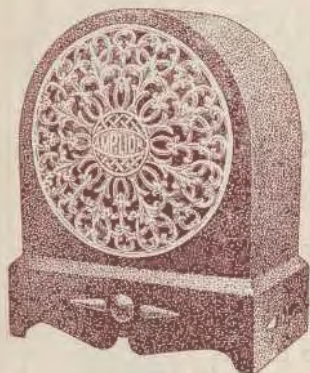

Type R.S.2.

# AMPLION

## Radiolux Amplion

### The Natural Tone Loud Speaker

**P**URE, smooth, natural tone and realistic reproduction in great volume, combined with artistic appearance and compact form are qualities which render this unique amongst contemporary instruments. Totally different in design, in appearance and in results, the Radiolux Amplion is a **REVELATION IN LOUD SPEAKER QUALITY.**

The Radiolux Loud Speaker, although of the enclosed type, possesses the same strength of tone as the ordinary horn type. It is the only hornless Loud Speaker in which the volume has not been decreased.

British Made Radiolux are now available for immediate delivery, but Australian made cabinets are shortly being produced, and will be finished to match any style of furniture or radio set—practically to suit customers' requirements. Place orders now, as delivery will be made in strict rotation.

Radiolux Amplions are finished in both wood and metal cases.

**OBTAINABLE FROM ALL RADIO MANUFACTURERS AND DEALERS**

Sole Distributors for Australasia :

**Amalgamated Wireless**  
(Australasia) Ltd.

Sydney - Melbourne - Adelaide - Brisbane - Perth - Wellington (N.Z.)

Sole Agents:—Amplion (A/sia) Ltd. 56 Margaret Street, Sydney.

Managing Director:—William Blegg.