

RADIO

IN AUSTRALIA
& NEW ZEALAND

Registered at G.P.O., Sydney, for transmission by post as a newspaper.

VOL, II

DECEMBER 24, 1924

No. 46



MAKE THIS A RADIO CHRISTMAS!



IS NOT COMPLETE WITHOUT THESE "WIRELESS PRESS" PUBLICATIONS.

THE WIRELESS ATLAS OF THE WORLD.

Comprising 75 Maps in a Handy Book Form.

Numerous requests for an Atlas of the World, showing all Wireless Stations, have been reaching us. We have, therefore, reprinted from "The Year Book of Wireless Telegraphy and Telephony," the Map Section, which has proved so useful.

Every station is keyed so that at a glance you can differentiate between Public, Direction-Finding, Official, Military, Private, Aviation or Broadcasting Stations.

PRICE 2/-. Postage 3d.

PRACTICAL AMATEUR WIRELESS STATIONS.

An "Experience" Book.

By J. A. WHITE.

Containing the best suggestions of thirty-three experimenters on Building, Installing and Operating Experimental Stations for Radio Communication. 136 Pages Profusely Illustrated.

PRICE 4/-. Postage 3d.

"THE WIRELESS AGE."

America's foremost Radiophone Review, is the most popular American wireless magazine published monthly.

PRICE, 2/-. Annual Sub., 24/-.

AN INTRODUCTION TO RADIO

Vols. 1 and 2.

Here is the real beginner's book — language not too technical — illustrations carefully selected — diagrams right — comprehensively dealing in Vol. 1 with an introduction to Radio, radio telephony and transmitting and receiving outfits. Vol. 2 gives an explanation of technical terms, vacuum tubes, and shows how to set up receivers and transmitters.

Price TWO VOLUMES **6/-**

POCKET DICTIONARY OF TECHNICAL TERMS USED IN WIRELESS.

By HAROLD WARD.

Do you ever come across wireless terms you cannot understand? This book, which will comfortably fit your vest pocket, contains over 1500 definitions. It's a handy little companion every wireless man should have with him.

PRICE 3/-. Postage 3d.

HOW TO CONDUCT A RADIO CLUB.

By E. E. BUCHER.

Covers Parliamentary procedure, indoor and outdoor experiments, 5,000-mile receiving sets, vacuum tube amplifiers and detectors and many other subjects.

Paper Cover. 148 pages. Fully illustrated.

PRICE 4/-. Postage 3d.

OTHER PUBLICATIONS INCLUDE:—

"CONQUEST,"

England's popular magazine of Science, Invention and Industry, different from all other similar magazines. It is the "story" magazine of accomplishment in many different fields. Monthly.

PRICE, 1/6. Annual Sub., 18/-.
per copy. 6 months, 9/-.

"THE WIRELESS WORLD"

England's Pioneer Wireless Journal, liked by all experimenters. Weekly.

PRICE, 6d. Annual Sub., 26/-.
6 months, 13/-.

OBTAINABLE FROM ALL LEADING BOOKSELLERS OR

THE WIRELESS PRESS

(Specialists in Wireless Books and Magazines)

"Gloucester House,"
44 Market Street,
MELBOURNE.

97 Clarence Street,
SYDNEY.

Australasia Chambers,
WELLINGTON,
N.Z.

RADIO

IN AUSTRALIA
& NEW ZEALAND.
Incorporating "Sea, Land and Air"

CONTENTS

Copyright Registered.

Volume II.	DECEMBER 24, 1924	Number 46
		Page.
Radiatorial—		
Vale 1924—Salve 1925		603
Crystal-Valve Circuits		604
Low-Loss Tuners		605
One-Tube Circuits		610
Low-Loss Inductance Coils		614
"Radio" Visits 2BL		616
English Amateur Operators		619
Broadcasting and Listening-in		620
Notes on Aerials		622
Re-building H.T. Batteries		626
Radio and the Antarctic		632
Strange Effect of an Ocean Breeze		633
An All-Wave Tuner		634
The United States Broadcasting Stations		636
Education by Radio		637
What is the Matter?		642
Queries Answered		644
Movements of Marine Wireless Officers		645

Published by

THE WIRELESS PRESS

Gloucester House,
44 Market Street, Melbourne.

97 CLARENCE ST.,
SYDNEY.

Australasia Chambers,
Wellington, N.Z.

PRICE, 6d. per Copy.

Subscription Rate: 10/- per annum (26 issues) throughout Australia and New Zealand; Foreign Rate, 12/6 (26 issues).

Obtainable from all Booksellers and News Agents, also the N.S.W. Bookstall Co., Ltd.—all branches.

Canada and U.S.A.:
The Wireless Press Inc.,
326 Broadway,
New York City.

Wholesale Distributing Agents:
GORDON & GOTCH (AUSTRALASIA), LTD.,
Sydney, Melbourne, Adelaide, Brisbane, Launceston, Perth,
Auckland, Wellington, Christchurch, and Dunedin, N.Z.

Great Britain:
The Wireless Press Ltd.,
12-13 Henrietta St.,
London, W.C.2.

Let's all be glad!

NOW THAT ALL RADIO DEALERS CAN SUPPLY

"PICO" Head-phones
25/-

These strong but very sensitive Headphones will do your set full justice. They are light and comfortable on the head, but they will give you years of service. They are as delicately precise as a valuable watch, but they are made for durability.

When at your dealers, see the

NEW UNITED Home Assembly Sets

PUT YOUR OWN TOGETHER ————— HALVE THE COST!

UNITED DISTRIBUTORS, LTD.,

(Wholesale only),

72 CLARENCE ST., SYDNEY.

592 BOURKE ST., MELBOURNE.

And at Brisbane, Perth, Adelaide, Hobart and Wellington.

WHY NOT GIVE

"PICO"

HEADPHONES

for

XMAS?



The "SIGNAL" AUDIO FREQUENCY TRANSFORMER

A Most Appreciable Christmas Gift to anyone who owns a Valve Set

It is a gift they will appreciate every time they tune-in for the programmes—because it ensures full volume while eliminating howl and distortion.

21/-

SECURES IT AT ANY RADIO DEALER'S.

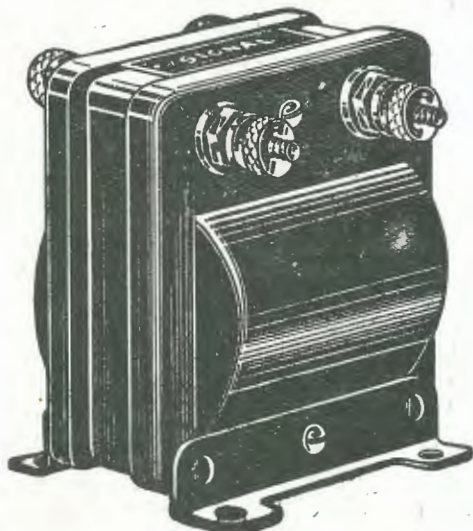

The "Signal" Transformer is strong and reliable—made in Australia exclusively for United Distributors Limited. That is why it costs only 21/-, although it is equal in every way to the most expensive imported varieties. Compare it.

5 to 1 and $3\frac{1}{2}$ to 1 and $2\frac{1}{2}$ to 1 ratios.

United Distributors Limited

(Wholesale only),

72 Clarence Street,
Sydney.

592 Bourke Street,
Melbourne.

And at Adelaide, Perth, Brisbane, Hobart and Wellington.



Radiotorial

Vale 1924—Salve 1925



IN the past this magazine has more or less successfully strived to make its "editorials" as novel in treatment and subject-matter as possible. It has been considered that "leading articles," as they are most generally written to-day, are a rather *un-necessary* evil, but as this evil still does exist, although, no doubt, before long, as he can see who would read the writing on the wall, they will become, to quote a misguided genius, "as dead as the dado," there is no reason why they should not be made pleasant during their declining days by making the type of matter as delightful to read and—let it be said—as pleasurable to write, as possible. To fulfil these requirements it is considered that *Radio's* Radiotorials should be a little "different." Usually, they are: But with the Radiotorial of the Christmas issue it is another matter—quite another matter.

AS Yuletide is a season when one looks back and thinks of, and, perhaps, regrets the things one did or might have done, and then, looking to the future, forms those inevitable New Year resolutions and plans—few of which, alas! will ever be carried out—so it is with the Radiotorial of the "Good Cheer" issue. One simply must pause a moment, draw breath, review the past and re-adjust one's sights on the target of the future.

IT is safe to say that hardly will there be published a holiday issue of any periodical in this Continent which will not contain a "leader," the theme of which will be in the nature of that outlined above. On this occasion, at least, the Radiotorial of the Christmas issue of *Radio in Australia and New Zealand* will be in no way different to those appearing in other Australasian journals.

NO other publications in Australia, do they concern sport, the stage, Labour questions, the film business, financial matters, primary products or other interests or callings, can look back on such a year as this closing one has been for Wireless.

IT is not intended to here recapitulate the triumphs of 1924; they are too fresh in our minds and so numerous that space precludes. Nor is it necessary to emphasise the proportions to which the general trade and the public interests have grown in contradistinction to the way they grew in 1923—the veriest schoolboy can realise that. What can be done, however, is to take the year as a whole and utilise the knowledge and experience gained from it for the betterment of the coming one.

WHILE on the subject, it might be as well as to state that Wireless should always be taken as a whole and a little less should be said concerning individual effort.

WIRELESS is a whole, and only by keeping this fact in mind can it make the swift and phenomenal progress that is its lawful right. Broadcasting, broadcast listening, experimental Wireless, both amateur and commercial, and all the other branches of the industry can be likened to those grotesquely fret-sawed segments of wood which we in our youth used to spend many absorbed hours in putting together, so as to evolve a wooden ball which, once completed, we could roll about to our heart's

content. If a segment were inserted in its wrong place, a portion of it would protrude from the sphere and this would retard or even stop its progress.

SUCH a simile illustrates the state of Wireless to-day.

As long as various parts or interests fit properly together, the ball will roll on as fast as we can push it. Let there be friction or lack of co-operation and the rate of progress will be hindered or even stopped. This would be unthinkable.

CO-OPERATION is the big secret of progress. Let us, then, at this time of "Peace on earth and goodwill toward men," adapt the spirit of Co-operation as our settled policy in all affairs affecting the progress of Wireless.

SEASON'S GREETINGS.

The Proprietors, Editor and Staff of "RADIO" extend their best wishes to all readers for a Merry Christmas and a bright and prosperous New Year.

Crystal-Valve Circuits

Employing Switches for changing a Crystal to a Valve Receiver or vice versa



In this, our Christmas issue, we publish several circuits of general interest to all broadcast listeners and of particular interest to many.

No doubt, a great number of listeners-in who have, with their modest crystal sets, enjoyed broadcast programmes for months past, will be requiring a valve set for Christmas, or a valve that can be added to their present apparatus.

But we must not blame Master or Miss Inexperience. We are the only ones to blame through not having a switch in circuit that would enable the children to listen-in if they wished to do so, without damaging our receiver.

It is quite a simple matter to add a switch or two and then the fears of burned-out valves will be allayed.

Fig. 1 shows the wiring and switching arrangement for a crystal-valve combination panel. C1 is the aerial

S1 are in the positions F, and I, respectively. When it is desired to use the valve instead of the crystal, the only change necessary is to throw switch S over the position G and S1 to J. This connects the aerial to a single valve regenerative set and, after the usual filament and anode battery adjustments are made, the valve receiver is in operation.

It will be noticed in Fig. 1 that a separate coil C is used for the crystal, "B" the aerial coil being common to both the secondary coil C of the crystal circuit and reaction coil D of the valve circuit.

Fig. 3 is a diagram of the single valve regenerative receiver which is connected in circuit when the switches S and S1 are placed in positions G and J respectively.

The coils for use with this receiver are of the usual honeycomb type and the necessary sizes for the various wave-lengths may be selected from the tables published in past issues of *Radio*. The aerial tuning condenser C1 is variable and has a capacity of .001 mfd., whilst the variable condenser C2 used in conjunction with the crystal circuit has a capacity of .0003

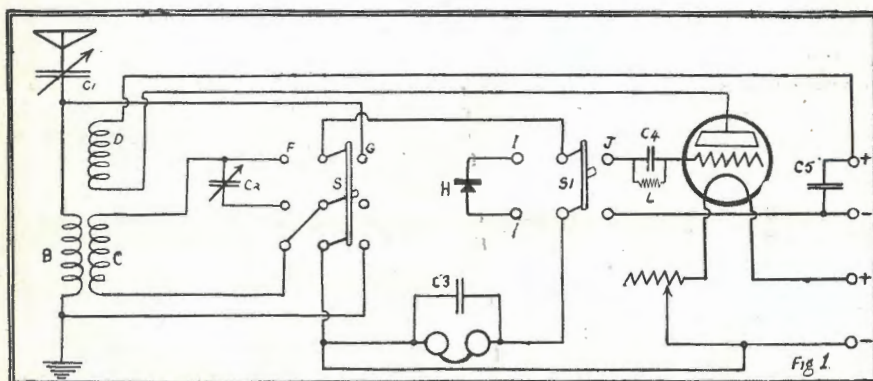

Wiring diagram of Crystal and Valve Combination Panel. Details are as follows: C1, Aerial Tuning Condenser; C2, Secondary Condenser of Crystal Circuit; C3 'Phone Condenser; C4, Grid Condenser; C5, High Tension Battery By-pass Condenser; B, Aerial Coil; C, Crystal Circuit Secondary Coil; D, Valve Regenerative Coil; S and S1, Change-over Switches; L, Grid Leak.

Having secured one, the necessary steps should be taken to protect it, as it is known the cost of a piece of crystal is about one shilling, but a valve—well, if one has been unfortunate enough to short one's high tension battery across the filament—one knows what valves cost.

How many experimenters and listeners-in have returned home at night to find that their pet valve—"the best valve in Sydney"—has been burned-out, owing to Master or Miss Inexperience endeavouring to tune-in the midday time signals or afternoon musical session? Quite a number (ourselves included).

Hours and hours of explanation and pools of tears will not replace that particular valve—because it was "the best valve in Sydney."

tuning condenser and B the aerial coil. By carefully following the diagram it will be seen, when the switch S is in the position marked F, and switch S1 in the position marked I, we have a complete inductively coupled crystal receiver, which will give results equally good as any other receiver of the loose-coupled type.

Those who are using a carborundum crystal should experience no more trouble changing over to the switching arrangement, than the users of non-potentially operated crystals, such as Galena. If carborundum crystal is at present being used, connect the potentiometer, battery and crystal between points I in place of H.

Fig. 2 is a diagram of the complete crystal circuit when switches S and

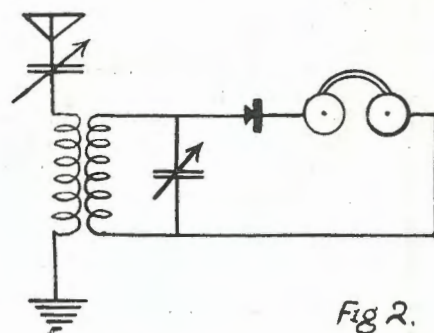

Diagram of Loose-coupled Receiver employed when switches S and S1 are in positions F and I respectively.

mfd. C3, the telephone fixed condenser, has a value of .001 mfd, the grid condenser C4, .0003 mfd. fixed capacity and C5, a by-pass fixed condenser of 1mfd., the latter being included in the circuit as a path for oscillating currents, which would be, if the condenser were not inserted,

considerably damped by the resistance of the H.T. battery. The grid leak L has a variable resistance of 2 to 5 megohms, and the filament a resistance that will vary according to the make of valve in use.

We feel sure a great number of readers will be pleased with the wiring diagram of this arrangement, as many have asked for a wiring sketch for a panel of similar design.

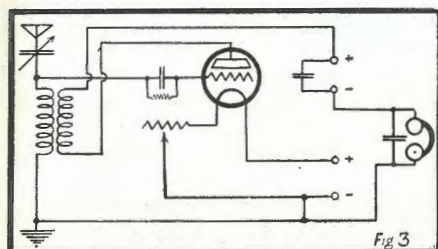
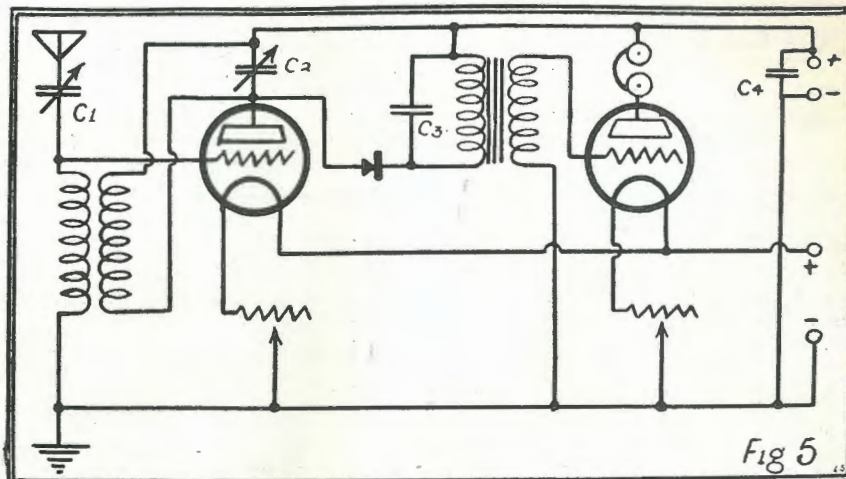

Diagram of Single Valve Regenerative Receiver connected to the aerial when switches S and S1 are in positions G and J respectively.

It is possible there are others who do not wish to discard an old friend—the loose-coupler, which has never given any trouble and always brought in good, clear, distortionless signals: There is really no need to do so; one can add a valve to the present set and decidedly stronger signals will be the result. This can be done at a very small cost.

Fig. 4 is a diagram of an ordinary loose-coupler, connected by means of a one to three ratio low frequency transformer to a single valve circuit. It will be found that this receiver is easy to construct and stable and simple to operate. However, particu-

negative lead, the case in most circuits, it will be readily seen, that by connecting the IS (input secondary) lead to the negative of the filament a resistance of anything up to 40 ohms is connected in series with the transformer secondary and a varying



Wiring diagram of a combined Crystal and Two-valve Receiver, using first valve as a Radio Frequency Amplifier, adopting the Tuned Anode method and a Crystal Detector, with one stage of Audio Frequency Amplification.

lar care should be taken when joining the transformer in circuit, to see that the input secondary lead is taken to the negative lead of the A battery and not to that of the filament.

As the filament resistance is in the

negative potential is applied to the grid. But should the lead be taken direct to the negative of the A battery, the resistance of the circuit is reduced and the grid receives a non-varying negative bias.

The values of the various condensers in this circuit are similar to those of Fig. 1: C1 is variable and has a capacity of .001 mfd.; C2, fixed, .001 mfd.; C3, fixed, .001 mfd.; C4, fixed, 1 mfd., and C5, .0003 mfd. variable. As in the other circuits, the value of the filament resistance will depend upon the type of valve used.

Fig. 5 is a diagram of a two-valve and a crystal combination, using one valve for radio frequency amplification, a crystal detector and the second valve as an audio frequency amplifier.

The radio frequency amplification in this circuit is of the tuned anode method, and as tuned anode was dealt with in the last issue of *Radio* (No. 45), it will not be necessary to deal

(Continued on page 618.)

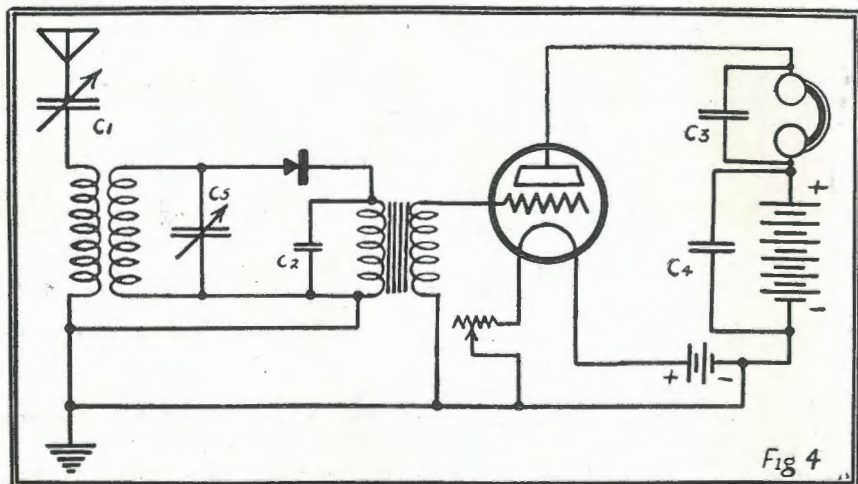

Wiring diagram of a Loose-coupled Receiving Set with one stage of Transformer-coupled Audio Frequency Amplification.

Do not worry what to give your friends for Christmas. Make them a present of a Receiving Set or Radio Parts.

Low Loss Tuners

By S. KRUSE.

Technical Editor of "Q.S.T."
(Reprinted from "Q.S.T.")

WE have lately received so many communications from our readers asking for details and particulars of a good Low Loss Receiver, that it has been decided to re-publish the article below which is reprinted from "QST," and has already appeared in "Radio."

WE can thoroughly recommend this receiver, as we have received scores of letters from highly satisfied experimenters who built it on the first occasion and they invariably state that the results they achieved were far beyond their most optimistic expectations.



HERE has developed a most remarkable amount of interest in the design of good tuners lately, but the past few years most of us have been using very, very poor tuners—and most of us would not even believe that they were poor.

WHAT IS A GOOD TUNER?

Let use decide at the start what a good tuner must do—then we can start thinking of the ways to make it do those things. Very well, a good tuner must—

1. Cover the right wave-length range;
2. tune sharply; that is, cut out unwanted signals;
3. be simple and have few controls;
4. not send out a strong carrier wave when receiving C.W. with an oscillating tube;
5. be absolutely reliable, so that the same dial settings will give the same result every time;
6. be low-priced and easy to build.

These are six things that we are going to demand of our tuner. We will now think them over, but at the start I will tell you that, when we are done with requirements No. 1 and No. 2, we will automatically have taken care of the rest.

WAVE-LENGTH RANGE.

The average broadcast receiver fits the broadcast waves. The average amateur tuner is a joke that starts at 180 or 190 metres and goes up (not down) to 700 metres or so. Recently I found that one of the strongest amateur stations in Illinois for years had been using a tuner that would not go below 195 metres; the Heavens know what its upper limit was! Yet the owner of this thing was sure that "the short waves are no good—they never get to us!"

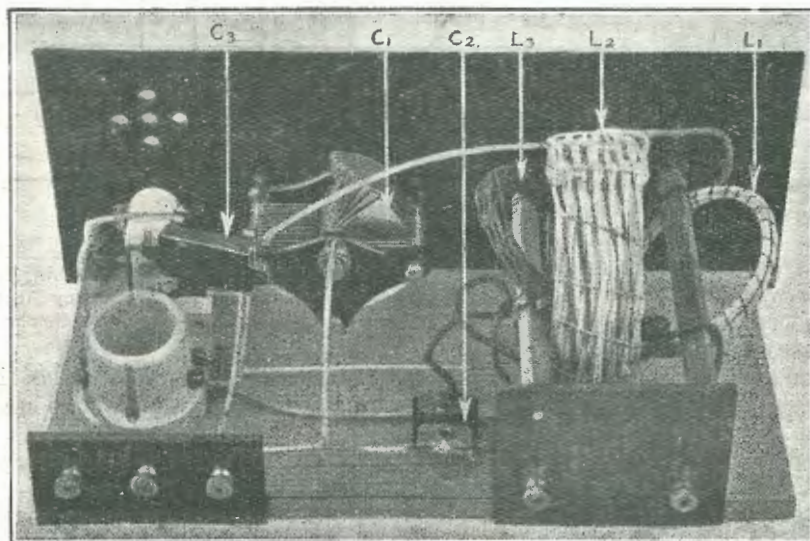

Fig. 1.

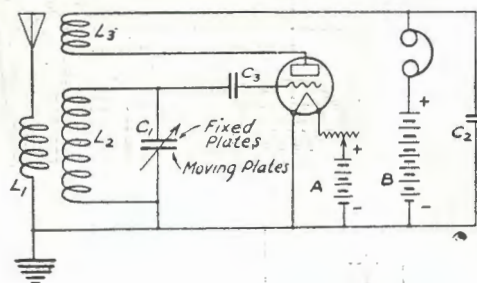

Fig. 2.



A BEAUTIFULLY SIMPLE COUPLER, BUILT BY PERRY O. BRIGGS AND USED AT 1BGF (U.S.A.).

Note the special shape of the condenser plates, suggested by Mr. Hassel; and also the low-resistance secondary coil. This rig has defeated and replaced several expensive tuners.

L1—Primary coil, six turns of No. 12 D.C.C. wire wound on 3in. tube and then tied together with thread to make it self-supporting. The coil is secured to a shaft, so that the coupling to the secondary can be varied by tilting the primary coil.

L2—Secondary coil, basket wound around 14 steel wire pegs set into a board on a 4½in. circle. The coil looks as if the wires are twisted together but this is not correct; the winding is made by passing the No. 12 D.C.C. wire outside of one peg and then inside of two as shown in the small sketch. The wire pegs are 3/32in. Before removing the winding from them the turns are secured with waxed thread.

L3—Tickler coil, 12 turns No. 18 bell wire wound on 14 pegs set in 2½in. circle. This coil is hinged also, being tilted by the tickler shaft.

C1—THE ONLY TUNING CONTROL, Fada variable condenser originally having capacity of 500 micromicrofarads (.0005 mf.), but with moving plates cut as suggested by Hassel.

C2—Fixed mica condenser, capacity 1,000 micromicrofarads, or .001 microfarads.

C3—Dubbler grid condenser—no leak used.

Wave-length range with the windings shown is 95-370 metres covering all amateurs and most broadcasting. To raise the range to cover all broadcasts increase the turns in L2 to about 40; the exact number needed will vary, as basket-wound coils cannot be made uniform by hand when using heavy wire. At the same time, it may be necessary to increase the number of tickler turns slightly to make the tube regenerate well on the upper waves.

Why is this? Partly it is a "hang-over" from the times when amateurs had a 375 metre special wave-length, and partly it is just plain carelessness.

The effect of over-large coils and condensers is a very bad one. Not only are all short-wave stations tuned in at the bottom of the condenser scale but the extra hardware introduces needless resistance. Note that in the tuners pictured in this article the range does not go above what is actually needed.

If you don't want to make a new tuner then peel some of the extra wire off your coil and get rid of the extra condenser plates, until the wave-metre tells you that you are just reaching up to 220 metres—then you can get down to 100 without trouble.

RESISTANCE AND SHARP TUNING,

A high resistance circuit will not tune sharply. There are no exceptions to this rule—a high resistance circuit will not tune sharply. Put that down as rule A—the first commandment in making any tuner that will be worth using. Just to get it down good and solid, let's say it once more, in capitals—A HIGH RESISTANCE CIRCUIT WILL NOT TUNE SHARPLY!!

Both amateur and commercial tuner-makers seem to be having an awful time in learning to believe that simple fact. They do all manner of weird things to get around it, they add more tubes, put in needless controls, invent curious circuits, and very rarely do the simple and sensible thing they should have started with—cut down the resistance of the tuned circuit. But interference increases all the time and even the slowest are now admitting that we must have sharper tuners. And quite a few are beginning to admit that the way to make sharper tuners is to use the same old circuits with lower resistances.

WHAT CAUSES THE RESISTANCE?

Before one can cut down resistances one has to know where they come from. One can divide the resistances that occur in a tuned receiving circuit into four general classes: the coil resistance, the condenser resistance, the resistance caused by things connected to the tuned circuit, and the resistance that is "coupled into the circuit."

COIL RESISTANCE.

About the worst defect of most tuners lies in the high resistance of the coils used. This resistance is not generally in the wire, at least not in the cases where wire larger than No. 16 A.W.G. (B. & S.) is used. The resistance is in the things that are near the wire—the tube on which the wire is wound, the varnish with which the coil is painted, sometimes even the insulation of the wire itself. A perfect coil would be one wound on air

and insulated with air. We can't make such a thing but we can come pretty close to it by using wedge-shaped strips, as shown in the Reinartz-type tuner of Fig. 4, or by making "basket" coils, as shown in the other two tuners. If you absolutely must wind the wire right on a tube, then at least follow the methods given by Mr. Hassel's article (*QST* for December); they are very much worth while. Above all things, avoid heavy varnishes, stranded or "Litz"

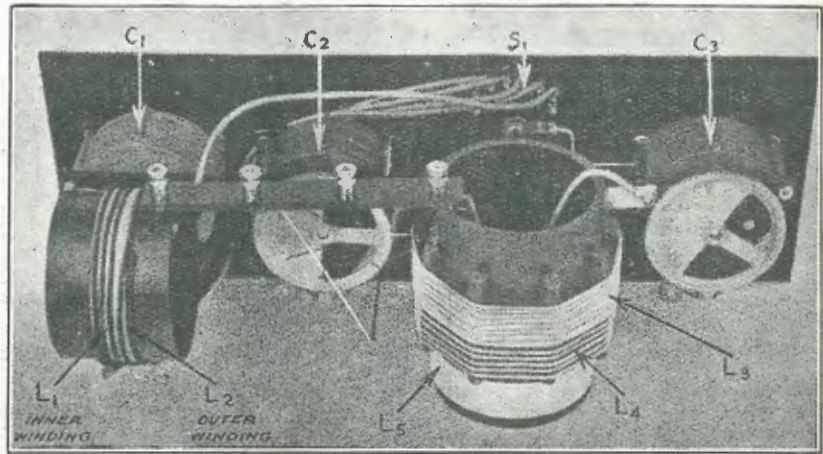

Fig. 4.



Fig. 5.

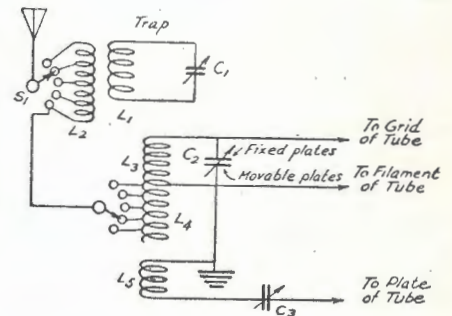

Fig. 6.

A CAREFULLY DESIGNED REINARTZ-TYPE TUNER BUILT BY BOYD PHELPS AND USED AT 1HX-10A-1XAQ (U.S.A.).

A WAVE TRAP IS BUILT INTO THIS TUNER.

- L1—Secondary of the wave trap. Thirteen turns of No. 16 D.C.C. wound on a 3/8 in. tube.
 - L2—Primary of the wave trap. Five turns of light single-conductor lamp cord wound directly over L1 and tapped at each turn to the upper switch on the panel. This switch changes the coupling of the trap to the antenna, or cuts the trap out when it is not wanted.
 - L3—12-turn secondary coil, wound of No. 16 D.C.C. wire over wedge-shaped wooden strips 3/8 in. high. These strips rest on the surface of a bakelite tube 3/8 in. in diameter. The turns of this coil are slightly spaced.
 - L4—Five-turn primary coil, wound of the same piece of wire as L3. Turns are spaced so that taps can be taken easily to the lower switch on the panel. This switch does NOT tune but adjusts the antenna coupling.
 - L5—Plate coil. Eighteen turns of No. 16 D.C.C. wire wound closely on the bakelite tube 1/2 in. below the primary.
 - C1—Trap-tuning condenser. 1,000 micromicrofarads (.001 microfarads).
 - C2 and C3—General Radio type 247 panel-mounting condensers with geared verniers. Capacity, 500 micromicrofarads (.0005 microfarads).
- Wave-length range with the windings shown is 90-225 metres, no secondary taps being needed for the amateur range. The tuning is practically unchanged with different antennas. Wave-length range of the trap is from 80 to 310 metres, allowing it to cut out troublesome 300 metres sparks such as NAO. To change this tuner to fit the broadcast range, increase the turns of the secondary coil L3 to about 40, increase the turns of the trap coil L1 to about 30.

wires, and soldering pastes. Use good heavy solid wires, tie them into place mechanically, instead of pasting them down, use resin for soldering, and keep the coils at least two inches clear of all other parts of the set—panels, condensers and rheostats included.

TAPS FROM COILS.

Tapped coils in the tuned circuit

are always poor business; only careful engineering will enable you to avoid trouble. Try to cover the wavelength range with a single coil and if you do not succeed use a separate loading coil, not too close to the main coil.

CONDENSER RESISTANCE.

As long as one uses a poor coil (like those of most tuners) it does

not make much difference whether the variable condenser is good or bad. But as soon as one uses a really good coil, there is a big difference between a not-very-good condenser and a really good one. This difference does not show up as a great increase on strong signals but in the form of a lot of new signals that were never heard before. In one particular case we found that we could read 6PL very nicely with a single tube when using a good condenser (a Cardwell in this particular test) but could barely hear him with a condenser having thick moulded composition ends. A General Radio 247 condenser gave about the same results as the Cardwell, while it was entirely impossible to hear the signals when using a fibre-insulated condenser.

WHAT MAKES A GOOD CONDENSER?

It is rather hard to set down airtight rules for recognizing a good condenser by looking at it. In general a good variable condenser is of the air type and is built so that leakage must go through long paths in material that is not too thick or wide. In the case of condensers with end-plates this means that the stator bolts should be far from the rotor bearing and that the end plates should be as thin as possible. Where

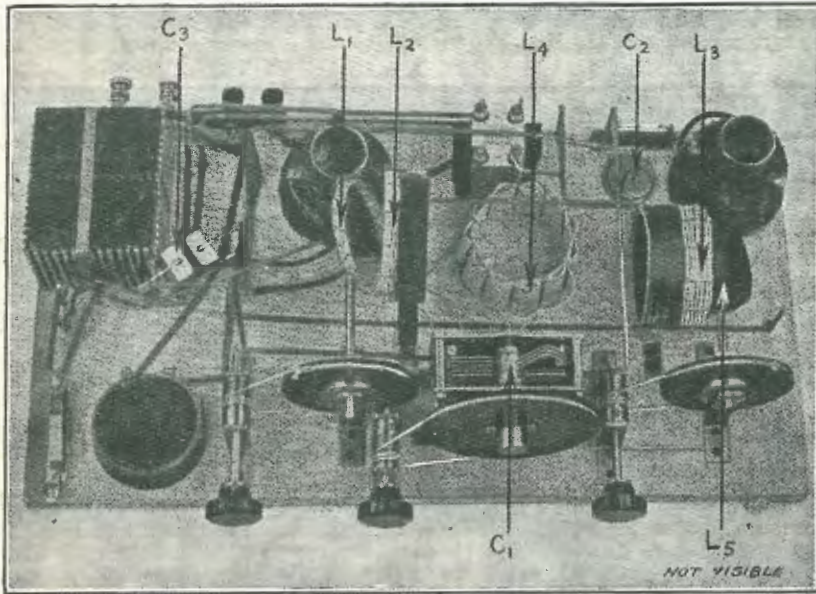

Fig. 7.

A RADICALLY DIFFERENT LOW-LOSS COUPLER BUILT BY F. H. SCHNELLE AND USED AT 1MO—IBHW—1KW (U.S.A.).

- L1—Antenna coil, five turns, 2½ in. diameter wound and mounted as in 1BGF tuner.
- L2—First section of secondary, six turns, No. 16 D.C.C. wire, basket-wound as shown below, diameter 3¼ in.
- L3—Second section of secondary, 12 turns wound same as L2.
- L4—Secondary loading coil, 30 turns, wound like L2 and L3. Other positions for this loading coil were tried but it disturbs the tickler action if not out in where indicated. A really satisfactory switching system has not been found; still the results are excellent over the entire range.
- L5—Tickler coil, 11 turns No. 28 D.C.C., 2½ in. diameter, arranged to be turned by tickler shaft.
- C1—Allen D. Caldwell, condenser, three rotary, four stationary plates, capacity about .0002 microfarads.
- C2—Grid Condenser mica, capacity, 1,000 micro-microfarads (.001 microfarads).
- C3—Mica by-pass condenser, capacity .001 microfarads.

Ratio of belted verniers is 6¼:1 on the secondary tuning condenser, but 4¼:1 on the tickler and the primary coil.

The two-part secondary completely avoids interaction between the tickler and the antenna-coupling.

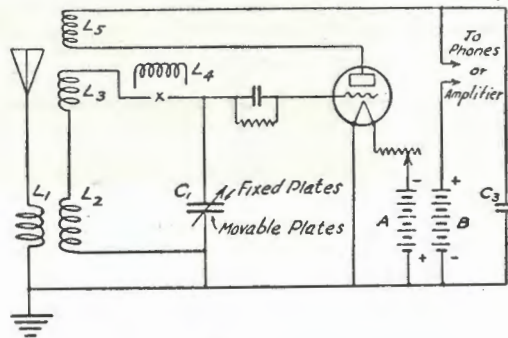

Fig. 8.

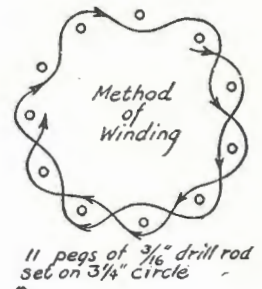

Fig. 9.

Either one of them can be moved without causing the note to slide around, as is the annoying habit of ordinary tuners.

The grid leak has a resistance of four megohms as a UV201A tube is used. Short wave range 63

to 123 metres; long wave range, 113 to 227 metres. For broadcast range, L2 should have 12 turns; L3, 20 turns; L5, 22 turns; and C1 a capacity of .0005 microfarads. Other values and dimensions unchanged.

If there are components in your receiving set that need renewal, buy them now and make sure that you will hear everything that is on the air during the Christmas holidays. It will be worth it.

insulating bushing are used they should be large and be turned spool-shaped (as in the large Coto-coil condenser) so that only the rims will touch. Naturally the use of thin insulating washers or small diameter bushings will result in a poor condenser; it will have high resistance and the zero capacity will be high. In any case, the insulating material must be good—black fibre and low-grade compositions are never good, while hard rubber or Pyrex glass can always be trusted. Moulded bakelite is also good, if carefully used, but sheet bakelite does not seem to show up quite as well, although much superior to fibre and compositons.

MEASURED RESISTANCES.

Different manufacturers measure their condenser resistances at all sorts of frequencies—the result being that no one knows anything. When writing to a maker, ask what the resistance is at 1000 cycles, a convenient value which ought to be standard. A 500 micromicrofarad (.0005 mf.) condenser, set at full capacity, should not have a resistance of over 60 ohms at 1000 cycles: a really excellent condenser will not have resistance of more than 20 or 25 ohms at 1000 cycles; assuming the same capacity.

MOUNTING THE CONDENSER.

Always connect the condenser so that the wire to the grid-leak and grid condenser comes from the stationary plates, and the wire to the filament comes from the rotary plates. It is then possible to tune in signals without trouble from "hand capacity," one of the most exasperating things in radio. This connection puts the stationary plates at high voltage, hence the screws that hold the condenser to the panel must not connect to the stationary plates. If they do, get a different condenser. Do not, however, make the mistake of throwing out a condenser, just because it has metal end plates. This construction is perfectly O.K. as long as the metal end plate is not connected to the stationary plates.

RESISTANCES "CONNECTED INTO" THE CIRCUIT.

We have finished when we have made a good coil, mounted it carefully, and connected it to a good variable condenser. The whole affair can

be ruined by connecting in a "moulded mud" socket or a camswitch of poor construction. In general, stick to the idea of not having any switches at all in the tuned circuit—it is a bad practice. Avoid composition sockets—they save 6d. and ruin the tuner. Get a good socket that is made of porcelain, hard rubber or moulded bakelite. If you are in doubt as to your socket, write to the maker and ask him what the material is.

When running leads from the "high" side of the coil to the stationary plates of the condenser, and from there to the tube, run them up in the air. Nine times out of ten it makes no difference at all, but make sure.

RESISTANCE "COUPLED INTO" THE CIRCUIT.

When one is finished assembling a good coil, a good condenser and a good socket into a tuned circuit, the whole result can be entirely ruined by too-close coupling to another circuit which has high resistance. Now an antenna circuit always has resistance that is very high; as a usual thing the resistance is 10 or more times that of a good circuit such as the one suggested. Naturally, it will spoil our beautiful secondary to couple closely to such a bad circuit—the signals will be louder but the sharpness of tuning will be entirely spoiled. The closest possible coupling is that obtained in a single circuit tuner—which is enough to account for the well-known broad tuning of that ancient circuit.

There are still other ways of coupling resistance into a circuit; any piece of metal placed near a coil will raise the resistance, so will any large piece of insulating material. Therefore, keep the coils well in the clear as stated before.

SHIELDING THE CABINETS.

Several experimenters complain that their sets do not work as well when in the cabinets as when outside. This simply means that the cabinets fit too closely—they violate the rule that coils must be kept in the clear.

Shielding around the shafts is usually worse than needless—it raises the resistance of the tuned circuits and it is quite needless if the tuner was pro-

perly designed. Where the purpose of shielding is to keep out static and such noises the cabinet should be made very large and lined with sheet copper, all parts of this lining being kept at least two inches from the tuner coils.

CUTTING DOWN RESISTANCE BY REGENERATION.

We are told by text books that regeneration has the effect of reducing the resistance of a poor input circuit. Ballantine does not agree with this and says (page 209, 1st edition) "The fact that the tickler coupling, or rather the feed-back energy, does not compensate for the actual resistance of the grid circuit, at least so far as signal response is concerned..... is also shown by the several curves, representing the effects of various inserted resistances in the tuned grid circuit."

Those who are interested in the theory of the matter may look up Ballantine's Fig. 117. It is only necessary to say that some dozens of us have experimentally checked Ballantine's statement and find that in practice he is entirely correct—regeneration does not make a poor secondary into a good one. The signal strength can be brought up by regeneration but it will never be as high as with a good secondary. Neither will the tuning ever be as sharp as if we had started with a low-resistance secondary; and, finally, the good secondary will bring into audibility some stations that cannot be heard with the poor secondary. These statements are, of course, beyond doubt when operating non-regenerative, but I am insisting that they are also true when operating regenerative and when operating with the tube oscillating.

About the worst form of the "compensation - of - resistance - by - regeneration" idea is the business of attempting to turn the antenna itself into a low-resistance circuit by regenerating into it. In the first place, the desired result does not take place—the thing never tunes sharply—and in addition there is sent out a carrier wave that makes life miserable for a five-mile radius, around, for anyone who happens to listen on the same wave-length.

(Continued on page 617.)

One-Tube Circuits

ANALYSIS of the Copp, Kauffman, Reinartz, Ambassador, Haynes, and other regenerative circuits, using honeycomb, spiderweb and other lattice-wound, as well as tube-wound coils.

(Reprinted by courtesy of "The Wireless Age.")

By JOHN R. MEAGHER.



We have selected a topic "near and dear" to a vast number of broadcast listeners; the much talked-of and little-understood subject of single-valve regenerative receiving circuits.

What immediately comes to mind when we say "single valve circuits"? Why, of course; all the numberless circuits that have appeared in radio papers. We have the Copp, the Kauffman, the Reinartz, the Ambassador, the Haynes, single, double and triple circuits of all kinds, the British aircraft, the honeycomb, the spider web,

others may be reduced to that simple one. (Shown in Fig. 1.). Let us look into the matter.

Simple tuning circuits first: In Figures A, B and C we have three tuning arrangements that look as though they were different. We can substitute B for A or A for B and, with proper design, cover the same wave-length range. The efficiency of one compared to the other depends upon the design; we are not concerned with that here. We point out merely that in effect A and B are alike. Now C is the same as B. To be sure, the shunt capacity across the

Glance now at antenna circuits. At D is shown a loose coupled or double circuit arrangement. Note that the secondary is similar to the B above and that B is the same as A. Now we know that it does not change the circuit to ground the filament in order to keep that section at ground potential, so the filament or bottom side of the secondary may be connected to the ground as shown in dotted lines. The circuit is not altered. Nor need we represent the primary as being to one side of the secondary; we may easily swing the primary about and without changing a single connection represent D as at E. Or, if we wish, instead of using a separate primary coil we may make dual use of a corresponding part of the secondary as shown at F. Here the primary is from the aerial connection on the coil to the ground.

The secondary is from the top of the coil to the ground. The primary and secondary turns may be the same as in E, so that in effect F is like E, and, as E is the same as D, all three are alike.

Again, we shall say that the effect on efficiency does not concern us here.

Consider for a moment the two main types of regenerative circuits, the tickler feedback as at G and the tuned plate as at H. The antenna circuit, does not bother us, as we have shown at D, E, and F, the similarity of apparently different antenna systems. At G the grid is excited—caused to vary in voltage with changes in plate current—which changes are caused by initial variations of grid voltage—by magnetic coupling with the plate circuit and to some extent by capacity coupling between the grid and plate. At H, the grid is excited partly by magnetic coupling between the grid and plate circuits, but mainly through the grid plate capacity. The latter is here of more importance than in the tickler feedback because the variometer may

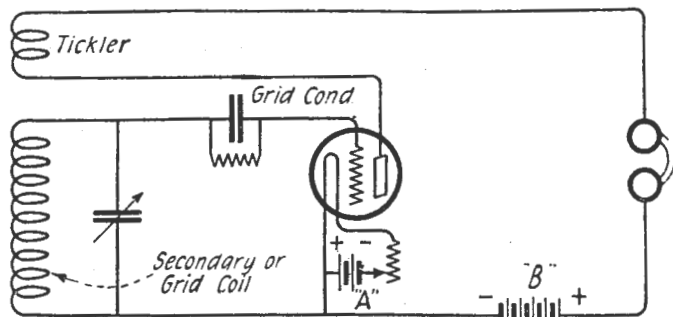

Diagram of the standard regenerative circuit

the variometer-variocoupler: and so on, without end.

There is no reason why each should not have its distinctive name and yet, as they are all like, it is not correct to say they are different from each other.

It has been said that one regenerative circuit should work as well as any other regenerative circuit, provided the design of each is equally good. Many readers accepted such a statement without a word, others doubted it and some thought it to be wrong. Among our own acquaintances in the radio field we do not know of a single person who would agree enthusiastically to the correctness of the statement. And yet now, in reaffirmation, we say that of all these circuits not one differs from the standard regenerator; even more, we say there is only one basic circuit and that all the

coil is made of two condensers in series, and a resistance R as indicated, but the condenser across the coil in B could be represented with its equivalent resistance in series, thus taking care of R. If the condensers VC and C in C are designed properly, they, in combination with the coil in C, will cover the same wave-length range as the arrangement shown at B. Thus C and B are alike, but A and B are also alike, so A, B and C are similar to each other. (C is meant to represent a single circuit aerial system with a shunt variable condenser VC; the antenna resistance is represented at R and the antenna-ground capacity at C.)

The fact that the relative efficiencies may be different, as stated above, should permit one to be sufficiently broadminded to accept the similarity of A, B. and C.

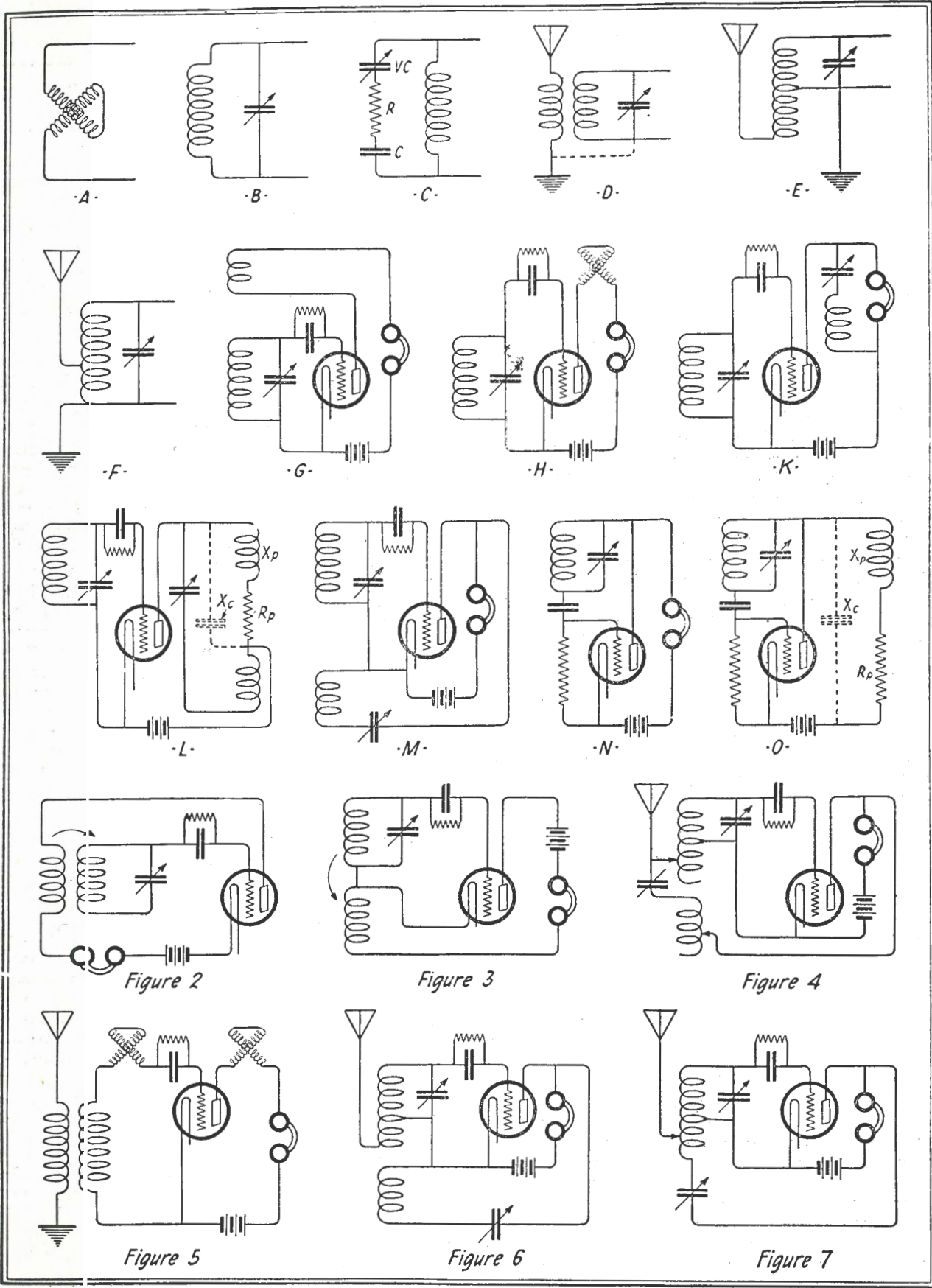

CIRCUIT DIAGRAM OF POPULAR ONE-TUBE REGENERATIVE CIRCUITS.

be set to offer a higher impedance to the plate current variations than the untuned tickler can offer. Therefore the plate voltage variations in the case of the variometer—or otherwise—tuned plate may be considerably greater than the voltage variations on the plate with tickler feedback. Consequently, the small grid-plate capacity plays a more important role with the tuned plate system. However, in both methods inductive and capacitative coupling is employed to a greater and smaller extent and, as in effect and results there is little actual difference between them, we may say that G is like H. Remember that in place of the variometer in H we may substitute the coil and condenser as from A to b.

Of course, in detail we must realise there is a difference in these circuits, but in general principle there is a similarity, which it is worth while to recognise in order to properly classify our knowledge of radio.

Now examine a method of regeneration that appears radically different from either G or H; this is the Weagent X circuit, as shown in K. Here the low frequency output is shunted by a series inductance and capacity. We like to think of this circuit as shown in L. Here the headset is represented by the inductance X_p , the resistance R_p , and the distributed capacity of the headset X_c . The total presents some low value of impedance to radio frequency variations, not sufficient, however, to make the plate voltage variations great enough to excite the grid through the small grid-plate capacity, but when the complete tuned circuit comprised of the headset (X_p , X_c and R_p), the coil and condenser is adjusted to the frequency of the plate current variations, there is a considerable drop across the headset, or in effect their impedance is increased and the action is similar to a regular tuned circuit such as H. Indeed, if we mentally substitute a condenser and coil in place of the variometer of H it will be noted that L is like H. K can also be shown, as at M, which is in every way identical with K. In M the plate coil may or may not be in inductive relation to the grid coil, if it is coupled to it, we could connect the aerial to a portion of it so the primary would be a section of the plate coil even as it may

be a section of the secondary coil as shown at F.

We have to consider still another arrangement. The Ultra-audion, as shown at N. This can be represented as at O, where the headset is shown as an inductance in series with a resistance and shunted by a condenser representing the distributed capacity X_p , R_p and X_c , respectively. This has a slight impedance to radio frequency variations, so the voltage on the plate will vary as the grid voltage variations affect the filament-plate resistance. Ordinarily the voltage fluctuations, being small because of the small impedance of the headset or external plate circuit compared to the filament-plate resistance would not be sufficient to excite the grid through the grid plate capacity so the grid is connected, not to a point (the filament) of constant voltage, but instead of the plate, which varies slightly in voltage. These variations are impressed directly on the grid through the tuned circuit and the grid or stopping condenser. Thus the voltage variations on the plate, even though they are small, serve to excite the grid. In a way, then, O can be compared to H as the grid is excited by the voltage variations on the plate and the plate voltage variations are made to excite the grid partly through the grid-plate capacity, but mostly through the direct connection from plate to grid. If the external plate circuit impedance is below a certain value in comparison with the internal plate impedance or plate-filament resistance, self-oscillation could not be secured. This condition applies also to H.

And now, for a second, let us look at the standard regenerative circuit of Figure 1. We can represent this in two similar diagrams, Figure 2 and Figure 3. At a casual glance they appear different, and indeed are known by different names, but a close inspection will show that they are alike.

Now to review the comparisons we have made, we have shown:—

A equal to B equal to C.

D equal to E equal to F.

G equal to H.

K equal to L equal to H equal to M.

N equal to O equal to H.

1 equal to 2 equal to 3.

And, of course, it can be seen that

G is equal to Figure 1 and as G is equal to H, it follows that G. H. K, L, M, N, O, 1, 2 and 3 are equal to each other. Very simple, yes?

And now, just for fun, let us compare two circuits in ordinary use that do not look at all like each other. The Reinartz and variometer variocoupler are fairly good extremes. See Figures 4 and 5.

First in accordance with (D equal E) change the antenna circuit of the variometer set to the still double circuit of E. In the secondary (Figure 5) change the tuned circuit from A to B, as we have shown A equal to B. Now for the plate circuit. We have shown M equal to L and H so we can replace H with M in our variometer set of Figure 5. This looks like Figure 6 now. And, of course, it is immediately apparent that the antenna coil may be changed as from E to F, so the primary is part of the secondary coil, or as mentioned before, we can make the primary part of some other coil coupled to the secondary, in this case the plate coil, as we have done in Figure 7. This looks a whole lot like Figure 4 now, doesn't it? Indeed, the only difference between 4 and 7 seems to be in the plate coil arrangement. Actually, they are alike, for obviously it does not matter here whether the condenser is placed between two sections of the plate coil or at either end. As a matter of fact, in operation, 7 would have a point of advantage over 4 as change of aerial inductance in 7 does not change the plate circuit adjustment as much as an equal variation in 4.

Any one-valve regenerative circuit is like the standard regenerator of Figure 1.

As a final word, the writer knows that it is essential to study this talk with an open mind. A great deal of information is presented here, which may enable the student to see circuits as a simple unit, rather than as a mass of unrelated details.

A WELL-KNOWN bird-lover was recently heard to remark that he did not know how sparrows and other small birds would get on when wireless eventually replaced ordinary land-line telegraphy, as there would be no wires for these birds to perch on!—*Punch*.

AUSTRALIA'S FIRST WIRELESS XMAS!

Special Christmas Gift

"Burginphone" Model 8

THE RECEIVER WITH A REPUTATION.

Only - - - £45

Valves, Batteries, etc., extra.

The high degree of selectivity and over-all efficiency attained in the design of the "Burginphone" is rivalled only by its rare craftsmanship and thorough ease of dependable operation.

This "Burginphone" Model 8 has proved itself capable of receiving 3 L.O. (Melbourne) in many parts of N.S.W., also 2 F.C. and 2 B.L. on a loud speaker under normal conditions.

Decide NOW and order a "Burginphone" for Christmas, which will please your family and assist in the entertainment of your friends.

Ask the nearest Radio Dealer, or write direct to us. We have an expert staff available for service anywhere.

BURGIN ELECTRIC CO. LTD.

LICENSED WIRELESS MANUFACTURERS AND SUPPLIERS,
340 KENT STREET — SYDNEY.

TELEPHONE: CITY 141, M 3069.

Low Loss Inductance Coils

A NEW form of interchangeable inductance coil having low losses and of simple construction. Air dielectric coils are becoming increasingly popular, and, in order to minimise losses, dead-end turns must be avoided. The loss due to the plug and socket holder is inappreciable, and the plug-in coil is convenient for the purpose of coupling.

By F. H. HAYNES.

(Reprinted by courtesy of "The Wireless World and Radio Review.")



ATTENTION has recently been devoted to the construction of tuning coils having minimum losses and in this connection experiments have been made with various forms of inductances for the pur-

apart from such considerations as these, there are certain fundamental aims in the design of the tuning inductances themselves which lead to improved reception.

Foremost among the causes of loss of efficiency in tuning inductances is the capacity which is present between the turns and the dielectric loss brought about by the insulating material. The writer has made tests with coils of various designs which show conclusively that coils having air dielectric are superior to those in which solid dielectrics are employed and particularly is this the case when tuning to short wave-lengths, say, below 600 metres.

The difficulty in the construction of an air dielectric coil is that of rigidly supporting the turns without adopting a design embodying a great deal of precision in instrument work. A description has already been published (in *The Wireless World*) of solenoid coils making use of insulating strips for supporting the turns. The construction consisted of shaping the turns of wire by bending round a former of suitable size and threading the spiral thus produced on to four insulating strips with uniformly spaced holes. Such a coil is not very difficult to construct, but as the number of turns increases, it will be found that the friction between the strips and the turns of wire increases so much that the finished

solenoid is apt to be tapering towards one end. It will be observed, moreover, that there is almost a limit to the number of turns that can be threaded on to the strips for as the number of turns increases, the friction becomes proportionally greater and there is difficulty in forcing the strips along the wire. Another objection exists inasmuch as the drilled strips are very liable to break, owing to their thinness and the weakening of them by the drilling of the holes.

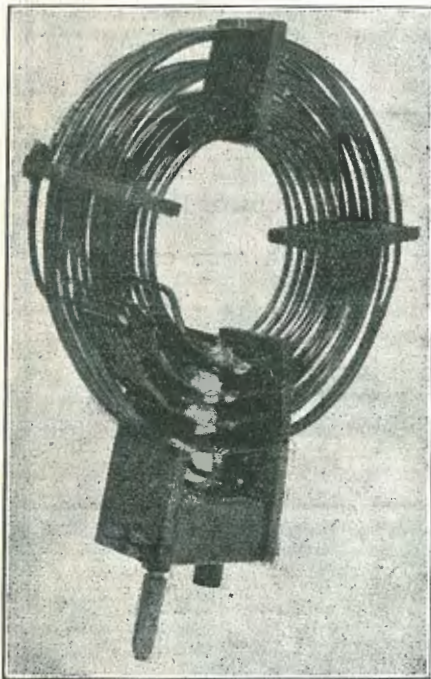

Low Loss Plug-in Coil of strong construction bound with No. 16 enamelled wire.

pose of determining those patterns which deliver a maximum energy to the detecting or amplifying apparatus. It is admitted, of course, that the ratio of inductance to capacity employed in the tuning circuit to produce maximum efficiency will depend upon the constants of the aerial system to which it is connected, but

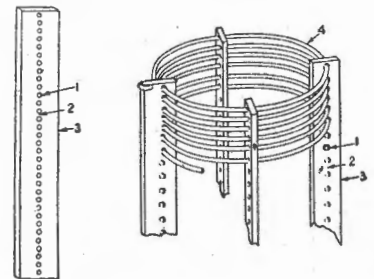

An Air Dielectric Solenoid inductance, made by threading the drilled slips on to a wire spiral.

Solenoids thus built up can be easily tapped out to tune to the required wave-length, but it became apparent that by making use of only a portion of a tuned coil that a loss of efficiency might arise, and it is therefore desirable to use coils embodying exactly the required number of turns. This leads one to make use of interchangeable plug-in coils and, although it may be suggested that the customary form of mounting with pin and socket is not good, tests reveal that providing the socket connection is well designed, the losses arising through this cause are almost negligible, whilst the great advantage is secured of interchangeability with

TEL.: CITY 4429

Charles D. Maclurcan
CONSULTING RADIO ENGINEER

MACLURCAN & LANE, LTD.
9-13 Brisbane Street, Sydney

standard coils, and inductances of various sizes. A single layer solenoid coil, too, requires more turns to produce a given inductance than a coil of more compact design, and bearing this and the foregoing points in mind, a plug-in air dielectric coil of the type shown in the accompanying illustrations was designed.

In this coil the long supporting strips with a tendency to snap are dispensed with and replaced by rectangular pieces. The difficulty of

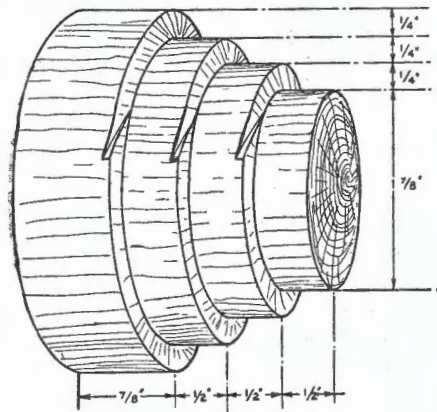

Former for shaping the turns for the several layers.

building a long single layer coil, owing to friction between turns and insulating pieces, is also overcome as considerably fewer turns are employed for each layer, whilst the finished inductance is much more compact and is interchangeable in a standard holder with other inductances.

The gauge of the wire selected for winding such a coil is governed primarily by the mechanical strength required in the finished coil. The coils shown are for tuning to wave-

lengths below 200 metres and have only twenty turns and, consequently, it was necessary to employ a heavy gauge wire such as No. 16 S.W.G. Wire as fine as No. 20 S.W.G. might be used where the spacing between the turns is less and the coil consists of a larger number of turns. The holes through which the wire has to pass should be about a third as large again as the diameter of the wire in order to simplify construction, for it will be found that the turns will lie quite uniformly together and remain quite evenly spaced as the turns will probably engage on one particular side of the holes.

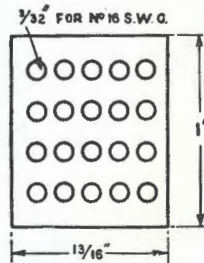

The supporting pieces: Being almost square, they are much stronger than the strips formerly employed and are easier to wind.

To shape the wire, a wooden former was made, having, in this instance, four rings of decreasing diameter and of the requisite total width. Rotating this former it was only necessary to wind each face full and then continue on to the next smaller face by passing the wire over a small cut to prevent the turns slipping. With all the four surfaces wound full the wire is allowed to run slack and is cut up into four coils, each comprising the same number of turns. It is quite easy now to thread the ebonite spac-

ing pieces on to the smallest coil and then to proceed to fit the other coils on to the ebonite pieces in turn. All four coils are thus wound in the same direction and they are connected in series by linking across the finishing end of one with the commencing end of the next.

A method of attachment for the pin and socket holder can be seen

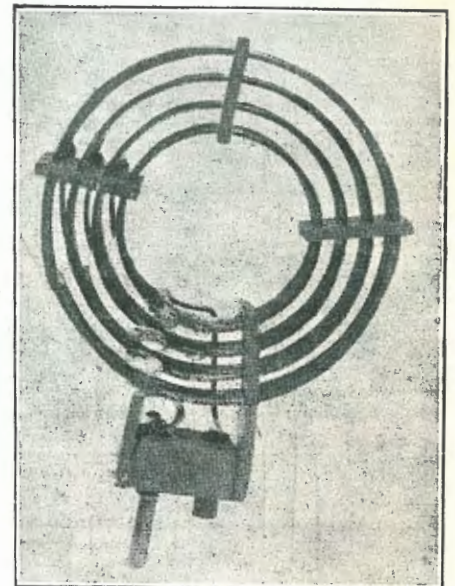

Another view, showing the spacing between the layers.

from the photograph and the tension put upon the ebonite strips which causes them to bend, produces a very firm grip upon the turns of the inductance. The wire employed in this instance, as with the coils previously described, has an enamel covering in order that the surface may not become oxidised, which would give rise to an increase in the high frequency resistance of the winding.

SPARE OUR BLUSHES!

Mr. W. V. K. Dunne, of Wooroona, Duaringa (Qld.), has forwarded a twelve months' subscription to "RADIO."

During the course of his letter he writes: "The publication ("Radio") is easily the best and most suitable for us unfortunates in the back-blocks, and I can assure you it is often referred to as a dictionary."

"Radio" Visits 2BL



MR MACLARDY, MANAGING DIRECTOR, CONSIDERING THE PLANS OF BROADCASTERS NEW HIGH POWER STATION.

PLANS
NEW HIGH
POWER
STATION
BROADCASTERS
LTD
SYDNEY

THE SYDNEY
G.P.O. CHIMES THE
HOURS DAILY
FOR THOSE
LISTENING IN.

MR G.A. SAUNDERS
"UNCLE GEORGE"
WITH "HECTOR" THE KNOWING
BIRD AND "DARKIE" THE
WIRELESS HORSE.



MR E. JONES
OPERATOR
2. B. L.

AMBASSADORS
NEW YORK
SYMPHONY
BAND

DANGER

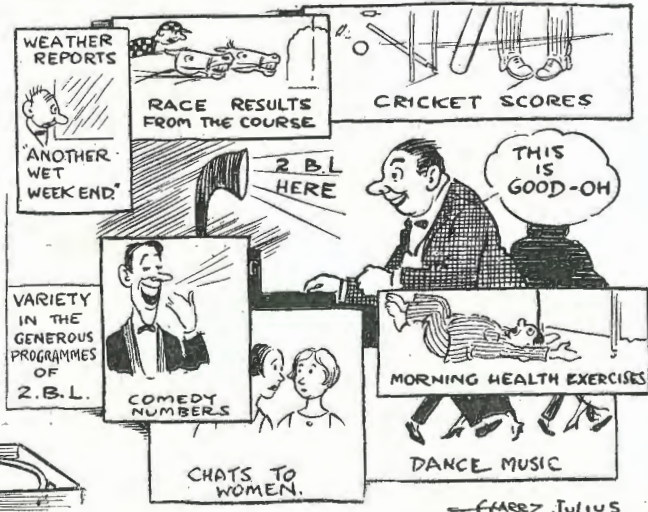

WEATHER REPORTS
RACE RESULTS FROM THE COURSE
CRICKET SCORES
ANOTHER WET WEEKEND

RACE RESULTS FROM THE COURSE

CRICKET SCORES

2 B.L. HERE

THIS IS GOOD-OH

VARIETY IN THE GENEROUS PROGRAMMES OF 2.B.L.

COMEDY NUMBERS

MORNING HEALTH EXERCISES

CHATS TO WOMEN.

DANCE MUSIC

-HARRY JULIUS

SOME IMPRESSIONS BY ARTIST HARRY JULIUS.

Low Loss Tuners

(Continued from page 609.)

SHORTENING UP THE CONVERSATION.

We have been talking about our two most important points—Wave-length Range and Sharp Tuning. This leaves four more points, but luckily we do not have to take them up; they will take care of themselves, as we shall see.

PLANNING A GOOD TUNER.

If we are to use the lessons learned above it would be a good idea to start by trying them on a very simple tuner; perhaps it will be so much improved that we do not need a more complicated one. The simplest tuner of all is the "single circuit"—but I draw the line at that. It is entirely too good a sending set when it starts oscillating, and it never can be made to tune really sharply, as I have stat-

ed above. The next most simple tuner is a two-circuit tuner in which the antenna is not tuned. This has no more adjustments than the single-circuit, but it does tune much more sharply, and it does not transmit so strongly. Then we may add regeneration by means of a tickler or a variometer in the plate. Personally, I prefer a tickler, as it has much less effect on the secondary tuning, also because it is far less "tricky" in handling.

WHAT IS NEW ABOUT IT?

What is there new about a loose coupler with a tickler? Not a thing—not a thing in the world. But just the same, there will be something very new and different in your radio shack if your coupler is re-built along the lines suggested in this paper. That something will be the results obtained. You will hear stations not heard before, you will forget interference that was terrible in the past. This is not mere talk, it has been plentifully proven by a large group of our mem-

bers. The old "loose coupler with a tickler" is still with us, and doing beautifully in its new form. In broadcast reception also we can so improve the plain two-circuit regenerative tuner that it will make most of the elaborate new circuits look rather small.

THE OTHER FOUR POINTS.

The other four requirements have now been taken care of, for we have a tuner that is (3) equipped with very few controls, (4) does not send out a strong carrier, because the antenna coupling is low, (5) is absolutely reliable in operation, and (6) is about the cheapest receiver in existence.

TEN SHILLINGS.

is the cost of one yearly subscription to "Radio." Send yours to-day to:—

The Circulation Manager,
"RADIO,"

97 Clarence Street, SYDNEY.

KEEP IN TOUCH WITH
RADIO PROGRESS
IN THE MOTHER COUNTRY

By reading

The
**Wireless World
and Radio Review**

6d — WEEKLY — 6d

"The Wireless World," which commenced publication in 1913, is universally recognised as the Leading Authority on Wireless Matters.

It caters not only for the amateur, but also for the advanced worker.

Packed from cover to cover with really useful articles and diagrams, every week readers find something new and interesting, and, what is more important—RELIABLE.

"The Wireless World" still maintains its high reputation for being the
LEADING WIRELESS JOURNAL.

THE WIRELESS PRESS,
97 Clarence Street, Sydney, N.S.W.



THE GIFT SUPREME.

**"LEVIAPHONE" SENIOR
CRYSTAL SETS.**

They mean hours of exalted joy, not only during Xmas, but throughout the whole year. Guaranteed Braybrook Wave Length (20 mile radius), and complete with one pair of Headphones, aerial wire and insulators. Will carry three pairs of phones. For **£3/3/-**

ASTROPHONE CRYSTAL SETS.

The De Luxe Model is in velvet-lined case, with patent spring lid; the ideal present; just a nice convenient size; will fit in your suit case for the holidays. Fitted with nickel-plated fittings. Guaranteed Braybrook wave length (20-mile radius) without headphones and aerial wire. Accessories, 30/- extra. For **£3/10/-**

Write for Illustrated Catalog. We Stock all Sets and Accessories.

**THE
LEVIATHAN**

PTY., LTD.,
Cr. Swanston and Bourke Sts., MELBOURNE.

(Continued from page 605.)
with it again here. The crystal may be of Galena or Carborundum, the former being the most convenient.

this type. This is to some extent overcome by coupling the tuned anode coil to the aerial coil.

The values of the condensers in

vary in size according to the wavelength to which it is desired to tune.

The three circuits given above should enable all listeners-in to have

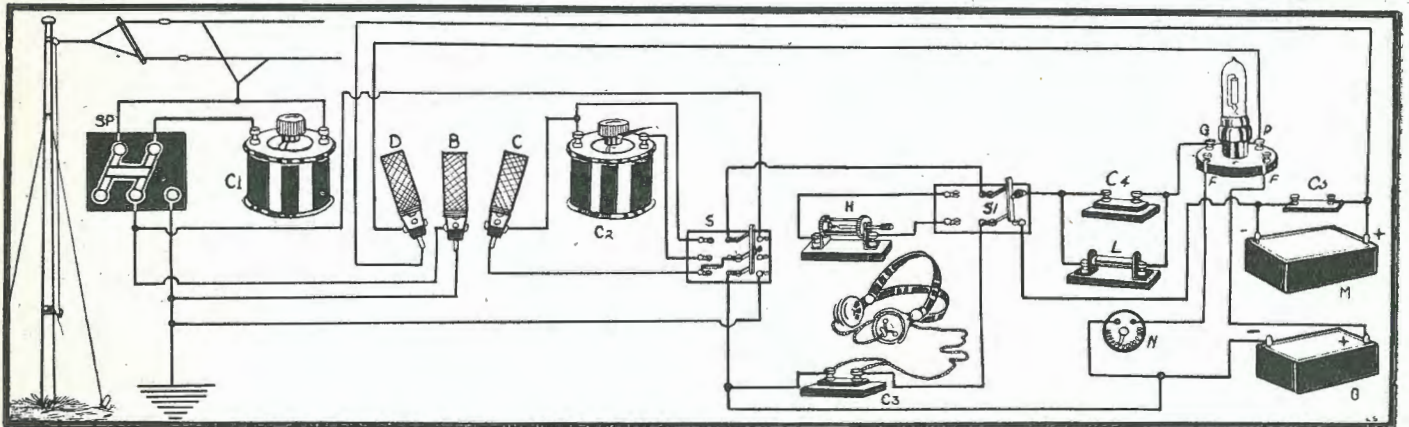

Pictorial diagram of the Crystal-valve Combination Panel. Details of component parts are as follow: SP, Series-parallel Switch; C1, Aerial Tuning Condenser; C2, Crystal Circuit Secondary Tuning Condenser; S and S1, Change-over Switches; B, Aerial Coil; C, Crystal Circuit Secondary Coil; D, Valve Circuit Regenerative Coil; H, Crystal Detector; C3, Telephone Condenser; C4, Grid Condenser; C5, High Tension Battery By-pass Condenser; M, High Tension Battery; L, Grid Leak; O, Filament Battery, and N, Filament Resistance.

Owing to the low resistance of the crystal circuit, the tuning of the anode circuit becomes somewhat flat and amplification is reduced in circuits of

Fig. 5 are as follows:—Aerial C1, .001 mfd.; Anode C2, .0003; C3, .001 mfd., fixed; C4, one to two mfd.

The honeycomb coils will, of course,

quite a busy time over the Christmas holidays trying each and finally selecting the one most suitable for the individual needs.

MAKE THIS A RADIO XMAS WITH

WILES Wonderful Wireless

384 PITT STREET
(NEAR GOULBURN ST.)

56-58 GOULBURN STREET
(1 DOOR FROM PITT ST.)

23 PITT STREET
(NEAR CIRCULAR QUAY)

SUITABLE CHRISTMAS GIFTS.

HEADPHONES.

Superphone, 4000 ohms	£1 1 0
Pico, 4000 ohms	1 5 0
Murdochs, 2000 ohms	1 5 0
Murdochs, 3000 ohms	1 7 6
N and K, 4000 ohms	1 7 6
No. 1 Special	1 7 6
Peerless Special, 4000 ohms	1 7 6
Frost, 2000 ohms	1 12 6
Trimms' Dependable	1 12 6
Brandes Matched Tone	1 15 0
Frost, 3000 ohms	1 17 6
Western Electric, 4000 ohms	1 17 6
Sterling, 4000 ohms	2 4 0
Trimms' Professional	2 5 0
Nutmeg, 3000 ohms	2 5 0
Silverton, 8000 ohms	2 10 0
Baldwin Type C	3 0 0

One-Valve (P1 Circuit) Broadcast Receiving Set, complete, ready to listen-in	£8 10 0
"Wondertone" Broadcast Crystal Set, our registered design No. 5014, highly polished rosewood finish, of exquisite design, complete with Headphones, Aerial Wire, Switch and Insulators	4 5 0
American R3 Loose Coupler Broadcast Crystal Set, in walnut finish, complete with Headphones, Aerial Wire, Switch and Insulators	3 15 0
Clearstone Loose Coupler Broadcast Receiving Set, in maple finish, complete with Headphones, Aerial Wire, Switch and Insulators	3 5 0
Single Slide Broadcast Crystal Receiving Set, complete with Headphones, Aerial Wire, Switch and Insulators	2 10 0

Add a Single Valve Amplifier to your Crystal Set and increase the Volume—1-Valve Amplifier complete, with Valve, A. and B Batteries 5 10 0

To use a Loud Speaker on your Crystal Set, 2-Valve Amplifier, complete with Valves, A and B Batteries 8 0 0

LOUD SPEAKERS.

Western Electric Baby	2 19 6
Manhattan "Junior" Adjustable Diaphragm	3 5 0
Amplion AR39, adjustable Diaphragm	4 0 0
Amplion, AR43, adjustable Diaphragm	5 0 0
Amplion AR3, adjustable Diaphragm	6 12 6
Manhattan "Senior," adjustable Diaphragm	8 0 0
Magnavox M4, adjustable Diaphragm	8 0 0

BUY RADIO FOR XMAS.

MAIL ORDERS

Clients who are unable to personally make their purchase from our Store can obtain their requirements through our Mail Order Department, which has been enlarged in order to maintain our prompt despatch policy during the Xmas period.

Mention "Radio" when communicating with Advertisers.

English Amateur Operators

ADVICES received from London make pleasing reference to the recent N.Z. successes in the matter of long-distance wireless. Mr. C. W. Goyder, the chief British operator, who is just now in the limelight is quite a young man, being only about 20 years of age. His experiments started before he left the Mill Hill School, and he was responsible for setting up a transmitter some months ago, by means of which he was one of the first amateurs to get into communication with other amateurs in the United States. He received much notice on that occasion, but he is naturally prouder of his latest

achievement in getting into touch with Mr. F. D. Bell, of Waihemo. The set he used was fitted in one of the rooms of the science laboratory at Mill Hill School. Mr. Goyder lives at Mill Hill, and he has been in the habit of getting up in the morning an hour or two before dawn and conducting his experiments. It was on a Saturday morning when Mr. Goyder was trying to connect with America, that he got into touch with N.Z. It was quite a surprise to the operators at both ends.

Mr. E. J. Symonds, of Gerrard's Cross, whose call sign is G2OD was really the first British experimenter to hear a N.Z. station. This was on the previous Thursday. He was also

the first to have his own Morse code messages heard in Maoriland the next morning.

Mr. Goyder, working the Mill Hill School set, then established the two-way communication on the Saturday morning. He repeated his performance on Sunday. The young experimenter states that in sending the messages, both he and Mr. Bell repeated each word twice but no sentence had to be repeated. Mr. Goyder received N.Z. on a two-valve set, comprising one detector and one low-frequency valve. His aerial is a transmitting one, 40ft. high, but electrically is only 15ft. off the school roof, with a counterpoise earth underneath it and is unscreened.

If you have never listened-in before do not neglect the coming great opportunity. Australia's broadcasting stations are transmitting, during the holidays, programmes the like of which have never before been heard in Australasia. Install a receiving set and enjoy yourself in a new way.

Acceptable XMAS Gift

BRIGHTEN THE SUMMER
HOLIDAYS WITH RADIO

Listen-in to all the latest Operas; hear the market and weather reports. Broadcasting from 6.30 a.m. to 11 p.m. Something of interest all the time.

Three-Valve Colmovox Model S. E. 22, complete with all accessories and Loud Speaker, £42/10/-.
Four-Valve Colmovox Model S. E. 23, complete with all accessories and Loud Speaker, £47/10/-.

We supply full instructions for the erection of aerial. It is not necessary to have any previous experience to install or operate Colmovox.

Write for Illustrated Catalogue and Price List.

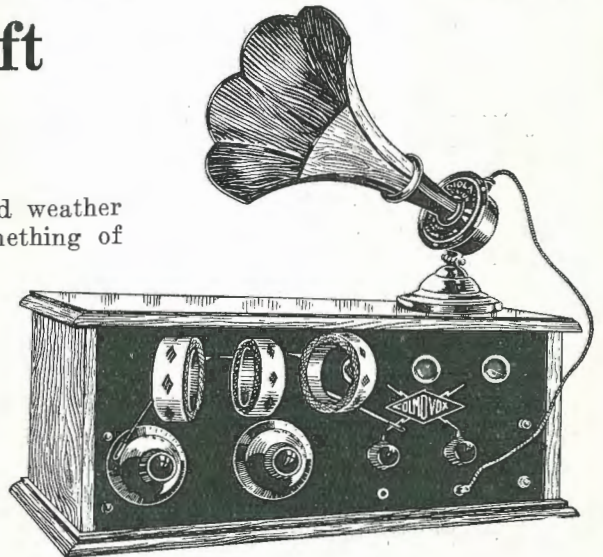

COLVILLE-MOORE
WIRELESS SUPPLIES, LIMITED,
10 ROWE STREET (NEXT HOTEL AUSTRALIA) SYDNEY

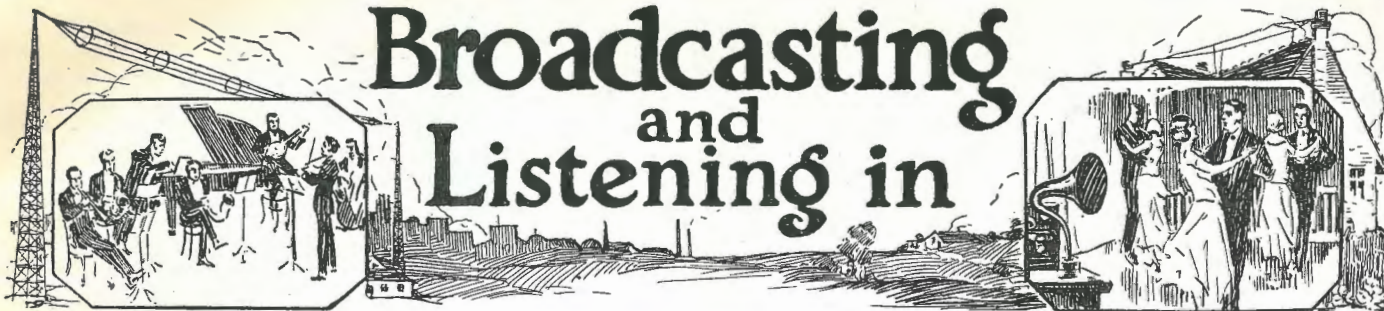

2FC

BROADCASTING TIMES.

Sydney Mean Time.
CALL SIGN 2FC, SYDNEY.
Wave Length: 1100 metres.
Power: 5 kilowatts.

Midday Session:

- 12.55 The Chimes of 2FC.
- 12.58 Time Signals from Farmer's Master Clock.
- 1.0 Coastal Farmers' Market reports, Stock Exchange information, Weather information, "Sydney Morning Herald" news service, Reuter's and Australian Press Association cables, "Evening News" midday news service.
- 1.30 Close down.

Educational Session:

- 3.0 The special Education Session, which has been arranged by the N.S.W. Department of Education, will be held on Mondays, Tuesdays, Wednesdays, and Thursdays of each week, Friday, Musical Programme from 3 p.m. to 3.45 p.m.
- 3.3 The Chimes of 2FC.
- 3.50 Musical Programme.
- Afternoon Stock Exchange information, late Weather information, "Evening News" afternoon news service.
- 4.0 Close down.

Early Evening Session:

- 6.30 The Chimes of 2FC.
- 6.33 Children's Hour.
- 7.10 Dalgety's Market reports (wool, wheat, stock), fruit and vegetable markets, late Stock Exchange information, Weather News, Shippings News, late "Evening News" news service, Reuter's and Australian Press Association cables.
- 7.20 Close down.

NIGHT SESSION:

- 7.55 The Chimes of 2FC.
- 8.0 Musical Programme.
- The evening entertainment broadcast from Station 2FC is varied and includes Theatrical transmissions from the Theatre Royal, Her Majesty's Theatre, The Criterion Theatre, The Palace Theatre, The Tivoli Theatre, Haymarket Theatre and the Prince Edward Theatre.
- Jazz music provided by the Wentworth Orchestra is also broadcast direct, and high-class musical entertainments provided at the Studios of 2FC, in which Sydney's leading artists participate, are also features of the programme.
- SATURDAY:** Midday, early evening and evening sessions as on week days, afternoon session as follows:—
- 3.15 The Chimes of 2FC.
- 3.18 to 3.45: Late Sporting information.
- 3.45 Close down.
- SUNDAY:** No midday, afternoon or early evening session. Church Services from one of several Churches, commencing at hour appointed for Divine Service, according to the Church, and varied by some Sacred Concert from the Studio of 2FC.
- 10.0 Close down.

6WF

BROADCASTING TIMES.

Perth Mean Time.
Wave Length: 1250 metres.

Midday Session:

- 12.30 Tune in to gramophone.
- 12.35 Market Reports of The Westralian Farmers, Limited.
- 12.38 News Service.
- 12.42 Weather Reports.
- 12.44 Gramophone Items.
- 1.0 Time Signal.
- 1.1 to 1.30 } Gramophone and Pianola.
- 1.31 Close down.

Afternoon Session:

- 3.30 Tune in to Pianola.
- 3.35 } Special programme, comprising to Talks, Gramophone, Pianola, Westralian Farmers' Studio Orchestra.
- 4.0 }
- 4.1 Close down.

Early Evening Session:

- 7.5 Tune in to Gramophone.
- 7.10 Bedtime Stories.
- 7.45 Market Report.
- 7.57 Weather Report.
- 8.0 Time Signal.
- 8.1 News Cables.

EVENING SESSION:

- 8.10 } Entertainment.
- to }
- Monday: 8.10, Lecture: 8.45, Westfarmers' Orchestra.
- Tuesday: 8.10, Professional Concert.
- Wednesday: 8.10, Theatre or Hall Broadcasting.
- Thursday: 8.10, Professional Concert.
- Friday: 8.10, Concert Evening and Lecture.
- Sunday: 7.20, Church Service.
- Saturday: 8.15, Westfarmers' Studio Orchestra.

SATURDAY:

- Midday Session:**
- 12.0 Tune in to Gramophone.
- 12.5 Market Reports of The Westralian Farmers' Ltd.
- 12.10 News Service.
- 12.15 Weather Report.
- 12.16 Gramophone and Pianola.
- 1.0 Time Signal.
- 1.1 Close down.
- Early Evening Session:**
- 7.5 Tune in to Gramophone.
- 7.10 Bedtime Stories.
- 7.45 Market Reports.
- 7.57 Weather Report.

Evening Session:

- 8.0 Time Signal.
- 8.2 News Cables.
- 8.15 Westfarmers' Studio Orchestra.

3LO

BROADCASTING TIMES.

Melbourne Mean Time.
Wave Length: 1720 metres.
MONDAY TO FRIDAY:

Midday Session:

- 12.55 Time Signals. "Argus" and "Herald" News Service, Reuter's and the Australian Press Association Cables.
- Afternoon Session:**
- 3.30 Musical programme.
- 4.45 "Argus" and "Herald" News Service.

Early Evening Session:

- 6.30 Children's Hour; "Billy Bunny" Stories.
- 7.0 "Argus" and "Herald" News Service, Reuter's and the Australian Press Association Cables.

Evening Session:

- 8.0 Theatrical Items, Lectures, Vocal and instrumental items.
- TUESDAY NIGHT.**
- Carlyon's (St. Kilda) Dance Orchestra.

SATURDAY:

- Midday Session:**
- 12.55 Time Signals. "Argus" and "Herald" News Service, Reuter's and the Australian Press Association Cables.
- Afternoon Session:**
- 3.15 Musical programme.
- 4.0 "Herald" News Service. Results of Races and other sporting events broadcasted immediately details received.
- Early Evening Session:**
- 6.30 Children's Hour; "Billy Bunny" Stories.
- 7.0 "Argus" and "Herald" News Service, Final Sporting Results.
- 8.0 Vocal and Instrumental Concerts.

SUNDAY:

- Afternoon Session:**
- 3.0 Pleasant Sunday Afternoon Services from Wesley Church.
- Early Evening Session:**
- 6.30 Children's Hour; "Billy Bunny" Stories.
- 7.0 Church Service.
- Evening Session:**
- 8.30 Concerts from the Studio.

BAGNIO, Manila, radio station recently picked up messages from the experimental broadcasting station of the General Electric Company at Schenectady, New York. Musical items were also heard.

MR. W. EDWARDS, F.I.M.T., who recently arrived in Sydney en route for N.Z., where he will install long distance radio sets is a DX radio expert who has predicted that in less than a year Sydney will be listening to dance music broadcast from the Savoy Hotel, London. Already, he says, Capetown is listening-in to the Savoy Band.

OVER 100 State schools are at present listening-in to the broadcast educational lectures of the N.S.W. Education Department. The organiser, Mr. W. S. Reay, recently stated that reports received from country schools were very encouraging and that a growing interest in these sessions is being exhibited by the parents and many people in the outback towns.

2BL

BROADCASTING TIMES.
Sydney Mean Time.
Wave Length: 350 metres.

Midday Session.
12 } Musical Programme, with News
to } Reports supplied by "The
2 p.m. } Guardian."

Afternoon Session.
3 } Musical Programme, with News
to } Reports supplied by "The
5 } Guardian."

Early Evening Session.
7 Nursery Rhymes and Bedtime Stories.
7.45. Pitt, Son & Badgery Stock Exchange Reports.

Night Session.
8 Nightly Concert.

EVENING ENTERTAINMENT.

Monday: "Jazz" night, with vocal items from the Studio.
Tuesday: Classical Studio Concert.
Wednesday: Dance Night.
Thursday: Broadcasters' Popular Concert.
Friday: "Jazz" night, with popular items from the Studio.
Saturday: Popular Concert.
Sunday: Classical and Operatic Concert.

SUBSEQUENT to prosecutions launched by the N.S.W. Postal Department against illegal listeners-in, the secretary, Mr. H. P. Brown, states that there has been an enormous increase in the number of licenses taken out.

TWENTY minutes after a photograph of President Coolidge was transmitted by wireless from London on November 30, it was reproduced in New York. The feat was carried out by the Marconi Company and, according to latest advices, the Radio Corporation of America expects to inaugurate almost immediately a regular wireless photograph service across the Atlantic.

THE Melbourne Police Wireless Patrol has hitherto been handicapped to a certain extent by the fact that so far only a receiver has been installed in the cars. Shortly, however, this will be remedied and transmitters will be placed on the floors of the machines, while telescopic aerials will be attached to the running boards.

AT LAST

we have the real British Condensers of Quality unexcelled. These British-made "Utility" Variable Condensers are quite low in price.

- .001 Vernier, 50 plate 19/6
- .0005 Vernier, 26 plate 17/-
- .001 Plain, 49 plate 16/-
- .0005 Plain, 25 plate 14/-

Each one of these High-class Condensers is fitted with a Genuine Radial Dial. Inspect these before buying.

If you prefer to assemble your own condenser, get a complete set of "Utility" Condenser parts. We have 3 sizes.

- .001, 49 Plate 8/6
- .0005, 25 Plate 6/6
- .0003, 13 Plate 5/6

NOW, about that Pair of Headphones you are going to give for Christmas.

Select one from this list. They will all give you satisfaction.

- Peerless Special 27/6
- Trimm Dependable 32/6
- Trimm Professional 45/-
- Red Seal (the Aristocrat of all Headphones) 45/-

Don't overlook the C.I.C. Loud Speaker Phonograph attachment at £2/2/-.



C.I.C. Loud Speaker Gramophone Unit, £2/2/6.



SEND FOR OUR PRICE LIST.

RADIO HOUSE, 619 George Street, Sydney

(NEXT GOULBURN STREET)

THE QUALITY RADIO STORE.

'Phone: City 1487.

Notes on Aerials

By R. C. PHILIPP (Ex-Wireless Officer, 2nd Corps, B.E.F.)

THE study of aerials and their various forms is an extremely interesting one. The beginner is not always very much concerned about the calculations involved in the different types, but he certainly does want to know the results to be obtained by using the various kinds, or perhaps he has a certain amount of space in which to put up an aerial and therefore

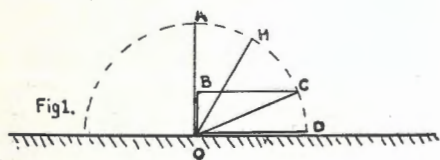

wishes to know the most efficient arrangement without undue experimenting. The following remarks may help in this direction, and they are written to those mainly concerned with listening-in to the broadcasting stations.

The first governing factor is the type of reception, whether crystal or valve. With a valve set the type of aerial is not always of such importance as it is to the user of a crystal

set, who, in order to get satisfactory results, must give his aerial careful consideration. The next thing to be considered is the distance from the broadcasting station. At 50 miles a crystal set will not give audible signals from a loop aerial, whereas a good single wire aerial, 30 to 40 feet high, should give good signals.

Now considering maximum signal strength, it is well-known that the ideal aerial would be a plain vertical wire. Therefore, looking at Fig. 1, and taking the outside aerials in this order of merit, the vertical aerial O.B.A. would be first, and next O.H., but since these types present obvious difficulties of erection (unless one happens to live next to a factory with a tall chimney!) we pass on to the usual arrangement, O.B.C. Then O.C. is next—which is very inefficient and should be avoided—and, lastly, to O.D., in which the signals would be a minimum.

From the last paragraph it is seen that the strength of signals depends upon the height, and where two aerials are of the same ultimate height, such as O.B.C. and O.C., then it is the average height which counts

—which, in the case of O.B.C., is just double that of O.C.

Remembering to keep B.C. as high from the ground, and as distant from all other objects (trees, buildings, etc.), as possible.

Now let us compare the characteristics of three different aerials, each using the same total (200ft. in the case of those constructed by the author for test purposes) length of wire, but occupying different amounts of space, as shown in Fig. 2, Fig. 3, and Fig. 4. Of the three, Fig. 2 gives the strongest signals, and is the most widely used. It is somewhat directional, depending upon the ratio of the horizontal length compared to the length of the vertical portion. As the vertical height becomes more and more in comparison with the horizontal length, so are the directional effects found to be less and less noticeable. In Fig. 3, the long, single aerial is replaced by one using a number of short parallel wires forming a compact arrangement. In this case the total length of wire is made up by using nine horizontal wires, each 19ft. 6in., spaced two feet apart and connected to the lead-in of 25ft. 6in., totalling, roughly, 200ft.

The signals will be found rather weaker than those of the single wire aerial, but, on the other hand, it is very directional and for anyone living within a few miles of the broadcasting station, I much prefer it to the outside aerial, since it is easily in-

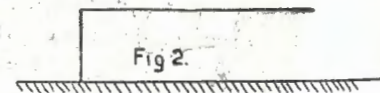

stalled in the average roof and will work a crystal set very well.

The type shown in Fig. 4 is still more directional, although it gives weaker signals, but, at the same time, will work a crystal set within a few miles of the transmitting station, and goes in one's roof extremely well. When working a valve set off this loop, it is usual to bring both ends down to the set and connect on to aerial and earth terminals, but with

FOR ALL BROADCASTING

We are now able to supply

:: 4-VALVE RECEIVERS ::

suitable for all wave-lengths, complete with Batteries, Valves, Loud Speaker, Aerial Wire, Insulators and all accessories, for the low price of

£40/10/-

This price includes the erection of aerial and installation of sets in Sydney and suburbs only, and for Country and Interstate orders is F.O.B. Sydney.

WRITE OR CALL.

Radio Construction Co.

EMPRESS BUILDINGS,

523 GEORGE STREET - - - SYDNEY.

a crystal set better results will be obtained by bringing only one end down and connecting it on to the aerial terminal while the earth terminal of the set is connected to earth in the usual way. Signals may be much improved by considerably increasing the length of wire used on the loop, for instance, for reception

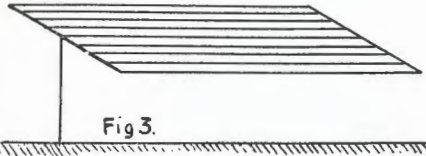

of 1,100 metre waves the author gradually increased the length of wire and found signals improve until about 550ft. of wire was used, after which any increase of length only produced a negligible increase in signal strength, and, later on, an actual decrease in strength (these results being obtained with a crystal set). With

a frame or loop aerial it must also be remembered that the larger we make our frame, the stronger will be the received signals, even though we keep the total length of wire the same by winding fewer turns. The voltage induced in a loop by the ether waves is proportional to the product of the height and length, that is, the area.

The effects of resistance in an aerial are not always understood. I have frequently been told by listeners-in that there is no need to use an aerial wire of, say, 3/20, as they can "hear beautifully" on a single wire of No. 30 gauge. No doubt, but signals would be improved by using the heavier wire, and, what is more important, tuning will be sharper. (In sharp tuning there is one position of the slide on our tuning coil which gives us the loudest signals, and a small movement away from that causes a sharp falling away in signal

strength, whereas in flat tuning the signals will not be so loud and are spread over a greater area of the tuning coil). In this connection it is worth remembering that the readability of a signal depends not only upon the strength of signals received, but also upon the relative strength of those signals compared to those

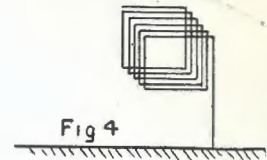

of the signals which we do not want to hear, that is to say, it is better to have weaker signals and no interference rather than to have loud signals accompanied by stations sending whom we do not wish to hear. This is where the loose coupler scores over the single coil set.

Radio is one of the greatest gifts given to mankind. Make the best of it during the holidays.



AUSTRALIA.

Make it a Radio Xmas and Listen-in

WITH

"IMPERIA" Headphones

4000 OHMS,

PRICE, 32/6.

POWERFUL AND SENSITIVE.

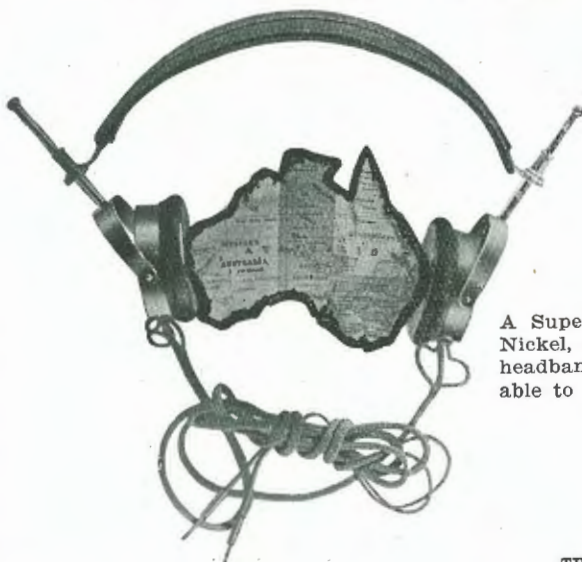

A Superior, Quality Guaranteed, Headphone. Headpieces are of Polished Nickel, and its large earcaps are of moulded Bakelite. The self-adjusting headband is covered with a fine-grained soft black leather, extremely comfortable to wear, and thoroughly hygienic.

OBTAINABLE FROM ALL PROGRESSIVE RADIO DEALERS, or

Harringtons LTD

ESTABLISHED
35 YEARS.

THE PREMIER HOUSE FOR ALL PHOTO AND RADIO REQUIREMENTS.

SYDNEY, 386 George Street.
KATOOMBA (N.S.W.), Katoomba Street.

ADELAIDE, 10 Rundle Street.
MELBOURNE, 286 Collins Street.
AUCKLAND (N.Z.), 140 Queen Street.

BRISBANE, 93 Queen Street.
WELLINGTON (N.Z.), 42 Willis Street.

Mention "Radio" when communicating with Advertisers.

Make this a Radio Christmas



A Radio gift will bring a radiant smile of appreciation. Here are some ideas which will guide you aright in selecting your Christmas presents, each one backed by the name of United Distributors, Ltd.

You can get them at these prices from any Radio Dealer.

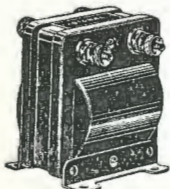

"SIGNAL" AUDIO FREQUENCY TRANSFORMER.

Ensures loud tone, free from distortion. Made in Australia. As good as the most expensive imported Transformers 21/-



"SIGNAL"

Home Assembly Sets.

Available in one, two, three or four valve sizes. Mission or polished finish Cabinets. Can be put together quickly with a screw-driver and a pair of pliers. They cost 5 to 11 guineas, and include "Frost" Parts, Signal Audio Frequency Transformer, etc.



"PICO" HEAD-PHONES.

Strong and sensitive, light and comfortable. Fully guaranteed 25/-

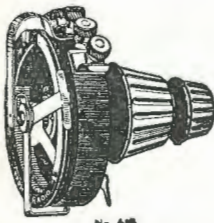

"FROST" RADIO RHEOSTATS AND POTENTIOMETERS.

- Nos. 650-2 Maroon Bakelite 6 and 35 ohm Rheostats 7/3
- Nos. 651-3. Same with Vernier 9/6
- No. 654. Maroon Bakelite 400 ohm Potentiometer 9/6
- Nos. 600-2. Metal Frame 6 and 35 ohm Rheostats. Price 5/6

LOUD SPEAKERS.

The "Music Master," the de luxe Loud Speaker, with an amplifying bell of resonant wood £12
 Atlas Loud Speaker £7/10/-
 Brandes Table Talker. Price .. £4/10/-

If your radio dealer does not stock these, send us his name and we will see that you are supplied.

UNITED DISTRIBUTORS Ltd.

(Wholesale only)

72 CLARENCE ST., SYDNEY.
 592 BOURKE ST., MELBOURNE.

And at Brisbane, Perth, Adelaide, Hobart, and Wellington.



CRYSTAL SETS.

- "Astrophone"—the Super Crystal Set £4
- Metro Crystal Set, complete £3/15/-
- Wizard Crystal Set 20/-
- Fortevox Crystal Set 16/-
- Try the new United Crystals, Made in Australia. Price 1/3
- Available in Galena, Midite, Hertzite, Pyrites, Claritone, Zincite. Clear and Strong.

You can depend THOROUGHLY on Frost Guaranteed Parts

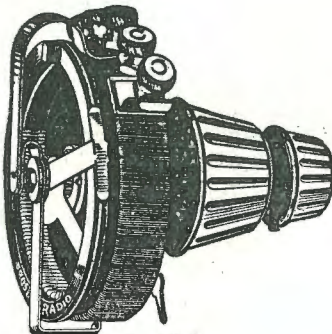

No. 610.

FROST-RADIO Bakelite Tube Control Unit.

Called for Short: "Pot-Rheo." Made of maroon bakelite. Combines in one unit rheostat with vernier, and potentiometer, with two-knob control. All controls work with extreme smoothness. A valuable addition to any set.

- No. 607, 6 ohm Vernier and 200 ohm Potentiometer 17/6
- No. 610, 35 ohm Vernier Rheostat and 400 ohm Potentiometer 17/6

FROST-RADIO Rheostats and Potentiometers.

Precision adjustment. Pieces of apparatus that reflect quality.

- Nos. 650-2. Maroon Bakelite 6 and 35 ohm Rheostats 7/3
- Nos. 651-3. Same with Vernier. 9/6
- No. 654. Maroon Bakelite, 400 ohm Potentiometer 9/6
- Nos. 600-2. Metal Frame 6 and 35 ohm Rheostats 5/6
- Nos. 601-4. Same with Vernier. 7/6
- Nos. 603-5. Metal Frame, 400 and 200 ohm Potentiometers 5/6

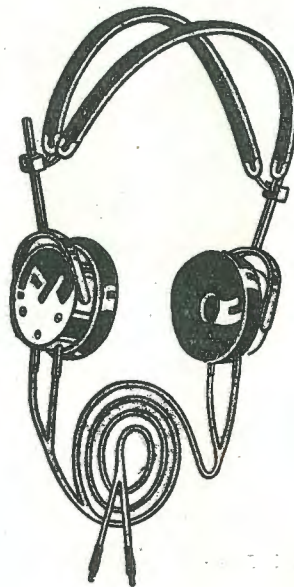

FROST FONES.

Made with watch-like precision to respond to the extremely small electrical currents of radio reception. While remarkably sensitive, they also are sturdy for many years of use.

- No. 161. Frost Fones, 2,000 ohm, Aluminium Head Pieces 32/6
- No. 171. Frost Fones, 3,000 ohm, Aluminium Head Pieces 37/6
- No. 172. Frost Fones, 3,200 ohm, Maroon Bakelite Head Pieces 45/-

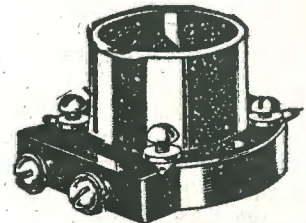

FROST-RADIO

No. 612.

FROST RADIO Sponge Base Sockets.

- No. 618. Moulded Bakelite Shock Absorber Socket for standard Base Valves 6/3
- No. 617. Same for U.V. 199 Valves 6/3
- No. 612. Moulded Bakelite Vacuum Tube Socket, Bakelite Panel, Maroon finish, for U.V. 199 Valves 5/-
- No. 107. Same for Standard Valves 5/-
- No. 616. Compact gang of three Shock Absorber Sockets, for panel or table mounting, for U.V. 199 Valves 24/6
- No. 619. Same for Standard Valves 24/6

FROST RADIO.

- Jacks, all styles 4/6 to 6/6
- Plugs, double and single . . 4/6 and 5/-
- 621. Parallel Switches 5/-
- 608. Push and Pull Battery Switches 4/-
- 400. Crystal Loose Couplers . . 75/-
- 410. Crystal Tuning Coil Slider 27/6

YOUR DEALER CAN SUPPLY ALL THESE!

United Distributors Limited

(Wholesale Only)

72 CLARENCE ST., SYDNEY.

592 BOURKE ST., MELBOURNE.

And at Adelaide, Perth, Brisbane, Hobart, Wellington.

Re-Building H. T. Batteries



It often happens on joining up a set that has been put aside for a few weeks to "listen-in" that it commences to "howl" immediately the first stage of audio is brought into operation. Provided that the adjustments are satisfactory, the trouble will almost surely be located in the high tension battery—due to one or more of the individual cells having become "dead." Of course, the best thing to do is to scrap the old battery and invest in a new one, but many amateurs will probably prefer to do the next best thing—re-build the faulty high tension battery.

One or more "dead" cells introduces a considerable resistance into the high tension circuit. This resistance acting as a coupling between valves sets up a howl, or causes crackling and other parasitic noises in the telephones, with consequent reduced strength of reception. The chemical consumption of zinc in faulty cells is sometimes due to dampness causing a short

circuit, or to the more probable effects of local action. Local action is

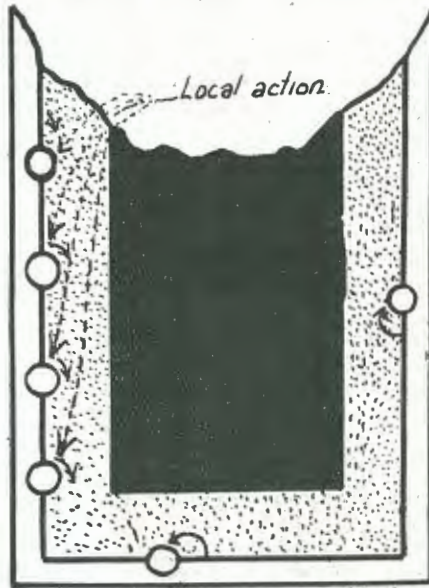

FIG. 1.

set up by the small particles of iron, carbon, and other impurities em-

bedded in the zinc sheeting, used to form the outer part of the cell, coming in contact with the electrolyte. These minute particles being electro-negative to the zinc, set up tiny currents of electricity as shown in Fig. 1, and their chemical action is in every respect similar to the chemical action of the cell itself. This action goes on continuously, whether the battery is in use or not, and thus puts a limit on the life of it.

If the high tension battery is built up of three-cell torchlight battery units, it is quite an easy matter to cut out the faulty cells and re-build them. A high resistance voltmeter placed across the positive and negative terminals of each unit should read from 3.5 to 4.5 volts. If the reading is much below 3.5, the unit should be marked with a cross for re-building. Failing a voltmeter test, a four-volt torchlight bulb may be used. (See Fig. 2.) If the bulb filament burns brightly, the unit may be considered in good condition, but if it burns

30/- EACH.



D.V. 3
Filament, 3 Volts,
.06 Amp.

D.V. 2
Filament, 5 Volts,
25 Amp.

Both Types Fit Standard American Socket.

MADE BY—



THE MAN WHO INVENTED BROADCASTING.

DE FOREST VALVES

TYPE D.V.2—Takes 5 Volts at 1 Amp. on Filament 30/- each

Plate Voltages, Detector 18-22½ Volts; Plate Voltages, Amplifier 60-150 Volts.

TYPE D.V. 3—Takes 3 Volts at .06 of an Amp. on Filament 30/- each

Plate Voltage, 16-22½ Volts, Detector; Plate Voltage, 60-120 Volts, used as an Amplifier.

Both Types Fit Standard American Socket.

WHOLESALE ONLY.

INTERNATIONAL RADIO CO. LTD.

200 CASTLEREAGH STREET, SYDNEY, N.S.W.

Phone: MA 1387.

Also at

91-93 COURTENAY PLACE, WELLINGTON, N.Z.

Brandes

The Name to Know in Radio



*Result of
16 Years'
Experience*

Are you getting long-distance radio stations—are you catching clear and distinct the faintest signals that mark the extreme range of a good receiving set? A Brandes "Matched Tone" Radio Headphone will make the faint signals understandable. The two receivers are perfect sound-mates—they are matched in tone to improve the clearness of the message. Brandes "Matched Tone" Headphones are guaranteed to get the best results obtainable from any set.

**BRITISH
MADE.**

OBTAINABLE FROM ALL RADIO DEALERS.

**PRICE
35/-**

Sole Australasian Distributors:

**Amalgamated  Wireless
(Australasia) Ltd.**

97 Clarence Street,
SYDNEY.

Collins Street,
MELBOURNE.

Manufactured in England by Brandes, Limited.

Matched Tone

TRADE MARK

TRADE
ENQUIRIES
INVITED.

Radio Headphones



with a red or dull red the unit should be crossed off. However, do not hold the lamp across the battery longer than a second, which is quite long enough to gauge its condition.

With a hot soldering iron remove the faulty cells by melting the solder holding the terminal tags together, then move all the effective cells together and re-solder the tags. Now, with a pen-

When the unit is re-built, test with a volt-meter, or lamp (see Fig. 2) and then, if satisfactory, dip the unit into a tin of melted paraffin-wax, and wrap around with wax-paper. A hot knife passed over the wax-paper, will cause it to adhere firmly to the unit.

If the centre cell of the unit is removed, care must be taken to replace the insulating paper separating it

tive of the first new unit to the negative terminal of the high tension battery on the set, placing the older cells towards the positive end.

This arrangement places the bulk of the current load on the new cells (while the older ones supply current to the amplifiers only), as the voltage from five to six units is usually ample for the average soft detector valve.

With cells of the block type, the cutting out process is a little more complicated. If possible, separate the rows, usually consisting of seven to ten individual cells, and cut out the "dead" cells with a penknife. If only one cell is inoperative, cut it right out and bridge the gap with a piece of fine wire, and then test the remainder of the cells with a volt-meter or lamp, as shown in Fig. 3.

Touching the first and fourth zinc should give the same voltage or glow as a good three-cell unit across the latter's positive and negative terminals. After the first and fourth cell, test the second and fifth, passing quickly down the row until they are all tested.

Fig. 4 shows two Australian ever-ready 21-cell batteries, a 10-cell geco battery unit battery re-built from the originals which were quite useless. They have now been giving good service on a three-valve set for over three months and are still going strong, and without the need for replacing the dead cells by new ones. Occasionally one cell will give out and has to be

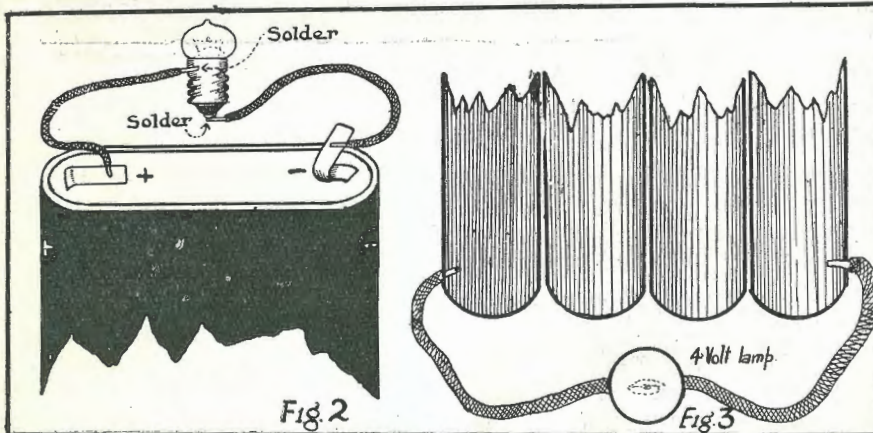

knife, remove the paper surrounding the faulty units, and there will be no difficulty in locating the "dead" cell or cells by the corroded deposit of the sal-ammoniac electrolyte on the zinc. With the back of a penknife, break away the top wax covering, and cut the wires connecting the faulty cell with the good cells. The consequent gap can either be bridged with a piece of thin wire, or by replacing with a good cell removed from one of the other faulty units.

from the two outer cells, otherwise a short circuit will probably result.

The reconstructed cells may now be added to the original battery.

In a battery of this kind, consisting of 25 three-cell units, only five units were found to need attention after the battery had been put aside for six weeks. Of course, if the original voltage is required, new units will have to be purchased to replace the worn-out cells.

If this is necessary, join the nega-

Buy a portable radio receiving set for Christmas, so that you can take it with you on your holidays at the seaside or in the mountains.

ANOTHER BOUQUET.

"I must thank you for your most interesting and valuable paper," writes an Auburn (N.S.W.) reader during the course of a letter to the Editor, "especially this week's number (No. 43). I think it is the best sixpenny-worth placed on the market. Before the day is out on which I buy it I have read it from cover to cover, missing not a word.

"I think Marconi's article is absolutely enthralling, and I hope to secure every copy until the article is ended. (This article was completed in Nos. 43 and 44.—Ed. "R.") I look forward every fortnight to your paper, and pass it round when I have read it—but I always re-claim it for future reference."

SPECIAL ANNOUNCEMENT

Free Gift Books!

XMAS SUBSCRIPTION OFFER

The Proprietors of "RADIO" have pleasure in announcing that they have decided to present to the first one hundred new subscribers to "RADIO" Magazine any one of the three under-mentioned books. The conditions are that such subscription must be received before January 15, 1925, and that the offer is limited to the first one hundred subscribers.

- 1. Bound Volume, SEA, LAND & AIR, Vols. 2 or 3.
Ordinary Price 17/6
- 2. YEAR BOOK OF WIRELESS TELEGRAPHY AND TELEPHONY, 1913-1919 editions (many containing full-size Wireless Map of the World).
Ordinary Price 15/-
- 3. HANDBOOK OF TECHNICAL INSTRUCTION FOR WIRELESS TELEGRAPHERS, by Hawkhead & Dowsett (1st Edn.)
Ordinary Price 7/6

As there is only a limited stock of the above publications, subscriptions will be filed in order of priority of reception.

This is a splendid opportunity to make an acceptable Xmas present to your Wireless friend—a year's subscription to "RADIO," together with a first-class book on Wireless.

Remit 10/- subscription NOW, and make sure of securing the book you like best.

FILL IN THIS FORM.

The Circulation Manager,
RADIO in AUSTRALIA and NEW ZEALAND,
97 Clarence Street, Sydney, N.S.W.

Dear Sir,—

I enclose herewith 10/- (ten shillings) for twelve months' subscription (twenty-six issues) to RADIO, commencing from the next number; also please send me book No. — (Number of book required.)

Please forward each issue of RADIO to—

Full name

Address

(Special)

removed by the aid of a hot soldering iron.

terminal of its neighbour, otherwise the wrongly joined up cell will act

of one cell reversed in a three-cell unit, the available voltage will be equal to three 1.5 volts or 1.5 volts instead of 4.5 volts. that a correctly joined up unit should give.



Re-built H.T. Batteries.

Do not forget to solder the negative terminal of one cell to the positive in opposition to the others, and taking the instance of the resultant loss

From a wide experience with high tension batteries it has been found that the life of a dry cell battery is proportional to its internal resistance when new. The higher its internal resistance, within limits, the longer the life of the cell. A good battery of 30 cells when new should have a resistance of about 15 ohms and rising to about 100 ohms towards the end of the useful life of the battery, thus the internal resistance is a very good indication of the useful life of a dry cell battery.

Let this Christmas be different to any one that has gone before. Let it be a real and up-to-date Yuletide. Buy or build a receiving set.

"RADION" Panels and Parts meet every requirement of the radio set builder

There are many reasons why you should build your radio receiving set with Radion panels and parts.

First: Radion has proven beyond a doubt to be the supreme insulation. It is made exclusively for radio work and far excels any other material in the four main characteristics required for wireless, namely, low angle phase difference; low dielectric constant; high resistivity and the low absorption of moisture.

Second: Radion is easily worked. It can be sawed, drilled, machined and otherwise worked without the slightest danger of chipping or cracking.

Third: Radion Mahoganite Panels have the actual surface graining of fine, highly polished mahogany while black Radion panels have a beautiful ebony finish.

Fourth: In cost, Radion is far more economical than any other material.

Fifth: Sets made with Radion Panels and Parts will give much better satisfaction.

Do not jeopardize the value of your receiving set by using cheap, trashy materials. It will pay you to always insist upon genuine Radion. Look for the name stamped on every piece.

International Radio Co., Ltd.
91-92 Courtenay Pl., Wellington N. Z.
200 Castlereagh St., Sydney, N.S.W.

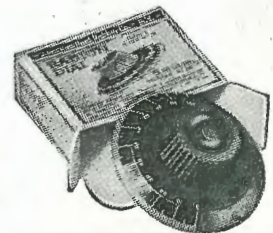
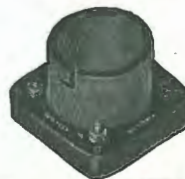

C42

ORMOND'S Components

Some of the little things —————

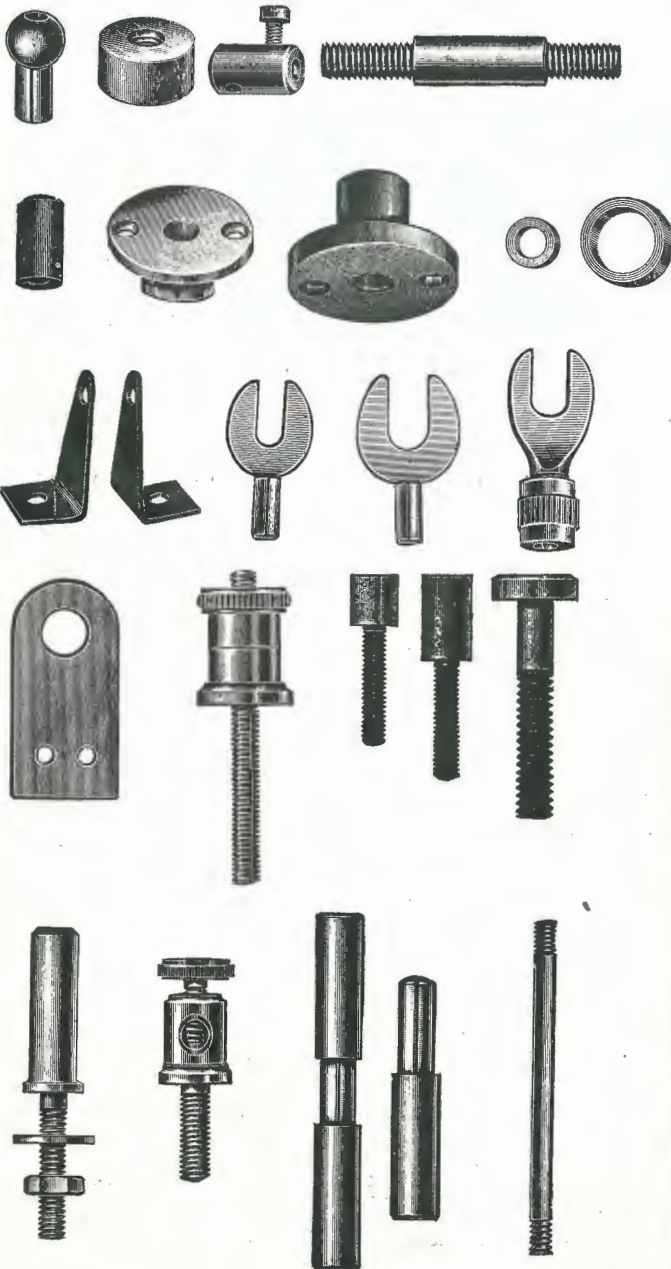

that make, not mar, your Wireless Set. Correctly designed, perfectly made and always low prices — and that's why Ormond's are always popular.

THE QUALITY IS HIGH—THE PRICE IS LOW.

ASK YOUR DEALER FOR ORMOND'S COMPONENTS.

ORMOND ENGINEERING CO.

199 Pentonville Road
KING'S CROSS, LONDON, ENGLAND.

BOX OF COMPLETE CONDENSER PARTS.

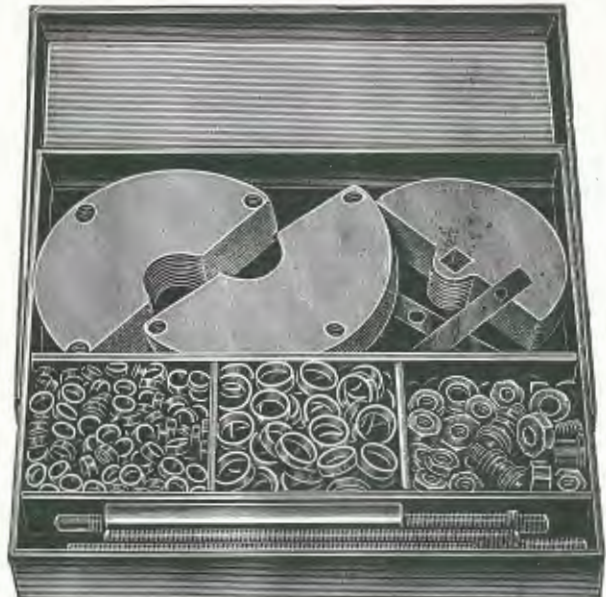

Radio in the Antarctic

(By C.E.C.)

THERE arrived in Hobart recently a Norwegian whaling vessel, the *Sir James Clarke Ross*, direct from Norway and bound for the Ross Sea. Her consort, three little steamboats

is fitted with every scientific appliance from a freezing plant (not that that will be required) to a darkroom for photography.

And one of the finest radio plants

Each of the little vessels that will accompany the expedition is also fitted with radio, so that at any moment it will be possible for the "mother ship" to call her "little ones" together for a big catch.

The chief wireless operator of the *Sir James Clarke Ross* is Mr. L. Jensen, who is as keen as mustard on his work and a born "experimenter." During the trip it is Mr. Jensen's intention to keep in touch with civilization as far as possible by means of the radiophone. It should be possible for Australian radio men to pick up his signals fairly easily, especially when the days begin to get shorter.

WIRELESS WHALING.

Down south amongst the ice floes, whaling is a hazardous occupation. Time and again during the last trip to the Ross Sea it was thought that one of the little whalers had been crushed to pulp in the ice pack.

But radio always came to the rescue. A voice out of the stillness of the Antarctic gloom brought hope to the commander of the expedition, Captain Larssen, and relief to a stricken crew. (At the moment of going to press we learn that Captain Larssen has since died.—Ed. R.)

During actual operations it was often the case that one of the little vessels came upon a school of whales in some isolated spot far from the main fleet. Then the radio would flash across the ether the magical message, "A fish! A fish!"

THE PRESENT VENTURE.

While the *Sir James Clarke Ross* was in her homeland in the early months of the present year, after her eventful cruise to the Ross Sea, she underwent numerous repairs and was generally overhauled.

Her radio equipment was added to and embellished, particularly the wireless telephone apparatus, which



"The Sir James Clarke Ross."

of not more than five hundred tons, are named *Star I*, *Star II*, and *Star III*, respectively.

Modern whaling is not like it used to be in the bad old days of the last century; the *Sir James Clarke Ross*

afloat is also to be found aboard this truly remarkable vessel. A wireless telephone installation of 1000 watts is installed in the spacious radio "shack" and the range of this set is considerable.

There is no better way of enjoying your holidays than by means of radio. Install a set and experience a real radio Christmas.

had been found so useful in southern waters.

When the vessel called at Hobart on the last occasion, Mr. Jensen intimated through the *Hobart News* that reports of reception from the *Clarke Ross* would be very welcome on his return from Antarctica. He would be transmitting almost every evening on 2100 metres, and he would also be listening-in for Australian stations.

The call is A.Q.E. Listen-in!

HEARD IN HOBART.

Mr. T. Watkins picked up the *Sir James Clarke Ross* on November 18 at his experimental station, 7AA, West Hobart. Gramophone records and announcements were heard very distinctly. The vessel was then berthed at Port Chalmers, N.Z.

MEDICAL AID BY WIRELESS.

TWO more instances of the use of wireless in securing medical treatment for sailors at sea have been reported.

The s.s. *Airway*, bound from Newport, Mon., to La Plata, on September 25, informed the *Desna* by wireless that an apprentice was dangerously ill and that medical advice was urgently needed. The *Desna* accordingly changed her course to meet the other ship, then some eighty miles to the northward. When the vessels met, the *Desna's* doctor went aboard the *Airway* and found the patient in a serious condition, suffering from double pneumonia. Medical facilities on the *Airway* being inadequate, the patient was transferred to the *Desna*, where he made rapid strides towards recovery, and on arrival at Liverpool was discharged to hospital. There is no doubt that the boy's life was saved by the aid of wireless messages.

Strange Effect of an Ocean Breeze

AN amateur listener-in, for the convenience of receiving his favourite broadcast station in bed, placed his set immediately in front of the partially open window of the bedroom. All went well for a few nights, when reception, for some mysterious reason, gradually became fainter and fainter. Stations that usually came in comfortably on two pairs of 'phones could just be heard, while DX stations were entirely inaudible. On mentioning this to a neighbouring amateur, who happened to have access to electrical testing instruments, it was decided to investigate matters. First the accumulator was re-charged, and then the H.T. Battery tested with a voltmeter and found to be quite in order. Then followed a general examination of all joints, and a thorough cleaning of contacts, but with little improvement. A megger, an instrument used to test insulation of telegraph and electric light lines, generating 250 volts, and giving an insulation test up to 20 megohms or twenty million ohms, was then brought into use. The aerial was tested and it was found that the insulation which should have read infinity was down to 9,000 ohms, a very low test indeed. The aerial was then lowered for inspection, and the compo. insulators were thoroughly washed in water and then re-hoisted. A further megger test showed that the insulation resistance was now over 20 megohms, or infinity. After this test the insulation of the panel was suspected, in view of its proximity to the window, and a test between the aerial terminal and negative terminal of the low tension battery of the sec-

ondary circuit measured 11,000 ohms, and further tests between other parts were only a few thousands ohms higher. A close examination of the back of the panel revealed a dampish film along the top of the ebonite, which smeared when rubbed with the finger. From this it became apparent that the poor results were due to no other reason than a layer of saline moisture being deposited on the panel and aerial insulators by a breeze blowing from the sea.

The remedy was to wipe the surface of the panel with a wetted rag well wrung out, drying with a warmed cloth, and then placing the whole set in front of a warm fire for a few hours for a thorough drying out. After this the set broke into oscillation on quite a loose reaction coupling and 2BL came in across the Tasman Sea comfortably on two valves, with two pairs of telephones in circuit.

The above stresses the absolute necessity of aeriels located near the sea coast being suspected of low insulation after a "blow" from seaward, and also the desirability of keeping a set out of a direct line from an open window, unless properly enclosed for protection against dampness.

A CORRECTION.

IN Figure 5 of the article entitled, "How to Make an Audibility Meter" (*Radio*, No. 45), the letterpress read, "Showing how to wind the Eureka wire inductively." The last word, of course, should have been "non-inductively."

ALL WIRELESS SETS AND REQUISITES

ARE OBTAINABLE AT — LOWEST PRICES — FROM

SWAINS, 119a and 123 Pitt St., Sydney

A FEW DOORS FROM THE G.P.O.

CRYSTAL RECEIVING SETS, from 25/-. Operative up to 25 miles from Sydney.

ONE-VALVE RECEIVING SETS, from 25/10/-. Operative up to 100 miles from Sydney

TWO, and UP TO SIX VALVE, from £28, Operative up to 5,000 miles from Sydney.

TO INCREASE THE EFFICIENCY OF YOUR CRYSTAL SET BUY OUR ONE-VALVE AMPLIFIER—Ready to connect up—Price £8; or the TWO-VALVE AMPLIFIER—which will operate a Loud Speaker—Price £9.

— WE SELL —

THE FAMOUS FROST FITTINGS, all makes of 'Phones and Loud Speakers — THE UNITED DISTRIBUTORS, LTD., HOME ASSEMBLY SETS and RADIOVOX SETS — STERLING 4-VALVE and 2-VALVE SETS, Loud Speakers and Phones — GALENA, ZINCITE, BORNITE, MOLYBDENITE, IRON PYRITES, AUSTRALITE CRYSTALS.

ALL THE LATEST BOOKS and MAGAZINES on WIRELESS in Stock.

Mention "Radio" when communicating with Advertisers.

An All-Wave Tuner

WHEN it comes to a three-valve set, you will have to go a long way to do better than can be done with the all-wave three-coil set about to be described—if you can put up a fairly good-sized aerial.

It is a regenerative set that uses either spider web coils for short wave-lengths, or honeycomb or duo-lateral coils for long wave-lengths. It con-

secondary coil, which is fixed. This is best done by using the regular honeycomb coil mounting. The drawing shows them separated for clearness but in practice they are mounted side by side, just as close as you can get them.

If you use honeycomb coils, you will require coils of 25, 35, 50, 75 and 100 turns to cover the broadcast-

and secondary coils separated about two inches.

There are two variable condensers used and it would be a good idea to have both of them verniers. One of the best verniers is the type in which the vernier is incorporated in the dial.

While a great deal has been written about logging stations on certain settings with a neutrodyne set, the same thing may be done on this type of set. If, due to variation in coupling, the secondary condenser must be moved a degree or so either way, it is accomplished quicker than it takes to tell it. In fact, after one has used a three-coil set for any length of time, all the tuning is done with the secondary variable condenser and the primary condenser only used when exceedingly sharp tuning on weak signals is necessary.

For day in and day out operation, summer and winter, you have to go a long way to beat a three-coil regenerative set which will do most of the things other five-valve sets do, and do them quieter. However, it will not work satisfactorily on a loop aerial, although we know of cases where some did, but we are not trying to pick out isolated cases, the article being intended for the average case.

sists of a primary, secondary and tickler as the tuner. Of course, for loud-speaker operation, two stages of audio frequency amplification must be included.

The drawing shows the three coils marked P, S and T. They are mounted together so the primary and tickler coils may be moved away from the

ing wave-lengths. The coil having more to do with the wave-length range of your set being the secondary. With loose coupling between primary and secondary, you will find tuning of this circuit very sharp and until you get accustomed to it, it is suggested that fairly close coupling be used. That is, have the primary

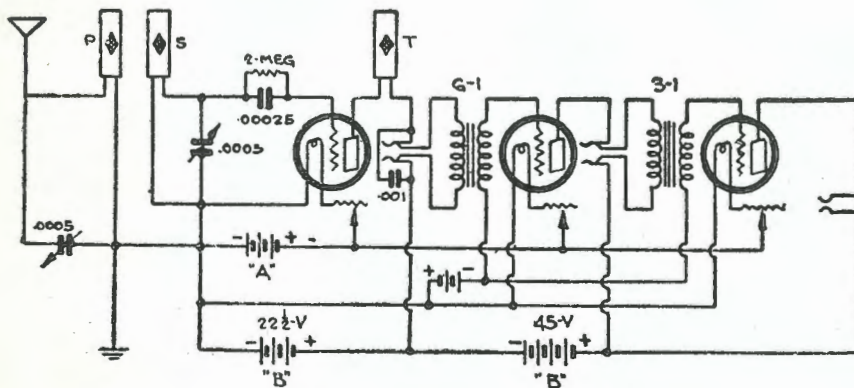

Listen to the best from Australia's concert platforms and theatres during your holidays. Take a receiving set with you. You will never regret it.

Wireless Receiving Sets Made to Order

I am prepared to make sets of any design, either complete or parts only.

VICTOR MARKS' Radio House
BEAMISH STREET, CAMPSIE.

If you use a crystal detector and want to hear signals and speech louder and clearer than you ever have before you should buy **Sacrystal**.

Sacrystal

is not an ordinary detector mineral; it needs care and intelligent handling, but the results from such attention will repay you a hundredfold.

Sacrystal

gives the very best results with any metallic springy contact when the point is flat or blunt, and, once secured, adjustment is permanent.

Buy a piece to-night at your Wireless Dealers, but be sure the container is stamped **SACRYSTAL**.

Retailed at 1/6 a box
from all Radio dealers or from
Miss P. SACHS,
Knox Street, Randwick, N.S.W.
Phone: R'wick 580.

In building this set, keep these things in mind. Make all the grid connections as short as possible, even though you have to lay the transformers on their sides, the shorter the better. The grid leak and condenser should be mounted directly on the socket.

HULA DANCE TO RADIO MUSIC.

IN Papeete on the Island of Tahiti in the South Seas, far removed from the world of affairs, George Bambridge, an old resident, again linked himself with civilisation through a radio receiver of his own construction.

In a letter received by KGO, A. C. Jewett, also of Papeete, tells how "Bambridge made himself a radio set with the object of picking up Morse. He made his own batteries on the back of an old gramophone record. Some of his gadgets are mounted on pine sticks whittled out by hand and held in place by rubber bands."

Suddenly one night, while listening for Morse there came floating out of the air the sweet tones of a violin. Bambridge was astonished. He immediately improved his set and now hears KGO programmes regularly, very much to his delight.

"Hawaiian dance music recently played by your stations," according to Jewett, "came through Bambridge's set splendidly. A Tahitian maid danced the Hula to it, and natives passing in the street thought it was a gramophone playing." Tahiti is seventeen miles south of the equator and about 4300 miles from KGO.

EDWARD WATERS & SONS

(Established 1859.)

PATENT and TRADE MARK ATTORNEYS,
CATHCART HOUSE,
11-13 Castlereagh St., SYDNEY.
Tel.: B 5987. (And at Melbourne.)

QUERIES ANSWERED. COUPON.

"RADIO
in
Australia & New Zealand."

December 24, 1924.

Telephone: 1180 City.

FOR SERVICE

GREEN & NORTON

(Formerly the Rapid Freight Despatch Co.)

CUSTOMS, SHIPPING &
FORWARDING AGENTS,

Broughton House,
49A King St., SYDNEY.

The Different
Christmas Gift!

WIRELESS

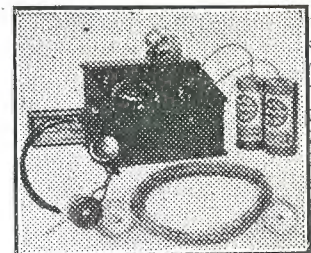

An Excellent Present.
**The "Comet"
One Valve Set**

Price, £8/12/6.

One-Valve Set, complete with valve, dry cell, 42V Ever-ready B Battery, 1 pair phones, aerial wire, insulators, and 4 coils; English type, and made specially by David Jones'. Nothing more to buy. Price, complete, £8/12/6.

DAVID JONES'

For Radio Service,

252 YORK STREET, SYDNEY.

STERLING PLATING & MFG. CO

(Late Stokes & Sons)

225 CLARENCE ST., SYDNEY.
ELECTRO, SILVER, NICKEL AND BRASS
PLATERS.
All kinds of Lacquering, Gilding, Brossing
and Oxidising Done.
Phone: City 6088.

The United States Broadcasting Stations

Feeling that such a list will prove of considerable interest and use to our many experimental readers, we herewith append particulars as to wave-length and call-sign of the principal United States broadcasting stations.

(Reprinted by courtesy of "The Wireless Age.")

KDKA Westinghouse Elec. & Mfg. Co., E. Pittsburgh, Pa. 326	KFEY Bunker Hill & Sullivan Mining & Concentrating Co., Kellogg, Idaho 360
KDPM Westinghouse Elec. & Mfg. Co., .. Cleveland, O. 270	KFEZ Associated Engineering Societies of St. Louis, St. Louis, Mo. 248
KDPT Southern Electric Co. San Diego, Calif. 244	KFFB Jenkins Furniture Co.....Boise, Idaho 240
KDYL Newhouse Hotel Salt Lake City, Utah 360	KFFE Eastern Oregon Radio Co.....Pendleton, Ore. 360
KDYM Savoy Theatre San Diego, Calif. 280	KFFR Nevada State Journal.....Sparks, Nev. 226
KDYQ Oregon Institute of Technology, Portland, Ore. 360	KFFV Graceland College.....Lamoni, Iowa 280
KDZB Frank E. Siefert Bakersfield, Calif. 240	KFFX McGraw Co.....Omaha, Nebr. 278
KDZE Rhodes Department Store Seattle, Wash. 270	KFFY Pincus & Murphy.....Alexandria, La. 275
KDZI Electric Supply Co. Wenatchee, Wash. 360	KFGC Louisiana State University...Baton Rouge, La. 254
KDZR Bellingham Publishing Co., Bellingham, Wash. 261	KFGD Chickasha Radio & Elec. Co., Chickasha, Okla. 248
KFAD McArthur Bros., Mercantile Co. .. Phoenix, Ariz. 360	KFGL Snell & Irby.....Arlington, Ore. 234
KFAE State College of Washington, Pullman, Wash. 330	KFGQ Crary Hardware Co.....Boone, Iowa 226
KFAF Western Radio Corp.....Denver, Colo. 360	KFGB Heidbreder Radio Supply Co.....Utica, Nebr. 224
KFAJ University of Colorado.....Boulder, Colo. 360	KFGX First Presbyterian Church.....Orange, Tex. 250
KFAR Studio Lighting Service Co....Hollywood, Calif. 280	KFGZ Emmanuel Missionary Coll..Berrien Spgs., Mich. 286
KFAW The Radio Den.....Santa Ana, Calif. 280	KFHA Western State College of Colo., Gunnison, Colo. 252
KFAY Virgin's Radio Service.....Medford, Ore. 283	KFHH Ambrose A. McCue.....Neah Bay, Wash. 261
KFBB F. A. Buttrey & Co.....Havre, Mont. 360	KFHJ Fallon & Co.....Santa Barbara, Calif. 360
KFBC W. K. Azvill.....San Diego, Calif. 278	KFHR Star Electric & Radio Co.....Seattle, Wash. 283
KFBE Reuben H. Horn.....San Luis Obispo, Calif. 242	KFI Earle C. Anthony (Inc.).....Los Angeles, Calif. 469
KFBG First Presbyterian Church.....Tacoma, Wash. 360	KFIF Benson Polytechnic Institute.....Portland, Ore. 360
KFBK Kimball-Upson Co.....Sacramento, Calif. 283	KFIO North Central High School.....Spokane, Wash. 252
KFBL Leese Bros.....Everett, Wash. 224	KFIQ Yakima Valley Radio Broadcasting Association, Yakima, Wash. 242
KFBS Trinidad Gas & Electric Supply Co. and the Chronicle News, Trinidad, Colo. 360	KFIU Alaska Elec. Light & Power Co., Juneau, Alaska 226
KFBU The Cathedral.....Laramie, Wyo. 283	KFIX Reorganised Church of Jesus Christ of Latter Day Saints, Independence, Mo. 240
KFCB Nielsen Radio Supply Co.....Phoenix, Ariz. 238	KFIZ Daily Commonwealth and Oscar A. Huelsmman, Fond-du-Lac, Wis. 273
KFCF Frank A. Moore Walla Walla, Wash. 360	KFJB Marshall Electric Co.....Marshalltown, Iowa 248
KFCP Ralph W. Flygare.....Ogden, Utah 360	KFJC Seattle Post-Intelligence.....Seattle, Wash. 270
KFCV Fred Mahaffey, Jr.....Houston, Tex. 360	KFJF National Radio Mfg. Co., Oklahoma City, Okla. 252
KFCZ Omaha Central High School.....Omaha, Nebr. 258	KFJI Liberty Theatre.....Astoria, Ore. 252
KFDD St. Michael's Cathedral..... Boise, Idaho 252	KFJK Delano Radio & Electric Co....Bristow, Okla. 233
KFDH University of Arizona.....Tucson, Ariz. 268	KFJL Hardsag Manufacturing Co....Ottumwa, Iowa 242
KFDJ Oregon Agricultural College.....Corvallis, Ore. 360	KFJM University of North Dakota; Grand Forks, N.D. 280
KFDX First Baptist Church.....Shreveport, La. 360	KFJQ Electric Construction Co., Grand Forks, N. Dak. 280
KFDY South Dakota State College..Brookings, S. Dak. 360	KFJR Ashley C. Dixon & Son.....Stevensville, Mont. 258
KFDZ Harry Q. Irverson.....Minneapolis, Minn. 231	KFJX Iowa State Teachers' College, Cedar Falls, Iowa 280
KFEC Meier & Frank Co.....Portland, Ore. 248	KFJY Tunwall Radio Co.....Fort Dodge, Iowa 246
KFEK Augsburg Seminary.....Minneapolis, Minn. 261	KFJZ Texas Nat'l Guard, 112 Cav., Fort Worth, Tex. 254
KFEL Winner Radio Corporation.....Denver, Colo. 254	
KFEQ J. L. Scroggin.....Oak, Nebr. 268	
KFER Auto Electric Service Co.....Fort Dodge, Iowa 231	
KFEV Felix Thompson Radio Shop.....Casper, Wyo. 263	

— QUALITY IN RADIO APPARATUS —

STROMBERG-CARLSON

Radio Head Set, 2-A	40/-
Loud Speaker, 1-A, with Cord and Plug	£7/10/-
Transformer Audio, 3-A	33/6
Transmitter, 7-L	25/-
Radio Jacks, Plugs, etc.	

JEWELL

Radio Measuring Instruments, built for accuracy and to last. A-B Battery Testers, R. F. Meters, Wave Meters, Valve Tester, Grid Leak Tester, etc.

DURHAM Variable Grid Leak, 2 to 10 Megs., 4/6.

Factory
Representatives:

L. P. R. BEAN & CO. LTD., 229 Castlereagh Street, Sydney

Melbourne: H. G. SMALL & CO., 360 P.O. Place. Brisbane: S. H. SMITH, 299 Adelaide Street. Adelaide: CHAS. ATKINS & CO., LTD., 90 Currie Street, Perth: T. MUIR & CO., 99 William Street. Hobart: J. COOPER, 90 Harrington Street.

Education by Radio

TWENTY thousand Californian school teachers scattered over the valleys and mountains of the State are now being aided by radio broadcasting. Theirs is the job every morning of getting over 600,000 children to be punctual in attendance at school.

From Monday morning, November 3, at 9 o'clock, however, their task has been easier, for a series of weekly programmes furnished by the State Board of Education and broadcast by KGO, the General Electric Pacific Coast station, has proved to be so interesting that children want to be at school in time to hear them.

Schools throughout the State report great enthusiasm for the new venture, according to Grace C. Stanley, Commissioner of Elementary Schools, State Department of Education, who has charge of the work. It is not known at the present time how many pupils actually listened in on the first programme, but schools in isolated districts, which were so greatly benefited are expected to be in the lead of those tuned in on the broadcasts.

It is planned to feature Californian history and geography in the lessons by radio. Professors of the various universities and colleges of the state and other eminent educators and story-tellers will contribute. No lesson will be more than twenty minutes long, and will begin with music and end with music. The story-telling method of teaching will be used. That is, interesting stories will be told about the geographical and historical features of the State, aimed to entertain pupil listeners as well as educate them. Fresh personalities will be thus brought constantly into the minds of the thousands of school children, each with a fascinating story about some river, mountain or character of Californian history. The problem of the country school teacher will in this manner not only be lessened, but teachers are enthusiastically reporting their belief that they themselves will receive benefit and instruction from speakers over the air.

This is said to be the first time in America that a state-wide plan to use radio in public schools has ever been attempted. The idea is said to have originated in a conference this summer on rural education held in San Francisco, when requests from dele-

gates that some attempt to reach the schools in the rural sections of the State by radio was made. A committee consisting of Will C. Wood, State Superintendent of Public Instruction, and Archibald Anderson,

President of the San Francisco State Teachers' College, was appointed to take up the question. After carefully studying the problem, the committee decided to work with the General Electric station, KGO.

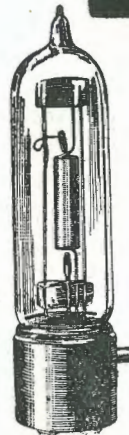

Weco valve, actual size. Can be used either as a Detector High Frequency Amplifier or Low Frequency Amplifier.

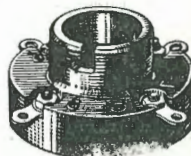

Weco valve Socket

WECOVALVES make all the difference

Small but supreme in clearness and long life, Weco valves are first favourites with radio enthusiasts. Weco valves improve the receptive qualities of any properly constructed receiving set and give wonderful results. They operate on dry cells—no accumulators being necessary.

A Brisbane experimenter, using one Weco valve, gets Sydney stations 2 B.L. and 2 F.C. with ease. Others using two Weco valves have heard K.G.O., Oakland, California, U.S.A., 4 Y.A., Dunedin, 5 A.B., Adelaide, and 6 W.F., Perth.

Stocks of Weco valves & Sockets now available to meet all requirements

Obtainable from any radio dealer. Wholesale from—

Western Electric Company (Australia) Ltd

192-194 Castlereagh St., Sydney. Telephone: City 336, 355 and 356.
And at 588 Bourke St., Melbourne. Telephone: Central 8336 and 8949.



(Continued from page 636.)

KFKA	Colorado State Teachers' Coll....Greeley, Colo.	273	KNT	Walter Hemrich.....Kukak Bay, Alaska	263
KFKB	Brinkley-Jones Hospital Assn., Milford, Kans.	286	KNX	Electric Lighting Supply Co., Los Angeles, Calif.	360
KFKQ	Conway Radio Laboratories.....Conway, Ark.	250	KOB	New Mexico College of Agriculture & Mechanic Arts, State College, N. Mex.	360
KFKV	F. F. Gray.....Butte, Mont.	283	KOP	Detroit Police Department.....Detroit, Mich.	286
KFKX	Westinghouse Elec. & Mfg. Co., Hastings, Nebr.	341	KPO	Hale Bros.....San Francisco, Calif.	423
KFKZ	Nassour Bros. Radio Co., Colorado Springs, Colo.	234	KQP	Apple City Radio Club.....Hood River, Ore.	360
KFLA	Abner R. Wilson.....Butte, Mont.	283	KQV	Doubleday-Hill Electric Co.....Pittsburgh, Pa.	270
KFLB	Signal Electric Mfg. Co.....Menominee, Mich.	248	KQW	Charles D. Herrold.....San Jose, Calif.	360
KFLD	Paul E. Greenlaw.....Franlinton, La.	234	KRE	Berkeley Daily Gazette.....Berkeley, Calif.	275
KFLE	National Education Service.....Denver, Colo.	268	KSD	Post-Dispatch.....St. Louis, Mo.	546
KFLQ	Bizzell Radio Shop.....Little Rock, Ark.	261	KTW	First Presbyterian Church.....Seattle, Wash.	360
KFLU	Rio Grande Radio Supply House, San Benito, Tex.	236	KUO	Examiner Printing Co.....San Francisco, Calif.	360
KFLV	A. T. Frykman.....Rockford, Ill.	229	KUY	Coast Radio Co.....El Monte, Calif.	256
KFLX	George R. Clough.....Galveston, Tex.	240	KWG	Portable Wireless Telephone Co., Stockton, Calif.	360
KFLZ	Atlantic Automobile Co.....Atlantic, Iowa	273	KWH	Los Angeles Examiner.....Los Angeles, Calif.	360
KFMB	Christian Churches of Little Rock, Little Rock, Ark.	254	KYQ	The Electric Shop.....Honolulu, Hawaii	270
KFMQ	University of Arkansas.....Fayetteville, Ark.	263	KYW	Westinghouse Electric & Mfg. Co., Chicago, Ill.	536
KFMR	Morningside College.....Sioux City, Iowa	261	KZM	Preston D. Allen.....Oakland, Calif.	360
KFMT	George W. Young.....Minneapolis, Minn.	231	WAAB	Valdemar Jensen.....New Orleans, La.	268
KFMW	M. G. Satern.....Houghton, Mich.	266	WAAC	Tulane University.....New Orleans, La.	360
KFMX	Carleton College.....Northfield, Minn.	283	WAAD	Ohio Mechanics Institute.....Cincinnati, Ohio	360
KFNF	Henry Field Seed Co.....Shenandoah, Iowa	266	WAAF	Chicago Daily Drivers' Journal....Chicago, Ill.	286
KFNG	Wooten's Radio Shop.....Coldwater, Miss.	254	WAAM	I. R. Nelson Co.....Newark, N.J.	263
KFNJ	Warrensburg Electric Shop., Warrensburg, Mo.	234	WAAN	University of Missouri.....Columbia, Mo.	254
KFNL	Radio Broadcast Association..Paso Robles, Calif.	240	WAAW	Omaha Grain Exchange.....Omaha, Nebr.	286
KFNV	L. A. Drake.....Santa Rosa, Calif.	234	WABB	Harrisburg Sporting Goods Co..Harrisburg, Pa.	266
KFNX	Peabody Radio Service.....Peabody, Kans.	240	WABD	Parker High School.....Dayton, Ohio	283
KFNY	Montana Phonograph Co.....Helena, Mont.	261	WABE	Y.M.C.A.....Washington, D.C.	283
KFNZ	Royal Radio Co.....Burlingham, Calif.	231	WABG	Arnold Edwards Piano Co.....Jacksonville, Fla.	275
KFOA	Rhodes Co.....Seattle, Wash.	455	WABH	Lake Shore Tyre Co.....Sandusky, Ohio	240
KFOC	First Christian Church.....Whittier, Calif.	236	WABI	Bangor Railway & Electric Co.....Bangor, Me.	240
KFOD	The Radio Shop.....Wallace, Idaho	224	WABL	Connecticut Agricultural College..Storrs, Conn.	283
KFOJ	Moberly High School Radio Club, Moberly, M.	246	WABM	F. A. Doherty Automotiv & Radio Equipment Co., Saginaw, Mich.	254
KFOL	Leslie M. Schafbuch.....Marengo, Iowa	234	WABO	Lake Avenue Baptist Church, Rochester, N.Y.	283
KFON	Echophone Radio Shop.....Long Beach, Calif.	234	WABP	Robert F. Weinig.....Dover, Ohio	266
KFPB	Edwin J. Brown.....Seattle, Wash.	224	WABQ	Haverford College Radio Club...Haverford, Pa.	261
KFPT	Cape & Johnson.....Salt Lake City, Utah	360	WABR	Scott High School.....Toledo, Ohio	270
KFQE	Dickenson-Henry Radio Laboratories, Colorado Springs, Colo.	224	WABU	Victor Talking Machine Co.....Camden, N.J.	226
KFQF	Donald A. Boulton.....Minneapolis, Minn.	224	WABV	John H. DeWitt.....Nashville, Tenn.	263
KFQY	Farmers' State Bank.....Belden, Nebr.	360	WABW	College of Wooster.....Wooster, Ohio	234
KFSG	Echo Park Evangelistic Assn., Los Angeles, Calif.	278	WABX	Henry B. Joy.....Mount Clemens, Mich.	270
KGB	Tacoma Daily Ledger.....Tacoma, Wash.	262	WABY	John Magaldi, Jr.....Philadelphia, Pa.	242
KGG	Hallock Watson Radio Service...Portland, Ore.	360	WABZ	Coliseum Place Baptist Church, New Orleans, La.	263
KGO	General Electric Co.....Oakland, Calif.	312	WBAA	Purdue University.....West Lafayette, Ind.	360
KGU	Marion A. Mulrony.....Honolulu, Hawaii	360	WBAH	The Dayton Co.....Minneapolis, Minn.	417
KGW	Portland Morning Oregonian.....Portland, Ore.	492	WBAN	Wireless 'Phone Corporation.....Paterson, N.J.	244
KGY	St. Martin's College.....Lacey, Wash.	258	WBAO	James Milliken University.....Decatur, Ill.	360
KHJ	Times-Mirror Co.....Los Angeles, Calif.	395	WBAP	Wortham-Carter Pub. Co. (Star Telegram), Fort worth, Tex.	476
KHQ	Louis Wasmer.....Seattle, Wash.	360	WBAV	Erner & Hopkins Co.....Columbus, Ohio	423
KJQ	C. O. Gould.....Stockton, Calif.	273	WBAX	John H. Stenger, Jr.....Wilkes-Barre, Pa.	360
KJR	Northwest Radio Service Co.....Seattle, Wash.	283	WBAY	Western Electric Co.....New York, N.Y.	492
KJS	Bible Inst. of Los Angeles, Los Angeles, Calif.	360	WBBA	Plymouth Congregational Church..Newark, Ohio	360
KLS	Warner Bros. Radio Supplies Co., Oakland, Calif.	360	WBBD	Barbey Battery Service.....Reading, Pa.	234
KLX	Tribune Publishing Co.....Oakland, Calif.	509	WBBG	Irving Vermilya.....Mattapoisett, Mass.	248
KLZ	Reynolds Radio Co.....Denver, Colo.	283	WBBH	J. Irving Bell.....Port Huron, Mich.	246
KMJ	San Joaquin Light & Power Corp., Fresno, Calif.	248	WBBJ	Neel Electric Co.....West Palm Beach, Fla.	258
KMO	Love Electric Co.....Tacoma, Wash.	360			

WIRELESS PRESS PUBLICATIONS

New and revised Catalogue now available. Send Stamped
 _____ and addressed envelope for Free Copy to _____

THE WIRELESS PRESS,

97 Clarence Street, SYDNEY.

44 Market Street,
 MELBOURNE, VIC.

Australasian Chambers,
 WELLINGTON, N.Z.

Amplification without Distortion

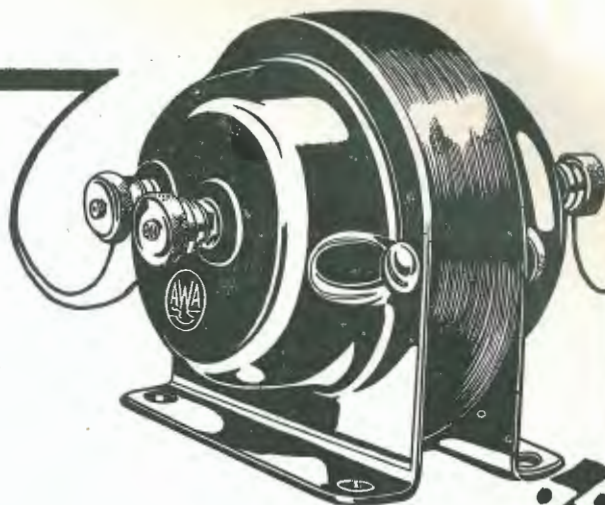

"If the Transformer has low insulation there will be a big loss of amplification in the Transformer itself."

Special Cotton, having very low dielectric capacity, gives efficient insulation between the layers and windings of the "AWA" Audio Frequency Transformer, reducing self-capacity to a minimum. This insulation is tested with 1000-volt pressure test, and any coil is rejected which does not give infinity reading.

The transformer is enclosed in heavy iron covers, giving very effective shielding and preventing inter-action between the transformer and the circuit.

AWA Audio-Frequency Transformers are supplied in ratios 5-1 and $3\frac{1}{2}$ -1.

Delivery of the correct article in perfect condition is ensured by packing in unbreakable cartons, with the ratio clearly shown on each end.

ITS AN



PRODUCT

PRICE, 30/-.

At all Radio Dealers.

Amalgamated  Wireless
(Australasia) Ltd.

97 Clarence Street,
SYDNEY.

Collins Street,
MELBOURNE.

RADIO DEALERS — KINDLY WRITE FOR TRADE PRICE LIST.

WBBL	Grace Covenant Church.....	Richmond, Va.	283	WDAP	Drake Hotel.....	Chicago, Ill.	360
WBBM	Frank Atlass Produce Co.....	Lincoln, Ill.	226	WDAR	Lit Brothers.....	Philadelphia, Pa.	395
WBBN	A. B. Blake.....	Wilmington, N.C.	275	WDAS	Samuel A. Waite.....	Worcester, Mass.	360
WBBP	Petoskey High School.....	Petoskey, Mich.	246	WDAU	Slocum & Kilburn.....	New Bedford, Mass.	360
WBBR	Peoples Pulpit Association.....	Rossville, N.Y.	273	WDAY	Radio Equipment Corporation....	Fargo, N. Dak.	244
WBBT	Lloyd Bros.....	Philadelphia, Pa.	234	WDBC	Kirk, Johnson & Co.....	Lancaster, Pa.	258
WBBU	Jenks Motor Sales Co.....	Monmouth, Ill.	224	WDBL	Immanuel Lutheran Church of Valparaiso, Valparaiso, Ind.		273
WBBV	Johnstown Radio Co.....	Johnstown, Pa.	248	WDBP	Superior State Normal School	Superior, Wis.	261
WBBW	Ruffner Junior High School.....	Norfolk, Va.	222	WDM	Church of the Covenant.....	Washington, D.C.	234
WBBY	Washington Light Infantry.....	Charleston, S.C.	268	WDZ	James L. Bush.....	Tuscola, Ill.	278
WBBZ	Noble S. Watson.....	Indianapolis, Ind.	227	WEAA	Frank D. Fallain.....	Flint, Mich.	250
WBS	D. W. May (Inc.).....	Newark, N.J.	360	WEAF	American Tel. & Tel. Co.....	New York, N.Y.	492
WBT	Southern Radio Corporation....	Charlotte, N.C.	360	WEAH	Wichita Board of Trade.....	Wichita, Kans.	280
WBZ	Westinghouse Elec. & Mfg. Co.,	Springfield, Mass.	337	WEAI	Cornell University.....	Ithaca, N.Y.	286
WCAD	St. Lawrence University.....	Canton, N.Y.	280	WEAJ	University of South Dakota..	Vermilion, S. Dak.	283
WCAE	Kaufmann & Bauer Co.....	Pittsburgh, Pa.	462	WEAM	Borough of North Plainfield, Nth.	Plainfield, N.J.	286
WCAH	Clyde R. Randall.....	New Orleans, La.	268	WEAN	Shepard Co.....	Providence, R.I.	273
WCAJ	Entreklin Electric Co.....	Columbus, Ohio	286	WEAO	Ohio State University.....	Columbus, Ohio	360
	Nebraska Wesleyan University, University Place, Nebr.		360	WEAP	Mobile Radio Co.....	Mobile, Ala.	360
WCAK	Alfred P. Daniel.....	Houston, Tex.	263	WEAR	Evening News Publishing Co....	Baltimore, Md.	261
WCAL	St. Olaf College.....	Northfield, Minn.	360	WEAU	Davidson Bros. Co.....	Sioux City, Iowa	360
WCAO	Sanders & Stayman Co.....	Baltimore, Md.	360	WEAY	Iris Theatre.....	Houston, Tex.	360
WCAP	Chesapeake & Potomac Tel. Co,	Washington, D.C.	469	WEB	Benwood Co.....	St. Louis, Mo.	273
WCAR	Southern Radio Corp. of Texas,	San Antonio, Tex.	360	WEBE	Roy W. Waller.....	Cambridge, Ohio	360
WCAS	William Hood Dunwoody Industrial Institute, Minneapolis, Minn.		280	WEBH	Edgewater Beach Hotel Co.....	Chicago, Ill.	370
WCAT	South Dakota State School of Mines, Rapid City, S. Dak.		240	WEBK	Grand Rapids Radio Co....	Grand Rapids, Mich.	360
WCAU	Durham & Co.	Philadelphia, Pa.	286	WEW	Hurlburt-Still Electrical Co....	Houston, Texas	263
WCAV	J. C. Dice Electric Co.....	Little Rock, Ark.	360	WEW	St. Louis University.....	St. Louis, Mo.	280
WCAX	University of Vermont.....	Burlington, Vt.	360	WFAA	Dallas News and Dallas Journal...	Dallas, Tex.	470
WCAZ	Carthage College.....	Carthage, Ill.	246	WFAB	Carl F. Woese.....	Syracuse, N.Y.	234
WCBA	Charles W. Helmbach.....	Allentown, Pa.	280	WFAM	Times Publishing Co.....	St. Cloud, Minn.	273
WCBC	University of Michigan.....	Ann Arbor, Mich.	280	WFAH	Electric Supply Co.....	Port Arthur, Tex.	236
WCBD	Wilbur G. Voliva.....	Zion, Ill.	345	WFAN	Hutchinson Elec. Service Co.,	Hutchinson, Minn.	360
WCBE	Uhalt Radio Co.....	New Orleans, La.	263	WFAV	University of Nebraska.....	Lincoln, Nebr..	275
WCBG	Howard S. Williams.....	Pascagoula, Miss.	268	WFBG	Robert B. Gable.....	Altoona, Pa.	360
WCBH	University of Mississippi.....	Oxford, Miss.	242	WFBH	Hotel Majestic.....	New York City	273
WCBM	Charles Schwarz.....	Baltimore, Md.	360	WFI	Strawbridge & Clothier.....	Philadelphia, Pa.	395
WCBX	Radio Shop of Newark.....	Newark, N.J.	233	W GAL	Lancaster Elec. Sup. & Const. Co.,	Lancaster, Pa.	248
WCCP	Coppotelli Brothers' Music House, Chicago Heights, Ill.		360	WGAN	Cecil E. Lloyd.....	Pensacola, Fla.	360
WCK	Stix-Baer & Fuller Dry Goods Co.,	St. Louis, Mo.	360	WGAQ	W. G. Patterson.....	Shreveport, La.	252
WCX	Detroit Free Press.....	Detroit, Mich.	517	WGAZ	South Bend Tribune.....	South Bend, Ind.	360
WDAE	Tampa Daily Times.....	Tampa, Fla.	360	WGI	American Radio and Research Corporation, Medford, Hillside Mass.		360
WDAF	Kansas City Star.....	Kansas City, Mo.	411	WGL	Thomas F. J. Howlet.....	Philadelphia, Pa.	360
WDAG	J. Laurance Martin.....	Amarillo, Tex.	263	WGR	Federal Tel. & Tel. Co.....	Buffalo, N.Y.	319
WDAH	Trinity Methodist Church (South),	El Paso, Tex.	268	WGY	General Electric Co.....	Schenectady, N.Y.	380
WDAK	The Courant.....	Hartford, Conn.	261	WHA	University of Wisconsin.....	Madison, Wis.	360
				WHAA	State University of Iowa.....	Iowa City, Iowa	484
				WHAD	Marquette University.....	Milwaukee, Wis.	280

INSURE WITH

The Liverpool and London and Globe Insurance Co. Ltd.

ASSETS EXCEED £20,000,000.

LOWEST RATES.

FIRE — ACCIDENT — MARINE

Head Office for Australasia:
62 PITT STREET, SYDNEY.

W. B. CLARKE, Local Manager for N.S.W.

Melbourne Branch:
415-7 COLLINS STREET.

R. M. EVANS, Local Manager for Victoria.

C. DANVERS, Manager for Australasia.

T. M. DOUGLAS, Assistant Manager for Australasia.

WHAG	University of Cincinnati.....Cincinnati, Ohio	222	WKAQ	Radio Corporation of Porto Rico, San Juan, P.R.	360
WHAH	Hafer Supply Co.....Joplin, Mo.	283	WKAR	Michigan Agri. College....East Lansing, Mich.	280
WHAK	Roberts Hardware Co.....Clarksburg, W. Va.	258	WKAV	Laconia Radio Club.....Laconia, N.H.	254
WHAM	University of Rochester (Eastman School of Music), Rochester, N.Y.	283	WKY	WKY Radio Shop.....Oklahoma, Okla.	360
WHAR	Seaside House.....Atlantic City, N.J.	275	WLAG	Cutting & Washington Radio Corporation, Minneapolis, Minn.	417
WHAS	Courier-Journal and Louisville Times, Louisville Ky.	400	WLAH	Samuel Woodworth.....Syracuse, N.Y.	234
WHAV	Wilmington Elec. Spec. Co....Wilmington, Del.	360	WLAL	Naylor Electrical Co.....Tulsa, Okla.	360
WHAZ	Rensselaer Polytechnic Institute.....Troy, N.Y.	380	WLAP	W. V. Jordon.....Louisville, Ky.	360
WHB	Sweeney School Co.....Kansas City, Mo.	411	WLAQ	Arthur E. Schilling.....Kalamazoo, Mich.	283
WHK	Radiovox Co.....Cleveland, Ohio	283	WLAV	Electric Shop.....Pensacola, Fla.	254
WHN	George Schubel.....New York, N.Y.	360	WLAW	Police Dept., City of N.Y.....New York, N.Y.	360
WIAB	Art A. Johnson's Garage.....Rockford, Ill.	252	WLAX	Putnam Electric Co.....Greencastle, Ind.	231
WIAC	Galveston Tribune.....Galveston, Tex.	360	WLB	University of Minnesota.....Minneapolis, Minn.	360
WIAD	Howard R. Miller.....Philadelphia, Pa.	254	WLBL	Wisconsin Dept. of Markets..Stevens Point, Wis.	278
WIAK	Journal-Stockman Co.....Omaha, Nebr.	278	WLW	Crosley Manufacturing Co.....Cincinnati, Ohio	423
WIAQ	Chronicle Publishing Co.....Marion, Ind.	226	WMAC	Clive B. Meredith.....Cazenovia, N.Y.	261
WIAS	Home Electric Co.....Burlington, Iowa	283	WMAF	Round Hills Radio Corp.....Dartmouth, Mass.	360
WIK	K. & L. Electric Co.....McKeesport, Pa.	234	WMAH	General Supply Co.....Lincoln, Nebr.	254
WIL	Continental Elec. Supply Co., Washington, D.C.	360	WMAK	Lockport Board of Commerce...Lockport, N.Y.	273
WIP	Gimbel Bros.....Philadelphia, Pa.	509	WMAL	Trenton Hardware Co.....Trenton, N.J.	256
WJAD	Jackson's Radio Eng. Laboratories, Waco, Tex.	360	WMAQ	Chicago Daily News.....Chicago, Ill.	448
WJAG	Norfolk Dairy News.....Norfolk, Nebr.	283	WMAV	Alabama Polytechnic Institute...Auburn, Ala.	250
WJAK	Clifford L. White.....Greentown, Ind.	254	WMAY	Kingshighway Presby. Church, St. Louis, Mo.	280
WJAM	D. M. Perham.....Cedar Rapids, Iowa	263	WMC	Commercial Appeal.....Memphis, Tenn.	500
WJAN	Peoria Star.....Peoria, Ill.	280	WMU	Doubleday-Hill Electric Co., Washington, D.C.	261
WJAQ	Capper Publications.....Topeka, Kans.	360	WNAC	Shepard Stores.....Boston, Mass.	278
WJAR	The Outlet Co.....Providence, R. I.	360	WNAD	University of Oklahoma.....Norman, Okla.	360
WJAS	Pittsburgh Radio Supply House..Pittsburgh, Pa.	286	WNAL	R. J. Rockwell.....Omaha, Nebr.	266
WJAX	Union Trust Co.....Cleveland, Ohio	390	WNAP	Wittenberg College.....Springfield, Ohio	275
WJD	Denison University.....Granville, Ohio	229	WNAR	C. C. Rhodes.....Butler, Mo.	231
WJY	Radio Corporation of America, New York, N.Y.	405	WNAT	Lenning Brothers Co.....Philadelphia, Pa.	360
WJZ	Radio Corporation of America...New York, N.Y.	455	WNAW	Henry Kunzman....Box 167, Fort Monroe, Va.	360
WKAA	H. F. Paar.....Cedar Rapids, Iowa	278	WNAX	Dakota Radio Apparatus Co., Yankton, S. Dak.	244
WKAD	Charles Loeff (Crescent Park) E. Providence R.I.	240	WNYC	Municipality of New York.....New York City	526
WKAF	W. S. Radio Supply Co.....Wichita Falls, Tex.	360	WOAC	Page Organ Co. (H. P. Maus).....Lima, Ohio	266
WKAN	United Battery Service Co.....Montgomery, Ala.	226	WOAE	Midland College.....Fremont, Nebr.	280
			WOAF	Tyler Commercial College.....Tyler, Tex.	360

Ask your Dealer for a K & C
Condenser

There is no better Condenser made

PACIFIC ELECTRIC Co. Ltd.

(WHOLESALE ONLY)

87 CLARENCE STREET, SYDNEY.

B 5891

SOLE AUSTRALIAN DISTRIBUTORS.

What is the Matter?

IT does not matter what kind of a radio set you have, if it is a valve detector, it will require upkeep. The first renewal will no doubt be your A battery, if it is of the dry cell type. The next will be the B battery and the last should be the valve.

In a great many cases the valve is the first renewal, but this is due to burning the filament too bright and is your own fault. Standard valves are guaranteed to detect and amplify and when they do that, it is up to you to nurse them along for a long life.

As stated previously, these three items are all that should require renewing. The rest of your set may need some attention from time to time to tighten loose connections but as far as renewals are concerned, the valve and batteries are about all that wear out.

When you buy a manufactured set, your dealer ought to prove to you that it is in good working order. He can very easily do this in his shop and if it will work there and does not in your home, it is not the fault of the set. It is not advisable to start tearing a manufactured set apart just because it does not work. You probably have batteries incorrectly connected, or your aerial and ground system is faulty.

In a home-made set almost anything can be wrong. The wiring may be wrong. You may have defective parts, or like the manufactured set, batteries or aerial and ground may be faulty. There are times when brand new valves are defective, but if you have an up-to-date dealer, he will have a device for testing every valve

he sells and when you buy of such a dealer, you are assured of a good valve.

Even though every part of your radio set is good, there is still the problem of tuning-in to the stations you want. If you have a single circuit set, the problem (if it may be called that) is easy, in fact, you may hear more than you want to at one time; if it is a two circuit set, you must tune both circuits to resonance for the desired signal; while if you have a neutrodyne set, you have three

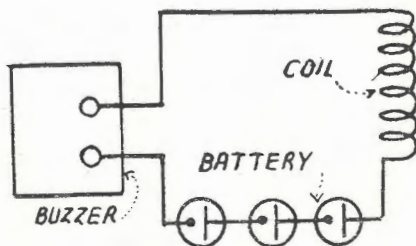

circuits to adjust and if any of them are very much out, you do not hear anything but crackling noises. In the latter case there is nothing wrong with your set, the trouble is with you.

If any of your variable condensers fail to vary the adjustments of your set, that condenser is no doubt short circuited. It may be a strand of wire touching rotor and stator plates or it may be an accumulation of dust.

If you can hear the long wave stations and not the short ones, your aerial may be too long for your type of set and on the other hand if you cannot tune up to the long ones, it may be too short.

If the signals are not as strong as they formerly were (we do not mean

fading) the B battery should be tested with a voltmeter. If they have dropped over 20 per cent. in voltage, a new one will give much better results. If you haven't a voltmeter handy, a 10 watt 110 volt incandescent lamp can be connected across the B battery terminals for an instant and the lamp should burn at a dull red. If it fails to do this on a 22½-volt battery, the battery is about done for.

Coils, whether they are tuning, transformer or tickler may have a poor connection or even be broken. These may be tested with a battery and buzzer, being connected in series with them as shown in the drawing. Telephones should not be used in place of buzzer.

NORTHBRIDGE RADIO CLUB.

THE club held the usual weekly meeting at the rooms, corner of Sailor Bay Road and Strathallen Avenue, Northbridge, at 7.30 p.m., Wednesday, December 3.

General business was quickly disposed of and that of the evening, which was a continuance of Mr. Beard's series of lectures dealing with Tuning, was then enjoyed.

The club's activities at present include a well-organised series of experiments under the direction of Mr. Beard. The club supplies all gear, etc., necessary to test various theories discussed during the evening, carrying reports of the results attained forward to the following meeting night for general discussion and comparison. Much very useful experimental work is being covered.

This procedure is to be continued and any person desiring to become a member of the club may obtain information from Mr. Cameron, Clanwilliam Street, Chatswood, or by attending the club rooms on Wednesday evenings at 7.30 p.m.

"The Theatre, Society and Home"

LIKE WIRELESS IT TOUCHES ALL PARTS OF THE WORLD

After Reading Please Pass on to a Friend. Larger Circulation Means More Advertisements :: More Advertisements Mean Extra News, Pars, and Home Chatter.

PUBLISHED MONTHLY. SOLD BY ALL BOOKSTALLS.

HEAD OFFICE: 16 BOND STREET, SYDNEY.

Branches: 100 King St., MELBOURNE; 75 Elizabeth St., BRISBANE; 32 Weymouth St., ADELAIDE.

WOAG	Apollo Theatre.....	Belvidere, Ill.	273	WRAF	The Radio Club.....	Laporte, Ind.	224
WOAH	Palmetto Radio Corporation...	Charleston, S.C.	360	WRAL	Northern States Power Co., St. Croix Falls, Wis.		248
WOAI	Southern Equipment Co.....	San Antonio, Tex.	385	WRAM	Lombard College.....	Galesburg, Ill.	244
WOAN	James D. Vaughn.....	Lawrenceburg, Tenn.	360	WRAN	Black Hawk Electrical Co.....	Waterloo, Iowa	236
WOAO	Lyradion Mfg. Co.....	Mishawaka, Ind.	360	WRAO	St. Louis Radio Service Co.....	St. Louis, Mo.	360
WOAT	Boyd M. Hamp.....	Wilmington, Del.	360	WRAV	Antioch College.....	Yellow Springs, Ohio	242
WOAV	Pennsylvania Nat. Guard, 112th Inf..	Erie, Pa.	242	WRAW	Avenue Radio Shop.....	Reading, Pa.	238
WOAW	Woodmen of the World.....	Omaha, Nebr.	526	WRAX	Flexon's Garage.....	Gloucester City, N.J.	268
WOAX	Franklyn J. Wolf.....	Trenton, N.J.	240	WRC	Radio Corporation of America, Washington, D.C.		469
WOC	Palmer School of Chiropractic..	Davenport, Iowa	484	WRK	Doron Bros. Electrical Co.....	Hamilton, Ohio	360
WOI	Iowa State College.....	Ames, Iowa	360	WRL	Union College.....	Schenectady, N.Y.	360
WOO	John Wanamaker.....	Philadelphia, Pa.	509	WRM	University of Illinois.....	Urbana, Ill.	360
WOQ	Western Radio Co.....	Kansas City, Mo.	360	WRR	City of Dallas, Police & Fire Signal Dept., Dallas, Texas		360
WOR	L. Bamberger & Co.....	Newark, N.J.	405	WRW	Tarrytown Radio Res'ch Lab., Tarrytown, N.Y.		273
WOS	Missouri State Market'g Bu, Jefferson City, Mo.		441	WSAB	Southeast Missouri State Teachers' College, Cape Girardeau, Mo.		360
WPAB	Pennsylvania State College..	State College, Pa.	283	WSAC	Clemson Agricultural Col., Clemson College, S.C.		360
WPAC	Donaldson Co.....	Okmulgee, Okla.	330	WSAD	J. A. Foster Co.....	Providence, R.I.	261
WPAC	Doolittle Radio Corp.....	New Haven, Conn.	268	WSAI	United States Playing Card Co., Cincinnati, O.		309
WPAK	North Dakota Agricultural College, Agricultural College, N.D.		283	WSAJ	Grove City College.....	Grove City, Pa.	360
WPAL	Avery & Loeb Electric Co.....	Columbus, Ohio	286	WSAN	Allentown Radio Club.....	Allentown, Pa.	229
WPAM	Auerbach & Guettel.....	Topeka, Kans.	360	WSAP	Seventh Day Adventist Temple.....	N.Y. City	263
WPAU	Concordia College.....	Moorehead, Minn.	286	WSAR	Doughty & Welch Elec. Co., Fall River, Mass.		254
WPAZ	John R. Koch.....	Charleston, W. Va.	273	WSAY	Port Chester Chamber of Commerce, Port Chester, N.Y.		233
WQAA	Horace A. Beale, Jr.....	Parkersburg, Pa.	360	WSAZ	Chase Electric Shop.....	Pomeroy, Ohio	258
WQAC	E. B. Gish.....	Amarillo, Texas	234	WSOE	School of Engineering.....	Milwaukee, Wisc.	246
WQAE	Moore Radio News Station.....	Springfield, Vt.	275	WSB	Atlanta Journal.....	Atlanta, Ga.	429
WQAF	Sandusky Register.....	Sandusky, Ohio	240	WSL	J. & M. Electrical Co.....	Utica, N.Y.	273
WQAL	Coles' County Tels. & Teleg. Co., Mattoon, Ill.		258	WSY	Alabama Power Co.....	Birmingham, Ala.	360
WQAM	Electric Equipment Co.....	Miami, Fla.	283		No call sign.....	Fall River, Mass.	360
WQAN	Scranton Times.....	Scranton, Pa.	280	WTAC	Penn Traffic Co.....	Johnstown, Pa.	275
WQAO	Calvary Baptist Church.....	New York, N.Y.	360	WTAF	Louis J. Gallo.....	New Orleans, La.	268
WQAQ	W. Texas Radio Co. (Abilene Dairy Reporter) Abilene, Texas		360	WTAG	Kern Music Co.....	Providence, R.I.	258
WQAS	Prince-Walter Co.....	Lowell, Mass.	266	WTAJ	The Radio Shop.....	Portland, Me.	236
WQAX	Radio Equipment Co.....	Peoria, Ill.	248				
WQJ	Calumet Rainbow Broadcasting Co., Chicago, Ill.		448				

(To be continued.)

Columbia "A", "B" and "C" Radio Batteries

The most satisfying and profitable Radio Batteries you can sell

Advertised all over the world.

COLUMBIA Radio Batteries are the result of constant study and experimenting in the largest laboratory of its kind in the world. They have been accepted everywhere as absolutely the best radio batteries made and they will give far more satisfactory results than any others. They will sell quickly and yield a good profit.

COLUMBIA Dry Cell Radio "A" Batteries are made especially for dry cell vacuum tubes and will greatly outlast any other type of ignition battery for this purpose.

COLUMBIA Storage "A" Batteries for vacuum tubes of one-half ampere or over have many characteristics which make them ideal for such use. They are shipped dry and charged as sold, thus always assuring a new, fresh and powerful battery.

COLUMBIA "B" Batteries are made in 22½ and 45-volt sizes. They are powerful and long lasting. Thoroughly insulated and waterproofed and furnished with Fahnestock Spring Clip Connectors.

COLUMBIA "Three" Batteries are suitable for use as an "A," "B" or "C" Battery. They are made of extra large sized cells and last unusually long time.

Write for an illustrated, descriptive circular.

NATIONAL CARBON COMPANY, Inc.

30 EAST 42nd STREET, NEW YORK, N. Y., U. S. A.

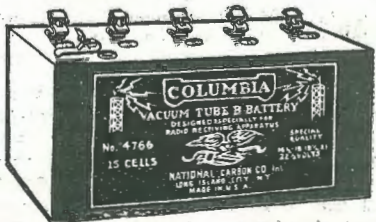
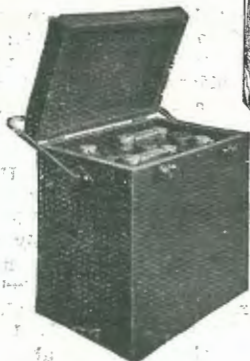



Queries Answered



H. J. T. Q.: Using No. 40 gauge enamelled wire on ebonite tubes two inches long by $\frac{3}{16}$ in. diameter, how many turns will be required on primary and secondary of a tuning transformer to get them in the right proportion? **A.:** If you will state the range of wave-lengths you wish to receive we will be pleased to assist you. **Q.:** How many turns are required on primary and secondary of audio frequency transformer? **A.:** For the primary, 10,000 turns No. 44 enamel and for the secondary, 40,000 turns on an iron wire core $\frac{3}{16}$ in. long and $\frac{1}{16}$ in. diameter.

B. B. N. (Annandale). Q.: Would circuit shown on p. 430, *Radio*, No. 42, give better results than a three-coil? **A.:** The article explains how to obtain increased range and selectivity with a two-coil circuit. Note the author states KGO has been picked up clearly in N.Z. KGO has frequently been heard by amateurs in this country using the same circuit. **Q.:** Would a 23 plate condenser be satisfactory in the secondary circuit? **A.:** Yes.

H. B. L. (Willoughby). Q.: Using 3-valve circuit (submitted), why is 2BL just audible while strong signals are received from 2FC? **A.:** You cannot be very far from the latter station; naturally, his signals are stronger. According to your circuit you have your primary condenser in parallel. Place this in series when receiving 2BL. **Q.:** Using the P1 can you suggest method of cutting out 2FC when receiving 2BL? **A.:** Use correct coils and an additional condenser across the plate coil shown on page 430, *Radio*, No. 42.

U. V. (Granville). Q.: Using P1 circuit, what is cause of unsatisfactory results and trouble with batteries (particulars submitted)? **A.:** Probably due to the following: Old cells when run down act as a series resistance in addition to generating a back E.M.F. due to internal chemical changes. When allowed to stand idle, the old cells recuperate slightly and the sudden overload on the filament may have reduced the thorium coating on this. Burn the filament at normal brilliancy for about an hour with H.T. switched off, as directed on the valve wrapper, this will restore vitality.

H. L. H. (Rockhampton). Q.: Is it necessary to have a chopper for I.C.W. transmission, or can this method of signalling be accomplished with rectified current (circuit submitted)? **A.:** An I.C.W.

transmitter with a D.C. plate supply would require a chopper. With A.C. on the plate I.C.W. can also be obtained, as at Sydney Radio, which makes use of a 400 cycle supply. Buzzer modulation on the grid is practically equivalent to I.C.W. The position of your key is suitable for C.W. transmission. **Q.:** Give information for constructing a transformer to step up from 240 volts A.C. to about 600 volts A.C. **A.:** You will need a closed laminated core $1\frac{1}{2}$ in. x $1\frac{1}{2}$ in. in area, external dimensions

tion. This, however, will only apply to stations due east of your locality. The distance from your aerial and the former heights will be in your favour. Your aerial is otherwise O.K.

L. R. J. (Mosman). Q.: Using the P1 circuit, what is cause of difficulty in getting receiver to oscillate? **A.:** Suggest you carefully check up connections. Possibly valve is at fault. Replace this with another type, also try different size coils. **Q.:** Being deaf in one ear, would you advise disconnecting one ear-piece? **A.:** The best method would be to short the connections on the earpiece not required. No record of your previous letter.

V. F. B. (Clarence River). Q.: Can you advise who KGW and GE11 are? **A.:** KGW is *Portland Morning Oregonian*, Portland, Ore.; transmitting on a wave-length of 492 metres. No record of the latter. See this issue for list of American broadcasting stations. Your reception is excellent.

J. H. H. (Manly). Q.: Will a DER valve with a 30 ohm rheostat be suitable for low wave-lengths? **A.:** Yes. **Q.:** How many turns will be required on rotor and stator of variocoupler to receive on wave-lengths from 90 to 200 metres? **A.:** You will get better results on these wave-lengths using spiderweb or basket coils. Constructional data appeared in previous issues of *Radio*.

H. J. P. (Wodonga). Q.: Using a UV200 valve as a detector, is a grid leak necessary? **A.:** It is usual to use a grid leak of from $\frac{1}{2}$ to two megohms, preferably variable. **Q.:** Are any fixed condensers necessary using circuit submitted, if so, where? **A.:** You will need a 'phone condenser which is usually a .001 m.f. fixed. **Q.:** Would a single wire aerial of about 120 feet long be more efficient than a two or four wire 50 feet long inverted L? **A.:** Yes, it would be advisable, however, to use aerial tuning condenser in series when receiving on short wave-lengths.

"A. B. C." (Glenelg). Q.: Can you recommend a simple circuit for receiving long distance on 80 to 100 metre wave-lengths, also circuit to give good results on Morse, spark, C.W. and broadcasting from 600 to 2,500 metres? **A.:** Some excellent circuits are given in the *Amateurs' Book of Wireless Circuits* by Haynes, and include the one you require.

READERS, PLEASE NOTE!

QUERY letters which are accompanied by our coupon and comply with the following directions will receive first preference.

MAKE your letter as brief as possible and write your questions one underneath the other. All letters must be signed in full, together with the address of the sender. For publication, the writer's initials will be used or a nom-de-plume, if desired, but on no account will any consideration be given to anonymous communications.

IF requested, answers will be forwarded by post, providing the letter of enquiry contains a stamped, addressed envelope and the coupon to be found elsewhere in this issue.

IT SHOULD BE NOTED THAT IT IS IMPOSSIBLE FOR US TO ANSWER QUESTIONS REGARDING THE APPROXIMATE RANGE OF EXPERIMENTERS' SETS.

7in. x 7in. and internal 4in. x 4in. Primary 800 turns No. 20 D.C.C., secondary 2,000 turns No. 30 D.C.C. A ford coil cannot be used.

J. G. A. (Rose Bay). Q.: Using circuit (submitted) and coils of correct value, should any difficulty be experienced in receiving Sydney amateurs? **A.:** No; you will, however, need smaller coils than for 2BL. **Q.:** Do you consider aerial in a bad position with regard to reception (sketch submitted)? **A.:** You will probably experience screening from stations in a direct line from Bellevue Hill and Rose Bay heights, particularly from the latter direc-

MODERN PRINTING

KEEPING in touch with all that is new and good in type faces and modern printing machinery makes us think

we can satisfy your printing wants.

We wish to announce that we can furnish everything it is possible to print and bind. Our charges, quality considered, are surprisingly low. We turn out work as quickly as you want it.

NORTH SYDNEY PRINTING CO.

195 ALFRED STREET,
NORTH SYDNEY.

Tel.: North 3178.

BACON & Co. Ltd.

PROCESS
ENGRAVERS
and
ILLUSTRATORS

31a PITT STREET
SYDNEY

'Phone: B 3368

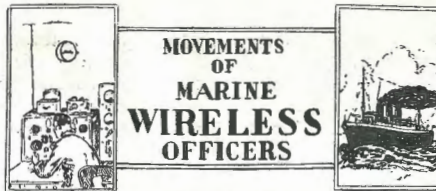

MOVEMENTS OF MARINE WIRELESS OFFICERS

NOVEMBER.

Mr. M. L. Robertson signed off s.s. *Goragon* as senior operator at Fremantle, 21st, and signed on s.s. *Jervis Bay* as second operator at Fremantle, same date.

Mr. F. M. Basden signed on s.s. *Yarra* at Newcastle, 25th.

Mr. L. E. Ashby relieved Mr. J. Carew on s.s. *Cycle* at Sydney, 28th.

Mr. J. Carew relieved Mr. E. T. Prentice on s.s. *Echuca* at Sydney, 28th.

Mr. H. F. Hartley relieved Mr. S. G. Jones on s.s. *Wyreema* at Sydney, 28th.

Mr. R. S. Taylor rejoined s.s. *Maunganui* as senior operator at Wellington, 10th.

Mr. G. M. Whiteside signed off s.s. *Waihora* at Auckland, 8th, and relieved Mr. C. F. G. Taylor on s.s. *Ngaito* at Wellington, 20th.

Mr. C. Britcher signed on s.s. *Waihora* at Wellington, 20th.

Mr. T. J. O'Leary signed on s.s. *Ellaroo* at Melbourne, 21st.

Mr. S. G. Jones signed off s.s. *Wonganelia* at Geelong, 25th.

Mr. J. S. McTavish relieved Mr. C. R. Waite on s.s. *Saros* at Melbourne, 27th.

DECEMBER.

Messrs. G. H. Hugman and R. B. Lowry signed off s.s. *Changsha* as senior and third operators, respectively, at Sydney, 1st.

Mr. W. C. Lucas signed off s.s. *Marsina* at Sydney, 2nd.

Mr. N. M. Leeder signed on s.s. *Tarcoola* at Sydney, 2nd.

Mr. W. C. Lucas relieved Mr. H. M. Watson on s.s. *Maira* at Sydney, 2nd.

Mr. A. E. Shepherd signed on s.s. *Marsina* at Sydney, 3rd.

Messrs. F. A. Cook and R. W. S. Bailey signed off s.s. *Jervis Bay* at Sydney, 3rd.

Messrs. V. M. Brooker and P. C. B. Holdsworth on s.s. *Jervis Bay* as senior and 3rd operator, respectively, at Sydney, 3rd.

WIRELESS SOCIETY OF NEWCASTLE.

ON Wednesday, December 3, at the Wireless Society of Newcastle's rooms, King Street, Newcastle, Mr. G. Seward, gave an instructive lecture to a large attendance of members on "Reflex Circuits," which was afterwards enthusiastically discussed by those present.

These lectures, which are arranged by the Technical Committee of the Society, are very popular with the members, who fully appreciate the effects of their knowledge obtained by actual experiments under local conditions, and which is far more interesting and instructive than that which can be obtained in the ordinary text book.

One new member was admitted. Any persons interested in the activities of the club may obtain information on application to the Secretary, Mr. S. Childs, 55 Ridge Street, Merewether.

Mention "Radio" when communicating with Advertisers.

HUGHES & CO.

HIGH-CLASS
CIVIL and NAVAL TAILORS

Our civil Suits are perfection in STYLE FIT, DURABILITY and PRICE. TAILOR-MADE on the premises under our own supervision. OUR NAVAL UNIFORMS and GOLD LACE work speak for themselves. CAPS, LACE, BADGES, UNIFORM BUTTONS always in stock. ONE Quality only — THE BEST.

70-72 Erskine Street, SYDNEY
'PHONE: City 77.

We are Sole Agents for

"ASHCOY"

Brand Best British Polished

Ebonite Panels

FOR RADIO WORK.

Each packed in a sealed envelope. Stocked in all the standard sizes for crystal and valve sets. Edges ground true to size.

ASK YOUR RADIO DEALER

Full Stocks of British Ebonite Sheets, Rods and Tubes.

WHOLESALE ONLY.

A. S. HARRISON & COMPANY,

'Phone: 5-7 Barrack Street, P.O. Box
B 4574. SYDNEY. 2581.

Learn the Morse Code. Tap the World's Wireless Messages. Be an experimenter and reach out beyond the broadcasting stage. Buy a

TAPOGRAPH Morse Instructor

and learn the code thoroughly in your spare time at home in a few weeks.

This wonderful instrument, simple in operation, is designed especially for wireless amateurs. By passing machine-perforated tapes, containing hundreds of different signals, through the Tapograph you can learn the code in a few weeks. Price, complete with valuable charts and instructions, high-toned buzzer and beginner's tape, containing hundreds of signals, is 25/- (postage 9d. extra). Sounder supplied in lieu of buzzer at small extra cost. Write for full particulars.

Let me quote you for any item of radio material you require. I supply any item or any set at lowest possible prices, direct from manufacturer to buyer. Write at once for Price List.

G. E. BRAY

Manufacturer's Agent, SOMERSET HOUSE,
Martin Place, SYDNEY.

J. M. B. (Bondi). Q.: Can you advise how to receive from very short wave-lengths up to about 1800 metres using tuning coils and circuit submitted? A.: You will get better results on these wave-lengths if you use spiderweb coils for short wave reception and honeycomb coils for long wave-lengths. Your tapped inductance is not suitable for covering the wave-lengths mentioned.

A. L. S. (Rozelle). Q.: Is a double slide tuner any improvement on a single slide crystal set? A.: Yes; you will get finer tuning. Q.: Could the former be used in the loose coupler set described in *Radio*, No. 37? A.: Use the loose coupler described which is a great improvement on both the single and double slide tuner. Q.: Can the loose coupler referred to be used for receiving on wave-lengths below 200 metres? A.: You will not get satisfactory results owing to "dead end" losses. Use spiderweb coils for short wave reception.

J. D. (Peakhurst). Q.: Using basket coils, how many turns are required for receiving on wave-lengths from 100 to 300 metres? A.: Approximately 15 to 30 turns for the primary. The exact number of turns, however, depends upon the size of the aerial and will have to be found by experiment.

H. M. (Sydney). Q.: Using a Phillips BV1 four electrode valve should the extra grid be connected to the positive side of the B battery when using the P1 circuit? A.: We have no experience with this particular type of valve. This, however, is being used in America in what is known as the "Solodyne" circuit using an "A" battery only, the extra or inside grid being connected to the positive of the "A" battery. Should you desire, we will be pleased to forward you this circuit, which is claimed reproduces telephony with a clarity equalled only by the crystal.

A. B. C. (Streaky Bay). Q.: Would the two-valve receiver published on page 398, *Radio*, No. 41, be satisfactory for receiving broadcasting from Adelaide and Sydney? A.: This should give you satisfactory results on 'phones. If, however, you require to work a loud-speaker, you will need to add a stage of audio for receiving from Sydney.

G. L. (North Sydney). Q.: Can a vario-coupler be used instead of honeycomb coils in circuit (submitted), employing a four electrode valve? A.: Yes, your wave range, however, will be limited. K is a variable grid leak.

J. Y. (Black Mountain). Q.: On what wave-lengths are 2GQ, 2YA and 2HM transmitting? A.: 250, 250 and 245 metres respectively. Q.: Would a single wire aerial 150ft. long be better for receiving on a crystal than a two-wire of the same length? A.: If you wish to receive on the low amateur wavelengths, use a single wire about 100ft. long and as high as possible.

T. W. S. (Hunters Hill). Q.: Recommend a three-valve circuit comprising one stage radio, detector and audio, employing three honeycomb coils. A.: Use the circuit published on page 516, *Radio*, No. 44. Q.: Would you advise using honeycomb coils in a two-valve receiver instead of a vario-coupler? A.: Yes. Will enable you to cover a greater range of wave-lengths, which is limited with a vario-coupler. Q.: Can short and long wave-lengths be received with a fixed radio frequency transformer? A.: No, using the circuit referred to you will not need a radio transformer.

E. P. D. (Avondale). Q.: Why is the positive of the "A" battery connected to the negative of the "B" in some circuits, while in others a common negative is used? A.: Depends upon the type of valve and circuit used. Q.: What size coils are required for 2BL, using a two-wire aerial with a total length of 125ft., 30ft. high? A.: Primary 50, secondary 75, and reaction 50. The size of the primary, however, will depend upon the size of the aerial tuning condenser used, you may possibly only require a 35-turn coil. Q.: Would better results be obtained with a shorter but higher aerial, single wire? A.: Yes, preferably 100ft. horizontal.

W. A. D. (Westmere). Q.: Using four AR06 valves would better results be obtained using different type of dry cell valve? A.: These valves are not recommended as low frequency amplifiers. Use either DE3's or UV199's. Although dry cells for the former may be used for filament heating, it is advisable, if possible, to use a 4½ volt accumulator, which will give more regular discharge, while less adjustment of the filament rheostat is required. Q.: Can an extra stage of radio with plug-in transformers be used? A.: Yes. Q.: Can a one-volt valve be used with a three-volt valve? A.: Yes; you will require separate "A" battery for the former.

G. T. (Dungog). Q.: Using circuit shown on page 430, *Radio*, No. 42, what should be the capacity of the 'phone condenser, grid condenser and value of grid leak? A.: The usual capacity of the 'phone condenser

is .001 m.f. fixed, and .0003 for the grid condenser, grid leak two megohms, preferably variable.

E. K. (Sydney). Q.: Using three-valve circuit (submitted) what is cause of difficulty in receiving 2FC, also howling? A.: Use the P1 circuit with two stages of audio amplification, published in *Radio*, No. 40, which should bring in all Australian and N.Z. broadcasting stations. For long distance work, use the three-valve receiver shown on p. 516, *Radio*, No. 44.

L. W. B. (Kairi, N. Q.). Q.: Using the 3-valve receiver published in *Radio*, No. 40, with a UV200 as detector and WD12's as amplifiers, with two separate "A" batteries, should the positives or negatives be connected together? A.: Connect the "A" batteries in series. Q.: Is a grid leak required? A.: Although not shown, this may be used to advantage. Q.: The "A" and "B" batteries are not connected, is this correct? A.: Through an oversight, no connection is shown, this should be between the negative of the "B" and the positive of the "A."

B. P. (Mount Waverley). Q.: Is aerial 150ft., including down-lead, too long for receiving short waves using the "Low Loss Tuner" described in *Radio*, No. 32? A.: You will probably need to reduce this for receiving on wave-lengths below 200 metres. You will also require a .001 m.f. variable condenser in series. Q.: Is radio or audio frequency best for short wave receivers? A.: Either may be used; use radio for long distance work.

D. C. F. (Macedon Upper). Q.: What is wave-length range of the Autoplex circuit, using two Red Seal Manhattan Variometers? A.: This depends upon the amount of wire on the variols, we have no information regarding the particular type you mention. Q.: What should be the value of the grid leak? A.: This is usually about two megohms, preferably variable. Q.: Is circuit (submitted) correct? A.: Circuit quite O.K. You will get better results, however, using the P1, and honeycomb coils.

E. R. W. (Pymble). Q.: What plate voltage does a Marconi DER valve require? A.: Between 30 to 50 as a detector, and 60 to 80 as an amplifier. Q.: What is the filament voltage? A.: 1.5-1.8. Q.: Is a six-volt accumulator suitable for this valve? A.: No. Q.: How many valves can be worked off a six-volt accumulator? A.: This depends upon the ampere hour capacity of the accumulator, usually five or six. Every extra valve increases the load and cuts down the time the accumu-

Make this Christmas a really enjoyable one. Install a Radio Receiving Set and listen to the best programmes that Australian broadcasting stations provide.

WIRELESS OPERATORS

IN the near future Wireless Operators will be required for ships trading to all parts of the World.

There is only one School in Australia where a Student can receive sound instruction in Wireless Telegraphy, and for the benefit of our readers a few of the advantages offered by this School are detailed.

1. The Instructors are all highly qualified men, combining 20 years' practical experience on Sea and Land
2. The School's equipment is of the very latest, and includes complete commercial installations.
3. Priority of appointment to the Students of the School is given in all vacancies occurring on board ships of the Australasian Mercantile Marine.

The time for enrolling is strictly limited, therefore write
_____ without delay to the _____

MARCONI SCHOOL OF WIRELESS

97 CLARENCE STREET
SYDNEY

44 MARKET STREET
MELBOURNE

lator can be used. Q.: What is cause of "whistling" in two-valve receiver (circuit submitted) when detector valve is not in circuit? A.: This is due to an open circuit in the primary of the audio transformer, no current flowing between the plate and filament when the latter is not heated.

F. A. W. (Northcote). Q.: Can you supply particulars for constructing a miniature crystal receiver? A. You will need to use flat inductances to get the receiver in the confined space you require which, however, will not give you results at the distance mentioned. You will require at least two valves for this purpose. Q.: Although signals from 3AR are satisfactory, why are signals on lower wave-lengths difficult to pick up? (Circuit of receiver and particulars of aerial submitted). A.: Your aerial is too large. Either reduce the length of this or use a condenser in

K. A. (Moonee Ponds). Q.: Using circuit shown on page 380, *Radio*, No. 41, why are signals louder when positive of C battery is disconnected? A.: Connections are evidently wrong, as it would be impossible to hear signals using both valves. The negative is connected to the 1S of the transformer and the positive to the negative of the "A" battery. Q.: What is cause of interference from V.I.M. when receiving from 3LO? A.: Evidently using wrong size coils. These should be 150 and 250 for 3LO. Size of the primary depends upon the size of the aerial and condenser. This can be found by experiment. Q.: Can 30-ohm rheostats be used with UV201A valves? A.: Yes, these should be preferably 25 ohms. Q.: Are "Signal" transformers as good as "Federal" transformers? A.: We are unable to answer questions regarding the respective merits of various makes of apparatus.

K. R. C. (Chatswood). As pointed out

L. H. (East Maitland). Q.: Can you supply information for constructing a step-down transformer for various voltages? A.: This would take too much space to answer in these columns. Obtain a copy of *Wireless Valve Transmitters* by James.

R. W. H. (Annandale). Q.: Can you supply me with the name of any firm repairing WD12 valves? A.: No. Q.: Is circuit (submitted) suitable for a UV199 or 201A valve for short and long wave work? A.: Yes. You must, however, use the correct filament and plate voltages. For WD12's filament voltage 4.5, plate voltage 20 to 80, and for the UV201A, filament voltage 6, plate voltage 20 to 100. For long wave reception you will require one or two honeycomb coils, instead of your present tapped inductance.

KGO HEARD IN JAPAN.

MILLIONS of people in the Orient may soon be sweeping the air for American radio programmes as a result of recent tests between KGO, the Pacific Coast General Electric station, and officials of the Japanese Ministry of Communications.

Confirming radiograms received, detailed reports by letter reached A. A. Isbell, manager of the Pacific Division of the Radio Corporation of America, from the Hon. Eitaro Yokoyama, Japanese Ministry of Communications, covering reception of the international test broadcast from KGO, August 30. After carefully checking the Japanese report with the KGO control room records, officials of the General Electric Company stated that no doubt existed but that Japanese listeners heard KGO's full two-hour broadcast.

Using a super-heterodyne receiver operators of the Hiraiso experimental station of the Electro Technical Laboratory, successfully picked up the KGO international programme and held it throughout. The Hiraiso station is situated about 500 miles northeast of Tokyo and commands the Pacific Ocean.

This is said to be the first time in history that a complete programme from an American radiophone station has been heard in Japan. Officials of the Japanese Ministry of Communications who received the broadcast are enthusiastic in their requests for more broadcasts from KGO, and that the DX radio fan will soon put in his appearance in the Orient is to be expected as a natural development.



A section of the new Radio Showroom of Messrs. Harringtons, Ltd. (Sydney).

series. See Efficient Crystal Receiving Circuits published in *Radio*, No. 34. Q.: Why is a buzzer necessary with a crystal set? A.: A buzzer is used to adjust the contact point on the crystal for best results, connections for this appear in the issue referred to. If you are close to the transmitting station the crystal may be adjusted by varying the point of contact, while the station is transmitting, in which case it will not be necessary to use a buzzer.

H. M. C. (Brunswick). Q.: Using the P1 circuit published in *Radio*, No. 36, what type of valve would you advise? A.: Any standard type, either dry cell or accumulator. The filament and plate voltage is usually given in the carton in which the valve is packed. Q.: Using this circuit, how would signal strength compare with the crystal receiver described in the same issue? A.: A valve being more sensitive than a crystal, you will get considerably stronger signals with a corresponding increase in range. Q.: Can a crystal be added to the above circuit? A.: No, use one of the "Crystal-Valve" circuits published in *Radio*, No. 39, full particulars are given.

in previous issues, through an oversight, no connection is shown between the "A" and "B" batteries in the three-valve circuit published in *Radio*, No. 40, this should be between the negative of the "B" and the positive of the "A," which will give a grid return from the first valve to the positive filament of the second. Although a variable grid leak is not shown, this may be used to advantage depending upon the type of valve used. Generally speaking, the resistance of a potentiometer, for the purpose used, should not be less than 300 ohms. The higher the value of the resistance, the less will be the current drawn from the L.T. battery. As the grid current necessary to prevent oscillation in an H.F. valve is generally a few microamperes, a current of one milliamp from the potentiometer resistance is sufficient to ensure a grid voltage proportional to the position of the potentiometer. The reason you are unable to hear 3LO or 6WF is probably due to using wrong size coils. You do not mention the sizes; try various combinations. We are unable to give you further assistance without more information such as ratio and type of transformers.

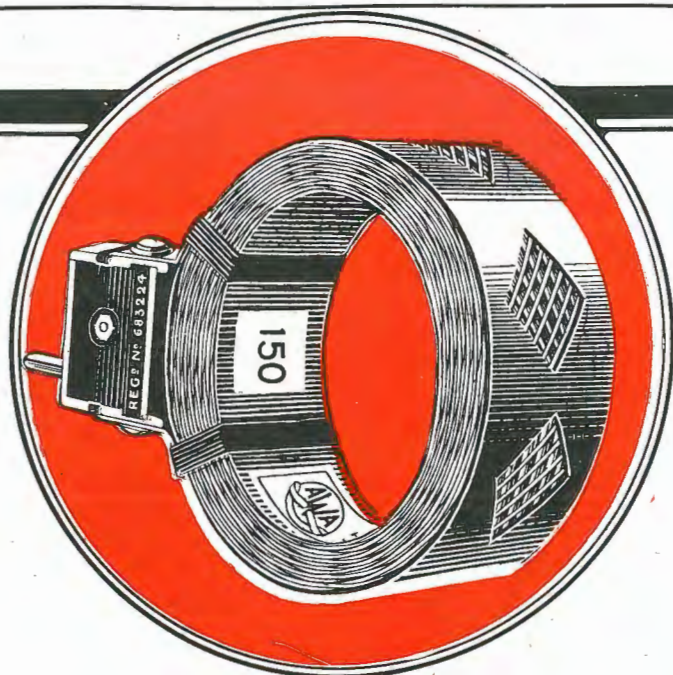

TUNING-IN!

In thousands of homes people are tuning-in on their radio sets.

Scarcely a sound; a slight turn, a faint noise; another adjustment, and then clearer and clearer comes music from the air.

Is your nightly "tuning-in" as simple as this?

If you want simple, quick and more selective tuning use A.W.A. Honeycomb Coils.

AWA Honeycomb Coils

are mounted on Igranic Honeycomb coil plugs with a black celluloid diamond strip, and then the shoulders are specially bound with black-waved thread, which holds the coil rigidly in position.

AWA coils offer very low radio-frequency resistance, and self capacity is at a minimum. They may be used as tuning, loading, coupling, or wave-meter inductances, ensuring the highest degree of efficiency for your set.

Made in sizes to suit your requirements. Each AWA Honeycomb coil is attractively boxed, and the wavelength table printed on the carton. Supplied unmounted.

No. of Turns.	Wavelength with .001 Condenser.	Mounted.	Unmounted.
20 ..	50-260 ..	6/9 ..	2/-
25 ..	100-375 ..	7/- ..	2/2
35 ..	150-525 ..	7/6 ..	2/2
50 ..	190-675 ..	7/9 ..	2/4
75 ..	240-925 ..	8/- ..	2/6
100 ..	340-1340 ..	8/3 ..	2/9
150 ..	500-1960 ..	8/6 ..	3/-
200 ..	650-2675 ..	9/- ..	3/6
250 ..	725-3575 ..	9/9 ..	3/9
300 ..	1050-4200 ..	10/6 ..	4/3
400 ..	1600-6000 ..	11/8 ..	5/-
500 ..	2000-7500 ..	13/6 ..	7/-
600 ..	3000-9000 ..	15/6 ..	9/-
750 ..	4000-11000 ..	16/9 ..	12/-
1000 ..	4500-16000 ..	£1/-/- ..	14/-
1250 ..	6310-18240 ..	£1/4/- ..	16/-
1500 ..	7635-22210 ..	£1/8/- ..	18/-

AT ALL RADIO STORES.

Amalgamated WORLDWIDE WIRELESS **Wireless**
(Australasia) Ltd.

97 CLARENCE STREET, SYDNEY.

COLLINS STREET, MELBOURNE.





I am DINKIE—you'll like me

I am the mascot of the latest Sterling Loud Speaker—"The little fellow with the Loud voice." My "Dinkie" Loud Speaker will go into the homes of tens of thousands of those who love Radio. It's small in size but big in volume—small in price but big in value. And as to its reproducing powers? Well! whether it is music, song or speech, "Dinkie" gives perfect reproduction, true in tone and ample in volume! The "Dinkie" will be widely advertised, and is destined to become the greatest seller radio has ever known. Costing little more than good headphones, what can stop it?

STERLING DINKIE Loud Speaker

The Sterling "Dinkie" Loud Speaker is supplied in a Brown tinted finish, complete with flexible cord.

DIMENSIONS:

Height over all, 13 in. Diameter of Flare, 7 in.
Diameter of Base, 4 in.

Ask your Dealer to Demonstrate.

STERLING TELEPHONE & ELECTRIC CO. LTD.
Manufacturers of Telephones and Radio Apparatus, etc.
210-212 TOTTENHAM COURT RD., LONDON, W.1
ENGLAND.

Sole Agents for N.S.W. and Queensland:

**THE LAWRENCE & HANSON
ELECTRICAL CO., LTD.**
33, York Street, Wynyard Square,
SYDNEY.

And Charlotte Street, Brisbane.

TO THE TRADE

The Sterling range of Radio Apparatus covers all that is necessary for perfect Radio reception and reproduction:—Crystal sets; 2, 3 and 4 valve receiving sets; 2 and 3 valve power amplifiers; world famous headphones; various types of loud speakers and every conceivable component. Lists and full particulars on application.



*Here's my
Loud Speaker*