

ISSUED EVERY — —
SECOND WEDNESDAY

SIXPENCE

RADIO

IN AUSTRALIA
& NEW ZEALAND

Registered at G.P.O., Sydney, for transmission by post as a newspaper.

VOL, II

OCTOBER 1, 1924

No. 40



ENTERTAINMENT BY RADIO



IS NOT COMPLETE WITHOUT THESE "WIRELESS PRESS" PUBLICATIONS.

THE WIRELESS ATLAS OF THE WORLD.

Comprising 75 Maps in a Handy
Book Form.

Numerous requests for an Atlas of the World, showing all Wireless Stations, have been reaching us. We have, therefore, reprinted from "The Year Book of Wireless Telegraphy and Telephony," the Map Section, which has proved so useful.

Every station is keyed so that at a glance you can differentiate between Public, Direction-Finding, Official, Military, Private, Aviation or Broadcasting Stations.

PRICE 2/- Postage 3d.

PRACTICAL AMATEUR WIRELESS STATIONS.

An "Experience" Book.

By J. A. WHITE.

Containing the best suggestions of thirty-three experimenters on Building, Installing and Operating Experimental Stations for Radio Communication. 136 Pages Profusely Illustrated.

PRICE 4/- Postage 3d.

"THE WIRELESS AGE."

America's foremost Radiophone Review, is the most popular American wireless magazine published monthly.

PRICE, 2/- Annual Sub., 24/-.

AN INTRODUCTION TO RADIO

Vols. 1 and 2.

Here is the real beginner's book — language not too technical — illustrations carefully selected — diagrams right — comprehensively dealing in Vol. 1 with an introduction to Radio, radio telephony and transmitting and receiving outfits. Vol. 2 gives an explanation of technical terms, vacuum tubes, and shows how to set up receivers and transmitters.

Price TWO VOLUMES 6/-

POCKET DICTIONARY OF TECHNICAL TERMS USED IN WIRELESS.

By HAROLD WARD.

Do you ever come across wireless terms you cannot understand? This book, which will comfortably fit your vest pocket, contains over 1500 definitions. It's a handy little companion every wireless man should have with him.

PRICE 3/- Postage 3d.

HOW TO CONDUCT A RADIO CLUB.

By E. E. BUCHER.

Covers Parliamentary procedure, indoor and outdoor experiments, 5,000-mile receiving sets, vacuum tube amplifiers and detectors and many other subjects.

Paper Cover. 148 pages. Fully illustrated.

PRICE 4/- Postage 3d.

OTHER PUBLICATIONS INCLUDE:—

"CONQUEST,"

England's popular magazine of Science, Invention and Industry, different from all other similar magazines. It is the "story" magazine of accomplishment in many different fields. Monthly.

PRICE, 1/6. Annual Sub., 18/-
per copy. 6 months, 9/-.

"THE WIRELESS WORLD"

England's Pioneer Wireless Journal, liked by all experimenters. Weekly.

PRICE, 6d. Annual Sub., 26/-
6 months, 13/-.

OBTAINABLE FROM ALL LEADING BOOKSELLERS OR

THE WIRELESS PRESS

(Specialists in Wireless Books and Magazines)

"Gloucester House,"
44 Market Street,
MELBOURNE.

97 Clarence Street,
SYDNEY.

Australasia Chambers,
WELLINGTON,
N.Z.

RADIO

IN AUSTRALIA
& NEW ZEALAND
Incorporating "Sea, Land and Air"

Managing Editor:
S. E. TATHAM.

Associate Editor:
N. H. THOMPSON.

CONTENTS

Copyright Registered.

Volume II.	OCTOBER 1, 1924	Number 40
Radiotorial—		PAGE.
The Mysteries of Wireless		339
A Design for a Single Valve Receiver		340
A Successful Demonstration		342
A Howl-less Regenerative Set		343
Words to the Wise—and Otherwise		343
A Special Three-valve Receiver		344
Does Radio Affect the Phonograph Business?		345
Do I Need an Aerial?		346
KGO Broadcasts Special Programme		347
Song of the Nightingale Broadcast		348
Trans-Oceanic High-power Wireless		348
Making a "B" Battery		349
Willis Island Radio Station		350
Dominion Trainees Instructed in Radio		351
Broadcasting and Listening-in		352
How and When to Use Crystal Detectors		353
A Few Words on Panel Insulation		354
Calls Heard		355
Auckland Radio Exhibition		358
Crystal Detectors		360
Amateur Radio Station ZZO		362
Amateur Transmitting Licenses		364
Unlicensed Receiving Sets		368
Jacks and Switches		370
Wireless for Coastal Vessels		370
New Broadcasting Station		372
Corrimal Experimenter Adds KGO to His DX List		374
Movements of Marine Wireless Officers		375
Coastal Radio Service		375
Queries Answered		376

Published by

THE WIRELESS PRESS

Gloucester House, 97 CLARENCE ST., Australasia Chambers,
44 Market Street, Melbourne. SYDNEY. Wellington, N.Z.

PRICE, 6d. per Copy.

Subscription Rate: 10/- per annum (26 issues) throughout Australia and New Zealand; Foreign Rate, 12/6 (26 issues).

Obtainable from all Booksellers and News Agents, also the N.S.W. Bookstall Co., Ltd.—all branches.

Canada and U.S.A.:
The Wireless Press Inc.,
326 Broadway,
New York City.

Wholesale Distributing Agents:
GORDON & GOTCH (AUSTRALASIA), LTD.,
Sydney, Melbourne, Adelaide, Brisbane, Launceston, Perth,
Auckland, Wellington, Christchurch, and Dunedin, N.Z.

Great Britain:
The Wireless Press Ltd.,
12-13 Henrietta St.,
London, W.C.2.

The NAME to know in RADIO

**WILES Wonderful Wireless
and Electrical Stores**

60-62 GOULBURN ST.

(1 door from Pitt St.)

384 PITT ST.

(Near Goulburn St.)

23 PITT ST.

(Circular Quay)

Construct your own Broadcast Receiving Set. We Drill Panel free of charge, and supply Complete Building Instructions with each Order.

3-VALVE BROADCAST RECEIVING SET, guaranteed range, 250 miles.

1 Bakelite 18 x 6½ x 1½	£0 11 3
1 .001 Condenser with Vernier ..	1 10 0
2 30 ohm Rheostats	0 10 6
1 Battery Switch	0 3 0
8 N.P. Terminals	0 2 8
1 No. 42 Panel Plug	0 3 9
1 No. 43 Panel Plug	0 5 9
1 Extension Handle	0 1 10
1 .00025 Grid Condenser Leak ..	0 0 9
3 V.T. Holders	0 12 0
2 Jefferson Star Transformers ..	2 5 0
1 Single-point Jack	0 4 6
Maple Cabinet	1 10 0
Panel Wire	0 2 0
	<hr/>
	£8 3 0

ACCESSORIES.

4 Mounted H.C. Coils, 130 to 3,000 Meters	1 11 0
3 U.V. 201A Valves	5 5 0
1 6-V. 40 amp. Accumulator ..	3 3 0
2 42-V. B Batteries	1 5 0
Loud Speaker and Headphones as selected. See Price List.	
	<hr/>
	£19 7 0

SAME QUALITY
SAME PRICE
SAME SERVICE



SPECIAL ANNOUNCEMENT.
Full Stocks to hand of Aerial Wire, Winding Wires, Valves, Headphones, Loud Speakers, etc.

4-VALVE BROADCAST RECEIVING SET, guaranteed range, 500 miles.

1 Bakelite, 24 x 9 x 1½	1 2 6
1 .001 Condenser with Vernier ..	1 10 0
1 .0005 Condenser with Vernier ..	1 7 6
2 No. 42 Plug	0 3 9
1 No. 43 Plug	0 5 9
1 No. 44 Extension Handle ..	0 1 10
3 30 ohm Rheostats	0 15 9
1 Battery Switch	0 3 0
8 N.P. Terminals	0 2 8
4 V.T. Holders	0 12 0
2 Jefferson Star Transformers ..	2 5 0
1 .00025 Condensers	0 0 9
1 Frehman Variable Grid Leak	0 5 6
1 Maple Cabinet	2 5 0
1 Single Point Jack	0 4 6
Panel Wire	0 3 0
	<hr/>
	£11 8 8

ACCESSORIES.

6 Mounted H.C. Coils	2 6 0
4 U.V. 201A Valves	7 0 0
1 6-Volt 40 amp. Accumulator ..	3 3 0
2 42-Volt B Batteries	1 5 0
Headphones as Selected. See Price List.	
	<hr/>
	£25 2 8

OUR GUARANTEE.

It is our intention that every article in this list shall be truthfully described. Therefore we guarantee everything you buy from us to be satisfactory to you in every detail. You take no risk whatever in sending us your order, for unless you are completely satisfied with the goods and your saving, you may send back everything you buy from us and we will promptly return your money and all transportation charges you have paid.

Please address all communications to our Head Office, 60-62 Goulburn Street.

W. HARRY WILES
RADIO AND ELECTRICAL SUPPLIES.
ESTABLISHED 20 YEARS.



The Mysteries of Wireless



HOW long have we had electricity with us? Something like a hundred and fifty years. And how much do we know about it? Comparatively speaking, precious little! We do not even know what electricity actually is, although we live in its age. We know the effects, of course, they are all around us, but as for the reason for them—ah, no!

NOR is this strange state of affairs at all different when we turn to wireless. We can give you a wireless explanation for anything that may trouble or confound you in your experiments or listening, but whether we actually, really, *know* is a different matter altogether.

FOR a simple instance, take the subject of "Fading," which has already occupied a good deal of space in the wireless columns of the daily press and periodicals.

YOU are listening to a broadcast concert or some brother enthusiast and they or he are coming in "with a roar." Then, although you have made no new adjustments in your set at all, have not touched it in any way, in fact, the voice or signals gradually and steadily begin to get weaker and weaker for no apparent reason until they eventually die away altogether. In a moment, you find that as slowly and steadily as the sound disappeared so it is returning, until all was as before and a great load slides off your mind.

THE explanation for this strange phenomenon, it has been agreed, is a mere damp, grey cloud which floats quietly into the path between the station you are listening to and your set, and that it is the means of stopping the sounds coming through.

BUT, unfortunately, proof has shown that where a set with an outdoor aerial experienced fading on a certain occasion, another one, in the same locality, with an indoor aerial, noticed no decrease in signal power at all!

ANOTHER bone of much technical—and otherwise—contention is that of crystal reception over long distances. A splendid example of it may be found on p. 355 in the section "Calls Heard." A newcomer to

Radio listening-in on his set—a small single slide crystal receiver—at South Ashfield heard the tag-end of a telephony message from a New Zealand amateur transmitting station! And this despite the fact that it is definitely held that the crystal receiving set will not pick up broadcasting station signals at a greater distance than from 15 to 20 miles!

POOH! There's nothing strange about that, says your Radio expert, it is obvious that the crystal set was energised by a near-by valve set. Perhaps so, *sometimes*, but there have been numerous recent occasions on which there was not another valve set within a distance of a hundred miles. Which does not shed much light on the matter by way of explanation, does it?

NOW we come to the Dead Spots—another state of affairs which, when discussed, has enjoyed the distinction of occupying a considerable portion of the columns of the Press. Those who are victims of this are to be condoled with, for while they live in the vicinity of one, many, and perhaps most, of the joys of Wireless will be denied them, for to be situated in such a locality means that they find it extremely difficult to receive from some or all broadcasting stations. In the cases where the broadcast listener or experimenter has his apparatus in a building which is more or less surrounded by tall buildings whose composition consists, to a great extent, of steel girders, or where power and lighting mains are near, this may so affect the immediate surroundings so far as they are suitable for wireless reception that it will be nearly impossible. But, on the other hand, there are many places in Australia where there are none of the drawbacks to successful reception outlined above, and where conditions are none the less most inimical to satisfactory reception. Echo answers why?

OTHER "well-known" mysteries—if one can use the term—are Body Capacity, and, of course, our old "friend," Static. Various explanations are given for them and just as variously confounded and so, when it's all boiled down, even the best of us do not seem to know half as much about Wireless as we would like to, do we?

A Design for a Single Valve Receiver

By F. L. DEVEREUX, B.Sc.

Reprinted from
The Wireless World and Radio Review.

THE receiver described below does not employ reaction and its tuning may therefore be carried out without fear of causing interference. It is silent in operation and will give months of service between each charge of the batteries.

THE aim in the design has been to produce an instrument possessing easy operation. A valve is therefore used as a detector and tuning is carried out essentially on a single dial. The wave-length range includes reception of all existing Australasian broadcasting stations.



WHEN receiving broadcasting by means of a crystal set one is never quite free from the doubt as to whether the adjustment of the crystal is the best obtainable. With

the receiver here described, on the other hand, one has the satisfaction of knowing that so long as the valve is switched on nothing can be done to improve signal strength and, instead of making adjustments every few

minutes the programme may be enjoyed in peace of mind.

No reaction is employed, so that the range of the set is only slightly greater than that of a crystal receiver, but the adjustment of the set can be left to any member of the household as it is impossible to cause interference with other receivers by oscillations, while the selectivity of this receiver is higher than that of a crystal receiver.

The receiver is tuned by means of a Sterling variometer, which gives a wave-length range of 250 to 2,750 metres in three stages when used in conjunction with a $0.0005\mu\text{F}$. fixed condenser and the Sterling barrel type switch. This switch has three positions, in the first of which the two variometer windings are connected in parallel and the fixed condenser is connected in series with the aerial. In the second position the condenser is disconnected and the windings are connected in series, while in the third position the condenser is in parallel with the windings which are still connected in series.

A 0.06 type valve is used and is supplied with filament current from two Exide DTG cells. One has to be careful in handling these cells on account of the acid, but they have been chosen because the voltage remains practically constant throughout the discharge. A fixed filament resistance can, therefore, be used instead of the variable resistance necessary in the case of dry batteries and the adjustment of the instrument is simplified. The maintenance costs are much lower when these cells are used as it is possible to listen for 290 hours on one charge, which should cost not more than a nominal sum. If the set

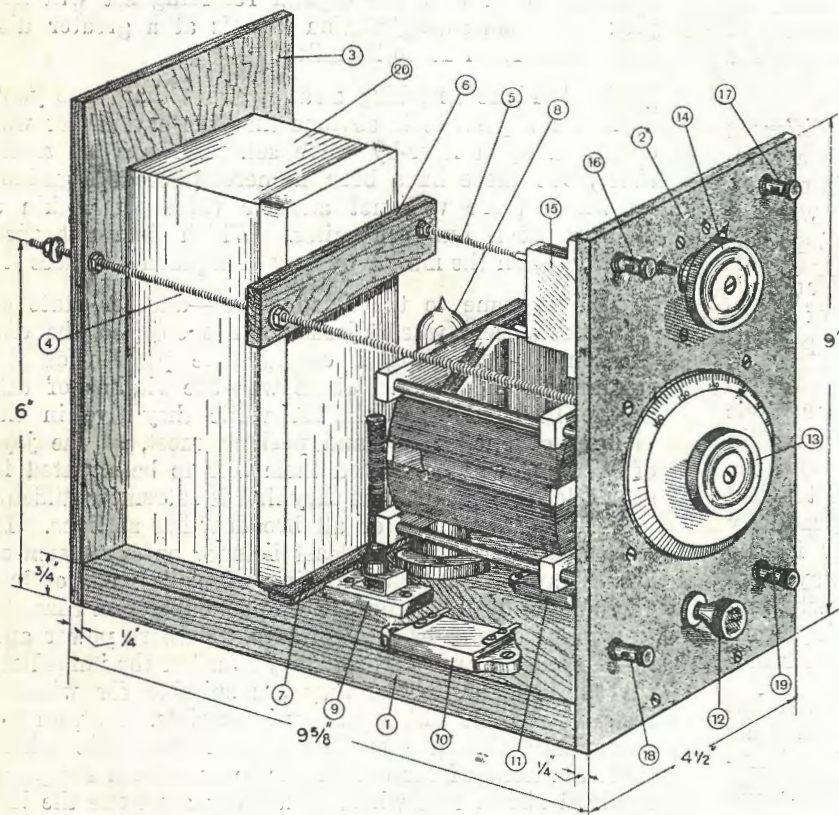
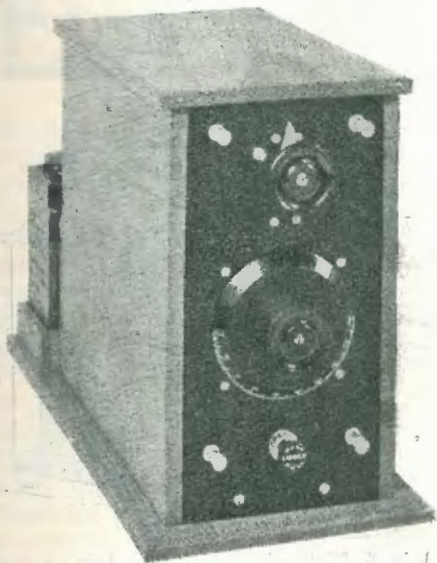

Fig. 1. The receiver unit showing arrangement of components. The parts indicated by numbers are as follows:—1, base; 2, ebonite front panel; 3, back panel; 4 and 5, rods screwed 4 B.A.; 6, battery clamp; 7, battery stop; 8, valve; 9, filament resistance; 10, telephone condenser $0.002\mu\text{F}$; 11, grid condenser and leak; 12, filament switch; 13, variometer dial; 14, rotary switch; 15, fixed aerial condenser, $0.0005\mu\text{F}$; 16, aerial terminal; 17, earth terminal; 18 and 19, telephone terminals; 20, H.T. battery. Most of the leading dimensions are given. The spindle of the variometer passes through the point of intersection of the diagonals of the front panel. The centres of the rotary switch 14, and filament switch 12, are $1\frac{1}{2}$ ins. from the top and bottom of the panel respectively.

is used for about four hours each day the batteries will not need attention for a period of two months.

A list of the components actually used is given below:—



The Finished Receiver.

Sterling variometer, type R 2674.

Sterling rotary switch, type R 2838.

Lissen two-way switch.

Fixed mica condenser, 0.0005 μ F (Dubilier).

Fixed mica condenser, 0.0003 μ F with two megohm grid leak attached.

Fixed mica condenser, 0.002 μ F (connected across telephones).

T.C.C. Mansbridge type condenser, 1 μ F.

Valveholder.

Fixed resistance, 20 ohms (Burndept No. 729).

Holder for resistance (Burndept No. 718).

H.T. battery (Siemens 36-volt, No. 827).

Two Exide DTG type cells.

Terminals, wire, etc.

The components, with the exception of the DTG cells, are all mounted in one unit, which may be removed from the container after the removal of two screws at the back. The basis of the unit, which is illustrated in Fig. 1, is formed by the base (1), the ebonite front panel, (2) and the wooden pack panel (3). The front and back panels are the same size and are held together by two 4BA rods (4) and (5), each 10 $\frac{1}{2}$ ins. in length. Full use is made of these

rods, for they not only give rigidity to the vertical panels but also serve to hold the unit in position in the containing case, to clamp the H.T. battery in position and to conduct the filament current from the exterior to the interior of the set. The insulation of the wood at the back of the panel is perfectly satisfactory for the comparatively low filament voltage. The wooden cleat (6) clamps the H.T. battery (20) to the back panel and the bottom of the battery is prevented from moving by the wooden stop (7). The valve and valveholder (8) and the fixed filament resistance (9) are mounted vertically on the base immediately in front of the H.T. battery. The telephone condenser (10) and the grid condenser and leak (11) are screwed to opposite sides of the base underneath the variometer. The ebonite front panel carries the filament current switch (12), the variometer (13), the three-way wavelength range switch (14), the fixed aerial tuning condenser (15), the aerial and earth terminals (16) and (17) respectively, and the telephone terminals (18) and (19). The H.T. condenser is not visible in this draw-

ing but may be seen at the side of the H.T. battery in the photograph in Fig. 2, which also gives a better view of the three-way barrel switch on the front panel. The H.T. condenser is included in order to ensure silent operation when the battery is approaching the end of its useful life. In passing it may be mentioned that there is absolutely no trace of any hissing noise when the valve is switched on; if reaction were used there would almost certainly be a certain amount of extraneous noise.

It is rather difficult to show the wiring clearly on an actual plan and elevation of the instrument and a diagrammatic wiring scheme has been prepared in Fig. 3. The wiring of the variometer and rotary switch will be found the most difficult part of this operation. There is not much space between the top of the variometer and the under side of the switch and the writer found it best to cut down the length of the inside soldering tags on the switch and to wire up as much of the switch as possible before assembling the panel. Contrary to the usual practice, the minus side of the H.T. battery has

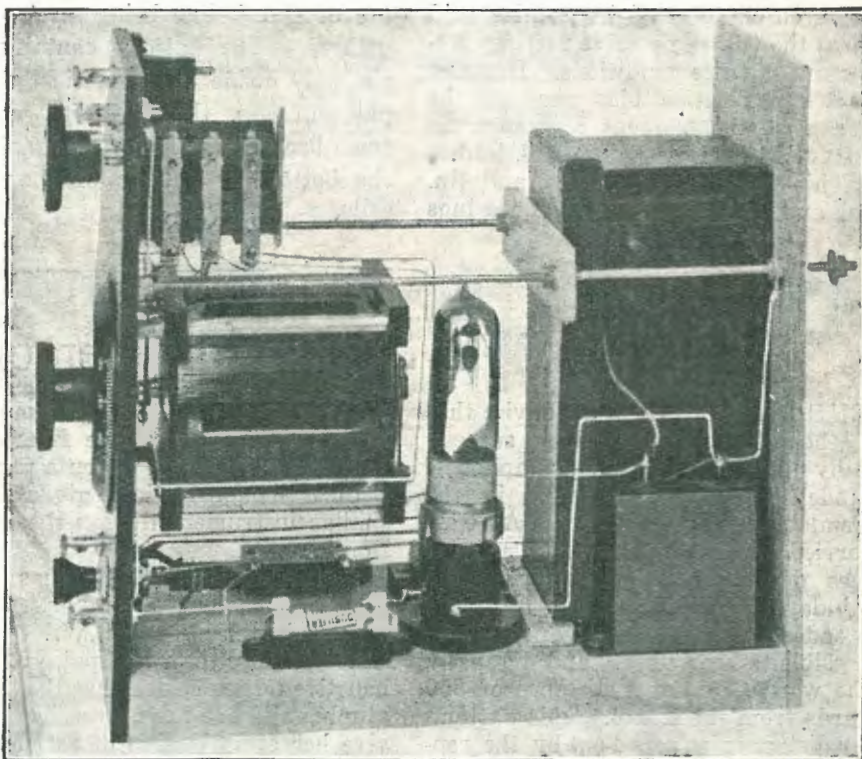

Fig. 2. The unit as seen from side opposite to that in Fig. 1. In addition to the components visible in the previous figure, the H.T. condenser at the side of the battery and the rotary switch on the front panel are clearly shown,

been connected to + L.T. This was done in order to shorten the wiring. If the screwed rod (5) is made the positive L.T. lead the wire to the earth terminal (17) is considerably shortened. The positive side of the L.T. battery is connected to earth in

of shellac varnish. No elaborate jointing has been attempted, the various pieces of wood being simply screwed together with $\frac{3}{4}$ in. No. 4 countersunk brass wood screws. The strength of the joints will be much greater if the edges of the wood are given a coat-

The dimensioned drawing of the box in Fig. 4 does not show the two 4BA clearance holes at the back through which the ends of the rods (4) and (5) pass to hold the unit in position. There should be no difficulty, however, in marking their

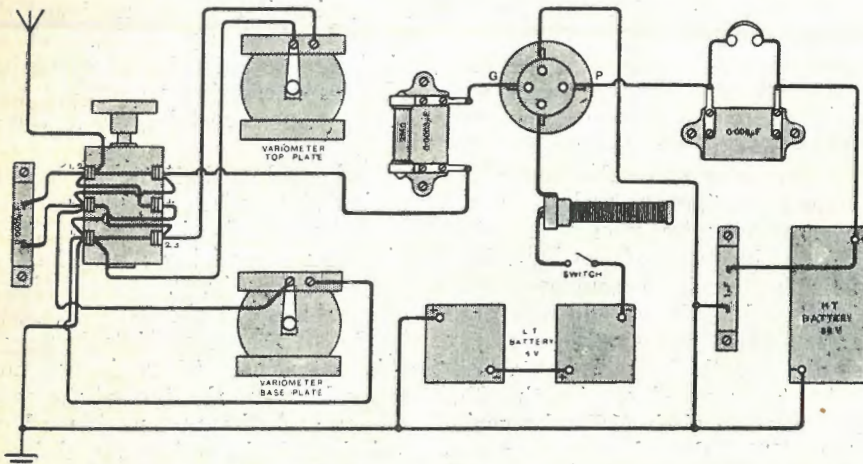

Fig. 3. Wiring Diagram. The base plate of the variometer is the plate nearest to the dial. The figures at the side of the rotary switch indicate the positions of the screws on the revolving drum; thus, in position 1, giving the lowest range of wave-lengths, all the pairs of contacts on the left of the switch are pressed together. In the second position, the top left hand and bottom right hand contacts are closed, while in the third position all the right hand contacts are closed.

order to obtain a slight positive grid bias; the 0.06 type valve rectifies better under these conditions. In order that the positive bias may not be excessive, the filament resistance is connected in the negative L.T. lead.

This was made from $\frac{3}{8}$ in. and $\frac{1}{4}$ in. oak and finished with several coatings

of glue before being screwed together. The battery container is painted inside with anti-sulphuric paint in case the batteries should come back from charge with acid on the bottom or outside of the glass cells.

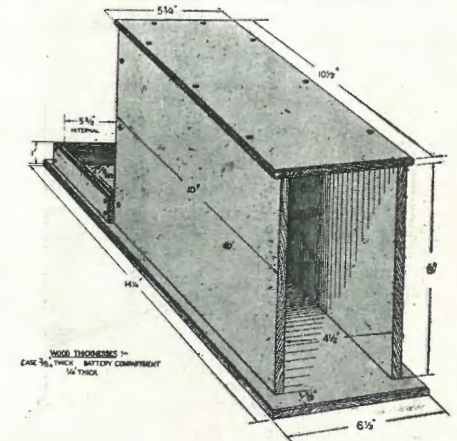

Fig. 4. Dimensions of the containing case. Two holes are drilled in the back through which the ends of the screwed rods 4 and 5 pass.

position when the unit is made and ready for insertion in the case.

Having connected the terminals of the L.T. battery to the ends of the projecting rods at the back, the receiver will be ready for use after connecting up the aerial, earth and telephones.

A Successful Demonstration

THE Burgin Electric Co. advise that their representative has successfully installed a "Burginphone" Model 9 five-valve receiver in the Condobolin Public School. At tests carried out during this installation it was demonstrated that during the midday transmissions from Farmer's broadcasting studio in Sydney it was possible to hear clearly and distinctly the words, etc., at a distance of 350 yards from the school. This particular distance was paced out by the representative. At night time, the people on the hotel verandah 600 yards away could hear the announcer from Farmer's very plainly.

Considering that Condobolin is about 250 miles air line from Sydney, this performance is on a parallel with a demonstration, given by a similar instrument during the recent Bourke tests.

A further installation has also been effected by the company at the West Maitland (N.S.W.) High School, where the Principal, after exhaustive tests, decided that the "Burginphone" five-valve receiver can give her every degree of satisfaction in the daytime; of course, this was naturally much stronger at night.

On Wednesday night, the first time when Grand Opera was broadcast

in Australia, the school hall was filled with over 150 people, and all listened to the excellent reproduction by wireless. On Thursday night, the second occasion of the transmission, the Principal again entertained quite a large number of friends.

These are practical instances of where wireless is of actual advantage to the schools, and the Burgin Electric Company are confident and are prepared to guarantee that their machines will reproduce on a loud-speaker anywhere within New South Wales under normal conditions. The sets used in both the above schools are of the five-valve type.

A Howl-less Regenerative Set



FOR all round results, whether it is distance or not that you are after, the single tube regenerative set is about as good as you can own, when one tube is all that you are to use. Several writers depreciate the regenerative set as being the one that is responsible for all the "birdies" you hear from time to time and while it is true the regenerative sets can make quite a fuss, so can the radio frequency type of set and the worst of it is, unlike the regenerative set, the owner of the radio frequency set does not hear the awful noise his set is putting out because the detector is not oscillating but instead, the amplifier tube or tubes. When the regenerative set gets bad, the person operating it soon becomes aware of it by the poor quality of signals coming from the telephones.

Not everyone knows how to properly operate a regenerative set, and the majority would not if they did know how, for they are after distance. That one word is what starts all this un-called for nuisance such as we term "birdies." It is the habit of trying to get everything out of the set that brings forth such noises and the wrath of your neighbours. The only remedy is to make your regenerative

set such that it cannot spill over and this can very easily be done by a little attention to the tickler coil, or, if you use a variometer, to the plate variometer.

In the average vario-coupler set, the tickler or rotor coil has from 60 to 80 turns of wire on it and this is what causes your set to go into oscillation with a "plop." As a rule, no matter how careful you are with your rheostat adjustment, the set will

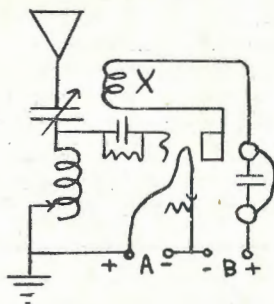

break into regeneration all of a sudden and spoil everything.

The remedy is to remove a few turns of wire from the rotor and try the set out for control of regeneration. In order to save yourself a lot of work, you might just as well take off all wire except 18 turns on each side of the rotor, giving you 36 turns on the rotor. In the majority of

cases this will be found too many turns, but it will be better to have too many on for your first test than not enough.

In case you never tried taking any wire from a tickler the following may help you. The rotor coil is divided into two sections and the end of each half pushed through the rotor form and soldered together. Just unsolder this connection and unwind each half of the rotor until you have 18 turns on each side, then connect them together as before (but it is not necessary to solder them for test), and you ought to be able to go over the entire wave-length scale without the set starting to squeal as it always has done. You may find that this may sacrifice a little signal strength but what is that compared to the peace of mind of an entire neighbourhood?

About the same plan may be used with a plate variometer, but take some wire off about the stator and rotor coils until the set will go into regeneration and out again with nothing more than a swishing sound.

The drawing shows a regenerative set and the numbers of turns of coil marked X should be reduced to control regeneration. This coil may be tapped, if desired.

Words to the Wise—and Otherwise

A SINGLE rheostat may be used on two amplifying tubes.

With stations using such widely scattered wave-lengths, the single circuit set has a good chance.

If you use a loud-speaker that needs a storage battery be sure and shut the current off when you have finished listening in.

Never get impatient with your set, the fault may be yours.

You can either use a plug and a jack or a double throw switch to shift from detector to amplifier.

Sharper tuning is obtained with inductive coupling than with conductive coupling.

Broadcasting stations like to hear from you regarding their programmes.

Besides reducing signal strength, burning your audions too bright will shorten their life.

Keep the B battery leads short and they are less liable to short circuit.

If your filament rheostat acquires a greenish deposit, clean it off or your set will be noisy.

Don't forget to clean off the flux after soldering.

One tube reflex makes a good portable set.

There is more to broadcasting than mere entertainment.

It is a good idea to have a series parallel switch for your primary condenser.

Most of the squeals you hear are caused by your own set when in an oscillating condition.

A long aerial is desirable but good results are sometimes obtained on a short one.

A Special 3-Valve Receiver

Operates Loud Speaker on all Australian Broadcast Stations

Using P1 Circuit with Two Stages of Audio Amplification



As time progresses, greater becomes the desire of those who possess crystal sets, to own a one-valve set, and the proud possessor of a one-valve set to become the owner of a three-valve receiver and so on.

As we have taken you, step by step, through the columns of *Radio*, from the crystal receiver to the two-valve receiver, we now publish what every-

A two-valve receiver will operate a loud-speaker, provided the receiver is in the vicinity of the broadcasting station, but for all-round success, three valves are recommended—one detector and two stages of Audio Frequency Amplification.

This three-valve receiver is (as is the single valve receiver) regenerative and to prevent it "howling," the following steps should be taken. Adjust your tuning filament and plate rheostats until you secure the maxi-

the operation of a single-valve and any wave-length from 100 metres to 2,500 metres may be tuned-in, providing the correct coils are used. In this circuit two coils and two condensers are necessary. Firstly, the aerial tuning condenser and primary coil, the latter also being known as a grid coil. The aerial condenser may be joined in parallel (for long waves) or series (for short waves) with the aerial coil. In Figure 1 the condenser is shown connected in parallel. The

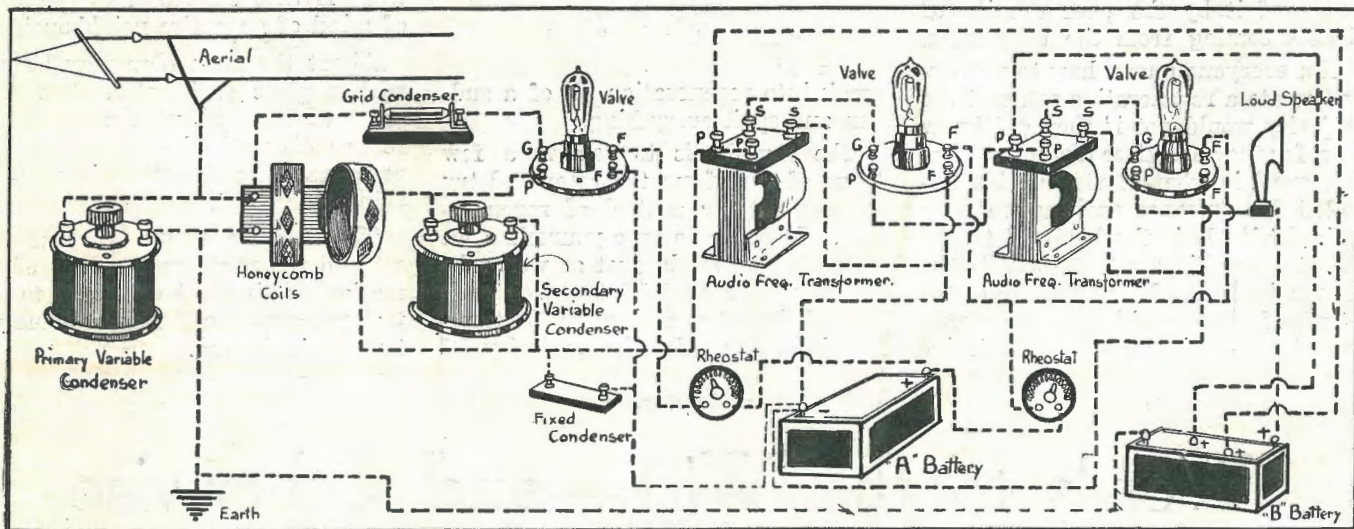

FIGURE 1.

Showing the P1 Circuit as a detector, with two stages of audio frequency amplification. The dotted lines indicate the wiring connections.

body has been awaiting patiently—a reliable three-valve receiver for loud-speaker work.

No doubt, a great number of readers of *Radio* who have built and operated the P1 single valve receiver and know its worth, will welcome this receiver with three valves, using the P1 with two stages of Audio Frequency Amplification. From experiments carried out this set has proved itself extremely efficient and simple to operate.

mum effect from the station you desire to receive, then loosen coupling (the distance between the two honeycomb coils) until your set just ceases to oscillate. When this position is found, other oscillating valves will not interfere with you, nor will your receiver interrupt others. At this point you will also secure wonderfully clear and distortionless music and speech.

The tuning components for this receiver are similar to those used for

secondary condenser is permanently shunted across the reaction coil.

A table of coils required for various wave-lengths is given below, using .001 microfarad aerial tuning condenser.

	A	R
100-250	25	35
250-350	35	35
300-500	50	50
600-1000	100	75
1000-1500	200	100
1500-2500	200	150

From the above table you may select the coils suitable for present broadcasting stations.

Following is a list of Australian broadcasting stations at present operating, with their call signs and wave-lengths:—

Broadcasters, Ltd., Sydney (2BL), on 350 metres.

The apparatus required to build this receiver is as under:—

- 1 Piece Bakelite Panel
- 2 Panel Mountings for H.C. Coils (one being variable).
- Honeycomb Coils and Plugs
- 1 Variable .001 mfd. Condenser
- 1 Variable .0003 mfd. Condenser.
- 1 Grid Condenser .0003 fixed
- 1 Fixed Condenser .0003 mfd.

ing Radio dealers. Owing to there being such a variety of apparatus available, readers should not encounter any trouble when making their choice.

The connections for the above circuit are very clearly shown, and if followed carefully during construction, no trouble should be experienced.

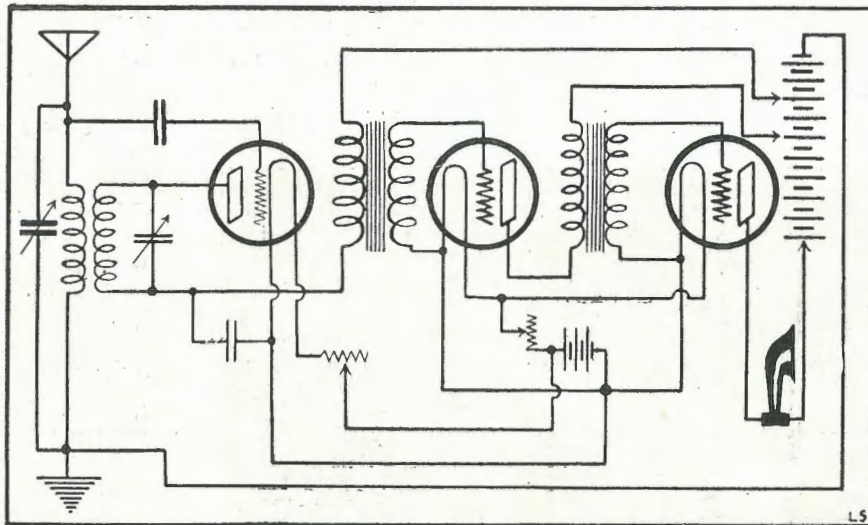

FIGURE 2.
Circuit diagram of the P1 with two stages of audio frequency amplification.

Farmer's, Limited, Sydney (2FC), on 1100 metres.

Westralian Farmers, Ltd., Perth (6WF), on 1250 metres.

Associated Radio, Melbourne (3AR), on 450 metres.

Another station will commence transmission on a wave-length of 1720 metres on October 7.

- 2 Filament Rheostats
- 3 Valves
- 1 A Battery
- 1 B Battery
- 1 Loud Speaker
- 2 Transformers First Stage, Ratio 1 to 4, Second, 1 to 3.

The above-mentioned components are procurable from any of the lead-

Here is a circuit that should bring in almost any Australian and New Zealand station on a loud-speaker. Write and advise the Editor of *Radio* of the results you get with this receiver, and any further information required will be gladly given. Address your letters to the Editor, *Radio*, Box 2516, G.P.O., Sydney.

Does Radio Affect the Phonograph Business ?



FEW mornings before this number of *Radio* went to press, the question arose among the staff as to whether the sale of "listening-in sets" affected the sale of talking machines. Some held that these sets, radiating music from the broadcasting studios which was real music and not "canned," people would greatly prefer listening to the actual rather than the artificial. Others again maintained that—well, quite a lot of things!

To settle the difference of opinion and cut a long story short, a repre-

sentative was despatched to interview one of Australia's leading phonograph dealers to get his opinion which was to be considered as final.

Here it is: "A happy relation is rapidly being established between the radio broadcasting interests and the phonograph industry. In some quarters when radio first sprang into prominence, there was a feeling that the phonograph industry would be unfavourably affected, but the same state of affairs in America has shown that radio may become a great aid to the phonograph industry. In the end, anything that helps to increase

the popularity of music helps the sale of phonograph records. Radio serves to popularize music, but as soon as a number is rendered at a radio broadcasting studio, no record of it remains. The audience is not satisfied with one reproduction. This is indicated by the many request programmes which are arranged in an attempt to meet the demand for a permanent record of successful numbers. Only a phonograph record personally selected, can suit the individual tastes of this diversified audience."

So there you are!

Do I Need an Aerial?

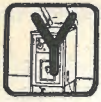

YOU may have heard that So-and-So did not use any aerial or antenna with his receiving set and still received broadcasted programmes. You, too, may want to do the same, but do not be misled into thinking that there is no collecting agency for the radio waves. There is, even though it may be short wires acting as aerial and counterpoise, or it may be in the form of a small loop inside the cabinet.

super-heterodyne sets the loop is contained in the cabinet, but it is there just the same. When a loop is used with a receiving set, the loop must be pointed in the direction of the station from which it is desired to receive for best results.

Any regenerative set will operate fairly well with just a ground connection. Sometimes it will be found best to connect the ground wire direct to the top of the coil and the grid condenser. This arrangement

as wood and glass, being non-conductors of electricity, do not stop the radio waves.

The advantages of the coil or loop aerial are selectivity, portability and compactness, while the disadvantages are very little energy is picked up by them and a sensitive receiving set is necessary for their use on any but local stations. Two pieces of lamp cord about 20 feet long, one used for an aerial and the other for a ground will give you a portable aerial and pick up much more energy than a loop.

Of the various types of aerials the outdoor aerial from 100 to 200 feet will collect the most energy if it is above all other objects that are near it. An indoor single wire aerial, between 50 and 100 is a good indoor type, while the loop two or three feet square is a poorer collector than either of the above.

All radio sets must have some form of aerial or ground because the aerial and ground are the collectors of radio energy. On local stations you can pick up programmes by disconnecting your aerial and ground entirely and just use the coils in the set for picking up energy but you do not get much but it is a good idea when atmospherics are very bad.

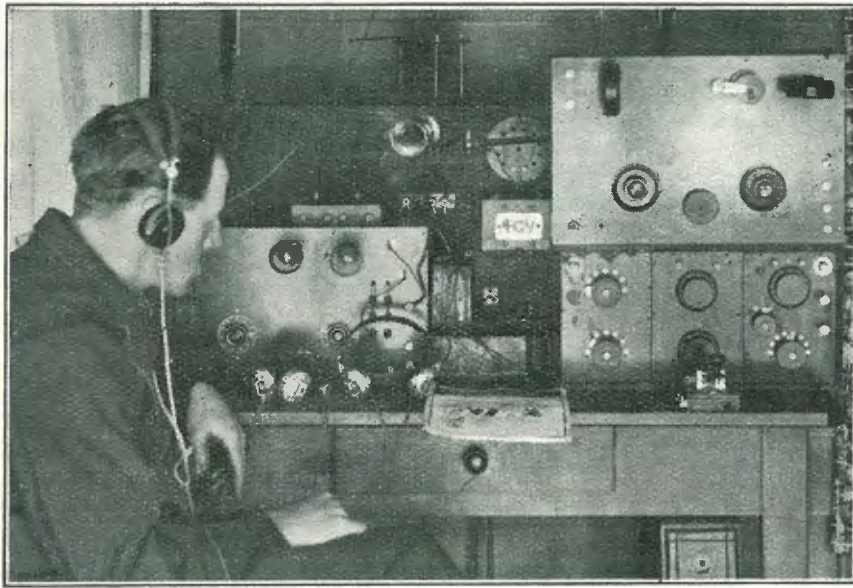

A photograph of Radio station 4CV, Charters Towers, North Queensland, and its owner-operator, Mr. Norman C. Husband.

Now with this small form of collector, the radio set must have several stages of radio frequency amplification in order to strengthen the radio signals before the detection takes place. The smaller the collecting agency, whether in the form of a single wire, loop or just a ground connection, the less energy you are going to pick up and the weaker will be the signals, using the same type of set on various collectors, or aerials. The average loop aerial is not much better than a single wire stretched about 15 feet, that is, it does not pick up any more radio energy.

When you read advertisements saying "no aerial or ground used with this set," you can be sure that a loop aerial is used. In the latest type

works well when a set is taken from place to place and no aerial is available.

When you are using an ordinary loop set, it will be found that signal strength will be materially increased by using a ground connection. It will broaden the tuning somewhat. An aerial may also be used with a loop but then you get away from the main advantages of the loop, selectivity and atmospherics.

An indoor aerial of any form is not good in a steel building or where there are a lot of steel parts such as lathes, girders, etc., which are connected to earth. These steel objects are conductors of radio waves and act as a shield to your set, conveying the radio energy to earth. Such objects

2JM HEARS KGO.

Mr. R. C. Marsden, the well-known owner and operator of 2JM, advises that he received KGO on a detector and one stage of audio frequency amplification. Mr. Marsden, whose station is situated at Edgecliff, Sydney, N.S.W., is certainly to be congratulated on this feat, as he received the programme from KGO with wonderful clearness and strength through many howling valves and interference from static.

WAITEMATA RADIO CLUB.

WITH headquarters at 67 Grey Street, Auckland, this club promises to do good work. It is intended to install a five-watt transmitter with the object of sending slow Morse out for the benefit of listeners-in wishing to learn the code.

A "B" battery for your detector tube, to be efficient should be tapped, or variable.

KGO Broadcasts Special Programme



As announced in *Radio*, No. 38, the Editor made special arrangements through the San Francisco office of the Radio Corporation of America for KGO, the General Electric Company's Broadcasting Station at Oakland, California, U.S.A., to transmit a programme especially intended for Australia and New Zealand.

This programme was transmitted on Saturday evening, August 30, on a wave-length of 312 metres, and since then the Editor has received hundreds of letters reporting the reception from experimenters in all parts of Australia and New Zealand.

The well-known Wireless Company—Radio Ltd.—Auckland, New Zealand, advises that the reception of KGO's programme in and around Auckland was splendid, as was also the case with quite a number of other stations throughout the Dominion, and the programme of speeches, musical items and announcements was clearly audible for upwards of two hours. An interesting item was a speech by the Governor of Idaho addressed to "Overseas friends in New Zealand and Australia."

Amongst Aucklanders reporting the reception of KGO were Messrs. W. H. Dowson, of Kaiwaka, and Mr. W. H. Hamblin, of Herne Bay, Ponsonby. Mr. Dowson states that he picked up the last special transmission at good loud-speaker strength. Mr. Hamblin said that KGO was

heard at good strength with detector alone. With an audio set added the volume was almost uncomfortable in the 'phones.

Hundreds of letters received reporting the reception of KGO included those from:—

- D. N. Lee, Smithson, Tasmania.
 W. Miller Hale, "Ben Nevis," Anglesea, via Geelong, Vic.
 W. P. Ward, Box 53, Clare, South Australia.
 A. E. Wright, Scarborough, South Coast, N.S.W.
 Collin C. V. Ormock, Eudunda, S.A.
 D. Barber, "Sardon," Elphin Rd., Launceston.
 G. C. Cawood, "Delwood," Bellingen, N.S.W.
 T. G. Taylor, Bettai Reservoir, Water Board, W. Maitland.
 A. J. Meagher, c/o. John Meagher & Co., Ltd., Forbes.
 F. C. Deakins, Dental Surgeon, Moree.
 Mr. Marlow, "Wandsworth," Quinton Rd., Manly.
 E. F. Burnett, Post Office, Enmore.
 J. K. Jellett, Berri P.O., River Murray, S.A.
 H. E. Grove, 35 Logan Street, Canterbury, Melbourne.
 P. L. Grant, Gowrie Station, Charleville, Qld.
 S. McCarthy, Macleay Street, Kempsey.
 R. Slater, 29 James Street, Northcote, Vic.

H. E. Rose, Yanganbil Station, Warren, N.S.W.

S. Birch, "Kallara," Wattle Tree Road, East Malvern.

T. R. Anthony, 12 Chestnut Road, Auburn.

E. M. B. Pell and C. P. Morgan, c/o. Bega Radio Supplies, Bega.

A. T. Cotton, "Kevedon," via Spring Bay, Tasmania.

J. J. Kelly, Rosedale.

D. S. Donkin, "Riversdale," Burdoo, N.S.W.

A. A. Leslie, Morgan St., Wagga

T. Evans, Charles Street, Blayney.

F. E. Smith, c/o. Elec. Light and Power Co., Ltd., Roma, Qld.

E. T. Marchant, Tia Post Office, via Walcha, N.S.W.

G. R. Thurston, King Street, Stockton.

The Editor of *Radio* takes this opportunity of expressing his very best thanks for the splendid co-operation of everybody in this test, especially some of the experimenters and broadcasting stations, who closed down during the transmission of KGO.

On behalf of all those who enjoyed the programme from KGO throughout Australia and New Zealand, this opportunity is taken of expressing the sincere thanks of both the Editor of *Radio* and those who heard the programme, to the General Electric Company for broadcasting such a splendid number of items from their well-known station KGO, at Oakland, California.

OBEY THAT IMPULSE!

Why lose your temper and waste your time searching all over town for the latest copy of RADIO?

Make sure of it now for a year ahead.

Insure your prompt receipt of each and every copy for the next twelve months by filling in this form:—

The Circulation Manager,
 "Radio in Australia and New Zealand,"
 97 Clarence Street, Sydney, N.S.W.

Dear Sir,—

I enclose herewith 10/- (ten shillings) for twelve months' subscription (twenty-six issues) to "RADIO," commencing from the next number.

I fully understand that by taking this course of ordering my copies in advance I shall be receiving them at a cost price of a little over 4d. each.

Please forward each issue of "RADIO" to:—

Full Name

Address

Song of the Nightingale Broadcast

WIRELESS aeriAs are almost as common as chimney pots in London to-day—and that is saying a great deal. Almost every second house in any suburban street has an arrangement of stick and wire stretched between the chimneys on the roof.

Wireless has become a mania. Men in the streets sell pocket wireless sets on trays like boxes of matches. There seems to be as many wireless shops as taverns—that also is saying a great deal. The general manager and the most junior clerk lose sight of the gulf between, when the most junior asks the general manager whether he has changed his "crystal set" for a "valve set" yet, or whether he found difficulty in getting the "wave length" last night.

I have visited several London houses where the whole family gathered round the fire in the evening to "listen-in." First there would be the children's bedtime talk, wherein Uncle Jeremiah and Aunt Susie told fairy tales. This was invariably followed by a chat to the elder members on the care they should take of the skin of their pearls. Father by this time snored comfortably.

The British Broadcasting Company is making laudable efforts to give interest to these concerts. I have heard some really good operas through the loud speaker, which has undoubtedly come to stay, at least in England.

Perhaps the best brain-wave the

B.B.C. has had yet resulted in the broadcasting of the song of the nightingale. Quite sceptical as to the success of such a proposal, I climbed innumerable stairs to my office about 8.30 on the appointed night, adjusted the valves, fitted the ear-pieces to my head, and waited.

Weird noises came out of a windy night, crackled and spluttered and died. I turned one of the valves. Far away came the futile strains of the Savoy jazz band. I turned the thing again. The weird whistlings returned. And then I waited, at first impatiently and then with much patience, says a writer in *The Evening Sun*.

Then it came.

Some sort of melody reached me. It was a 'cello being played in an old-world Surrey garden, where the nightingales sang every night. It was noticed that when the 'cello was played the nightingales sang, as though they liked the tone of the instrument. So it was the 'cello I heard. The melody was infinitely sweet. I think it was by Traumarei. Still, except for the unseen 'cellist, the night was silent.

So perfect was the wireless that I could actually hear wind rushing through the trees, and could sense that peculiar feel of the country at night, when the clouds scud away on the wings of a boisterous wind. In the faint distance, a dog barked twice.

Then three chirrups came, very distinct and near. The 'cello stopped. Some more fluttery chirrups followed, and then came a wonderful trill. An answering cadence of trills came from further away, but grew nearer, until there seemed to be a trio or even a quartet trilling and warbling divine-ly. The quartet became a choir.

I was listening for the first time to the love songs of English nightingales on a spring night. I didn't see the dusty rows of books or the knobby switchboard before me. I saw rows and rows of dingy little houses in back streets of appalling slums, brushed with the clean breath of the old Surrey garden, and the night wind, and for an hour they were one with the rose-clad cottages that exist only in dreams, and the flush-faced listening children lost their paleness and grew bright-eyed like fairy tale children. . . .

But it was only for half an hour. The rapturous song grew fainter and then ceased. The voice of the 'cello tried in vain to recall it. There were only the weird noises in the ear-phones again.

The rows of books before me had never seemed so dusty, nor the switchboard so knobby, nor the thought of the rows and rows of dingy houses and stinking streets so repugnant. . . .

Just as I turned the valve to "O" the jazz band had the last word . . . as usual.

Trans-Oceanic High-power Wireless

THE high-power wireless station which Amalgamated Wireless (A/sia.) Ltd. will shortly erect in Australia will be capable of operating a direct communication service between Australia and England and North America. In each of the capital cities of the Commonwealth there will also be a feeder station for direct communication with the high-power station and with the other feeder stations. The charge on all classes of messages between here and the United Kingdom and vice-versa, will be reduced 33 1-3 per cent. on existing rates. Deferred messages will be charged at the rate of 1/- per word,

and week-end messages, 6d. per word. There will also be a corresponding reduction for press and government messages. The station will contain the most modern and efficient equipment obtainable to-day, and will embody the most advanced scientific ideas in modern wireless communication. The transmitting apparatus will consist of an electronic valve set having a power unit of 1000 k.w., with duplicated plant, which will supply energy to a highly efficient aerial system supported by 20 lattice-steel masts, each 800 feet high. The receiving equipment will consist

of five complete sets of the most modern high power commercial apparatus obtainable. Each equipment will be capable of receiving simultaneously with others from a different direction, and they will all be able to receive messages while the transmitting station is working at full power. The central office will be equipped with automatic high speed transmitting and receiving apparatus, capable of working at speeds up to 120 words per minute, and the signals will go direct to England in 1-15th of a second. A corresponding station will be worked in Canada to deal with traffic to and from North America.

Making a "B" Battery



YOU may be one of the large number of broadcast listeners whose B batteries do not last very long and who have to replace them every couple of months. This is both expensive and annoying, because as the B battery voltage falls off, the signals become weaker until finally it is impossible to hear any stations at all.

Unless you can afford to purchase the higher grade, higher priced B battery, you will be bothered by run down B batteries continually when the inferior grade are used. The remedy is to make up your own B batteries from flash light batteries.

The best type to use are the long cylindrical ones consisting of two or three cells. Those about an inch in diameter and three inches long will last from six to nine months in your set. If you purchase the three cell battery you will require five such batteries for a 22½ volt B battery. Each cell gives 1½ volts.

A three cell battery similar to those used in large flashlights is shown in figure 1. The dotted lines indicate the three cells inside the cardboard container. This container should be cut at points marked X, which will give you three separate cells with individual cardboard containers. Five such batteries will give you 15 cells and they are placed in a cardboard or wood box with the centre or posi-

tive terminal up as shown in figure 2.

The cells are connected in series, that is, the zinc container of one cell is connected to the carbon or middle terminal of the next one and the zinc of that to the carbon of the next one. When you have finished connecting the cells this way, you will find that you have a zinc at one end and a carbon at the other that is not con-

If it is desired to have a higher voltage such as 45 volts for amplifying tubes or even high voltages, the same procedure should be followed except the taps on the extra B batteries will not be required. The cells may be placed in one large box or in separate boxes. The latter will make a little more work but it is preferable.

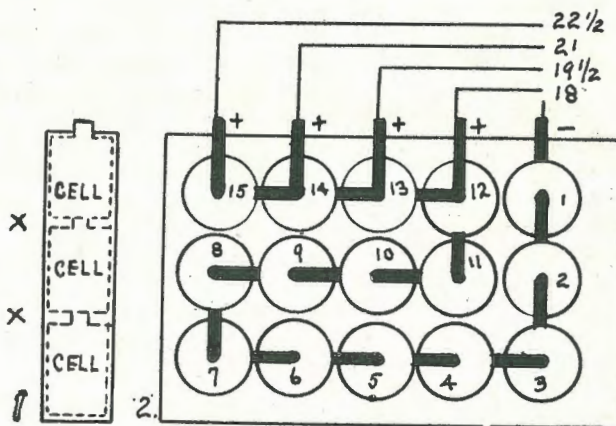

nected to anything. The carbon is the positive lead from the battery and the zinc is the negative lead. These go to their respective circuits of the set.

If you desire to have a variable B battery, taps should be taken off at the 11th, 12th, 13th and 14th cells, which will give you a variable voltage from 16½ to 22½ volts, which will suffice for a critical detector tube.

After the cells have all been connected up it is a good plan from an electrical viewpoint to cover the cells with beeswax or tallow to exclude moisture. When this is done, the box should be a trifle larger than required to just hold the cells and the beeswax heated and poured over the cells until it covers them at least one-quarter inch. A little higher will not hurt them as the wax shrinks when cool.

2AQ, NEW ZEALAND.

MR. MORTON COUTTS, operator of station 2AQ, Taihape, was a visitor to the recent Auckland radio exhibition, and in the course of conversation mentioned having received several pleasing reports from different parts of Australia. This gentleman, who speculates in 50-watt bottles, gives the amateurs some very fine programmes considering that he is situated in one of the centre county districts of New Zealand. Another visitor to Auckland during Radio Week was Mr. McMillan, of Thames. He had with him a home-made five-valve neutrodyne receiver which he had constructed himself. The method

of mounting was most unique, as he had been to some trouble to drill a piece of plate glass which he used as a panel upon which to mount the component parts. The only drawback to this experiment which Mr. McMillan experienced was that the moisture is liable to collect on the surface due to the breathing of the operator, but he hopes to overcome this by frosting the outer surface of the panel.

2CM RECEIVED IN U.S.A.

MR. C. D. MACLURCAN, of Sydney, has received over 25 QSL cards from American experimenters,

reporting the reception of signals from 2CM. Until recently, practically none of these checked up with his log. During the last month, however, several reports of undoubted receptions have been received both by card and direct QSL by radio. These are from 6CGW, 6CAE, 6EC, 6ZX, 6AWT and 6CNH. If any amateur has logged 6CAE, will they please let Mr. Maclurcan know?

Mr. F. D. McMaster, of "Dalketh," Cas-silas, N.S.W., advises having received a programme broadcasted from KGO on a detector and two stages of audio frequency amplification. The modulation was perfect and the reception was wonderfully clear.

Willis Island Radio Station

By N. STOCKTON.



WILLIS ISLAND RADIO STATION was established in November, 1921, for the dual purpose of collecting meteorological data and issuing cyclonic warnings and weather reports to shipping and North Queensland coastal towns.

North Queensland has been sadly ill-treated by cyclonic depressions during the last decade. On March 23, 1911, the Adelaide S.S. Co's. fine passenger steamer *Yongala* foundered off the Great Barrier Reef with over 1,500 souls aboard, and on several occasions since then, practically all important North Queensland towns have suffered from the visitations of the "storm god." The *Douglas Mawson* foundered in the Gulf of Carpentaria on March 28, 1923. If she had been equipped with wireless, the disaster would undoubtedly not have occurred, as sufficient warning was given by the many weather reports broadcasted by wireless telegraphy.

Early in 1921, after representation by the Queensland Government, the Federal Ministry decided to establish a meteorological station in the South Seas as directly in the path of the depressions as possible. After inspection, Willis Island was finally chosen, and a party left Melbourne immediately with the necessary gear. By November 1 of the same year, the station was officially opened, and the first meteorological message was transmitted by Capt. J. K. Davis, Commonwealth Director of Navigation, who spent the first season of six months on the island.

Willis Island is situated 270 miles due east of Cairns (N.Q.) and is only a few acres in extent. The island, at the highest point, is only 26 feet above h.w.m., but little or no damage is done by the heavy seas that roll in, as they are broken up on the coral reef, which practically surrounds the island.

Sufficient food and water is supplied for the whole season, and during that period the party of two radiotelegraphists and a meteorologist are completely isolated from the

outside world. To while away the time, tennis, fishing, swimming, and indoor games are indulged in.

Two substantial concrete buildings were erected, and, with a view to eliminating any possible chance of disaster from cyclones, extra care was taken in construction. The concrete walls are over a foot in width and the foundation goes down 12 feet. The roof is bolted and chained down and all shutters and doors are double-barred. A dug-out has also been constructed, where one month's emergency rations and water are stored. In case of dirty weather, the party may take refuge in the dugout, which is substantially built up with sand-bags and heavy timber.

The wireless cabin is of three rooms. The first is the operating room, and the controls are so arranged as to be within easy reach of the officer on duty. Behind the operating room is another room, containing the motor generator, oil engine, switchboards, and emergency storage battery service. The remaining room is the wireless and meteorological storeroom, where all extra gear, etc., is kept. The living quarters comprise six rooms—bedrooms (2), living-room, kitchen, storeroom and bulk storeroom.

The transmitting apparatus is a $1\frac{1}{2}$ kw. asynchronous rotary spark transmitter. Three wave-lengths are used, viz., 450, 600 and 800 metres. Dubilier condensers, tested to 15,000 volts are used. The emergency transmitting apparatus consists of aero "A" type transmitter, power being obtained from 40-volt storage battery service.

The receiving apparatus consists of type model L (Naval) one-valve unit, the "juice" being obtained from a storage battery in the operating room. Australian made Expanse "B" valves are employed, and remarkable results have been achieved with these.

All Australian coastal radio stations, with the exception of Wyndham and Geraldton, have been heard

in the daytime, and at night stations from all over the world "blow" in. Telephony from Wellington, Ravana Island, Sydney, Brisbane and Townsville was heard using only the one valve. The four-wire antennæ, 120 feet long, is supported by two masts, each 86 feet in height.

Weather recording instruments consist of electric anemometer, for recording direction and velocity of wind, Dines anemometer, mercurial barometers, barograph, wind vanes, rain gauge, thermometers and theodolite. The latter is used in conjunction with daily balloon flights for recording upper air currents.

During the official cyclonic season (November 15 to May 1), weather reports are broadcasted thrice daily—at 9.30 a.m., 4.45 p.m. and 8.45 p.m. These signals have been picked up over a distance of 2,000 miles, which, for a $1\frac{1}{2}$ kw. station, is a fairly remarkable achievement. In conjunction with the forecasts issued from Brisbane and Townsville sufficient warning is given to shipping of the approach of any cyclonic disturbances.

Myriads of seabirds inhabit the island, and at times they almost completely obscure the sky. They keep up an incessant chatter night and day and during the nesting seasons it is impossible to walk over parts of the island without breaking the eggs. Turtles are very common, and as many as 20-30 greenbacks have been seen on the beach at one time. Sharks abound and a wary eye is kept open for them whilst swimming.

Press news is picked up from Sydney, Cooktown and Townsville Radios, so the staff is well in touch with events of the outside world.

Much valuable data has been collected by the Commonwealth Meteorological Bureau from Willis Island, and the establishment of this station has gone far to assuage the fear naturally felt by the public in travelling on the North Queensland Coast during the cyclonic season.

Dominion Trainees Instructed in Radio

THE Defence Department of New Zealand has instituted an instructional course of wireless training in connection with the establishment of the various signal units, and for this purpose radio sections have already been formed at Auckland, Wellington and Christchurch. Up to the present no attempt has been made to utilise wireless as a means of inter-communication between various military depots, the activity of the different wireless sections being confined to purely instructional work. However, using 120 watt continuous wave sets, communication between Auckland and Wellington has been established by trainees during both day and night periods.

Auckland is equipped with a 30 watt continuous wave set in addition to the 120 watt set mentioned above, and at times very useful work is carried out "spotting" artillery units of that command. Wellington has similar equipment with the addition of an extra 30 watt set and two 85 metre forward spark sets. The installation

in Christchurch is confined to one 30 watt set. All wireless stations are under the direction of the officers commanding the New Zealand Corps of Signals at the various depots, and wave-lengths used range from 1,000 to 3,000 metres, and are specially chosen to avoid clashing with amateur, broadcasting and other commercial wave-lengths. Signals from military wireless units have been heard clearly in many parts of New Zealand, but as operations are mainly confined to the hours of daylight, no record distances have been attempted.

The training at the various depots is proceeding smoothly, the instructional courses being undertaken entirely by trained wireless officers of the Telegraph Service. In this respect, the Defence Department has been exceedingly fortunate, as the majority of the personnel are already skilled telegraphists, mechanics, or wireless operators with commercial station experience.

During a recent "refresher" course at Trentham Military camp,

near Wellington, where officers and N.C.O.'s from various depots gathered for an intensive course of signal training, full use was made of wireless in the field, and under conditions that were as near actual war operations as possible.

A petrol-driven motor-generator was used at the "dump" for recharging accumulators, and all repairs to instruments were carried out by the Corps' mechanics. The lines of communication between battalion headquarters and camp headquarters were maintained by the 30 watt sets. The advance stations were erected on hill-sides in the midst of dense scrub, and in the most unfavourable positions, according to the tactical scheme in operation, and the whole of the traffic received from company units by means of power-buzzer, forward spark sets, land line telegraphs, etc., was transmitted to camp headquarters without a hitch, in spite of intermittent showers, and gusty winds which prevailed on the majority of field days.

MARKET REPORTS BY WIRELESS

What a great benefit it would be to hear the official market reports and know the exact position in regard to the crop and other prices within an hour or two of their operation. The Daily Newspaper probably reaches you too late to be of any immediate use. By "listening-in" at specified and advertised times you can hear the latest reports of all markets and the Stock Exchange.

The Weather report is invaluable to the man on the land, so is the exact time. This is all announced by the Wireless Broadcasting Station from Sydney, and can be heard in any part of New South Wales with one of our "Burginphone" Wireless Receivers.

The introduction of Broadcasting is going to bring your station up-to-date, and make the lot of your family, your employees and yourself much brighter.

Quite recently the Government Educational Department held an official test of wireless reception at Bourke. This test was made before a Committee, of which Mr. James Nangle, Superintendent of Technical Education for New South Wales, was Chairman. During these tests our "Burginphone" receiver performed to every satisfaction. The official speech made by the Minister for Education, Mr. Bruntnell, and also the Director of Education, Mr. Smith, was actually received on our "Burginphone" receiver and amplified to such an extent that children in the next class-room could hear all that was being said by these gentlemen in Sydney, 400 miles from Sydney.

Our "Burginphone" receivers are among the very few that have been recommended by the Minister for Education for use in the State Public Schools and by the various Parents' and Citizens' Associations.

Send for Illustrated Catalogue and Price List.

Burgin Electric Company Ltd.

391-3 GEORGE STREET, SYDNEY.

(Transmitting Station 2 W.V., 352 Kent Street, Sydney.)

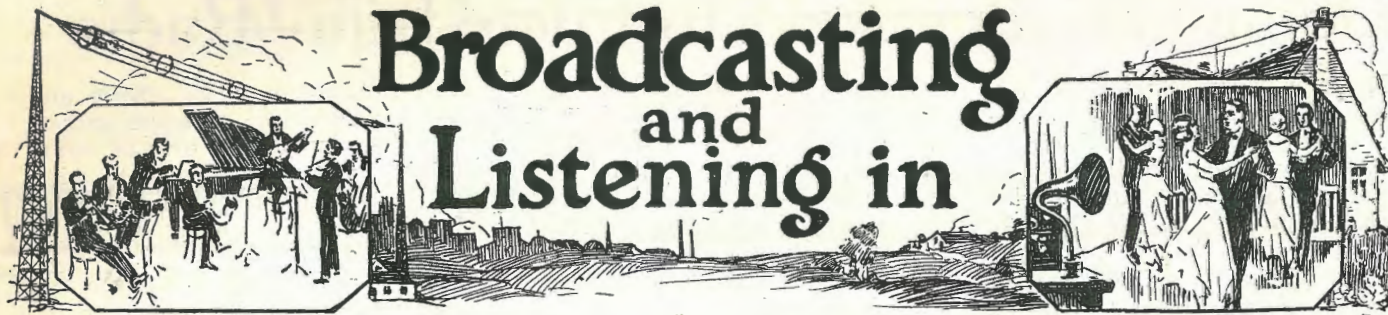

VERY different to those obtaining in other countries are the conditions under which broadcasting will be carried on in Italy shortly. Listeners-in are to be taxed from the

main the property of the concession company, a rental being charged for them.

THE broadcasting of moving pictures will be possible within a year, states Col. E. H. R. Green, New York, who is the son of Hetty Green, who has already claimed to have perfected a device which will function at short distances.

THE Queensland Ministry intends to spend about £3,000 on building and equipment at the Peel Island lazarette for lepers. Among the improvements will be a wireless installation to link the sufferers with the

2FC

BROADCASTING TIMES.

Sydney Mean Time.
Wave Length: 1100 metres.

Midday Session:
12.55 Tune in to the Studio Chimes.
12.58 Time Signals from Farmer's Master Clock (Sydney Observatory Time), Stock Exchange Intelligence, Weather News, "Sydney Morning Herald" news and cable service, "Evening News" midday news bulletin.
1.15 Close down.

Afternoon Session:
3.30 Studio Chimes.
3.33 Musical programme by Farmer's Orchestra broadcast direct from Farmer's Oak Luncheon Hall. Numbers will be played at intervals to 4.45.
4.45 Stock Exchange, weather, afternoon news.
5.0 Close down.

Early Evening Session:
6.30 Studio Chimes.
6.33 Children's Hour.
7.0 Dalgety's Market Reports, Fruit and Vegetable Markets, Stock Exchange, Shipping News, Sussex Street Markets, Late News.
7.15 Close down.

Night Session:
8.0 } Entertainment.
to }
10.0 } See list hereunder.

EVENING ENTERTAINMENT.

As far as possible the following schedule is adhered to:—
Monday: Theatre Night.
Tuesday: Popular Concert
Wednesday: Studio Concert.
Thursday: Studio Concert.
Friday: Classical Night.
Saturday: Jazz Night.
Sunday: Semi-Sacred Concert (7.30 to 9.30 p.m.).

GRAND OPERA artists from Count Filipini's company recently contributed items to a concert which was broadcast from the studio of the South Australian Broadcasting Company.

W. R. FINLAYSON, a Progressive candidate of Caulfield (V.), claims to be the first candidate in Australasia to broadcast his address to the electors by wireless. He recently used a friend's transmitter to speak to a large number of listeners in the Elsternwick district.

SEVERAL times recently the Sydney Metropolitan Fire Brigade has used wireless in order to ascertain the vicinity of a fire. On one occasion information was received at the fire station that a glare in the sky could be noticed in the direction of Rozelle, but further than that no information could be secured, although the police station, the local telephone exchange and other means were appealed to without success, until as a final expedient 2FC was communicated with. Listeners living at Rozelle were asked to assist the brigade, and a few minutes later a radio enthusiast living close to Robson Park telephoned the Fire Brigade that the glare was caused from burning off operations in the park,

6WF

BROADCASTING TIMES.

Perth Mean Time.
Wave Length: 1250 metres.

Midday Session:
12.30 Tune in to Sonora.
12.35 Market Reports of The Westralian Farmers, Limited.
12.42 News Service.
12.55 Weather Report.
1.0 Time Signal.
1.1 }
to } Sonora and Pianola.
1.30 }
1.31 Close down.

Afternoon Session:
3.0 Tune in to Piano Player (Duo-Art).
3.5 }
to } Special programme, com-
4.0 } prising talks, Sonora
and Pianola.
4.1 Close down.

Early Evening Session:
7.0 Tune in to Sonora.
7.5 Bedtime Stories.
7.45 Market Reports.
7.55 Weather Reports.
8.0 Time Signal.
8.2 News Cables.

Night Sessions:

Monday: 8.10, A Lecture; 8.45, Music, Pianolo and Sonora.
Tuesday: 8.10, Professional Concert.
Wednesday: 8.10, Concert Evening.
Thursday: 8.10, Professional Concert.
Friday: 8.10, Talk on Wireless to Amateurs by a Representative of the Affiliated Radio Society; 8.45, Concert Evening.
Saturday: No Saturday afternoon, only from 12 to 1, and again at 7.0, 8.10, The Westfarmers Studio Cabaret Jazz Orchestra, under the direction of Irwin Lawrence.
Sunday: 7.30, Mr. C. H. Coff's Choir. Close down at 9 p.m.

With the exception of Saturday, when the station closes down at 10.30 p.m., all other evening sessions conclude at 10 p.m.

start for the purpose, it is pointed out, of eventually developing free broadcasting. The Italian Government will decide who is and is not to have receiving sets and all these will re-

outside world and thus give them a greater measure of diversion and interest than their present isolation permits,

How and When to Use Crystal Detectors



AS the crystal detector means less financial outlay in the beginning and practically no upkeep, such as burned out tubes, new B batteries, etc., and is a better rectifier of radio energy than an audion, it is coming into wide use, especially in the reflex sets.

The old bugaboo about adjusting the catwhisker all the time has been

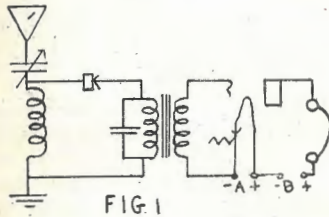

eliminated, either by using a crystal detector that requires little if any adjusting, or one that is fixed by the manufacturer. If you have never used a crystal detector, it will be a revelation to you, for you will hear good, clear radio signals for the first time. There is no distortion for a crystal detector cannot oscillate and blur the programmes.

Before throwing your audion detector aside or selling it and its accessories so as to get more parts, it will be well to tell you of a disadvantage of the crystal detector. It cannot be used in a regenerative set and is not good, as a rule, for distances greater than from 10 to 50 miles. That does sound like a big objection, doesn't it?

As a crystal detector is a potential operated device, it works best on strong signals. In fact, on local stations it is just as good, if not better than an audion, for in many cases an audion will "block" on heavy signals.

The strength of signals received on a crystal detector may be increased in two ways. Either audio frequency amplification in the form of one, two or three stages for the operation of a loud-speaker, or by the use of radio frequency amplification before detection takes place, for getting greater distance: or a combination of both types which will give you distance, clear signals and volume.

Figure 1 shows one stage of audio amplification. One or more steps may be added in the same man-

ner but a fixed condenser is not required across the primary of the other audio transformers as is the case on the detector.

Figure 2 shows a stage of radio frequency amplification and one of audio, using a common A and B battery for radio and audio frequency amplification. Where radio frequency amplification is used it is advisable

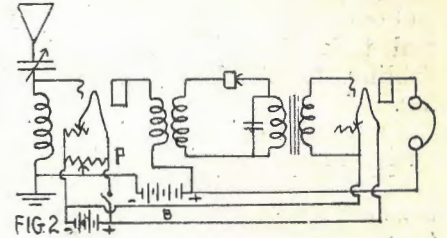

to use a potentiometer (P) to obtain the proper grid bias on that tube. Where a potentiometer is used it is best to have a battery switch to open the circuit when the set is not in use thereby lengthening the life of the A battery before recharging it, although very little current is drawn from it by the potentiometer being shunted around it.

Have You Seen The new Gramophone Attachment for utilising your Gramophone as a Loud Speaker. It is simply fitted to the Tone Arm in place of the ordinary speaker. It has a beautiful tonal quality on account of its adjustable Mica Diaphragm.

NOW, ABOUT VALVES AND HEADPHONES!



C.I.C. Loud Speaker Gramophone Unit. £2/2/6

We make a Special Carton for sending Valves to the country. It is almost impossible for the postal people to break a valve packed in this carton.

The New Prices of Valves.

PHILLIPS, D1, D2 and E	18/6
MARCONI, R	19/-
MULLARD	19/-
DE FOREST	35/-
RADIOTRON	35/-

Headphones of High Quality that we Stock.

PEERLESS, 2000 ohm	32/6
TRIMM, 2000 ohm	32/6
TRIMM, 3000 ohm	45/-
RED SEAL—the Aristocrat of all Headphones	50/-



WE HAVE ALL OTHER BRANDS.

SEND FOR OUR PRICE LIST.

RADIO HOUSE, 619 George Street, Sydney
THE QUALITY RADIO STORE.

A Few Words on Panel Insulation

By BRAINARD FOOTE, Radio Engineer.

NOW that the day is passed when the Radio set builder wound his own coils and wrapped his own condensers, the construction of a receiver becomes mainly a job of assembly. The enthusiast buys an array of instruments, a panel to mount them on and some dials to operate them. His real task, then, is one of cutting, drilling, countersinking and mounting.

To expedite his work, he requires an insulation material which can be readily worked with the few simple tools ordinarily possessed by the amateur. And it isn't every style of panel which wears well, looks well, but doesn't ruin the edge of the drill or the teeth of the hack-saw.

dispensable as well, for the energy picked up on the antenna is too precious to be wasted. In tests of a number of "balky" receiving sets, I have found excessive loss through panel material, which, though very hard and strong, was of a fibrous nature and absorbed moisture. Stood on the radiator for an hour or so, the sets resumed operation after a fashion, but they represented a waste of labour and effort that was, to their well-meaning constructors, truly appalling.

Another characteristic of a panel which in truth is of more than passing importance is its appearance. The front of the set is in sight day and night, and a panel containing excess

as the material brought out especially for Radio, is attested to by the results obtained at the New York Electrical Testing Laboratories and the U.S. Bureau of Standards in their electrical tests of Radio insulation. These organizations report Radion as having the lowest dielectric constant, phase angle difference, water absorption and the highest resistivity of insulation materials.

To meet the specifications for every type of receiver, Radion is furnished in as many as 18 standard sizes, protected against damage by envelope packing. Since the cutting is done by the manufacturer, the edge is accurate, and buyer and dealer alike are relieved of the sawing operation.

IF

[With apologies.]

By "QRX."

If you can hold your point while all around you static roars and crashes;

If you can make your interrupter send out more than feeble dashes:

If you can send your forty words a minute, nor use the "nervy" touch;

And run your words together till they read like so much Dutch;

If you can listen to the Nippon ships nor hanker for their gore

When they clutter up the atmosphere with thirty calls or more:

If you can answer every foolish question asked nor show your biting wit;

You're much too good to be at sea, my son—I'll tell the world—you're IT.

Then there are some other qualities, not so apparent off-hand, which the insulation selected must have. The physical nature of the panel should be such that water absorption is practically nil. A loose-fibred substance into which water can penetrate will not only buckle and swell, but, what is far more serious where results are concerned, institute so much leakage between binding posts that signals are weakened or regeneration impossible to obtain.

Low dielectric constant and a low phase angle difference are also essential to prevent the passage of radio frequency current through the insulation material. High resistivity is in-

of free sulphur in its make-up which thus yellows with age, is no attraction. Indeed, a roughening of the surface allows dirt and dust to lodge on the panel, and in that way considerable surface leakage loss takes place. The high finish of the panel should be retained both on front and rear, for this very reason.

The older forms of hard rubber were considered standard for electrical instrument insulation before the advent of broadcasting, but when it came to radio frequency currents, a special grade had to be developed to fill the bill, and this is Radion. I believe that Radion is the ideal insulation for use in Radio, and its success

Panels are stamped "Radion" as well.

Amateurs like the lustrous finish of the material because it insures a neat and scientific appearance. Besides the black panel, a grained panel material called "Mahoganite" is also available, with dials and knobs to match. "Mahoganite" is a clever imitation of grained mahogany, showing the high lights and faint tints of the wood in faithful reproduction. I have used Mahoganite to make up a number of "parlour models," and with a handsome cabinet, Mahoganite panel and gold-lettered dials to suit, a "Rolls-Royce" receiver may be assembled which will grace any drawing-room.



Up to date, Mr. W. E. Hagarty, of Longreach, Central Queensland, has heard KGO on two valves—one detector and one audio—three times. On the last occasion, August 22, he asked several neighbours over to his house to listen in and "The Rosary" and several other vocal and pianoforte solos were heard with ease.

6WF, the Westralian Farmers' broadcasting station have written to Mr. G. R. Martin, of Greenwich (N.S.W.), and congratulated him on his fine performances in hearing them on two and four valves. They also state that although at the time of writing transmissions were made on a power of 300 watts, this is soon to be increased to five kilowatts.

Using a single valve, the list of stations given below form the DX list of Mr. C. A. Cullinan, of Diggers Rest (V.), for the period between August 16 and 31 last. The figures in brackets indicate the strength of signals and are based on the English system. Australia: 2AY ('phone, R7; CW, R8); 2DE (R3); 2DS, 2HM ('phone, R4); 2LC (R8); 2RJ ('phone, R6); 2YL, 2ZZ, 5BF, 5BP (R5); 5BX, 5DO, 7BK. N.Z.: 1AO (R5); 2AP, 2AR (R5); 3AD (R6); 3AF, 3AL, 4AA (R6); 4AG (R8); 4AK (R7); 4AP (R5); 4AR, 4AD (R5). U.S.A.: 5APC (R4); 6CGW (R7). 4AG is the loudest station Mr. Cullinan hears. The condenser used by this experimenter is a 13-plate with normal spacing and ebonite end-plates. A brass bearing is used in each plate, while some fine oil is poured between the shaft and the bearing forming a small condenser. The only defect in this is hand capacity which is very bad but tuning is extremely sharp; a 4.1 vernier



often being of no avail. With the above arrangement Mr. Cullinan finds there are no noises as one often gets with the ordinary type of friction connection.

Using two valves—one detector and audio—Mr. A. G. Hecker, of Temora (N.S.W.), writes to say that he has heard the following stations on 'phone lately:—N.S.W.: 2HM, 2GQ, Riverina Wireless Supplies, Wagga. V.: 3AR. S.A.: 5AC, 5AB, Adelaide Radio Co. N.Z.: 4YA. U.S.A.: KGO; this station having been heard on several occasions, while on the evening of September 7 last Mr. Hecker copied down all announcements made between 6 p.m. and 7 p.m., local time. The real "punch" in this record are the facts that this experimenter is only 16 years of age and lives 210 miles from Sydney.

The following should prove of considerable interest to users of simple crystal sets and clearly demonstrates what may sometimes be done with wireless apparatus of this type. On the evening of September 7, Mr. Eric Knight and his wife, of South Ashfield, Sydney, had just heard concerts broadcast from 2FC and 2BL, these stations coming in beautifully clear when, after they had closed down, he moved the single slide to within about an inch of the end and heard a gramophone selection from a local amateur very clearly. Then,

pushing it half an inch further he heard very faintly: "Hello! Hello! Hello! New Zealand 2AB station calling." This was repeated two or three times. This occurred at 10.24 p.m. local time,

Although only 15 years of age, Mr. J. C. Prideaux, of Charters Towers (Q.), is a real, "dyed-in-the-wool" experimenter and can hear 2FC any night on his one valve (WD12) set with its 100 ft. long and 30 ft. high aerial.

Mr. L. E. Rix, of Harden (N.S.W.), writes that on Sunday evening, September 7 he heard KGO on a home-constructed three-valve set loud enough to work a loud speaker. At 6.25 the transmission came in so clearly that one could hear the applause and the laughter of a man. The aerial used for this reception was 70 ft. long, of the T type, and consisted of a single strand held 30 ft. from the ground.

Mr. C. D. Maclurcan writes:—Last night (September 9), I wished to get a message over to Frank Bell, 4AA, New Zealand, and being unable to call 4AA direct myself, owing to other tests at the time, I asked Jack Davis, 2DS, to put it over. This is how it went:—2DS sent it first to 2AC, N.Z. 2AC relayed it to X3AA (Orbell on the s.s. *Port Curtis*, 3,000 miles away). 3AA then got QSO 4AA and gave it to him. Bell sent a reply first to X3AA who relayed it to 2DS direct. Later I worked 4AA direct, who confirmed both messages and answer. There were no mistakes, and when it is realised that 2DS worked 3,000 miles (without repeats) to X3AA one must admit it is fine business. Gang! This is the stuff to give them. Congratulations 2DS.

2AQ, TAIHOPE, NEW ZEALAND
MR. MORTON COUTTS, of Tai-

hope, was a visitor to the recent Auckland exhibition. Thousands throughout the Dominion have listened-in to 2AQ, and it is interesting to learn from Mr. Coutts that he has had reports of clear reception of his broadcasting from Melbourne and

Sydney and from inland towns in N.S.W.

ACROSS THE WATER.

AT Invercargill a local resident was listening-in on a receiving set at a friend's house when he was astonished to hear it announced that his

sister, Miss V. Brook, of Dunedin, would sing, "Ever of Thee I Am Fondly Dreaming." He also heard her sing several other numbers. Miss Brook had been in Sydney for the past few weeks, but her brother had no idea that she was to sing at a concert on that particular evening. The concert was heard through 2BL.

ALL WIRELESS RADIO SETS AND REQUISITES

ARE OBTAINABLE AT — LOWEST PRICES — FROM

SWAINS, 119a and 123 Pitt St., Sydney

A FEW DOORS FROM THE G.P.O.

CRYSTAL RECEIVING SETS, from 30/-. Operative up to 25 miles from Sydney.

ONE-VALVE RECEIVING SETS, from 25/10/-. Operative up to 100 miles from Sydney.

TWO, and UP TO SIX VALVE, from 228, Operative up to 5,000 miles from Sydney.

TO INCREASE THE EFFICIENCY OF YOUR CRYSTAL SET BUY OUR ONE-VALVE AMPLIFIER—Ready to connect up—Price 27/7/-; or the TWO-VALVE AMPLIFIER—which will operate a Loud Speaker—Price 210/10/-.

— WE SELL —

THE FAMOUS FROST FITTINGS, all makes of 'Phones and Loud Speakers — THE UNITED DISTRIBUTORS, LTD., HOME ASSEMBLY SETS and RADIOVOX SETS — STERLING 4-VALVE and 2-VALVE SETS, Loud Speakers and Phones — GALENA, ZINCITE, BORNITE, MOLYBDENITE, IRON PYRITES, AUSTRALITE CRYSTALS.

ALL THE LATEST BOOKS and MAGAZINES on WIRELESS in Stock.

Choose Wisely the First Time

The great variety of Frost Rheostats and Potentiometers enables you to select exactly the one most suited to your set—and to choose it with the confidence that you are obtaining the most reliable that money can buy. They include every type from No. 607 Tube Control Unit—the only combination of rheostat, with vernier, and potentiometer—to the simple metal frame Rheostats Nos. 600 and 602.

All are scientifically designed to give smooth and accurate control.

From the Frost lines described below you can select those most applicable to your needs.

FROST RHEOSTATS AND POTENTIOMETERS.

FROST-RADIO Metal Frame Rheostats and Potentiometers.

Equal in operation to the best moulded type, with precision, operation of all moving parts and guaranteed resistance wire. Frame made of heavy sheet brass, nickel-plated and formed so as to give a rigid construction both to the windings and the contact arm. Central mounting thimble with locating tip prevents turning when mounted on panel. Washers provided to fit panels of varying thickness. Fluted moulded knob and nickel-plated pointers.

No. 600, 6 ohms 5/6

No. 602, 35 ohms 5/6

FROST-RADIO Bakelite Potentiometer.

A handsome potentiometer, with genuine maroon bakelite frame and black polished bakelite knob. Wound with best grade resistance wire, with smooth-working lever and knob. Has three knurled brass binding posts, nickel plated and polished. A feature of this potentiometer is the panel method of mounting, with single hole attachment and locating tip to maintain in desired position.

No. 654, 400 ohms 9/6

FROST-RADIO Metal Frame Vernier Rheostat.

Same design as No. 600 Metal Frame Rheostat, but with special type Vernier, which gives precision adjustment over the range of a single wire by means of a smooth-working vernier arm rotated by the knob, a piece of apparatus that reflects quality.

No. 601, 6 ohms 7/6

No. 604, 35 ohms 7/6

FROST-RADIO Bakelite Tube Control Unit.

Made of maroon bakelite, with black bakelite control knobs. Combines in one unit rheostat with vernier, and potentiometers, with two-knob control. Finest materials throughout. Fitted with fine nickel-plated knurled binding posts. All controls work with extreme smoothness. A valuable addition to any set.

No. 607, 6 ohms Vernier and 200 ohms Potentiometer 17/6

No. 610, 35 ohms Vernier Rheostat, and 400 ohms Potentiometer 17/6

United Distributors Limited

WHOLESALE ONLY.

28 Clarence Street,
SYDNEY.

592 Bourke Street,
MELBOURNE.

Also at HOBART, PERTH, BRISBANE and ADELAIDE.

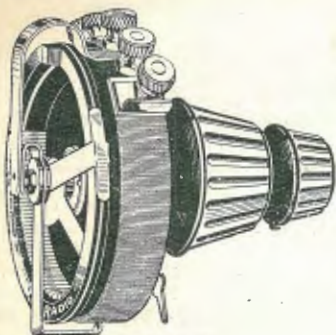

No. 610

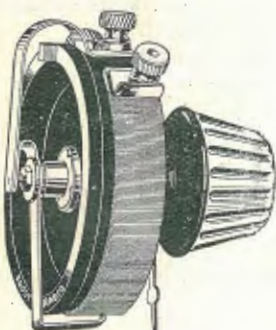

No. 604

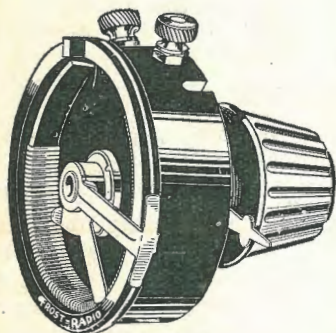

No. 654

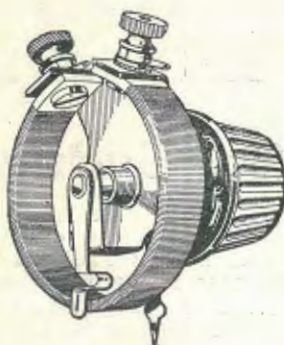

No. 600



Build your *Signal Set*
to-night
Listen-in tomorrow
night

Put it together yourself
with a
screwdriver & a pair of pliers



What could be Simpler ?

A screwdriver and a pair of pliers, a few hours' most interesting work—and your Signal Home Assembly Set is ready for you to listen-in. You cannot possibly make a mistake. The clear diagram and minute instructions supplied with the Set are easy to follow.

You save money this way, and you enjoy the advantage of understanding all about your set.

Signal Home Assembly Sets

comprise all parts with the exception of Valves, Batteries, Headphones and Aerial Equipment. They are completely standardised and thoroughly tested, ensuring clear and uniform reception.

Why not adopt this easy method of marching with the times? Enjoy to the full the pleasures which your friends command. Buy a Signal Home Assembly Set, and you will quickly understand the popularity of radio.

Model P, 1 Valve	£5/10/-
Model Q, 2 Valves	£9/9/-
Model R, 3 Valves (Audio Frequency)	£11/11/-
Model S, 3 Valves (Radio Frequency)	£11/11/-
Model T, 4 Valves (Radio Frequency)	£13/13/-

MANUFACTURED BY

United Distributors Ltd.

(WHOLESALE ONLY),

28 Clarence Street, 592 Bourke Street,
SYDNEY. MELBOURNE.

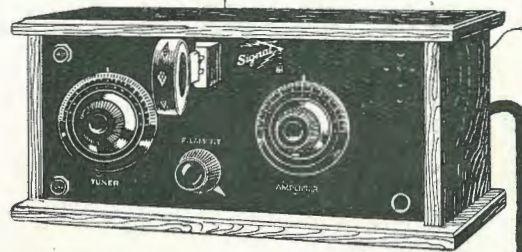

Auckland Radio Exhibition

IF the large crowds that attended the Auckland University to witness the first exhibition of wireless apparatus arranged by the Auckland Radio Association, were to be taken as any criterion of the interest displayed in radio matters in the Dominion, then it may safely be presumed that New Zealand is entirely en masse with enthusiasm for that science.

The display of amateur-made sets both in competitive and exhibitors' classes was well worthy of inspection

magnetic action which operates the diaphragm of the telephone was illustrated experimentally and a practical demonstration of transmission and reception given. The electric discharges seen and heard issuing from a Tesla coil were picked up by a receiving set at the other end of the room and amplified through a loud-speaker. At the conclusion of Mr. Salt's address Mr. White gave a demonstration in reproduction with an amplifier to illustrate that a loud-

ring to the uses of this branch of radio in war-fare, the lecturer said that Sir H. B. Jackson, Admiral of the Grand Fleet, had stated that the famous Battle of Jutland was indirectly brought about by the careful work of the direction-finding staff of the British Admiralty.

The fourth lecture delivered during the course of the exhibition was given by Mr. E. H. R. Green, M.Sc., the subject being "The Electron," and as in the case of the others was most capably handled and much appreciated by the large audience.

The exhibition which was held for four nights in the Science Department of the Auckland University Building was a great success for the initial effort of the local Radio Association.

Interesting lectures were given each evening and indeed were so well attended that seating accommodation could not be found for all those who attended them.

In addition to the list already published the following prizes were awarded in Class III:—Best single valves, V. G. Penny, 1; J. C. Stewart, 2. A special prize was awarded in the multi-valve class to D. Stewart, aged 13½, who constructed a very good four-valve set. The special prize donated by Mr. E. Horton for the best crystal set, value under 15/-, was divided between R. Taylor and K. E. Corbett.

Several interesting exhibits were made by the trade and private individuals, including a honeycomb coil winder made by Mr. J. Bingham and a low loss tuner by Mr. P. Harwood. An unique display of different types of valves was also made by Mr. N. Edwards, of 1AA. Altogether the Auckland Radio Association expect to add about 100 new members to their already large number, which should easily place them as the largest body of their kind in New Zealand.

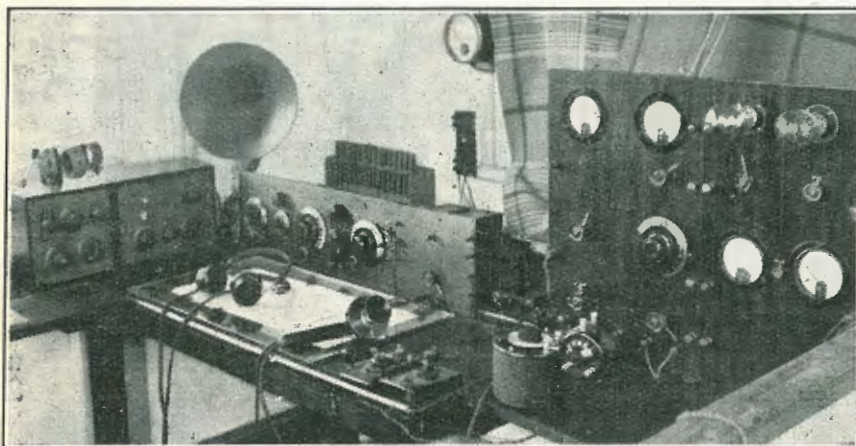

The above is an interesting photograph of the wireless apparatus owned and operated by Mr. J. Davis, of Vaucluse, who is well-known to all experimenters for his fine work in conjunction with Mr. C. D. Maclurcan in the trans-Pacific low-power, short-wave tests held early this year. On the left is the long-wave receiver. In the middle the short-wave, low-loss, one radio detector and one audio. On the right is the transmitter (15 watts). One of Mr. Davis' latest performances is the two-way communication with X3AA on s.s. "Port Curtis" when this vessel was 2,800 miles from Sydney.

and attracted much favourable comment. In the single valve exhibits there were some very fine sets, Mr. V. G. Penny securing first honours and second prize going to Mr. J. C. Stewart.

In the course of an exceedingly interesting address delivered at the exhibition, Mr. G. Salt, M.Sc., explained in a most simple manner the methods of projection and reception of wireless waves and the value of these. Wave action of the electro-

speaker, properly used, does not produce that distortion too frequently noticed.

In his address on the principles and application of radio direction finding, Mr. G. H. Munro, M.Sc., said that so comprehensive had direction-finding now become that accuracy to within half a degree could be relied upon. There were, however, conditions not yet fully investigated which made direction-finding over long distances at night less reliable. Refer-

DEAR READER! WHEN YOU HAVE FINISHED WITH THIS COPY OF "RADIO" LEND IT TO A FRIEND — DON'T KEEP A GOOD THING TO YOURSELF!

"RADION" Panels and Parts meet every requirement of the radio set builder



There are many reasons why you should build your radio receiving set with Radion panels and parts.

First: Radion has proven beyond a doubt to be the supreme insulation. It is made exclusively for radio work and far excels any other material in the four main characteristics required for wireless, namely, low angle phase difference; low dielectric constant; high resistivity and the low absorption of moisture.

Second: Radion is easily worked. It can be sawed, drilled, machined and otherwise worked without the slightest danger of chipping or cracking.

Third: Radion Mahoganite Panels have the actual surface graining of fine, highly polished mahogany while black Radion panels have a beautiful ebony finish.

Fourth: In cost, Radion is far more economical than any other material.

Fifth: Sets made with Radion Panels and Parts will give much better satisfaction.

Do not jeopardize the value of your receiving set by using cheap, trashy materials. It will pay you to always insist upon genuine Radion. Look for the name stamped on every piece.

International Radio Co., Ltd.
91-92 Courtenay Pl., Wellington N. Z.
200 Castlereagh St., Sydney, N.S.W.

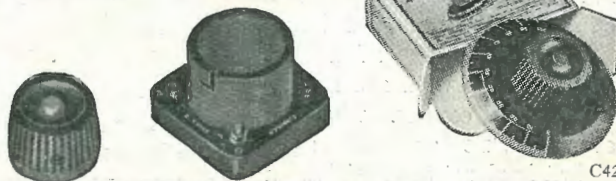

C42

FALLON CONDENSERS



We have pleasure in announcing that we have been appointed the Sole Agents in Australasia for the Fallon Condenser Company of London.

A market is assured for these well-known high-class condensers. We have stocks on hand and arriving. Do not turn away good business when your customers ask if you can recommend a good condenser at a reasonable price.

We invite applications from first-class firms who are in a position to act as Sole Distributors in each State for Fallon's products.

The Westralian Farmers Limited

569 WELLINGTON STREET, PERTH.

Cable and Telegraphic Address: "WESFARMERS, PERTH."

Crystal Detectors



THE crystal detector is a very excellent rectifier of radio frequency energy, it is rapidly supplanting the audion detector.

While this is as it should be, there seems to be a lot of misunderstanding of just the best way to mount them, or what kind of a point to use with them.

The galena has long been the favourite of the old amateur, but due to its requiring a fine light contact, the broadcast listener is not so well pleased. Due, no doubt, to the fact that the broadcast listener wants results with as little fussing as possible. The silicon crystal while not being quite as sensitive has the advantage that a blunt contact with some pressure will give good results. The iron pyrites crystal is not as good as the other two, but is about as sensitive on any spot as on another. The manufactured or synthetic crystal is in about the same class and it is with these types that the so-called fixed crystal has become so popular. If the latter type are inclosed so as to exclude dust and moisture, they will not

require any adjustment over several months use, and if a contact that will not corrode is used, there is not telling how long the crystal will hold up.

Some people make the mistake of thinking that instead of using one contact point, why not have several and then the set will always be in

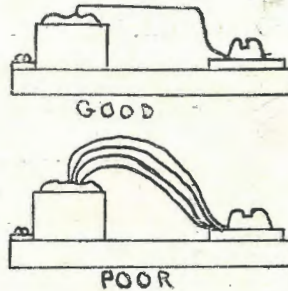

adjustment? It does not hold good in practice because while one point may have a sensitive spot, one or two of the others may be touching one that is not sensitive and may be practically short-circuiting the crystal and little if any signals will be heard.

Another idea that has gained considerable headway is to have the

crystal surrounded by metal filings. While this type does hold up for awhile, all ever used went bad sooner or later.

A good type is shown in the drawing and consists of a cup in which a piece of metal is embedded with a solid piece of wire touching the crystal, firmly but lightly. The wire should be of a metal that will not corrode and the crystal should be covered up so as to be dust-proof. The entire outfit is not any larger than the circumference of a halfpenny and about three-eighths of an inch high. The one the writer has referred to has been in constant use since the first of the year, and only on one occasion was it ever touched for readjustment and then the wire was merely moved a fraction with a small penknife.

The less you handle a crystal the better it will be, for no matter how clean you think your fingers are, they will leave a film on the surface of the crystal which may stop energy from coming through and being rectified. The difference between a poor crystal and a good one is its ability to allow current to pass in one direction better than in the other.

AN APPRECIATION.

ONE of the wide circle of readers of "RADIO"—Mr. A. E. Williams, of Balwyn, Melbourne, Victoria—has written to the Editor as follows:—

Dear Sir,—

On Friday, August 8, I purchased your edition of "RADIO" of August 6, and was very much taken by the one-valve set that you described, so I purchased the necessary parts and put it together. On Tuesday night following I listened to a very good programme from 3AR.

Hoping that others who tried this circuit have as good results,

I am, Yours faithfully,

(Signed) A. E. WILLIAMS.

Ormond's Components

for the Home Constructor —

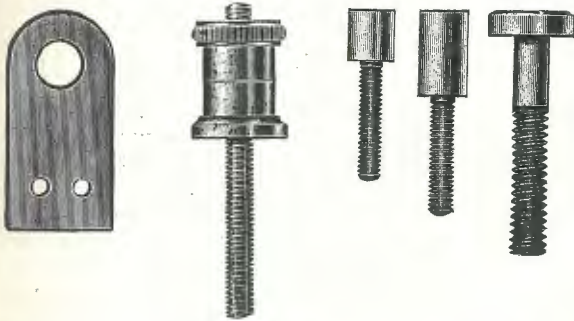

SPECIALY designed, and made throughout with particular care. In every case the finished product is subject to rigid inspection, thereby guaranteeing perfect working and satisfactory results to all users of Ormond's Components — they are British made.

The quality is high ————— the price is low.

ASK YOUR DEALER FOR ORMOND'S COMPONENTS!

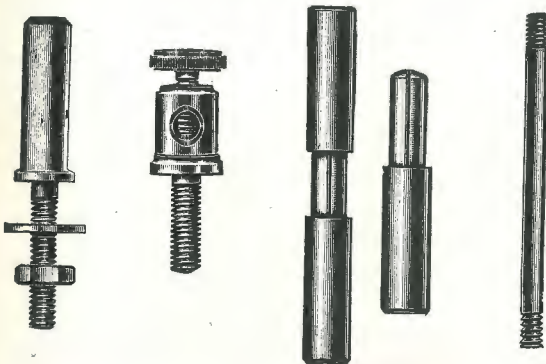

ORMOND

Engineering Co.

199 Pentonville Road,
KING'S CROSS, LONDON, ENGLAND.

BOX OF COMPLETE CONDENSER PARTS.

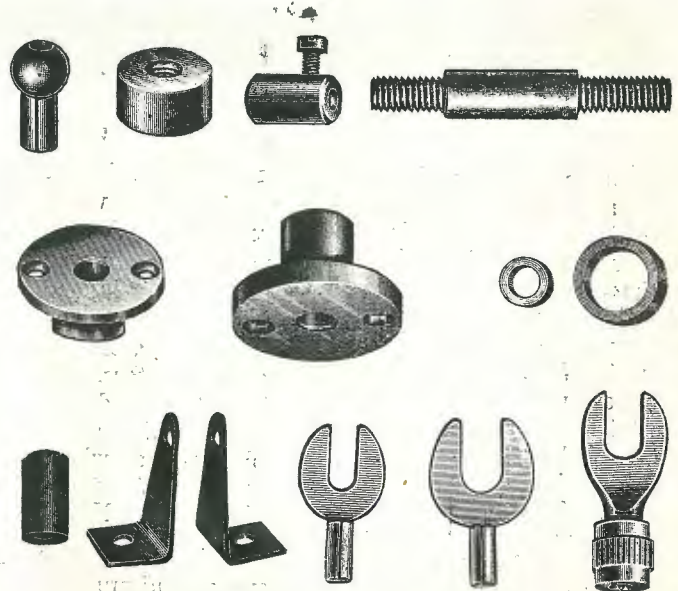
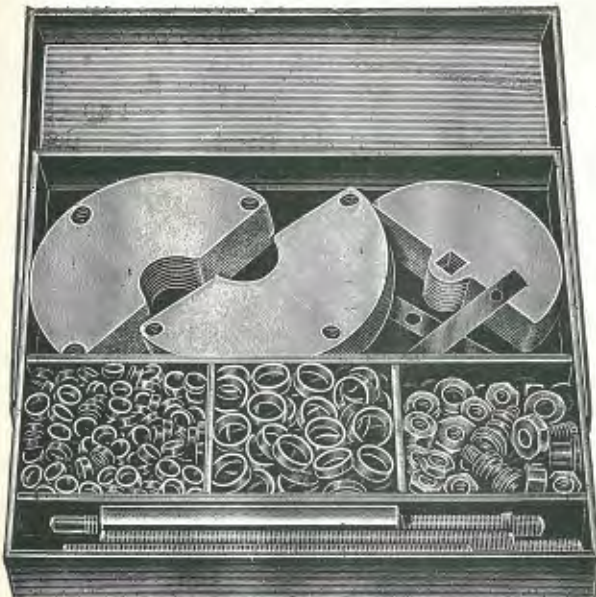

Amateur Radio Station 2ZO



SITUATED near South Grafton, and beside the North Coast Railway, about 285 miles air line from Sydney is Radio 2ZO owned and operated by T. R. Willmot. Viewed from the train, the aerial system forms a prominent sight. The aerial is a twin "T" type on 6ft. spreaders, 50 feet high and 150 feet long. Earth connection is to a plate of galvanised iron buried about 3ft. in the ground. Practically all the apparatus at 2ZO is home-made, with the exception of

was made, and, after trying out a number of different circuits, it was found that for a single valve, the standard three-coil circuit with slight modifications gave the best results. This set is now kept as a standard for comparative test with other experiments.

In this set, only one variable condenser is employed, and that is for tuning the secondary inductance. A primary condenser was tried at first, but was later dispensed with as no appreciable benefit was gained by its use. The valve used is a "Radio-

The long panel at back of photo carries the spark transmitter, the oscillation transformer being mounted in the centre. The standard inductively coupled circuit is used, but experiments are at present being carried out with a circuit described by Mr. J. G. Reed in a recent issue of *Radio*. (Needless to say, a copy of the experimenter's favourite magazine holds a prominent position in the photo.) The small panel is being arranged to control this set which will receive its high tension supply from the spark coil. Three transmitting keys are shown, one is used for spark, one for I.C.W., and the third for buzzer practice. As the range of the spark set is limited, it is 2ZO's intention to "punch some holes" through the ether, in an endeavour to raise some QSL's from Sydney "fans" with I.C.W. Look out for him!

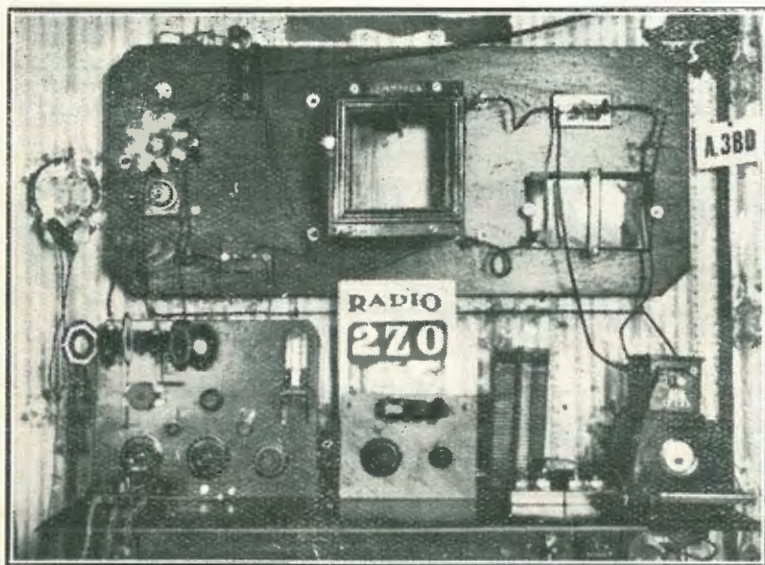

2ZO.

valve, knobs and dials, and 'phones. 2ZO commenced experimenting early in 1911 and later joined the Wireless Institute of N.S.W., being one of the pioneer members of that body, holding a transmitting and receiving licence until the outbreak of war in 1914. When restrictions were lifted, experiments were continued with crystal receivers, and some good DX was carried out.

On one occasion, signals from Colombo Radio (VPB) were heard, and the reception was subsequently confirmed by a letter from the officer-in-charge of that station.

With the advent of the valve, entirely new experimental apparatus

tron WD 11," worked off a two-volt accumulator with suitable filament resistance. A novel grid condenser, made from two sheets of tin-foil mounted on hinged plates gives good results. The capacity is varied by means of a fine screw. Among the experimenters, 2ZO has logged 14 from the 3rd district (including 3BD, whose QSL card can be seen in the photo, and whose sigs. are QSA; two in S.A., two in Q. and two in N.Z. besides N.Z. 1YA).

Before KGO increased his power, speech and music from him was heard on four occasions at good strength in the 'phones.

RADIO 1AO.

TWO very pleasing letters have recently been received by Mr. Russell White, of 1AO (N.Z.), which point to a very creditable performance as his signals have been picked up by two American amateurs on three different occasions. 9EFU reports that he picked up 1AO on December 19, 1923, at 2.15 a.m., Central States time, while that well-known station 6CGW writes that he logged Mr. White on July 6 and 19 at 2.15 a.m., Pacific Coast Time. A description of Radio 1AO appeared in *Radio*, No. 37, and in view of the power used, Mr. White has every reason to be justly proud of the performance of his fine little transmitter. A low loss tuner is now used for reception and very fine results are being obtained with it. Up to date, over 520 different American amateurs have been copied. An interesting report is given by Mr. W. H. Dowson, of Kaiwaka, North Auckland, who receives KGO, 2BL, and several other long distance stations, using only three WD11 dry cell tubes, one notable point being that he claims no fading is experienced at all.

Knowledge Fascinates

OF the thousands of amateurs who have taken up Wireless only a negligible number have rested content after having simply bought or made their set. All seek further enlightenment than is necessary to light the valves or to find the sensitive spot on the crystal. This information is sought from books or/and journals. Authentic and reliable books such as are published by the Wireless Press, are invaluable, but a journal is also a necessity. The premier British wireless journal is

The Wireless World and Radio Review

Price 9d.

Every issue of this weekly contains information both for the veriest amateur and the advanced experimenter, and it also caters for those who place themselves between these categories. Sets are described and current news of interest to wireless enthusiasts is given. A useful section to all is the readers' queries pages.

"The Wireless World" is obtainable from most newsagents.

THE WIRELESS PRESS.

Sydney: 97 Clarence Street.
Melbourne: 44 Market Street.
Wellington, N.Z.: Australasia Chbrs.

THE THERMIONIC VALVE AND ITS DEVELOPMENT IN RADIO TELEGRAPHY AND TELEPHONY

(By J. A. FLEMING, M.A., D.Sc., F.R.S., Etc.)

THIS is a revised and largely re-written edition of Dr. Fleming's book of the same title, which appeared in 1919, having the added interest and prestige of coming from the pen of the man who made the pioneer invention upon which practically all recent advances in Radio depend. The scope of the work is perhaps best indicated by the chapter headings:— 1, Scientific Principles; 2, the Fleming Rectifying Valve; 3, the Three and Four Electrode Valves; 4, the Theory of the Three Electrode Valves; 5, Thermionic Valve Construction; 6, the Thermionic Valve as a Generator of Oscillations; 7, Thermionic Valves as Amplifiers and Detectors; 8, Thermionic Valve-testing; 9, Thermionic Repeaters and Relays, and 10, Thermionic Plant. The book is of 440 pages, and contains also 280 figures and illustrations. (Wireless Press: Price, 18/-.)

NEW ADDRESS.

MESSRS. HENRY G. SMALL & COMPANY, Victorian Agents for Messrs. L. P. R. Bean & Company, Ltd., of Sydney, have recently changed their address. Readers will please note that the new address is—Henry G. Small & Company, "Melbourne House," 360 Post Office Place, Melbourne.

We are Sole Agents for

"ASHCOY"

Brand Best British Polished

Ebonite Panels

FOR RADIO WORK.

Each packed in a sealed envelope. Stocked in all the standard sizes for crystal and valve sets. Edges ground true to size.

ASK YOUR RADIO DEALER

Full Stocks of British Ebonite Sheets, Rods and Tubes.

WHOLESALE ONLY.

A. S. HARRISON & COMPANY,

'Phone: 5-7 Barrack Street, P.O. Box
B 4574. SYDNEY. 2591.

Sacrystal

THE MOST SENSITIVE
WIRELESS
DETECTOR!

Sacrystal

is a local product of the
New South Wales
Molybdenite Mines of
Miss P. Sachs, of
Randwick, Sydney.

There are no sensitive
SPOTS—it's all sensi-
tive!

Sacrystal

is obtainable at all the
leading
Wireless Dealers.

PRICE: 1/6 per Box.

2AJ Short, W., Queenscliff Road, Manly.
 2AL Cooper, A. E. C., "Edale," Cecul Street, Ashfield.
 2AR Hudson, W. H., 1 Terrace Road, Dulwich Hill.
 2AS Grigg, H. E., 370 Military Road, Mosman.
 2AT Swinburne, E. C. R., 39 Parkview Road, Manly.
 2AY Curston, J. C., "Maruna," Burwood Road, Burwood.
 2BB Crocker, E. B., 14 Roseby Street, Marrickville.
 2BC Hurl, N. J., "Strathcona," Northcote Avenue, Killara.
 2BF Forsythe, L. E., Sailor Bay Road, Northbridge.
 2BK Leverrier, F. N., "Lorette," Wentworth Road, Vaucluse.
 2BM Vears, E. T., "Pipitea," Cross Street, Leura.
 2BV Waverley Amateur Radio Club, 42 Evans Street, Waverley.
 2BY Arnold, E. C., Carthage Street, Tamworth.
 2CA Bonwill, E. W., Cowra.
 2CH Henry, C. H., Bridge Street, Uralla.
 2CI Charlesworth, R. H., 173 Parramatta Road, Haberfield.
 2CJ Sewell, P. L. H., 12 Dillon Street, Paddington.
 2CL Caletti, G., 114 Baptist Street, Redfern.
 2CM Maclurcan, C. D., "Namunula," Agnes Street, Strathfield.
 2CR Todd, L. V. G., Dennison Street, West Tamworth.
 2CS Swain, L. T., 49 Everton Street, Hamilton.
 2CW Beer, J., 42 Thomas Street, Ashfield.
 2CX Stowe, H. A., "Rawane," Royal Street, Chatswood.
 2CY Parker, P. S., 12 Weldon Street, Burwood.
 2CZ Exton, G. W., Lismore.
 2DE Renshaw, R. P., "Waimea," Lord Street, Roseville.
 2DH Mawson, E. R., "Daisydale," Wonga Street, Campsie.
 2DJ David Jones Ltd., 22 York Street, Sydney.
 2DK Whitburn, R. P., 7 Hatheon Street, Leichhardt.
 2DN Blanchard, G. E. H., 60 Bligh Street, Newtown.
 2DS Davis, R. R., Fisher Avenue, Vaucluse.
 2EC Gorman, C. A., 31 Scgenhee Street, Arncliffe.
 2ED Gregory, H. R., "Gerrobbar," Walton Crescent, Abbotsford.
 2EM Moore, E. J. T., 6 Lower Wycombe Road, Neutral Bay.
 2FA Colville, S. V., 10 Rowe St., Sydney.
 2FB Bishop, F. E., 7 Ellamang Avenue, Kirribilli.
 2FF Western Suburbs Radio Association, 77 Park Road, Auburn.
 2FP Baker, E. J., 62 Estell St., Marysville.
 2FS Smith, A. C., 38 Cheltenham Road, Croydon.
 2GC Challenger, G. R., 77 Park Road, Auburn.
 2GF Chilton, G. F., Radio Station Enclosure.
 2GM Cutts, G. M., "Carwell," Highbury Street, Croydon,



NEW SOUTH WALES.

2GP Mackay, C. S., Urunga.
 2GQ Barlow, E., Faulkner St., Armidale.
 2GR Marks, J. S., Ritz Flats, Salisbury Road, Rose Bay.
 2GU Dunn, R., 324 Anzac Parade, South Kensington.
 2HB Botton, H. W., 350 George Street, Sydney.
 2HF Thompson, F., 12 Pearson Street, East Balmain.
 2HH Wireless Institute, N.S.W. Division, 82 Pitt Street, Sydney.
 2HM Marshall, H. A., Allingham Street, Armidale.
 2HS Fagan, R. J., Sunny Ridge, Mandurama.
 2HY Bongers, G. S., "Marmora," Rawson Street, Rockdale.
 2IJ Gray, A. H., Florence Street, Killara.
 2IN Payne, J., 143 Avoca Street, Randwick.
 2JC Fraser, H., Roderick St., Tamworth.
 2JI Wilson, W. A., Archbold Rd., Roseville.
 2JM Marsden, R. C., Victoria Road, Edgecliffe.
 2JS Stanley, J. M., Northcote Street, Crow's Nest.
 2JT Luckman, C., 14 Queen Street, Croydon.
 2KC Fry, R. H., Brighton St., Croydon.
 2LF Ginger, L. V., 93 Middle Head Road, Mosman.
 2LO Schultz, L. N., "Waraba," Burns Bay Road, Lane Cove.
 2LR Lismore and District Radio Club, (R. H. Atkinson), 12 Park Street, Ashfield.
 2LY Shaw, R. H., 129 Grafton Street, Woollahra.
 2MA Amalgamated Wireless Ltd., 97 Clarence Street, Sydney.
 2MB Amalgamated Wireless Ltd., 97 Clarence Street, Sydney.
 2MC Amalgamated Wireless Ltd., 97 Clarence Street, Sydney.
 2MD Amalgamated Wireless Ltd., 97 Clarence Street, Sydney.
 2MJ Newman, W. H., Cooney Road, Artarmon.
 2MR Stewart, J. E., Carrick Street, Mayfield, Newcastle.
 2MU Nangle, J., Tupper St., Marrickville.
 2OI Whitaker, A. T., 31 Railway Crescent, Banksia.
 2QY Williams, E. A., Crown Street, Wollongong.
 2RA Vickery, K. J., Kilbridge Street, Hurlstone Park.
 2RY Volkman, Reg. V., Post Office, South Grafton.
 2SO Newcastle Radio Club, 25 Winship Street, Hamilton.
 2SP Evans, R., "Carth Craig," 6 Flood Street, Clovelly.
 2SS Wright, A. E., Main Street, Scarborough.

2SX Slade, H. C., "Rockleigh," Lang Street, Croydon.
 2ST Tatham, S. E., "Kulmura," 72 Thrupp Street, Neutral Bay.
 2TS Gill, A. W., "Illaroo," Greengate, Killara.
 2UI Illawarra Radio Club, 75 Montgomerie Street, Kogarah.
 2UR Creamer, A. H., 10 Hereford Street, Glebe Point.
 2UU Roberts, R. G. C., 9 Church Street, Ashfield.
 2UW Sandel, O., Mooramie Avenue, Kensington.
 2VM Derrick, V. M., 3 Birriga Road, Bellevue Hill, Woollahra.
 2VX McIntyre, D. G., Livingstone Avenue, Pymble.
 2WU Morley, W. H., Rangers Avenue, Watersleigh.
 2WV Burgin Electric Co., 352 Kent St., Sydney.
 2XA James, H. K., 12 Rosemount Avenue, Summer Hill.
 2XI Craig, W. A., 11 Rockleigh Street, Croydon.
 2XX Mingay, O. F., Kuring-gal Chase Road, Turramurra.
 2YA Haynes, B. L., Sumarez Station, Armidale.
 2YB Croydon Radio Club (Cutto), Land Street, Croydon.
 2YC Crawford, C. T., 18 Lindsay Street, Burwood.
 2YE Manly and District Radio Club (Swinburne), Wentworth Street, Manly.
 2YF Clarke, F. P. R., "Winona," Lauderdale Avenue, Manly.
 2YG Allsop, R. C., "Moondah," Bent St., Lindfield.
 2YH Hannan, W. E., 449 Darling Street, Balmain.
 2YI Nolan, P. S., 152 Bellevue Road, Double Bay.
 2YJ Sainsbury, R. E., "Kermanshah," Wallaroy Road, Concord West.
 2YK Olsen, N. P., 18 Hunter Street, Newcastle.
 2YL Lendrum, A., 220 Doncaster Avenue, Kensington.
 2YM Scott, J. L., 80 Hunter St., Sydney.
 2YN Thomas, C. P., 71 Nelson Street, Annandale.
 2YP Bergin, M. W., "Keera," West Maitland.
 2ZA Keagh, W. G., 24 Harrow Rd., Stanmore.
 2ZB Balmain District Radio Club, 29a Ballast Road, Balmain.
 2Z Lavington, E. M. E., Bennet Street, Bondi.
 2ZD Brain, S. F., 85 Bland Street, Ashfield.
 2ZE Laker, F. J. F., Harffleur Street, Deniliquin.
 2ZH New System Telephones Co., 280 Castlereagh Street, Sydney.
 2ZI Dixon, R. H., c/o. C.S.R. Co., Congong, Tweed River.
 2ZJ Simpson, A. W., Duri.
 2ZK Marsh, S., Carrington Street, West Wallsend.
 2ZL Otty, W., Killingworth.
 2ZM Deane, P. M., Clarence St., Burwood.
 2ZN Cottrell, J. W. M., 23 Dolphin Street, Randwick.

(Continued on page 366.)



FOR £19/10/-

COMPLETE

2-Valve Set

Two-Valve Set "made by David Jones" from high-class materials. Comprises regenerative circuit, with audio-frequency amplification, enclosed in handsome Rosewood Cabinet. Complete with 2 201A Radiotron Valves, 4-volt Accumulator, 1 B. Battery, 1 pair 'Phones, Aerial Wire and Insulators. Price **£19/10/-**

DAVID JONES'

RADIO DEPARTMENT,
252 YORK STREET,
SYDNEY.

FOR SALE

One Pair T.M.C. (New Systems) HEAD-PHONES (4000 ohms). These have been hardly used, and are in excellent condition. Cash price, 30/-. Apply
The Associate Editor, "Radio,"
87 Clarence Street, Sydney.

A New Valve *that saves you money*

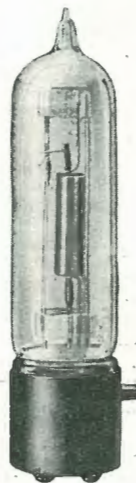

Numerous Radio enthusiasts in Australia have for some time heard of the wonderful results and economy of the

WECOVALVE

Western Electric Co. (Aust.) Ltd., having completed their arrangements for the supply of these valves throughout Australia desire to inform the public that Wecovalues are obtainable from their regular radio dealer.

The Wecovalve stands in a class by itself
It is entirely free from Microphonic Noises

The world renowned oxide coated filament as used in the manufacture of the most expensive Western Electric valves is also employed in the construction of the Wecovalve thereby ensuring a phenomenally long life and an efficiency equal to the very best of high temperature valves.

It is essentially an all-purpose valve and can be used

either as a detector or amplifier. A single dry cell only is required for filament heating.

Suitable sockets to mount Wecovalues are available, or adapters can be supplied which enables you to fit them to any standard British socket.

Further particulars from your regular radio dealer or direct from

Western Electric Company
(Australia) Ltd.

192-194 Castlereagh Street, Sydney

Phones: City 356 and 366

TRY CAMPSIE FIRST!

Whether you want a screw or a super-set you will find the quality and prices right. Some of my Specialities are:—

TRIMM'S DEPENDABLE 'PHONES at 32/6; and
RADIOTRON VALVES (201A and 199) at 35/-

VICTOR MARKS' Radio House

BEAMISH STREET, CAMPSIE (next Campsie Street).

POSTAGE PAID ON ALL GOODS.

- 2ZR Perdiau, W. J. S., 47 East Esplanade, Manly.
 2ZT Bean, L. P. R., 86 Muston Street, Mosman.
 2ZU Gilmour, N. G., 156 Kurraba Road, Neutral Bay.
 2ZV Universal Electric Co., 19 Royal Arcade, Sydney.
 2ZW Huggins, D. R., 13 Yeo Street, Neutral Bay.
 2ZX Olsen, N. P., "Normanhurst," Macquarie Street, Waratah.
 2ZY Sidey, R. L., Highfield St., Lindfield.
 2ZZ Smith, C. P., 83 Cabramatta Road, Cremorne.
 2ZFI Newtown District Radio Club (Celtic), 83 King Street, Newtown.
 2ZGT McIntosh, R. E., Burn's Bay Road, Lane Cove.

VICTORIA.

- 3AB Weatherson, W. A., 23 Melby Av., E. St. Kilda.
 3AG Gurr, A. F., 224 McKillop Street, Geelong East.
 3AM Dohrmann, G. S., 2 Hopetoun Avenue, Canterbury.
 3AP Morris, R. D., 6 Bealiba Road, Caulfield.
 3AU Milligan, S. H., 117 Autumn Street, Geelong.
 3AY Jenvy, W. W., 12 Lord Street, East Caulfield.
 3BC Brighton Radio Club (R. P. Whalley), Wilson Hall, Brighton.
 3BD Cox, E. H., 5 Gibson Street, Elsternwick.
 3BG Osborne, L., Terang.
 3BH Whitelaw, C. R., Mooroolbark.
 3BK Cumming, W. H., 57 Kooyong Road, Armadale.
 3BL Fitchett, J. C., Salisbury Street, Balwyn.
 3BM Love, H. K., "Lindum," Ferncroft Avenue, East Malvern.
 3BP Hood, J. H., 6 Alexandra Street, East St. Kilda.
 3BQ Howden, W., Hill Street, Box Hill.
 3BU Conelly, D. A., "Larnokk," Balaclava Road, East St. Kilda.
 3BY Holst, H., 27 Bamba Rd., Caulfield.
 3CA Dorward, W. H., 44 Orlando Street, Hampden.
 3CB Sievers, W. F., 30 Leaney Street, East Richmond.
 3CC University of Melbourne, Melbourne.
 3CD Corbett, Derham & Co., Pty., Ltd., (R. F. Hall), 573-585 Lonsdale St., Melbourne.
 3CH Clarke, F. W., 165 Cardigan Street, Carlton.
 3CP Philpott, C. H., 16 Glenleith Avenue, Geelong.
 3DB Hobart-Duff, 27 Westgarth Street, East Malvern.
 3DD Osborne, L. F. G., "Louisville," Darling Road, East Malvern.
 3DF Short, F. D., 2 Mozart Street, East St. Kilda.
 3DL Fells, L. C., North Road, Caulfield.
 3DM Chambers & Co. (N. Culliver), 57 Simpson Street, East Melbourne.
 3DV Beattie, H. S., 1 Bishop St., Box Hill.
 3DX Van Cooth, J. R., Wattletree Road, East Malvern.
 3EC Y.M.C.A. Amateur Wireless Society, Cr. Short and High Sts., Bendigo.
 3EL Boyd, N. J., 100 Orrong Road, Elsternwick.
 3EM Doudney, H. W., Holy Trinity Vicarage, 7 Dickens St., Balaclava.
 3EN Leonard, A. B., Drouin.
 3EP Givens, J., 19 Logan Street, Canterbury.
 3ER Rivers, E. R., St. Kinnord Street, Essendon.
 3FA Abrahams, F., c/o. Mrs. Solomons, Murphy Street, South Yarra.
 3FH Hall, R. F., Glindabourn Avenue, Toorak.
 3FM Decrespyny, R. C., 20 Black Street, Middle Brighton.
 3GB Glover, M. A., 24 Victoria Road, Camberwell.
 3GH Hale, W. M., "Ben Nevis," Harvey Street, Essendon.
 3GI Creswell, Commander F. G., 2 Balmoral Avenue, East Kew.
 3HE Kruger, F., Camp Street, Carlton.
 3HH Maughan, F. H., 15 Staniland Av., Malvern.
 3HQ Good, E. J., "Rock Grove," Private Mail, Glenrowan.
 3II Miles, G. T., Highfield Road, East Camberwell.
 3JD Dane, J. E., Toorak Rd., Hawthorn.
 3JH Holland, F. H. J., "Cotswold," St. Kinnord Street, Essendon.
 3JP Mitchell, H., Kean Street, Caulfield.
 3JR Dunstan, W. J., 7 Cameron Street, Ballarat East.
 3JU Hull, R. A., 38 Charnwood Road, St. Kilda.
 3JZ Whalley, R. P., "Enmore," Bridge Street, Sandringham.
 3KF Harkin, D. J., 68 Hardiman Street, Kensington.
 3LM Malvern District Branch Wireless Institute (E. J. Masters), 16 Sutherland Road, Armadale.
 3LQ Downey, W. E., Hopkins House, Hopkins River, Warnambool.
 3LS Busch, R. T., 30 Wordsworth Street, Moonee Ponds.
 3MA Amalgamated Wireless Ltd., 422 Little Collins St., Melbourne.
 3MC Amalgamated Wireless Ltd., Canterbury.
 3MD Amalgamated Wireless Ltd., in the vicinity of Melbourne.
 3ME Amalgamated Wireless Ltd., in the vicinity of Melbourne.
 3MF Amalgamated Wireless Ltd., in the vicinity of Melbourne.
 3MP Hosken, S. V., 42 Melville Street, Hawthorn.
 3NN Brown, H. R., Yanac.
 3NS Norris and Skelley, 211 Elizabeth Street, Melbourne.
 3OK Conry, W. H., 32 Irving Avenue, Armadale.
 3PJ Smyth, B. L., 10 Keera Street, Geelong West.
 3PO Roberts, A. H., 103 Bent Street, Northcote.
 3QW Muir, J. A., 10 Young St., Brighton.
 3RF Cordingley, C. H., 77 Bank Street, E. Ascot Vale.
 3RG Homberg, S. G., Waverley Road, E. Malvern.
 3RY Wilson, W. A. G., 4 Webster Street, Ballarat.
 3SJ Mitchell, S. J., 5 Brandon Street, Brighton.
 3SK Short, O., 10 Redan St., St. Kilda.
 3SL Southwell, L. W., c/o. Mrs. Neal, High Street, Seymour.
 3SM Gay, A. H., Warragul.
 3SW Gadsden, S. W., 5 Miller Grove, Kew.
 3TK Kinsella, T. W., Mayo Park, Lubeck.
 3TM Buck, A. H., 750 Glenhantly Road, Glen Huntly.
 3TU Leckie, R. C., Bamfield Street, Sandringham.
 3UI Dalton, R. M., San Mateo Avenue, Mildura.
 3UX Steane, G. W., Earle Street, Mont Albert.
 3UY Oliver, J. Nilsen, 90 Tyrie St., Geelong.
 3UZ Oliver, J. Nilsen, 45 Bourke Street, Melbourne.
 3VR Abbot, R. N., "Fleu-de-lis," St. Elmo Avenue, Alphington.
 3VS Philpott, O. J., 26 Lumeah Road, Caulfield.
 3WT Tressider, W. L., 13 Nettle Street, Bendigo.
 3XC Xavier College (Rev. Baker), Kew.
 3XF Chaffer, M., 41 Norwood Crescent, Moonee Ponds.
 3XN Leaney, W. G., 12 Henry Street, Northcote.
 3YA Geelong Wireless Club, Guild Hall, Myers Street, Geelong.
 3YW Edgar, J. M., 12 Henry Street, East Geelong.
 3YY Bush, A. M., 54 Brougham Street, Bendigo.
 3YZ McKeown, A., 54 Yarra Street, Alphington.
 3ZA Bardin, W. F., 226 Station Street, North Carlton.
 3ZC Brock, H. E. E., 8 Ngarveno Street, Moonee Ponds.
 3ZD Taylor, C. F., 133 High St., Kew.
 3ZE McGregor, K. W. A., 23 Molesworth Street, Armadale.
 3ZI Barbour, K. H., 1 Irving Avenue, Armadale.
 3ZJ Lempriere, C. L., Terrara Road, Vermont.
 3ZK Bradley, P. R., Beach Crescent, Sandringham.
 3ZL New System Telephones, 25-27 Queens Bridge Street, South Melbourne.
 3ZM Owen, C., 22 Kendall Street, South St. Kilda.
 3ZN Israel, M. S., 53 Blessington Street, St. Kilda.
 3ZO Johnson, E. H., 105 Moorabool St., Geelong.
 3ZP George, H. A., 195 Ballarat Road, Footscray.
 3ZQ Ballarat Radio Club (J. Matthews), Y.M.C.A., Ballarat.
 3ZR Snaith, S. L., 1 Byron Street, Footscray.
 3ZS McMahon, G., Edinburgh St., Diamond Creek.
 No. 2430 Kells, A. C. E., 366 Ascot Vale Road, Moonee Ponds.

QUEENSLAND.

- 4AC Waters, L., Rankin St., Innisfail.
 4AE Wireless Institute (Queensland Division), Edward St., Brisbane.
 4AK Milner, J., "Beswick," Kelvin Grove, Brisbane.

(Continued on page 368.)

INSURE WITH

The Liverpool and London and Globe Insurance Co. Ltd.

ASSETS EXCEED £20,000,000.

LOWEST RATES.
FIRE — ACCIDENT — MARINE

Head Office for Australasia:
62 PITT STREET, SYDNEY.

W. B. CLARKE, Local Manager for N.S.W.

C. DANVERS, Manager for Australasia.

Melbourne Branch:
415-7 COLLINS STREET.

R. M. EVANS, Local Manager for Victoria.

T. M. DOUGLAS, Deputy Assistant Manager for Australasia.



STROMBERG-CARLSON

SUPER No. 2-A Radio Headset SENSITIVE

£2/5/-.

Why buy a cheap inferior set when you can obtain a high efficiency No. 2-A at half the cost of an equal set? It is built by Telephone Manufacturers of 30 years' standing. **DURABLE, COMFORTABLE, ACCURATELY REPRODUCES VOICE and MUSIC.** Permanent adjustment, unaffected, by climatic and temperature changes. Also **RADIO PLUGS and JACKS; MICROPHONES, all types.**

Ask your dealer or write us direct.

Aust. L. P. R. BEAN & CO. LTD., 229 Castlereagh St., Sydney Reps.

Interstate:—**BRISBANE:** S. H. Smith, Radio House. **ADELAIDE:** Chas. Atkins & Co.
PERTH: T. Muir & Co., 99 William Street. **MELBOURNE:** Henry G. Small, "Melbourne House,"
 360 Post Office Place. **HOBART:** J. A. Cooper, 90 Harrington Street.

"The Theatre, Society and Home"

LIKE WIRELESS IT TOUCHES ALL PARTS OF THE WORLD

After Reading Please Pass on to a Friend. Larger Circulation Means More Advertisements :: More Advertisements Mean Extra News, Pars, and Home Chatter.

PUBLISHED MONTHLY. SOLD BY ALL BOOKSTALLS.

HEAD OFFICE: 16 BOND STREET, SYDNEY.

Branches: 100 King St., MELBOURNE; 75 Elizabeth St., BRISBANE; 32 Waymouth St., ADELAIDE.

RADIO DEALERS! THIS MAGAZINE IS THE ONLY ONE OF ITS KIND IN THE COMMONWEALTH AND NEW ZEALAND. EACH ISSUE IS EAGERLY AWAITED AND READ BY "LISTENERS-IN," BROADCASTING COMPANIES, AMATEURS, EXPERTS, AND ALL CONNECTED WITH WIRELESS ACTIVITIES. THEY ARE ALL PROSPECTIVE PURCHASERS. GET IN TOUCH WITH THEM BY ADVERTISING IN "RADIO."

WRITE FOR RATES AND ALL PARTICULARS TO THE MANAGER, THE WIRELESS PRESS, 97 CLARENCE STREET, SYDNEY.

- 4AN Gibson, E. McL., Kirkland Avenue, Greenslopes, Brisbane.
- 4AU Finney, M., Arthur Terrace, Red Hill, Brisbane.
- 4BI Junction Park Radio Club, "Carlisle," Long Street, Fairfield.
- 4BO Odgers, N. F., Anne Street, Charters Towers.
- 4BW Cooper, A., Jr., Byrne Street, Mareeba.
- 4CC Isles, C. W., Charlton Street, Ascot, Brisbane.
- 4CG Stephens, A. N., Railway Parade, Clayfield, Brisbane.
- 4CH Dillon, A. E., Brown Street, New Farm.
- 4CK Norris, E. L., Hume Street, Toowoomba.
- 4CM McDowall, V., Preston House, Queen Street, Brisbane.
- 4CS Geraghty, J. A., St. Joseph's College, Nudgee.
- 4CV Husband, N. C., Aland St., Charters Towers.
- 4EG Gold, E. E., Lindsay Street, Toowoomba.
- 4EH Miller, H., "Broadway," Kitcheners Road, Ascot.
- 4EI State Engineer (J. W. Sutton), G.P.O., Brisbane.
- 4EZ Queensland Institute of Radio Engineers, Bowen Terrace, New Farm.
- 4FA Wright, W. H. H., Hume Street, North Toowoomba.
- 4FE Y.M.C.A. (A. L. Hinds), Edward St., Brisbane.
- 4FJ Price, J. C., Bardin Estate, Paddington Heights.
- 4FK Matthews, F. T., 57 Annie Street, New Farm.
- 4GC Maryborough Wireless Club (T. T. McCoy), Richmond Street, Maryborough.
- 4GE Fortescue, C., Arthur Street, Toowoomba.
- 4GF Fortescue, C., Arthur Street, Toowoomba.
- No. 1217 Hobler, H. L., Lennox Street, Rockhampton.

SOUTH AUSTRALIA.

- 5AC Cook, J. R. P., 37 Johns Road, Prospect.
- 5AD Snoswell, A. R., Harris St., Exeter.
- 5AE Honnor, J. H., Alpha Rd., Prospect.
- 5AH Williamson, F. L., 25 Dequetteville Terrace, Kent Town.

- 5AI Lloyd, H. B., 16 Trinity Street, College Town.
- 5AQ Brother Joseph, Sacred Heart College, Glenelg.
- 5AV Wireless Institute (S.A. Division), 20 Grange Road, Hindmarsh.
- 5BF Miller, F. G., Murray Bridge.
- 5BG Kauper, H. A., 20 Gurney Street, Dulwich.
- 5BN Bald Motor and Electric Works (E. A. Cooper), 31 Pulteney Street, Adelaide.
- 5BP Caldwell, W. A., 53 Hughes Street, Unley North.

DOMINION BROADCAST STATIONS.

THE following New Zealand stations broadcast regular entertainments:—

Auckland: 1YA and 1YB on 330 metres.

Wanganui Radio Club: 2AH, on 155 metres.

Gisborne Radio Club: 2YM, on 335 metres.

Wellington Associated Wireless Traders, 2YK, on 300 metres.

British Electric and Engineering Co., Dunedin, 4YA, on 370 metres.

Programmes are sent as follows:

Monday: 2YM, 1YB.

Tuesday: 1YA, 2YK, 2AH, 4AB

Wednesday: 1YA, 4YA.

Thursday: 1YA, 2YK.

Friday: 1YA, 2YK, 4AB.

Saturday: 1YB, 2AH, 2YM, 4YA.

Sunday: 1YB, 2YM, 2YK, 4YA.

- 5BQ Jones, L. C., Carlisle Road, Westbourne Park.
- 5CN Sagar, E. N., Railway Terrace, Largs Bay.
- 5DA Buckerfield, S. R., 4 Regent Street, Parkside.
- 5DN Jones, L. C., 146 Rundle St., Adelaide.
- 5DO St. Peters College Radio Club (F. B. Oldfield), St. Peters College, Adelaide.
- 5FT Fitzmaurice, J. S., St. Andrews St., North Walkerville.

- 5GB Bailey, G., Commercial St., Mount Gambier.
- 5HR Rhodes, N., 12 Goyden St., Kadina.
- 5RB Bedford, R., Cottage Hospital, Kyancutta.

WESTERN AUSTRALIA.

- 6AB Cecil, C., 75 Duggan St., Kalgoorlie.
- 6AC Spark, J., 23 Mount St., Perth.
- 6AF Sibly, A., Third Avenue, Inglewood.
- 6AK University of Western Australia, Perth.
- 6AM Kennedy, P., 210 Walcott Street, Mount Lawley.
- 6AQ Matthews, V. J., Beachboro Road, Bayswater.
- 6BB Park, J. C. W., 29 Suburban Rd., South Perth.
- 6BG Technical School (W. G. Hayman), Perth.
- 6BH Burrows, F. H., 9 John St., Claremont.
- 6BP Stotts Business College, 81 Georges Terrace, Perth.
- 6BR Wireless Institute (W. A. Division), Central Fire Station, Perth.
- 6CJ Darley, E. J., Darley Street, South Perth.
- 6DA Saw, F. W., Cr. Bedforddale and Benbury Roads, Armadale.
- 6DY Thomas, H., 26 Third Avenue, Inglewood.
- 6WP Phipps, W. R., 97 Rupert Street, Subiaco.

TASMANIA.

- 7AA Watkins, W. T., 146 Warwick St., Hobart.
- 7AB Smith, A. C., "Beulah," 21 High St., Launceston.
- 7AK Deegan, S. E., St. Virgils College, Hobart.
- 7AL Scanlon, W. L., 37 Hill Street, West Hobart.
- 7AQ McCabe, W. B., Clarence Point, West Tamar.
- 7AR Johnson, C. F., 33 Hill Street, West Hobart.
- 7BE Stipek, J., St. Helens Hotel, St. Helens.
- 7BN Wills & Co., Pty., Ltd., (A. Smith), 65 George Street, Launceston.
- 7BX Preston, T. A. C., Railway Row, Queenstown.
- 7FP Philbin, F. T., Box 29, Queenstown (Orr Street).
- 7OM O'May, R. D., Elouera Esplanade, Bellerive.

Unlicensed Receiving Sets

THE Postmaster-General's Department expresses surprise that a number of users of wireless receiving apparatus have so far failed to obtain Broadcast Listeners' Licenses and are continuing to make use of their sets illegally.

It will be realised that the merits of a broadcasting programme are directly influenced by the income of the Company licensed to undertake the work; and those users of wireless receiving apparatus who

are operating illicitly are not only pirating on the Companies concerned but are preventing those who are honourably fulfilling their obligations from reaping the benefits which should accrue were all listeners paying their just contribution.

GREAT efforts were made in drawing up the recent Wireless Regulations to facilitate the development of broadcasting and to bring within the range of the whole com-

munity, at a very low cost, the benefits to be derived from high grade broadcasting stations.

It is only by the constant and hearty co-operation of all concerned that real success can be achieved, and an earnest appeal is made to everyone interested in wireless broadcasting to loyally co-operate with the Department in order to ensure that the full benefits arising from the service may be secured for the community at large.

Radio without an Aerial!

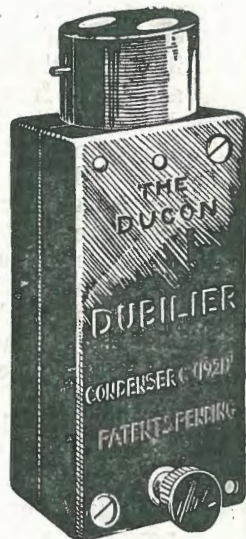

If you are unable to erect an aerial, that doesn't stop you from enjoying the pleasure of the local broadcast programme.

The Ducon Attachment for Radio Receivers —

enables you to make use of the electric lighting circuit as an aerial, picking up broadcast concerts perfectly.

Your receiver must not be connected directly to the lamp socket, or damage to both your receiver and the lighting circuit will result.

The Ducon forms a safe and efficient attachment between your receiver and the lamp socket—it uses no current and is tested to 2,500 volts.

PRICE: 12s. 6d.

Obtainable from all Radio Dealers.

Amalgamated  **Wireless**
(Australasia) Ltd.

97 Clarence St., Sydney.

Collins St., Melbourne.



Jacks and Switches



JACKS are handy things to have in a receiving set in order that you can quickly change from detector to one or two stages of amplification but some jacks make a set inefficient by not making good contact. This is especially true of cheap ones and they should not be used, for

O.K., you know that part of the circuit is in operating condition and you look in the amplifier for trouble. On the other hand, if the detector and tuner do not work properly, it will be detected when the telephones are plugged into the detector circuit and it can be quickly located, whereas if you did not have jacks you would

connect one circuit to the other, such as the detector and first stage of audio frequency, or the first and second stages of audio frequency amplification. In this type there are usually four contacts on the jack, the two outer ones connecting to the "output" circuit and the two inner ones going to the "input" circuit. When the plug is inserted in the jack, it pushes the two outer contacts out and away from the inner ones, thus disconnecting the output of the first circuit to the input of the second. If poor jacks are used, the contacts of the jacks do not make good contact when the plug is withdrawn and this either leads to a noisy set or one that goes "dead" due to an open circuit at the jack.

Jacks may also be used where one is going to use several pairs of telephones at one time. A "jack box" can be rigged up having several "closed circuit" jacks in series, in the box and any number of telephones may be plugged in at one time depending on the number of Jacks you have. This is shown in the drawing

Jacks may also be used along the same line but in various rooms of the house and if you have a portable loud-speaker, it may be moved to any room in the house if you have leads from your audio frequency there. Thus you could have radio in the sick room, listen to any of the dinner concerts during the dinner, or if it happens to be a night for dance programmes, move the loud-speaker downstairs and move most of the furniture out of the rooms.

Single point switches may be used in place of jacks to switch from detector to one or two stages of audio but is not as handy as using jacks.

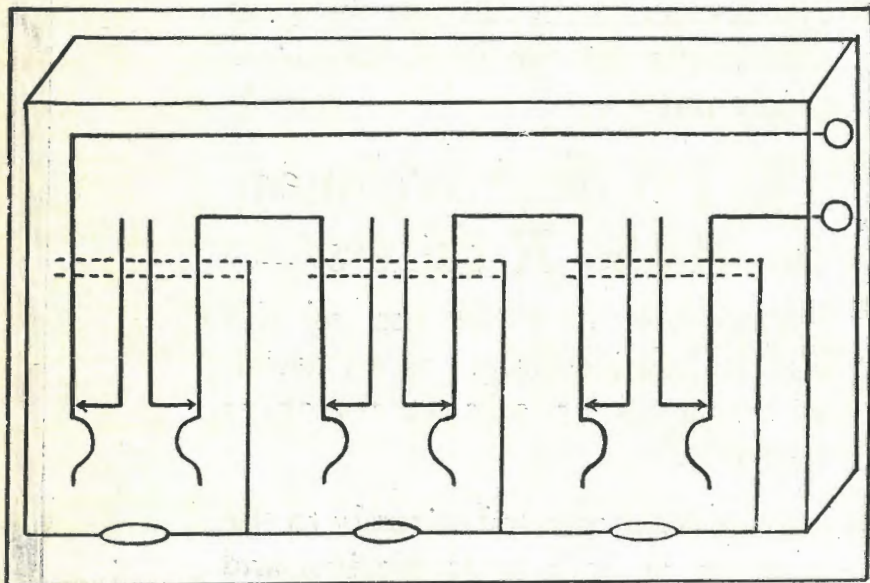

a loose connection means noise and a poor connection means weak signals.

Jacks are not used on the various steps of radio frequency amplification but are almost invariably used on the detector and audio frequency stages. One good feature of using them is in hunting for trouble on a set. You can eliminate the various circuits quite readily by the use of plug and jacks. If your set happens to go bad, you can plug the telephones in on the detector and if everything sounds

not know whether the fault was in the detector circuit, first or second stage of audio frequency amplification.

In picking out the jack for your particular circuit be sure and get the correct one. There are open circuit, closed circuit and filament control jacks. The first type is the last jack in a circuit and as the name implies, it causes an "open circuit" when the telephone or loud-speaker plug is not inserted in it. The closed circuit type of jack is used to con-

Wireless for Coastal Vessels

IN connection with the recent disaster to the coastal steamer *Ripple*, a large and influential deputation waited upon the Minister of Marine (Hon. G. J. Anderson) with suggestions in reference to wireless equipment of all vessels trading between New Zealand ports. The Minister stated that the Government would shortly be summoning a conference of

representatives of all sea-going interests to consider the best means of fitting passenger ships with wireless. He hoped the Shipping Act would be so amended this session as to bring about this reform. Members of the deputation insisted that the Minister should exercise power to stop seamen going to sea when it was dangerous to do so. The expense of delay to

shipowners should not outweigh the value of men's lives. The Minister said he wanted to take practical as well as sympathetic action, but they must be careful not to drive ships out of the New Zealand registry. He had hoped wireless telephony might have met the position that had arisen regarding smaller vessels, but was informed this was not practicable.

For the Cosser Valve use the Kilbourne
and Clark 6 ohm Vernier Rheostat with
the Micrometer control

PACIFIC ELECTRIC CO.

(WHOLESALE ONLY)

87 CLARENCE STREET, SYDNEY.

SOLE AUSTRALIAN DISTRIBUTORS.

Columbia "A", "B" and "C" Radio Batteries

The most satisfying and profitable
Radio Batteries you can sell

Advertised all over the world.

COLUMBIA Radio Batteries are the result of constant study and experimenting in the largest laboratory of its kind in the world. They have been accepted everywhere as absolutely the best radio batteries made and they will give far more satisfactory results than any others. They will sell quickly and yield a good profit.

COLUMBIA Dry Cell Radio "A" Batteries are made especially for dry cell vacuum tubes and will greatly outlast any other type of ignition battery for this purpose.

COLUMBIA Storage "A" Batteries for vacuum tubes of one-half ampere or over have many characteristics which make them ideal for such use. They are shipped dry and charged as sold, thus always assuring a new, fresh and powerful battery.

COLUMBIA "B" Batteries are made in 22½ and 45-volt sizes. They are powerful and long lasting. Thoroughly insulated and waterproofed and furnished with Fahnestock Spring Clip Connectors.

COLUMBIA "Three" Batteries are suitable for use as an "A," "B" or "C" Battery. They are made of extra large sized cells and last unusually long time.

Write for an illustrated, descriptive circular.

NATIONAL CARBON COMPANY, Inc.

30 EAST 42nd STREET, NEW YORK, N. Y., U. S. A.

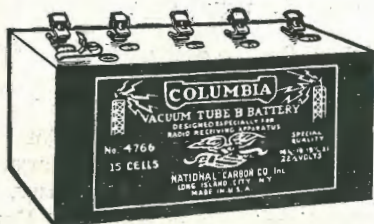
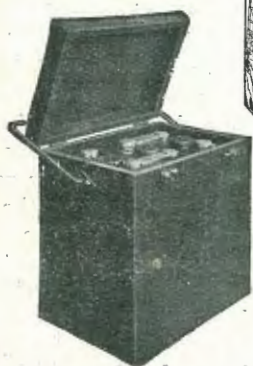

New Broadcasting Station



ORK has been started on the Denver, Colorado, broadcasting station of the General Electric Company. In the late "fall" or early winter a new voice will be on the air. This station will complete the General Electric's nation-girdling system of three stations, the first of which WGY, opened at Schenectady, N.Y., early in 1922, and the second, KGO, at Oakland, California, early in 1924.

In the construction of the Denver Station, full advantage will be taken of the experience gained in the operation of both the Schenectady and Oakland broadcasting plants. Every technical advance proved by extended use will be included in the equipment and the entire plant, like the Oakland station, will be housed in its own building. Provision will be made in the equipment to go to higher power than is now permitted should the regulations of the U.S. Department of Commerce be changed.

The station, a two-storey structure, will be located on a 300 x 250 feet plot, four miles from the heart of Denver, and on the main eastern motor highway. The studio building will be 58 x 47 feet and the first floor will be divided into reception room and offices for the executives, the correspondence and the programme forces. On the second floor will be two studios, a waiting room and a control room for the station's amplifying equipment.

The first and main studio will be 45 x 22 feet in size, big enough to comfortably accommodate large musical organisations like bands and choruses. The deadening or reverberation period will be made variable through the use of movable hangings and floor coverings. As a programme varies from speaker to band, or soloist to orchestra, different degrees of deadening are required to secure perfect tone quality and the Denver station will so be equipped that it may be readily changed to care for the different extremes of sound. The ceilings and parts of the side wall will be sound deadened by means of a one inch felt covering over which decorative tapestry cloth will be hung.

Separated from the main studio by the control room will be a second and smaller studio. This arrangement has proved most successful at KGO in that one number may follow another with only the spacing of an announcement between them. This means that the listener is saved the annoyance of waits between numbers. The second studio also permits an artist to rehearse or tune his instrument before performing for "the air." The location of the control room between the two studios enables the operators who control the amplifying and microphone equipment to observe activities in either studio.

The power house will be a one-storey building, 93 feet long and 42 wide and will be directly back of and connected to the studio building. The power house will be divided into two sections, a motor generator room and a power room. In the motor generator section will be eleven motor generator sets which are required to furnish current for filament lighting, plate current for the power amplifier tubes, generator, field excitation and grid bias potentials. This room will also house the power transformers, the distribution panels and the starting compensators for the motors.

In the power section and located along opposite sides of the room will be two complete transmitting equipments, either of which may be placed in service at the will of the operator at the control panel. Should any difficulty arise with one set, the other may be put into operation without interruption of programme.

The amplified voice currents from the control room in the studio building will be brought to the power station operators' power control board from which point they may be connected to the transmitter in use.

The power tubes will be of the water-cooled type nominally rated at 20Kw. These higher powered tubes are used at a lower output than their rating in order that greater reliability and freedom from distortion may be obtained. A departure from the usual circuit arrangements will be made in the Denver station in that a master oscillator circuit will be util-

ised to assist in obtaining constant frequency for transmission and freedom from harmonics. The output of both transmitters may be connected to an artificial antenna unit which will be located directly under the lead-out insulators. The purpose of this feature is to test the equipment without radiation. Through this unit either set may be connected to the antenna and counterpoise.

The fifteen thousand volt plate supply for the water-cooled tubes will be furnished through a kenetron rectifier consisting of a six-phase, 220 volt to 15,000 volt transformer, the output of which will be rectified through six UV-219 kenetron tubes. Any ripple will be eliminated by means of smoothing reactors and a bank of condensers.

Unlike WGY, where the towers are located on top of a five-storey building, a quarter of a mile from the control room or KGO, where the towers are built on the ground also a quarter of a mile from control room and studio, the towers of the Denver station will be built on the ground, one on each side of the studio building. The antenna wires will be directly above the power-house. The towers will be of steel, 150 feet high and triangular in shape. They will support a three wire multiple-tuned antenna. Distance between towers will be 260 feet and the spreaders will be 120 feet apart, one down lead going directly into the power room over the artificial antenna unit and the second down-lead will terminate in the tuning equipment, located in a small building at one end of the antenna. The counterpoise, consisting of a network of wires insulated from the ground and supported 15 feet above the ground by steel poles, will be used as a part of the antenna system replacing the usual ground connection.

Plans for the new station have been prepared under the direction of Martin P. Rice, manager of broadcasting for the General Electric Company. H. D. Randall, Denver manager for the General Electric Company, will have direct supervision of Denver broadcasting station.

**FREE
Practice
Set**

**FREE
Gramo-
phone**

Service

**FREE
Books**

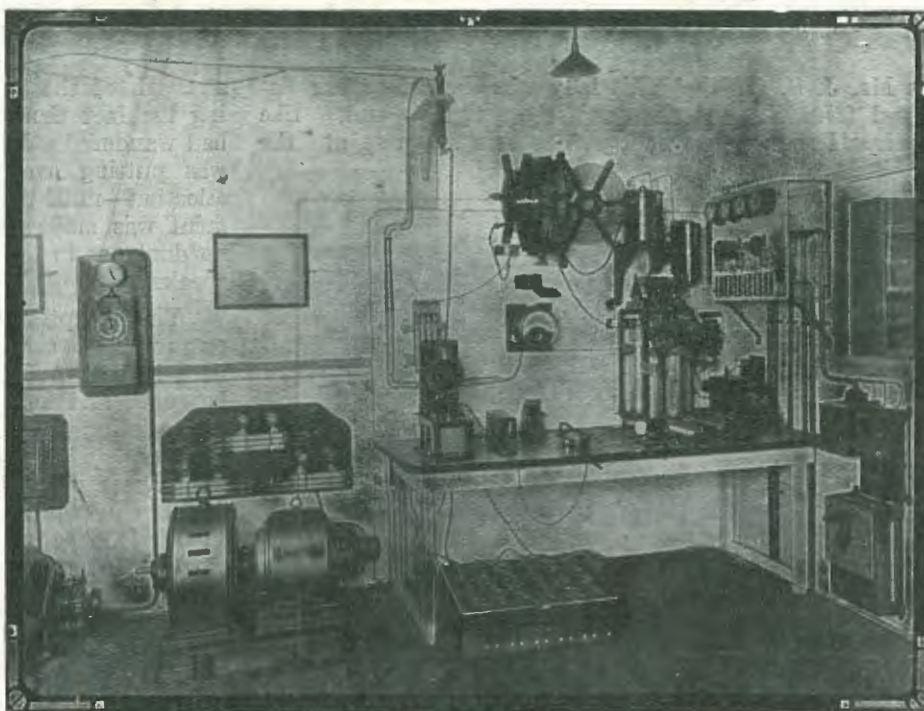

MARCONI STUDENTS OPERATE THIS TYPE OF STATION.

WIRELESS

IS GROWING SO RAPIDLY THAT IN THE
VERY NEAR FUTURE QUITE A NUMBER OF

**WIRELESS OPERATORS
WILL BE WANTED**

TAKE ADVANTAGE OF THIS UNIQUE POSITION
AND ENROL TO-DAY WITH THE _____

MARCONI SCHOOLS

AS THE TIME IS LIMITED.

WRITE TO-DAY TO

Marconi School of Wireless

97 Clarence Street, SYDNEY,
AND

Gloucester House, 44 Market Street, MELBOURNE.

Corrimal Experimenter Adds KGO to his DX List

"LAST night," writes Mr. J. S. G. Worland, of Corrimal (N.S.W.), in a recent letter to *Radio*, "I received

"This lady was the only other listener at the time, and, like myself, evinced no surprise at the

strength of the reception—considering the fact that some experimenter had wandered off his wave-length and was putting over a real orchestral selection—until the closing announcement was made in accents that left no doubt as to the nationality of the speaker.

"This reception was obtained without resort to aerial re-action as was used by Mr. A. E. Wright, of Scarborough, and is, of course, obtained by coupling to the tuned anode inductance. The fact that no aerial re-action was used is, perhaps, unique, judging by the nightly caterwauling in this locality at any rate!

"It is almost impossible to do any DX work until broadcasting has ceased or before it has started."

"I can fully verify the above report," states Miss E. M. Potter.



Mr. Worland sends us this snap of a portion of his Radio room.

ed KGO, the transmission coming in as clear as a bell and at good audibility on a three-valve set—one Radio Frequency, one Detector, and one Audio Frequency—carrying eight high resistance telephones.

"On listening with the first two valves only the stations was easily audible—it was certainly no whisper, as some experimenters have reported their reception to be.

"The closing announcement was as follows:—'The music just transmitted was by— (static obliterated the name) orchestra at the Hotel St. Francis, San Francisco. This is station KGO—station KGO. Signing off now at 12.55. Good morning!'

"This corresponded exactly with 6.55 p.m. local time," continues Mr. Worland; "and the above can be verified in detail by Miss E. M. Potter, public school teacher, of Balgownie.

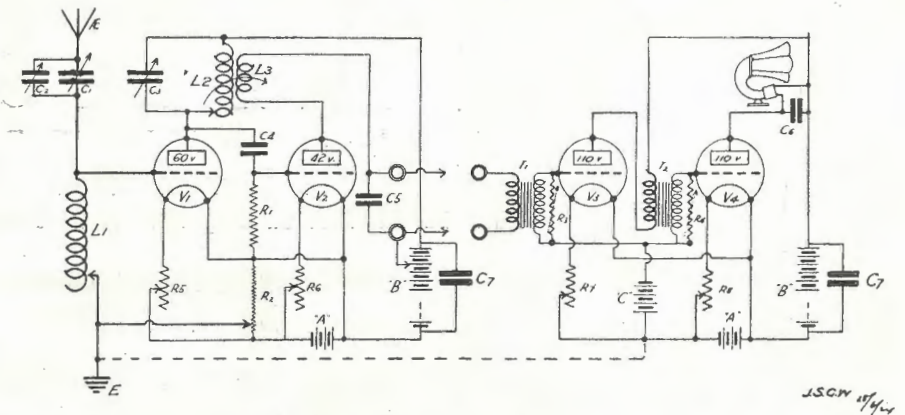

The following are the details of Mr. Worland's set:—C1: .0005 mf. C2: .00005 mf. C3: .00025 mf. C4: .00025 mf. C5: .002 mf. C6: .002 mf. C7: 2.0 mf. R1: 1 Meg. (Electrad.). R2: 250 ohms (Cutler-hammer). R3, R4: 70,000 ohms to $\frac{1}{2}$ Meg. R5, R6, R7 and R8: Each 10 ohms. T1: "United," 5:1. T2: "Kellogg," $4\frac{1}{2}$:1. L1: 50 turns No. 20 s.w.g. s.s.c. $3\frac{1}{2}$ in. dia. solenoid coil, tapped six places. L2: 75 turns No. 28 s.w.g. d.c.c. $3\frac{1}{2}$ in. dia. solenoid coil, tapped six places. L3: 30 turns No. 24 s.w.g. d.c.c. $1\frac{1}{2}$ in. dia. centre basket coil, nine slots. AE: Single wire, 55 ft. high, flat top 80 ft. long. E: Water supply pipe. Switches for loading coils, series parallel arrangement and auxiliary fixed condensers are not shown. V1: Mullard "KA," special type for RF work. V2: Ediswan "AR." V3: Ediswan "R." V4: Ediswan "R."

SAVE YOUR TIME AND MONEY! BY SENDING 10/- TO THE WIRELESS PRESS, 97 CLARENCE STREET, SYDNEY, FOR 12 MONTHS' SUBSCRIPTION (26 ISSUES) TO "RADIO" YOU WILL SAVE 3/- AND THE RISK OF DISAPPOINTMENT.

STERLING PLATING & MFG. CO

(Late Stokes & Sons)
 225 CLARENCE ST., SYDNEY.
 ELECTRO, SILVER, NICKEL AND BRASS
 PLATERS.
 All kinds of Lacquering, Gilding, Bronzing
 and Oxidising Done.
 Phone: City 6088.

EDWARD WATERS & SONS

(Established 1859.)
 PATENT and TRADE MARK ATTORNEYS,
 CATHCART HOUSE,
 11-13 Castlereagh St., SYDNEY.
 Tel.: B 5937. (And at Melbourne).

BACON & Co. Ltd.

PROCESS
 ENGRAVERS
 and
 ILLUSTRATORS

**31a PITT STREET
 SYDNEY**

Phone: B 3368

**SECOND-HAND WIRELESS
 APPARATUS.**

Ever-ready 60-volt Batteries, Non-tapable
 Reading, 45 to 50 volts each 6/-
 Audio-frequency Transformers, Ratio 1 to 3,
 Iron Core Type, have never been in use, 15/-
 Glass Test Tubes, with glass separators, 2d.

Also quantity other Second-hand
 Wireless Accessories.

**AMALGAMATED WIRELESS
 (AUSTRALASIA), LIMITED.**

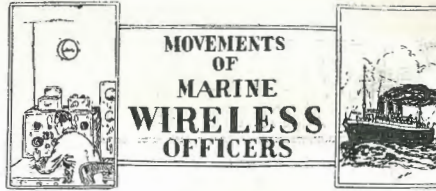

**MOVEMENTS
 OF
 MARINE
 WIRELESS
 OFFICERS**

SEPTEMBER.

MR. F. R. SNAPE, relieved Mr. J. Mc-Tavish on s.s. *Largs Bay* as third operator at Sydney, 6th.

Mr. T. F. Neal signed off s.s. *Iron Chief* at Newcastle, 5th, and relieved Mr. W. C. Smith on s.s. *Iron Age* at Newcastle, 5th.

Mr. A. W. Hodge signed off s.s. *Goulburn* at Melbourne, 2nd, and relieved Mr. F. Kettlewell on s.s. *Wonganella* at Melbourne, 3rd.

Mr. F. Kettlewell signed on s.s. *Goulburn* at Melbourne, 3rd.

Messrs. F. W. Basden and R. G. C. Roberts signed on s.s. *St. Albans* as 2nd and 3rd operators respectively at Sydney, 9th.

Mr. J. W. McKay relieved Mr. O. S. Kelly on s.s. *Mackarra* at Sydney, 9th.

Messrs. A. E. Shepherd, J. Ouvrier and J. S. McTavish signed on s.s. *Taiyuan* as senior, 2nd and 3rd operators respectively at Sydney, 9th.



**COASTAL
 RADIO
 SERVICE**

STAFF CHANGES.

MR. C. M. URQUHART, Radiotelegraphist, has been transferred from Wyndham Radio to Perth Radio, on completion of his term of tropical service.

Mr. G. Morrison, Radiotelegraphist, has been transferred from Melbourne to Sydney Radio.

Mr. M. Mortimer, Radiotelegraphist, Sydney Radio, has been transferred to Darwin Radio, as Officer-in-charge.

Mr. E. H. Smellie, Radiotelegraphist, Darwin Radio, has been transferred to Perth Radio.

Mr. A. R. Finch has proceeded to Papua for the overhaul of masts and aerials at Port Moresby and Samarai Radio Stations.

FOR SALE

Special BROADCAST RECEIVER, wave range between 150-2,000 metres, 4 valves (worked off dry cells); all batteries, aerial, loud speaker, etc., completely equipped ready to work. Enclosed in highly polished maple cabinet. Price, complete, £35. Absolute Bargain.

Also several original genuine Auditron Valves, each with two Filaments, 45/- each.

Apply Box 3182, G.P.O., Sydney.

HUGHES & CO.

HIGH-CLASS
 CIVIL and NAVAL TAILORS

Our civil Suits are perfection in STYLE FIT, DURABILITY and PRICE. TAILOR-MADE on the premises under our own supervision. OUR NAVAL UNIFORMS and GOLD LACE work speak for themselves. CAPS, LACE, BADGES, UNIFORM BUTTONS always in stock. ONE Quality only — THE BEST.

70-72 Erskine Street, SYDNEY
 Phone: City 77.

**MODERN
 PRINTING**

KEEPING in touch with all that is new and good in type faces and modern printing machinery makes us think

we can satisfy your printing wants.

We wish to announce that we can furnish everything it is possible to print and bind. Our charges, quality considered, are surprisingly low. We turn out work as quickly as you want it.

NORTH SYDNEY PRINTING CO.

195 ALFRED STREET,
 NORTH SYDNEY.

Tel.: North 3178.

FOR SERVICE

GREEN & NORTON

(Formerly the Rapid Freight Despatch Co.)

CUSTOMS, SHIPPING &
 FORWARDING AGENTS,

**Broughton House, King St.,
 SYDNEY.**

Telephone: 1180 City.

L. W. (Lakemba) submits circuit of a receiver which he proposes to use. Q.: Is it regenerative? A.: You can make the set regenerative by connecting a reaction coil to terminals C3 and C4. Q.: Is it necessary to use a grid leak? A.: Yes, if you employ a hard valve. Connect across Condenser B. Q.: What would be the effective range? A.: We cannot say. Q.: What are the connections marked C for? A.: Possibly some system adopted by the makers. Q.: Is an A battery necessary? A.: Yes. Connect between terminals C7 and C8.

V. K. (Lidcombe) is constructing a loose coupler set described in *Radio*, No. 37. Q.: What type of head-phones, of an average price, are the best? A.: You should use a pair of head-phones wound to 2,000 ohms resistance. Any of the following makes will be suitable. "Radiola," "Expansion," "Trimm," "N.S.T.," "Sterling," etc. See advertisements in this magazine. Q.: What crystal should I use? A.: "A.W.A.," Galena or "Q.S.T.," obtainable from most Radio dealers. Q.: How many sheets of tinfoil 1in. x 2in. with a dielectric of waxed paper will be necessary for a .001 m.f. 'phone condenser? A.: With waxed paper the thickness of that on which you wrote you will need about 12 sheets, six on each side.

D. P. P. (Cheeple, Qld.). Q.: What is inductance value of coils M and L3, and what is capacity of C3? (Reference "Vacuum Tubes" by Bucher page 97, fig. 63.) A.: For 1,100 metres coils S and P of M should be 100 turn honeycomb coils. L3 should be of 200 turns. C3 should be .0005 m.f. Q.: Where should one stage audio frequency be connected? A.: An audio stage cannot be used unless separate H.T. batteries are employed. We suggest you use the ordinary three-coil regenerative circuit with one stage audio. This will give exactly similar results with less apparatus and fewer controls.

E. F. B. (Enmore). Q.: What is value of condenser 21 plates mica encased (particulars of receiver submitted)? A.: Approximately, 0.0005 m.f. Q.: Would better results be obtained if aerial were made higher and set re-wired as per diagram on page 221 *Radio*, No. 36? A.: Yes. Q.: Will the above condenser be of any use in the P1 circuit? A.: Yes. A condenser for fine tuning is essential for valve circuits.

R. L. (Lower Portland). Q.: What is cause of difficulty in receiving on the "S.T.150" using UV199 valves and "Samson" transformer? A.: We can only suggest the grid leak is at fault. Experiment with different valves and report your results.

G. C. (Merewether). Q.: Would better results be obtained if height of aerial mast were increased? A.: For crystal reception the increased height would be better. If you intend using regenerative valves very little difference will be experienced. Q.: Would it be better instead of using an inverted L aerial, if the two poles were added together

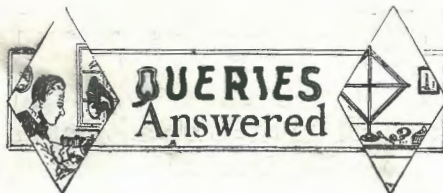

and an umbrella type erected? A.: For crystal reception the higher the better. If you intend using regenerative valves very little difference will be experienced.

R. H. B. (Hornsby). Q.: Can three WD12's and one "Mullard Ora" valve be worked from a 4 x 80 amp. hr. accumulator, using separate filament control for each valve? A.: Use small fixed resistances in series with the WD12 filament resistances. These can be obtained from any supply house. Q.: What is the correct ratio for audio transformers for first and second stages? A.: It is usual to have a lower ratio in the second stage, although, if similar ratios are used in each, a resistance of 0.5 megohms across the secondary of the second transformer will stabilise the operation.

G. R. (Wycheproof). Q.: Can a six volt accumulator be used for "Ora" valves, and thereby obtain a negative potential on the grid? A.: Yes, providing you use a six to ten ohm variable filament resistance in series with the L.T. supply. You must connect the low potential end of the grid leak to the positive L.T. terminal. Q.: How can the above accumulator be made to last longer? A.: You will not get any longer life from the six volt accumulator. Why not get another four volt unit and put the two in parallel? You will then get double the use.

L. R. M. (Hornsby). Q.: Are Spiderweb coils as good as honeycomb coils? A.: Only for short waves. Q.: Using Spiderweb coils, how many turns are required for Farmer's and Broadcasters? For 2FC use 100 turns on 2in. diameter and for 2BL, 25 turns, or preferably, 50 turns with a series condenser. Use similar size reaction coils. Q.: What voltage does the WD valve require on the plate? A.: About 40 as a detector, 50 to 80 as an amplifier. Q.: Will a Frost vernier rheostat be satisfactory for this valve? A.: Yes, providing not more than two volts are used for the L.T. Q.: Will the P1 circuit operate a loud-speaker nine miles from 2FC? A.: No. You will need at least two valves for good signals. Q.: Constructing a two-plate variable condenser 3in. dia. x 1/16in. thick, what distance should the plates be apart for .001 and .0005? A.: Using air as a dielectric, the spacing should be 1.5 mils. for .001 m.f. and 3 mils. for .0005 m.f. This spacing is impracticable unless you possess special apparatus to make so fine an adjustment. We suggest you purchase a commercial condenser.

J. W. W. (Turramurra) asks for further particulars regarding "One Valve Amplifier" published in *Radio*, No. 37. A.: You can combine the two circuits by taking

the primary leads of the audio transformer on page 250, No. 37, and connecting in place of the 'phones across condenser "L" on page 224, No. 36 issue.

R. C. (Sydney). Q.: Which is correct way of connecting series-parallel switch (diagram of receiver submitted)? A.: You should connect the series-parallel switch so that the grid-filament connections of the valve are always across the inductance coils. Q.: Should the negatives of the two batteries be joined and earthed? A.: It is advisable for the negative H.T. and positive L.T. to be connected together and earthed.

J. M. M. (Lake Boga). Q.: Using plug-in transformers, would placing a variable condenser across the primaries improve tuning (circuit submitted)? A.: Yes, tuning the radio transformers will greatly improve results. Q.: Where should a potentiometer be placed to stabilise the circuit? A.: Use the potentiometer to control the potential of the grid of the first Radio valve.

J. B. D. (Concord). The circuit you submit is unintelligible. Forward complete circuit, together with full particulars when we will endeavour to assist you.

H. F. L. (Hobart) submits circuit of receiver he proposes to construct. Q.: Is diagram correct? A.: No. The .001 condenser should be connected across the transformer, not in series. Q.: Would this receiver be easy to tune? A.: Yes. Q.: Are condenser values correct? A.: Yes.

V. D. (Ballarat). Q.: What size coils should be used in aerial, anode and reaction (diagram and particulars of receiver submitted)? A.: The size of the coils depends upon the wave-lengths of the station or stations from which you desire to receive. See *Radio*, No. 15, giving number of turns for wave-lengths up to 22,000. Q.: Would another grid condenser be an improvement? A.: No. Q.: What size coils are necessary to receive on 1,100 and 312 metres? A.: For 1,100 metres: aerial, 150; anode, 200, and reaction, 100. For 312 metres: 35, 75, and 50 respectively. Q.: Are transformer connections correct? A.: Yes. Q.: Would a potentiometer be an advantage? A.: A potentiometer is not necessary.

D. McL. (Moss Vale). Q.: How much would the P1 circuit cost to assemble? A.: To buy the complete set assembled would cost you approximately £10; purchasing the parts separately about £8. Q.: What type of valve and coils would you recommend? A.: We would suggest either a DER, DE3 or UV201A. Use honeycomb coils specified in article. Q.: How many valves would be required to pick up Sydney broadcasting stations and work a loud-speaker? A.: You will need at least three valves for good loud-speaker results, or a two-valve reflex. Unless you decide to purchase the receiver ready-made, we would advise you to read up some practical book on the subject.

That Sensitive Point!

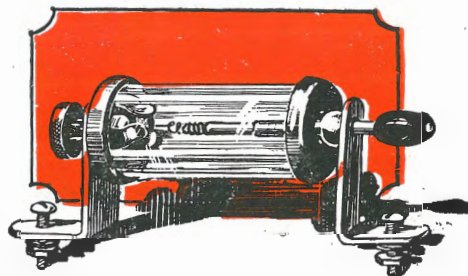

A sensitive point on your crystal is easily found when you use an A.W.A. Crystal Detector. No joyous minutes of entertainment are lost in futile search for the "Magic Spot." By means of the universal ball joint the spiral contact wire is quickly adjusted, and when in position is not easily dislodged.

Another notable feature is the improved crystal holder, which consists of three spring prongs, ensuring perfect electrical contact with any form of crystal. Both the spiral contact wire and the crystal are enclosed in a glass tube which protects them from dust and dampness.

The A.W.A. Crystal Detector is highly nickelled; by mounting one on your set you will make it a possession envied by all beholders. It is sold unassembled.

Procurable from all
Radio Dealers.



Amalgamated WORLDWIDE WIRELESS **Wireless**
(Australasia) Ltd.

97 Clarence Street, Sydney
Collins Street, Melbourne

Radio Dealers kindly write for Trade Price List.



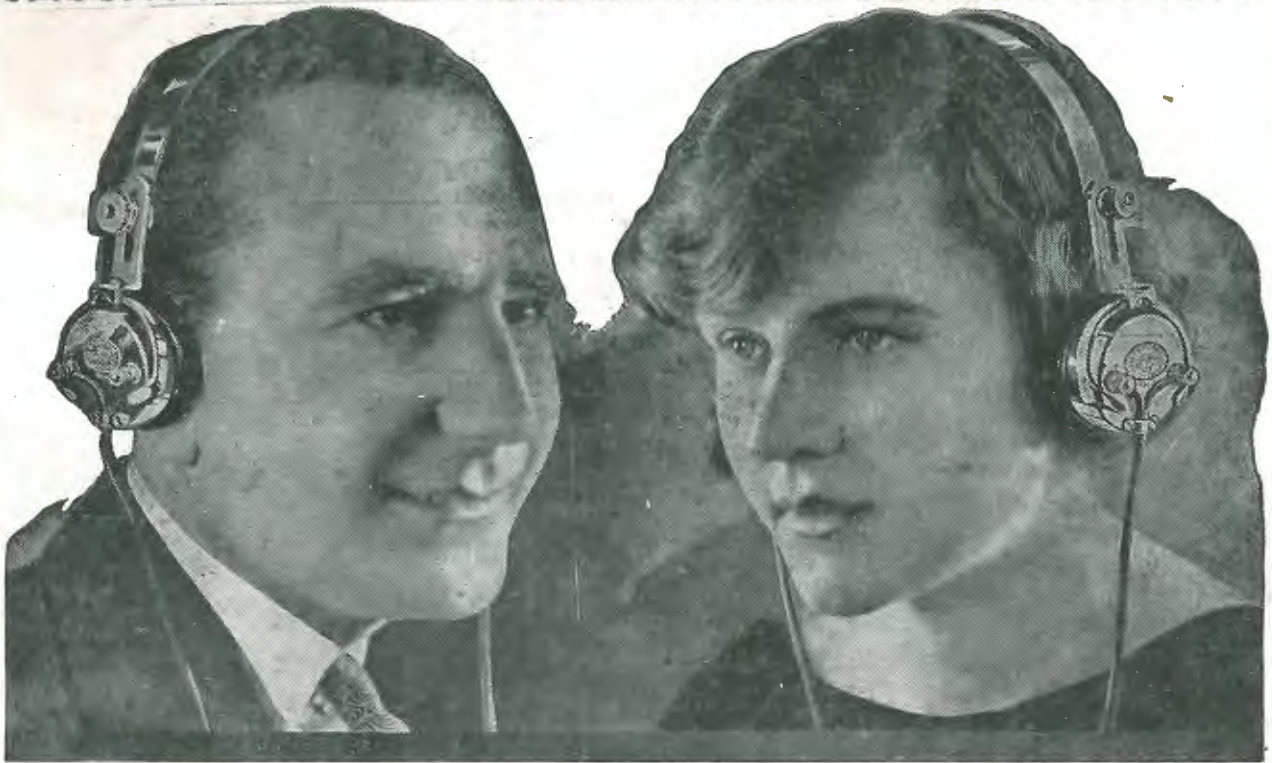

Listen and you will hear

Worth listening to! THE STERLING BABY Loud Speaker

Flawless in reproduction, natural in tone, distortionless, and wonderfully loud for its size. It is supplied in two resistances: 120 or 2,000 ohms and in the following finishes—Black Enamel, Brown Floral Design, Black and Gold Floral Design and Black Matt decorated Oriental Style. Height overall 19"; diameter of flare 10½"; diameter of base 5½".



Write for **STERLING**
DESCRIPTIVE BOOKLET
No. 364 B.
SENT POST FREE.

all that is broadcast with a fidelity beyond question, with a clearness beyond compare, and with a comfort beyond belief—if you use *Sterling Headphones*. Men and women alike approve them everywhere. Get the utmost out of radio music and speech.—*Listen with Sterling Headphones.*

Reception on *Sterling Headphones* is so wonderfully different to the ordinary run of radio results. The secret is a simple one. For the delightful mellow clearness and the amazing comfort of *Sterling Lightweight Headphones* are due, firstly, to better design and secondly, to a real pride in careful construction. Reasons often given we know, but nevertheless true and indisputable.

Sterling headphones have polished duralumin headbands and are supplied in three resistances 120, 2,000 and 4,000 ohms the pair.

Ask your dealer for

STERLING Lightweight Radio Head Telephones

DELIVERY FROM AUSTRALIAN STOCKS.

Distributors for Australasia:

N.S.W. and Queensland: LAWRENCE & HANSON, ELECTRICAL CO., LTD., 33 York St., Sydney.
Victoria: WARBURTON, FRANKI & CO., LTD., and LAWRENCE & HANSON, ELECTRICAL CO., LTD., 398 Post Office Place, Melbourne.
South Australia: NEWTON, MACLARAN & CO., LTD., Adelaide.
Western Australia: CHAS. ATKINS & CO., LTD., Perth.
New Zealand: TURNBULL, JONES & CO., LTD., Auckland, Wellington, Christchurch and Dunedin.

THE STERLING TELEPHONE & ELECTRIC Co. Ltd., *Manufacturers of Telephones and Radio Apparatus, etc.*
210-212, TOTTENHAM COURT ROAD, LONDON, W.1, ENGLAND.

Works: DAGENHAM, ESSEX.