

The
Queensland

RADIO NEWS



A MAGAZINE for the
SET CONSTRUCTOR &
BROADCAST LISTENER

6

JULY 2nd 1928

VOL. IV.

NO. 6

THE AMPLION JUNIOR HANGING CONE

SPECIALLY BUILT TO SUIT AUSTRALIAN CONDITIONS

100 Per Cent
BRITISH

Get Yours
NOW!



Model A.C.2 (illustrated)

£3/5/-

Model A.C.2-H. (to hang from ceiling), complete with fittings

£4

As will be seen from the illustration, the Junior Hanging Cone speaker is intended to hang from the picture rail. In such a position, a speaker will be heard to the best advantage and with its dark brown frame and handsome copper tinted diaphragm it is decidedly ornamental in appearance as well as efficient in action. This model is ideal for an average set in the average room.

Large shipments of the Amplion Junior Hanging Cone, Model A.C.2, have recently been landed in Australia, and it should be readily obtainable from any radio dealer. This Speaker, designed by British engineers and built by British mechanics for service in Australia, incorporates all the essential Amplion features, which have made Amplion Cones so popular in England and America.

The
World's
Standard

AMPLION

Wireless
Loud
Speaker

NOTE—This Cancels all Previous Announcements

A.1. QUALITY at C.3. PRICE



It's the old story of the chain!

Consider every link when you choose radio valves—look for special features—check correct construction, constancy, current economy, characteristics—

But decide by the filament! . . . upon this vital part depends the value you receive for your money.

Demand a big filament, a tough filament—a filament that cannot be broken except by the very roughest handling. . . .

THE WONDERFUL MULLARD P.M. FILAMENT

This supreme filament will serve you a thousand times round the clock and then continue the same perfect operation as when new. Obtainable in a complete range of Mullard P.M. Valves to give improved results in all circuits.

Mullard

THE · MASTER · VALVE

British-Made Mullard P.M. Valves are obtainable from every radio dealer in Australia. Whether 2, 4, or 6 volt, there is a P.M. Valve to suit your need.

*Supplied in
English or
U.X. Base*

Arks. 20-28.

The Mullard Wireless Service Co. Ltd., Nightingale Lane, Balham, London, England,

The Pacific Flyers at 3LO



The Southern Cross Crew and Friends visit 3LO Melbourne Studio. James Warner, Wireless Operator of the Southern Cross, listening in on 3LO Melbourne's Ascot Vale Short Wave Station that picked up the news of the flight for listeners of 3LO Mel-

bourne. Capt. Kingsford Smith is shown handling the control of 3LO Melbourne during the broadcasting of dance music on the evening of the reception by the Aero Club and 3LO Melbourne.

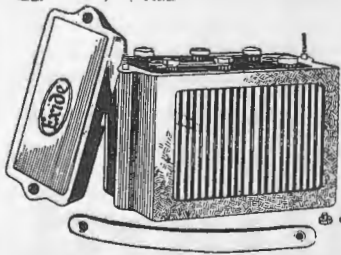

EXIDE

PORTABLE
WIRELESS BATTERY

Types— { 3CZW, 3-1TL
 3CZT, 4-1TL

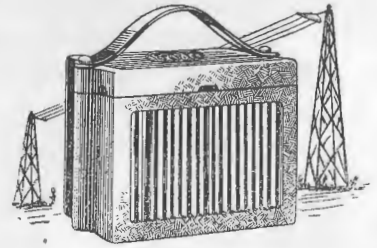

Improvement on top of improvement has been the history of EXIDE Wireless Batteries. The latest and newest EXIDE production (illustrated above) which has just arrived is the finest wireless battery in economy, service and appearance yet come to Australia. This battery comprises 3 2-volt composition cells fitted into a beautifully finished Hard Rubber Composition Container with dust-proof lid and imperishable carrying handle.

Connectors are detachable and the battery may be readily used for 2, 4 or 6 volt service.

A special feature of the lid is the conveniently placed vents which allow battery leads to be run out in practically any way. The two types available are:— 3CZW-3-1TL (capacity 30 ampere-hours continuous—60 ignition) and the 3CZT-4-1TL (capacity 40 ampere hours continuous—80 ignition). Ask your radio dealer to show you this new Exide Battery.

At all Good
Radio Dealers

Exide WIRELESS BATTERIES

At all Exide
Dealers

EXIDE BATTERY SERVICE (Q.) LTD.

Adelaide Street (opposite St. John's Cathedral), BRISBANE. Also at Stanley Street, Sth. Brisbane.

The biggest individual effort yet put forward by any one section of Queensland industry.

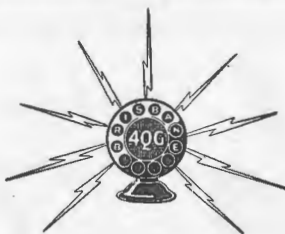

Come and bring your friends. There will be much to see, much to hear, and much to learn.

For One Mighty Week!

THE

Radio and Electrical Exhibition

A mammoth showing of all that is new in Radio Apparatus, displayed in a manner that will interest and instruct.

Dazzling displays of electrical fittings and appliances, with actual demonstrations of the many methods of using electricity in the home.

Broadcasting demonstrations every afternoon and evening. Ample seating accommodation.

Bedtime story sessions at 6.30 every evening by combined story-tellers.

**BOHEMIA
THEATRE**

Stanley St., Sth. Brisbane

**JULY
16 TO 21**

From 10 a.m. to 10 p.m.

This Space Donated by "The Queensland Radio News"

Free! for JULY Only!



A startling offer for one month only. If you are thinking of buying a new set, NOW is the time to do it!

WIRELESS LICENSES!

Choose your New Receiver at Mick Simmons Ltd. in July, and the price of a Listener's License for one year (24/-) will be handed back to you in cash.

The purchase of any receiver to the value of £12 and over entitles you to the cash refund of 24/-.

Call and make your choice from our fine range. We have some fine three-valve receivers selling for £12 and upwards.

Buy Your New Set in JULY and Save 24/-

This is a genuine offer. Our prices are at all times keen, but this Big Cash Concession puts the Mick Simmons Radio Section right in the lead of all competition.

SHORT WAVE MATERIAL

Listen in to PCJJ and other international short-wave stations on a short-wave set. You'll need these parts:—

1 Airzone S.W. Coil Kit (13-135 metres)	55/-
1 Pilot .00015 Condenser	11/3
1 .00025 Reaction Condenser	9/6
1 .00025 Grid Condenser	2/6
1 10-meg Grid Leak	2/-
2 Emmco Vernier Dials at 7/6	15/-
2 B.T. Sockets at 7/6	15/-
2 Rheostats at 3/9	7/6
1 Panel, 12 x 7 x 3/16ths	7/6
1 Baseboard	2/-
1 Radiokes R.F. Choke	8/6
1 7-1 Signal Transformer	21/-
8 Engraved Terminals at 4d	2/8
1 Terminal Strip Strip	6d

MAKE YOUR OWN SHORT-WAVE COILS.

Airzone's New Idea! Space wound coils mounted on celluloid and sold in lengths of about 11 inches. Price 7/6 each.

Mick Simmons Ltd.

"The Home of Sport"

QUEEN STREET

BRISBANE

ALFRED T. BARTLETT
Editor

LEIGHTON GIBSON
Technical Editor

The
QUEENSLAND
RADIO NEWS

MONDAY, 2nd JULY, 1928.

The Voice of the Broadcasting Station



If one were to attempt a computation of the aggregate audiences that listen-in to the voice of the announcer of a large broadcasting station during the course of twelve months, a sum total would be reached that would run far into the millions.

And what a mixed audience it would represent! Were it possible to assemble these millions into one huge gathering, university professors would rub shoulders with labourers; titled citizens would mingle with tradespeople—but the attention of all would be centred upon the utterances of one man.

The announcer is the voice of the broadcasting station, and as such he has a very real duty to perform—not only to his station, but to the listening public.

It has been rightly said that an announcer's mode of speech exerts a vast influence upon the speaking habits of listeners—particularly the young. For this reason alone, the broadcasting announcer's responsibility must rest heavily upon his shoulders.

The prestige of a broadcasting station is, to a large extent, made or marred by its announcer. A cultured voice that speaks correct English, unaffected in its style, flawless in its pronunciation and enunciation, and bright with personality, is the type of announcing that wins prestige for the station and respect from its listeners.

The qualifications of a good broadcasting announcer are as many as they are varied. He must be well educated with a complete mastery of King's English. He also should possess a general understanding of local and foreign affairs. A knowledge of languages is very helpful, but not altogether essential, while at least a nodding acquaintanceship with the works of the great composers is imperative. He should be versatile enough to take his place upon the program when necessary, and should possess sufficient initiative to make impromptu announcements when the occasion arises.

It will be seen that the position of broadcasting announcer is one which few men can successfully fill. The fact that a man possesses a good radio voice does not of necessity qualify him for the position; yet the character of the announcements which emanate from some of our broadcasting stations would seem to indicate that this qualification alone has been responsible for the appointment of their announcers.

Perhaps the salary offered is not substantial enough to attract the right type of man. If this be the case, the broadcasting stations concerned should not hesitate to amend the remuneration, for the scholarly announcer will quickly repay the difference in salary in dividends of prestige and general satisfaction.

QUEENSLAND RADIO NEWS



— There's a place for everything, and the place for a topical-tune-in-chorus is NOT midway through the programme; yet this happened on the evening of June 11th.

* * * *

— The thanks of listeners are due to 4QG for the prompt and lengthy services rendered prior to the arrival and during the visit of "The Southern Cross" airman to Brisbane. Long and lonely vigils were kept by 4QG engineers in order to give listeners the latest information even before the newspapers received it.

* * * *

— Time was when Olsen and Goodchap's concerts were well worth the listening. Of late the quality has dropped to a very mediocre standard. "The Nocturnians," who contributed to a recent programme, were most disappointing.

* * * *

— Mr. Erich John seems to know the taste of the people. The entertainments of his concert party are invariably good, and the concert of June 18th was no exception to the rule. A delightful programme, skilfully chosen, thoughtfully grouped, and excellently rendered. Thanks, Erich!

* * * *

— The great improvement in 4QG's transmission could not be more convincingly evidenced than in the brass band broadcasts from the studio on Monday evenings. The pity of it is, though, we have to wait up until 9.30 to hear half-an-hour of it. Why not scatter the numbers through the programme?

* * * *

— Listeners who were unable to attend the football match, England v. Queensland, were disappointed to learn that a description of the game was not broadcast by 4QG. Beyond brief announcements of the progress of the scores, no one would have known that such an eventful "battle" was being waged at the Exhibition Oval. It seems a pity that arrangements for broadcasting could not have been made on such an important occasion as this.

* * * *

— The longest hour of radio music on record is provided by the monthly relays from St. Barnabas' Church, Red Hill. The second hour by the "dance band" is even longer than the first. Such programmes may be economical for the station, and publicity for the church concerned—but they are NOT appreciated by the listeners.

— A broadcasting announcer should possess enough musical knowledge to distinguish Drdla's "Souvenir" from Schubert's "Serenade." On May 19th, a violin solo, announced as the former, when played by the artist, proved to be the latter. No apology nor correction was offered at the conclusion of the item.

* * * *

— The "incidental music" to the radio adaptation of "A Christmas Carol" was so inappropriate that it would have been better left out. The stirring strains of a 20th century march played outside Scrooge's window on that Christmas Eve of long ago, was enough to make poor old Charles Dickens turn in his grave.

* * * *

— In the cast of the above play, "The Ghost of the Future" was played by Mr. I. N. Visible. The Invisible Ghost! This calls to mind another instance where name suited the part. In the early days of 4QG this number appeared upon the programme: "He Wipes the Tear from Every Eye," sung by Miss Onions.

OREGON WIRELESS MASTS

IN the use of Masts to carry Wireless Aerials, Rosenfeld's Oregon has proved to be the most serviceable. The Oregon for these masts is specially selected.

Call, 'phone 5991, or write to us for further particulars and prices of Wireless Masts.

You can purchase your Masts in one length of Oregon Pine, from 30ft. lengths of 3 x 3, to 80ft. lengths of 6 x 6, also 4 x 4, and 5 x 5 to any length.

ROSENFELD & Co. (Qld.) Ltd.

"The Oregon Specialists"
TIMBER MERCHANTS.

Moray Street, New Farm, Brisbane
Phone C. 5991.

A Good THREE for £5



BECAUSE of its all-round excellence and reliability, the circuit chosen for this fine three-valve receiver was the well-tried and proved three-coil

arrangement, followed by a two-stage transformer-coupled audio amplifier of conventional design, as shown in Fig. 3. Really good quality parts have been used throughout, which accounts for the splendid performance of this inexpensive set. Naturally, there are no "trimmings," but no really necessary component has been omitted, as witness the vernier tuning dial and cushioned detector socket—items which usually are dispensed with in low-priced receivers.

In the circuit diagram, L1, L2 and L3 are the primary (aerial coil), secondary (grid coil), and tickler (reaction coil), respectively, of the Radiokes three-coil tuner. This particular tuner was chosen because of a highly desirable feature which it possesses—a primary coil which is capable of adjustment in its relation to the secondary. The usefulness of this feature will be explained under the heading of "Tuning." The tickler or reaction coil is, of course, variable, and is rotated by means of a knob on the front panel. Used with the .0005-mfd. tuning condenser C1, this tuner covers a wavelength range of approximately 200 to 550 metres—the entire "broadcasting band."

Radio-frequency energy flowing in the detector plate circuit is bypassed around the primary of the first transformer T1 by the fixed condenser C3; this condenser is quite indispensable, as the circuit

of "The Queensland Radio News" has no room in its columns for any but receivers of undoubted quality. Consequently, when the Technical Editor, set out to evolve a Three-valve Set which could be built for the modest sum of £5, his task was no easy one.

The fact that the cost of the receiver described in this article falls within a few pence of the sum mentioned, is no accident; it is the result of painstaking design and very careful selection of parts.

As far as tone, volume, and range are concerned, the completed receiver has proved itself to be in the front rank of three-valvers. At the present time it is rendering yeoman service, and represents, we think, the very best value possible for the outlay necessary for its construction.

It will be understood, of course, that the sum of £5 covers the receiver only, exactly as it appears in our illustrations. The cost of the accessories necessary to place the set in operation will vary according to the type of valves, loudspeaker and batteries chosen.

By

THE TECHNICAL EDITOR

an effort to create artificial "mellowness" in fundamentally poor receivers.

Construction.

Fig. 4, the panel drilling diagram, furnishes all the dimensions necessary for laying out the panel. Only the centre hole for the variable condenser is shown, as a drilling template invariably accompanies the condenser itself, and, if attached temporarily to the face of the panel while the positions of the screw-holes are pricked through with a centre-punch, provides an easy means of ensuring that the holes will be drilled in the right place. The same remark applies to the vernier dial, which is supplied complete with mounting screws and full directions.

So that the panel will present a well-finished appearance, it should be prepared by filing and sandpapering its edges until a smooth surface is obtained and all saw marks disappear. After being drilled, the application of a little

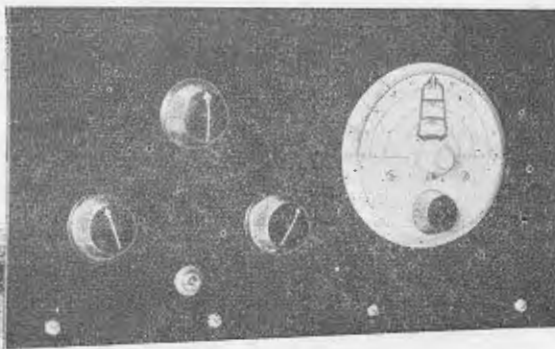

FIG. 1—The large dial on the right is the main tuning control or station selector. Reaction is controlled by the upper knob at the left, while the two lower knobs belong to the filament rheostats. Between these two knobs may be seen the output jack.

methylated spirits on a smooth rag will remove all greasy marks. Sometimes a bakelite panel which is badly marked may be improved wonderfully by the happy combination of Brasso and elbow grease. This is mentioned by the way.

When the panel is finished, it should be screwed to the baseboard, after which the condenser, vernier dial, tuner, jack and the two rheostats are secured in place. The remaining parts are screwed to the baseboard in the approximate positions indicated by the drawing. In mounting the valve sockets and transformers, care must be exercised to see that the terminals of these instruments face in the correct direction. For instance, in referring to the drawing (Fig. 5), it will be seen that the "P" (plate) and "B+" terminals of the transformers face towards the right-hand end of the baseboard, viewing it from the back. Similarly, the valve sockets must be mounted with the arrow pointing in a direction corresponding with that shown in the drawing. The grid condenser C2 is mounted about half-an-inch above the baseboard by means of a long screw which passes through one eyelet hole in the condenser (the left-hand one, from the back), a short piece of ebonite tube or even a small block of wood acting as a spacer.

Note the miniature bakelite panel, screwed to the back edge of the baseboard, which carries the aerial and earth terminals. This small panel, measuring 3in. x 2in., also has a hole drilled through it level with the baseboard, through which the battery cable passes, thus anchoring it in place.

Wiring.

"Glazite," a soft-drawn tinned 18-gauge wire covered with an easily-removed insulation, was used to connect up the various components, and gave very satisfactory results. As usual, the filament circuits are wired first, care being taken to solder any joints which must be made. Many people find it difficult to follow the conventional diagram (Fig. 3), so the pictorial diagram (Fig. 5) has been prepared for their assistance. This will be found quite easy to follow if time and care is taken to trace each connection from point to point. Do not make the mistake, though, of bending each wire to the exact shape shown in the drawing. The artist must draw each wire so that it will show clearly, and for that reason he is forced sometimes to choose a round-about route for a connection. You see, he cannot draw one wire above another, so he must show them side-by-side.

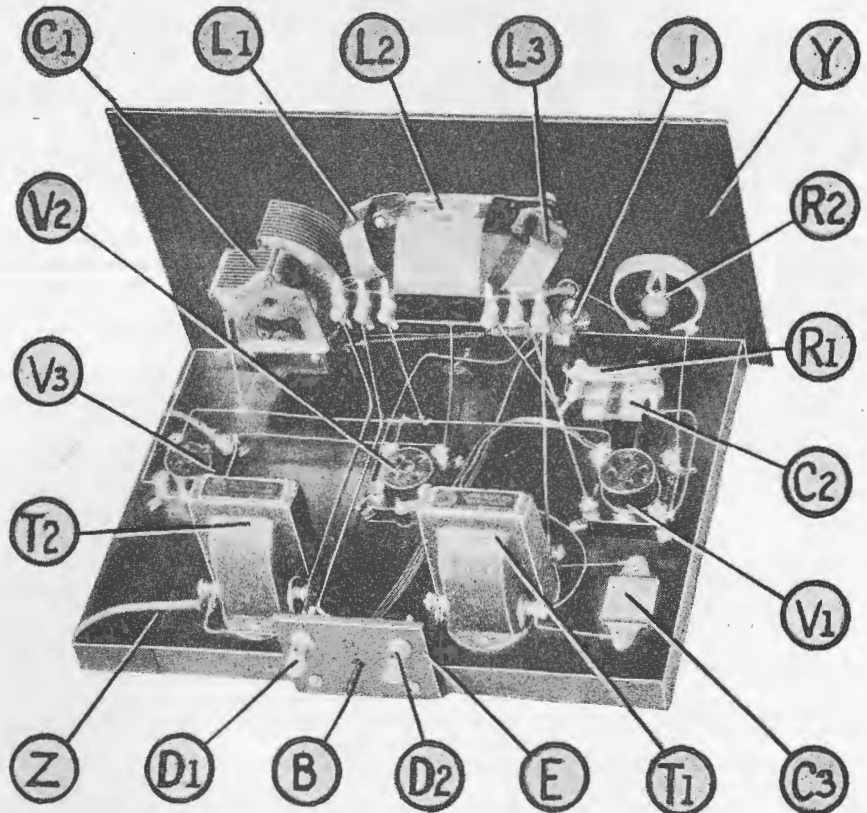

FIG. 2—A Rear View of the Completed Receiver. The two loose wires at the left are the "C" battery connections. The layout is simple, and the connections short and direct.

The Parts and Their Cost

B—Acme Celatsite 5-wire battery cable	2/6
C1—Emmco .0005-mfd. Stratelene condenser	12/6
C2—De Jur .00025-mfd. grid condenser with clips ...	1/6
C3—Simplex .001-mfd. fixed condenser	1/6
D1, D2—Nickelled phone terminals, 4d. each	/8
Y—Bakelite terminal panel, 3 x 2 x 1/2 in.	/6
J—Electrad single circuit jack	1/3
L1, L2, L3—Primary, secondary and tickler of Radi-	
okes three-coil tuner	14/6
R1—H. & H. 3-meg. grid leak	2/-
R2, R3—Monarch 30-ohm. rheostats, 3/3 each	6/6
T1, T2—A.W.A. Superaudio transformers, 3 1/2 to 1	
ratio, 18/- each	36/-
V1—Emmco balanced socket	2/6
V2, V3—Parker U.X. sockets, 2/- each	4/-
Y—Bakelite panel, 13 x 7 x 1/2 in.	7/6
Z—Pine baseboard, 12 x 9 x 1/2 in.	1/-
R.E.L. vernier dial	3/9
Emmco arrow knob (for tickler control) 1/-	
1 Coil (10 feet) Glazite wire	1/3



**Total Cost
of Parts**

£5/0/5

Your job is to connect together the points which are joined together in the drawing by the black-and-white lines, and, as a rule, you should run your wires by the shortest possible route. You might find it helpful to darken in each wire in the drawing with pencil or pen as you make the corresponding connection in your set. This will guard against the chance of leaving out perhaps one connection under the impression that your set is completed—a very easy thing to do. Notice that some wires—particularly the one joining together the positive (left-hand) terminals of the three valve-sockets—have one or more wires connecting on to them at points midway between terminals. These joints are best soldered; it is perhaps unnecessary to mention that the covering must be scraped off the wire whenever any joints are made, or wherever it is clamped under a terminal.

In screwing down the fixed condenser C3, do not tighten down the screws too much, or the plates will be bent and the capacity changed. The screws should be just tight enough to hold the wires in firm contact with the lugs. It will be observed that the battery cable is connected directly to the terminals on the components, thus obviating an unnecessary and tiresome row of battery terminals. The colours of the five wires comprising the cable are marked in the drawing, and should be adhered to if possible. Some makes of battery cable,

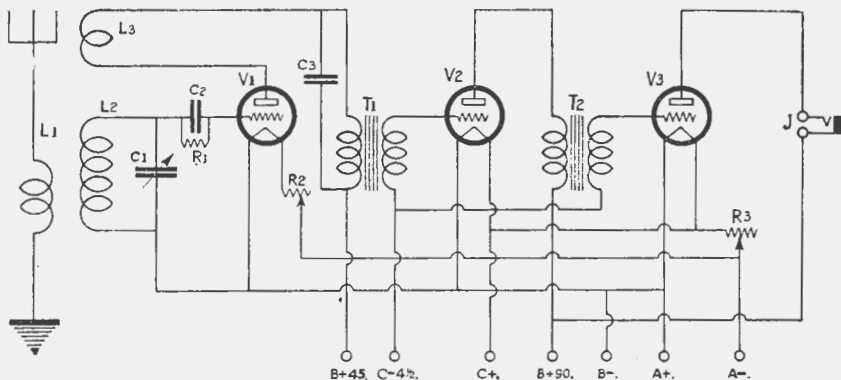

FIG. 3—Showing the Circuit in Diagrammatic Form. The rheostats R2 and R3 control the filament temperature of the detector and audio valves respectively.

We Surprised Ourselves!

The beautiful tone quality and excellent "punch" delivered by this set was a revelation—even to the "Tec. Ed."

Here is a little set that will enjoy wide popularity. It is absurdly inexpensive; it is easy to build; and, above all, it puts up a splendid performance.

however, are coloured differently from those shown, and, in that event, the constructor is at liberty to please himself as to which colour he uses for "A" battery positive, etc. The colours simply provide a means of identifying each wire at the other end—the battery end—of the cable. For instance, in the present receiver, the black wire is connected to the filament rheostats, which we know should be connected to the negative of the "A" battery. Therefore, at the battery end of the cable, the black wire must go to the negative terminal of the "A" battery, and so on. It will be understood that it would make absolutely no difference if the wire we connected to the rheostats happened to be purple, or any other colour, provided the wire of similar colour was connected to "A" battery negative at the other end.

Connecting the Batteries.

It is most important that all connections in the set should be checked over carefully before connecting up the batteries and inserting the valves. This applies in particular to the filament circuits, as one wrong connection here may spell disaster in the form of three burnt-out valves—rather a costly way of discovering a mistake.

Assuming that you are quite satisfied as to the correctness of your wiring, turn the knobs of both rheostats as far as they will go towards the left counter-clockwise), and connect the batteries as follows:

The **black** wire to the negative terminal of your accumulator ("A" battery). The **red** wire to the **positive** terminal

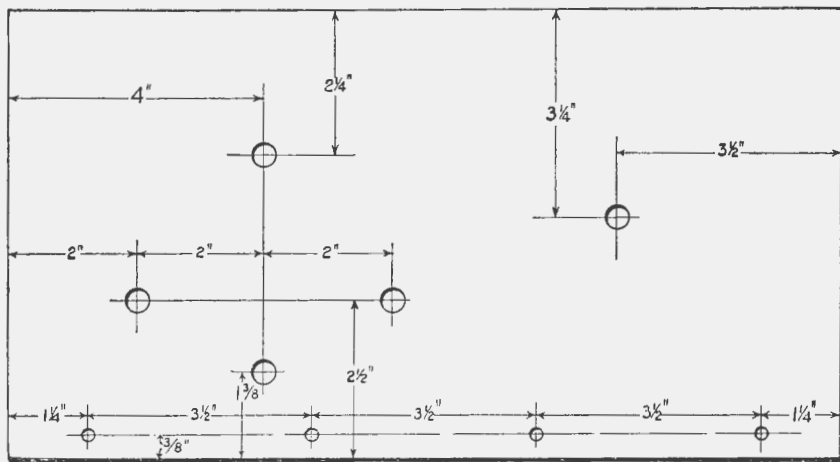

FIG. 4—Dimensions for laying out the panel are given in this drawing. The panel measures 13 x 7 inches.

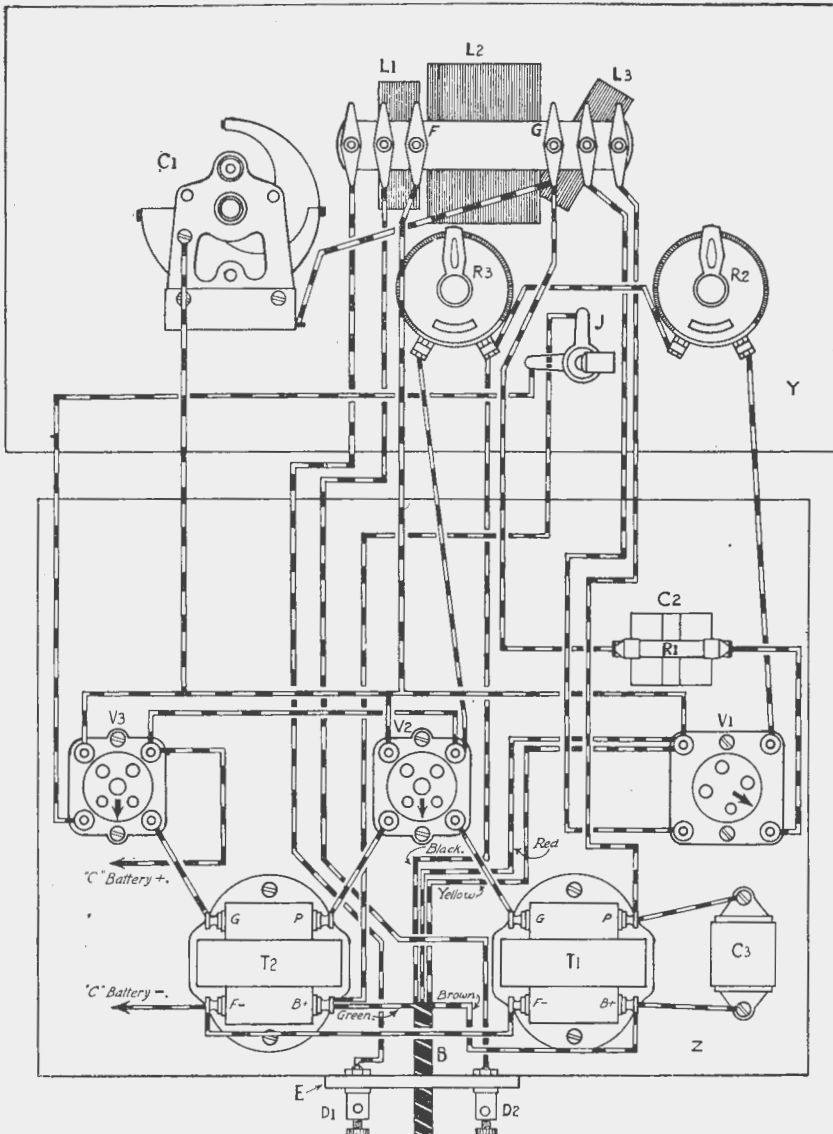

FIG. 5.—For those who cannot follow Fig. 3, this Pictorial Diagram is given. The various connecting wires are represented by the black-and-white lines. Note the connections for the battery cable "B": black to "A" battery negative; red to "A" positive; yellow to "B" negative; brown to "B" 45 volts; and green to "B" 90 volts. This is explained fully in the text.

of the same battery. A minus sign usually distinguishes the negative terminal, while the positive is indicated by a plus sign, or is coloured red. If you intend to use 4-volt valves, then you must have a four-volt accumulator; for six-volt valves, a six-volt accumulator must be used.

For best results a "B" battery voltage of 90 should be used, this being furnished by two 45-volt batteries connected in series. Connect the **yellow** wire to the negative (minus) terminal of one "B" battery. The **brown** wire goes to the "plus 45" terminal of the same battery, and from this same terminal a short piece of wire is taken to the "minus" terminal of the second "B" battery. The **green** wire is connected to the "plus 45" terminal of the second battery.

Now a 4½-volt "C" battery is connected to the two wires at the left-hand end of the base-board (referring to Fig. 5), the wire marked "C plus" being connected to the positive terminal of the battery, and the other to the "minus 4½" terminal. After the set is in operation, the effect may be tried of moving the last-mentioned wire to the "minus 3" terminal of the "C" battery, leaving it on the terminal which gives better results. In any case, do not omit the "C" battery, as it is a necessity for the proper operation of the amplifier, and, besides effecting a considerable saving in "B" battery consumption, greatly improves the tone quality.

Valves.

As to the matter of valves, we can only say that there is a wide range from which to choose, and it is a safe policy to be guided in this respect by the counsel of your dealer, who will be able to offer you sound advice. In our set, we are using three Cossor valves, type 410-L.F., working on a small 4-volt accumulator, and these valves are giving every satisfaction. Using these valves, and assuming that the receiver is in use for an average of three hours each night in the week, a 20-ampere-hour accumulator such as may be obtained for a small sum from any radio dealer, may be expected to give about three weeks' service for each charge.

While a dry "A" battery consisting of three dry cells is feasible with suitable valves, a small accumulator is strongly recommended, as, in our opinion, it is false economy to use dry cells—which must be replaced frequently and are not at all satisfactory under continuous use—when an accumulator is procurable for such a reasonable outlay, and is so easily and cheaply recharged.

Operation.

When the valves have been pushed into their sockets—the pin on the side of the valve being immediately above the arrow-head or dot on top of the socket—the aerial and earth wires are to be connected to the two terminals on the back of the set; it is immaterial in this receiver as to which is which. The loud speaker cord must be equipped with a phone plug, which is inserted in the jack on the panel and pushed well home.

No battery switch is provided, the set being turned on by turning both rheostats about three-quarters of the way to the right. Attention must now be paid to the three-coil tuner. It will be found that it is possible to swing the primary coil L1 away from the large coil (secondary) L2. To begin with, set this coil as close to the secondary as possible—that is, parallel with it.

When the knob which rotates the tickler coil L3 is turned towards the right (clockwise), the set should go into oscillation, this state being indicated by a soft thump and then a continuous hissing sound.

To tune in a station, turn this knob to the right until oscillation is present, then slowly rotate the vernier dial until a whistle or carrier-wave is heard. Now turn the tickler knob back towards the left until the music or speech is clear. A further slight adjustment of the vernier dial probably will be necessary for maximum volume. The desired strength may be obtained by varying the tickler knob; the volume will increase as this knob is turned towards the right, until a point is reached at which the circuit will break into oscillation and a howl will be heard. City dwellers will find that this control will have practically no effect on a local station; it is really an "intensifier," whose function is to increase the sensitivity of the circuit sufficiently to permit reception of distant stations. The two rheostats should be experimented with for best reception. They are not at all critical in adjustment, but should be turned no further towards the right than is necessary to give maximum results. Whenever you are finished listening, be sure to turn both rheostats as far as they will go to the left; this

switches off all current, and it is unnecessary to disconnect any wires from the receiver.

When used in the city area, this receiver works very well with a simple wavetrapp, such as has been described several times in past issues of this journal. At a distance of 2½m. from 4QG, no trouble was experienced in eliminating the local station and tuning in 3LO Melbourne, with a "Q.R.N." wavetrapp connected between the aerial wire and the receiver. It will be as well to make mention at this point of a peculiar absorption effect which was noticeable on the wavelength of 2FC Sydney, while the wavetrapp was in use. This effect (which the writer has often noticed on many other types of receiver operating with a wavetrapp) was easily overcome by the simple expedient of swinging the movable primary coil L3 away from the secondary coil until 2FC was received at good strength. It is worth recording that this station, when tuned-in to maximum intensity, oftentimes was far too strong to be comfortable in a large room. Here is an important point, however: When receiving any station on a lower wavelength than 4QG (such as 2BL and 3LO), the best results were obtained with the primary coil set parallel with the secondary. Only on stations above 4QG was it necessary to move the primary at an angle.

The size and type of aerial does not matter greatly, but, as is usual, it will be found that a long, high wire will yield best results on distant reception. By "long" is meant up to 100 feet. Of course, if the set is located close to 4QG, a much shorter aerial may be advisable in order to permit the necessary degree of selectivity to eliminate the local station.



Ask your dealer for Diamond

DIAMOND Radio Batteries

Ask your dealer for Diamond

Diamond Radio Batteries are powerful, silent, and outlast any other make of Dry Cell. More than a million are manufactured in Australia annually. Every cell is guaranteed, and should a fault be found in any Diamond Dry



Cell it will immediately be replaced. Remember, a Radio Set is no better than its battery, therefore it is most essential to choose a battery that will give long and honest service. Such are Diamond Dry Cells.

RETAIL PRICE LIST

- "A" Buzzer Cells, 1.5 volt 2/9 each.
- "B" 60 volt Super B. Battery, 27/6 each.
- 45 volt Super B. Battery, 22/6 each.

- 60 volt Standard B. Battery, 18/ each.
- 45 volt Standard B. Battery, 15/ each.
- "C" 4.5 volt "Biacon" C. Battery, 3/3 each.

Wholesale only from:—
JOHN REID & NEPHEWS,
 CHARLOTTE STREET,
 BRISBANE.

Manufactured by
WIDDIS DIAMOND DRY
CELL COY. LTD.
 W. Melb., Vic.

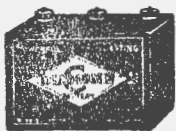

SUPPLIED TO
ALL GOVERNMENT
DEPARTMENTS

CLYDE

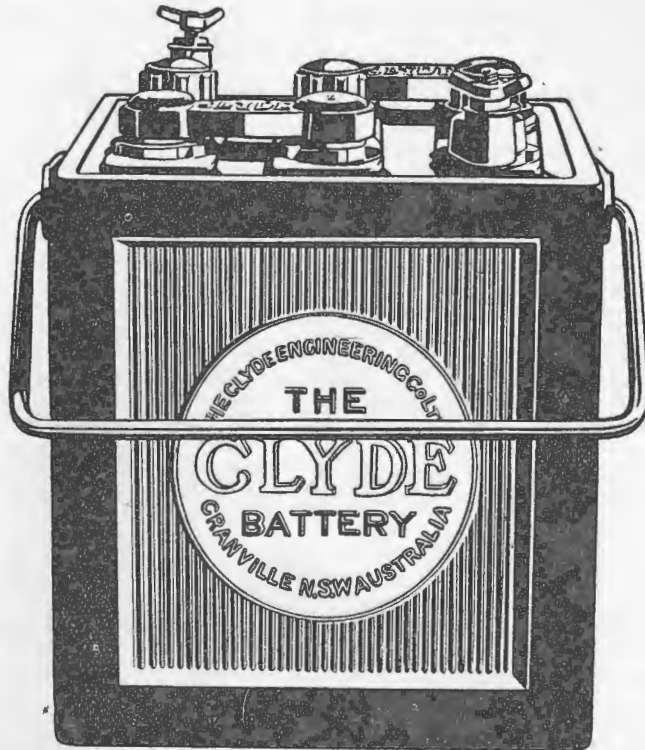

*Clyde for Cars
Radio and
Home Lighting*

It hardly needs our continued assurance to convince you that Clyde is a good battery.

If you want more, just ask the man who has been using a Clyde Radio Battery for twelve months or more.

Provided he has given it decent, ordinary atten-

tion, he will tell you that it is as good to-day as the day he bought it.

He will tell you that it has given him—right through—steady, silent service, without trouble or worry—that it has stood up to its work as a good battery should.

Depend upon it. You're quite safe in buying a Clyde

Made by the CLYDE ENGINEERING CO. LTD., GRANVILLE

Battery Sales Dept., MAIN SERVICE STATION, 106-110 Goulburn Street, SYDNEY

The Radio and Electrical Exhibition

The much-talked-of Radio and Electrical Exhibition is but two weeks away, and by all indications, this Show is going to provide a wonderful week for Brisbane.

Elaborate plans and arrangements have been proceeding for weeks past, and it is anticipated that the big Bohemia Theatre will prove none too large to accommodate the huge crowds that will throng the building from 10 a.m. to 10 p.m. each day.

The Exhibits.

Practically every radio house in Brisbane will be represented at the Radio and Electrical Exhibition, and each exhibitor is vying with his competitor in arranging displays of the latest and most efficient wireless apparatus.

All the new and wonderful ideas that are associated with the science of radio will find a place at the Exhibition. Batteryless sets, battery eliminators, the new A.C. valves, screen-grid valves, material for building A.C. sets, the latest ideas in short-wave equipment, etc., will be on view.

The big electrical houses will also display electrical equipment for the modern home and office. They will prove how economically and efficiently electricity may be utilised in making housework lighter and homes brighter.

The Amateur Section.

One of the features of the Exhibition will be the amateur section, which is being run under the direction of this journal. At the time of going to press with this issue, a splendid response in the shape of entry forms has greeted our appeal for support from the amateurs. Ten sections, covering every field of amateur radio, have been arranged, and a heavy prize list, donated by the Radio Traders of Brisbane, is offered.

<i>Dressing Rooms</i>		STAGE <i>4QG Demonstrations.</i>	<i>Dressing Rooms.</i>		
1. 2. 3. <i>Amateur Exhibitors' Stands.</i>		Orchestral Well.	10. 11. <i>Crackson Bros.</i>		
		SEATING			
4. <i>W. & Henleys'</i>		ACCOMMODATION	12. 13. <i>Noyes Bros.</i>		
		14. <i>Mullard Valves.</i>			
5. 6. <i>Philips Radio.</i>				15. <i>Edgar O. Hudson</i>	
		7. 8. 9. <i>Amalgamated Wireless J. B. Chandler; Sole Q'land Distributors.</i>		16. <i>W. G. Watson.</i>	
19. <i>Harringtons Ltd.</i>				17. <i>James Campbell.</i>	
		20. 21. 22. <i>Australian General Electric Co., Ltd.</i>		18. <i>Warburton Franki.</i>	
25. <i>Melton & Co., —and— Radio Supplies Unlimited.</i>				23. <i>Brisbane City Council.</i>	
		Offices.			

At the last Radio Exhibition, the amateur stall was the big attraction. The skill and ingenuity of the entrants, particularly in the novel sections, were of a very high order.

This year, with more entrants, more license holders and a greater all round interest in radio generally, the exhibits should be better still.

Those readers desirous of entering for any of the sections detailed elsewhere in this issue, are reminded that entries close on Monday, July 9th. Entry forms are available at all radio traders or direct from 4QG or this office.

4QG to Broadcast from the Stage.

Practically the whole of the sessions of the week (July 16th to 21st inclusive) are to be broadcast from the Radio and Electrical Exhibition. The stage will be arranged in the form of a broadcasting studio, and the artists will appear thereon. Thus those people who visit the Exhibition will enjoy a three-fold attraction. They will be enabled to view the many attractive displays; they will witness an actual demonstration of broadcasting; and they will be provided with musical entertainment by the artists appearing.

Bedtime Story-tellers to Appear Every Evening.

The hearts of juvenile listeners will bound with glee when they know that the beloved bedtime story-tellers will be in attendance at the Exhibition every evening from 6.30 to 7.15 p.m. to tell the stories and to personally meet the children. Huge crowds are expected at these sessions, and the Director of 4QG has issued a piece of advice to mothers that might well be heeded. In view of the undoubted popularity of the bedtime story session, mothers or fathers and their children are advised to be at the Exhibition early to avoid the crush.

Good Seating Accommodation.

It is worthy of note that good seating accommodation has been provided at this year's Exhibition. At the last Radio Exhibition the only seating accommodation available was in the gallery, which was not only inconvenient to reach, but far removed from the stage.

The plan of the exhibits published herewith shows that good seating accommodation has been provided on the main floor of the Exhibition.

It will thus be possible for visitors to wander around the stalls, inspect the exhibits, and then seat themselves comfortably in the main body of the hall and enjoy the entertainments provided on the stage in the form of broadcasting demonstrations.

The Premier to Open the Exhibition.

The Premier, Mr. W. McCormack, M.L.A., has consented to officially open the Radio and Electrical Exhibition on Monday, July 16th. The ceremony will take place on the stage at 8.15 p.m. The function will, of course, be relayed.

A Souvenir Handbook.

Those who visit the Exhibition will doubtless want to secure some souvenir of this big show. A handsome souvenir handbook is now in the hands of the printers, and will be available at the Exhibition for a nominal sum.

Make a Point of Being There.

It behoves every wireless listener who can attend to make a point of attending Brisbane's great Radio and Electrical Exhibition. It will be the biggest individual display yet made in Brisbane by any one industry, and its success can only be assured by the practical support of the listening public.

Bring Your Friends.

If you have friends who are not yet won for wireless, bring them along to inspect the new radio apparatus. The Radio Inspector will be attendance to supply any information and issue licenses.

WIRELESS LINKS.

Before the end of this year, it is said, all the great cities of Europe will be exchanging programmes for wireless broadcasting. London is, of course, prominent in the scheme. Special telephone lines are now being laid. The difficulties are many—both technical and political—but they are steadily being surmounted.

Let Me Teach You MORSE

If you would become proficient in Morse Sending and Receiving, let me coach you, as I coached 4RB, 4AZ, 4BO and others, including commercial operators. Sounder or Buzzer method; speed and proficiency guaranteed; terms moderate.

CHAS. RUNGE

(3 Years' Experience as a Morse Instructor; Several Years as a Commercial Operator.)
Address enquiries c/o "Queensland Radio News,"
Box 1095 N, Brisbane.

TISIT

A Liquid Solder

No Heat Required
No Soldering Iron Needed

TISIT is a liquid solder that is applied cold with a stick. No heat or soldering iron required. It is heat-proof and acid-proof. Easy to use and always ready. Dries in 20 minutes.

TISIT is the only known solder for aluminium, and is used successfully on radios, steam pipes, cracked radiators, cracked cylinder heads, petrol tanks, leaky milk cans, pans, pails, kitchen utensils—in fact, any place where solder can be used.

PRICE: 2/11 per bottle, sold by all hardware stores and radio Dealers.



Queensland Distributors:

Canada Cycle & Motor Agency (Q) Ltd.

Adelaide and Creek Sts., BRISBANE

My Early Broadcasting Experiences



It is one thing to have accomplished things in the past, and quite another to recount them after the lapse of some six or seven years, but I will try to ransack my brain for some of the earliest episodes in connection with broadcasting and my association with it, and to tell you of some of my early experiences on the air.

My first contact with broadcasting was at 2LO London. In those days they had a tiny studio off the Strand, and everything appertaining to broadcasting was looked upon as a clever and precocious toy. I naturally had great feelings of expectation and eagerness to find out what it all meant and whether it was not really—in a sense—a huge joke to make artists sing into some mysterious apparatus, which faced one in a darkened room, draped in such a state as to make it look more like a padded cell for a raving and dangerous lunatic.

And so, one evening, I found myself in these surroundings, accompanied by a dread silence, due to the padding, which removed all possible trace of echo or overtone. The lack of ventilation in those days, coupled with the dim light and sombre drapings, made me feel that I was about to undergo some "hair-raising" experience. However, I was soon set at ease by a genial young fellow who acted as an accompanist, clerk, and keeper of the microphone—and later I learned that his duties also included the cleaning of the studios.

In this connection I would like to point out the fact that there were only a few persons associated at that time with the actual transmission of wireless entertainment and news, and consequently each man had to act in a "general cook" capacity. Of course, we know that 2LO is now one of the most gigantic organisations of its kind in the world; that its studios are the finest; its staff numbers many hundreds; and its offices occupy a tremendous building at Savoy Hill, off the Strand.

As soon as I had to start singing my song into the microphone, I experienced a terrible shock, commonly known as "microphone fright," resulting in a partial paralysis both of brain and voice. The experience had the effect of making me sweat just as though I had been in a Turkish bath. I suppose I must have been singing (though I was not conscious of it) for,

By

RAYMOND ELLIS A.R.A.M.

Mr. Raymond Ellis is recognised as being one of the most successful broadcasting artists in the world. This exclusive article will be read with interest by Australian listeners who have enjoyed the privilege of hearing Mr. Ellis sing from 2FC and 4QG, during his sojourn in Australia



a few minutes later, when the engineer in charge of the control room peered in through some curtains with the remark, "Would you, please, Mr. Ellis, not yell into the microphone?" I answered that I was not aware I had been singing, as I had not heard one tone of my voice—resounding anywhere within the precincts of this temporary lunatic cell—whereupon he at once, with a twinkle in his eye, assured me that I was being heard quite all right, and that the deadening of the sound was essential for broadcasting, and that I must take it easy and the result would be satisfactory.

A few moments later I emerged from the cell, feeling once more a "free man" and having again the pleasant joy of breathing fresh air and hearing myself actually talk. Since that experi-

ence—which was by no means very pleasant—I have appeared on numerous occasions on the air at 2LO, and as time went along the technicalities regarding broadcasting improved rapidly, and conditions for vocal broadcasting became more pleasant.

I have always a very happy recollection of one experience when, for the first time in the history of wireless entertainment anywhere in the world, an actual opera was broadcast from Covent Garden Opera House by 2LO in January, 1923. The Opera in question was "The Magic Flute" (by Mozart), performed by the British National Opera Company, and I was in the cast playing that delightful role of "Papageno." I remember distinctly on that night how several mechanics on the staff of 2LO were busying themselves in the wings of the Covent Garden stage, endeavouring to obtain a good land-line transmission through to their 2LO station, while their announcer quietly from the wings, occasionally interrupted the music as it was being broadcast to tell the people what was being enacted on the stage as they were listening to the music. In those days it was thought essential to give such explanations. As we know now, many works are given with explanatory notes beforehand, thus preparing listeners for what is coming later.

I will never forget the remarkable sensation that the broadcast of this opera—"The Magic Flute"—caused in the world, for the very next morning the whole of the English Press had wonderful front page comments in large type, proclaiming this new toy of wireless entertainment as the greatest achievement

in modern science, and it may interest you to know that since that day, wireless in Great Britain assumed such importance that to-day it is the finest organised system of wireless entertainment disseminated anywhere in the world.

Since those early days I have had the pleasure of being broadcast on many occasions—too many to remember—from Covent Garden and various other theatres in London and the provinces. It may interest listeners to know that in those early days, fees at 2LO were no better than the fees offered in Australia by the various stations in their early financial struggling times, but of course we know that 2LO now pays the highest fees for broadcasting in the British Empire. These are a few details of my connection with broadcasting in its early beginning.

For the last two years I have had the extreme pleasure of being a resident in Australia, where broadcasting, to my mind, has made remarkable strides, especially considering that the population is so small and the income of the various stations is accordingly small. It is really remarkable how some of the stations have been able to carry on so far with such success.

I find that some Australian programmes are built in an elastic manner, thus giving an opportunity of inserting any item of interest at the very last moment. That is, to my mind, a most commendable idea, as it gives variety frequently to the programmes at a time when it is most essential. In Great Britain, programmes are arranged months ahead, and they are carried out practically in their entirety, without adding anything that may be of interest to the listening public at the eleventh hour. I understand that elasticity in British programmes has very recently set in. Knowing the sport-loving instinct of Australians generally, I think that the description of various sporting events is a splendid idea, for it affords opportunities for people to follow these events from points which they could not possibly reach otherwise.

My association with broadcasting in Australia has been a very pleasant one. I have appeared practically at all stations, and have enjoyed the experience tremendously. I desire, however, to make a special reference to 2FC Sydney, with which station I have been mostly associated during my sojourn in Australia, but they were numerous. I have found the people responsible for the destiny of 2FC very human indeed. I believe I am making no mistake when I state that 2FC possesses the only musical manager controlling a broadcasting station in Australia, who is a keen business man as well as possessing a delightful personality, thus obtaining wonderful results from his artists. My association with 2FC has been very pleasant, and as an artist I appreciate very much the conditions existing there, for, above all, for an artist to give of his best he must be surrounded by people who are well disposed towards him, and who understand the temperament and all that appertains to artistic entertainment. Such an atmosphere definitely exists at 2FC.

Another station at which I recently appeared was 4QG Brisbane, where the surroundings, too, are very pleasant, and I have since learned that the 4QG Director has been an associate for quite a while with that bubbling personality—Mr. Oswald Anderson—of 2FC, and, by the way, these two gentlemen have a

very high opinion of each other—and that is how it should be.

In closing, I would like to tell Queensland that 4QG station has a capable director and is aided by very fine staff, and I am grateful to them all for assisting me and making my recent visit to 4QG a happy one.

WHERE TO PUT THE LOUD SPEAKER.

"A place for everything—and everything in its place." So ran an old copybook heading, and it is essentially true of the loudspeaker.

There is one position in every room where a speaker will be heard to the best advantage, and generally this is found to be at some spot above the level of the listener. The actual place, however, can only be determined by experimenting.

There is a new cone speaker now available in this country, which is designed to hang from the picture rail—the Amplion Junior Hanging Cone. It has a copper finished diaphragm, surrounded by a chocolate brown frame, and is strikingly handsome in appearance. It is easy to place such a speaker to advantage. Giving wonderfully natural reproduction and being cheap as well as useful and ornamental, this speaker has become one of the most popular cones in England. Incidentally it is 100 per cent British.

ITALIAN BROADCASTING.

The Italian broadcasting station has substituted the Mussolini Hymn for the Royal Anthem at the close of its programmes.

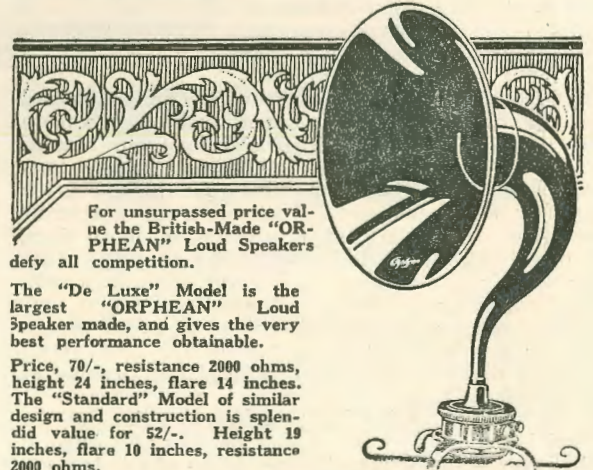

For unsurpassed price value the British-Made "ORPHEAN" Loud Speakers defy all competition.

The "De Luxe" Model is the largest "ORPHEAN" Loud Speaker made, and gives the very best performance obtainable.

Price, 70/-. resistance 2000 ohms, height 24 inches, flare 14 inches. The "Standard" Model of similar design and construction is splendid value for 52/-. Height 19 inches, flare 10 inches, resistance 2000 ohms.

The "ORPHEAN GEM" the STANDARD MODEL. cheapest efficient British Loud Speaker, is obtainable in marvellous price value. Costs only 30/-. Height 19 inches, flare 10 inches, resistance 2000 ohms. The "Oriel," for those who favour the cabinet type, is a splendid instrument at 60/-. Size, 15 inches by 9 inches by 4½ inches. Enclosed in an artistic Oak Cabinet.

Write for Illustrated Leaflets No. 17 to

LONDON RADIO MFG. CO. LTD.

STATION RD., MERTON, LONDON, S.W. 19, ENGLAND
The NEW ZEALAND LOAN and MERCANTILE AGENCY
CO., LTD.

538 COLLINS STREET, MELBOURNE

DON'T YOU THINK YOUR RADIO SET COULD BE IMPROVED ?

If Philips "Miniwatts" are NOT in every socket of your receiver, then certainly there is ample room for improvement. It is only when you take a full set of these mighty valves home, and place them in your receiver, that you realise they are DIFFERENT. See that you are using the *correct types* by either writing to us, or asking a GOOD dealer.

Whatever you do, see that you get a copy of our attractive and informative Valve Folder.

Don't forget to Visit
Stands 5 and 6
at the
Radio and
Electrical Exhibition



Advt. of Philips Lamps (Australia) Ltd. (Radio Department), Head Office and Showrooms, Cnr. Clarence and Margaret Sts, SYDNEY, N.S.W.

PHILIPS

"MINIWATTS"

8R31

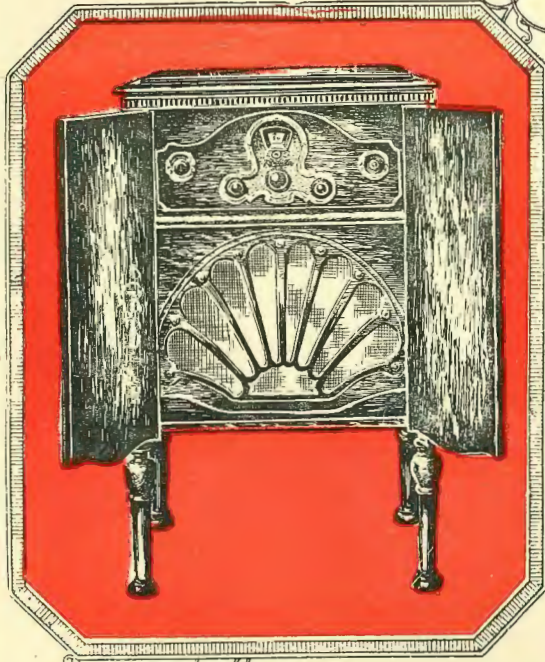

From Grand Opera to the Lightest Orchestra with Perfect Precision and Harmony.

The realistic tone of the RADIOLA Screened Six will bring you singers as if you were in their presence, and dance orchestras as if they were in the same room. This exquisite quality is attained through scientific shielding—electrically and mechanically correct.

Music is reproduced as it was produced at the broadcasting station, even the lowest bass or the highest treble is given its true quality and value. The RADIOLA is a six valve uni-control floor Cabinet Receiver.

It has built-in Amplion Cone Speaker, apartments for housing power equipment or batteries, illuminated station selector and volume and intensifier controls. You must see and hear the RADIOLA Screened Six to appreciate it fully.



A Fine Range of Models

Small and Large

In its Table Type Cabinet this RADIOLA is extremely artistic and pleasing in appearance. Like the RADIOLA Screened Six, it is a six valve receiver of the uni-controlled type. Stations are tuned in by means of a single illuminated dial. The perfect mellowness of tone, and full volume of this super-instrument, makes an appeal to the most cultured musician, whilst its high efficiency and ease of control make it simple enough for a child to operate. You must hear this new RADIOLA to realise what it brings you in Radio.

The New RADIOLAS

Completely Manufactured in Australia by

Amalgamated Wireless
(Australasia) Ltd.

Distributors for Queensland

J. B. CHANDLER & Co.

Queensland's Largest Radio Store

Adelaide Street

BRISBANE

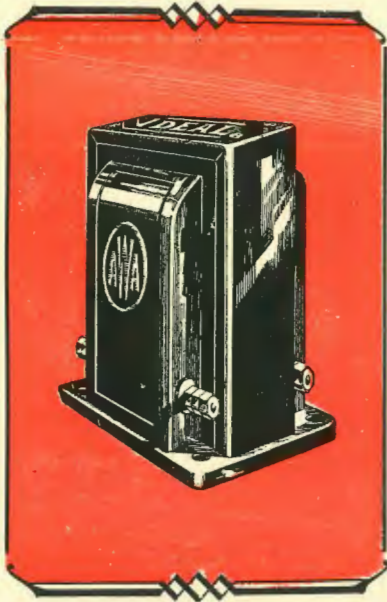

The Transformer that gives Realism to Radio Reception~

Wonderful realism in reproduction. What radio enthusiasts have hoped for and radio engineers have striven for since the inception of radio—that describes the new A.W.A. IDEAL Transformer. Designed by the research engineers of A.W.A., the special features which make the A.W.A. IDEAL Transformer outstand are: increased size of iron core, more copper used in windings, minimum air gap, robust construction, and handsome phosphor bronze enamel finish—all conducting to make it the IDEAL Transformer. Instal A.W.A. IDEAL Transformers in your receiver. The result will be flawless realism, even to the ear of the trained musician.

A.W.A. IDEAL TRANSFORMER.

Supplied in following ratios: 2-1, 3½-1, 5-1, and 9-1. Output Transformer, 1-1.

Makes Tuning Easy and Efficient

The new A.W.A. Logarithmic (Centraline) Condensers have been designed especially for Australian conditions. They meet the demand for a variable condenser suitable for use either singly or in "gang operation." These condensers have been designed with true logarithmic characteristics which eliminates bunching of stations and makes tuning easy. The insulating material has been kept extremely low; minimum capacity is low; true alignment with contact bearings and rigid construction ensure free from all troubles.

A.W.A. LOGARITHMIC (CENTRALINE) CONDENSERS.
Procurable in all standard capacities.

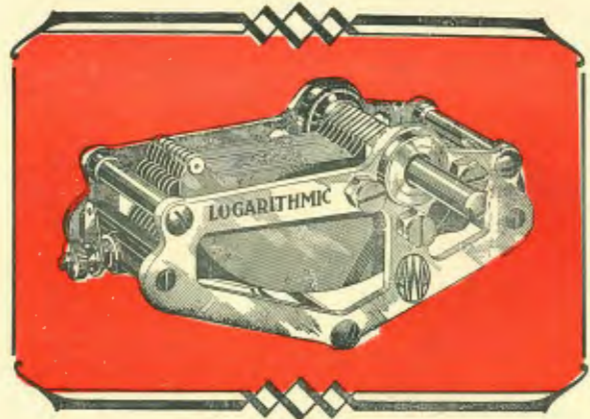

Wholly Manufactured in Australia by

Amalgamated Wireless
(Australasia) Ltd.

Distributors for Queensland

J. B. CHANDLER & CO.

Queensland's Largest Radio Store

Adelaide Street

BRISBANE

SO THIS IS TRACKSON'S PRICE!

SPECIFICATIONS

2 stages of audio frequency; 2 stages radio frequency; 1 detector, shielded parts and tested condensers approved by leading radio laboratories; highly sensitive and extremely selective.

Every "World" Receiver is complete with cable of 7 coloured strands, each strand marked with its proper connection to batteries and accessories.

Size of Cabinet 21 x 9 x 9 ins.

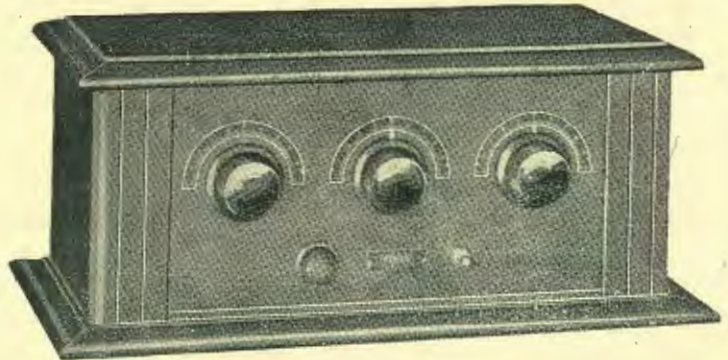

World "Compact" 5-Valve Receiver

A small but powerful 5-Valve Set with all the volume, tonal quality, and distance-getting ability of high-price sets. Handsome two-tone mahogany cabinet, inlaid design on sides. A high-grade receiver at a value made possible by the huge production of The World Radio Corporation, U.S.A.

Set Only **£12** (B)

With First Class Accessories **£21/10/-** (B)

WORLD RADIO

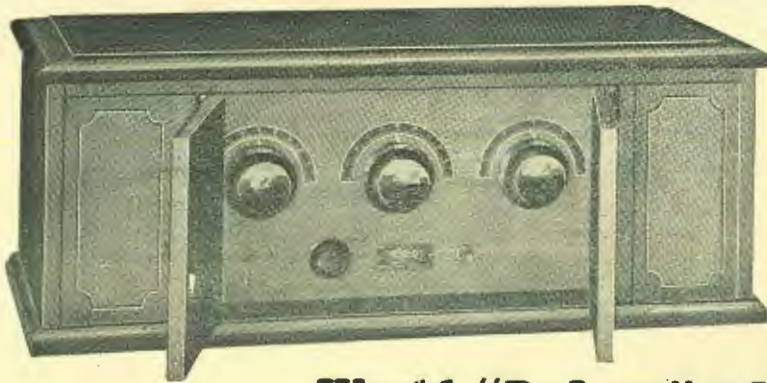

GUARANTEE

Each set is carefully inspected by experts before leaving the factory. It is unconditionally guaranteed against faulty workmanship and materials for a period of 12 months. Any defects in workmanship or materials arising will be made good, free of charge, providing the set is returned properly packed—transportation charges prepaid. This guarantee is void if set is tampered with.

Set Only **£13** (B)

With First Class Accessories **£22/10/-** (B)

World "De Luxe" 5-Valve Receiver

This model is similar to the "Compact," the only difference being the larger cabinet (24 x 10 x 10 inches), and the folding panel doors. Outwardly and inwardly "World" Radio Sets are masterpieces of radio receiver design. Selective, powerful, simple, and amazingly sweet. Note the startling price, and read the guarantee.

TRACKSON BROTHERS LTD.

157-159 Elizabeth Street, BRISBANE

Be Sure to Visit Stands 10 and 11 at the Radio Exhibition

Broadcasting the DUMB!

"Impossible!" you say. But is it? This article tells of a remarkable broadcast and a wonderful work that is being done at the Blind, Deaf and Dumb School.

RARADOXICAL though this heading may appear, it is nevertheless true. On Saturday, May 16th, a party of children from the Blind, Deaf and Dumb School at Dutton Park, paid a visit to 4QG at the invitation of Uncle Ben. The session which followed was not only an entertainment, but was also an education, for listeners actually heard for the first time in history, the voice of a dumb boy and girl speak into the microphone!

In company with Mr. Holle (headmaster) and Miss Chamberlain (music mistress), a happy, laughing party of children was whisked up in 4QG's elevator to the roof of the lofty State Insurance Building. Overjoyed at the prospect of meeting Uncle Ben and Brighteyes, they could hardly wait to reach the studio.

Most of them laughed and sang with Uncle Ben around the microphone. But they could not see him. Others were strangely silent, and although they could not hear the singing or join in the laughing of their playmates, they used their eyes to the utmost advantage in gazing at the wonders of the beautiful studios.

Listeners who were fortunate enough to hear the solos and part song of the eight blind children will not forget the sweetness of their voices for a long time.

Chatting with a representative of this paper, Mr.



Little Marie, aged 5 years, and totally blind, sings "Oh Dear, What Can the Matter Me?"

Holle explained that most deaf and dumb children were not really born dumb. Because of their total deafness, they had never heard their own or anyone else's voice. A child learns to speak only by imitation. These children had never learned to speak simply because they have never heard speech or never realised or heard the sounds that their own vocal organs are capable of producing.

So, before the microphone, this little deaf and dumb chap, with one hand placed on his own chest, and the other on the chest of Mr. Holle, repeated his vowels and simple words by feeling the vibrations caused by certain sounds and moving his lips in imitation of his teacher.

By the courtesy of the headmaster, Uncle Ben and "Ikey," together with a representative of this paper, were conducted through the institution—and what a revelation it proved to be!



The blind children who sang so nicely from 4QG recently. Miss Chamberlain, their teacher, is standing at the right, while Uncle Ben stands at the left of the picture.

Educating the Blind.

The education of the blind children, principally by the Braille system, was fully explained to the party. Most readers are already aware of the principles governing this method of reading and writing. By means of a system of perforated dots, letters and words are impressed in to thick paper. The children are taught to read by running their forefinger along these impressions.



The Headmaster, Mr. S. Holle (centre), Uncle Ben (right), and "Ikey" (left) with the two dumb children, Lena Newton and Walter Bergeman, who spoke from 4QG.

Geography is taught by the aid of a huge globe upon which continents and islands are raised in relief, while arithmetic is taught on special "slates" made to hold a series of raised metal type, a different style being provided for each figure from 1 to 0.

Educating the Deaf and Dumb.

Whilst the education of the blind was most interesting, the education of the deaf and dumb was nothing short of marvellous.

The first class to be visited in this school was the infants' class. Here were tots of four and five who did not even know the meaning of the words "father" or "mother."

A lady teacher, whose greatest virtue must surely be patience, restores dead vocal chords to life. Normal children of four or five years of age are not always easy to teach, and these children, because of their affliction, are naturally backward.

First of all the child has to be taught to breathe properly, and the vocal organs, relaxed through disuse, have to be brought into a normal condition. By showing the deaf child how to form a sound and letting him feel the vibrations on the teacher's chest, head, or throat, it soon understands that it has to imitate the open mouth of the teacher, and so opens its mouth and tries to produce a vibration like that which it has felt. The lesson goes on at intervals until good sounds are produced. The characters for the sounds are then written on the blackboard, and then pointed to when the sound is made. This example sufficiently explains the method of teaching the elementary sounds, instruction and drill, which often occupy the whole of the deaf child's first year at school.

As the higher classes were visited, a corresponding advancement was noticed in the ability and work of the children.

Lip-reading is taught as soon as the child has acquired sufficient knowledge of the language.

Time was—and not so very long ago—when the deaf and dumb were taught solely by their own silent language. To-day, by modern methods such as practised in the Queensland Blind, Deaf and Dumb School, children are taught to speak and lip-read as well, which helps them to enjoy life to a far greater extent than were they confined to the one mode of conversing.

In the senior class some most astounding demonstrations of lip-reading were given. Mr. Holle walked into the class-room and, pointing to one of the girls in the class, told her to take her book from her desk, open it at a certain page, and lay the opened book on the teacher's table.

The child was totally deaf, yet by reading the headmaster's lips, did as she was bid with alacrity. One by one the children, at the command of Mr. Holle, went through a severe test of lip reading without a fault. By their training, the deaf are taught to "hear" and, though dumb, are taught to speak their answers.

Tests of mental arithmetic, geography, etc., were given them, and the ready response shown by the children was conclusive evidence of the thoroughness of this wonderful method of teaching the deaf and dumb to lip-read and speak, and to the thoroughness of their training.

Recreations.

At play the children are quite normal. Excellent playgrounds are provided and are taken full advantage of the children. The school boasts a football team, a basket ball team, and a tennis team. A "jungle gym," specially imported from America, is

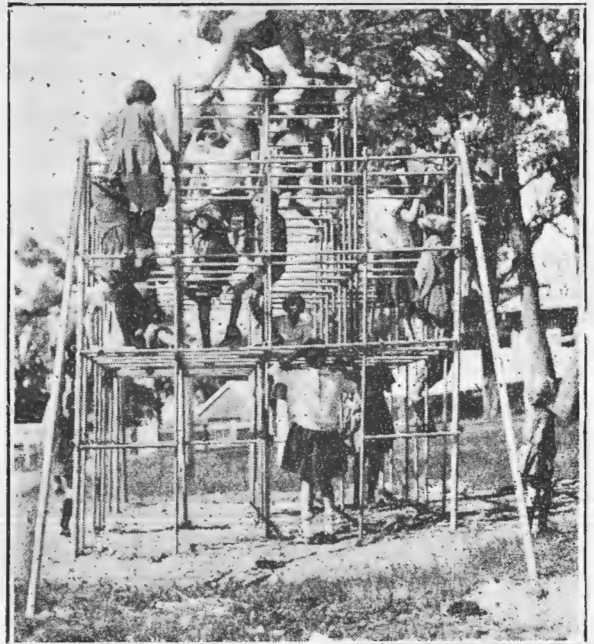

The blind children playing on the "Jungle Gym." They are quite safe on these bars, and derive great exercise from them.

erected in the grounds, and is freely availed of by the energetic youngsters, who climb up and down through the bars with great enjoyment. Even the blind girls and boys are safe upon the "jungle gym." Our picture shows some of the blind children playing "blindman's buff"—in real earnest.

Perhaps the fact which struck one most was the wonderfully happy face and contented nature of every child. Struggling to learn under enormous han-

dicaps, yet as happy, or perhaps happier, than many children in possession of all their faculties, the blind, deaf and dumb children provided a lesson that would do many of us good to see.

The State Government is accomplishing a truly humanitarian task in educating these children, and great credit is due to the officials of the school for the splendid work they are accomplishing.

Progressive Radio Wholesaler Moves into Larger Warehouse

Evidence of the steady yet consistent progress of radio in Queensland is given by the rapid expansion of some of the leading warehouses handling radio lines.

The well-known merchant firm of Edgar V. Hudson, which has been identified with "the little old house" in Charlotte Street for the past four years, have now moved to a more commodious warehouse comprising two floors and a basement, situated right next door to the old premises. This move has been made imperative by an ever-increasing demand for the lines distributed by this enterprising firm, and the necessity for additional storage space.

An attractive and well-appointed show floor provides facilities for showing and demonstrating the wide range of wireless and electrical goods stocked. The showroom and offices occupy the ground floor. Trade sales are catered for by an extensive stock and sales rooms on the first floor.

Messrs Hudson have recently been entrusted with the Queensland distribution of De Jur, Deal, Amper-

ite, Racon, Mayolian, Marinette, and other American radio manufacturers, in addition to the lines that they have so well represented in Queensland for some considerable time, viz., Mullard, Ferranti, Radiokes, Emmco, Cyl-don, Advance, and others of equal merit.

The fine new premises should enable this progressive firm to handle their growing trade with the same attention to service and detail that has always been a feature of the business and a considerable factor in the success attained.

The activities of the firm are under the personal supervision of the principals, both of whom have had a wide experience in the field of radio merchandising. The knowledge thus gained is reflected in the wise choice of lines and keen foresight which have always been characteristic of the radio department.

Messrs Edgar V. Hudson's new address is 53 Charlotte Street, while the telephone number has been changed to Central 8622, and the P.O. Box to 522-H.



Front view of Edgar V. Hudson's New Radio Warehouse. At left: Mr. Edgar V. Hudson. Right: Mr. Fred Hoe (principals).

Big Agency Taken Over by Messrs. J. B. Chandler & Co.

Quite a stir was created in trade circles during June, when it was announced that Messrs. J. B. Chandler & Coy. had been appointed sole Q'ld. Agents for Messrs. Amalgamated Wireless (A'sia) Ltd.

The latter company, who for the past two years have operated a branch office in King House, have come to an agreement with Chandler's, whereby it is considered the many well-known A.W.A. lines can be

handled quite efficiently in Queensland, without the expense of maintaining a branch office.

Messrs. J. B. Chandler & Coy. are to be heartily congratulated upon securing such a splendid line as A.W.A. products, and we have no doubt but that the new distributors will prove worthy agents for such worthy products.

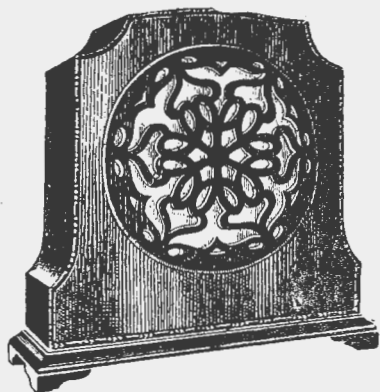

MODEL A.C.9.

Amplion's greatest masterpiece—a revelation in Cone Speaker Design. In handsome Chippendale Mahogany.

£9/10/-

All The New
AMPLION
Cone Speakers
are at
TRACKSON'S

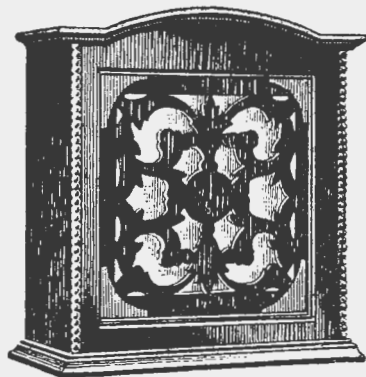

MODEL A.C.7.

A stately model in Jacobean Oak. Like all Amplion Cones, the tone is surprisingly rich, full and realistic.

£7/15/-

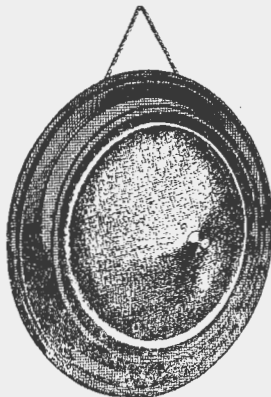

MODEL A.C.2.

This model is designed to hang from the picture rail. Handsomely figured in rich tones of Brown. As beautiful to the ear as it is to the eye.

£3/5/-

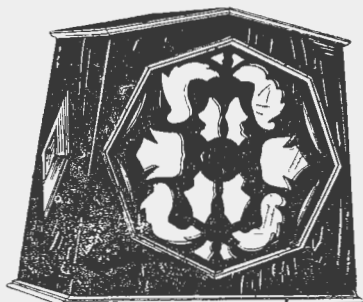

MODEL A.C.5.

Amplion Cones give no undue prominence to either bass or treble—they give a true reproduction of the original. This symmetrical A.C.5 model in Oak.

£7/7/-

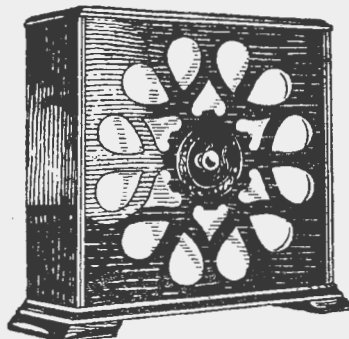

MODEL A.C.4.

A lower-priced model in a plainer cabinet. A popular speaker selling at a popular price.

Oak	£5/5/-
Mahogany	£5/10/-

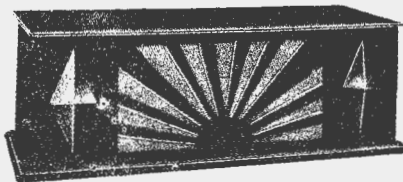

AMPLION CABINETTE.

A world's wonder value. A genuine Amplion Cone, covered by the usual Amplion Guarantee. Good tone, good appearance, good value. **£2/10/-**

TRACKSON BROS. LTD.

157-159 Elizabeth Street, Brisbane

Be Sure to Visit Stands 10 and 11 at The Radio Exhibition

Features from JULY Programmes

4QG BRISBANE.

The month of July promises to be a very busy one at 4QG. The Radio and Electrical Exhibition, which is to be held between July 16th and 21st, will have a big effect on programmes some special programmes having been arranged for broadcasting from the Bohemia Theatre, Stanley St., South Brisbane, where the Exhibition will be held.

The following is a forecast of July's features:—

SUNDAY, JULY 1st.—The morning and evening services will be relayed from St. Stephen's Roman Catholic Cathedral.

MONDAY, JULY 2nd.—Mr. Erich John's party of Radio Artists will provide the programme. The items including groups of Grand Opera selections, Tyrolese songs, classical songs, and a Characteristic group of Dream Songs.

TUESDAY, JULY 3rd.—The Brisbane Municipal Concert Band will provide a full programme of band and vocal music.

WEDNESDAY, JULY 4th.—Will be the customary dance night at 4QG.

THURSDAY, JULY 5th.—On this date a somewhat different programme will be given. The Queensland Debating Society's Union have arranged a radio debate, the subject being "That the Average Australian Gives too Much Attention to Sport." This will occupy the first part of the programme, and a Studio Concert will follow.

FRIDAY, JULY 6th.—The entire night's programme will be provided by the members of the Queensland Musical Literary and Self Aid Society for the blind, and will be relayed from the Club Rooms, Vulture Street, South Brisbane.

SATURDAY, JULY 7th.—The London Trio will provide the main portion of the programme.

SUNDAY, JULY 8th.—The morning and evening services will be relayed from All Saints Church of England, Wickham Terrace, Brisbane.

MONDAY, JULY 9th.—Mr. Arthur Sharman's Party will provide the full programme.

TUESDAY, JULY 10th.—The first portion of the programme will comprise an Hawaiian play specially written for radio purposes by Miss Thelma Champion. The Studio Orpheans will provide the second portion of the programme.

WEDNESDAY, JULY 11th will be the customary dance night.

THURSDAY, JULY 12th.—On this night the Richmond Party will provide the first portion of the programme and Mr. Arthur Boyle is organising the second portion.

FRIDAY, JULY 13th.—An Irish night will be held.

SATURDAY, JULY 14th.—Will be quite a good night, as the whole evening is being devoted to the Smoke Concert from Commercial Travellers' Club.

SUNDAY, JULY 15th.—The City Congregational Church Services will be relayed morning and evening.

MONDAY, JULY 16th.—Is the opening night of the Radio and Electrical Exhibition, the ceremony being performed by the Hon. W. McCormack, M.L.A. (Premier of Queensland). The combined bedtime story tellers at 4QG will be personally appearing on the stage every night and entertaining little listeners to the show.

TUESDAY, JULY 17th.—A first-class programme will be provided from the Radio and Electrical Exhibition including selections by the Federal Band, Ernest Lauri the versatile entertainer from the principal theatres, and leading 4QG artists.

WEDNESDAY, JULY 18th.—At the Radio and Electrical Exhibition will be a popular night, the Excelsior Band and leading artists taking part.

THURSDAY, JULY, 19th.—Hawaiian music will be broadcast from the Radio and Electrical Exhibition.

FRIDAY, JULY 20th.—Mr. Erich John's party of Radio Artists will contribute to the programme.

SATURDAY, JULY 21st.—In addition to the usual sporting broadcast, there will be relays from the Radio and Electrical Exhibition, a popular programme being provided at night time.

SUNDAY, 22nd.—Morning and evening services will be relayed from the Baptist City Tabernacle.

MONDAY, JULY 23rd.—Miss Lena Hammond (contralto), and Miss Gladys Frost (pianiste) will provide the first portion of the programme, and the second portion will be taken up by the radio play written by Miss Thelma Champion.

TUESDAY, JULY 24th.—An interesting description of the Soldiers Settlement Hatchery Association will be relayed from the Gap.

WEDNESDAY, JULY 25th.—Will be an ordinary dance night, but there will be an impromptu programme for half an hour by the Federal Band.

THURSDAY, JULY 26th.—The first part of a Radio Mystery Drama in which all listeners are asked to participate will be given.

FRIDAY, JULY 27th.—Something novel will be broadcast in the shape of a flute quartette.

SATURDAY, JULY 28th.—Miss Blanche Burns' party of radio artists will entertain for the main portion of the programme.

SUNDAY, JULY 29th.—The complete morning and evening services will be relayed from St. Andrew's Presbyterian Church, Creek Street, Brisbane.

MONDAY, JULY 30th.—The ever popular "Bohemians" will provide the programme.

THURSDAY, JULY 31st.—The second and final portion of the Radio Mystery Drama will be given from 4QG.

2FC SYDNEY.

SUNDAY, JULY 1st.—6.5 p.m.—Roland Foster in operatic lecture recital, "Tales of Hoffmann."

MONDAY, JULY 2nd.—8.20 p.m.—The Orphan's Wail—monthly entertainment of the North Sydney Orphan's Club.

TUESDAY, JULY 3rd.—8.0 p.m.—Rus. Garlinz and his "Sparklers."

WEDNESDAY, JULY 4th.—8.0 p.m.—Prologue and Stage Presentation from Capitol Theatre.

THURSDAY, JULY 5th.—8.10 p.m.—H. W. Varna Company: "A Royal Divorce."

FRIDAY, JULY 6th. 8.0 p.m.—Humphrey Bishop, revue programme.

SATURDAY, JULY 7th.—8.10 p.m.—2FC Studio Orchestra—programme of popular music.

SUNDAY, JULY 8th. 9.30 p.m.—Beatrice Tange (pianist).

MONDAY, JULY 9th.—8.15 p.m.—From Conservatorium Hall—recital by Gladys Evans and Signor Cacialli.

TUESDAY, JULY 10th.—8.10 p.m.—N.S.W. Tramway Band.

WEDNESDAY, JULY 11th.—8.0 p.m.—From Sydney University—Debate, Sydney University v. Bates College U.S.A. Subject, "That Efficiency has become a deplorable feature in modern life".

THURSDAY, JULY 12th.—8 p.m.—From Sydney University: Continuation of debate, Sydney University v. Bates College (U.S.A.). Subject: "Prohibition."

FRIDAY, JULY 13th. 8.30 p.m.—Edgar Warwick Revue Coy.

SATURDAY, July 14th. 9.15 p.m.—H. W. Varna Company: "Tilly of Bloomsbury."

SUNDAY, July 15th. 9.30 p.m.—Peter Gawthorne (English baritone).

MONDAY, July 16th. 8.15 p.m.—Madame Phyllis Howe (soprano).

TUESDAY, JULY 17th. 8.20 p.m.—Roy Agner (Australian pianist), recently returned from London.

WEDNESDAY, July 18th. 8 p.m.—Royal Apollo Club (choral performance).

THURSDAY, JULY 19th. 8.10 p.m.—Sydney Male Voice Choir.

FRIDAY, JULY 20th. 8 p.m.—Congress Band.

SATURDAY, JULY 21st. 8.30 p.m.—Lecture recital with musical excerpts from "La Mascotte," by Hon. R. B. Orchard and principals.

SUNDAY, JULY 22nd. 9.30 p.m.—Jules Van der Klei ('cellist). (Russian pianist).

MONDAY, JULY 23rd. 9.45 p.m.—Signor Ubaldo Russo and Linda Bradford (duets and solo items).

TUESDAY, JULY 24th. 8.20 p.m.—Alexander Sverjensky (Russian pianist).

WEDNESDAY, JULY 25th. 8.30 p.m.—Wally Baynes and Willie Shine (entertainers).

THURSDAY, JULY 26th. 8.37 p.m.—H. W. Varna Company: "Arms and the Man."

FRIDAY, JULY 27th. 8.15 p.m.—Lionel Lawson (violin recital).

SATURDAY, JULY 28th. 8.20 p.m.—Charles Lawrence and Len Maurice (popular duets).

SUNDAY, JULY 29th. 9.40 p.m.—Austral Quartette.

MONDAY, JULY 30th. 8.35 p.m.—Traditional Irish music recital directed by Rev. N. M. McNally.

Now — you can get Good Music—ALWAYS



THERE'S a great musical treat in store for you the first time you use Cossor Valves. From the sweet high notes of the violin to the throbbing of the drums every sound is re-created with a wealth of colour and atmosphere, surprisingly beautiful and true in detail. Such perfect music is due largely to the super-sensitive Kalenised filament with which every Cossor Valve is fitted. But, remember—you can't get this remarkable Kalenised filament and, therefore the same outstanding quality of reproduction, with any other valve. It is an exclusive Cossor development.

From Good Radio Dealers Everywhere

when you use

COSSOR

the Melody maker

**In 2, 4 or 6 Volt
Types**

The "Q.R.N." FLIVVER Crystal Set

The "Q.R.N." Flivver really offers about the "most" crystal set for the money, and A-1 results are assured. The cost? About twelve and sixpence, exclusive of headphones, of which you most likely have a spare pair lying around.

By the TECHNICAL EDITOR.

IN publishing constructional details of this small crystal receiver, we feel we are presenting something which will be welcomed by a large number of our readers. In spite of the fact that it is so simple and inexpensive to make, the Flivver crystal set does not, by any means, give "cheap" results. Although it is not to be supposed that he makes a hobby of the game, the Technical Editor must confess to having made no fewer than seven of these little sets at odd times, and they have given great satisfaction in every case. Used in connection with a good outdoor aerial and a water-pipe earth, it has always been possible to receive 4QG on the loudspeaker within a distance of four miles

from the station. Outside this radius the sets have not been tried. Please do not place the wrong construction on that remark about loudspeaker reception. By this we most emphatically DO NOT mean that it will be possible to entertain the next-door-but-one neighbour with music from your crystal set. To give an idea of the strength one may expect from the flivver, it may be mentioned that, at a distance of approximately two and a half miles from 4QG, it is generally possible to understand every word of the announcements about twenty feet from the speaker. The aerial used is 35 feet high, and 80 feet long, and the earth would stand quite a lot of improvement. On the

headphones, several pairs of which may be used, reception is absolutely beautiful.

Winding the Coils.

The few parts necessary, as specified in the accompanying list, may be purchased from any radio dealer. Having procured the parts, and before proceeding any further, it will be well to treat the wood baseboard to a couple of coats of shellac varnish, allowing each to dry thoroughly. Shellac varnish is prepared by dissolving a sufficient quantity of ordinary flake shellac in methylated spirits to produce a thin, easy-flowing varnish.

Now for the coils. Of course you know how to wind the spider-web coils: Starting in the middle, the wire is anchored by threading it through a small hole punched in the former, a few inches being left over for subsequent connec-

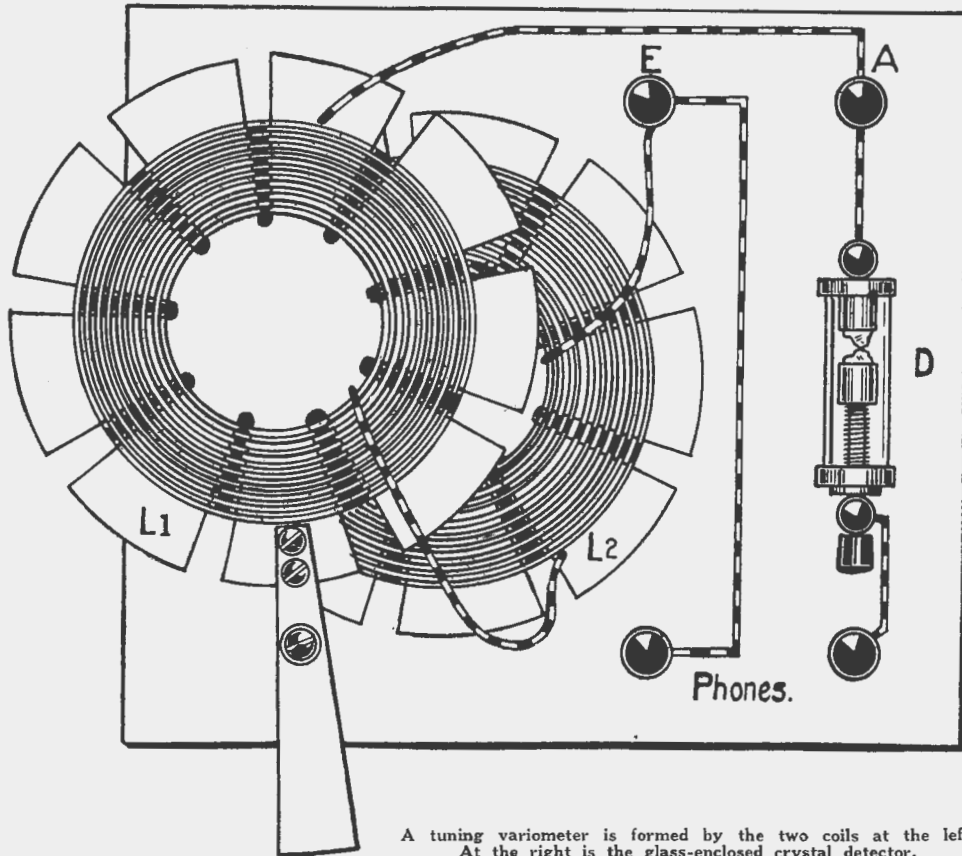

A tuning variometer is formed by the two coils at the left. At the right is the glass-enclosed crystal detector.

tions. Now wind on twenty-five complete turns, taking the wire "under and over" the spokes of the former, and finishing off the winding by anchoring the wire at the outside. Do not put varnish of any kind on the coils—they are quite rugged enough, and considerably more efficient, without it. Twenty turns are wound on the remaining former in the same way, and it is most important that both coils be wound in the same direction.

A hole is now punched through the centre of the former on which the 25-turn coil is wound, and the coil (L2) screwed down to the baseboard in the position shown in the drawing. The former should be raised up slightly by slipping two or three washers on the screw between former and baseboard.

The 20-turn coil (L1) requires a little more preparation before it can be wound. A handle should be fashioned out of cigar-box wood or thin bakelite, and bolted to one spoke of the spider-former, as shown. This handle may be about 4 or 5 inches in length, and a hole is drilled through it close to where it is secured to the former, in order to accommodate the pivot screw shown. This pivot screw passes through the handle, then through either a sufficient number of washers or a block of wood of such size that, when mounted, the moving coil will just clear the stationary coil (screwed to the baseboard).

It will now be seen that tuning is accomplished by swinging the 20-turn coil back and forth over the 25-turn coil, these two being connected in such a way that they form a variometer, as explained further on. The pivot screw—which should be a good long one—is screwed into the baseboard just tightly enough to allow the moving coil to swing stiffly.

When the four terminals and the crystal detector are mounted as indicated in the drawing, the parts are ready to be wired together. A word about the crystal detector will not be amiss at this point. The "Lion-Micro" semi-fixed detector is specified because, unlike any of the catwhisker type, it requires practically no adjustment when once a sensitive spot is located, and what adjustment is needed is merely a matter of turning a small knob. Thus, although it is more expensive, this type of detector is much to be preferred over the catwhisker variety, as it is extremely sensitive, and

exhibits none of the annoying faults so characteristic of the latter.

Using the single flexible wire listed, a connection is run from the **inside** end of the fixed coil (L2) to the top left-hand terminal. From the **outside** end of the fixed coil (L2), a wire is taken to the **inside** end of the moving coil (L1). This connection must be sufficiently long to allow the moving coil to be swung well out to the left, almost clear of the fixed coil. Now from the **outside** end of the moving coil (L1), join a wire to the right-hand top terminal, making this wire long enough to allow the moving coil the necessary freedom of movement. From the same terminal, a connection goes to one end of the crystal detector, and from the other end of the detector to the right-hand bottom terminal. This completes the wiring, and the set is now ready to use. Perhaps it should be made clear that, wherever a connection is made, the wire or wires must be bared and thoroughly cleaned. It is an advantage, though not a necessity, to solder any joints.

Tuning-in.

A description of the manner in which the phones, aerial and earth are connected and a station tuned-in is almost superfluous, but we are including a few particulars just to make sure. The aerial is connected to the terminal marked "A," the earth to "E," and the headphones to the lower terminals. "Tuning" is confined to two simple operations—finding the most sensitive spot on the crystal, and varying the relationship between the two coils. The sizes of coils given are correct for aeriels of average dimensions. If it is found, however, that the loudest response is obtained when one coil is directly over the other, the effect should be tried of adding five turns on to the moving coil. On the other hand, if signals are strongest when the distance between the coils is maximum, try taking five turns off the moving coil. This adding and subtracting procedure probably will be uncalled for, but it is mentioned just in case the results fall short of expectations.

In conclusion, we might say that if the Flivver crystal set proves as good and reliable a servant as its petrol-consuming namesake, this article will have served its purpose. It has already done so in our hands—see if it does in yours!

The Material

- | | |
|---|--|
| 1 Lion-Micro crystal detector (D). | 4 Nickelled phone terminals. |
| 2 Grodan spider formers without plugs
(L1 and L2). | 1 yd. Single flex. |
| 4-oz. 24-gauge D.C.C. wire. | 1 Wood baseboard 8 x 7 x $\frac{3}{4}$ inches. |
| | 1 Strip wood or bakelite. |
| | Screws. |



Don't Forget to Visit Stands 5 and 6 at the Radio and Electrical Exhibition

An ELECTRIC LIGHT SOCKET— An ACCUMULATOR ?

Then you need a
**PHILIPS BATTERY
CHARGER**

WHETHER they be on a car or Radio, accumulators are most inconvenient when it comes to having them constantly recharged.

Providing you have an electric light socket, much trouble, expense and inconvenience may be done away with by using the type of Philips Charger suitable to your needs—and it's surprising the number of cells, rates and accumulators for which you may purchase a Philips Charger.

Ask your dealer for particulars and folders.

Type "Four-Fifty":	Charges "A" Accumulators	£4/15/
Type "1009":	Charges "A" & "B" Accumulators	£6/15/
Type "366":	For Heavy Duty Accumulators	£8/10/
Type "1001":	Charges "B" Accumulators	£5/5/

SOLD BY EVERY RADIO DEALER

PHILIPS

BATTERY CHARGERS



Resign from

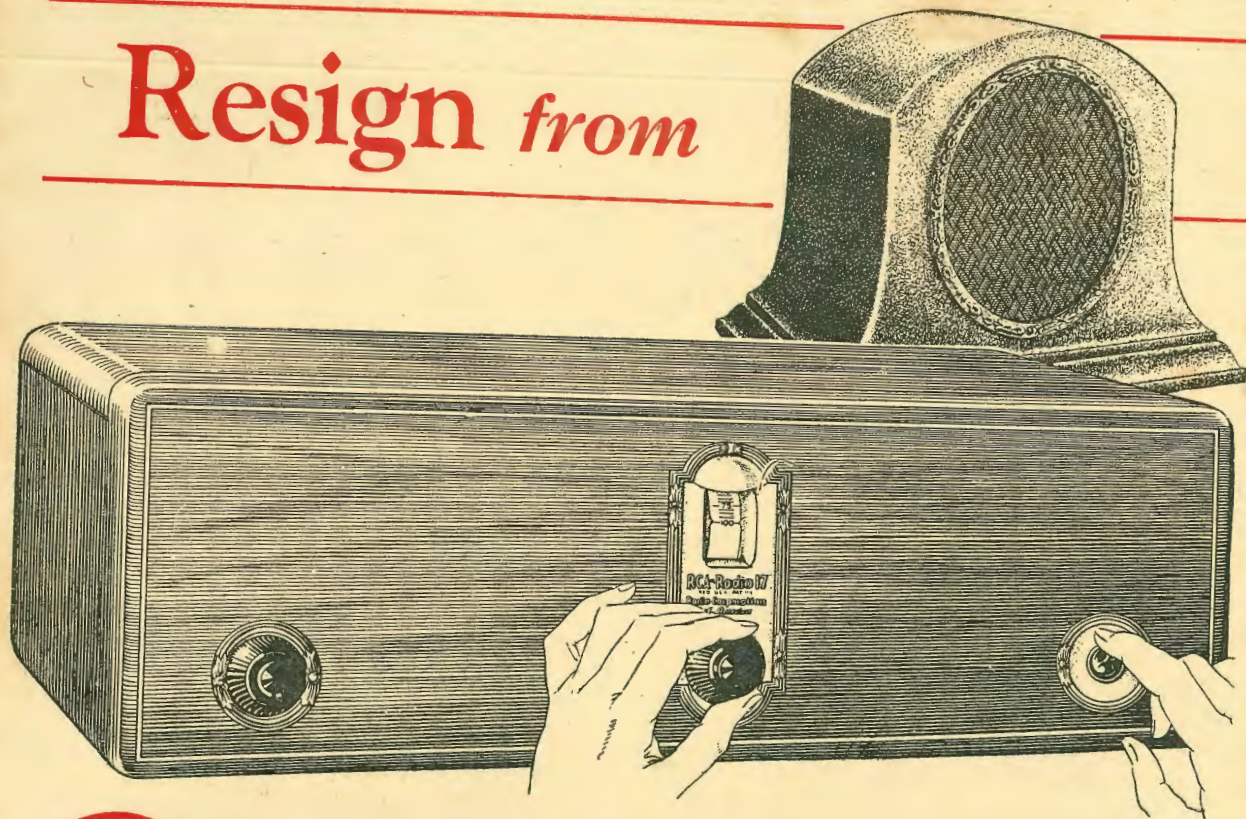

the "Battery Porters"



Here's the New Radio!
Battery-less! ~ Bother-less!

HERE is radio that is both mechanically and musically greater. It works direct from the powerful, unvarying house lighting current without batteries or battery eliminators. It brings amazing volume to Interstate reception. It brings new tone, too—tone that ranges from the deep harmonies of a cathedral organ to the trilling of a flute. Yet it costs no more to operate than a small 60 watt electric lamp. Stop carrying heavy batteries to and from service stations. Say good-bye to "fading" reception. Go to-day and hear this new R.C.A. Receiver Model 17.

RCA RECEIVER MODEL 17 COMPLETE WITH **RCA LOUDSPEAKER 100A**

Here is the new radio—battery-less, botherless. Just plug into a power point or electric light socket. Snap a switch, turn a single dial. This new Receiver is twelve months in advance of anything yet developed. In America it was heralded as "the greatest advance in radio since the inception of broadcasting." Hear the Model 17 to-day. It is new even to its valves, which are of special A.C. type to enable it to work off the ordinary A.C. current without need of rectifying devices. It is another achievement of the Radio Corporation of America and its associates, General Electric Company, and others. Listen to the rich, full clarity of its tone. Stand and admire its sleek, shining mahogany cabinet. Note such cunning refinements as the tiny pilot light which not only illuminates the station indicator, but also serves to show at a glance whether the current is on or off. At £75 (which, remember, includes the cost of the heavy dull bronze ten guinea R.C.A. Model 100A Loudspeaker) it offers remarkable value.

The famous R.C.A. Loudspeaker 100A is standard equipment with this new R.C.A. Receiver Model 17. Only 100A can reproduce without trace of distortion the torrential volume of which this new light-socket radio is capable. Whatever you do, you should hear this R.C.A. 100A Loudspeaker. It virtually unmuffles radio, bringing a new, radiant clarity to it such as you have never before heard.

AUSTRALIAN
GENERAL ELECTRIC
Australian General Electric Company, Ltd

Acherley House, Cr. Queen and Adelaide Streets
BRISBANE

And at FLINDERS STREET EAST, TOWNSVILLE

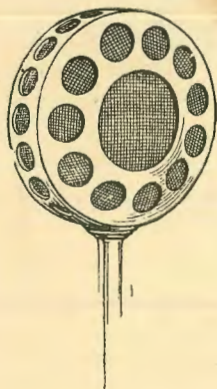

"Stand by" —
for **RADIO'S**
MOST SENSATIONAL
ANNOUNCEMENT

Radiokes Guarantee

We hereby unconditionally guarantee in Perpetuity this instrument which has been tested and inspected, and is free from mechanical and electrical defects.

Should it for any reason prove defective or become damaged we will be pleased to repair and test same free of charge. The complete faulty instrument must be returned to our factory, 130 Sussex St., Sydney, together with any broken parts thereof, carriage paid and return postage included.

This Guarantee of Perpetual Service is made between the user and the Metropolitan Electric Co., Ltd., and in no way obligates the dealer through whom this apparatus was purchased.

METROPOLITAN ELECTRIC CO., LTD

NOTE.—In effect the above Guarantee means that any Radiokes Products (excluding valves) you may have in your possession will be kept in working order, so long as you choose to avail yourself of this liberal offer. There is no excuse whatsoever for any Radiokes apparatus to be out of commission. Whatever be your breakage or wear Radiokes will make it good free of charge and without quibble. This agreement is between you and our factory.

The famous Radiokes Products are obtainable from all high-class radio dealers. They realise the satisfaction of merchandising Radiokes Quality Products.

We urge you to buy with discrimination. You pay no more for Radiokes; so you owe it to yourself to refuse unknown and inferior imitations, *No others are "Just as Good."*



Distributor for Queensland

EDGAR V. HUDSON

53 Charlotte St. BRISBANE

NEW RECEIVERS REVIEWED

During the past month, we have tested two fine receivers—one an Australian production, and the other the product of a widely-known American factory. Both are splendid receivers, and we give below some observations which were made during the course of these trials.

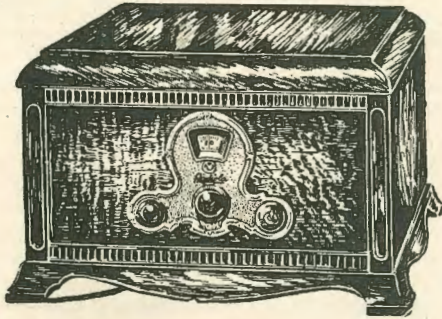

The Radiola Straight Six

Messrs. J. B. Chandler & Co., Adelaide Street, Brisbane, who are now sole Queensland distributors for A.W.A. lines, submitted a sample of the Radiola Straight Six receiver in the battery-operated model. This set is manufactured at the Sydney factory of Messrs Amalgamated Wireless (A/sia.) Ltd., and certainly is a credit to the designers and builders.

One is first struck with the beautiful cabinet work and the unique appearance of the wooden panel, the figuring and the toning of both of which is exquisite. The single tuning knob, with its illuminated indicating window, is grouped with the volume control and on-off switch on a bronze escutcheon plate of uncommon design. On opening the lid of the cabinet, a glimpse is obtained of the six Marconi "Economy" valves, the heavy duty "B" and "C" batteries, and the chassis-mounted receiver assembly. Tuning is accomplished by three of the new A.W.A. Logarithmic condensers operated by the single friction-drive dial mechanism; this latter is perfectly free from lost motion of any kind.

The only exterior connections to the set are those of the 4-volt "A" battery, loudspeaker, and aerial and earth. All battery wires are plainly coloured and marked, and the instruction book makes the battery connections a very simple matter indeed. Up to 135 volts may be used on the set, but our tests were carried out with a maximum of 90 volts.

When the Radiola Straight Six is switched on, and a station tuned in, it is immediately apparent that the outstanding feature of the set is its magnificent tone quality, made possible by the use of the A.W.A. "Ideal" distortionless transformers, and a power-valve in the last stage. This perfection of reproduction is evident on the distant stations as well as the nearby ones, and straightaway places the receiver in the class of a fine musical instrument. The set is powerful, has good distance-getting qualities, and is very nice to

handle, both the tuning and volume controls being the last word in smoothness. Unfortunately, however, some of these things appear to have been secured at a slight sacrifice of selectivity, for, at a distance of four miles from 4QG, it was not possible to tune in 3LO without the aid of a wavetrap. At the same time, there is no doubt that tone quality and ease of control come first by a long way, and, after all, the necessity of a simple wavetrap is not by any means a serious disadvantage. On a short indoor aerial, all the main Australian stations were received at good loudspeaker strength, while the New Zealand stations were weakly audible on the speaker. As far as current consumption is concerned, the A.W.A. Straight Six is most economical—an important point, particularly to country users.

* * * *

The Atwater-Kent Model 33

The American firm of Atwater Kent has long been famed for its high-grade radio parts and receivers, and to-day operates a factory with probably the largest output of radio receivers in the world. Their latest range of receivers have a very high reputation to live up to, and we were particularly interested in testing a sample of the Model 33 six-valve battery-operated set.

In appearance, the Atwater Kent receivers are dignified and unpretentious—they look good. Following the bandbox idea, the plain cabinet is remarkably compact, and is capable of being fitted piecemeal into a phonograph cabinet if a combined electric phonograph and radio receiver is desired. Every inch of available space has been utilised, and an inspection of the interior reveals some very fine workmanship.

Single-dial tuning makes the operation of selecting the various stations an extremely simple one, and the combination of three stages of tuned radio-frequency amplification, valve detector, and two high-quality audio stages gives great sensitivity and enormous volume on distant stations.

So far, we have not come to the really high spot in the performance of the Atwater Kent 33. This is its wonderful selectivity, which is better than most super-heterodynes, and certainly all that could ever be desired in this direction. It is without doubt the most selective receiver we have ever tested, and this is accomplished without making the tuning in any way critical. Working on an outdoor aerial at a distance of two miles from 4QG, there was a distinct region of absolute silence between 4QG and 3LO. A further idea of this knife-like selectivity may be gleaned from the fact that 2FC could be heard over four degrees on the dial as compared with only seven in the case of 4QG!

In order that the set may show the current economy so necessary for country locations, where battery

charging is a matter of great difficulty, the receiver has been fitted with six Osram valves, thereby reducing the filament drain to the low value of six-tenths ampere.

Either 90 or 135 volts of "B" battery may be used, the higher voltage being recommended for best reproduction. The tone quality is very good, and speech is clear and natural. An interesting component is the "compensator," provided for the purpose of adapting the receiver to the particular aerial with which it is to be used. We were also greatly taken with the volume control, which is something worthy of the name; it permits a smooth, stepless graduation of volume, from a mere whisper up to maximum.

The A.O.P.C. Course

The following announcement which we have received from the Eastern Suburbs Radio Club, will be read with interest by those of our readers who contemplate studying for the A.O.P.C., as a preliminary to breaking into the ranks of the Amateur Transmitters. It was received too late for insertion in the "Club Activities," which appear on page 55.

"On Wednesday night, June 20th, we were treated to a surprise visit from Cliff Gold (4CG) who, during the course of the evening, kindly offered to conduct a weekly class covering the A.O.P.C. examination. His offer was gratefully accepted, so the class will be held every Wednesday evening at the club rooms.

"Anyone desiring to study for the Amateur Operator's Proficiency Certificate should not fail to take advantage of this opportunity of being coached by one who has had quite a lot of experience in amateur work. They may do so by joining up with the Club for the period during which the lectures will be given."

Warner's Wireless a Closely Guarded Secret

One of the most modest, unassuming chaps in the world is Warner, the wireless operator of The Southern Cross, whose work enabled the living, breathing story of the flight to be sent out far and wide. He was very reticent about the set that had done so well. He talked airily enough about the manner in which he did the work, but he guarded close the actual technicalities of the magic box of tricks that did the work.

The finest wireless set used in a plane in Australia, for design, for weight, for range is that made by Wackett, for his Widgeon II. It weighs only 100lbs. and was designed by the aviator himself. It would be interesting to compare this, with the set of the Southern Cross. Warner, however, is under a pledge of secrecy to interests in America, who are to get the full story of the radio work of the journey. Telegrams from every State have reached him, asking for his description. He good-humoredly shakes his head, and in his inimitable drawl says—"Wal, I would if I could, but y'see, I jest can't, that's all." It is expected that he and Lyon will each make about £50,00 in America, hence the secret of their desire for a quick return.

What's on To-night ?

Don't wonder any more—send a P.N. for 9/6 to Box 1095N, G.P.O., Brisbane, and the "Broadcast Bulletin" will be posted to you for one year. Contains full details of all the radio programmes.

Wetless Radio Parts

Reduction in Price

Messrs. J. Wetless, the well-known Sydney manufacturer of radio parts, announce a reduction in the prices of their range of components.

The Wetless Solodyne Kit, now retails for 65/-, while the list price of the Space Wound Browning-Drake Kit has been reduced to 35/- . At 13/- and 18/6, respectively, the Single Rotor Tuner and Double Rotor Tuner represent excellent value, as they are manufactured from first-class materials, and are thoroughly tested before leaving the factory at Rockdale.

Wound with green silk covered wire, supported on a framework of bakelite strips, and supplied complete with two neutralising condensers and a circuit diagram, the Air Wound Neutrodyne Kit is very reasonably priced at 35/- . A popular line is the Wetless Reinartz tuner, which has proved itself to be very efficient, and an ideal component for constructing an inexpensive receiver. This sells for 10/6, and the radio-frequency choke at 5/6.

Midget condensers of the neutralising and balancing type are produced in six different capacities, the prices ranging from 4/3 in the case of the 3-plate size to 6/3 for the 13-plate. The Wetless range of fixed mica condensers, which have enjoyed wide popularity for a long time, are manufactured in two distinct styles, and in all standard capacities. The prices of the type "A" range from 1/6 to 1/9. The type "B" condensers are a superior line, the bakelite outside plates being clamped rigidly between metal faces at four points. Both types are provided with eyelet holes and soldering lugs, and employ the best quality ruby mica insulation; this enables them to stand up to the 1000-volt insulation test which is imposed by the manufacturers.



"DING DONG! DING DONG!!"

Wedding bells rang in the month of June for our old friend, "Bob" Littler, technical expert with Messrs Wireless House Limited. We hasten to offer our sincere congratulations to "Bob" and to the young lady who is now Mrs. Littler.



Curious bystander (listening to broadcast concert):
"What makes all those pauses in the music?"

Wearly Dealer: "Sparrows on the aerial picking off the currents."

DON'T GUESS

Make certain of what you are going to listen to by sending 9/6 to Box 1095N, G.P.O., Brisbane, for 52 weekly issues of the "Broadcast Bulletin" Posted every Thursday evening. Programmes commence from following Monday.

All About the New Screen Grid Valve

By THE TECHNICAL EDITOR

The success of present-day broadcast receivers employing radio-frequency amplification is due, in no small measure, to the high state of development of the modern valve. Fortunately, the time is past when the same type of valve had to be used in every socket in a multi-valve receiver, irrespective of the function which it was expected to perform. Nowadays, we have valves which, after a tremendous amount of costly research work on the part of the manufacturers, have been designed especially for one particular purpose, and, for maximum results, must be used for that purpose and no other. Because of this, there is no gainsaying the fact that the success of a home-constructed receiver depends, to a very great extent, upon the amount of intelligence which is displayed in the selection of the valves.

In one department of activity, valve manufacturers seem to have lagged behind the excellent progress which has been made in other directions. We have very sensitive and stable detector valves, and audio-frequency amplifying valves which have reached an almost incredibly high state of perfection. The radio-frequency amplifier, however, suffers from several serious defects, not one of which can be entirely overcome while the ordinary three-electrode valve or "triode" is adhered to. The three electrodes referred to are, of course, the filament, grid, and plate.

The Four Electrode Valve.

For some considerable time, we have been hearing about the four electrode valve, or "tetrode"—a valve having the usual filament and plate, but equipped with two grids instead of the usual one. While exceptional results have been claimed for these valves from time to time, they do not appear to have been a general success, and production has never reached a large figure.

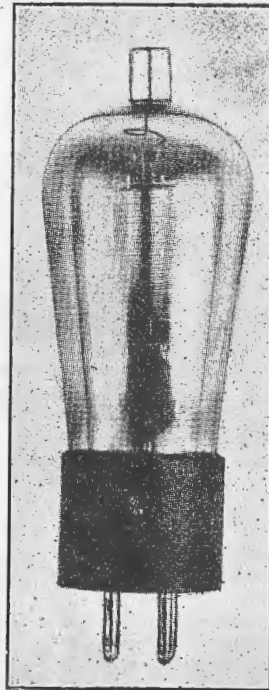
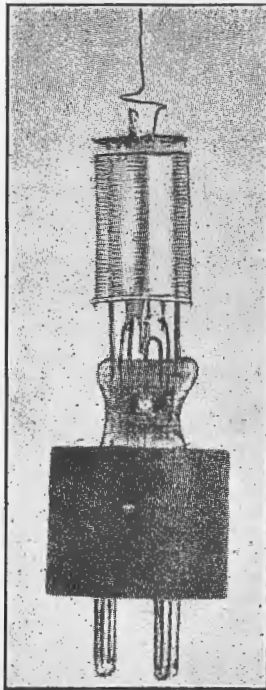

Two views of the new U.X.222 Screen Grid Valve. Note the grid terminal on top of the valve. The screen grid is connected to the regular grid prong in the base.

Within the last few months, however, the latest development of the four-electrode valve—the long-heralded "screen grid" valve—has made its appearance upon the Australian market, and, just before this issue goes to press, information is received that the new valves are available at long last in Brisbane.

Although several of the larger valve manufacturers—notably Philips (Holland) and Osram (England)—have produced a model of this type of valve, up to the time of writing, we have only been able to secure a sample of the Radiotron U.X.222, two views of which are reproduced on this page. The screen-grid valves manufactured by Osram and Philips (which are expected here at any moment), while differing slightly in mechanical construction, follow closely the same general principles of design incorporated in the U.X.222, so a description of one will serve for all.

It is important to understand that the screen grid valve is marketed under several different names, all of them being correct, and expressing exactly the same meaning. The similarity between "screen" grid and "shield" grid is self-evident; and it must be noted that the correct terms are "screen" and "shield"—NOT "screened" and "shielded," as one frequently sees. The relationship of the term "shielded plate" or "screened plate" is not so apparent, until it is remembered that **it is the grid which does the screening or shielding**, and the plate which is screened or shielded. In this article, we are using the term "screen grid" exclusively, as that is the name which appears to be most popular, and it is desirable in the interests of clarity to avoid the use of alternative terms.

General Description.

We find upon examining the U.X.222 that, externally, it appears very like a 201A, with an additional terminal in the shape of a small brass cap on top of the

"WETLESS"

GUARANTEED RADIO PRODUCTS



SOLODYNE SHIELDED COIL.

"Wetless" Solodyne Kit with two Neutralising Condensers. Price 70/- per kit.



NEUT COIL KIT

"Wetless" Neut. Kit, with two neutralising condensers Price 35/- per kit
"Wetless" Radio Frequency Choke. Price 6/6 each

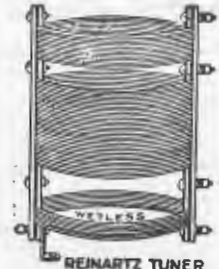

REINARTZ TUNER

"Wetless" Reinartz Tuner. Price 10/6 ea.



BROWNING DRAKE

"Wetless" Browning-Drake Kit with Neutralising Condenser. Price 38/6 per kit.



DOUBLE ROTOR TUNER

"Wetless" Double Rotor Tuner. Price 18/6 ea.



SINGLE ROTOR TUNER

"Wetless" Single Rotor Tuner. Price 13/- ea.

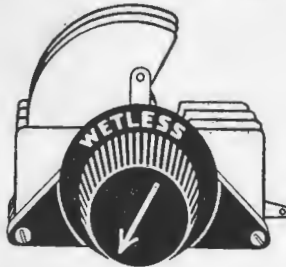

MIDGET CONDENSER

"Wetless" Midget Condensers, 3-plate, 4/3; 5-plate, 4/9; 7-plate, 5/3; 9-plate 5/6; 11-plate, 5/9; 13-plate, 6/3 each.

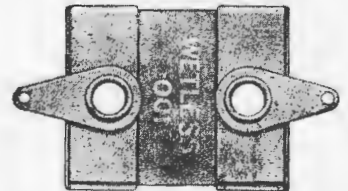

"B" TYPE.

"B" TYPE.

GRID CONDENSER is specially made for attaching directly to valve socket terminal

"WETLESS" MICA CONDENSERS

A. TYPE.

.0001
.00015
.0002
.00025
.0003
.0004
.0005
.001
.002
.00025 (with clips, 1/9 each.)

1/6 Each

B. TYPE.

.0001	2/6
.00015	2/6
.0002	3/-
.00025	3/6
.0003	3/6
.0004	3/6
.0005	3/-
.001	5/6
.002	5/6
.00025 (with clips),				2/6 each.

2/- Each

Ask Your Dealer for "WETLESS" Guaranteed Radio Products

BRISBANE DISTRIBUTORS WANTED

Manufactured by — — J. WETLESS, 28 King Street, ROCKDALE, N.S.W.

glass bulb. This cap connects to a small-diameter spiral grid which surrounds the straight filament; this spiral is the ordinary or "control" grid—NOT the "screen" grid. Outside this grid there is a cylindrical plate of rather large diameter, spaced at a relatively great distance from the grid and filament.

The real difference from the ordinary three-electrode valve or "triode" is found in the "screen grid," which is a sort of shield, insulated from the plate, but covering both its outer and inner surfaces. Actually this screen consists of two overgrown spiral grids of close mesh, but different diameter. One is of a size to slip between the plate and the ordinary grid, without touching either; the other is just large enough to slip over the **outside** of the plate. These two sections of the screen-grid are connected together, and the lead brought out to the usual grid prong of the valve base.

As a result, we have a valve in which the plate is screened very thoroughly from the grid, even the leads from the two being widely separated from each other, emerging as they do at opposite ends of the valve.

Application.

In its application to the science of radio communication, the screen grid valve offers almost unlimited possibilities. Its greatest **immediate** field of usefulness, however, would appear to be in connection with the amplification of signals at radio-frequencies—that is, before they reach the detector. Indeed, the new valve bids fair to revolutionise this very important branch of the art, for one highly significant reason—at last we are offered a **simple and positive means of side-tracking that ancient bug-bear of plate-grid capacity within the valve, with its attendant tendency to oscillate when used as a radio-frequency amplifier.**

Think what this will mean: a perfectly stable amplifying system without the necessity to resort to neutralising, "lossers" (usually in the form of resistances), or any other method of suppressing oscillation and engendering stability. Not only that: the screen-grid valve gives us a tremendous gain per stage of amplification as compared with the old three-electrode valve used under the same conditions. This means to say that, supposing one stage of amplification using the ordinary valve magnifies an incoming signal 15 times, a stage of screen grid amplification might increase this figure to something like 45—clearly an enormous improvement as far as sensitivity and efficiency are concerned.

In the realm of short waves, the screen-grid valve has come as a particular boon and blessing, as it will make possible effective radio-frequency amplification of wavelengths as short as three metres! With the old type valves this has been considered a practical impossibility. Already it has been shown that a four-valve short-wave receiver employing one screen grid stage demonstrates a sensitivity superior to that of a seven-valve super-heterodyne.

The usefulness of the screen-grid valve is not by any means confined to radio-frequency amplification, although, as we remarked, in that field lies its greatest immediate scope. As a high-gain audio amplifier, in connection with a coupling transformer of suitable design, the new valve will yield the same great amplification per stage, while used as an oscillator, an important advantage which may be expected from its

use is much greater steadiness of the emitted wave than we have been used to with ordinary valves, because of the negligible effect of inter-element variations caused by heating and vibration.

Not Interchangeable with Ordinary Valves.

In case a misconception should arise in the minds of set constructors, it must be stated quite definitely at this point that the screen-grid valve is NOT interchangeable with the older three-electrode valve, as it is not just a matter of removing one valve from its socket and plugging in the other. The amplifier system must be designed especially for the new conditions under which it is to operate, and it is best to start right from the beginning when installing a valve of the screen grid type, rather than to attempt to adapt an existing receiver. To begin with, the advantages obtainable with the screen-grid method will be almost entirely lost unless a very complete system of screening is employed in the amplifier itself. The valve must itself be screened externally, this being accomplished usually by a metal box which fits snugly over the valve, a clearance hole being provided at the top in order to accommodate the control grid terminal. The coils must be designed to match as far as possible the impedance of the valve, which is unusually high. In order to provide the desirable high impedance in the plate circuit, it has been found that the old familiar "tuned anode" method of coupling stages gives good results, although the problem of selectivity is inclined to enter into the argument at this point.

As a radio-frequency amplifier, the control grid is connected into the circuit, much in the same way as usual, except that it is biased with a small negative potential. A positive bias of the order of 45 volts is applied to the screen grid; this does not mean the provision of extra batteries, as one would at first suppose, because it is perfectly practicable to obtain the bias from a tapping on the "B" battery.

A Word in Conclusion.

We have been asked why we have not so far published particulars of a receiver incorporating the screen-grid valve. The answer is, of course, that no models of the valve were available, therefore it was impossible for us to carry out any experimental work in that direction. Our policy is, of necessity, a conservative one; we believe in placing before our readers only sets which have been actually built and whose operation has attained a high standard of excellence under actual working conditions. Moreover, we make every effort to present receivers which are composed of parts which are readily obtainable on the local market. In our opinion, it is not in the interests of the great majority of our set-building readers to describe receivers which require a number of special parts which must be made by hand, sometimes of material which is difficult to procure.

The Technical Editor is now in possession of some of the new screen grid valves, and, as soon as we are satisfied that we have a set which is really outstanding in its performance, and as soon as the necessary parts are available to the public, then—and only then—will we publish the constructional information. The results which have been obtained in the necessarily hurried tests which have so far been carried out, lead us to believe that such an article will be forthcoming in a very early issue, and readers may look forward to it with the assurance that, when it comes, it will be something "out of the box."

AMONG THE AMATEURS

(By "Lambda.")

Warner and KHAB.

KHAB, the short-wave set of the "Southern Cross," provided the event of outstanding interest this past month. Very many short-wave receivers were tuned-in to the signals from Kingsford Smith's big Fokker for at least a part of the duration of the historic flight, and Warner's terse announcements of the progress they were making provided everybody with a never-to-be-forgotten thrill.

Beyond the fact that he was using a single 50-watt fed with A.C. at about 500 cycles, the amiable Warner could not be enticed to say anything about his apparatus. As he explained in his own way: "Waal, I would if I could, but sure I can't!" By which he meant that, as he was under contract to an American paper, it was impossible for him to divulge any information to anyone else. However, it is known definitely that the transmitter used the well-known Armstrong tuned-grid, tuned-plate circuit, probably because of the inherent stability of this arrangement. A trailing wire aerial was used, which was responsible for the rather severe swinging which was noticeable at times. Evidently the designers considered that the extra equipment, and consequently increased weight, which the use of a crystal-controlled set would necessitate, would not be justified. Another consideration undoubtedly was the factor of reliability, which always is greatest with simple apparatus. The "broadness" engendered by the use of raw A.C. on the plate was relied upon to make the signals readable in spite of slight changes in wavelength. That the theories of the designers were amply borne out in practice is now known to everybody. Nothing is known of the receiver beyond the fact that it was totally screened, and that little direct interference was experienced from the ignition system. This is rather remarkable when it is remembered that the small matter of 54 spark-plugs were firing goodness knows how many shots per minute, and doing their level best to make life miserable for an already harassed operator. (Each of the three nine-cylinder Wright "Whirlwind" motors would, of course, have dual ignition.)

Work on Five Metres.

4AW and 4NW have got going again on the 5-metre band, which seems to have received very little attention for some time. Of course, this kind of work is often discouraging, but it is very interesting, and well worth while if one can spare the time. At least it is breaking new ground, which is more than a lot of us can claim to have done! The distance between 4AW and 4NW is not great, we know—one quarter mile, to be exact. Still, reliable communication has been established over that distance, which is a start in the right direction. 4AW works on 5 metres, while 4NW listens on 5, and replies on 32. A signal strength of R8 was obtained when the power input at 4AW's end was 60 watts, using a three-tube receiver, and R-5 on the small input of 0.45 watts.

Very mysterious are the activities of 4PN, who, we believe, is delving into the joys and sorrows of radio picture transmission, or perhaps, television. This television business may be quite all right in some ways, but it looks to me as if it's going to cause us married men a devil of a lot of trouble. The searchlight of public opinion will be as nothing compared with the searching possibilities of "television in the home." Talk about making a rod for your own back!

4LJ Rebuilds.

From LJ comes the news that he has rebuilt and, what is rather surprising to those who have ever scrapped a dejected-looking heap of junk in favour of a thing of beauty and a joy forever, 4LJ actually finds that he gets out better than before. Truly the day of miracles is not past. (Napoleon, Chap. 27, op. 6.)

4GO works an occasional Yank on 32, but does more with his 240-metre 'phone set. 4CG was heard last night coaxing more or less sweet music from what sounded something like a pipe organ, but which was not. No; the half-formed illusion was rudely shattered when the soloist wound up a truly brilliant concerto with a terrific blast that evidently discouraged the microphone for good, and no doubt gave it a life-long prejudice against mouth organs of all sorts and conditions. Though the transmission certainly had plenty of punch, a non-partisan critic might still be inclined to award the palm for quality of modulation to 3LO or 2FC.

4WA puts out a hefty signal, and was heard in contact with aj-4BK recently. His 32-metre phone is fair, but the carrier is not at all suitable for telephony as yet. Too rough, OM., if you don't mind my mentioning it.

Phone from 4NW.

Good 250-metre phone is coming from 4NW. In fact, the quality of the music and speech is almost comparable with that of 4RM. The reason is that Tom has got his Heising modulating system working to some purpose, and is feeding the speech frequencies from the mike (which is supported by rubber) into the two audio stages of his broadcast receiver. This boosts things up so much that quite a large proportion of the whoops and wails incidental to the domestic life of the House of Starkie is broadcast as an atmospheric background. Seriously, though, 4NW's music is well worth listening to (can't say the same for his voice), and the B.C.L.'s who can tune down to 250 metres are assured of a pleasant hour's entertainment between 5.30 and 6.30 on Sunday afternoons. Always provided, of course, that the musically-inclined Thomas doesn't feel it incumbent upon him to bring his saxophone to bear!

They say the truth is often unpalatable, and there's a limit to what even hams—who, considered as a tribe, are notoriously truthful—will stand of it, so mayhap 'tis time for "Lambda" to pull the power switch, until our next session, four weeks from now. 73, everybody.



TESTED AND RECOMMENDED

A Department of Investigation, conducted for the benefit of our readers. Every piece of material featured on these pages is subjected to a rigorous and searching test before publication. No remuneration is received for the publication of these paragraphs.

THE NEW EXIDE RADIO BATTERY.

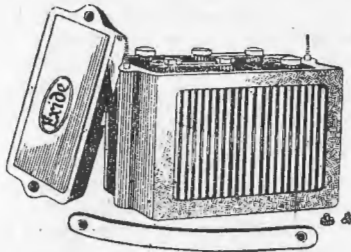

From Messrs Exide Battery Service (Q.) Ltd., Adelaide St., Brisbane, we have received a sample of the new Exide Hard Rubber Composition Container Radio Battery. The battery submitted is a 6-volt

size, with a continuous discharge capacity of 40 amp-hours, and is listed as type 3-CZT-4-1TL. There is also available a 6-volt 30 amp.-hours battery of similar pattern in type 3-CZW-3-1TL, and we are advised that full stocks of both types have just been landed in Brisbane.

In appearance, the new Exide battery is finer, perhaps, than any radio battery we have seen. The hard rubber composition container is beautifully moulded, with curved ends and fluted sides. A moulded cover of attractive design is clamped to the battery by means of quickly-removable nickelled nuts, this same operation completely detaching the acid-proof rubber carrying handle. The cover performs several functions: First of all, it gives the battery a "finished" appearance so desirable when it is to be installed in a well-furnished room; it prevents damage to nearby rugs, cloths, etc., often caused with an open battery by an invisible acid-spray while the battery is charging or discharging; it precludes the possibility of short-circuiting the terminals by a piece of wire or metal being accidentally dropped across them. So that there will be no difficulty in the matter of bringing out connecting wires to the receiver and battery-charger, the cover is provided with small ports through which the wires pass. The connecting straps between the cells are removable, and heavy lead-coated terminals are standard equipment. A point which is often neglected by battery manufacturers is that of marking the polarity of the terminals clearly. In the Exide battery, positive and negative signs are moulded into the tops of the cells, where they are plainly visible. It will be understood that a real test for a storage battery occupies a period of perhaps a year or more, and for that reason we could not subject this battery to any other test than a fortnight's use on a five valve set. However, we feel we are safe in basing our assurance of the battery's quality upon our knowledge of the splendid service rendered by the older types of battery manufactured by this famous English factory.

THE GRODAN RADIO-FREQUENCY CHOKE.

The Radio-frequency Choke Coil manufactured by Messrs. Grose and Daniell, of Sydney, and submitted for test, was found to function excellently under all conditions. In construction the Grodan Choke is unusual, and it offers several advantages over the general design of radio-frequency choke coils. The coil itself is wound in sections on a slotted skeleton former, and is, practically speaking, "wound on air." This has the very desirable effect of reducing the distributed capacity of the coil to a minimum. An exclusive feature, and a valuable one under certain circumstances, is the taps which are provided, thus enabling one to choose the section of the choke which gives the best results for any particular requirement. Either 200, 300 or 500 turns may be connected into the circuit merely by changing one connection. Extreme rigidity is achieved by the use of bakelite end plates, and the coil is protected from mechanical injury by a cylinder of celluloid. The instrument is well-finished, and can be highly recommended. Our sample came from Messrs Edgar V. Hudson, Charlotte Street, Brisbane.

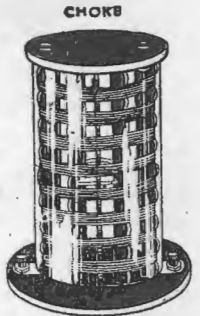

THE PHILIPS POWER PLUS "B" and "C" ELIMINATOR.

Through the courtesy of Messrs A. H. Hills, Perry House, Brisbane, Queensland representatives for Philips Radio, we have been able to subject a Philips Powerplus "B" and "C" Eliminator to lengthy and exhaustive tests. The eliminator has been used as a power supply unit on many different types of receiver, and in all cases gave perfect results.

The Philips "B" and "C" Eliminator consists in reality of two separate units—the "B" supply unit and the "C" unit. The "B" unit is equipped with a Philips full-wave rectifier valve No. 506, a very effective filter system, and specially designed wire-wound resistors in order to provide various plate voltages. A very valuable feature is that there is not one variable resistance in the complete eliminator, which means that the output should be entirely free from the frying and crackling noises which are often traceable to faulty resistances in power supply units. The fixed resistors referred to are wire-wound and covered with a pro-

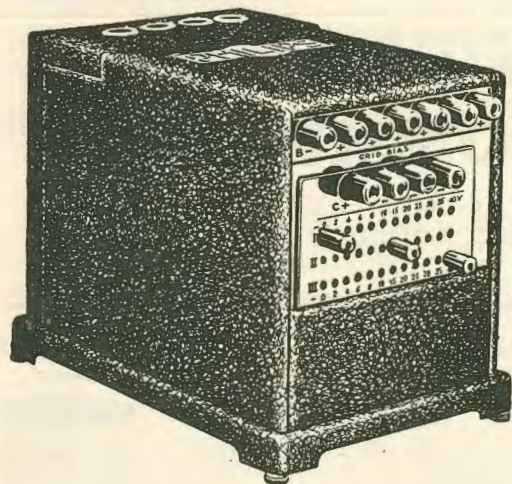

protective varnish, and therefore are impervious to atmospheric changes. In the "C" supply section, a Philips 3006 half-wave rectifier valve is used in conjunction with a filter and fixed tapped resistor.

A very ingenious arrangement is provided to enable the user to select various values of "B" and "C"

voltage to suit the requirements of his receiver. In the illustration the top line of plugs connects to the "B" supply. The voltage obtainable depends, naturally, upon the load drawn by the receiver, but it may be mentioned that the maximum voltage obtainable under "no load" conditions is in the vicinity of 210 volts. With a five valve set drawing somewhere about 15 milliamps, this figure would be reduced to something like 180 or 190 volts. In addition to the common negative, six distinct values of voltage are available, so that the detector, radio, and audio amplifiers may all be supplied with appropriate plate voltages.

The system adopted for adjusting the "C" voltage within fine limits is decidedly unique. Besides a common positive, three separate sockets and plugs are incorporated (immediately below the line of "B" plugs) allowing three different "C" voltages to be fed into the set at the same time. The voltage at each socket is variable from 2 to 40 volts simply by shifting the small plugs which can be seen in the illustration.

While the exterior of the instrument is very finely finished, one must see the interior in order to fully appreciate the beautiful workmanship and fine design which is built into it. The Philips Powerplus "B" and "C" Eliminator operates with an entire absence of hum, consumes a negligible amount of current, and is, we find, a wholly satisfactory piece of apparatus in every respect.



The Brisbane Excelsior Band

which is to broadcast
from

The Radio and Electrical
Exhibition, July 16, 18,
and 21

AN APOLOGY

In our last issue, we announced that the Peridyne Five with Resistance Coupling would be among the receivers described in the July issue.

We regret, however, that it has been found impossible to publish the article this month. In the August issue, readers may look forward with confidence to a very comprehensive article covering the construction of this receiver, which our tests have shown to be the most powerful five-valve set we have so far constructed.



A CROSS in this square
denotes that your subscrip-
tion expires with this issue.

Subscription 6/6 year



The
IGRANIC
 SUPERSONIC
 HETERODYNE OUTFIT

There is no finer performance than Super-Heterodyne performance, and no finer Super-Heterodyne than Igranitic, which can be built from this Outfit with the addition of a few extra components. The Outfit contains the following Special Components and Accessories: One Oscillator Unit, four Self-Stabilising Reactance Units, one Igranitic Special Output Transformer, six Igranitic Antimicrophonic Valve Holders, five Igranitic Fixed Grid Leaks, six Igranitic-Freshman Fixed Condensers, two special Fixed Condensers, seven Special Unit Bases, two Collapsible Metal Angle Brackets, two Special Slotted Busbars, and all necessary connectors, clips, insulating bushes, terminals and screws for assembling the seven units. PRICE (including License Fee) £25

SOLE AGENTS

Noyes Bros.
 (Sydney) Ltd.
 PERRY HOUSE BRISBANE

WRITE FOR ILLUSTRATED
 CATALOGUE



Well Over a MILLION Satisfied ATWATER KENT

Let Their Judgment Guide You—

THROUGHOUT the world, each night more than a million homes enjoy the best Radio has to offer with Atwater Kent. If you find the choice of a receiver difficult, reflect that no man ever made and sold a million of anything that wasn't dependably satisfactory. That's the secret of Atwater Kent popularity. **IT SATISFIES.**

In the fifteen-acre factory with a capacity of 8000 sets per day, these receivers are manufactured to a standard proven design. Each receiver must pass 159 gauge and electrical tests before it leaves the factory.

Small wonder, then, that Atwater Kent Receivers give the same faultless performance night after night.

Atwater Kent Prices

Six and Seven Valve One Dial
Atwater Kent Receivers,
£ 25/10/ to £ 37/10/
without valves or equipment.

Radio Speakers, £ 3/15/
£ 4/10/, £ 8/15/ (New
Model E).

Complete Outfits from
£ 43/10/.

also Console and Writing Desk
models.

LET US DEMONSTRATE TO YOU TO-DAY

Brisbane and Southern Queensland Distributors for Atwater Kent Radio.



Wireless House

LIMITED

City Buildings

Edward Street

BRISBANE

Owners Have ENDORSED It!

RADIO

Atwater Kent Wins on Every Count

Appearance

Atwater Kent is a marvel of compact design. The receivers occupy no more space than a row of a dozen books. The handsome dark brown crystalline finish of the receivers and speakers will blend into any scheme of furnishing, and improve the appearance of any room.

Simple Operation

Just a turning of Atwater Kent's ONE dial and every station within range comes in, sharply, clearly and distinctly, each in its turn. With Atwater Kent a novice can get results formerly only possible to experts.

Beautiful Tone

The rich mellow tone of Atwater Kent is a never ending source of delight. Owners tell us that no other feature gives them more pleasure than the amazingly faithful way in which their receivers recreate music and speech.

Power

Despite its small size, Atwater Kent Radio has tremendous power. As a distance getter it is second to none, bringing in the distant stations just as easily as the locals.

Prices

It is the enormous popularity of Atwater Kent receivers that makes it possible for you to buy them at such phenomenally low prices. The huge production makes possible economies that are passed on to you.

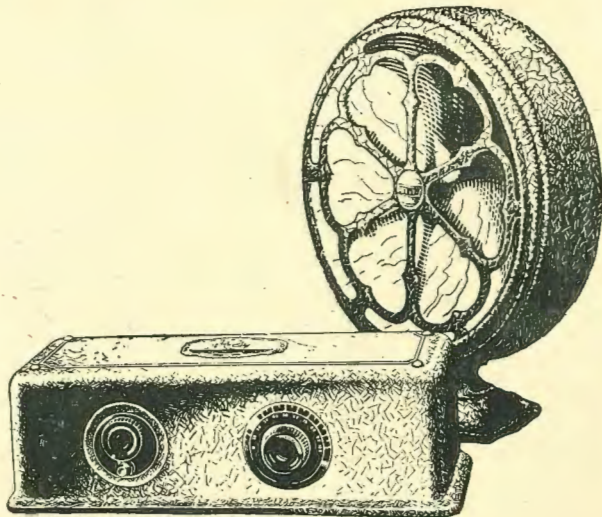

**Model 35 (6 Valve) with
Model E. Speaker**

**The Receiver that made Atwater
Kent's One Dial Control
World Famous**

*Let us Demonstrate to You
To-day*

**Clip and Send
for
Free Literature**

**Messrs Wireless House Ltd, City Buildings,
Edward Street, Brisbane.**

**Please send me your latest FREE
LITERATURE on Atwater
Kent Radio.**

Name

Address

BALKITE RADIO POWER

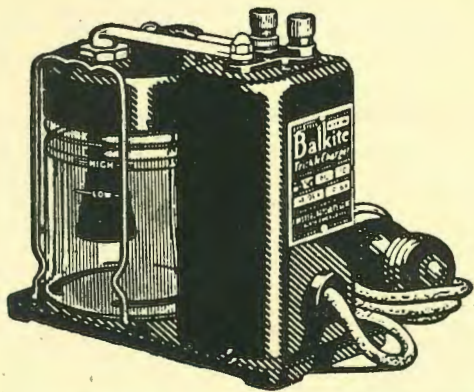

BALKITE TRICKLE CHARGER

Over 750,000 in use. Charging rate about $\frac{1}{2}$ ampere. As a trickle charger automatically keeps your "A" battery fully charged.

NEW PRICE £3/10/

*Direct
from
the
Light
Socket*

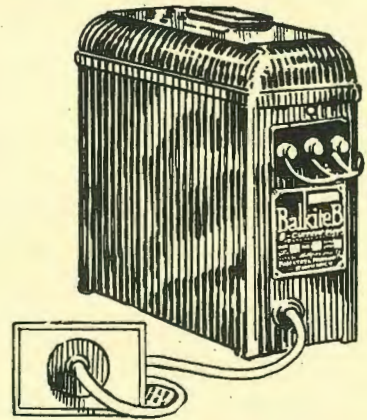

The New BALKITE "B" ELIMINATOR

The noiseless, tubeless, permanent, light socket "B" power supply.

MODEL BW for set with 5 valves (201A type) or less **£8-19-6**

MODEL B135 for sets with 8 valves and up to 135 volts **£13-10-0**

Trickle Charging Began With Balkite

and Balkite still leads in popularity, service and number in use

Trickle charging, now the most convenient and most popular of all means of charging your radio "A" battery, was not possible until the development of the Balkite Trickle Charger. For Balkite was the first charger that could be connected permanently to your "A" battery and the light socket. It was the first charger that kept the battery always fully charged. And Balkite was the first charger that converted your battery into a complete power unit supplying "A" current from the light socket.

To-day there are over 750,000 Balkite Trickle Chargers in use. Just as it was first in making trickle charging possible, Balkite has always been first in popularity and number in use. Balkite is the standard trickle charger, tried and proved by use in the hands of its thousands of owners.

Like all Balkite Radio Power Units, this charger is a permanent piece of equipment. It has no tubes and nothing to replace or renew. It is noiseless in operation and can usually be used during reception. It is very compact and small, and its current consumption is very low.

The Balkite Trickle Charger can be used as a trickle charger with any 6-volt radio "A" battery. Thus used, it keeps your battery always at full power and in effect converts it into a light socket "A" power supply. With 4-volt batteries, it can be used as an intermittent charger of the usual type. Or as a trickle charger if a resistance is added. Charging rate is approximately $\frac{1}{2}$ ampere.

Add a Balkite Trickle Charger to your "A" battery. Know the convenience of permanent silent "A" power from the light socket always.

Wholesale Only

O. H. O'BRIEN [Sydney]

37-39 Pitt Street, SYDNEY

654-664 Bourke Street, MELBOURNE

Receiving the "Southern Cross"

Activity at A.W.A. La Perouse Station

The use of radio as an adjunct to air travel has been amply demonstrated during the course of the trans-Pacific flight. In view of its service during the present flight, it is interesting to note that Major J. C. Fitzmaurice of the aeroplane "Bremen," in the course of a recently article, stated that the trans-Atlantic flight had led him to the conclusion that for an undertaking of this kind, wireless is absolutely essential.

The question of wireless had, he said, received serious consideration, but it was decided that the weight of the set could be more efficiently utilised by carrying more benzol. This, he considered, was the one weak point in the organisation of the "Bremen" flight, and he now realised that had they had wireless equipment on board they could have been given their exact position by direction finding stations along the American coast, and would also have known the precise direction and velocity of the wind over the sea, and would have accomplished their objective easily. He considered wireless absolutely essential in all future undertakings of this nature.

Ever since Kingsford Smith left San Francisco, the operators at the A.W.A. receiving station at La Perouse kept continuous touch with short-wave, long-distance 4-valve receivers specially designed by A.W.A. Day and night, with headphone clamped to their ears, two operators listened-in for the signals, and such messages as were received were written down by each, one thus checking the other. The radio signals from the "Southern Cross" were easily distinguishable from other signals, more particularly on the true note reception, or in other words, the note of the 250 cycle frequency generated by the "Southern Cross" wireless equipment.

When the airplane was climbing, they noticed a drop in the note frequency, indicating that the air speed was lower during the climb. This is due to the generator being wind driven. When the airplane was flying at a high altitude of 8000 feet and commenced to descend to a lower altitude, a great change was noticed in the frequency of the signals, this being due to the higher speed coming down. Fading, soaring and swinging effects were also apparent in the transmissions from the airplane, but the time period of the variations was much slower and consequently did not interfere to any extent with the reception of the signals. This applied more particularly to the flight from San Francisco to Honolulu, but between Honolulu and Suva the varying effects were less marked. Anyone who has heard the roar of an airplane engine and first heard the true note from the airplane wireless signal, would be liable to think that the signals were caused by the roar of the engine, the

true telegraphic note being very similar to the roar of the engine.

The operating staff at A.W.A. receiving station at La Perouse were very glad to meet the wireless operator, Warner, in whom they recognised a kindred spirit, and as remarked by one of the staff, "he knows his onions." He carried out his job very successfully throughout the whole trip, in spite of the buffeting and rain storms through which the plane passed. There is nothing of the stunt business about Warner—he takes every possible precaution to assist the operators receiving the signals on short. Ever since the plane left California a double watch has been specially maintained at La Perouse station.

Situated on the headland of La Perouse, the A.W.A. Sydney receiving station is one of the most modern receiving stations in the world, and is the collecting medium of the greater part of the commercial traffic of the South Pacific.

The small and somewhat unpretentious building houses wireless equipment incorporating the most ingenious and scientific ideas of modern radio experts. This station receives commercial traffic emanating from London and the Continental countries, via the beam feeder station at Braybrook, near Melbourne; ship's messages from vessels in the Pacific and Tasman Sea; messages from trawlers operating off the N.S.W. coast; commercial traffic from the A.W.A. Australian coastal radio station; from the A.W.A. island radio station at Rabaul and the French Administration's station at Noumea. In addition, British press messages, sent out by the British Government twice daily from the big station at Rugby, are received here, as well as overseas broadcasting from England and America and put on land lines to the studio of 2FC.

The whole of the transmitting equipment is centred at the A.W.A. station at Pennant Hills, such transmitters being "remote controlled." The ship service, trawler service and the short-wave service to Rabaul, Fiji, and Noumea, etc., are "remote controlled" from the La Perouse station.

Under this method all the operators are centred at La Perouse, and the tapping of the keyboard actuates the particular transmitter at Pennant Hills, the personnel at the latter station comprising a very small staff of maintenance engineers.

The efficiency of this method may be instanced in the case of marine services, where an operator receiving messages from a ship is able simultaneously to operate the keyboard actuating the marine transmitter at the Radio Centre, Pennant Hills, thus maintaining two-way conversation with the ship with which he is in communication.

Special provision was made by A.W.A. to aid the fliers in their trip from Suva to Brisbane. Requests were for several days broadcast to all ships at sea, asking that the wireless officer-in-charge should keep a watch for signals from the "Southern Cross," with a view to giving such assistance or advice as may be necessary.

In order to ensure the reception of messages from Australia by the "Southern Cross" whilst in flight, A.W.A. made available no less than three transmitters, each one of which transmitted continuously from the time the plane left Suva until its arrival in Australia. Each of these transmitters were tuned to different wavelengths and comprised a super-high-power short-wave installation and a 5 k.w. short-wave transmitter at A.W.A. Radio Centre, Pennant Hills. In addition, a 5 k.w. short-wave transmitter operated from Brisbane. In addition to the special short-wave services to the plane, there were also the normal

services of 600 metres and 740 metres, which latter is the wavelength used for direction finding.

All these sets were available to the plane upon request and could be operated separately or simultaneously. A.W.A. made special provision to augment the staffs available at Brisbane coastal radio station; A.W.A. Radio Centre, Pennant Hills; and A.W.A. receiving station at La Perouse.

Before the "Southern Cross" left Suva the Radio Centre, Pennant Hills, transmitted continuously to the A.W.A. radio station at Suva, and to H.M.D.2 "Pioneer" lying off Naselai Beach, forwarding all weather messages.



2FC and 2BL Activities

We have received an interesting statement from the managing director of the N.S.W. Broadcasting Company Ltd., setting forth the activities of 2FC and 2BL. It reads:—

Perhaps it is fitting at the present moment, when so much publicity has been given to a statement issued by a high authority in the Postmaster-General's Department, to remind listeners throughout this and the adjoining States, of some of the features that have been broadcast in programmes from 2BL and 2FC.

The New South Wales "A" class stations have to their credit the first transmission in any part of the world of a full sitting of Parliament, the description of the arrival of a fleet at sea, the broadcast for the first time in the world of two complete Gilbert and Sullivan Operas. Both these stations also described the events in the Great Public Schools Regatta in 1925, several years before the British Broadcasting Corporation described the Oxford-Cambridge boat race.

Descriptions of horse racing in the running were first undertaken in New South Wales some considerable time previous to any other Australian or overseas station undertaking this work. The development of special market sessions for country listeners was first established in New South Wales, and the news sessions of the "A" class stations here to-day, are far in advance of those of any other State.

In the field of relay work, 2FC and 2BL have always taken the premier positions. London was first heard through Holland on 2BL, and Australia was first relayed in England by the British Broadcasting Corporation through 2FC.

New South Wales programmes have been relayed on no less than five occasions, and so far no other State has had a programme relayed through the British Broadcasting Corporation. Dealing with this matter, Mr. H. A. Hankey, secretary of the English branch of the Empire Broadcasting League, who recently visited Australia, stated: "In Canada, U.S.A., on the Continent of Europe, in the British Isles, in India and Africa, 2FC is on the lips of all radio enthusiasts. It is not only simply logged, but relayed and discussed

more generally than perhaps any other station on the air. Nearly every radio journal, whether printed in English or foreign language, has, during the last six months, been discussing the world broadcasting of Sydney."

Long before any other State saw the value of descriptive broadcasting of sporting events, 2BL had described Interstate football, and 2FC Interstate cricket. The first church service and the first theatrical performance in Australia fell to the credit of the Sydney stations.

Quite recently American stations have claimed as records a broadcast from 6000 feet in the air, and the description of a film during its presentation in a theatre. Over two years ago, one of this company's stations carried out a transmission from 10,700 feet in the air, and 3000 feet under Sydney Harbour from within a coal mine, and described a film during its full presentation.

The Sydney stations can claim a world's record in the direction of having, during their short lifetime, transmitted over 110 distinct works in the form of theatrical performances. They have also transmitted over a longer daily period than any other station, and claim that their programmes are equal to, if not more diversified than, those of any other country.

2BL and 2FC can between them claim that every avenue in musical, theatrical and utilitarian broadcasting, has been explored, very often at a cost far out of proportion to the revenue available to them from licenses, but both stations have always placed service above cost.

SUBSCRIPTION FORM

"QUEENSLAND RADIO NEWS."

Box 1095N, G.P.O., Brisbane.

Please send me the "Queensland Radio News" for 12 months. I enclose cheque or P.N. for 6/6.

Name

Address

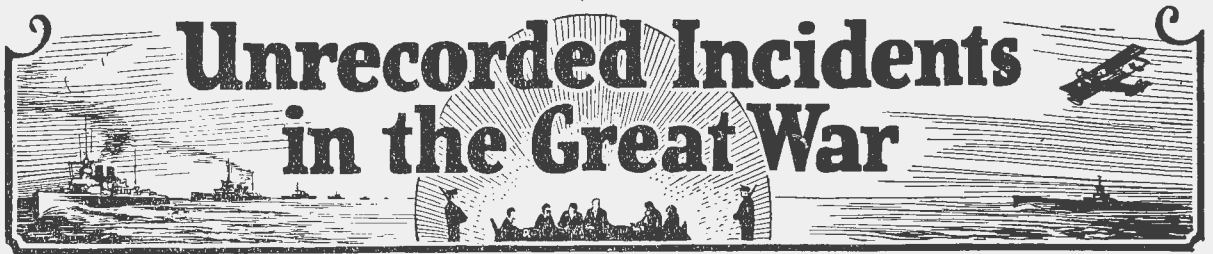

(By Robert Ware.)

A thrilling series of Secret Service yarns—built around actual incidents during the Great World War—and told in a manner that grips your interest.

Episode No. 4. ~ "The Zeppelin of Zeebrugge"

I.

H.M. sloops "Delphinium" and "Rhododendron" had reached the eastward end of their patrol and, describing a huge arc, commenced the short ten mile hop towards the setting sun. Patrolling between Heyst and Blankenberghe, eternally on the lookout for enemy submarines was not very pleasant in the month of January. Dull, leaden skies—more or less continually obscured by storms of rain and sleet—and a piercingly cold wind which never ceased, made the task anything but a picnic. The monotonous regularity of the patrol made constant vigilance somewhat nerve-trying, but the knowledge that any moment might find an enemy submarine risking a torpedo, or floating a mine to the surface, kept everyone on the qui-vive in spite of everything.

This afternoon had, however, been unusually clear and the "watery" winter sunshine had done its best to mitigate the cheerless round of the Flanders patrol.

About 4 p.m. the sloops were dead abeam of Zeebrugge—"Rhododendron" being about half a mile inshore of "Delphinium," and almost two hundred yards ahead.

Suddenly a wild shout came from the lookout of "Rhododendron" who, though half-frozen, was excitedly gesticulating with one hand, whilst, with the other, he pointed to a swiftly approaching "feather" of spray.

"Ye Gods! A submarine—coming full tilt at us!! Hard aport, Quartermaster—cut the devil in two!" yelled Lieutenant Chambers of the sloop "Rhododendron," and, in obedience to his command, the vessel swung almost at right angles and listed to an alarming degree.

"Now, then, chaps, jump on her just abaft the periscope!" yelled the excited youngster—and his crew, not one whit less excited than their commander, grinned with glee at the thought of the coming crash as the sharp bows of the sloop tore through the flimsy plates of the "under-sea-boat." Joyfully the patrol boat put her full eighteen knots into the job, and just missed the racing "feather" by about twelve feet. Every mother's son in the British war vessel tensed himself for the welcome impact of steel against steel. But no impact came, and the "feather" sped on with undiminished speed.

"Well, I'm damned!" gasped Chambers. "That's a — funny submarine."

"It's not a sub, sir," piped the shrill voice of a young midy, "it's travelling too fast."

"By jove, you're right, son!" returned the flabbergasted naval officer. "But what the hell IS it?"

"Dunno, Sir," dutifully replied the kid as he watched the rapidly vanishing disturbance in the sea. "Lok, it's changed its course, Sir!" Chambers—and, indeed, all on board—did not need the boy's information, for they, too, had noticed the mysterious action of this weird thing. My Holy Aunt, he'll run right into 'Delphinium'! was the irrepressible youth's next comment—then the weird contraption suddenly disappeared.

"He's dived—drop those depth charges!" yelled Chambers as he collected his scattered senses, but, before a man could move a step, "Rhododendron" reeled from a heavy underwater explosion, and a mighty wall of water rose and overwhelmed "Delphinium."

"My God, it's a—torpedo!" came from the throat of every dazed watcher, but Chambers—his mind once more working normally—sent his ship round and raced to pick up his fellow countrymen who were leaping from the rapidly sinking sloop, and swimming for safety.

II.

"You're quite certain that the torpedo which sank 'Delphinium' changed its course?"

"Absolutely positive, Sir, every eye was on the thing when we thought we were ramming a blanky submarine—and when nothing happened we couldn't keep our eyes off it. After it had travelled about three or four hundred yards, it suddenly swerved and headed straight for "Delphinium." At our sudden burst of energy, "Delphinium" held herself ready to rush to our assistance, and did not see the 'feather' until a moment before it disappeared. For a few minutes we were all 'up a tree,' and in those few minutes the damage was done. I've often cursed myself for not dropping a depth-charge or letting drive with our guns or something—but, Sir, you really cannot conceive the pace at which the thing was travelling. We were too astonished after our attempt at ramming it to collect our wits in time."

"I know how it is, Lieutenant," said the Chief of the British Naval Intelligence Department. "I've been caught myself with the devilish cunning of our 'friends,' the enemy. As a matter of fact, I estimate



 EVER-READY RADIO BATTERIES



 FOR LONGEVITY IN SERVICE

POWER - LONG-LIFE ECONOMY

These are the necessary and most desirable features in any good radio dry battery. Every make of battery possesses a measure of power, but few also combine the qualities of long-life and unequalled economy as does an "EVER-READY."

For what good is power, if the cost of that power is not commensurate with the long and trouble-free service it should give?

EVER-READY Radio Batteries are made in Australia—the user is saved the cost of packing, freightage, and duty, which the overseas article must carry. They come to you fresh from the factory—there is no deterioration of materials or loss of power whilst in transit. And there's a range of types to suit all requirements. Wire an EVER-READY in now—for better reception.

Queensland Distributors

Edison Swan Electric Co., Ltd.

156 Creek Street

BRISBANE

New 45-Volt H.T. "B" Batteries

The new EVER-READY 45-volt HEAVY DUTY "B" Battery is made up of 30 large cells in moisture-proof containers, with positive screw terminal taps at 18, 24, 30, and 45 volts. Heavy Gauze Zinc Containers, High-grade Chemicals, perfectly balanced, and the whole efficiently insulated, insures long life and noiseless reception, **warranted to give service NOT EXCELLED by any other make of battery of equal size and capacity.**

EVER-READY 45-volt SUPER SERVICE "B" Battery is similar in design to the above listed Heavy Duty Battery, but the cells are of even sturdier build and more powerful output capacity.

PRICES

Ever-Ready H.D. 45V. 23/6

Ever-Ready S.S. 45V. 27/6



that the time between your attempt to ram the thing and the sinking of 'Delphinium' was—more or less—one minute. Seeing that you were busily watching the mysterious device, and wondering what the blazes it was for a period of possibly thirty to forty seconds only, and, during the remaining portion of the minute, watching for some further sign of it, I don't think you could have done much to warn 'Delphinium.' Next time you meet one, however, you'll recognise the breed and act accordingly."

"What was it, anyway, Sir?" asked Lieutenant Chambers with an almost childlike faith in the ability and knowledge of "Dumb" Hilton of the Intelligence Service. "Was it some damned magnetic contrivance?"

"No," laughed Hilton, "it was merely the practical application of world-wide experiments to produce a wireless-controlled surface torpedo."

"And all we can do is just to dodge these things with every ounce of speed we can muster, I suppose, Sir?"

"Yes, for the present your only hope is to keep bow on whenever you see a 'feather' approaching—steam towards it until it dives, and then steer off as hard as you can, and it will pass you. Once it is submerged it cannot change its course or even rise again. Of course, it might not be taken under the surface—its movements are entirely in the hands of the person operating the control-station."

"The control-station!" echoed Chambers, his voice registering astonishment and doubt. "But, Sir, we patrol about fifteen miles from the coast—more often than not we cannot see the shore."

"I know. There are, however, certain things which you see, and which see you, every day you are on duty, but you've got used to them by now," said Hilton with a smile.

The younger man wrinkled his brows and thought furiously. Suddenly comprehension dawned, and his face lifted eagerly: "Not Zepps., Sir?" he asked quickly.

"Precisely," retorted Hilton grimly. "Sitting up in the sky at ten or twelve thousand feet a Zeppelin is pretty safe from damage from our patrol boats, but yet they are only two miles from you actually, and, with the wonderful glasses they have, the enemy can easily follow the wake of their engine of destruction and direct it where they like."

"But, Sir," broke in his junior in a puzzled voice, "the Zepps. couldn't drop the blighted things from the clouds—and a torpedo can't travel fifteen miles—?"

"I'm surprised at your denseness, Lieutenant Chambers," interrupted Hilton with mock severity. "Haven't you ever heard of an 'egg-laying' submarine?"

"My Godfather!" gasped Chambers. "Well, I'll be frizzled—what the devil will they get up to next?"

III.

Lieutenant Chambers returned to his patrol off the Belgian coast, convinced that if there was one man in the British Empire who could outwit the devilish German cunning—that man was Commander Robert Hilton, R.N. Only vague rumours of the brilliant exploits of the Chief of Britain's Naval Intelligence Department were known—even in the Navy—owing to the great secrecy with which his movements and operations were shrouded.

Immediately, however, the members of the Flanders Sea Patrol were told that this wonderful Naval Officer was on the trail of Germany's latest application of science to warfare, they shed their fear of the weird contrivance as easily as they flung their heavy oilskins from their broad shoulders.

This man whom the Navy had almost raised to the point of mythical heroism and genius, had said, "For the present you must dodge the things." Very well, now they knew what they had to deal with, they'd "dodge" them alright.

Hilton, realising that this new departure of the enemy was capable of proving a nasty thorn in the side of the British Navy, had immediately retired to his experimental workshop, and, with two or three carefully chosen assistants, toiled practically day and night on his problem. Meanwhile a succession of calm, clear days in the North Sea had generated increased activity in the use of "wireless-torpedoes" by the Germans. In every instance, it was now noted, a long, grey Zeppelin hovered at a tremendous height, directly above the patrol boats, but the time of attack by torpedoes varied each day.

The day after "Rhododendron" returned to her station, the Royal Air Force made a daring attempt to attack the huge airship, but on sighting the British machines, the Zeppelin lazily drifted over Zeebrugge and a swarm of Gothas and Taubes rose from the German aerodrome.

In the air fight which followed, one British machine was brought down in flames and two others were forced to land and their crews captured, and, although the enemy aeroplanes suffered the greater punishment, the risk of fighting such overwhelming odds so far from their base, placed the British airmen at such a disadvantage that further aerial attacks on the "Zeebrugge Zeppelin" were abandoned.

The question of abolishing the Flanders Coast Patrol was momentarily spoken of, but, as the Admiralty pointed out, the occasional loss of a patrol boat was the price we had to pay for hampering enemy submarines in their departure from and entry into their bases on the Belgian coast.

Inspired by the moderate success achieved, Germany plied her new weapon with increasing vigour, until soon, instead of one wireless-torpedo being directed at a British patrol boat, no less than three, each on a divergent course, made "dodging" a matter of extreme difficulty. Still, the Admiralty would not agree to the removal of our patrol, and Hilton worked harder than ever.

IV.

It was well past midnight and London was enfolded in complete darkness, yet two figures in overalls toiled feverishly in a small room in the rear of the Admiralty building.

"Another hour and we'll fix it, Atkinson," breathed the Chief of the Intelligence Service as he scratched in the junk box for a contact stud. "Tired?" he added with a yawn.

"Not a bit, Sir, I've only been with you since eight bells, you know," responded the artificer-electrician with a smile. "Don't know how on earth you stand up to it, Sir."

"Oh! I'll get some sleep on the way over to Zeebrugge," laughed Hilton. "That is, provided we don't have any excitement," he added.



The Golden Voice!



**Perfect Curve— Perfect Tone
Full Amplification**

The GOLDEN VOICE Transformer has been designed to reproduce the notes of all musical instruments, including the low notes of the drum and kettle-drum and the lowest organ notes with equal volume to all other frequencies.

The GOLDEN VOICE covers the full scale without distortion up to 8000 cycles, that is, the full range of the harmonic scale.

The world has not yet seen a transformer which compares with this latest triumph of Emmco. No finer contribution to perfect radio reception has ever been made. An engineering masterpiece, scientifically designed and fulfilling every single requirement of modern broadcast reception.

AT ALL DEALERS.

PRICE
42/6

Made in ratios
No. 1 & No. 2
for 1st and 2nd
stages of audio.

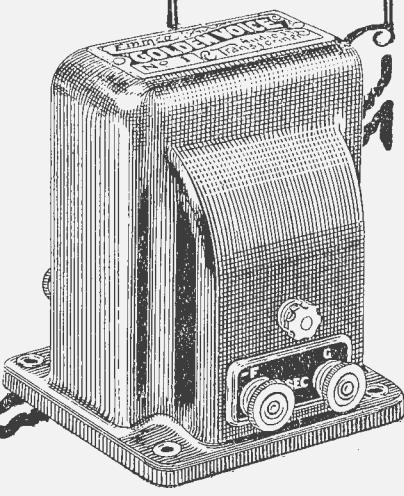

Other EMMCO Transformers.	
Cavalier Transformer	21/-
Emmco Transformer (metal case)	17/6
Emmco Midget Transformer	13/9

The Chief had been working for nearly thirty hours without taking a moment's rest, and now, although he would never have admitted the fact, was feeling the strain of the mental and physical exertion. Well within the hour, however, he gave the hastily-rigged machine a complete test with a vernier wavemeter and, apparently satisfied, told Atkinson to call the S.N.O. Sheerness.

In less than a minute the great Naval Dockyard was apprised of Hilton's successful experiment and, giving instructions for one of the speedy Admiralty cars to come and pick him up, the brilliant Naval Officer turned to pack up the result of the last week's energy.

"Shall I come with you, Sir?" the polite question scarcely veiled Atkinson's eagerness to see the outcome of his chief's brainwave.

"Yes; you may as well see how the 'jigger' works," replied Hilton with a happy laugh, "you can take care of it on the way over."

"Trust me for that, Sir," came the joyful response.

Hilton was received aboard the scout-cruiser "Faraday" with keenest delight—everyone turning out to welcome the naval man who had achieved such incredible successes against the enemy's cunning.

Robert Hilton responded genially to the respectful salutes of the oilskin clad seamen, and cheerfully accepted the hospitality of the ward-room before turning-in.

Just as daylight broke, however, he stretched his weary body in the neat, wholesome smelling bunk and, by the aid of a marvellously trained will, cleared his whirling brain of all action, and fell asleep immediately. Four hours later the long, sleek, grey shadow was with the Belgian Coast Patrol, and had exchanged formalities.

Atkinson, being summoned by the Commander of H.M.S. "Faraday," was vehemently opposing the suggestion to awaken Hilton. The young officer in command of the scout-cruiser smiled at the artificer's earnest pleading to let "the Chief" sleep on.

"Not a wink of sleep has he taken for two days until now, Sir, and there isn't any need for him to be on deck."

"But, Atkinson, he wants that 'thingamajig-what's-this' fixed up as soon as possible," persisted "Faraday's" commander.

"Leave that to me, Sir," assured the now important Atkinson, "I'll have it working in no time."

Hilton, with a subconscious sense of approaching danger, however, awakened at the moment, and hastily donning a pair of overalls, appeared on deck before the zealous artificer had time to "hook-up" the connections in the wireless room.

Atkinson started a little guiltily and, jumping to the salute as the tall broad shouldered form of the Chief filled the little cabin doorway, flushed with dismay and embarrassment.

"Quite alright, Atkinson," laughed Hilton, noticing the other's confusion; "only I decided while asleep to conduct our experiment on one of the M.L.'s."

V.

The tiny high-speed motor launch M.L.15 flung the water from her overhanging bows in a hissing roll of foam as she sped from "Faraday's" side at twenty knots.

Hilton had not been an hour too soon, for he had no sooner transferred his "box of tricks" to the tiny

grey craft than an enemy Zeppelin was observed over Zeebrugge, heading seawards.

As the huge airship gradually came overhead, even Hilton felt the excitement of the game. He had taken a more than ordinary risk in using such a diminutive craft as an M.L. for if a surface torpedo happened to strike them everything would be blown to pieces.

However, he was backing his brains against those of his country's enemy, and his only regret was that others were forced to accompany him on his dangerous errand. Any regrets he may have had, however, had now to be cast on one side, for about half a mile nearer shore three small sprays of foam suddenly appeared on the smooth surface of the water and began to approach with ever-increasing speed.

Ordering the M.L. to be headed in the same direction as that in which the "feathers" were travelling, Hilton waited in silence until they were within a hundred yards of the stern of the motor launch.

"Let her go like hell—and dodge these things as they overtake us, Lieutenant!" he suddenly yelled.

The estwhile shipping clerk who had spent his holidays motor-boating round the Norfolk Broads, flashed a wide grin at the overall-clad figure, and echoed, "Trust me for that, Sir."

Staring at the onrushing torpedoes—his most powerful prismatic binoculars glued to his eyes—Hilton watched every visible detail for a sudden change in their course. The M.L. was doing almost twenty-eight knots and was being slowly overhauled by these rushing engines of destruction, and to get in their way was the last thing to be desired.

Evidently the observers in the Zeppelin high above them did not consider the tiny motor launch worth attention, for gradually the periscope-like projections

A Reliable Battery

Without a reliable battery your set is practically useless—you can never hope for clear reception.

Instal a C.A.V. British Battery—the battery especially constructed for radio work—and receive that smooth even flow of power which ensures perfect reception.



**RADIO
"A" & "B"
Batteries**

Queensland Distributors

Barnes Auto Co.

CORNER NORTH QUAY & QUEEN ST.

Sterling

BRITISH MADE

LEADERSHIP IN WIRELESS

Sterling Model "61" introduces a new standard of high quality long range reception. Incorporating three Marconi S. 625 Valves, an anode bend detector and two resistance coupled low frequency stages, it is more sensitive than the best superheterodyne circuits.

The Incoming Signals are received on a small frame and magnified over half-a-million times before reaching the loud speaker. At each stage the utmost care is taken to prevent distortion, while a special circuit maintains the correct proportion of overtones and harmonics essential to natural speech and music.

Complete Shielding obviates local interference and "pick-up" on the coils of the receiver itself. The cabinet is lined entirely with metal, and a sealing device incorporated to prevent magnetic leakage of the hinged cover, thus ensuring perfect stability, while the frame aerial and four tuning controls provide a high degree of selectivity.

Two Wave-Length Ranges of 250-550 metres and 1,000-1,900 metres are available, covering all usual broadcast transmissions with no change of coils, the transfer from one range to the other being effected by a single switch.



MODEL 61 Six-valve Receiver

incorporating
THREE MARCONI TYPE S. 625
SHIELDED VALVES

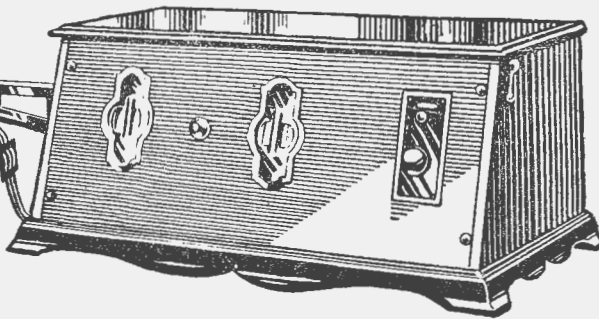

Full particulars, prices, etc. from our representative—

A. COLLINS

ROOM 12, 5th FLOOR, DAILY TELEGRAPH BUILDINGS,
SYDNEY, N.S.W.

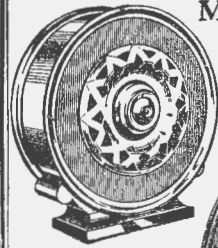

Model 105
Cabinet
Cone

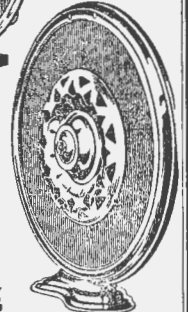

Model
75
Cone

Sterling

CONE SPEAKERS

Nothing so strikingly distinguished, so perfect in performance, has ever appeared in loudspeaker design. Never before has the acute sensitivity of the horn type speaker been combined with the greater attractiveness of the cone.

MODEL 105 CABINET CONE

Sound emission is from both sides, and whichever way the cone is turned, the entire musical scale is heard to perfection.

MODEL 75

A feature of no little value is the ease with which it may be kept free from dust.

Sterling

TYPE 33

Of great volume capacity, reproducing melody faithful to the original by retaining the tones and overtones which give music its beauty and charm. Exceedingly pleasing in appearance. Mahogany or Walnut finish.

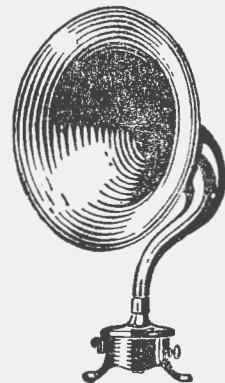

TYPE 33

Made by the Sterling Telephone & Electric Co. Ltd., London.

drew abeam—two on the port side and one on the starboard.

Suddenly the speeding missiles swung hard to starboard.

There was a combined yell of warning, above which Hilton single command, "Dodge!" could plainly be heard. The lightly built shipping-clerk-commander flung his weight on the wheel, but the force of the water on the rudder was more than he could overcome.

"Get ready to jump," yelled Hilton as, with a bound, he was at the young Lieutenant's side, and with a mighty heave, swung the motor boat almost on her beam ends.

M.L.15 all but "turned turtle" in that terrific swerve—her port engine raced as its propellor came clear of the water—and the green sea poured over the starboard gunwhale.

The consequent loss of speed, however, saved M.L.15, for before she was on an even keel the nearer of the two port torpedoes flashed across her bows. Bathed in perspiration and panting with mingled fear and hope, her crew saw the shining cigar-shaped terror as it slipped through the clear water barely three feet under the surface. They heard the high-pitched hum of the twin screws as they drove their deadly load on its mission.

There being no hope of overtaking the speeding torpedoes, Hilton raised his eyes to learn the reason for the sudden change of direction, and saw, with horror, that the almost stationary "Faraday" was the target for which they were heading.

Praying that the Germans in the Zeppelin, who controlled these fiendish devices, would not submerge them before his own apparatus reached its full power, Hilton quickly threw the double-pole switch over.

Instantly there came a shrill metallic whine from the cabinet, which gradually crept higher and higher as the electric motor gathered speed. Praying harder than ever for "split seconds" of time, Hilton sighed a fervent "Thank God!" as the messengers of destruction began to describe a wide, circling movement and slid almost alongside the grey sides of "Faraday." Grasping a control handle, Hilton gazed intently at the rapidly turning projectiles and, suddenly, with a grunt of satisfaction, disconnected the motor, and kept the hissing arc on a steady wavelength.

With phenomenal luck, he had gained complete control of the wireless torpedoes, and had sent them rushing to the spot from whence they had come.

VI.

The captain of the under-sea-boat U.C.47 was decidedly unlucky. Having floated three of the new controlled torpedoes to the surface at exactly the hour commanded, he decided to rise and enjoy the sight of a "verdampft Englischer" patrol-boat departing for Davy Jones' Locker.

His periscope showed a long, low scout-cruiser of the latest type built by Britain, right in front of the tell-tale "feathers" of spray, and his fat, under-exercised body was convulsed with joy.

He turned from the periscope to climb the conning-tower ladder, for his submarine was now almost awash.

Suddenly, there was a mighty roar, and U.C.47 disappeared in a shower of iron fragment, while the German naval officers, fifteen thousand feet up in the air, saw the unbelievable spectacle of their latest submarine torpedoing itself.

HELLESENS

The Super

DRY CELL

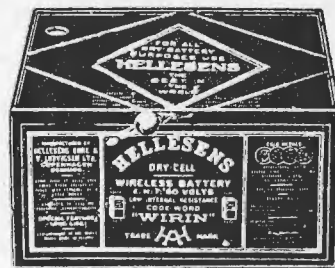

The Battery that RECUPERATES while idle!

The world's oldest battery company introduces the century's latest dry cell improvement—the wonderful

No. 7 Recuperating Agent

This exclusive feature is to be found in no other dry cell. It ensures longer life and full value for every penny spent.

See for yourself how superior the New HELLESENS are. Connect one up to your set and take regular voltmeter readings. You'll be surprised.

PRICES

Standard Capacity—	
45V.	14/-
60V.	18/6
Triple Capacity—	
45V.	21/-
60V.	27/6

At All Good Radio Dealers
or Direct from

BRISBANE ELECTRICAL CO.

(T. Tonks)

ELIZABETH STREET (Next to 4QG),
BRISBANE.

*Once the Price
of the Parts*

£3-15-0

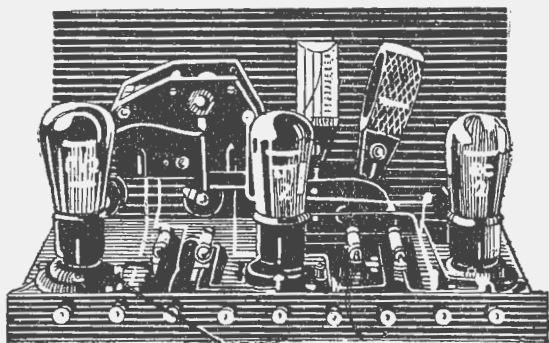

*Now the Price
of the Set*

**R.C. Threesome Wired & Ready
for Service - at the price of the parts**

ON the surface it seems incredible—a really fine 3-valve, resistance coupling set at so low a price. Yet when the Edison Swan Electric Co. Ltd., make an offer you are quite sure of it being genuine. They are selling their famous R.C. Threesomes, wired and ready for use at the old price of the parts. These popular sets were originally offered unassembled—just the parts, with a blue print and instruction book on how to build them. Even at that, the wireless world agreed it was the best value ever seen. So you can understand the enthusiasm shown now that these sets are presented absolutely complete and ready for service—AND AT THE OLD ORIGINAL PRICE OF THE PARTS.

Once the Price of the Parts. **£3-15-0** Now the Price of the Set.

A limited number only is offered at this price. Order yours at once.

EDISWAN

THE EDISON SWAN ELECTRICAL CO. LTD.

156 CREEK STREET, BRISBANE.

Please send me full information of your "Complete R.C. Threesome" offer.

Name.....

Address.....

Club Activities



Wooloowin Radio Club [oa-4WN]

Despite the criticism hurled at 4WN in last month's issue by some dear old soul styling itself "Mother of Ten," club affairs have been going on very well of late.

The field day about which that "lady" passed so many scathing remarks, was almost quite respectable, though it must be admitted that some of the places in which clues had been concealed were rather low down—the treasure itself being buried—but this was balanced by one at a certain station being extra high!

The transmitter used on the field day is still in working order, and it is hoped to have another day out in the near future. 4FK Kenna was responsible for the construction of the transmitter, the power for which was supplied through a Ford spark coil from the car battery. Excellent reports were received on transmissions made with the car in motion. 4FK thinks that with a few minor alterations the 'mitter would be very suitable for aeroplane work. So far no 'planes have been donated to the club, and it would thus appear that 4FK will not be a rival to KHAB of the "Southern Cross" for some time to come.

During the past month one of our members delivered a lecture to the Toombul Club, and came back to give a glowing account of the interior decorations of their shack. Some few weeks ago one of the Toombul gang delivered an interesting lecture on house wiring to 4WN. Should any other club be desirous of arranging an inter-change of lectures they are invited to write to 4WN.

Harold Stevenson of 4RG has been on a trip to Sydney on his motor bike, so brother Charlie has had a busy time keeping the filament fires going at 4QG, 4RG and occasionally at 4WN.

The club's transmitter is once again being rejuvenated, and some new gear, including a U.X.210 valve, is to be purchased in preparation for the Wireless Exhibition. Individual members are also very busy getting their entries ready for this, and the total number should be considerably greater than was the case last year.

Club meetings—to which visitors are welcome—are held every Thursday night. Correspondence can be addressed direct to the Club, care of Mr. F. J. Thomas, Willmington Street, Wooloowin.

Eastern Suburbs Radio Club

The second annual meeting of the above club was held this month at the club rooms, corner of King and Stanley streets, East Brisbane. The attendance was very satisfactory.

The secretary and treasurer submitted their reports for the approval of the members. Club finances are

fair, considering the amount of money that has been expended on club gear.

The equipment at the club's station is nearly complete. A new aerial is being erected and a rectifier is being built under the supervision of Mr. A. Bauer, who is the club operator. When these are completed the club will be on the air with a wavelength of 23 metres.

Officers elected were: Secretary and treasurer, Mr. R. Gardner; and Morse instructors, Messrs A. Bauer and S. Mackenzie.

During the forthcoming year the club expects to be very active, and it is hoped to have many lectures and debates. New members are wanted to strengthen the club. The annual fee is 5/-. Radio enthusiasts wishing to join up will be welcome. The club meets every Wednesday at 8 p.m. Interested members desirous of obtaining further information are requested to communicate with the secretary, Mr. R. B. Gardner, "Hollywood," Minkin Street, Toowong.

Toombul Radio Club

Since last report, the telephony transmitter of the club, 4TC, has been testing on 240 metres, and reports on the tests have been received from numerous listeners in the district.

On Monday, June 11th, a euchre party and dance was held under the auspices of the club, in the Northgate School of Arts, and was voted by all as a pronounced social success.

Wednesday, June 13th, saw a very interesting lecture delivered in the club-room by Mr. Vern McKenna (4FK) of the Wooloowin Radio Club. Mr. Kenna chose as his subject, "Meters; their Construction, History and Use."

Meetings of the club are held every Wednesday evening in the club-rooms, corner Eton Street and Sandgate Road, Nundah.

Indooroopilly Radio Club

A radio club has lately been formed at Indooroopilly and will be known as the Indooroopilly Radio Club, or, in short, the I.R.C.

We are as yet small in numbers, having only a dozen members at our back. Nevertheless, we are very enthusiastic. Our main object is the A.O.P.C. As a body we are out to assist those who know nothing at all about wireless, and by so doing, we hope to arouse a general interest in that most fascinating study.

The club will meet every Friday night at the residence of Mr. Rose, Chemist, Station Road, Indooroopilly, and a cordial invitation is extended to anyone interested in wireless generally.

We are fortunate in having among us some who are in a position to deliver lectures, etc., and the future success of the club seems assured.

The President is Mr. C. Beswick, Railway Parade, Indooroopilly; the secretary is Mr. Les Williams, Salisbury Street, Indooroopilly.

Either of these gentlemen would be pleased to give further information to anybody interested in the movement.

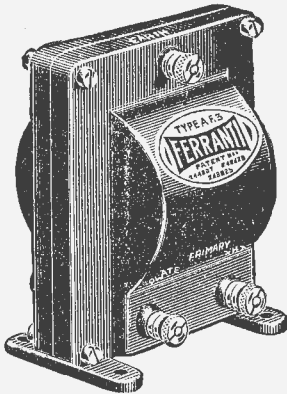

BRITISH MADE
AUDIO FREQUENCY
TRANSFORMER

TYPE AF 3 - - - - 45/-

The charted performance of the Ferranti AF 3 Transformer is published below. Note the **UNIFORM AMPLIFICATION**

and buy your transformers only from manufacturers who publish the curve showing actual charted performances of their product.

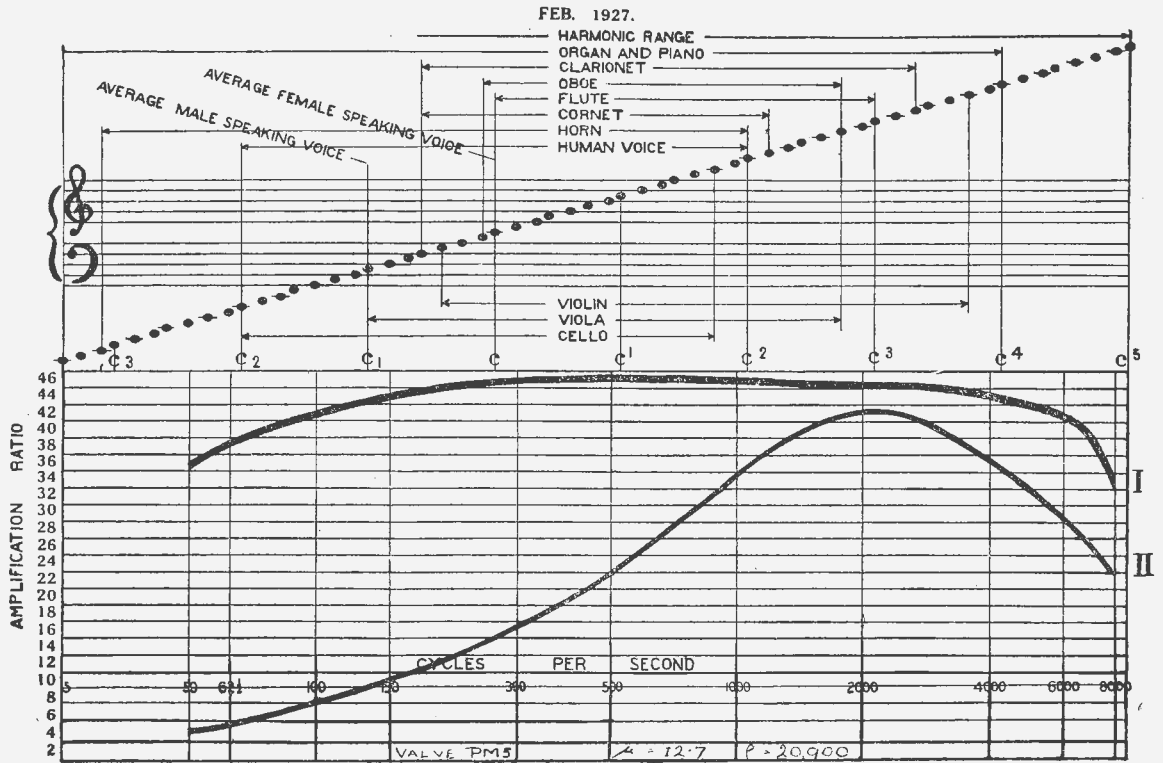

Curve 1.—The Ferranti A.F.3 Transformer.

Curve 2.—A well-known transformer made in Australia

The "Ferranti" Transformer is designed to improve your set by increasing the efficiency of your Loud Speaker, and is constructed in two types. A.F.3 (up to 410,000 ohms), 45/-—no better Transformer at any price—and A.F.4 (up to 90,000 ohms), 34/-. No better transformer available at the price.

Isolate your Loud Speaker with a Ferranti Output Transformer.

Obtainable from every Radio Dealer in Australia. ,

Dealers please communicate with: A. BEAL PRITCHETT (AUST.), LTD., Sydney & Melbourne.
WEDMA LIMITED, Adelaide EDGAR V. HUDSON, Brisbane. GIBBS, BRIGHT & CO., Perth. I.

Broadcasting the Pacific Flyers

To 4QG falls the honour of broadcasting the arrival of the gallant "Southern Cross" airmen, and every listener will agree that every function was carried out in a manner that did the station and its officials great credit.

4QG's description of the arrival was re-broadcast by other "A" class stations in Southern States, enabling the whole of Australia to hear the vivid description of the completion of the historic flight.

Right throughout the journey of the "Southern Cross" to Australia, 4QG engineers kept in constant communication with Warner, the opera-



Capt. Kingsford Smith and Mr. C. T. P. Ulm broadcasting their first direct message in Australia through Station 4QG.

The group was photographed in Lennon's Palm Court, and those in it, reading from left to right, are:—Mr. J. W. Robinson (Director of 4QG), Capt. Kingsford Smith, Mr. C. T. P. Ulm, and Mr. Jack O'Hagan (Lennon's).



tor, and frequently broadcast first-hand and authentic information concerning the progress of the 'plane.

The photographs were taken upon the occasion of the State dinner tendered to the airmen on the night of their arrival in Australia.

The State Dinner which was tendered by the Government of Queensland to Capt. Kingsford Smith and his three companions on their arrival in Brisbane. The Premier, Mr. McCormack is seen in the centre of the picture just behind 4QG's microphone; Capt. Smith is to the left of him, and Mr. C. T. P. Ulm is to the right. Mr. Warner, the radio operator, is the next but one to Mr. Ulm.

An *Invitation!*

The **NATIONAL RADIO EXHIBITION** **OLYMPIA, LONDON, ENGLAND** **September, 22nd to 29th**

Exhibitors are anticipating with pleasure the opportunity of meeting many overseas visitors during the run of the show, and extend a very hearty welcome ~

To keep in touch with Radio's latest developments you must come to Olympia ~ but ~

**DON'T FORGET THE
DATE**

Sept. 22nd to 29th



Organised by

THE RADIO MANUFACTURERS' ASSOCIATION

Astor House, London, W.C.2 England

This department is conducted for the assistance of our readers. Except under special circumstances, we do not undertake to supply answers by mail.

Questions Answered

By the TECHNICAL EDITOR

Questions received before the 20th of the month will be answered in the following month's issue. Queries arriving after this date are deferred until the next issue.

L.H., Sandgate.—"I am submitting the circuit diagram of portion of a five-valve tuned-radio-frequency set, using neutrodyne coil kit. To date this set has functioned very fair, but on an average night it is not possible to entirely eliminate 4QG from 3LO Melbourne, all the other stations being O.K. Considering my distance from 4QG, this should not be so, and I am to ask you do you think my first radio stage is partially rectifying? If so, would you be good enough to show me the way to add a bias to the grids of my radio valves? Of course, I am only assuming that this may be of assistance."

Answer.—It is unlikely that the occurrence you mention is taking place, and, as a general rule, it is unnecessary to bias the grids of the r.f. valves in a neutrodyne, when the usual values of plate voltage are used. At the same time, to satisfy yourself, it will do no harm to try the effect of a negative bias applied to the two r.f. valve grids, so we are mailing you a diagram showing the correct connections. In the same sketch, we are showing a correction which you should make in the connection of the 1-mfd. by-pass condenser which you have shunted across the "90-volt" terminals. When using a variable resistance in the "B" battery lead to the r.f. valves as an oscillation control, the by-pass condenser always should be connected from the coil side of the resistance to the filament—not, as you have shown, from the "B" battery side. It is possible for this to have some adverse effect on the selectivity, though I do not think this is so in your case. As the interference, apparently, is only slight, why not try cutting ten or fifteen feet off your aerial? Another way to improve selectivity is to use a counterpoise instead of a direct earth. For this, try a thirty-foot length of any handy wire connected to your earth terminal instead of the earth wire, and simply laid on the floor. It may be fixed permanently by stapling around the skirting board. This counterpoise will almost certainly cure the trouble. Apart from removing turns from the primaries of the r.f. transformers (which is inadvisable in the coil kit you mention), the only way to improve selectivity in the receiver itself is to turn the r.f. rheostat to the lowest possible point, and to reduce the "B" battery voltage on these valves. You might let us know if any of these suggestions help you.

"A.G.," Moregatta, via Cairns.—"I have an eight-valve Super Het., and I have a lot of trouble with the transformers. Four have gone out of action the last twelve months. Would it be the fault of the transformers, or would the "C" battery have any effect on them (being run-down, or too much)? I use Ever-Ready 4.5 volts. I have sent for a transformer to take the place of the one that is gone. Also please send me a copy of the 'Q.R.N.' for August, 1926, with the details of 'How to Make an Inexpensive "B" battery from Your Old Dry Cells' (sixpence in stamps enclosed)."

Answer.—Please accept our apology for missing your letter last month. The copy of the August (not July) 1926 issue has been mailed to you. The battery described has been, and still is, remarkably popular and gives excellent results. Regarding the trouble you are having with your Super-Het., it is fairly certain that the trouble is with the transformers themselves. It is understood that breakdown of the primary is by no means unknown with the transformers mentioned, particularly under humid weather conditions. As you do not mention any other trouble with the set, I assume it is giving good reception; if this is the case, it may be concluded that there is no fault in the set which would have any deleterious effect on the transformers.

You do not say if it is the first stage or the second stage transformer which gives trouble, or both. This information would be helpful. In any case, the conditions of the "C" battery would not affect the windings, one way or the other, except that the "B" battery current flowing through the primaries would be a little heavier when the "C" battery was run down; not heavy enough to cause damage, however. Think your trouble will disappear with the installation of the new transformer; have never heard of one of these breaking down yet.

"H.G.B.," Booval.—"I have been informed that, in early issues of the "Q.R.N." there was a full description of the A.O.P.C. course, as regarding Morse and theory of same. Would it be possible for me to secure these issues, and, if so, what would be the cost? I would be very much obliged if you could secure them for me, as I am an intending Ham."

Answer.—The series of articles covering the Amateur Operators' Proficiency Certificate Examination was published in the issues running from October, 1926, to October, 1927 inclusive (thirteen issues). However, the April, 1927, and July, 1927 issues are now out of print, but we shall be glad to forward you the remaining eleven issues upon the receipt of P.N. value 3/8. These issues will give you a clear idea of the course, and a close study of the material they contain should afford you a very good chance of success in the examination, which is not difficult. The main thing is to practice your Morse until you are able to copy a buzzer at 15 words a minute, single sending—allowing five letters per word. The examination speed is 12 per minute, but you must have a margin to allow for nervousness, which, as most of those who have "been there" know, has a very demoralising effect on one's speed! Wish you all success.

"D.S.," Cleveland Line.—"(1) Which is the most efficient method of tuning a 15-valve P-1—plug-in coils or a three-circuit tuner, and what advantage has one over the other? (2) Do you think a B-406 valve in the first audio stage, preceded by an A-415 would give better results than an A-415 as the second valve? (3) Can I use an Amperite or Tempryte on the second valve instead of a 15-ohm rheostat?"

Answer.—The circuit you have in mind is the three-coil circuit—NOT the P-1, though this name is often incorrectly applied to the standard three-coil arrangement. The P-1, which is rarely seen nowadays outside the radio room of a ship, has only TWO coils—the grid coil and the reaction—the aerial and earth being directly connected to the grid coil, hence its lack of selectivity. A three-coil tuner will give you greater satisfaction, as the ordinary "solenoid" type of coil wound on a bakelite tube is more efficient than any of the concentrated inductors, such as the honeycomb and spiderweb coils. Besides this, the three-coil arrangement is better mechanically, and the chance of a faulty contact which is always present with plug-in coils is eliminated. Have a look at the three-valve receiver described in this issue, which uses such a tuner. Yes, by all means use the 415 in the detector socket, and the 406 in the audio end. The 415 is designed expressly for detecting. (3) An Amperite or Tempryte is excellent for controlling the amplifier filament potential. For the B-406 on a 4-volt battery, use a type 2-C Amperite, or a 3-ohm Tempryte.

"R.R.W.," Darra.—"I would like to know if an ordinary outdoor aerial would collect enough energy to work a sensitive relay, without boosting up with valves? My object in desiring this in-



formation is that I want some means of recording the time signals from 4QG on a revolving drum, which is governed by a clock."

Answer.—No; it is not possible to actuate a relay directly from the aerial. For one thing, such energy as would be received is radio or high frequency, and has to be rectified, or converted into a uni-directional current before it will perform any work. In any case, the amount of energy received, even with very powerful signals, is so minute that, without being amplified, it will not operate any relay that so far has been devised. The most sensitive telegraph relay produced—the new Western Electric—takes only 0.4 milliamp., but quite a considerable amount of amplification is necessary before it can be operated by a radio signal. The well-known Gulstad polarised relay, which is the most sensitive instrument used in ordinary line work, requires about 3 milliamps. A strong signal will actuate the Gulstad if a detector followed by a power amplifier is interposed between aerial and relay. Regarding your other query, I am just as anxious as you to start on the screen-grid valve. Until just recently, however, no supplies were available in Brisbane, but as I write I have before me the first U.X.222 released in Brisbane, so you can expect a set built round this valve in an early issue.

"C.W.," Fairfield.—"Would you be good enough to forward me a copy of the 'Q.R.N.' for November, 1926. I wish to get the construction of the crystal set to operate without aerial or earth contained therein. Also I would be pleased to receive a diagram showing the correct connections for the carborundum crystal stabilising unit (sixpence enclosed)."

Answer.—The copy you require has been forwarded to you, and a diagram showing the circuit you ask for has also been mailed. Write if you require any further information.

"W.P.," Cremorne, Sydney.—"Referring to the recent A.O.P. Certificate series in your paper, I would be obliged if you would let me know if the 'Q' signals then published are still up-to-date. I have here a "Radio Guide," issued by A.W.A. Ltd., in which appears a similar list, but which on closer examination differs somewhat from that published by you."

Answer.—The list of "Q" signals, as published in the A.O.P.C. series, has been revised, and the list appearing in the "Radio Guide" may be regarded as authentic. In order to meet the requirements of aircraft stations, an additional list has been prepared, but this may be disregarded as far as the A.O.P.C. course is concerned.

"K.S.J.," Ayr, Nth. Qld.—"I have a ——— set, and until just recently, it has been going perfectly. About a month ago, 3LO and 2BL disappeared, and am unable to receive them at all, no carriers being present. All other stations are received perfectly."

Answer.—It looks as though one of the rotors of the three-gang tuning condenser has slipped out of alignment with its neighbours. Open the lid of the set and see if the three sections of moving plates move in line with the left hand station selector is moved. You do not say if the carriers of the higher wave stations are heard, nor if stations lower in wavelength than 2BL are received at good strength. Try changing round the valves—the U.X.199 detector may be faulty—and checking up on the your battery voltages. If this brings no response, I think your best course will be to send the set to the agents, who are exceptionally well equipped to carry out service work. Advise them that you are sending it, and give details of the trouble. This particular set is guaranteed against defects for twelve months, and any repairs will be made free of cost in this period. The receiver should be sent complete with valves, but no other equipment is necessary.

"Old Reader," Brisbane.—"I enclose a circuit of a two-valve Reinartz that I have built, using a 3-in former with 20 turns of 26-g. wire for aerial coil spaced about $\frac{1}{16}$ in. from the grid coil. I am getting good results from Southern stations. I have been told that by using a 7-plate variable condenser in place of the .0005 in the grid tuning I can use the set for short-wave work. I have had the loan of a 7-plate condenser and have wound coils as follows: 3 turns in aerial and 9 turns for grid coil, with the tap at the 4th turn for reaction, but so far have only been able to receive Morse code, even at 11 p.m. I would be pleased if you could let me know through the 'Q.R.N.' what number of turns it would take for the aerial coil, and the grid coil, including the tap for reaction. I intend using 22-g. D.C.C. wire, wound on 2-7/8 in. formers, with valve legs and sockets for mounting. Would

the 2-meg. grid-leak at present in use be sufficient, or should I use one of higher value, say 5 to 10 megohms? I notice when using the small coils that there is a great deal of hand capacity when I touch the reaction condenser. How can I overcome this when using short-wave coils, so that any alteration, if necessary, will not affect the working of the set on the higher wavebands? Please give me the number of turns for 30 to 60 and 60 to 100 metres wavebands if possible."

Answer.—The Reinartz circuit in its ordinary form is not suited to short-wave operation, because of the fact that as it is impossible to earth any part of the variable reaction condenser, body capacity is always troublesome. By making a slight alteration, you can change your set to a modified Reinartz, so that it will give excellent results on both long and short waves. A diagram showing the suggested change is being mailed to you, and you will see that the main alteration necessary is to provide SEPARATE grid and reaction coils, instead of the single tapped coil serving both purposes. The grid coil will have the same number of turns as are at present between the grid end of your coil and the reaction tap, while the reaction coil will have a similar number to the turns you have between the PLATE end and the tap. For the short waves a primary winding of 5 turns should be used, and it must be coupled variably to the grid coil. The grid coil is wound on the same tube as the reaction, and about $\frac{1}{16}$ in. from the filament end, the ends of the coils being brought out to four valve legs, as you suggest. With the 7-plate condenser, you will need three plug-in coils to cover a range of approximately 10 to 70 metres, which is the band in which practically all of the short-wave phone stations are working. Particulars are as follows: Coil 1, 10 to 30 metres, 3 turns grid coil and 4 or 5 turns reaction. Coil 2, 30 to 50 metres, 8 turns grid and 6 turns reaction. Coil 3, 50 to 70 metres, 20 and 12 turns. It may be necessary to experiment a little with the reaction coils, so that the set will oscillate readily over the whole band. For short-wave work, a grid leak of between 5 and 10 megohms resistance usually is preferable to one of lower value. One of 7 megohms will be O.K. for both short-wave and broadcast reception. 5SZ, England, on 24 metres, will be received on Coil No. 1, and the best time is between 4 and 7 o'clock every morning. They are still quite strong at 7 a.m., which is early enough for comfort these mornings! PCJJ and several others come in on Coil No. 2.

HENLEY

Winding Wires

SCC, DCC, SSC, DSC.
Enamelled, Enamelled SCC.
WHITE & GREEN.

In 4oz., 8oz., 1lb., and larger reels. No. 6 to No. 47

Special Flexible For Radio Work

Also all types of Insulated and bare, and Cables
for Aerials.

Insulating Tapes. Resin Cored Solder.

THE HENLEY
Wiring System

W. T. Henley's Telegraph Works Co. Ltd.

Central: 7044. 59 ELIZABETH ST.

ULTRA R.E.L. Vernier Dials

Price 3/9

Here is a Vernier Dial standard in every way and equal in performance to vernier dials selling for twice as much, at a price you will hardly miss. It is a handsome metal dial with bakelite knob and a reading of 180 degrees. Ample provision is provided for logging stations, and it fits the usual $\frac{1}{2}$ -inch spindle. This dial may be attached to any set, and in operation is a revelation in smooth control. Discard your old set dials and fit ULTRA R.E.L. Vernier Dials this week end. You'll be delighted with the result.

Instal an

“ELTAX” Gold Seal “B” Battery

Every one of these new “ELTAX” Batteries shows its full voltage or more, and if you instal one or two of them in your set you are assured of strong, clear, unfailing radio reception for many, many months. Each battery is conveniently marked and tapped.

45-volt Light Duty, with 9 tappings, PRICE 12/6
45-volt Double Duty, with 9 tappings, PRICE 17/6
60-volt Light Duty, with 9 tappings, PRICE 18/-
60-volt Double Duty, with 9 tappings, PRICE 25/

Call and Inspect

J. B. CHANDLER & CO.

Queensland's Largest Radio Store

45 ADELAIDE STREET (Next Allan & Stark's) BRISBANE

Use CHANDLER Components

for the

“A GOOD 3 FOR £5”

(Described in this Issue of “The Q.R.N.”)

With Chandler components at hand you may go right ahead and build this excellent three-valve receiver in less time than it takes to tell. You will find that this set does all that is claimed for it, and perhaps more if you use the components outlined below—

LIST OF PARTS

1 Acme Celatsite 5-Wire Bat. Cable	2/6
1 Emmco .0005 mfd. Stratelyne Con- denser	12/6
1 De Jur .00025-mfd. Grid Conden- ser with Clips	1/6
1 Simplex .001-mfd. Fixed Condenser	1/6
2 Nickelled Phone Terminals	/8
1 Electrad Single Circuit Jack	1/3
1 Radiokes Three-Coil Tuner	14/6
1 H. & H. 3-meg. Grid Leak	1/6
2 Monarch 30-ohm Rheostats	6/6
2 A.W.A. Superaudio Transformers, 3½ to 1 ratio	36/
1 Emmco Balanced Socket	2/6
2 Parker U.X. Sockets	4/
1 Bakelite Panel, 13 x 7 x $\frac{1}{8}$ in.	7/7
1 Bakelite Terminal Panel, 3 x 2 x $\frac{1}{8}$..	/6
1 Pine Baseboard, 12 x 9 x $\frac{1}{8}$ in.	1/
1 R.E.L. Vernier Dial	3/9
1 Emmco Arrow Knob	1/
1 Coil (10ft.) Glazite Wire	1/3

£5/-/-

Meet Us at the Exhibition

EDGAR V. HUDSON

See Us at our New Warehouse

THE LEADERS IN RADIO MERCHANDISING

AT THE

RADIO AND ELECTRICAL EXHIBITION

BOHEMIA THEATRE

JULY 16 to 21

STAND 14

Mullard Valves

Full and latest information on the wonderful P.M. Valves. The valve that with its great economy, lasting filament, and pure tone, captured the Australian market in 1926 and has held a prominent position ever since.

Ferranti

The world famous makers of TRANSFORMERS that have no equal.

EXPONENTIAL HORN SPEAKERS.

The latest improvement.

RADIO METERS.

The finest line yet made.

STAND 15

Radio

The latest and best in Wireless. Special showing of new lines in

DE JUR COMPONENTS

DEAL BATTERIES

LUXOR, DAYFAN, KOLSTER SETS

EMMCO

Eliminators and Chargers
Condensers, Transformers, Dials

AMPERITE Filament Controls

RADIOKES Coil Kits & Shields

CYLDON CONDENSERS.

ADVANCE COMPONENTS

GRODAN

Build your own Kits.

STAND 16

Electrical

Especially featuring Electrical comfort in the home. Displaying and operating the very latest models of **Universal Electric Ranges, Electric Washers, Toasters, Grills, Coffee Percolaters, Radiators.**

AUTOMATIC IRONS.

The beautiful clean **BELLING ELECTRIC FIRES.**

The smooth, quiet, efficient **CENTURY FANS.**

The best of everything electrical.

NOTE—

NEW PHONE

Cent. 8622

NEW ADDRESS

53 CHARLOTTE STREET

NEW P.O. BOX

522H