

THE AUSTRALASIAN

PRICE, 1/-

Registered at the G.P.O. as a newspaper for transmission by post at a special rate.

Radio World

VOL. 6 NO. 10

MARCH 16 1942

Change to price 1/3

FOUR-VALVE
MANTEL MODEL

HARMONICS IN
REPRODUCTION

AMPLIFIER DESIGN
FOR ECONOMY

FULL GUIDE TO
SHORT WAVES

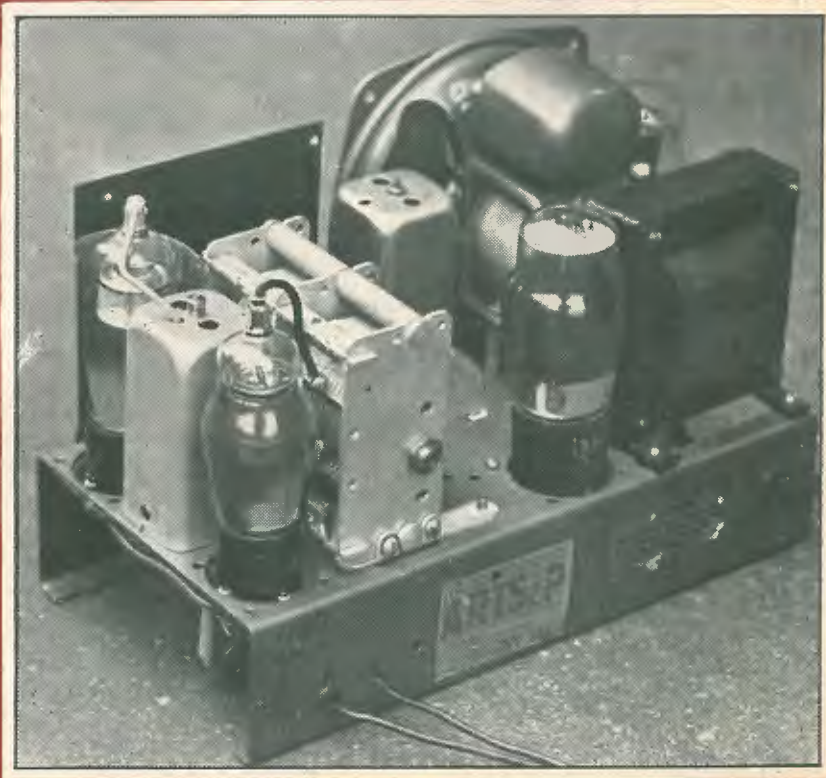

BUILD THIS SET FOR YOURSELF!

Radio Dealers Service Men . .



With the partial curtailment of radio manufacture it becomes of the utmost importance to keep the old receivers in efficient working order. This vital work is reliant on you, the Radio Dealers and Service Men. Replace with modern components! CROWN RADIO PRODUCTS have for years enjoyed an unparalleled nation-wide reputation for efficiency and reliability, due to strict attention to design and production details, coupled with the Technical Enquiry Department second to none. Crown components are obtainable from our AUTHORISED DISTRIBUTORS (listed below), who will be pleased to place at your disposal their specialised knowledge of CROWN RADIO PRODUCTS, "the Reliable Line."

New South Wales
Bloch & Gerber Ltd.,
 46 York St., Sydney.

Homecrafts Pty. Ltd.,
 100 Clarence St., Sydney.

Lawrence and Hanson Electrical Pty. Ltd.,
 33 York St., Sydney.

John Martin Pty. Ltd.,
 116 Clarence St., Sydney.

Martin de Launay Pty. Ltd.,
 289 Clarence St., Sydney.

United Radio Distributors,
 234 Clarence St., Sydney.

Queensland
A. E. Harrold, 123
 Charlotte St., Brisbane.

Trackson Bros. Pty. Ltd.,
 157 Elizabeth St., Brisbane.

Victoria
Healings Pty. Ltd.,
 263 Swanston St., Melbourne.

Homecrafts Pty. Ltd.,
 211 Swanston St., Melbourne.

South Australia
Gerard & Goodman Ltd.,
 192 Rundle St., Adelaide.

A. G. Healing Pty. Ltd.,
 Pirie and Pulteney Sts., Adelaide.

Radio Wholesalers Ltd.,
 31 Rundle St., Adelaide.

West Australia
Atkins (W.A.) Ltd.,
 894 Hay St., Perth.

Carlyle & Company,
 915-917 Hay St., Perth.

Tasmania
W. & G. Genders Pty. Ltd.,
 53 Cameron St., Launceston, and 69 Liverpool St., Hobart.

Factory Representatives

E. H. Cantelin, 2
 Coronation Drive, North Quay, Brisbane.

Healings Pty. Ltd.,
 263 Swanston St., Melbourne.

A. M. Ralph, 68
 Flinders St., Adelaide.

V - - - - V - - - -

★ ★ ★ ★ ★ ★ ★ ★ ★ ★

USE—

★ Crown components ★
 ★ for the ★
 ★ "LITTLE COMPANION" ★

CROWN RADIO COMPONENTS INCLUDE

- ★ B/C Coils, "Permotune" or Air Core ★
- ★ S/W Coils, "Permatune" or Air Core ★
- ★ I.F. Transformers, "Permatune" or Air Core ★
- ★ Tuning Units (with and without R.F. Stage) ★
- ★ Dials (edgelit and celluloid) ★
- ★ Trimmers ★
- ★ Padders ★
- ★ Voltage Dividers ★
- ★ W/W Resistors ★

★ ★ ★ ★ ★ ★ ★ ★ ★ ★

Crown



RADIO PRODUCTS PTY. LTD.

51-53 MURRAY STREET
 PYRMONT — SYDNEY

Telephone MW 2628
 (2 Lines)

The "RELIABLE"

LINE

THE AUSTRALASIAN RADIO WORLD

Devoted entirely to Technical Radio

and incorporating
ALL-WAVE ALL-WORLD DX NEWS

★ Proprietor —

★ Publisher —

★ Editor —

A. G. HULL

★ Editorial Offices —

117 Reservoir Street, Sydney

Phones: M 4078 - M 4079

★ Office Hours —

Week-days: 9 a.m. - 5 p.m.

Not open Saturday morning

★ Subscription Rates —

6 issues 5/3

12 issues 10/6

24 issues £1

Post free to any address

★ Service Departments —

Back Numbers, 6d. ea., post free

Reply-by-mail Queries, 1/- each

Laboratory Service, 2/6 per set

Vol. 6

MARCH, 1942

No. 10

CONTENTS

CONSTRUCTIONAL —	
"Little Companion"	5
TECHNICAL —	
Economy in Amplifier Design	13
Copper Wire Production	14
Harmonics in Reproduction	15
SHORT-WAVE SECTION —	
Breaking into DX	22
Short-wave Review	24
New Stations	25
Loggings of the Month	26
THE SERVICE PAGES —	
Guide to Back Numbers	18
Answers	30

EDITORIAL

At the moment of writing, the future, to put it mildly, is obscure.

Nobody can possibly imagine that the prospects are rosy, and so I have been doubly pleased to find that my readers have expressed their confidence in me so positively by renewing subscriptions. At the moment our list of direct subscribers is the highest it has ever been in the history of the publication.

New subscriptions have come along steadily during the past month and quite a considerable proportion of these have taken advantage of the special offer of £1 for two years!

Such expressions of confidence have spurred me to make every effort to safeguard the future. Precautions have been taken, and even a direct hit on the office by a 500-lb. bomb will not stop the old "Radio World" from coming out on time every month.

But I feel that it is up to me to do my bit for the national effort, and so I am at present engaged on a matter directly connected with the war effort. This means the temporary suspension of the laboratory service, and may mean delays in the queries service, but I am sure that readers will appreciate the difficulties of the moment.

V for Victory!

A. G. HULL.

You Can't Miss with R.C.S. Trolitul Coils and Dials

For the "LITTLE COMPANION"

R.C.S. Products fully represent "The Coil People's" aim to supply the radio constructor with the ultimate in precision-manufactured coils. R.C.S. Trolitul Coils are the highest standard obtainable, years of experience in the radio field having made "The Coil People" supreme in the production of first-quality coils.

For the "LITTLE COMPANION"—

Coil Kit Code K198, consisting of R.C.S. D.W. Bracket
and 2 Permeability I.F.'s £2 15 0
R.C.S. Dial, DA-8 13 6

R.C.S. PERM. TUNED I.F.'s

The new R.C.S. permeability-tuned I.F.'s are wound on special Trolitul formers into which are inserted the adjustable iron cores. These R.C.S. permeability-tuned I.F.'s are the most dependable and efficient I.F.'s it is possible to produce. They should be used whenever the optimum in results is required.

465 K.C. I.F.'s
When two I.F.'s are used:
IF162 1st .. 13/9
IF163 2nd .. 13/9
When three I.F.'s are used:
IF164 1st .. 13/9
IF164 2nd .. 13/9
IF163 3rd .. 13/9

465 K.C. I.F.'s
IF166 1st 7/6
IF167 2nd 7/6
Air Core 175 K.C.
1E68 1st 7/6
1E69 2nd 7/6



IF162

SYDNEY: Bloch & Gerber — Martin de Launay — Fox & MacGillycuddy — Lawrence & Hanson Electrical — John Martin — Radio Equipment — Radio House — United Radio Distributors — Homecrafts Ltd.

ADELAIDE: Gerard & Goodman — A. G. Healing — Newton, McLaren Ltd.

BRISBANE: Chandler's — Trackson's — Homecrafts.

TASMANIA: W. & G. Genders, Launceston — W. & G. Genders, Hobart — W. & G. Genders, Burnie.

MELBOURNE: A. J. Vealls — Homecrafts — Hartley's.

WEST AUSTRALIA: Carlyle & Co., Perth.

DO NOT WRITE DIRECT TO—

R.C.S. RADIO Pty. Ltd.
SYDNEY, N.S.W.

R.C.S. DIAL DA-5

DA-1, DA-2 are single-glass D/W Dials. The DA-1 is a standard dial for use with R.C.S. coils and "F" type condensers, and the DA-2 is for use with the "H" type. The DA-5 dial is for 1600 to 550 k.c. and 13.7 to 40 metres, with an "H" type condenser. All this series are edge-lit and wedge-driven, and the escutcheon aperture is approximately 7" x 4-7/8."

DA-1 Standard D/W Dial 22/6
DA-2 Communications Dial 22/6
DA-5 13.7 to 40 metres D/W Dial, "H" Condenser 22/6
DA-6 Mantel Set Dial, D/W "H" gang 18/9
DA-7 Portable Kit Dial, D/W "H" gang 9/-

DA-8 Same as DA-7, but ready assembled 13/6
A newly-released R.C.S. Kit Dial has 0-100 scale. This dial with all parts supplied is suitable for replacement and for crystal and small T.R.F. sets. Code DA-9 9/-

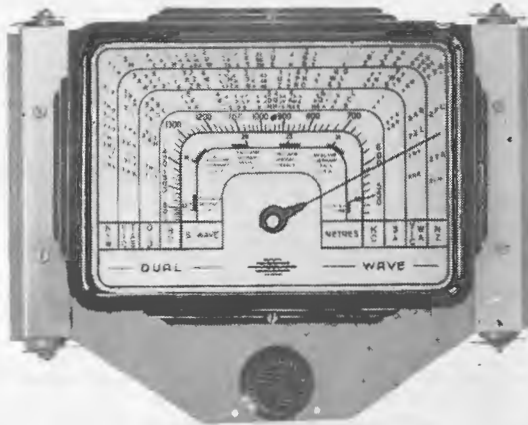

R.C.S. TROLITUL BROADCAST COILS

These coils are available in both Air Core and Permeability tuned types. The latter are adjusted to ensure maximum efficiency in our laboratories.

AIR CORE "H" GANG
E342 Aerial 6/6
E343 R.F. 6/6
E344 Osc. 6/6
PERM. TUNED "H" GANG
E345 Aerial 8/6
E346 R.F. 8/6
E347 Osc. 8/6



T.R.F. TYPE-AIR CORE

T88 Aerial 6/6
T89 R.F. 6/6
T87 R.F. with reaction 6/6
T81 Reinortz 6/6

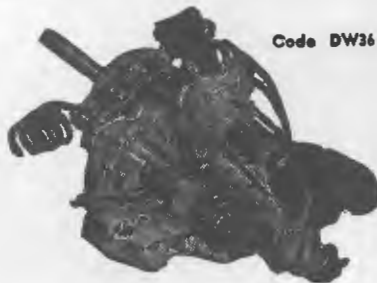

Code DW36

R.C.S. D.W. UNIT

Type DW36, as illustrated, consists of Aerial and Oscillator Coils, Wave Change Switch, the necessary B.C. and S.W. Trimmers and Padder mounted together, wired up ready to assemble into a set utilising 465 k.c., the bands being S.W. 13.7 to 40 metres, and B.C. 1600 to 550 k.c.

Code DW36 £1/7/6

"LITTLE COMPANION"

★

A modern mantel model
available in kit form.

★

OWING to present conditions, it is not easy to buy a complete kit of parts with which to build a popular type of four-valve mantel model. Gang condensers, electrolytic condensers, even hook-up wire and flex may be found to be scarce.

In many cases we have had complaints from our readers who have ordered a complete kit of parts from their dealer, received everything except for one item, say the hook-up wire, and they have then been put to a lot of worry and expense trying to locate a suitable length of wire.

All of which is by way of an explanation of this technical feature article, which represents a step in the direction of closer co-operation between the "Australasian Radio World" and a couple of advertisers.

Knowing the demand for kits and appreciating this type of business, the Melbourne wholesale firm of J. H. Magrath Pty. Ltd. has made a com-

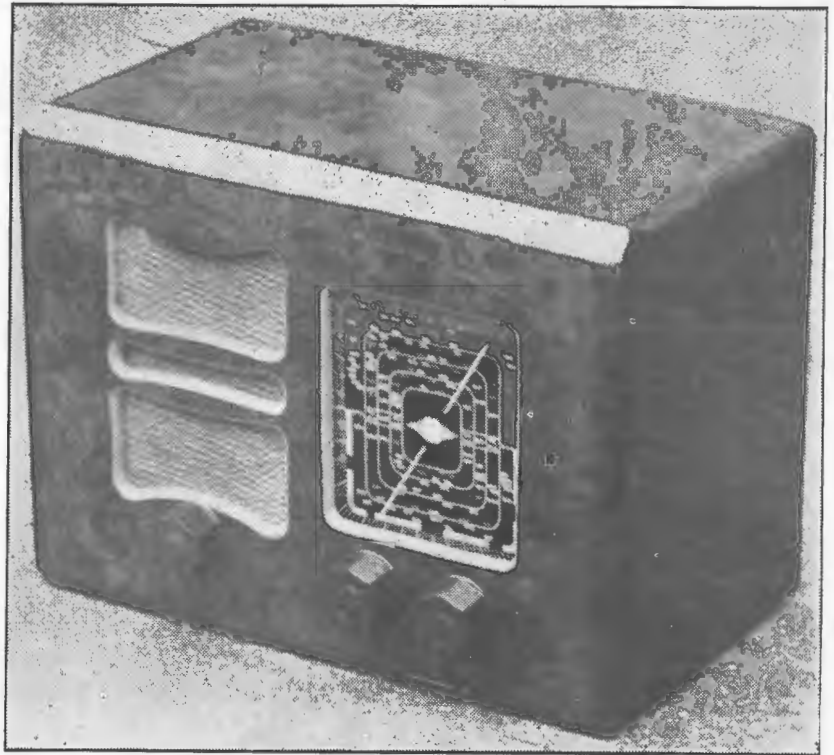

ABOVE: The completed set in cabinet. BELOW: A photograph of the chassis ready for fitting.

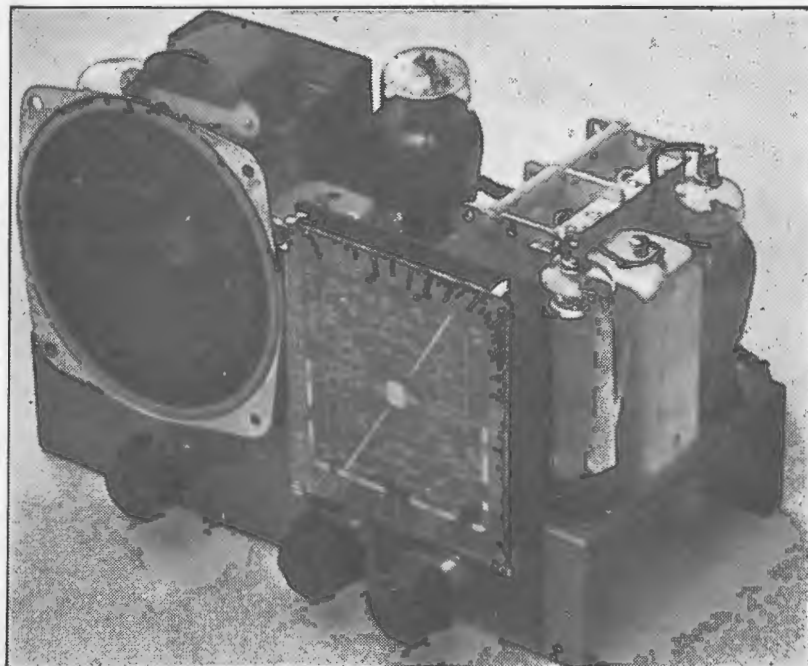

plete kit available to the radio trade. It will be available to the public in Melbourne through the well-known retail house of Arthur J. Veall Pty. Ltd., and elsewhere in the Commonwealth through various radio shops.

The kit is complete in every detail and includes every screw, nut and solder lug for the assembly of a dual-wave mantel model which is capable of splendid performance. The kit provides a most attractive little cabinet in which to house the completed chassis.

This cabinet is made of wood, with a photographic veneer to give a beautifully grained finish.

Kit Not Essential

It is not by any means essential for the set to be assembled from the kit mentioned, and those who have a few components on hand can shop around in the ordinary way and collect a kit for themselves.

From our point of view this technical article is no different from our usual run of articles, all capacity and

(Continued on next page)

THE YEARS AHEAD

What the future may hold for Australia no one can say. That victory will eventually be ours no one can deny, but in the meantime the way may be fraught with great hardship and peril. During these troublous times, therefore, it is the duty of every citizen, every business, to "carry on" . . . a slogan that John Martin Pty. Ltd. is determined to observe to the letter as long as it is humanly possible to do so. The public can, therefore, rely on a continuation of that value and service that has so firmly established the name and reputation of "The Friendly Wholesale House."

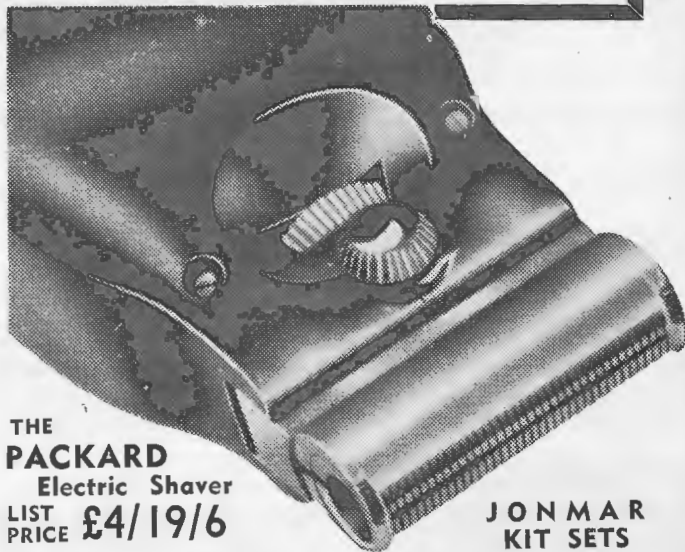

THE PACKARD
Electric Shaver
LIST PRICE **£4/19/6**

Now that blades are so hard to get, buy a **PACKARD** Electric Shaver. As safe to use as a telephone, it gives quick, clean shaves in half the time. The ultimate in shaving luxury, more than a million Packards have already been sold. And the price, including step-down transformer or special portable six-volt battery, is only **£4/19/6**. Order to-day while stocks are still available.

JONMAR
KIT SETS

You save time, money and disappointment by using Australia's finest — the **JONMAR** Kitset. All components, and only the best branded types are used, are carefully tested before packing, and every Kitset is fully complete. You'll find a Jonmar Kitset takes all the "bugs" out of construction — and the prices are the lowest in the State, too! Note: John Martin's technical experts are always glad to advise you on any constructional problem.

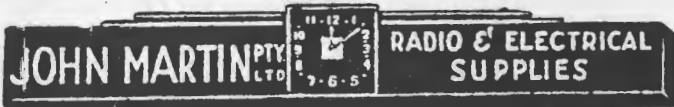

116-118 CLARENCE STREET, SYDNEY

J16

LITTLE COMPANION

(Continued)

resistance values being given, together with photographs and picture diagrams for the guidance of set builders. A valuable additional feature, however, is the knowledge that those who want to buy a complete kit in a sealed box can do so. Naturally the parts in this kit will be exactly the same as those shown in the photographs, a

CROWN COLOUR CODE

AERIAL COIL			
A	Green	G	Brown
E	Braid	F	Black
OSCILLATOR COIL			
G	Blue	P	Yellow
E	Braid	B	Red
INTERMEDIATES			
P	Green	G	Brown
B	Red	F	Black

R.C.S. COLOUR CODE

AERIAL COIL			
A	Black	G	White
E	Braid	F	Cut busbar
OSCILLATOR COIL			
G	Yellow	P	Red
E	Braid	B	Green
INTERMEDIATES			

Lettering embossed in moulded base

BRITANNIC COLOUR CODE

AERIAL COIL			
A	White	G	Blue
E	Purple	F	Black
OSCILLATOR COIL			
G	Yellow	P	Green
E	Purple	B	Red
INTERMEDIATES			
P	Green	G	Purple
B	Red	F	Black

RADIOES COLOUR CODE

AERIAL COIL			
A	Black	G	White
E	Braid	F	Cut busbar
OSCILLATOR COIL			
G	Yellow	P	Red
E	Braid	B	Green
INTERMEDIATES			

Lettering embossed in moulded base

minor point which is sometimes helpful to beginners.

The Circuit

The circuit provides the usual type of dual-wave mantel model with the four valves as follows: a 6A8G converter, followed by a 6G8G, of which the pentode portion is used as an intermediate amplifier and the diode portion as a diode detector. The audio output of the detector is then fed directly to the output pentode, a type 6F6G. The other valve is the conventional rectifier.

The Chassis

With the kit, the chassis has the power transformer, gang condenser and dial already mounted on the chassis. This particular dial, which is

ROLA LOUD SPEAKERS

The World's Finest Sound Reproducers

MADE IN THE WIDEST RANGE OF MODELS
AVAILABLE IN AUSTRALIA

WHEN the highest quality of sound reproduction is required, together with robustness, efficiency and economy, there is only one loud speaker — ROLA. There is a specially - designed Rola Speaker that ideally fulfils every purpose, whether in theatre or public address systems, in high quality radio receivers or the midget personal radio.

ROLA Speakers are on service with the Navy, R.A.A.F., Army, A.R.P. Organisations and Police. In war, as in peace, Rola is the BEST of all Loud Speakers.

YOUR local Distributors have a full stock of Rola Speakers and Parts, and are equipped to carry out repairs and adjustments.



The Rola Company [Aust.] Pty. Ltd.

The Boulevard, Richmond, Victoria

N.S.W.: 116 Clarence Street, Sydney

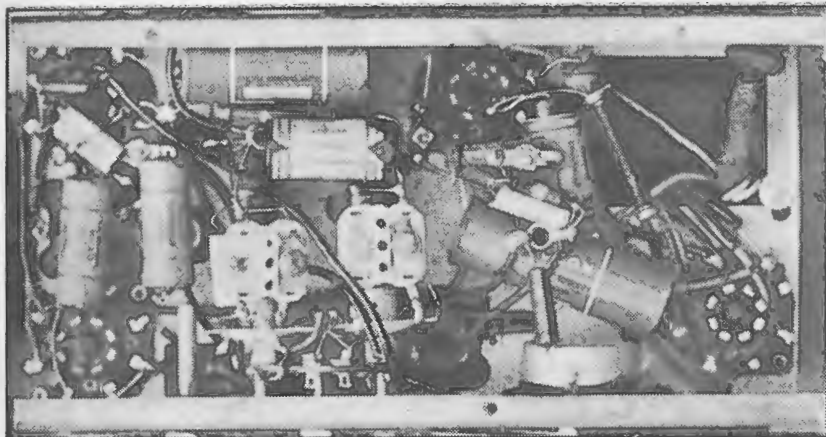

A photograph of the wiring, showing the layout of the minor components.

under one of the screws holding the valve can should be earthed in this way, too, just to make sure that the screen is effective.

Filter Condensers

Two filter condensers are provided, one of 8 mfd. capacity and the other of 16 mfd. The main point to watch about these little units is in regard to their polarity, it being most important to see that the positive end, which is indicated by being coloured red, is connected to the live side of the high tension. In the case of the 16 mfd. unit the negative side is connected to earth through the main bias resistor of 400 ohms. The other filter condenser has its negative side earthed to the base.

(Continued on page 10)

LITTLE COMPANION

(Continued)

cuit diagram to make quite sure that it is correct and complete.

In most cases the minor components will support themselves by their own terminal wires, but it is quite a good scheme to make a rigid wiring assembly by making full use of the several valve socket terminals which are not connected to the valve elements. For example, there are four vacant terminals on the socket of the 5Y3G, and a couple on the 6F6G. One of the vacant terminals on the rectifier socket can be put to good use as a mounting for the resistor and condenser units associated with the high tension centre tapping.

A thoroughly effective earthing is essential for all the terminals so indicated, and it is not good enough to consider these earthed just because

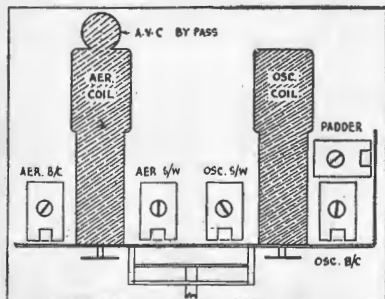

Layout of the trimmers on the Britannic coil bracket.

terminal lugs have been fitted under screw heads. Even if the paint does not interfere with the electrical efficiency of the joint, there will be losses in the metal of the base, especially when handling short-waves. Correct procedure is to run around and join up every earth terminal with a piece of bare copper wire which is provided in the kit. A terminal lug

YES, the "Aegis" kit for the "Little Companion" contains every component you need for the assembly of an efficient dual-wave mantel model. Insist on the "Aegis" kit as featured in this issue.

WRITE FOR QUOTATIONS

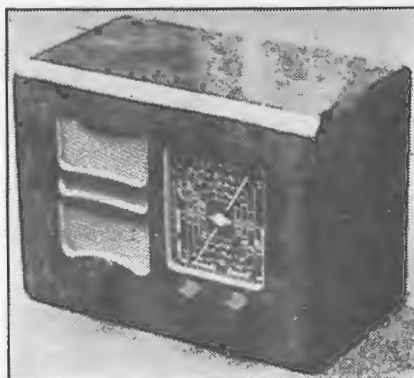

The original "Little Companion" as built from the "Aegis" kit.

★
INTER-OFFICE COMMUNICATORS AND SIGNAL TRACERS ARE OUR SPECIALTIES

★
MAGRATH'S are also Agents for:
MARQUIS PRODUCTS — W.W. Potentiometers, Knobs, Formers, etc.
WESTERN CABINETS — As recommended by "Radio World."
UNIVERSITY TEST EQUIPMENT — Oscillators, Voltmeters, etc.

AEGIS — Power Transformers, Chassis and a complete range of quality Kitsets.

J. H. MAGRATH PTY. LTD.

208 LITTLE LONSDALE STREET, MELBOURNE, C.1

Phone: Central 3688-4414

"The name
to know
in Radio"



RADIOKES

Technically superior, Radiokes Trolitul components will enable you to get the best out of any receiver. Exclusive design and production processes ensure the utmost in reliability and efficiency — you can't go wrong with RADIOKES Trolitul Coil Kits!

For the "Little Companion":

Radiokes Coil Kit,
Type CK198 £2/15/-

Radiokes Dial
DWD-8 13/6

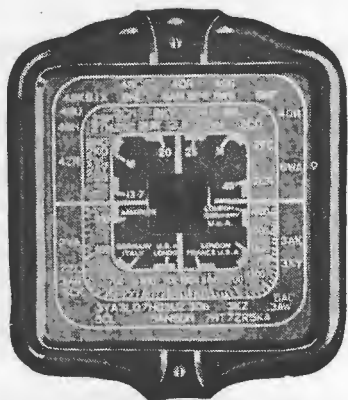

Type
DWD-9
Dial



Radiokes DWD-9 Dials are specially designed for replacement purposes and are also suitable for crystal and small 1 or 2-valve T.R.F. sets. Walnut escutcheon aperture is 3 in. x 3 in., and all parts for the dial are supplied ready to assemble. Dial is scaled 0-100, and this portable dial can be edge-lit.

Code DWD-9 Price 9/-
AVAILABLE FROM ALL LEADING STORES

RADIOKES Pty. Ltd.
P.O. Box 90
BROADWAY - - - SYDNEY



A photograph of the "Aegis" kit, exactly as it unpacks from the box.

LITTLE COMPANION

(Continued)

Power Transformer Connections

The power transformer may or may not have the wires marked to show which are which, and as there is no terminal panel provided this may cause some perplexity.

However, with the colour code known it is simple.

First, there are two yellow leads of flexible braided wire to take the a.c. power input. The power flex should be carefully joined to these and the whole connection made thoroughly shock-proof by the use of insulation tape, as it is the one spot where real danger exists.

Coming from the same side of the power transformer are two other wires, these being of solid copper,

covered with enamel and finally encased in yellow spaghetti sleeves. These are the connections for the 6.3 volts for the heaters of the first three valves. One side of this heater circuit should be earthed at the socket of the 6A8G valve, and the whole of the wiring of the heaters is carried out with twisted wires to avoid any chance of hum pick-up.

From the other side of the power transformer come the leads for the rectifier valve. There are two wires of red hook-up wire, stranded wire with a braided cotton covering. These run to the two plates of the rectifier socket. A similar wire but of black colour denotes the centre tapping of this winding, which is earthed through the main bias resistor of 400 ohms, the negative side of the 16 mfd. electro-

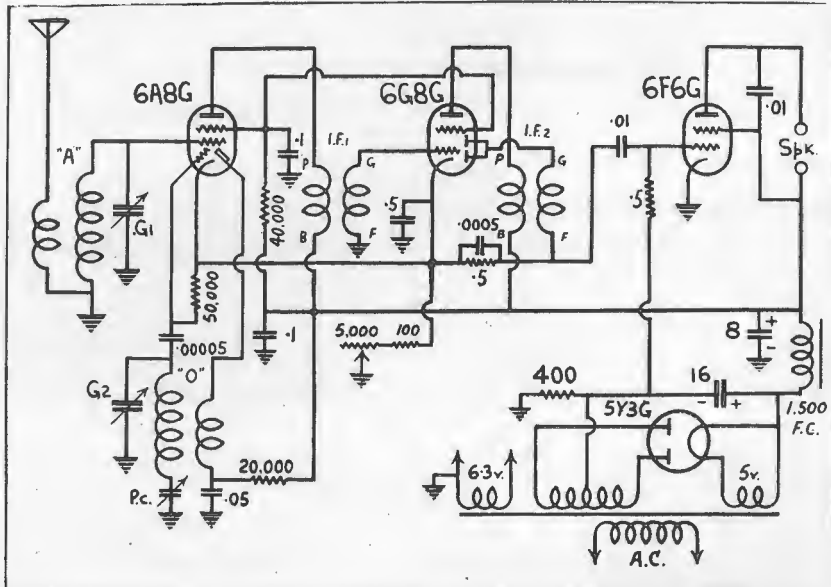

Circuit schematic for the "Little Companion." The set has dual-wave coils, but these, with their switching, are not shown that way on this diagram.

lytic condenser and the bottom end of the half-megohm grid leak resistor also joining on to the junction of this wire and the bias resistor. From the same side of the power transformer come two wires of enamelled copper wire, inside red spaghetti sleeving. These wires supply the five volts necessary for the filament of the rectifier.

From this position they pick-up the rectified high tension for the set, so care must be taken to see that they do not get a chance to short-circuit to the base. For example, where they come through the base to the underside, it is desirable to see that there is no chance of the insulation being scraped off by sharp edges of the metal of the base.

Finally, there is a stray little bit of copper wire which comes out without any spaghetti or braiding or colouring. This wire is the connection for the electrostatic shield between the power transformer windings. It should be earthed to the base.

The Speaker

The speaker is mounted to the chassis and wired directly into the set, but this job should be left until the rest of the wiring has been completed. The speaker cone is made of paper and it is quite easy to put your finger through it, or damage it in some way while the chassis is upside down for the wiring job.

When wiring in the speaker it is necessary to know the difference between the two pairs of wires, one pair going to the input transformer and the other to the field coil winding. An inspection of the speaker to trace these wires through to their destination should be sufficient to identify them. Once the two pairs have been

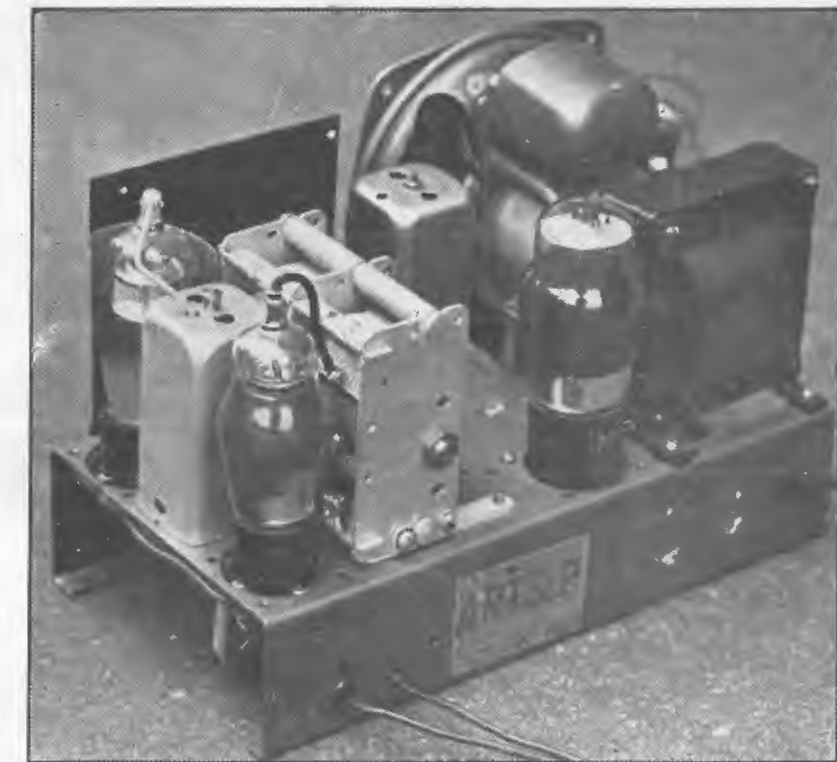

Another view of the chassis, which shows the layout of the components.

established there is no need to worry further as either wire of each pair can be used, so long as each pair has been identified correctly.

The Coil Unit

The coil bracket will be the last component to be fitted, and again a certain amount of care will be found necessary to avoid damaging the

windings, or the fine wires which run down to the terminals.

The Tuning Condenser

The tuning condenser is mounted above the base. There are one or two important points to be noted in regard to this unit. The framework must be effectively earthed and a

(Continued on page ?)

AMPLION

5E7 for the "LITTLE COMPANION"

- Greater output.
- Increased power-handling capacity.
- 3-ohms voice coil.
- Speaker dust-proofed back and front.

ELECTRICALLY-WELDED LOUD-SPEAKER

- Extended frequency range.
- New type cones.
- Transformers sealed and impregnated.

Amplion 5" loudspeakers are the standard small units.

ELECTRICALLY WELDED



TYPE

5
E
7

"Ask for Amplion — it sounds better"

Write for Diphonic Data and Publications 88C and 88D

AMPLION (A'sia) Pty. Ltd.

382 KENT ST.,
SYDNEY



Ask Yourself WHY!

Within the past five years Eimac Tubes have moved into first place. Today they are in the sockets of some of the most important radio transmitters in the world. What is the reason behind this? Perhaps it is because of the extraordinary economies they bring about in day-in and day-out operation. Perhaps it is their unusual performance capabilities, their stamina and great dependability . . . or perhaps it is because Eimac tubes never fail prematurely because of gas released internally (they're guaranteed against such failures, the only tube on the market that carries such a guarantee). Chances are though, you'll find it is not any one but all these points combined that has won this recognition . . . anyway you find it, the fact remains that . . .

In the Field of Electronics, the overwhelming trend is to

Eimac
TUBES

Eitel-McCullough, Inc. • San Bruno, California

FOLLOW THE LEADERS IN THE FIELD OF RADIO COMMUNICATIONS

There's an Eimac tube to fit your needs from 35 watts to 2000 watts plate dissipation . . . *Get full information now!*

Foreign Division

FRAZAR & CO., LTD.

301 CLAY STREET, SAN FRANCISCO, CALIFORNIA, U. S. A.

CABLE "FRAZAR"

ECONOMY IN AMPLIFIER DESIGN

WAR-TIME means that many types of components are unobtainable, while the price of others has risen considerably. Australian designers rack their brains to find replacements and to simplify circuits, but they are only receiving a foretaste of what English designers have had for the last two years.

Some "midget" components show a marked tendency to increase in size and replacement of an old type brings difficulties.

Circuits may be "simplified" by using the same cathode resistor and by-pass condenser for a number of valves. A common screen supply may

By —

JOHN W. STRAEDE
B.Sc., A.M.I.R.E.

7 Adeline Street, Preston, Victoria

be used for two successive valves that are "in cascade" and so out of phase.

Push-pull output seldom requires a by-pass condenser across the common cathode resistor. This applies particularly to class A operation, with well-matched valves. Another advantage of push-pull operation is that less filtering of the H.T. supply is required—sometimes no power choke is required, even when a permag. speaker is used. This is common practice in the smaller amplifiers made in America. Decoupling is used to give extra filtering for the previous stages. Hum is not so high as might be expected.

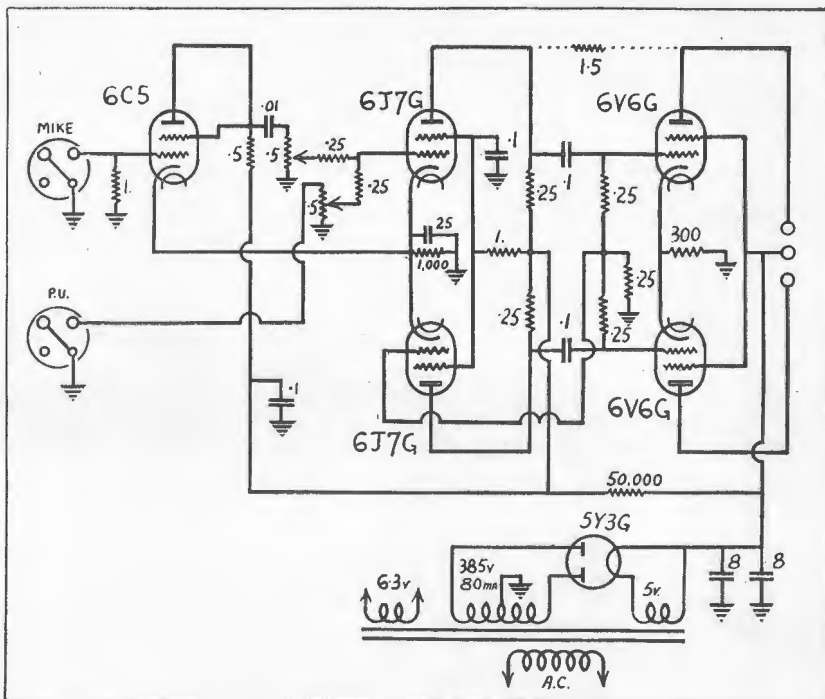

Suggested circuit for an all-purpose amplifier.

The type of phase-changer, phase-splitter or phase-inverter needs consideration. Paraphase circuits have two valves in antiphase and if these valves are of the same type they can share a cathode resistor and also the cathode by-pass condenser may be omitted in some cases.

Floating paraphase, giving an automatic near-balance, is a suitable form providing inverse feedback is not applied over more than one stage. The "near-balance" obtained is better than that usually obtained in a paraphase circuit using a tapped grid resistor.

(Continued on page 20)

FOR CERTAIN SATISFACTION

No piece of equipment is better than the valves it uses . . . no one can afford to take the risk of breakdowns or unreliability. That is why every set-builder should —

SPECIFY and INSIST on MULLARD VALVES

Mullard Valves have that extra reserve of efficiency and dependability that has made the name of **Mullard** a household word wherever the British flag flies.

FOR ANY PURPOSE THERE NEVER HAS BEEN A BETTER VALVE THAN MULLARD

MULLARD-AUSTRALIA PTY. LTD.
367-371 Kent Street, Sydney, N.S.W.
Telephone - - - - - MJ 4688

Mullard



For the "Little Companion" described in this issue, Mullard valves are specially recommended. The types required are:—
1—6A8G, 1—6G8G, 1—6F6G and 1—5Y3G.

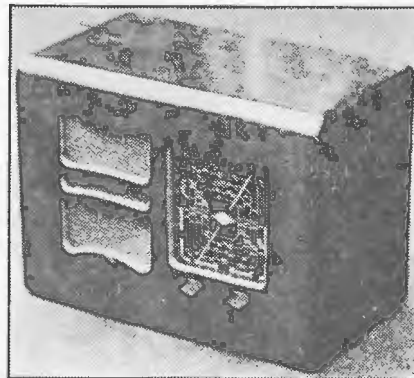

ART IN COPPER WIRE PRODUCTION

MANY humorous things have been said about the use of the word "Wireless" to describe that set of phenomena which is now almost universally termed Radio. It is quite true that the actual signals travel from the transmitting aerial to the receiver without conveying wires, but wire plays a most important part in the complete process. For example,

on a ship's transmitting apparatus there are about 300 miles of wire in the transformer. Even in our receiving sets the amount of wire employed is considerable.

Few realise the art which is employed in the manufacture of wire. Copper plays, perhaps, the most important part in wire manufacture, but, of course, there are other materials

used in the manufacture of special or resistance wires.

Copper

Copper, as we all know, plays its part in the currency, and with gold and silver is recognised as one of the universal equivalents in our exchange system. The price of copper may vary from day to day, and for this reason a constant watch has to be kept by the wire manufacturers and electrical firms on this aspect of the case. When the copper bars are to be made into wire, or copper strips

Greatly magnified cross-section of finished IRC Type BT Insulated Resistor, showing the unique internal construction. Element is completely sealed by moulded, insulating phenolic. Leads anchored inside insulation cannot turn or pull loose.

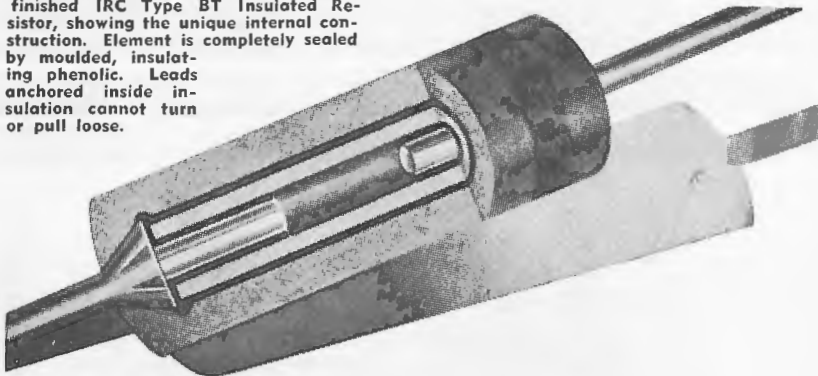

INSULATION (AS SUCH) is only Part of the Story

The IRC Insulated Resistor was designed from the ground up for what it is — an integral, scientifically constructed unit offering a new and distinctly different approach to resistance engineering problems.

IRC resistor insulation did not come in the nature of an afterthought. It did not come as something added to an old and possibly outmoded type of resistor construction.

IRC insulation is far more than an insulator. It assures humidity characteristics hitherto unobtainable. It facilitates rapid, low cost resistor manufacture. It anchors the leads. It seals the unit from end to end. Above all, it simplifies and modernises the use of an exclusive resistance principle that has proved its superiority since the early days of Radio — the famous filament type of resistance element.

Insulation is highly important in itself, to be sure. But it is only part of the story. Not this protection but what it protects is the final determining factor of quality — and here IRC Insulated Resistor construction reigns supreme.

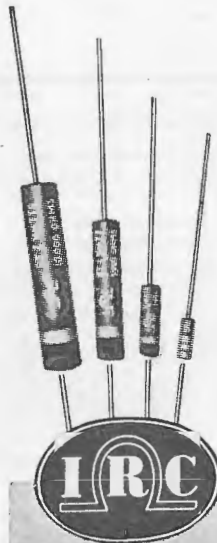

SOLE AGENTS FOR AUSTRALIA:

Wm. J. McLELLAN & CO.

BRADBURY HOUSE, 55 YORK STREET, SYDNEY.

**INSULATED Type BT
RESISTORS**

Interest is added to this article by the recent announcements that the Rola Company is now in full production of various types of copper wire at their factory at Richmond, Victoria.

as employed in commutator segments, etc., they are placed in a container and put into a crucible and melted at a temperature which makes the copper liquid glow at a white heat.

All round these furnaces are large tubs of water, into which the workmen can jump if, as often happens, their overalls catch on fire owing to the heat from the ingots. The latter are about 5ft. in length and 9in. thick; they are grabbed by the operators with long pincers and propelled along the steel floors, thence to be placed between rollers, which shape and flatten the metal to a workable size. If it is to be strip, the whitened metal will be run backwards and forwards until, like a snake from the nether regions, it is 60ft. to 70ft. in length, sliding over the polished steel floor, sending sparks hither and thither during its progress, a most awe-inspiring sight.

When round wire is required, the metal is run through different shaped rollers and, owing to the enormous length it reaches, is turned back on itself through adjacent rollers, so that it actually travels through several rollers at a time, with many loops all over the floor. It is during the latter process that men have had their legs trapped in the loops of white-hot metal, with disastrous results. Having obtained a length of copper sufficiently reduced in diameter, the next job is to draw it cold, down to the size of wire required, and this is done in easy stages.

Wire Drawing

The first stage sees the copper, the size of a man's wrist, being drawn by a chain, the links of which would

(Continued on page 30)

THE IMPORTANCE OF HARMONICS

THE terms "harmonics" is so frequently associated (in technical literature) with distortion, that listeners may be pardoned if they form the impression that harmonics are noxious things to be avoided at all costs. Yet this is quite an erroneous idea, for harmonics are perfectly normal phenomena and, when naturally produced, are in no way an annoyance—indeed they are essential to good reproduction. Distortion, in one of its most distressing forms, is simply a matter of harmonics in the wrong place.

There are few listeners who do not know that sound is the result of air vibrations, that these vibrations have definite frequencies ranging up to about 20,000 per second, and that the frequency determines the pitch of a note, shrill notes being of high frequency than deep notes.

Notes and Harmonics

It is, perhaps, not quite so well known that a simple note consisting of a single frequency is of comparatively rare occurrence, in fact, only experienced in certain scientific instruments specially designed to give a simple frequency. All normal musical notes are more or less complex in nature, consisting of the basic frequency or "fundamental" which gives them their general pitch, and a varying number of additional frequencies bearing simple numerical relationships to the fundamental, such as twice, three times, four times the fundamental frequency, and so forth. The number and relative strengths of these additional frequencies of "harmonics," as they are termed, give the note its characteristic "tone," and enable a differentiation to be made between the notes of a violin and, say, a piano.

It will, therefore, be obvious that if for any reason the proportion of harmonics is upset either by the suppression or partial suppression of some or by the addition of others, a form of distortion will occur, and the ear will recognise that the sound is not of the tonal quality which one would expect.

Two further things must be explained, the first being in connection with the nature of music and noise. It has been explained that practically all musical notes are of complex harmonic structure; but that structure is still sufficiently simple for the ear to analyse it and recognise its characteristic quality; and a musical note is therefore more or less pleasing to the ear. If, however, a sound is of such a type that the ear cannot analyse and appreciate it, we no longer call it a musical note, but a

noise. A sound becomes a noise if either or both of two things occur; first, if the number and strengths of the harmonics are such that the sound is too complicated or unfamiliar for the ear to recognise it as music; second, if the duration of the sound is so short that the ear has not time to analyse it.

The other point is that certain harmonics are more distasteful to the ear than others. It is not difficult to understand why this should be, if the table included here is examined.

In this table there are four columns, the first giving the number of the different harmonics, the second the

musical name of the corresponding note, taking the C below middle C of the piano as the fundamental, the third giving the mathematical value of the corresponding frequency, and the fourth the actual frequency of the note as tuned on a piano.

The Effects of Odd and Even Harmonics

It will be observed that by successively doubling the frequency the pitch is raised one octave, so that the second, fourth, eighth and sixteenth harmonics of the fundamental correspond to the different "C's" on the

(Continued on next page)



"University"

SUPERTESTER

The very latest in Valve and Circuit Testers.

Write for free test equipment catalogue

Obtainable from leading Wholesalers in all States

RADIO EQUIPMENT PTY. LTD.

E. S. & A. BANK BUILDINGS, BROADWAY

Telephone: M 6391 and M 6392

Telegrams: RAQUIP, Sydney

HARMONICS

(Continued)

piano, each one octave above the other. Clearly these harmonics cannot produce a discord, and an excess of them merely produces the effect of a shriller overall pitch. Moreover, the true pitch and the tuning pitch of all these C's are identical. Now take the third harmonic—it is the G above the first octave, and the sixth and twelfth harmonic and so on are also G's. Sound these notes together on your piano—the fundamental C, the upper C's and the G's, and you will not find them unpleasant. Even the fifth and tenth harmonics representing the E's are not too bad, and in all these notes the true and musical pitches are not very different. But now try playing the seventh, ninth, eleventh and thirteenth harmonics as shown in the table, together with the fundamental, and you will be rewarded with "a horrid noise." So we see that if harmonic distortion is present, that due to the even harmonics is not so unpleasant as that due to the odd harmonics, and this has an important bearing on the design of "quality" radio equipment.

To see how spurious harmonics may be produced in a radio receiver refer to Figs. 1 and 2, which show respectively a fundamental wave with a second and third harmonic, and how these three waves can be combined into a single wave. Now just as fundamentals and harmonics can be combined to produce a more complicated wave form, so can any complicated wave form be analysed into a fundamental and a number of harmonics. So the musical wave form of the signal in a radio set represents the combination of the various harmonics forming the notes broadcast, and can be analysed by suitable apparatus. But if anything should occur

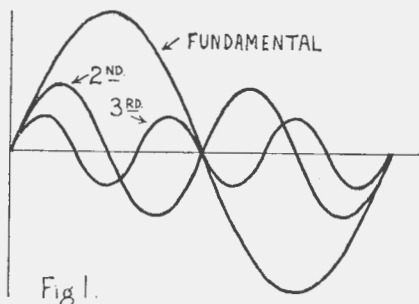

Fig 1. Curves to represent the fundamental frequency and its second and third harmonics.

in the set to distort the wave form, to change its shape, then the new wave form, if analysed, would show quite a different combination of harmonics—

harmonic distortion would have occurred.

Overloading

The usual form which harmonic distortion takes is due to partial rectification of a low-frequency signal, commonly known as overloading, and it can be proved both mathematically and experimentally that the practical result of overloading is to introduce additional harmonics. This gives a spurious shrillness to the reproduction and, if distortion is considerable, a very unpleasant quality results.

Several important and interesting points now arise. In the first place, overloading a triode valve produces in

TABLE OF HARMONICS

Harmonic	Notation	Mathematical Frequency	Piano Frequency
Fundamental	C	129	129
2nd	C	258	258
3rd	G	388	388
4th	C	517	517
5th	E	647	652
6th	G	776	775
7th	B Flat	905	922
8th	C	1035	1035
9th	D	1164	1161
10th	E	1293	1304
11th	G Flat	1423	1463
12th	G	1552	1550
13th	G Sharp	1681	1642
14th	B Flat	1811	1843
15th	B	1940	1953
16th	C	2070	2070

the main a range of even harmonics which, as has been shown, is not quite so unpleasant as odd harmonic contamination. A pentode, on the other hand, produces a greater proportion of odd harmonics than a triode. Thus, when it is stated that a pentode is more easily overloaded than a triode, this is only part of the story. On account of its greater sensitivity a pentode is overloaded before a triode, but, in addition, the result of overloading a pentode is far more disastrous from the quality point of view than in the case of a triode, owing to the greater odd harmonic content of the output.

Valve Limits

Valve manufacturers quote optimum loads, maximum signal handling capacities, and similar data based upon reasonably good reproduction. This is usually taken as five per cent. second harmonic distortion in the case of triodes, but a pentode may be operated at five per cent. second harmonic distortion, or even less, and still give very bad reproduction, simply because the more deadly third and other odd harmonic distortion is very much greater. It is as well, therefore, to obtain the fullest possible information concerning the characteristics of any

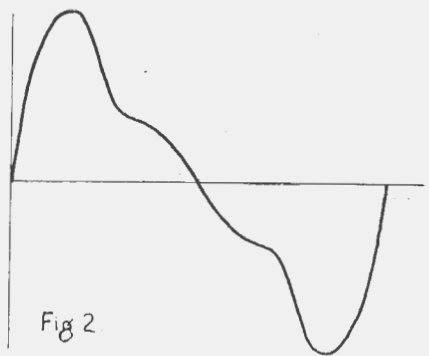

Fig 2. The resultant wave form of the three curves shown in Fig. 1.

valve used in the output stage. No one wants three watts of output containing, say, ten per cent. total harmonic distortion if, by limiting the input and taking a slightly smaller maximum output, the harmonic content could be reduced to five per cent. or even less.

The next point of interest is that certain valve arrangements automatically produce a lower degree of harmonic distortion than others. The most important of these is the push-pull circuit in which the even harmonics in the outputs of the two valves cancel out each other. As a result, two triode valves operated in push-pull will give an output remarkably free from harmonic distortion, even when they are slightly more heavily loaded than is permissible with single valves.

On the other hand, push-pull with pentodes, while quite successful from most points of view, does not give so great an improvement.

Other Causes

It has been indicated that harmonic distortion is mainly due to partial rectification of the audio-frequency signal, and usually occurs as the result of applying to the grids of valves signals too great for them to amplify with perfect fidelity owing to the curvature of their characteristics. It may also be due to insufficient or excessive negative grid bias, or to the failing emission of an amplifying valve. The remedy in each case is obvious, namely, a judicious use of the volume control, correct adjustment of grid bias, and a watchful eye on the anode currents of the various valves, particularly the detector and low-frequency stages.

Another cause of harmonic distortion is saturation of a low-frequency transformer by the passage of an excessive D.C. component of the anode current. This can be obviated by the use of generously-designed transformers, or by adopting the resistance-fed arrangement of coupling.

—“Practical Wireless” (Eng.).

DEPENDABILITY



A FACTOR OF VITAL IMPORTANCE
— EFFICIENT COMMUNICATION
BETWEEN SEA, LAND AND AIR.

AUSTRALIAN MADE

RADIOTRON

Valves . . . Always Available

STANDARD TO AIR FORCE TRANSMITTERS AND RECEIVERS

A GUIDE TO BACK NUMBERS

IN THESE times of scarcity of paper we find it difficult to put as much editorial matter into each issue as we would like to do. Fortunately, however, we have always made a practice of storing away a good supply of back numbers, and this stock is now proving invaluable to our readers who want to turn up some article on theory, get an explanation of some radio subject about which they are not quite clear, or obtain a circuit to suit the particular components that happen to be on hand.

For the guidance of those who wish to avail themselves of our special offer of these back numbers at 6d. each, post free (or 5/- per dozen), we have prepared the followist list of that issue which might appeal to you.

All enquiries for back numbers should be addressed to the Australasian Radio World at 117 Reservoir Street, Sydney.

May, 1936

The first number, with "All-World Two" battery set with coil data, "Eaglet" short-wave Two," good article on doublet aerials, valve charts and a general purpose amplifier.

June, 1936

Three sets described, the "Sky-Hawk" t.r.f. four-valve a.c. set, "Air Commodore 5" for a.c., and the "Dual-wave

Master Five" for battery operation with two-volt valves. Also in this issue is the first of the series, "Radio Step by Step," dealing in this issue with molecules, atoms and electrons.

July, 1936

Circuits included the "Sky Cruiser Battery 4," 5v. a.c. dual-wave "Simplified Moneysaver," the "Metz 5" and the "Simplex" crystal set. Other technical articles included the second in the series, "Radio Step by Step," dealing with volts, ohms and amps, a general article on vacuum tube voltmeters, and "Breaking into the DX Game."

August, 1936

The "Empire Short-wave Three" for two-volt battery valves was the main circuit feature of this issue. Other articles included a stroboscopic grammo motor speed indicator, a nine-range d.c. multimeter to use an 0-1 milliammeter, Part 3 of "Radio Step by Step," dealing with direct and alternating currents, an article on beam power valves, and an article on aircraft radio.

September, 1936

Part 4 of "Radio Step by Step" dealt with condensers in this issue. Other articles included the "Outdoor Portable," and contained as a supplement a large strobo speed indicator.

October, 1936

"The Beginner's Battery Two" and the "Air Ace" d.w. a.c. five were the two main technical features of this issue, with other articles dealing with the making of a cheap microphone, building an output meter, and a general technical article dealing with the characteristics of pentodes.

January, 1937

With the "Fidelity 5" as the main article and several interesting articles on general subjects, such as Amateur Radio in Russia, building a radiogram unit, reflexing superhets, the story of television, plotting frequency response with the cathode ray oscilloscope and other similar articles.

May, 1937

The "Empire" all-wave battery-operated three-valve circuit was featured in this issue, together with the "International" six-valve a.c. superhet, and general articles dealing with the application of inverse feedback, and another with valves.

August, 1937

Featured in this issue was the circuit of the Radiotron amplifier known as A115, which used a pair of 2A3 type triodes in the output, with an all-resistance hook-up using a phase-changer. This amplifier has proved itself to be a splendid performer and carries a strong recommendation.

September, 1937

The "Tom Thumb" portable was described in this issue. It uses two 49 type pentodes, the first as a space-charge detector.

October, 1937

This issue contained the coil winding data for the "Tom Thumb," also a circuit for an a.c./d.c. type of 6-valve superhet, suitable for use from d.c. power mains. Another interesting article is No. 11 in the series "Radio Step by Step," dealing with detection and the action for the detector valve.

November, 1937

Probably the finest set of its kind, the "De Luxe Fidelity Eight" was a feature of this issue. Incorporating a pair of 2A3 type triodes in the output stage, this receiver was capable of giving fine reproduction, and proved more popular than later versions of this same receiver which were published from time to time. Another feature of this issue was the description of a five-valve dual-wave broadcast receiver, together with full coil winding data for the dual-wave coils to suit the 1C6 (1C7G) type converter valve specified. This data is not often

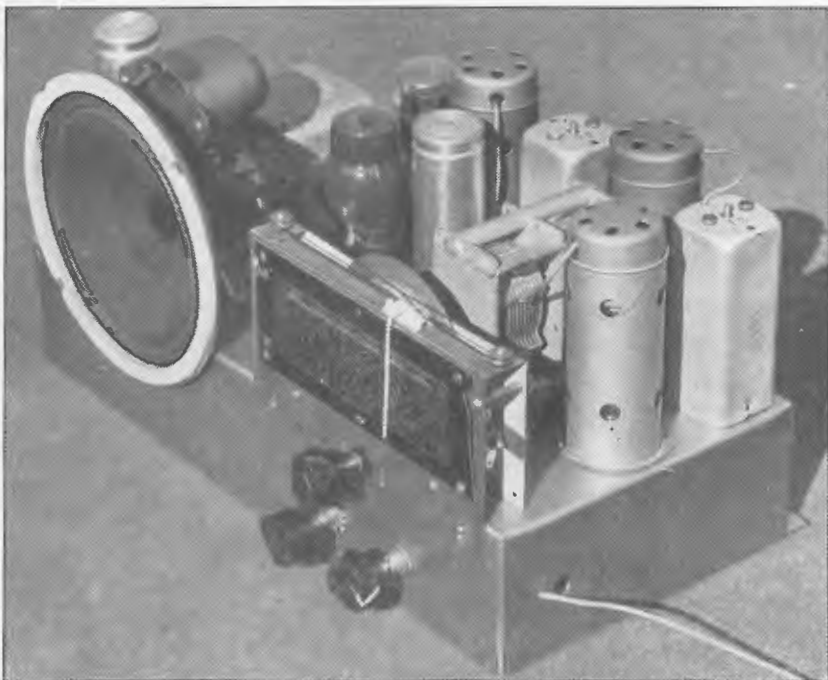

Chassis of the "Trade Builder," a reliable circuit which was featured in the issue of August, 1941.

found, and there has been a steady demand on this issue for this feature alone.

December, 1937

The most effective battery-operated short-wave receiver described was the "Battery Amateur Communications Superhet" in this issue. Full coil winding data appeared with the article. Another item in this issue which is often called for was the circuit sketch and instructions for fitting a "magic eye" tuning indicator.

January, 1938

Further details of the "Battery Amateur Communications Superhet" were given in this issue, also a circuit for an eight-valve t.r.f. receiver designed to give high-quality reproduction. A feature of this circuit was the use of a high-impedance "reflex" detector to ensure lowest distortion at this point.

February, 1938

Even when judged by the latest standards, the circuit of the "Fidelity Dual-wave Six," featured in this issue, must be accepted as one of the best. Another article in this issue which should be of interest to all is one which covers the full explanation of the way in which the radio signal is handled throughout the various stages of a receiver from the time it arrives at the aerial until it is heard in the loudspeaker as music.

March, 1938

A type of circuit often asked for, but seldom found, is a two-valve short-waver to use a.c. type valves and operate either from batteries or from an a.c. power pack. Such a set "Jones Supergainer" described in this issue. Complete coil data was included. Another technical feature of this issue covered a most unusual receiver, a superhet using only two valves and a rectifier, yet having 4 watts of power output to drive a loud-speaker.

April, 1938

Called the "Comet," a circuit in this issue was a four-valve superhet which must go down in history as marking the introduction of this type of set, which later became very popular. It was the first of its kind to use the 6F7 as a combined intermediate amplifier and detector. This article was also continued in the May issue. Instructions for the building of an "infinite" baffle for a loud-speaker were also given in this issue.

May, 1938

Started in the April issue and continued into this one was a splendid article by F. R. and A. H. Graham on the subject of short-wave aerials for DX reception. This article is as valuable today as ever, and should have a great appeal to many of our readers who are interested in getting best reception results.

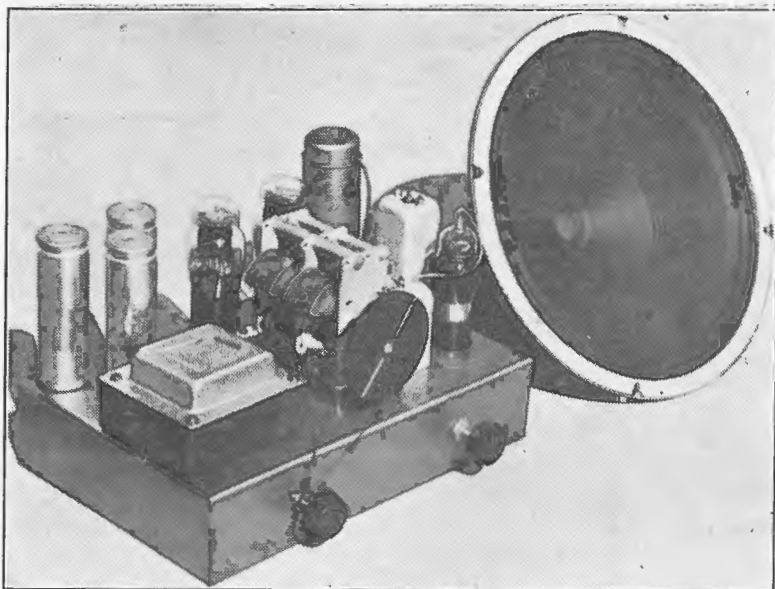

Quality of reproduction far in advance to that obtained with an ordinary set can be obtained quite simply with the "Local Tone Four," which was detailed in the issue for February, 1941.

June, 1938

A series of three articles on the tracking down and suppression of interference noise from electrical machinery, flashing signs and that sort of thing, ran in the issues of April, May and June. The series can be recommended as a complete set of answers to all who have problems of this kind.

July, 1938

A compact four-watt amplifier using a 6V6G output valve with inverse feedback. It is a neat little amplifier and one which could be recommended for a number of purposes.

August, 1938

Two circuits and a description of the construction of a combination V.T. Voltmeter and Multimeter are in this issue. The first set is a four-valve battery t.r.f. set with all-wave coverage, and the other a revised version of the "De Luxe Fidelity 8," this time with beam power valves in push-pull in the output and inverse feedback.

September, 1938

Starting in this issue is a series of articles covering the construction of a battery receiver stage by stage. In this issue a start is made with an effective one-valver, to which the other valves are added to make up the finished set. Another article covers a nine-valve receiver designed with no other aim than giving the finest quality from local stations.

October, 1938

Principal feature is the revised version of the "Amateur Communications Eight," featuring octal-based valves. The second

article on the little battery set also appears, covering the addition of the r.f. stage to the original one-valver. Also included is an a.c. version of the "Air-Ace," which was originally described as a battery set. It is a t.r.f. job, with r.f. stage, screen-grid detector and two audio stages.

November, 1938

Full details of recommended coils for use with the EK2G converter valve, for both broadcast and short-wave bands appears in this issue, together with data on checking the correct operation by measuring the oscillator grid current.

December, 1938

Radio dealers and service-men will be interested in the resistance and capacity checker which is the subject of a constructional article in this issue. The "Hi-Fi" speaker baffle, designed to suit the Rola K12, is also featured. Coil winding data for the 6K8G type converter valve are in this issue, too, and still another feature is the first of a series on home recording.

January, 1939

The second of the series of three on home recording appears in this issue. The series can be recommended as one of the most thorough to ever cover this interesting field for experimenting and commercial application.

February, 1939

Designed by the well-known Don Knock, a communications type receiver to cover from 10 to 1,000 metres is described in this issue, together with full coil winding data.

(Continued on next page)

INDEX TO BACK NUMBERS

(Continued)

March, 1939

Another outstanding designed by Don Knock was featured in the March, 1939, issue. This receiver was a 7-valve superhet for short-wave reception, described in detail together with full coil winding data to cover from 10 to 80 metres. For the radio serviceman there was detailed a pocket multimeter with many attractive features in addition to its handy size.

April, 1939

A thoroughly reliable and highly efficient five-valve battery set to use two-volt valves was featured in this issue, also a marine receiver tuning from 15 to 600 metres, a three-valve battery set called the "Sky Hawk," and a general technical article dealing with the subject of "Q."

May, 1939

One of the most popular of the baby sets was the original "Tiny Tim," described by that well-known Victorian DX listener, Mr. J. Ferrier, of Coleraine. On this receiver Mr. Ferrier logged 29 different countries, which must be reckoned good going for a two-valve midget portable.

June, 1939

Features of this issue include a test-bench multi-vibrator, making a Reiss

microphone, and the "Economy Fidelity" 7-watt amplifier, using a 6L6 type beam power valve in the output. This amplifier proved itself to be an exceptionally fine performer.

July-August, 1939

This double-number contained the "Sky Chief" d.w. five-valve a.c. circuit, the third of the series on the little battery set, the second article on the "Economy Fidelity" amplifier, and several other feature articles.

September, 1939

Features include "Falcon" dual-wave battery four, "Atlas" all-wave battery three-valver, a description of a six-band frequency meter, and the second of a series on the oscilloscope.

October, 1939

The "Vulcan" five-valve short-wave superhet for battery operation was featured in this issue, also the concluding article on the "Falcon" dual-wave four. An amplifier to use a pair of 2A₃ type valves in push-pull and deliver 13½ watts of power output is also included.

November, 1939

An excellent article on meters for a.c. and d.c. measurement appears in this issue, also details of two short-wave superhets.

December, 1939

A rather out-of-the-ordinary article

appeared in this issue, describing the construction of a small power amplifier to operate from batteries. Three of the two-volt type were listed in the valve line-up for this amplifier. Other circuits included the "Air Scout" communications six, and further data on the "Vulcan."

January, 1940

Of interest to servicemen and others is the article on modulated oscillators in this issue. Included is a circuit and full coil winding data for an a.c.-operated modulated oscillator, using a pair of 6J7G valves with a 5Y3G rectifier.

February, 1940

How to align a receiver by means of a modulated oscillator is fully covered in this issue, which has as its main technical feature the original five-band communications eight-valver.

March, 1940

Three important circuits appeared in this issue, the "World Standard," the "Wonder One" and the "Dandy Three."

April, 1940

The "Junior" short-wave converter for a.c. operation, the "Bedsider 2" and two amplifiers, together with the "Fundamental" power unit, were described in this issue.

May, 1940

For a powerful dual-waver little more can be asked than that provided by the "De Luxe Fidelity 8" described in this issue, which also included a special amplifier supplement.

June, 1940

A booster unit to go ahead of any a.c. set in order to give increased sensitivity appeared in this issue, together with the "Fidelity Six," the "Vibra" quality amplifier for battery operation, also "Old Reliable" and the "Mystery" dual-waver.

September, 1940

The full description of the winning amplifier in the 1940 Amplifier Championship was published in this issue, the "Star" battery dual-waver, and the "Cauntry" long-range crystal set.

October, 1940

Three sets were described in this issue—the 1940 "Reinartz," the "Itsy-bitsy" mantel model and the "Hi-Fidelity 5." Two other articles proved popular. They were dealing with "Oscillator Grid Current" and "Intermediate Transformers."

November, 1940

Fitted with a loop aerial the "Transport" a.c. receiver offered a handy arrangement in the form of a portable of a somewhat different type to the usual battery-operated job. The "Straight 4" was another circuit featured, also two further circuits from the amplifier championship, one of these being a modern version of the old direct-coupled circuit. It has since proved itself to be capable of fine results, and is very simple and economical.

ECONOMY AMPLIFIER

(Continued from page 13)

All right. So far using paraphase, the general voltage amplifier (or driver) and phase inverter share the same cathode resistor, same by-pass condenser, same screen supply. Now an extra valve for microphone amplification can be tagged on and it too can share! It is suggested that this extra valve be a triode and that its gain be limited to avoid instability, though the writer found no trouble in using three pentodes of the 6B8G or 6J7G type. Hum is likely to be troublesome with too high a gain, especially when as few components as possible are being used.

Further economies are possible by using valve sockets as inputs in place of jacks which to-day are either unshielded or unobtainable (or both!). Making a simple jack is not so difficult, as might be expected and designs for two types are shown. One involves drilling a half-inch bolt and is rather bulky—the other requires rather more care but much less elbow grease.

For those a bit dubious about the same cathode supply to three tubes, the resultant voltage from V_2 and V_3 is not zero but small and out of phase with V_1 , so the only result in practice is a slight loss in the usual bass drop

due to the reactance of the by-pass condenser.

If non-floating paraphase were used, then the resultant voltage across the resistor from V_2 and V_3 might be large and in phase with V_1 , giving instability—shown as a howl or motor-boating when the microphone control is turned up even when no microphone is connected.

The values shown in the circuit are not critical. 6F6G outputs can be used if the common bias resistor is increased to 40 ohms. The important thing is that the plate/screen high tension supply to V_2 , V_3 and V_4 be decoupled to reduce hum and that V_1 and V_2 are of the same type.

The output of the circuit shown depends on the H.T. voltage of the power transformer. Using a standard 385-volt transformer, the output is approximately 14 watts on continuous signals and much higher on peaks. With 330 volts each side, the output is about 12 watts. The actual output depends on the permissible distortion. If the common bias resistor for the 6V69 outputs be further increased beyond the usual, the output is restricted but overload occurs very gradually and the distortion on overload is of a different type—grid current distortion being absent. American designers use up to 390 ohms. By-passing is helpful with the higher values.

LITTLE COMPANION

(Continued from page 11)

short wire should connect it up to the main earthing wire. Then both wires running from the fixed plate sections must be as short and direct as possible—on no account covered with copper braiding or otherwise shielded—and the aerial unit with its lead running up to the cap of the converter valve must not be mixed with the oscillator section, which has only one lead, running to the grid condenser.

Alignment and Adjustment

After the set has been thoroughly checked, the aerial can be connected and the power switched on. After due time has been allowed for the valves to heat up, it should be possible to tune in a station by rotating the dial. The set may still need a certain amount of alignment to obtain maximum efficiency, but as it goes together it should at least bring in the local stations.

Once a station has been tuned in at the low (high frequency) end of the band, such as 2SM in Sydney or 3AW in Melbourne, the broadcast aerial trimmer can be adjusted to give best results, the volume control being kept back as far as possible while this is being done so that the volume level is kept at a whisper. This makes it easier to tell whether you are getting the best position for this trimmer.

Next, the broadcast padder is adjusted by swinging up to the other end of the band and bringing in 2FC or 3AR. The padder is then adjusted to give best results, at the same time rocking the dial to and fro. Some prefer to adjust the padder to give most static and noise, when the set is

December, 1940
The "R.W. 13/42" dual-waver, the "Xmas Portable" and the original "Tip Top" were described in this issue, also a tone corrector unit for use with magnetic pick-ups.

January, 1941
Two more champion amplifier circuits were given in this issue, which contained the circuit of the "Countryman's Six" and also a push-pull a.c. operated receiver of seven valves.

February, 1941
Compensated acoustics came into the limelight with a bang when the first of the series of articles on this subject appeared in this issue. Circuit feature was the "Local Tone 4."

March, 1941
Featuring "The Acoustic Compensated Superhet," and the second article on this

"LITTLE COMPANION"—Parts List

- 1—Mantel cabinet to suit (Western).
- 1—Chassis, size 10 x 5 x 2 (Arcadian).
- 1—Power transformer, 40 ma. type.
- 1—Dual-wave coil bracket (Radiokes, R.C.S., Crown).
- 2—Intermediate transformers (Radiokes, Crown, R.C.S.).
- 1—2-gang condenser to suit (Stromberg-Carlson).
- 1—Dial to suit (Crown, Radiokes, R.C.S.).

- ### CONDENSERS:
- 1—8 mfd. 525v. electrolytic (T.C.C.).
 - 1—16 mfd. 525v. electrolytic (T.C.C.).
 - 1—5 mfd. tubular condenser (T.C.C.).
 - 2—1 mfd. tubular condensers (T.C.C.).
 - 1—05 mfd. tubular condenser (T.C.C.).
 - 2—01 mfd. tubular condensers (T.C.C.).
 - 1—00005 mfd. mica condenser (T.C.C.).
 - 1—0005 mfd. mica condenser (T.C.C.).

- ### RESISTORS:
- 1—100 ohm 3-watt resistor (I.R.C.).
 - 1—400 ohm 3-watt resistor (I.R.C.).
 - 1—20,000 ohm 1-watt resistor (I.R.C.).
 - 1—40,000 ohm 1-watt resistor (I.R.C.).
 - 1—50,000 ohm 1-watt resistor (I.R.C.).
 - 2—.5 megohm resistors 1-watt (I.R.C.).
 - 1—5,000 ohm potentiometer (R.C.S., Radiokes).

- ### SUNDRIES:
- 3—Knobs, 1—dial light and holder, 4—octal sockets, 1—volute can, power flex, 3 yards hook-up wire, bare wire, solder iugs, cap clips, screws, nuts, washers, etc.

- ### SPEAKER:
- 1—5" midget speaker, 7,000 ohm load, 1,500 ohm field coil (Amplion, Rola).

- ### VALVES:
- 1—6A8G, 1—6G8G, 1—6F6G, 1—5Y3G (Radiotron, Mullard).

The brands mentioned are our own recommendations and not necessarily those supplied in the "Aegis" kit.

tuned at the top end of the band, but not actually on to any station. With a correctly-matched coil, gang and dial it becomes possible to get correct padder setting by adjusting it to pull the dial indicator into position, having first set it on to a station at the low end.

Short-wave Adjustment

Adjustment for short-wave is even simpler, as no padder adjustment is required. Tuning in a station on the 19 or 25 metre band, the short-wave aerial trimmer is adjusted to give best results and left at this setting. That is all there is to it.

Intermediate Alignment

The intermediate transformers may also need a fraction of a turn of adjustment, but this is best carried out by a good serviceman with an oscillator. Those who do not have any equipment of this kind, however, may try a fraction of a turn in either direction with the intermediate trimmers, but this should be done very

subject, this March issue was further strengthened by the circuit of the "Club Special." Both of these circuits have enjoyed immense popularity.

April, 1941

A receiver designed for use in a car was detailed in this issue, also the "Master 4" battery set for vibrator operation, and a version of the "Club Special" also for vibrator operation.

May, 1941

The biggest and strongest issue of the "Radio World" was this one, containing a 24-page supplement for servicemen, and featuring the "All World 2," the "C.R.P. 6" and a simple amplifier with expansion. Also included in this issue were the details of a "Servi-meter."

(Continued on page 24)

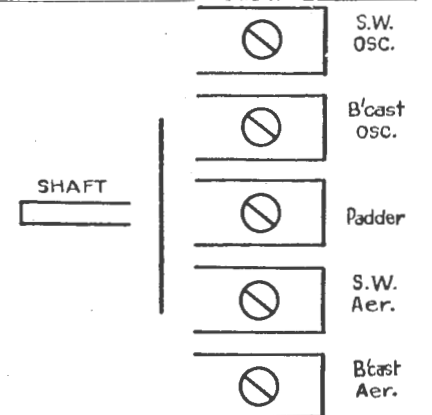

Trimmer layout for the R.C.S. and Radiokes coil brackets.

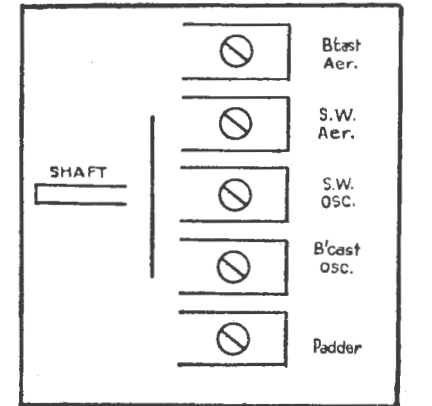

Here is the trimmer layout for the Crown coil bracket.

carefully, the object being to get a peak position for each screw, a fraction of a turn on either side of which will drop the volume a bit for any given setting of the volume control. This adjustment is best carried out on a fairly weak station, but only after the aerial trimmer adjustment has been thoroughly carried out.

BREAKING INTO THE DX GAME

THIS article is, as its title implies, intended as a guide for the uninitiated only, and is in no way intended for the hardened dxer who will have learned long ago the few simple hints and aids which it contains. That wise old saying, "Practice makes perfect," applies very definitely to the hobby, and all the hints and helps in the world will be valueless unless one is prepared to apply oneself intelligently and tenaciously to the art.

System Necessary

To become a successful exponent of dxing, one must approach the subject systematically. Haphazard methods will avail nothing. Firstly, the receiver must be an efficient one—a superheterodyne for preference on account of its selectivity, which is essential, and its distance-getting ability. As to size, I would suggest at least five valves as a minimum and eight as a maximum. A well-designed five-valve receiver is not only very efficient, but has the added advantage of low noise level, while a multi-tube job of nine or more valves has often such a high noise level that the advantage in the number of valves is lost on that score alone.

Selectivity Required

Then again, there is the important point of selectivity to be considered. Any receiver which has not the ability to completely separate stations 10 k.c. apart without interference is of very little use to a dxer, especially if he resides in a district where there are high-powered local stations.

The Aerial

The aerial system must be the subject of deep consideration, and I strongly recommend height as against length. A single mast 60 feet in height with a 7/20 wire dropping straight down to the receiver will generally give far better results than an "L" aerial using a hundred feet of wire.

Directional Effects

Many enthusiastic dxers of my acquaintance who appreciate the advantage of directional aeriels, and who fortunately have the necessary space to use them, have installed antennae designed to receive signals from a given direction, but unfortunately this is not possible for the majority of dxers, hence my advice to operate non-directional type aeriels. A flat top aerial of the "L" type, not under

60 feet between the masts, and with a height of 25 feet or over will, nevertheless, give excellent results.

Insulate Stay Wires

All stay wires should be well insulated and as clear of buildings as possible. This also applies to the lead-in. Insulated wire may be used effectively, but wherever a joint has to be made this should be well soldered. Where bare copper wire is used (7/20 is a good gauge) it should be regularly inspected for corrosion caused by exposure to the atmosphere, and should be entirely renewed at least every two years.

Earthing

The earthing system is of the utmost importance at all times, if successful reception is to be achieved. This can be obtained in many ways, the simplest of which is our old and well-tried friend, the water-pipe. Be sure not to select the gas service pipe or the bathroom hot water service for earthing purposes. Not only are they useless, but they may be dangerous.

To obtain a good earth from a water pipe, it is best to solder the wire direct to it, but, owing to the fact of the water keeping the pipe very cold and the difficulty of sufficiently heating it to a soldering temperature to ensure a good job, earthing clips can be used simply and effectively. Where water is not laid on, a good earth can be obtained by burying a copper or other metal plate four or five feet below the ground, and soldering the earth wire to it. After refilling the excavation, keep the ground reasonably damp by the frequent application of water.

Experience being the best tutor, our novice dxer would be well advised to attempt only the easiest of DX in the earlier stages.

The smaller "B" class transmitters provide good experience, but are often much harder to log than might be expected. The larger Australian stations are easily received, and are scarcely worthy of being considered real DX.

Eastern Stations

Having gained some experience in distant reception, the next effort should be directed to Eastern stations, Chinese and Japanese, and again little difficulty will be experienced with the very high-powered ones. Manila (Philippine Is.), India and the nearer countries will follow in due course, and then, after experience has been gained, an attempt can be made for European and American broadcasters.

SAVE MONEY WITH A SUBSCRIPTION!



Order Yours To-Day

Make sure you get every issue as soon as it is published. Place an order with your newsagent or send direct to us for a subscription.

**IT SAVES YOU TIME!
IT SAVES YOU MONEY!**

We guarantee that every subscriber has his copy posted the same day it comes off the press.

SPECIAL RATES	
★ 6 issues ..	5/3
★ 12 issues ..	10/6
★ 24 issues ..	20/-
POST FREE	

Enclosed please find remittance for 10/6 in payment for an annual subscription

to the "Australasian Radio World," commencing with the issue.

NAME

STREET and NUMBER

CITY STATE

THE AUSTRALASIAN RADIO WORLD
117 RESERVOIR STREET, SYDNEY

Do not make the mistake of losing heart should success not immediately crown your efforts; stations are there to be received. Ears must become attuned to hearing correctly, and that which in the early stages appears to be just an unintelligible jumble of noise will eventually be clearly understandable and quite readable.

Use a Timetable

When one is about to make a train journey, it would be considered utterly ridiculous to wander casually to the railway station at any old time. The very first thing a prospective traveller would do would be to consult a timetable. The same thing applies to dxing. Stations are only receivable at given times, and any attempt to pick them up must be made then. These times are readily ascertainable, as is the time of the year that reception is at its peak.

Freakist atmospherical conditions often play pranks and apparently give the lie to accepted principles, but these can be disregarded. Dxers must be in a position to know the exact time in any country in the world, and for this purpose a reliable time converter is a necessity and a most important part of the dxer's stock-in-trade. A call-sign book giving the QRA (addresses) and location of the world's broadcasting stations is also a necessity, and these valuable adjuncts often help to trace a station whose signals have been hardly decipherable.

Keeping a Log

This aspect of dxing is of great importance. In the first place, one's memory is a very weak reed and should never be relied on. Every station received, with full particulars of what was heard, should be immediately entered in the log book. Especially is this the case with foreign stations whose language is not understood, but who occasionally make an announcement in English. This should be specially noted as also any particular identifying signal used, such as the ringing of a bell, striking a gong, or chimes.

Reports sometimes go astray and a second report is necessary. Here again the log plays an important part. With stations that are easy to receive the loss of a report may not be a matter of moment, but it often happens that a very difficult one to receive goes astray and the value of the log book then becomes apparent. In compiling the log, only actual matter heard should find a place, blanks being left to denote missed signals. The strength of the signals should be faithfully noted as should fading, interference of any kind,

wavelength or frequency, and readability.

Preparing a Report

Having received a station, the next thing to do is to compile a report which will be of use to the recipient. The simple fact of having received a given station is not accepted very favourably by station engineers; rather would they receive a report containing little of the actual subject matter of the broadcast, but a good description of the technical details as heard.

This does not mean that before a verification of reception is given a thoroughly technical report must be submitted. Were that the case I am afraid very few dxers would be in a position to boast of their hundreds of "veries," but what is confidently expected is: details of fading, type of country (high or low), weather conditions, type of receiver in use, particulars of aerial system, quality and strength of signals, particulars of interference and, if possible, the source of it. This information is simple to supply, and requires only the most elementary knowledge of radio.

It is usual to denote the strength of signals by the use of the "R" code, ranging from R1 (scarcely heard) to R9 (very strong), but unless you are in a position to accurately gauge signal strength it is better to say it in plain English. Some dxers, in the hope of receiving favourable consideration,

make the mistake of exaggerating the strength of a station's signal. Not only is this bad dxing and worse reporting, but it tends to lessen the confidence of the recipient station in you, as they are quite aware of the possibility of the actual manner in which their transmission would be received in a given locality, according to the receiver in use.

As an instance, should several reports arrive from a given destination and dxers using six or more valves given them R4, then an exaggerated report from a four-valve user giving, say, R7, would in all probability only succeed in hastening the report's progress towards the W.P.B. Other abbreviations in general use are QSB, QRI, QSA, QRN and QRM, but again, unless you thoroughly understand the correct meanings do not apply them; use plain language, and you can rest assured that your effort will be understood.

This article is not offered as a complete review of the subject of dxing, but purely as a help to beginners, the author's main desire being to offer a basis on which a start may be made and some of the pitfalls avoided. By joining a good DX Club, such as the one fostered by this journal, the beginner will have the advantage of practical help from experienced members. That an ounce of practice is worth a ton of theory is an old saying which may be very aptly applied to dxing.

ALL-WAVE ALL-WORLD DX CLUB

Application for Membership

The Secretary,
All-Wave All-World DX Club,
117 Reservoir Street, Sydney, N.S.W.
Dear Sir,

I am very interested in dxing, and am keen to join your Club.

Name

Address

(Please print both plainly)

My set is a

I enclose herewith the Life Membership fee of 3/6 (Postal Notes or Money Order), for which I will receive, post free, a Club Badge and a Membership Certificate showing my Official Club Number.

(Signed)

(Readers who do not want to mutilate their copies can write out the details required.)



Shortwave Review

CONDUCTED BY
L. J. KEAST

NOTES FROM MY DIARY

Just as the Sun Went Down

The long-awaited crystal arrived at KZND, Manila, just before the Japanese invasion, but it enabled them to make the anticipated change from 34.13m to 31.53m, and the resultant signal surpassed the former. I trust it will not be long before General Douglas MacArthur's station is on the air again.

Good-Oh!

Some time ago I read where the B.B.C. stated experiments had shown that speech needed to be slowed down to 100 words per minute in order for it to be heard clearly over short-waves. (I am afraid friend Robert Harris forgets this quite often when reading the News.) Evidently KGEI heard this, as Bob Goodman is probably one of the-most-easy-to-listen-to news readers on the air, and in striking contrast to what we have been accustomed to from American stations. Through KGEI, on 41.38m, at 8 p.m. he is a treat.

Incidentally, a weekly feature from KGEI is The Telephone Hour, sponsored by The Bell Telephone System,

"Music You Love, the Way You Like to Hear It," given on Tuesday nights from 7 p.m.

Hi-Gang!

One of the jokes from session on February 24: "Why does Quisling always sit in the front row at the cinema?" "Because it's the only time he can feel he has the Norwegians behind him."

No Service

Mr. Clack tells me he has had two reports to Chungking returned, the envelopes being marked "Not transmissible. No Service. Return to Sender."

Before and After

I cannot understand why the B.B.C. omit mentioning the name of their speakers at the end of a talk, in addition to introducing them prior to the commencement. There is so much to be heard at the present time on the short waves that one may be pardoned for making a "tour" or the ether, but it is very aggravating to happen on a delightful talk and listen for the best part of fifteen minutes, only to hear at the conclusion, "This is the British Broadcasting Corpora-

tion." Then patience is further exhausted by them leaving the air without any comment. Reason for my moan is that GRH, on 30.53m, was picked up at 3.1 p.m. on Sunday, February 22, and held till they left the air at 3.15 p.m.

Canaries Give Way to Gongs

Came across the Roman canaries on Sunday at 3.20 p.m. and left the set tuned to 31.15m. At 3.29 the birdies faded out and beautiful chimes preceded an announcement by the female announcer. After station particulars, a talk on tea was given and the Americans were informed that most of the tea they had been drinking had come from Japan and not from China as was generally supposed.

Henry Stokes Returns

Had a great but very pleasant surprise on Thursday evening, February 26, when we were told over 2FC that the news commentary would be given by Henry Stokes. This great fellow had only arrived a few minutes previously from Singapore. His last broadcast from there was on February 10. His talk from Sydney was splendid and, I figure, will be an incentive to the war effort.

BACK NUMBERS

(Continued from page 21)

June, 1941

Another circuit to embody acoustic compensation was the powerful "Super Seven" dual-waver in this issue. A circuit which aroused considerable interest also appeared. This was the "Parry-phase" amplifier which used a 6J8G to drive a pair of 6V6G type beam power valves in a most simple yet effective way, with inverse feedback included.

July, 1941

A simple four-valve broadcast super-het to operate from a vibrator power unit was offered in this issue as a solution to the problem of the countryman faced with an inadequate supply of batteries. A power oscillator for more code classes was another article in this issue.

August, 1941

Pre-amplifier circuits for use with low-gain microphones do not appear very often, yet as much sought after. A circuit of this kind appears in this issue, together with the "Trade Builder" mantel model, an all-wave one-valver, and the crystal circuit to end all crystal circuits.

September, 1941

This issue stands out as the start of the "Signal Tracer" series, the first of these being given. The "Simplest" five-valve t.r.f. set for a.c. operation was also presented in this issue as an economical proposition capable of giving results out of all proportion to the cost.

October, 1941

The "1941 Dandy" mantel model, the "Tone Control Amplifier" and several other interesting items appear in this issue.

November, 1941

The winning essay in the battery circuit contest was published in this issue, the "Elementary" signal tracer, details of an inter-office communicator, the "Nugget" dual-wave five for a.c. operation and also details of a handy 12-watt amplifier.

December, 1941

This special Christmas issue introduced the subject of variable selectivity for the "Acoustic Compensated Superhet," a medium-cost signal tracer, and the "1942 Tip-Top," as well as several other articles, making it a strong issue.

Short-Wave Clubs Short

American Radio Clubs have been hit very hard by the war, as most of them, being international in character, had as many members overseas as local and now that the U.S.A. is at war they show signs of being compelled to conserve paper. Doubtless the infrequent mails are also being felt. Latest issues of club organs make very little reference to Australian reports and, knowing their anxiety to receive information of Oriental stations which, because of the difference in time, are not heard so well in the States, I invariably forward a sheaf of notes, and their absence convinces me the mails to the U.S.A. must be as erratic as those from there.

Anzac Tattoo

Probably quite a number tune to Station Ananias (designated in records as DJR, Berlin) on 15,340kc, 19.56m, for the "news" at 11 p.m. Well, for a little diversion, keep tuned on a Saturday night, as a few minutes after the "news" has been given you will find precisely at 11.15 p.m. that "Anzac Tattoo" is put over. It is termed a session from the enemy

NEW STATIONS

PRE-9, Fortaleza, 6105kc, 49.14m: This new Brazilian station is being heard between 6 and 8 a.m. Also heard on 15,165 or 15,170kc three hours later. Address reports to Snr. J. Dummer, Director, Caixa Postal 143, Fortaleza (I.S.W.). (Fortaleza is a seaport in the State of Ceira, Brazil, with a population of 98,848.—Ed.)

PRF-3, Sao Paulo, 6095kc, 49.22m: Another new Brazilian station being heard in U.S.A. from 10 a.m. to 1 p.m. and also on 11,765kc, around 7.30 a.m. Announce as "Radio Difusora, Sao Paulo." Address: P.O. Box 252, Sai Paulo. (Sao Paulo is the capital of a Brazilian State of the same name, 112,278 sq. miles on Atlantic coast. One of the most flourishing commercial cities of South Brazil; population, 900,000. Great coffee export.—Ed.)

WCRC, New York, 15,270kc, 19.64m: This is one of the frequencies mentioned in January issue. Heard around 8 a.m. ther one of the Columbia Broadcasting System frequencies that is most likely to go into regular use any day. Mostly foreign language till 8.15 a.m.

Radio Mediterraneo, Valencia, 7035kc, 42.66m: A welcome addition to the fast diminishing stations of Sunny Spain. Opens at 7 a.m. with march. Fine strength signal and good musical records. Woman announcer. Station closes at 8 a.m. Slogan, "Voz Espana." (Valencia is the capital of a Spanish Province of the same name; population of 324,129. Exports wine, fruit, corn, etc. Museum and interesting cathedral.—Ed.).

Paris Mondial, Vichy or Paris., 6200kc, 48.39m: Reported as being heard in mornings round about 6 o'clock. This is a good band for Europeans at this hour and signal strength may be indicative of an early winter.

pest, the capital of Hungary. This was Edition No. 7.

News in English is given from Bangkok on 25.61m from 11.15 to 11.30 p.m.

Moscow is using 42.85m for telephony.

Kubishev, on 24.81m, is very loud at 11.40 p.m. Same programme on 33 and 49m bands.

Heard VLQ, 9610kc, 31.2m, giving News in Dutch at 12.30 a.m. on March 8.

This came in beautifully and I heard Big Ben strike at 11 p.m. We were told that "News from Home" by Howard Marshall . . ." and the signal faded out. I quickly tuned to an alternative frequency, but no result. Then tuned to DJR, Berlin, as I was anxious to hear "Anzac Tattoo" at 11.15. No sign of a station here, either. Running right down the 19m band, no London or European transmitter could be heard; only station was YDC, Java. By 11.30 there was no sign of the wanderers returning. Andbody else notice this phenomena?

A letter from Roy Hallett just to hand, and inter alia he says: "I say, did you try for 'Anzac Tattoo' on February 28? I did, and around 11.15 p.m. I could not raise a whisper from Europe (Berlin, London, Rome or anywhere else). The Nirom and other Asiatics were quite good." (See reference elsewhere to February 28.—Ed.)

Mr. Hugh Perkins, of Malanda, Q., sends an air-mail letter to say he heard SPW, Warsaw, 13,635kc, 22m, at 2.03 a.m. with an R8 signal. (That's a voice from the past or, more likely, a new voice from an old post.—Ed.)

A letter from Mr. Neville Gandy, of Auckland, shows that from 9 o'clock to mid-day, as in Australia, very few stations are audible.

Mr. Perkins is another who insists GRE is on 19.51m, and he is also in agreement with me in expressing pleasure that at last we hear News in English from YDC (1.30 p.m. and 8.15 p.m.).

Brief Mention

Tokyo broadcasts in Dutch at 1 a.m. on 31.37m.

Berlin, on 24.73m, at 11.30 p.m. gives special programme for Spain in Spanish. Same time as Bordeaux.

On March 7, Berlin announced that we were being taken to the "European Cafe" and "Palais de Danse" in Buda-

to the enemy, specially transmitted to the East and Middle East for the Anzacs wherever they are. In order to hold interest, listeners are promised a list of Austalian prisoners in Germany will be read. This is done at the end of the twenty minutes' show "from the enemy to the enemy." This programme (I have heard three issues) is worth listening to if only to note a new slant on propaganda.

Yes or No

Station programmes from the States carry the reservation, "Subject to change due to war conditions."

Sets Settled

Dr. Gaden has arrived at Quilpie with bags and baggage, DX receivers

HERE ARE SOME TO LOOK FOR

Press Wireless, in conjunction with the U.S. Department for the Co-ordination of Information, has begun a series of test transmissions from Los Angeles to Australia:—

KJES, Los Angeles 9390kc, 31.94m.
12.30 a.m. to 1.30 a.m.

KJEP, Los Angeles 10,750kc, 27.90m.
2 a.m. to 3 a.m.

KGT9, Los Angeles 15,580kc, 19.20m.
9 a.m. to 10.30 a.m.

and everything, and an air-mail letter tells me that the district — which, by the way is more or less familiar to him — is O.K. for short-wave reception. Well, that's good news.

Microphone Magazine

Berlin, through DJW, 9650kc, 31.09m, gives a summary of programmes ahead under the title, "Microphone Magazine." This feature is heard on Fridays at 11.45 p.m.

Meet Mr. Condon

We welcome to our club a new member, Austin S. Condon, of Laura, South Australia, and what a fine list of loggings accompanied a very nice letter. Thank you, Mr. Condon!

News From Over the Tasman

Our good friend and member, J. J. Fitzgerald, late of Randwick, has arrived in New Zealand and is delighted with reception in the Shaky Isles. He promises to send a report and, with the "Ultimate" I sold him, I bet he will pull them in.

Heterodyne

Most reporters have referred to the interference on 41.38m at 10.30 p.m. caused by VLQ-9, and in South Australia at this hour the excellent signal from KGEI is put out of business. Mr. Condon laments that KGEI left 31.02m.

February 28

I have often, in these pages, expressed my interest in "News from Home," by Howard Marshall, through GSF on Saturday nights at 11 p.m. Well, on February 28, I tuned to London about 10.35 and listened to "Calling British forces in the Far East."

NOTICE TO DX CLUB MEMBERS

Members of the All-Wave All-World DX Club are advised that they should make a point of replenishing their stock of stationery immediately, as all paper prices have risen, and we expect that it will be necessary to increase prices by at least 25%.

Already it has been found necessary to abandon the log-sheets and club stickers. However, while stocks last, the following stationery is available at the old prices, as shown.

REPORT FORMS.—Save time and make sure of supplying all the information required by using these official forms, which identify you with an established DX organisation.
Price 1/6 for 50, post free

NOTE PAPER.—Headed Club natepaper for members' correspondence is also available.
Price 1/6 for 50 sheets, post free

ALL-WAVE ALL-WORLD DX CLUB, 119 Reservoir Street, Sydney

The MONTH'S LOGGINGS

ALL TIMES ARE AUSTRALIAN EASTERN DAYLIGHT SAVING TIME
(Quite possible authorities will revert to Standard Time after March 31)

Pressure on space makes it impossible to give full schedules as has been our custom. However, we are mindful of how helpful these particulars have been and we will record principal alterations that are noted. It is quite likely a complete list of schedules will be printed quarterly or perhaps a frequency check at intervals.

AUSTRALIA

VLG-7, Melbourne 15,160kc, 19.79m
Used in special session for North America from 3.25 a.m. to 3.55 a.m.

VLO, Sydney 9615kc, 31.21m
Much better than **VLR** and no fading (Gaden).

VLQ-10, Sydney 9590kc, 31.28m
This is another that may be brought into use very shortly.

VLR, Melbourne 9580kc, 31.32m
Considered difficult to log at Quilpie. I can hear them but fades a lot (Gaden).

VLG, Melbourne 9580kc, 31.32m
For British Isles. 5.55 to 6.20 p.m.

VLQ-9, Sydney 7250kc, 41.38m
Heard the other night opening at 10.30. Poor **KGEI!** Wonder what effect is at other end. Some co-operation required somewhere.

OCEANIA

Fiji:
VPD-2, Suva 15,160kc, 19.79m
Schedule: 3 p.m. to 3.30 p.m.
French session. Excellent strength.

AFRICA

Algeria:
TPZ, Algiers 12,120kc, 24.76m
See **TPZ-2**.

TPZ-2, Algiers 8960kc, 33.48m
Excellent signal at 6.15 p.m. Gives News in French at 7 p.m.; closes 7.20 p.m.

Belgian Congo:
OPM, Leopoldville 10,140kc, 29.59m
Being heard weakly. Asking for reports. Closes at 6.45 a.m. with Belgian National Anthem.

Egypt:
Cairo 9690kc, 30.96m
Heard this station at 1.30 a.m. one morning (Gaden). Announced as Egyptian Broadcasting Co.

Radio Cairo, Cairo 5980kc, 50.17m
Music till 7 a.m. News in English till 7.15 a.m., when same News is given in French. Closes at 7.30 a.m.

Ethiopia:
Addis Ababa 9625kc, 36.16m
From just after 1 a.m. till 2.30 a.m.

French Equatorial Africa:
FZI, Brazzaville 11,965kc, 25.06m
News in English at 6.45 a.m.

Morocco:
CNR, Rabat 8035kc, 37.34m
5 a.m. to 11 a.m. Best at 6.30.

Portuguese East Africa:
Mozambique:
CR7BE, Lourenco Marques 9840kc, 30.48m
Still one of the loudest morning stations. Good till 8 o'clock.

Portuguese West Africa:
CR6RA, Laanda Angola 9470kc, 31.68m
Monday, Tuesday, Wednesday and Thursday, 6.30 a.m. to 7.30 a.m.
Can just hear (Gaden).

Senegal:
FGR, Dakar 9410kc, 31.83m
Heard around 6.15 a.m. (Nelson and Gaden). Note change in frequency.

Transvaal:
ZRH, Johannesburg 6007kc, 49.95m
Schedule: 2.30 a.m. to 8 a.m. News 6.30. News in Afrikaans at 6.45 a.m. B.B.C. News at 7.45.

AMERICA

Central:
Costa Rica:
TIEMC, San Jose 11,900kc, 25.21m
May just be heard after **XGOY** leaves the air.

El Salvador:
YSR, San Salvador 6270kc, 47.85m
(Note change in frequency.—Ed.) "La Voz de El Salvador" is being heard with a very good signal from 11 a.m. to 3 p.m. (Dissinger, U.S.A.).

Guatemala:
TGWB, Guatemala 6470kc, 46.37m
"La Voz de Guatemala" heard in parallel with **TGWA**, **TGWW** and **TGW**. 11.30 a.m. to 5 p.m.; 4.45 a.m. to 7.45 a.m.; midnight to 1 a.m. (Dissinger, U.S.A.).

TGQA, Quezaltenango 6405kc, 46.38m
"La Voz del Quezaltenango" heard in parallel with **TGQ**, long wave, from noon to 2.30 p.m. and on Sunday to 4 p.m. (Dissinger, U.S.A.).

TGZ, Guatemala 6195kc, 48.50m
"Radio Morse," pronounced in Spanish "Radio Morsey," 11.30 p.m. to 2 a.m., 10 a.m. to 3 p.m., and Sunday to 7 p.m. (Dissinger, U.S.A.).

Panama:
HP5A, Panama City 11,700kc, 25.64m
Has improved lately at 4 p.m. and seems clear of interference. Reported audible at 8 a.m. in some localities.

North:
WRCA, New York 17,780kc, 16.87m
Quite good with News at 1 a.m. (Cushen).

KGEI, San Francisco
"This is the United States of America broadcasting from the Fairmount Hotel in a round-the-world service." Transmitting on the . . . Various bands are mentioned, to suit the particular hour. At the time of compiling these notes a fairly consistent schedule appears to be in operation, and my records show:

15,330kc, 19.57m: Opens with News. News is also given at every hour till closing on this frequency at 2.30 p.m.

13,690kc, 21.91m: Opens with News at 1 p.m., 2 p.m. and 3.20 p.m.

11,950kc, 25.41m: News 3.15, 5 and 6 p.m.

10,410kc, 28.81m: News 5, 6, 7, 8 and 10.30 p.m. Generally poor signal at night.

7,250kc, 41.38m: Opens at 3 p.m. with News. Also News at 6, 7, 8, 10.30, 11.30 p.m., 1.30 a.m. and 2.45 a.m. Excellent at 8 p.m. At 10.30 News is often overpowered by **VLQ-9**, but can be heard splendidly on 43.73.

6,860kc, 43.73m: Opens at 7 with News. News also at 8, 10.30 11.30 p.m., 1.30 a.m. and 2.45 a.m. News in Chinese at 10.45 p.m. The transmission on 43.73 may be heard through **KRCA**, Honolulu, at 10.30 p.m. Dr. Gaden reports a test on Sunday, February 21. Signal was R-9, Q-5. "This is **KRCA**, of R.C.A. Incorporated in Honolulu, testing prior to a point-to-point transmission; this is not a broadcast."

WGEA, Schenectady 15,330kc, 19.57m
Listen to "March of Time," 8 a.m. to 8.30 a.m. Sundays.

WCRC, New York 15,270kc, 19.64m
This is another of the frequencies referred to in January issue that is now being heard in tests. Heard the other night at 11 p.m.

WLWO, Cincinnati 15,250kc, 19.67m
Reported heard just after midnight.

WBOS, Boston 15,210kc, 19.72m
News at 1 a.m. and 2 a.m.

WNBI, Boundbrook 15,145kc, 19.81m
Fair at 1 a.m. (Cushen).

KKQ, Bolinas 11,950kc, 25.11m
Heard at 5 p.m. when News from Fairmount Hotel is given.

WCRC, New York 11,830kc, 25.36m
Reported testing at 8 a.m.

WRUL, Boston 11,790kc, 25.45m
Excellent signal every morning. Special session for Australia on Tuesdays, Thursdays and Saturdays at 8.15 a.m. Closes at 9.25 a.m.

WRUL, Boston 11,730kc, 25.58m
Commentary at 9.45 a.m.

WLWO, Cincinnati 11,710kc, 25.62m
Schedule: As suggested by Dr. Gaden, **WLWO** is now heard at 8.30 a.m. at excellent strength. Fades after 10.

WRUW, Boston 9700kc, 30.93m
Commentary at 9.45 a.m.
See remarks above (25.45m).

WRCA, New York 9670kc, 31.02m
9 a.m. to 8 p.m. News 5 p.m. and 7.45 p.m. News at 7.45 p.m. always worth hearing. Sorry not more English in other sessions (Clack).

WGEO, Schenectady 9530kc, 31.48m
More or less on all day and will probably provide a better signal than **WGEA** in "March of Time."

KEQ, Honolulu 7370kc, 40.70m
Heard at 11 p.m. in point-to-point with "Frisco (Gaden). (Thanks to Dr. Gaden's wire, I heard, on March 5, description of bombing of Honolulu on March 4.—Ed.)

WGEA, Schenectady 6190kc, 48.47m
News at 6 p.m.

WCRC, New York 6170kc, 48.62m
Good in evening till closing at 9.30 p.m.

WRUS, Boston 6040kc, 49.66m
This is the new call-sign for the old **WRUL** frequency. Not intended for us. Tune **WRUL**, 25.45m.

Mexico:
XEQQ, Mexico City 9680kc, 30.99m
Fair just after midnight.
The best at 4 p.m., also heard at midnight

XEWW, Mexico City 9503kc, 31.57m
XEBT, Mexico City 6005kc, 49.96m
The best of the 49m. Mexicans (Cushen).

South:
Bolivia:
CP-38, La Paz 9480kc, 31.63m
"Radio Nacional de Bolivia," 9.30 a.m. to 1.30 p.m. Station in parallel is **CP-3** and not **CP-2** (Dissinger, U.S.A.).

CP-5, La Paz 6200kc, 48.39m
"Radio Illimani," Government station, In-gavi 321. Heard very well from 10.15 p.m. to midnight and from 10.30 a.m. to 3 p.m. (Dissinger, U.S.A.).

Brazil:
PRE-9, Forteleza 15,170kc, 19.78m
This is another frequency used about 10 a.m. (I.S.W.).

PRE-9, Forteleza 6105kc, 49.14m
Reported being heard around about 7 a.m.

PRF-3, Sao Paulo 11,765kc, 25.52m
Also said to be on this frequency.

PRF-3, Sao Paulo 6094kc, 49.20m
This is another new Brazilian station, according to American reports. Heard around breakfast time.

PRA-8, Pernambuco 6010kc, 49.92m
Quite O.K. at 6.30 a.m. (Gaden).

Chile:
CB-1180, Santiago 11,975kc, 25.05m
Still heard at good strength at 3 p.m. and around 11 p.m. (Cushen).

Colombia:
HJCF, Bogota 6235kc, 48.08m
"La Voz de Bogota." Heard on this new frequency 11 a.m. to 3 p.m. (Dissinger, U.S.A.).

HJCD, Bogota 6160kc, 48.70m
"Nuevo Granada." Heard with powerful signal from 2 to 3 a.m. and 8 a.m. to 3.30 p.m. (Dissinger, U.S.A.).

HJDE, Medellin 6145kc, 48.76m
"La Voz de Antioquia." Most powerful Colombian station. Heard from 1.30 a.m. to 2 p.m.

Ecuador:
HCJB, Quito 12,460kc, 24.08m
 Heard at R6, on February 23, at 9.40 a.m.
 (Perkins).

Peru:
OAX4J, Lima 9340kc, 32.12m
 Nightly at midnight, Sundays at 3 p.m.

THE EAST

Burma:
XYZ, Rangoon 6007kc, 49.94m
 Doubt if on air by time these pages are printed, but when last heard—English from 12.30 a.m., News 1.30 a.m.

China:
XGOX, Chungking 15,190kc, 19.75m
 Special session for U.S.A. from 11 a.m. to 1 p.m. with News at mid-day. Reception only just fair here. Probably O.K. in Queensland. Special session for England from 8.30 to 9 p.m. Reception here is fair.

FFZ, Shanghai 12,068kc, 24.86m
 Gives News in Russian at 9.30 p.m.

XIRS, Shanghai 11,980kc, 25.02m
 Is now heard at 6.45 p.m.

XGOY, Chungking 11,925kc, 25.16m
 Note slight change in frequency. News 7.30 p.m., 9.15 p.m., 10.30 p.m., 11.30 p.m. and 3.15 a.m.

XGRS, Shanghai 11,675kc, 25.7m
 Note slight change in frequency. Now giving excellent signal. Comedy session at 10.30 p.m.

XGOI, Chungking 9660kc, 31.06m
 At 11.10 p.m., announcement, "This is XGOI, the Voice of China. The time is now 10.10, and here is the first edition of the News." Is reported being heard on 30.85m at 12.30 a.m.

JTHK, Hongkong 9525kc, 31.49m
 According to A.B.C. Weekly this is the Jap call-sign for our old **ZBW-3**. Heard from 8 p.m. till after midnight. News at 12.10 a.m.

XLMA, 9370kc, 32.02m
 Still fair at 10.30 p.m. (Gaden).

XGOY, Chungking 5950kc, 50.42m
 News at 12.30 a.m. Good signal also at 7.10 a.m. News in Chinese at 7.15 a.m.

Dutch East Indies:
PMA, Bandoeng 19,380kc, 15.48m
 News is now given at 11.45 p.m. Signal is generally good, but indications ore that this is not a good frequency for us at this hour. Try **YDC** for News at 8.15 p.m.

..... 15,230kc, 19.70m
 Gives News at 8.15 p.m., but appears to leave the air at 9 p.m.
 Same programme as **YDC** on occasions.

YDC, Bandoeng 15,150kc, 19.81m
 Now more or less a continuous service, as also **PLP**, 27.27m; **PLS**, 28.94m, and **YDB**, 31.41m. Now gives News at 1.30 p.m. and 8.15 p.m.

French Indo-China:
Radio Saigon 10,240kc, 29.29m
 Has replaced the old 25.47m transmitter. Excellent strength. News at 9.15 p.m. and 10.30 p.m. New frequency suits Victoria (Sheldrick) and West Australia (Walker).

India:
VUD-3, Delhi 15,290kc, 19.62m
 Now gives News at 7 p.m.

VUD-4, Delhi 11,830kc, 25.36m
 In view of terrific interest in the East, News from this station is welcomed at 11.30 p.m.

VUD-2, Delhi 9590kc, 31.28m
 Probably a better signal than **VUD-4**. News at 11.30 p.m., also at 2.50 a.m.

VUD-2, Delhi 6130kc, 48.94m
 Opens up at 12.15 a.m. News heard here also at 2.50 a.m.

VUY-2, Dacca 6072kc, 49.41m
 This is a new Indian, reported being heard from midnight to 2.15 a.m. **VUY** is the longwave station at Dacca—1167kc.

Japan:
 The chief Japanese transmitters, as far as we are concerned, are:—

JZJ, Tokyo 11,800kc, 25.42m

JZI, Tokyo 9530kc, 31.46m

JVW, Tokyo 7257kc, 41.34m

From the above at 8 and 11 p.m., "News" is given and talks in English are likely at any tick of the clock. On Fridays at 11.15 messages from prisoners-of-war are given. At 5.30 p.m. News is heard from 31.46m.



“ULTIMATE”
features FULL BANDSPREAD

Short-wave stations spread up to sixteen times further apart on the Full Bandspread Dial! Each Short-wave Band located on a separate scale. Divisions marked in megacycles and fractions of a metre. Short-wave stations tuned in as easily as local stations! Placing and re-logging now simplicity itself! The "ULTIMATE" Full Bandspread Short-wave Tuning Dial revolutionises Overseas Tuning and Reception! Investigate the new "ULTIMATE" before you decide on a Radio Set. Newly-released illustrated literature now available.

Cut out this Coupon and post to-day.

GEORGE BROWN & CO. PTY. LTD., 267 Clarence Street, Sydney.
 Please send me particulars of "ULTIMATE" Full Bandspread Receivers as advertised in "Australasian Radio World."
 NAME
 ADDRESSR.W



GEORGE BROWN & CO. PTY. LTD., 267 Clarence St., Sydney

LOGGINGS (Continued)

JLG-4 15,105kc, 19.86m
Announcements and News at 9.55 a.m.
Heard again at 1.10 p.m. in News for U.S.A.

..... 31.35m
Undoubtedly the old **KZRM**. News at 9.55 a.m. (Dr. Gaden also refers to the two above stations at this hour.—Ed.) News also given at 5.30 p.m.

Malaya: Singapore:

No more! Henry Stokes, A.B.C. commentator gave his last broadcast from here on Monday, February 10. He left the island on February 11 (see Diary). I think the station announcer with the B.B.C. voice that we have heard for so long from **ZHP** is Eric

Davis. This man spoke over the Pacific edition of Radio Newsreel at 8.30 p.m. on February 21. He now gives News to B.B.C. from Java.

Manchuria:
MTCY, Hsinking 9545kc, 31.43m
News at 8 a.m.

Philippines:
KZRC, Cebu 6100kc, 49.18m
The only Philippine station left under old regime.

KZRH, 31.12m, and **KZRM**, 31.35m.
Being used by Japanese announcers.—Ed.

Secret Philippine Station 9643kc, 31.11m
"The Voice of Freedom, broadcasting from somewhere in the Philippines," opens with News nightly at 9.30. Often morse on top, but News can be followed. When first heard several weeks ago, they closed about

9.53 with "Star-spangled Banner," but now continue after News with music and at 10 p.m. News in some Filipino dialect. At 10.15 more music—off at 10.30. Mr. Hugh Perkins sent air-mail letter re station continuing after 9.50. Heard well at Raymond Terrace (O'Brien). Opens again at 8.30 a.m. (I think the 9.30 p.m. session is also on 48.94m.—Ed.)

GREAT BRITAIN

"This is London calling."

GRE, London 15,375kc, 19.51m
As far as I can find out, this station is only used on Tuesdays and Fridays from 9.30 p.m. to 9.45 p.m. and at 12.30 a.m. on Wednesdays and Saturdays, excepting that I heard them in Pacific transmission on March 7 at 8.20 p.m., but they left the air at 8.30 without any announcement. On Friday, March 6, at 9.29 p.m., I heard a female announcer say, "This is London calling in the overseas service on 16.86 and 19.51m: Here is our News commentary in — (I could not catch this) and spoken by Mrs. —."

GSI 15,260kc, 19.66m
Coming on again at 10 p.m., but not up to **GSV**, **GSF** or **GSD** (Gaden).

GSF 15,140kc, 19.82m
Excellent transmitter at 10 p.m.

GRV 12,040kc, 24.92m
Heard in Eastern Service with an R9 signal (Perkins).

GSD 11,750kc, 25.53m
Probably the most consistent of the B.B.C. transmitters and one of the earliest of the after-lunch stations.

GRJ 7320kc, 40.98m
Splendid at 6.45 a.m. (Gaden).

GRS 7065kc, 42.49m
Heard in Pacific session only (Gaden).

BRN 6194kc, 48.43m
Excellent signal at 7.15 a.m. (Gaden).

EUROPE

Bohemia:

DHE4C, Prague 11,880kc, 25.25m
Transmits irregularly to North America. 8.50 a.m. to 3 p.m. (Globe Circler).

DHE4A, Prague 11,840kc, 25.34m
Reported being heard at 7.30 a.m.. Can be identified by old Czechoslovakian nine-note signal. No English.

France:

Radio Vichy, Vichy 9520kc, 31.51m
Heard with good signal at 6 p.m. (Hallett).

Paris Mondial, Vichy or Paris, 6200kc, 48.39m
Reported heard at 6 a.m.

Radio Vichy, Vichy 17,850kc, 16.81m
Good signal at 9.30 p.m.

Radio Vichy, Vichy 15,240kc, 19.68m
Good at 10.30 p.m.

Germany:

DJR, Berlin 15,340kc, 19.56m
Listen to "Anzac Tattoo" on Saturdays at 11.15 p.m. (Perkins).

DZH, Berlin 14,460kc, 20.75m
Good signal at 9.30 p.m.

DJW, Berlin 9650kc, 31.09m
At 11.45 p.m. on Fridays gives Microphone Magazine, which is a summary of programmes ahead. On February 27 gave particulars up to and including March 14.

DWX, Berlin 6130kc, 48.95m
This new German gives English News at 5.30 a.m.

COPPER WIRE

(Continued from page 14)

do justice to a steam-roller transmission system, through a tapered reducer. When the wire is drawn down to really fine sizes, such as those used for making radio tuning coils or transformers, etc., it is taken through numerous diamond dies, each successive die having a smaller diameter hole than its predecessor. During the latter process the wire passes through cooling baths. Having reduced the conductor to the requisite size, it now remains to cover it with suitable insulation.

We may have cotton covering, silk, rubber, cellulose compound, in fact there is a galaxy of insulations at our disposal. In radio the commonest forms of insulation are enamel, silk, cotton, cotton and cellulose, cotton and wax, and, of course, oiled cotton (i.e., systoflex), and V.I.R. (vulcanised india-rubber). To enamel the wire it has to be run through several baths of the insulating material and baked after each bath. The general temperature plays a very important part in this process, as does local climatic conditions.

It is interesting to note that one well-known transformer concern insists on an enamel insulation which will have a "breaking point" beyond that of the wire conductor. This means that when the wire is stretched it will actually break before the enamel surface. One can appreciate the reason for this precaution owing to the number of bends in a length of wire employed in the secondary winding of the transformer and the enormous pressure existing in the internal turns.

Covering the Wire

In cotton covering the wire travels horizontally, and reels of cotton are arranged radially around the conduc-

tor. There has to be a correct relationship between the velocity of the wire and the revolutions per minute of the cotton reels which spin round and round in a big circle, lapping the core with the right amount of cotton. D.C.C., or double cotton covered wire, necessitates two sets of reels revolving in opposite directions. In order to impart a braided covering the reels move around a vertically travelling wire. Actually the reels take an eccentric course similar to children playing "in and out the windows."

The famous Litzendraht wire, or Litz as it is known, is composed of three sets of three wires, each set of three being twisted and then the three lots twisted together; this ensures that each conductor shall come to the surface alternately, and since H.F. currents travel on or "near" the surface of conductors, Litz reduces the H.F. resistance as compared with ordinary wire. It is important to note that genuine Litz has each conductor separately insulated either by silk covering or enamel.

Preventing Electrolysis

It very often happens that when a coil is employed in a humid atmosphere, a green spot appears on the wire which finally eats it away and causes a breakdown; this is known as electrolysis, and is due to the passage of a steady current through a conductor in a damp environment. Especially did this "green spot" occur in the early "spaghetti" resistances. A cure has been found by winding the wire on a non-absorbing core, sealing the ends and last, but not least, by the employment of a wire free of iron content.

Such is the care exercised in modern wire production that it was found in one factory that breakdowns were due to the peculiar moisture on the skin of the hands of two sisters employed in handling the wire.

Italy:
Rome:
ZRO-3 9630kc, 31.15m
 News in English for Australia of 6.20 p.m.

Poland:
SPW, Warsaw 13,635kc, 22m
 Heard with an R8 signal on February 26 at 2.03 a.m. Very fine musical variety programme (Perkins).

Russia:
 Transmission from either Moscow or Kuibyshev. Still difficult to give any reliable schedules, but the following can be tried:
 — 15,230kc, 19.69m
 Heard from 10 a.m. till about 11.50 a.m. News at 10.10 a.m.
 —, Moscow 13,115kc, 22.87m
 Although only Russian used, is excellent strength at 8 p.m.
 —, Sverdlovsk 12,060kc, 24.88m
 English from 7 p.m., but often jammed by morse.
 —, Moscow 11,890kc, 25.23m
 Heard from 8.15 to 8.40 a.m. News at 8.30 a.m.
 —, Kuibyshev 10,075kc, 29.78m
 News at 11.40 p.m.

Siberia:
 —, Khabarovsk 9566kc, 31.36m
 Good afternoon and evening (Gaden).
 —, Khabarovsk 9545kc, 31.43m

Excellent at 11.30 p.m. At 11.35 p.m. gives News in Russian from Soviet Information Bureau for Russian Fleet. Announces also on **RW-33**, 1256m.

Spain:
Radio Mediterraneo, Valencia, 70.35kc, 42.66m
 Opens at 7 a.m. with march. Slogan, "Voz Espana." (See "New Stations.")

Switzerland:
HER-3, Schwarzenburg 6165kc, 48.66m
 Still heard of a morning with a musical programme, but no English. Only chance of hearing English from Switzerland is on Saturdays and Tuesdays from 12.45 a.m. through **HBH**, Geneva, 18,480kc, 16.23m., or **HBJ**, 14,535kc, 20.65m, at 4.45 p.m. on the first Sunday of the month.

Vatican City:
HVJ 15,120kc, 19.84m
 Heard beautiful chimes at 5.25 p.m. on March 7. Followed by station announcement at 5.30. Man read very slowly in Italian. Excellent signal.

HVJ 6005kc, 49.96m
 Heard at 6.15 a.m. (Cushen, Gaden). This is a new frequency for **HVJ**.—Ed.

Scandinavia:
Sweden:
SBP, Stockholm 11,710kc, 25.63m
 Is now heard at 7.25 p.m.

MISCELLANEOUS

Canada:
CBFY, Montreal 11,705kc, 25.63m
 Heard at good strength from 11 p.m.

CFRX, Toronto 6070kc, 49.42m
 Opens around 10.30 p.m.

CFRX, Toronto 6070kc, 49.42m
 Requires sorting out from morse, but heard around 11 p.m.

West Indies:
COCQ, Havana 8850kc, 33.9m
 Very good around 11 p.m. Heard religious service in English from 11.45 till midnight. Comes in well most mornings, 8.30 a.m. till 10.30 a.m. (Condon).

COCQ, Havana 6375kc, 47.06m
 Fair from 10.40 p.m.

COK, Havana 11,620kc, 25.82m
 Good, morning, afternoon and night. Heard February 19, around 8.15 a.m., with good signal. English spoken frequently. Asks listeners to send reports. Verification cards and metal registration plate promised. Address: Sports Palace, Havana, Cuba (Condon).

COCY, Havana 11,745kc, 25.54m
 "Radio Havana, Cuba." Heard with English announcement when closing at 5.15 p.m. (Condon).



FOR BEST RESULTS

—SENSITIVITY

—SELECTIVITY—

RELIABILITY—

USE ONLY MULLARD

THE CHOICE OF BRITAIN'S
 BETTER RADIO MANUFACTURERS!
AND AUSTRALIA'S TOO!

Mullard THE MASTER
RADIOVALVE

Mullard-Australia Pty. Ltd., 367-371 Kent Street, Sydney, N.S.W. Telephone: MJ 4688



SPEEDY QUERY SERVICE

Conducted under the personal supervision of A. G. HULL

A.N. (Campsie) enquires about back numbers.

A.—So far as we know, there is no back number available which contains an article quite along the lines you require. In this issue you will find a complete resume of the technical features of the back numbers available, and by running through these you will get an idea of several issues which should interest you.

F.R. (Randwick) enquires about the patent licence plate.

A.—If you are a manufacturer of radio sets for sale, then you should take the precaution of paying patent royalty by the purchase of a licence label which is attached to the chassis. The wholesaler who supplies the components will supply the plate, at a cost of 3/6 per cathode stream. The cathode stream idea means that you have to pay for twin valves just as though it is two separate valves.

A.R. (Cremorne) enquires about electrolytic condensers for "Tip-tap."

A.—Since you cannot get the same type as those shown in the original set you will have to use the tubular type which are available. These should be perfectly satisfactory in every way and the only point to watch will be in regard to the mechanical side of mounting them. A couple of easily-constructed clips should be sufficient. You will have to see that the negative side of the first one is connected to the centre tap and the bias resistor, but not to earth.

F.P. (Macksville) has some 500 and 525-volt dry electrolytic condensers and wants to know if they would be O.K. for use in the second or third filter position, with a 600-volt condenser in the first.

A.—They should be quite O.K. for the use suggested, provided of course, that there is nothing out of the ordinary in the matter of the voltages used. If the set provides for the use of a voltage divider or some bleed across the high tension there will not be the same high peak as if all voltages are obtained by means of series resistors. Similarly, the type of output valve will make quite a difference, according to whether it is directly or indirectly heated. With indirectly-heated valves and no bleed or divider, the peaks may be very high, not only on the first filter condenser but on all of them, as without current drain

there is no voltage drop in the filters or field. Wet electrolytics proved very serviceable, but they are not obtainable at present. The wet does not break down and short-circuit when overloaded, which was another of its attractions.

R.H. (Sofala) enquires about the battery position.

A.—So far as we know there is no sign of a let-up in the battery position and it is doubtful whether they will be plentiful again until after the war. Your local dealer, however, should be in a better position to tell you about this. A few batteries are still being made and delivered, but not enough to go round.

The new telephone numbers for
A. G. HULL
publisher of the
"AUSTRALASIAN
RADIO WORLD"

are
M 4078 and M 4079
(two lines)

Please note that technical queries
are NOT answered by telephone.

E.R. (Woy Woy) enquires about the portable set described by Mr. Noy in a recent issue.

A.—There is a two-gang condenser for the main tuning, with a 7-plate midget across the aerial section for trimming purposes. The reaction condenser would be a 23-plate job. Audio transformer would be an ordinary 3 or 3½ to 1 transformer. Greater power output could be obtained by fitting a pentode output valve, but this would upset the filament circuit arrangement.

S.T. (Hurstville) enquires about the power-handling ability of a Rola 10/20 type permagnetic speaker.

A.—This speaker should be able to handle the six watts output of your amplifier without difficulty. The main thing to watch out would be for super-sonic frequencies which may occur through parasitic oscillation or something of the kind. Although of a frequency beyond the range of the human ear, these may be actually loading the speaker and

causing the overload. With inverse feedback, the suppression of this trouble is sometimes quite a problem. A condenser from the plate of one of the output valves to earth might help, also grid suppressors right at the socket of each of the output valves. The suppressors can be resistors of anything from 1,000 to 10,000 ohms. Keep the capacity of the coupling condensers down to .01 mfd., which should be ample for a satisfactory low-note response.

A.B. (Young) makes some enquiries about power of transmitters.

A.—Yes, it would be quite in order to refer to the Australian broadcasting stations as low-powered. The majority are under a kilowatt rating, only a few go up near 10 kw. whereas in the United States there are a few stations of 500 kw. The majority of American stations, however, are fairly low in power. Even at the best it is found that a 500 kw. station does not necessarily put out a signal 500 times as powerful as that from a 1 kw. outfit. Doubtless, however, stronger power would mean a better service, and a signal more suited to drowning out static and noise. We should imagine that it would be quite useless to start worrying about this subject until after our present difficulties have been cleaned up.

A.N. (Tamworth) has an amplifier which fails to give a sound.

A.—Obviously there must be a mistake somewhere or else a faulty component. We suggest you try to locate the trouble by putting the pick-up leads in to the grid of the second valve. If the amplifier then works, even if softly, you will know that the fault is in the first stage. If the amplifier still fails to work, take the coupling condenser off the grid terminal of the second valve socket and put it on to the plate connection, then taking the valve out. By this means you are feeding the output of the first valve directly into the audio transformer. This should give some result, even if tone and volume are not correct. If so, it will indicate that the trouble lies in the second stage. If, on the other hand, you still get no result you will know that the trouble lies in the output stage. Looking for troubles, we suggest first that you re-check the valve socket connections, as it is easy to get these wrong. Make sure that the key of the octal sockets is actually pointing in the direction you think it is!

In fact, you might even go further with the step by step suggestion and put the two pick-up leads on to the two grid connections of the output valves, which should give you some reproduction at low volume if the output stage is correctly hooked up and the high tension is getting through.

Many thanks for the kind remarks.



LIKE-A-FLASH Overhead Cutting Head and Cutting Gear £5/5/-
MAKE YOUR OWN RECORDINGS. Cutting head and overhead cutting unit complete, £5/5/-
 Plain Records, 2/11, 3/11, 4/11, 5/11. Cutting Needles, 2/-.
 Aluminium discs, 1/-, 1/6.

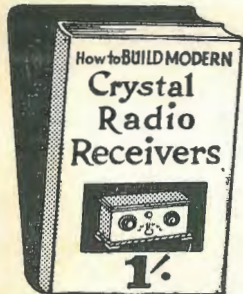

NOW READY 1/2 posted

Also How to Build 1 and 2-Valve Battery Sets, 1/-.
 Now ready—All About Aerials, 1/-.
 Radio Dictionary, 1/-.
 Outline of Wireless, 1/-.
 4-in-1 Metal and Bakelite Pocket Screw-driver Sets, 2/-.



No. 1.—Adjustable Morse Code Key, with long or short taper arms, splendidly made and finished. Strong reliable heavy plated fittings mounted on bakelite moulded base, 12/6.
 P.M.G. Type Sounders 35/-.

No. 2.—P.M.G. Type adjustable Morse Code Key, strong and reliable; will last a lifetime. Heavy plated fittings on thick solid wooden base. Perfect action.

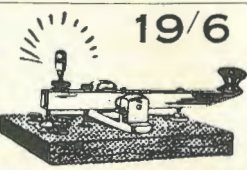

19/6

42/6

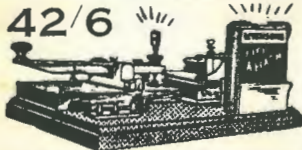

No. 3.—Set comprising No. 2 Morse Code Key P.M.G. Type, with light. Professional De Luxe Buzzer Battery. Throw-over Switch for buzzer or light. Use as required. Mounted on baseboard. Complete.

The Superhet Manual, by Camm, 10/6.
 The Wireless Constructor's Encyclopaedia, by Camm. Nearly 400 pages. Cloth bound. Profusely illustrated. 7/6.
 Everyman's Wireless Book, by Camm. A splendid edition. 8/6.
 Wireless Terms Explained, by Decibel. 5/6.
 An Elementary Wireless Course for Beginners, by Reyner, 6/6. A most outstanding edition.

LEVENSON'S WIRELESS

Wholesale, Retail. Games, Hobbies, Novelties, and Slot Machine Specialists.
 226c PITT STREET, SYDNEY

Everything from A to Z in Radio at Sane Profit Prices.
 'Phones: M 2525 and M 2526-7. Goods forwarded C.O.D. Post or Rail. (C.O.D. Mail within N.S.W. only. Not Interstate). We welcome Prepaid Telegrams and Long-Distance 'Phone Calls.

SPECIAL! SPECIAL!

Cosmocord Crystal Pickup
 British manufacture

List Price 84/-

Now 49/6

Special price to traders, lots of 6 or more.



COSMOCORD CRYSTAL TYPE BRITISH BUILT AND DESIGNED GRAMOPHONE PICK-UP DE LUXE, with volume control built in as illustrated, 59/6.

AMPLION British built Gramo-Radio Pick-up with volume control. Moulded bakelite tone arm. List Price 37/6 Now 32/6. Dealers write for wholesale price.

COLLARO Spring Gramophone Motor and Turntable, 30/-.



Reconditioned Hygrade 'phones, 20/-, 21/-.

Headphones—13/6, 15/-, 17/6, 21/-, Ericsson's Professional 4,000-ohm 'phones, 47/6.

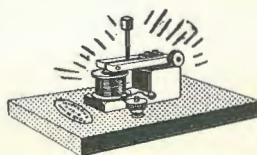

Highest-pitch Buzzer, finger-tip adjustment for professional or amateur use, 11/3.

VALVES AT SANE PROFIT PRICES. ALL GUARANTEED.
 New 227 Valves, 5/9; used, 3/6.
 New 4XP, 5/-; S215, 5/-; MH4, 2/6. 38, 78, used 5/6.
 Raytheon B.H. Rectifier, new, 15/-; DU10, 5/-; 2A6, 35, used, 5/6.
 Used 224, 5/6. 610RC, 610XP, new, 6/6. Used 42, 5/6.
 New 41MRC, ML4, 3/-.
 445U Rectifier, 5/-.
 PM22, new, 7/6. Used 1C6, 6A7, 6A8, 6B7, 6U7, 6F6, 6F7, 6L7, 6/6. Used 57, 58, 59, 6/6; 201A, 3/6; A409, 6/6; A615, E406; E452, 6/6.
 Used PM6, PM5B, A609, 6/6. Used 6J7, 6J8, AL2, EK2, 2B7, 226, 5/6.
 New PM12, PM2A, 18/-.
 Let's know your valve wants.

Radiokes Straight-vision Illuminated Dials, 5/-.
 Circular Stop Light type, 4/-.

Strong Bench Vyce, 6/9.

Pilot single-drum DIALS. Were 27/6, but now 3/6.
 4-Gang British-built, Bath-tub Condensers. With cover and trimmers. 49/6. Now 10/6.
 Insulated Lining-up Tools. Two sizes. 2/- and 2/3.

Pick-up Heads. Fit and suit all tone arms and gramophones. For operating gramophone 19/6, 22/6 each.



MICROPHONES

Batteryless hand-holding type, 30/-.
 Others, bench type, 15/-, 17/-, 21/-, 30/- and 45/-.



High-pitched "Stay Put" adjustable Tone Buzzer, 4/3.
 Adjustable Buzzers in Bakelite cases, 4/6, 5/6.
 Special price to traders. Write for lists.

Just arrived! British-made Gramophone Pick up Needles. Will play 10 records. 100 in tin, 2/6.



Extra loud and medium, 2/6.

Collaro Highest Definition Pickup. New needle holder. Sturdy, compact, well made, with Volume Control. 50/-.



SET TESTING LEADS WITH SILK FLEX and METAL TIP ENDS. 3/9 value. NOW 2/6

Police Patrol Multi-Strand Rubber-covered Aerial. Needs no separate lead - in. 50ft., 3/3; 100ft., 6/6.
 Man-o-war Heavy Duty Insulated Aerial, multi-strand wires, 50ft., 6/6; 100ft., 13/-.



27/6

No. 5.—Outfit comprises the P.M.G. No. 2 Morse Code Key, with adjustable buzzer and battery all mounted on a stained baseboard, ready for immediate operation. Battery included.



22/6

No. 6.—A real good little outfit which incorporates the No. 1 adjustable Morse Code Key, in moulded bakelite base, with a smart little adjustable buzzer all complete to operate. Junior model, 13/6.

TECHNICIANS — Just arrived
 The Second Edition of the **RADIO**

LABORATORY HANDBOOK
 by M. G. SCROGGIE,
 B.Sc., A.M.I.R.E.
 The finest text book of its kind ever published.
PRICE, 21/-

The Book of Practical Radio, by Scott Taggart, 8/6.
 The Wireless Service Manual, by "The Wireless World," 8/11.
 The Australian Official Radio Service Manual, 12/6. Circuit book of all standard 1940 and 1941 receivers.

Nq 621.38405 AUS

**SKILLED
LEAD AT
ALL TIMES**



**There is no Future for the Unskilled !
BECOME A SKILLED RADIO
ENGINEER AND GUARANTEE
YOUR FUTURE**

The old world as we and our fathers knew it is changing before our very eyes, changing moreover in a way which has a deep significance for every one of us. Existing trends indicate that very soon unskilled individuals will find themselves guided into avenues of existence not necessarily of their own choosing—it is the **SKILLED TECHNICIAN ALONE** who can remain master of his own destiny.

**TRAIN AT HOME OR AT OUR
BENCHES**

The Australian Radio College offers ambitious men a sound proven course in Radio Engineering. Sound because it is the result of many years' successful operation, proven because hundreds of ex-students owe their present jobs and success to the College. You can learn with equal facility in your own home (by means of our correspondence course) or attend night classes at the modernly-equipped College workshops.

COSTS LITTLE

Think of this — for a few pence per day — actually less than many fellows spend on tobacco — you can prepare yourself for a man-sized job in Radio.

START TO TRAIN NOW

Don't delay commencing your technical training a moment longer. We at A.R.C. can show you how to enter one of Australia's fastest-growing, most vital of all industries—"Radio and Communications." Here is an industry of indisputable value in peace or war, an industry in which you can strike a man-sized blow for your country as well as yourself.

**PREVIOUS KNOWLEDGE
UNNECESSARY**

You don't need a knowledge of Radio or Electricity. We'll give you all you need of both—you'll start at the beginning, building up knowledge just as carefully and systematically as you would lay brick after brick in its place when building a wall. You get the knowledge you want presented in a manner that makes it easy to learn FAST.

AUSTRALIAN RADIO COLLEGE

Broadway (opp. Grace Bros.),
Sydney. Telephone: M6391-2.



"CAREERS IN RADIO" is a book every ambitious man should read. Published by The Australian Radio College Pty. Ltd., it is available to you free. The coupon is for your convenience.



**MAIL
COUPON
NOW**

To Mr. L. B. GRAHAM,
The Australian Radio
College Pty. Ltd.,
Broadway (opp. Grace
Bros.) Sydney

Telephones: M 6391 - M 6392.

Sir,

Please send me your book "Careers in Radio and Television." It is understood I am under no obligation in making this request.

NAME
ADDRESS

SEND FOR FREE BOOKLET

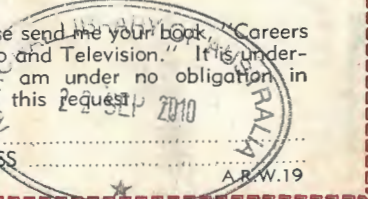

A.R.W.19