

**THE
AUSTRALASIAN**

PRICE, 1/-

Radio World

VOL. 4 NO. 8

JANUARY 1, 1940

Registered at the G.P.O.,
Sydney, for transmission
by post as a periodical.

**RADIO WORLD ALL-WAVE
SERVICE OSCILLATOR**

**DAVENTRY FIVE-VALVE
DUAL-WAVE SUPERHET**

**SERVICE OSCILLATORS :
CHOOSING A "MIKE"**

**LATEST OVERSEAS S.W.
AND B.C. BAND DX NEWS**

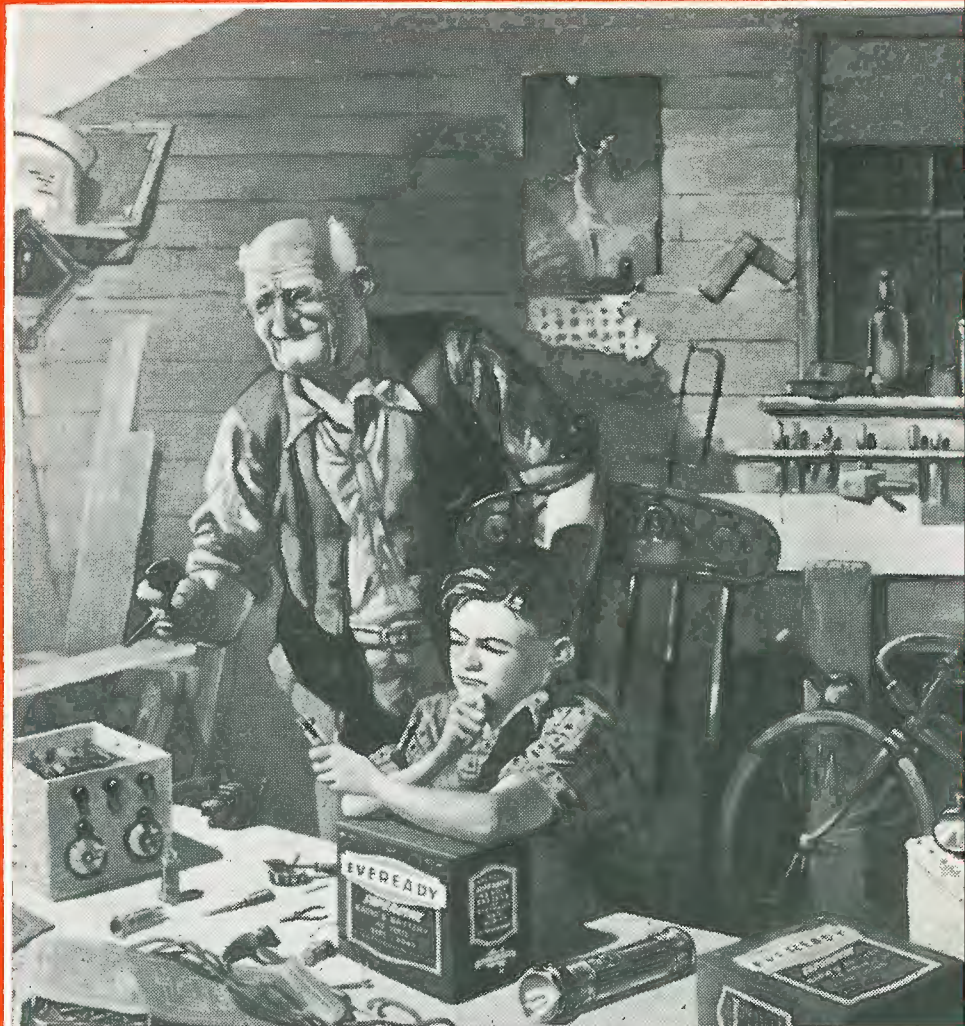

—FROM THE 1940 EVEREADY CALENDAR (see page 8).

BRIMAR VALVES

... The Choice
Of Experts!

Leading radio engineers the world over use and recommend BRIMAR—the British-made valves specially chosen for the huge marine radio installations on the world-famous liners, "Queen Mary" and "Queen Elizabeth," and for dozens of other services where maintenance of communications is of vital importance.



BRIMAR VALVES Recommended for "Radio World" Receivers

For highest sensitivity, freedom from microphonic troubles, and best all-round performance, Brimar valves are strongly recommended for all "Radio World" circuits. Suitable valve types for the receivers described this month are as follows:—

- "DAVENTRY DUAL-WAVER"
Use Brimar types 6K8G mixer, 6G8G combined i.f. amplifier, diode second detector and a.v.c. voltage rectifier, 6J7G pentode audio driver, 6V6G beam output valve, 5Y3G rectifier.
- "PICNIC" and "LOOP" PORTABLES
Brimar 1.4-volt valves are specified for the "Picnic Portable Four" and "Loop Portable Three" described in the Oct., Nov. and Dec. issues of "Radio World." Insist on Brimar, and ensure peak performance.
- "VULCAN PRE-SELECTOR UNIT"
Use Brimar type 1N5G 1.4-volt r.f. pentode.



BRIMAR VALVES

BRIMAR DISTRIBUTORS:

N.S.W.: Standard Telephones & Cables Pty. Ltd., 258-274 Botany Road, Alexandria. QUEENSLAND: Trackson Bros. Pty. Ltd., 157-9 Elizabeth Street, Brisbane. SOUTH AUSTRALIA: Radio Wholesalers Ltd., 31 Rundle Street, Adelaide. WESTERN AUSTRALIA: M. J. Bateman Ltd., 12 Milligan Street, Perth. VICTORIA: Naves Bros. (Melb.) Ltd., 597-603 Lonsdale Street, Melbourne. TASMANIA: W. & G. Genders Pty. Ltd., 69 Liverpool Street, Hobart; 53 Cameron Street, Launceston; also at Burnie. NEW ZEALAND: Standard Telephones & Cables Pty. Ltd., P.O. Box 638, Wellington; P.O. Box 983, Christchurch.

EVERY BRIMAR VALVE IS 10 TIMES TESTED.

R.C.S. COILS FOR HIGH FIDELITY RESULTS

R.C.S. DUAL WAVE UNITS

Type DW24, as illustrated, consists of Aerial, R.F. and Oscillator Coils, Wave Change Switch, the necessary B/C and S/W Trimmers and Padder mounted on a rigid steel base, wired up ready to assemble in a set utilising 465 k.c. and an R.F. Stage. The bands are S/W 16 to 50 metres, and B/C 1500 to 550 k.c.

Retail Price
DW24 for A.C. operation £3 7 6
DW25 for Battery operation £3 7 6

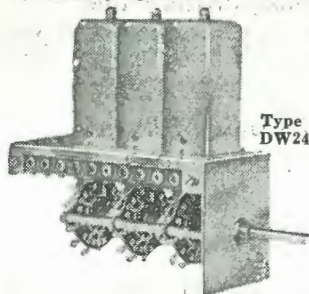

Type DW24

Type DW29, as illustrated, consists of Aerial and Oscillator Coils, Wave Change Switch, the necessary B/C and S/W Trimmers and Padder mounted together, wired up ready to assemble into a set utilising 465 k.c., the bands being S/W 16 to 50 metres, and B/C 1500 to 550 k.c.

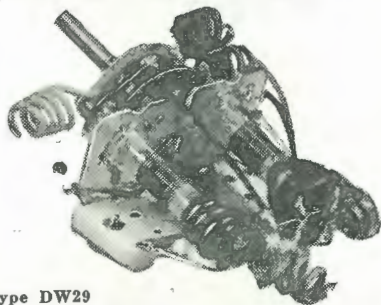

Type DW29

R.C.S. Type DW29 Dual Wave Unit. Retail Price £1 7 6

R.C.S. TROLITUL TUNING COILS

The new R.C.S. Trolitul Tuning Coils, as listed and illustrated, provide the highest Q coils yet produced. They are wound on and supported by a combined Trolitul former and base, thus lending themselves to an accuracy and precision hitherto unobtainable, resulting in a higher standard of efficiency than has been available before. All R.C.S. Trolitul Coils are suitable for standard type valves.

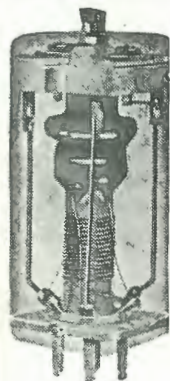

Type G19

R.C.S. TROLITUL DUAL WAVE COILS

These coils have the B/C and S/W Trimmers incorporated. The Oscillator coil also contains the S/W Padder. S/W 16 to 50 metres, B/C 1500 to 550 k.c.

| | |
|--------------------------------|--------------|
| Cat. No. | Retail Price |
| G19. Aerial Air Core | 14/- |
| G20. R.F. Air Core | 14/- |
| B21. Osc. Air Core | 14/- |

R.C.S. TROLITUL BROADCAST COILS

These coils are available in both Air Core and Permeability tuned types. The latter are adjusted to ensure maximum efficiency in our laboratories.

| | | |
|------------------------|-----|--------------|
| Air Core. | | Retail Price |
| Cat. No. | | |
| E282. Aerial | 6/6 | |
| E283. R.F. | 6/6 | |
| E284. Osc. | 6/6 | |
| Permeability. | | |
| E279. Aerial | 8/6 | |
| E280. R.F. | 8/6 | |
| E281. Osc. | 8/6 | |

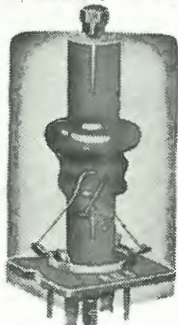

Type E284

R.C.S. TROLITUL T R F COILS

These coils are designed specially for T R F sets. Their general appearance is the same as the B/C superhet. coils illustrated.

| | | |
|-----------------------------------|-----------|--------------|
| Cat. No. | Air Core. | Retail Price |
| T69. Aerial | | 6/6 |
| T70. R.F. | | 6/6 |
| T71. R.F. with reaction | | 6/6 |
| T72. Reinartz B/C | | 3/3 |

R.C.S. TROLITUL SHORTWAVE COILS

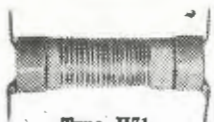

Type H71

These coils are the latest product of our factory, and the former, after being moulded from Trolitul, is grooved in a lathe, thus keeping the winding accurately spaced and providing perfect tracking. The four lugs are moulded, two in each end, as illustrated, so that the coil will fit snugly across the two-bank wave change switch. They may be had in 5 bands, as listed.

| | | | | |
|--------|--------|------|------|--------------|
| Metres | Aerial | R.F. | Osc. | Retail Price |
| 10 | H68 | H69 | H70 | 2/10 |
| 20 | H71 | H72 | H73 | 2/10 |
| 40 | H74 | H75 | H76 | 2/10 |
| 80 | H77 | H78 | H79 | 2/10 |
| B/C | H80 | H81 | H82 | 2/10 |

R.C.S. TROLITUL INTERMEDIATE TRANSFORMERS

The new R.C.S. Trolitul I.F.s are extremely stable, due to new methods of construction made possible by the use of Trolitul formers and base. No loose wires to shift and alter frequency. Positively the best I.F.s yet produced.

| | |
|-------------------------|--------------|
| Cat. No. | Retail Price |
| Air Core, 465 k.c. | |
| IF107. 1st I.F. | 7/6 |
| IF108. 2nd I.F. | 7/6 |
| Iron Core, 465 k.c. | |
| IF109. 1st I.F. | 11/- |
| IF110. 2nd I.F. | 11/- |
| Air Core, 175 k.c. | |
| IE68. 1st I.F. | 7/6 |
| IE69. 2nd I.F. | 7/6 |

Type IF107



The new R.C.S. Permeability tuned Intermediates are wound on special Trolitul formers into which are inserted the adjustable iron cores. These R.C.S. Permeability tuned I.F.s are the most dependable and efficient intermediates it is possible to produce. They should be used whenever the optimum in results is required.

Perm. Tuned, 465 k.c.

| | |
|-------------------------|--------------|
| Cat. No. | Retail Price |
| IF113. 1st I.F. | 13/9 |
| IF114. 2nd I.F. | 13/9 |



Type IF113

NEW R.C.S. DIALS

For some time we have felt that we should provide dials for use with coils of our manufacture, thus assuring perfect tracking. The dials illustrated are the result of considerable thought and engineering experimentation in our laboratory. Both types are single glass Dual Wave dials, the type DA2 having been designed especially for use with our Five Band Communications Receiver coil kit, and the "H" type condenser. Type DA1 is a standard Dual Wave dial for use with R.C.S. Coils and the "F" type condenser.

DA1. Standard D/W Dial, Retail Price, 22/6



Type DA1

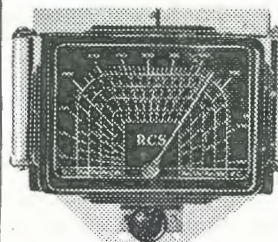

DA2. Communications Dial — Retail Price 22/6

Type DA2

R.C.S. Coil Kit and Parts for Sets featured in Current Issue.

THE DAVENTRY DUAL WAYER

Coil kit with iron core I.F.s K122. Retail Price £2/9/6
Coil kit with permeability I.F.s K123. Retail Price £2/15/-

R.C.S. PARTS FOR VULCAN PRESELECTOR UNIT

| | |
|--------------------------------------|----------|
| CV37 Star Midgets | 4/3 each |
| CV40 Star Midgets | 5/11 " |
| PT49 Potentiometer | 5/- " |
| RF82 Three pie R.F. Chokes | 4/6 " |

Obtainable from your local dealer or direct from

R.C.S. RADIO PTY. LTD.

50 GLEBE ST., GLEBE
Telephone MW 2405

Can We
Build That
**COMMUNICATIONS
RECEIVER For You?**

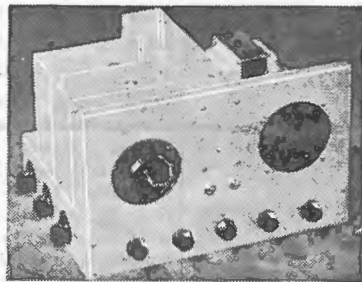

During the past few years we have built to private orders from all over the Commonwealth communications receivers of all types. Only highest-grade components used . . . results: are guaranteed.

WRITE NOW FOR FREE QUOTATION.

**Want A Receiver
Lined Up Or Serviced?**

If so, we are fully equipped to handle the job for you. For years we have specialised in building and servicing all types of receivers (A.C., D.C., A.C./D.C., vibrator, battery, dual-wave, all-wave or short-wave), amplifiers of all types (P.A. systems a speciality), auto and portable radios. Sets built to individual requirements, or we will design to suit any conditions.

"Little Wanderer" Portable Radio

City, beach or bush . . . anywhere, at any time, a flick of a switch will bring you a wealth of radio entertainment from this sensational new 1.4-volt portable radio.

MAIN FEATURES INCLUDE:

- Powerful five-valve superhet circuit (using 1.4-volt valves) specially developed to give maximum in performance with minimum running costs.
- Six-inch Rola P.M. speaker with high-sensitivity magnet ensures ample volume with superb tone.
- Litz-wound iron-cored coils and i.f. transformers give exceptionally high sensitivity.
- New improved a.v.c. system, station-calibrated dial, non-directional lid aerial, with provision for attaching outside aerial.

PRECISION RADIO

L. T. MARTIN, M. Inst. R.E. (Aust.)

20 CARRINGTON ST. NORTH,
STRATHFIELD, SYDNEY.

'Phone UM 7858

The Australasian
RADIO WORLD

Incorporating the
ALL-WAVE ALL-WORLD DX NEWS

Managing Editor:
A. EARL READ, B.Sc.

Vol. 4. JANUARY, 1940. No. 8.

CONTENTS:

| | |
|---|----|
| The Daventry Dual-Waver | 3 |
| The Story Of R.C.S. Radio (2) | 6 |
| Five-Band Communications Superhet | 8 |
| Service Equipment (3) | 10 |
| Vulcan Pre-Selector Unit | 13 |
| Choosing A Microphone | 15 |
| "Radio World" All-Wave Oscillator | 17 |
| Waverley Radio Club Notes | 25 |
| What's New In Radio | 26 |
| New Headquarters For Marconi School | 28 |
| "Communications Eight" A Fine Performer | 30 |
| Shortwave Review | 31 |
| Broadcast Band DX Notes | 37 |

The "Australasian Radio World" is published monthly by Read Publications. Editorial Offices: 117 Reservoir Street, Sydney, N.S.W. Telephone FL 2842. Cable address: "Repress," Sydney. Advertisers please note that copy should reach office of publication by 14th of month preceding that specified, for insertion.

Subscription rates: 1/- per copy, 10/6 per year (12 issues), post free to Australia and New Zealand.

With the cabinet covered in cream airway canvas contrasting with the green dial and brown knobs and escutcheon, the "Daventry Dual-Waver" is a particularly attractive design.



The Daventry Dual-Waver

Powerful and compact, this up-to-date 4/5 dual-wave superhet makes an ideal receiver for picking up latest war news bulletins from overseas.

In normal times a widely popular type of receiver, the mantel model dual-waver has since the outbreak of war enjoyed exceptional sales. The reasons for this are not hard to find. In the first place, a modern receiver of this type is fully capable of picking up war news bulletins from stations all over the world, even using only an indoor aerial of reasonable

efficiency. Secondly, receivers of this type are generally compact, and are easily carried from room to room to suit the convenience of the owner. Thirdly, the cabinet represents a much smaller proportion of the total cost than in the case of a console; hence mantel models give the greatest radio value per pound spent than any other type.

The "Daventry Dual-Waver" illustrated above has been designed to incorporate all these features. The circuit is a well tried and proved one, but at the same time it is up-to-the-minute in the features it incorporates.

As an experiment a wooden cabinet was used, covered with the airway canvas now so popular for 1.4-volt portables. A cream-coloured canvas was chosen, and in the finished receiver it blends very harmoniously with the brown escutcheon and knobs and green edgelit dial.

The cabinet, incidentally, was built to the Editor's specifications by Western Manufacturing Co., 18 Third Avenue, Five Dock.

The coil unit used is the standard R.C.S. type DW29 dual-wave unit. Introduced some months ago, it soon became a firm favourite with set builders and the trade generally.

For greatest gain, two of the latest permeability tuned 465 k.c. high-gain i.f. transformers types 1F-113 and IF-114 were used in the "Daventry Dual-Waver." An excellent fea-

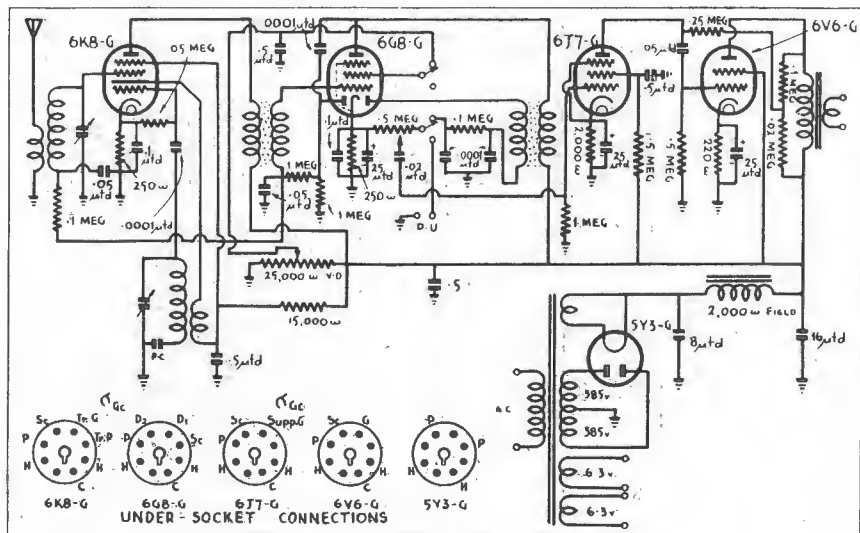

Circuit of the "Daventry Dual-Waver."

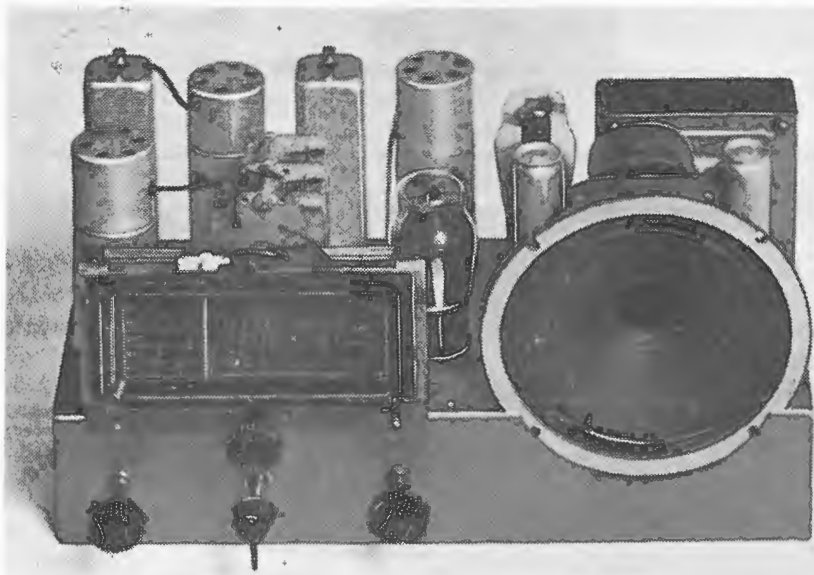

This view of the "Daventry Dual-Waver," and the rear view below, show the compact, well-spaced layout adopted.

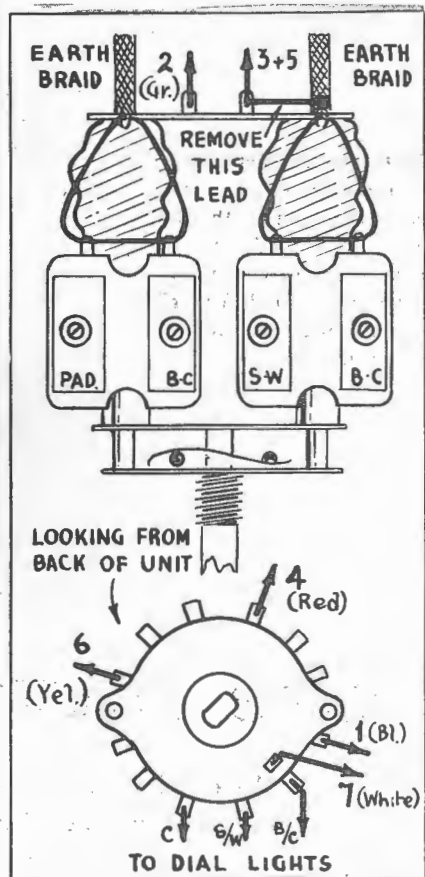

"DAVENTRY DUAL-WAVER"—List Of Parts.

- 1—steel chassis, 15" x 7" x 3," stamped and drilled to specifications (Acorn).
- 1—power transformer, 80 mill. 5v. 2a., 6.3v. 2a., 385v., CT 385v. (Radiokes).
- 1—D.W. coil kit, 2—465 k.c. iron-core I.F.'s (see text for alternative types available) (R.C.S., Radiokes).
- 1—2-gang condenser (Stromberg-Carlson).
- 1—dial and escutcheon (Efco).
- 1—special mantel cabinet (Western (Mfg.)).
- 4—knobs.
- 3—valve shields.
- 5—octal wafer sockets.
- 1—4-pin speaker socket.
- 4—terminals, 2 red, 2 black (Dalton).
- 1—power socket and plug.
- 1—power cable and plug.
- 3—midget grid clips.
- 1—.5 megohm potentiometer (I.R.C.).
- 1—25,000 ohm voltage divider (R.C.S., Radiokes).
- 1—D.P./D.T. rotary type toggle switch (or 6 x 2 single-deck Yaxley switch).
- FIXED RESISTORS:**
- 1—220 ohm 1-watt carbon (I.R.C.).
- 2—250 ohm 1/3 or 1/2-watt carbon (I.R.C.).
- 1—2,000 ohm 1/3 or 1/2-watt carbon (I.R.C.).
- 1—15,000 ohm 1/3 or 1/2-watt carbon (I.R.C.).
- 1—20,000 ohm 1/3 or 1/2-watt carbon (I.R.C.).
- 1—50,000 ohm 1/3 or 1/2-watt carbon (I.R.C.).
- 3—1 megohm 1/3 or 1/2-watt carbon (I.R.C.).
- 1—25 megohm 1/3 or 1/2-watt carbon (I.R.C.).
- 1—5 megohm 1/3 or 1/2-watt carbon (I.R.C.).
- 3—1 megohm 1/3 or 1/2-watt carbon (I.R.C.).
- 1—1.5 megohm 1/3 or 1/2-watt carbon (I.R.C.).
- FIXED CONDENSERS:**
- 4—.0001 mfd. mica (T.C.C.).
- 1—.02 mfd. tubular (Ducon).

- 3—.05 mfd. tubular (Ducon).
- 2—.1 mfd. tubular (Ducon).
- 4—.5 mfd. tubular (Ducon).
- 2—8 mfd. wet electrolytics (T.C.C.).
- 1—8 mfd. semi-dry electrolytics (T.C.C.).
- 3—25 mfd. semi-dry electrolytics (T.C.C.).
- SPEAKER:**
- 1—dynamic speaker to match single 6V6G, 2,000 ohm field (Rola, Amplion).
- VALVES:**
- 1—6K8G; 1—6G8G; 1—6J7G; 1—6V6G; 1—5Y3G (Brimar, Radiotron, Mullard).
- MISCELLANEOUS:**
- Push back, 2 doz. 3/8" nuts and bolts, solder tags, dial lights, copper shielding.

ture of these new i.f.'s is that, while they give easily the highest gain of any type on the market, in any receiver using them there is a remarkable freedom from instability troubles in the i.f. channel. However, for those who are not prepared to pay the extra for this new type of i.f., any

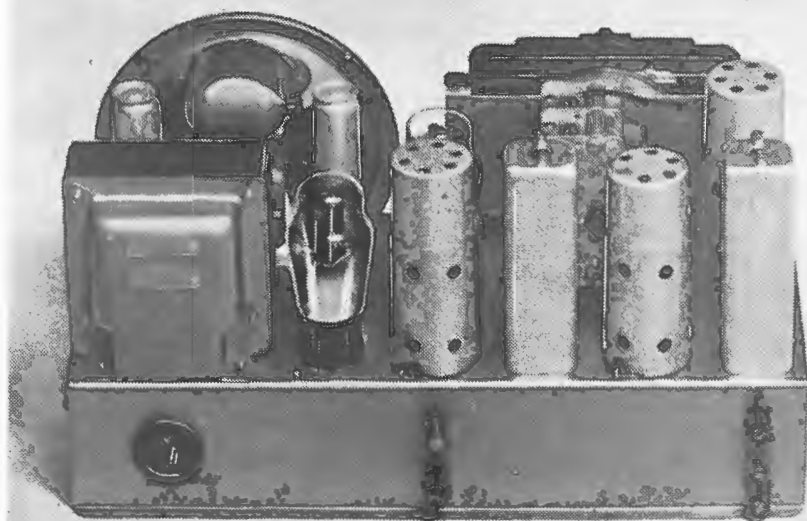

standard iron-cored or air-cored type can be used with, of course, a slight loss in sensitivity.

The equivalent Radiokes dual-wave unit and permeability tuned i.f.'s are types DAU-1 and IFP, respectively.

A Standard Circuit.

The circuit of the "Daventry Dual-Waver" uses a 6K8G mixer oscillator (alternatively, a 6A8G can be used here). Next follows a 6G8G, the pentode section being employed as i.f. amplifier, one diode as second detector and the other as a.v.c. voltage rectifier. Then follows a 6J7G pentode first audio stage driving a 6V6G beam output pentode, inverse feedback being included to level frequency response and improve tone, which incidentally in this receiver is particularly good.

However, as tastes in tonal quality vary, a suggestion here that is well worth trying is to connect a .005 mfd. condenser from the plate of the 6J7G driver to earth. This results in the slightly deeper tone that is often preferred by set-builders.

In assembling the "Daventry Dual-Waver," the parts to mount first are the power transformer and power socket, together with valve and speaker sockets. The heater wiring for the first four valves is put in by soldering a pair of twisted leads to

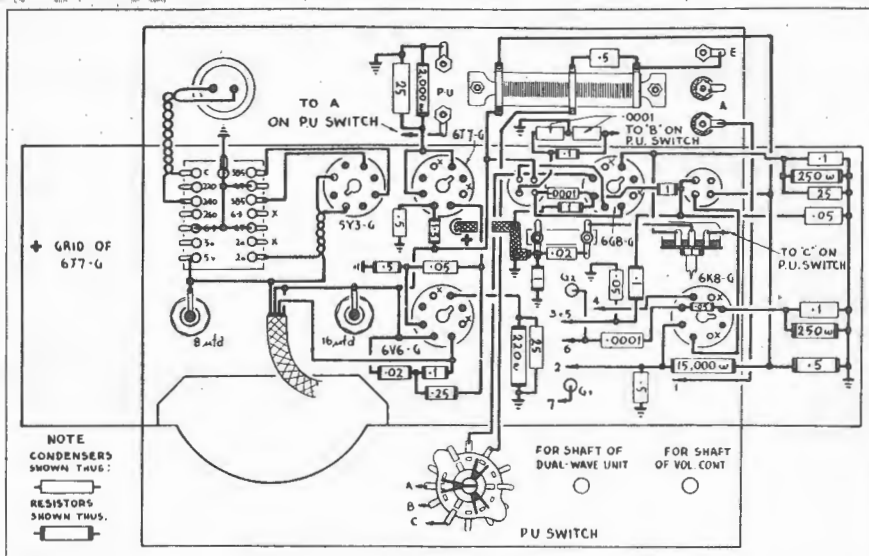

In this wiring sketch and that opposite of the coil unit, leads to the latter are numbered correspondingly.

the "6.3 volt 2 amp." lugs on the power transformer panel and running them to the heater lugs on the 6V6G socket. A further pair of twisted leads is then run from the 6V6G socket to that for the 6J7G, and so on until the four 6.3-volt heaters are wired. If the power transformer is provided with two 6.3-volt windings, then one of these is used for

the 6V6G and the other for the first three valves.

Wiring The Rectifier.

Next, the 5Y3G rectifier socket can be wired by running a pair of twisted leads from the "5 volt 2 amp." winding to the filament terminals of the 5Y3G, and a further pair from the two "385-volt" lugs on the power

(Continued on page 39)

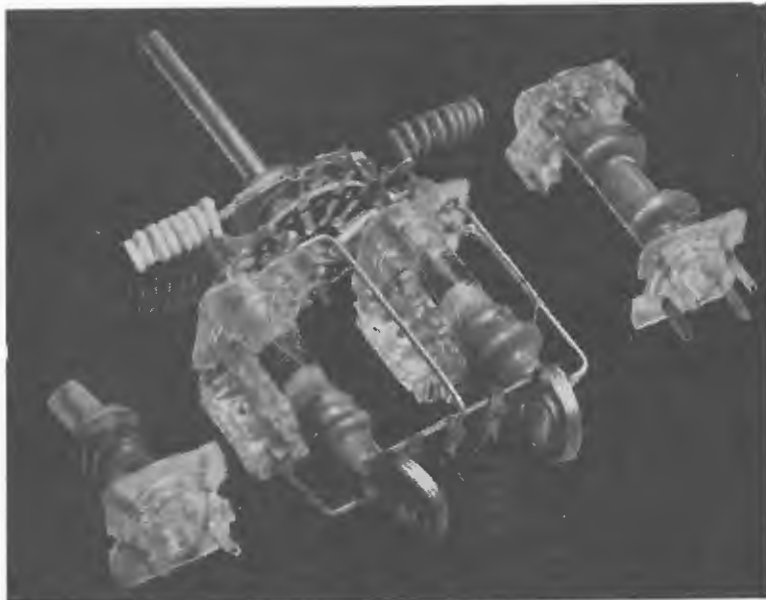

Daventry Dual-Waver needs the DAU-1

for the BEST Results

RADIOKES new type DAU-1 Dual-Wave Tuner saves time and money in installation—just solder the leads and turn the lock-nut for complete assembly! The use of TROLITUL guarantees maximum efficiency in operation.

- * Trolitul insulation throughout ensures maximum efficiency.
 - * Laboratory aligned and tested.
 - * Compact and easily installed.
 - * Saves time and money!
- List Price, £1/7/6.

RADIOKES INTERMEDIATE TRANSFORMERS. The new Radiokes Trolitul I.F.s are extremely stable, due to new method of construction, made possible by use of Trolitul formers and base.

- Air Core, 1st, 465 K.C., sq. can, 3" x 1 3/8."
- Air Core, 2nd, 465 K.C., sq. can, 3" x 1 3/8."
- Iron Core, 1st, 465 K.C., sq. can, 3" x 1 3/8."
- Iron Core, 2nd, 465 K.C., sq. can, 3" x 1 3/8."
- Type I.F.A. (Air Core), price 7/6.
- Type I.F.I. (Iron Core), price 11/-

ALL YOU WANT in RADIO FROM

RADIOKES

Radio Suppliers Pty. Ltd.
Wingello House,
Angel Place,
Sydney.
Phone: BW 4557

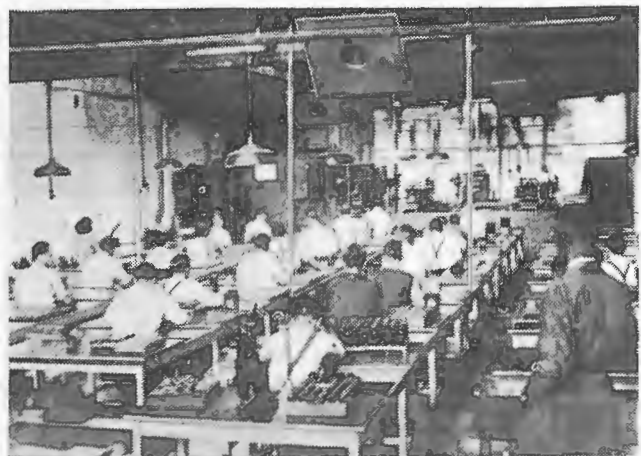
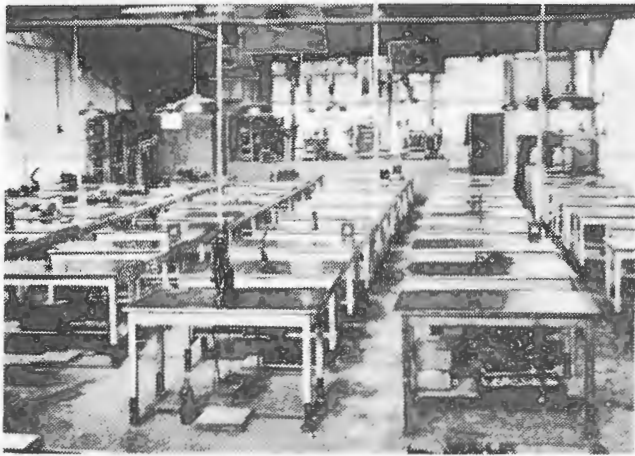

Excellent natural lighting is a feature of the R.C.S. factory that is apparent from these views showing a portion of the assembly section. The rows of polished steel-topped tables form production lines down which trays of components in various stages of assembly are passed from one operative to another, finally going to the test laboratory and then to the store.

The Story of RCS Radio (2)

Hundreds of thousands of radio parts of all kinds leave the R.C.S. factory annually for distribution throughout the Commonwealth. This instalment describes the vital part that efficient factory organisation plays in maintaining this huge output.

IN the ten years of progress outlined briefly in last month's instalment, R.C.S. Radio has grown to such an extent that to-day this company is the largest manufacturer in Australia of radio components on sale throughout the Commonwealth to the general public. In addition, some hundreds of thousands of parts are sold annually to the radio trade.

To maintain this huge output, and at the same time to ensure a high standard of quality in all lines, careful factory organisation has been essential. Right through from raw materials to finished product, every step

in the manufacture has had to be carefully planned, and various tests devised to safeguard uniformity of performance.

Carefully-Planned Factory Layout.

For smoothest operation, the factory has been laid out systematically in various sections comprising the design laboratory, raw material store, machine shop, injection moulding plant, coil winding and general assembly sections, inspection and testing laboratories, components store, and the usual suite of offices with sales, accounts and order departments.

In the factory, particular attention has been paid to lighting. A glass saw-tooth roof provides excellent natural lighting that can be supplemented when necessary by several dozen 14-kilowatt lamps.

These serve the several hundred assembly tables, which are fitted with highly-polished sheet steel tops. These

tables are arranged in production lines, trays of components in the process of assembly being passed down each line from one table to another before finally going to the inspection and testing laboratories, and from thence to the store.

In the machine shop are several thousands of dies used for pressing out all metal parts for the several hundred different components manufactured.

Injection Moulding Plant.

From the new injection plant come the dozens of different Trolitul mouldings used in the manufacture of coils of all types, midjet variable condensers, trimmers, etc.

Practically from the time Trolitul was first introduced into Australia, R.C.S. Radio adopted it as the standard insulating material for all components. A new injection moulding plant designed specially to handle it was installed about twelve months ago, and a variety of dies designed and made in the machine shop. Incidentally, the company is holding at the moment particularly large stocks of Trolitul, augmented at the out-

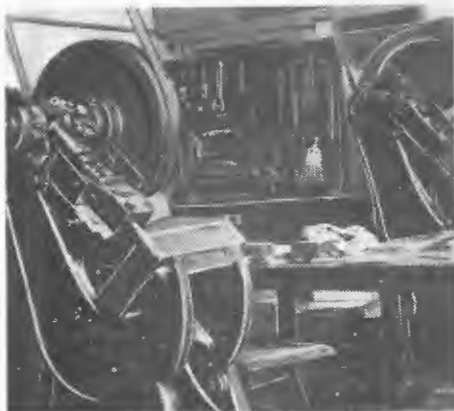

This view of portion of the machine shop shows two of the presses used to stamp out all metal parts used in the assembly of components.

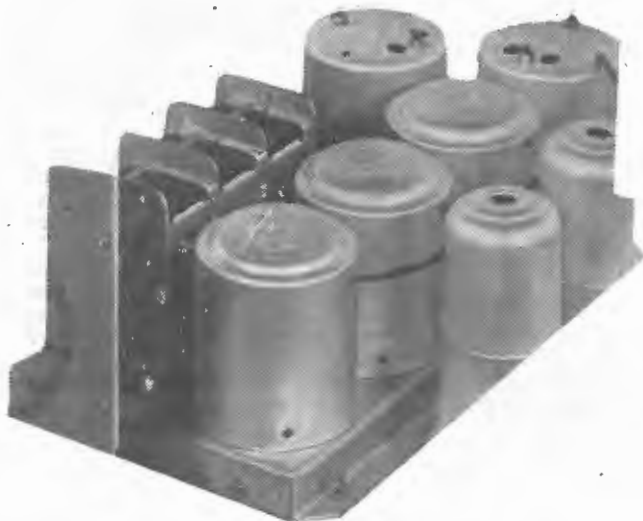

The R.C.S. Heterotuner mounted in position on a receiver chassis. This complete superhet tuning assembly was developed in 1934 by Mr. Bell and for several years was widely popular among set-builders.

break of war, and hence there is no fear of any shortage.

The decision to instal a complete plant for producing Trolitul mould-

ings was reached only after exhaustive tests on its mechanical and electrical properties. According to Mr. Ron. Bell, proprietor of R.C.S. Radio,

there is no other material on the market to compare with it, both as regards its extremely low-loss characteristics and the ease with which it can be moulded.

Lavishly-Equipped Laboratories.

In radio component manufacture a vital factor is the provision made for designing components, and for checking them as they come off the production lines. In the R.C.S. factory, elaborate design and test laboratories with some thousands of pounds' worth of test equipment, have been installed for this purpose.

(To be continued next month)

A Two-Way Code Practice Oscillator.

Whilst learning the morse code I designed a circuit that would transmit and receive signals with only one length of twin flex connecting the "stations," so that a friend and I

(Continued on page 39)



The PALEC "G" TYPE ALL-WAVE OSCILLATOR—OUTPUT METER

The new "G" series of modulated Oscillators is outstanding and unique in respect of (1) the variety of models available, and (2) the adaptation to the popular priced service Oscillator of several important features hitherto exclusive to standard signal generator design. The latter may be gauged from the following SPECIFICATIONS:—

- **FREQUENCY RANGE:** 160 k.c. to 24 m.c. in SIX BANDS, as follows: 160-300, 400-800, 800-1,600 kilocycles, and 3-6, 6-12 and 12-24 megacycles. It will be noted that an unusually low frequency ratio is maintained throughout (2:1). This allows for a well-spaced, uncrowded, direct-reading dial.
- **ACCURACY:** A frequency accuracy of 0.5% may be expected, with a guarantee of 1%. This degree of precision with a DIRECT-READING dial is exceptional.
- **ATTENUATOR:** The special attenuator network consists of a continuous variable control (calibrated 0-10) and a four-step ladder (calibrated x1, x10, and x100 and High Output) network. The impedance of the above is both constant and low (45 ohms), a feature being the reliability of REPEAT READINGS.
- **READINGS:** The latter is of great value for sensitivity or comparative performance tests of radio receivers.
- **R.F. AMPLIFIER:** An R.F. Amplifier stage is employed to improve both normal stability and amplitude level to a marked degree.
- **MODULATION:** 400 cycle modulation at a mean value of 30%—can be switched in or out.
- **TUBE STAGES:** R.F. Oscillator—R.F. Amplifier, A.F. Modulator—Rectifier.
- **BATTERY VALVES:** On the Battery Model 1.4-volt Tubes are used, with a drain of 6 m.a. on the "B" and 200 m.a. on the "A" battery (batteries enclosed).
- **DUMMY ANTENNA:** An external standard I.R.E. Dummy Antenna is supplied.
- **OUTPUT METER:** The built-in Output Meter, when supplied, consists of our large square type meter, with three ranges—10, 25 and 100 volts A.C.

MODELS

| | |
|--|----------|
| Model GA, A.C. Operated | £11 15 0 |
| Model GAO, A.C. Operated, with built-in Output Meter | 15 15 0 |
| Model GAV, A.C. Vibrator, dual operation from power supply or 6-volt accumulator | 13 15 0 |
| Model GAVO, A.C. Vibrator with built-in Output Meter | 17 15 0 |
| Model GB, Battery Operated | 11 15 0 |
| Model GBO, Battery Operated, with built-in Output Meter | 15 15 0 |

All prices subject to alteration without notice.

PATON ELECTRICAL PTY. LTD.

90 VICTORIA ST., ASHFIELD, N.S.W. Telephones: UA1960-UA1982.

LEADING DISTRIBUTORS ALL STATES.

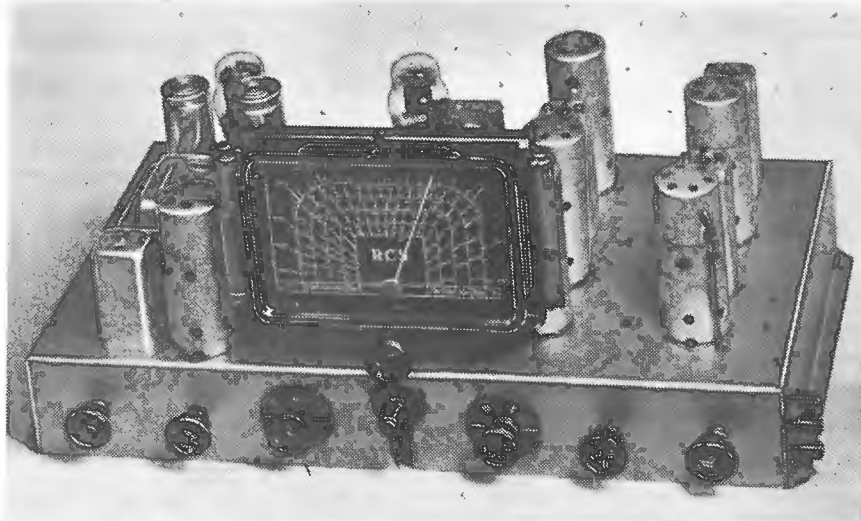

The five-band eight-valve communications superhet to be featured in next month's issue, with a detailed point-to-point wiring plan that will enable even inexperienced set-builders to complete the construction successfully. Housed in a black crackle-finished steel cabinet, this receiver compares more than favourably with overseas models, both as regards appearance and performance.

5-Band Communications Superhet

A special directly-calibrated dial and new high-gain permeability-tuned i.f. transformers have been developed by R.C.S. Radio for use with the R.C.S. five-band coil assembly, tuning from 9.8 to 545 metres.

IN the December issue of "Radio World" an article appeared announcing the release by R.C.S. Radio of a five-band coil assembly, tuning from 9.8 to 545 metres. While units of this kind have been on the overseas markets for some years, this is the first to be released in Australia, and so widespread popularity was predicted for it, particularly in view of its extremely high overall efficiency. This prediction has been borne out by the inquiries that are being received from all over Australia by the manufacturers.

In the article mentioned, it was stated that a complete description of the eight-valve communications superhet shown in the illustration accompanying it would appear in the January, 1940, issue. However, we must apologise to readers for the fact that this description cannot appear until the February number, as, while sample units with special dials to suit are available, full production on both

has been delayed due to the intervention of the Christmas holidays.

In the meantime, on this page appears a further front view of the receiver showing the special R.C.S. five-band directly-calibrated dial (bands being 10, 20, 40 and 80 metres and "broadcast"). The scale is calibrated in kilocycles on the broadcast band,

and in megacycles on the short waves.

In the receiver shown, the wave-band switch with specially engraved indicator plate is located on the front wall of the chassis underneath the tuning knob.

A separate view of the dial also appears on this page, together with an "X-Ray" view of the new R.C.S. permeability tuned i.f. transformer, three of which are used in the Communications Superhet, illustrated above. These i.f.'s are wound on special trolital formers, in which are inserted the adjustable iron cores. Exceptionally efficient, their use is recommended wherever highest gain is required.

1940 Eveready Calendar: This Month's Front Cover.

The illustration on this month's front cover is reproduced from the 1940 calendar issued by Eveready (Australia) Pty. Ltd.

In full colour, it is an excellent art study that typifies the spirit of radio experimenting.

The scene is a toolshed, and on the bench alongside the youth are two Superdyne "B" batteries, while an Eveready torch lies between. A bicycle in the background provides the reason for an electric cycle lamp and new refill, which stands on a case alongside.

This new Eveready calendar would make a bright addition to any showroom, yet it completely tells the story of the Company's products.

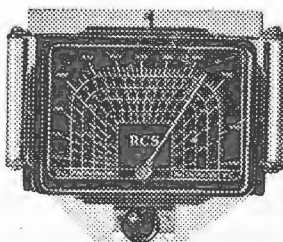

This latest R.C.S. dial type DA2 has a directly-calibrated five-band scale.



Three of these new high efficiency permeability-tuned R.C.S. i.f.'s are used in the receiver shown above.

WHEREVER YOU GO THIS SUMMER

Take a 1.4 Volt
Portables!

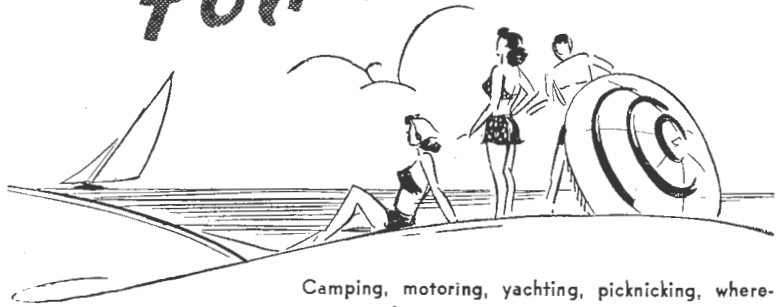

Camping, motoring, yachting, picknicking, wherever you go or whatever you do outdoors this summer, TAKE A 1.4 VOLT PORTABLE RADIO ALONG! The ideal companion for outdoor days, you can carry and use it anywhere because it needs no outside aerial, no power point or plug. Just put it down, switch it on, and tune in to your favorite station. You don't even have to worry about accumulators because models are equipped with dependable Eveready dry batteries, the smoothest and most economical source of power for both portable and country radio receivers.

Most set manufacturers have produced special 1.4 volt portable models, lighter, more convenient and more compact than anything you have ever seen. A few are shown below. Others can be seen at almost any radio dealer's showrooms.



7.—AIRZONE Model 457; 4-valve Broadcast. 16 Guineas. (£17/10/- in W.A.)

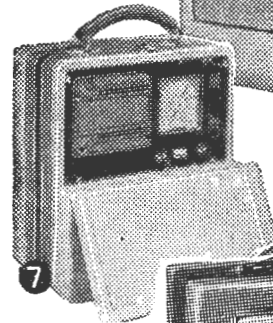

1.—FISK RADIOLA. "Portable Five." 5-valve Broadcast. 18 Guineas. (19n. higher in W.A.)

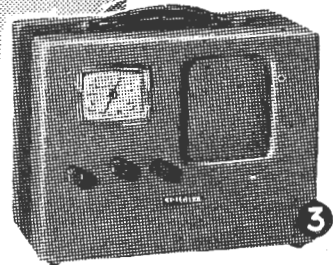
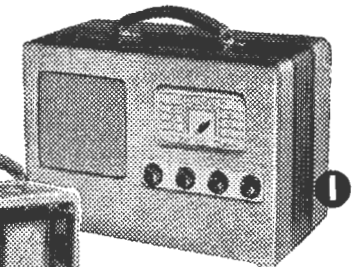

3.—KRIESLER, Model 4K85. 4-valve Broadcast. Price, 16 Guineas, N.S.W. (Prices slightly higher in other States.)



EVEREADY (Aust.) PTY. LTD., SYDNEY, N.S.W.



Equipped with
EVEREADY
TRADE-MARK

RADIO BATTERIES

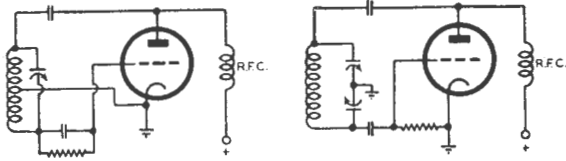

These three sketches (A, B and C—left to right) show, respectively, the Hartley, Colpitts and electron-coupled oscillator circuits.

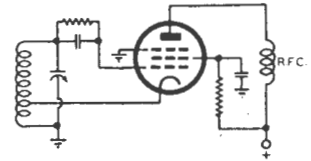

Modulated Oscillators

The design and application of modulated oscillators is discussed in this instalment from the Radiokes Lecture Service series.

THIS subject was introduced in Lecture 3 and the requirements of frequency coverage and calibration were pointed out. For convenience, the basic circuit diagrams of the Hartley, Colpitts and Electron-Coupled oscillators have been reprinted and are shown as Figs. A, B and C, respectively. The output voltage from these oscillators has a constant frequency and amplitude and is unmodulated (see Fig. 1).

When such a voltage is applied across the aerial input circuit of a receiver, it will be amplified by the r.f. and i.f. stages in the same manner as a carrier input voltage, but being unmodulated, it will not produce an audio-frequency component in the plate circuit of the detector and hence an audible output in the loudspeaker. An unmodulated oscillator cannot therefore be used for aligning a receiver in the normal manner.

An unmodulated voltage is nevertheless useful for tracing such faults as background noise, modulation hum, and microphonicity in the radio-frequency portion of a receiver, while excessive regeneration in these stages may also be readily detected by noting the amount of "swishing" produced as the receiver is tuned across a weak unmodulated signal.

Modulation.

In the majority of applications, circuit adjustment is usually carried out

by observing audio-frequency power output as indicated by some form of output meter, so that it is necessary for the r.f. input voltage from the oscillator to be amplitude-modulated at an audio frequency. For testing purposes, a "standard signal" has therefore been adopted and consists of an r.f. voltage of constant frequency, modulated to a depth of 30% by an audio voltage having a frequency of 400 c/s. The wave-form of this standard signal is represented graphically in Fig. 2. Adherence to this standard, although desirable, is not strictly necessary for normal service work.

The output voltage of a modulated oscillator should be as free as possible from frequency modulation, i.e., variation of the frequency of the r.f. voltage about a mean frequency (see Fig. 3), since this causes the signal to be broad and consequently unsuitable for use in aligning sharply tuned circuits.

Modulation From A.C. Mains.

Possibly the simplest method of obtaining modulation is to apply a 50 cycle A.C. voltage directly to the plate of the oscillator valve, as shown in Fig. 4. With this arrangement, oscillation ceases during each alternate half-cycle, when the plate becomes negative with respect to cathode. The waveform is therefore similar to that shown in Fig. 5. Fre-

quency modulation may be serious, and the signal is usually broad and difficult to use.

Considerable improvement can be effected by supplying the plate with a D.C. voltage upon which the 50 cycle A.C. voltage is then superimposed. By this means, it is possible to obtain a sinoidal wave-form and to adjust the percentage modulation to that required. In practice, however, it is found that a higher modulation frequency is desirable.

Self-Modulation.

Under certain circumstances, an oscillator may be made self-modulating, and it is then said to be "squegging." For this purpose, the time constant of the resistor and condenser in the grid circuit is made very long (preferably by increasing the capacitance of the condenser), so that the grid "blocks" and breaks the oscillation at a suitable audio frequency.

The modulation percentage is usually very high and the wave-form far from sinoidal. A well-adjusted "squegger" has a modulation envelope similar to that shown in Fig. 6. Frequency modulation is usually serious, and the application of the arrangement is consequently limited.

Audio Oscillators.

In the better class of equipment the required modulation voltage are

FIG. 1

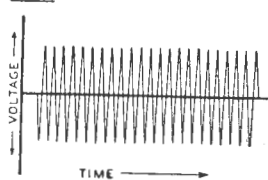

FIG. 2

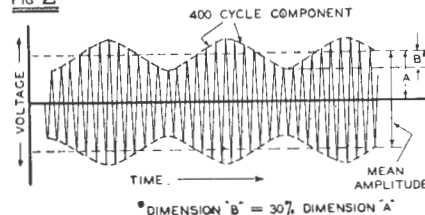
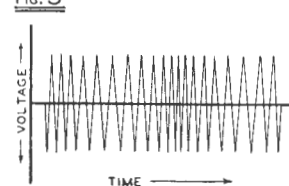

FIG. 3



almost invariably provided by a separate audio oscillator.

An audio oscillator is similar in principle to an r.f. oscillator but necessarily uses very much higher values of inductance and capacitance in the tuned circuit. The wave-form is largely dependent on the characteristics of the tuned circuit and very careful design is necessary if the output is to be sinoidal. In general the "Q" factor of the inductance should be as high as possible, which means in effect that resistive loading across it should be reduced to a minimum.

In small service oscillators where some audio distortion can be tolerated, it is possible to use for the inductance the windings of a small audio transformer. Under such circumstances, it is usually advisable to inspect the wave-form on a cathode-ray oscillograph.

The high-frequency oscillator may be modulated in a number of ways, but plate modulation is most commonly used. Whatever the method, the object is to vary the amplitude of the high-frequency signal at an audible rate without affecting its fundamental frequency.

Attenuation.

The radio-frequency voltage developed by a modulated oscillator is comparatively high, and only a small fraction of it is required for receiver testing. For normal service work, the r.f. output voltage on all bands should be adjustable, either continuously, or in frequent steps between approximately 0.5 volt and 2 microvolts.

Such a requirement demands that the whole assembly be effectively shielded so that the only outlet for r.f. voltages is by way of a suitable attenuator network.

For effective shielding it is necessary to shield individually all major components, and to encase the whole in a heavy gauge metal case. Thin shielding is usually quite ineffective. Any shafts leading through the panel of the oscillator should be properly earthed, and ventilation holes covered with wire gauze. Where the oscil-

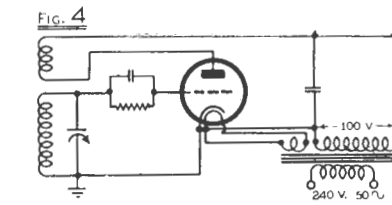

lator operates from A.C. mains it is necessary to filter the power leads at the point of entrance to the case. A good earth connection is also desirable. It will be found that effective shielding is very much more difficult to obtain at higher frequencies.

Attenuators may be roughly divided into three classes, namely resistive, inductive and capacitive.

Resistive Attenuators.

Fig. 7 shows a simple type of resistive attenuator. A suitable r.f. voltage is fed from a low-impedance link coil to the outer terminals of a potentiometer, and the output is taken from the variable tapping. The degree of attenuation which may be achieved is dependent largely on the stray capacitances (shown as C) between the input and output leads.

The output impedance, which may be an important consideration, obviously varies with the setting of the control. The input impedance is also liable to vary under certain circumstances and may lead to some frequency shift due to variable loading on the oscillator coil.

Fig. 8 shows a type of attenuator which is widely used in standard signal generators. With correct design, it is possible to obtain adequate attenuation, with input and output impedances which are fairly constant for all settings of the control.

Inductive Attenuators.

Inductive attenuators vary a great deal in mechanical design but depend on the same general principle, namely, that of varying the mutual coupling between a coil connected to the output terminals and a coil carrying the radio-frequency currents generated by the oscillator. Fig. 9 shows the fundamental circuit. The Faraday Shield is usually included

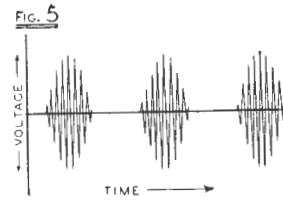

and serves to eliminate direct capacitive coupling between the coils.

This type of attenuator provides a ready means of attaining a constant low-impedance output characteristic, but has the disadvantage that the variation in mutual coupling between coils may lead to some frequency shift. This effect can usually be made small by restricting the range of the attenuator.

Figs. 10 and 11 show the basic circuit and the construction of an inductive "piston attenuator."

Capacitive Attenuators.

A capacitive attenuator is in reality a small variable condenser which is connected in series between the output terminal and a point of higher r.f. potential (see Fig. 12).

This type of attenuator has a high-impedance output characteristic and must be shunted by a resistor when connected in the grid circuit of a valve. Variation in capacitance may cause some frequency shift, but this may usually be minimised by restricting the range of control.

Fig. 13 shows the construction of a capacitive "piston attenuator" which has been widely used in modulated oscillators.

Output Impedance.

When the output of the oscillator is fed directly to the grid of a valve the actual output impedance is seldom important provided that there is a D.C. path between grid and cathode.

When the oscillator is connected to the aerial terminal of a receiver, the loading imposed by the oscillator on the first tuned circuit should simulate that of an average aerial. For this purpose, manufacturers of standard signal generators provide a "dummy antenna," containing standardised values of resistance, capacitance and

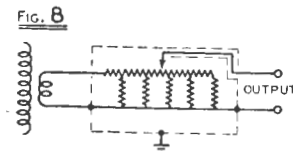
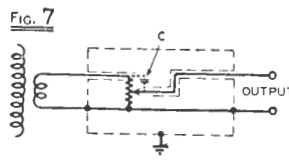
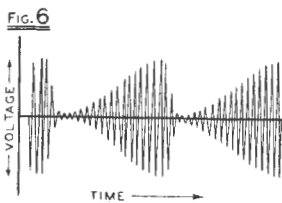

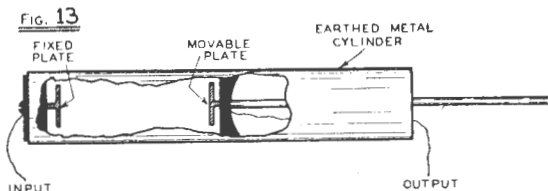
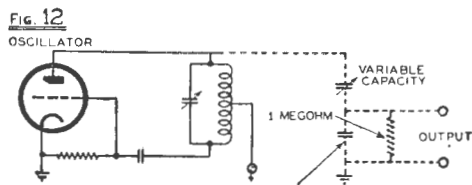
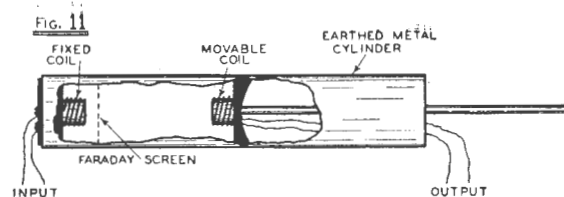
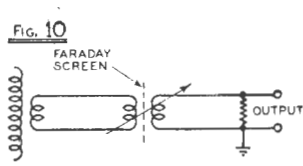
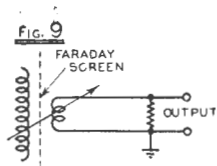

inductance, which may be connected in series with the oscillator output lead. Fig. 14 shows the dummy antenna which has been adopted as standard by the American Institute of Radio Engineers. The characteristics of this dummy antenna are only correct if the output impedance of the signal generator is low (i.e., less than about 50 ohms).

In the majority of cases, it is possible to neglect the effect of output impedance and to make final adjustments to the aerial coil trimmer with a normal aerial connected to the receiver. Sufficient signal may be ob-

tained simply by twisting the output lead of the oscillator

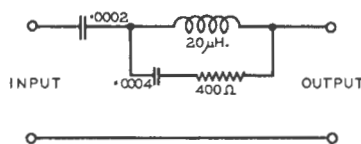

Fig. 14.

lead, and increasing the output voltage.

Output Voltage Measurement.

For laboratory or receiver production work it is necessary to know ac-

curately the value of the output voltage. For this purpose, standard signal generators incorporate some means of measuring the output voltage, usually by means of either a thermo-couple or a valve voltmeter. This facility, however, is seldom warranted in oscillators intended for service work, and an arbitrary scale on the attenuator control for purposes of comparison is usually quite sufficient. In such cases, actual calibration in microvolts must be regarded as approximate only.

(Continued on page 39)

RADIO MECHANIC'S COURSE

by

HOME STUDY

Cash Fee £11/14/-

Terms £13

This is a thoroughly comprehensive and up-to-date course of training for Radio Mechanics and Servicemen.

NO PREVIOUS RADIO KNOWLEDGE REQUIRED

Practical Instruction can be arranged for, if desired.

Other courses conducted by the School are for RADIO ENGINEERS, TECHNICIANS, COMMERCIAL and AIRCRAFT WIRELESS OPERATORS and TALKING PICTURE OPERATORS.

Write or call for full particulars

MARCONI SCHOOL OF WIRELESS

47 YORK STREET, SYDNEY ————— 'PHONE BO 522

Conducted under the auspices of Amalgamated Wireless (A/sia) Ltd., Australia's National Wireless Organisation.

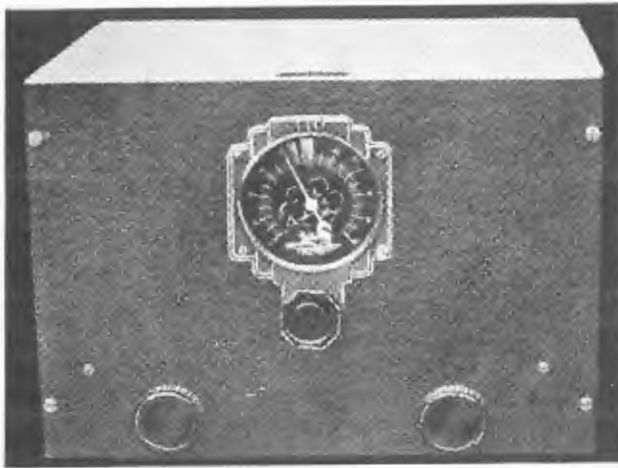

A front view of the completed unit, which uses a 1N5G r.f. pentode in a regenerative hook-up to provide effective signal boosting.

Vulcan Pre-Selector Unit

This single-valve regenerative pre-selector unit, while designed primarily for the "Vulcan Shortwaver" described last month, can be used with any superhet to boost signal strength on the short waves.

ALTHOUGH this pre-selector was designed particularly for operation in conjunction with the battery-operated "ham" superheterodyne using the new 1.4-volt valves (as described by Harry D. Hooton—W8-KPX—in the Sept., 1939, issue of "Radio News": article re-printed in October "Radio World."—Ed.), it can be used with practically any short-wave receiver of either the superheterodyne or tuned-radio-frequency type. For the superhet not having a tuned r.f. stage ahead of the mixer, this unit affords a positive relief from image interference. It also enables the operator, especially when listening on the frequencies higher than 14

megacycles, to bring in with good volume weak stations that otherwise would be lost in the noise level.

The circuit is extremely simple and straight-forward. The valve is the 1.4-volt type—the type 1N5-G, which requires no "C" bias and only 1.5 volts of "A" and 90 volts of "B" power. The filament and plate currents are only 0.05 amperes and 1.2 milliamperes, respectively. Thus it may be readily understood that two or three flashlight batteries connected in parallel for "A" current and a couple of "mid-get" size 45-volt "B" blocks will furnish all of the power required, even for a considerable period of time. In designing the preselector unit, enough

space back of the sub-base has been left to permit the batteries to be placed inside of the cabinet. This is quite convenient as it allows the pre-selector to be removed from the receiver, when its use is not desired, without disturbing the receiver batteries or connections.

Electron-Coupled Regeneration.

An examination of the diagram shows that the circuit is of the electron-coupled variety, the tickler being placed in the screen-grid circuit. The r.f. choke, L4, is quite essential to the proper operation of the circuit and should be of good quality. The resis-

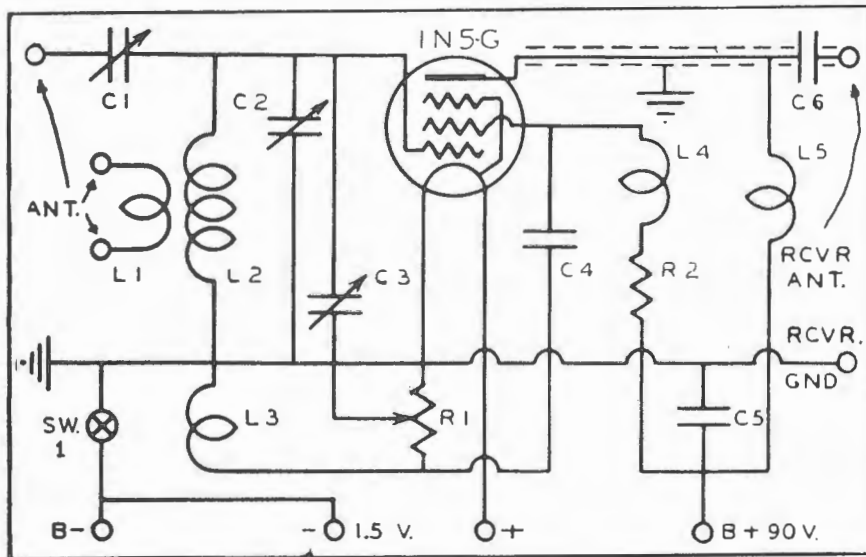

Circuit of the pre-selector:—C1—3-30 mmfd. midget; C2—100 mmfd. (band-set); C3—35 mmfd. band-spread; C4—0.006 mfd. mica; C5—0.5 mfd., 400 volts, paper; C6—0.00025 mfd., mica; R1—2,000 ohms, ½ watt; L1, L2, L3—plug-in coils (see coil table); L4, L5—R.F. chokes, 2.5 MH, midget.

COIL DATA.

| Band meters | Turns L2 | Spaced over | Wire size | L3 | L4 |
|-------------|----------|-------------|-----------|-------|----|
| 10-20 | 3 | 1 3/4" | 14E. | 2 1/2 | 3 |
| 17-41 | 9 | 1 3/4" | 16E. | 4 | 4 |
| 40-80 | 17 | 1 3/4" | 22E. | 6 | 6 |
| 80-160 | 35 | 1 3/4" | 24E. | 9 | 9 |
| 160-270 | 58 | 1 3/4" | 28E. | 14 | 6 |

All coil forms 1 1/2" diameter. All tickler and antenna coupling coils are wound close with No. 30 d.s.c. wire. Spacing refers to the length of the winding on the form, not the distance between turns. Range given is only approximate.

This rear view shows the general chassis layout, with the 1N5G on the left, tuning condenser in the centre and coil on the right.

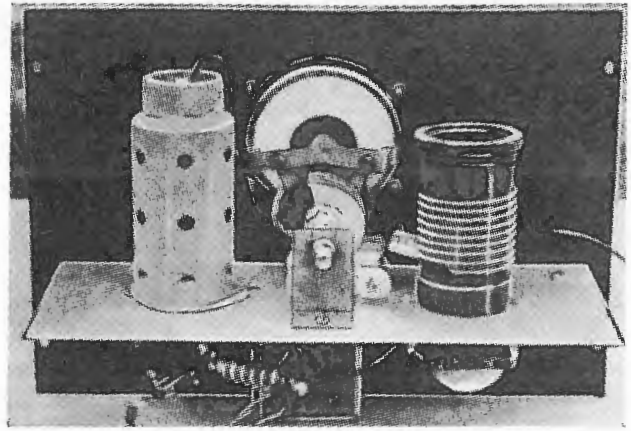

tor, R2, is used to drop the screen voltage to the point where maximum sensitivity is obtained. The value used has been determined with the aid of a sensitive voltmeter and should not be changed. The method of controlling regeneration by shunting a 2,000 ohm potentiometer, R1, across the tickler coil was found to be superior to the method of varying the potential applied to the screen.

The coils are of the six-prong, plug-in type, five being required to cover the full range from 9½ to 200 meters.

The condenser, C2, of 100 mmfd. maximum capacity is the band-setting condenser; the 35 mmfd. condenser, C3, is used to spread the bands out over the entire 270 degrees of the tuning dial. Provision has been made for using either a plain single wire type of antenna or a doublet antenna. When using the doublet antenna, it is advisable to remove the primary winding from the plug-in coils all except three or four turns. If the entire winding is used for coupling the antenna to the grid circuit, difficulty in obtaining regeneration may be encountered.

were made to several points. The output lead from the 1N5-G plate to the antenna post on the receiver must be kept short—not over one or two feet long at the most—and must be shielded. The cable used for the shielded lead should be of the low-capacity type; otherwise, most of the signal, especially on the high frequencies around 28 megacycles, will be by-passed to the ground and lost.

Operation Pointers.

The operation of the pre-selector is simplicity itself. Hook up the batteries and the antenna and ground wires. Connect the shielded wire to the antenna and ground posts on the receiver. Tune in a signal on the receiver, set the preselector tuning dial at about one-half scale and rotate the band setting condenser until the signal is loudest. Turn up the regeneration control, R1, until the pre-selector is operating just below the point where oscillations begin. If a plain one-wire antenna is used, coupling condenser, C1, should be adjusted, at the same time varying the regeneration control, until the best results are obtained. Do not, under any circumstances, permit the 1N5-G to oscillate; when in doubt as to whether the circuit is oscillating or not, adjust the regeneration control to just below the point where a loud "click" is heard in the receiver when the pre-selector grid is touched with the finger.

If desired, the doublet antenna winding may be removed from the coils and a separate antenna-series trimmer condenser placed inside of each coil form. Once adjusted, these coupling condensers require no attention, and the proper antenna adjustment will be made automatically when the coils are changed.

"Vulcan" Pre-Selector Unit.

List of Parts.

- 1 aluminium chassis, 9 in. x 4 in. x 2½ in., with aluminium panel, 9 in. x 6½ in.
- 2 35 mmfd. midget variables, C1 and C2 (R.C.S., Radiokes, Raymart).
- 1 100 mmfd. midget variable, C3 (R.C.S., Radiokes, Raymart).
- 1 2,500 ohm potentiometer, R1 (R.C.S., Radiokes).
- 1 vernier dial (Raymart).
- 1 on/off switch.
- 1 octal wafer socket.
- 2 s.w., r.f. chokes (R.C.S., Radiokes, Raymart).
- 3 small knobs.
- 1 len. 4-wire battery cable.
- 3 terminals, 2 "A," 1 "E."
- 1 type 1N5G valve.
- 6 6-pin plug-in coil formers.

FIXED CONDENSERS:

- 1 .00025 mfd. mica (C6) (T.C.C.).
- 1 .005 mfd. mica (C4) (T.C.C.).
- 1 .05 mfd. eubular (Ducon).

FIXED RESISTORS:

- 1 10,000 ohms, ½-watt carbon (I.R.C.).

BATTERIES:

- 2 midget 45-volt "B" batteries (Eveready).
- 1 midget 1½-volt "A" battery (Eveready).

MISCELLANEOUS:

- Hook-up wire, solder tags, midget grid clip, 1.4-volt valve shield, wire for winding coils.

The Construction Outlined.

The construction of the unit is not at all difficult. Drill and cut the various holes in the panel and sub-base before any of the parts are mounted. Mount the valve and coil sockets and the tuning condensers in the positions that will give the shortest and most direct r.f. wiring between them. The various r.f. chokes, by-pass condensers and fixed resistors are mounted directly on the socket terminals themselves, their tinned wire leads being of sufficient stiffness to hold them erect. Use either the solid or stranded, tinned, push-back hook-up wire for making the connections between the various parts. Keep the leads as short and direct as possible without sharp bends or turns and solder each joint carefully with a clean, hot and well-tinned iron and rosin-core solder.

All of the negative (ground) leads are connected to a single length of insulated bus wire which is soldered to the chassis at one point only. This method of construction helps to eliminate instability and noise that would be caused by eddy currents circulating in the metal chassis if the connections

Choosing A Microphone

The relative merits of the five most popular types of microphones-- carbon, condenser, crystal, dynamic and ribbon-- are discussed in this article

By NORMAN HEAD

Engineer, Amplion (A'sia) Pty. Ltd., Sydney.

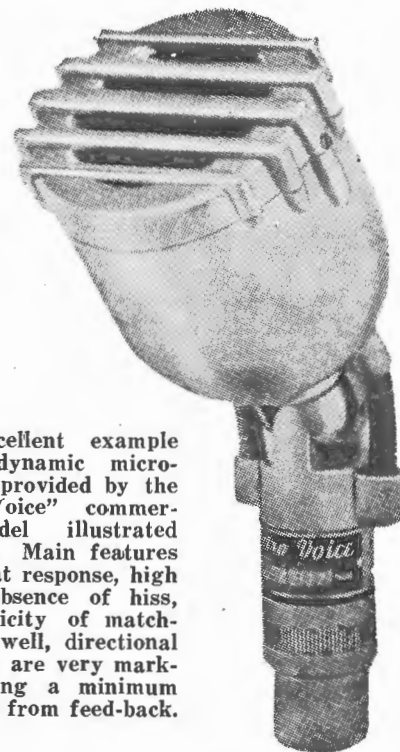

An excellent example of the dynamic microphone is provided by the "Electro-Voice" commercial model illustrated alongside. Main features include flat response, high output, absence of hiss, and simplicity of matching. As well, directional properties are very marked, ensuring a minimum of trouble from feed-back.

verberation are reduced by 30% to 40%.

Crystal Microphone Is Newest Type.

Most recent of microphones is the crystal, more commonly seen in the form of a light diaphragm attached to a bimorph element of rochelle salt; this is the "motor" form. The true crystal microphone consists of a crystal element on which the sound waves directly impinge, causing electrical waveform generation without diaphragm mechanics.

The crystal microphone response may be straight-line from zero cycles to a point above 4,000 cycles, where it rises due to self-resonance. It requires no excitation and the output is high. Due to self-resonance and cavity resonance, reproduction may have an unnatural "sharpness" unless compensated.

The dynamic, or moving coil microphone, is found in many spheres and is associated with high quality, simplicity of use and most useful output rating. Directly similar to the loudspeaker, it employs a diaphragm of light construction coupled to a moving coil in a magnetic field. Use of permanent magnets of high order, extremely light mechanism and easily designed acoustic networks provide

EXACTLY inverse to the loudspeaker is the microphone. And just as the one is at an extreme end of the circuit, so is the other; that a pick-up may start the immediate train is a fact, but between the original and the reproduction is the microphone, terminating in the loudspeaker.

In between, a circuit is required to follow faithfully the complicated pattern of the microphone currents, and the vagaries of the speaker. Corrections for the variation in the final link, the speaker, are usually made in the final amplifier stage. And since "straight-line" amplification is accepted as the main requirement of amplifiers, little correction of the input is effected or desired. That leaves the expert or connoisseur with the thought of straight-line microphone response.

Four Commonest Types.

The most commonly-used types are carbon, condenser, crystal, dynamic and ribbon (or velocity). Oldest is the carbon microphone, generally most sensitive. Its disadvantages are high noise level and instability, counterbalanced by economy in original cost. Carbon microphones are incapable of accurate calibration because of variation of resistance due to "packing" of the granules. The fidelity of the carbon microphone is usually directly comparable with its cost. The condenser microphone has a

very high impedance, necessitating special treatment of coupling transformers, and low sensitivity. It is characterised by high values of cavity resonances, is critically capacitative and requires polarising voltages of high figures. Although the simplicity of the response curve makes compensation easy, a unit of good fidelity is expensive.

The ribbon or velocity type is in fairly common use to-day, and perhaps gives the closest approach to straight-line response. This type of microphone, although termed "velocity," is, strictly speaking, a pressure-gradient microphone. A ribbon of very light corrugated metal is suspended with close tolerance in a magnetic field, which is usually provided by a permanent magnet. The impedance is extremely low—the output of this type of microphone is comparable to that of condenser types, but this is off-set by its fidelity.

In some types, extreme care has to be taken to avoid middle-frequency hum; because of the low impedance, the pre-amplifier need not be in the same housing, but may be some distance away.

Ribbon microphones are easily over-loaded, and sudden loud transients may blow the ribbon entirely out of the air gap, but they are particularly adapted to low level pick-up. Due to zero acoustic pick-up at the sides, unwanted sound and room re-



Indifferent TONE QUALITY

mar
radio enjoyment

The brilliance and tone fidelity of to-day's radio programmes may be completely marred by worn-out valves.

Studio realism, broadcast by modern stations, can be reproduced in your home only when the valves in your radio function efficiently.

To secure the full pleasure of listening,

Re-valve with



RADIOTRON VALVES

Sealed for your protection



To Destroy
"TONE BOGEY"
Re-valve with
RADIOTRONS
The valves in the sealed cartons

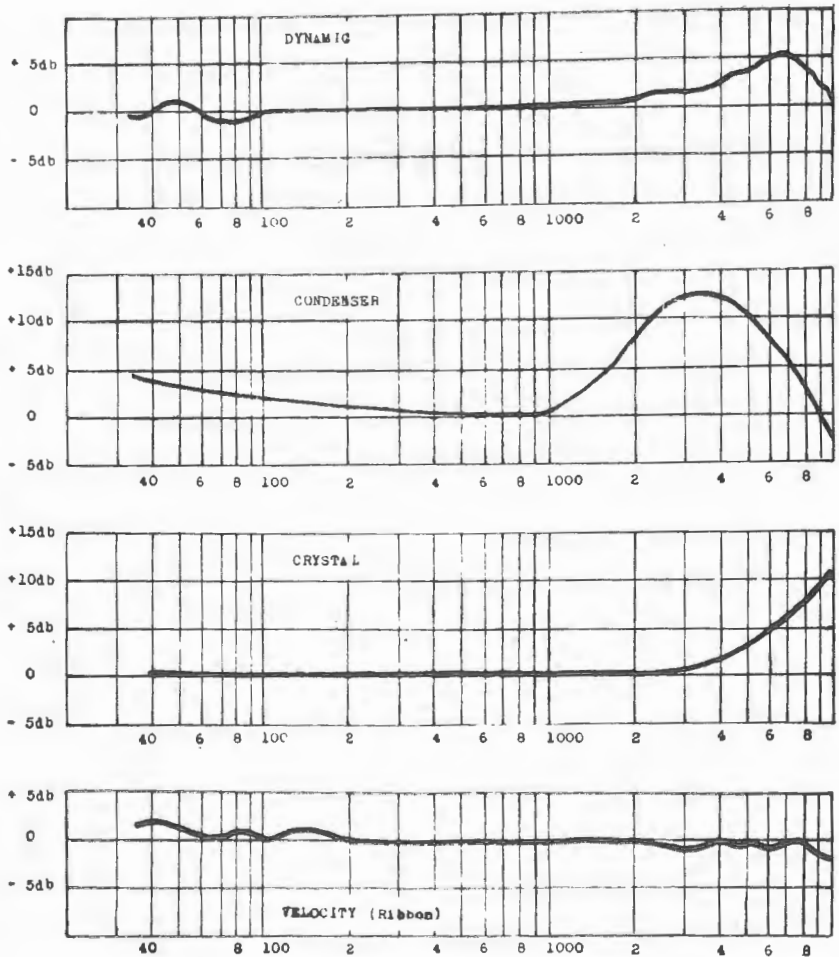

Typical response curves of dynamic, condenser, crystal, and velocity microphones.

simple effective compensation coupled with high fidelity and high output.

The mass of the moving parts and acoustic network give the dynamic microphone a flat response, equalled only by the most expensive types.

Cavity resonance is avoided in the dynamic microphone by the use of several features:—A baffle is devised to minimise pressure cancellation between the two sides of the diaphragm; acoustic networks equalise the back- and front-of-diaphragm pressure; effective air-column resonance and mass-effect resonances are thus reduced.

Dynamic Gives Minimum Feed-back Trouble.

Also, the dynamic microphone is extremely directional. The Electro-Voice microphone illustrated here is relatively non-responsive to frequencies above 500 cycles per second from the back. Feed-back trouble is less

with this type of unit than with any other. As can be seen from the typical curve, the main peak is about 6500 c/s. and is only about 5 db.

The level of the unit shown is comparable with the crystal, being slightly higher, and only less than the carbon type. The output is -54 db. below reference point to 10 milliwatts on a 500-ohm line.

The Electro-Voice requires no excitation, having a high quality Alnico magnet of large proportions. The high output is due to the light diaphragm and aluminium voice coil which is formerless, wound "on air." There are no peaks of any consequence and no unnatural response. Hiss is absent, and impedance is low, enabling it to be used directly on lines of medium length; the impedance is not nearly as low as that of the ribbon type, and is usually of the order of 10 to 30 ohms. No difficulty is experienced in matching. The medium-low impedance, direct-to-grid

(Continued on page 25)

A front view of the completed instrument, which covers from 150 k.c. to 30 m.c. in five bands. The two top controls are, left, attenuator, and right, wave-band switch. Alongside the attenuator are three pin-jacks—high and low r.f. output and earth. At left and right of the tuning control, with its five-band directly-calibrated scale, are the modulator and on/off switches, respectively, while the pin-jack at lower left is for a.f. output. The coils, band-switch, and attenuator are housed in a steel box, which is itself enclosed by the crackle-finished steel cabinet, providing particularly effective shielding against r.f. leakage.

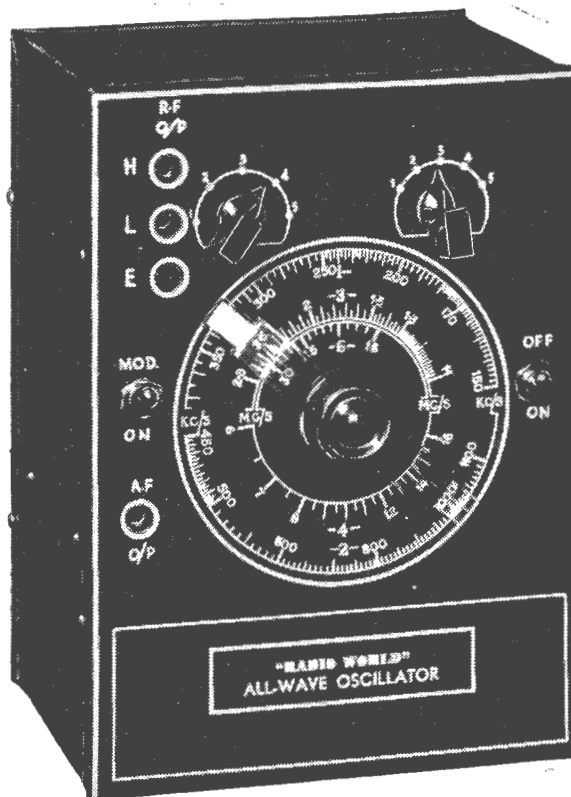

“RADIO WORLD”

All-Wave Service Oscillator

Flexibility, accuracy and simplicity of assembly are all combined in this low-cost all-wave service oscillator, which uses the new 1D8GT 1.4-volt valve as triode modulator and pentode e.c. oscillator.

NEXT to a multi-meter, easily the most valuable test instrument an experimenter can possess is an all-wave oscillator. The sensitivity of any receiver is directly dependent on the degree of accuracy with which it has been aligned, and while alignment by ear generally produces satisfactory results, for peak performance, alignment by oscillator is essential. Furthermore, imperfect alignment can often result in the presence of “birdies” and various forms of instability—faults that are sometimes wrongly blamed on the circuit.

There is no lack of data on test oscillators, for dozens of different designs are available in various magazines and text-books. However, most of them possess one or more serious disadvantages that to some extent destroy their usefulness.

Host Of Attractive Features.

The “Radio World” Service Oscillator illustrated above has been designed to eliminate those faults, and to incorporate every important feature an instrument of this type should possess. It is completely shielded, is compact and portable, and as well has a particularly efficient attenuator system for controlling output—an essential in these days of receivers with a.v.c. and fractional microvolt sensitivity. A minimum of parts has been used, though no attempt has been made to reduce the cost at the expense of performance.

The requirements of complete shielding, portability and low cost ruled out the use of a.c. from the start, for the mains cannot be filtered cheaply against all harmonics, nor could the oscillator then be used in non-reticulated areas. Thus battery is used as an electron-coupled oscil-

operation was decided upon. This brought in the question of running costs, which was solved very successfully by using one of the latest 1.4-volt valves, the 1D8GT combination diode triode pentode.

Running Cost Is Negligible.

The battery equipment comprises an Eveready Type Q18 “A” cell and a PR 45-volt “B” unit. “A” and “B” drains, respectively, are .1 amp. and approximately 4 mills. This means that about 400 hours of continuous operation, representing over twelve months of normal service, can be obtained from a single set of batteries. Taking this remarkably low running cost into consideration, an a.c. operated model is not justified, particularly in view of its greatly increased cost and much more complex circuit.

The pentode section of the 1D8GT is used as an electron-coupled oscillator, giving plenty of output with ex-

EXTRA PROTECTION!



POWER WIRE WOUND RESISTORS

That special coating on I.R.C. Power Wire Wound Resistors is just as rough and tough as it looks. It is the most durable coating yet developed. It is practically impervious to moisture and heat. It offers EXTRA PROTECTION against the most common causes of resistor failure. It gives you true airplane-submarine resistance-dependability—at not one penny of extra cost. Its amazing superiority can be demonstrated by any test you care to name.

Insist on I.R.C. Power Wire Wounds—the only resistors having this exclusive feature.

Write for engineering data direct to the—

SOLE AGENTS FOR AUSTRALIA:

Wm. J. McLellan & Co.
Bradbury House,
55 York Street, Sydney.

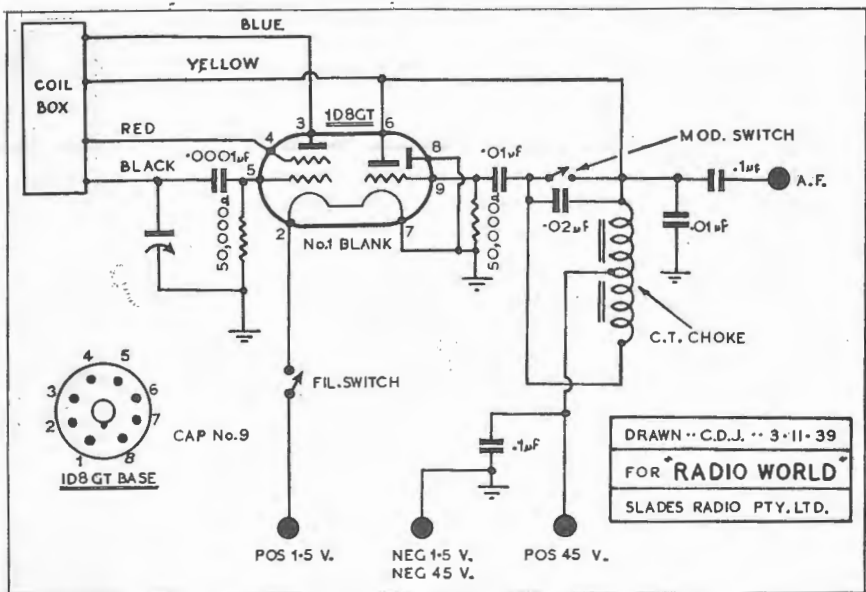

Circuit of the oscillator, with under-socket connections of the 1D8GT. There are only four colour-coded leads from the coil box, which greatly simplifies wiring. In the view and sketch opposite, the assembly is shown upside down, the most convenient position for wiring.

cellent stability. The triode section is used as a separate modulator—a very desirable feature, as a self-modulated valve does not give smooth r.f. oscillation, with the result that a “hash” instead of a clean carrier wave is generated.

The audio oscillator section of the circuit uses a centre-tapped modulation choke, the circuit constants being arranged to give a steady 400-cycle audio note. This can be used either to modulate the r.f. carrier generated by the oscillator, to give an audible note from the speaker when a receiver is being aligned, or else the a.f. output can be used separately if desired.

The instrument covers five wavebands, operating on fundamental fre-

quencies on four of them (from 150 k.c. to 16 megacycles). For the fifth band (from 16 to 30 megacycles), second harmonics from band 4 are used. The oscillator thus covers the shortwave and broadcast bands, and all intermediate frequencies from 150 k.c. upwards.

Full-Size Front Scale Elsewhere.

Elsewhere in this issue will be found a full-size reproduction of the scale used for the instrument. (A copy of this on heavy art paper is supplied with each kit of parts. Copies are also available from “Radio World,” price 1/6d. each, post free).

As the scale shows, there are five front panel controls on the instrument. The top left control is the

“Radio World” All-Wave Oscillator.

- 1 special Calstan all-wave oscillator foundation kit, comprising ready-drilled steel crackle-finished cabinet, 7½ in. x 6½ in. x 10 in., all-wave oscillator unit (comprising five-band coil assembly and attenuator mounted in steel box, with modulation choke and condenser gang bolted in position), tuning knob and celluloid indicator, scale for front of cabinet printed on heavy art paper.
- 1 octal wafer socket.
- 1 type 1D8GT valve.
- 2 s.p. s.t. on/off switches.
- 1 pin-jack.
- 1 set test leads.
- 1 10 lug resistor panel.

- 2 small instrument knobs.

FIXED CONDENSERS.

- 1 .0001 mfd. mica (T.C.C.).
- 2 .01 " tubular (Ducon).
- 1 .02 " " "
- 2 .1 " " "

FIXED RESISTORS:

- 2 50,000 ohm ½-watt carbon (I.R.C.).

BATTERIES:

- 1 45-volt “B” unit (Eveready PR45).
- 1 1½-volt “midget” “A” unit (Eveready Q18).

MISCELLANEOUS:

- Nuts and bolts, solder tags, sheet of celluloid to fit over scale (optional), hook-up wire, midget grid clips.



136 Multi-
meter A.C./
D.C. Model,
£9/5/-.
D.C. Model,
£6/15/-.
Prices plus
tax.

Model 136 Multimeter

This popular Model 136 Multimeter includes the new "R" type meter, which is made to give extreme sensitivity and at the same time possesses sound, robust movement. Its sensitivity of 20,000 Ohms per volt enables voltages such as a.v.c. and critical screen and bias to be measured satisfactorily without the aid of a vacuum tube voltmeter. Such a meter needs expert manufacture, and only "Calstan" are able to make and guarantee a 20,000 Ohms per Volt type. The 136 Multimeter is available in A.C./D.C. and D.C. types, the D.C. type being ready for conversion to A.C. at any time.

RANGES.—A.C./D.C. MODEL 136:
A.C., D.C. and Output Volts, 2, 5, 10, 50, 250, 1,000.
D.C. Milliamps, 1, 10, 50, 250.
Microamps, 100, enabling current as low as 2 microamps to be measured.
Ohms, 0-1,000, 0-10,000, 0-1,000,000 and 0-10,000, 000.
All from internal batteries.
D.C. MODEL D136:
Same as above, but no A.C. ranges. Provision is made, however, for inclusion at a later date if desired.

(CALibrated to STANDARD)

TEST EQUIPMENT

Push-Button-Operated MULTIMETERS

The "Calstan" series of push-button-operated Multimeter with other available lines, such as the "Calstan" 609 Analyser Unit and 136 Multimeter, present to the Radio Serviceman a portable testing laboratory, which is not only unique in design and appearance but, above all, LOW in cost. The outstanding features set out on the right are typical of all models . . .

RACK AND PANEL CONSTRUCTION.

"Calstan" rack and panel unit construction series are now available in steel, crystalline-finished racks. Any number may be bolted together—either horizontally or vertically—to form an efficient service test panel. The bolting process is very simple—just bolt the new purchase to the old with the four screws supplied by "Calstan." No stanchion or framework is necessary, and consequently there is no increase in price—just adopt price of single unit in portable case. Unit construction enables the purchaser to build up a very complete and comprehensive test kit, without the inconvenience, and sometimes impossibility, of an expensive initial outlay. Uniformity of construction and appearance enables the later additions to harmonise perfectly with the earlier purchases.



MODEL 142
UNITESTER



MODEL
140

- NEW FULL-SIZE RECTANGULAR METER
- UNIT CONSTRUCTION THROUGHOUT
- FOOL PROOF PUSH-BUTTON OPERATION
- EVER LASTING FINGER PROOF PANNELLING
- AVAILABLE IN SINGLE OR DOUBLE UNITS
- AVAILABLE WITHOUT CASE, FOR RACK AND PANEL MOUNTING
- D.C. MAY BE CONVERTED TO A.C. AT LATER DATE

PRICES AND DETAILS

The Series to date comprises—

MODEL 140 (As Illustrated). A high-grade push-button operated multimeter for the measurement of D.C. Volts, D.C. Milliamps and Ohms. RANGES: 1, 10, 100, 500 Ma.; 10, 50, 250, 500 Volts. Two Ranges Ohms from internal battery, and extra high range available from external 45-volt battery. Price, complete with test prods and instructions, in carrying case, £5/15/-. Without case, £5/6/-. 140 and 609, in case, £9/5/-.

MODEL D141. A high-grade instrument with similar specification to 140. Wired for D.C. measurements only, but all necessary provision made for the inclusion of A.C. components at a later date. Price, with test prods and full operating instructions, in carrying case, £6/2/6. Without case, £5/13/6. With 609 in carrying case, £9/12/6.

MODEL 141. This instrument has similar specifications to 140 and D141, and is suitable for all A.C. and D.C. measurements. Price, with test prods, alligator clips and full operating instructions, in carrying case, £7/15/-. Without case, £7/6/-. With 609 in carrying case, £11/5/-.

MODEL 142 (As Illustrated), designed for the measurements of practically all components encountered in the radio, electrical and sound trades. Incorporates the new "R" type rectangular meter and etched nickel silver panel. Unit constructed so as to fall in line with the present and proposed release of standard size instruments. Contains a built-in power supply, which will operate from any A.C. main in Australia. Will also supply from the "Calstan" Vibrator unit, enabling country users to make tests by means of a 6-volt accumulator. Although capable of major tests, this instrument occupies no more space than the Model

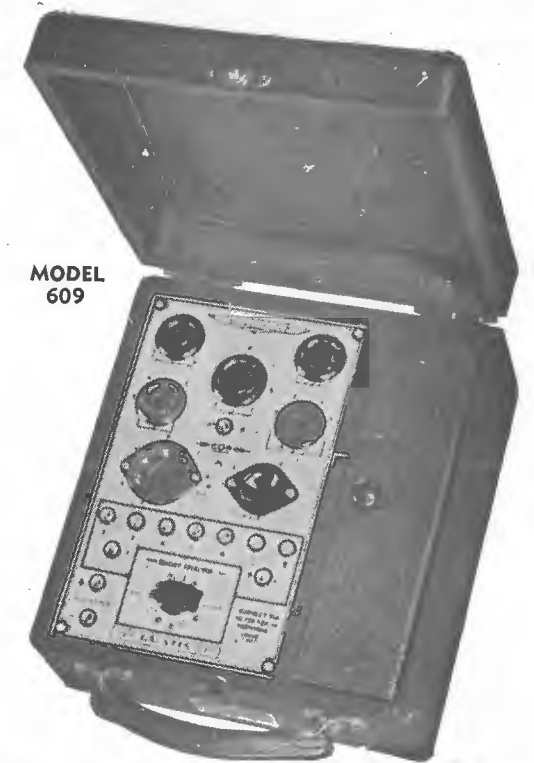

MODEL
609

140 Multimeter. All tests are read direct on the scale, needing no further calculation. Scale designed to give maximum vision and ease of reading. Available with 609 Analyser Unit. With this arrangement the two units form one of extreme flexibility and versatility. The tests and ranges are as follows:—Output volts: 10, 50, 250, 1,000. Decibels: Minus 18 to Plus 43. A.C. volts: 10, 50, 250, 1,000. D.C. Volts: 10, 50, 250, 1,000. D.C. Milliamps: 1, 10, 50, 250. Ohms: 25 Ohms to 10 Megohms. Inductance: 0.2 Henry to 200 Henries. Capacity: 0.0025 Mfd. to 50 Mfd. Impedance: 5 Ohms to 1 Megohm. Electrolytics: 10, 25, 250. Volt types showing condition on scale. Supplied with all necessary leads and operating instructions. Prices: In portable case, £12/12/-. Without case, £12/2/6. With 609, in dual portable case, £15/15/-. With steel rack, £12/12/-.

MODEL 609 (As Illustrated). A high-grade Analyser Selector Unit which enables the 140 series of multimeters to be used to best advantage. Incorporates these features . . . All R.M.A. numbering permanently etched in the finger-proof panelling. This being a great time saver enables the operator to cope with the ever-increasing types of valves and subsequent alterations to the base designations. Rapid selection of the circuit under test is accomplished by means of a rotary switch, thus eliminating the necessity for shifting the numerous wires with every test made. Price, with all necessary wires, adapters and instructions, in carrying case, £3/5/-. Without case, £2/15/-. For prices with multimeter, see prices on multimeters.

Model 222 VALVE TESTER

The "Calstan" 222 Valve Tester is a high-grade unit capable of testing all valves on the Australian market, as well as the new 1.4 series. The 222 Valve Tester combines the "R" type meter. The case is covered with black leatherette and the corners are metal protected. The panel is silver grey and finger-proof. Available in three models—Emporium, Counter and Portable. Also available with external or internal vibrator unit which enables it to operate for A.C. or 600-volt battery.

Prices, with Vibrator:—
Emporium £12 5 0
Counter £11 5 0
Portable £11 15 0
With the external Vibrator, £1/15/- extra.
With internal Vibrator:—
Emporium £14 0 0
Counter £13 0 0
Portable £13 10 0
Prices plus tax.



MODEL
222
VALVE
TESTER

SLADE'S RADIO PTY. LTD.

LANG STREET, CROYDON . . . Phones UJ5381-82

Makers of Highgrade Radio & Electrical Testing Equipment

Distributors: N.S.W.: Radio Equipment Pty. Ltd., Martin de Launay Ltd., Bloch & Gerber Ltd., United Radio Distributors, John Martin Ltd., Electric Service Co., Newcastle. QUEENSLAND: Chondlers Pty. Ltd. SOUTH AUSTRALIA: Radio Wholesalers Ltd., Adelaide. WEST AUSTRALIA: Norman L. Burnell & Co., 13 Queen Street, Perth. VICTORIA: Australian General Electric Ltd., Melbourne; Arthur J. Voall Pty. Ltd.; Hartley's Ltd., Flinders Street, Melbourne. TASMANIA: Oatlands Garage, Oatlands. NEW ZEALAND: New Zealand Electrical Equipment Co. Stocks also available from Turnbull and Jones, all branches.

attenuator, its scale being calibrated from 1 to 5 to enable readings to be noted if desired. There are two ranges of r.f. output—high and low—providing very effective control with a minimum r.f. signal that closely approaches zero. The top right control is the wavechange switch, the bands being numbered correspondingly on the dial scale below. The switch on the left is the modulator on/off control, while that on the right is the main on/off switch

(in the "A+" lead). The pin jack (bottom left) is for audio frequency output.

Unusually Simple To Build.

A particularly important feature of the instrument is its ease of construction. The five coils, wavechange switch and attenuator are all housed inside a steel box, which incidentally provides valuable additional shielding. The unit is supplied completely wired and tested, and all that is

necessary for the builder to do is to connect four colour-coded leads into circuit.

As well, the single-gang condenser and modulation choke are mounted on the top and at the rear of the coil unit, respectively, while holes have been tapped for mounting the 1D8GT socket and the resistor panel (see rear view). This arrangement not only greatly simplifies the assembly, but also enables the manufacturer to supply each unit ready calibrated to the 5-band direct-reading scale supplied, with an accuracy that is more than sufficient for all practical purposes.

Two Calstan Kits Of Parts.

The "Radio World" All-Wave Oscillator was developed with the cooperation of Mr. C. Jones, chief test equipment engineer of Slade's Radio Pty. Ltd., well-known manufacturers of Calstan test equipment.

Two kits of parts are available to readers—a foundation kit and a complete kit of all parts required, including valve, batteries and steel cabinet.

Those who have odd resistors and condensers and perhaps a 1D8GT on hand will be particularly interested in the Calstan All-Wave Oscillator Foundation Kit, which comprises a ready-drilled steel crackle-finished cabinet, 7½ x 6½ x 10 inches, with metal battery partition, all-wave oscillator unit (comprising five-band coil assembly with switch and attenuator mounted in a steel box, and with modulation choke and condenser gang bolted in position) tuning knob, celluloid indicator and a scale for the front of the cabinet, printed on heavy art paper.

The unit is ready aligned and tested at the factory, and when wired into circuit will provide servicemen and experimenters with a directly-calibrated instrument that is as efficient and accurate as many commercial oscillators costing several times the amount.

The Construction Outlined.

After the complete kit of parts as listed elsewhere has been obtained, the construction can be commenced.

The combination all-wave coil and attenuator unit, together with the 1D8GT socket and associated resistors and condensers can all be assembled and wired before the unit is mounted on the rear of the front panel.

The first job is to mount the valve
(continued on page 24).

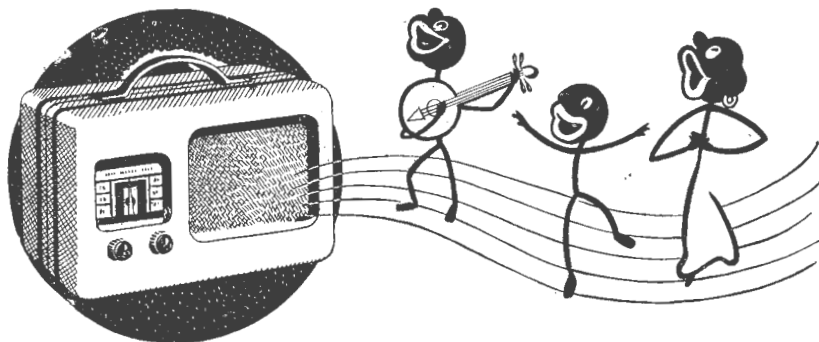

Rola

Loud Speakers Alone have ALL THREE ESSENTIALS to make Your Portable a SUCCESS

- Richness and purity of tone.
- High efficiency at all volume levels.
- Compactness, lightness and all-time dependability.

Rola 5- and 6-inch permanent magnet models are the very speakers for your portable set. Special magnets, moulded polyfibrous diaphragms, special transformers, patented dustproofing and acoustic filter all combine to give these speakers vast superiority in their group. Their abnormally high efficiency makes them ideal for use in conjunction with the special 1.4-volt valves and light portable batteries with which they were designed to work. Little wonder that the manufacturers of Australia's best portable sets have made heavy demands upon the Rola factory for supplies of these amazing little speakers.

See your distributor immediately and order the speakers that will give your portable radio set the professional touch, for the new 5-4 model is now available.

5-4 The lightest permanent magnet speaker available in Australia **25/-**

Write for Specification Sheets and Full Price List .

ROLA COMPANY (Aust.) PTY. LTD.

The Boulevard, Richmond, E.1., Vic.

116 Clarence St., SYDNEY, N.S.W.

New Zealand representative:

SWAN ELECTRIC COMPANY, LTD., High Street, Auckland.

R.F
O/P

H

L

E

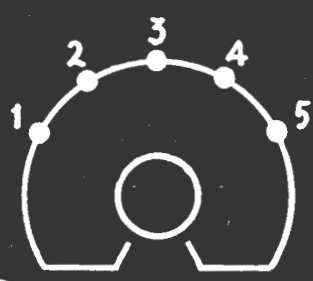
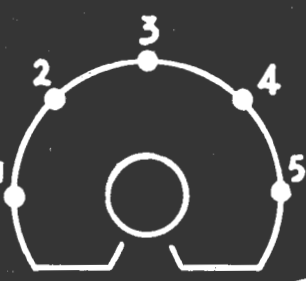

MOD.

ON

A.F

O/P



OFF

ON

"RADIO WORLD"
ALL-WAVE OSCILLATOR

socket and resistor panel, using $\frac{1}{2}$ " and $\frac{1}{4}$ " spacers, respectively, on the top and rear of the coil unit. (See wiring diagram and rear view of oscillator). The wiring is then put in in accordance with the circuit and wiring sketch.

Next, undo the screws holding the front of the steel cabinet in place, and mount on the front panel the pin jack (for A.F. output), and the two on/off switches. At this stage the scale can also be placed in position, a sheet of celluloid being placed over it for protection if desired. Lastly, mount the coil unit assembly in position and wire in circuit the three front panel components mentioned above.

The front panel can now be bolted back on the steel cabinet. Before the back is put on, however, bolt in position the battery shelf, which extends from side to side, 3" from the floor of the cabinet.

The Battery Equipment.

The battery compartment thus made houses the "A" and "B" batteries—an Eveready Type Q18 "A" unit, and an Eveready PR 45-volt "B" unit, respectively. Next, the four battery leads can be connected up and the rear of the cabinet bolt-

ed on. After the control knobs have been fitted, the instrument is ready for operation.

Coil Unit Supplied Ready-Calibrated.

Each Calstan oscillator unit supplied is wired into the original experimental model before leaving the factory and adjusted against a standard signal generator for frequency coverage on all five bands to ensure reasonably accurate calibration. For all practical purposes the standard of accuracy thus obtained is perfectly satisfactory. However, for those who desire it, the instrument after completion can be sent to the Calstan factory (Slade's Radio, 61a Lang St., Croydon, N.S.W.) for re-calibration against a standard signal generator.

Alternatively, the two lowest frequency bands can be given a final adjustment on broadcast station fundamental frequencies and harmonics by means of the two trimmers accessible through the two holes at the rear of the coil box (see rear view). Frequencies in "band 2" falling within the broadcast band (i.e., from 550-1100 k.c.) can be checked directly by beating the output from the oscillator with a signal picked up by a receiver from a station operating on a suitable portion of the band. (A

t.r.f. type of receiver will obviate any possibility of image signals giving rise to confusion).

The process is as follows: Run a lead from the "H" r.f. output socket, alongside the receiver lead-in. With the oscillator switched to "band 2," rotate the attenuator control full on, and turn the on/off switch to the "on" position.

Next, tune in on the receiver a broadcast band station operating on a frequency between 550 and 1100 k.c.—for example, 2FC on 610 k.c.—and adjust the oscillator tuning control accurately to this frequency. If the calibration of band "2" is correct, a heterodyne whistle will be heard, caused by the beating between the oscillator and b.c. station carriers. A very slight adjustment of the band "2" trimmer will then enable zero beat to be obtained. On the other hand, if no heterodyne whistle is heard, the position of the trimmer should be carefully varied until it is, when a further slight adjustment to find zero beat will complete the calibration.

Next, a check can be made of band "1," which extends from 150 to 550 k.c. and takes in all the intermediate frequencies in common use. Har-

(Continued on page 39)

ANNOUNCING! . . . A special technical service for "RADIO WORLD" readers

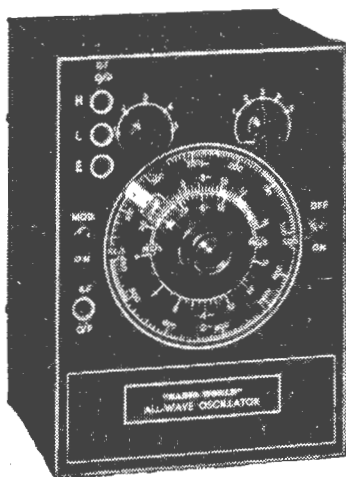

Our modern service laboratory, well equipped with a variety of up-to-date test instruments for trouble-shooting, and with a qualified radio engineer in charge, is at the disposal of readers for solving any technical design or service difficulty. Receivers of all types aligned with guaranteed accuracy at moderate charges. (Standard 4/5 dual-wave superhets, 7/6).

"RADIO WORLD" ALL-WAVE OSCILLATOR

The sensitivity of any receiver depends directly on the accuracy with which it is aligned. The "Radio World" All-Wave Oscillator described this month is the cheapest, most accurate and most flexible instrument of its type we have yet seen. Write for our prices on the Foundation Kit, complete kit of parts, and instrument ready assembled and tested.

Our rapidly-increasing mailing list proves to us that our prices and service are second to none. You can prove this as well by sending us a trial order.

"DAVENTRY" DUAL-WAVER

A compact mantel model dual-waver that can be easily carried around the house is invaluable for picking up the latest war news from overseas, and the "Daventry Dual-Waver" described in this issue is ideal for the purpose. Write for our special New Year offer covering the complete kit of parts.

LAMPLOUGH RADIO COMPANY

I.O.O.F. BUILDING, 100 CLARENCE STREET, SYDNEY PHONE: BW 5438.



The Electro-Voice velocity type microphone.

Choosing A Microphone.

(Continued from page 16)

coupling transformers are of simple design, usually contained in the base of the unit itself.

The dynamic microphone is unaffected by temperature or humidity changes, and can be used in tropical climates without trouble. Also small in size, it is well suited to P.A. or auditorium work, because it does not hide the user; mounting rings are unnecessary and mechanical vibration seldom causes objectionable noise. Simple to use, the dynamic microphone is fast becoming popular since it is now being produced at prices well below that associated with other quality units.

Complete Data Free On Request.

The Amplion Company advise that in addition to their present range of ribbon type microphones, they are now able to supply a high quality dynamic (moving coil) type, which has unusually high output, similar to the crystal, at a moderate list price. The Company will be pleased to supply further technical data and information on application.

Waverley Radio Club Notes.

By F.A.B.

THINK it was Bobby Burns who write about "seeing ourselves as other see us." When Jack Howes brought a portable recording unit to

the Club several weeks ago the members had an opportunity to hear themselves as others hear them. The result was astounding. All members were agreed on the fact that they were unable to recognise their own voices, although they could recognise those of others. Several items were executed (murdered) by the club "quartet," and on the whole a most enjoyable evening resulted.

Jack Howes once more entertained the members when he brought along his projector to the Club. Several fine films supplied by the Shell Oil Company provided an excellent night's entertainment.

Half-yearly election of officers took place on December 12. Leo Walters remains president, Jack Howes will continue as a very able secretary, and Eric Johnson fills the position of treasurer, an office which experience had shown him to be capable of filling very efficiently.

I will now conclude, hoping to see some new faces in the New Year at the club-rooms, "Almont," 13 Macpherson St., Waverley.

KEENLY PRICED KIT-SETS

VEALLS specialise in Kitsets and can offer unequalled value in low price, fast, expert service. Same careful, individual attention given to all orders big or little. Get the habit Try VEALLS First.

Picnic Portable 4

Fully described in Nov.-
Dec. issues Radio World. **£10/10/0**

For only £10-10-0 VEALLS will supply everything necessary including valves, cabinet and speaker. Freight paid to your nearest station.

The VELCO Master Battery 5

Write for full constructional details post free. **£11/17/6**

Designed for economical and reliable reception in the country. Complete Kit, valves, batteries and speaker included in the price—only £11-17-6.

The Velco Master A.C. 5

A real high fidelity A.C. 5 valve
super heterodyne. **£11**

£11 buys everything necessary including valves and speaker. Write for big free folder giving full constructional details.

THE MELODIOUS PUSH PULL THREE.

Battery 3-valver gives 5
valve output. Full details **£10/10/0**
price

THE MELODIOUS 1.4-VOLT FOUR.

£10/10/0 Uses latest 1.4v.-valves. Write for full details.

VEALLS

490 Elizabeth St., 168 and 243 Swanston St., Melbourne; 299 Chapel St., Prahan; 5 Riversdale Rd., Camberwell; 99 Puckle St., Moonee Ponds. F 3145 (6 lines).

ALL LETTERS TO BOX 2135T G.P.O., MELBOURNE.

What's New In Radio

Radiotron Designer's Handbook: Third Edition.

The third edition of the "Radiotron Designer's Handbook," which is at present in the course of being published, is expected to be available early in the New Year. Copies will then be procurable through the principal booksellers or direct from Amalgamated Wireless Valve Co. Pty. Ltd., of 47 York Street, Sydney.

This handbook, the first two editions of which proved so widely popular, has been completely re-written from cover to cover and enlarged to such an extent that it can now claim to be an invaluable book of reference to all those engaged in radio engineering.

Including no less than 40 chapters, the following subjects are fully covered:—Radio frequencies, rectification, filtering, receiver components, tests and measurements, valve characteristics, general theory, together with tables, charts and sundry data.

A large proportion of the material is unobtainable from text books or other sources, and has been written specially to meet the demand for such information. Very complete treatment has been given on negative feedback, tone compensation, tuned circuits, rectification, filtering, transformers, receiver tests and measurements, valve testing, valve voltmeters and the graphical representation of valve characteristics.

The entire edition is copiously illustrated with diagrams and a large number of curves has been given for the graphical solution of special problems. Useful tables have also been given, these including very complete tables of capacitive and reactive inductances and the impedance of a resistance and capacitance in parallel.

This new edition of the Radiotron Designer's Handbook, with its 300 pages, has been produced as a Radiotron service, and every radio technician should make a point of including it in his reference library. The price will be 3/-.

A monthly review of latest releases in sets, kit-sets and components

New Palec Diode Type Vacuum Tube Voltmeter.

A wide variety of uses will be found by servicemen for the recently-released Palec vacuum tube voltmeter illustrated below. This instrument is of the peak reading diode rectification type, used in conjunction with a degenerative amplifier. This feature renders the calibration independent of variations in valve constants, due, for



example, to ageing or replacement. Brief specifications are as follow:—

Ranges: 0 to 2.5 volts r.m.s.; 0 to 10.0 volts r.m.s.; 0 to 50.0 volts r.m.s.

Scale Accuracy: This is within $\pm 2\%$ over the range of 20 cycles to 50 megacycles.

Waveform Error: On complex waveforms, the voltage is .707 of the scale reading voltage, while on distorted waveforms, the calibration may be in error equal to the sum of the harmonic percentages.

Frequency Error: The instrument is non-reactive over the indicated frequency range, and is within 3%.

Input Impedance: At 50 cycles the input impedance is approximately 5 megohms and becomes correspondingly lower as the frequency increases. From the voltage reduction point of view the input impedance at 50 cycles is 3.5 megohms.

Frequency Range: 20 cycles to 100 megacycles.

Input Capacity: The total input capacity across input terminals is 3.5 uuf.

Power Factor: Due to the use of Mycalex insulation for the input terminals and valve socket, the losses at high frequencies are mainly in the glass envelope of valve and across the resistances, with the result that the power factor at the high frequency end of the range is approximately 2%.

Meter: The meter cannot be damaged by overloading the input circuit, irrespective of what range is being used.

Regulation: Changes in line voltages $\pm 10\%$ does not affect the calibration or interfere with operation.

Zero Adjustment: Once the zero setting on the lower range is adjusted, no correction is then required in switching from one range to another.

Power Consumption: The power consumption of the instrument is less than 7 watts, and due to the low currents, etc., used in amplifier, etc., the life of the valves is extremely long.

Complete data on this and other Palec instruments, including meters of all types, is available free on request from Paton Electrical Proprietary Ltd., 90 Victoria St., Ashfield, N.S.W.

★

1940 Amplion Pick-up.

Details of the new 1940 Amplion pick-up are contained in a pamphlet just to hand from Amplion (Aust.) Pty. Ltd., of 371 Kent St., Sydney.

British made and guaranteed, this new pick-up has a finely finished bakelite moulded arm with volume control built into the base, and separate arm rest. To ensure proper tracking, the head is set to the correct tangent angle to give finest possible reproduction, together with minimum record wear. The output averages three-

quarters of a volt, while frequency response is particularly good, being entirely free from objectionable resonances.

Included in the pamphlet is a reproduction of the Amplion stroboscope to ensure correct playing speed of records.

Further details of the above can be obtained by writing the address given.

★

New Rola Midget Model Electro-Dynamic.

The Rola Company (Aust.) Pty. Ltd. last month announced the release of a new electro-dynamic speaker expressly designed for use in ultra-compact radio receivers. Known as K5, this speaker is of entirely new design, and combines a high degree of efficiency with hitherto unobtained compactness. It will replace F4 when present small stocks of components of this speaker have been exhausted.

The magnet structure, cone housing and transformer have been arranged

Latest Rola release, the new K5 is a midget electro-dynamic type designed for use in ultra-compact receivers.



so that all parts of the speaker fit within a 5-inch diameter and occupy a maximum depth of 2 5/16." The speaker is shallow in design and is ar-

ranged so that when mounted on a chassis, it takes no more space than a small radio valve. Yet, despite its reduced dimensions, K5 preserves the

Insist on

RAYMART

CRAFT A CREED



RAYMART CERAMIC SHORTWAVE MICROVARIABLES.

RMX Dielectric ensures greatest efficiency at high frequencies—all-brass construction, ball-bearing drive, ball-race electrically shorted out to ensure freedom from noise.

| | |
|-------------------|------------|
| Type | List Price |
| VC40X, 40 mmfd. | 7/6 |
| VC100X, 100 mmfd. | 7/9 |

Rola

Use "The world's Finest Sound Reproducers" for the last word in high fidelity reproduction and sterling performance.

RAYMART R.F. CHOKES.

Genuine American 2.5 mh. National Type, precision pie-wound on isolantite form with wire pig-tails.

Type CHN. List Price, 5/6.

SHORTWAVE AND ULTRA-SHORTWAVE EQUIPMENT.

for the "DAVENTRY DUAL-WAVER" and "VULCAN PRE-SELECTOR UNIT".

Used and recommended by the Technical Editor for the "Vulcan Pre-Selector Unit" and other units and sets, Raymart equipment is invariably specified by leading technicians and experts all over the world. Scientific design and precision construction ensure higher standards of efficiency and dependability.

"The Friendly Wholesale House" can supply everything for your constructional needs at the lowest prices in the State. Write John Martin Pty Ltd. with details of your requirements.

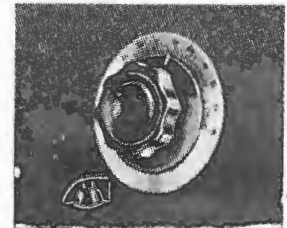

RAYMART PRECISION DIALS.

Specified for the "Vulcan Pre-Selector Unit," individually spun, heavy solid nickel dials, with engraved (not etched) divisions.

| | |
|-------------------|------------|
| Type | List Price |
| TXD, diam. 4" | 12/9 |
| TXJ, diam. 2 3/4" | 9/6 |

Reduction drive for use with above, ideal for vernier tuning, gives 6:1 reduction.
Type ERD. List price, 9/-.

Telephone BW 3109 (2 lines).

Telegrams: "Jonmar", Sydney.



116-118 CLARENCE STREET, SYDNEY.

essential ruggedness that is characteristic of all Rola speakers.

A special process of manufacture is employed to guarantee that none of the delicately adjusted components move from their original position. There are no screws, nuts or bolts in the assembly. Diaphragm, field coil

and transformer have been designed to withstand the abnormally high temperatures developed in small cabinets.

In addition to providing unprecedented compactness, this speaker combines high efficiency with remarkable power handling ability for a unit

so small. It has been designed to work in conjunction with standard power valves whose output it will take without distortion. The field has been designed for 3 or 4 watts excitation (according to ventilating arrangements). Limit resistance is 2500 ohms.

New Headquarters For

Marconi School

Now Occupying Two Floors of Fourteen-storey A.W.A. Building



COMPLETION of the A.W.A. Building at 45-47 York Street, Sydney, has enabled the Marconi School of Wireless to make a new and handsomely appointed home at a time when the demand for trained men is becoming increasingly great.

The study of radio makes a strong appeal to many young men. In Aus-

tralia several thousands have held an experimenter's licence. Few, however, have the qualifications which would enable them to take a position as wireless officer on a ship, to operate the radio equipment of an air-liner, to serve in a broadcasting, coastal or island radio station, or to design and supervise the construction and erection of wireless transmitting stations.

The purpose of the Marconi School, founded by Sir Ernest Fisk in 1913, is to train men for such positions.

Many of the senior executives of A.W.A. passed through the Marconi School; thousands of other ex-trainees are to be found either upon the Company's staff in Australia or scattered up and down the world following their chosen profession.

Every year new phases of radio are developed. Explorers now carry wireless into the uttermost wilds, new appliances appear on ships, broadcasting apparatus is elaborated, further radio aids to aircraft are devised. The progress thus indicated emphasises the need for the training which is given by the Marconi School.

The new Marconi School has an instructional staff of nine in Sydney (in addition to five in Melbourne)—experienced men in every phase of wireless on land, on sea and in the air.

The School occupies two floors of the sound-proof building. Morse tables are equipped with radio-frequency transceivers by means of which the students practise the sending and receiving of wireless traffic under conditions virtually identical with those met in the commercial operating services. An "apparatus room" contains several marine wireless stations complete with direction finders and auto alarm distress signal receivers.

Also there are a complete broadcast station, aircraft transmitter and receiver. One room has been electrically screened for the testing of the selectivity, sensitivity and fidelity of broadcast receivers; rows of benches have been set up for the training of broadcast technicians, radio mechanics and service men. Lessons are given in the construction of broadcast receivers, the servicing and adjustment of transmitters and transmission lines.

Five separate courses are available to Marconi School students—a five years' course for engineers, a three years' course for technicians, and a two years' course for wireless operators, a year's course for radio mechanics and talking picture operators. For the convenience of these last, the Marconi School incorporates an up-to-date theatre.

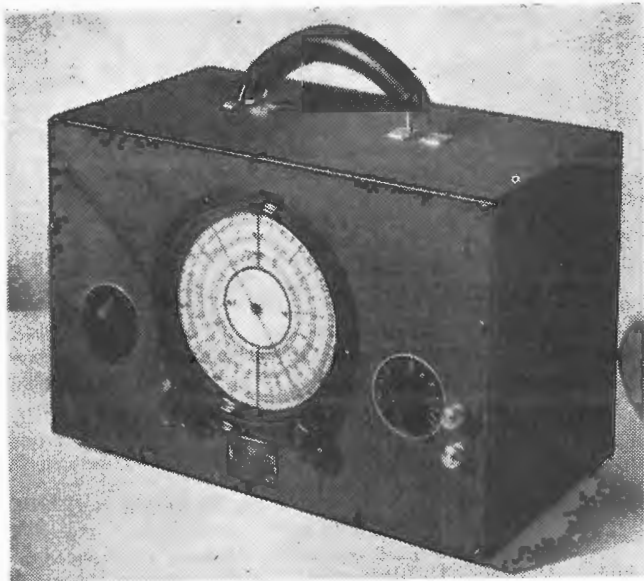

A.W.A. Test Oscillator.

Illustrated above is the A.W.A. modulated test oscillator which will supply modulated or unmodulated frequencies between 100 and 20,000 kilocycles. The instrument is assembled in a black lacquer-finished steel case fitted with carrying handle, dimensions being, height 10½", length 14", depth 7½". Valve equipment comprises two type 30 Radiotrons, while for "A" and "B" current supply, four 4.5-volt bias batteries (drain 60 m.a.), and one 60-volt light duty "B" battery (drain 3 to 5 m.a.), are required.

There are six frequency ranges, as follows:—

Range A: 96 k.c. to 250 k.c.

Range B: 240 k.c. to 600 k.c.

Range C: 560 k.c. to 1420 k.c.

Range D: 90 metres to 220 metres (1,360 k.c. to 3330 k.c.)

Range E: 37 metres to 96 metres (3,120 k.c. to 8100 k.c.).

Range F: 15 metres to 38 metres (7,900 k.c. to 20,000 k.c.).

All ranges are directly calibrated on a rotovisor type dial, A, B and C being marked in kilocycles, and D, E and F in metres.

Calibration accuracy is better than 1 per cent. on Range C, and within 2 per cent. on other ranges.

Typical Service Tests.

With this oscillator, the following

tests may be carried out rapidly and efficiently:—

1. Alignment of I.F. and R.F. circuits at any desired frequency.

2. Adjustment of receivers provided with wavelength or kilocycle scales to correct dial calibration by setting trimmers and adding condensers.

3. Examination of gang t.r.f. circuits for errors in tracking.

4. Measurement of overall sensitivity of all types of receivers at any frequency, and gain of i.f. amplifiers.

5. Examination of noise level at higher sensitivities by comparison of audio outputs between modulated and unmodulated carrier of equal strength.

6. Determination of stage gain in i.f. or r.f. amplifiers.

7. Testing of valves for performance under working conditions by insertion of several in succession in a given socket in a receiver, and noting the change in stage gain or overall sensitivity.

8. Checking of performance of a.v.c. in receivers.

9. Measurement of selectivity of i.f. or r.f. amplifiers in terms of band width in kilocycles for input signals one hundred or one thousand times larger than the signal on tune required to give some chosen value of audio output.

10. Determination of image ratio

The A.W.A. modulated test oscillator, which is housed in a black lacquer-finished steel case with carrying handle.

or the ratio of the microvolts input at the image, or second spot frequency to the microvolts at the wanted signal frequency, both giving equal audio output.

Altogether, this instrument possesses features that make it ideal for general servicing of all types of receivers. Flexible, simple to operate and of robust construction, it represents excellent value at £14/14/- (less batteries). Further details are available free on request from Amalgamated Wireless (A'sia) Ltd., York St., Sydney.



Valve Tester Circuit In T.C. 70.

Philips Technical Communication No. 70 (October-November, 1939) features an article with circuit, outlining the general design of a universal valve tester that will check both continental and American type valves.



New Van For John Martin's Ensures Smart Service For Dealers.

Shown below and overleaf are two views of the British Bedford panel van purchased recently by John Martin Pty. Ltd. to improve their already excellent service to dealers in metropolitan, Newcastle and South Coast districts. This van, which is intended for carrying traveller's samples only, and not for deliveries, is the forerunner of a proposed fleet to give complete coverage of New South Wales.

The van, which is smartly finished in green duco, of course carries the firm's name prominently displayed, together with those of Rola speakers





A view of the British Bedford van purchased recently by John Martin Pty. Ltd.

and Ken-Rad valves, two widely-sold lines which John Martin Pty. Ltd. handle.

★

Ducon Semi-Dry Electrolytics.

Complete data on the latest Ducon Compact Series of semi-dry electrolytics, including detailed sketches showing full dimensions, are contained in Bulletin No. 21 just issued by the Ducon Condenser Pty. Ltd., 73 Bourke St., Waterloo.

A particularly wide variety of types is included, in capacities ranging from 4 to 500 microfarads, and with working voltages from 6 to 525 volts. Two pages are devoted to pigtail types, and three to the latest vertical types designed for above-chassis mounting.

Full characteristics, including capacity tolerance, power factor and maximum operating leakage, are given of each type.

Copies of this Bulletin are available free on request from the address given above.

★

In Last Month's Issue.

We wish to draw the attention of readers to the fact that the article published on page 32 of last month's "Radio World" was supplied by Amplion (Aust.) Pty. Ltd., and that general opinions expressed therein are the views of that company, and not necessarily those of this magazine.

★

Radiotron Designer's Handbook.

With the latest issues of "Radiotronics," published by Amalgamated

Wireless Valve Co. Pty. Ltd., is enclosed a card giving details of a special offer to subscribers in connection with the Radiotron Designer's Handbook to be published in January, 1940.

The standard price for this publication is 3/-, plus 4d. postage, but subscribers to "Radiotronics" can obtain it for 2/9, post free, from Amalgamated Wireless Valve Co. Pty. Ltd., 47 York St., Sydney.

"Communications Eight" A Fine Performer.

I think after you have taken so much trouble to enlighten and please, I have a duty to perform in expressing my thanks and appreciation for placing before the public for our use and enjoyment the "Radio World," and in it that circuit known as the "Communications Eight," which has given me so much enjoyment during the last few months. I would like to state that it is a marvellous set; its performance and efficiency is all one desires.

Not having the time and instruments to build it, I was very fortunate in finding one of your advertisers, Mr. L. T. Martin (Precision Radio, of Homebush), who has not only given satisfaction, but his courtesy to me has been wonderful, making it possible for me to get such amazing results.

One thing that impressed me more than another is the absence of noise.

It is the quietest set I have ever listened to, and that is the opinion of others who have heard it.

I am using a doublet aerial, 35-foot poles; this aerial suits the set splendidly. I don't want to weary you with what I have received, but to-day, for instance, the amateurs, W's, at 11 a.m. came in like locals, and Sunday night Russia on 25m. band had to be tuned down. Sufficient to say that I have received every country worth listening to, all at full speaker strength, of course at the proper time to listen in.—A. Ovington, 29 Queen St., Homebush.

An Appreciation From England.

I was very pleased to receive my club badge and certificate, together with your interesting letter. The "Radio World" is a very fine publication and certainly puts our English magazines in the shade. I was particularly interested to see that you mentioned 1.4-volt valves a long time before they were publicised in Great Britain.

Before the war I owned an "artificial aerial" transmitter. The set in use here at present is a home-built o-v-1 using 2-volt battery valves. The fundamental circuit in my radio remains constant, but I am always adding stages to it and vice versa, so I think I can truly be called an experimenter. I have been an SWL for about 2½ years, the latter part of this period having been spent experimenting on 1.7 mc. My calls are HAC and HBE, and I would like to exchange QSL cards with other members of the Club.

At the beginning of October the DX in London was not too good. There were the usual millions of Americans, with occasional South American 'phone stations on 14 mc. Of course as most European "ham" stations are off the air, you can guess that it's pretty dull. One star station received here is MTCY, "The Voice of Manchukuo," on the 25m. commercial band. It is received here pretty consistently at about R5-6, the station itself being situated at Hsinking in Manchukuo.

Well, here's best 73's to you and all my Australian coppers, and I'll wish you a Merry Xmas, as I expect the letter will arrive about that time.—Phil Clifton (AW525DX), 99 Nowell Rd., Barnes, SW13, London, England.

Shortwave Review

CONDUCTED BY
ALAN H. GRAHAM

Summer Conditions: Night Reception Best ★ Many New Stations Reported ★ Latest News of Projected Stations and Schedule Changes ★ Amateur Bands and UHF Notes ★ Full List of the Month's Loggings.

Random Jottings.

Review Of Conditions.

With the close of the year, summer conditions become more and more evident, with a definite falling off in morning reception; with conditions during the forenoon and early afternoon very poor; with an ever-increasing noise-level making things difficult on the lower frequencies; and, finally, with evening reception splendid. From about 8.30 p.m. conditions on all bands between 13 and 31 metres are really excellent. Signals on 13 and 16 metres are worth some attention, their clarity being a convincing proof that it is possible to find real entertainment on the short-wave bands.

New Stations Listed.

Included in the list of the month's loggings readers will find many new stations. Located in every quarter of the globe, many of these new stations are of outstanding interest to keen dx-ers. Fears expressed in some quarters that the outbreak of war would result in drastic curtailment of shortwave transmissions are now shown to have been quite groundless. As a matter of fact, the tendency is definitely in the other direction. Each month readers of these columns will have noted details of projected transmitters, and many of these will take the air early this year. With the development of shortwave broadcasting as a means of spreading propaganda, few countries can afford to remain silent, and governments throughout the world are hastening to ensure that their views will be aired to the world at large. An interesting development in this direction is the inauguration of an Australian short-wave service, full details of which are given elsewhere in these columns.

Overcrowding On The Shortwave Channels.

This considerable increase in the number of shortwave transmitters now on the air, whilst providing SWL's with much interesting DX, also has very obvious drawbacks. For some time past listeners have been concerned at the overcrowding on some of the shortwave broadcast bands. At the present time, the 30-31

metre band is most adversely affected, as there are many more stations operating on these frequencies than can be comfortably accommodated. Moreover, there has been a veritable stampede to acquire frequencies on the newly-announced 41-metre broadcast band, on which over 30 stations have already made reservations, despite the fact that the band only covers 100kc. At present the higher frequency bands are not crowded, but a definite tendency by many European and American stations to utilise allocations on 13, 16 and 19 metres will soon alter that.

Amateurs Still Interest.

Despite the number of amateur stations compulsorily off the air be-

cause of the war, interesting 20-metre DX is still reported by many readers who are mainly concerned with amateur band loggings. A full list of countries in which amateur transmitters are still permitted to operate is given in the Amateur Review section.

News (?) Broadcasts.

Since the first novelty of the war has worn off, and the full weight of the censorship regulations have been felt, the majority of the news broadcasts lack interest. At times they are merely boring, consisting chiefly of futile and inevitably incorrect speculation, endless repetition of the same items, and fantastic propaganda. Even the American sessions lack spice.

Details of news broadcasts and weekly war talks from Daventry are worth noting.

Full news bulletins are given at the following times (the transmitters shown are beamed towards Australia):—At 2 a.m. (GSJ, GSF, GSG);

ALL-WAVE ALL-WORLD DX CLUB

Application for Membership



The Secretary,
All-Wave All-World DX Club,
117 Reservoir Street,
Sydney, N.S.W.
Dear Sir,

*I am very interested in dxing, and am keen to join your Club.
The details you require are given below:*

Name.....

Address.....

[Please print
both plainly.].....

My set is a.....

[Give make or type,
number of valves,
and state whether
battery or mains
operated.].....

*I enclose herewith the Life Membership fee of 3/6 [Postal Notes
or Money Order], for which I will receive, post free, a Club badge and
a Membership Certificate showing my Official Club Number.*

(Signed).....

[Note: Readers who do not want to mutilate their copies of the "Radio World" by
cutting out this form can write out the details required.]

at 3.30 a.m. (GSD); at 7.45 a.m. (GSD); at 10.30 a.m. (GSC); at 4.15 p.m. (GSD, GSB); at 7 p.m. (GSD); at 9.30 p.m. (GSJ, GSF, GSG) and at 11.15 p.m. (GSJ, GSF, GSG).

Interesting programmes heard regularly from Daventry include "London Log," with the well-known B.B.C. personality, Howard Marshall, at 5.30 p.m. on Saturdays and at 1.15 and 8.45 a.m. on Sundays; "Background to the News" on Tuesdays and Fridays at 1.15 and 10.15 a.m. and 4.45 p.m.; "In England Now," on Wednesdays and Saturdays, at 1.15 and 8.45 a.m. and 6.15 p.m.; "Matters of Moment," on Thursdays, at 1.15 a.m. and 2.30 and 7.30 p.m.

Official Observers.

A word of very heartfelt praise to the Official Observers who contribute so much to the success of this shortwave section of the "Radio World." We regret to record the resignation of two of our West Australian Observers, Messrs. George La Roche and Cyril Anderson. Our best wishes to both, especially to O.M. Cyril, who is now serving with the 2nd A.I.F.

Readers Reports Requested.

Readers are requested to write the Shortwave Editor on any matters concerning these columns. Reports of reception conditions are especially appreciated; all such reports will be acknowledged. Enquiries on any matters relating to shortwave reception will be answered by mail. Address all letters to Alan H. Graham, 258 Lower Plenty Rd., Rosanna, N22, Victoria.



Latest Station Changes And Schedules

Andorra.

Another new country for the keen dx-er. Reports from overseas indicate that "Radio Andorra" has been testing on the 25-metre band. Exact frequency is a bit obscure, being given variously as 11850kc. and 11835 kc. For those readers whose geography is a little rusty, we might mention that Andorra is in the Eastern Pyrenees, being a small, semi-independent State of 190 square miles, which pays a small tribute to France and Spain as joint suzerains. The chief industry is smuggling. Hi.

Australia.

The new Australian station in Perth, VLW, has been reported testing on both 48 and 25 metres. VLW is one of the stations to be used in the Australian shortwave service, which will have come on the air by the time these notes appear in print, the opening date being December 22.

Full schedule for these transmissions are:—

For Europe, through VLQ, 9615kc.,

31.2m.: In German, Dutch, French and English. From 5 to 7 p.m.

For Southern Europe, through VLQ2, 11870kc., 25.25m. In Turkish, Italian, Spanish, English and Arabic. From 5.30 to 6.30 p.m.

For North America, through VLQ. In English. From 7 to 8 a.m.

For North America and the Pacific, through VLQ. In English. From 7.30 to 8.30 a.m.

For India, through VLQ. In English. From 11.15 to 11.45 p.m.

For South America, through VLQ. In English and Spanish. From 9.30 to 10 p.m.

For Africa, through VLW3, 11830 kc., 25.36m. In English and Afrikaans. From 3.30 to 4.30 p.m.

For the East, through VLR, 9580 kc., 31.32m. In English and Dutch. From midnight to 12.30 a.m. Through VLR3, 11880kc., 25.23m. In English. From 9.30 to 10 a.m.

Algeria.

Plans for a powerful shortwave transmitter are now being considered. It is hoped to start transmissions at the end of this year.

Belgian Congo.

The new 250-watt station at Leopoldville operates under the call, OQ-2AA, on either 9525 or 15170kc., 31.49 or 19.77m. However, its present schedule, 10.25 a.m. till noon, makes reception in this country rather improbable for the present, at least.

China.

No appearance of the "Shortwave Review" seems complete these days without news of additional Chinese stations.

The latest transmitter is reported as being on 7970kc., 38.5m. Located in Shanghai, the call of this station, already reported in New Zealand, is thought to be XHHB.

Some details re XPSA recently received may be of interest. Located at Kweiyang, XPSA operates on 7010kc., 42.2m. (official frequency is given as 6970kc., but that is definitely wrong). Power is 10kw.; and the station is on the air from 6-9 a.m., and from 8.30 p.m.-1.30 a.m. News in English is broadcast at 11.30 p.m. Reports are greatly appreciated.

Cuba.

Further information regarding the new station at Santa Clara, COHI, indicates that it will also transmit on the 25-metre band, on approx. 11800 kc. (Radex).

Latest alterations in frequencies of Cuban stations are as follow:—COCE, on 12230kc., 24.53m.; COCX, on 11753 kc., 25.52m.; COCA, on 9700kc., 30.93 m.; and COBC, on 9350kc., 32.08m.

France.

The new 100kw. stations are gradually coming on the air. At present

two of these are operating on 9680kc., 30.99m., and 11843kc., 25.35m. No calls have yet been assigned, the stations merely being in the experimental stage as yet.

Latest official schedules from Paris show a change in call-sign for the 11855kc., 25.23m., transmitter; it now operates with the calls TPB-11 and TPB-12 (not TPA-3 and TPB-7, as before).

French Indo-China.

Apart from "Radio Saigon," there has been considerable activity by other stations in F.I.C. "Radio Volonté," in Saigon, is reported as operating regularly on 7100kc., 42.25m., commencing a recorded programme at 11.30 p.m. with the "Marseillaise."

In addition, "Radio Boy-Landry" is transmitting on three frequencies, namely, 6215kc., 9675kc., and 11685 kc., or 48.27m., 31.01m. and 25.68m.

Hawaii.

It is reported that the "Voice of Hawaii" programmes are being relayed through KHB, Kahuku, on 17120kc., 17.5m., from 10-10.30 a.m. on Sundays (QSA-5).

Eire.

The latest available schedule for the Irish station at Athlone is:—On 17840kc., 16.82m.: Daily 3.30-5 a.m.; odd days of the month, 7.30-11.30 a.m.; even days of the month, 7.30-8.30 a.m. On 9595kc., 31.27m.: Even days of the month, 9.30-11.30 a.m. and 12.30-1 p.m.

Luxembourg.

"Radio Luxembourg," recently heard on 25 metres, have been testing on 6090kc., 9527.5kc., 11782.5kc. and 15330kc. (49.26m., 31.49m., 25.46 m. and 19.56m.). Whether these experimental transmissions are still being carried on is obscure, as "Radio Luxembourg" has not been reported in this country for some weeks now. QRA for reports is Wireless Publicity Ltd., Electra House, Victoria Embankment, London, WC2. (Tune-In).

Mauritius.

VQ8JM, Port Louis, is reported from several sources as broadcasting irregularly on 7190kc., 41.7m. (Radex, Tune-In).

Paraguay.

ZP-8, Asuncion, to operate on 11850kc., 25.32m., with a power of 500 watts, is a new station (Univer-salite).

Switzerland.

The Swiss transmitters of the League of Nations are again on the air. HBO, HBL and HBP are all operating for North America around 10 a.m., whilst HBF, 18450kc., 16.2m., transmits a programme for the Orient on Saturdays from 4.45 to 6.45 p.m. Syria.

It is understood that a new station at Damascus is now transmitting on 12295kc., 24.4m.

U.S.S.R.

A feature of the past few weeks has been the number of new Russian stations heard. No calls are available for these stations, but full details of frequencies and times of transmission are given in the list of the month's loggings.

Yugo-Slavia.

Full details of the Belgrade stations are now available. YUB (this is understood to be new call for station previously listed as YUA) on 6100kc., 49.18m.; YUC, on 9505kc., 31.57m.; YUE, on 11735kc., 25.57m.; and YUF-YUG, on 15240kc., 19.68m. (Universalite).



Ultra-High-Frequency Notes.

Conditions Disappoint.

The promise of some good U.H.F. reception during December was not fulfilled. After a good period at the end of November, the unsettled weather in our locality resulted in almost a complete "black-out" during December. The police bands were most affected, and, at the time of writing, no signals have been heard on 8 and 9 metres for the past fortnight. Conditions on 10 and 11 metres are very little better.

Police Bands.

Towards the end of November conditions were quite good, and one or two additional loggings were made. Police stations definitely identified this year are:—

- WPDS, St. Paul, 33800kc., 8.9 m.
- KQCI, Glendale, 33800kc., 8.9 m.
- KQBH, Kansas City, Kansas, 33100 kc., 9.06m.
- KQAN, Fort Worth, 33100kc., 9.06m.
- WRBH, Cleveland, 33100kc., 9.06m.
- KQAO, Long Beach, 33100kc., 9.06m.
- KQ—, National City, 33100kc., 9.06m.
- KQBV, Los Angeles, approx. 9.4m.
- WQIE, Newark, 30700kc., 9.7m.
- KQBR, Alameda, 30700kc., 9.7m.
- WQKB, Evansville, 30700kc., 9.7m.

11-Metre Band Loggings.

Only W8XNU remains a regular on 11 metres, and signals from this station are now very poor. The other stations listed below were heard in the last week of November.

W4XA, 26150kc., 11.47m., Nashville: Only very occasionally now; usually with football descriptions on Sunday mornings.

W8XNU, 25950kc., 11.56m., Cincinnati: Very good at end of November;

heard regularly still, but signals weak and hard to copy.

W9XA, 26100kc., 11.49m., Kansas City: Frequency altered again from 26000kc. Seldom heard.

W9XH, 26050kc., 11.51m., South Bend: Heard once at end of November; closes 9.30 a.m.

W9XJL, 26100kc., 11.49m., Superior: Heard, with bad QRM from W9XA, late in November. Signals weak.

W9XPD, 25900kc., 11.58m., St. Louis: Very weak, but heard at times just above W8XNU.

9-Metre Band Notes.

No sign yet of the 31600kc. broadcast stations. Even if this band does open up, it will probably be of little value, as the latest information available shows over 30 American stations licensed to use this frequency.

The harmonic of KGEI on 9.78m. has been heard very well indeed in New Zealand, though it seldom exceeded R4 in our locality.



Amateur Bands Review.

The following list of countries in which amateur stations are still permitted to transmit is as accurate as is possible under the circumstances. Incidentally, readers will have noted that Cuban amateurs are no longer on the air. The war is not the reason for this ban imposed by the Director of Radio.

Countries In Which Amateurs Still Operate:

South America: Colombia, Chile, Brazil, Bolivia, Argentina, Ecuador, Peru, Paraguay, Uruguay, Venezuela.

Central America: Costa Rica, El Salvador, Guatemala, Honduras, Nicaragua, Panama, Canal Zone.

West Indies: Puerto Rico, Dominican Republic, Haiti.

Europe: Belgium, Holland, Portugal, Spain.

Africa: Belgian Congo, Tangier International Zone.

Oceania: Hawaii, Philippines, Dutch East Indies, American islands.

Asia: Japan, China.

North America: United States, Mexico, Alaska.



Calls Heard.

(Reports for 20 metres from Messrs. Bantow, Hastings, Cushen, Taylor and Chapman. For 10 metres, from Mr. Taylor and the S.W. Ed.)

10 Metres.

South America: CE3AC (Chile).

Oceania: KA-1ER, 1GX, 1ME, 1LZ, (Philippines); K6-BAZ, GQF, MVV, OJI, PIT, PLZ, QLB, QRD, QXU, QXY, ROJ, RRM, PIR (Hawaii).

United States: W-1CND, 1BBX, 1HDQ, 1LMB, 2LIR, 2FXB, 2CJA, 2CQX, 2AII, 2KAX, 3BBA, 3GNA, 3AWX, 3GRO, 4FUM, 4MV, 4EDD, 5IJM, 6FFN, 6FZD, 6IEF, 6IMI,

Have Your "RADIO WORLD" Posted To You Direct

Readers who want to take the "Radio World" on a subscription basis and have their copies posted to them direct each month are invited to complete the coupon below (annual sub., 10/6). New readers are advised that all back numbers in Volumes 1, 2 and 3 are still available, price 9d., post free, for all copies up to and including the December, 1938, issue, and 1/-, post free, for subsequent numbers.

Enclosed please find remittance for 10/6 in payment for an annual subscription to the "Australasian Radio World," commencing with the.....issue.

Name

Street and No.

CityState.....

Country

THE AUSTRALASIAN RADIO WORLD
(see page 2 for new address)

Note:—N.Z. Subscribers should remit by Money Order.

6KYL, 6MIW, 6NWG, 6PAI, 6PMJ, 6QHE, 6QPH, 6DUC, 6RCT, 6OXV, 6QUZ, 6CDO, 6HGN, 6AWV, 6QMJ, 6NKF, 6OAK, 6FVM, 6RRU, 7FVO, 7GFK, 7GMV, 7GUL, 7HCD, 7HCS, 8SOE, 9BRZ, 9JUL, 9KDA, 9RGT, 9ZIX, 9DLC, 9EW, 9ZNA, 9LMX, 9YZK, 9ARK, 9NWN, 9CXV.

20 Metres.

South America.

Venezuela: YV5AK.
Ecuador: HCLFG.
Argentina: LU4DM.
Peru: OA- 4L, 4C, 4AI, 4R.
Chile: CE- 1AR, 1AO, 3EW, 3CZ, 3CG, 3AC, 3BK, 3CE, 3AG, 4AC.
Brazil: PY- 2AR, 2SN.

Central America.

Costa Rica: TI2RC.

Africa.

Tangier International Zone: EK-1AF.

Belgian Congo: OQ5AB.

Pacific.

Guam: KB6- OCL, 1LT.
Canton Is.: KF6- JEG.
Baker Is.: K6- LEJ, NYD, OJI, OQE, MVA, QHU, CGK, MZQ, ILW, OCM, BNR.

The East.

China: XU- 1A, 1B, 5W, 6PL, 7HV, 8AM, 8RB, 8ZA, 8RJ, 8RP, 8MY, OA.
Japan: J- 2CS, 2NG, 2KN, 2NQ, 2XA, 7CB.
D.E.I.: PK- 1DM, 1MF, 1OG, 2LZ, 3GD, 3MP, 3RP, 4KS.
Philippines: KA- 1FG, 1CS, 1CM, 1CW, 1AC, 1AG, 1AP, 1JP, 1GC, 1GX, 1DL, 1AF, 1LZ, 1GS, 1ME, 1KF, 1OZ, 1JG, 1BB, 1BH, 1ER, 1GE, 1SM, 3BW, 3KK, 3RA, 4RF, 4LH, 7EF, 7FV, 7RF.

★

Reports Acknowledged.

Mr. W. M. Chapman (Kensington, N.S.W.): Many thanks for very comprehensive report. Yes, that reference in the last issue to South African amateurs remaining on the air after November 1 was wrong. The new Russian stations are certainly difficult to follow. Will see what can be done about those mystery stations you mention.

Mr. A. T. Cushen (Invercargill, N.Z.): Report to hand. Will look forward to some real DX loggings from you in the new year when you instal that new receiver.

Mr. W. E. Bantow (Edithvale, Vic.): Pleased to receive such an interesting report. Would be pleased if you will check up on station on 6110kc., listed as VUC, Calcutta, as we believe this transmitter is not in use at present.

Mr. O. G. Washfold (Camberwell, Vic.): Your report was most certainly

of some use, and we hope to hear from you regularly.

Mr. D. J. Hastings (Brisbane, Qld.): Despite that QRM you seem to have little difficulty in logging some very fine DX on 20 metres. OQ5AB, PY-2AR and PY2SN are certainly real catches.

Mr. J. C. Taylor (Hurstville, N.S.W.): Many thanks for list of 10 and 20 metre loggings. Your Sunday morning sessions on 10 are getting results, CE2AC being a fine logging.

Mr. J. Ferrier (Coleraine, Vic.): Many thanks for photo of shack. U.H.F. conditions have certainly been most disappointing.

Mr. H. I. Johns (Nelson, N.Z.): Thanks for yet another fine report. Conditions in N.Z. seem a good deal better than they are in our locality, especially on 49 metres in the afternoon.

★

The Month's Loggings.

In future, stations not listed in this section in the previous issue will be indicated by an asterisk (*).

South America.

Peru.

*OAX4T, 9556kc., 31.38m., Lima: This station is heard occasionally opening at 11 p.m., but, more often than not, it is inaudible on account of QRM.

OAX5C, 9350kc., 31.95m., Ica: Now heard only on Sundays; better signal in N.Z.

OAX4J, 9340kc., 32.12m., Lima: Heard fairly regularly still; early mornings around 7 a.m., and on Sunday afternoons till closing at 4 p.m.

OAX4Z, 6077kc., 49.37m., Lima: Heard in the late afternoons in N.Z.; also believed to have been testing around 9 p.m.

Ecuador.

HCJB, 12460kc., 24.08m., Quito: This well-known station has had a fresh lease of life and is again putting in a very fine signal around 10 p.m. (Chapman).

*HC2CW, 9135kc., 32.84m., Guayaquil: This unusual station is being heard in N.Z., closing after 3 p.m.

Colombian Republic.

*HJFK, 9740kc., 30.8m., Pereira: New South American station heard with good signal from 10 p.m. As is usual with these stations, the first half-hour's transmission is mainly news in Spanish.

Chile.

CB-960, 9600kc., 31.25m., Santiago: Heard quite well from 10 p.m. nightly.

Brazil.

*PRA-8, 6015kc., 49.87m., Pernambuco: Although this station has not been heard here lately, it is reported from N.Z., opening at 7 a.m. with a fair signal.

Argentina.

*LRA-1, 9690kc., 30.96m., Buenos Aires: Still heard weakly on some mornings; best when it opens earlier at 7 a.m. on Saturdays.

Uruguay.

CXA-8, 9640kc., 31.12m., Colonia: Only Uruguayan station reported this month. Heard weakly on Sundays—both afternoon and evening.

Central America And West Indies.

Guatemala.

TGWA, 15170kc., 19.78m., Guatemala City: Now being heard at good strength in the early mornings—best around 7 a.m. on Mondays (Washfold).

TGWA, 9685kc., 30.96m., Guatemala City: Best during special DX programmes on Sunday afternoons. Also on weekdays, closing between 2.30 and 3 p.m. (Washfold, Johns).

*TGWB, 6486kc., 46.25m., Guatemala City: Now harder to log on Sunday afternoons on account of high noise-level.

*TG-2, 6195kc., 48.4m., Guatemala City: Another Sunday afternoon station; best around 5.15 p.m.

Costa Rica.

TIPG, 9615kc., 31.21m., San Jose: Still very strong from 10 p.m.

TILS, 6165kc., 48.66m., San Jose: Also opens at 10 p.m., but not nearly as good as a few weeks ago.

Panama.

HP5A, 11700kc., 25.64m., Panama City: Still very erratic, but sometimes at good strength after 10 p.m. (Chapman).

HP5J, 9590kc., 31.28m., Panama City: Fair signal from 10 p.m.

*HP5K, 6005kc., 49.96m., Panama City: Good old regular, opening with waltz.

Cuba.

(Once again we would remind you that the following frequencies were correct at time of writing, but will probably be out of date by the time they appear in print).

*COGF, 11800kc., 25.42m., Matanzas: Heard weakly from 11 p.m. and sometimes in the early morning.

COCM, 9850kc., 30.46m., Habana: Heard irregularly from 11 p.m.

COCH, 9437kc., 31.8m., Habana: Weakly at nights, but spoilt by morse QRM.

COBC, 9350kc., 32.08m., Habana: As is mentioned elsewhere, this station has changed its frequency. Back to old channel from 9985kc. Opens with fair signal at 9.55 p.m.

COBZ, 9030kc., 33.32m., Habana: Irregular; a weak signal on occasions around 11 p.m.

COCQ, 8850kc., 33.9m., Habana: Perhaps the best of the Cubans at present; from around 9.50 p.m.

*COJK, 8685kc., 34.54m., Camaguey: Heard once or twice of late, opening just before 10 p.m.

Dominican Republic.

*HIIN, 12486kc., 24.03m., Trujillo City: Heard just below HCJB, but not nearly as loud as that station. Scheduled to open at 9.40 p.m.

North America.

Mexico.

*XEWV, 15160kc., 19.79m., Mexico City: Heard with a fair signal on Sunday afternoons. (Chapman).

XEWV, 9503kc., 31.57m., Mexico City: Very reliable station. Heard daily till around 4 p.m. with fairly strong signal.

*XEBT, 6000kc., 50m., Mexico City: Reported at good strength in N.Z.; Sundays, till closing at 4.30 p.m. (Johns).

United States.

WCBX, 21570kc., 13.91m., New York: Fairly strong signal on some nights around midnight. (Chapman).

WPIT, 21540kc., 13.93m., Pittsburgh: Heard occasionally at night around 10 p.m., though GSJ and GST tend to blot it out.

WNBI, 17780kc., 16.87m., Bound Brook: Very nice signal in the early morning, best between 7 and 8 a.m. Also heard during forenoon, but hard to follow because of bad fading. (Bantow, Johns).

*WRCA, 17780kc., 16.87m., Bound Brook: Not heard in our locality but reported from Sydney with weak signal from 11 p.m. (Chapman).

WGEA, 15330kc., 19.56m., Schenectady: Good early morning station, with steady signal till 8 a.m. (Chapman, Bantow).

KGEI, 15330kc., 19.56m., San Francisco: Very weak now and erratic; around noon.

*WCAB, 15270kc., 19.65m., Philadelphia: Another early morning station, heard best around 8 a.m. (Chapman).

*WRUL, 15250kc., 19.67m., Boston: Heard on some mornings around 7 a.m.; used alternatively with WRUW, 15130kc.

WCBX, 15270kc., 19.65m., New York: Still another early morning American station, closing at 6.30 a.m. Erratic, but signals very strong on some mornings.

WPIT, 15210kc., 19.72m., Pittsburgh: Fairly strong signal around midnight.

*WRUW, 15130kc., 19.83m., Boston: Nice strong signal on some mornings, with same programme as WRUL on 25 metres. Closes at 8 a.m. (Chapman).

KKZ, 13690kc., 21.91m., Bolinas: Used for special relays to Hawaii on Sunday afternoons.

KKQ, 11950kc., 25.1m., Bolinas: Also

used for special relays on Sundays, and sometimes on week days around 3 p.m. (Chapman).

WPIT, 11870kc., 25.26m., Pittsburgh: Regular morning station around 7 a.m., with good signal (Bantow).

WCBX, 11830kc., 25.36m., New York: Very strong signal from 7-9 a.m.; news in several languages.

WRUL, 11790kc., 25.45m., Boston:

DX Club Requirements.

All-Wave All-World DX Club members are advised that the following DX requirements are obtainable from Club headquarters, 117 Reservoir St., Sydney.

REPORT FORMS.—Save time and make sure of supplying all the information required by using these official forms, which identify you with an established DX organisation.

Price . . . 1/6 for 50, post free.

NOTEPAPER.—Headed Club notepaper for members' correspondence is also available. Price, 1/6 for 50 sheets, post free.

DX CLUB STICKERS.—Enlarged two-colour replicas of the Club badge, in the form of gummed stickers, designed for attaching to envelopes, QSL cards, etc. Price, 5 dozen for 1/6, post free.

DX CLUB LOG SHEETS.—Designed by the Shortwave Editor, these headed and ruled log sheets are indispensable to dxers who wish to keep a simply-prepared and accurate list of loggings. Price, 3 dozen for 1/6, post free.

Good signal till closing at 8 a.m. (Chapman).

WRUW, 11730kc., 25.58m., Boston: Used on some mornings; opening with a fairly strong signal at 8.30 a.m. (Cushen).

WRCA, 9670kc., 31.03m., Bound Brook: Heard with weak signal in the afternoons, closing at 4 p.m. (Chapman).

WCAB, 9590kc., 31.28m., Philadelphia: Fair signal till closing at 5 p.m.; news just before signing off. (Chapman, Washfold).

WBOS, 9570kc., 31.35m., Boston: Strong afternoon station; closes at 5 p.m.

WGEA, 9550kc., 31.41m., Schenectady: Barely audible in the mornings from 8.15 a.m.

WGEO, 9530kc., 31.48m., Schenec-

tady: Opens at 6 a.m. with strong signal. (Chapman, Bantow, Johns).

KGEI, 9530kc., 31.48m., San Francisco: Heard from 4 p.m.; and also from 10 p.m. when QRM from JZI is bad. (Chapman).

*WPIT, 6140kc., 48.86m., Pittsburgh: Reported with excellent signal from 3-4 p.m. Sundays in N.Z. Very weak in our locality. (Johns).

WCBX, 6120kc., 49m., New York: Weakish signal till 5 p.m.

WLWO, 6060kc., 49.5m., Cincinnati: Heard fairly well on some afternoons; best on Sundays when on till 5.30 p.m. Also at night around 10 p.m.

*WBKM (ex-W4XB), 6040kc., 49.65m., Miami Beach: Reported from N.Z. with strong signal on Sundays at 3.30 p.m. (Johns).

*WRUL, 6040kc., 49.65m., Boston: Reported from N.Z. on special test with TG-2, Guatemala. (Cushen).

AFRICA.

Kenya Colony.

VQ7LO, 6083kc., 49.31m., Nairobi: Consistent early morning station; heard best towards close after 5 a.m. (Chapman).

Ethiopia.

I2AA, 9650kc., 31.09m., Addis Ababa: Good signal around 2 a.m. call was previously IABA.

Canary Is.

EAJ-43, 10360kc., 28.96m., Tenerife: Hard to log now; at times just audible around 6 a.m.

Algeria.

TPZ-3, 8960kc., 33.48m., Algiers: Quite a good signal until closing at 7 a.m.

Mozambique.

*CR7BH, 11718kc., 25.6m., Lourenco Marques: Reported at good strength from N.Z.; from 8 p.m. on Sundays, with religious service. (Johns).

Madagascar.

*Radio Tananarive, 9695kc., 30.95 m., Tananarive: Quite good on 1-2 a.m. transmission, opening, of course, with the "Marseillaise."

*Radio Tananarive, 6060kc., 49.5m., Tananarive: Same time and same programme as the 9695kc., transmitter.

South Africa.

*ZRO, 9752kc., 30.77m., Durban: Have found this station difficult to log after midnight.

*ZRL, 9606kc., 31.23m., Klipheval: Also heard only once or twice, around 2 a.m.

*ZRK, 6097kc., 49.2m., Klipheval: Fairly good signal from 3 a.m.; closes at 7 a.m. on week-days.

*ZRH, 6007kc., 49.94m., Roberts Heights: Just fair till closing at 6.30 a.m.

*ZNB, 5900kc., 50.85m., Mafeking, British Bechuanaland: May be heard daily except Mondays, 4-5.30 a.m.

OCEANIA.

New Caledonia.

FK8AA, 6122kc., 49m., Noumea: Still heard at good strength in the late afternoons.

AUSTRALIA.

VLR-3, 11880kc., 25.25m., Lyndhurst: Used in the mornings and afternoons. (Washfold).

*VLW, 11830kc., 25.36m., Perth: New station heard testing at good strength; to be used in new overseas service. (Washfold).

VLR, 9580kc., 31.32m., Lyndhurst: Replaces VLR-3 for night session. (Washfold, Johns).

*VLW, 6130kc., 48.94m., Perth: Tests heard on this frequency. (Washfold).

THE EAST.

Philippine Is.

*KZRH, 9660kc., 31.06m., Manila: New frequency for KZRH; heard at good strength; scheduled from 7 p.m.-1 a.m. (Bantow, Washfold).

KZRM, 9570kc., 31.35m., Manila: Good night station; very reliable and excellent signal. (Chapman, Washfold, Bantow).

KZIB, 9500kc., 31.58m., Manila: Also a good signal from 8 p.m.; widely reported at good strength. (Washfold, Bantow, Chapman).

KZRM/KZEG/KZRF, 6140kc., 48.86m., Manila: Still heard well; this transmitter uses all of the calls mentioned. (Chapman, Bantow, Washfold).

KZRH, 6110kc., 49.1m., Manila: Also heard at night. (Chapman).

KZIB, 6040kc., 49.67m., Manila: Not as loud as other P.I. stations on this band. (Chapman).
Malaya.

ZHP, 9690kc., 30.96m., Singapore: One of the most reliable signals to be heard; best between 10 and 11 p.m. (Bantow, Chapman, Washfold).

ZHJ, 6080kc., 49.3m., Penang: Hard to hear now; but from N.Z. it is reported at good strength. Announces in English from 9.30-11.30 p.m.; power increased to 1kw. (Johns).

India.

VUD-3, 15290kc., 19.62m., Delhi: Heard on occasions after mid-day and in late afternoon. (Bantow).

VUD-18, 4960kc., 60.48m., Delhi: Very good indeed at present, from 10.30 p.m.; maintains strength till close at 3.30 a.m. (Bantow, Chapman).

VUD18, 4960kc., 60.48m., Delhi: Note new call. News at 10.30 (Chapman).

VUM-2, 4920kc., 60.98m., Madras: Just fair. (Chapman).

VUB-2, 4880kc., 61.48m., Bombay: Just audible. (Chapman).

VUC-2, 4840kc., 61.98m., Calcutta: Fairly strong. (Chapman).

Burma.

XYZ, 6007kc., 49.94m., Rangoon: Not very strong now, best in the early a.m. (Chapman).

French Indo-China.

Radio Saigon, 11780kc., 25.47m., Saigon: Exceptionally strong signal from 9 p.m. Replaces the 49m. transmitter as regular evening station. Power increase to 12kw. reported. (Chapman, Bantow, Washfold, Johns).

*Radio Boy-Landry, 9680kc., 30.99m., Saigon: Testing on new frequency. Heard nightly till after midnight.

*Radio Volonte, 7100kc., 42.25m., Saigon: Reported weakly in N.Z. from 11.30 p.m., opening with the "Marseillaise."

Radio Saigon, 6116kc., 49.05m., Saigon: Believed to have gone off the air on December 10; replaced by 25-metre station. (Bantow, Johns).

Hong Kong.

ZBW-3, 9525kc., 31.49m., Hong Kong: Regular strong signal at night. (Chapman, Bantow, Washfold).
China.

XGOX, 15190kc., 19.75m., Chungking (?): Excellent signal at night.

XGOY, 11900kc., 25.21m., Chungking (?): Very reliable station; heard early morning and at night. (Cushen, Chapman, Bantow, Washfold).

XMHA, 11850kc., 25.32m., Shanghai: Quite good at night.

XGOK, 11820kc., 25.38m., Canton: Fairly regular at night.

XPSA, 7000kc., 42.8m., Kweiyang: Good signal nightly. (Bantow).

XOJD, 6880kc., 43.6m., Hankow: Still some doubt as to call, but majority of overseas sources favour XOJD and not XJOD.

*XHBB, 7970kc., 88.5m., Shanghai: Call doubtful; heard in N.Z. Manchukuo.

MTCY, 11775kc., 25.48m., Hsinking: Good morning session from 7 a.m. (Chapman).

MTCY, 6125kc., 48.98m., Hsinking: Used at night. (Bantow).

Thailand.

HS8PJ, 9510kc., 31.55m., Bangkok: Not on the air every night, but always good signal when logged.

*HS6PJ, 19020kc., 15.77m., Bangkok: Used on Mondays from 11 p.m.; heard weakly on occasions.

Taiwan.

JIE-2, 9695kc., 30.95m., Tyureki: Same programme as JFO, relaying JFAK. Hard to hear.

JFO, 9635kc., 31.13m., Taihoku: Never very loud, but usually audible at night.

JIE, 7295kc., 41.13m., Tyureki: Fair signal around midnight. (Chapman).

Japan.

JZK, 15160kc., 19.79m., Tokyo: Good strong signal; best at night. (Chapman).

JZI, 11800kc., 25.42m., Tokyo: Best from 10 p.m. at night. (Chapman, Johns).

JVW-3, 11720kc., 25.6m., Tokyo: Fair from 8 p.m. (Chapman, Bantow, Washfold).

JLG-3, 11705kc., 25.63m., Tokyo: Also heard at night.

JZI, 9535kc., 31.47m., Tokyo: At night from 10 p.m.; but makes a good job of interfering with KGEL.

JVW, 7258kc., 41.34m., Tokyo: This new station is still heard well from 6-7 a.m. (Chapman).

Dutch East Indies.

YDC, 15150kc., 19.8m., Bandoeng: This station puts on a really entertaining programme at night. (Chapman, Cushen, Washfold).

PLP, 11000kc., 27.27m., Bandoeng: Relays YDC; fair. (Chapman, Washfold).

PMN, 10260kc., 29.24m., Bandoeng: As PLP; fair. (Washfold).

YDB, 9550kc., 31.41m., Bandoeng: Quite good at midnight.

YDX, 7220kc., 41.55m., Medan: Strong, native programme.

PMH, 6720kc., 44.64m., Bandoeng: Very loud, native programme. (Chapman).

YDD, 6045kc., 49.63m., Bandoeng: Fair some nights.

EUROPE.

Sweden.

SBP, 11705kc., 25.63m., Motala: Heard some mornings; and reported from N.Z. as heard at 8 p.m. on Sundays. (Johns).

SBT, 15155kc., 19.79m., Motala: Reported with good signal around 7 a.m. in South Australia.

Yugo-Slavia.

*YUG, 15240kc., 19.68m., Belgrade: New frequency for Belgrade; reported from N.S.W. and Qld. in early morning.

YUC, 9505kc., 31.56m., Belgrade: Not as loud as formerly in early mornings. (Chapman).

Turkey.

TAP, 9465kc., 31.7m., Ankara: Heard well every morning; also now on the air from 10 p.m. on weekends. (Bantow).

Portugal.

CSW-6, 11040kc., 27.17m., Lisbon: Good signal till 6 a.m. or 7 a.m. (Chapman).

CSW-7, 9740kc., 30.08m., Lisbon: Seems to be opening at either 6 or 7 a.m., with nice, clear signal.

Belgium.

ORK, 10330kc., 29.04m., Ruysselede: Regular signal in early morning till 6 a.m. (Chapman).

Holland.

PCJ-2, 15220kc., 19.71m., Huizen: Best in special session for Australasia, Tuesdays, 6 p.m.

PCJ, 9590kc., 31.28m., Huizen: Fair signal at 6 a.m. (Chapman).

PHI-2, 17770kc., 16.88m., Huizen: Fair signal some nights.

Spain.

EAQ, 9860kc., 30.43m., Madrid: Only weak in early morning.

Norway.

LKV, 15170kc., 19.78m., Oslo: Still heard from about 2 a.m.; weakens a good deal by 6 a.m. (Chapman).

Switzerland.

*HBO, 11402kc., 26.32m., Geneva: This League station is again on the air; heard one Sunday at 7 p.m. (Chapman).

Vatican City.

*HVJ, 15120kc., 19.84m., Vatican City: May be heard at times just before midnight.

U.S.S.R.

*New station, call and location unknown, on 9680kc., 30.97m. Scheduled from midnight-6.20 a.m.; very loud on opening. (Chapman).

*New station on 11640kc., 25.77m. Used irregularly; very loud. (Chapman).

*New station on approx. 5710kc., 52.4m. Heard nightly at good strength.

*RKI, 7520kc., 39.89m., Moscow: Not used regularly; heard sometimes at midnight.

Also logged: RV-96, on 19.47, 19.75, 31.51 and 49.75m.; RAN, RNE and RKI, 19.95m.

France.

*Paris Mondial, 11843kc., 25.35m.,

Paris: New 100kw. station; strong signal in early morning. (Bantow).

Paris Mondial, 9680kc., 30.99m., Paris: Much weaker now in afternoons. (Bantow).

*TYA-2, 9040kc., 33.19m., Paris: Now heard again in late afternoons.

Also logged: TPA-2, TPB-3, TPB-6, TPA-4, TPB-11 (41.21 and 25.23m.) and TPB-12.

Italy.

*2RO-15, 11760kc., 25.5m., Rome: New station, heard testing at 1 a.m.; very strong.

*2RO-5, 15170kc., 19.78m., Rome: Also a new station, testing around midnight.

Also logged: 2RO-3, 2RO-4, 2RO-9, 2RO-6, 2RO-8, 2RO-12, IRF, IQY, IQA.

England.

The best stations on the Daventry transmissions are set out below:—

Transmission 1: Early, GSD; after 6 p.m., GSF and GSD.

Transmission 2: Before midnight, GSJ; after midnight, GSF.

Transmission 4a: GSD.

Transmission 4b: GSB and GSD.

Transmission 5: Signals from all stations poor.

Transmission 6: Very poor

Letter-Box Section.

Joseph A. Bull, Caron, W.A.: Thank you for interesting letter and kind offer of assistance. Have written you re latter matter.

H. Whyte-Meach, Sydney, N.S.W.: Pleased to hear your views on contest. Am writing you further re matters mentioned.

Tom Cows, Timaru, N.Z.: Received your cheery note. Am forwarding information required.

Eric W. Watson, Christchurch, N.Z.: Pleased to get your views on club management. Sorry I could not assist with publicity. Will write you in near future.

R. A. Kelly, Wellington, N.Z.: Thank you for notes. Have sent you information by separate letter.

M. E. Tribe, Inglewood, N.Z.: Sorry to hear about your set. Write again.

G. E. Notley, Moonah, Tas.: That is the sort of letter I want. Send me a monthly list of loggings.

Merv. A. Branks, Invercargill, N.Z.: Merv. is B.C. Editor of the N.Z. "DX-tra." Thanks for letter, Merv. Noted source of QRM. Especially bad at nights, they tell me. Hi! Hi!

Ray Simpson, Concord, N.S.W.: Can't agree B.C. DX is difficult. Write again.



Inter-Club Notes.

N.Z. DX Club: We are much indebted to this club for its kind offer of assistance from time to time and all members of this club are eligible to compete for the Pacific Trophy. Persons requiring further information should write to Merv. A. Branks, 5 Dublin Street, Invercargill, N.Z.



Best Stations Of The Month.

Owing to the poor reception from Asia at the moment, it is proposed to publish a European list in three parts.

Anyone desiring information should write to me C/- 188 Chapel Street, Prahran, Victoria. Return postage is unnecessary.

Here is Part I. of the European list:—

536kc., 10kw., Bolzano, Italy: Identifies with whistle or song of a nightingale.

536kc., 50kw., Wilno, Poland: Signal was call of cuckoo and, if relaying from Warsaw, they superimposed the letter "W" over the programme being relayed. Signal now, if still on air, would probably be same as German stations.

546kc., 120kw., Budapest, Hungary: Interval during programmes; a phase of nine notes in two-part harmony, four notes repeated, followed by

Broadcast Band DX Notes Conducted by Kevin A. Crowley

Station Notes And News.

Australia: The P.M.G.'s Department has notified us of the following changes:—2RG, Griffith, to 1070 kc., power increase to 200 w.; 2XL, Cooma, to 920kc.; 3UL, Warragul, to 880kc.; 4VL, Charleville, to 920 kc.; 5MU, Murray Bridge, to 1460kc.; 7DY, Derby, to 1450kc.; 7UV, Ulverstone, to 900kc.; 2BH, Broken Hill, to 570kc.; 4AY, Ayr, to 970kc.; 2DU, Dubbo, power to 150w.; 4RO, Rockhampton, power to 200w.

America: List of new call signs and frequency changes will be published next month.



Specials.

American stations are the best midnight scoops at the moment. Listen for them between 11 p.m. and 1 a.m.

Listen for these. They are very easy loggings at present:—

600kc., KFSD, San Diego.

610kc., KFRC, San Francisco.

640kc., KFI, Los Angeles.

680kc., KPO, San Francisco.

780kc., KEHE, Los Angeles.

790kc., KGO, San Francisco.

900kc., KHJ, Los Angeles.

1010kc., KQW, San Francisco.

1050kc., KNX, Los Angeles.

1300kc., KSL, Salt Lake City.



Contest Notes.

The Editor of "Radio World" has kindly donated three twelve-month subscriptions to "R.W." as additional prizes in the Pacific Trophy contest. Dx-ers will best show their thanks by entering wholeheartedly into the contest.

Allocations of these prizes is as follows:—(1) Best Australasian log; (2) best Indian log; (3) best Chinese log. Receiver, location and time of reception will all be considered in awarding these prizes.

initial notes, thus: G sharp, BABG sharp, BABG sharp. Call, "Hallo. Itt Radio Budapest," followed by "Hallo! Hier Budapest" and "Voici le poste radiophonique, Budapest, Hongrie."

556kc., 100kw., Beromunster, Switzerland: Interval signal: Clock ticking. Male announcer. "Hallo, hier Schweizerischer Landessender, Beromunster." Relays to other Swiss stations.

565kc., 100kw., Athlone, Eire: Dual announcements in Gaelic and English. Identification signal not known.

565kc., 3kw., Catania, Italy: See Bolzano, 536kc.

565kc., 10kw., Klaipeda, Lithuania: Not known to make English announcements. Identification signal unknown.

565kc., 3kw., Palermo, Italy: See Bolzano, 536kc.

574kc., 100kw., Stuttgart, Germany: Uses a metronome (ticking 200 times per minute) during intervals in programme. Signs with "Heil Hitler."

583kc., 20kw., Alpes-Grenoble, France: Announces only in French. Identification signal unknown.

583kc., 50kw., Madona, Latvia: No information available. Should be loggable in Australia.

592kc., 100kw., Vienna, Germany: Same as Stuttgart, 574kc.

601kc., 15kw., Athens, Greece: No particulars available.

601kc., 10kw., Sunsvall, Sweden: See Stockholm, 704kc.

610kc., 20kw., Florence, Italy: See Bolzano, 536kc.

620kc., 15kw., Brussels, Belgium: All announcements in French. Call "Ice, Bruxelles, emissions d'essais," repeated between sessions and most items.

625kc., 10kw., Kourbyshev, U.S.S.R.: Does not feature English session. Closes with "Internationale."

629kc., 20kw., Christiansand, Norway: No information available.

629kc., 20kw., Lisbon, Portugal: English sessions unlikely.

629kc., 20kw., Trondelag, Norway: No information available.

638kc., 120kw., Prague, Germany: Announcer says, "Halo! Radio Praha Vysila" in Czech, German, French and English.

648kc., 10kw., Petrozavodsk, U.S.S.R.: See 625kc.

658kc., 100kw., Cologne, Germany: See Stuttgart, 574kc.

668kc., 70kw., North Regional, Gt. Britain.

677kc., 100kw., Sottens, Switzerland: Male and female announcers. "Allo! Allo! Ici Radio Suisse Romande Sottens" ("Geneve," "Lausanne").

686kc., 20kw., Belgrade, Yugo-Slavia: Announces in German and in Italian, as well as in Croat.

695kc., 120kw., Paris, France: Identification signal unknown but announces frequently as "Radio Mondiale."

704kc., 55kw., Stockholm, Sweden: Call, "Stockholm Rundradio," or "Stockholm Motala," if Motala is relaying. Call is repeated. Relays to several stations throughout Sweden.

713kc., 120kw., Rome, Italy: Signal, bells of Rome and whistle of birds. Announcer says, "Radio Roma," or "Radio Roma-Napoli."

722kc., 1kw., Frederikstad, Norway: No information available.

722kc., 17kw., Hilversum 2, Holland: Call, "Hier, Hilversum, Holland," coupled with name of broadcasting company providing the broadcast.

722kc., 10kw., Kharkov, U.S.S.R.: See 625kc.

731kc., 3kw., Madrid, Spain: No information available.

731kc., 5kw., Seville, Spain: No information available.

740kc., 100kw., Munich, Germany: See 574kc.

749kc., 100kw., Marseilles, France: No information available.

749kc., 1kw., Pori, Finland: See Helsinki, 895kc.

758kc., 120kw., Katowice, Poland: Very doubtful if still on air.

767kc., 60kw., Burghead, Great Britain.

776kc., 250kw., Sortavala, Finland: See 895kc.

776kc., 10kw., Italino, U.S.S.R.: See 625kc.

776kc., 120kw., Toulouse, France.

785kc., 120kw., Leipzig, Germany: See 574kc.

795kc., 7.5kw., Barcelona, Spain: No information available.

795kc., 50kw., Lwow, Poland: Probably off air now.

804kc., 5kw., Penmon, Anglesey, Great Britain.

804kc., 70kw., Welsh Regional, Great Britain.

814kc., 50kw., Milan, Italy: See Bolzano, 536kc.

823kc., 12kw., Bucharest, Roumania: Uses metronome (160 beats per minute).

832kc., 35kw., Kiev 2, U.S.S.R.: See 625kc.

832kc., 40kw., Rueil-Malmaison, France.

832kc., 10kw., Stavanger, Norway: Has been verified by Australian dx-ers.

841kc., 100kw., Berlin, Germany: See 574kc.

850kc., 1kw., Porsgrund, Norway.

850kc., —, Saragossa, Spain.

850kc., 100kw., Sofia, Bulgaria.

850kc., 3kw., Valencia, Spain.

859kc., 10kw., Simferopol, U.S.S.R.: See 625kc.

859kc., 100kw., Strasbourg, France.

868kc., 50kw., Poznan, Poland: Probably off air now.

877kc., 70kw., London Regional, Great Britain.

886kc., 15kw., Graz, Germany: See Stuttgart, 574kc.

886kc., 15kw., Linz, Germany: As for Graz.

895kc., 10kw., Helsinki, Finland: Male and female announcers. All announcements and calls given in Swedish and Finnish. May not be transmitting now. Most Finnish stations relay Helsinki.

895kc., 1.5kw., Limoges, France.

Should any reader be able to furnish further information regarding stations listed above, we would be very grateful to receive such information.



Review Of Conditions and Listening Times.

The American and Europeans are now booming in. Best times for DX are:—11 p.m.-1 a.m. (Yanks) and 2.30 to 6 a.m. (Europeans).

The changeover to summer conditions has proved rather trying because of the static barrage. DX, however, has been exceptionally good, and many FB catches have been reported.

DX is better than in January, 1939, and it looks like a bumper year for Europeans between now and early April, because many stations are opening earlier and closing later because of present European politics. We may yet again hear the broadcast of the bombing of cities by air, such as we experienced during the Spanish conflict in 1936.

QSL Exchange Bureau.

The following readers would like to exchange QSL cards with members of the All-Wave All-World DX Club:—
A. E. Watson, Lloyd St., Murtoa, Victoria.

John H. Lilburne (AW541DX), Post Office, Murtoa, Victoria.

Percival Roy Horan (AW531DX), George St., Bowen, Nth. Q'land.

L. R. J. Knighton (AW298DX), 245 Armagh St., Christchurch, New Zealand.

Code Practice Oscillator.

(Continued from page 7)

could learn the code together. The circuit is shown in the accompanying diagram.

A simple oscillating valve is used with a standard broadcast coil. Such valves as the 30 in the 2-volt series or an A415 or a B406 in the 4-volt series would be ideal for this purpose.

With the switches in the positions shown in the diagram, communication is from A to B. At the end of a message the switches are switched

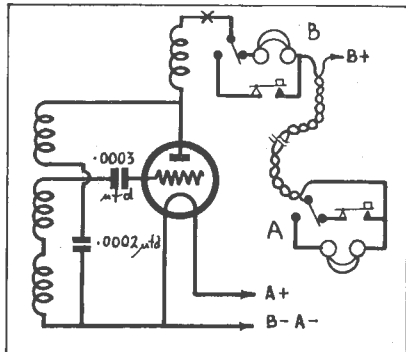

over and communication is reversed.

A recorder inserted at the point marked "X" will help to correct faulty sending, and will also act as a guide to messages sent and received.

The layout can be arranged to suit the constructor, so long as "A" is on one baseboard and "B" and the oscillator on another.

"Radio World" All-Wave Oscillator.

(Continued from page 24)

monics of the fundamental frequencies generated by the oscillator are used in this test, which is carried out in the following way.

Switch the oscillator to band "1," and adjust the pointer to 475 k.c. The first harmonic of this frequency is 950 k.c., which is 2UE's frequency of transmission. Now adjust for zero beat as before. Similarly, the second and third harmonics of 175 k.c. are 700 and 1400 k.c., respectively, stations operating on the former being 2NR, Northern Rivers, N.S.W., and 7DY, 2PK and 4MB. (The station chosen for the check will of course depend on the builder's location).

With the calibration of bands "1" and "2" checked in this way, and adjusted if necessary, the oscillator is ready for service. (The three short-wave bands require no adjustment; their calibration is not so critical, and

is guaranteed to be substantially accurate).

Complete information on the procedure of aligning receivers—both superhet and t.r.f.—using a service oscillator is given in the excellent Radiotron Lecture Service series of articles at present being published in "Radio World," and so nothing further on these lines is needed.

Sufficient to say that builders of this instrument will be delighted with its flexibility, accuracy of calibration, and ease of operation, especially in view of its low initial and upkeep costs.

Output Meter Description.

While alignment of receivers by ear using a service oscillator is fairly accurate, for maximum possible accuracy in the adjustment of tuned circuits, the use of an output meter is recommended.

An instrument of this type can be built very cheaply, while the construction and operation are both perfectly straightforward. Full constructional data will be published in "Radio World" in the near future.

Modulated Oscillators.

(Continued from page 12)

Editor's Note: The continuation of this article will be found overleaf.

Daventry Dual-Waver.

(Continued from page 5)

transformer panel to the rectifier plates. The remainder of the components, with the exception of the dual-wave coil unit, can now be mounted.

Next, commencing at the plate of the 6K8G mixer oscillator, wire the first i.f. transformer, then the pentode section of the 6G8G second i.f. transformer. 6G8G diodes, 6J7G and finally the 6V6G.

All pigtail components are taken point-to-point, except in cases where

support is required in the form of a terminal strip, supported clear of the chassis by means of $\frac{3}{4}$ " bolts and brass spacers.

Short Direct Wiring Essential.

All wiring should be as short and direct as possible, and well-spaced. The three leads from the volume control, which is mounted on a bracket near the centre of the chassis, should all be covered with shielding braid for their entire length, the braid being earthed at various points. Note also that in the case of the three dry electrolytics, the ends painted red or otherwise indicated as being positive should be connected to cathode.

A Yaxley 6 x 12 single-deck switch has been used for the changeover to pick-up. Though shown on the front wall of the chassis in the wiring sketch, it is actually mounted on the back wall by means of spacers, the shaft being extended by means of a coupler, $\frac{3}{4}$ " brass rod, and a bush. Note that three leads from this switch are lettered A, B and C, their destinations being marked correspondingly.

The next step, following completion of the wiring as far as possible without mounting the coil unit, is to bolt the latter in place and wire it. In the underchassis diagram, leads going to the coil unit are all numbered, and their destinations will become apparent when the diagram is studied in conjunction with that of the coil unit published elsewhere.

The numbered leads and their destinations should be studied in conjunction with the colour coding slip supplied with each unit.

Check Of Wiring Essential.

After all coil unit connections have been made, the wiring should be thoroughly checked. The chassis is then inverted, and the grid clips and control knobs fitted. Next, the valves and speaker can be plugged in, the aerial and earth connected up, and the set switched on.

If the rectifier shows any signs of distress in the form of flashes or a blue glow, then switch off immediately, as this indicates a serious error in the wiring. If, however, the heaters all light up and a faint hum is heard from the speaker, it can be assumed that everything is in order, and that the set is ready to be aligned.

Aligning The Set.

To do this, set the wave-change switch to broadcast and turn the volume fairly well up. There should now be a fair amount of noise coming through the speaker.

Please Note New

**"RADIO
WORLD"**

Address:

117 Reservoir St.,
Sydney.

Telephone FL 2842

The chassis can now be inverted and the broadcast band alignment completed. Set the broadcast aerial and oscillator trimmers about half-way out (see under-chassis photo) and the padder about one-quarter way out.

Next, tune in a station somewhere around 220 metres and adjust the aerial trimmer for best results. Then swing over to the other end of the band and tune in a station on about 500 metres. The padder should be turned gradually while the dial is being rocked backwards and forwards over the station. A point will be found where volume is loudest, and this is the correct setting.

The entire process can be repeated, when the broadcast alignment should be fairly exact.

On the short waves, all that is necessary is to tune in a station on about 25 metres, and adjust the s.w. oscillator trimmer for best results.

Taken all round, the "Daventry

Dual-Waver" is an outstanding design that would be difficult to improve upon. Both gain and selectivity are excellent, volume is more than ample for domestic use, and tone compares favourably with that from many first-grade consoles.

Modulated Oscillators.

(Continued from page 12)

Radiotron Modulated Oscillator.

Fig. 15 shows a practical design for a modulated oscillator. The radio frequency voltage is generated by a 6J7G connected as an electron-coupled oscillator, and the output is taken from a 50,000 ohm potentiometer in the plate circuit. A reasonably smooth control may be obtained if a well-tapered potentiometer is used in this position. The various bands are selected by means of a double-pole six-way wave-change switch. Modulating voltages are applied to

the suppressor grid of the oscillator valve, the depth of modulation being controlled by the 0.5 megohm potentiometer.

The second 6J7G may be used either as an audio amplifier for external modulation voltages, or as a Hartley oscillator for internal modulation.

Reasonably sinoidal wave-form may be obtained by using for the inductance a standard push-pull speaker transformer. The associated components marked with an asterisk were correct in the experimental model but may need modification with different transformers.

The power supply shown is recommended, although any other may be used which provides the required supply voltage and current. If the oscillator is to be really useful it should be fully calibrated on all bands, preferably by drawing a complete set of curves of frequency against dial setting.

(To be continued next month)

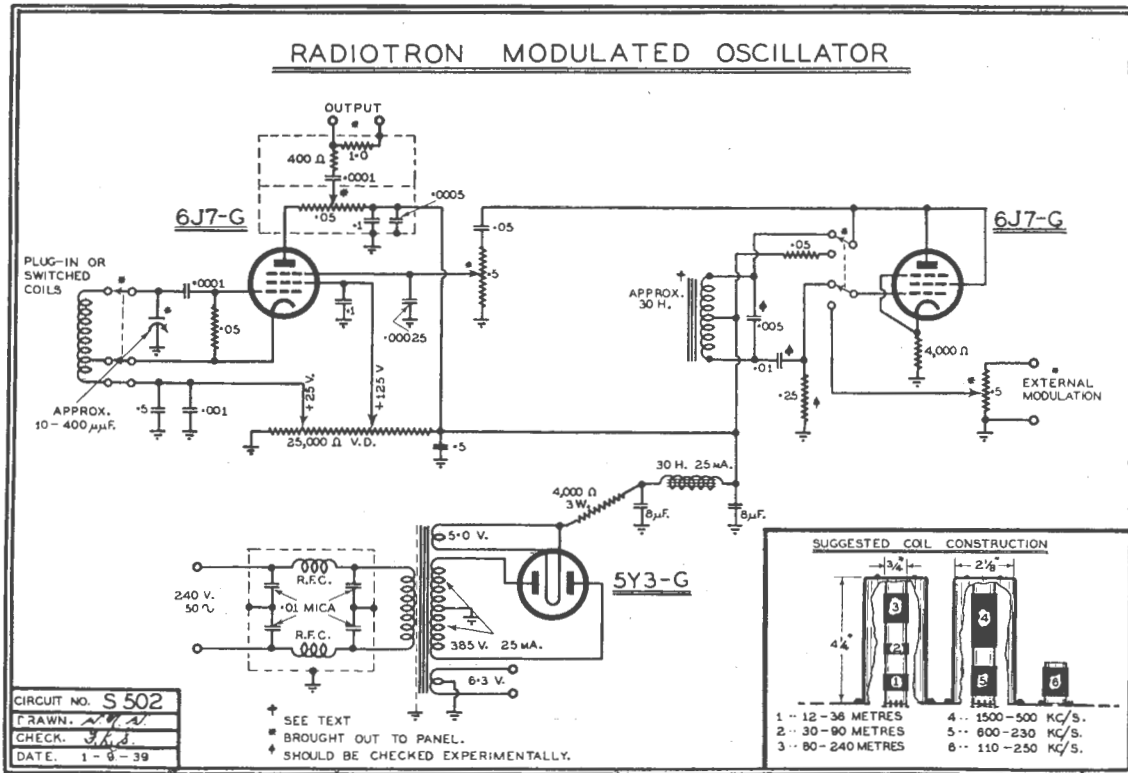

Fig. 15. Circuit arrangement of Radiotron Modulated R.F. Oscillator.

APPROXIMATE COIL DATA.

| Band | Wire | Turns | Layers | Tap* | Winding |
|----------------|------|-------|--------|------|-------------|
| 12-36 Metres | 22 | 7.5 | 1 | 1.5 | 16 T.P.I. |
| 35-105 Metres | 27 | 19.5 | 1 | 2.3 | Close Wound |
| 80-240 Metres | 27 | 19 | 1 | 6 | Close Wound |
| 1500-500 Kc/s. | 31 | 190 | 1 | 15 | Close Wound |
| 600-210 Kc/s. | 31 | 310 | 3 | 20 | Length = 1" |
| 250-100 Kc/s. | 33 | 610 | 5 | 30 | Length = 1" |

*Should be adjusted for best results.

Incomparable



IN PERFORMANCE ★ IN BEAUTY ★ IN VALUE

The new 5-valve Fisk Radiola table model strikes an entirely new note in radio receiver design. Matchless tone quality enables programmes to be received with unbelievable realism, extreme sensitivity is provided by new A.W.A. circuits and improved tuning arrangements set new standards in convenience and efficiency. The strikingly beautiful cabinet has exquisitely graceful lines and is a masterpiece of modern streamline simplicity. Moulded in durable "Radelec" it is available in a range of attractive colours.

New built-in loop aerial—just plug in to power or light socket!



Ebony or Walnut
.... 16 guineas

Jade Green or
Ivory, 17 guineas
(A.C. operation)



THE FISK **RADIOLA**

AUSTRALIA'S FINEST
BROADCAST RECEIVER

Manufactured and Guaranteed by Amalgamated Wireless (Australasia) Limited

The Australasian Radio World, January 1, 1940.

Most versatile instrument ever!



THE
D1503 **DELTA**
MULTITESTER



- ★
- 1. COMPLETE VALVE TESTING (American and Continental Valves). (Emission Method).
- 2. SET ANALYSER (A.C./D.C. Voltage, D.C. Milliamperes, Ohms).
- 3. CONDENSER TESTER. ● Combines in one instrument the equivalent of eight separate units. ● Complete tests for all valves by the emission method. ● Separate Diode Test. ● Neon Short Test detects slightest leakage. ● Electrolytic Condenser test. ● Paper Condenser Test (for shorts and opens). ● D.C. Voltmeter 10-50-250-1,000 Volts at 1,000 ohms per volt. ● A.C. Voltmeter 10-50-250-1,000 volts. ● D.C. Milliammeter 1-10-50-250. ● Ohmmeter, 0.2-10 megohms, in four ranges, 0.2-500 ohms; 0-10,000 ohms; 0-100,000 ohms; 0-10 megohms. ● Line voltage adjustment.
- Attractive, durable, black, silver and red etchea panel. ● Triplet Model 426 D.C. Instrument, square de luxe case, 4½" x 4½,"
- Portable leatherette covered case, 15" x 9" x 6½," sturdily constructed. ● Full instructions and accessories.

PRICE £16/10/-.

Save 30/- on the Triplet Signal Generator Model 1230

Still a few left at these greatly reduced prices. Previously £6/10/-, NOW £5. Secure yours while they last. Model 1230 All-Wave Signal Generator supplies a continuously variable signal. Frequencies are 100-18,000 k.c., controlled on six fixed positions. Batteries, tubes and six individually calibrated graph charts are supplied. Price, £5 (for one month only and available to readers of "Radio World" exclusively).

★
W. G. WATSON & CO. PTY. LTD.
279 CLARENCE STREET, SYDNEY.
BRANCHES ALL STATES.