

THE
AUSTRALASIAN

Registered at the G.P.O.,
Sydney, for transmission
by post as a periodical.

Radio World

1/-

VOL. 13 NO. 6

NOVEMBER 15, 1948

SOUND!



When you think of Sound think of the new Rola Model 8 M (P.A. Type) loudspeaker, which has been specially engineered for Sound system designers and users. Model 8 M (P.A. Type) has been designed to provide the utmost in intelligibility — that crisp, clean speech reproduction

which is an essential in any Sound system. To facilitate flexible and economical stockage we supply Model 8 M (P.A. Type) without transformer, but provide a range of Type "C" Isocore transformers to match impedances from 500 to 25,000 ohms to the voice coil of the loudspeaker. Transformer mounting brackets are fitted to each loudspeaker. For high sensitivity, brilliant response and large power handling capacity select the Rola 8 M (P.A. Type). It's a sound investment for Sound.

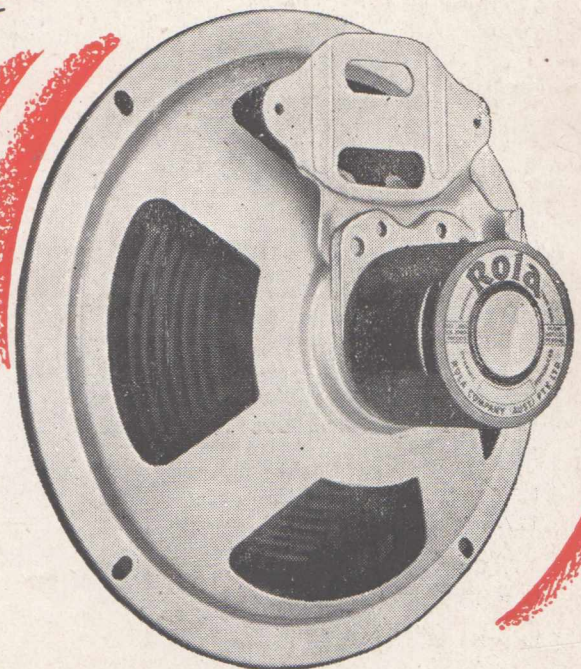

ROLA LOUSPEAKERS WITH ANISOTROPIC ALNICO

ROLA CO. (AUST.) PTY. LTD., THE BOULEVARD, RICHMOND, VIC.
ALSO AT 116 CLARENCE ST., SYDNEY

CROWN COMPONENTS

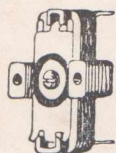
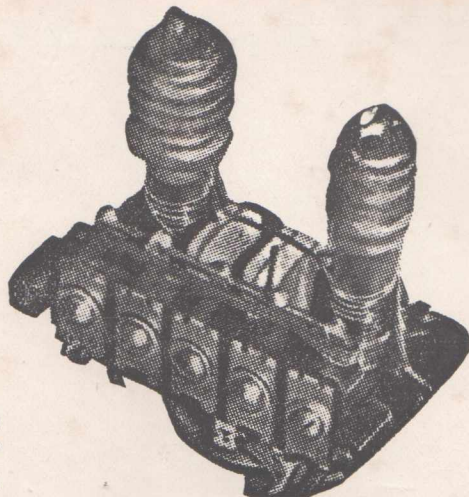

**P.12.
STANDARD
5-PLATE
PADDER
CONDENSER**

455 Kc. using Polystyrene base.
For use in conjunction with H.
gang condenser. Price 2/6.

**455 Kc.
STANDARD
"PERMA-
TUNED" I.F.
TRANS-
FORMER**



In aluminium Can. First Stage
P.T.31, Second Stage P.T.32.
Price, 13/9.

**IRON CORED
SHORT WAVE
COILS**

I.C. 62 aerial,
I.C. 63 R.F.,
I.C. 64 oscillator,
13 to 42 metres, for use on
standard H. gang. Price 4/9.



**D.C. 2A TUNING
UNIT**

(13 to 42 metres) 1600
to 550 Kc/s. for use
with H gang condenser.
Suitable for compact
chassis construction. Price, 36/-.

**STANDARD "PERMATUNE" COILS
IN ALUMINIUM CANS**

Aerial PC53, R.F. PC54, Osc. PC55. Iron-
cored. For use with H gang condenser. Wound
on Polystyrene formers. Price 8/9.

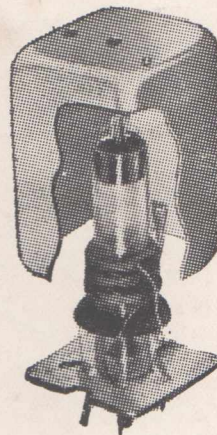

**AIR CORE
S/W COILS**

13 to 42 metres,
Z.C.59 aerial,
ZC.60 R.F., ZC61
oscillator, for use
with H gang.
Price, 2/10 Each.



**M.E.B.
TRIMMER
CONDENSERS**

2 to 35 mmfd. on
Polystyrene base.
Price, 1/1.



R.F. CHOKE

Standard general
purpose honey
comb winding, will
carry up to 50
M/a. Price, 1/10.



D.P. 3A Tuning Unit: 3 Stage, range 13 to
42 metres, 1,600 to 550 Kc/s. Price,
£4/17/-.

B.F.O. 455 Kc/s. Oscillator Coils. Price,
12/-.

R.F. Coil with reaction in aluminium can.
Price, 9/10.

Reinartz Coil in aluminium can. Price, 7/6.

Crown 
RADIO PRODUCTS PTY. LTD.

51-53 MURRAY ST.

PYRMONT, SYDNEY. TELEPHONE: MW 2628

THE AUSTRALASIAN RADIO WORLD

Devoted entirely to Technical Radio

and incorporating

ALL-WAVE ALL-WORLD DX NEWS

PUBLISHED BY THE PROPRIETOR—

A. G. HULL,
Balcombe St., Mornington, Vic.
Phone M'ton 344.

Technical Editor—

PAUL STEVENS
21 Fletcher's Av., Bondi, N.S.W.
Phone FW 6157.

Short-wave Editor—

L. J. KEAST
7 Fitzgerald Rd., Ermington, N.S.W.
Phone WL 1101.

Ham Notes by—

DON B. KNOCK (VK2NO)
43 Yanko Av., Waverley, N.S.W.

ADVERTISING REPRESENTATIVES—

In N.S.W.: Amalgamated Publications
Pty. Ltd., 83 Pitt St., Sydney. Phone
B 1077.

In Victoria: R. I. McKillop, Regency
Advertising Contractors, 60 Market
St., Melbourne. Phone M 1279.

REPRESENTATIVES

In Queensland: John Bristoe, Box 82,
Maryborough, Q.

In New Zealand: H. Barnes & Co., 4
Boulcott Terrace, Wellington.

In England: Anglo Overseas Press Ltd.,
168 Regent St., London, W1.

*Distributed throughout the World
by Gordon & Gotch (Asia) Ltd.*

SUBSCRIPTION RATES—

12 issues 10/6

24 issues £1

To N.Z. and Overseas:

12 issues 12/-

POST FREE

Address for all correspondence—

AUSTRALASIAN RADIO WORLD
Box 13, Mornington, Vic.

Vol. 13

NOVEMBER, 1948

No. 6

CONTENTS

De-Luxe Amateur Receiver	5
Equipment Valves For 1949	9
The Man Before Marconi	11
Junior Feedback Amplifier	15
Home-Made HI-FI Pick-Ups	17
A Personal Radio Set	19
The "Q-Plus" Coils	22
Resistor Faults	25
R.C.S. Coils Submerged	29
Tuning Range For Receivers	30
Among Our Readers	31
Calling C.Q.	35
Shortware Review	39
Speedy Query Service	42

EDITORIAL

The announcement that the Government intends to restrict the use of Frequency Modulation to the national broadcasting service is a sad blow to the radio industry.

Frequency modulation offers great possibilities for expansion and development, if only we were blessed with authorities who would allow the ether to be as free as the air we breathe or even as open as the roads we travel. The use of F.M. could be a boon to civilisation.

Imagine the radio development which would follow if the present broadcasting system was retained intact, but 25 extra F.M. stations licensed in every major town. You could have a station for the local newspaper in Bathurst, for example, as well as one operated by each local church, another by the Masonic lodge, another by the local town Council, one by the local departmental store. And then at Orange, a few miles away, you could have another twenty-five stations, operating on similar wavelengths, yet not interfering with the Bathurst stations. Each transmitter could be a simple affair with a power rating of a hundred watts or less and costing about £100. With such a set-up it would be only a matter of months before every home would have an F.M. receiver alongside the present receiver.

What objection can be raised to such a scheme is beyond me. Possibly the present owners of commercial licences would be afraid lest so many additional licences would affect the goodwill of their present licences.

As it is, I will be amazed if there is a rush of buyers for F.M. sets on which to receive a relay of the national programme!

—A. G. HULL.

F.M.

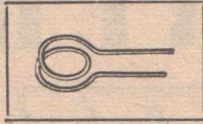

COILS

FOR R. & H. F.M. TUNER

These coils are machine wound from No. 12 gauge copper wire heavily silver plated, and are accurately spaced to cover the F.M. band 88-110 M/C.

Aerial Coupling Coil
Aerial Coil
Oscillator Coil

Type E362 2/6 ea.
Type E363 2/6 ea.
Type E364 2/6 ea.

F.M. 10.7 MEG. INTERMEDIATE TRANSFORMER

Type No IF180. Price 13/- ea.
Wound on Polystyrene Formers, moisture proofed with high frequency lacquer. Can size 1 3/4" dia x 2 1/2" High. 50 mmf silver mica condenser moulded in base necessary at these high frequencies.



NEW STANDARD INTERMEDIATES

455 K.C. I.F.'s—with shunt silver mica Condenser Moulded in Base.
IF170—1st IF171—2nd. 13/- ea. IF174 Low Gain, 13/- each.

NEW PERMEABILITY TUNED COILS

- 1 Wound on Polystyrene formers.
- 2 Engraved with number and letters for easy identification.
- 3 7/41 2 pie litz High Q Secondary.
- 4 Extra High Impedance Primary.
- 5 Fitted in round shield 2" high x 1 3/4" dia with 2 mounting feet, 1/8" Whitworth thread.
- 6 The can being printed with all technical specifications etc.
- 7 Polystyrene sealed coils.
- 8 Special sealing channel for iron core screw.
- 9 Cores adjustable from top of chassis



E356 Aerial
E357 R.F.
E358 Osc.
7/6 each retail.

MIDGET VARIABLE CONDENSERS

M.C. Type with Face and Back Supports

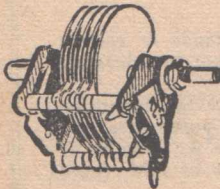

Type	mmfd	Plates	Price
CV41	10	2	7 3
CV42	15	3	7 9
CV43	25	4	8 4
CV44	35	5	9 0
CV45	50	7	9 6
CV46	70	9	10 0
CV47	100	14	11 3



VIBRATOR CHOKES

TC58 Low Tension 3 Amps 50 M/H 5 ohm D.C. Res. 15 0
TC70 High Tension 50 Henries 450 ohm D.C. Res 75 M/A 15 0

FILTER CHOKES

TC60 100 M/A 30 Henries 250 ohms D.C. Res 13 6
TC65 50 M/A 30 Henries 400 ohms D.C. Res. 13 6
TC79 125 M/A 30 Henries 13 6

RADIO FREQUENCY CHOKES

RF81 Silk Honeycomb R.F. 1 9
RF82 3 pie 1.7 M/H R.F. 4 6
RF83 4 pie 2.5 M/H R.F. 4 6
RF84 5 pie 4.0 M/H R.F. 4 6
R.F. 85 6 pie 7.0 M/H R.F. 4 6
RF86 Cotton Honeycomb R.F. 1 6
RF106 Vibrator Low Tension R.F. 4 3



F.M. DISCRIMINATOR TRANSFORMER RADIO DETECTOR

Type No. IF181 Price 17/6 ea.
Freq 10.7 mags. Cap 50 mmf.
Wound on Polystyrene Formers, moisture proofed with High Frequency Lacquer. Can size 1 3/4" dia. x 2 1/2" High. 50 mmf silver mica Condenser moulded in base necessary at these high frequencies.



IF YOUR LOCAL DEALER CANNOT SUPPLY

If you have been unable to purchase R.C.S. components from your local retailer, write us, and whilst we cannot supply you direct, we will arrange for your retailer to receive supplies immediately or advise you where supplies can be obtained.



DE-LUXE AMATEUR RECEIVER

Here is the story of how one of our most prominent Hams built himself a fine communications receiver using coils which give wide coverage, yet cost quite a moderate sum. The complete circuit is too much to publish in full, but anyone with sufficient technical knowledge to tackle this job will have little difficulty in working it out, using the circuit in the July issue as the basis and making amendments as outlined in this article.

THE old receiver like "Topsy" had just grown. From a simple Don Knock amateur receiver of five tubes it had, after years of trying this that and the other developed into a nine tube job with double conversion among

So it was decided to really "go to town" with the construction of a brand new receiver which would incorporate all the good points proven in the old job together with some new ones as well as an entirely different appearance—a "new look" in fact.

By
ALF. BARNES (VK2CE)

87 Murrivierie Road
North Bondi, N.S.W.

other things and was a pretty good performer.

The trouble was that all this experimenting had taken place without a change of well-ventilated chassis and panel. Speaker and power supply were separate accessories and to be quite truthful the writer thought it high time that a complete change was made.

Most of all, band-switching for purely amateur coverage would be incorporated, arguments against this notwithstanding, and with this in mind much checking through periodicals and queries over the air took place.

As far as overseas factory-built receivers are concerned the writer is firmly convinced that the inflexible amateur rule "Short leads essential," is mostly ignored. We have never personally had the opportunity of examining the under-chassis of a factory-built receiver, but by careful proportionate measuring from photographs in "Q.S.T." We have been able to

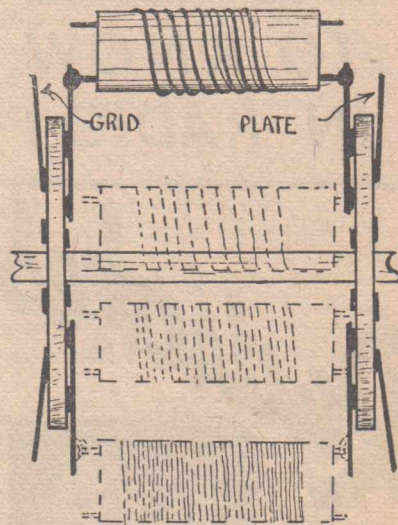

Method of mounting coils on switch.

get a good idea of what is done.

Take one of the high priced American jobs for instance. It has three rows of coils with five coils per row and taking the ten meter coil which is nearest the valve socket we have from grid pin to coil switch a five inch lead. Next we find a three inch lead from switch to coil, a six inch lead from switch to band-set condenser and finally a five inch lead from switch to band-spread condenser. The lower frequency coils have still longer leads because they are further from the valve sockets.

To shorten a long story we had decided to copy the arrangement of this factory built job, but this plan went by the board when we heard about the introduction of

(Continued on next page)

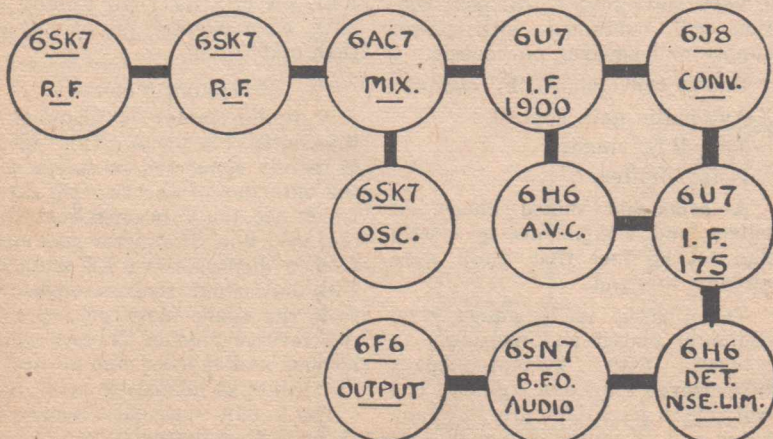

Diagram to explain the valve line-up.

Radiokes

**THE NAME
TO KNOW
IN RADIO!**

Radiokes

RADIOKES D.W. UNITS. Highly selective with exceptional wide range. To match 'H' type gang condenser. Incorporates 4-in-1 podder. Solidly mounted with coils. Ask for type DWO-1

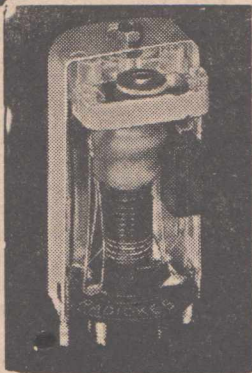

When buying radio parts and components, follow the lead of amateurs and experts alike — specify Radiokes — your guarantee of test-set performance, precision construction and technical excellence.

RADIOKES

PTY. LTD.
P.O. BOX 90
BROADWAY — SYDNEY

R-56

Page 6

DE LUXE

(Continued)

locally made coilsets especially designed for band-switching receivers. These coils incorporate an exceedingly cunning idea which does away completely with connecting leads between switch and hot coil leads. The coils are wound on polystyrene formers 1¼-in. long and ½" diameter, the windings terminating at a pair of pins at each end. At one end we have a grid pin and a B+ pin and at the other end we have the Plate pin and earth or A.V.C. The idea is to mount each set of coils between two switch wafers of the "shorting plate" type. The axis of the coils of course lie parallel with the the switch shaft. By so doing the coil pins are soldered directly to the switch contacts; one wafer switches grid circuits, and the other wafer switches plate circuits. B positive and Earths are common and all hooked together. With the correct type of switch installed, all unused coils are short-circuited—a most important feature. So then our coil switching problem was solved in a very satisfactory manner.

Coil Switching

We seem to have talked a lot on the subject of coil switching but this is due to the fact that this particular section called for more thought than the rest of the receiver put together. Other ideas put into our new receiver include—

Very solid mechanical construction self contained with power supply and speaker on chassis.

Double-conversion I.F. channel.

Automatic gain control.

Two R.F. stages.

Noise limiter.

A somewhat mixed choice of valves and components is mostly due to the fact that these were already to hand.

The Chassis is 16 gauge steel cadmium plated and measures 18 x 12 x 4 with bottom edges turned over for extra rigidity. The coil switch partitions are 16 gauge brass and 16 gauge copper shields are mounted across the single-



Diagram of coil connections.

ended valve sockets between grid and plate with a fold of thin sheet fibre to insulate the shield from adjacent low-potential socket lugs. The front panel is made from 16 gauge sheet steel enamelled bluish grey with speaker grill balancing home-made tuning dial. A large U shaped handle made from ¾" steel rod is bolted to each end of the chassis. These handles are handy for carrying receiver, but as well they make excellent supports when one is working with receiver upside down.

Tuning Condenser

The tuning condenser is made from an old substantially built four gang broadcast condenser. This was cut down to two stator and one rotor plate per section. The rotor plates were reduced in size to a semi-circle of ¾" radius. This arrangement gives ample band spread on 80, 40, 20, 15 and 10. Bandsetting is arranged for with a five gang commercial trimmer for each coil gang.

Controls from right to left are: RF gain, wave change, tuner, IF gain. Next a multi-contact switch with three positions, AVC on and BFO off, AVC off and BFO off, AVC off and BFO on. Finally we have noise-silencer on or off and then audio gain.

Tuning Meter

A tuning meter is mounted in top-centre of panel. This meter is merely connected in series with the cathodes of the two IF valves which are the only ones hooked to the AVC line. The meter was made from a disposals O-I RF ammeter with burnt out thermocouple. We took the scale plate off, sprayed the reverse side of it with white lacquer and marked out an arc of "S" points as judged by ear.

The 6J8 second converter changes from 1900 k/C to 175 k/C. It uses a standard self-controlled

circuit with home wound coil. No trouble has been experienced with drift or harmonics.

A.V.C.

Particularly strong AVC action is incorporated using a separate 6H6 valve fed through 100 pf from the second IF plate. No delay bias is used so that the noise level is kept well down for phone. For CW the AVC is shorted out and IF gain reduced with the manual control. RF stage normally operate with full gain.

Noise Limiter

The noise limiter circuit really does work. It is the most effective of many that have been tried. A switch is provided because the impact limiting effect interferes with the readability of CW, so we find the limiter particularly useful when the local click merchant appears on the band. Unlike many limiters, this one does not spoil quality or volume of telephony transmissions.

IF Channel

IN the past, receivers built by the writer had incorporated the common single-frequency channel of 465 kC or thereabouts. With this arrangement "pulling" of the high-frequency oscillator always was a problem and image interference in the form of Chinese music, etc., was ready to pop up in the middle of the twenty metre band at any time. A higher intermediate frequency of course is a cure for these troubles, but receivers equipped with such usually have tuning as broad as a barn door and as we have found even two or three 1900 kC IFS, do not provide nearly enough selectivity.

The obvious thing to do, failing a tricky crystal gate, is to use both high and low IF channels as the writer first did a couple of years ago. The first IF amplifier of 1900 kC presents an image-free amateur band, whilst selectivity to the reasonable limit for telephony is provided by the 175 kC second IF channel. Contrary to usual opinions, the 6J8 standard converter circuit does not give any trouble with frequency drift or excessive noise level and a few simple

calculations will show that harmonics from this converter do not fall into amateur bands.

It should be kept in mind that the main purpose of the intermediate-frequency channel is to provide selectivity with gain as a secondary consideration. Sensitivity should be part and parcel of the front end of the receiver design.

No Instability

With this double conversion job, IF oscillation and instability does not crop up because the two channels have widely differing frequencies. As mentioned previously, strong AVC is applied to the two IF grids by using a separate 6H6 without delay bias. This means that even a weak signal is sufficient to generate a bias voltage which flattens noise level. When switching in the beat-frequency oscillator for CW reception, it is necessary to back off the manual IF gain control as the signals will otherwise overload the IF and second converter stages.

R.C.S. Coils

The manufactured coils used in the band-switching front end are designed to work with a 465 kC IF channel and a 6K8 frequency changer. It was found that with one exception the mica compression coil trimmers would permit of tuning to the five bands when using the 1900 kC IF channel. We found it necessary to remove eight turns from the 80 metre oscillator coil.

The separate 6SK7 oscillator "squegged" badly at first on the

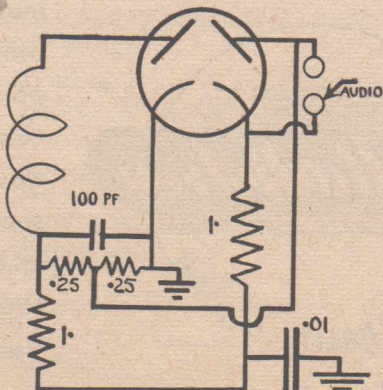

Circuit of noise limiter.

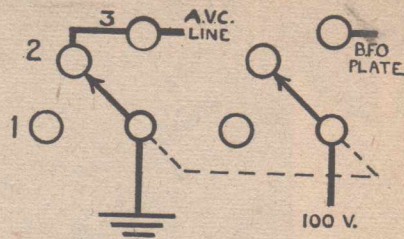

1	AVC. ON - BFO OFF
2	" OFF - " "
3	" " - " ON

Switching of the a.v.c.

ten metre band. In other words the same stations appeared in several places on the dial. This was cured by removing two turns from the ten metre oscillator plate winding.

The higher frequency bands called for a rather slack setting of the compression trimmer screws. It was felt that a setting like this may not be stable, so these trimmers were packed with additional pieces of mica so that the screws could be tightened a little more without getting out of resonance.

On "Ten"

Ten metres is of course the real testing ground for medium-high frequency receivers. The set described is the writer's best so far in spite of the fact that standard pentodes are used in the radio-frequency stages. High-gain tubes such as 6AC7 and 6AK5 etc., have been tried, but the difference in signal-noise ratio does not warrant a change, for with tubes of the latter type, cross-modulation and instability when at point of maximum sensitivity are extremely bothersome. It will be noted however that the writer uses a 6AC7 mixer. Without doubt this is the best mixer ever we have used.

Voltage regulation is not incorporated in the power supply. Such, if incorporated, may be a slight help only on the ten metre band where signals sometimes tend to drift off the dial setting.

It is certainly a pleasurable

(Continued on page 30)

Valve examination and test



Branding,
Packing and
Sealing

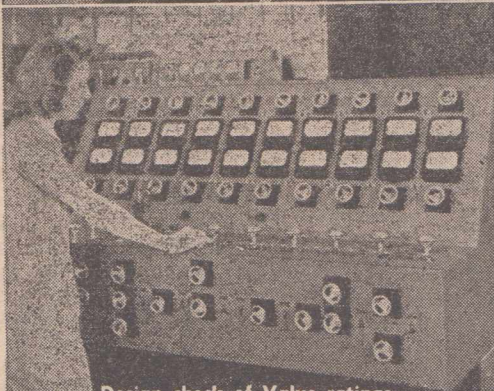

Design check of Valve ratings



**QUALITY
CONTROL**

Design for quality



Quality in a radio valve must be in-built during its production; only materials, parts and final assembly conforming strictly to laid-down standards, are responsible for Radiotron's maintained leadership as the "World's standard Valve".

AMALGAMATED WIRELESS VALVE COMPANY, PTY. LTD.

47 YORK STREET, SYDNEY.

EQUIPMENT VALVES FOR 1949

Every year the Amalgamated Wireless Valve Co. Pty. Ltd., manufacturers of Radiotron Valves, offers a list of recommended valve types for use by receiver manufacturers. Naturally this list does not include special types in other brands of valves, but is a handy guide to the types likely to be in steady production during the year.

THE following list shows the Radiotron range of equipment types recommended for use by receiver and amplifier manufacturers in new equipment.

Additions

Type U52/5U4-G has been added in place of type 5V4-G for large amplifiers. Type X61M triode hexode has been added as an alternative to type 6J8-GA where high gain is required. Type 6J8-GA has replaced type 6J8-G for an indefinite period. Type 6SN7-GT twin triode has been added to complete the range.

Miniatures

The four miniature 7 pin A.C. types are primarily intended for use in auto. sets and sets incorporating F—M, but may also be used in ordinary A—M receivers. Type 6BE6 is an almost exact equivalent of type 6SA7-GT, which has now been dropped from the list of recommended equipment types. Type 6BA6 may be used in R.F. and I.F. amplifiers as an alternative to type 6SK7-GT; it is particularly valuable as an untuned R.F. amplifier. Type 6AV6 has improved characteristics but is otherwise an equivalent of type 6B6-G or 6SQ7-GT.

For Amplifiers

Type 6J7-G/1620 takes the place of the older type 1603 as a non-microphonic amplifier, while type 807 remains in the list as a high power amplifier.

A.C./D.C. Range

A complete range of AC/DC valves with a heater current of

0.16 ampere has been added. These are all octal based. Printed characteristics are now in course of preparation.

EQUIPMENT TYPES

The following types are recommended for use in new equipment (1949).

1.4 Volt Miniature Battery Range

- 1R5—Converter.
- 1S5—Diode, pentode.
- 1T4—Remote cut-off RF pentode.
- 3S4—Power amplifier pentode.
- 3V4—Power amplifier pentode.

2 Volt Battery Range

- 1C7-G—Pentagrid converter.
- 1H4-G—General purpose triode.
- 1J6-G—Class B twin triode.
- 1K5-G—RF pentode.
- 1K7-G—Duo-diode, pentode.
- 1L5-G—Power amplifier pentode.
- 1M5-G—Remote cut-off RF pentode.

Rectifiers

- 5Y3-GT—Full wave rectifier, directly heated.
- 6X5-GT—Full wave rectifier, indirectly heated.
- U52/5U4-G—Full wave rectifier, directly heated.

AC Range

- 6A8-G—Pentagrid converter.
- X61M—High gain triode hexode.
- 6J8-GA — Triode-heptode converter.
- 6G8-G—Duo-diode remote cut-off pentode.
- 6J7-G—RF pentode.
- 6SJ7-GT—RF pentode.
- 6SK7-GT—Remote cut-off RF pentode.
- 6U7-G—Remote cut-off RF pentode.

- 6SN7-GT—Twin triode.
- 6SQ7-GT—Duo-diode high-mu triode.
- 6B6-G — Duo-diode high-mu triode.
- 6V6-GT—Beam power amplifier.

AC Miniature Range

- 6AU6—RF pentode.
- 6BA6—Remote cut-off RF pentode.
- 6BE6—Pentagrid converter.
- 6AV6 — Duo-diode high - mu triode.

High-Power Amplifier

- 807—Beam power amplifier.

Non-Microphonic Amplifier

- 6J7-G/1620—Triple-grid amplifier.

0.16 amp. AC/DC (Octal base)

- X76M—Triode Hexode Converter.
- W76—Remote Cut-off RF pentode.
- DH76—Duplex-Diode Triode.
- KT71—Power Output Tetrode.
- U76—Half-wave High-Vacuum Rectifier.

SOME SPEAKER VC IMPEDANCES

	ohms
Magnavox, Standard	1.7
Magnavox, midgets	3.0
Rola 8-10 series	2.3
Rola 5-6 series	3.7
Amplion, standard	1.25
Amplion, 5" midget	3.25
Jensen	8.0
Saxon	8.0
Croydon	8.0
Gulbransen	8.0
Utah	8.0
Goodmans 12" Hi-fi	15.0
RCA Photophone	12.0
Rola G12	8.4



These Amazing **KINGSLEY UNITS** Now Available . . .

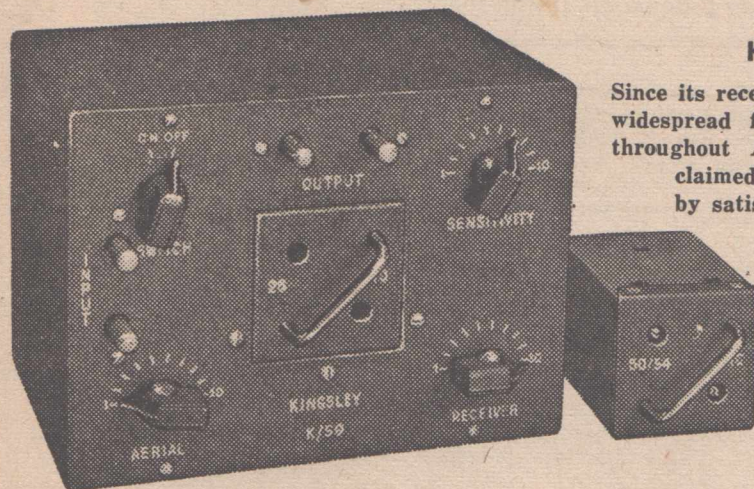

KINGSLEY K/S9'er SIGNAL BOOSTER

Since its recent introduction the K/S9'er has met with widespread favour, many hundreds now being used throughout Australia. The K/S9'er does everything claimed for it, and is being acclaimed everywhere by satisfied users. It operates on 10 metres, and additional plug-in coil boxes to operate on the 6 and 20 metre bands are now available at little extra cost. Completely assembled, less valve. £5/5/- plus Tax.

Plug-in Coil Boxes, 6-20 metres,
each 15/- plus Tax.

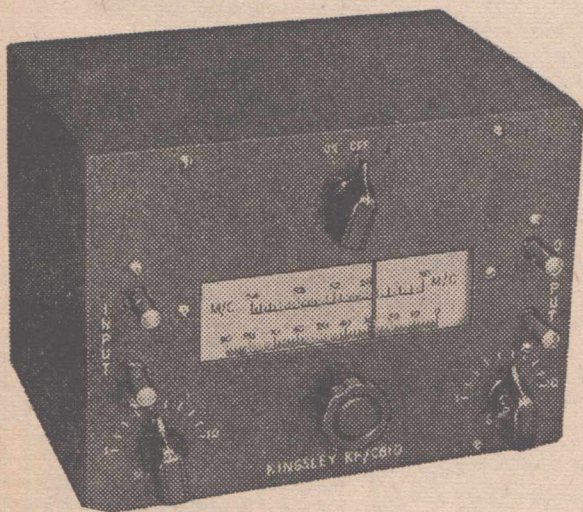

KINGSLEY SHORT WAVE CONVERTER

Ready for immediate use on 50/54 megacycles (6 metres) band, the KF/C6 is completely assembled, aligned, and adjusted.

No amateur operator can afford to be without this amazing unit. Acclaimed throughout the Commonwealth as an outstanding success.

Completely assembled, less valves £6/18/6 plus Tax.

Available all authorised Kingsley radio distributors.

Complete installation and circuit details of both units are obtainable on application.

If your regular supplier is unable to supply your requirements of Kingsley products, drop us a line mentioning his name and address.

Ask for—Insist on DEMAND Genuine Kingsley Parts from your supplier



KINGSLEY RADIO

KINGSLEY RADIO PTY. LTD.

380 St. Kilda Road, Melbourne, Victoria . Phones: MX 1159, MX 3653

THE MAN BEFORE MARCONI

From the latest copy of "QST" from America comes this true story of an inventor who discovered wireless phenomena long before Marconi. Truth is indeed stranger than fiction and even the Hollywood movie makers seldom offer such an interesting tale of coincidences and circumstances.

THE story of a successful failure is embodied in the life of Dr. Mahlon Loomis who was born in Fulton County, New York, in 1826. His temporal span of sixty years marks an epoch in a series of events each building on the other so logically that they could interestingly be made into a movie "natural."

Little is known about the early life of Dr. Loomis save that in his youth the family moved to Virginia. One fact stands out. People said that as a youngster, "He was always inventin' things." The compliment was confirmed in later years.

In September, 1848, Loomis travelled to Cleveland to study dentistry under a local practitioner. The following winter he taught school in Cuyahoga County, Ohio, for sixty-five dollars, board and washing. By the summer of 1849 he knew enough dentistry to tour the neighbouring counties and earn fifty dollars per month, a considerable sum near the half mark of the nineteenth century. Later he returned to Virginia and continued his practice.

Born To Invent

The inventing virus of his early days could not be arrested. He patented a mineral-plate (kaolin) process for making artificial teeth in 1854. He also received a patent for his invention in England.

Lincoln was already in the White House when Mahlon Loomis turned his attention to electricity. He was trying to force the growth of plants by burying metal plates connected to batteries. Loomis wanted to dispense with batteries. He rea-

soned that electrical charges—static electricity in the air—might be utilized. By means of kites carrying metal wires, he observed that electrical charges could be obtained from the atmosphere. The attempt to use this natural source of electricity to replace batteries in order to make plants grow failed. But the experiment had borne fruit.

A Startling Discovery

Loomis had come upon a startling discovery! Whenever a kite wire was sent aloft in one region, a flow of electricity to ground could be detected in another kite wire some distance away! And the galvanometer proved it. Instantly the full meaning of his discovery and its implications captured the imagination of the New York-born dentist. He quickly discerned that telegraphy without wires was a distinct possibility.

But this kindly man was without adequate funds to develop fully the secret revealed to him by Nature. Loomis sought to interest people in his invention to acquire the necessary financial support. But imagine trying to convince people then that air could be a carrier for electrical impulses when such persons had been only recently converted, with difficulty, to the wired telegraph! People were incredulous and the inventor became the butt of ridicule and coarse humour.

Skeptics had to be convinced. The patient, tireless dentist managed to scrape together enough money to conduct an experiment. In 1868 (or 1866) Loomis, in the presence of scientists and others, communicated between two moun-

tain spurs in the Blue Ridges of West Virginia, some eighteen miles apart. On each of the peaks he set up kites attached to wires and connected to the ground through galvanometers. The operators of each party were provided with telescopes so that each could sight the other's station. Loomis produced electrical discharges when he touched his kite wire to the ground, but had no means of detecting them except for the galvanometer at the far point which deflected to indicate a passage of current. He had sent out true radio waves and it was the first time that such signals had been transmitted over a distance without wires!

Only Mixed Interest

Scientists began to interest themselves in the field as yet unnamed radio. They confirmed the report of Loomis and looked upon his work with mixed interest. Some of them may have known that a Scotchman, James Bowman Lindsay, between 1844 and 1853 sent wireless messages short distances with the aid of batteries. Also that Professor Joseph Henry in 1842 had demonstrated the flow of electrical currents. Hence to them Loomis was confirming what they already knew. But the discoveries of Dr. Mahlon Loomis were independently made and without knowledge of either man or his works.

The mountain experiment confirmed the full implications of his discovery. Now he realised and hoped that telegraphy without wires could be made a quick, cheap means of communication without the necessity of constantly repair-

(Continued on page 12)

BEFORE MARCONI

(Continued)

ing wires downed by storms or marauding Indians. Mahlon Loomis also spoke of utilising this new means of telegraphy as a safety device for inter-train communication.

But this newfangled idea brought forth no financial angels. In desperation Dr. Loomis turned to Congress for \$50,000 in order to continue further experimentation. It was his plan to go to two high points in the Rocky Mountains and establish stations between Mt. Hood and Mt. Shasta.

In January, 1869, Senator Sumner of Massachusetts introduced a bill in answer to Loomis's petition for financial aid. The petitioner had hoped that the bill

would be sent to the Committee on Appropriations; instead it was relegated to the Committee on Patents. No action was forthcoming at that session of Congress.

The bill introduced by the Massachusetts senator aroused the New York and Massachusetts press to a high pitch of skepticism and disapproval. However, the newspapers in the nation's capital were on the whole friendly to Loomis. One journal pleaded, "... We hope that American pride will not suffer it (Loomis's discovery) to pass out of our hands, and the credit and honor be reaped by others." How prophetic!

Financial Problems

The American discoverer of wireless a few months later travelled to New York where he was able to interest favorably a capitalist named Austin Day and

others in supporting his venture to the Rocky Mountains. He was elated at this promise of financial relief. Plans were taking form to go westward when a group of speculators in New York succeeded in advancing the price of gold, thereby creating a disastrous panic on September 24, 1869. The day became historically known as Black Friday. This debacle involved Loomis's patrons in losses so serious they were compelled to withdraw their promise of financial aid. It was also a dark day for the hopeful inventor. He returned to Washington to resume practice. But not for one moment had the persevering inventor abandoned his great enterprise.

The Senate had remained indifferent to the inventor's appeal for funds. All that had transpired in that august body with regard

POWER TRANSFORMERS

The reliable quality and uniform performance of Trimax have meant an ever-increasing demand by users everywhere, including the P.M.G.'s Department, Broadcasting Stations and leading experimenters. This recognition has resulted in temporary shortages which our production has not yet overtaken.



by **TRIMAX**

29-35 FLEMINGTON ROAD,
NORTH MELBOURNE, VIC.

Interstate Representatives:

N.S.W.:

L. B. Graham,
5 North York Street,
SYDNEY

QUEENSLAND:

Chandlers Pty. Ltd.
Cnr. Albert & Charlotte
Streets,
BRISBANE

S.A.:

C. N. Muller,
Woranda Buildings,
Grenfell Street,
ADELAIDE

W.A.:

R. D. Benjamin,
197 Murray Street,
PERTH

TASMANIA:

W. & G. Genders Pty. Ltd.,
53 Cameron Street,
LAUNCESTON

INQUIRE FROM YOUR NEAREST SUPPLIER

to his petition was its transference to the Committee on Appropriations in March, 1870, following a request by Senator Pomeroy.

Dr. Loomis rightly concluded that if Congress would not advance money for further experimentation, it would certainly grant him a charter to continue work and also to sell stock. So in July, 1870, Congressman Bingham introduced H.R. 2390 to incorporate the Loomis Aerial Telegraph Company with the right to capitalise not in excess of two million dollars. But this bill hardly fared better than the Senate's disinclination to comply with the request initiated by Senator Sumner. America was then going through the period that followed the Civil War and was primarily concerned with reconstruction. Imagine Loomis watching the spectacle of his cherished dream roving from committee to committee.

Jeers, Ridicule

Just as with the atomic bomb, the "mad dreamer" was called upon to show that his invention worked on water too. About 1870 Loomis communicated between two ships two miles apart on Chesapeake Bay. This experiment was rewarded with jeers, ridicule and haughty laughter by those who were determined to remain unconvinced. But the stalwart man maintained his composure and was even more convinced that his discovery was highly practicable.

By 1871 Congress still had taken no action to grant Loomis a charter of incorporation. But he still sought financial aid. A group of Chicago capitalists interested themselves in the doctor's work and communicated that information to him. Dr. Loomis hurried to the Windy City. Yes, the Chicago financiers agreed to underwrite for \$20,000 the venture to the Rocky Mountains in order that Loomis could erect the stations, pay his workers, and maintain his family while away. Plans were immediately undertaken to make the project a reality. Suddenly on October 8, 1871, the great Chicago Fire unleashed its fury. The backers of Dr. Loomis were burned out. Broken-hearted, he returned to Washington.

Finally in May, 1872, the bill to incorporate the Loomis Aerial Telegraph Company reached the floor of the House of Representatives. Many congressmen were either indifferent to the proposal or amused by the thought of granting a charter to a "crazy inventor" with a still crazier scheme.

Congressman Conger of Michigan rose to champion Loomis and the bill. In a flourish of masterful oratory, only too prophetic, he cajoled and shamed the House membership into action. The House reluctantly voted and the bill was defeated because of the absence of a quorum, although a majority favored it. However, the bill automatically came up on the calendar the next day and was passed.

Loomis hoped that the Senate would act before the summer adjournment. But fate decreed otherwise. Only one joyous note entered into the long, waiting weeks. In July, 1872, the first radio patent issued in the United States, bearing number 129,971 and titled "Improvement in Telegraphing," was granted to Mahlon Loomis. Hardly a soul recognised or appreciated the contents of that piece of paper.

Aerial Telegraph

In January, 1873, the Senate undertook to consider the bill to incorporate the Loomis Aerial Telegraph Company. Skeptical members with due dignity saw little merit in granting the charter to promote a wild idea still in an experimental stage.

"States' rights" argument blocked the fondly-cherished project during the first day's consideration. It seemed a staggering blow to Loomis who reeled but did not fall. Senator Anthony, in support of the Loomis bill, advised the Senate to follow an American poet's advice by quoting:

"But sneer not thou at those who rise to loftier illusions."

"Great truths are oft," the Sage replies, "foreshadowed by delusions."

The next day, as if some miraculous transformation had taken place, all objections of the previous day were suddenly withdrawn. At the conclusion of the roll call the vote was yeas 29, nays 12, absent 33. President Grant signed the bill.

LOUD-SPEAKER CRYSTALS?

We may yet have loud-speaker crystal sets and crystal amplifiers. According to an article in the July issue of "Audio Engineering" (U.S.A.) the germanium crystals can be built into an amplifier, and details are given of a recent development of the Bell Laboratory, known as the Transitor. This crystal device can amplify and oscillate. It requires no vacuum or heater, yet produces power amplification of the order of 100. Power output is about 25 milliwatts.

Dr. Loomis, now armed with a patent and a Congressional charter, sought investors. But capital was not forthcoming. Every hope and aspiration seemed to turn into a daily repetition of Black Friday. Dark clouds were gathering over the nation. Undaunted, Loomis strove to make the charter an effective instrument.

The year 1873 looms ominous in American financial history. Debtors struggled desperately to obtain money. The pandemonium which followed is indescribable. At the end of 12 months 89 railroads had defaulted on bonds; there were more than 5,000 commercial failures.

Can you picture Dr. Loomis holding the patent in one hand and the charter in the other, while all around him the financial structure was collapsing? The frenzy of speculation was reaping doom everywhere.

Loomis was steeped in gloom but not defeated. People would not buy stock. The charter for which he had valiantly struggled remained just a piece of paper.

Almost to the end of his days the mind of Mahlon Loomis remained active and creative. A patent for a convertible valise was issued to him in May, 1881. In November of the same year he received another patent for a cuff-and-collar fastening. A fourth patent for an electrical-thermostat improvement was granted to him in March, 1886.

The prophet without honor spent

(Continued on page 28)



VALVES AND THEIR APPLICATIONS

By M. G. SCROGGIE, B.Sc., M.I.E.E. (Eng.)

No. 2: Mullard TWIN TRIODE ECC32

THERE are quite a number of special circuits, such as multivibrators and push-pull drivers, that use a pair of similar triodes; for these purposes twin triodes usually save cost and space.

Each triode in the ECC32 is a normal type with an amplification factor of 32 and a plate resistance of 14,000 ohms. Used with a 0.1 M-ohm coupling, the voltage gain is nearly 30, and varies little with the supply voltage, which chiefly affects the signal output obtainable. For low distortion (2-3%) the output at 200 volts is 45 V peak, and at 400 V is 115 V peak. The ECC32 is not restricted to designs with common cathodes; and the capacitance between anodes is less than 1 pF. In a 2-stage amplifier, the grid pin farther from the heater pins should be used for input.

For driving push-pull amplifiers or providing symmetrical c.r.t. deflecting voltages, there are several well-known phase-inverter circuits. The gain obtainable from most of them, using a pair of similar valves, is approximately equal to that of one ordinary stage. In the cathode-coupled or Schmitt circuit it is only about half as much, and a negative voltage has to be provided; but it is a very versatile sort of circuit, and especially suitable for c.r.t. deflection.

Ideally, the signal anode currents would be equal and opposite, so would cancel out in R_c . In practice they must be sufficiently unequal for their difference to give enough voltage drop in R_c to drive V2 oppositely to V1. To minimise this inequality, R_c should be large—of the same order as R_{a1} and R_{a2} —and the voltage gain per stage also large. With the ECC32, for example, the difference in outputs need be only about 5%; and this, if not negligible, can be corrected by making $R_{a1} < R_{a2}$.

A feature of this circuit is that if one wants to mix another signal in the balanced output, without coupling the two signal sources, the grid of V2 is available for doing so.

It is obvious, too, that by coupling the anode of V2 to the grid of V1 it can be made to generate sustained oscillations, of a type depending on the couplings. If a 2-phase output is not needed, R_{a1} can be short-circuited. A very stable constant-frequency oscillator, using an untapped inductor, may be based on this arrangement, which is easily seen to be an earthed-grid triode driven by a cathode follower. Used as an amplifier, it is capable of covering a very wide frequency band.

The following are a few references to details of the foregoing schemes:

"Cathode-Coupled Push-Pull Amplifiers," O. S. Puckle; *Electronic Engineering*, July, 1943.

"The Cathode-Coupled Double-Triode Stage," Emrys Williams; *Electronic Engineering*, May, 1944.

"Cathode-Coupled Oscillators," F. Butler; *Wireless Engineer*, 1944.

"Cathode-Coupled Wide-Band Amplifiers," G. C. Sziklai and A. C. Schroeder, *Proc. I.R.E.*, Oct., 1945.

"Self-Balancing Phase Inverters," M. S. Wheeler, *Proc. I.R.E.*, Feb., 1946.

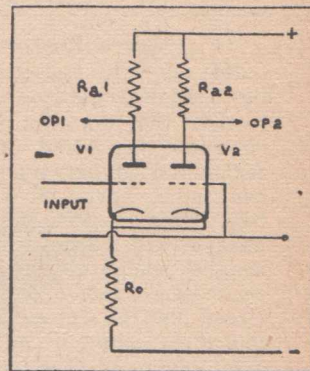

BASIC CATHODE-COUPLED CIRCUIT



This is the second of a series written by M. G. Scroggie, B.Sc., M.I.E.E. (Eng.), the well-known English Consulting Radio Engineer. Reprints for schools and technical colleges may be obtained free of charge from the address below. Technical Data Sheets on the ECC32 and other valves are also available.

Mullard—Australia Pty. Ltd.

Head Office:

35-43 Clarence St., Sydney

Distributors in all States

JUNIOR FEEDBACK AMPLIFIER

Superb Reproduction at Moderate Volume

THE problem of re-creating a satisfactory illusion of reality in reproduced music, and the problem of adequate frequency response and fidelity, would appear, regarding the amplifying equipment solely, to have been solved. Williamson's push-pull negative feedback amplifier appears to be singularly successful.

Expense

However, in view of the expense associated with this equipment, particularly regarding the extended high-note response (30 kc) and high power output, which, in my humble opinion, does not warrant the extra expense, I set about and designed a three-tube amplifier having equal characteristics, excepting output and upper register, as Williamson's equipment.

I have heard and compared both Williamson's and his smaller unit, and, operating both at a sufficiently low level, to be within the limit of home listening, I state

emphatically that it was impossible to detect any difference. In fact, I preferred my own unit, but of course, I was possibly biased in this respect. There is a full description of this equipment, which I hope may be of interest.

The Circuit

The circuit is fairly straightforward, consisting of a 6J7 pentode direct coupled to a 6A3, with negative feedback fed from voice coil back to the cathode of the 6J7. A one megohm potentiometer controls the input to the 6J7, while

a small capacity shunted from the hot end to the moveable wiper gives a slight degree of upper register boost at low volume settings. The amount of boost varies with the control set at normal room volume (this setting depends on the signal input of course, the input used on test was one volt).

High Lift

The highs begin lifting at approx. 6000 cycles and increases smoothly to 9DB boost at 18kc/s. This boost nicely compensated for the high-note attenuation of the speaker. A Rola G12 was used in this instance, loaded by a vented enclosure, which held the bass response quite level down to 25 C.P.S.

Unfortunately, there is a weak link, and that, as usual, is the output transformer. The transformer used was wound by the Red Line Company about two years ago. Its weight is 6 lb. In case it should be of interest, the type Number is 6649. When ordering it, I specified a high-fidelity type, not stating any particular frequency response. After frequency run of this amplifier was taken, I feel I must take off my hat to this company, as will be evident when I describe curves taken.

Performance

Standard equipment was used to take a frequency run, output check, and total harmonic distortion. The gain control was set at maximum (to render the upper register boost inoperative) and a constant input of 1 volt was used in the frequency run. The secondary of the output transformer was loaded with an 8-ohm non-inductive resistor and the output C.R.O. and output meter taken from there.

(Continued on next page)

By

WILLIAM DARRAGH

Dip. Radio Eng.

129 Empress Avenue,

West Footscray, Vic.

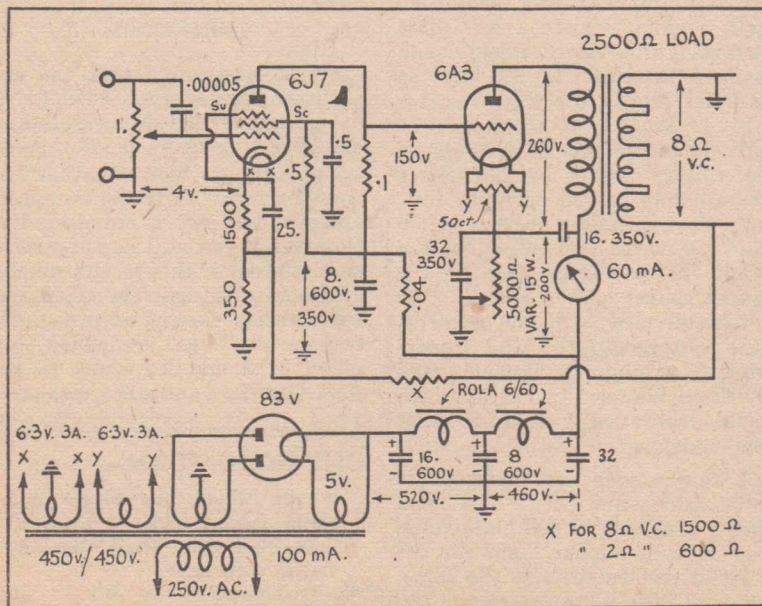

JUNIOR

(Continued)

Frequency Response

On the frequency run, the amplifier overall, was flat within $\pm .5$ DB from 10 C.P.S. to 18 kC/s; reference frequency was 400 C.P.S., and down to 10 C.P.S., where the B.F.O. turned sour, the response was perfectly level! At 18 kC/s, there was a sharp drop, no doubt due to the output transformer limit.

Distortion Figures

Distortion, checked at 30; 100; 1000; 5000 and 10,000 C.P.S. showed a total of .15 per cent. up to full output, across the distortion analyser.

Power Output

Maximum undistorted output, measured across the voice coil winding, was 2.7 watts. Peak volts input for full output was 1.75

volts. Hum level measured was practically non-existent.

I feel sure that these results, coupled with the low cost of this amplifier, will no doubt appear very attractive.

Construction Details

The 5,000 ohm variable bias resistor in the circuit is for adjustments of the 6A3 plate current, I have in the original amplifier a fixed value of 3,275 ohms, which suits this set-up. It might not be a suitable value in another identical amplifier due to slightly varying conditions.

The original chassis is rather large to accommodate over-size components; actually the chassis measures 16"x9"x2½", and was originally cut to suit parallel push-pull 6A3's. If correct-size components are used, its dimensions could be almost halved. The main reason why I used such large equipment was that I had same on hand, and did not deem it necessary to purchase smaller units.

In order to ensure correct operating conditions and to make sure that performance is up to expectations it is desirable to check the voltages whilst setting the main bias resistor.

A voltmeter across from the centre-tap of the 6A3 heater to earth will indicate the plate current of this valve, which should be held as close to 60 mA. as possible. So, if the bias resistor is set to about 3,000 ohms the voltage should be 180. If 4,000 ohms the voltage would be 240 for a 60 milliamp plate current. Putting the voltmeter across from plate to earth the high tension should be 460 according to the figures shown on the circuit. This is then divided with 260 effective plate voltage for the 6A3 (measuring from plate to filament) and 200 from filament to earth, which would theoretically take a 3,333 ohm resistor.

A fair amount of tolerance is permissible and the 6A3 will readily stand up to 300 plate volts, then drawing higher plate current of effective bias remains the same. But with high plate voltage on the

6A3 it may be advisable to keep the plate current at the normal 60 mA by using other than 3,333 ohms and 200 volts. In all cases the true test is by ear and incorrect bias settings will soon make themselves heard.

Voltage Requirements

Quite good performance can be obtained with lower voltages, such as those likely to be obtained from a 385 volt, 125 mA transformer, but in all cases the maximum power output is largely governed by the effective plate voltage on the 6A3. For example with about 350 volts high tension you may get satisfactory tonal quality with about 200 on the plate and 150 to earth, but the power output of the 6A3 with 200 volts on the plate will be a lot less than the 2.7 watts mentioned as obtained with the voltages shown on the circuit, viz., 460 actual volts of high tension on load.

Enquiries Welcomed

In conclusion, I will welcome any mailed enquiries, or results obtained, should any one construct this amplifier. I wish to state again, that, without doubt, its performance depends to a large extent on the output transformer, although excellent results are obtained also with a standard type.

Editor's Note

(It will be noted that the output transformer type 6649 is not listed in the Red Line section of our buyer's guide in the September issue. Enquiry indicates that this transformer was made to special order and is not a standard line. However it can still be supplied to special order if this receipt number is quoted, with delivery about four weeks after receipt of order. The transformer has secondary tapings of 8 and 2.3 ohms to suit Rola G12, K12 and other speakers.)

ONE GOOD TURN—

If you would like bigger and better issues, make a point of supporting those firms who advertise with us.

**KELMAN
INDUSTRIES**

manufacturers

of

**CONNISEUR
PICK-UPS**

Brochures available on
request, without
obligation.



Box 40, Hawthorn, E.2
Victoria

Home-made Hi-Fi Pick-Ups

Mr. F. A. Burgess of 56 Ninth Avenue, Railway Estate, Townsville, G. writes as follows:—"I read with considerable interest the article by Mr. A. March in the May issue in which he described how he built a high-fidelity gramophone pick-up. I would like to tell of another method of making a moving coil unit which may, or may not, be better.

The Coil

I secured a small piece of plastic tuning about one eighth of an inch in diameter and about half an inch long, cut a notch in each end and wound about twelve turns of fine gauge wire on it, lengthwise. Then I slipped a small piece of valve rubber over each end, pierced the plastic tubing in the centre to take a sapphire needle and mounted it

by simply clamping it between the faces of the pole pieces. The two small pieces of rubber held it firmly and yet were flexible enough to allow the coil ample movement and supplied the right amount of damping. The arrangement worked quite well and is suitable where there is not much clearance between the two poles.

Pre-amp Essential

The output voltage is very, very low, but the assembly is about as small and as light as it is possible to get, so that the damping need only be extraordinarily light, and the weight of the pick-up on the record less than a quarter of an ounce.

I have also used this idea for mounting the armature of a "Garrard" magnetic pick-up of pre-war

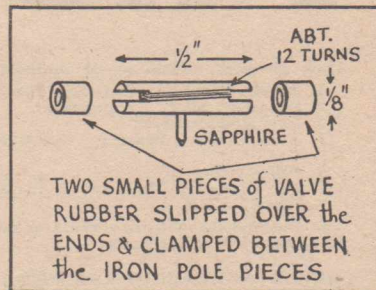

design. I cut the top of the armature length by half, slipped two pieces of valve rubber over the ends and clamped it between the pole pieces. It reduced the output voltage terrifically, but the weight on the record was also reduced and the records lasted ten times as long.

Other Comment

With reference to your recent remarks about quality reproduction, I am quite in agreement with you. The game is hardly worth the price and even if perfect high-fidelity is achieved I doubt whether people would really want it. The big missing link is the loudspeaker. Feedback from the voice coil seems to have become standard. Now I was wondering if it would be possible to take feedback a stage further, and have a second winding on the voice coil former to provide a feedback voltage. This voltage could then be amplified by a valve if necessary, and applied to the beginning of the amplifier. Such an arrangement might overcome resonances in the cone and should also have a solid damping effect on the cone. Maybe the idea is screwy. It is certainly a little unweildy.

Finally I must say that your magazine is still the best in Australia. Tons of luck and all that sort of thing."

A HIGH-NOTE DIFFUSER

Here is a handy little tip from one of our subscribers who is keen on the finest quality of reproduction. He suggests that when using a speaker baffling scheme such as that described by Mr. Davies in the March 1947 issue it may be found that the high frequency notes are inclined to become beamed straight out along the axis of the speaker. Use can be made of this feature for the better reproduction of orchestral and organ music by providing a special separation of the instruments.

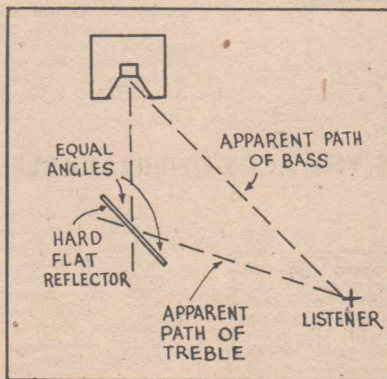

As will be seen from the diagram, the listener sits at a point about 45 degrees from the axis of the speaker and a hard flat surface about 2 ft. 6 ins. square is set up about 3 or 4 ft. out in front of the speaker and adjusted at an angle to reflect the high frequency beam to the listener. The result

gives quite a good stereoscopic effect, according to Mr. D. L. Robinson of 13 Dumblane Street, Hughesdale, Victoria, who sent along the suggestion. For best results the speaker baffle should be of the totally enclosed type so that there is no back wave.

A NEW

Phonomotor

Look at these smooth power features!

1. Ample Power at Constant Speed.
2. Superior Idler Arrangement.
3. Low Rumble Level.
4. Anti-friction Bearing Construction.
5. Self-starting.
6. For Operation From — 50 Cycles 200-250 Volts.

The Phonomotor will give you trouble-free, superior performance!

QUICK FACTS ABOUT THE MOTOR:

Motor is the induction type, squirrel cage rotor with shaded poles and of open construction.

The turntable, which is a steel pressing, is driven by the motor through a vertical shaft which rotates a rubber-tyred idler wheel, which in turn is spring loaded against the inside rim of the turntable.

All bearings fitted are self lubricated and normally require no attention. The lower end of the motor shaft runs on a hardened steel ball to give minimum friction and the quietest possible running conditions.

The standard model voltage range is 200/240 volts 50 cycles A.C. The normal speed of the turntable is 78 RPM and when playing the heaviest track-loaded 12-inch record, varies less than 1 per cent. No means of adjusting the speed is provided or is necessary. Voltage input can be varied plus or minus 10 per cent. of the normal voltage with little effect on the turntable speed.

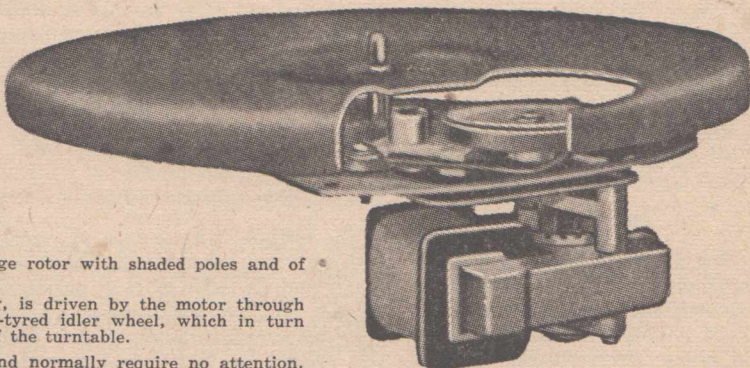

Price £5/8/3

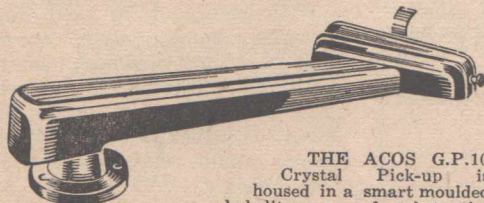

THE ACOS G.P.10 Crystal Pick-up is housed in a smart moulded bakelite arm of substantial

ALSO THE FAMOUS ACOS G.P.10 PICK-UP FEATURING THE UNBREAKABLE CRYSTAL

section to ensure minimum resonance. Ingenious base and bracket assembly affords easy movement horizontally and vertically, and ninety-degrees lift-back for needle replacement. Arm movement is vibration-free. Adjustable needle pressure . . . convenient finger lift for placing on record! An ACOS G.P.10 will give you new-found fidelity!

Price 48/6

INCORPORATES THE ACOS UNBREAKABLE CRYSTAL



The ACOS G.P.9 Cartridge contained in this pick-up is specially constructed to be proof against humidity and temperature variations. If desired, can be purchased separately and interchanged in most crystal pick-ups. Price 22/1

Accidental dropping, other hazards, cannot fracture the crystal contained in the G.P.9 Cartridge. Motion of stylus is passed to crystal "B" via rubber coupling "A" which relays lateral impulses from disc grooves, whilst effectively absorbing foreign vertical movements.



ON SALE AT ALL GOOD RADIO STORES

Sole Australian Distributors

AMPLION (AUSTRALASIA) PTY. LTD.

36-40 Parramatta Road, Camperdown, Sydney, N.S.W.

SO/FP.1.

PERSONAL

(Continued)

maximum output is limited to room volume and also to prevent it being started in a window rattling competition with standard receivers. The sensitivity of this 2-valve (plus rectifier) affair is equal to that of the average straight 4-valve set. I had good reception of stations 60 to 100 miles away in daytime.

An ECH35 converter in conjunction with a high gain IF trans-

former was used to get the necessary sensitivity. It is followed by a 6B8G, the only available diode-pentode with straight characteristic, which is used as reflex amplifier. To my knowledge the use of a reflex valve in the output stage is quite original with exception of a circuit I published in the "Radio World" many years ago, which used an EBL1 in the same position. The EBL1 circuit gave full output, but was very hard to stabilize and therefore no proposition.

The reflex circuit for the 6B8G is based on the simple Teleconda

version. There is no initial bias, the cathode being earthed. A .2 Meg resistor feeds directly from the top of the .5 diode load to the bottom end of the grid coil of the first IF transformer. This provides bias depending on the strength of signal and would, in a super control valve, regulate the gain as AVC. This sort of thing is, however, not wanted here, as we have to work on a characteristic as straight as possible to keep the gain up and distortion low. To counteract the output reducing effect of overbiasing on strong signals, I made arrangements for an effective increase of screen voltage, which was done by a separate dropping resistor for the 6B8G. Although it would be simple to connect the 6B8G screen up to the ECH35, this proved unsatisfactory, as the screen voltage did not sufficiently increase with signal strength. The separate dropping resistor for the 6B8 is 50,000 ohms, which results in a no-signal screen voltage of about 100 volts, increasing to 150 and more on strong signals.

High Load

As the whole success of our little receiver hinges on getting the maximum undistorted output out of the 6B8, we have to use the highest possible matching impedance for the speaker transformer in the plate circuit. I used a 25,000 ohm type, which gives a distinct improvement on the ordinary 7,000 ohm ones.

Volume Control

The volume control in this set is a 5000 ohm RCS type in the cathode lead of the ECH35. To get the necessary minimum bias, I bent up the contact ring about $\frac{1}{8}$ " before the maximum position, which leaves sufficient resistance in circuit and at the same time forms an effective stop for the wiper arm.

The output circuit of this set has special arrangements for the connection of personal speakers and ear phones, for which it is ideally suited. There is no simpler method of listening to a programme without disturbing others than to get a personal speaker attached

TELECONDA R4841

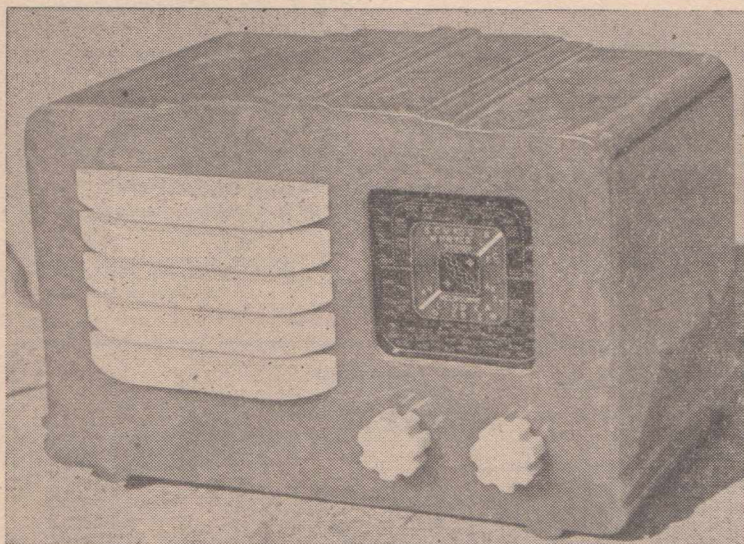

KIT SET, complete £12/10/-

including Valves, Sales Tax

KIT SET, including Sales Tax £8/10/-

not including valves, sockets, resistors, condensers, sundries

DISCOUNTS TO TRADE AND SUBSCRIBERS TO
"AUST. RADIO WORLD"

POWER PORT KIT, less 5Y3 £3/10/-

A.C. Power Unit to fit any Portable Radio (retailing complete £7/19/6)
(Described Feb., 1948)

POSTAGE, FREIGHT EXTRA

P. STEVENS

21 FLETCHER AVE., BONDI, N.S.W.

to the set by a long lead as close as possible to your ear, which gives you clear reception on low volume level. It is much preferable to the usual way of going into contortions in order to get your head close to the speaker in the set, which has been the theme of quite a few comic cartoons.

Our set has provisions for both crystal and dynamic types of personal speakers. The crystal speaker is connected directly across the primary of the speaker transformer via two .05 MF safety condensers, with a .1 resistor in parallel to dampen out undesirable capacity effects. The tone of this crystal speaker, which is known as the "Hushatone," seems unduly high pitched on loud volume, but turning it down and listen to it closely or through a pillow makes it very pleasant. In fact, this type was originally intended as under-the-pillow speaker for listening in bed, especially for hospital receivers, where disturbance of other tal speaker, in the vicinity of patients has to be avoided.

Crystal Speaker

The high impedance of the crystal, 35,000 ohms, is particularly suited to the plate circuit of the 6B8G and the sensitivity of the receiver under these conditions becomes high enough to receive local stations on a short piece of aerial wire only about 3 or 4 feet long.

The dynamic-type personal speaker marketed under the name "Pillophone" consists of a highly sensitive 3" speaker in a small plastic housing. It connects directly to the secondary of the output transformer of the main speaker, which can be silenced by a switch in the voice coil lead. The Pillophone can be used in the same way as the "Hushatone"; you can attach it to the back of your chair, put it under your pillow, hold it in hand or stick it under the collar of your coat.

Finally, for complete privacy in listening, you can attach ear-phones, also to the secondary of the output transformer.

The set was built up on an ordinary, standard 4 valve mantel chassis with cabinet and dial to

match. In place of the output valve was a 4-pin socket, the two thick pins connected to the secondary of the output transformer, the thin pins to the primary via two .05 condensers with a .1 Meg resistor across for the Hushatone crystal speaker. (Fig. 1.) A wiper-type switch (self cleaning contacts) was put in the voice coil circuit of the main speaker. Both personal speakers and ear-phones carry a 4-pin plug, the wires being connected to the respective pins. Unnecessary to say, that, of course, any sort of plug and socket can be used in this place.

The total B-current drain of this set is only about 20 mA and therefore actually only a 20 mA power transformer would be needed. These are not available on the market with a voltage of 250 volts secondary, so a standard 40 mA type was used. As we built the set onto a standard chassis, there was no point in saving space. There are some 150 volt, 80 mA transformers on the market, which

are definitely unsuitable. They are hardly smaller than the 40 mA 250V type, cost about the same and supply insufficient B voltage for the 6B8 to be driven to full power. A Rola 6/60 choke in conjunction with 2 8MFD electrolytics provide adequate filtering and hum is negligible. Due to the low current flow the inductance of the choke becomes much higher than 6 Hy, as it is rated for 60 mA.

The set just described fulfils all needs of listening for a vast majority of people. It brings all the locals at medium room volume on a short piece of aerial, has all facilities for intimate listening through personal speakers or ear-phones. Its cost is well below that of 4-valve receivers. It is a definite commercial proposition as "second set" for the home or hire set for hospitals. It is however not for people whose idea of a "good radio," is a set with which they can roar the house down if necessary.

A SET FOR CAR AND HOME

"CARLECTRIC" FOR NEXT ISSUE

This is an almost revolutionary new combination receiver for car and home we are going to feature next month. Although a single unit type, its unique shape allows it to be fitted into practically any make of car. It can be put in or taken out in less than one minute, these actions merely involving the handling of two plugs and two wing nuts on the dash. At home, or in any hotel or boarding house it can be plugged directly into 240V AC, and brings in any station including New Zealand on a 6 ft. piece of wire as aerial. Intended to be used standing on the floor, it makes an ideal chair side "consolette," which takes very little room and does not clutter up the always scarce chairs and tables in hotel rooms. Its current consumption is only just on 3 amps and it can therefore be used in tents or caravans, in motor launches or on the camping ground,

wherever there is a 6V battery available.

A novel chassis lay out makes it easy to build and to service, no special precautions are necessary to keep out the dreaded vibrator hash. Due to special features, ignition and other noises can be kept down without any suppressors on the car itself. Installed in a Ford car, usually notorious for its noisiness, no interference could be noticed even between stations, although the car was not "deloused" in any respect.

A most important point is the very low price of the receiver, a kit-set will cost you less than half of a similar type on the market.

So get your copy next month and build the first receiver of this type ever described in an Australian radio magazine.

THE "Q-PLUS" COILS

BEING busily engaged on the completion of their new factory at Auburn, a suburb of Melbourne, the makers of "Q Plus" coils, R. W. Steane & Co. Pty. Ltd., were too busy to get their full lists of products ready in time for our September issue, but now we have them. We feel sure that the full details of the range will be of great interest to many readers, as, up till now, there has not been much said in the technical press about these coils.

The Range

Basically, the coils resolve themselves into the following series:—

M. Series—Midget, unshielded.

M.S. Series—Midget, shielded.

P. Series—Standard size, progressively wound.

L.A. Series—Loops.

M.I.F. Series—Midget I.F. Transformers.

I.F. Series—Standard I.F. Transformers.

D.W. Series—Various types dual-wave brackets.

R.F.C. Series—Various types radio frequency chokes.

M. Series

These are claimed to be the smallest in Australia, having full-size efficiency. They are permeability tuned, and iron clad using especially high permeability and high "Q" iron-powder cups. Full 5/41 litz wire is used and the inside of the can is treated with iron powder so as to minimize the close fitting shields. Particular attention is made to the coupling factor as the full efficiency of the coils cannot be realised unless this is correct.

Single-hole mounting is used and special flush soldering lugs are used to enable components to be mounted directly underneath—this is important on midget chassis as experience has shown that until truly midget resistors and con-



A photo of the Q-Plus coil kit for car radio, with a match-box for comparison of size.

densers are available in this country, every square inch of "under chassis" space is needed.

Included in this series is the new car radio coil kit which has a specially-tapped secondary winding to enable both the correct impedance match to be made for whip-type aerials with shielded lead-ins and also to allow a trimming condenser to finally adjust for individual aerials.

Kit For Car Set

The kit, which is supplied complete with recommended circuit, etc., consists of 1 only type Q plus 5S oscillator coil, 1 only Q plus AC2S aerial coil, 1 only Q plus RC2S RF coil, 1 only Q plus IC1 ignition hash coil (this little choke is fitted in series with the aerial

lead and aids reduction of ignition noise), 1 only Q plus MIF1 midget 455 kC IF transformer and 1 only Q plus MIF2 midget IF transformer.

Reinartz, Too

Also included in this series is the new "Q Plus" midget Reinartz coil whose construction is of the same type as the above midget car radio coils and whose size is claimed to be the smallest available.

Dimensions of Type MS Coils

Aerial, RF and Oscillator— $\frac{3}{4}$ " \times $\frac{3}{4}$ " \times $1\frac{1}{2}$."

Midget IF Transformers— $\frac{3}{4}$ " \times $\frac{3}{4}$ " \times 2."

(Continued on next page)

"Q Plus" Midget Oscillator coils are available for the following type converter valves: 1R5, 6J8GA, ECH35, 6SA7 and 6B6.

MS Series

As above, except they are shielded.

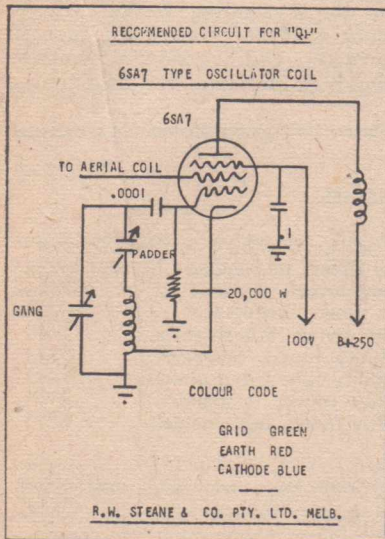

P Series

These are to be released shortly and will have standard size cans, i.e. 1 3/8" x 1 3/8" x 2 1/2". As their name implies they are wound progressively with 5 strand litz wire with optimally-coupled high-impedance primaries. They are permeability tuned and have the special "Q Plus" double lug moulded into high-resistance and non-softening plastic bases. The "Q" factor of this series of coils is so high that care must be taken in alignment or else the full circuit gain will not be obtained. It is interesting to note that most leading manufacturers use progressively wound coils and that "Q Plus" are in this field, enabling everyone to avail themselves of this high performance coil.

LA Series

These consist of types LM and LS of which the former is the well-known midget loop aerial, which has the special aerial loading coil.

Solid wire is used on this loop as it is considered that the higher

signal pick-up at the high frequency end of the B/C band is more desirable than at the lower end where national stations transmit with greater power.

Type LS, which is to be released

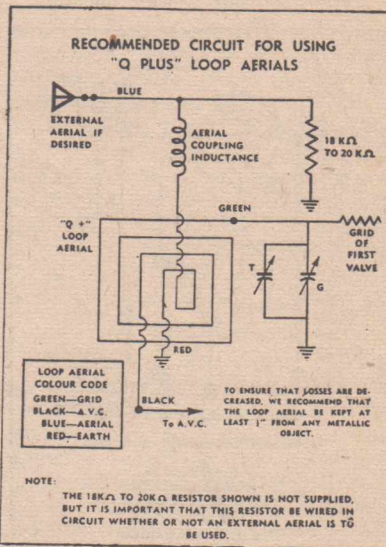

(Continued on next page)

AN APOLOGY—May we be permitted to apologise to those who have waited so long for this kit of coils.

YOUR REWARD—The sensitivity obtainable now—Surprised even us—Better than we had earlier expected.

"Q PLUS" CAR-RADIO COIL KIT

THE KIT COMPRISES OF

- 1 only "Q Plus" Q+055 oscillator coil.
 - 1 only "Q Plus" Q+AC25 aerial coil.
 - 1 only "Q Plus" Q+RC25 R.F. coil.
 - 1 only ignition hash coil.
 - 1 pair "Q Plus" midget I.F. Transformers.
- Complete with recommended circuit and a host of construction tips.

RETAIL PRICE 57/6

Now at long last you can build yourself a car-radio with the performance of the commercial units—for "Q Plus" engineers have made available these special coils which match the whip-type antenna with coaxial lead-ins.—Midget in size; giant in performance.

SPECIFICATIONS

Size:

Aerial, R.F. and Oscillator Coils— $\frac{3}{4}$ " x $\frac{3}{4}$ " x $1\frac{1}{2}$ ".
I.F. Transformers, $\frac{3}{4}$ " x $\frac{3}{4}$ " x 2".
Phantom Drawing showing 2/3 size "Q Plus" midget coil construction.



CONSTRUCTION

All coils are Litz wound, permeability tuned with iron pot surrounds—Can specially lined with iron dust to increase efficiency.

Single hole mounting with special flush solder lugs, for small chassis.

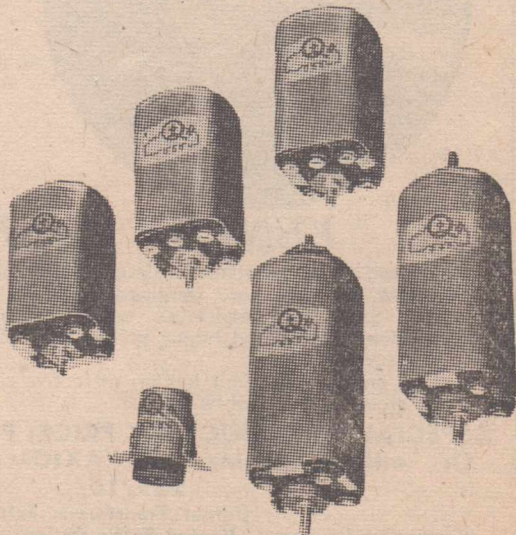

STOCKED BY ALL MODERN RADIO HOUSES THROUGHOUT AUSTRALIA
R. W. STEANE & CO. PTY. LTD. — Auburn, Vic.

Q-PLUS

(Continued)

shortly, is as above, but with the larger dimensions necessary for standard size portables.

Dimensions

Type LA—4 $\frac{3}{8}$ " × 4."

Type LS—not finally decided.

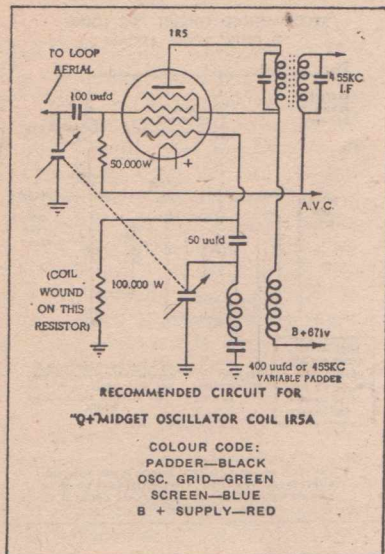

MIF Series

These are similar to the MS series with the exception of their longer can. They are litz-wound, iron-clad coils with permeability tuning. Condensers are negative temperature coefficient ceramic 100 uF type. They are available in types Q plus MIF1, and Q plus MIF2, which is specifically designed for use when preceding a diode valve.

Dimensions

Midget IF transformers— $\frac{3}{4}$ " × $\frac{3}{4}$ " × 2."

IF Series

The standard size "Q Plus" IF transformer offers the discerning user the cheapest 7/41 litz wound permeability-tuned IF transformer on the Australian market. Silvermica condensers are used on both primary and secondary windings and high-efficiency iron-dust tuning

"Q PLUS" PRICES

M & MS SERIES

Oscillator Coils

O1—Midget for 1R5 (Wound on $\frac{1}{2}$ watt, 100,000 w resistor)	4/9
O2—Midget for 1R5—permeability tuned, unshielded	6/11
O2S—Midget for 1R5—permeability tuned, shielded	7/11
O3—Midget for 6J8—permeability tuned, unshielded	6/11
O3S—Midget for 6J8—permeability tuned, but shielded	7/11
O4—Midget for ECH35—permeability tuned, unshielded	6/11
O4S—Midget for ECH35—permeability tuned, but shielded	7/11
O5—Midget for 6SA7—permeability tuned, unshielded	6/11
O5S—Midget for 6SA7—permeability tuned, but shielded	7/11

AERIAL COILS

AC1—Midget, permeability-tuned, iron-clad, aerial coil, unshielded	6/11
--	------

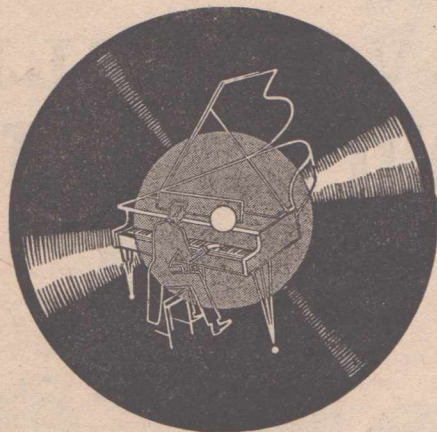

VENTED BAFFLES

Illustrated is the special model designed for the famous **GOODMAN'S "ADIOM 12"** Speaker. Designed for better listening the unit is solidly constructed of $\frac{7}{8}$ " core wood handsomely figured in Queensland Maple and highly polished, to take its place with pride in any surroundings.

Totally enclosed the unit has an attractive silk front and the inside is generously lined with heavy felt.

SPECIAL INTRODUCTORY PRICE: Polished, £15/15/-.
Or with **GOODMAN'S "AXIOM 12" SPEAKER,**
£29/10/-.

(Output Transformer Extra)

Consult us for Special Vented Baffle Designs or your other problems.
Mail Orders Especially Catered For

ANNOUNCE

RECORD ENTHUSIASTS

R. W. STEANE & CO. PTY. LTD.
143 High Street, Kew, Vic.

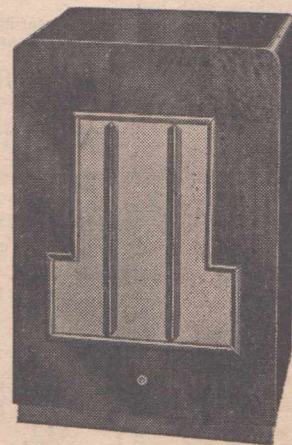

RESISTOR FAULTS

PROBABLY the most common cause of receiver trouble is failure of one or more of the many resistors which go to make up a circuit, particularly

in the case of multi-valve receivers such as the modern superhet. Although it is a wise precaution first to have the valves tested before looking elsewhere for faults,

this is not necessarily the best method of approach or the quickest as, in nine cases out of ten, the trouble is not due to the valves at all. Even if one or more of the valves proves to be faulty, it is always possible that this fault has developed due to some faulty component, particularly resistors. Therefore replacing the valve with a new one does not necessarily cure the seat of the trouble.

Q-PLUS

(Continued)

slugs are used. The base is of high resistance, non-softening phenolic bakelite with special double-tag soldering lugs.

Dimensions

1 3/8" × 1 3/8" × 3."

DW Series

only types Q plus DW1 and Q plus DW2, which are designed for the 6J8GA and 1R5 converter valves respectively. The construction consists of two midget iron-clad and permeability-tuned B/C aerial and oscillator coils with air-cored shortwave coils wound on 3/4" former for high performance. Frequency coverage—13 to 42 metres.

Available shortly will be a complete range of dual- and tri-wave boxes designed for the most popular converter valves and using the

progressively wound series of coils. There will be 32 types in this range so that it should be the most comprehensive range in Australia.

RFC Series

To be released shortly: "Q Plus" will be making a complete range of R.F. chokes modelled on the lines of leading American brands.

The range will include types for "ham" operators as well as receiving types. All will be covered by rigid specifications as to inductance, self-capacity, etc., and will be wound on highest quality ceramic formers.

Knobs

"Q Plus" Recess Knobs are ideally suited for portable receivers, amplifiers, etc., where detuning by knobs, etc., is a problem. They are available in the following colours—green, blue, grey, red, black, wine, ivory, walnut, pink and lemon.

Symptoms

There are, of course, certain symptoms which point definitely to certain components other than resistors, such as a flashing or blue glowing rectifying valve, which in the majority of cases points to a short across the H.T. supply usually due to a breakdown of one or more of the smoothing condensers. Another obvious fault is an open circuit of the speaker transformer primary, which is indicated when the screen of the output pentode gets red hot due to no plate voltage being present. There are other well-known symptoms which can be observed without the aid of instruments which point to definite components, but in cases where no definite indication is given by the set's behaviour, or where the enthusiast lacks the experience necessary to interpret these symptoms, it is generally the wisest and quickest plan first to check the resistances.

The symptoms accompanying a faulty resistor are many and varied, but they can be briefly listed as silence in the receiver, noise, poor quality, low volume and various intermittent faults. In cases where a receiver suddenly goes "dead" a short circuit may have occurred, but more than likely it will be due to an open resistor. Noisy operation is sometimes due to poor contact of a wire or some component, but if this is in the form of a steady crackling or excessive hissing sound the chances are that one of the resistances is faulty. This may

(Continued on next page)

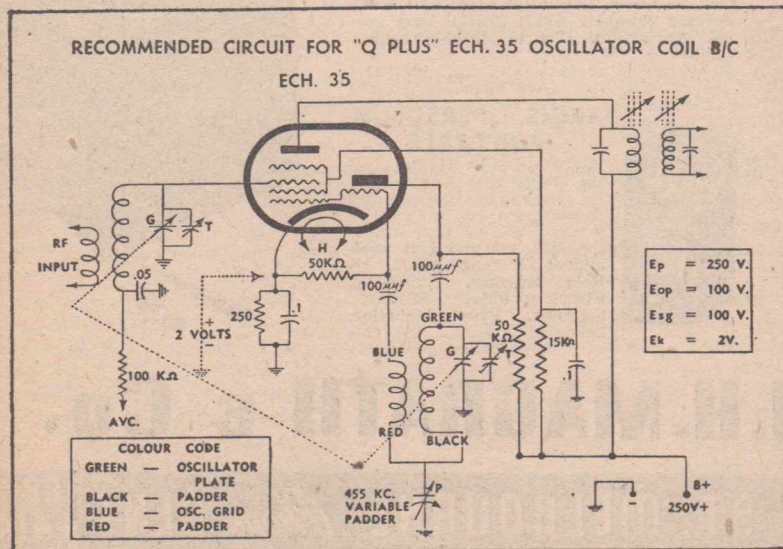

RESISTORS

(Continued)

only show up after the set has been on for some time and the resistance has had a chance to warm up. A poor contact on a variable resistor will also give this indication.

Deterioration in quality may be due to a change that has taken place in the value of the resistor. It will often happen that this will increase, but quite often the reverse takes place; this is generally caused by excessive heating due to overload. Intermittent faults of various types are often caused by the value of a particular resistance varying. A small, microscopic crack in the resistance may open as the resistor heats up, thus breaking the circuit or forming a high resistance joint which im-

mediately closes again as the resistance starts to cool off.

In the case of variable resistors, a large number of faults resulting in noisy operation or intermittent working are due to accumulation of dirt between the resistance track and the sliding contact. This can often be cured by cleaning with a piece of cloth slightly moistened with petrol. Only a gentle wipe over should be made; just sufficient to ensure the removal of any foreign deposit, as excessive rubbing will remove the carbon or other resistance compound used.

Avoiding Trouble

In home constructed sets future trouble is often set up by careless soldering of resistances. To do this successfully it should not be carried out too close to the metal

caps, as the heat may be the cause of future trouble due to poor contact or oxidation between this cap and the resistor element. It is usually a good plan to leave at least one inch of the pigtail between the joint and the resistor. Even then a good hot iron should be used so that the solder will fuse as quickly as possible before too much heat is conducted to the resistor. When making such a connection direct to chassis, tin the latter first and leave a good blob of solder, then do the same with the resistor pigtail. A quick press with a well-heated iron will quickly fuse the two together. Tinning of all components first should always be carried out, as not only does it reduce the time necessary for the joints to be soldered, but

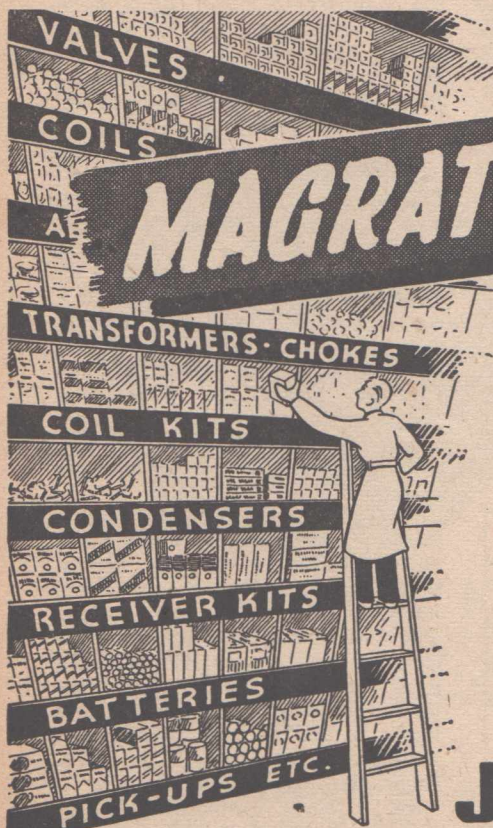

MAGRATHS HAVE THEM..

The Famous AEGIS PORTABLES



AEGIS VOYAGER Kit Set

As illustrated at right this compact 4-valve battery-operated portable measures only 8 ins. x 6½ ins. x 7 ins. when assembled and weights but 12 lbs. Kit includes Minimax Batteries, Super-Het Circuit, Rola 3" Permaga Speaker, Aegis Special loop aerial, Aegis J10. IF's in durable leather cabinet

Price, including batteries £12/12/-
(Not including Valves)

AEGIS PERSONAL PORTABLE

Weighing only 4½ lbs., yet the Aegis PP4 is a powerful 4-valve battery portable measuring 4 ins. x 4½ ins. x 9 ins. Supplied complete to the last nut and bolt with midget 2 gang AWA, 3" Rola Speaker, Super-Het Circuit 67½v. Minimax batteries. Price including batteries £12/12/-
(Not including Valves)



J.H. MAGRATH & Co.

208 LT. LONSDALE ST., MELBOURNE *Phones: CENT. 3688* 4414

it also ensures a perfect electrical joint.

Nearly as many resistances are ruined by overloading as are damaged by bad soldering, and this is nearly always due to the fact that the constructor has omitted to calculate the amount of power the resistance will be called to carry, or, having done so, deliberately exceeds this, thus causing overheating with resultant breakdown. It is the simplest thing in the world to calculate the wattage rating required. All that has to be done is to multiply the value of the resistance in ohms and the square of the current in amperes. As an example, a resistance of five ohms passing two amperes must be rated for $5 \times 2 \times 2 = 20$ watts, but as we usually work in milliamperes, the result would have to be divided by 1,000,000, thus a resistance of 100,000 ohms passing 4 milliamperes would have to dissipate $100,000 \times 4 \times 4$ divided by 1,000,000 = 1.6 watts. In such a case, two watts rating should be employed to allow a good safety margin. It is as well to warn constructors at this point of the tendency of some very high temperature resistances on the market to melt the solder at the point of contact. These are usually of the small and very high wattage rating, and in such cases it is better to clamp the contacts under terminal bolts, or else use a very high temperature solder.

Old Resistors

Many set constructors resort to the use of resistors salvaged from old sets. This is never a wise plan, unless you have a good combination ohm-volt-milliammeter for checking purposes. Even with this instrument it is never wise just to check the resistance, as this may alter, as previously explained, after it has been in use for a while. Therefore, if you intend to use them it is better to make the test by deliberately applying an overload for a short period and noting any change in the resistance value or break in the circuit used under test. This could consist of a battery and lamp in series with a milliammeter (that is when dealing with resistances only called upon to handle milliamps, which is usually the case). The lamp (or

you could use another resistance) should be chosen so that the total wattage is slightly in excess of the resistance rating under test. If no detrimental results are observed you can assume the resistance is in good order. However, if you are in any doubt or if you are unable to carry out this test it would be better to purchase new ones, as they are not very expensive items. Another point which should be considered when dealing with old resistors is the type of circuit you intend to use them in. One of the difficulties associated with high gain circuits, particularly of the superhet type, is background noise in the form of "hiss." This has been reduced to almost negligible proportions in modern sets due, in no small measure, to the improved technique in the manufacture of resistances as well as valves. Many of the old type resistors, even if in new condition, would cause excessive noise of this type if used in the earlier stages due to the cumulative effect of all the resistances followed by the enormous amplification in the following stages.

Checking Receivers

One of the quickest methods of making preliminary checks when a faulty resistor is suspected, and a method which will appeal to those not fortunate enough to possess a meter, is to test by substitution, that is, connecting another resistor in parallel with the one under suspicion. You may think that a large stock of resistances would be required to cover the wide range of values to be tested, but this is not so. For the very short period of time necessary to make this form of test, four or five resistors of, say, 50,000 ohms, 0.1, 0.25, 0.5, megohms and 1 megohm are usually all that is required, although one or two lower values, such as 250 ohms to 2,000 ohms, will be handy for checking bias resistors. These can be mounted on a board and either terminals or a switch used to select the nearest one to the value required. A pair of test leads should be used for checking. If the receiver fault is such that it can be switched on for a short time without doing any harm, the test can be quickly carried out

while in this condition, a quick "dab" across each suspect resistor being all that is usually necessary. This method will only show up open circuit resistors or those which have increased in value to such an extent as to have almost a similar effect, but by far the majority of resistor faults are of this nature.

Testing

In cases where the resistor has decreased considerably or where shorts are suspected, one end will have to be disconnected. You can ignore the quality or other effects which may result when you have located the faulty resistor, as this will clear up as soon as you have replaced the one used for testing with another of the correct value. If, for any reason, you wish to leave the testing resistor on for some time, it would be wiser to choose one having a value equal or up to 50 per cent. higher than the one under test to avoid any chance of damage to valves or other components. The same method can be used, of course, for testing condensers quickly by using a testing range of, say, 4 mfd, 0.5, 0.1, 0.01, 0.0005 and 0.00025 mfd. These are all that are usually required for quick testing purposes. The 4 mfd. should preferably be of the ordinary type (not electrolytic), as you will not have to worry about correct polarity. This condenser is handy for testing either smoothing condensers in the H.T. filter circuit or cathode by-pass condensers.

This method of testing may seem crude, but it is both effective and time saving. In any case, it is about the only practical way of chasing faults, unless you are equipped with a good combination meter. Even then you will probably locate resistor trouble more quickly by this method, although you can quickly find out which stage of the receiver is at fault by making voltage checks at the socket of each valve first.

—From "Broadcaster" (W.A.).

MAKE SURE—

Our improved issues are selling so fast that you may miss out unless you place a regular order with your newsagent. Do it

—NOW!

Direct - Coupled Version

I RECENTLY built up an amplifier to Williamson's famous circuit, using valves and other components I had on hand, but being a direct-coupled enthusiast I thought I would have a try at converting the circuit, and here it is.

Williamson went to great trouble to reduce phase-shift, even using the direct-coupled phase inverter

By

H. D. SWIFT

22 Dundas Place,

Albert Park, Vic.

for this very purpose, so why didn't he finish the job and use direct coupling between drivers and output?

Anyhow, I figured I could reduce phase-shift even further by this method, and the circuit diagram shows the extreme simplicity and ease with which it can be done.

Points of interest are:—

1. The 50,000 ohm potentiometer for topping off 250 V for the drivers must be a wire-wound job (I burnt out a carbon one) or it can be replaced with a 22,000 ohm and an 18,000 ohm 1 watt.

2. If it is a wire-wound one, the shaft must be insulated from the chassis.

3. The 250,000 potentiometer in the plate circuit of the drivers, controls the bias on the 2A3's and must be adjusted for balance.

4. Hum is absolutely non-existent by virtue of the bridge circuit formed by the 1875 ohm resistor and 50,000 ohm potentiometer and the mid-point connection from cathodes of the 2A3's to the 2-16 microfarad filter condensers.

BEFORE MARCONI

(Continued from page 13)

his declining years on a farm. Before Dr. Loomis passed away in October, 1886, this man of sanguine temperament declared, "I know that I am by some, even many, regarded as a crank—by some perhaps as a fool—for allowing myself, to the sacrifice of material advantages, to abandon a lucrative profession and pursue this ignis fatuus, but I know that I am right, and if the present generation live long enough their opinions will be changed—and their wonder will be that they did not perceive it before. I shall never see it perfected—but it will be, and others will have the honour of the discovery."

Perhaps Loomis rather than Marconi would have been known as the father of radio had he the coherer detector which was brought out by Professor Edward Branley of the Catholic University of Paris in 1890.

ONE GOOD TURN—

If you would like bigger and better issues, make a point of supporting those firms who advertise with us.

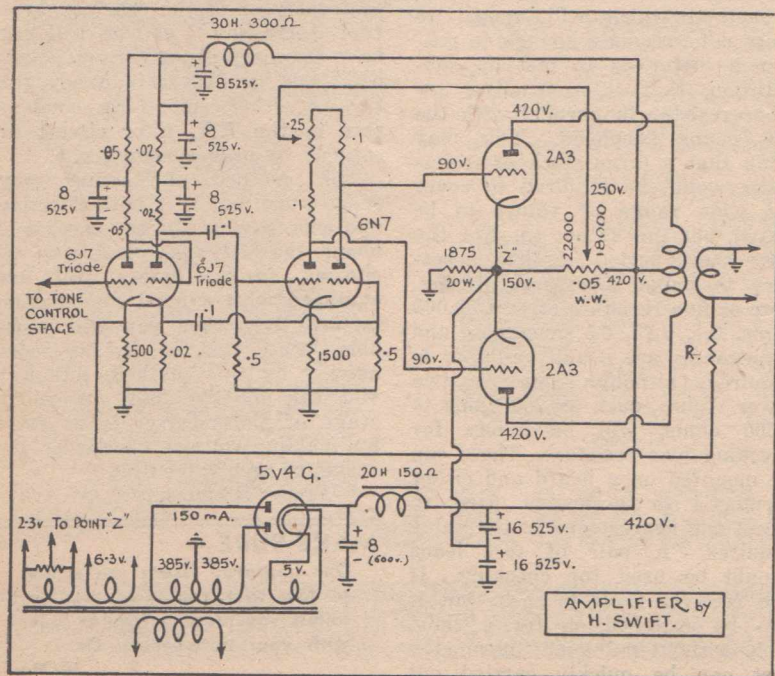

R.C.S. Coils Submerged

WATER is known as nature's greatest solvent. It dissolves anything from an Aspro tablet to a mountain. It also has the property to penetrate the finest cracks and pores, which often becomes a great nuisance. In the form of vapor it floats through the air with the greatest of ease and settles down, wherever it feels like, causing iron to rust, other metals to corrode, people to get electric shocks from bakelite light switches and radio sets to lose their efficiency.

Effect of Humidity

The more humidity there is in the air, the more it tends to settle down on objects, while on the other hand wet objects, such as washing, does not get dry. "Muggy" days like this are very frequent in Australia's coastal areas and precautions are necessary to minimise the detrimental effects of humidity.

Radio sets are one of the main sufferers from these climatic conditions and coats of wax are being used to protect power transformers, chokes, coils and IF transformers etc. from moisture. In most cases the main purpose is to prevent corrosion, but in the case of IF transformers, another very important factor, the "Q" of the condenser, comes into the picture. A protective layer of wax will only offer an efficient barrier to moisture, as long as there are no cracks, even of a microscopic nature in it. However such tiny cracks will appear, wherever the liquid wax is forced to set around a conductor after dipping. The conductor itself will expand, whenever it is warmed up (radios happen to get warm after a while) contract, when it cools off, to a different degree than the surrounding wax and so soon a small space will appear between wax and conductor, into which water is being sucked

by one of nature's tricks called "capillarity."

If we dip a thin glass tube into water, we will notice, that the water level inside the glass tube is higher than the surrounding water. The thinner the glass tube, the higher will the level be inside, the more water will be sucked into the tube. Porous matter, such as blotting paper or the wick of a kerosene stove, actually consist of millions of microscopically small tubes, and we all know how they suck up liquid. The same "capillarity" brings the sap of trees and plants from the roots right up to the top; without it no plant life could exist.

Penetration

And it is the same capillarity action again, which will drag any moisture covering a tiny crack right into it. It won't rush in, it will take its time, but eventually will get further and further in. If water penetrates along the terminal of an IF transformer, it will soon get to the trimmer condenser and to the insulation between the plates. The result will be considerable lowering of the "Q" factor, resulting in decreased selectivity and gain. The time it takes for the water to penetrate depends on the humidity in the air. We know from the last war, how quick the steaming humidity of a jungle could finish off a radio set, which would have worked perfectly for years in our climate. "Tropic proofing" has become a science. It was found that condensers and other components moulded into certain plastics remained moisture proof, long after wax covered ones had broken down.

As it is of utmost importance for the sake of "Q" to keep the capacitors of an IF transformer free from moisture, RCS Radio started experiments with condensers

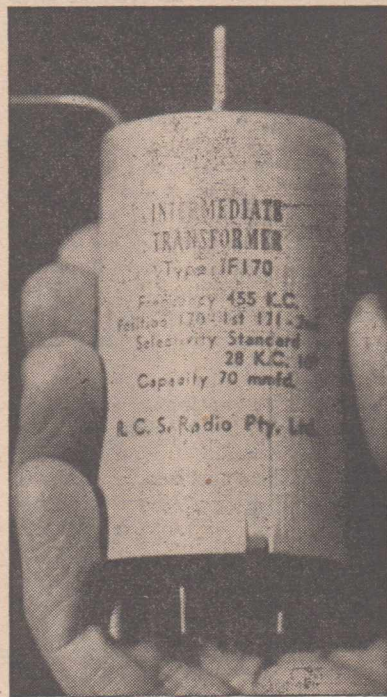

The latest R.C.S. i.f. transformer, with the specification printed on the can.

moulded directly into the base of the polystyrene former of their product. From my own experiments with samples, I can state that the claims made in advertisements of this firm are 100% true.

I obtained three sample IF transformer formers, of which I soaked two in water, to which I had added salt and vinegar, for 3½ days. I then put them to test on a precision "Q" meter, comparing them with the one I had not put in. There was not the slightest difference in "Q," all three being exactly the same. We then tested a waxed condenser of the same type by checking the "Q" first, then im-

(Continued on next page)

Tuning Range For Receivers

Advice From the P.M.G.'s Dept.

The P.M.G.'s department has announced that in accordance with the recommendations of the recent International Conference it has been decided, to utilise the 540 kilocycles frequency for the National station recently established at Longreach. In the circumstances it is desirable that all broadcast receivers manufactured in the future should cover the range 540 to 1600 Kc/s as a matter of course. In this connection, it may be found necessary to share the 540 Kc/s channel with another station elsewhere in Australia at some future date.

Some alternations have also been made to the tropical and high frequency bands for short-wave broadcasting services, which it may be found necessary to utilise in the future to service listeners in remote parts of Australia, New Guinea and Papua. The full ranges of these bands are as follows:

Tropical Broadcast Bands.

2300 - 2495	kC/s
3200 - 3400	"
4750 - 4995	"
5005 - 5060	"

Shared bands with priority to Broadcasting.

Note: "Tropical Zone" includes that section of Australia North of Latitude 35°S.

High Frequency Broadcast Bands:

3900 - 3950	kC/s
3950 - 4000	"
5950 - 6200	"
7150 - 7300	"
9500 - 9775	"
11700 - 11975	"
15100 - 15450	"
17700 - 17900	"
21450 - 21750	"
25600 - 26100	"

Share with Aeromobile Services.
Share with Fixed Services.

Exclusive broadcasting bands.

The frequencies referred to in the preceding paragraph will not be finally determined pending discussions which are at present being held in Geneva. It is not anticipated that there will be any

major changes to those specified above. The Department will advise the position as soon as any conclusion has been reached. Any decision arrived at is unlikely to be known within the next nine months.

R.C.S. TEST

(Continued)

mersioning it into water for about an hour. The "Q" test afterwards showed a decrease of about 20%. The wax cover of this condenser seemed to be in perfect order, the pig tails well covered and no visible cracks.

From these tests I am certain that RCS really have something there. There is another commendable feature about these IF's; as well as coils: they all carry, printed on the can, a description of their technical details, the type, selectivity, capacity, frequency, etc., so that you know exactly what you are buying. The sales personell of most radio firms display a shocking lack of even elementary knowledge of their goods. Some know enough about radio to give you an

8 mfd electrolytic, when you ask for an RF choke, but most of them think, that a communications receiver is a job with the PMG.

Actually one cannot expect skilled radio men to spend their time as sales men in a radio shop. But as it is of great importance when buying radio components to get exactly what you want, I would strongly recommend to other manufacturers to follow RCS's lead and print all details worth knowing on their products. It would save the customer and last, but not least, themselves a great deal of annoyance.

DE LUXE

(Continued from page 7)

convenience to change bands by the mere clicking of a switch. The old plug-in job worked very well but the twenty loose coils presented quite a storage problem and were often plugged into the wrong sockets! With a band-switching job one really gets an idea of just how crowded the bands are these days, for no matter what band one switches to, one usually clicks smack on to a station!

In these days of "twanny metre foam" one is apt to forget that the lower frequencies still are good for DX now and then. Heard a KH6 working a ZL on 80 recently.

SUBSCRIPTION FORM IS ON

PAGE 42

AMONG OUR READERS

News and Views from Subscribers

"I HAVE read your magazine for four years continuously, and all copies I could get hold of before that. I regularly receive copies of all other technical matter available at my work, but find that often the articles you publish are written in a way that is easily understood, without entering the realm of higher algebra, and the contributors seem to be practical men who impart useful knowledge on subjects which it is often hard to get reliable information about. As a member of the technical staff of a large Adelaide retail and manufacturing radio firm, my work covers service, experimental design work and testing of manufactured sets. As a result of much checking and measurements I have a good idea of the relative performance of most commercial receivers and radio-components on the market, and Kingsley coils take some beating, although most well-known brands of components are very efficient. If a new component is put on the market, we make a test of it in a set and compare the performance and if thought suitable or necessary, use it. Compression trimmers are out for good with us now, and we remove them from a brand line of dual wave units and substitute air trimmers and wire wound trimmers, which are far more stable over a period. There are really many ways of improving the performance and stability of commercial coils for optimum results, but they are only found by practical experience. In commercial set design, cost is the limiting factor which binds one down, so the set has to be made with bass boost or treble cut tone controls to cater for the tastes of the masses who use the set to listen to everything from races to symphonies and the

NOTE

As several hundred of these letters are received each month it is not possible to find space to publish them all. It is simply a matter of drawing a few "out of the hat" each month, so please do not be offended if you have written, but your letter has not been published.

moronic efforts of Sinatra, Phil Harris and the Dorseys, etc.

Cost Of Hi-Fi

The use of high fidelity audio circuits involves such a great increase in the cost of the set that few would be prepared to pay the extra, and the majority of listeners would only turn the tone control to bass, to eliminate needle scratch, which is the bugbear of hi-fi reproduction of present type of mediocre records used by the public. Despite the publicity blurb of the big manufacturers, little technical advance is evident in radio today and it is only by cabinet design and propaganda about the superiority of a certain arrangement of the speaker to allow the noise to get out three different ways at once, that sells new sets. Through working on defence equipment during the war, I came in contact with transmitters and the urge to operate my own gear struck me, but the Morse code is not up to scratch yet for the AOCF exam, and I'm hoping for the best. I am in the VK5 division of WIA. I heard a special automatic record player model imported from England by my employers, which is in two units. One unit contains the amplifier and two speakers of an

oval shape, and the other unit houses the pickup turntable and the on-off switch, volume control, bass boost and treble boost control, and a so-called needlescratch filter control. The apparatus sounded very impressive and appeared to have volume expansion incorporated, but there was an objectionable needlescratch present on all but new records when the listener was near the speaker console. Personally I don't like the idea of using ex-disposals gear in a ham shack, and would prefer to build my own rig up and not have to modify and make-shift with unsatisfactory gear and crude keying methods and frequency instability. In conclusion your magazine is ideal for keeping in touch with new products advertised, and useful experimental circuits for receivers, and I hope you are able to enlarge your issues and cater still more for the man who is interested in strictly the technical side of radio and amplifier work. Paul Stevens is doing an excellent job."

—D. E. Francis, 99 O'Connell St., North Adelaide.

* * *

"I am a grazier and live well out in the bush and wireless is my main hobby. My wife and family derive great enjoyment from the radio programmes. I do too, of course, but I am specially interested in the technical side of radio and in the construction of receivers, both broadcast and short-waves."

I am a keen short-wave listener, which is a necessity in this part of the world during the summer if one is to use the wireless at all. Even on the fairly high frequencies the static is very bad some nights.

(Continued on next page)

F.M. Adaptor For £3

This is a well designed American design manufactured by several firms over there, which we hope to feature, with all special parts to be made available to the home constructor, within the next two months. A similar circuit was shown as "Fre-Modyne" in the FM article of the Sept. issue Radio World, but this one will be slightly different. It also uses only a single twin triode and does not boast a noise limiter, but due to the inher-

ently lower noise level of the very high frequency band it will still be an improvement on AM. To people, who are not normally plagued by static on their standard AM sets, the only advantage of FM will be the additional number of stations to listen to; and to this vast majority our little adaptor, costing only about $\frac{1}{3}$ of standard types, will be dedicated.

—P.S.

OUR READERS

(Continued)

Occasionally, during a cyclone, I have known the interference so bad it was impossible to listen on any frequency of all. It caused a kind of fast motor-boating, as you might call it. The first time I heard it I thought it was a fault in the set, but a trial on another receiver soon convinced me."—H. E. Fox, Myuna, Collinsville, Queensland.

* * *

"I'm just another of the Bowyang family, have a pretty steady job out on one of the gold mines here as a painter. Yes, painting and decorating is my trade and radio is my hobby. The reading of circuits, building of sets, wiring them up and so on is all O.K. to me, but when it comes to mathematics I look the other way. If so and so designs a set and you publish the circuit the specifications are near enough for me. I have been patiently waiting for the arrival on the market of something better in the way of valves of the ac/dc series. It is certainly unfortunate now for anyone living in a dc area, as is much of Kalgoorlie and the Boulder district."—W. H. Corless, 4 Outridge Terrace, Kalgoorlie, W.A.

* * *

"I have built the Club Special with vibrator as described in the April 1941 issue, and I am very pleased with the set. At present I am not using the vibrator unit as

the local current is D.C. I am using the D.C. for the high-tension supply with a six-volt battery for the heaters. It works out very well, as I get little interference through the mains, actually less than with the vibrator, and it is less expensive. Most of the radio sets here use D.C. eliminators. Some of them get a lot of interference, and others get hardly any."—V. A. Hoffman, Box 148, Loxton, South Australia.

ROLA MOUNTINGS

In the "Among Our Readers" department of the July issue, a correspondent, in asking that radio hobbyists receive more consideration from manufacturers, says, "For example, the Rola Company could be asked why the mounting bracket is now missing from the five and six inch speakers."

The Rola Company tells us they have always fitted loudspeaker mounting brackets to Rola models 5C, 6H and 6K intended for the resale market. The only five and six inch Rola loudspeakers not provided with mounting brackets are those supplied (optionally) to radio set manufacturers for equipment purposes and these are covered by a special warranty which becomes void if the loudspeaker is sold separately.

It would appear that our correspondent is confusing the resale and the equipment type five and six inch Rola loudspeakers.

"I am a schoolteacher but, I am afraid, more interested in radio, particularly sound. Any article on amplifiers interests me greatly. However, I am rather cramped here as there is no A.C. or D.C. and I have to depend on vibrators for power supply. At present I am using two power supplies from the FS6, in parallel, to run a 13-watt job for dances."—E. Sant, Sofala, via Bathurst, N.S.W.

* * *

"A.R.W. is duly appreciated and every issue is welcome. I read it with interest from Editorial to Speedy Query Service. The personal paragraphs are quite an interesting feature, displaying a variety of background. That last remark suggests that I should contribute to the variety; so: age, 49; farming, wheat and sheep. Was first in a wide radius to acquire a two-valve receiver in 1925, when 6WF was on 1250 metres and the only broadcast station in West Australia. Gave many people their first experience of radio reception, on headphones. Plenty of static, always worst of course for visitors. Nowadays, with radio servicing added to farming and plus study of a radio course, no time is left for DX hunting. Hope to take it up again some time—the Short-wave Review is tantalising. I like reading about the Editor, too. Hope the new abode is right up to expectations."—A. T. Threlfall, Nalkain, West Australia.

HERE AND THERE

"Querex." There's a Heath Robinson or Punch-like flavour in humorous sketches appearing in issues of "Short-Wave Magazine," England, the theme, of course, being essentially amateur radio. May issue depicts an obvious Ham walking away from a fishmonger's barrow, with the fishy gent remarking to a client . . . "then ee picks up the 'Addick an sez 'I'll give that Ess Nine or suthinck.'"

MODEL AEROS

The Model Aeronautical Association is holding the Australian National Championships at Bankstown, N.S.W., on November 20 and 21.

RADIO'S
LATEST
FASHION
PLATE

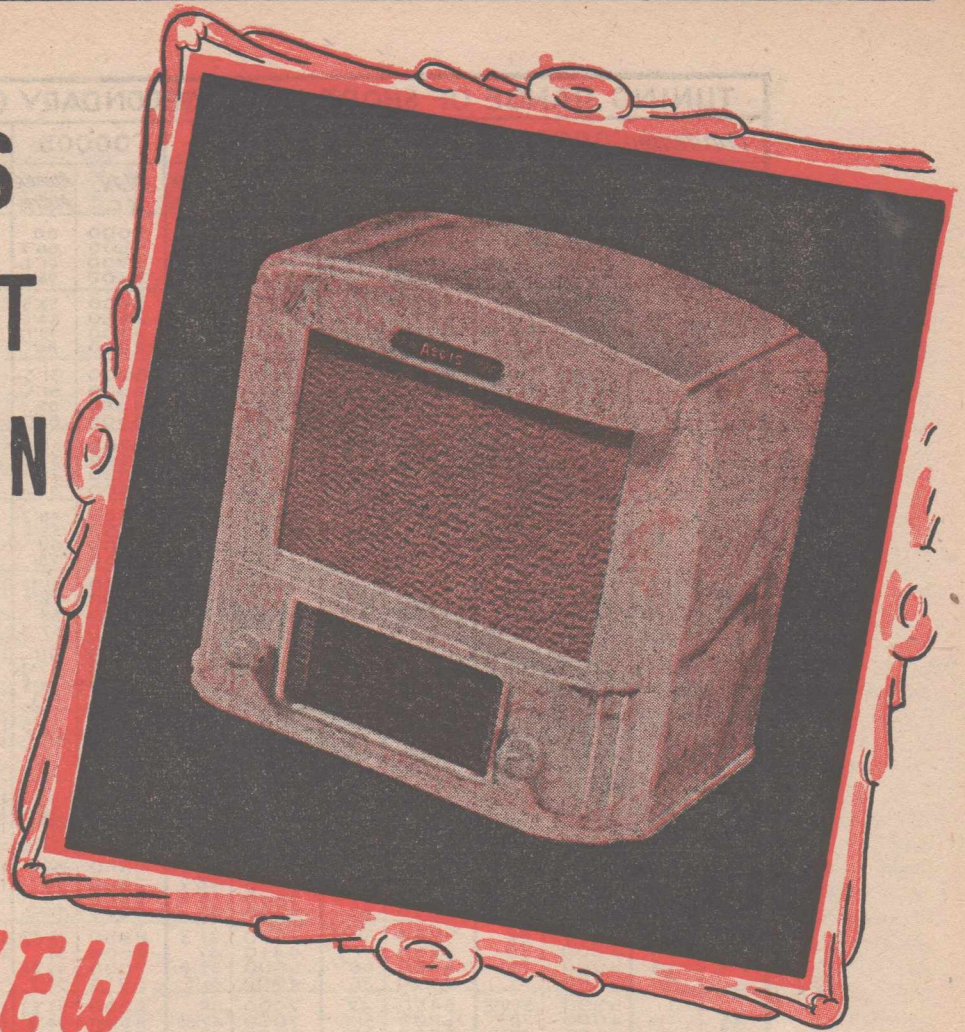

The NEW

AEGIS *Marble* **CABINET**

As usual, Aegis presents the latest kit set attraction for hobbyists! This time it's the ultra-smart marble cabinet in which to use either of these two popular and proved Aegis kits.

AVAILABLE WITH THE "METROPOLIS"

KS4/B. The famous 4-valve BC Mantel Receiver with every Aegis quality feature including Rola 5C Speaker, Cadmium-plated chassis, Edge-Lit Straight Line Dial, etc.

AND THE "RURAL 4" KIT ASSEMBLIES

KSR/4. The ideal country receiver with everything for top battery performance including Rola 6H Speaker, Straight Line Dial, etc.

NOW BOTH
£10/10/-

plus any valves or
batteries required

£10/-/- with Walnut
Cabinet

AEGIS
MANUFACTURING COMPANY PTY. LTD.
208 Lt. Lonsdale Street,
MELBOURNE, VICTORIA

AGENTS

IN ALL STATES

TUNING RANGE OF SHORT-WAVE SECONDARY COILS											
Condenser-00025				00015		0001		00005		Minimum	
Turns 24disc	Diam. Former	Max. K.C.	Approx Metres	Max. K.C.	Approx Metres	Max. K.C.	Approx Metres	Max. K.C.	Approx Metres	K.C.	Approx Metres
30	1 INS	2230	134.5	2900	103.5	3550	84.5	5000	60	7000	42.8
	1 1/4	2000	150	2600	116.4	3200	93.5	4500	66.5	6400	46.6
	2	1650	181.8	2150	139.5	2670	112.4	3700	81.1	5400	55.5
26	1 1/2	1350	222.2	1760	170.5	2160	138.5	3100	96.5	4750	63.2
	1 1/4	2500	120	3250	92	3950	101.5	5600	53.5	8000	37.5
	2	2080	144.2	2570	117	3280	91.5	4650	64.5	6600	45.2
24	1 1/2	1790	167.6	2300	130.4	2850	105.3	4100	73.17	5750	52.2
	2	1500	200	1830	163.9	2370	126.5	3380	89	4800	62
	1 1/4	2530	118	3300	90.5	4050	74.07	5800	51.5	8100	37
22	1 1/2	2200	136.4	2850	105.3	3480	86.2	4900	61.2	7000	42.8
	2	1920	156.3	2500	120	3050	98.5	4350	69	6150	49
	1 1/4	1570	191.1	2030	147.5	2500	120	3500	85.7	5000	60
20	1 1/2	2720	110.3	3600	83.3	4400	68.5	6200	48.2	8800	34.2
	2	2300	130.4	2970	101	3700	81.1	5200	57.2	7500	40
	1 1/4	2050	146.3	2570	112.4	3270	91.5	4630	64.5	6550	45.5
18	1 1/2	1650	181.8	2150	139.5	2670	112.4	3700	81.1	5300	56.2
	2	2850	105.3	3500	86.2	4300	74.07	6500	46.2	9100	33
	1 1/4	2550	117.5	3300	90.5	4050	74.07	5750	52.2	8100	37.04
16	1 1/2	2230	134.5	2900	103.5	3550	84.5	5000	60	7150	41.96
	2	1790	167.6	2300	130.4	2800	107.1	4000	75	5650	53.5
	1 1/4	3200	93.5	4200	71.5	5150	58.5	7300	41.10	10300	29.2
14	1 1/2	2760	109	3600	83.3	4400	68.5	6200	48.2	8800	34
	2	2500	120	3250	92.5	3950	76	5600	53	8000	37.5
	1 1/4	1990	150.8	2550	118	3200	93.5	4430	67.3	6250	48
12	1 1/2	3300	90.5	4300	69.5	5300	56.5	7500	40	10600	28.3
	2	2800	107.1	3700	81.1	4500	66.5	6350	47.2	9000	33.3
	1 1/4	2400	125	3150	95.2	3860	77.7	5500	54.5	7500	39.7
10	1 1/2	2230	134.5	2900	103.5	3550	84.5	5000	60	7000	42.8
	2	3500	85.7	4550	66.5	5600	53.2	8000	37.5	11300	26.2
	1 1/4	3150	95.2	4070	74	5000	60	7100	42.25	10050	30
8	1 1/2	2700	111.1	3500	85.7	4300	69.5	6150	49	8700	34.5
	2	2300	130.4	2970	101	3700	81.1	5200	57.2	7300	41.1
	1 1/4	4000	75.0	5250	57.5	6450	46.51	9100	33	13000	23.08
6	1 1/2	3600	83.3	4700	63.5	5750	52.4	8200	36.6	11600	25.8
	2	3300	90.5	4200	71.5	5150	58.5	7300	41.10	10300	29
	1 1/4	2500	120	3250	92.2	3950	76	5600	53.4	8000	37.5
4	1 1/2	4230	71.07	5400	55.5	7100	42.25	8350	36	12000	25
	2	4020	75	5020	59.5	6200	48.2	7600	39	10900	27.5
	1 1/4	3600	83.3	4300	69.5	5430	55.5	6900	46	8600	35
2	1 1/2	2950	102.1	3620	83	4500	67	5500	54.2	7500	40
	2	4720	64	5880	51.02	7270	41.3	8950	33.52	13000	23.08
	1 1/4	4300	70	5200	57.5	6410	47	8600	35	11600	25.8
9	1 1/2	3940	76.1	4400	68	5600	53.5	7000	42.86	8970	33.7
	2	3250	92	3950	76	4900	61.5	5910	50.7	7400	40.54
	1 1/4	5330	56.06	6420	47	7900	38	9000	33.33	14000	21.43
7	1 1/2	4300	70	5600	51.6	7050	42.55	8800	34.2	12550	23.8
	2	4150	72.5	5000	60	6400	47	7840	38.2	9300	32.2
	1 1/4	3450	87	4300	70	5380	56	6500	46.2	8200	36.5
5	1 1/2	5560	54	7100	42.25	8650	35	10860	27.5	15000	20
	2	4900	61.5	6400	47	7700	39	9700	30.6	13500	22.2
	1 1/4	4420	68	5580	54.5	7100	42.25	8550	35.2	10900	27.5
3	1 1/2	3850	78	4500	66.5	5950	50.5	7300	41.1	9200	32.7
	2	6300	47.8	8000	37.5	9500	31.7	11900	25.1	16000	18.75
	1 1/4	5560	54	7270	41	8540	35.2	10800	27.5	15400	19.5
1	1 1/2	5200	57.5	6500	46	8000	37.5	9700	31	12050	25
	2	4250	70.5	5450	55.05	6800	44	8200	37	10400	29
	1 1/4	7100	42.5	9000	33.33	10600	28.2	13350	22.5	20000	15
2	1 1/2	6400	46	8050	37.1	9170	32.7	12000	25	17330	20.9
	2	6000	50	7500	40	8600	35	11000	27.27	13650	23.7
	1 1/4	4600	65.5	6220	48	7700	39	9400	32	11600	28.2
1	1 1/2	8580	35	10300	29.5	11900	25.1	14670	20.4	20600	14.5
	2	7200	41.67	9630	31.5	11100	27	13200	22.73	19000	15.7
	1 1/4	6800	44	8700	34.5	10500	28.57	12500	24	15800	19
1	1 1/2	5650	53	7540	39.8	9000	33.33	11230	26.7	13600	22
	2	9600	31.8	11800	25.2	13200	22.73	16360	18.3	25000	12
	1 1/4	8000	37.5	11600	25.5	12500	24	15800	19	23400	12.8
1	1 1/2	7900	38	10300	29.5	11900	25.01	14150	21.2	23000	15
	2	7200	41.5	9340	32.5	10950	27.3	13050	23	17800	16.8
	1 1/4	10000	30	13660	22.06	14680	20.4	18300	16.3	25500	11.7
1	1 1/2	9800	30.4	13300	22.56	14000	21.43	17950	16.8	24200	12.4
	2	9400	32	12430	24.1	13660	22	16900	17.75	23700	12.6
	1 1/4	8750	34.3	11900	25.1	13270	22.7	15950	19	23000	12.87
1	1 1/2	10800	28	14600	20.6	16200	18.5	18450	16.25	26000	11.4
	2	10600	28.3	14250	21	15100	19.8	17700	17	25000	12
	1 1/4	10100	30	13200	22.7	14760	20.3	17330	17.25	24000	12.5
1	1 1/2	9700	30.8	12400	24	13700	21.9	16500	18.2	23400	12.8

CALLING CQ!

Conducted by Don B. Knock, VK2NO

From Don Pratt, ZL3KI, of Christchurch, NZ . . . "There have been quite a few openings for 6 metre men in New Zealand, mostly between ZL1 and ZL4. Good contacts have been had. There were a few brief openings between ZL1 and ZL3. As in Australia, it is considered that the band is frequently open, but lack of activity brings negative results. Most of the ZL openings have been between 3 and 7 p.m. local time. ZL3AQ, Ashburton, had the first ZL1/ZL3 contact with ZL1HY of Waihi. ZL3KI was second, making contact with ZL1VI of Cambridge. Also, ZL3KI was the first ZL3 to work a ZL2 on 6 metres. Since then he has worked all ZL districts, being the

first to achieve this. Don says that consistent ground-wave communication is had with ZL4BN in Dunedin. The transmitter at ZL3KI uses 12 watts to an 807 with a 3 element wide spaced beam 18 ft. high. The receiver has an EF91 RF stage, this valve being slightly better than a 6AK5. In Christchurch he hears quite a few odd harmonics from 80 metre stations, falling in the 6 metre band, and finds them handy for tuning purposes, but deceiving at times . . ." (in VK we don't take so kindly to unwanted harmonics, especially between 50 and 52 mC/s (VK2NO).

* * *
Ken Maloney, ex VK2UC and now very active as ZL2LV, is to

be found at week-ends with a strong phone signal on 10 metres. He is active also on 6 metres using an 829B in the final. He says that the Big Breakthrough period of December 1947/January 1948, caught most of the ZL VHF devotees napping, but since then there is plenty of activity. He reports also that a few months ago ZL2FZ was hearing W's on 6 metres and that CE1AH (Ida) heard a few ZL and VK stations on CW. She didn't pay much attention to them because she is not very proficient at the morse code!

* * *
Bill Potter, VK2WP, who is one of the two-decade Old Timers, and sports phone on 40 these days, tells me that the Wollongong Radio Club is looking for contacts with Sydney stations on 6 metres. That shouldn't be very difficult with concentration, but there is that hurdle of the ranges in between.

* * *
A new-old station with an excellent phone transmission in the Sydney area on 6 metres is Alan Llewellyn, VK2AH. In pre-war times he was for a spell with the Baird Television concern in England, and suffered the unpleasant experience of seeing the extensive TV labs at the old Crystal Palace go up in smoke. With the smoke went an interesting job. He is using an 815 in the final on 6 metres and has two 3 element beams, one for reception and the other for transmission . . . (what is the matter with a changeover relay OM?) VK2AH is planning for FM transmission on the 144 mC/s band.

CORRECT OPERATING PROCEDURE

For CW

Two stations using the callsigns VK1AA and VK2AA will be considered for the purpose of illustration.

Calling CQ or calling VK1AA—"CQ, CQ, CQ de VK2AA, VK2AA, VK2AA" . . . this is repeated in entirety three times until actual contact is made. The only conclusion for the call should be "AR."

Contact Made—"VK1AA de VK2AA" once only is required, followed by "BT." VK2AA then sends his over and gives "AR," followed by "VK1AA de VK2AA K."

Final Signature at End of Contact—"VK1AA de VK2AA SK," which means that VK2AA is completely finished with VK1AA and will look over the band for calls from other stations before transmitting again.

For Telephony
Calling CQ or Another Station

"Hello CQ (or VK1AA), this is VK2AA calling." Repeated three times. At the conclusion of the call one of these phrases may be applied: "VK2AA is looking over the band from the High (or Low Frequency) end . . . over." Or "VK2AA is going to the receiver . . . over" Or "VK2AA is standing by at the receiver . . . over." Look around the band for a period of three minutes and, if no answer is received to the call, the procedure may be repeated. It is very bad practice to call long CQ's.

Contact Established—"Hello VK1AA, VK2AA answering (or replying). Your signals received." (If less than QSA5, give the readability report in approved manner.) When signing at the end of the over: "VK1AA, this is VK2AA . . . over."

Signing Off—"VK1AA, this is VK2AA signing off" and "looking around the band" or "closing down," as may be decided.

(Continued on next page)

HAM NOTES

(Continued)

The 10 metre band is coming to life for contact with Britain in the evenings and frequently G's are heard at two peak periods. The first falls about 1830 hours and the second at 2100 hours E.A.T. Signal strength is not yet consistently strong but such stations at G8TH and G8FI reach a useful S7-8 level. VK6's are well in evidence in the early evenings and a strong station in Ceylon is VS7RF. The writer, in distinct contrast to the 20 metre band, finds great difficulty in working with G's on 10 metres, despite the use of a well-adjusted 3 element close-spaced array. The overall height of 18 ft. is suitable for the clear get-away over the Pacific to USA, but is heavily screened to the North West by rising ground. The old regulars on 10 metres, such as VK's 2EQ, 2WB, and others can be heard working the DX daily. There appears to be no falling off in the overall strength of W and

NEWS FROM AEGIS

The Aegis Manufacturing Co. Pty. Ltd., announces that it has now released for general sale their crystal filter unit type CF/1. This unit is a completely assembled and wired affair, all ready to have the crystal and valve popped in to it. The special "ham" price for this unit is 75/-, plus tax.

It is interesting to hear that the big four-band tuning unit released by Aegis in our July issue is proving popular and the first production run was soon snapped up. Arrangements have been completed for increased production facilities and a big batch of units is now coming off the line at a steady rate.

Another item worth mentioning: Aegis have installed a special type of printing machine so that all Aegis coils and intermediate transformers will in future have clearly printed on the outside of the can the full story about the product inside, including the colour code.

Japanese Island stations, who are mostly around the S nine mark for hours.

One wonders why it is that Aurora conditions in the Southern Hemisphere don't seem to produce interstate DX on 6 metres as is the case with the Aurora Borealis in U.S.A. and Britain? Maybe it is lack of activity at the time, but I know of many VK2's, who, on spotting the familiar red glow have immediately switched on the gear with hope. All 6 metre DX recorded in Eastern Australia seems to have been of the Sporadic E variety.

—DBX

PERTINENT PONDERINGS

Those on the look-out for more than usually stable VFO's should take note of what is known as the Clapp Colpitts oscillator circuit. This was described in the May 1948 issue of "QST" U.S.A. and has many features of considerable interest. One is that the oscillator may, it is claimed, be keyed without any suggestion of keying chirp. Output is via the cathode circuit and the scheme is simple enough to knock together at short notice.

* * *

Whilst idly listening to doings on 7 mC/s I was interested in the remarks by a VK2 to the effect that a friend of his had gone to considerable trouble at a country location to erect a multi-section Sterba-type curtain for 20 metres, but that nothing would make it draw "soup." That seemed to be rather drastic, assuming that the wire lengths were even in the vicinity of Handbook formulae, but a chance remark gave the clue. It was to the effect that the array was made up from ex-Army telephone cable of the D8 stranded steel (plus one of copper) variety. It is quite out of the question to cut half-waves according to formula in this kind of wire, for the simple reason that the RF resistance of the small gauge stranded steel is very high. To hit resonance at the required fre-

STANDARD CLASSIFICATION OF FREQUENCIES

Under 30 kC. Very low frequencies. VLF.

30 to 300 kC. Low frequencies. LF.

frequencies. UHF.

300 to 3000 kC. Medium frequencies. MF.

3000 kC to 30 mC. High frequencies. HF.

30 mC to 300 mC. Very high frequencies. VHF.

300 mC to 3000 mC. Ultra High

3000 mC to 30,000 mC. Super High frequencies. SHF.

quency will call for cut and try methods, and it will be found that to resonate in the centre of the 20 metre band a half-wave length of D8 will be somewhere about 29 or 30 ft. in length, and not 32 or 33 ft. With a multiple array such as the Sterba, it will be even a shorter length of the steel wire for each half-wave section. This ex-telephone cable has many uses around amateur stations, but at my own I use it for lightweight guying purposes. The last thing I would do is to use it for radiators, unless there simply happened to be nothing else round the place. Don't quote fencing wire either . . . that is a different story, being solid conductor with a nice useful surface area.

* * *

What is the word that is in these days most overdone in the amateur phone vocabulary? No . . . you are wrong . . . it isn't 'Roger,' but the word 'INCIDENTALLY.' Let us change it forthwith to "by the way" or something similar.

* * *

There is an answer to everything. Old Timer Hermann Asmus, VK3ET, who works CW by means of one of those dinky little Type 3 Mk 2's on 7 mC/s and won't touch phone, came back at my reference to having passed 36 years actively engaged in amateur radio

with . . . "not bad Buddy . . . but I've been a hardworked commercial for over 43 years . . . so what." Hermann is a brass-pounder in Melbourne's Central Telegraph Office, which explains his aversion to the spoken as against the symbolic word. He tells me he has a few surplus 1N34's.

* * *

Nonmetallic permanent magnets, known as "Electrets," are now being made of plastics, usually by solidifying a molten wax in a strong DC electric field.

—Ohmite News

* * *

In the August issue of QST there are the details of a ham band superhet designed to give selectivity. It features double conversion with one rf stage, one if stage at 1600 k/C and FIVE stages of if at 72 k/C plus the usual audio end and lots of voltage stabilisers. Of course the selectivity is too great for use with phone reception; the receiver being designed mainly for cw work.

* * *

It is bad practice to use CW abbreviations on telephony communication other than in the recognised methods of reporting signals, i.e., "QSA5 R8," etc. The use of the expression "Hi" and whistling into a microphone are practices to be shunned at all costs."

—D.B.K.

* * *

In ARW 1948, Ted Cowthron (VK5JE) stressed the DX features of the much maligned 40 metre band, thereby adding weight to our contention that the old DX stamping ground is as good a spec as ever. In support thereof, Trevor Evans (VK2NS) "the Old Sock" says . . . "I agree with your remarks re DX and phone on 7 mC/s as I have made WAC on the band without much trouble except for the phone problem." If anybody should know the lure of elusive DX it is the versatile VK2NS who bowled over sundry trophies and whatnot in the earlier DX days . . . and nights.

AMATEUR TRANSMITTING LICENCES

Information from the P.M.G. gives the following current information:

Alterations

VK2GE, E. B. Mais, Commonwealth Bank, Moree, N.S.W.
 VK2CZ, C. Petrick, 4 Oak Street, Blackwall, via Woy Woy, N.S.W.
 VK2QI, C. Bowler, "SS Iron Master," 25 Castle Street, Randwick, N.S.W.
 VK2ADB, D. G. Caldwell, Ashfield Hotel, Ashfield, N.S.W.
 VK2AF, A. J. Williams, 94 Docker Street, Wagga, N.S.W.
 VK2AIP, R. G. Thorburn, 21 Fernbank Street, Marrickville, N.S.W.
 VK2AGW, A. E. Hay, 6 Provincial Road, Lindfield, N.S.W.
 VK2DJ, D. S. Johnson, 134 Griffiths Street, Balgowlah, N.S.W.
 VK2AHW, H. T. J. Stone, 36 Wellesley Street, Summer Hill, N.S.W.
 VK3AKC, G. Griffiths, 59 Flemington Road, Nth. Melbourne, Vic.
 VK3PB, P. C. Bennett, C/- 3SR, via Shepparton, Vic.
 VK3TU, J. F. Irvine, 15 Rathmines Road, Auburn, Vic.
 VK3QL, S. H. Le Breton, Post Office Quarters, Kanira, Vic.
 VK3AFL, F. C. Lambert, 117 Gould Street, Bairnsdale, Vic.
 VK3QV, W. J. Budge, Austral House, Benalla, Vic.
 VK3ZO, J. A. Cunliffe, 21 High View Road, East Preston, Vic.
 VK3QK, J. T. Pearse, 31 Redan Street, East St. Kilda, Vic.
 VK3ALL, Dr. K. M. Kelly, the Vice-Chancellor's House, University, Carlton, Vic.
 VK3AGS, G. E. Sheeran, 8 Winifred Street, Essendon, Vic.
 VK3TJ, R. W. Torrington, Thistle Street, Pascoe Vale, Vic.
 VK4NW, H. J. L. Woolonugh, Shorncliffe Flats No. 3, Shorncliffe Parade, Sandgate, Qld.
 VK4KJ, W. E. C. Sawyer, OTC Radio Station, Thursday Island.
 VK4PL, W. S. F. Proposch, Fitzroy Street, Nanango, Qld (previously cancelled, now renewed).
 VK4VK, R. A. J. Taylor, Department of Civil Aviation, Karumba, Qld.

VK4RP, A. R. White, C/- P. J. Mackinnon, Victoria Point, Brisbane, Qld.
 VK5IJ, I. L. Griffin, 39 Brougham Street, Magill, S.A.
 VK5BR, A. L. Butler, David Terrace, Murray Bridge, S.A.
 VK5IS, I. Shearer, 68 Cremorne Street, Unley, S.A.
 VK5CN, S. K. Howard, Mobile, Northern Territory.
 VK5PR, K. W. Kilsby, Ming Aiy, S.A.
 VK6SN, A. W. Sowden, 4 Wynelham Street, Victoria Park, W.A.
 VK6AX, H. G. Leybourne, "SS Asphaltion," C/- Dalgety and Co., Fremantle, W.A.
 VK6JW, J. C. Watson, 12 Bernard Street, Claremont, W.A.
 VK6HM, C. W. B. Holman, "Green Gables," 52 Federal Road, Boulder, W.A.
 VK7CJ, A. E. Finch, 12 Augusta Road, Newtown, Hobart, Tas.

Cancellations

VK2AYG, R. C. Allsop, 30 Trafalgar Avenue, Roseville, N.S.W.
 VK3NZ, C. W. Adams, 30 Erica Avenue, Glen Iris, Vic.
 VK4CY, H. R. Greber, Grand Hotel, Wharf Street, Maryborough, Qld.

Issues

VK2ATK, K. T. Andrew, 32 Aeolus Avenue, Ryde, N.S.W.
 VK2ALN, Rev. L. E. Winton, The Rectory, Wyalong, N.S.W.
 VK2QZ, A. J. C. Robertson, 6 Lachlan Flats, 108 Brook Street, Wagga, N.S.W.
 VK2AKL, A. Fairhall, Trevallyn, via Paterson, N.S.W.
 VK2EP, K. W. Craig, 22 Henby Street, New Lambton, N.S.W.
 VK3ASL, S. E. Lesser, 155 Powlett Street, East Melbourne, Vic.
 VK3AWK, W. E. Loveland, River Street, Quambatook, Vic.
 VK3AOK, G. H. Vardy, C/- Miss Jance, 11a Reatan Street, St. Kilda, Vic.
 VK5OD, Rev. R. C. Cutherberlet, Port Pirie Central Methodist Mission, Port Pirie, S.A.
 VK5FN, R. J. Poole, 11 Short Avenue, Da Costa Park, Glenelg, S.A.

OBSERVATIONS OF 28mc.

MAIN reason why so many VK's have adhered faithfully and exclusively to Ten during the past three or four years is undoubtedly the sheer fascination of the behaviour of the band. It is at the same time the most exasperating yet alluring channel available for amateur communication. At peak period, signal level reaches an intensity quite unknown to lower frequencies at a given distance and it is, during the appropriate season, commonplace to find G stations appearing on receiver dials with such strength that the fact that they ARE 12,000 miles distant is unbelievable. In the same breath, however, it is also commonplace to find that virtually in the middle of a syllable, that DX station will vanish into thin air as the band goes temperamental, and "folds." Also, at unexpected times stations appear on the dial from parts of

the world wherewith communication at 14 mc/s may be quite infrequent and somewhat of a rarity.

Judging by the attractive features of Ten, one may assume that if and when, war and suchlike calamity excepting, international amateur radio acquires the much-talked of 21 mc/s band (Fifteen metres), that region may prove to be even more fascinating. For the nonce, however, it is the Ten metre band that provides an outlet for DX enthusiasm, and in the early summer months the evenings in Eastern Australia are productive of mightily strong phone signals from Britain and various European countries. The business of working consistently with these stations is, however, in some locations, a very different coloured horse to the 20 Metre steed. Immediate local screening by rising ground in the vicinity of the station at this end can prove to be a real stumbling block for the business of working in the requisite north-westerly direction. It is one thing to hear these stations, and quite another to attract their attention, if the antenna system or array is but a few feet above ground. Ten is a band where height above ground for the array IS of real importance, whereas at half the frequency such consideration is not vital. The man with a 60-foot tower and well-adjusted rotary array atop will do far better than he with an array 22 feet or so up, and with intervening ground in the desired direction.

The lower elevated array may still be properly tuned, but will fail to make the grade. The writer's station is an instance of this. A 3-element CS beam with Foldipole radiator is used at about 18 feet above ground, on the same rotary pole as the 3-element WS beam for 6 metres, which is at 30 feet. The terrain to the north-west rises gradually until the station location is below the level. To the north, east and south-east there is a clear open view across the Pacific, and no trouble is experienced with work with U.S.A., New Zealand and Japanese areas. But to the north-west and west, the Ten-metre rotary is futile. The

G's just cannot be heard at any reasonable level, nor can their attention be attracted. Only way out of the impasse has been to titivate the 20-Metre G8PO beam array in such a manner as to make it behave well on Ten. This beam is arranged for directivity on 20, north-west and south-east for short and long routes respectively to Britain. To use two regular dipoles cut for 20 on Ten without any other consideration would result in a nondescript radiation pattern akin to a lot of wire hanging in the air functioning as some kind of Marconi affair. In the writer's case, however, the G8PO system comprises two Delta-fed dipoles with 300 ohm K25 Telecon lines. By arranging each dipole with an insulating bar at the centre, two terminals and shorting links, the beam can be lowered, the links opened for Ten metre operation, and closed for 20 metres. On Ten the system becomes two half-waves in phase, backed by two more half-waves in phase at a quarter-wave delay, with controllable directivity as on 20 metres. Actually each radiator is a Windom type in this set-up.

It functions very nicely and has enabled the writer to work with many G stations on Ten that simply could not be contacted on the lower elevated rotary array. The G8PO system is 43 feet high. No doubt a simple Folded Dipole at the height would bring good results but the expedient outlined makes use of an existing system without adding more antennae to those already gracing the skyline. The gain is noticeable and as good as this system proves to be, it would be infinitely more effective erected on flat country with a clear north-western vista. At the current period many evenings are producing strong phone signals from Britain and Europe; such stations as G8TH in Reading, G5TZ Plymouth, and G8NK London being outstanding. A very strong station from Holland is PA-zero-XZ. An interesting and unexpected contact on Ten has been Arie Bles, now north of Australia as PK4DA, and when at

(Continued on Page 42)

FOR BEST RESULTS R.F.P. COILS

Slug tuned coils specially designed for the most efficient results. Coils are wound on $\frac{3}{8}$ " dia. former and are fitted with a convenient plastic mounting.

Available in Aerial, R.F. and Oscillator for the following ranges:

32 to 10 mc/s	} 3/-
12 to 3.5 mc/s	
18.7 to 6 mc/s	
7.5 to 2.5 mc/s	} each
3.8 to 1.5 mc/s	} 4/6
1.6 to .54 mc/s	

Plus postage

Price's Radio

5 & 6 Angel Place
Sydney

Shortwave Review

CONDUCTED BY

L. J. KEAST

NOTES FROM MY DIARY

B.B.C. IN SINGAPORE

At the request of His Majesty's Government, the B.B.C. assumed on August 8, 1948, responsibility for the British Far Eastern Broadcasting Service, which, since the liberation of Malaya, has been operating in Singapore under the auspices of the Foreign Office.

Adjustments have been made in the programme and administrative arrangements of this service during the past few months. The transfer of responsibility of the Foreign Office to the B.B.C. did not, therefore, necessitate any change in the revised scope of British Far Eastern Broadcasting Service activities.

This is the first time that the B.B.C. has had direct responsibility for conducting a broadcasting service based outside the United Kingdom. Formal licences granted locally accord with the B.B.C.'s charter and licence in the United Kingdom.

The programmes of the British Far Eastern Broadcasting Service will, pending the construction of high-powered transmitters, continue to radiate from its existing small transmitters.

The programmes consist largely of rebroadcasts of B.B.C. transmissions from London in its Far Eastern and General Overseas Services, together with B.B.C. transcriptions (recorded programmes). With English as the main language, specialised services are included in Japanese, Chinese (Kuoyu and Cantonese), Siamese, Indonesian-Malay, Dutch, and Burmese over an aggregate period of seven-and-a-half hours a day.

—“London Calling.”

Singapore schedule at present is: 15.30mc, 19.61m; 11.73mc, 25.58m; 6.77mc, 44.13m: 7.15 p.m.-2.45 a.m.—News 7.20 B.B.C. news at 9 p.m. and 11 p.m.

9.65mc, 30.96m: 6 p.m.-9 p.m. with B.B.C., also heard at 11 p.m., closes at 2.45 a.m.

CANADIAN BROADCASTS

CHLS, Sackville, 9.61mc, 31.22 m; CHOL, Sackville, 11.72mc, 25.6m: Sundays, to Australia, 4.45-10.30 p.m.

CKCX, Sackville, 15.19mc, 19.75m; CHOL, Sackville, 11.72 mc, 25.6m: News at 9.30 a.m.

SCHEDULE CHANGE ON SWEDISH TRANSMITTERS

As and from October 9

SBO, Stockholm, 6.065mc, 49.46 m: 5.15 p.m., 11 a.m. and again at 5.10 p.m.

SBU, Stockholm, 9.535mc, 31.47 m: 5.15 p.m.

SDB-2, Stockholm, 10.78mc, 27.83m: 1 a.m.

SBT, 15.155mc, 19.8m: 1 a.m.

UNITED STATES INTERNATIONAL BROADCASTS

To the Pacific and East

(Latest air-mail list)

KGEI, 9.53mc: 8.45 p.m.-12.30 a.m.

KWID, 9.57mc: 10 p.m.-1.05 a.m.; 1.15-6.45 p.m.

KNBA, 9.65mc: 5.15-6.45 p.m.; 7 p.m.-1.05 a.m.

KCBF, 9.70mc: 7 p.m.-12.30 a.m.

KNBI, 9.75mc: 7 p.m.-1.05 a.m.

KGEX, 11.73mc: 3.30-6.45 p.m.; 7 p.m.-1.05 a.m.

KNBX, 11.79mc: 7 p.m.-1.05 a.m.

KWIX, 11.86mc: 7 p.m.-12.30 a.m.

New Stations

ZL-3, Wellington, 11.78mc, 25.47m; ZL-4, Wellington, 15.28 mc, 19.63m: These long-awaited New Zealand stations are now on the air, having opened at 5 p.m., Sydney time, on Monday, September 27. Programmes are beamed to Australia from 5-7 p.m.

Manila I, 11.89mc: 7 p.m.-1.05 a.m.

KWID, 11.90mc: 3.30-9.30 p.m.

KNBI, 15.13mc: 5.15-6.45 p.m.

KCBR, 15.13mc: 7 p.m.-1.05 a.m.

KCBA, 15.15mc: 1.15-6.30 p.m.

KGEI, 15.21mc: 3.30-8.30 p.m.

KNBX, 15.25mc: 3.30-6.45 p.m.

KRHO, 15.25mc: 7 p.m.-1.05 a.m.

Manila I, 15.33: 5.15-6.45 p.m.

KCBA: 7 p.m.-12.30 a.m.

KRHO, 17.80mc: 5.30-6.45 p.m.

KCBF, 17.85mc: 1.15-6.30 p.m.

The following stations, like those listed in September issue, should be heard on a reasonably good dual-wave receiver providing care is exercised. It has been compiled from reports from Miss Dorothy Sanderson, Arthur Cushen, Rex Gillett, Dr. Keith Gaden, "Radio Australia," W.A. Short Wave League, "Universalite," DX Bulletin (N.Z.), The N.Z. Dextra, "Radio News" and my own observations:

SOUTH AMERICA

Argentina

LRY, Buenos Aires, 9.44mc, 31.78m: Is reported from New Zealand as signing off at 2 p.m.

LRM, Mendoza, 6.18mc, 48.54 m: Programme of music at 8.30 p.m.

Brazil

PRL-8, Dio de Janiero, 11.72mc, 25.60m: News in Spanish at 8.15 p.m.

Chile

CE1190, Valparaiso, 11.90mc, 25.21m: Heard signing off at 2 p.m. with "Land of Hope and Glory."

CE970, Valparaiso, 9.72mc, 30.86m: Same remarks as above.

CE622, Santiago, 6.22mc, 48.23 m: Opens at 9.30 p.m., signs at 2.10 p.m. with English. This sta-

tion is asking for reports. Address is: P.O. Box 2626.

CE615, Santiago, 6.15mc, 48.79 m: Excellent till 2 p.m.

Colombia

HJCD, Bogota, 6.16mc, 48.70m: Very fine signal till sign off at 2.20 p.m. daily.

HJCT, Bogota, 6.20mc, 48.40m: Excellent. News in Spanish at 2 p.m. . . . signs at 2.20 with Colombian National Anthem.

HJFB, Manizales, 6.105mc, 49.14m: "Radio Manizales" moved here from 6.225mc. Good signal from opening at 8.15 p.m.

Ecuador

HC5HC, Cartagena, 4.96mc, 60.36m: Heard till sign off at 2 p.m.

HC2ET, Guayaquil, 4.71mc, 63.50m: Same as above.

HC2AK, Guayaquil, 4.64mc, 64.65m: Has been heard as late as 3.30 p.m. on Sundays.

(The above stations are shown for the benefit of our Pacific Area readers. The report comes from Arthur Cushen. Conditions would have to be remarkably good for us to hear them.—L.J.K.)

But here is an Ecuadorian you can hear:

HJCB, Quito, 15.10mc, 19.85m: Spanish session in talk and hymns from 4.30 p.m.

HJCB, Quito, 9.958mc, 30.12m: Talk and hymns at 2.30 p.m.

Peru

OAX4W, Lima, 9.38mc, 32.00 m: Closes at 2.30 p.m.

OAX5E, Chíncha, 6.17mc, 48.62 m: "Radio Chíncha" heard till sign off at 2 p.m.

OAX4G, Lima, 6.095mc, 49.26 m: Signs with "Good-night Melody" at 2.45 p.m.

Mexico

XEQQ, Mexico City, 9.68mc, 30.99m: Good at 3 p.m.

XEBT, Mexico City, 9.62mc, 31.19m: Excellent at 3.30 p.m.

XEUZ, Mexico City, 6.12mc, 49.95m: Very strong till 2 p.m.; gives calls XEFO and XEUZ often.

XEOI, Mexico City, 6.015mc, 49.97m: Good signal and heard signing at 1.55 p.m., sometimes

later. Gives call XEUY-XEOI. EUROPE

Czechoslovakia

OLR-5A, Prague, 9.55mc, 31.41 m: News at 5.45 and 7.45 a.m.

OLR-4B, Prague, 11.76mc, 25.61 m: News at 3.45 a.m.

France

Radio Paris, 21.74mc, 13.81m: From 1.45-2 a.m. can be heard transmitting to Brazzaville, French Equatorial Africa.

Radio Paris, 17.77mc, 16.88m: Opens at 10 p.m.

Radio Paris, 10.23mc, 29.33m: 2 a.m.-9.15 a.m.

Radio Paris, 9.56mc, 31.37m: News in French at 3.30 p.m.

Radio Paris, 6.20mc, 48.39m: 9.15 p.m.-12.15 a.m.

Germany

Radio Leipzig, 9.73mc, 30.84m: German news and good music from 2.15 p.m.

Radio Munich I, 11.87mc, 25.27 m; II, 9.54mc, 31.45m; IV, 7.25 mc, 41.38m; III, 6.08mc, 49.36m: 2-8 a.m.

Radio Stuttgart, 6.19mc, 48.47m: Heard at good strength when opening at 2 p.m. Although all speech is in German, transmitter is in U.S. Zone.

Holland

PCJ, Hilversum, 15.22mc, 19.71 m: "Happy Station" programmes with Eddie Startz, Mondays and Thursdays at 1.30 a.m. Tuesdays at 6.30 p.m.

Spain

La Voz de la Falange, Madrid, 7.38mc, 40.60m: Miss Sanderson reports receipt of letter from Madrid giving power as 200 watts and being on the air from 8-9.30 a.m.

Italy

Radio Rome, 15.12mc, 19.84m: News in English at 10.15 a.m.

Radio Rome, 11.81mc, 25.40m: Special programme to South Africa at 7-7.20 a.m. News in English at 10.15 a.m.

HVJ, Vatican City, 11.685mc, 25.68m: Fair strength till closing at 6.50 a.m.

Radio Rome, 6.085mc, 49.30m: Has special programme to S. Africa

from 7-7.20 a.m. (Can also be heard on 11.81mc.)

Roumania

Radio Bucharest, 11.88mc, 25.25 m: Heard around 6 a.m.

Switzerland

HER-6, Berne, 15.305mc, 19.60 m: 11.30 a.m.-1.30 p.m.

HEI-2, Berne, 6.345mc, 47.28 m: United Nations Broadcasts in English, 3.40 p.m., 6.40 p.m. and 6.40 a.m.

HEI-5, Berne, 11.715mc, 25.61 m: News in French at 4.15 p.m.

U.S.S.R.

Radio Moscow, 15.23mc, 19.70 m; 15.41mc, 19.46m; 15.39mc, 19.48m; 11.88mc, 25.25m; 11.87 mc, 25.27m: To North America from 10.45-11.15 p.m.

11.96mc, 25.08m: Gives broadcast in English to N. America with news at 9.30 a.m. Mail Bag at 10 a.m. Programme to N. America also from 10.15-11.15 p.m.

9.38mc, 32.00m: News at 8.15 a.m., followed by music.

Poland

Radio Warsaw, 6.22mc, 48.23m: News in Polish at 6.45 a.m.

SCANDINAVIA

Denmark

OZG, Skamlebak, 11.805mc, 25.42m: Musical programme at 5.30 p.m.

Norway

LLN, Oslo, 17.83mc, 16.83m: Home service from 3-9 a.m.

LKQ, Oslo, 11.735mc, 25.56m: Church service at 4.15 p.m.

LKJ-2, Oslo, 6.13mc, 48.88m: Heard in the early morning.

LLG, Oslo, 9.61mc, 31.22m: At 4.30 p.m. Good musical programme; church service at 5.15 p.m. Strong signal.

Sweden

SBP, Stockholm, 11.705mc, 25.63m: English commentary at 5.45 p.m.

MISCELLANEOUS

Babamas

YSUA, San Salvador, 6.25mc, 48.06m: Heard at good strength till sign off at 3 p.m.

Arabia

ZNR, Aden, 6.75mc, 44.4m: Heard around 2 a.m.

Canada

CKNC, Sackville, 17.82mc, 16.82 m: News at 1.30 p.m.
CKCS, Montreal, 15.32mc, 19.58m: News at 12.30 p.m.
CBLX, Montreal, 15.00mc, 19.88m: Weather reports, news and music at 10 p.m.
CHOL, Sackville, 11.72mc, 25.60m: News at 8.15 p.m.
CHLS, Sackville, 9.61mc, 31.22 m: Good at 7.15 p.m.

Egypt

Radio Omdurman, 9.67mc, 31.02 m: Reported as moved here from 9.57mc.

SUX, Cairo, 7.865mc, 38.15m: Arabian programme at 7.30 a.m.

French West Africa

FHE-2, Dakar, 15.39mc, 19.49m: Heard in morning till 6 o'clock.

Greece

SVD-2, Athens, 7.30mc, 41.13 m: Very strong signal till sign off at 7.30 a.m. English heard at 2.30 a.m. Easily identified by several flute notes.

WEST INDIES

Cuba

COCY, Havana, 11.735mc, 25.56m: Heard again after a fair period of silence; relays COHI; signs at 2.03 p.m. in English.

COBC, Havana, 9.37mc, 32.00 m: Good at 9.15 p.m. News in Spanish followed by music.

COCH, Havana, 9.452mc, 31.73 m: Fair signal at 9.45 p.m.

COCX, Havana, 9.265mc, 32.36 m: News in Spanish at 1.45 p.m.

COKG, Santiago, 8.955mc, 33.50m: Good programme of music at 3.30 p.m. Heard again at 9.30 but much interference.

Haiti

HHCA, Port-au-Prince, 4.60mc, 65.23m: Heard occasionally at 9.30 p.m. with music. Announcement in French at 9.45.

Madagascar

FIQA, Tananarive, 6.06mc, 49.50m: News in French at 3.45 a.m.

Monaco

Radio Monte Carlo, 6.035mc, 49.70m: 4-8.15 a.m.

Morocco

CNR-3, Rabat, 9.08mc, 33.04m: News in French at 7.15 a.m.

Radio International, Tangiers, 6.20mc, 48.39m: News in English at 6 a.m. (This station was heard for a short time on 6.265mc).

Persia

Radio Tabriz, 11.96mc, 25.08m: Schedule, 8-9.30 p.m.

Radio Baghdad, 7.092mc, 42.32 m: Schedule is given as 11 p.m.-5 a.m.

Radio Tabriz, 6.09mc, 49.26m: Schedule, midnight-4 a.m. News in English at 3.20.

Samoa

ZMBG, Apia, 7.70mc, 39.15m: Heard at 6.25 p.m. on Fridays and Saturdays.

Trinidad

VP4RD, Port-au-Spain, 9.63mc, 31.15m: Opens at 8 p.m. in Eng-

lish news, local news, musical programme.

Turkey

TAQ, Ankara, 15.195mc, 19.75 m: Mailbag at 6.30 a.m. on Mondays.

TAP, Ankara, 9.465mc, 31.7m: Opens at 1 a.m. News at 2.45.

Yugoslavia

Radio Belgrade, 6.10mc, 49.15 m: Present schedule, 3.15-4.15 p.m.; 9.30-11.45 p.m.; 2.50-7.15 a.m. Has English news period at 3.50 and 6.30 a.m.

FROM LATEST SCHEDULES, RECEIVED BY AIR MAIL, OF U.S.A. WEST COAST STATIONS

For listeners' convenience I am featuring hours on the air:

10 a.m.-1.30 p.m.—

KCBR, Delano, 15.13mc, 19.83 m: To South America.

KGEX, 'Frisco, 17.88mc, 16.78 m: To South America.

KNBA, Dixon, 21.46mc, 13.98 m: To South America.

KNBI, Dixon, 11.77mc, 25.49 m: To South America.

KNBX, Dixon, 15.25mc, 19.67 m: To South America.

KWID, 'Frisco, 17.76mc, 16.89 m: To South America.

1.15-6.30 p.m.—

KCBA, Delano, 15.15mc, 19.80 m: Alaska/Aleutians.

KCBF, Delano, 17.85mc, 16.81 m: Alaska/Aleutians.

GEORGE BROWN & CO. PTY. LTD.

267 CLARENCE STREET, SYDNEY. Phone: M 2544

DISTRIBUTORS TO THE TRADE FOR

ROLA SPEAKERS ● EVEREADY BATTERIES ● AEGIS

RADIO COMPONENTS ● ULTIMATE RADIOS ● MULLARD

VALVES ● I.R.C. RESISTORS

And All Brand Line Radio Components

★ AEGIS 4 VALVE AND 5 VALVE KIT SETS COMPLETE NOW AVAILABLE

Speedy Query Service

Conducted under the personal supervision of A. G. Hull

V.A.H. (Rockhampton, Q.) enquires about resistance-coupled r.f. stages.

A.—Yes, this is one of the coming things, as mentioned recently. We have a circuit on hand which we have been trying to squeeze in for the last couple of issues. Will probable get it into next month's. This type of r.f. stage allows the use of a two-gang tuning condenser, makes alignment simpler and gives splendid results from a noise-to-signal point of view.

T.L. (Lane Cove) has a battery-operated portable and wants to build a power unit to allow it to be operated from the a.c. mains when in use at home.

A.—A unit of the kind you require was detailed in our February, 1948, issue. Copies are available

from our Back Dates dept.

W.K. (Perth) has a direct-coupled amplifier and a Conniseur pick-up, but is not too happy about low note response.

A.—The whole key to the trouble is contained in your remarks about not using bass compensation. The Conniseur (English) pick-up is of the magnetic type and needs bass compensation. It is not a matter of your own particular taste or anything like that. It is simply that records are made with a flat characteristic whilst the pick-up is not. Our July issue showed several compensation circuits as supplied by the English manufacturer and you won't go wrong if you follow them out. You should find that proper equalisation will give you the results you desire.

BARGAIN CORNER

Advertisements for insertion in this column are accepted free of charge from readers who are direct subscribers or who have a regular order placed with a newsagent. Only one advertisement per issue is allowed to any subscriber. Maximum 16 words. When sending in your advertisement be sure to mention the name of the agent with whom you have your order placed, or your receipt number if you are a direct subscriber.

WANTED: Following valves or substitutes: AK2 converter, AF2, ABC1 and E463 output valve. A. F. Wright, Sandgate Road, Nundah, Q.

WANTED: One Clipsal heavy duty morse key, and January, 1948, issue of Radiotronics. Apply J. W. Nairn, 22 McLean St., Morwell, Vic.

FOR SALE: BC348 radio converted to A.C./D.C. In first-class condition with 5-page instruction book. Also Taylor T20 tube, as new. C. Paterson, 211 Main Street, Peterborough, S.A.

FOR SALE: FS6 transmitter and vibrator unused. Receiver stripped down. Sell or exchange. Offers to A. K. Head, 12 Peverill Street, Balwyn, Vic.

WANTED: All issues of A.R.W. right from first issue onwards. Prepared to pay reasonable price, singly or bound in volumes. Clifford A. Lloyd, 79 Victoria Street, Lewis-ham, N.S.W.

WANTED TO BUY: Any old issues of Australian Official Radio Service Manuals. Reply stating years of models in each volume and prices. J. F. Vale, Kununoppin, West Aust.

WANTED: Service manuals for No. 19 and 1143A. Particulars to G. Virtue, 4 Ewing Street, Lismore, N.S.W.

OBSERVATIONS (CONT.)

home in Holland PA-zero-UM. Arie was a visitor not so long ago to many VK2 stations. Those who work with him are asked, at present, not to try to QSL. He is "under-cover" for the reason that the military authorities in the region do not sanction amateur operation owing to the uncertain state of affairs prevailing.

SAVE MONEY
WITH A
SUBSCRIPTION!
Order Yours To-Day



Make sure you get every issue as soon as it is published. Place an order with your newsagent or send direct to us for a subscription.

IT SAVES YOU MONEY!
IT SAVES YOU TIME!

We guarantee that every subscriber has his copy posted the same day it comes off the press.

Enclosed please find remittance for 10/6 in payment for an annual subscription to the "Australasian Radio World," commencing with the.....issue.

NAME
STREET and NUMBER
CITY STATE

AUSTRALASIAN RADIO WORLD

Balcombe Street
Morningson
Victoria

RATES	
* 12 issues	10/6
* 24 issues	20/-
POST FREE	
To N.Z. & Overseas:	
12 issues	12/-

TRANSFORMERS OF DISTINCTION

RADIO RECEIVER TYPE

The transformers listed in this section have been designed specially for use by manufacturers in standard types of radio receiver sets; but they may, of course, be applied to any electrical apparatus for which their specifications make them suitable.

Coil temperature rise with continuous operation will not exceed 30-35 degrees Centigrade over ambient. These units are constructed to permit sub-panel wiring, and are fitted with drawn steel covers finished in smooth transmission grey.

All these units are baked and impregnated with super insulating varnish and are specifically made for use under adverse climatic conditions.

Item 1. Type No. 4212
 Prim: 240v . . . 35vA 50 cps
 H.T.: 210 CT 210v 40 mA
 Fils: 5v-2A 6.3v-3A
 Base: 3 x 2½ x 2" H Wgt 2lb 8oz
 Mntg: H2 "S" is 1½"

Item 2. Type No. 4282
 Prim: 240v . . . 37vA 50 cps
 H.T.: 280 CT 280v 40 mA
 Fils: 5v-2A 6.3v-2A
 Base: 3-3/8 x 2-7/8 x 1¾" H Wgt 2lb 13oz
 Mntg: H14 "S" is 1"

Item 3. Type No. 6382
 Prim: 200-230-240v . . . 45vA 50 cps
 H.T.: 385 CT 385v 60 mA
 Fils: 5v-2A 6.3v-2A
 Base: 3-3/8" x 2-7/8" x 1¾" H Wgt 2lb 12oz
 Mntg: H14 "S" is 1-3/8"

Item 4. Type No. 6292
 Prim: 200-230-240v . . . 40vA 50 cps
 H.T.: 290 CT 290v 60mA
 Fils: 5v-2A 6.3v-2A
 Base: 3-3/8 x 2-7/8 x 1-7/8" H Wgt 3lb 2oz
 Mntg: H14 "S" is 1-1/8"

Item 5. Type No. 8383
 Prim: 200-230-240v . . . 60vA 50 cps
 H.T.: 385 CT 385v 80 mA
 Fils: 5v-2A, 6.3v-3A, 2.5v-5A
 Base: 4 x 3½ x 2-1/8" H Wgt 4lb 14oz
 Mntg: H10 "S" is 1½"

Item 6. Type No. 8382
 Prim: 200-230-240v . . . 60vA 50cps
 H.T.: 385 CT 385v 80 mA
 Fils: 5v-2A 6.3v-3A
 Base: 4 x 3½" x 2-1/8" H Wgt 4lb 12oz
 Mntg: H10 "S" is 1½"

Item 7. Type No. 8302
 Prim: 200-230-240v . . . 54vA 50 cps
 H.T.: 300 CT 300v 80 mA
 Fils: 5v-2A 6.3v-3A
 Base: 4 x 3½ x 1¾" H Wgt 4lb 2oz
 Mntg: H10 "S" is 1"

Item 8. Type No. 10382
 Prim: 200-230-240v . . . 62vA 50 cps
 H.T.: 385 CT 385v 100 mA
 Fils: 5v-2A, 6.3v-3A
 Base: 4 x 3½ x 2¼" H Wgt 5lb 11oz
 Mntg: H10 "S" is 1½"

Item 9. Type No. 10302
 Prim: 200-230-240v . . . 52vA 50 cps
 H.T.: 300 CT 300v 100 mA
 Fils: 5v-2A, 6.3v-3A
 Base: 4 x 3½ x 2" H Wgt 4lb 10oz
 Mntg: H10 "S" is 1½"

Item 10. Type No. 12382
 Prim: 200-230-240v . . . 80vA 50 cps
 H.T.: 385 CT 385v 125 mA Cond. Input
 Fils: 5v-2A 6.3v-3A
 Base: 4 x 3½ x 4¼" H Wgt 6lb 9oz
 Mntg: H10 "S" is 1½"
 D.C. Volts Choke Input Cond. Input
 5V4 310v 430v
 5Z3 300v 400v
 5Y3 275v 360v

RED LINE EQUIPMENT PTY. LTD.

TRANSFORMER ENGINEERS

WORKSHOPS: Cent. 4773.
 2 Coates Lane, Melbourne.
 City Office: MU-6895 (3 lines),
 157 Elizabeth St., Melbourne.

DISTRIBUTORS
 SOUTH AUSTRALIA:
 Gerrard & Goodman
 Radio Wholesalers Pty. Ltd.
 Newton McLaren Ltd.



DISTRIBUTORS
 VICTORIA:
 Homecrafts Pty. Ltd.
 Arthur J. Veall Pty. Ltd.
 Radio Parts Pty. Ltd.
 Howard Radio
 and all leading wholesalers.
 NEW SOUTH WALES:
 United Radio Distributors Pty. Ltd.
 QUEENSLAND:
 A. E. Harold
 B. Martin

A GUARANTEE OF DEPENDABILITY

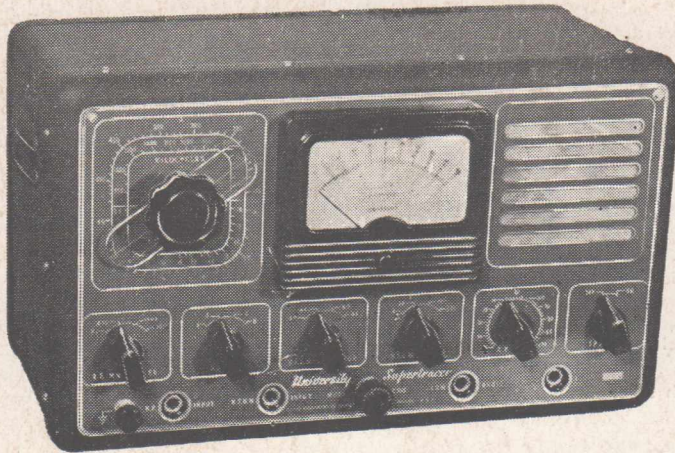

HERE IT IS!

THE NEW SUPERTRACER



This is the most modern, up-to-date and efficient service instrument that anyone could desire. It is easy-to-use and gives rapid and accurate location of faults in radio receivers and similar equipment. It speeds up testing, servicing and production and will rapidly detect faults which render a receiver inoperative or which make it intermittent or lacking in sensitivity or which cause oscillation, distortion or hum.

It is an attractive, accurately constructed instrument, housed in a brocade finished steel case measuring $14\frac{1}{2}$ inches long by $8\frac{3}{4}$ inches high and $8\frac{1}{4}$ inches wide over controls. The front panel is heavily etched brass with raised nickel plated lines and letters on a wine coloured enamelled background. This striking but dignified colour scheme adds prestige to your organisation and sets the seal of reliability upon your shop equipment.

The instrument comprises a two stage tuned R.F. amplifier, a diode detector and two stage A.F. amplifier and, of course, a loudspeaker and power supply. In addition, a vacuum tube voltmeter measuring up to 500 volts A.C. or D.C. at a resistance of 11 megohms on D.C. and 10 megohms on A.C. is provided. The tuning range of the R.F. circuits is 175 to 490 K.C., 550 to 1550 K.C., 1.5 to 4 megacycles and 6.3 to 18 megacycles. R.F. sensitivity is such that input voltage of the order of a few millivolts may be detected on all ranges so that the instrument is suitable for use in any district where alternating power mains are available. A capacity type R.F. multiplier in the input circuits in conjunction with the V.T.V.M. enables stage gain measurements to be made.

TEST PROBES: The R.F. test probe is fitted internally with a very small series capacity of a few micro-microfarads so that it does not produce an appreciative detuning effect when applied to

- A "SUPER" SIGNAL TRACER
- A V.T.V.M. FOR A.C. AND D.C.
- A SERVICE SHOP IN ITSELF

the grid or plate of R.F. or I.F. stages in a receiver. The A.F. test probe is a conventional shielded lead for feeding A.F. into the tracer or A.F. out from the tracer for testing A.F. amplifiers or speakers. The D.C. probe contains a series 1 meg. isolating resistor so that the V.T.V.M. may be used to measure plate, bias or A.V.C. voltage under actual operating conditions, without disturbing the action of a receiver.

VACUUM TUBE VOLTMETER: The V.T.V.M. features a centre zero scale for direct voltage measurement so that voltages which are either positive or negative with respect to a receiver's chassis are instantly indicated without the necessity of reversing test leads or operating a reversing switch. Zero is at the left for alternating voltage ranges and operation covers the audio frequency range. Voltage ranges are 0/5, 0/25, 0/100 and 0/500 volts at an input resistance of 11 megohms on D.C. and 10 megohms on A.C. ranges. In conjunction with the amplifying stages of the tracer, the meter will indicate R.F. or A.F. voltages down to a value of less than 1 millivolt. Indications are provided by a large, clearly marked rectangular meter with illuminated scale fitted in an attractive modern plastic case measuring $4\frac{3}{4}$ inches x 4 inches. The V.T.V.M. and tracer may be used simultaneously for observing signals at two distinct points in a receiver. This feature greatly facilitates location of intermittent faults.

POWER SUPPLY: Operation is from A.C. power mains at a voltage between 220 and 260 volts and at a frequency between 40 to 60 C.P.S.

IT'S A *University* INSTRUMENT

Made by RADIO EQUIPMENT PTY. LIMITED, 5 North York Street, Sydney