



AMATEUR RADIO



Published in the interests of the Wireless Institute of Australia, Official Organ of all divisions of the W.I.A. and R.A.A.F.W.R.



PRICE

6D

JANUARY, 1940

Let us quote you for your
PRINTING REQUIREMENTS



The House of Good Printing

**285 - 287 LATROBE STREET,
MELBOURNE, C.I**

Opposite "The Argus" Office

Telephone MU 2897

After Hours FU 6795

AMATEUR RADIO

Published in the Interests of Radio Amateurs and
Experimenters throughout Australia.

VOL. 8. No. 1.

1st JANUARY, 1940

OUR ORGANISATION

Publishers.—

WIRELESS INSTITUTE OF AUSTRALIA
(Victorian Division)
191 Queen Street, Melbourne, C.I.

Editorial Department.—

W. R. GRONOW (VK3WG),
Editor.

R. H. CUNNINGHAM (VK3ML)
Technical Editor.

C. SERLE (VK3RX)
Notes Editor.

V. E. MARSHALL (VK3UK)
Compilation.

H. N. STEVENS (VK3JO)
Distribution.

L. T. POWERS (VK3PS)
Secretary.

Advertising Department.—

BEDGGOOD ADVERTISING CO.,
129 William Street, Melbourne.
Phone: MU 4046

Sydney Representative—

J. H. FRASER

8 Deakin Avenue, Haberfield. UA 1725.

Printers.—

H. HEARNE & CO. PTY. LTD.,
285 Latrobe Street, Melbourne, C.I.

Accounts Department.—

LARGE & POWERS,
Chartered Accountants (Aust.),
422 Collins Street, Melbourne.

MSS and Magazine Correspondence
should be forwarded to The Editor,
"Amateur Radio," Box 2611W, G.P.O.,
Melbourne.

Subscription Rate is 6/- per annum in advance (post paid).

NOTE.—Advertisers' change of copy must be in hand not later than the 20th of the month preceding publication, otherwise the previous month's copy will be reprinted.

CONTENTS.

	Page
Editorial - - - - -	3
Selecting an Intermediate Frequency - - - - -	4
The R.S.G.B. Carries On -	9
Modulated Oscillators for Receivers - - - - -	12
DX Notes - - - - -	17
Federal and Victorian QSL Bureau - - - - -	18
Divisional Notes—	
New South Wales - - -	19
Victoria - - - - -	19
South Australia - - - -	20

IMPORTANT—

R.A.A.F. VACANCIES - 10

DIVISIONAL ADDRESSES.

FEDERAL HEADQUARTERS:
BOX 2611W, G.P.O., MELBOURNE

NEW SOUTH WALES:
BOX 1734JJ, G.P.O., SYDNEY.

VICTORIA:
BOX 2611W, G.P.O., MELBOURNE.

QUEENSLAND:
BOX 1524V, G.P.O., BRISBANE

SOUTH AUSTRALIA:
BOX 284D, G.P.O., ADELAIDE.

WESTERN AUSTRALIA:
BOX N.1002, G.P.O., PERTH.

TASMANIA:
BOX 547E, G.P.O., HOBART.

CROWN RADIO PRODUCTS

ANNOUNCE

NEW

POPULAR PORTABLE COIL KIT

Two Iron Core I.F. Transformers, square can, $2\frac{3}{8}$ " x $1\frac{3}{8}$ "

One Midget Pye Wd. Osc. Coil.

One Special Loop Aerial Coil.

One 465kc. Padding Condenser.

LIST PRICE 32/6

For use with Stromberg-Carlson Type "G" Condenser.

Suitable Dials Available.

Kit is cartoned, and circuit diagram with assembly instructions provided.

**Build your own "Portable with
"CROWN" RELIABLE COIL KIT.**

CROWN RADIO PRODUCTS PTY. LTD.,

51/53 MURRAY STREET, PYRMONT, N.S.W.

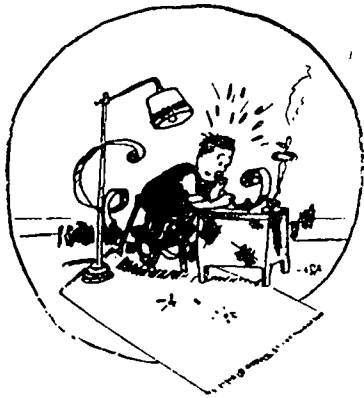

EDITORIAL

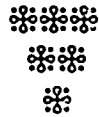

The Magazine Committee had hoped to provide details of Hams who were serving with the various branches of the Defence Forces, but unfortunately the censorship restrictions do not permit of the publication of such information. However, this **CAN** be said, the response of the amateur movement to the Call for Service has been literally astounding. Within two months of the outbreak of war practically every amateur able to join had enlisted in one of the signal branches of the three services. We know of one Signals Unit, and a key unit, too, that has fourteen Hams out of a total personnel of sixteen. It can be truly said that no section of the community has given greater co-operation than the Amateur movement, even if we do say it ourselves!

We would like to wish all members a very happy New Year and express the hope that 1940 will bring as many PLEASANT surprises as the number of UNPLEASANT ones 1939 produced!

Looking back on 1939 in retrospect, it can certainly be said that few years in our history brought up so many and varied incidents. The year opened with the most disastrous bush fires in our country's history, and brought forward one of our greatest opportunities to prove the value of Ham Radio to the civil community. Then the blows started to fall. Firstly, Cairo, with the announcement of shared channels on 7 mc, and the feeling that we were fortunate to escape with only a few scars. The 1st of September brought in the new conditions agreed upon at Cairo, and two days later, the greater blow fell—WAR, and the withdrawal of our Experimental Licences. The rest of the year we have already commented on.

If we had a distorted sense of humor, we could say that no further blow could fall on Ham Radio in 1942 at the next 'International Convention, because in-

dications are the war will still be in full swing then, and there won't be a Convention anyhow!

W.I.A. NEWS DIGEST.

Amateurs Application Knocked Back.

The Chief Radio Inspector has notified the W.I.A. that its application for restoration of experimental licenses on Ultra High Frequencies has been refused.

Despite this refusal, Federal H.Q. is endeavouring to have this decision reversed, and every effort will be made to bring this application to a successful conclusion.

Proposal for Official Institute Station.

F.H.Q. has applied for allocations between 7,200 K.C. and 7,300 K.C. for official station in each State to disseminate Institute information and items of general interest.

Radio Register Forms pouring into Headquarters.

We are again enclosing a register form in this issue. If yours has not been sent in—do it now! A form would also be appreciated from non-members, so that a complete survey may be compiled. Pass on this form to a non-member if yours is already posted.

Commercial Certificate Regulations Need Amending!

Why should applicants for commercial operator's certificates be compelled to prove practical experience on ship or shore stations when such stations are not available except to employees of those stations?

Where are our country correspondents?

Very little news of country zones is being received. Any notes on happenings in **your** zone would be appreciated.

Factors Determining the Choice of an Intermediate Frequency

By R. Lackey, A.M.I.R.E. (Aust.).
(Chief Instructor, Australian Radio
College).

Apart from the selection of tubes and operating conditions, the selection of an intermediate frequency, or perhaps I should say, the selection of intermediate frequency transformers, has a greater effect on a receiver's final performance than that of any other components.

We are all familiar with the effect of I.F. transformers designed to operate at the same I.F., but with differing values of "Q" factor. I do not propose to go into the effect of varying the "Q" of I.F. transformers operating at a certain frequency but rather to discuss the effect of typical transformers operating at different frequencies.

When the superheterodyne first became popular as an ordinary broadcast receiver during 1930 or 31, practically all manufacturers employed a standard I.F. of 175 K.C. The years that followed have seen a gradual change to frequencies in the vicinity of 460 K.C., so that 175 K.C. is now practically unused except in the case of a few automobile receivers. At the present time most receivers for short wave frequencies employ an I.F. in the vicinity of 460 K.C., but it seems likely that in the near future there will be a change to a higher I.F. in this type of set. Two suitable frequencies are 1645 or 1675 K.C.

It is interesting to examine the reason for the selection of the various frequencies used.

Two of the most important factors which have to be considered in choosing a frequency are sensitivity and selectivity. Both of these factors are largely dependent on the "Q" of the I.F. transformers. As Q

reactance
equals $\frac{\text{reactance}}{\text{resistance}}$ it is quite obvious

that in the case of low and high frequency transformers tuned by the same capacity and constructed along similar lines the reactance will increase as the reciprocal of the frequency and at the same time the

H.F. resistance will decrease at low frequencies, although the greater amount of wire employed on the coil tends to keep the resistance approximately constant. The increased reactance, however, means that a low frequency transformer would have a higher "Q".

In recent years the "Q" of high frequency transformers has been improved by using a smaller capacity condenser for tuning, about 100 mmfds. max. instead of about 200 mmfds. max., thus increasing the reactance. At the same time, H.F. resistance has been decreased by employing litz wire and low loss insulators in the transformer construction, also by the use of H.F. iron cores.

Although this improvement in "Q" means that the sensitivity of a modern receiver using a high I.F. is approximately the same as older types using a low I.F., it does not follow that the selectivity is the same, as will be seen later.

In the following examples I will compare I.F. transformers having a similar "Q", but in one case operating at 175 K.C. and in the other case at 455 K.C.

The selectivity of a superheterodyne receiver in rejecting interfering signals on channels adjacent to a desired station is determined almost exclusively by the selectivity of the I.F. transformers.

After passing through the frequency changer tube, signals from an unwanted station, 10 K.C. away from those of a desired station, would produce an I.F. 10 K.C. on one side of the I.F. In the case of a 455 K.C. I.F. the difference in frequency be-

10
tween the two signals is $\frac{10}{455}$ x

100
 $\frac{100}{455}$ % or 2.2%, while with 175 K.C.

1
I.F. the frequency difference is 5.7%. Thus, roughly speaking, the selectivity of the 175 K.C. I.F. amplifier

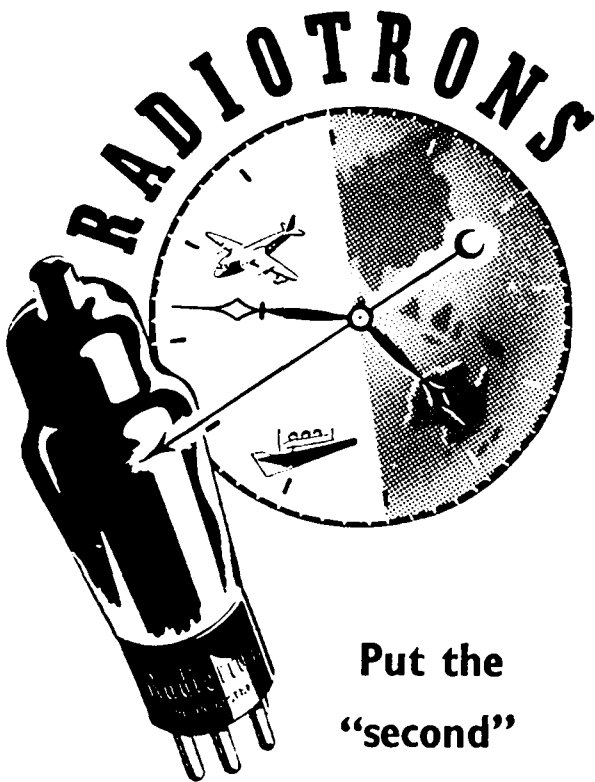

Put the
"second"
hand on the
clock of communication

In the space of a split second, the latest news flashes across the world to you with clarity and brilliance — when your radio is re-valved with



Sealed for your protection

is $\frac{5.7}{2.2}$ or 2.6 times as good as the 455 K.C. amplifier. Of course, these calculations neglect many minor factors which affect the selectivity, but they serve to give some indication of the variation in selectivity which can be expected.

From the point of view of sensitivity and particularly of selectivity, a low I.F. has a big advantage. As far as stability is concerned also, a low I.F. has the advantage, for capacitive feed back through stray wiring capacities or through the internal plate to grid capacity of tubes, decreases in proportion to the frequency. There are many other facts however, which also have to be taken into consideration and which have forced a sacrifice in sensitivity, selectivity and stability in order that they may be dealt with more favourably.

TONE QUALITY.

Tone quality is one of the most important characteristics of receivers for broadcast reception although this is not important in the case of a communications receiver used mainly for the reception of speech or morse code signals.

A receiver employing a 175 K.C. I.F. is inclined to be too selective for good quality reproduction of high pitched sounds. The effect is two-fold. Firstly, if good reproduction is to be had of frequencies up to 5000 cycles, it is necessary that the I.F. amplifier pass with approximately equal strength all frequencies in a band width of 10 K.C., i.e., sidebands up to 5 K.C. on either side of the resonant frequency.

A second manner in which extreme selectivity affects A.F. reproduction is that the low decrement of the high "Q" circuit causes a comparatively slow decay of the oscillations induced by a sudden transient such as a pistol shot or percussion instrument. Instead of the transient finishing abruptly it gradually decreases in strength and this fact is worthy of consideration in the case of high fidelity receivers.

From the foregoing it is obvious that there is a tendency for a low I.F. to be too selective so that the reproduction of high pitched audio frequencies and transients suffer.

INTERFERENCE.

One of the main reasons for the change from low to high I.F.'s is that many forms of interference, other than simple adjacent channel interference, are solved by the use of high frequency.

"DOUBLE-SPOT" TUNING.

As the name implies, double-spot tuning consists of receiving the same station at two separate points in the tuning range of a receiver. It is brought about by the fact that an intermediate frequency is produced both when the oscillator frequency is higher than the signal frequency by the amount of the intermediate frequency or when it is lower than the signal frequency by the amount of the intermediate frequency. To give a numerical example, consider a station operating on 1,400 K.C. with an I.F. of 175 K.C. in one instance and 455 K.C. in a second instance. In the case of the 175 K.C. set the oscillator frequency is 1575 K.C. If the tuning dial is now rotated until the oscillator frequency is 1,225 K.C., or in other words until the tuning dial corresponds to a position for receiving a station on 1,050 K.C. the difference between the oscillator frequency and the original 1,400 K.C. station will still produce the I.F. of 175 K.C. and this 1,400 K.C. station would be received with the dial in position for 1,400 K.C. and also in a position corresponding to 1,050 K.C. This fact is minimised by employing highly selective circuits before the grid of the frequency changer tube, but cost limits the number of tuned circuits before the grid of the frequency changer to one in most instances, and one tuned circuit is unable to prevent powerful signals from reaching the grid of the following tube even though they are 350 K.C. away from its resonant frequency.

In the case of a 455 K.C. I.F. the oscillator frequency for a station on 1,400 K.C. will be 1,855 K.C. It would be impossible for the receiver to bring in this station on a second spot on the tuning dial, because the oscillator frequency would only be lower than the signal frequency by 455 K.C. when the set was tuned to receive a signal of 490 K.C. This frequency, however, is outside the broadcasting band and ordinary receivers are not capable of being tuned to such a low frequency. Double spot tuning is quite annoying in broadcast receivers employing an

I.F. of 175 and it is far more annoying in short wave receivers, even though they employ an I.F. of 455 K.C. Just as the use of a higher I.F. cures the trouble in the case of a broadcast receiver, so the use of a higher I.F. would cure it in the case of a short wave receiver and the use of an I.F. of 1,645 or 1,675 K.C. would make a big improvement in this direction.

IMAGE INTERFERENCE.

This form of interference is very similar to double spot tuning only it is caused by two separate stations producing the intermediate frequency at the same time. If a powerful local station is separated in frequency from some desired station by twice the intermediate frequency it is possible for both these signals to produce the intermediate frequency at the same time and to interfere with one another.

As a numerical example, consider a receiver tuned to 600 K.C. If the I.F. is 175 K.C. the oscillator frequency will be 775 K.C. If a powerful station is operating on 950 K.C. and this station is able to pass through the first tuned circuit so that it reaches the grid of the frequency changer it will mix with the oscillator frequency and produce the intermediate frequency, because $950 - 775$ equals 175 K.C.

This form of interference also responds to an increase of I.F.

If the same 600 K.C. station is being received and an I.F. of 455 K.C. is now used, the oscillator frequency will be 1,055 K.C. An interfering signal to beat with this oscillator frequency would have to be 455 K.C. higher again or in other words 1,510 K.C. This is actually outside of the broadcast band as we know it at the present time, but as the broadcast band is to be extended to 1,600 K.C. it is remotely possible for image of a station operating at a higher frequency than 1,500 K.C. to cause image interference in the future. As the circuit before the grid of the frequency changer is tuned to 600 K.C. however, it has a very good chance of eliminating any interfering station so widely separated from the original frequency.

Image interference is also very troublesome in short wave receivers and here again an increase of intermediate frequency to a value in the vicinity of 1,650 K.C. would result in a considerable improvement.

An actual example of one preva-

lent form of image interference in modern broadcast receivers even though they employ an I.F. of 455 K.C. is that the radio station operated by the Police Department on 1,725 K.C. will beat with the oscillator frequency of a set when it is tuned to receive a station on 810 or 820 K.C. The result of this is that the signals from the Police Station can be heard quite distinctly in many areas around the city and suburbs when a receiver is tuned to 810 K.C. or thereabouts.

OSCILLATOR HARMONICS.

Still another form of interference is produced as a result of interfering stations mixing with harmonics of the oscillator frequency. In addition to producing the fundamental oscillator frequency the types of oscillator circuits used in modern broadcast receivers produces quite a considerable percentage of both second and third harmonics of the oscillator fundamental. If any interfering signal from a powerful station is separated from the oscillator harmonics by the amount of the intermediate frequency, it will produce an intermediate frequency and its

modulations will either be heard from the speaker or will beat with the desired station causing an annoying whistle. For a numerical example, consider a receiver tuned to a station on 550 K.C. and using an I.F. of 175 K.C. The oscillator frequency in this case is 725 K.C., and its second harmonic is 1,450 K.C. Now any powerful station which is operating at a frequency of 175 K.C. higher or or lower than 1,450 K.C., that is any station operating on 1,625 K.C. or on 1,275 K.C., could produce spurious intermediate frequency if it reaches the grid of the frequency changer. It will be noted that these interfering frequencies are widely separated from the desired frequency, and consequently any tuned circuits before the grid of the frequency changer will have an excellent chance of rejecting the unwanted signals, but if the unwanted signals come from a powerful nearby station, they can quite easily cause interference. This trouble responds to an increase of I.F. as we will see in the next example. When an I.F. of 455 K.C. is used, the oscillator frequency for the 550 K.C. station



United Radio Distributors Pty. Ltd.

cordially invite all their friends, when in Sydney, to call in to see—

**NEW HALLICRAFTER COMMUNICATION RECEIVERS
UNIVERSAL RECORDING MACHINE.
UNIVERSAL MICROPHONES**

and many other interesting samples which our Managing Director has brought back from America.

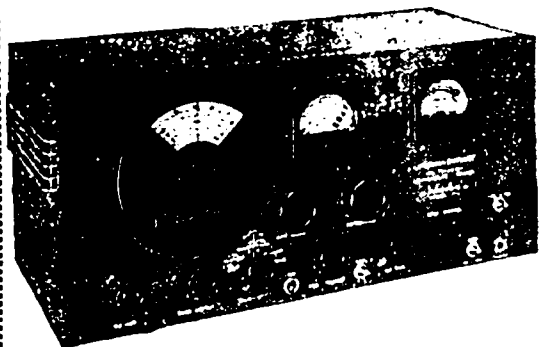

Top Left—Universal Recorder.

Below—Hallicrafter Skyraider

**234 CLARENCE STREET,
SYDNEY.**

'Phones: MA 2382, MA 7891

will be 1,005 K.C. The second harmonic of this is 2,010 K.C. and interference could only be caused by stations operating on 2,010 plus or minus 455 K.C., that is, 2,465 K.C. or 1,555 K.C. As both these frequencies are well outside the broadcasting band, and they are evenly more widely separated from the desired station than in the last example, there is considerably less chance still of this form of interference. To show that it is not completely remote, interference is caused by the Police Broadcasting Station beating with the 2nd harmonic of the oscillator when a receiver is tuned between 630 and 640 K.C. If the tuning dial is actually set to 635 K.C., the oscillator frequency will be 1,090 K.C., its second harmonic will be 2,180 K.C., and this is exactly 455 K.C. higher than the frequency used by the Police Station.

This same form of interference occurs when tuning to short wave lengths, and here again increasing the I.F. value in the vicinity of 1,650 K.C. will effect a considerable improvement.

FREQUENCY CHANGER HARMONICS.

Due to the bend in the characteristic curve of the frequency changer tube, harmonic frequencies will be generated of all signals which reach the grid of this tube. For example, if a station is operating at a multiple of the I.F. one of its harmonics will beat either with the oscillator frequency or a harmonic of the oscillator frequency to produce interference in the form of annoying whistles. For example, take the case of a signal having a frequency equal to twice that of an I.F. of 455 K.C. This would be a station operating on 910 K.C. When this signal reaches the grid of the first detector, there will also be produced its second harmonic which is 1,820 K.C. The oscillator frequency is 910 plus 455 K.C. or 1,365 K.C. It will be observed that this oscillator frequency is also 455 K.C. lower than the second harmonic of the signal frequency and so interference results. This form of interference is not effected in any way by the degree of selectivity before the grid of the frequency changer, and contrary to most of the other forms of interferences examined, it is less pronounced with a low intermediate frequency than with a high one. This is due to the fact that it would only be the 3rd or 4th harmonic of the signal frequency

which would beat with the second or third harmonic of the oscillator frequency when a low I.F. is used. As succeeding harmonic frequencies decrease in strength the extent of interference would also decrease.

In selecting an I.F. it is naturally necessary to see that the frequency chosen does not correspond to that of a powerful long wave station, and also to see that the frequency does not correspond to the difference between the frequencies of two powerful local stations.

If the intermediate frequency is the same as that of some broadcasting station, then strong signals from this station on reaching the grid of the frequency changer would be able to pass straight on through the I.F. amplifier. This consideration is of importance in determining a suitable frequency for a short wave receiver. The frequencies of 1,645 and 1,675 K.C. suggested in this paper have been chosen because they are not occupied by any powerful station here in New South Wales at any rate.

The frequencies of 175 K.C., 455 K.C., 1,645 K.C., and 1,675 K.C. are all quite different to the separation in frequency of any powerful New South Wales stations. If an I.F. were chosen which was equal to the difference in frequency between two powerful stations, signals from these two stations would mix in the frequency changer producing the I.F. and the modulations of both would be heard from the speaker.

There are many other possibilities of interference which have not been treated, but all the commonly experienced ones have been dealt with. Summarising the various forms of interference, it is evident that a high I.F. has a considerable advantage over a low I.F., and it is mainly with the object of eliminating troublesome whistles and interference from reception with the change from low I.F.'s to high I.F.'s has taken place. Some indication of the care with which an I.F. must be chosen can be obtained from this paper, but the two standard frequencies of 175 K.C. and 455 K.C. fulfil practically all requirements as far as broadcast reception is concerned, while the proposed frequencies of 1,645 or 1,675 K.C. should be quite suitable for short wave receivers. It is interesting to observe that the Post Master General's Department has decided to allocate a clear channel between 450 and 460 K.C. especially for I.F. use.

The R.S.G.B. Carries On

Extract from the Editorial of the September, 1939, "T. and R. Bulletin" indicates English Amateurs' attitude to war conditions, and corresponds closely to our own views already expressed. It is up to YOU to work along these lines and let us have what information you can for publication in your magazine.

A MESSAGE TO YOU FROM THE COUNCIL.

War or no war, it is our intention to carry on the work of the Society to the very best of our ability. The pillars on which the Society stand must not be allowed to crumble or decay, for it is essential that when Peace returns, the organisation must be strong and virile, fully prepared to safeguard the interests of its members.

An important factor is to keep "The T. & R. Bulletin" in existence, and this we shall do with the co-operation of our many advertisers who have promised their support. That its size must be reduced will be obvious to all, but we shall continue to publish articles and news of general interest.

During the months of strain which lie ahead we recommend that members should, as far as circumstances permit, carry on with experimental work within the terms of their normal broadcast licences. In particular we hope that members will endeavour

to correlate information concerning general conditions so that a monthly summary may be recorded. Numerous amateur signals will still be heard, and we know of no reason why details of such reception should not be published, whilst experimental work on the bench, particularly with regard to receivers, valves, measuring gear, and components is still possible.

As mentioned earlier, the co-operation which has been promised by "Bulletin" advertisers encouraged us to carry on, and we believe that members at home and abroad will see to it that those who have offered their support in the important field of advertising will have no reason to regret their decision. Experimental amateur radio must not be allowed to die in Great Britain; let each one of us to-day pledge to keep it alive by supporting to the best of his or her ability, the National Society in Great Britain, your Society and ours.

CRYSTALS

STILL

465 KC GATES - - - - - £2

2,000 KC Oscillators for double-detecting Supers - - - - 10/-

I.F. TRANSFORMERS

1,600 k.c. Litz Wound Sirufer I.F. Transformers — Trolital Insulation, 16/- each.

Set of 3, including Crystal Gate, 70/-

IMMEDIATE DELIVERY FROM—

MAXWELL HOWDEN-VK3BQ 15 CLAREMONT CRESCENT CANTERBURY, E.7., VIC.

Tel. WF 5090

ROYAL AUSTRALIAN AIR FORCE

VACANCIES FOR MEN WITH WIRELESS OR ELECTRICAL QUALIFICATIONS.

Apply to your nearest Recruiting Centre for details of enlistment as:—

(1) **WIRELESS OPERATORS (For Training)**

FOR MEN WITH A SOUND EDUCATION AND WITH OR WITHOUT ABILITY IN MORSE CODE.

(2) **AIRCRAFT ELECTRICIANS (For Training)**

FOR MEN WITH GARAGE OR OTHER TECHNICAL EXPERIENCE.

INSTRUCTORS WANTED

Applications will be received from men for the following Civilian positions:—

(a) **MORSE INSTRUCTORS (Civilian)**

FROM EXPERIENCED TELEGRAPHISTS.

(b) **RADIO THEORY INSTRUCTORS (Civilian)**

FROM MEN WITH A SOUND KNOWLEDGE OF RADIO PRINCIPLES AND WITH EXPERIENCE IN HANDLING TRANSMITTERS.

Full Details may be obtained on application to:—

THE SECRETARY,

Air Board, Victoria Barracks,

Melbourne, S.C.I.

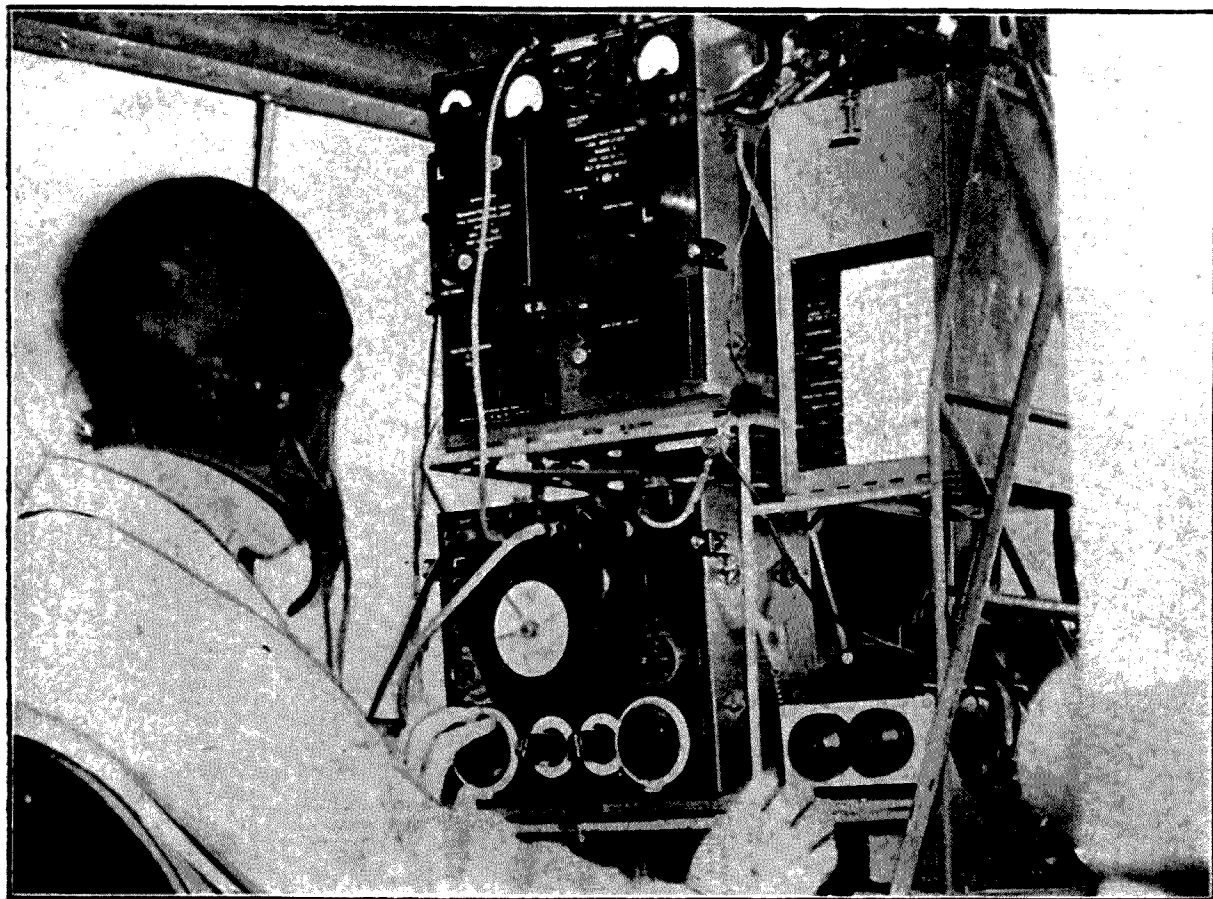

TRAINING A WIRELESS OPERATOR FOR THE R.A.A.F.

A visit to the Air Force Signal School, at Point Cook, Melbourne gives a clear idea of the comprehensive training a recruit receives before being passed out of the School as a fully-fledged Service Wireless Operator.

The R.A.A.F. takes eight months to train a Wireless Operator to the required standard "from the raw." In the first fortnight, the trainee undergoes a course of drill, and is introduced to Air Force discipline. The following eight weeks see him engaged in a Theory course, which involves study of elementary mathematics and science. In the next eight weeks he takes a course of Radio and Electrical Theory. In the third eight weeks he is instructed in the practical side of radio and in the use of the equipment he will encounter under Service conditions. In the final eight weeks he studies Air Force operations procedure, engages in exercises under actual flying conditions, gains experience of mobile land operation, and takes part in squadron signals exercises.

During all stages of the course, he is continually practising the transmission and reception of Morse, the average time required to work up to the requisite standard of 25 w.p.m. being 450 hours. The R.A.A.F. method of teaching Morse is of particular interest. Instead of following the conventional practice of sending each letter at a speed commensurate with the number of words per minute, the R.A.A.F. instructors start the trainee off with code letters sent at the maximum speed, 25 words per minute, although the groups of letters may result only in an aggregate speed of 15 w.p.m.

This is done by putting a Wheatstone Automatic Transmitter with a selector device, which eliminates possibly one in every four or five letters when the transmitter is operated at 25 w.p.m. In the first case, the resultant speed of signals heard by the trainee would be 18 to 19 w.p.m., and in the second case, 20 w.p.m. At the same time, each individual character is being sent at 25 w.p.m. It is claimed for this method that the necessity for aural and mental re-adjustment as speeds are increased, is eliminated. Adjustment of the selector device enables more than seven different speeds to be obtained from the Wheatstone Transmitter.

When the trainee has reached a reasonable degree of proficiency with the code, he is introduced to actual operating procedure. For this purpose, a number of small huts, each capable of holding two operators is connected by landlines with the signal office. These huts are connected to remote controlled transmitters, and the whole system placed in operation to duplicate service conditions. In addition, portable equipment is taken out in motor lorries and, with their personnel are set down around the aerodrome. From these points they too, work back to the signal office and exchange traffic with the operators at this base station.

Finally, flying experience is given to the recruit so that he becomes familiar both with the aircraft equipment and the conditions under which it must be used.

Radio Amateurs enlisting, or other recruits, who possess equivalent qualifications, are only put through a short Signals Course in Morse and Radio Theory to take them to the necessary standard. Then they proceed with the normal instruction in Service equipment, operating procedure, etc., before being passed out as a fully trained Service Operator. They are then attached to units in one of the most essential positions in modern warfare, that of providing communications.

Modulated Oscillators for Receivers

By courtesy, Amalgamated Wireless
Valve Co. Pty. Ltd.

For convenience, the basic circuit diagrams of the Hartley, Colpitts and Electron-Coupled oscillators are shown as Figs. A, B, and C, respectively. The output voltage from these oscillators has a constant frequency and amplitude and is unmodulated (see Fig. 1).

When such a voltage is applied across the aerial input circuit of a receiver, it will be amplified by the R.F. and I.F. stages in the same manner as a carrier input voltage, but being unmodulated, it will not produce an audio-frequency component in the plate circuit of the detector and hence an audible output in the loud-speaker. An unmodulated oscillator cannot therefore be used for aligning a receiver in the normal manner.

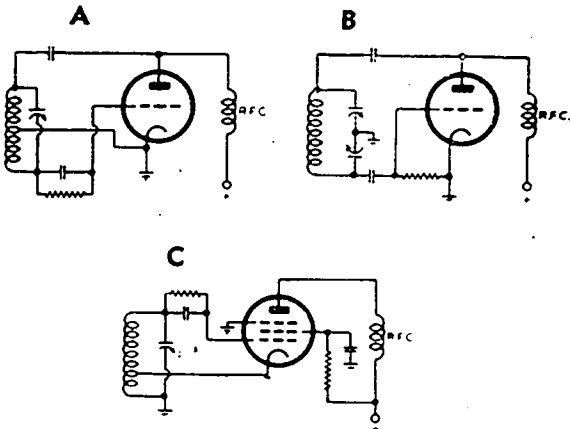

An unmodulated voltage is nevertheless useful for tracing such faults as background noise, modulation hum, and microphonicity in the radio-frequency portion of a receiver, while excessive regeneration in these stages may also be readily detected by noting the amount of "swishing" produced as the receiver is tuned across a weak unmodulated signal.

Modulation.

In the majority of applications, circuit adjustment is usually carried out by observing audio-frequency power output as indicated by some form of output meter, so that it is necessary for the R.F. input voltage from the oscillator to be amplitude-modulated at an audio frequency.

FIG. 1

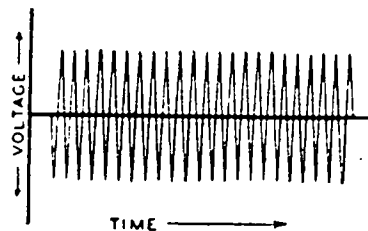

For testing purposes, a "standard signal" has therefore been adopted and consists of an R.F. voltage of constant frequency, modulated to a depth of 30% by an audio voltage having a frequency of 400 c/s. The wave-form of this standard signal is represented graphically in Fig. 2. Adherence to this standard, although desirable, is not strictly necessary for normal service work.

FIG. 2

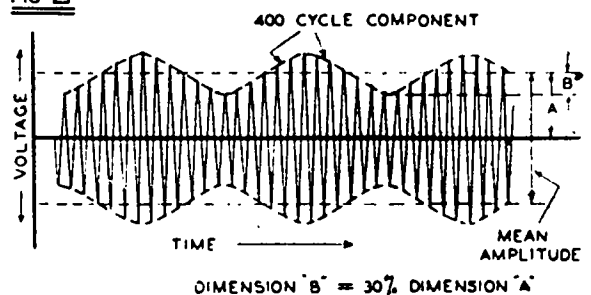

The output voltage of a modulated oscillator should be as free as possible from frequency modulation, i.e., variation of the frequency of the R.F. voltage about a mean frequency (see Fig. 3), since this causes the

signal to be broad and consequently unsuitable for use in aligning sharply tuned circuits.

FIG. 3

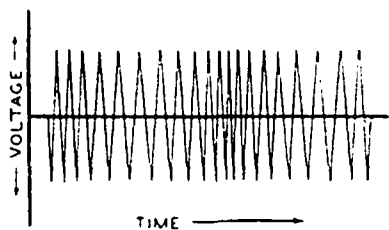

Modulation from A.C. Mains.

Possibly the simplest method of obtaining modulation is to apply a 50 cycle A.C. voltage directly to the plate of the oscillator valve, as shown in Fig. 4. With this arrangement, oscillation ceases during each alternate half-cycle, when the plate becomes negative with respect to cathode. The waveform is therefore similar to that shown in Fig. 5. Frequency modulation may be serious,

and the signal is usually broad and difficult to use.

Considerable improvement can be effected by supplying the plate with a D.C. voltage upon which the 50 cycle A.C. voltage is then superimposed. By this means, it is possible to obtain a sinoidal wave-form and to adjust the percentage modulation to that required. In practice, however, it is found that a higher modulation frequency is desirable.

FIG. 4

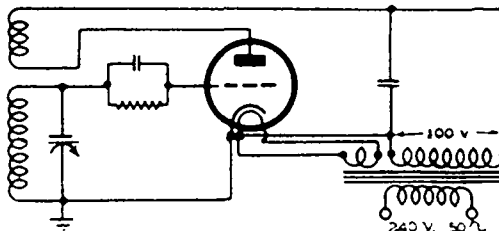

Self-Modulation.

Under certain circumstances, an oscillator may be made self-modulating, and it is then said to be "squegging." For this purpose, the time

AEGIS

QUALITY PARTS

Include: Dials, Edgelit; Coils Solenoid, B/C and S/W; Coils Permeability Iron Core; Dualwave Kits; R.F. Chokes; Power Transformers; Microphone Stands; Padding Condensers

Trolitul Coil Formers with Lugs, 1/3 each.

We are also factory representatives for Marquis Radio Lines, S/W Formers, Potentiometers Instrument Knobs, etc.

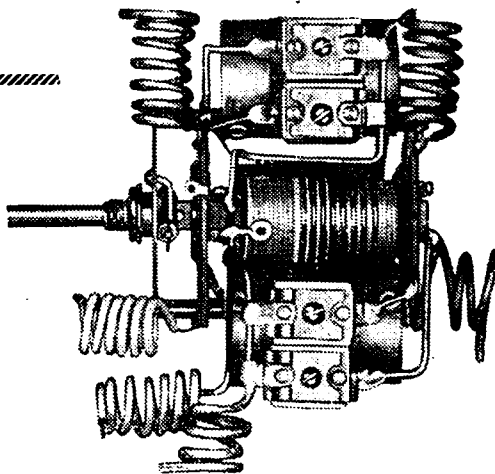

AEGIS DUAL WAVE TUNING KIT TYPE DW4

Self-contained, comprising Aerial, Oscillator, Short Wave and Broadcast Coils, four separate Ceramic type Trimming Condensers, Yaxley two-band Switch. All coils mounted and wired, and color-coded. Matched to Stromberg Type H Condenser. **The ideal Wave Kit for Manufacturers, Experimenters and Replacement.** Available in A.C. or Battery Oscillator Types.

"AEGIS" DW4 KIT. Price, 25/-

J. H. MAGRATH PTY. LTD.

208 Little Lonsdale St., Melbourne, C.1. Cent. 3688

N.S.W. AEGIS Representative: Reg. Rose Pty. Ltd., Sydney

constant of the resistor and condenser in the grid circuit is made very long (preferably by increasing the capacitance of the condenser), so that the grid "blocks" and breaks the oscillation at a suitable audio frequency.

FIG. 5

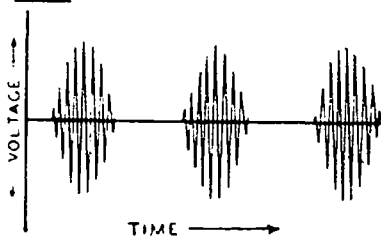

The modulation percentage is usually very high and the wave-form far from sinoidal. A well-adjusted "squegger" has a modulation envelope similar to that shown in Fig. 6. Frequency modulation is usually serious, and the application of the arrangements is consequently limited.

FIG. 6

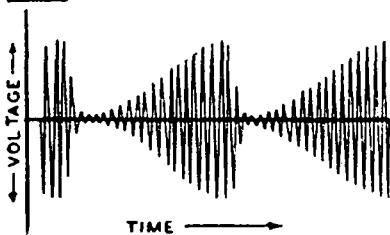

Audio Oscillators.

In the better class of equipment the required modulation voltage are almost invariably, provided by a separate audio oscillator.

An audio oscillator is similar in principle to an R.F. oscillator but necessarily uses very much higher values of inductance and capacitance in the tuned circuit. The wave-form is largely dependent on the characteristics of the tuned circuit and very careful design is necessary if the output is to be sinoidal. In general the "Q" factor of the inductance should be as high as possible, which means in effect that resistive loading across it should be reduced to a minimum.

In small service oscillators where some audio distortion can be tolerated it is possible to use for the inductance the windings of a small audio transformer. Under such circumstances, it is usually advisable to inspect the wave-form on a cathode-ray oscillograph.

The high frequency oscillator may be modulated in a number of ways, but plate modulation is most commonly used. Whatever the method, the object is to vary the amplitude of the high frequency signal at an audible rate without affecting its fundamental frequency.

Attenuation.

The radio-frequency voltage developed by a modulated oscillator is comparatively high, and only a small fraction of it is required for receiver testing. For normal service work, the R.F. output voltage on all bands should be adjustable, either continuously, or in frequent steps between approximately 0.5 volt and 2 microvolts.

Such requirements demand that the whole assembly be effectively shielded so that the only outlet for R.F. voltages is by way of a suitable attenuator network.

For effective shielding it is necessary to shield individually all major components, and to encase the whole in a heavy gauge metal case. Thin shielding is usually quite ineffective. Any shafts leading through the panel of the oscillator should be properly earthed, and ventilation holes covered with wire gauze. Where the oscillator operates from A.C. mains it is necessary to filter the power leads at the point of entrance to the case. A good earth connection is also desirable. It will be found that effective shielding is very much more difficult to obtain at higher frequencies.

Attenuators may be roughly divided into three classes, namely resistive, inductive and capacitive.

FIG. 7

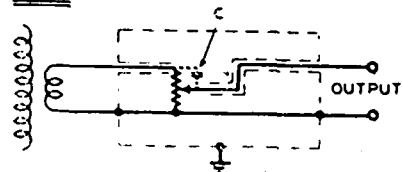

Resistive Attenuators.

Fig. 7 shows a simple type of resistive attenuator. A suitable R.F. voltage is fed from a low-impedance link coil to the outer terminals of a potentiometer and the output is taken from the variable tapping. The degree of attenuation which may be achieved is dependent largely on the stray capacitances (shown as C) between the input and output leads.

The output impedance, which may be an important consideration, obviously varies with the setting of the

control. The input impedance is also liable to vary under certain circumstances and may lead to some frequency shift due to variable loading on the oscillator coil.

Fig. 8 shows a type of attenuator which is widely used in standard signal generators. With correct design, it is possible to obtain adequate attenuation, with input and output impedances which are fairly constant for all settings of the control.

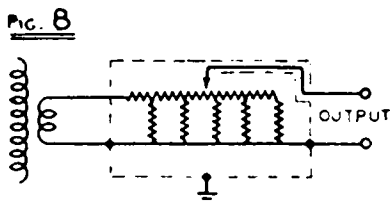

Inductive Attenuators.

Inductive attenuators vary a great deal in mechanical design but depend on the same general principle, namely, that of varying the mutual coupling between a coil connected to the output terminals and a coil carrying the radio-frequency currents generated by the oscillator. Fig. 9 shows the fundamental circuit. The

Faraday Shield is usually included and serves to eliminate direct capacitive coupling between the coils.

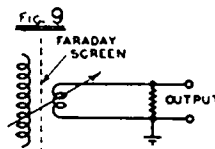

This type of attenuator provides a ready means of attaining a constant low-impedance output characteristic, but has the disadvantage that the variation in mutual coupling between coils may lead to some frequency shift. This effect can usually be made small by restricting the range of the attenuator.

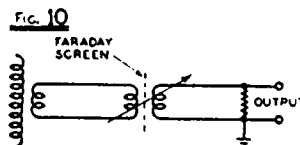

Figs. 10 and 11 show the basic circuit and the construction of an inductive "piston attenuator."

FOR...

RECEIVER EFFICIENCY—

FIT EDDYSTONE MICRODENSERS AND ENSURE SATISFACTION

EDDYSTONE

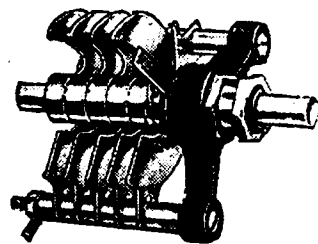

Famous Microdensers

- 1. Brass construction throughout with DL-9 high frequency insulation.
- 2. Both stator and rotor sections soldered to ensure low series resistance.
- 3. Every vane and whole condenser lacquered to prevent oxidisation and consequent H. F. losses.
- 4. Will not change capacity constants due to oxidisation after years of use, or change in efficiency.
- 5. Long spindle bearing, absolutely noiseless on highest frequencies.
- 6. No losses of any sort are measurable when a microdenser is put in circuit with the most efficient coil procurable.

No. 1094— 3-18 M.MFD. Price, 6/9 No. 1129—4-40 M.MFD. Price, 7/-
No. 1130—4.5-100 M.MFD. Price, 8/- No. 1131—5-160 M.MFD. Price, 12/9
IT PAYS TO BUY THE BEST. YOUR DEALER CAN SUPPLY.

BRISBANE: Chandlers Pty. Ltd.
 MELBOURNE: P. & L. Wireless Pty. Ltd.
 ADELAIDE: Gerard & Goodman Ltd.

SYDNEY: United Radio Distributors Pty. Ltd.
 PERTH: Carlyle & Company.
 HOBART and LAUNCESTON: W. & G. Genders Pty. Ltd.

Capacitive Attenuators.

A capacitive attenuator is in reality a small variable condenser which is connected in series between the output terminal and a point of higher R.F. potential. (See Fig. 12).

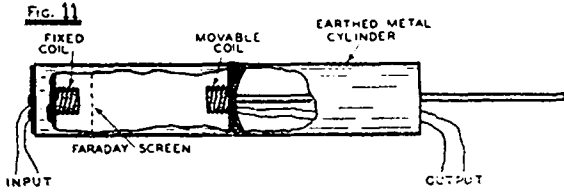

This type of attenuator has a high-impedance output characteristic and must be shunted by a resistor when connected in the grid circuit of a valve. Variation in capacitance may cause some frequency shift, but this may usually be minimised by restricting the range of control.

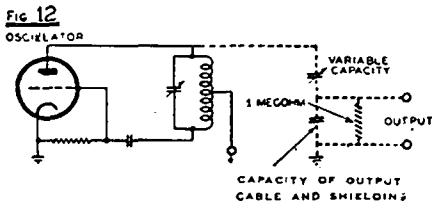
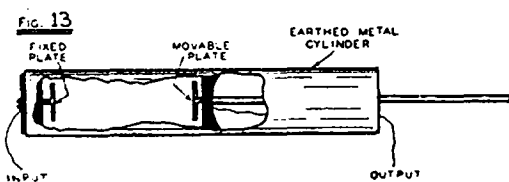

Fig 13 shows the construction of a capacitive "piston attenuator" which has been widely used in modulated oscillators.

Output Impedance.

When the output of the oscillator is fed directly to the grid of a valve the actual output impedance is seldom important provided that there is a D.C. path between grid and cathode.



When the oscillator is connected to the aerial terminal of a receiver, the loading imposed by the oscillator on the first tuned circuit should simulate that of an average aerial. For this purpose, manufacturers of standard signal generators provide a "dummy antenna," containing standardised values of resistance, capacitance and inductance, which may be connected in series with the oscillator lead. Fig 14 shows the dummy antenna which has been adopted as standard by the American Institute of Radio Engineers. The characteristics of this dummy antenna are only correct if the output impedance of the signal generator is low (i.e., less than 50 ohms).

In the majority of cases, it is possible to neglect the effect of output impedance and to make final adjustments to the aerial coil trimmer with a normal aerial connected to the receiver. Sufficient signal may be obtained simply by twisting the output lead of the oscillator around the aerial lead, and increasing the output voltage.

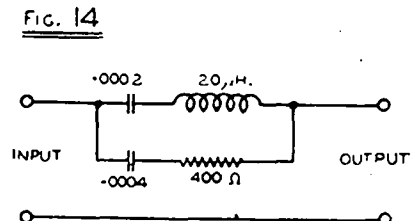

(Continued on Page 22)

DX Notes

By VK3MR

Following the scarcity of news last issue, this month is no exception, and "things is tuff." Out of the heart of Australia a much climatized apparition in the shape of BERS 195, has appeared, and is enjoying the cooler (?) weather of Sydney. Eric's name first came before the Ham world when he used to hear all the short wave CW sigs on their overtones on about 160 metres and a full and convincing report was sent to the unfortunate ham who had to decipher the letter! His pet "nick name" was "The Overtone King," but now he is known in respectable circles as VK5TK. He has had 13 years of listening, and during that time has heard 173 official countries, and 144 have qsl'd. It becomes obvious that he has taken the receiving side seriously, as he has won 3 cups and 8 BERU certificates and, in all, 13 different certificates. His

bread-winning hobby has been brass pounding for the P.M.G., but is now mixed up with aviation. News from little known places seems to be the order, as I have also heard from VK7AB, who assures me that Tasmania is still in existence although rapidly getting smaller and beautifully less. Doug has been getting excellent reports on 10 mx from U.S.A. using a centre fed 135 ft. ant., and just prior to hostilities, had purchased much oregon for his new beam, but now is using some to start up the fire in the a.m.'s. Like 3KX, he finds that fishing is even more difficult than working dx. What is your final list of countries, om? Ditto, 2DG. I have had enquiries for the gra of Fritz Haas ex OE1FH, who is reported to be in VK5 somewhere. Who will oblige. The dx page in the R.S.G.B. mag. has now been changed to "The Month Off the Air!"

PHONE B 4148

COMMERCIAL AND
ART PRINTERS

98-100 HARRINGTON STREET, SYDNEY

*Specialise in the Printing of . . .***QSL CARDS***which are Distinctive and Attractive*

Federal and Victorian QSL Bureau

R. E. Jones, VK3RJ, QSL Manager.

The flow of incoming cards has almost ceased, only 200 being received during December, in lieu of the customary 3500.

VK stations should seize the respite and bring their QSL's up to date.

Cards for the following VK3 stations are making their final appeal. If unclaimed by January 31st they will be destroyed. A stamp to the Bureau, 23 Landale Street, Box Hill, will relieve them.

VK3AC, AP, BH, CQ, CU, DJ, EF, EH, GX, HI, HV, IF, IS, IU, KQ, KT, LI, ND, NP, PH, QE, QG, ST, TF, UC, UV, UX, VA, VB, VD, VW, XK, XU, XZ, ZC, ZD, ZJ.

CONTEST NOTES.

R. E. Jones, VK3RJ,

RESULTS OF THE 1939 VK-ZL 80 METRE FONE CONTEST.

The results of the above contest have been released by the N.Z.A.R.T.

UNLIMITED SECTION.

1st	VK2NY	1020	points
2nd	VK3WE	1010	"
3rd	VK3DG	845	"
4th	ZL2GX	695	"
5th	VK2OE	605	"
6th	ZL2JB	465	"
7th	VK3CH	420	"
8th	ZL3CP	380	"
9th	VK4JF	345	"
10th	ZL2WQ	315	"
11th	ZL2JR	275	"
12th	VK2HZ	140	"
13th	VK3OR	120	"
14th	VK4AW	105	"
15th	VK4LN	40	"

LIMITED SECTION.

1st	VK2AJK	570	points
2nd	VK2YL	335	"
3rd	VK3TL	265	"
4th	VK5BG	255	"
5th	VK5RN	190	"
6th	VK3EF	165	"

Logs from VK4HA and VK3IG were received after the closing date and therefore could not be accepted.

Certificate Awards will follow in due course to the winning stations.

HAMS!!

DO NOT REMAIN INACTIVE, REBUILD YOUR RECEIVERS,
AND OF COURSE USE THE BEST_____

EDDYSTONE COMPONENTS

Victorian Agents—

P. & L. WIRELESS SUPPLIES PTY. LTD.
213 ELIZABETH STREET, MELBOURNE

F 4323 Write or Call for a Catalogue.

Divisional Notes

IMPORTANT.

To ensure insertion all copy must be in the hands of the Editor not later than the 18th of the month preceeding publication.

N.S.W. DIVISION.

President: H. F. Petersen, 2HP.

Vice-Presidents: W. G. Ryan, VK 2TI and F. Carruthers, VK2PF.

Secretary: C. Horne, VK2AIK.

Treasurer: H. Ackling, VK2PX.

Editor of Notes for this Division:
J. H. Fraser.

Interstate and Country Visitors should ring FX3305.

No notes arrived from VK2 this month, although we delayed going to press as long as possible. Chaps! Let your Notes Editor know what you are doing, and tell him early, as copy must be sent to Melbourne before the 18th of each month.

VICTORIAN DIVISION.

KEY SECTION NOTES.

By VK3CX.

The attendance at the December K.P.S. meeting was very large and after many mishaps with the elevator, which necessitated many of the boys getting out one floor short and tramping up the stairs, the meeting opened at 8.10 p.m. with QW in the chair.

Business was rapidly disposed of and after R.J. had distributed the usual batch of QSL's, which continue to roll in, the main item of the evening was presented.

It was a lecture by Mr. Quadling, of the Marconi School, on "Direction Finding." It says much for his prowess as a lecturer, when the boys even forgot to light their cigarettes, and at the conclusion of the lecture

the questions came at him from all sides. It seems that there is going to be quite a lot of interest taken in D.F. in the near future.

Many new faces were noticed at the meeting, and it appears that now the lads cannot talk to each other over the air, they are forced to come to the monthly meetings to have personal contacts. The gang are still retaining their interest and much work is being done on receivers. The latest to succumb to the craze is H.K., who has just completed a 13 tube job, but wants something to put in the upper left corner of the panel to match the "R" meter in the upper right corner. CX suggested that he include an electric clock, but he still wants other suggestions.

CZ is back from gold hunting. The best that he could do was to see the hole that someone once got something out of, and so he is forced to go back to the office with his dreams of striking it rich. Hard luck, Arthur. B.G. is still grinding crystals, and is running short of material, so if you have a nice big piece of quartz, you know what to do with it. Playing cricket recently, CX found that two members of the opposing team were PG and HT. He won't say who won, but we can guess. CX's antenna is still radiating — during a recent thunderstorm he found 3 inch sparks jumping from one feeder to the other. He wants to know if the bloke up above has a permit from the R.I. to send out spark transmissions like that. Ho, hum—see you next month, fellows.

SOUTH AUSTRALIAN DIVISION.**DIVISIONAL NOTES.**

By VK5RN (Not RM).

Early in December, Professor Kerr-Grant very kindly gave us a lecture on "Modern High Voltage Generators and their application in modern transmutation experiments." In his lecture, Professor Kerr-Grant dealt with generators of all types and illustrated his talk with lantern slides. Although the attendance at this meeting was not so good as was expected, everyone present had an intensely interesting evening. The lecture started at 8 p.m. and finished at 9.30 p.m.

The second class commercial exam. took place early this month, and three of our members sat for it. However, many more will be taking the March exam. On Tuesday, December 5, the theory and regulations exams. were held, and on Wednesday, candidates were taken down to Port Adelaide to have a practical test on commercial equipment, including direction finding apparatus.

We learn that VK3EF will be coming over to S.A. for a short stay during Xmas, but by the time these notes appear, Bert will be safely home again in Warracknabeal, but anyway, we hope that he enjoyed his stay in VK5, and that he will repeat his visit in 1940.

To keep the old Xmas "Spirits" up, the Xmas meeting will be held as usual on Wednesday, December 20, and we expect that this meeting will be well attended, as it has always proved a popular function in the past, and should prove even more popular now that we are denied our field days and other activities.

Our code practice classes have recently taken the form of practice in handling telegrams in the correct (?) commercial style. We have a buzzer and two keys connected in series, and an operator at each key so that the result is perfect "break in" operation, added to which both operators are within talking range of each other and can, if all other methods fail, send the telegram by voice.



The Power Equipment with a Powerful Reputation . . .

THE Organisation responsible for the production of . . .

**HILCO TRANSFORMERS
CHOKES, etc.**

has proved its high standards for an article of extreme merit as accepted by the largest consumers in Australia.

**ALL PRODUCTS GUARANTEED FOR
TWELVE MONTHS.**

HILCO TRANSFORMERS PROPRIETARY LIMITED

97-111 BERKLEY ST., CARLTON, N.3., Vic. 'Phones; F1661-2
CABLES & TELEGRAMS: "HILCOY," MELBOURNE.

Another of our members, VK5ZZ, has joined the R.A.A.F., and has gone to Victoria for 8 months' training; we wish him every success and safe landings.

In addition to the list of stations published last month, we have received yet more cards from Headquarters, and they are still arriving, although not in such large quantities as previously.

Although Xmas will be over when these notes appear in print, I can still take the opportunity of wishing everyone a prosperous New Year, and good listening for 1940.

H A M S !

**DO YOU WANT TO BE
BACK ON THE AIR?**

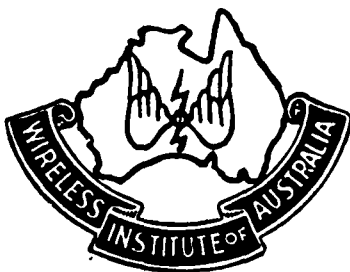

The Wireless Institute of Australia

is the recognised spokesman of the
AUSTRALIAN AMATEUR.

If you are not a member—

Join Now !

When the time comes that we can reasonably expect to go back on the air, we want to say that we represent—

EVERY ACTIVE HAM

in the Commonwealth.

Strengthen our hand by writing to The Secretary of the Institute in your State to-day.

All addresses are on the title page.

RADIOTRON DESIGNER'S HANDBOOK.

Third Edition.

The third edition of the Radiotron Designer's Handbook, which is at present in the course of being published, is expected to be available early in the New Year. Copies will then be procurable through the principal booksellers.

This handbook, the first two editions of which proved so widely popular, has been completely rewritten from cover to cover and enlarged to such an extent that it can now claim to be an invaluable book of reference to all those engaged in radio engineering.

Including no less than 40 chapters, the following subjects are fully covered: Radio frequencies, rectification filtering, receiver components, tests and measurements, valve characteristics, general theory, together with tables, charts and sundry data.

A large proportion of the material is unobtainable from text books or other sources, and has been written specially to meet the demand for such information. Very complete treatment has been given on negative feedback, tone compensation, tuned circuits, rectification, filtering, transformers, receiver tests and measurements, valve testing, valve voltmeters and the graphical representation of valve characteristics.

The entire edition is copiously illustrated with diagrams and a large number of curves have been given for the graphical solution of special problems. Useful tables have also been given, these including very complete tables of capacitive and reactive inductances and the impedance of a resistance and capacitance in parallel.

This new edition of the Radiotron Designer's Handbook, with its 300 pages, has been produced as a Radiotron service, and every radio technician should make a point of including it in his reference library.

The price will be 3/-.

(Continued from Page 16)

Output Voltage Measurement.

For laboratory or receiver production work it is necessary to know accurately the value of the output voltage. For this purpose, standard signal generators incorporate some means of measuring the output voltage, usually by means of either a thermo-couple or a valve voltmeter. This facility, however, is seldom warranted in oscillators intended for service work, and an arbitrary scale on the attenuator control for purposes of comparison is usually quite sufficient. In such cases, actual cali-

bration in microvolts must be regarded as approximate only.

Radiotron Modulated Oscillator.

Fig. 15 shows a practical design for a modulated oscillator.

The radio frequency voltage is generated by a 6J7-G connected as an electron-coupled oscillator, and the output is taken from a 50,000 ohm potentiometer in the plate circuit. A reasonably smooth control may be obtained if a well-tapered potentiometer is used in this position. The various bands are selected by

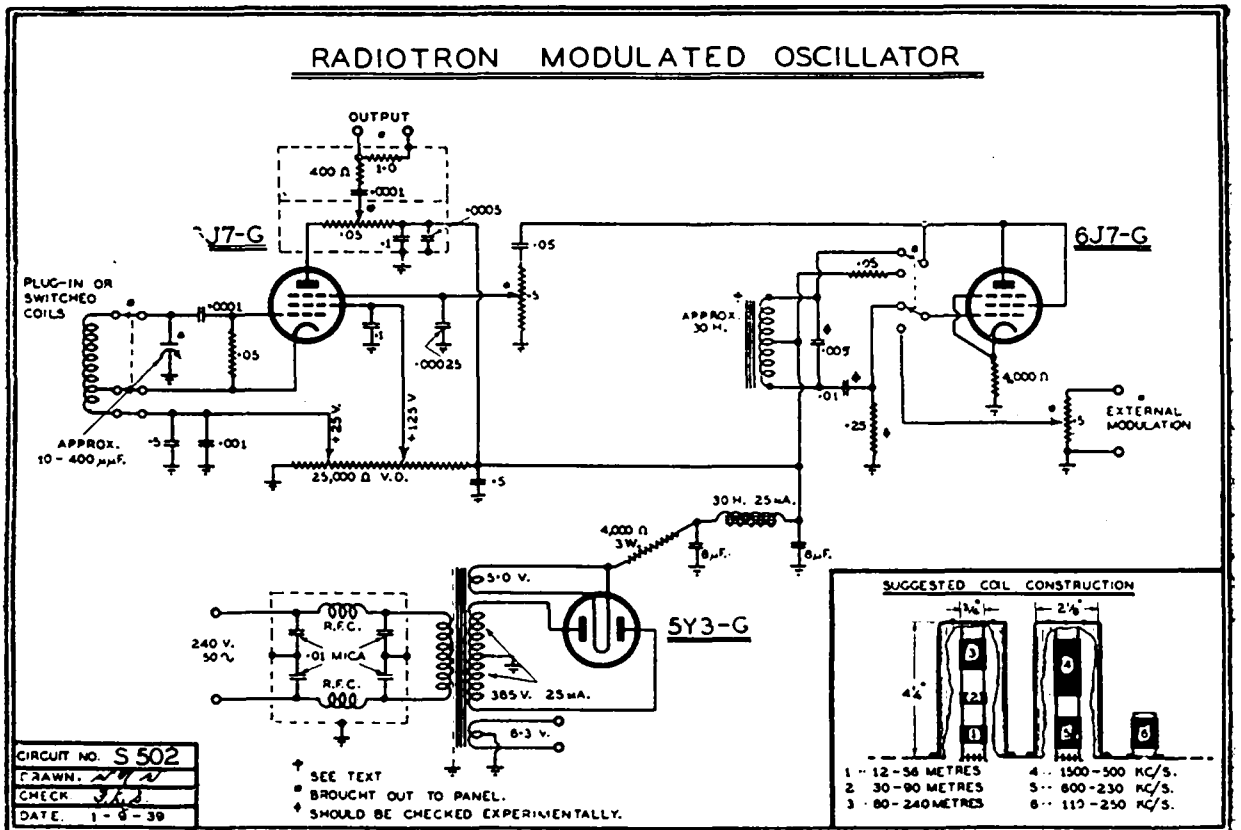

Band	Wire	Turns	Layers	Tap*	Winding
12-36 metres	22	7.5	1	1.5	16 T.P.I.
35-105 metres	27	19.5	1	2.3	Close Wound
80-240 metres	27	63	1	6	Close Wound
1500-500 Kc/s.	31	190	1	15	Close Wound
600-210 Kc/s.	31	310	3	20	Length = 1 in.
250-100 Kc/s.	33	610	5	30	Length = 1 in.

*Should be adjusted for best results.

FIG. 15. Circuit arrangement of Radiotron Modulated R.F. Oscillator.

Submit Your Transformer Problems To Us



We are illustrating our new die-made steel case used in our range of stalloy cored audio transformers of all sizes.

This type of case has just been released, and offers a number of advantages over other makes available on this market, such as—

- Reversible mounting
- High grade stoved black wrinkle enamel finish
- Cadmium plated brass soldering lugs

The new case is particularly attractive in appearance, and where "dressing" is important, you cannot do better than specify "Trimax."

Even if you are not rebuilding, we know you'll have a Merry Xmas—and to all our customers and friends we take this opportunity of saying—
"Good Luck—and a Happy and Prosperous New Year."

HARRY CLIFF.

RUPERT C. PETERSON.

TRIMAX TRANSFORMERS
(A DIVISION OF CLIFF & BUNTING PTY. LTD.)

Registered Office:

29-35 FLEMINGTON RD., NORTH MELBOURNE.

PHONE: F 9127 (2 lines)

means of a double-pole six-way wave-change switch.

Modulating voltages are applied to the suppressor grid of the oscillator valve, the depth of modulation being controlled by the 0.5 megohm potentiometer.

The second 6J7-G may be used either as an audio amplifier for external modulation voltages, or as a Hartley oscillator for internal modulation.

Reasonable sinoidal wave-form may be obtained by using for the inductance a standard push-pull speaker transformer. The associated components marked with an asterisk were correct in the experimental model but may need modification with different transformers.

The power supply shown is recommended although any other may be used which provides the required supply voltage and current. If the oscillator is to be really useful it should be fully calibrated on all bands, preferably by drawing a complete set of curves of frequency against dial setting. A typical calibration curve is shown in Fig. 16.

On the broadcast and short-wave bands sufficient reference points may usually be found by heterodyning the oscillator against stations of known frequency, and listening for zero beat in a receiver. Some care has to be exercised particularly on the short-wave band to avoid confusion due to harmonics from the service oscillator and "second spot"

tuning effects in the receiver.

On the 465 Kc/s I.F. band a more indirect method must be adopted. The approximate dial setting for 465 Kc/s may readily be found by feeding the output of the oscillator through the I.F. channel of a receiver known to be aligned at or near this frequency. Once having determined the approximate setting, accurate calibration may be carried out with the aid of the second harmonics.

If, for example, the receiver is tuned to a station on 930 Kc/s, and the oscillator output lead brought close to the aerial terminal, a beat note will be heard as the oscillator is tuned through 465 Kc/s. Similarly with the fundamental on 460 Kc/s the second harmonic will fall on 920 Kc/s. By repeating this process it should be possible to draw an accurate calibration curve for the whole band.

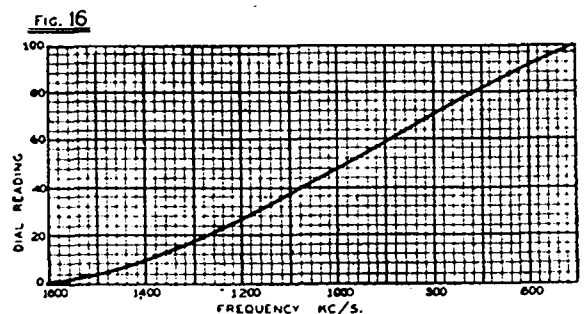

Calibration of the 175 Kc/s I.F. band is also possible by similar means, but greater care must be exercised in discriminating between the various harmonics.

(To be continued).

HAMS

WHEN REBUILDING YOUR RECEIVER
REPLACE YOUR OLD SPEAKER WITH

AMPLION

THE NEW 12in. ELECTRICALLY WELDED
SPEAKERS

MODEL	Air Gap Flux	Weight of Magnet	POWER OUTPUT.		Diameter	PRICE
			Undistorted—Max			
V	8,300	12 ozs.	10 watts	15 watts	12 $\frac{3}{16}$ "	£2 3 0
VL	9,000	22 „	13 „	20 „	12 $\frac{3}{16}$ "	£2 16 0
VP3	12,000	64 „	20 „	30 „	12 $\frac{3}{16}$ "	£5 10 0
VP2	9,000	20 „	12 „	18 „	12 $\frac{3}{16}$ "	£3 6 6
VPI	7,500	14 „	8 „	12 „	12 $\frac{3}{16}$ "	£2 10 0

Types V and VL are Field Type Speakers.
Types VPI, 2, 3 are Per-Magnetic Speakers.

**SILVERED
MICA**

T. C. C.

**CERAMIC
CONDENSERS**

T.C.C. Silvered Mica Condensers are guaranteed to maintain their capacity under all temperatures, thus insuring no frequency drift in Supers. The foil is actually plated on the mica.

We can supply these Condensers in any per cent. of accuracy, including 0%.

The Capacity Range is from 10 mmf to 800 mmf.

LIST PRICE, 1/- EACH.

We are Agents for—

I.R.C. RESISTERS.

T.C.C. CONDENSERS.

AMPLION SPEAKERS.

BRUNO MICROPHONES.

BIRNBACH INSULATORS.

TRIMAX TRANSFORMERS.

**AUSTRALASIAN ENGINEERING
EQUIPMENT CO. PTY. LTD.**

370 Little Collins St., Melb. Phone: F 5585

WESTON

Instruments

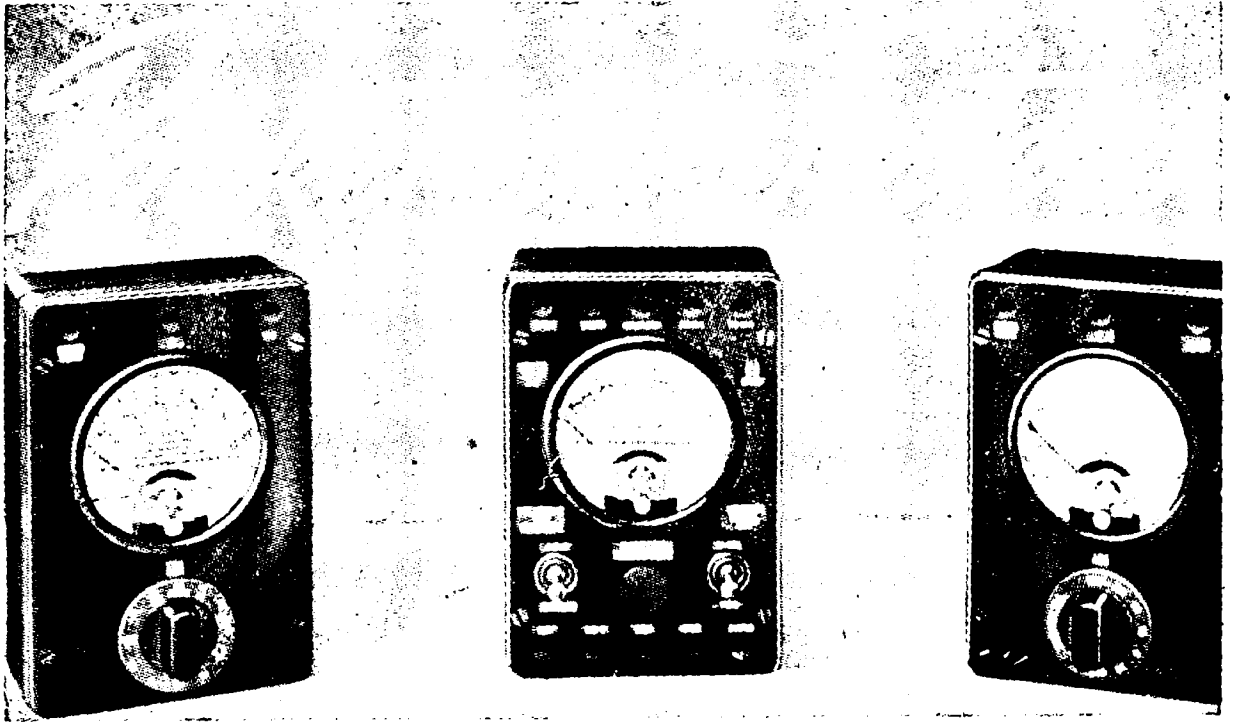

Essential Equipment in Every Experimenter's Kit . .

Small and compact, these pocket size Western Test Units are admirably suited for all testing and experimental purposes. They can be carried conveniently in your coat pocket or can be stored away in a table drawer for easy reference.

Model 695 (on left).—Power Level Meter, Voltmeter, Output Meter. A rectifier type voltmeter, which gives readings in decibels as well as volts. Ideal for all types of audio equipment.

Model 697 (Centre).—Volt-Ohm-Milliammeter. This unit covers a.c. and d.c. voltage, d.c. milliamperes and ohm ranges. Precision resistors are used throughout. Voltage, current and resistance ranges are brought out in pin jacks and are selected by toggle switches.

Model 571 (on right).—Output-Meter. This has a constant resistance of 4000 ohms on each range, and is usually used as a terminating device on sound line or receiver output circuits.

Write or call for literature and full particulars.

Warburton Franki (Melb.) Ltd.

380 BOURKE STREET, MELBOURNE. MU 6353
Also at Sydney and Brisbane.

AMATEUR RADIO



Published in the interests of the Wireless Institute of Australia, Official Organ of all divisions of the W.I.A. and R.A.A.F.W.R.



PRICE

6^d

FEBRUARY, 1940

Let us quote you for your
PRINTING REQUIREMENTS



The House of Good Printing

**285-287 LATROBE STREET,
MELBOURNE, C.I**

Opposite "The Argus" Office

Telephone MU 2897 After Hours FU 6795

AMATEUR RADIO

Published in the Interests of Radio Amateurs and
Experimenters throughout Australia.

VOL. 8. No. 2.

1st FEBRUARY, 1940

OUR ORGANISATION

Publishers.—

WIRELESS INSTITUTE OF AUSTRALIA
(Victorian Division)
191 Queen Street, Melbourne, C.I.

Editorial Department.—

W. R. GRONOW (VK3WG),
Editor.

R. H. CUNNINGHAM (VK3ML)
Technical Editor.

C. SERLE (VK3RX)
Notes Editor.

V. E. MARSHALL (VK3UK)
Compilation.

H. N. STEVENS (VK3JO)
Distribution.

L. T. POWERS (VK3PS)
Secretary.

Advertising Department.—

BEDGGOOD ADVERTISING CO.,
129 William Street, Melbourne.
Phone: MU 4046

Sydney Representative—
J. H. FRASER

8 Deakin Avenue, Haberfield. UA 1725.

Printers.—

H. HEARNE & CO. PTY. LTD.,
285 Latrobe Street, Melbourne, C.I.

Accounts Department.—

LARGE & POWERS,
Chartered Accountants (Aust.),
422 Collins Street, Melbourne.

MSS and Magazine Correspondence
should be forwarded to The Editor,
"Amateur Radio," Box 2611W, G.P.O.,
Melbourne.

Subscription Rate is 6/- per annum in advance (post paid).

NOTE.—Advertisers' change of copy must be in hand not later than the 20th of the month preceding publication, otherwise the previous month's copy will be reprinted.

CONTENTS.

	Page
Editorial - - - - -	2
Modulated Oscillators for Receivers - - - - -	4
A Review of Radio Re- ceivers - - - - -	11
Putting the Vacuum Tube Voltmeter into Service	13
Federal and Victorian Q.S.L. Bureau - - - -	14
28-56 M.C. Notes - - - -	15
Divisional Notes - - - -	16
Correspondence Section -	24

IMPORTANT—

R.A.A.F. VACANCIES - 10

DIVISIONAL ADDRESSES.

FEDERAL HEADQUARTERS:
BOX 2611W, G.P.O., MELBOURNE

NEW SOUTH WALES:
BOX 1734JJ, G.P.O., SYDNEY.

VICTORIA:
BOX 2611W, G.P.O., MELBOURNE.

QUEENSLAND:
BOX 1524V, G.P.O., BRISBANE

SOUTH AUSTRALIA:
BOX 284D, G.P.O., ADELAIDE.

WESTERN AUSTRALIA:
BOX N.1002, G.P.O., PERTH.

TASMANIA:
BOX 547E, G.P.O., HOBART.

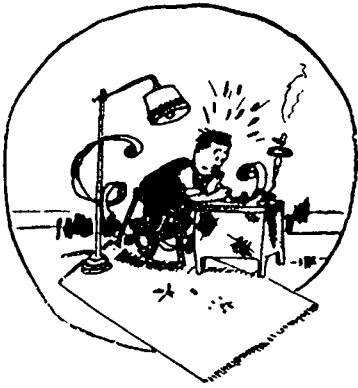

EDITORIAL

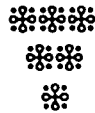

We have been requested by F.H.Q. to publish the terms of the application for re-allocation of licences. As already advised in January issue, this application was unsuccessful, and every effort is being made to have this decision reversed.

15th November, 1939.

The Chief Inspector, Wireless,
—Mr. J. M. Martin—
Radio Inspectors Branch,
Treasury Buildings,
Treasury Gardens,
Melbourne, C.1.

Dear Sir:

Re **EXPERIMENTAL LICENCEES
AND ULTRA HIGH FREQUENCY
ALLOCATIONS.**

On behalf of the Federal Council of the Wireless Institute of Australia, I beg to apply for allocation of portion of the undermentioned Ultra High Frequency Spectrum for transmission experiments to all Experimental Licencees throughout Australia.

The Wireless Institute represents approximately twelve hundred experimenters throughout the Commonwealth and we are also aware

that our application is heartily supported by numerous non-members of our organisation.

In asking that permission be given for the operation of Experimental Radio Stations, we would mention that much valuable knowledge has been and can be obtained from the continued study and operation of experimental transmission and receiving equipment. The suggested allocation is as follows:—2.5 meters (112 MC) and below, with a power of 25 watts. It is felt that these frequencies are of no value for service communications and would provide experimenters with an object for serious study. The allocation of these frequencies for experimental communication would also permit all licencees an opportunity for continued practice in "Morse" transmissions with a consequent effect on their value as radio operators in the service of the Commonwealth.

We would be prepared to make available suitable wave measuring equipment in each division, as required for the use of experimenters in locating these frequencies correctly; also we would undertake to extend the activities of the present Vigilance Committees in co-operation with the Postmaster-General's

Dept. to monitor these bands with a view to maintaining a close observance of the regulations.

It is hoped that you will agree to this request, as we feel it is essential to encourage the study and development of radio transmission on these frequencies, as the possession of a trained body of radio enthusiasts is of vital importance to the Country.

We would remind you that seven hundred Experimental Licences are now serving as Wireless Operators and Technicians with the various Services and have thus proved the value of their study and application of radio in a time of need.

Thanking you in anticipation of your agreement to this application.

I am,

Your faithfully,

(Signed) WILLIAM R. GRONOW,
Federal President,
Wireless Institute of Aust.

N.B.—Attached is a more detailed summary of our suggestions.

- (1) Transmission to be limited to 112 MC and frequencies above.
- (2) Maximum power input 25 watts.
- (3) Transmission to be limited to class A1, A2, A3 waves.
- (4) Licences to be re-issued on individual application only; the Department to withhold issue if it is deemed advisable. This application is being presented subject to the above conditions, for the following reasons:—
 - (a) Frequencies of 112 MC and above are of no value to the Services, whilst frequencies, at least up to 60 MC will probably be utilised.
 - (b) By the opening of 112 MC and frequencies above, no interference to either service or commercial stations will be possible with such low power.
 - (c) The frequencies proposed are

useless for any form of illicit communication.

- (d) The re-instatement of experimental licences for operation on these frequencies will provide a very desirable incentive for men who have not yet enlisted to study for the Amateur Operators' Certificate of Proficiency, and thus provide the Commonwealth with a steady potential source of W/T operators, for the needs of the three Services. (As you are no doubt aware, the latter are being forced to train men without knowledge of Radio as W/T Operators, because practically all Amateurs who are eligible for enlistment have joined up). This does not mean, however, that the number of Experimental Licences likely to be re-applied for will be small, because not only are a considerable number of Amateurs engaged in Reserved occupations, but in addition, there are many both physically unfit and over age. In addition, it can be considered as certain that the greater majority of those serving in the Forces would re-apply immediately).
- (e) The Wireless Institute of Aust. as the Officially recognised Amateur body in Australia is prepared to provide an adequate monitoring organisation not only of transmissions, but also of equipment in a manner and through an organisation approved by the Department.
- (f) The opening up of these frequencies (112 MC and above) requires a high degree of technical knowledge and skill for effective communication; thus the possibility of transmissions being made by unqualified and unlicensed persons may be considered as unlikely.

Modulated Oscillators for Receivers

By courtesy Amalgamated Wireless Valve Company Pty. Ltd.
(Continued from January Issue).

ALIGNING RECEIVERS.

The alignment of superheterodyne receivers is a fairly standardised procedure and does not involve any great difficulties provided certain precautions are taken. Final alignment should only be carried out after all voltages have been adjusted, and should preferably be the last operation on a chassis. It is not good practice to carefully align a receiver and then to disturb the wiring or subject the chassis and components to undue stresses.

As a general rule, the input voltage from the modulated oscillator should be kept small and alignment carried out with the gain control (or controls) of the receiver in the maximum position. The use of small input voltages is particularly important when dealing with a receiver equipped with A.V.C. since at higher signal inputs the A.V.C. becomes fully operative and changes in output level are greatly reduced by its action. Furthermore, the R.F. and I.F. amplifying valves have a certain input capacitance, which is effectively in parallel with the tuned grid circuit and varies with the gain of the stage. If the tuned circuits are aligned with a large input signal errors may occur on weak signals where the valves are operating under relatively higher gain conditions.

Some form of output meter (such as that incorporated in the Radiotron Volt-Ohm-Milliammeter) is almost essential when aligning receivers, as it is then possible to observe variations in output voltage which could not be detected by ear. If no out-

put meter is available, the power output should be kept to a low level, at which the ear is more sensitive to small variations in volume.

Aligning the I.F. Transformers.

To align the I.F. transformers, the output of the modulated oscillator must be fed into the signal grid of the frequency changer. For exact measurements of sensitivity, the normal grid cap should be removed and the D.C. return made through the output circuit of the modulated oscillator to the chassis, or to some appropriate point when the normal grid return is to a source of negative bias.

This is not always convenient and for purposes of alignment the normal grid cap may be left in position and the oscillator output connected between grid and chassis. A condenser of 0.001 μ F. capacitance connected in series with the "hot" lead will prevent any initial bias being "shorted out" by the modulated oscillator.

Unless there is a definite reason, it is not advisable to alter the intermediate frequency of an existing receiver. Many manufacturers do not adhere rigidly to 465 Kc/s and prefer to use some slightly different frequency. Unnecessary alteration of the I.F. in such receivers may lead to trouble with "joeys" and will upset dial tracking. The frequency of the modulated oscillator should be adjusted for greatest output from the receiver and then, without alteration of the frequency the settings of the individual trimmers should be checked. With new receivers this does not hold, and the I.F. trans-

CONDENSERS and RESISTORS



DUCON-CHANEX

GUARANTEE

*Complete
Reliability*

Under the most exacting
conditions.

Ducon Condensers are admirably suited to withstand the peculiar conditions of amateur and experimental work.

In the new transmitting units of 2FC and 3LO, Ducon Condensers were installed, being specially chosen for their unique quality.

For all Condensers and Resistors
specify

DUCON CHANEX

73 BOURKE St. WATERLOO. N.S.W.
450 COLLINS St., MELBOURNE, C.I

formers may be aligned to the intermediate-frequency for which the coil kit is designed.

In cases where the I.F. transformers have not been aligned, it may be necessary to adjust the second transformer (by feeding the signal to the grid of the I.F. amplifying valve) before any signal can be obtained from the frequency changer.

Tuning Circuits.

Alignment of the tuning circuits presents little difficulty in the case of receivers in which the dial is marked only in terms of an arbitrary scale. The procedure usually adopted is then as follows:—

The stations on the high-frequency end of the band are set to a satisfactory position by means of the oscillator trimmer. Reducing the capacitance of this trimmer will shift the stations towards the centre of the dial scale, while increasing it will have the opposite effect. The modulated oscillator is set to 1400 Kc/s and the output lead connected to the aerial terminal in place of the aerial. The signal is carefully tuned in and the aerial and R.F. trimmers adjusted for maximum output. The modulated oscillator is now set to 600 Kc/s and, with the receiver tuned to this frequency the padding condenser is adjusted to give maximum output, the gang being "rocked" to allow for alteration in oscillator frequency. The optimum adjustment is that when any variation in the padder setting causes a falling off in output, no matter which way the gang condenser is turned. Having adjusted the padder, it is necessary to recheck the aerial and R.F. trimmers at 1400 Kc/s.

Unless definitely necessary, the setting of the oscillator trimmer in a receiver should not be altered, since any alteration is likely to be very disconcerting to a client who has carefully memorised the posi-

tions of the various stations on the dial. It is usually sufficient to check the adjustment of aerial and R.F. trimmers and of the padding condenser.

Calibrated Dials.

When the receiver dial is calibrated with station names, or in terms of frequency and/or wavelength, the same general procedure should be followed, aligning first the trimmers and then the padding condenser.

With the padding condenser adjusted, the receiver is tuned to a station at the low-frequency end of the band (e.g., 2FC or 3AR on 610 and 620 Kc/s respectively) and the dial pointer set to its calibrated position. A local station on about 1300 Kc/s is then brought to its calibrated position by means of the oscillator trimmer. The aerial and R.F. trimmers must then be readjusted using the modulated oscillator. Then, providing the dial is calibrated to the particular gang condenser and coil kit used the remaining stations should fall near their calibrated positions.

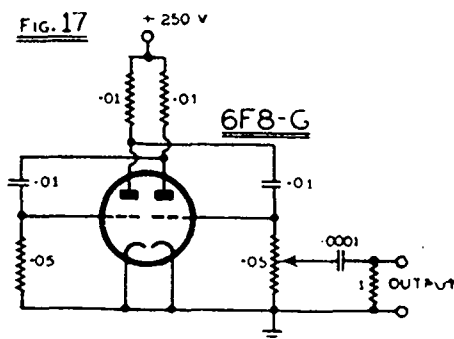

The general rule therefore is to set the dial pointer by the low-frequency stations and adjust the positions of the high-frequency stations to coincide with their dial calibrations by means of the trimmers.

This rule also holds in receivers where the tuned circuits are aligned inductively by means of variable iron cores. The process may be rather more tedious, however, since

the adjustments on the high and low-frequency ends of the band are less independent.

As previously stated, the output impedance characteristic of the modulated oscillator may differ considerably from those of the average aerial, and may influence the setting of the aerial trimmer. This trimmer should accordingly be rechecked on a weak station (located at the high-frequency end of the band) with the normal aerial connected. If the receiver is fitted with a sensitive tuning indicator this operation is greatly simplified.

Short Wave Bands.

On the short wave bands, the shortcomings of service oscillators in regard to output impedance and attenuation are usually severe, and satisfactory alignment in the normal manner may be very difficult. Under such conditions, it is advisable to

FIG. 18

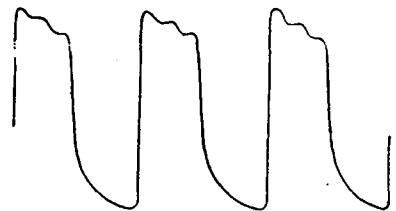

align the tuning circuits with the normal aerial connected, and the output lead of the oscillator twisted around it. As before, no higher input voltage should be used than is necessary to give a satisfactory reading on the output meter.

In the majority of receivers the padding condenser is of fixed capacitance and adjustment cannot readily be made for tracking. Should "dead spots" occur in the band, it may be necessary to effect a compromise in the setting of the trimmers so that more even sensitivity will be obtained across the band. Such a measure should not, however, be necessary in a well-designed receiver.

If the padding condenser is of fixed capacitance the only means of setting the dial calibration is by means of the oscillator trimmer at the high-frequency end of each band. Care must be exercised to discriminate between the signal and the "image" which may be very prominent in small receivers. (The occurrence of "images" or "second spots" was discussed at greater length in Lecture 1).

Another effect which must be appreciated is the "crossing over" effect. In the majority of receivers, the oscillator is tuned to a frequency higher than the signal frequency, the oscillator coil being slightly smaller than the aerial and R.F. coils. If, however, the range of the trimming condensers is great, it is sometimes possible at the high-frequency end of the band to tune the local oscillators to a frequency lower than that of the signal frequency circuits. Under these conditions, as the receiver is tuned across the band the resonant frequency of the aerial and R.F. Circuits decreases more rapidly than that of the oscillator circuit and a point of cross-over occurs beyond which the oscillator frequency is above the signal frequency. At the point of cross-over, i.e., where the two frequencies are equal, instability is likely to be experienced.

The reverse process can also take place when the oscillator is operated at a frequency lower than the signal input frequency.

MULTIVIBRATORS.

The multivibrator is a form of oscillator which, in addition to the usual fundamental frequency, produces also a large number of equally spaced harmonics. For this reason and also for the fact that it is simple to design and construct and hence relatively inexpensive, it is extremely useful in service work. The usual form of multi-vibrator oscillator consists of a two-stage resistance-coupled amplifier, in which the output voltage of the second valve is fed back through a resistive capacitive network to the grid of the first valve. The fundamental frequency

and hence the spacing of the harmonics is determined by the time constant of the coupling condensers and resistors. A multivibrator may be designed having a fundamental frequency of approximately 500 c/s, and producing harmonics spaced every 500 c/s to approximately 20 Mc/s (15 m.).

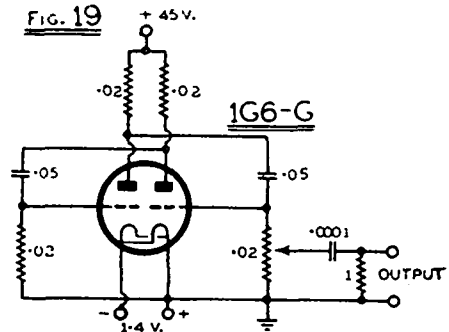

The high-frequency harmonics may be picked up by a normal radio receiver, but are too close to be individually separated, and constitute a continuous signal across the whole of each wave-band. After rectification, the audio-frequency components consist of the fundamental 500 cycle tone together with its audible harmonics.

Fig. 17 show the circuit of a practical multivibrator oscillator using the twin-triode type 6F8-G. Connected as shown, the circuit produces a wave-form similar to that shown in Fig 18. The amplitude of the harmonics steadily decreases with increase of frequency although from an experimental oscillator sufficient output voltage could still be obtained at 12.5 metres to align a sensitive receiver.

The output voltage may be varied by means of the 0.05 megohm potentiometer in the output circuit, but complete attenuation can only be accomplished if the whole assembly is effectively shielded. The same general precautions are necessary as outlined in connection with modulated oscillators.

Total plate current for the two triode sections of the oscillator shown is approximately 15 milliamps.

Fig. 19 shows an alternative design using type 1G6-G operating entirely from dry batteries. The battery drain is very low, being 100 mA. for the filament and approximately 3 mA. for the plate supply.

The output on all bands is less than that given by the A.C. version, but is useful up to approximately 15 Mc/s (20 m.) above which the output falls off rapidly.

Application of Multivibrator.

As will readily be appreciated such an instrument cannot be calibrated in terms of frequency, and consequently cannot be used for aligning I.F. transformers or calibrating dials in terms of frequency. It is, however, extremely useful for aligning the tuned circuits, especially on the short wave bands.

Having once set the oscillator trimmer to a satisfactory position (at the high-frequency end of the band), the output lead of the multivibrator may be connected to, or brought near the aerial terminal of the receiver, and the signal frequency circuits then align for maximum output in the speaker.

The receiver may then be tuned to the low-frequency end of the band, and the padder adjusted for maximum output. It is unnecessary to rock the gang condenser, since with the multivibrator in operation, there is always a signal present, no matter to what frequency the receiver happens to be tuned. After adjusting the padder, the aerial and R.F. trimmers should be re-checked at the high frequency end of the band.

Another important advantage in the use of the multivibrator is that it is possible to check, quickly and easily, each wave-band in a receiver for dead-spots or variations in sensitivity by the simple expedient of listening to the output from the multivibrator, as the receiver is tuned across each band. The output from the multivibrator falls gradually with rising frequency, but does not vary greatly from point to point.

FINIS.

A.O.C.P. CLASS.

The Victorian Division are still conducting classes for those desirous of obtaining their A.O.C.P. in readiness for the time when we get back on the air again. All interested are invited to get into touch with the class manager, Mr. W. F. Sievers, 26 Lesney Street, Richmond. Telephone J 2517.



Indifferent

TONE QUALITY

mars

radio enjoyment

The brilliance and tone fidelity of to-day's radio programmes may be completely marred by worn-out valves.

Studio realism, broadcast by modern stations, can be reproduced in your home only when the valves in your radio function efficiently.

To secure the full pleasure of listening,

Re-valve with



**RADIOTRON
VALVES**

Sealed for your protection

Technical Editor

R. H. Cunningham (VK3ML) and his bride officiate at Wedding Reception.



(Block by courtesy "Argus," Melbourne).

The wedding of Bob Cunningham was celebrated at "Grosvenor," Queen's Road, Melbourne, after a ceremony at The Melbourne Church of England Grammar School Chapel. VK3ML is now serving with the Royal Australian Air Force with the rank of Flight-Lieutenant at R.A.A.F. Headquarters, Melbourne.

His wife is beautiful enough to take Bob's mind off both R.A.A.F. and "Amateur Radio." We wish them all the best for their future happiness, and trust that she will inspire him to greater efforts in the production of technical articles.

ROYAL AUSTRALIAN AIR FORCE

**VACANCIES FOR MEN WITH WIRELESS OR
ELECTRICAL QUALIFICATIONS.**

Apply to your nearest Recruiting Centre for details of enlistment as:—

(1) WIRELESS OPERATORS (For Training)

FOR MEN WITH A SOUND EDUCATION AND WITH OR WITHOUT ABILITY IN MORSE CODE.

(2) AIRCRAFT ELECTRICIANS (For Training)

FOR MEN WITH GARAGE OR OTHER TECHNICAL EXPERIENCE.

INSTRUCTORS WANTED

Applications will be received from men for the following Civilian positions:—

(a) MORSE INSTRUCTORS (Civilian)

FROM EXPERIENCED TELEGRAPHISTS.

(b) RADIO THEORY INSTRUCTORS (Civilian)

FROM MEN WITH A SOUND KNOWLEDGE OF RADIO PRINCIPLES AND WITH EXPERIENCE IN HANDLING TRANSMITTERS.

Full Details may be obtained on application to:—

THE SECRETARY,

Air Board, Victoria Barracks,

Melbourne, S.C.1.

A Review of Radio Receivers

By courtesy Amalgamated Wireless Valve Company Pty. Ltd.

(Continued from December Issue).

(D) POWER OUTPUT STAGE.—

In this stage of a receiver, power output is of much greater importance than high voltage-amplification, so that in the design of power valves the latter is usually sacrificed in order to obtain increased handling capability.

In most radio receivers, the power output stage consists of a single power valve operating under Class A1 conditions. In an ideal Class A1 amplifier, the excursion of grid voltage is never such that the grid becomes positive with respect to the cathode, or more negative than the cut-off bias, while the wave-form of the output voltage is an exact reproduction of that of the input voltage. Moreover, the average D.C. plate current is constant between zero and full power output. In practice, the plate current may vary slightly under normal operating conditions, while some distortion is always present. The latter is, however, inaudible below certain limits.

With a normal triode output valve, the distortion with a resistive load is chiefly second harmonic. It is, therefore, usual to recommend operating conditions which give the maximum power output for 5% second harmonic distortion, since it is usually agreed that this is the smallest percentage which can be detected by ear, although with some types of reproduction very much higher percentages can be tolerated.

If the operating plate voltage and maximum grid voltage are maintained constant to the recommended conditions and the plate load resistance is increased, it will be found that both the power output and the distortion will decrease. The plate efficiency of a triode (i.e., the ratio of optimum audio power output to D.C. power input) is relatively low, being of the order of 20 to 25 per cent.

The plate efficiency of a pentode output valve is usually higher (approximately 30%), and for a similar power output requires less excitation than a comparable triode. For optimum power output, consistent with reasonable distortion, the load resistance is usually adjusted to give zero or a small percentage second harmonic distortion combined with about 7% third harmonic distortion.

The characteristics of a beam tetrode valve, such as type 6L6-G are such that it cannot conveniently be arranged to produce such low values of second harmonic distortion, although the percentage of third harmonic distortion is much lower than with a pentode. Type 6L6-G under typical Class A1 conditions produces approximately 10% second and 25% third harmonic distortion.

It will therefore be obvious from the above, that, even under ideal conditions, a typical pentode or tetrode valve produces at full out-

put much higher distortion than a comparable triode. In addition, it should be remembered that third and higher odd harmonics are much more distressing to the ear than second and higher even harmonics.

Both pentodes and tetrodes are alike in that they are very critical with regard to plate load resistance, and any variation from the specified values is likely to be accompanied by a sharp rise in harmonic distortion. Also, both types are characterized by a high value of plate resistance. Both these factors are very important, as will be seen from the following necessarily brief discussion of the effects on the overall performance of the loudspeaker.

The load impedance, presented by a typical dynamic loudspeaker to the plate circuit of the output valve, is vastly different from the purely resistive load which has been so far assumed. At the bass resonance of the cone, the speaker load behaves as a tuned circuit. Above and below this frequency, the nature of the load is largely reactive, and the impedance may rise to many times its stated value. Without entering into further detail, it can be stated that the effect with a triode valve is not extremely serious. As the value of the load impedance increases with rising frequency, the distortion and power output tend to be reduced, although the voltage developed across the load impedance increases slightly.

The characteristics of a pentode or tetrode, however, are such that an increase with frequency in plate load impedance reduces the power output at the fundamental frequency while the harmonic distortion increases rapidly, accompanied by the generation of high peak voltages in the plate circuit as a result of the higher plate load resistance and the lower damping by the higher valve plate resistance.

The harmonic distortion produced gives to the reproduction an apparent "brilliance," which may at times be very distressing to the ear. In receivers having pentode or tetrode output stages, it is therefore usual to fit some form of "tone control" to restrict the high frequency response. Such a tone control should preferably be connected across the output transformer, where, in addition to achieving the required treble attenuation, it reduces to safe values the peak plate voltages developed.

An important characteristic of a loudspeaker is the resilience of the cone, as a result of which the cone once having received an impulse continues to vibrate for an appreciable period of time when the driving force is removed. This effect is most marked at the "bass resonant frequency." The net result is that transients lose their clarity, and the reproduction of sounds involving them becomes very unnatural.

A triode output valve, having a comparatively low value of plate resistance, tends to damp this free oscillation of the speaker cone much more effectively than a pentode or tetrode, which have much higher plate resistances.

Comparatively recent investigation has shown that it is possible, by employing the principle of negative feedback, to obtain from a pentode output valve, performance comparable to that of a triode both with regard to low harmonic distortion and speaker damping, while retaining at the same time the high plate efficiency which is characteristic of such valves. Space will not permit further discussion of this very important subject, and for further information it is suggested that the reader refer to the numerous articles which have appeared in *Radiotronics* and elsewhere.

Putting The Vacuum Tube Voltmeter into Service

In all equipment associated with or including vacuum tubes of any kind whatsoever, resonant and other types of high impedance circuits are always found. Such circuits must be used in order to obtain sufficient amplification from the tubes, which are in themselves high resistance devices. The impedance for instance of an r.f. circuit such as is used in the first and second stage of a receiver may be as high as 2 or 3 megohms when tuned to resonance with an incoming signal.

To make any measurements of potential across such a circuit it is obvious that a meter having a resistance as high as 3 or 4 megohms would be required as a lower meter resistance placed across a circuit might change the potential conditions as much as 50%. About the only connection that can be made across a circuit of this type without upsetting the circuit potentials would be that of another vacuum tube, the connection being made across the grid and cathode of said tube.

A properly designed vacuum tube voltmeter will enable the serviceman to take direct measurements on gain per stage on receivers to check the operation of the oscillator tube in superheterodyne models and to locate trouble in automatic volume control circuits. For uses such as these the instrument will be found practically indispensable as readings on such circuits cannot be obtained without equipment of this type.

The vacuum tube voltmeter is, as the name implies, nothing more than a vacuum tube connected through a meter in its plate circuit to a suitable power supply. The grid and cathode of the tube are connected across the circuit to be measured, the potential across said circuit causing a change in grid voltage on the tube and thus, a resultant change in plate current is indicated on the instrument. As the impedance from grid to cathode of the tube is practically infinite, no load whatsoever is placed on the circuit and under normal conditions

the potential will not be altered in any way.

As the vacuum tube is also a rectifier, potentials of any frequency placed across the grid and cathode of the vacuum tube voltmeter will result in a direct current deflection on the instrument in the plate circuit. For this reason the vacuum tube voltmeter can be used for measuring audio as well as radio frequency potentials provided the circuit is worked out correctly to cover this broad range of frequency.

Because any given vacuum tube is considerably limited as to the range of potentials, which may be applied to its grid circuit the overall direct range of a vacuum tube voltmeter is restricted as compared to a standard a.c. or d.c. voltmeter as such. Further, the scale of a vacuum tube voltmeter is not uniform throughout its entire operating range. These two reasons make it essential that the vacuum tube voltmeter selected by the serviceman have a number of ranges so that accurate readings may be made over the entire range of the device.

A satisfactory vacuum tube voltmeter for modern servicing should read as low as .5 volt and as high as 15 volts in order that measurements may be made of gain per stage and overall gain in an amplifier (or higher using multipliers).

Because of the characteristics of the vacuum tube and of the vacuum tube voltmeter circuit, it is necessary to have several arcs on the scale of the indicating instrument because the several ranges will not track accurately on a common arc.

Since the vacuum tube voltmeter requires an appreciable amount of power to drive it and since it is rarely used by the serviceman in the field, most satisfactory equipment will be that which is operated from the lighting circuit provided that the design of the equipment is such as to eliminate the effect of line voltage fluctuations.

(To be continued).

Federal and Victorian QSL Bureau

R. E. Jones, VK3RJ, Federal QSL Manager.

Writing from Mozambique, CR7BC, Manuel Pereira da Silva, Caixa Postal, 812, Lourenco Marques, requests me to endeavour to extract a card from the following VK stations to whom CR7BC has already sent his card:—VK2VN, JX, ADV, HV, JU, VK3LP, VK4SD, VK6NL, 6MU. What about it fellows?

Another good one for the stamp collectors. CE3BF, Roberto Wood, Box 366, Santiago, Chile, is a rabid collector, wanting to exchange.

All licences of French amateurs and those in the French Colonies have been suspended for the duration, likewise those in British possessions, while in Great Britain, licenses have been cancelled. Additional countries off the air are Latvia, Sweden, Esthonia, Italy, U.S.S.R., Germany, Jugoslavia, Cuba, Netherlands East Indies and the Belgian Congo.

Lists of cards on hand at the Bureau will not be published until licenses are restored and things get under way again. The last list was published in the January issue of "Amateur Radio."

An interesting visitor to Melbourne during January was Jim Hillhouse, VK4ZO, of Collinsville, Queensland. Jim looked in fine fettle, and enjoyed the splendid weather which this State turned on in his honor.

Philatelic hams desiring an exchange contact in U.S.A., should contact W2GW, Walt Bostwick, 1334 Putnam Ave, Plainfield, N.J., U.S.A.

On the unimpeachable authority of Snow Campbell, VK3MR, we learn that the marriage of Buck Bachelor, VK7JB, with Joy Crowder, VK7YL, took place during January. Snow hoped to be an interested spectator of the event.

Overseas ham publications are feeling the strain of finding items of interest while their subscribers are temporarily closed down. Most of the journals have shrunk to a shadow of their original size, one exception being "R.C.A.," the official journal of the Argentine Radio Club, whose November issue was one of 100 pages, especially enlarged to celebrate the anniversary of the foundation of the club.

CONTEST NOTES.

R. E. Jones, VK3RJ, Federal Contest Manager.

VK-ZL 80 METRE PHONE CONTEST.

Comment by NZART, Contest Manager.

From the list of scores (published in "Amateur Radio," January, 1940) it will be seen that the awards go to VK2NY and VK2AJK, while the N.Z. award will go to ZL2GX. As no entries were received from N.Z. in the Limited Section, it naturally follows that no N.Z. award can be made in this section. The general average of neatness in the preparation of logs was very good, two logs in particular standing out in this respect, these being those of VK2OE and VK2HZ. It is a pity all competitors did not read as far as Rule 14, which stated that all entries in the transmitting section were to state whether for the "Limited" or "Unlimited" section. Compliance with this rule would have saved much trouble in sorting out the entries. More entries could have been received, especially from those stations whose calls appear frequently in the logs of competitors. It is evident that several stations participated, but neglected to submit logs. The performance of the winner of the unlimited section was almost rivalled by the runner up, only 10 points behind. Another ZL contact would have reversed the positions.

28-56 MC Notes

Another month has passed, and believe me, these notes are becoming increasingly difficult to write since information has dropped to zero level these last couple of issues. Perhaps some of the fellows have gathered sufficient sixpences from the Xmas puddings to start the new receiver; if so, I would be pleased if they could post along the dope, or perhaps they haven't got over that extra helping—anyway, here's hoping. Ten metres has been very dead this last week and only shows life during the early mornings and until 9 a.m. Of the few stations, apart from the usual W's showing up at present, the following give some variety: J3FX, KA1LZ, KA1AP, KA1ER, XU8AM, best around noon, HC1JB qso'd by many K6's. W9YHQ is a portable operating near Honolulu and has fair signals. The majority of K6's come through as usual; evidently that distance seems to be the limit for best signals. 112 mc has been keeping the lads' interest at the last couple of KP meetings and I have been getting ideas for antenna systems which we may yet be able to put into practice. Unfortunately, living in the city, we can't try out some of those nice big Rhombics or Vee beams that take the eye, such as are described in some of the Yankee mags; still, if we get on 112 mc. it will be a different story. Just think of it, 8 ft. 6 in. is a full wave on $2\frac{1}{2}$ metres. The following figures will show what would be possible. The Vee beam has a different angle between the two wires at the feeder end depending on the number of waves in each leg, and 110 degrees is the angle for one wave on each leg, 70 degrees for 2 waves, 60 degrees for 3 waves, 52 degrees for 4 waves, 45 degrees for 5 waves, and when you remember that a five wave on each leg Vee beam is just about 40 feet long over all, it shows what can be done. Tuned feeders are probably the easiest to match with such an antenna. The Rhombic or diamond even takes our thoughts.

Remembering that 8 ft. 6 in. is a full wave, a rotary diamond with a full wave on each leg is even possible. The following figures for the angle at the feeder and terminated ends are, 120 degrees for a 1 wave on each leg size, 80 degrees for 2 waves, 66 degrees for 3 waves, 56 degrees for 4 waves, and 50 degrees for 5 waves on each leg. The last named is only 46 ft. 6 in. on each leg, which makes the antenna app. 78 ft. long by 36 ft. wide. The terminating resistor is usually near the value of the surge impedance of the feeder line and must be used if best results are to be obtained. When the three element beams are considered, the small size is obvious and a real signal squirter is possible. In the States they are finding that 112 mc. will do practically all that 56 mc. will do, and a record has just been put up for a long distance contact by W9WYX and W9VTK. After several local contacts of 20 miles or so, a contact of 105 miles was obtained, using $\frac{1}{2}$ wave doublets fed by lamp flex, but the results indicated a more satisfactory contact with better antennae; consequently 3 element beams were made to be followed by a trip with the portable gear; W9WYX, at Genoa, from a 60 feet look-out tower, and W9VTK, at Mount Evans (14,460 ft. high). The first call gave results and an r3 sig was brought up to r9 with a few adjustments, giving a perfect 2 hour contact, over an air line distance better than 120 miles. W9WYX used a rig having 6L6 co, 807, 809 and HK24PP final, all powered from a gas driven generator installed in a Chev. truck. W9VTK used a 42 co. 6V6g, 807 combination a Vibrapack power. Results like this certainly make 112 mc. attractive.

(We are still trying and still hoping that we will be able to try out these new frequencies at an early date.—Editor.)

Divisional Notes

IMPORTANT.

To ensure insertion all copy must be in the hands of the Editor not later than the 18th of the month preceeding publication.

N.S.W. DIVISION NOTES.

At the December General Meeting, which was held a week earlier than usual, because of the nearness of Xmas, we had two visitors of note. They were Laurie Williams, VK9WL, and Bruce Chapman, VR4BA.

During the general business part of the meeting the Secretary announced that owing to ill-health, one of our Vice-Presidents, Mr. F. Carruthers, had been forced to resign from the Council. Fred's friends the whole State over will be sorry to learn that Fred has suffered a nervous breakdown, and will not be able to take an active part in the affairs of the Institute for a long time to come. In addition, Fred has been advised by his medical adviser that he should give up all his interests elsewhere, too. A motion was moved by Mr. M. Meyers that a letter be sent to Mr. Carruthers expressing the regret of all members present at hearing of his breakdown. Mr. Meyers said that losing Mr. Carruthers would be a great loss to the Institute, because he had worked with Fred on the Council himself, and knew just what a tower of strength he was and how hard he worked for the Institute.

Mr. Ross Trehearne spoke on the activities of American Amateur Stations on the U.H.F.'s, and mentioned some of the new technique which was finding favour amongst the experimenters over in the States, and how they were paying a great deal of attention to the tank tuning condenser. Mr. Trehearne stressed the fact that it was very necessary for the boys out here to keep up with modern trends, and that he intended to point out any outstanding developments that may take place in the future, and where to find the articles on them.

An interesting talk on Ham Radio in New Guinea, and some facts about the country itself, was given by Laurie Williams. Laurie had some photographs which proved very interesting, especially the one which showed a boat almost covered with pumice powder in the Rabaul Harbour.

Laurie spoke about receiving conditions, and mentioned the fact that communication on any of the bands higher than 40 mx. was quite impossible, and even 40 mx. itself was no good sometimes. He also spoke of the great distances between stations, and how they used to hold meetings of the New Guinea Amateur Radio League via 40 mx. on a common frequency. The New Guinea Amateur Radio League is a body affiliated with the W.I.A., and has over twenty members scattered all over New Guinea and Papua. Mr. Williams is its president.

Then Bruce Chapman told us about Ham Radio in the Solomon Islands. Bruce spoke of the trouble that one went to to get on the air with any power at all, and how he and VR4AD, his nearest Ham neighbour, fared in the VK-ZL Dx Test of 1938. It is worthwhile noting that Bruce won the Junior Section of the 1938 VK-ZL Dx Test with a power input of only 12 watts to the last stage. Bruce had the highest score for any station outside New Zealand and Australia.

An interesting discussion took place afterwards on the differences in climates, conditions and cordials (?) in New Guinea and the Solomon Islands and Sydney. We learnt, amongst other things from Laurie, that the people up in Salamaua won't drink any liquor of Sydney origin, and that the only good beer comes from VIM. (We are given to understand that all beer is good.—Ed.)

Mr. Meyers conveyed to those present the season's greetings from all the boys at Richmond. He told us that there are about 40 Hams up there now. Reciprocal greetings were given to Mr. Meyers to be passed on to all the boys at Richmond. Morry says we won't recognise 2HZ when we see him again.

By the way, Snow, if you happen to read my notes, Morry thinks it is about time you cut out all those despairing remarks you keep passing about him and the job of traffic manager. You should talk, you old buzzard.

A new member, Mr. G. Cottel, was present at the meeting.

However, if you want to see some real good gear when you come to Sydney, call in and see the wonderful range of accessories that Mr. Long, of United Radio Distributors, has brought back with him from the States. Those "Sky Riders" will make you impatient to have a go at handling them on the air, and that recording outfit is a real snifter. All the best till next time. —73 Jack.

WAVERLEY CLUB NOTES.

I think it was Bobby Burns who wrote about "seeing ourselves as others see us." When Jack Howes brought a portable recording unit to the club several weeks ago, the members had an opportunity to hear themselves as others hear them. The result was astounding. All members were agreed on the fact that they were unable to recognise their own voices, although they could recognise those of others. Several items were executed (murdered) by the Club "quartet," and on the whole a most enjoyable evening resulted.

Jack Howes once more entertained the members when he brought along his projector to the Club. Several fine films, supplied by the Shell Oil Company, provided an excellent night's entertainment.

Half yearly election of officers took place on December 12. Leo Walters remains President, Jack Howes will continue as a very able secretary, and Eric Johnson fills the position of treasurer, a position which

FOR...

RECEIVER EFFICIENCY—

**FIT EDDYSTONE MICRODENSERS
AND ENSURE SATISFACTION**

- 1. Brass construction throughout with DL-9 high frequency insulation.
- 2. Both stator and rotor sections soldered to ensure low series resistance.
- 3. Every vane and whole condenser lacquered to prevent oxidation and consequent H. F. losses.
- 4. Will not change capacity constants due to oxidation after years of use, or change in efficiency.
- 5. Long spindle bearing, absolutely noiseless on highest frequencies.
- 6. No losses of any sort are measurable when a microdenser is put in circuit with the most efficient coil procurable.

No. 1094—3-18 M.MFD. Price, 6/9

No. 1130—4.5-100 M.MFD. Price, 8/-

IT PAYS TO BUY THE BEST.

No. 1129—4-40 M.MFD. Price, 7/-

No. 1131—5-160 M.MFD. Price, 12/9

YOUR DEALER CAN SUPPLY.

BRISBANE: Chandlers Pty. Ltd.
MELBOURNE: P. & L. Wireless Pty. Ltd.
ADELAIDE: Gerard & Goodman Ltd.

SYDNEY: United Radio Distributors Pty. Ltd.
PERTH: Carlyle & Company.
HOBART and LAUNCESTON: W. & G. Genders
Pty. Ltd.

EDDYSTONE

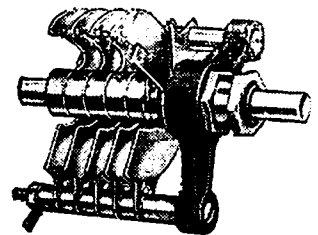

Famous Microdensers

experience has shown him to be capable of filling very efficiently.

I will now conclude, hoping to see some new faces in the New Year, at the Club-rooms, "Almont," 13 Macpherson Street, Waverley.

VIC. DIV. COUNTRY NOTES.

By 3YW.

I note in January "A.R." the fact that country hams had been naughty and not sent in any scandal, and worse and worse, 3BM either must have joined the army; been too busy getting the crop in; or just plain forget the mag. this month, anyhow.

Since arriving in Stawell, I find I'm the town's only ham. What a pleasure the B.C.L.'s have missed! However, there is another laddie who rejoices under the name of Waite, who only has code to click on, and he will be A.O.P.C. and all ready to clutter up the B.C. programmes when our aged fingers start pounding the brass again. As for myself, I am busy planning a new RX, a double det. super plus noise silencer in the I.F. stages, so it will keep me out of mischief for many moons to come, then perhaps we might look at the possibilities of loop aerials, which I think the newer hams would find surprising. I remember building one for a FD and getting W's very nicely on the old "det. and audio," so with a super they should be very fb at present. I do most of my listening on the 36 metre ship band and thereabouts, and one night on that band will show you that hams are not the only ones who call by the hour.

3XB, of beam aerial and battery fame, located at Rupanyup, is also building a new rx, a super this time. I tried to plant the seeds of discontent 12 months ago, but no, he still stuck to the old T.R.F. (an fb one at that), but the bug must have bit anyway. Ivor is putting things together and soon will have an fb battery rx. That might sound funny, but XB is about five miles from the nearest power point, so batteries are necessary. Anyway, he does not have to worry about line noises, hi.

NORTHERN ZONE NOTES.

By VK3BM.

Letters have been received from 3ZK, 3YW, 3MR, 3IR, and Chas. Stanford, 3NN's second Op., for which many thanks.

3ZK reports that he and 3EC are having CW practice together, and if the war lasts long enough, will qualify at 16 per! Jim is complimentary about improving "Amateur Radio," and is eager to try 5 Mx., if the ban is lifted.

3EC is building a yacht and fitting his truck in readiness for holiday trip gold digging at Mt. Tarrangower.

3YW has moved to Stawell, A.C. laid on and no T.X. to pump it into, is experimenting with double IF and noise silencing in the Super.

3OR has had a fortnight's leave to attend affairs at home, but is now back at Signals Office. Other hams there are 3OW, 3HG, 3KR, 3YM, 3JM, 3BG, 3VQ, 3KJ, 5FL, and several others whose calls I can not remember.

3TL has just received an FB variable freq. Bliley rock from U.S.A. Treb. is an officer of considerable experience and has again offered his services.

3JG has designed and is building a super Moth class yacht to be sailed on Lake Boga. The designing is nearly as difficult as that of a good Ham super het.

3QZ has also joined the Lake Boga Yacht Club.

Chas. Stanford, well-known over 3NN's mike, has enlisted in the Signals. He had just graduated from a radio college course, and has landed an FB job with the Military on radio maintenance. His brother, Alex., is also there.

3MR has sat for his 1st class ticket. Rumor has it that the 12 w.p.m. stumped him.

Letter received from 3CE. Roy has completed a nice harvest. He had an FB 100 foot lattice mast ready to erect in September. It is still on the ground. Has built the popular 3 tube super with FB results. He was called up by the R.A.A.F. W.R., but obtained leave to take off his harvest; is now awaiting further developments.

Verne Berrett, often heard from 3ZK, has recently been making his reputation as a swimmer.

3QZ and 3BM have done quite a bit of successful public address, using 3BM's former 80 watt modulator and a swag of high fidelity speakers.

3KR was recently home on leave. He likes his job at the Sigs. office. Rumor has reached here that 3OR's fist, always good, has become the pride of that same office!

NOTES.

By VK3MR.

This enforced inactivity is leaving a trail of rack and panel (sorry, ruin) behind it, the latest victim being 3RJ, our QSL manager, who finds time hanging heavily on his hands, so that even increased work in the garden can not fill that empty space. Similar tales are reaching us every day. 3XB, of QRP fame, is feeling the strain also, as he idly gazes at his Vee beams and sighs heavily. Ivan has worked PK6XX and YS2LR on 7 mc., which is rather unusual. How they hear these stations on 40 mx, beats me! 3QB, who has never worked on 20 mx, has worked 50 countries on 7 mc.; on low power, too. Good work, Jack. These notes are being written in VK7, where a deep silence has fallen. It is my pleasure to mention that two of the most active stations in Tasmania have commenced a life QSO. Bill Bachelor and Joy Crowder were married on Monday, 15th January. This was a real radio romance, which has ended so happily. The wedding breakfast was conducted with a definite radio flavour and many and

varied were the CQS and uncomplimentary remarks passed by the hams present, via knives and forks balanced on china and used as keys! We trust that there QSO will be R9 and no QRM. While wearily wandering around Hobart, I came across Jim Anderson, who had his call 3LM issued to him just before the close down—What a blow.

Those looking for some reliable frequency checks are advised to listen for W.W.V. running 20 k.w. on Tuesday, Wednesday and Friday on the following times and frequencies: Noon to 1.30 p.m. on 10,000 k.c.; 20,000 k.c. at 2 p.m. to 3.30 p.m. E.S.T. American time. 1000 cycle modulation is used and the accuracy is better than 1 part in 5,000,000.

KEY SECTION NOTES.

By VK3CX.

The January K.P.S. meeting was held on the 16th, being this late due to the holiday season. The attendance was not as large as was expected, but with R.J. in the chair, the meeting got under way after all the lads had to climb up six flights of stairs due to the lift refusing to

PHONE B 4148



COMMERCIAL AND
ART PRINTERS

98-100 HARRINGTON STREET, SYDNEY



Specialise in the Printing of . . .

QSL CARDS

which are Distinctive and Attractive

work. If this goes on much longer, I'm in favor of shifting the Club-rooms to some ground-floor joint.

The Minister of Propagation — sorry — Propaganda, has announced the engagement of R.X. at last. Cedric is definitely off the air now, boys, but we all join in wishing the happy couple all the best.

CX and OM went swimming recently and ran into JB who was similarly engaged. RN spent his Xmas touring, going through Ballarat and Ararat, where he called on SE and GN. He reports a good trip, but UM is still gradually recovering from his Christmas Carols, namely War, Wine and Women. We haven't seen much of this war stuff, but we know plenty about the other two.

XJ is an ardent listener on the S.W.—B.C. bands, and in between gets rid of the weeds in his garden. He says that he now has the best garden in the district — thanks to Adolf!

WU says that unlike XJ his garden is the worst in the district as he is run off his legs servicing BC sets, and in the spare moments he doesn't get he reads Radio and looks forlornly at the remains of his rig.

TE is now interested in portable receivers, but still finds time to listen on ham bands, and UR listens to overseas BC stuff with some code practice to keep his hand in, while CO has given up ham radio and is busy increasing his speed in the R.A.A.F.

SG is interested in the alleged "discovery" of Cathode Modulation in U.S.A.—he says "evidently Australia doesn't count."

QV still talks about erecting 10 element rotary beams, and JO reports that the magazine is still being posted (we thought that it was being delivered personally), and that the gear has gathered much dust. CP has been testing "Unity—no that's not a girl—Coupling" between RF and 1st det. and sez it's the goods. HK is still busy on his receiver, and is using an oscilloscope with freq. modulated oscillator for lining up the I.F. stages and getting selectivity response curve on the screen.

UE has just returned from a four weeks' vacation in Sydney—has pulled down his antenna and erected a b.c. antenna for reception of war news.

The next K.P.S. meeting will be held on February 6th, so if you get

the magazine before that date, don't forget to turn up, as a most enjoyable evening is assured.

VK4 NOTES.

By VK4ZU.

Well, the poor attendance at the last General Meeting doesn't give a chap much incentive to write these notes, but we must keep the old flag flying. In case some of you are still unaware of the change of rooms, I will repeat 4AW's remarks of last month. The meetings will in future be held in the rooms of the Diggers' Association, Essex House, Adelaide St., opposite Anzac Square, Brisbane. The meetings are held on the last Thursday in each month.

We had the pleasure of hearing a very fb lecture by 4HR entitled "Studio Control Technique." Tibby pointed out a host of features employed in B.C. stations design, features well applicable to Ham Radio. (What about this article for "A.R.," Ed. Have it put into print. We need it and how).

However, it's not very encouraging giving lectures to a mere handful of enthusiasts, so don't forget to roll along to the meetings, chaps. If it would help at all, I would like to point out that there are about a dozen rather luxurious arm chairs for our exclusive use, but it's a case of first come first served, so it's up to you, Hi.

WHO'S WHO.

4RT—John very busy these days. The faster the grass grows the more he likes it. I don't know, some people do have queer ideas. As far as I am concerned, it needn't grow at all.

4HU Just made one of his periodical flying visits to Brisbane. No, George doesn't use an aeroplane, it's done in a Vauxhall.

4LT—Still in camp. Had this scribe for a cobber until recently, but is now Ham Radio's sole representative in the camp in question. Albert is Brass Pounding.

4JP—George been taking photographs of some local shacks.

4ES—Now I would say that Herb. has used his head. He goes and gets married, so that by the time we get back to CQ, 73, etc., he will be nicely settled down. Good work, OM, and congrats.

4RY—Bills the man who sees that you receive your copy of the Mag.

Don't let the old and ancient game get you down, Bill. Anyway, I bet you can lick 4AW any time.

4SN—Well, it's a pity all you country chaps don't drop us a line as often as Frank does. How does the new 8JK pan out for reception, OM?

4KS—Keith, as mentioned recently, is a member of R.A.A.F. Reserve. Saw you at Kelvin Grove Signal Drill Hall some time ago, but just couldn't just catch your eye.

4KF—Suppose you are having a spell from work for a time, Keith. I take it that your pupils have a long Xmas vacation.

4OK—Finished that new shack yet, Jack? One of our local Hams, 4FL I think it was, had plans well under way for a really classy model, complete with air conditioning, lounge chairs, etc., but I never heard whether it was completed. Wat say, Frank?

4RC—Bob has taken up Table Tennis, so I hear. How about all you fellows letting us know what you do with yourselves these days. Have fallen rather deeply into the clutches of Photography myself.

4KH was staggered the other day

to hear that Bill has another super. on the way. How about an article for "A.R." Bill? You could title it "The First Twenty Supers. are the Worst." HI.

Well, I would like to devote a bit of space to our Country Members now, but it's very hard to compile notes from nothing. Was Mark 4XO the only one who could write notes for the Bundaberg Zone? Also, how about some dope from the Rockhampton Radio Experimenters' Association. Phew! What a mouthful! Cheerio till next month.

S.A. DIVISION NOTES.

By VK5RN.

December and January have been fairly uneventful months, as no meetings were held over the Xmas and the New Year holidays. Code practice classes have been resumed, however, and these take place every Wednesday, and not twice weekly as was previously the case.

Our President, VK5JT, has been very busy moving from his old Q.R.A., as he has taken over the Coronation Hotel, where he has al-



The Power Equipment with a Powerful Reputation . . .

THE Organisation responsible for the production of . . .

HILCO TRANSFORMERS CHOKES, etc.

has proved its high standards for an article of extreme merit as accepted by the largest consumers in Australia.

ALL PRODUCTS GUARANTEED FOR
TWELVE MONTHS.

HILCO TRANSFORMERS PROPRIETARY LIMITED

97-111 BERKLEY ST., CARLTON, N.3., Vic. 'Phones; F1661-2
CABLES & TELEGRAMS: "HILCOY," MELBOURNE.

ready decided to hold a special meeting when the ban is lifted. We wish Joe the best of luck with his new enterprise.

Our Xmas meeting consisted largely of a Post Mortem on the second class commercial exam., which several of our members took early in December. The results are not yet out, but they are just about due now, and it shouldn't be long before they are known.

We have heard nothing from the country gang since the war started, except that Frank (5BF) is contemplating building a new receiver after the style of the H.Q. 120X, having sold his old set—so what about a note from some of you, to let us know what's happening out in the "wide open spaces."

ROUND TASMANIAN RADIO SHACKS.

It was intended to write this whilst in Melbourne at Easter and forward it to the Editor of "A.R." then, but as a Y.L. upset the schemes and the writer was not then a W.I.A. member, it just did not happen.

Since we were to spend almost a month in Hobart, and as neither my pal (Fred) or I had any connections there, we decided, knowing we would have much spare time, to call on the Tasmanian Secretary and see what could be done about visiting some interesting shacks.

After our arrival on the 17th February, we finally found "Chum" Moorhouse, and told him of our objects. He agreed to co-operate, and introduced us to a couple of the boys there and then. They just happened to be in the shop at the time. A tour of the stations was arranged for Saturday the 25th, and after a short ferry trip, we arrived at Bellerive. A short walk and we were on VK 7KV's doorstep. Unfortunately our visit clashed with the Bellerive Regatta, and so Keith could not show us around himself. Keith's rig was explained by "Chum," who knew it fairly well. He had tons of room for antennae, and had erected doublets for 7 mc., 14 mc., and a vertical doublet for 56 mc., work. His transmitter consisted of a large box in which all tuning gear was located. Tubes, etc., were on top. An 800 was used in the final with an 809 immediately preceding it, quite a family of 46's were used as oscillators and doublets. We were told by "Chum" that

KV could change from 7 to 56 mc. by altering the final coil and throwing a few D.P.D.T. switches. Also present in KV's shack was one of those "Jones" stabilised oscillators for use on 56 mc. Very little was actually being done on this band, despite the gear in evidence. His receiver was a five tube superhet. of conventional design.

Next visited was 7CM, who lived about a quarter of a mile away. His transmitter was a rack mounted job capable of operation on either 7 or 14 mcs., 'phone or CW'. He used an E.C.O. quite a bit and didn't always hit the band! (I heard him around 6.7 mcs. one night). Still, I suppose this has been cleared up by now. Going into C.M.'s shack one was likely to get caught in the maze of wires present—sort of "Come into my parlour," said the spider to the fly. Despite the haywire appearance, this ham worked some fine DX. Keying was done by a bug made from scraps of brass and aluminium.

The next on our programme was 7KQ, chief engineer of broadcasting station 7HT. He only uses a low power rig on 7 mcs., and his main interest then was rag-chewing with fellow-broadcast engineers in Melbourne. The final was a 6L6G grid modulated for 'phone by a small "P"-based Phillips pentode driven from a condenser mike and pre-amplifier. The condenser mike used was fitted into the front of the pre-amplifier, and was a particularly good job constructed by the owner. Antennae used were Zepp fed doublet on 7 mc, and Jones' "all band" for reception. On 56 mcs., a vertical doublet indoors and a half wave with quarter wave matching stub, and twisted feeder approximately 100 ft. long outdoors. Some portable equipment had been constructed for a 56 mc. DX test from the "Pinnacle" of Mount Wellington to Victoria on Sunday, Feb. 26. The gear was capable of either 'phone or I.C.W. transmission. Receiver was a very small four valve R.C. superhet. A M.O.P.A. transmitter for 56 mcs. then under construction and was to be used in conjunction with a Reinartz rotary beam at a later date.

7KQ had no room in his car for two passengers or we should have gone along with him to witness the tests. Undaunted, however, we set out on foot to see something of the country and the experiments, too.

We arrived at the Pinnacle at about 3 p.m., and wandered around in the bitter cold, it was a very dull misty day, and even rained a bit, looking for their site. This we failed to find and so we returned to Hobart. Later we heard the experiments had been unsuccessful.

The following Monday evening, March 6th, we visited Australia's first "ham," Mr. Fred Medhurst, VK7AH, ex-Post Office Engineer, and retired Captain of Signals. He told us about his first QSO with H.M.S. St. George from his station XFM, in 1901, on the occasion of the visit of the then Duke and Duchess of York. He also showed us much

of the old gear used. His home "Cranleigh" is like a radio museum, and he enjoyed showing us his treasures as much as we enjoyed listening to his tales and looking at his relics. The evening was topped off by a delicious supper served by the "Cranleigh" ladies.

Although Mr. Medhurst is not active nowadays, it is interesting to note that he was W.A.C. on 'phone, using a 201A modulated by another 201A and with about three watts input. The following Wednesday we visited him at his office in Hobart, and he showed us photos of the first "Blinking Billy" station. He gave us QSL cards as souvenirs.

On the 12th March, we visited 7YL as had been arranged and enjoyed an evening with her. She is a school-teacher at Sandy Bay and, at the time of our visit, had most of 7JB's gear and was operating on 200 metres on Sunday afternoons in lieu of him. Her transmitter consisted of 53 oscillator 46 dbler, 210 buffer and a 800 final with 40 watts input modulated by a pair of 50's operating class "A". A D2 mike was used and receiver a seven tube superhet. The antennae was a 132 ft. Zepp. fed job.

Another ham whose shack we saw was "Chum" Moorhouse, Sec. of W.I.A. in Tas. He had recently moved and rebuilding was in progress. Transmitter then ready for the air consisted of 47 osc., 46 buffer doubler, and an E406 final. The receiver then under construction was an A.W.A. "All World Eight." A long stick was also being prepared for erection. Had there been no "WAR" he would be making quite a hole in the air by now. No news of his station has, to my knowledge, appeared in "A.R.," but I noticed the W.I.A. exhibit at Launceston consisted largely of his gear.

—Sydney T. Clark.

H A M S !

**DO YOU WANT TO BE
BACK ON THE AIR ?**



The Wireless Institute of Australia

is the recognised spokesman of the
AUSTRALIAN AMATEUR.

If you are not a member—

Join Now !

When the time comes that we can
reasonably expect to go back on the
air, we want to say that we represent—

EVERY ACTIVE HAM

in the Commonwealth.

Strengthen our hand by writing to The
Secretary of the Institute in your State
to-day.

All addresses are on the title page.

Correspondence Section

Iron Knob,
South Australia.

The Editor, "Amateur Radio,"

Sir,—Having lots and lots of spare time now, and being too lazy to swat my study courses, I have been admiring the collection of QSL cards on my walls, and instead of being like the ancient, who moaned past glories, I have been saying what a smart guy I am to have worked all those people.

Why should we grizzle 'cause we are temporarily squashed? I may have a different mentality to others, but I get a certain amount of satisfaction from the fact that my rig is almost intact, and barring the essentials that our P.M.G. demanded out our racks and panels, breadboards, etc., are as of old, insofar that if the call came, I'll bet 90 per cent. of Aussie's hams could be on the air within a short time. We are experimenters, and as experimenters we should know blindfolded where this and that should go, and what wire to connect, so here is one ham at least, who gets not that sinking feeling at entering the holy of holies. Anyhow look at the practice we are now able to get copying that com.

Also, Mr. Editor, what wonderful qsl's we should be able to design now we have leisure to study our wall ornaments. Look anywhere and it is "To Radio.....ur.....RST.....
Trans..... watts rxpse
qsl 73s etc." They say great minds think alike, well, hams the world over must be great minds. Out of 100 cards (my shack wall is panelled so that 100 cards fit a panel) 93 said "To Radio," the others varied slight-

ly. We all are aware that our cards are to disseminate salient facts regarding what the other chap's signal sounded like to us, and also a reminder of our gear, etc., but could we not try for a little originality in our cards; then, why, oh, why 73s. Do ye young in heart never learn, dear children, it is 73, 73! 73 is an ancient line abbreviation of "best wishes," and not best wisheses as your extra "s" conveys. I'll forgive "Vy 73" as conveying extra enthusiasm on the other chap's part, hi. I had one chap stutter out on his key my very best 73 ss! and so I sent back, after trying to explain just 73, and lo and behold, he came back with mny 73ss.

Oh, I nearly forgot, please tell them that "es" is thought NEVER written 73.

LEITH COTTON,
Still VK5LG, M.W.I.A.

AMATEUR RADIO REGISTER.

In this issue, we again enclose a register form, and we suggest that, if you do not use this yourself, you pass it on to the chap around the corner. Whether you are serving at present or not, you are requested to fill in the form and post it as directed. This is not intended to be a register of those who are serving with the various services only, but a register of all VK hams, and it is essential that everyone supply us with the information required, as it is intended to use this for further negotiations for restitution of our licenses.

TRANSFORMERS . . .

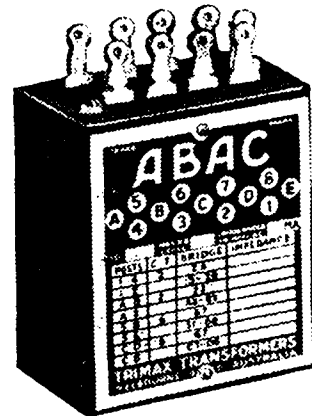
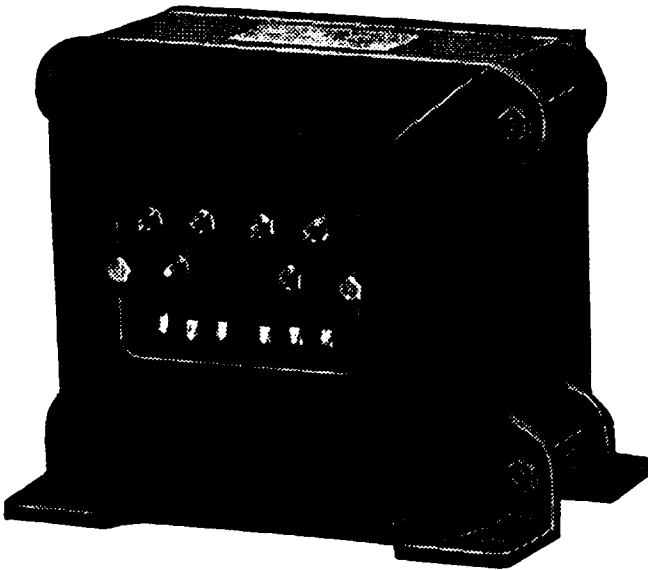
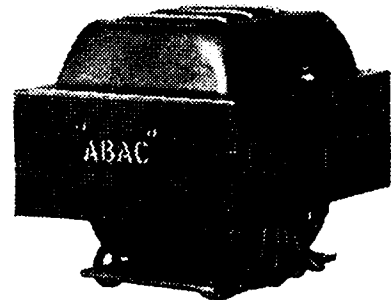
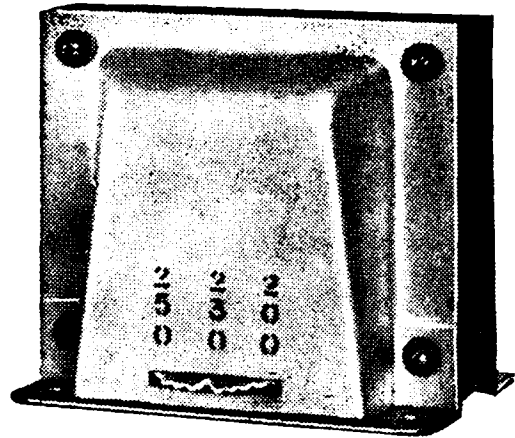
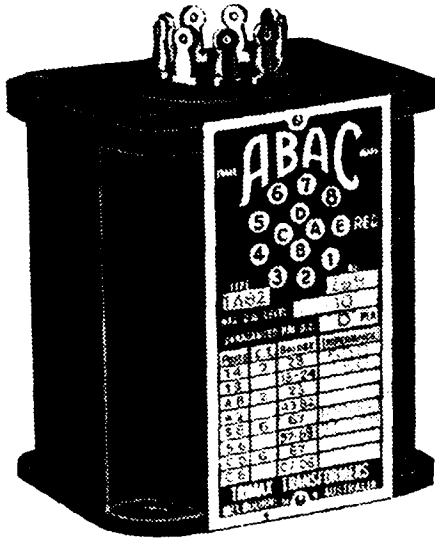

MANUFACTURED BY

TRIMAX TRANSFORMERS

(A DIVISION OF CLIFF & BUNTING PTY. LTD.)

Registered Office:

29-35 FLEMINGTON RD., NORTH MELBOURNE.

PHONE: F 9127 (2 lines)

HAMS

WHEN REBUILDING YOUR RECEIVER
REPLACE YOUR OLD SPEAKER WITH

AMPLION

THE NEW 12in. ELECTRICALLY WELDED
SPEAKERS

MODEL	Air Gap Flux	Weight of Magnet	POWER OUTPUT. Undistorted—Max		Diameter	PRICE
V	8,300	12 ozs.	10 watts	15 watts	12 $\frac{3}{16}$ "	£2 3 0
VL	9,000	22 ..	13 ..	20 ..	12 $\frac{3}{16}$ "	£2 16 0
VP3	12,000	64 ..	20 ..	30 ..	12 $\frac{3}{16}$ "	£5 10 0
VP2	9,000	20 ..	12 ..	18 ..	12 $\frac{3}{16}$ "	£3 6 6
VPI	7,500	14 ..	8 ..	12 ..	12 $\frac{3}{16}$ "	£2 10 0

Types V and VL are Field Type Speakers.
Types VPI, 2, 3 are Per-Magnetic Speakers.

**SILVERED
MICA**

T. C. C.

**CERAMIC
CONDENSERS**

T.C.C. Silvered Mica Condensers are guaranteed to maintain their capacity under all temperatures, thus insuring no frequency drift in Supers. The foil is actually plated on the mica.

We can supply these Condensers in any per cent. of accuracy, including 0%.

The Capacity Range is from 10 mmf to 800 mmf.

LIST PRICE, 1/- EACH.

We are Agents for—

I.R.C. RESISTERS.

T.C.C. CONDENSERS.

AMPLION SPEAKERS.

BRUNO MICROPHONES.

BIRNBACH INSULATORS.

TRIMAX TRANSFORMERS.

**AUSTRALASIAN ENGINEERING
EQUIPMENT CO. PTY. LTD.**

370 Little Collins St., Melb. Phone: F 5585

AMATEUR RADIO



Published in the interests of the Wireless Institute of Australia, Official Organ of all divisions of the W.I.A. and R.A.A.F.W.R.



PRICE
6^d

APRIL, 1940

WESTON

Instruments

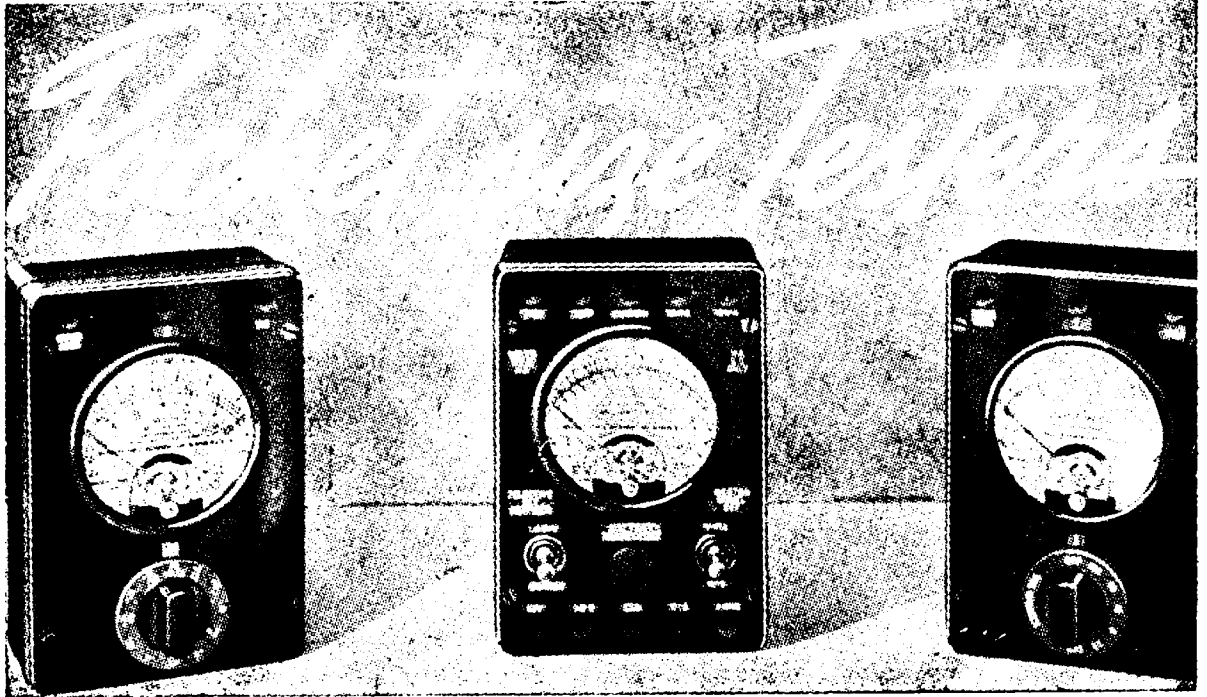

Essential Equipment in Every Experimenter's Kit . .

Small and compact, these pocket size Western Test Units are admirably suited for all testing and experimental purposes. They can be carried conveniently in your coat pocket or can be stored away in a table drawer for easy reference.

Model 695 (on left).—Power Level Meter, Voltmeter, Output Meter. A rectifier type voltmeter, which gives readings in decibels as well as volts. Ideal for all types of audio equipment.

Model 697 (Centre).—Volt-Ohm-Milliammeter. This unit covers a.c. and d.c. voltage, d.c. milliampere and ohm ranges. Precision resistors are used throughout. Voltage, current and resistance ranges are brought out in pin jacks and are selected by toggle switches.

Model 571 (on right).—Output-Meter. This has a constant resistance of 4000 ohms on each range, and is usually used as a terminating device on sound line or receiver output circuits.

Write or call for literature and full particulars.

Warburton Franki (Melb.) Ltd.

380 BOURKE STREET, MELBOURNE. MU 6353

Also at Sydney and Brisbane.

AMATEUR RADIO

Published in the Interests of Radio Amateurs and
Experimenters throughout Australia.

VOL. 8. No. 3

1st APRIL, 1940

OUR ORGANISATION

Publishers.—

WIRELESS INSTITUTE OF AUSTRALIA
(Victorian Division)
191 Queen Street, Melbourne, C.1.

Editorial Department.—

W. R. GRONOW (VK3WG),
Editor.

R. H. CUNNINGHAM (VK3ML)
Technical Editor.

C. SERLE (VK3RX)
Notes Editor.

V. E. MARSHALL (VK3UK)
Compilation.

H. N. STEVENS (VK3JO)
Distribution.

L. T. POWERS (VK3PS)
Secretary.

Advertising Department.—

BEDGGOOD ADVERTISING CO.,
129 William Street, Melbourne.
Phone: MU 4046

Sydney Representative—

J. H. FRASER
8 Deakin Avenue, Haberfield. UA 1725.

Printers.—

H. HEARNE & CO. PTY. LTD.,
285 Latrobe Street, Melbourne, C.1.

Accounts Department.—

LARGE & POWERS,
Chartered Accountants (Aust.),
422 Collins Street, Melbourne.

MSS and Magazine Correspondence
should be forwarded to The Editor,
"Amateur Radio," Box 2611W, G.P.O.,
Melbourne.

Subscription Rate is 6/- per annum in advance (post paid).

NOTE.—Advertisers' change of copy must be in hand not later than the 20th of the month preceding publication, otherwise the previous month's copy will be reprinted.

CONTENTS.

	Page
Editorial- - - - -	3
Putting the Vacuum Tube Voltmeter into Service - -	4
Recent Developments in Radio Telephony - - - -	11
Latest Handbooks Re- ceived - - - - -	15
Federal and Victorian Q.S.L. Bureau - - - - -	17
Short Wave and DX Section - - - - -	18
Divisional Notes - - - - -	19
Correspondence Section -	24
IMPORTANT—	
R.A.A.F. Vacancies - -	14

DIVISIONAL ADDRESSES.

FEDERAL HEADQUARTERS:
BOX 2611W, G.P.O., MELBOURNE

NEW SOUTH WALES:
BOX 1734JJ, G.P.O., SYDNEY.

VICTORIA:
BOX 2611W, G.P.O., MELBOURNE.

QUEENSLAND:
BOX 1524V, G.P.O., BRISBANE

SOUTH AUSTRALIA:
BOX 284D, G.P.O., ADELAIDE.

WESTERN AUSTRALIA:
BOX N.1002, G.P.O., PERTH.

TASMANIA:
BOX 547E, G.P.O., HOBART.

TRANSFORMERS . . .

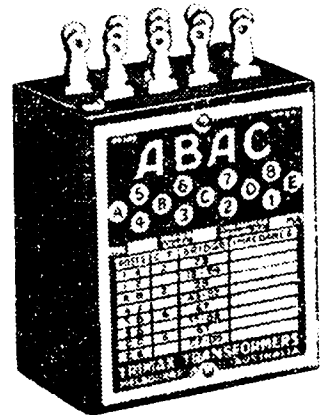
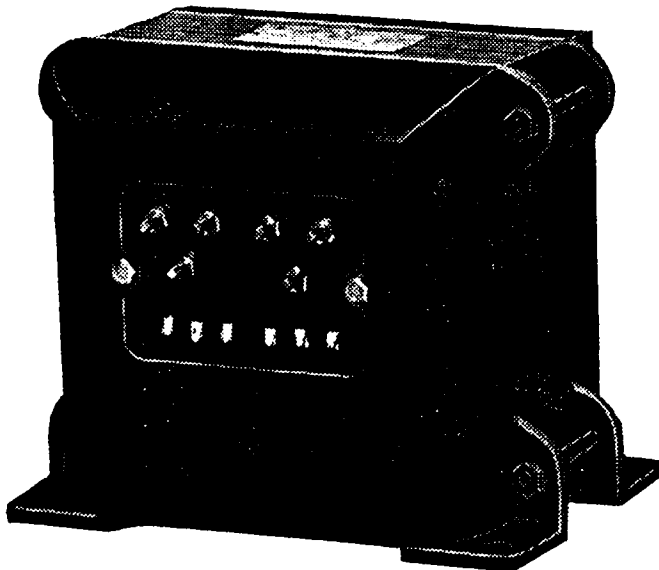
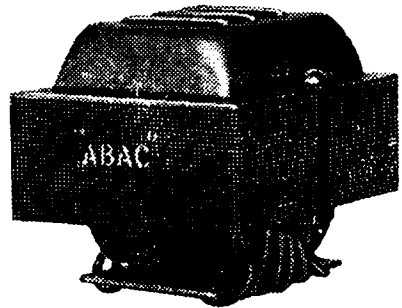
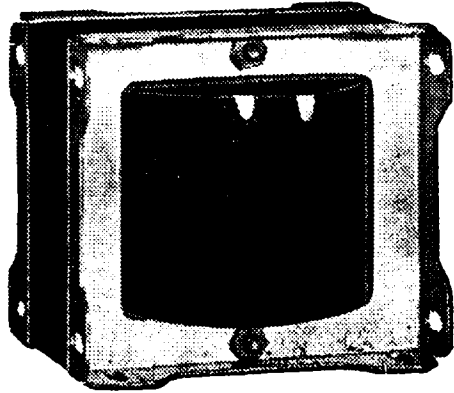
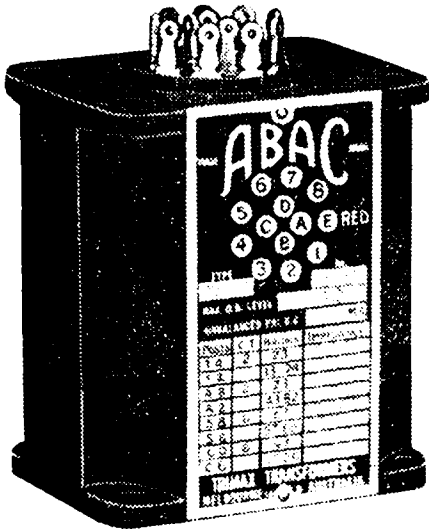

MANUFACTURED BY

TRIMAX TRANSFORMERS

(A DIVISION OF CLIFF & BUNTING PTY. LTD.)

Registered Office:

29-35 FLEMINGTON RD., NORTH MELBOURNE.

PHONE: F 9127 (2 lines)



EDITORIAL

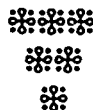

It has been revealed that short wave transmissions have been carried out by some misguided individuals on Amateur Bands. In times of Peace, the Wireless Institute has often championed the cause of those unfortunates who have overstepped the mark either through ignorance or over enthusiasm. But in time of War we offer no sympathy to those who are foolish enough to break the law in such flagrant fashion. No excuse can be accepted for this behaviour, and every right thinking Amateur feels a justifiable indignation that such persons should endanger the spirit of goodwill that has always existed between the Australian Amateur and the Powers that be. Such a selfish and irresponsible attitude has considerably upset any chances the Australian Amateur may have possessed with regard to the restitution of our experimental licences, and it is the duty of all real amateurs to cooperate with the Authorities in suppressing any further illicit transmissions. We can hardly expect the penalty to be slight, and we don't mind saying that we hope it won't.

.. This month we are presenting a combined issue of the March and April efforts of technical and notes contributions. It represents an issue as unique in the annals of Amateur Radio as our "1636" issue; in that the latter was a typographical error, and the former forgetfulness—on the part of our contri-

butors. However, in all seriousness, we are not anxious to curtail the regular publication of "Amateur Radio" to further bimonthly issues, which will not be necessary if we receive the continued support of our contributors in all States. One of the most surprising things to us has been the tendency for the Australian Amateur to drop his bundle under the present conditions. We were always of the opinion that the VK ham was able to meet any condition and to overcome any obstacle in an emergency, such as that exists to-day. It hardly seems possible that the hobby of radio can lack spheres of interest that would attract the attention of the true experimenter. "Amateur Radio" can only continue publication so long as support is forthcoming, such as that evidenced by the N.S.W. and Queensland Divisions, who respond to our urgent appeal for support so effectively.

We are attempting to institute a new section in this issue to attract the interest of the S.W.L., and we hope that our readers will contribute short wave notes and DX information to help make this innovation a complete success. The Editorial Committee is taking steps to secure the rights to re-publish overseas articles of outstanding interest, and we hope to make the magazine the chief link in binding the W.I.A. together during these uncertain times.

Putting The Vacuum Tube Voltmeter into Service

(Continued from February Issue).

Care should be used in selecting the vacuum tube voltmeter, to make sure that the device will function satisfactorily over a wide frequency range since the vacuum tube voltmeter will be used occasionally on d.c., occasionally on commercial frequencies, frequently in the audio range, and most often on radio frequency currents. With receivers now including the short wave bands, it is necessary that the vacuum tube voltmeter be able to handle frequencies of the order of 10 to 20 megacycles with negligible errors.

Care should be used in selecting the vacuum tube voltmeter to insure the selection of an instrument that has a minimum number of controls to operate for any given purpose. This statement is not intended to convey the idea that a vacuum tube voltmeter with a minimum number of controls would be the best, but rather that the number of controls that must be manipulated for any given reading or between any two successive readings, should be a minimum. The device must be provided with adequate controls for adjustment and the conversion of the circuit to take care of RMS, peak, and d.c. readings. Since the vacuum tube voltmeter contains radio tubes which will change from time to time it is essential that the circuit be equipped with adequate adjustments to maintain calibration in use.

Up to approximately 15 volts the vacuum tube voltmeter input circuit should be connected directly to the grid of the tube so as to make the input impedance of the device as high as possible, thus placing the least possible load on the circuit under test. For voltages above 15 volts the serviceman may provide himself with a voltage divider. If such a divider is used the resistance of the total divider should be appropriate for the circuit across which it is connected. Obviously, for high impedance circuits the voltage divider must have considerable resistance and for best results should contain a resistance equal to 10 to 20 times the impedance of the circuit

across which it is connected. For low impedance circuits the resistance of the voltage divider can be proportionately lower. It should be noted that for practically all normal uses of a vacuum tube voltmeter the range .2 to 16 volts is ample. Only occasional requirements will be encountered for voltages in excess of 16 volts.

When using a voltage divider in conjunction with a vacuum tube voltmeter care must be taken to allow for the load introduced on the circuit by the voltage divider since the high impedance of the grid circuit of the vacuum tube voltmeter is no longer the determining factor.

When taking measurements on circuits where there is no returned path for the grid circuit of the vacuum tube voltmeter is only necessary to return the grid through a suitable resistor and to connect the vacuum tube voltmeter to the circuit under test through a suitable blocking condenser. For most vacuum tube voltmeters, a three megohm resistor and a .00025 microfarad condenser will be found satisfactory for this application.

It should be noted that readings taken with the above combination on alternating currents, will be peak values and that to obtain the effective value of the reading a multiplying factor of .707 should be used. Since most vacuum tube voltmeter indications are used proportionately it is often unnecessary for the user of the device to reduce peak readings to effective value readings.

It should be noted that when taking measurements across grid circuits that are a.v.c. controlled, or where a d.c. grid voltage is introduced between the grid of the receiver tube and the ground, if direct measurements are to be made across this grid circuit, the bias voltage should be eliminated by grounding the a.v.c. lead in the receiver, or the d.c. blocking connector should be used with the vacuum tube voltmeter. The former method is preferred as the blocking connector does place a

slight load, i.e., approximately 3 megohms, across the circuit to be measured. If neither of these precautions are taken, the d.c. bias voltage will be read on the vacuum tube voltmeter causing extreme errors in reading.

The vacuum tube voltmeter should be so designed and built as to permit direct access to the grid terminal of the vacuum tube voltmeter tube so that for high frequency work the connecting circuit between the circuit under test and the vacuum tube voltmeter grid and its cathode, can be as short and free from loss as possible. This precaution becomes increasingly necessary as the frequency is increased over five megacycles.

One of the most important measurements that can be made on a superheterodyne receiver is that of oscillator performance. To make this measurement the vacuum tube voltmeter should be set on its highest range. Connections can then be made from the stationary plates of the oscillator tuning condenser to ground. For this connection it is recommended that the grid be connected to the stationary plate and the ground terminal to the chassis. See Figure 24.

With the receiver turned on, a reading should be obtained on this range, the usual potential of oscillator circuits running somewhere between 6 and 16 volts. There is no need to use any d.c. blocking condenser as the oscillator test circuit is always connected from the grid of the oscillator tube to ground.

It may be found that a better reading will be obtained on one of the lower voltage ranges, and if so, the switch should be turned to one of these ranges, either the receiver turned off or the lead disconnected from it, and the zero setting readjusted if necessary. The receiver can then again be turned on and with approximately a half scale reading the receiver dial should be rotated from one end of the band to the other. The oscillator voltage will vary to some extent but should in all cases maintain a potential of at least 60% of the highest value.

If the receiver is an all-wave type, it should be switched to each of the short-wave bands and operation of the oscillator tube on each of these bands noted. If there are any dead spots or points where the oscillator ceases to function they will be im-

mediately apparent by sudden drops to zero of the instrument pointer. These conditions can then be rectified by inspection of the oscillator circuit, inspection of the tube electrodes and a test of the tube itself. The oscillator cathode biasing resistor and its associated by-pass condenser are often causes of trouble in this circuit.

These should be inspected carefully and if erratic operation is still apparent either the plate voltage on the oscillator should be increased or the bias resistance dropped in value approximately 10%. An open in the oscillator grid coupling condenser is often the cause of dead spots.

Measurements of gain per stage are of extreme value in all types of receivers as such measurements tell definitely how much work each tube with its associated circuit is doing. To make this measurement, an oscillator having a reasonably high output voltage and good attenuation characteristics should be connected to the antenna and ground posts of the receiver to be tested.

With the oscillator turned on and a signal tuned in, the meter can be connected directly across the grid circuit of the stage to be measured. If it is an r.f. or i.f. stage, the leads from the meter to the test circuit should be kept as short as possible, and preferably, the short voltmeter grid lead should be removed entirely.

The a.v.c. tube should be removed from the receiver or, if this is not possible, the a.v.c. lead should be grounded to the chassis. See Figure 25. If neither of these operations can be carried out, then the d.c. blocking connector should be used.

By turning the oscillator to its full output and tuning in the signal a reading should be obtained on the vacuum tube voltmeter. This reading should be noted and the meter connected to the grid of the following tube. The ratio of the two readings will be the gain across this particular stage. In making this measurement the circuit under test may be thrown slightly off resonance by the tube capacity placed across the circuit. The shunt trimmers for this circuit should be slightly readjusted to allow for the tube capacity if exact readings are required.

Each individual coil of the receiver may be checked for resonance with its tuning condenser by referring to the circuit of Figure 26. The vacuum tube voltmeter is connected directly across the grid circuit, and

the oscillator tuned to the required resonant frequency of the tuned circuit under test. The padder, trimmer or air dielectric condenser should be adjusted until a sharp resonant point is noted on the vacuum tube voltmeter scale. A definite peak indication should be obtained showing that the coil actually resonates and is not just passing energy from previous circuits, the resonant characteristic being proof that the coil and condenser are doing their job correctly.

While measurements are made across plate tuned circuits, care should be taken to protect the input of the vacuum tube voltmeter from the d.c. plate potential applied to the tube. The meter should be connected either directly across the plate coil

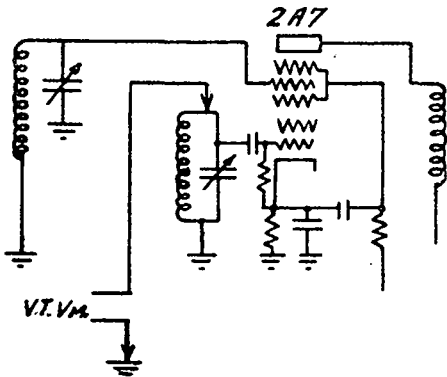

Figure 24.

or through the d.c. blocking connector to the chassis of the receiver. By using this same type of circuit the actual r.f. potential across any coil can be measured. When making either the adjustment for resonance or the measurement it may be found that a slight readjustment of the trimmer condenser will be required due to the tube capacity of the 78 tube being placed in parallel with the trimmer of the padder condenser. However, this correction can be made by moving the vacuum tube voltmeter on to the next stage and re-adjusting the trimmer of the first stage to give maximum reading across the second circuit.

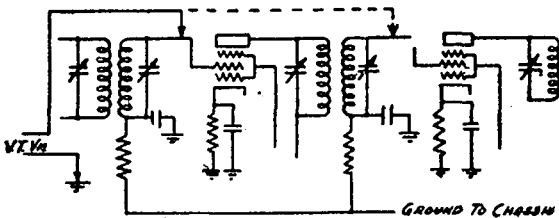
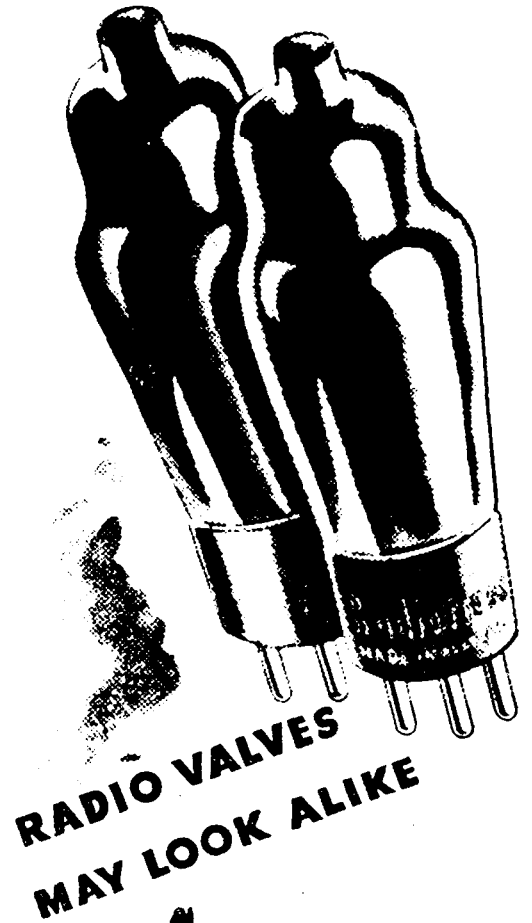

Figure 25.

The first requirement for making adjustments of this type is an r.f.



but.

Radiotrons stand out in popularity with radio owners and broadcasting engineers as the most dependable and best known radio valve.

Revalue with
RADIOTRON
VALVES

★ SEALED FOR YOUR PROTECTION



Advt. of Amalgamated Wireless Valve Co. Pty. Ltd.

voltage of sufficient magnitude to give ample readings on the vacuum tube voltmeter. If the frequency of the trap circuit to be adjusted appears in the broadcast band, then a tuned r.f. receiver can be set up and turned on, with the oscillator connected to the antenna and ground terminals. By setting the oscillator control to the frequency required for the resonance of the trap circuit and tuning the receiver to this frequency, considerable voltage can be built up across the second or third receiver stage.

When adjusting the oscillator be sure to set the attenuator at the maximum position using the high output jack. A small coupling coil of 10 to 20 turns having the same

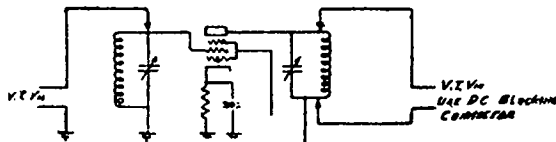

Figure 26.

diameter as that of one of the tuned r.f. coils can be wound up quickly and placed over the end of the receiver tuning coil. With the same number of turns on the other end of this coil circuit brought out at a convenient place on the bench or table, a field can be set up for adjusting the trap circuit. See Figure 27.

The coil and condenser forming the trap circuit should be connected directly across the input to the

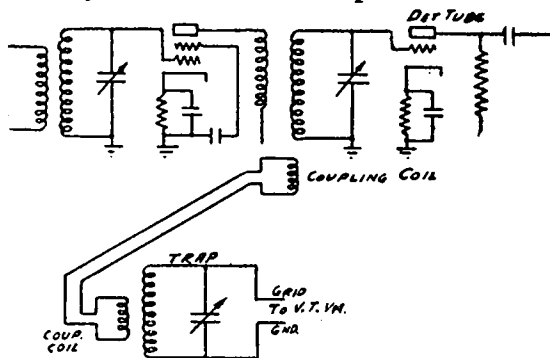
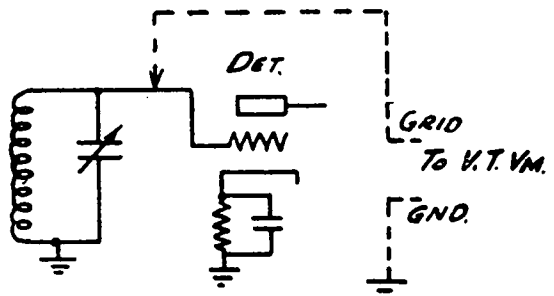

Figure 27.

vacuum tube voltmeter with the coil brought out from the receiver coupled closely to the trap circuit. The trap padder should be adjusted for maximum deflection on the vacuum tube voltmeter. If the trap is to be resonated with a fixed condenser, turns should be removed from the coil one at a time until a maximum reading is obtained.

If it is convenient to get at the coils in the tuned r.f. receiver, the

trap circuit can be adjusted by placing it directly in the field of the receiver coil. To make sure that the efficiency of the trap circuit is good, the trap should be tested for continuity at other frequencies. To do this the trap should be connected as shown in Figure 28, in series with the test oscillator and with the receiver and oscillator tuned to a frequency other than that to which the trap is adjusted, a reading should be obtained on the vacuum tube voltmeter. If no reading or a very low reading is obtained, it is obvious that the trap circuit will not pass to a great extent, frequencies on each side of the resonant point. This can be corrected by using a smaller coil and a larger condenser.



RECEIVER DETECTOR CIRCUIT

Figure 28.

The degree of attenuation of the trap circuit on any frequency can be measured by taking a reading with the trap in series with the oscillator and then shorting out the trap circuit and noting the second reading.

If the trap circuit is to be designed for frequencies somewhere in the intermediate band then a superheterodyne receiver should be set up and the oscillator connected from the grid of the first detector tube to the chassis. The amplification obtained in the i.f. section of the receiver can then be used to build up the voltage as mentioned in the previous paragraphs.

It is quite often found advantageous to connect a trap circuit resonated to the intermediate frequency in series with the antenna connection in the superheterodyne receiver. Such an arrangement will cut down to a considerable extent the image ratio of the receiver or, in other words will limit feedback of the intermediate frequency potential into the antenna circuit.

Alignment and adjustment of a.v.c. receivers can be handled accurately and rapidly by making use of the

vacuum tube voltmeter as an a.v.c. voltmeter indicator. The ground connection should be made directly to the a.v.c. lead which carries voltage to the various r.f. and i.f. tubes with the grid of the vacuum tube voltmeter connected to the chassis of the receiver. With the test oscillator connected either to the first detector tube or to the antenna and ground posts of the receiver, adjustments of the various trimmers can be made for maximum a.v.c. swing on the vacuum tube voltmeter.

If exact alignment is to be carried out by this method, the r.f. stages

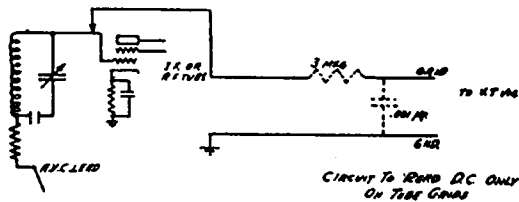

Figure 29.

should be aligned first. As an increase in signal at the input to the second detector tube will result in an increase in a.v.c. voltage, exact alignment of all the tuned circuits can be made without changing the position of the vacuum tube voltmeter.

On some receivers a.v.c. amplification is used. In such cases with the oscillator connected to the first detector tube and a signal tuned in, the trimmers that resonate the a.v.c. amplifier tube circuits should be adjusted for maximum a.v.c. voltage, this being indicated on the V.T.V. instrument. D.C. voltage readings can be taken directly with the vacuum tube voltmeter. The indications must be transferred to d.c. volts by reference to calibration curves supplied with the device. Line a.c. volts at all frequencies are most important, the instruments are cali-

brated in a.c. with d.c. curves supplied.

To make sure that the a.v.c. operation of the receiver is correct, the attenuator of the oscillator should be manipulated back and forth with a corresponding change in a.v.c. potential indicated by the meter. If correct action does not take place the resistors in the a.v.c. circuit of the diode detector should be examined, as the drop across these resistors determines the a.v.c. potential. If a separate a.v.c. amplifier tube is used, this tube and its associated circuit should be examined to make sure that it is functioning properly.

Occasionally the resistors connecting from the return circuits of the r.f. or i.f. coils to the a.v.c. control lead become open or the by-pass condensers in the grid return circuits become shorted. Either of these two difficulties will stop a.v.c. action on the tube grid. To make sure that this action is taking place directly on the grid of the tube, the circuit shown in Figure 29 should be used. The condenser across the input circuit of the vacuum tube voltmeter will short out the radio frequency at that point while the d.c. potential applied to the grid of the tube will be indicated by the meter.

Following out this same arrangement proportional a.v.c. action on each tube can be determined. On some receivers twice the a.v.c. voltage is applied to the i.f. and pre-selector circuits as is used on the converter tube. To note a.v.c. action, adjust instrument to read full scale on 1.2, 3, or 6 volt range. When voltmeter is connected to tube grid, deflection will be down scale.

Tests for gain per stage can be made quickly and accurately by making use of the V.T.V. The amplifier or audio section of the receiver

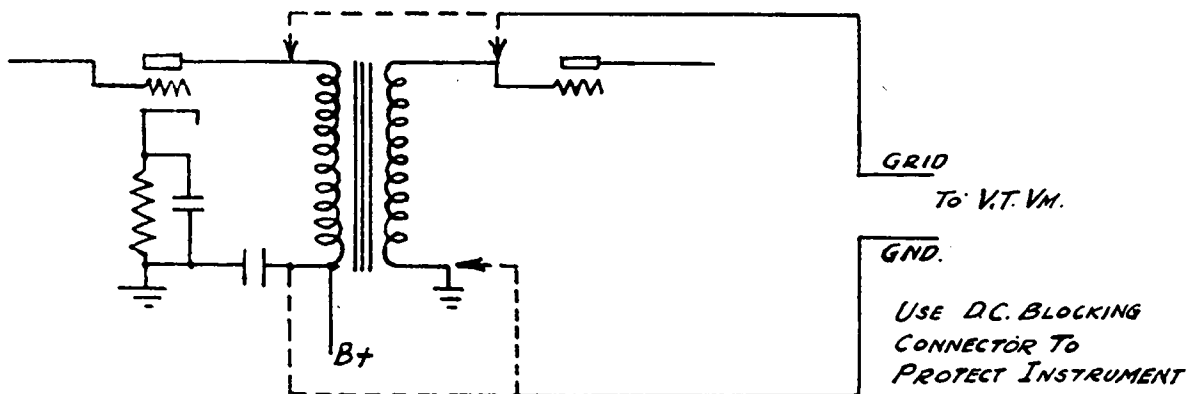

Figure 30

under test should be connected to an oscillator which will produce a constant audio output reading. The oscillator can then be turned up until a reading is obtained across the first audio transformer on the vacuum tube voltmeter as shown in Figure 30. By connecting the V.T.V. to the secondary of this same transformer the step-up ratio in voltage can be determined. The voltmeter can then be moved along the primary and secondary windings of the transformers in succeeding stages and readings taken giving the overall gain or gain per stage.

If gain per stage or overall gain measurements in decibels is required, the voltage ratio can be converted to decibels using any of the d.b. charts available. The readings may be taken directly by using any d.b. meters. It should be remembered when calculating the overall d.b. gain of an amplifier that the input and output impedances should be figured at the same level; in other words if an amplifier is equipped with a 500 ohm input and the output terminates in a speaker voice coil, the reading taken across the speaker voice coil should be referred back to the reading that would have been obtained were it a 500 ohm line. If this correction is not made, then care should be taken in stating the overall gain of the amplifier with reference to the two different output impedances.

If the gain of the amplifier is to be tested at some other frequency a beat frequency oscillator should be connected across the input and readings taken at other audio frequencies. If fidelity curves are wanted they can be taken by making use of the circuit shown in Figure 31, or for best results the rectifier voltmeter placed across the output of the beat frequency oscillator should be replaced by the vacuum tube voltmeter so as to permit the reading of the input and output voltages of the amplifier on the same device. In this connection it should be noted that the vacuum tube voltmeter has a flat frequency curve, the instrument being good to better than 3% for the frequency range 40 cycles through 50 megacycles. This flat frequency response curve of the vacuum tube voltmeter permits accurate fidelity curves to be taken.

The V.T.V. can be used to measure voltages across by-pass condensers at various frequencies determining the by-passing action of these condensers

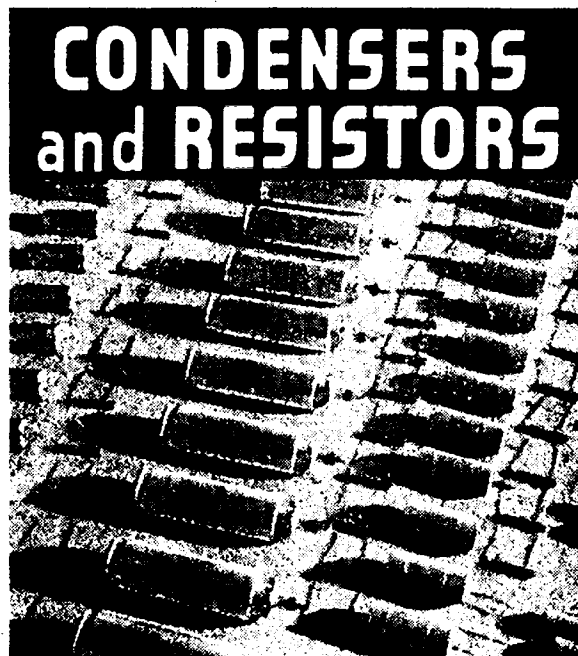

CONDENSERS and RESISTORS

DUCON-CHANEX
GUARANTEE
*Complete
Reliability*

Under the most exacting
conditions.

Ducon Condensers are admirably suited to withstand the peculiar conditions of amateur and experimental work.

In the new transmitting units of 2FC and 3LO, Ducon Condensers were installed, being specially chosen for their unique quality.

For all Condensers and Resistors
specify

DUCON CHANEX

73 BOURKE St. WATERLOO. N.S.W.
450 COLLINS St., MELBOURNE, C.I

in any circuit. When making such measurements, care should be taken to make sure that electrostatic pick-up to the grid lead of the voltmeter is not taking place. This can be avoided in extreme cases by using a short shielded lead to the grid or by keeping the other side of the voltmeter grounded.

Audio transformer ratios can be measured quickly and accurately by using the circuit in Figure 32. This figure shows the method of measuring impedance ratio and frequency response characteristic of a 200 ohm

series with the condenser used in the d.c. blocking connector making connection to an audio frequency source of potential. If the condenser is O.K. a reading will be obtained on the vacuum tube voltmeter. If the condenser is open, no deflection will be obtained when the audio source of potential is turned off.

The voltmeter can be used in many other circuit measurements including the drop across chokes, resistances, r.f. coils and other such circuits. The only general precautions that are to be taken in these cases,

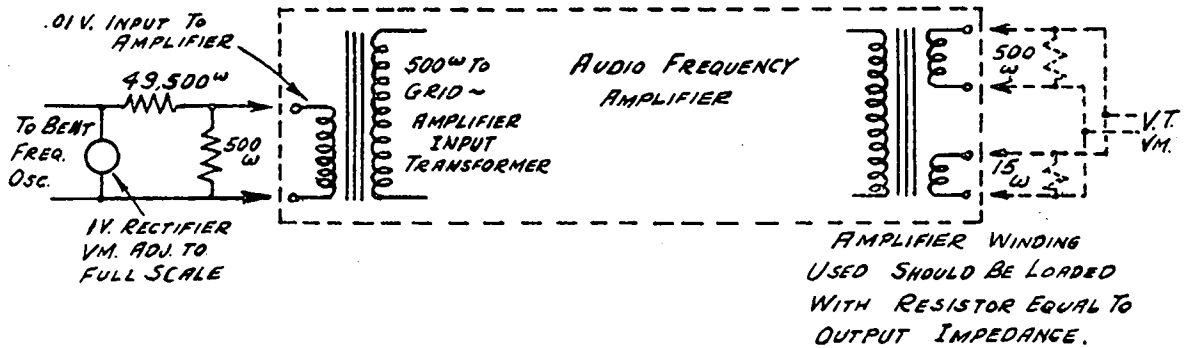

Figure 31

to grid audio transformer. It should be noted from the figure that 200 ohms appear across the input, whereas the transformer secondary is across the grid and ground connections of the vacuum tube voltmeter. If the transformer under test is to work into a definite load, say 10,000 ohm carbon resistor should be connected across the secondary using the same type of circuit. If the correct loading resistors are not used, the frequency characteristic and impedance ratio of the transformer will not correspond at all with the actual conditions in the amplifier or the receiver.

It is often difficult to obtain continuity readings on condensers having capacities below 250 micro-microfarads. These may be checked for continuity by connecting them in

is to make sure that no electrostatic pickup is appearing in the grid of the tube or in other words, the reading is determined only by the drop across the circuit component being measured.

The vacuum tube voltmeter is limited only in its usefulness to the ability of the operator. Many uses beyond those mentioned above can be made of this instrument. As the serviceman becomes more familiar with his vacuum tube voltmeter he will find it of greater and greater help and will ultimately consider it to be one of the tools with which he cannot function properly.

Cathode ray tubes and oscillographs have found their place in the radio field and will continue to be of importance in receiver design and
(Continued on page 23)

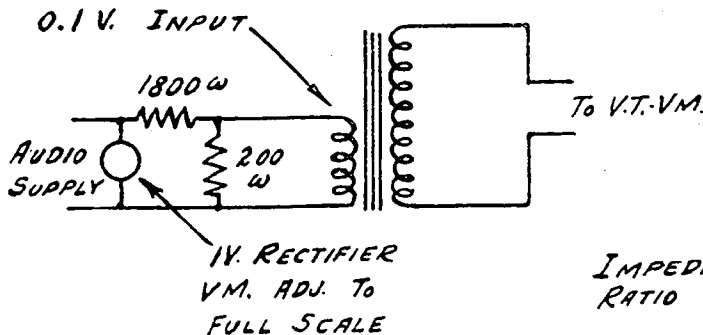

LOADING RESISTOR MAY BE USED ON GRID SIDE. THIS WILL SOMETIMES IMPROVE FREQ. RESPONSE.

$$\text{IMPEDANCE RATIO} = 100 (\text{V.T. VM. READING})^2$$

Figure 32

Recent Developments in Radio Telephony

By Ross F. Treharne, ex VK2IQ.

[This article is merely intended to draw attention to recent advances in Amateur Radio Telephony Technique, and to present briefly the principles involved. Two/one voice modulation, cathode modulation and frequency modulation are discussed. Reference to the original papers is recommended for more complete treatment of detail. The article constitutes notes of a lecture delivered before the New South Wales Division of the Institute in February.]

Amplitude Modulation.

In order to understand recent developments in amateur modulation technique, it is necessary to revise elementary definitions of modulation.

In the most commonly employed systems of Radio Communication, information is transmitted by varying the **amplitude** of the radiated waves. If we describe such a wave by means of a time-amplitude graph and then draw a curve through the peaks, and then the troughs, the **envelope** so described represents the modulating components, e.g., the audio, etc. In a wave of this type there are present, in addition to the carrier frequency **side band** frequencies² consisting of the carrier plus and minus the modulating frequency components.

The degree of modulation, or **modulation factor**, for a sinoidal (sine wave) variation of amplitude can be expressed as:—

$$m = \frac{E_o - E_{min}}{E_o}$$

where m = modulation factor

E_o = average envelope amplitude

E_{min} = minimum envelope amplitude.

However, when the envelope is not sinoidal it may be necessary to define the modulation separately for peaks and for troughs.

Then, if m_p and m_n are the **positive** (peak) modulation and **negative** (trough) modulation factors respectively, we have

$$M_p = \frac{E_{max} - E_o}{E_o}$$

and

$$M_n = \frac{E_{min} - E_o}{E_o}$$

where E_{max} is the maximum envelope amplitude.

Further, an **average modulation factor**, m_a , can be defined as:

$$M_a = \frac{1}{2} \frac{E_{max} - E_{min}}{E_o}$$

If the modulation factor is multiplied by 100 the product is called **percentage modulation**.

In order that the modulating components be capable of being reproduced without **distortion** the envelope should follow them closely. It follows then that the maximum percentage of modulation in the negative direction cannot exceed 100% without envelope distortion, since $E_{min} = 0$ when $m_n = 1.0$. However, in the positive direction the percentage can exceed 100%, without distortion, under certain conditions.

The degree of modulation which can be accepted without envelope distortion is known as the **modulation capability** of the transmitter.

Under no circumstances should the modulation capability be excessively exceeded since the consequent harmonic distortion³ of the envelope gives rise to high side bands.

Two/One Voice Modulation.

It has been found⁴ that the wave form of the **average male voice**, when transmitted through an amplifier of limited bass response, has a **symmetrical peaks** which are about twice as high in one direction as in the other. Now if the modulation percentage with such speech is limited to 100% in both directions, the mean percentage modulation cannot exceed 75%, since, when the 2E peak is modulating 100% the smaller (E) peak can only modulate 50%.

However, using a 2/1 voice it is

possible to achieve 150% mean modulation without exceeding the modulation capability, that is without distortion or additional interference. The modulation capability in the negative direction is primarily fixed by the carrier "cutting off" and is limited to 100%, but in the positive direction the modulation may be well above this without envelope distortion provided the amplifier is capable of the peaks. In this direction safe emission, grid drive, and plate loading primarily determine the modulation capability.

It is quite probable that many stations have unknowingly employed this method, as the requirements for such a plate modulated system are (a) that the polarity of the modulator leads be such that the larger peaks be in the positive modulation direction, and (b) that the modulated amplifier be capable of 200% positive modulation. The latter requirement would, no doubt, be fulfilled by many stations using unusually large

tubes with low input and high grid drive. This may explain the often encountered remark that "A's modulation is much deeper than B's yet both are using as much modulation as they dare."

An important feature of this system is that **heterodyne interference** is not increased yet the strength of the modulation is increased FOUR times approximately, or alternatively, for the same modulation strength the heterodyne is quartered.

Cathode Modulation.

Cathode modulation is essentially a **combination** of **grid bias** and **plate modulation**, and combines some of the advantages of both.

Grid bias modulation is fundamentally an efficiency modulation system, that is the efficiency, and consequently the output of the amplifier is varied in accordance with the grid bias. For example, assume a peak efficiency of 80%, then the resting, or carrier, efficiency cannot

U. R. D. RADIOs and COMPONENTS

ARE EASIER to BUY

● Just over two years ago, U.R.D. had one floor comprising showroom, stockroom and office. To-day it occupies two large floors and, only recently, alterations were necessary in order to cope with the increased business.

WHY?

Just because more and more "VK's" and more and more dealers have found it easier and cheaper to buy from us — easier because of our large stocks, cheaper because our specialisation in Short Wave equipment enables us to buy more advantageously.

New Telephone Exchange Makes Buying Still Easier

Our new Rotary Telephone Exchange, the most modern procurable, with additional lines and extensions will save you time when ordering by 'phone.. Just dial MA 9251, when the switchboard will automatically put you through on a vacant line.. Try it—we like to hear from you.

United Radio Distributors Pty. Ltd.

234 Clarence St.,
SYDNEY.

Telephones:
MA 9251 (3 lines)

Telegrams:
URD Sydney

exceed 40% if 100% sinoidal modulation is to be employed. But if only 70% modulation be required, the resting efficiency can be increased to 53% since less output swing is required. This results in 33% more carrier. Now if the amplifier be plate modulated a further 30% the signal will be 100% modulated. A rough calculation of the audio power required to do this gives 10% of the input and yet the efficiency is about 53%.

Normally the distortion 6 would be high due to the grid operating in the grid current region, but by loading the plate circuit heavily there is some cancellation of the distortion by the plate curvature.

With tubes of amplification factors between 15 and 25 introducing the modulating voltage into the **cathode** circuit gives about the correct swing to both plate and grid. In some cases it is necessary to use a tapped transformer to obtain the optimum ratio.

The application of two/one voice modulation is readily obtained with considerable advantage.

Frequency Modulation.

If, instead of varying the amplitude, the **frequency** 7 of the wave is changed in accordance with the modulating signal, keeping the amplitude constant, we have frequency modulation. The extent or range of the frequency variation is made proportional to the modulating signal, and the **rate of variation**, that is the number of times the frequency is changed between maximum and minimum per second gives the modulating frequency.

An analysis of a frequency modulated wave indicates the presence of many additional **side band frequencies**. When a carrier of frequency f_0 is modulated at a rate of f_s , the resultant wave contains components, f_0 , $f_0 + f_s$, $f_0 - f_s$, $f_0 + 2f_s$, $f_0 - 2f_s$, $f_0 + 3f_s$, $f_0 - 3f_s$, . . . etc. However, if the rate of frequency range variation to the audio frequency is made large the second order and higher components are small. It is general to employ a **band width** of 100 kc. when the audio range is 20,000 cps. This wide band width makes the use of UHF necessary.

Frequency modulation can be accomplished in many ways, the most elementary of which consists of an

oscillator whose frequency is varied by means of a **mechanically** operated variable condenser. The moving plate is actuated as a loud speaker diaphragm is operated, giving capacity fluctuations which are transformed into radio frequency fluctuations, in the tank of the oscillator. More conveniently, an electrical variable reactance can be constructed by making use of the Miller Effect 8 in a tube. It can be shown that the effective **reactance** 9 of a tube can be made a function of the grid potential and if such reactance is shunted across the oscillator tank, and the grid voltage varied in accordance with the modulating signal, appropriate frequency modulation can be accomplished.

Armstrong's method 10 is a more complex system, and will not be treated here.

The **reception** of frequency modulated signals requires the use of special circuits.

(a) The signal is first collected and amplified in a more or less conventional antenna, rf, convertor and if channels with the exception that a wide **200 kcs channel** be employed in all circuits. This does not present difficulty since the response does not have to be flat as amplitude variations, within limits, do not effect the audio response.

(b) The frequency modulated intermediate frequency (1500 kcs., for example) is then passed through an amplifier operated near saturation point so that any large increase in signal is reduced in amplitude. In effect it tends to maintain a more constant level with consequent noise peak reduction.

(c) The signal is now converted into an amplitude modulated wave by means of a **discriminator**. The simplest form consists of a detuned i.f. transformer. Consider the signal applied to an i.f. transformer which is tuned to peak a little more than 100 kcs. higher than the mean frequency of the signal. The response through the transformer will be a function of the difference between the resonant frequency of the transformer and the instantaneous signal frequency. That is a frequency fluctuation produces an amplitude fluctuation. If the operating point on the transformer is suitably chosen this relation can be made linear.

(Continued on page 16)

ROYAL AUSTRALIAN AIR FORCE

VACANCIES FOR MEN WITH WIRELESS OR ELECTRICAL QUALIFICATIONS.

Apply to your nearest Recruiting Centre for details of enlistment as:—

(1) **WIRELESS OPERATORS (For Training)**

FOR MEN WITH A SOUND EDUCATION AND WITH OR WITHOUT ABILITY IN MORSE CODE.

(2) **AIRCRAFT ELECTRICIANS (For Training)**

FOR MEN WITH GARAGE OR OTHER TECHNICAL EXPERIENCE.

INSTRUCTORS WANTED

Applications will be received from men for the following Civilian positions:—

(a) **MORSE INSTRUCTORS (Civilian)**

FROM EXPERIENCED TELEGRAPHISTS.

(b) **RADIO THEORY INSTRUCTORS (Civilian)**

FROM MEN WITH A SOUND KNOWLEDGE OF RADIO PRINCIPLES AND WITH EXPERIENCE IN HANDLING TRANSMITTERS.

Full Details may be obtained on application to:—

THE SECRETARY,

Air Board, Victoria Barracks,

Melbourne, S.C.1.

Latest Hand-books Received

By VK3ML.

RADIOTRON DESIGNERS' HANDBOOK—Third Edition.

Edited by F. Langford Smith (B.Sc., B.E., Member I.R.E. (U.S.A.), M.I.R.E. (Aust.), A.M.I.E.E (Aust.).

To produce a text book of 352 pages to cover all the phases of radio receiver and amplifier design in treatise form would undoubtedly be an impossibility. Such a feat could have been done many years ago, but, now each phase is a science of its own and requires its own authorities specialising in its own sphere. However, in a laboratory, workshop or design room, a condensed version of the major subjects likely to be handled is of extreme importance. The Radiotron Designers' Handbook has been published to meet this end, and we have had the pleasure of reviewing this very useful handbook compiled by Mr. Langford Smith, of the A.W. Valve Co. Pty. Ltd.

We could call the publication a "Radio Dictionary" or "Glossary of Radio Terms" in that it is a handbook covering a wide field, in a condensed form, of radio reproduction apparatus design data. Our review is from the Amateurs' point of view, and in it we find a wealth of handy technical information of value in planning the construction of ham receivers, etc. The sections are eight in number. Part I covers Audio Frequencies in 13 chapters, which handle amplifiers, power output stages and loudspeakers, biasing, fidelity, negative feedback, tone compensation, recording, decibels, etc., etc. Part II treats radio frequencies in 8 chapters with amplifiers, frequency conversion, detection, A.V.C. and A.F.C. amongst the subjects therein. Rectification, filtering and hum occupy all of Part III. The receiver components, such as transformers, voltage dividers and tuning indicators receive four chapters under Part IV. A subject usually little written about—Testing and measuring receiver performances—takes up Part V and is of special interest. Parts VI, VII and VIII with the remaining eight chapters cover

valve characteristics, general theory and sundry data; whilst a comprehensive index is to be found at the back.

The foreword claims, "the information is arranged so that all those interested may derive some knowledge with the minimum effort in searching," and we would sincerely recommend this 1940 publication to all keen hams as a member of the book shelf. (McGill's Agency, Elizabeth Street, Melbourne, price 3/-).

THE "RADIO" HANDBOOK.

(Sixth Edition).

Although amateur radio transmissions are at a standstill in Australia, the science is still marching on in neutral countries. The rapid advancements can well be followed by studying the latest "Radio" Handbook just received.

The sixth edition of this publication carries a total of 640 pages, including a comprehensive index and advertising catalogue. The editors claim a thorough revision over previous editions and not merely a bringing up-to-date. To keep abreast with rapid advancements in commercial equipment the majority of apparatus shown in the constructional sections is newly built for this edition. It is a vital importance that all this apparatus should be of proven performance, and we are assured that this is so. So many hams have been discouraged in the past by building "according to specifications" and finding that some gear fails to work to expectations. Some journals have left us with the impression that an odd article or two has obviously been written especially for the press with too scanty a try out beforehand. However, our experience of the past in actual construction work tells us that the technique and styles adopted by the "Radio" editors are pretty sound and, as a general ham "Bible," the "Radio" Handbook leaves little to be desired.

For those desirous of commencing the ham game and sitting for the A.O.P.C. there are several chapters

in the handbook devoted to elementary and advanced theory that make it highly suited as a textbook. The "Radio" Handbook has become universally known over Australia and needs no introduction to our readers. (McGills, Melb. price).

THE A.R.R.L. HANDBOOK.

1940 Edition.

The production of amateur radio handbooks since 1926 has given the A.R.R.L. an opportunity of learning by experience just what a publication of this nature should contain. Several fine technical editors have devoted much time to the set-up of the A.R.R.L. handbooks in the past and now, with George Grammer as the compiler-in-chief, the 1940 edition reflects the pains and efforts of previous workers.

Periodically, such a handbook requires a thorough combing and overhaul to permit modern theories, designs, and methods of presenting them to be set-up afresh. At the same time as being up-to-date the A.R.R.L. Handbook still carries the air of conservatism in each chapter giving one the feeling that the "meat" is solid and technically sound. This material can be relied upon and it is for this reason that the A.R.R.L. provides us with a more or less standard text book for A.O.P.C. seekers. However, as the Australian Amateur's ticket demands much deeper theoretical knowledge than given in such handbooks, we suggest to any such aspirants that they use these handbooks in conjunction with say the Admiralty Handbook.

A very welcome feature of the 1940 A.R.R.L. Handbook is the bibliography of articles in QST at the end of each chapter where one can find more extensive descriptions of certain apparatus. Going to 575 pages, the A.R.R.L. has covered the matters of general theory and construction in 32 chapters in a very clear form. The authors have imparted their knowledge in a very easy style and it is through this and the modernity of the handbook that we recommend the 1940 Radio Amateurs' Handbook to all hams, both young and old. (McGill's, Melb. price).

(Continued from page 13)

(d) The resultant amplitude modulated wave is then **detected** and amplified as usual.

The principal advantage of frequency modulation is the great reduction in static and man made noise. The receiver will respond to radio frequency modulation only and not to amplitude modulated waves of which noise mainly consists. Further, considerable improved fidelity of audio frequency response is available since, as shown above, the amplitude response of the tuner is not critical.

Foot Notes:

1. The equation to the wave envelope can be expressed as:

$$y = E_0 + E_1 \sin(w_1 + z_1) + E_2 \sin(w_2 + z_2) + \dots \text{etc.}$$

where E_0 is the average envelope amplitude and $E_1 E_2 E_3 \dots w_1 w_2 w_3 \dots$ and $z_1 z_2 z_3 \dots$ etc. are the amplitudes, frequencies and phases of the modulating components.

2. In general, each component of the envelope variation will give rise to two additional waves (side bands) of frequencies, $W_c + W_1$, $W_c - W_1$, $W_c + W_2$, $W_c - W_2$, $W_c + W_3$, $W_c - W_3$, . . . etc., where W_c is the carrier frequency.

3. Distortion of the envelope may introduce additional components of higher frequency giving rise to excessively remote side bands. For example, fourth harmonic distortion of a 5000 cps. modulating note would give rise to side bands 40 kcs. wide.

4. See Radio Dec. 39. p. 11.

5. See Frank C. Jons: Radio Oct. 39, and QST Nov. 39. Edmonds: QST Dec. 39. Dawley: Series Cath. Mod., Radio Dec. 39. Turney and

5. See Frank C. Jones: Radio Oct. 39. Operating Data.

6. See Terman "Radio Engineering."

7. See Radio, Jan. 40. Terman, loc. cit.

8. See Radiatron Designers' Handbook, chapt. 7.

9. See Phillips Tech. Com. No. 64. page 4.

10. See Radio, Jan. 36.

Federal and Victorian QSL Bureau

R. E. Jones, VK3RJ, QSL Manager.

G4AW, S. Garnett, Telegraphist on H.M.S. Hector, was a visitor to Melbourne during February. Unfortunately he missed seeing most of the boys, but his letter read at the February meeting of the Key section of the Victorian Division ensured him some mail. We hope to have more intimate contact with him on his return from ZL.

A member of the Australian Air Force, Tim Teehan, ZL2SK, was welcomed to the March meeting of the Key section of the Victorian Division. Other visitors—all in the popular blue uniform—to the February and March meetings were VK2 EAU aka ama ip tq 4cw 5rk and locals in 3dg 3yf and 3ys. Other interstaters at present incarcerated at Point Cook include VK2HY ams 3GW, 5HR, 5LK, 5ZZ.

W9VKF, L. A. Morrow, writing on January 9th, concludes "All of us W stations owe the Federal QSL Bureau and its manager a large debt of gratitude for the excellent way in which VK cards have been handled." Quite a thrill to get a letter of appreciation.

Pleased to hear from John Tutton, VK3ZC, who at the moment of writing was holding down one or two pips in a militia Artillery camp at Mt. Martha, Vic.

Also another one to bob up in the post was Robbie, VK3US, who is languishing at the Aeradio station, Canberra, and who hopes to strike more civilised spots in the near future.

Observations on 7mc during February/March revealed that phone stations at good strengths and owning good Aussie voices are occasionally to be heard. Truly the day of the pirate is not past.

Still a few oversea cards are straggling into the Bureau. Anyone who considers there may be one for him among these can ascertain definitely if he cares to write and include return postage.

The campaign sponsored in West Australia and directed towards all VK6 Federal Parliamentarians, and designed to bring plainly before their notice the claims of hams to have at least the ultra ultra high freqs allocated to them, during the time we are forbidden the use of lower freqs,

is to be unleashed this month. These West Aust. chappies were good enough to postpone their campaign at the Institute's request, while more constitutional methods were tried. Now these have failed, go to it VK6, and more power to your elbow.

A welcome and interesting visitor in the shape of Syd. Maddern, VK6 MN was present in Melbourne in the early part of March. Syd., who fills out the attractive uniform of the R.A.A.F., was over on Air Board business.

Congratulations to the following hams, who were successful in passing the examination for transfer or appointment as Mechanic, Broadcasting (P.M.G.): Keith Heitsch, VK3HK; Tom Lelliott, VK3ZW; and Roy Buckerfield, VK5DA.

H A M S !

**DO YOU WANT TO BE
BACK ON THE AIR?**

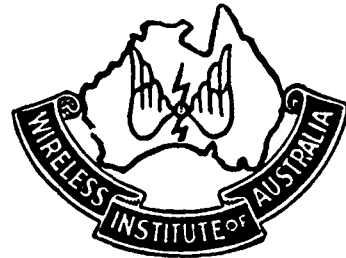

The Wireless Institute of Australia

is the recognised spokesman of the
AUSTRALIAN AMATEUR.

If you are not a member—

Join Now !

When the time comes that we can reasonably expect to go back on the air, we want to say that we represent—

EVERY ACTIVE HAM
in the Commonwealth.

Strengthen our hand by writing to The Secretary of the Institute in your State to-day.

All addresses are on the title page.

Short Wave and DX Section

SHORT WAVE AND DX NOTES.

We are publishing for the first time a new section, which we anticipate will prove of interest. This section introduces a new sphere of activity for hams, who are invited to submit their contributions of DX observations. It is hoped from the notes submitted that our readers will be able to obtain first hand comments, signal strengths and details of general short-wave conditions, which should prove of great assistance to all shortwave enthusiasts. Contributions are invited from Hams and SWL's of anything of interest heard during the month.

With enthusiastic support, this Section could easily become one of the most popular features of "Amateur Radio." We would also like to include call lists of stations heard on the Amateur Bands.

From observations made over the week ending 15/3/40, the following stations are on the air regularly:—

7.45 a.m.—2RO3, Rome, 31.13 m. Excellent volume and quality.

8 a.m.—WGEO, U.S.A. 31.48 m. Fair volume, otherwise clear.

VUM2, 25.32 m. 11.30 p.m. Very good volume.

VUD2, 31.28 m. 11.30 p.m. Very good volume.

VUM2 call is doubtful, but relays VUD2.

K2RM, 31.35 m., KGEI, 31.48 m., both coming in about midnight very well, and promise constant, good reception.

XGOY, 31.39 m., 12.30 a.m. Usually on 25.21 m. Female voice announced return to that wave length.

GSF, 19.82 and Saigon, 25.75 and KF6JEG, 20 m. are all excellent volume about midnight.

DJB, Germany, 19.74 m. Rather faint, midnight.

ZBW3, 31.49. Rather faint, midnight.

KZIB, 31.95 m. Good volume, midnight.

The following amateurs have been also heard: KF6JEG, K6BNR, PK3 GD, WIPKJ, WIGND, KAIRV, W2 GW and XU8ZA.

Static and fading, if any, was only slight over this period.

By J. F. Miller.



The Power Equipment with a Powerful Reputation . . .

THE Organisation responsible for the production of . . .

**HILCO TRANSFORMERS
CHOKES, etc.**

has proved its high standards for an article of extreme merit as accepted by the largest consumers in Australia.

**ALL PRODUCTS GUARANTEED FOR
TWELVE MONTHS.**

HILCO TRANSFORMERS PROPRIETARY LIMITED
97-111 BERKLEY ST., CARLTON, N.3., Vic. 'Phones; F1661-2
CABLES & TELEGRAMS: "HILCOY," MELBOURNE.

Divisional Notes

IMPORTANT.

To ensure insertion all copy must be in the hands of the Editor not later than the 18th of the month preceeding publication.

N.S.W. DIVISIONAL NOTES.

The January Meeting of the VK2 Division marked a milestone in the history of Institute in this State. Originally founded in New South Wales in 1910, the Institute gradually expanded until it became a Commonwealth wide organisation, with a Division in each State, and the New Guinea Amateur Radio League affiliated with the New South Wales Division. In 1922, the Division became an incorporated body, registered under the Companies Act of N.S.W., and it is interesting to note the names of the signatories to the Articles and Memorandum of Association. They were as follows: Charles Dansie Maclurcan, 2CM; John Herbert Pike, 2JP; Walter Renshaw, 2DE; Harry Stowe, 2CX; Malcolm Perry, John Wilson, and Charles Bartolomew. These were names in those days that were known throughout the amateur sphere, particularly Charles Maclurcan, 2CD.

From 1922 until 1932, the character of the Institute gradually changed, due mainly to the great progress that Radio was making in the Commercial sphere, so much so that from 1932 till 1935 it could not be regarded as an Amateur body. In 1935, through the courtesy of the Institution of Radio Engineers (Aust.), the Association of Radio Amateurs, who had been functioning in the interim as the Amateur body, were given permission to use the name Wireless Institute of Australia, New South Wales Division. This permission was obtained mainly by the efforts of the then President and Secretary, F. M. Goyen, 2UX, and R. H. W. Power, respectively. In 1937, the charter was handed back to the Amateurs, and since that time the Council has been carrying out certain formalities made necessary by present day requirements. The Divisional Vice-President, W. Ryan, VK2TI, has been the driving force in the Divisional Council's efforts to re-

gain the charter, and it was fitting that he should be in the chair at this first meeting under the original charter.

VK2TI in his remarks, stated that Council were very gratified to know that their efforts had at last been rewarded, and he felt sure that many of the older members of the Division shared this gratification. Unfortunately, the ban on transmissions marred the rejoicings, but members should realise that once hostilities cease, there will be a well organised and representative body ready to take up cudgels on behalf of the hams.

No ballot was necessary for the election of Council only seven nominations being received. They were as follows: Messrs. Ackling, Carruthers, Fraser, Goyen, Peterson, Ryan and Treharne. These members will be elected to their respective positions prior to the February meeting.

VK2RA, Ray Priddle, delivered a very interesting lecture on a subject somewhat removed from Radio. 2RA is a member of the leading firm of structural engineers in Sydney, and he chose for his subject "Some Considerations in the Design of a Modern skyscraper." Judging by the number of questions the Lecturer had to answer it is quite certain that his talk was one of the most interesting delivered.

An old timer present at this meeting was Arthur Simmonds, VK2GS, and he was given a hearty welcome by the Chairman.

A FEW PERSONAL PARS.

VK2AHM.—Jeff Whyte, of V beam fencing wire antenna faire, way out at Wentworth, feels lonely occasionally, so rings up Tubby Vale, 3MK, and has a qso per medium of the landline. Jeff is also a little peeved about the ban on transmissions as he was anxious to make the DXCC with his 6 watts input.

VK2TJ — Way up at Groot Eylandt is beginning to wonder what its like to feel cold. He reckons our heat waves would be classed as blizzards up at his qth. Roger would be pleased to hear from any of the lads. Qth. Aeroradio Station Flying Boat Base, Groot Eylandt.

VK2EO.—Dave, that old DX hound, is pounding brass "somewhere in Australia," and has some great ideas about his new rig when he gets back on the air, and would be pleased to hear from any of the gang. Correspondence should be addressed c/- Box 1734 JJ, G.P.O., Sydney.

VK2AFJ.—Several enquiries from the La Perouse district have been made regarding the whereabouts of John. Wonder why?

VK2RA.—Finding time heavy on his hands these days has decided to become engaged. All the best, Ray. One thing about it, you'll be able to bring your Qsl's up to date now. Hope all your troubles are little ones.

VK2PF.—Fred has been bitten by the high fidelity (?) bug. Invites the gang to high brow recitals of records. Enjoying much better health these days. No doubt it's the amplifier.

VK2TI.—At a long last has received a card from Utah. Very pleased about it. Why?

It has been rumored that the R.A.A.F.W.R. had to order an outside in parachutes for a certain very well known VK2.

VK2AJF.—John Field, way down in Deniliquin is complaining of the cool (?) weather, and is sympathising with the gang in V.I.S. they've only had three days with a temperature over a 100 degrees. John heard a K6 working KC4USC, the Snow Cruiser, and is anxious to get back on the air again.

N.S.W. DIVISIONAL NOTES.

The February General Meeting of the Institute was held as usual at Y.M.C.A. Buildings, Pitt Street, Sydney. The Chairman announced that Councillors — who had been elected unopposed — had now been appointed to their various offices. These were as follows:—

President: H. Peterson.
 Vice-Presidents: F. Goyen and W. G. Ryan.
 Secretary: C. Horne.
 Treasurer: H. Ackling.
 Publicity Officer: W. G. Ryan.
 Technical Officer: R. Treharne.
 Magazine Manager: R. Treharne.

The Meeting was informed that the Morse Code Classes had been re-organised, and that Messrs. Priddle and Ryan would in future be in charge on alternate Tuesday nights. Meeting was informed that it had been decided to fall in line with other bodies doing this work, and that a small charge would be made to each student. These classes are held every Tuesday night at Y.M.C.A. Buildings, Pitt Street, Sydney, and are open to all. A Beginners' class commences at 7 p.m., and Advanced class (10 words per minute and over) at 8 p.m. Further particulars may be obtained by ringing FX 3305.

It has been decided to present all Members going abroad with any of the Fighting Services with a letter of introduction, written in several languages, to the various National Societies that it is thought that they may possibly come in contact with.

Upon the conclusion of General Business, a very interesting and instructive lecture entitled "Cathode and Frequency Modulation," was delivered by the Technical Officer, Ross Treharne. In his talk, 2IQ gave ample evidence that he had made a deep study of this subject, and upon conclusion members showed their appreciation in no uncertain manner.

KEY SECTION NOTES.

By VK3CX.

The attendance at the March K.P.S. meeting was not as good as was expected, only 26 turning up, but amongst those were three distinguished visitors in the form of VK3YS, VK2TQ, and ZL2SK. One thing that this war has done is to bring to our meetings large numbers of hams from distant places, thus giving the locals a chance to see what the other men look like.

ZL2SK gave some very interesting information to a group of interested listeners about ham conditions in New Zealand, and although they are, or were, permitted to use 100 watts, I think we are much better off here in Australia with the multitudinous privileges which our Radio Department allows us.

Our "Ole Bill," not of better hole fame, but just famous as 3WG, was the main item on the programme, and after telling the boys how very close we were to receiving permission to transmit on 2½ metres—actually it was only a matter of the Admiralty say either "Yes" or "No," and they

happened to pick the wrong word — he proceeded to give us the low down on "Photo Electric Effect." A most interesting lecture, which was illustrated in no mean style by JO, whose motto is "We can't show all the pictures, so we only show the best." Bill's lecture was most favorably received, and those who didn't attend certainly missed something worth while.

RJ (the acting chairman) distributed some QSL cards. At one time he used to bring the QSL's to the meeting in a heavy suit case, but now he just pops them into his vest pocket. Strange as it may seem, he still suffers ham QRM, just ask him about it. He gave some interesting dope about a few misguided coots who are breaking their necks to get into one of the nice cells at the local Gaol, all through their idea that transmitters are meant to be used.

A monitoring scheme was inaugurated under which about a dozen of the boys are going to listen for one hour two nights each week and the results will appear in this month's magazine.

XS was recently reading a love story in which the conversation turned to a radio programme, and the heroine said that her reception of same was marred by dots and dashes from one of the local amateurs down the street. Must have been a prewar story.

FR is still trying to get his receiver to work so that he can hear all the rare DX, while IW spends some of his time listening to the DX that he would like to work. HK is still trying to locate an 1852 tube to finish off his new receiver—he hopes to have it finished by the time the war is over. IG says there is no truth in the rumor that his 90 feet tower has been loaned to the local birds to build their nests in. XJ doesn't know whether to be happy or sorry about the fact that the gang picked him out for a ham when he was 200 yards away. They said they knew him by his walk—guess its another case of too much keying with the left foot.

RX has not been seen his engagement was reported in the local papers, and ML apparently has not yet recovered from his honeymoon. QV has an excellent recipe for a concoction which he calls a "rum teaser"—next time you see him near a pub ask him about it and MAYBE he will invite you in to try it.

CX had an interesting letter from

G4AW, who is on a warship in these waters. He hopes to be along to a meeting in the near future. CX has been doing a spot of listening, and has heard a few who caused his trigger finger to itch, amongst them were AC4YN at s7, HI3M, YV5ABY, and numerous CE, LU, PY, HH, J8, KH6 and KB6. Wont there be a rush for the key as soon as the ban is lifted.

The 15th of the month saw a very convivial gathering at one of the local pubs. HC, WG, OC, CX and a couple of others had gathered to help RX drown his sorrows in view of his forthcoming nuptials. After a highly successful dinner, the night was finished at the Tivoli Theatre. RX received a suitably engraved pewter pot and loads of good advice from the married men present.

Next month we are promised a lecture on "Audio Recording" complete with records and hot music. It should be worth while, so don't forget to turn up.

QUEENSLAND DIVISION.

By VK4LT.

The monthly meeting of the Queensland Division of the W.I.A. was held on Thursday, the 25th January, at Headquarters, Diggers' Assoc. Rooms, Adelaide Street.

About half a dozen of the usual Die Hards rolled up, regardless of the terrific heat which we have been subjected to for over 10 days past.

The dress worn would have suited a picnic party rather than a meeting of former famous hams. But we just had to keep cool.

Mr. A. Walz (VK4AW) presided.

The meeting got organised after Herb (VK4ES) arranged the fan to everyone's satisfaction, about 8.15 p.m. Members present included: AW, RY, XO, KK, OK, ZU, ES, JF, KS, LT.

The chairman welcomed VK's 4OK, KK and XO, all country boys now in the Big Smoke.

After this was discussed, a Card Sorting Party took place, and the Boys received their few paltry Cards (luxuries).

The Technicians told us all about the Mystery German Station, and how it was worked. Better not mention names in case Adolf tries to contact them Hi' Hi'.

Then at 9.30 the heat drove the members to the newly found Refreshment House, and there the party told tales and cooled off till about 11 p.m., having had quite an enjoyable evening.

All members should note meetings are held on the last Thursday of each month at H.Q. Diggers' Rooms, Adelaide Street, opp. Anzac Park, so how about coming along and keep the gang together.

Any news regarding what some of you boys are doing now would be appreciated by the Scribe, and don't complain if the notes are short this time, as I have been out of circulation for three months.

VK4KS.—Keith now a member of the Australian Corp of Signals, and going into camp for three months. Be like old times, Keith, with a key to play with, but no Mikes Hi'.

VK4XO.—Mark in the City now before QSYing to VK2 for his further exams. Best of luck.

VK4OK.—Jack, the 8 Watt 'fone lad, from the Woolly West, on Service in the R.A.A.F. in Brisbane. Key Puncher.

VK4KK.—Also a Wire Op. in the R.A.A.F. at Brisbane with Jack.

VK4ES.—Herb now well married. Main past time is "guzzling" Ice Cream. Also VK4 Fan expert.

VK4CJ.—Member of the R.A.N. over in DX lands. After some old QSL. Cedric. Hi'.

VK4RF.—Fred also a member of R.A.N. in VK3 Depot at present.

VK4ZU.—Howard swatting up on Photography. Dearer hobby than Radio, boy.

VK4FB.—Fred now a first-class Grass Cutter. He spends his spare time motoring in his Baby Flea.

VK4LT.—Back in circulation after 13 weeks' Brass Pounding in a nearby Fortress. Trying hard to dig up notes to write for the Mag. So let's have any dope you have, Boys.

VK4SN.—Sa Frank, posted u a ltr before Xmas, but it's come home agn. Hrd u had shifted. Let's hve all the dope, OM.

VK4LT.—I'm making radio pay at last. Since back frm Camp, flat out fixing B.C. sets abt the district. Wud like to hr sum dpe frm country Hams.

VK4 DIVISION.

By VK4LT.

The Monthly Meeting of the Queensland Division (VK4) was held at H.Q. in Essex House, Adelaide

Street, on Thursday night, 29th February officially, but owing to a certain member forgetting the key to the Room, the gang gathered in a nearby posh looking cafe, and it was here our Hon. Chairman, Mr. Arthur Walz, presided over a very enjoyable meeting.

Although the weather was damp, the hard-heads rolled along as usual. These included VK4's AW, RY, ZU, HR and Friend Eric, JF, ES, LT, XO, PX and UU.

Business was dealt with between milk drinks and Peach Melba Sundaes, Hi'.

Final arrangements were made for the Treasure Hunt to be held on March 9th, and all Members are to be at H.Q. on Sunday at 0930.

Then the burning question of the Annual Dinner was discussed, and it was decided to hold it on the second Friday in April, the 12th, at Atcherly House, this being subject to confirmation after our next Monthly Meeting.

All members are invited and we ask all to make a special effort to attend our next Monthly Meeting, on Thursday, 28th March, to finalise matters.

Then, after Tibby, 4HR, and Eric had finished their big fat cigars, the bill was met by our prosperous Chairman, AW, and the meeting closed about 10.30 p.m.

Still looking for dope from you Country Hams, so what about slipping some along to this lad?

So don't forget the Dinner, gang, and don't forget to let us know who is coming.

VK4JF.—Jack never misses a meeting. Pity a few more like u OM.

VK4XO.—Mark vy interested in YL's Club Meeting, also held in our Select Cafe Meeting, Hi'.

VK4HR.—Tibby and his friend, Eric, smoked stagnant cigars during the meeting, much to the discomfort of members. Reckons he sold the Modulator to get 'em. Must had a lot of change. Hi'.

VK4JM.—Just hrd this poor chap-pie has now an XYL. Best luck, OM.

VK4JX.—Jack vy busy racing abt in his car, keeping B.C.L.'s satisfied.

VK4JB.—Oscar back in the sheep country. Wonder if he ever dreams of DX out there.

VK4GA.—Now has shifted to Westbrook I hr.

VK4JP.—George spending a holiday at Southport, then motoring south. Half ur luck this wx, OM.

VK4UR.—Jack, I hr is building an amp wid pr of pp 807's. Are u building a picture show to go wid em also, pal? Just think of the neighbours. Hi'.

VK4KS.—Keith pretty hot stuff wid rifle in camp. Ask XO.

VK4PX.—Arthur awaiting patiently fer WAC certificate. Also keen on sailing.

VK4RY.—Bill has another verified country, ES. Cards still cmg thru'. Still sees we get A.R. each month.

VK4MC.—Real talkie expert.

VK4KH.—Bill just listens and thinks wat he wud only do if——.

VK4FB.—Fred has plenty of "Time" on his hands to keep him gng. Hi'.

VK4AW.—Doesn't tell a bad yarn. Ask Herb.

VK4ZU.—Mac still keen on his Photography.

VK4FL.—Wat abt a visit next Meeting, Frank?

VK4UU.—Motor bike Bill still manages to balance our budget fer us.

VK4ES.—Herb spending time, money and worry (if possible) on his Baby—the Car.

VK4OK and KK.—These two lads still W/O's in R.A.A.F. in Brisbane at present. Gess cudnt wangle leave the last Meeting. Hope u both can wangle the Dinner OK.

VK4FY.—Believe to have gone to Camp.

VK4DM.—Another stranger. Hw abt a Meeting, Dave?

VK4TH.—Gess under water while writing these Notes. Here's hping all well, OM.

NOTES FROM MT. GAMBIER.

By 5CJ.

VK5TW is away in Adelaide on holidays at present. Tom has been instructing radio class in morse code and theory of radio.

VK5BN has ben called up in 21 years of age group and is stationed with the 3rd Light Horse Regiment at Mt. Gambier. Graham was very disappointed when war was declared as he had just finished a new rig and had 460 volt D.C. installed. The rig was never used.

I have been using my modulator equipment for P.A. work. At present I am getting the B.B.C. news in the evenings for local station. Twice weekly I have been taking a morse class at radio club. I have also found time to clean up the shack. Tell any of the hams at Laverton that they will always receive a warm welcome if they call in when they are over at the Mount on a flight.

—VK5CJ.

(Continued from page 10)
occasionally in test work. The cathode ray tube and vacuum tube voltmeter are similar in that neither instrument draws any appreciable current from the circuit to which it is connected. The oscillograph gives a picture of the wave form of voltage or current in the circuit under test. It does not, however, give any measure of amplitude and therefore comparative measurements are quite difficult to make with this type of equipment.

The vacuum tube voltmeter, on the other hand, reads potential or voltage drop across a resistor or condenser but will not give a picture of the wave form. As most of the measurements that the serviceman encounters are in connection with amplitude the vacuum tube voltmeter is in general of greater value than the oscillograph. Actually, when measurements of wave form are taken on an oscillograph there is not a great deal that the serviceman can do about altering that wave form. The single exception to this is that of flat topping intermediate frequency transformers in superheterodyne re-

ceivers. This particular procedure can be carried out with an oscillator and an output meter but of course a better picture of conditions is obtained with the oscillograph.

Other measurements on receivers can, of course, be made with the oscillograph showing pictures of the wave form at different points in the receiver, particularly in the audio circuit. However, when attempts are made to obtain readings of gain per stage, a.v.c. action, or oscillator r.f. potential, no accurate measurements in volts can be taken. In addition, the vacuum tube voltmeter will read d.c. potential directly in volts whereas on the oscillograph a shift in position of the axis will be the only visible effect.

With these facts in mind it appears that the oscillograph and the vacuum tube voltmeter will run concurrently in service work, but to the average serviceman it is felt that a great deal more use can be made of the vacuum tube voltmeter, as most of the measurements are in volts, either r.f., a.f., or a.v.c.

FINISH.

Correspondence Section

Torquay, Vic.,
Feb. 1, 1940.

Dear Sir,

I am enclosing an interesting extract from the T. and R. Bulletin, connected with the new Regulations in England.

"Extract from Defence Regulations, 1939."

"In pursuance of the powers conferred upon him by the Defence Regulations 1939, the Postmaster General has issued an order prohibiting the acquisition or supply of wireless transmitters and certain other electrical apparatus except under the authority of a Post Office Permit.

"Applications for permits should be made on special forms which can be obtained from any Head Post Office.

"The following is an extract from the order: 'No person shall, except under the authority of a permit granted by the P.M.G. for the purpose, sell, purchase, let, hire, supply, dispose of, acquire or distribute any of the undermentioned articles:—

'(a) Wireless transmitters which are designed to be used or are capable of being used for communicating by wireless telegraphy, wireless telephony or wireless television or for the purpose of indicating position or direction (such as navigational beacons or landing beacons) or for the purpose of the remote control of machinery.

'(b) The following articles intended for use as parts of wireless transmitters, namely, high frequency inductors, spark coils, quenched and rotary spark gaps.

'(c) Any wireless receiving apparatus which is designed to be used also as a wireless transmitter or which can be adapted for the purpose of being used as a wireless transmitter by the operation of a switch or by the charging of screwed or plug connections.

'(d) Line carrier telegraph equipment or line carrier telephone equipment.

'(e) High frequency equipment (being equipment which generates or uses high frequency current at frequencies greater than 10,000 cycles per second and having a maximum output exceeding 10 watts) including

such equipment intended for use in connection with furnaces and medical apparatus.

(f) Electronic valves capable of an anode dissipation exceeding 10 watts.

'(g) Piezo electric quartz plates or piezo electric tourmaline plates cut to oscillate at any specified frequency.'

VK5RN.

5 Waimea Street,
BURWOOD, N.S.W.,
9/3/'40.

The Editor,
"Amateur Radio,"

Dear Sir,

I would like to draw attention to certain inaccuracies in the article "Resistance Coupled Amplifiers" of "Amateur Radio," December, 1939. On page 11, in the formula (eqn. 2) giving the ratio of amplification at high frequencies to amplification at medium frequencies (r_h), the term $\frac{R_a}{X_{cs}}$ should appear SQUARED, that is—

$$r_h = \frac{1}{\sqrt{1 + \frac{(R_a)^2}{X_{cs}}}}$$

Similarly in equation 3.,

$$r_l = \frac{1}{\sqrt{1 + \frac{(X_{cc})^2}{R_b}}}$$

where r_l is the ratio of amplification at low frequencies to the amplification at medium frequencies.

Further, in equation 1.,

$$X_c = \frac{1}{2 \pi f C}$$

where X_c is the capacitive reactance in ohms of a condenser of C farads, at a frequency of f cycles per second.

Yours sincerely,

Ross F. Treharne, VK2IQ.

HAMS

WHEN REBUILDING YOUR RECEIVER
REPLACE YOUR OLD SPEAKER WITH

AMPLION

THE NEW 12in. ELECTRICALLY WELDED
SPEAKERS

MODEL	Air Gap Flux	Weight of Magnet	POWER OUTPUT. Undistorted—Max		Diameter	PRICE
V	8,300	12 ozs.	10 watts	15 watts	12 $\frac{3}{16}$ "	£2 3 0
VL	9,000	22 ..	13 ..	20 ..	12 $\frac{3}{16}$ "	£2 16 0
VP3	12,000	64 ..	20 ..	30 ..	12 $\frac{3}{16}$ "	£5 10 0
VP2	9,000	20 ..	12 ..	18 ..	12 $\frac{3}{16}$ "	£3 6 6
VPI	7,500	14 ..	8 ..	12 ..	12 $\frac{3}{16}$ "	£2 10 0

Types V and VL are Field Type Speakers.
Types VPI, 2, 3 are Per-Magnetic Speakers.

**SILVERED
MICA**

T. C. C.

**CERAMIC
CONDENSERS**

T.C.C. Silvered Mica Condensers are guaranteed to maintain their capacity under all temperatures, thus insuring no frequency drift in Supers. The foil is actually plated on the mica.

We can supply these Condensers in any per cent. of accuracy, including 0%.

The Capacity Range is from 10 mmf to 800 mmf.

LIST PRICE, 1/- EACH.

We are Agents for—

I.R.C. RESISTERS.

T.C.C. CONDENSERS.

AMPLION SPEAKERS.

BRUNO MICROPHONES.

BIRNBACH INSULATORS.

TRIMAX TRANSFORMERS.

**AUSTRALASIAN ENGINEERING
EQUIPMENT CO. PTY. LTD.**

476 Latrobe St., Melb. Phone: F 5585

Let us quote you for your
PRINTING REQUIREMENTS



The House of Good Printing

**285 - 287 LATROBE STREET,
MELBOURNE, C.I**

Opposite "The Argus" Office

Telephone MU 2897 After Hours FU 6795

H. HEARNE & CO. Pty. Ltd., Printers, Melbourne

AMATEUR RADIO



Published in the interests of the Wireless Institute of Australia, Official Organ of all divisions of the W.I.A. and R.A.A.F.W.R.



PRICE

6^d

MAY, 1940

WESTON *Instruments*

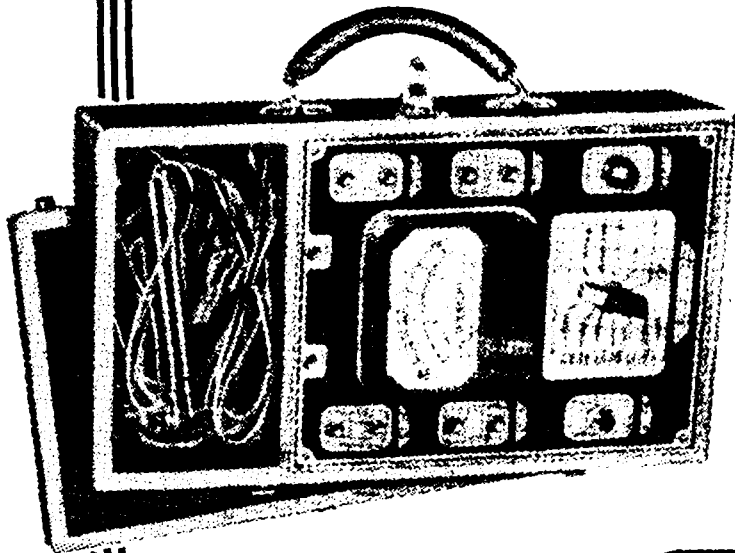

Left—

MODEL 772 TYPE 2 ANALYSER. A keenly priced quality analyser—sensitivity 20,000 ohms per volt D.C., 1,000 ohms per volt A.C.—for measuring A.C. and D.C. volts — D.C. current only — Decibels and Ohms (Ohmmeter entirely battery operated). Accurate within 2% on D.C.; 1,000 volt range 3%. A.C. accuracy within 3%. AVC, AFC, diode and grid currents also accurately measured.

Right—

MODEL 669 VACUUM TUBE VOLTMETER. A true vacuum tube voltmeter in every respect. Measurements obtainable on frequencies from 40 cycles to 50 megacycles. Guaranteed accuracy 3% at low frequencies—not more than 6% at 50 megacycles; operates directly from any 105-130 volt, 42-60 cycle line (a 230/115 volt transformer supplied with instrument if required), a neon bulb being used to keep line fluctuations out of the instrument circuit. Ranges: 0-1.2-3-6-8-12-16 volts full scale. Multiplier extends ranges to 12-30-60-80-120-160 volts full scale.



Warburton Franki have complete stocks of all radio and testing equipment. Write, 'phone or call for full particulars. Enquiry entails no obligation.

Warburton Franki

(MELB.)
LTD.

380 BOURKE STREET, MELBOURNE, C.1.

MU 6355.

OPEN FRIDAY NIGHTS TILL 9 P.M.

AMATEUR RADIO

Published in the Interests of Radio Amateurs and
Experimenters throughout Australia.

VOL 8. No. 4.

1st MAY, 1940

OUR ORGANISATION

Publishers.—

WIRELESS INSTITUTE OF AUSTRALIA
(Victorian Division)
191 Queen Street, Melbourne, C.I.

Editorial Department.—

W. R. GRONOW (VK3WG),
Editor.

R. H. CUNNINGHAM (VK3ML)
Technical Editor.

C. SERLE (VK3RX)
Notes Editor.

V. E. MARSHALL (VK3UK)
Compilation.

H. N. STEVENS (VK3JO)
Distribution.

L. T. POWERS (VK3PS)
Secretary.

Advertising Department.—

BEDGGOOD ADVERTISING CO.,
129 William Street, Melbourne.
Phone: MU 4046

Sydney Representative—

J. H. FRASER

8 Deakin Avenue, Haberfield. UA 1725.

Printers.—

H. HEARNE & CO. PTY. LTD.,
285 Latrobe Street, Melbourne, C.I.

Accounts Department.—

LARGE & POWERS,
Chartered Accountants (Aust.),
422 Collins Street, Melbourne.

MSS and Magazine Correspondence
should be forwarded to The Editor,
"Amateur Radio," Box 2611W, G.P.O.,
Melbourne.

Subscription Rate is 6/- per annum in advance (post paid).

NOTE.—Advertisers' change of copy must be in hand not later than the 20th of the month preceding publication, otherwise the previous month's copy will be reprinted.

CONTENTS.

	Page
Editorial - - - - -	3
Radiatron Senior Amateur Receiver - - - - -	4
High Fidelity Auditorium Permanent Magnet Moving Coil Repro- ducers - - - - -	7
Short Wave Broadcasting Stations - - - - -	12
Microphone Types - - - -	15
Federal and Victorian Q.S.L. Bureau - - - - -	17
Short Wave and DX Sec- tion- - - - -	18
Divisional Notes - - - - -	20
Waverley Radio Club - - -	22

IMPORTANT—

R.A.A.F. Vacancies - - 14

DIVISIONAL ADDRESSES.

FEDERAL HEADQUARTERS:
BOX 2611W, G.P.O., MELBOURNE

NEW SOUTH WALES:
BOX 1734JJ, G.P.O., SYDNEY.

VICTORIA:
BOX 2611W, G.P.O., MELBOURNE.

QUEENSLAND:
BOX 1524V, G.P.O., BRISBANE

SOUTH AUSTRALIA:
BOX 284D, G.P.O., ADELAIDE.

WESTERN AUSTRALIA:
BOX N.1002, G.P.O., PERTH.

TASMANIA:
BOX 547E, G.P.O., HOBART.

**You wouldn't put
solid tyres on a
Rolls Royce, so why
fit an ordinary loud-
speaker to a quality
set ?**

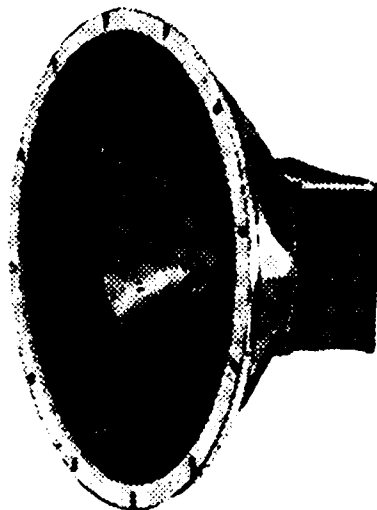

GOODMANS 10 INCH
HIGH FIDELITY SPEAKER

With your present loudspeaker you quite probably can't notice any difference between a studio broadcast and a session of recorded music.

Admittedly some of the latest vertical cut recordings are good, but there is always a difference between "potted" music and a live artist show when you use a GOODMANS QUALITY SPEAKER.

CALL IN AND HEAR ONE AT
J. H. MAGRATH PTY. LTD.,
208 LITTLE LONSDALE STREET, MELBOURNE.

WHOLESALE ONLY FROM THE AUSTRALIAN AGENTS:

TRIMAX TRANSFORMERS

(A DIVISION OF CLIFF & BUNTING PTY. LTD.)

29-35 FLEMINGTON ROAD, NORTH MELBOURNE

F 9127 (3 LINES)

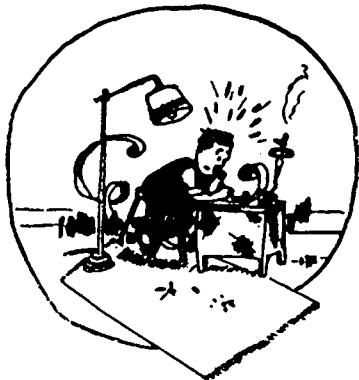

EDITORIAL

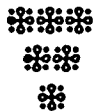

MR. J. M. MARTIN'S APPOINTMENT AS CHIEF INSPECTOR WIRELESS.

We record with sincere pleasure the fact that Mr. J. M. Martin's appointment as Chief Inspector Wireless, has been confirmed by the powers that be.

His genial personality, not always readily apprehended through his official communications, is already known and appreciated by every official of the W.I.A., not forgetting those few amateurs who have been fortunate or unfortunate enough, as the case may be, to have received an invitation "into the presence" for some fatherly advice.

Which advice by the way is designed to ensure a reasonable interpretation of the "Regulations," coupled with a sincere desire to give the amateur a "fair go."

We feel that this appointment ensures a continuation of that co-operation which the W.I.A. has always possessed with the P.M.G.'s Department. We all sincerely wish him every success in his new office.

BANNED TECHNICAL PUBLICATIONS.

The Customs Import Licensing Regulations are here in force, and how—. It is not too strong to say that we are horrified to observe that such outstanding publications as Q.S.T. — Electronics — Radio, etc., were placed on the prohibited list, except for individual subscriptions. These overseas technical magazines are one of the few things that an intelligent community must have, if it is to advance in Radio and Electricity.

No country, especially Australia, which is striving to build up its secondary industries, can afford to prevent any of its intellectually minded citizens from improving their technical knowledge, by making the purchase of these magazines more difficult. Also we feel that such readers are definitely penalised from purchasing these publications by annual subscriptions, which is difficult to produce in a lump sum, whereas a monthly purchase from a bookstall is hardly missed from the pocket of the humblest worker. We can do without some of the questionable overseas literature exhibited so freely to-day, but not, definitely not, without our leading American technical publications.

This subject will be taken up by the W.I.A. with the Controller General of Customs at Canberra without delay.

AUSTRALIAN AIR LEAGUE.

The Victorian Division has offered to conduct Instructional Classes for members of the above Society, with a view to training the personnel in Wireless Telegraphy. The course will cover elementary radio and electricity, paying particular attention to morse code and operating procedure. These classes will be held in the Division's Rooms one night each week and should prove of great value to those participating. A small charge will be made, and it is anticipated that about thirty students will be enrolled.

Although the standard will not be quite as high as that necessary for the A.O.C.P., it will, however, provide the students with a good basic training in radio, thus fitting them to undertake operational duties in their own organisation.

Radiotron Senior Amateur Receiver

Extracted from "Radiotronics" No. 102.

Nearly three years ago we described a receiver which had been constructed in our laboratory and which was then believed to be ideal for amateur reception of 'phone and C.W. During the past few months we have received many requests for information on this receiver, together with any comments which we could make to bring it more up-to-date. Since we have not yet been able to carry out the necessary extensive development work for a new receiver we are pleased to describe in this article the features which we would consider desirable in such a new design. At some future date we hope to complete this design and describe the receiver in Radiotronics.

The Radiotron Senior Amateur Receiver was described in Radiotronics 75 (30th April, 1937), pages 30 to 34. For the benefit of those who do not have this copy available the valve arrangement is listed below:—

R.F. Amplifier	Radiotron 956
Mixer.....	Radiotron 6L7
H.F. Oscillator	Radiotron 6D6
Noise Silencer	Radiotron 6L7
Noise Amplifier	Radiotron 6C6
Noise Rectifier	Radiotron 6H6
1st I.F. Amplifier	Radiotron 6D6
2nd I.F. Amplifier, Diode Detector and BFO Mixer.....	Radiotron 6B7S
Beat Frequency Os- cillator	Radiotron 6J7
A.V.C. Diode and Audio Amplifier	Radiotron 75
Power Output	Radiotron 42
Magic Eye Tuning Indicator.....	Radiotron 6G5
Power Rectifier.....	Radiotron 80

When the Senior Amateur Receiver was in the process of design it was realised that a single R.F. stage using type 6D6 did not have sufficient gain to give low noise level on the highest frequency band (30 Mc/s). Consequently a single Acorn valve (type 956) was adopted as giving improved gain under these conditions without necessitating the use of a four-gang condenser. Subsequent experiments with regeneration,

either in the mixer or in the R.F. stage, showed that, as a means of increasing R.F. sensitivity it was subject to certain disadvantages in that it had a serious effect on the tuning and on the image ratio as well as necessitating an additional control. It became obvious that, for a receiver of high sensitivity, two R.F. stages are highly desirable. If a suitable four-gang condenser is not available it should be possible to make use of a combination of two 2-gang condensers suitable for ganging. If two R.F. stages are used there is no necessity for using Acorn valves, since type 6U7-G will give reasonable gain at all frequencies, having the additional advantage of being Australian made.

The frequency converter stage is one which may be arranged in many ways. The original receiver used type 6L7 with a 6D6 oscillator; this was quite satisfactory and may be used with confidence. It has the disadvantages that the 6L7 is not Australian made and that a separate oscillator valve is essential.

Types 6J7-G and 1851 are both excellent as mixer valves, but are critical with regard to oscillator voltage; they also introduce complications in the circuit design.

Type 6K8-G is excellent in many respects and does not require a separate oscillator. With two R.F. stages the somewhat higher noise level of this type would probably not be noticeable. A further advantage is that full A.V.C. may be applied with negligible frequency shift during fading.

Type 6A8-G may be used with a separate oscillator.

Type 6J8-G has many good features and, all factors considered, would probably be our first choice in a new design. It is now Australian made, it does not need a separate oscillator (except perhaps below 13 metres), it has excellent oscillator frequency stability provided that A.V.C. is not applied to its signal grid, and has a very low noise level.

It has the disadvantages of being degenerative and of introducing loading on the tuned grid circuit, although with two R.F. stages these effects should not prove serious. Plate tuning of the oscillator would probably be justified.

Type 6J8-G is in principle the same as the 6L7 with a separate oscillator, but the grid of the oscillator is internally connected to the third grid of the mixer. The performance is comparable with that of the 6L7 and some slight advantage over the 6L7 exists at the highest frequencies owing to the short leads and direct connection of the oscillator to the mixer section. The conversion conductance is slightly lower than that of the 6L7.

Crystal Filter and Noise Silencer.

The crystal filter is highly desirable for C.W. reception under difficult conditions but, as much listening is done on 'phone only, some users may prefer to omit the crystal altogether and thereby to save one valve. If the crystal filter is omitted the noise silencer as originally used may also be omitted, since its principal intention is to prevent "ringing" of the crystal due to transient peaks. An audio frequency "level limiter" of satisfactory design is considerably cheaper and may be equally as efficient as the noise silencer operating at intermediate frequency. A satisfactory level limiter would require to be adjustable so as to cut at any required depth of modulation, and should ideally be automatically controlled by the A.V.C. so that its action is not affected by the strength of carrier. Limiting circuits using a valve such as the 6H6-G are well known, but at the present time we are investigating one which does not require the use of such a valve. If this is successful it will be described at a later date.

If the crystal filter is required for C.W. reception it is desirable for it to be protected by a noise silencer operating at I.F. In the original circuit the gain in the single stage noise amplifier was not sufficient to give operation on weak impulses such as the ignition interference from cars. A higher gain in this channel, or a circuit rearrangement to give the same effect if this is possible, would be desirable.

The I.F. Amplifier (apart from the

noise silencer stage which has very little gain) consists of two stages and experience has shown that the gain was unnecessarily high. Some form of flat-topping the I.F. transformers is very helpful when high selectivity is not required. A tertiary coil which may be switched in or out of circuit is simple to add to existing I.F. transformers, but its adjustment requires the use of a frequency modulated oscillator (wobbulator). If a two position selectivity switch is used, it is helpful to arrange matters so as to adjust the gain of the I.F. Amplifier, as the switch is moved, giving uniform gain in both positions. A subsidiary continuously variable I.F. gain control is an additional worthwhile feature.

The A.V.C. system as used in the original receiver could be improved by using a three or four position switch control of the time constant giving a very long time constant for C.W., a medium value for general use and a very short one for very rapid fading. The same switch could also be used for switching off the A.V.C.

A more elaborate tone control than that used in the original receiver appears to be desirable. One having independent control of bass and treble attenuation and three positions on each (including one with zero attenuation) should satisfy all requirements.

The layout of such a receiver is one of the most important factors in its satisfactory operation. The original receiver which was built in our laboratory was on a single chassis, and was rather cramped for space. As a separate loudspeaker is almost essential in any case (in order to avoid microphony) one practicable arrangement with many good features is to use one chassis for the tuner and a separate chassis for the A.F. Amplifier, Power Pack, etc., and Loudspeaker. Alternatively a single chassis and external loudspeaker may be used. Rigidity of the tuning chassis is essential for satisfactory operation, and nickel plated steel with solid brass bar reinforcement (as used in the original receiver) is recommended.

The coil switching arrangement presents some difficulties. If listening is restricted largely to one or two bands it may be practicable to use plug-in coils. Those who have experienced the pleasure of multi-

band switching will not relish the work involved in changing four coils each time the frequency band is changed. A multi-band switching system is often regarded as being too ambitious for the average amateur constructor, although in our opinion it is quite practicable. A compromise may be adopted in the combination of the two systems. For example, a three position switching system may be used, switching to either of two sockets for plug-in coils or to a fixed set of broadcast coils. By this means either of two short wave bands or the broadcast band may be switched in without any changing of coils. Various other arrangements could be adopted to suit the requirements of the individual constructors such as for example a three position switch covering short wave bands, of which one could be a plug-in coil and the other two popular bands such as the 20 and 40 metre bands, the coils of which could be permanently in circuit.

A satisfactory band spreading arrangement is essential for such a receiver. In the original receiver the band setting condensers were not ganged, but this arrangement has been found to be rather unsatisfactory and a ganged control will be used in any future design. This introduces additional complications, particularly if four tuned sections are required, as would be the case with two R.F. stages. In spite of these difficulties we are of the opinion that such an arrangement is desirable and practicable provided that the constructor is prepared to take the necessary trouble. We hope to say something further about a method of band-spreading for this receiver at some future date.

FEDERAL CONVENTION.

Owing to the war, with its consequent effect on all Divisions of the Institute, Federal Headquarters realised that there was no good purpose to be served by calling the usual Federal Convention which should have been held this year. At the present moment, adequate machinery is available between Divisions and F.H.Q. to adjust anything of a Federal nature, and it was felt that the expense of a convention would not be justified at the present time.



RADIOTRON VALVES are supplied in factory-sealed cartons — YOUR guarantee that the valve you buy is new. The carton must be destroyed to remove the original valve . . .

For more enjoyable radio entertainment



HIGH FIDELITY AUDITORIUM PERMANENT MAGNET MOVING COIL REPRODUCERS

By courtesy of "Trimax" Transformers Pty. Ltd. Agents for
"Goodman's" English Speakers.

The High Fidelity Auditorium Loudspeakers described in this bulletin have been developed with a view to producing, commercially, Loudspeakers which represent as high a standard of reproduction as present day knowledge permits.

The 12 inch Model is designed for use with inputs up to 12 watts peak, necessitating the use of a voice coil of not less than 1½ in. diameter. Such a rating, however, is unnecessarily high for domestic and light Public Address work, and so the 10 in. Model, fitted with a 1 in. voice coil is offered for inputs up to 6 watts peak. In designing the Goodman's Auditorium Loudspeakers, the following specifications was kept constantly in view:—

1. Level response.
2. Frequency range.
3. Reduction of sub-harmonics.
4. Transient response.
5. Elimination of Bass modulation of the upper frequencies.
6. Freedom from hum.

To obtain a flat response it is necessary to employ a magnetic field of high flux density, to damp down resonance due to the tension of the surround and centreing device. A flux density of 16,000 lines per sq. cm. was considered to be as high as commercially practicable for either a Permanent Magnet or Energised Field, so this figure was chosen as a basis for the 12 in. Auditorium Loudspeaker. In the case of the 10 in. Model, the highest flux density obtainable on a 1 in. pole, i.e., 13,000 lines per cm. is used. It was found essential to employ a special grade of material for the centre pole to carry the enormous flux density necessary to obtain this figure.

It was the designers' aim to construct instruments capable of reproducing frequencies from 50 cps to 12,000 cps without any audible peaks or dips in the output. Tackling the

lower register first, it was obvious that a fairly large cone would have to be used, to radiate a reasonable amount of power without undue axial movement of the diaphragm. Realising that it would be impossible to obtain real top response with a diaphragm of this construction, attention was turned to various types of "Tweeter Units." These worked fairly satisfactorily, but unfortunately their output was badly attenuated at frequencies below 3,500 cps, thus preventing the usual upper middle resonance to be filtered out from the large diaphragm speaker.

Experiments were then carried out with an additional small cone inside the main diaphragm, and as was anticipated, proved very successful. Not only was it possible to obtain a response up to 14,000 cps. but the usual 2,000 cps. to 3,000 cps. resonance was entirely eliminated, due to the damping action of the small cone on the voice coil. Considerable experimental work was entailed, to obtain the exact combination of sizes and angles of the two cones.

In the 10 in. Model, the Speech Coil is approximately 1 in. diameter and wound with sufficiently heavy gauge wire to efficiently carry the A.C. current supplied to it, having the optimum number of turns for the impedance of the coil. A 1 in. coil has also the advantage of lightness in weight, consequently extending the frequency range in the upper register. Due to the extreme lightness of the Voice Coil and Centreing Device, the Diaphragm assembly must also be light in weight. This is essential to obtain the maximum efficiency from the voice coil. By limiting the actual moving section of the diaphragm to a diameter of 9 in., a fairly rigid cone may be employed giving freedom from break-up and consequent reduction in sub-harmonics.

Reference to the response curves of Goodman's High Fidelity Twin

Diaphragm Auditorium Reproducers shows their practically level response from 50 cps. to 12,000 cps.

Particular attention is drawn to the decibel scale against which the curves are plotted. This must be taken into consideration if comparison with other published curves is made. The apparent falling off in output from 50 cps. downwards is attributable to the use of only a 42in. baffle for recording purposes. A baffle of this size is insufficient for full reproduction of the lowest frequencies. Actually, the speakers have a useful output from 25 cycles to 14,000 cycles in the 12 in. model and from 40 cycles to 14,000 cycles in the 10 in. model, although no actual measurements have been made for frequencies above 12,000 cps.

A very objectionable form of distortion prevalent with loudspeakers capable of reproducing high notes, is that due to the formation of sub-harmonics of the applied frequency. Such distortion manifests itself as harshness in the extreme top of the frequency scale.

Sub-harmonics, as their name implies are dividends of the original frequency, in contradistinction to harmonics, which are multiples of the original frequency. The cause of sub-harmonics has not been definitely established, but, the almost universally accepted theory can be defined as follows:—

If a strip of resilient material is fixed at one end, and pressure applied to the other, in a direction parallel to its longitudinal axis, the strip will bow in one direction. If now the pressure is released, the strip will not only return to its normal position, but owing to its momentum will tend to bow slightly in the opposite direction. If pressure is again applied to the end of the strip, before it has had time to return to its original position, the flexing will proceed in an opposite direction to that caused by the first pressure.

It will thus be seen that although we have applied two complete cycles we have only obtained one vibration of the strip. By the use of a curved sided or exponential cone, the effect described above, can be almost entirely eliminated. It is fairly obvious that if we start with a strip which, in its quiescent condition, is already curved, pressure applied intermit-

tently to one end will only tend to increase and decrease the amount of curvature. For the centre cone a curvature of comparatively small radius is necessary, whereas only a slight curvature is used in the main diaphragm, where sub-harmonics are not likely to be troublesome, due to the fact that the main diaphragm is only used to reproduce the lower frequencies. Another very desirable feature of the curved diaphragm is that owing to its increased radial rigidity, a very much lighter and thinner material may be used. The centre cone employed in these Auditorium Loudspeakers are specially impregnated under extreme pressure, thus forming a very hard and rigid, but extremely light diaphragm. (These exponential cones are fully covered by Letters Patent, Pat. No. 451,754).

The reproduction of transients (viz. the ability of the loudspeaker to follow the sudden rise and fall of the almost vertical wave front of a train of sound waves such as is radiated by percussion instruments) is governed almost entirely by the motion-al inertia of the coil and diaphragm assembly, and the damping action due, mechanically, to the centring device, and electrically, to the



10 inch Model Goodman Speaker.

magnetic field in the gap. The field creates a back e.m.f. in the coil which is 180 degrees out of phase with the input voltage of the signal, tending to restore the voice coil to its original position. The greater the field density the greater the damping action. Since the back e.m.f. is de-

pendent on the velocity of the coil and the field strength, it will be apparent that magnetic damping is superior to mechanical as in the latter case, the restriction of the centreing device will have an adverse effect on the low notes and will cause rectification or frequency doubling. On the other hand, magnetic damping has less effect on pure notes than on transients. Unfortunately, some form of centreing device is necessary to prevent the coil rubbing on the sides of the gap, but these Auditorium Speakers employ devices having long flexible arms, which only have a very slight restrictive effect on the movement of the voice coil. Considerable care had to be taken to ensure that the movement should be strictly linear over the maximum possible travel of the voice coil. The cause of motional inertia of the diaphragm can be divided into two classes, one due to the actual mass or weight of the coil, etc., and the other due to the mass of the air column acted upon by the diaphragm. It is obvious that the first difficulty can

only be dealt with by making the voice coil, diaphragm, etc., as light as it is possible with reasonable rigidity. The second difficulty is rather more troublesome to overcome but in the case of the Auditorium twin diaphragm Speakers, the motional resistance during the reproduction of transients is very materially reduced by introducing a compliance by means of a slight softening of the main diaphragm at its apex, so that the diaphragm does not respond to any sudden movement of the voice coil. This movement of the voice coil is transmitted direct to the centre diaphragm which is extremely light and rigid and has considerably smaller area than the main diaphragm and is therefore admirably suited to the handling of transients. A noticeable feature of these Auditorium Loudspeakers is their ability to give smooth bass response with a simultaneously clear, crisp transient response, or attack.

Bass modulation of the upper frequencies is the cause of a very unpleasant form of distortion which

GOODMANS

HIGH FIDELITY

LOUD SPEAKERS

FOR

1. Level Response.
2. Wide Frequency Range.
3. Reduction of Sub-Harmonics.
4. Good Transient Response.
5. Elimination of Bass Modulation of the Upper Frequencies.
6. Freedom from Hum.

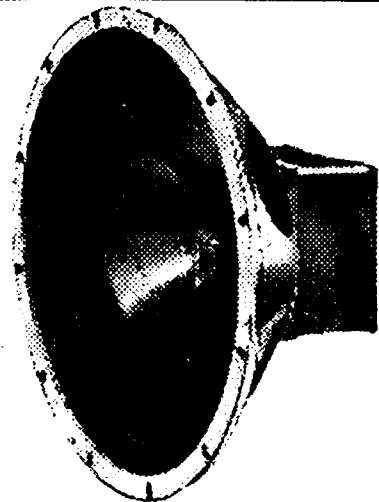

GOODMANS 10" HIGH FIDELITY LOUDSPEAKERS.

CALL IN AND HEAR ONE

J. H. MAGRATH PTY. LTD.

208 LITTLE LONSDALE ST., MELBOURNE.

Cent. 3688

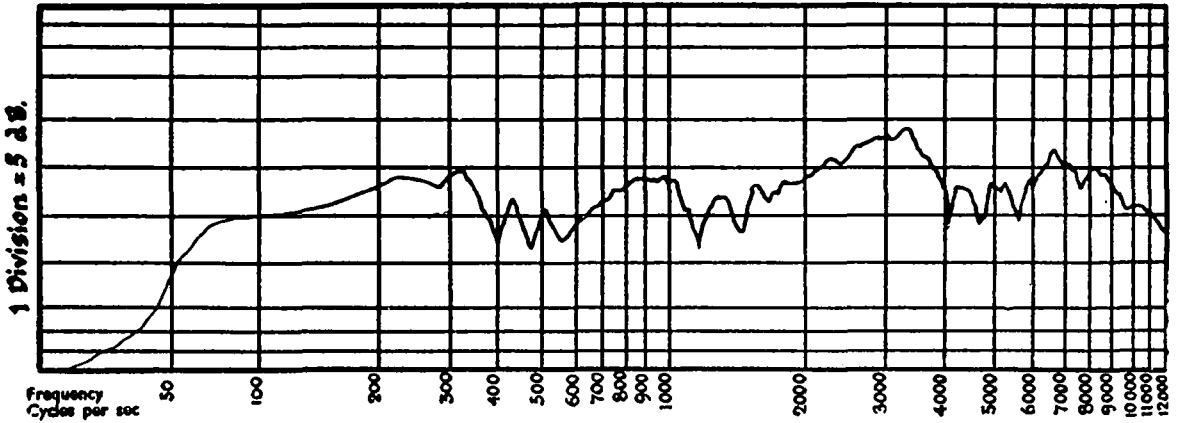

12 inch High Fidelity Twin Diaphragm AUDITORIUM Loudspeaker.

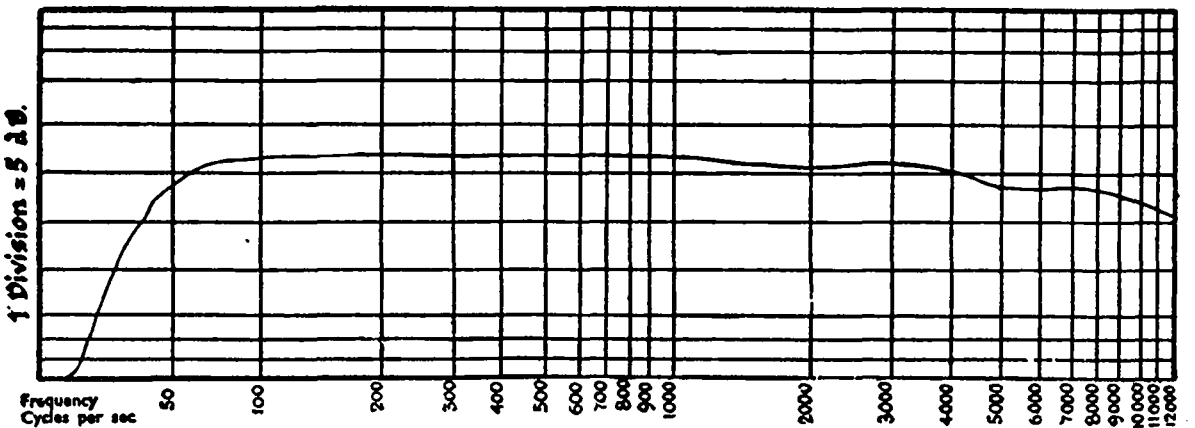

AUDITORIUM Output Transformer. Heavy Duty type for 2 P.X. 25 Voles P/P.

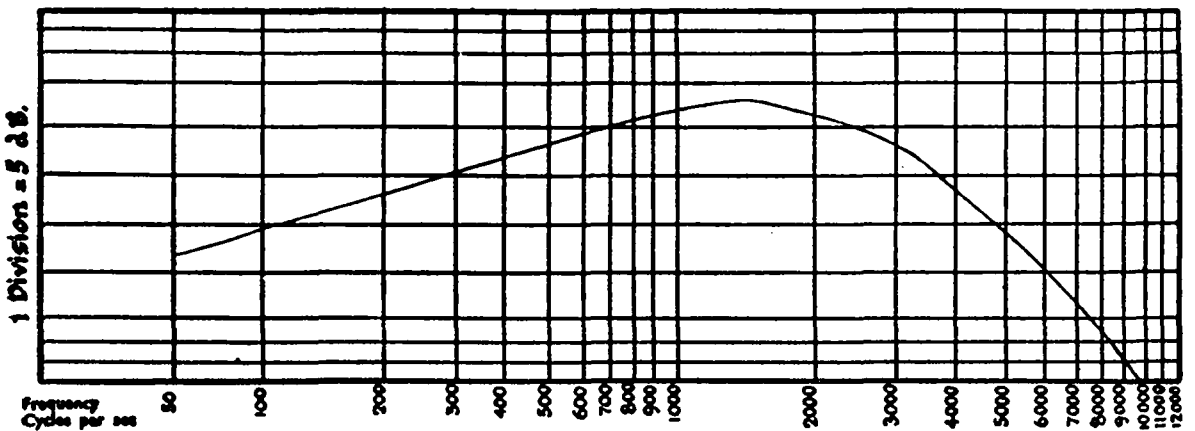

Typical 5 Valve Super-heterodyne RECEIVER.

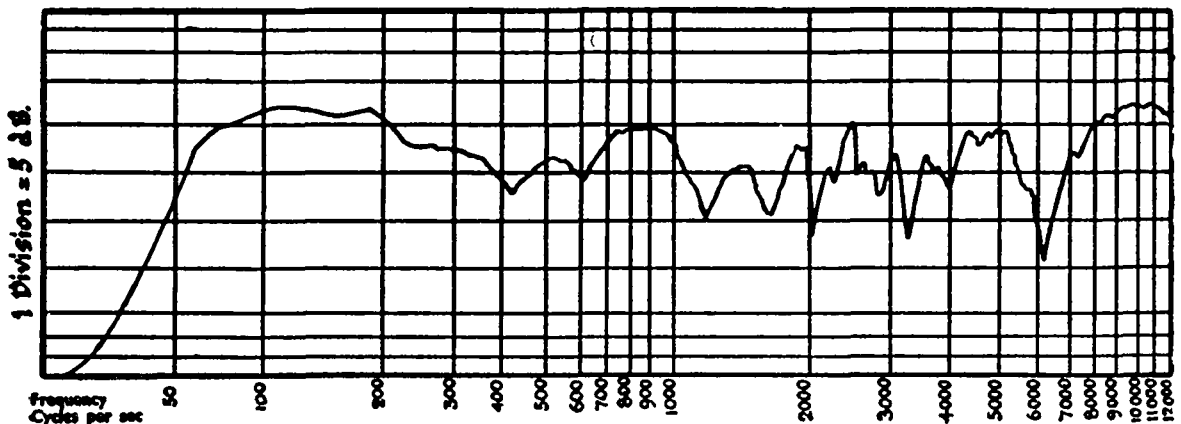

10 inch High Fidelity Twin Diaphragm AUDITORIUM Loudspeaker.

manifests itself as a ripple superimposed on the high notes. It very often gives a "throttled" tone to the reproduction. This is caused by the voice coil, during its axial travel at low frequencies (where the movement is at a maximum) cutting a magnetic field of varying intensity. Assuming a coil the same length as the gap, and with the coil at rest, the whole of the coil will be acted upon by the magnetic field, but immediately the coil starts to move, some of the turns will pass outside the field, or at any rate into a field of very much lower flux density. Since the driving force exerted by the coil on the diaphragm is the product of the flux, turns and current, a reduction in the flux means a reduction in the driving force. Take for example, a 50 cps. note with 1000 cps. note superimposed on it. During one half cycle of the 50 cps. vibration of the voice coil starting from the centre of the gap, or in other words through a phase angle of 180

degrees, the result will be $\frac{1000}{50 \times 2}$

equals 10 complete cycles of the 1000 cps. note. But each cycle will be gradually decreasing to a minimum and then increasing in intensity from the previous cycle, so that instead of reproducing a steady note at 1000 cps. we shall have a note with its intensity varying at the rate of 100 cps. This may be remedied either by arranging that the coil is very much longer than the gap, or that the gap is very much longer than the coil. In the first case a similar number of turns of wire is always in the gap, whilst in the second the coil is operating in a field of constant strength since the coil does not travel beyond the end of the gap. Both these methods cause a diminution in sensitivity, but owing to the greater axial length of the gap required for the second method, a much larger magnetic system is required to supply the increased total flux. In the Auditorium Speakers the first method is employed, to overcome the difficulty with the greatest economy of field strength. It has generally been presumed that Energised Moving Coil Loudspeakers are superior to Permanent Magnet types. The question of flux density is governed by the amount of magnetic material employed. Prior to the introduction of special alloys it would have been

necessary to employ enormous magnets at prohibitive prices in order to obtain flux densities approaching those obtained by energised loudspeakers.

In designing the Auditorium Loudspeakers it was decided to fit Permanent Magnets, provided flux densities, at least equal to those of large energised speakers consuming 30 watts in the field, could be obtained. These densities were standardised as 16,000 lines per sq. cm. for the 12 in. model using $1\frac{1}{2}$ in. diam. pole, and 13,000 lines per sq. cm. for the 10 in. model using a 1 in. pole. By the use of nickel aluminium cobalt alloy, it was found possible to obtain these flux densities, in either specified gap. It is safe to assume that very few large energised speakers receive the full energising current recommended by their manufacturers, owing to the expense and difficulty of installing the necessary equipment. A Permanent Magnet however, is constantly giving its full flux density, and except in the case where an accumulator is used for supplying the field current, the Permanent Magnet has the very definite advantage of minimising any tendency for a 50 cps. or 100 cps. hum.

To operate either of these twin diaphragm Auditorium Loudspeakers successfully, it is necessary that a high grade receiver or amplifier be used. The output stage should have a large reserve of power, to keep the percentage of second harmonic down to an absolute minimum. Owing to the extreme efficiency in the upper register of these Auditorium Loudspeakers, any harmonic distortion present in the amplifier will be immediately apparent and will appear as a rattle in the loudspeaker. Two medium slope triodes working in push-pull and having a combined output of 10 to 12 watts are strongly recommended for the 12 in. model. In the case of the 10 in. speaker, the use of a single 6 watt medium slope triode has proved very successful. It is advisable to incorporate some form of variable selectivity device in the high frequency side of the receiver, so that when possible, full advantage may be taken of the maximum side bands transmitted.

Where the speaker is intended for the reproduction of gramophone records, it is absolutely essential to employ a "scratch" filter. This should, for preference, be variable.

SHORT-WAVE BROADCASTING STATIONS OF THE WORLD IN ORDER OF FREQUENCY

Reprinted from "The Wireless World."
With acknowledgments.

Stations of which the names are "indented" are working outside the regular broadcasting bands.

Station	Call Sign	Mc/s	Ms.	Station	Call Sign	Mc/s	Ms.
49-Metre Band (6.00-6.20 Mc/s)				Sydney (Australia)	VK2ME	9.59	31.28
Moscow (U.S.S.R.)	RNE	6.00	50.00	Athlone (Ireland)	—	9.59	31.28
Pretoria (South Africa) ..	ZRH	6.01	49.94	British Oversea Service	GRY	9.60	31.25
Zeesen (Germany)	DJC	6.02	49.83	Moscow (U.S.S.R.)	RAL	9.60	31.25
Moscow (U.S.S.R.)	RW96	6.03	49.75	Zeesen (Germany)	DXB	9.61	31.22
Boston (U.S.A.)	WRUL	6.04	49.67	Cape Town (Sth. Africa)	ZRL	9.61	31.22
British Overseas Service	GSA	6.05	49.59	Sydney (Australia)	VLQ	9.61	31.22
Motala (Sweden)	SBO	6.06	49.50	Budapest (Hungary)	HAD	9.62	31.17
Cincinnati (U.S.A.)	WLWO	6.06	49.50	Rome (Italy)	I2RO3	9.63	31.15
British Overseas Service	GSL	6.11	49.10	Wayne (U.S.A.)	WCBX	9.65	31.09
Wayne (U.S.A.)	WCBX	6.12	49.02	Vatican City	HVJ	9.66	31.06
Lahti (Finland)	OFD	6.12	49.02	Buenos Aires (Argentine)	LRX	9.66	31.06
Pittsburgh (U.S.A.)	WPIT	6.14	48.86	Rome (Italy)	I2RO9	9.67	31.02
Winnipeg (Canada)	CJRO	6.15	48.78	Zeesen (Germany)	DJX	9.67	31.02
Wayne (U.S.A.)	WCBX	6.17	48.62	Paris-Mondial (France) ..	TPA4	9.68	30.99
Schenectady (U.S.A.)	WGEO	6.19	48.47	Moscow (U.S.S.R.)	RW96	9.69	30.98
Vatican City	HVJ	6.19	48.47	British Oversea Service	GRX	9.69	30.96
Rome (Italy)	IAC	6.35	47.20	Buenos Aires (Argentine)	LRA1	9.69	30.96
Radio-Nations (Swit- zerland)	HBQ	6.67	44.94	Lisbon (Portugal)	CSW7	9.74	30.80
Valladolid (Spain)	FETI	7.07	42.43	Rome (Italy)	IRF	9.83	30.52
41-Metre Band (7.20-7.30 Mc/s)				Madrid (Spain)	EAJ7	9.86	30.43
British Overseas Service	GSW	7.23	41.49	Zeesen (Germany)	DZC	10.29	29.16
Tokio (Japan)	JVW	7.25	41.34	Buenos Aires (Argen- tine)	LSX	10.35	28.99
British Overseas Service	GSU	7.26	41.32	Lisbon (Portugal)	CSW6	11.04	27.17
Lisbon (Portugal)	CSW8	7.26	41.32	Radio-Nations (Swit- zerland)	HBO	11.40	26.31
Zeesen (Germany)	DXM	7.27	41.27	Moscow (U.S.S.R.)	—	11.64	25.77
Paris-Mondial (France)	TPB7	7.28	41.21	Rome (Italy)	IQY	11.67	25.70
Zeesen (Germany)	DJI	7.29	41.15	25-Metre Band (11.70-11.90 Mc/s)			
Moscow (U.S.S.R.)	RWG	7.36	40.76	Motala (Sweden)	SBP	11.70	25.63
Moscow (U.S.S.R.)	RKI	7.52	39.89	Paris-Mondial (France) ..	TPA4	11.72	25.60
Moscow (U.S.S.R.)	—	8.07	37.17	Winnipeg (Canada)	CJRX	11.72	25.60
Budapest (Hungary)	HAT4	9.12	32.88	Huizen (Holland)	PHI	11.73	25.58
Bucharest (Rumania) ..	—	9.28	32.33	Boston (U.S.A.)	WRUL	11.73	25.58
Radio Nations (Swit- zerland)	HBL	9.34	32.12	Vatican City	HVJ	11.74	25.55
Ankara (Turkey)	TAP	9.46	31.70	British Overseas Service	GSD	11.75	25.53
St. John's (Newfound- land)	VONG	9.48	31.64	Rome (Italy)	I2RO15	11.76	25.51
31-Metre Band (9.50-9.70 Mc/s)				Zeesen (Germany)	DJD	11.77	25.49
Belgrade (Yugoslavia)	YUC	9.50	31.58	Hsinking (Manchukuo) ..	MTCY	11.77	25.49
Lahti (Finland)	OFD	9.50	31.58	Saigon (French Indo- China)	FZR	11.78	25.47
British Overseas Service	GSB	9.51	31.55	Boston (U.S.A.)	WRUL	11.79	25.45
Melbourne (Australia)	VK3ME	9.51	31.55	Rome (Italy)	I2RO4	11.81	25.40
Paris-Mondial (France) ..	—	9.52	31.51	British Overseas Service	GSN	11.82	25.38
Schenectady (U.S.A.)	WGEO	9.53	31.48	Wayne (U.S.A.)	WCBX	11.83	25.36
Tokio (Japan)	JZI	9.53	31.48	Lisbon (Portugal)	CSW5	11.84	25.34
Motala (Sweden)	SBU	9.53	31.48	Zeesen (Germany)	DJP	11.85	25.31
Moscow (U.S.S.R.)	—	9.53	31.48	Budapest (Hungary)	HAD	11.85	25.31
Zeesen (Germany)	DJN	9.54	31.45	British Overseas Service	GSE	11.86	25.29
Vatican City	HVJ	9.55	31.41	Pittsburg (U.S.A.)	WPIT	11.87	25.27
Schenectady (U.S.A.)	WGEO	9.55	31.41	Sydney (Australia)	VLQ2	11.87	25.27
Zeesen (Germany)	DJA	9.56	31.38	Paris-Mondial (France) ..	TPA3	11.88	25.25
Pittsburg (U.S.A.)	WPIT	9.57	31.35	Melbourne (Australia)	VLR3	11.88	25.25
Millis (U.S.A.)	WBOS	9.57	31.35	Chungking (China)	XGOY	11.90	25.21
British Overseas Service	GSC	9.58	31.32	Moscow (U.S.S.R.)	—	11.90	25.21
Melbourne (Australia)	VLR	9.58	31.32	Moscow (U.S.S.R.)	RNE	12.00	25.00
Huizen (Holland)	PCJ	9.59	31.28	Zeesen (Germany)	DZH	14.46	20.75
				Radio-Nations (Swit- zerland)	HBJ	14.54	20.64
				Rome (Italy)	IQA	14.79	20.28

19-Metre Band (15.10-15.35 Mc/s)				Zeesen (Germany).. DZG 15.36 19.53			
Moscow (U.S.S.R.)	RKI	15.04	19.95	Budapest (Hungary) ..	HAS3	15.37	19.52
Rome (Italy)	I2RO12	15.10	19.87	Moscow (U.S.S.R.)	RW96	15.41	19.47
Zeesen (Germany)	DJL	15.11	19.85	16-Metre Band			
Vatican City	HVJ	15.12	19.84	17.75-17.85 Mc/s)			
Paris-Mondial (France) ..	TPB6	15.13	19.83	Zeesen (Germany)	DJE	17.76	16.89
Boston (U.S.A.)	WRUL	15.13	19.83	Huizen (Holland).....	PHI	17.77	16.88
British Oversea Service..	GSF	15.14	19.82	Paris-Mondial (France) ..	TPC3	17.77	16.88
Motala (Sweden)	SBT	15.15	19.80	Pittsburg (U.S.A.)	WPIT	17.78	16.87
Moscow (U.S.S.R.)	RW96	15.18	19.76	Bound Brook (U.S.A.)	WNBI	17.78	16.87
British Oversea Service..	GSO	15.18	19.76	British Oversea Service..	GSG	17.79	16.86
Lahti (Finland)	OIE	15.19	19.75	British Oversea Service..	GSV	17.81	16.85
Zeesen (Germany)	DJB	15.20	19.74	Rome (Italy)	I2RO8	17.82	16.84
Chungking (China)	XGOX	15.20	19.74	Wayne (U.S.A.)	WCBX	17.83	16.83
Ankara (Turkey)	TAQ	15.20	19.74	Zeesen (Germany)	DJH	17.84	16.82
Pittsburg (U.S.A.)	WPIT	15.21	19.72	Athlone (Ireland).....	—	17.84	16.82
Lisbon (Portugal)	CSW4	15.21	19.72	Paris-Mondial (France) ..	TPB3	17.85	16.81
Huizen (Holland)	PCJ2	15.22	19.71	13-Metre Band			
Podebrady (Bohemia)	OLR5A	15.23	19.70	(21.45-21.75 Mc/s)			
Paris-Mondial (France) ..	TPA2	15.24	19.68	British Oversea Service..	GSH	21.47	13.97
Boston (U.S.A.)	WRUL	15.25	19.67	Schenectady (U.S.A.)	WGEA	21.50	13.95
British Oversea Service..	GSI	15.26	19.66	Rome (Italy)	I2RO16	21.51	13.95
Wayne (U.S.A.)	WCBX	15.27	19.65	Philadelphia (U.S.A.)	WCAB	21.52	13.94
Philadelphia (U.S.A.)	WCAB	15.27	19.65	British Oversea Service..	GSJ	21.53	13.93
Zeesen (Germany)	DJQ	15.28	19.63	Pittsburg (U.S.A.)	WPIT	21.54	13.93
Delhi (India)	VUD3	15.29	19.62	British Oversea Service..	GST	21.55	13.92
Buenos Aires (Argentine) LRU	15.29	19.62		Wayne (U.S.A.)	WCBX	21.57	13.91
Rome (Italy)	I2RO6	15.30	19.61	Schenectady (U.S.A.)	WGeo	21.59	13.89
British Oversea Service..	GSP	15.31	19.60	British Oversea Service..	GRZ	21.64	13.86
Schenectady (U.S.A.)	WGEA	15.33	19.57				
Zeesen (Germany)	DJR	15.34	19.56				

U.R.D.

RADIOS and COMPONENTS

ARE EASIER to BUY

● Just over two years ago, U.R.D. had one floor comprising showroom, stockroom and office. To-day it occupies two large floors and, only recently, alterations were necessary in order to cope with the increased business.

WHY?

Just because more and more "VK's" and more and more dealers have found it easier and cheaper to buy from us — easier because of our large stocks, cheaper because our specialisation in Short Wave equipment enables us to buy more advantageously.

New Telephone Exchange Makes Buying Still Easier

Our new Rotary Telephone Exchange, the most modern procurable, with additional lines and extensions will save you time when ordering by 'phone.. Just dial MA 9251, when the switchboard will automatically put you through on a vacant line.. Try it—we like to hear from you.

United Radio Distributors Pty. Ltd.

234 Clarence St.,
SYDNEY.

Telephones:
MA 9251 (3 lines)

Telegrams:
URD Sydney

ROYAL AUSTRALIAN AIR FORCE

VACANCIES FOR MEN WITH WIRELESS OR ELECTRICAL QUALIFICATIONS.

Apply to your nearest Recruiting Centre for details of enlistment as:—

(1) **WIRELESS OPERATORS (For Training)**

FOR MEN WITH A SOUND EDUCATION AND WITH OR WITHOUT ABILITY IN MORSE CODE.

(2) **AIRCRAFT ELECTRICIANS (For Training)**

FOR MEN WITH GARAGE OR OTHER TECHNICAL EXPERIENCE.

INSTRUCTORS WANTED

Applications will be received from men for the following Civilian positions:—

(a) **MORSE INSTRUCTORS (Civilian)**

FROM EXPERIENCED TELEGRAPHISTS.

(b) **RADIO THEORY INSTRUCTORS (Civilian)**

FROM MEN WITH A SOUND KNOWLEDGE OF RADIO PRINCIPLES AND WITH EXPERIENCE IN HANDLING TRANSMITTERS.

Full Details may be obtained on application to:—

THE SECRETARY,

Air Board, Victoria Barracks,

Melbourne, S.C.1.

Microphone Types

By A. E. Walz (ex VK4AW).

The function of a microphone is to convert sound into electrical energy, and the quality of reproduction depends on the type used and its efficiency in its particular class. An amplifier can reproduce only that which is put into it, so it should be borne in mind that a little thought exercised in the choice of microphone equipment amply repays the user.

Of the five common types in wide use to-day, the single button carbon is the most common, being used in telephone, office, Deaf Aid and general communication where speech is the only important consideration. This type consists of a diaphragm which is actuated by the compressions and rarefactions of the air (sound waves) exerting a variation of mechanical pressure on a bank of carbon granules, usually placed between two carbon electrodes, one of which is attached to the diaphragm. The variation of pressure on the granules causes a corresponding variation of resistance to an external D.C. voltage applied with a subsequent variation of current through the microphone transformer primary.

The Double Button type is a variation of the previous mentioned, consisting of a very thin stretched diaphragm with carbon granule chambers on each side. This type gives better quality output than the single button variety with loose diaphragm, in that the stretched diaphragm's natural frequency is in the region of 8000 C.P.S., well up on the scale, and of its low, even harmonic distortion due to the old push pull principle.

Another variation of the carbon mike is the Reiss, which was so popular a few years ago. It consists briefly of a wide channel of high grade granules between two carbon or gold-plated brass electrodes embedded in a block of very "dead" material such as wood, marble being used in the better types, the granules being fronted by a mica diaphragm. The purpose of the diaphragm was not so much to impart sound pressure to the granules as to merely keep the granules in place, the sound pressure

acting directly on the granules. The output of this type is fairly low in comparison with the single button, and the energising voltage owing to the high resistance of the large area of granules. The Reiss was used extensively by nearly all Broadcasting Stations until quite recently, when better class mikes became readily available. They were used for both studio and outside broadcasts, and even now some broadcasting stations still rely on the Reiss for outside work. The main advantages are low cost, fairly good output, correct impedance for use on long leads, and ideal for speech frequencies. The main disadvantage of carbon mikes are high noise or hiss level, and inconsistent output due to "packing" and a tendency to "blast."

Another type, the Condenser, requiring more mechanical skill in its construction, has been used mainly in studio work, but has not been a very firm favorite in ham use. It briefly consists of a stretched thin Dural diaphragm, closely spaced and insulated from a perforated back plate (perforations to relieve back pressure), with an applied voltage in the region of 200 v. The mike acts as two plates of a condenser with its dielectric under constant strain by the applied voltage, any variation of capacity caused by sound pressure on the front plate, causing an A.C. voltage to develop, which is applied to the grid of a valve via the usual condenser coupling method. It is essential that this type have the following amplifier stage directly at the head of the condenser itself to prevent hum, R.F. pick-up and variation in capacity due to frail leads. The condenser type is sensitive to changes in barometric pressure and humidity, and in some cases the mike is used with a gas dielectric. Its disadvantages may be gleaned from the foregoing, and advantages chiefly entire absence of noise level and very high quality output. On good authority, railway whistles could be heard over a network using one of these mikes at a local studio, when same whistles could not be noticed by the announcing staff at the station.

The crystal microphone of the diaphragm type, which has gained such popularity among hams of recent years, depends for its action on a Rochelle salt crystal, which, when pressure is exerted in the form of bending the crystal, develops a voltage across alternate plates, actually grown into the crystal itself. The diaphragm, which is conical, is attached at its centre to the centre of its crystal, which is anchored at both ends to a solid base. The large surface area of the diaphragm on being agitated by sound waves, exerts a bending on the crystal, thus causing a voltage to be developed. The chief advantages are simplicity, reasonable output level and good quality. The disadvantages, chiefly in the earlier types, lies in the fact that the crystal could not withstand humidity and moisture, and had the bad habit of suddenly disintegrating.

The more costly type of crystal dispenses with the diaphragm and uses a number of crystals as cells connected in series parallel to increase the output level, the sound pressure being exerted direct on the crystals themselves. The cost of apparatus of this class, of course, is beyond the average ham, but it finds favour in broadcasting and recording studios.

The velocity or ribbon type, another which has been constructed and used by numerous hams, is of the inductor type, and depends for its action on a $\frac{1}{2}$ mil. corrugated strip of dural, actuated in a magnetic field. The same principle exists in an induction disc motor and in the movement of a millimeter, the coil of which is wound on an aluminium form, so that when the needle moves quickly an E.M.F. is set up in the former thus retarding or damping the swinging action of the needle as it comes to rest. The advantages of this type are ruggedness and high quality output and ability to cut down pick-up from side on and in the double ribbon types big reduction of audio feedback. Disadvantages are prone to pick-up stray 60 cycle hum from magnetic fields, R.F. pick-up, and boominess when spoken into closely, although this can be overcome. This type relies on the sound velocity affecting the ribbon rather than the sound pressure, hence the term "velocity microphone."

(To be continued).

METRO-GOLDWYN-MAYER'S NEW RELEASE "RADIO HAMS."

America's foremost hobby discoverer, Pete Smith, has found out what makes Amateur Radio appeal, and tells the story well in his new specialty for Metro-Goldwyn-Mayer in "Radio Hams."

"Radio Hams" opens with a view of amateur operator Jimmy Mulligan at work with his gear. He is thinking perhaps, Smith suggests, of duplicating the feat of a Z.L. ham, who saved the life of a noted M-G-M cameraman, Clyde De Vinna, while he was filming "Eskimo," in Alaska, in 1932.

A ham himself, De Vinna was conversing with a ZL friend thousands of miles away, when he was overcome by fumes from his coal stove. The ZL, realising that something was wrong, quickly contacted another "ham," who lived nearby, and secured his assistance. A doctor was called and De Vinna's life was saved.

Another thrilling episode to be seen in the film concerns an amateur who was in a plane during a hurricane in an attempt to locate a missing vessel. He managed to keep the entire Atlantic seaboard posted on his position. Just before sighting the ship, his plane ran out of gas, but he managed to radio the ship's position before he and his pilot crashed and were killed.

This picture shows some of the interesting sidelights of "ham" radio, and will prove of interest to all amateur operators.

The film will be screened at the following Victorian Theatres, and interstate readers are advised to watch for announcements of its screening at their local theatres.

"Camden," Caulfield, May 25-31; "Embassy," Malvern, May 25-31; "Westgarth," Westgarth, May 25-31; "Planet," Thornbury, May 25-31; "Moonee Ponds," Moonee Ponds, May 25-31; "Plaza," Ormond, June 1-7; "Waverley," East Malvern, June 1-7; "Balwyn," Balwyn, June 1-7; "Vogue," Hawthorn, June 1-7; "Gardenvale," Gardenvale, June 8-14; "Grand," Footscray, June 8-14; "Sun," Yarraville, June 15-21; "Village," Toorak, June 15-21; "Astor," North St. Kilda, June 15-21; "Glen," Glenferrie, June 15-21; "Orient," Heidelberg, June 22-28; "Empire," Brunswick, June 22-28; "Western," West Brunswick, June 22-28; "Town Hall," North Melbourne, June 22-28; "Port," Port Melbourne, June 29-July 5; "Kinema," Albert Park, June 29-July 5; "National," Richmond, June 29-July 5; "Burnley," Burnley, June 29-July 5; "Liberty," East Brunswick, June 29-July 5; "Plaza," Coburg, June 29-July 5; "Star," Preston, July 29-July 5; "Regal," North Essendon, July 13-19.

FEDERAL and VICTORIAN QSL BUREAU

R. E. Jones, VK3RJ, Q.S.L. Manager.
Amateur Licences retored in
Lithuania.

The L.R.M., the association of Lithuanian amateurs, who number 130, the transmitting licences being 64, report that their licences were suspended on 17th September, 1939, owing to the proximity of war. Many of the amateurs went into the army, and after the defeat of Poland and the restoration of Vilnius to the Lithuanians—Vilnius was taken from Lithuania by Poland in 1920—LY1J and LY1S provided valuable communication units for the government. Whilst in Vilnius, LY1J and LY1S visited what SP amateurs were still left, and found only a few, as most of the others had joined the Polish army. Licences were restored to Lithuanian amateurs on January 7th, 1940, the only condition imposed being that they did not work with belligerent countries. In normal times, LY hams must not use phone until over one year on cw has been fulfilled. The license also permits a power of 50 watts, but after two years it is possible to ask for and secure power up to 1000 watts.

The final list of cards on hand for VK3 hams is as follows:—

VK3CB, BG, DJ, EF, FW, FG, FZ, GN, GX, IJ, KX, LL, LM, NS, NP, PF, PH, UD, UP, VJ, VB, VD, VZ, VY, WT, XD, XP, XQ, XU, ZD, ZJ, ZR, KEC, GSJ.

These may be obtained from the Bureau in the usual manner.

A letter from G2MI, Q.S.L. Manager of the R.S.G.B., to this Bureau, presumes to give instructions and advice as to how a Q.S.L. Bureau should be run!!! Further advice is also tendered to the W.I.A. as to how it should run its affairs. Needless to say this bird is barking up the wrong tree and is a little behind the times with his reading, and as you may have suspected, has been told in no uncertain manner "just where he gets off."

One of our most unfortunate hams, VK3KV, who received his ticket, made six contacts, and then like the rest of us, lost his licence, has now announced the arrival of a junior op. We don't know whether the young fellow will ever learn the code—unless we get on the air after the war—but we hope so. Congratulations, om.

GERMAN AMATEURS USED AS PROPAGANDA STATIONS.

Amateurs all over the world have been wondering why certain German amateurs were allowed to remain on the air when war started. As more of them will shortly be on the air the following may be of interest.

From a reliable correspondent in U.S.A., VK3CX learns that D4BIU, who was until recently a student at Brown University in U.S.A., and who was on the Atlantic returning to Germany at the outbreak of war, has now obtained permission to come on the air again and according to this American amateur, he recently stated that a further 30 D stations would shortly be active. The German's main mission seems to be to work with as many American amateurs as possible.

The American amateurs have been asked by the A.R.R.L. not to
(Continued on page 19)

H A M S !

DO YOU WANT TO BE
BACK ON THE AIR ?



The Wireless Institute of Australia

is the recognised spokesman of the
AUSTRALIAN AMATEUR.

If you are not a member—

Join Now !

When the time comes that we can
reasonably expect to go back on the
air, we want to say that we represent—

EVERY ACTIVE HAM

in the Commonwealth.

Strengthen our hand by writing to The
Secretary of the Institute in your State
to-day.

All addresses are on the title page.

Short Wave and DX Section

SHORT WAVE AND DX SECTION.

We were pleased to hear from C. Wadsley, of Albert Park (Vic.), who gives us the following details:—

April 12th to 17th—

42 metre band—W, K6, KA stations heard at fine strength between 2100 and 2200 EST.

31 metre band.—Australians VLQ and VLQ5 both maximum strength, Manilla, Germany (where is the Ark Royal?) and Delhi. Best time to listen is from 2100 to 2400 EST.

The Delhi station gives news at 2230, for five minutes, which will enable you to identify it.

From K. Heitsch, 3HK, we hear that KZRM, on 31 metres, can be heard at 8.30 p.m. on news at good strength; also KZRD about 11 p.m. on the same band. On the 14th April, WCAG on 31 was fair strength at 9.45 a.m.

Paris, on 25 metre band, from 1.40 p.m., on Sundays, is worth while listening to, and in case your French is weak, there are announcements in

English, and news from time to time.

3HK reports also that 14 mc (20 metre) phone stations are still active. During the evenings of the week ending 18/4/40, the following were heard up till about 11 p.m.:—

XE1AC, XE2CX, CO2GY, KF6 JEG, K6MVA, KA1JH, W1FH, W1 JSG, W5KT, W3FJU, W5HXK, W8 SPU, W8IHP, W9GCH, W9QI, W9 UYB, KA1JJ, and J2XA.

On cw, XU5HR, KA1DM and the 2nd, 4th, 5th, 8th, and 9th U.S.A. districts were heard on 20.

Our thanks goes to our contributors for the above information, and we look forward to further news of general conditions, both good and bad, which will enable us to keep a check on conditions so that when the time comes for Australians to make themselves heard on the air, we will know the best bands.

As G2MI put it, "Wait till peace rages in Europe—!" He also tells us that the "G's" refer to the Hamburg announcer as "Lord Blitzspitch." Try saying it quickly!



The Power Equipment with a Powerful Reputation . . .

THE Organisation responsible for the production of . . .

**HILCO TRANSFORMERS
CHOKES, etc.**

has proved its high standards for an article of extreme merit as accepted by the largest consumers in Australia.

**ALL PRODUCTS GUARANTEED FOR
TWELVE MONTHS.**

HILCO TRANSFORMERS PROPRIETARY LIMITED

97-111 BERKLEY ST., CARLTON, N.3., Vic. 'Phones; F1661-2
CABLES & TELEGRAMS: "HILCOY," MELBOURNE.

IDENTIFICATION WANTED.

19.7 m., 1 a.m.-3 a.m. Opening chimes similar to those broadcast by our "A" class stations, 9 strokes, repeated at 10 sec. intervals for 10 minutes before time signal given on the hour. Fanfare of trumpets and completion of what appears to be news service, given alternately by man and woman. No English spoken in whole broadcast.

SHORT WAVE NOTES

By F. Smith.

The final week-end of March was extremely uncertain as far as short wave reception was concerned. Reports in the daily newspapers of a very severe magnetic storm affecting the whole earth were the cause of this.

Of interest to us who were hams and are now relegated to listeners is the following list of overseas hams working on 20 metres in a contest. Between R5 and R7 in strength:—These are heard regularly and at between W1GNO, PK1JR, XU8ZA, PK3GO, XU8AM, PK4OA, PK2AY, and PK4JO. Other hams were heard namely, KF6JEG, K6MVA, K6HZQ.

Commercial stations heard during the period ended 18/4/40 were:—XGOY, 25.21 m., late evening, good reception and constant. Saigon, 25.47 m. Early evening onwards. Excellent. JZI, 31.46 m. Late evening, fair strength, quality O.K. KGEI, 31.48 m. Late evening, fair strength, quality O.K. KZIB, 21.55 m. 11 p.m. onwards. Good strength, slow fading. HSP6, 37.56 m. Midnight onwards. Good strength, bad fading. XMHA, 25.32 m. Early evening. Fair reception, some fading. VUDZ, 31.28 m. Late evening. Speaker strength. Excellent. KZRM, 31.35 m. to 10 p.m. on Very strong, slight fading. JZJ, 25.42 m. 10 p.m. on. Fair strength, news in English, as with JZI at 10.30 p.m. KZRH, 31.06 m. Early evening, very strong. DJR, 19.74 m. Late evening, very strong. DJQ, 19.63 m. Late evening, good strength. GRK, 30.96 m. Late evening, fair strength. strength. DJH, 16.81 m. English ZHP, 30.96 m. Early evening, fair news at 10 p.m., fair strength. JWV3, 25.59 m. Late evening, fair strength. RV96, 19.76 m. 7 p.m. Not reported until 17/4/40. Moscow at fair strength.

Australian short wave stations heard at full speaker strength dur-

ing the evening are:—VLW2, 31.08 m. VLQ, 31.20 m., VLR, 31.29 m. Interference from static on the above list was not extremely severe.

Of interest to those "night owls" who like to do their listening in the "wee small hours," the following are given:—KGEI, 31 m. Midnight onwards. Reception is generally very good. News at 12.30 a.m. Rome, 25 m. Strong signal. English news, 1.30 a.m. Paris, 25 m. Strong signal. English news at 1.45 a.m. broadcast for North America.

Radio Saigon, 25 m. are very strong and relay the above news session. Listen for them.

KZRH, 31 m. Very strong and at 1.15 p.m., broadcast a request session, and ask for request numbers from Australian listeners. Well worth hearing. XGOY, after midnight, are fairly good on 25 m.

India (VUD), 25 m. English news 1.45 a.m. Good. MCC7 China, 25 m. Good strength around 1.15 a.m. KZRM, 31 m. Another old favourite. Close down 1.30 a.m. Australian S.W. stations carry on until about 1.30 a.m.

Acknowledgments to Mr. F. J. Miller and Mr. Barrasford for their very excellent lists from which the above were taken.

(Continued from page 17)

contact amateurs in belligerent countries, but this request has not been acted upon, and the Germans can be heard in daily contact with stations in the U.S.A. They are disseminating their propaganda in this method and the authorities here may well consider the advisability of permitting certain VK stations to come on the air solely for the purpose of combating this German attempt to build up friendships with neutrals.

Consider, for instance, the German amateurs contacting amateurs in U.S.A. alone—in the U.S. there are approximately 60,000 active amateurs. Continual contact with German stations will possibly lead the average American amateur (as well as his family and immediate friends) to come to the belief that his new-found friend in Germany is being very harshly treated by the Allied Blockade and the Allies generally. There is then born a new enemy to the Empire instead of a friend who may possibly be retained were he permitted the opportunity of contact with his old friends in Australia.

Divisional Notes

IMPORTANT.

To ensure insertion, all copy must be in the hands of the Editor not later than the 18th of the month preceeding publication.

N.S.W. DIVISIONAL NOTES.

The April General Meeting of the Institute was held at Y.M.C.A. Buildings on Thursday, 18th April. The attendance was excellent. The Divisional President, H. Peterson, VK 2HP, occupied the chair, and in opening the meeting extended a hearty welcome to Messrs. John Foldi, VK 4KT, of Papua. A. D. Boyle, ZL2VM and Malcolm Perry, ex-XCP, ex-A2MP and ex-VK2DG.

Members were informed that Council had received the resignations of Cec. Horne, 2AIK, from the Secretaryship, and Ross Treharne, 2IQ, as Technical Officer. These resignations were received with regret. 2AIK, who is in the Department of Education, found that his work in this field prevented him giving his whole attention to the Institute. Cec is a distinct loss to the Division, as during his term of office as secretary, he proved himself a very conscientious officer, whose only thought was the welfare of the W.I.A. Ross Treharne, 2IQ, is a student at Sydney University, and his studies, this year, preclude him from taking any active part in the affairs of the Division. It is expected that before very long Ross will have attained the degree of B.Sc.

Wal Ryan, VK2TI, was elected to the position of Secretary and Messrs. Alan Joscelyne, VK2AJO, and Fred Carruthers, VK2PF, were elected to the two vacancies on the Council.

Members were informed that the Division had not given up hope of getting back on the air, and that F.H.Q. had been written to pointing out that in the early days of the war that Government of South Africa had allowed the S.A.R.R.L. to have two stations on the air on Sunday mornings transmitting news to amateurs. Now the ban has been further lifted. Persons approved by the S.A.R.R.L. and found suitable by the authorities are now to be allowed to transmit.

The ban on publications from non-sterling countries was also pointed out to members, and particular reference was made to Q.S.T. and Radio. Members were informed that they would be able to obtain Q.S.T. through the Institute by forwarding postal note for £1/1/ for 12 months subscription. This, incidentally would be considerably less than the price paid to book stalls prior to the ban on importations.

It has been decided to make a presentation of a wallet with the Institute badge attached to all members of the Division serving overseas. In addition, a letter of introduction to the various national societies written in five different languages, will also be given members.

At the conclusion of general business, a very interesting talk was delivered by Mr. Malcolm Perry, ex-XCP, ex-A2MP, and ex-VK2DG. Malcolm is a foundation member of the Division, or perhaps I should say, the Institute, and was the first secretary, duly elected on the 14th March, 1910, at a meeting held at the Hotel Australia. Mr. Perry had for his subject "Pioneer Days," and traced the history of Amateur Radio from the year 1905 up to the time that he relinquished his position as secretary in 1923. Among many interesting points brought out in the talk was the fact that the Institute in 1911 furnished the radio operators for the Mawson Expedition to the South Pole. It was quite interesting to hear the first secretary of the Wireless Institute of Australia and the present secretary pointing out what the Institute did in the old days and what it did in the present age.

Upon conclusion of the lecture, a vote of thanks was moved by Mr. Carruthers, 2PF, and seconded by Ross Treharne, 2IQ, and carried by acclamation. Mr. Perry in his reply stated that he felt it an honor to be asked to address members of the Wireless Institute of Australia—the

oldest amateur body in the world today, and stated his willingness to again address members whenever they so desired.

VK4KT, John Foldi, from Papua, is bemoaning the cold(?) weather that he experienced here in VK2 since he came down late in February of this year. John by the way had an addition to the family recently, and is now the proud father of two junior ops. John also is an old timer and was dabbling in radio during the last war.

2YC is wearing a big smile these days. No more cards in the QSL bureau.

2ADE, Chas. Miller, has gone looking for the DX that he used to work. We don't know yet whether it is ZC 6EC or G6WY.

2TI. Wal would like to know the guy who drew that caricature in the T. and R.

2HP, Harold is tickled quite pink that after twenty-six years he will soon have a daughter in the family.

VICTORIAN DIVISION.

KEY SECTION NOTES.

By VK3CX.

The April meeting of the Victorian Division held some surprises—the main one being that RJ was at last heard on 'phone. The meeting opened with RJ in the chair, and an attendance of 25, the usual batch of QSL's were distributed and the gang were introduced to the main distinguished visitor of the evening, who was G6LU. He gave us a very interesting account of how English hams were closed down by the authorities at the outbreak of war, and what happened to their gear. One would almost think that G6LU was a dinkum Aussie by his command of their language.

The event of the evening followed—D.H. giving a most interesting lecture on how to make your own gramophone records. The apparatus used was demonstrated by its owner, S.B. in collaboration with D.H. which added materially to the edification and enjoyment of the gang. The best part of the night was when S.B. produced a blank disc and proceeded to make a recording of all the boys present at the meeting. 'Twas then that we lost faith in mankind for our one and only RJ—the maestro of the key

—was heard speaking into a mike—and let me tell you, he made a much better job of it than 95 per cent. of the 'phones that I have heard on the air. As soon as everyones' voices had been recorded, the machine was turned round and the record played back to the meeting. Much amusement was caused by the fact that the mike was particularly sensitive and picked up all the back chat that was going on around the room while speakers were pausing for breath. The meeting closed after 2300, everyone agreeing that it had been one of the best.

One of our foremost DXers has been bitten by a new bug—it's QK, who has been spending his time at Churchill Island fishing and shooting. You should hear him tell about the one that got away, and with the gun it's just another case of "run, rabbit, run!"

Everyone seems to be going bush—here's RN building a five roomed shack out in the mulga, complete with bell-birds as alarm clocks. SQ is building transceivers and selling them to the Forestry Commission, and TE has just returned from a 1500 mile trip in VK5 with a baby Austin and trailer.

And did you hear about the two ladies in London recently, said one, "Emma, dear, who knows with these 'ere hair raids we might both be blown into maternity." "Yus, dearie, and with these 'ere blackouts we won't know who did it neither!" Or maybe I shouldn't have mentioned it.

XJ has his own personal visiting cards printed now—ask him for one as they are well worth seeing. Incidentally, he has now built a regenerative preselector onto the front of his Hallicrafters SX16 and says it's fb. FR is building an amplifier and hopes to follow it up with a modulator—gawd knows what for. ZU says he heard some QRM on 20 metres band (personally I don't believe him), but says it was a W contest—don't you wish you were in it, too?

JO had a letter from 7KQ, which reveals that Gil is more fortunate than most hams in that he is still able to play around with transmitters. 7HT is the transmitter in question, and has been occupying most of Gil's time. However, he has promised to help us keep the mag. going and we can look out for a technical

article from him shortly. We wish there were more like him.

And did you hear the story that there is a big possibility of certain ZS stations being allowed back on the air again? Don't know how true it is but if they get back on there's hope for us yet. And in regard to this getting on the air business — don't let your enthusiasm run away with you like a certain interstate ham, who was heard working 40 metre 'phone with another state. He was caught, and I don't know what is gonna happen to him, but I, for one, wouldn't like to be in his cell.

SOUTH AUSTRALIAN NOTES,

During the last nine years I have seen many changes in the S.A. Division of the Institute, and I would not like to see the division fail for lack of interest. I remember the first meeting I attended was at the A.N.A., Flinders Street, introduced incidentally by Doug. Whitburn, 5BY; later we moved to Rundle Street, where we nested for quite a few years. I've seen many of the now ex-hams take the exams for their tickets and remember how much the socials we held on meeting nights were appreciated.

Many old members will recall that the ham tests we held were great successes.

So last year (April 19th, 1939) members decided to incorporate the W.I.A. in their State, and the Society of the W.I.A., S.A. Division was formed. The attendances were fine and everything was going well until, suddenly, comes the war, and away the members went to join various units.

As one of the Foundation members of the Society, I should like to remind such members as may be available, that only by their co-operation can we expect to keep the spirit of Amateur Radio alive in this State.

Some of the members still come along for code practice, but we need more.

We are holding our annual meeting, Wednesday, 17th April, so look for the report of this meeting to see how we intend spending the coming year.

WATERLEY RADIO CLUB TO CELEBRATE ITS 21st ANNIVERSARY

It was the year 1919. The Great War of 1914-18 was over. The Peace that was to be an everlasting one had been signed. The youth of the country was now free to lay down arms — arms that had been so valiantly carried — and to turn to the pursuits of Peace. Out came the football jersey, the cricket flannels, tennis racquets and hockey sticks. The more technical minded turned to their hobbies, and out Waverley district quite a few chaps were interested in the comparatively new science of Wireless.

Among these amateurs of those days—possibly looked upon as having some strange mental kink—were Frank Geddes, Jnr., Frank Leverrier, Eddie Bowman, E. Swinbourne, R. D. Charlesworth, Les Holdsgrove, Alan Burrowes, C. Doyle, G. Thompson and Malcolm Perry.

Wireless intrigued these young fellows and the procedure adopted to discuss the various problems associated with transmitting and receiving on 1100 metres (?) was for them to meet and discuss their troubles at the various homes. This was not satisfactory. Messrs. R. Charlesworth, F. Geddes, E. Bowman and Alan Burrows decided that the experimenters in the Waverley District should be organised.

On the night of January 27th, 1919, a meeting was held at the home of Mr. R. Charlesworth and the Waverley Amateur Radio was the outcome. Mr. R. Charlesworth was elected President, F. Geddes, Vice-President, and Alan Burrowes, secretary. Mr. F. Geddes Senior, made a room available at his residence, 13 MacPherson Street, Waverley, and from that date to the present time all meetings have been held at that address. A visit to the club-room to-day will show a wonderful display of real DX QSL cards. I have before me, by courtesy of Gordon Thompson, ex-2GT, the first license issued to the club and it differs quite a lot from the present day experimental license, not only that it costs £2, but the whole Regulations are contained in its five pages!

It was issued on the 18th August, 1921, and was numbered 249.

Prior to the issue by the P.M.G. of this license, wireless was controlled by the Navy, and permission had been granted to use 1100 metres, with a call sign using the prefix N followed by a serial number.

With the advent of Post Office control, wave lengths below 200 metres were made available to experimenters and the first transmitter using a VT1 with 90 volts on the plate was constructed by Messrs. Thompson, Leverrier and Geddes, and great was the excitement when a report was received from Campsie.

No doubt, if any of the foundation members had seen the fine exhibits of gear shown by the Club at the Exhibitions recently, sponsored by the New South Wales Division, their thoughts would have flown back to the VT1.

By 1922, the Club had made considerable progress, and in conjunction with the Wireless Institute of Australia, organised the Trans-Pacific tests with Californian amateurs. Through the courtesy of Malcolm Perry I was able to see one of the original entry forms. Entrance fee was ten shillings, and if you did not intend to take part you were asked to sign a declaration that you would not transmit during the period of the contest, which was an endeavour to hear American signals at stated periods. Almost 100% co-operation was received from non-participants. Just think of that. Fancy suggesting to some of the present day "ex-fone hounds" to observe a silent period during the VK-ZL, B.E.R.U. or A.R.R.L. DX Contests! Incidentally, the band used was 200 metres, and the contest was won by a ham at Ramsgate.

The next move was to 80 mx, and A2BV was one of the first calls on that band, which was considered U.H.F. in those days. The 80 mx. transmitter was built by Gordon Thompson. In the meantime a 70 foot mast had been erected, and great things were expected from the new receiver and antenna.

In its usual go-ahead manner the Club organised the VK-ZL Tests on 80 metres. This was a test for two-way communication, and was the fore-runner of the VK-ZL 80 mx contest now controlled by the N.Z. A.R.T. and the W.I.A. This initial

contest was won by Jack Davis, 2DS, of Watson's Bay.

Prior to the Trans-Pacific and Trans-Tasman Tests, the Club was well to the fore with its social activities. The first successful Radio Music Dance held in Australia took place at the Athenaeum Hall, Beach Street, Coogee, on 22nd September, 1922. Quoting from the programme, "The music will be transmitted by Mr. R. Allsop, Wireless Electric Company, Beach Street, Coogee. Mr. Allsop is also kindly installing his Magnavox, which shall be the means used to amplify the wireless music. The music received will be Pathe Sapphire Disc Records." Shades of Jim Davidson! Unfortunately, the licence held by 2YG did not cover the location from whence the transmissions were made, and several weeks after, Ray received a please explain from the R.I.! There must have been a Vigilance Committee even in those days.

Shortly after the 80 mx Trans-Tasman Tests, experiments were carried out by the Club, in conjunction with W. Cottrell, 2ZN, on five metres, using a Split Colpitts circuit, with 201A's as the oscillating medium. Experiments on wave lengths as low as 2½ metres, measured by Lecher Wires, were also made.

The first Club Journal was published sometime in 1924 and ran for approximately 18 months. A magazine was again published in 1934-1935, and the technical articles were of a very high standard.

Looking through some notes it would appear that during 1926 the burning topic among all Radio Clubs was whether they should affiliate with the W.I.A. Some remarks by Alan Burrowes are very illuminating in their frankness regarding the necessity for affiliation.

In 1933, the first Television transmission in Australia took place between the home of Mr. Pickering, VK2KI, located at North Bondi, and the Club Rooms, at Waverley. For some considerable time Mr. Gordon Wells and Mr. Pickering had been experimenting with mechanical scanning, and their efforts were brought to a successful conclusion on this winter night of 1933.

The first public demonstration of television in Australia was given at the Wireless Institute of Australia Amateur Exhibition, held at the

HAMS

WHEN REBUILDING YOUR RECEIVER
REPLACE YOUR OLD SPEAKER WITH

AMPLION

THE NEW 12in. ELECTRICALLY WELDED
SPEAKERS

MODEL	Air Gap Flux	Weight of Magnet	POWER OUTPUT. Undistorted—Max		Diameter	PRICE
V	8,300	12 ozs.	10 watts	15 watts	12 $\frac{3}{16}$ "	£2 3 0
VL	9,000	22 ..	13 ..	20 ..	12 $\frac{3}{16}$ "	£2 16 0
VP3	12,000	64 ..	20 ..	30 ..	12 $\frac{3}{16}$ "	£5 10 0
VP2	9,000	20 ..	12 ..	18 ..	12 $\frac{3}{16}$ "	£3 6 6
VPI	7,500	14 ..	8 ..	12 ..	12 $\frac{3}{16}$ "	£2 10 0

Types V and VL are Field Type Speakers.
Types VPI, 2, 3 are Per-Magnetic Speakers.

SILVERED
MICA

T. C. C.

CERAMIC
CONDENSERS

T.C.C. Silvered Mica Condensers are guaranteed to maintain their capacity under all temperatures, thus insuring no frequency drift in Supers. The foil is actually plated on the mica.

We can supply these Condensers in any per cent. of accuracy, including 0%.

The Capacity Range is from 10 mmf to 800 mmf.

LIST PRICE, 1/- EACH.

We are Agents for—

I.R.C. RESISTERS.

T.C.C. CONDENSERS.

AMPLION SPEAKERS.

BRUNO MICROPHONES.

BIRNBACH INSULATORS.

TRIMAX TRANSFORMERS.

**AUSTRALASIAN ENGINEERING
EQUIPMENT CO. PTY. LTD.**

476 Latrobe St., Melb. Phone: F 5585

Let us quote you for your
PRINTING REQUIREMENTS



The House of Good Printing

**285 - 287 LATROBE STREET,
MELBOURNE, C.I**

Opposite "The Argus" Office

Telephone MU 2897 After Hours FU 6795

AMATEUR RADIO



Published in the interests of the Wireless Institute of Australia, Official Organ of all divisions of the W.I.A. and R.A.A.F.W.R.



PRICE
6^d

JUNE, 1940

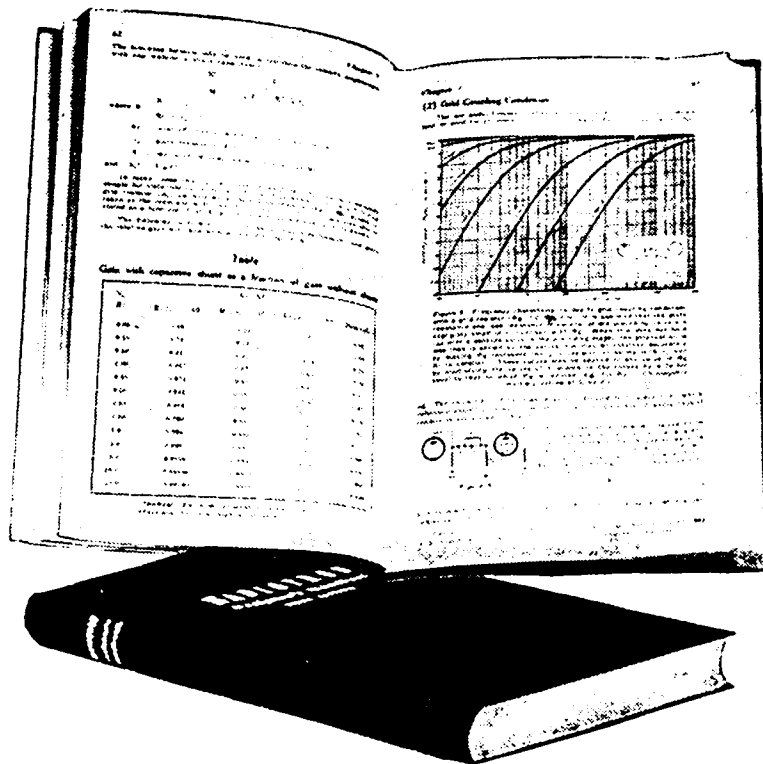

350 Pages in the RADIOTRON DESIGNER'S HANDBOOK

Between its covers, radio engineers, amateur experimenters, technicians and service men will find in the Radiotron Designer's Handbook, 40 chapters covering a wealth of technical information.

Over 300 diagrams deal exhaustively with the continually progressing science of radio. Special attention has been given to radio conditions and requirements in Australasia and a detailed cross reference index in alphabetical order is included.

Paper bound, 8vo, 3/- (postage 4d.), obtainable from
Booksellers and Stationers or direct from:—

**AMALGAMATED WIRELESS VALVE CO.
PTY. LTD.**

47 YORK STREET, SYDNEY - - - - - G.P.O. BOX 2516 BB

Cloth Bound Edition, 7/6 (Postage 6d.), obtainable only
from Amalgamated Wireless Valve Co. Pty. Ltd.

AMATEUR RADIO

Published in the Interests of Radio Amateurs and
Experimenters throughout Australia.

VOL. 8. No. 5.

1st JUNE, 1940

OUR ORGANISATION

Publishers.—

WIRELESS INSTITUTE OF AUSTRALIA
(Victorian Division)
191 Queen Street, Melbourne, C.I.

Editorial Department.—

W. R. GRONOW (VK3WG),
Editor.

R. H. CUNNINGHAM (VK3ML)
Technical Editor.

C. SERLE (VK3RX)
Notes Editor.

V. E. MARSHALL (VK3UK)
Compilation.

H. N. STEVENS (VK3JO)
Distribution.

L. T. POWERS (VK3PS)
Secretary.

Advertising Department.—

BEDGOOD ADVERTISING CO.,
129 William Street, Melbourne.
Phone: MU 4046

Printers.—

H. HEARNE & CO. PTY. LTD.,
285 Latrobe Street, Melbourne, C.I.

Accounts Department.—

LARGE & POWERS,
Chartered Accountants (Aust.),
422 Collins Street, Melbourne.

MSS and Magazine Correspondence
should be forwarded to The Editor,
"Amateur Radio," Box 2611W, G.P.O.,
Melbourne.

Subscription Rate is 6/- per annum in advance (post paid).

NOTE.—Advertisers' change of copy must be in hand not later than the 20th of the month preceding publication, otherwise the previous month's copy will be reprinted.

CONTENTS.

	Page
Editorial - - - - -	3
Infinite Baffle Type High Fidelity Loudspeaker -	4
Broadcast Music - - -	6
News in English from Abroad - - - - -	8
Short Wave and DX Section - - - - -	10
Divisional Notes - - - -	14
IMPORTANT—	
Volunteers for Signals A.I.F. - - - - -	3

DIVISIONAL ADDRESSES.

FEDERAL HEADQUARTERS:
BOX 2611W, G.P.O., MELBOURNE

NEW SOUTH WALES:
BOX 1734JJ, G.P.O., SYDNEY.

VICTORIA:
BOX 2611W, G.P.O., MELBOURNE.

QUEENSLAND:
BOX 1524V, G.P.O., BRISBANE

SOUTH AUSTRALIA:
BOX 284D, G.P.O., ADELAIDE.

WESTERN AUSTRALIA:
BOX N.1002, G.P.O., PERTH.

TASMANIA:
BOX 547E, G.P.O., HOBART.

**You wouldn't put
solid tyres on a
Rolls Royce, so why
fit an ordinary loud-
speaker to a quality
set ?**

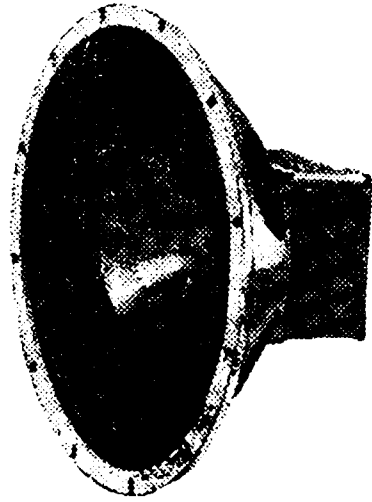

GOODMANS 10 INCH
HIGH FIDELITY SPEAKER

With your present loudspeaker you quite probably can't notice any difference between a studio broadcast and a session of recorded music.

Admittedly some of the latest vertical cut recordings are good, but there is always a difference between "potted" music and a live artist show when you use a GOODMANS QUALITY SPEAKER.

CALL IN AND HEAR ONE AT
J. H. MAGRATH PTY. LTD.,
208 LITTLE LONSDALE STREET, MELBOURNE.

WHOLESALE ONLY FROM THE AUSTRALIAN AGENTS:

TRIMAX TRANSFORMERS

(A DIVISION OF CLIFF & BUNTING PTY. LTD.)

29-35 FLEMINGTON ROAD, NORTH MELBOURNE

F 9127 (3 LINES)

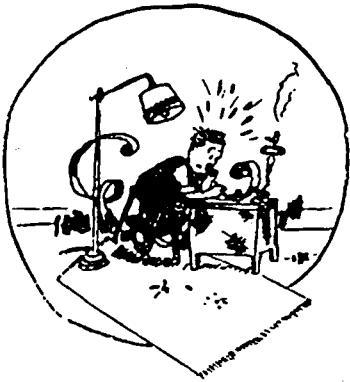

EDITORIAL



Owing to the increasing difficulty in obtaining copy for publication in "Amateur Radio," the magazine committee has now decided to adopt a new policy by printing technical articles from overseas journals which are not generally available to our readers. The committee feels that a digest of some of the better overseas publications which have been denied the technical reader, because they are not now available on the book-stalls, would provide both our readers and our magazine with technical articles of exceptional merit. This attempt to provide interesting and instructive reading will in no way debar our Australian contributors from forwarding copy to us, but it will enable us to produce the magazine more promptly, as we will have sufficient material available each month in order to go to press on time. Contributions from various listeners have shown an improvement this month, and we are anxious to increase this section. Interstate listeners are requested to forward notes of conditions on short waves together with lists of calls heard.

We have remarked before, and we will repeat, that it causes great discomfort to us to read in the daily press paragraphs relating the detection and punishment of amateur operators, who are using transmitting equipment contrary to the regulations. It seems to us that such cases misrepresent the position, as only one of the offenders appears to be the holder of an amateur operator's certificate of proficiency. These reports cer-

tainly detract from the fine effort of "Amateurs" generally, who have shown their patriotism by joining the services in such great numbers. Over seven hundred amateurs are serving, and we don't see why one thoughtless individual should spoil such a fine response. If you know anyone who is operating his equipment in this way, force him to stop for your own protection as well as the good name of Ham Radio.

VOLUNTEERS FOR SIGNALS A.I.F.

Volunteers are urgently required for enlistment in Signals A.I.F.

Qualifications.

A.O.P.C. desirable, but not essential.

Trades Required.

Radio Mechanic.

Linesman.

Telegraphist.

Instrument Mechanic.

Wireless Operator.

Pay for these trades is 7/- and 8/- per day.

Should you anticipate joining the 2nd A.I.F., we would be pleased to interview you at 8 p.m. at Signal Depot, Albert Park, on Thursday, 6th June.

Address enquiries by letter to—
ADJUTANT,

Signals, 7 Aust. Div.,

SEYMOUR.

“Infinite Baffle” Type High Fidelity Loudspeaker

By Courtesy of “Trimax” Transformers Pty. Ltd., Agents for “Goodman’s” English Speakers.

The problems involved in sound reproduction of frequencies, down to 40 cps., lie not only in the driving unit, but also in the method employed to couple the Unit with the surrounding air. The construction of Loudspeaker units capable of giving this response, without resonance, is comparatively easy. Unfortunately, it is impossible to operate such units satisfactorily, due to the enormous size of baffle or horn required for adequate air loading.

With large diaphragm type Loudspeakers, sound waves are radiated from both the front and rear of the diaphragm, and are 180 deg. out of phase with each other. When the air in front of the diaphragm is being compressed, that at the rear is being rarified. This causes air to travel from the front of the Speaker to the rear and vice-versa. Since sound is produced by variations of air pressure, it will be obvious that where the path from front to rear of the diaphragm is comparable to one quarter the wave length of the note being produced, very little radiation will take place. A baffle increases the length of the air path, but it will be realised that when the length of one sound wave at 40 cps. is approximately 27 ft., the difficulty of accommodating a suitable baffle becomes a practicable impossibility. The use of a horn offers very little, if any, advantage over a baffle, from the point of view of size. Theoretically, the diameter of the flare should be equal to a quarter the wave length of the lowest frequency to be reproduced. In practice, this can be reduced slightly, but not sufficiently to make a horn capable of reproducing frequency down to 40 cps., a domestic possibility. To overcome this difficulty, it is usual to so arrange the stiffness of the suspension of the diaphragm to produce a resonance in the bass. Below the resonant frequency this stiffness prevents damage to the diaphragm assembly, also reduces risk of bass modulation of the upper frequencies due to the

voice coil moving out of the magnetic field.

This method although reasonably satisfactory as a means of increasing bass response, unfortunately introduces resonances higher up the frequency scale, in addition to causing frequency doubling below the fundamental resonance frequency. Although comparatively small in magnitude, these resonances undoubtedly adversely affect the transient response, due to the tendency to artificially prolong the radiation of sound after the applied current has ceased.

Realising all these difficulties, Goodman’s thoroughly investigated the possibilities of “Infinite Baffle” type Loudspeakers. With these loudspeakers the radiation from the reverse side of the diaphragm is confined to an enclosed box. The idea is not new, but hitherto results have been unsatisfactory, due to the fact that loudspeakers of orthodox type, designed for baffle loading, have been used. With such a combination, reproduction is characterised by boominess and lack of low bass. This effect is often termed “box resonance,” and assumed to be the actual resonance of the materials used in the construction of the box. Provided, however, the box is made of fairly thick material, actual box resonance can be ignored. The actual cause of the trouble is of an entirely different nature.

When air is confined in an enclosed space, having a single orifice, the air in the orifice can be made to resonate at a particular frequency which is governed by the volume of air in the box and the area of the orifice. Such a system is termed a “Helmholtz resonator.” A common example of this effect may be observed when a current of air is blown across the mouth of a bottle. With a cabinet, having a loudspeaker unit mounted in one wall, the movement of the cone sets the air in motion, and at the resonant frequency of the system the sound output is considerably aug-

CONDENSERS and RESISTORS

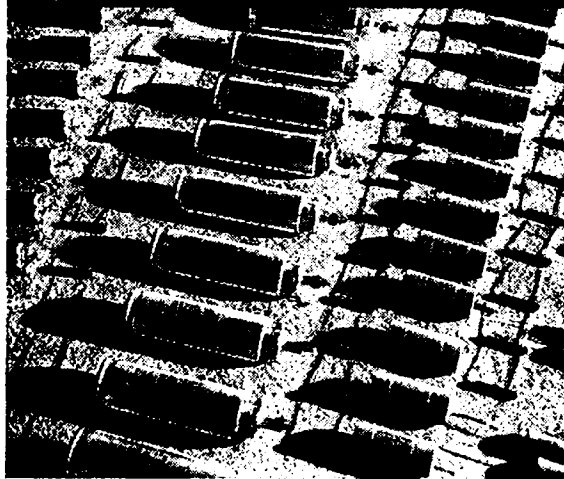

DUCON-CHANEX
GUARANTEE
*Complete
Reliability*

Under the most exacting
conditions.

Ducon Condensers are admirably suited to withstand the peculiar conditions of amateur and experimental work.

In the new transmitting units of 2FC and 3LO, Ducon Condensers were installed, being specially chosen for their unique quality.

For all Condensers and Resistors
specify

DUCON CHANEX

73 BOURKE St. WATERLOO. N.S.W.
450 COLLINS St., MELBOURNE, C.I

mented by the resonator effect. Unfortunately, the stiffness of the cone suspension is added to the stiffness of the air in the box, with a consequent rise in the resonant frequency. For example, a loudspeaker having a fundamental resonance at a frequency of 50-60 cps. whilst operating in free air, has, when mounted in a medium size cabinet, a resonance well above 100 cps. This, of course, would be very objectionable. Additionally, the output below the resonant point would be considerably attenuated due to the added stiffness. If, however, a special loudspeaker unit is used, designed to have practically no mechanical restrictions of diaphragm movement, so that the fundamental resonance is below 20 cps., then the resonance of the complete system can be brought down to a frequency practically below audibility. Actually, for Goodman's "Infinite Baffle" Loudspeaker a final fundamental resonance at 40 cps. is used. This gives a slight lift in the response at this frequency, which is probably the lowest audible note likely to be encountered.

To obtain such an extremely low resonance, the actual diaphragm surround is entirely dispensed with, the cone edge being held central by means of three radial strips of very light material.

A large diameter centreing device, having exceptionally long arms, maintains the voice coil in a central position in the magnetic gap. Some degree of the extreme flexibility of the suspension may be gauged by the fact that if the diaphragm is lightly blown a movement of over $\frac{1}{4}$ inch may be obtained.

Due to the absence of any restraint at the edge of the cone, almost complete elimination of cone resonance is obtained. This combined with an extremely high flux density magnet, and light diaphragm assembly gives a phenomenally good transient response. The ability of this loudspeaker to give really faithful reproduction of percussion instruments, etc., is probably one of its most notable features.

To reduce risk of chassis resonance and sound reflection, a specially designed cast aluminium chassis, consisting of three streamline arms radiating from a plate fixed at the back of the magnet, is used. The large diameter centreing device is located on small bosses on the chassis.

(Continued on Page 9)

Broadcast Music

DIFFICULTIES IN GIVING FAITHFUL REPRODUCTION OF ALL MUSICAL TONALITIES.

By Douglas N. Linnett.

Despite the remarkable progress that has been made, all forms of mechanical music, such as broadcasting and the gramophone, still fall short of the original performance.

The slight imperfections are in the volume handling and in the frequency range. The cause of the trouble is the mechanical limitations set by land lines, amplifiers, and other equipment included in the chain between the performer and the listener.

Such disabilities are inherent in the apparatus, so that it is necessary to introduce a general supervisory control to compensate for the inability to handle successfully, the wide variations in sound met with in any musical number.

For instance, an orchestral item introduces an extremely wide range between the softest and the loudest passages. They place a very big strain upon all of the transmitting equipment from the microphone to the aerial which cannot reproduce all the tonalities faithfully.

Of course the apparatus would not break down; but it cannot accomplish the difficult task of reproducing, with equal facility, the upper as well as the lower limits of range in tone, and at the same time deal with the infinite variety between them.

The variations are so wide that no land line, or transmitter for that matter, could successfully handle them. Outside noises are apt to override the pianissimo passages, while the fortissimo would overload the equipment.

Fortunately, the ear is not as sensitive to change as electrical equipment, and it has been found that realistic reproduction can be obtained when the variations are condensed between one and thousand instead of one and a million as found in an orchestral item. The smaller variations can easily be handled by modern equipment.

The original volume variations, therefore, have to be condensed in some manner so that they will fit

within the safe limits as set by the mechanical apparatus. This can only be done by some form of control which must be handled carefully to retain the colour of the original. Naturally, the control must be near the initial performance.

Many expedients have been tried; but as yet, no satisfactory solution has been found. It is a very real problem that has received much thought and research by broadcasting organisations throughout the world.

Manual control approaches closest to the ideal. Unfortunately, this introduces the human element as responsible for maintaining the best results. Everything depends upon the operator, who must have a comprehensive musical appreciation because it is within his power to spoil the whole programme from an artistic point of view.

This operator must be fully aware of the tonal variations in the music to be broadcast, because he must adjust his equipment to the proper operating level without affecting the balance of the work.

So he can make or mar the whole programme since everything depends upon his appreciation of the requirements in the music to be broadcast.

It would be impossible for him to give listeners a faithful reproduction of the original unless he had a very sound knowledge of music. He has to anticipate the change. An adjustment, more or less sudden, would alter the volume in a manner not intended by the conductor or composer; while he may allow the fortissimo passages to commence before toning down. That would distort the music.

Eagerness may also cause trouble, because the operator may adjust the level of volume to avoid loud passages, with the result that the soft notes become almost inaudible.

The difficulties are quickly appreciated. The control operator must be a versatile musician as well as a competent radio technician at the

present stage in the technique of broadcasting. In effect, he is the conductor for the radio audience, and the chief person responsible for the artistic and realistic reproduction of any musical item.

The work is well done, as listeners can judge any evening, for it will not be disputed that broadcasting has reached a plane which is capable of giving genuine musical pleasure to the critical listener. The shortcomings in the equipment are not readily perceptible.

Another difficulty met with in broadcasting music comes from blending the various instruments to give due emphasis to each part. This has a definite bearing upon the reproduction of mechanical music.

Musical sounds have different carrying qualities, so that one affects the microphone more than another. The instruments, therefore, must be placed in relation to the microphone so that one section does not drown another, or the wood wind swamp the strings.

Unfortunately, no hard and fast rules can be laid down, as conditions

vary so much from studio to studio, with the result that trial and error becomes the only guide. This begins by placing the violin near the microphone on account of its soft tone compared with other instruments of harsher note.

For instance, a jazz band would be so placed that the violins would be near the microphone and the piano close by at the side. Saxaphones and clarinets would be further back, and the harsher wind instruments, such as cornet and trombone, would be at a greater distance still. Banjo, traps, and drums would find themselves as far as possible away from the microphone because their sharp tone has a tremendous carrying power.

The soft reed instruments of a band be placed well forward, and the larger, such as French horns and trombones, would be at the back of them. Snare drums and base drums would be as far away from the microphone as possible.

The cello in the studio orchestra would take the position nearest the microphone, and the piano would be
(Continued on Page 13)

GOODMANS

HIGH FIDELITY

LOUD SPEAKERS

FOR

1. Level Response.
2. Wide Frequency Range.
3. Reduction of Sub-Harmonics.
4. Good Transient Response.
5. Elimination of Bass Modulation of the Upper Frequencies.
6. Freedom from Hum.

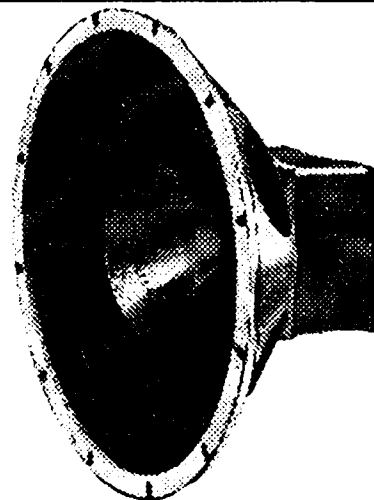

GOODMANS 10" HIGH FIDELITY LOUDSPEAKERS.

CALL IN AND HEAR ONE

J. H. MAGRATH PTY. LTD.

208 LITTLE LONSDALE ST., MELBOURNE.

Cent. 3688

News in English from Abroad

Regular Short-Wave Transmissions.

Reprinted from "The Wireless World." (With acknowledgements).

NOTE:—Times shown British Summer Time. Add 9 hours for Australia.

Country:	Station	Mc/s	Metres	Daily Bulletins (B.S.T.)
America				
	WNBI (Bound Brook)	17.78	16.87	6.0.
	WCBX (Wayne)	6.12	49.02	7:55 a.m.
	WCBX	9.65	31.09	5.0 a.m.
	WCBX	11.83	25.36	12.30 a.m.‡, 12.45 a.m.‡, 2.55 a.m., 11.50§‡
	WCBX	15.27	19.65	7.30§
	WCBX	17.83	16.83	2.0, 3.0‡, 5.0‡
	WGEO (Schenectady)	9.53	31.48	12.25 a.m., 9.30‡, 10.55§‡, 11.15‡.
	WGEA (Schenectady)	9.55	31.41	12.15 a.m.
	WGEA	15.33	19.57	2.0, 10.55§‡.
	WGEA	21.50	13.95	9.30.
	WPIT (Pittsburg) ..	6.14	48.86	4.0 a.m.‡, 5.0 a.m.‡, 5.30 a.m.‡.
	WPIT.....	11.87	25.27	12.45 a.m.‡.
	WRUL (Boston)	6.04	49.67	12.0 midnight.
	WRUL	11.79	25.45	9.30§‡.
	WLWO (Cincinnati)	6.06	49.50	7.25 a.m., 12.0 midnight‡.
China				
	XGOY (Chunking)	11.90	25.21	12.10, 11.0.
Finland				
	OFD (Lahti)	6.12	49.02	12.40 a.m., 7.20, 9.40, 10.30.
	OFD.....	9.50	31.58	12.40 a.m., 2.15 a.m., 7.20, 10.30.
	OIE	15.19	19.75	12.40 a.m., 7.20, 10.30.
France				
	— (Paris Mondial)	9.52	31.51	2.0 a.m., 4.30 a.m., 6.15 a.m.
	TPA4	9.68	30.99	9.15 a.m., 8.30.
	TPA4	11.72	29.60	2.0 a.m., 4.30 a.m., 6.15 a.m.
	TPA3.....	11.88	25.25	2.0 a.m., 4.30 a.m., 6.15 a.m., 9.15 a.m., 8.30.
	TPC3.....	17.77	16.88	12.0 noon.
French Indo-China				
	F2R (Saigon)	11.78	25.47	12.0 noon, 4.30.
Germany				
	DJC (Zeesen)	6.02	49.83	8.0
	DXM	7.27	41.27	12.15 a.m.
	DJI	7.29	41.15	11.15.
	DJA	9.56	31.38	7.15.
	DXB.....	9.61	31.22	8.15, 9.15.
	DJB	15.20	19.74	10.15 a.m., 2.15, 5.15.
	OLR5A (Podebrady)	15.23	19.70	8.50
Hungary				
	HAT4 (Budapest).....	9.12	32.88	12.30 a.m.‡, 1.30 a.m.
	HAS3	15.37	19.52	2.55‡.
Ireland				
	Athlone	9.59	31.28	6.45, 10.0 (10.5 Sun.).
	17.84	16.82	6.45, 10.0 (10.5 Sun.).
Italy				
	I2RO3 (Rome).....	9.63	31.15	4.0 a.m., 7.35 a.m., 7.28, 10.15.
	I2RO9	9.67	31.02	12.30 a.m.
	I2RO4	11.81	25.40	4.0 a.m., 4.45, 8.25.
	I2RO6	15.30	19.61	4.0 a.m., 7.35 a.m., 12.15, 8.25.
	I2RO8	17.82	16.84	12.15, 4.45.
Japan				
	JVW (Tokio)	7.25	41.34	9.5.
	JZI	9.53	31.48	9.5.
Manchukuo				
	MTCY (Hsinking) ...	11.77	25.49	3.50, 7.30, 10.0.

Country: Station	Mc/s	Metres	Daily Bulletin (B.S.T.)
Rumania			
Bucharest.....	9.28	32.33	10.55‡.
Russia			
RNE (Moscow).....	6.00	50.00	11.0.
RW96.....	6.03	49.75	1.0 a.m., 9.0, 10.30.
RWG.....	7.36	40.76	10.30.
RKI.....	7.52	39.89	10.30.
—.....	8.07	37.17	9.0, 10.30.
—.....	9.53	31.48	11.0.
RAL.....	9.60	31.25	1.0 a.m., 9.0, 10.30.
RW96.....	9.68	30.99	9.0.
—.....	11.64	25.77	11.0 a.m.
—.....	11.90	25.21	11.0 a.m.
RNE.....	12.00	25.00	1.0 a.m., 4.0‡.
RKI.....	15.04	19.95	1.0 a.m.
RW96.....	15.18	19.76	8.0 a.m.
Spain			
FET1 (Valladolid)	7.07	42.43	8.45.
EAJ7 (Madrid)	9.86	30.43	4.25.
Sweden			
SBO (Motala)	6.06	49.50	10.45.
SBU.....	9.53	31.48	10.45.
SBT.....	15.15	19.80	7.15.
Turkey			
TAP (Ankara).....	9.46	31.70	8.15.
TAQ.....	15.20	19.74	1.15.
Yugoslavia			
YUC (Belgrade)	9.50	31.58	10.30.

(Continued from Page 5)
 arms. This method of construction produces an extremely rigid assembly with a minimum of material. This centreing device is of unusually open construction to minimise risk of sound radiation from the device itself in addition to reducing reflection. The loudspeaker cabinet is approximately an 18 inch cube, and is made of thick section laminated board. To prevent reflection and the formation of standing waves at high frequencies, the inside is lagged with special sound absorbing felt.

In general design, the diaphragm assembly follows the same general principle as that used in the 10 inch High Fidelity Auditorium Loudspeaker (the construction of which is dealt with in detail in our Technical brochure, "The Attainment of an Ideal"). Both the main and centre cones are made from slightly different materials to those used for the diaphragms of the 10 inch High Fidelity Auditorium Loudspeaker, to compensate for the difference of loading. The Permanent Magnet has an extremely high flux density, giving an exceptional degree of magnetic damping to the voice coil. An interesting experiment is to short circuit the voice coil and gently pull

the diaphragm forward for about 1/4 inch. When released the diaphragm takes 2 to 3 seconds to return to normal. This test will serve to illustrate the entire absence of resonance in the unit.

To sum up, the advantages claimed for the "Infinite Baffle" Loudspeaker are:—

- (1) Really true reproduction down to 40 cps.
- (2) Complete freedom from frequency doubling.
- (3) Exceptionally good transient and high note response.
- (4) Freedom from "colouration" (due to reduction of cone resonance).

An additional feature of this loudspeaker is that the acoustic output increases with rise in frequency up to 5,000 cps. Above this frequency the output remains practically level to 12,000 cps. Since it is very seldom that audition takes place directly on the axis of the loudspeaker, it is felt there should be some compensation for the focussing of high notes, which is, unfortunately, inevitable. The rise in output is not taken beyond 5,000 cps., as this would only increase background noise to an unbearable extent.

Short Wave and DX Section

OVERSEAS BROADCASTING.

A Monthly Retrospect.

By Jack Harrower,
(Short Wave Editor, "Radio Times.")

The freedom of another independent state has been sacrificed at the Altar of Nazism.

As I write, the Netherlands army has surrendered before the terrific onslaught of the invader. With their surrender the greater part of Holland falls into the hands of Germany, including the headquarters and factory of Philips Radio, Eindhoven.

Although their business activities will be carried out by the various Philips agencies throughout the world, amateur operator and DXer alike will miss the cheery word of greeting from their international short wave transmitter, PCJ, the "Happy Station."

PCJ succeeded in portraying an atmosphere of friendship and goodwill even at a time when the country was in constant fear of attack.

On March 12, 1927, the Philips Radio Laboratory, in Eindhoven, first bridged the gulf between Holland and its colonies with its experimental transmitter, PCJJ.

This great feat was greeted enthusiastically by settlers in the Dutch East and West Indies, who promptly brought up the question of a broadcasting service for the colonies, and so the PHOHI (Philips Broadcasting Holland-India) came into existence.

In the autumn of 1929, the first transmissions by the new PHI were broadcast on 16.88 metres. The results were good from the beginning, and the station soon became an integral part of the Dutchman's life in the outposts of the Fatherland. The PHOHI brought the Dutchman compensation in his loneliness far from the homeland.

Internal dissension in Holland, however, led to the closing of PHI for two years, at which time strong agitation for the re-opening of the service was commenced. The station was ultimately re-opened on December 24, 1932. Satisfactory results were not obtained until April 16, 1934, after many months of experimental work carried out on different frequencies.

After so many years of activity one

of the true pioneers of short wave broadcasting is absent from the dial. Perhaps PHOHI will again call the world in the not so distant future through PCJ, the "Happy Station."

The broadcasting services of two other countries also suffered at the hands of the invader. They were "Radio Luxembourg," Europe's most powerful long-wave commercial outlet, and the Belgian network.

"Radio Luxembourg" had planned the use of short wave as an expansion to its long-wave service, but this was abandoned at the outbreak of war. ORK, Brussels, operated on 29 metres with a power of 11 kw., but was not consistently heard in Australia.

S.W. SNIPPETS.

CBS and its international short wave outlets, **WCBX** and **WCAB** are broadcasting a series of "Salutes to the Americas" to the 1940 New York World's Fair. All the programmes originate from Latin America and are short-waved Monday, 5 a.m. A.E.S.T., and feature national and folk music supplemented with talks by Government officials. The opening salute came from Brazil.

The American service of "**Paris Mondial**" has been rearranged resulting in the 11 a.m. programme closing at 3.45 instead of 3.30 p.m. and the Californian broadcast being advanced 15 minutes, and is now slated from 4 to 5 p.m. The 11 a.m. schedule is radiated on 11,720, 11,845, and 9,520 kc., and the latter broadcast on the one frequency of 9,520 kc. "Paris Mondial" is one of the best signals on 25 metres in the afternoon.

Possibly one of the best signals from the point of view of strength, quality and entertainment value is the NIORM transmitter YDC 15,150 kc. in their late afternoon broadcast. The programme comes in between 6 and 7.30 p.m. A.E.S.T., and light music is played throughout. One interesting feature is that no announcements are made excepting on the half hour, and the programme consists mainly of popular American recordings.

The Eastern District zone of North America is now being covered from Tokyo through JLS2 16.81 metres 17,845 kc.

TAP, Ankara, Turkey, is now operating from 3 a.m. to 8 a.m. daily on 9645 kc.

FFZ, Shanghai, is nightly heard on 12,090 kc., when opening at 8 p.m. The station is operated from the French quarter of the international settlement.

KGEI is forwarding an interesting brochure on the 1940 Golden Gate Exposition at Treasure Island, to all listeners sending reports.

ETHERettes.

Annual report of Columbia Broadcasting System shows a net profit for 1939 of over five million dollars, as compared with three-and-a-half millions for 1938. There was a net loss of 72,975 dollars by the Columbia Recording Corp.

Regarding television the report stated that the CBS actively continued preparation for television broadcasting in New York with studio facilities constructed in the Grand Central Terminal building and studio equipment installed.

Gerald Cock has arrived in N.Y.C. from England to take up his new position as American rep. for B.B.C. He is successor to Felix Greene, who plans going into the motion picture industry in U.S.A.

Edward Braddock, with R.C.A., Camden, for the past 11 years has been appointed manager of amateur radio sales for the company. Ed. operates ham tx W3BAY from his home in Haddonfield, N.J.

Joseph Conn, N.B.C. television engineer, married Leonore Kingston, Chicago radio actress, on April 1. Both hams, the couple have been communicating via the H.F.'s between New York and Chicago since July last year.

The three electrode vacuum tube invented by Dr. Lee De-Forest, Jan. 1907, was selected as one of the 19 greatest inventions, by a committee of scientists and industrialists during observance of 150th anniversary of the signing of the first American patent law.

WSJC, Winston-Salem, Nth. Carolina, joins N.B.C., June 26, as the 188th affiliated station. Formerly affiliated with CBS the station operates on 1310 kc. with 250 watts.

WDRG has filed an application with the FCC for a 50 kw. Frequency Modulated station. It figures on reconstructing the 1,000 watt W1XPW, which it now has on the Meridan Mountains and operated on FM.

W1XPW was the first licensed FM station in U.S.A.

The FCC has revoked the licence of KGFI, Texas. Charges are same as the six whose licences were ordered revoked last month. It was charged that the station transferred stock without FCC authorization.

SHORT WAVE NOTES.

By F. Smith.

The following stations are regularly heard on the bands indicated, from midnight onwards.

25 metres.—Rome.—English news session, 1.40 a.m. Signal strength is usually only fair at this time.

Paris—Also gives English news at about the same time as Rome, but signal strength is a little better.

Saigon—Re-broadcast above news, but are putting in a much stronger signal.

London—News at 2 a.m. at good signal strength.

India—News session in English at 1.50 a.m. Very strong signal.

China—Call sign of this station is doubtful. Two different sources give at FFZ and XFZ. Fair signal strength, giving news in English at 12.55 a.m.

Manchukuo— M.T.C.Y. Broadcast in English at 1.15 a.m. Signal strength is very good.

31 metres. — U.S.A. — KGEI.—News in English at 12.30 a.m. Good steady signals. W6FFN was logged on the 20 m. band at 1.25 a.m. at R7.

Phillipines — KZRM — Fair signal strength. Close down, 1.30 a.m.

KZRH.—Also fairly constant signal after midnight.

VLQ5 and VLR, Australia, are giving good reception of an early morning.

Static and other noises were more or less non-existent over the month ending, May 18th, when this list was completed.

AROUND THE DIAL.

Overseas Stations Heard

By J. F. Miller.

DXU—15,320 Kc. 19.58 m.—Berlin —One of the new German and is received at quite good strength.

DJQ—15,280 Kc. 19.63 m.—Berlin —Only a little below strength of DJB. Frequently carries the same programme. English news at 10 p.m. appears to be stopped from both stations.

DJB—15,200 Kc. 19.74 m.—Berlin —This station is heard regularly and

at almost any time of the day or night. Particularly good around midnight.

DXS—15,160 Kc. 19.79 m.—Berlin—Another of the new ones, and also heard at fair strength. All these three DX stations appear to have same programme.

DXT—15,230 Kc. 19.70 m.—Berlin—Is also one of the new Germans heard at fair strength during the early morning.

GSF—15,140 Kc. 19.82 m.—London—Heard regularly whenever on the air. Always at good strength, particularly around midnight.

TPA2—15,245 Kc. 19.68 m.—Paris—Good around 2.0 a.m. when this station closes with the "Marsellaise."

JKZ—15,160 Kc. 19.79 m.—Tokio—Excellent station, with news in English at 10.30 p.m. Bad interference when DXS is on the air.

PCJ2—15,220 Kc. 19.71 m.—Huizen Holland—This station last heard on the 24th March with a special broadcast to the Far East, which opened at 11.57 p.m.

VLM6—15,275 Kc. 19.6 m.—Sydney—This phone station heard calling KNY, San Francisco, at 1.50 p.m. on 25th March.

2RO6—15,300 Kc. 19.61 m.—Rome—Particularly good around 4.0 p.m., with English news at 4.35 p.m.

HCJB — 12,460 Kc. 24.08 m. — Quito, Ecuador — Has improved slightly, but is badly spoilt by morse.

FFZ—12,050 Kc. 24.89 m.—Shanghai—This new French station can be heard clearly at 1.0 a.m. with news in English, followed by one hour's uninterrupted musical programme.

RNE—12,000 Kc. 25.0 m.—Moscow—This Russian is excellent around 2.0 a.m., and can be heard quite well at various other times.

XGOY—11,900 Kc. 25.21 m.—Szechewan, China—One of the regularly heard at fair strength.

TPA4—11,885 Kc. 25.24 m.—Paris—Excellent strength around 3.0 a.m.

VUD4—11,870 Kc. 25.28 m.—Delhi, India—Most lists show this station as VUM2, Madras, but recent verification gives it definitely as this call. Heard regularly around 10.0 p.m.

GSE—11,860 Kc. 25.29 m.—London—Heard around 1.30 a.m. at good strength.

TPC8—11,845 Kc. 25.33 m.—Paris—Particularly good during late afternoon. Closing at 4.0 p.m.

2RO4—11,810 Kc. 25.4 m.—Rome

—Good during the early morning and till 8.0 a.m.

JZJ—11,800 Kc. 25.42 m.—Tokio—Quite good during both morning and evening. News in English at 10.30 p.m.

Saigon — 11,780 Kc. 25.47 m. — French Indo China—This is one of the loudest stations on the band. Woman announcer asks for reports at 7.0 p.m.

DJD—11,770 Kc. 25.49 m.—Berlin—Heard quite well in the early morning.

XGOK—11,650 Kc. 25.75 m.—Canton, China—Seems to be mainly native programme.

GSD—11,750 Kc. 25.53 m.—London—This is one of the most regular and loudest of the London stations.

TPB7—11,718 Kc. 25.6 m.—Paris—Excellent strength just before 4.0 p.m. Reports asked for, address given as French Government Short Wave Station, Paris, Mondial, 12 Rue Armand Moisant.

PLP—11,000 Kc. 27.27 m.—Bandoneng, Java—Just fair, but comes in regularly.

PMN—10,260 Kc. 29.24 m.—Same location, carries same programme as PLP.

ZHP—9,700 Kc. 30.94 m.—Singapore—Re-broadcast B.B.C. news service at 11.30 p.m.

KZRH—9,640 Kc. 31.12 m.—Manilla—A good regular station, with excellent musical programme. News at 11.45 p.m.

2RO3—9,630 Kc. 31.15 m.—Rome—Heard at 8.0 a.m. at particularly good volume.

VUD3—9,590 Kc. 31.28 m.—Delhi—Regularly heard at good strength.

KZRM—9,570 Kc. 31.35 m.—Manilla—Another regular on this band. Has excellent "Quiz" programmes. News in English at 10.45 p.m.

DJA—9,560 Kc. 31.38 m.—Berlin—Fair strength only.

KGE1—9,530 Kc. 31.48 m.—Treasure Island, U.S.A.—New, coming through at excellent strength. Good news service at 12.30 a.m.

WGEA — 9,556 Kc. 31.41 m.—Schenectady, U.S.A.—Heard in special broadcast to Far East at terrific strength around 4.0 p.m. Reports asked for.

TPC—9,520 Kc. 31.51 m.—Paris—Another French station heard at excellent strength around 4.0 p.m.

HSP6—7,968 Kc. 37.65 m.—Bankok Thailand—Heard just before closing at 11.45 p.m.

(Continued from Page 7)

to its right. Violins are behind them and next follows the traps and drums, bass saxaphones, slide trombone, clarinet and cornet.

Such relative positions are necessary in order that the music will be blended harmoniously at the microphone. The effect is thoroughly appreciated when one takes the trouble to distinguish and make a note of the different instruments, stating whether they sound natural or not.

Very keen ears will be required to detect the deficiencies in the equipment whether it is in respect of fundamental tones, or in regard to the harmonics set up by the various instruments. Nowadays, there is nothing of the harsh, tinny, mushy or blurred notes that were the rule rather than the exception a few years ago, for broadcasting can now give the most realistic music, from which the critical listener can derive real pleasure.

RADIOTRONICS BULLETINS.

New Issue Released.

The latest issue of Radiotronics by Amalgamated Wireless Valve Co. Pty. Ltd. is bulletin No. 103, in which an announcement is made that type 6J8-9 and five of the 1.4 volt GT series of valves, are now being manufactured in Australia. This brings the total of Australian made Radiotrons to fifty-five (55)—a complete list of these being given.

An item of particular interest at the present time is that describing low screen voltage operation of the beam power tetrode Radiotron 6V6-G. With a bias of —5 volts and a total cathode current less than 20mA, a power output of 1.5 watts is obtainable with a load of 14,000 ohms.

This is a suitable arrangement for small table model receivers where low heat dissipation is essential. The high grid sensitivity is also a valuable feature.

(Continued on Page 16)



The Power Equipment with a Powerful Reputation . . .

THE Organisation responsible for the production of . . .

HILCO TRANSFORMERS CHOKES, etc.

has proved its high standards for an article of extreme merit as accepted by the largest consumers in Australia.

ALL PRODUCTS GUARANTEED FOR
TWELVE MONTHS.

HILCO TRANSFORMERS PROPRIETARY LIMITED

97-111 BERKLEY ST., CARLTON, N.3., Vic. 'Phones; F1661-2
CABLES & TELEGRAMS: "HILCOY," MELBOURNE.

Divisional Notes

IMPORTANT.

To ensure insertion, all copy must be in the hands of the Editor not later than the 18th of the month preceeding publication.

NOTES FROM FEDERAL HEAD-QUARTERS.

Calendar No. 24 of the I.A.R.U., although dated December, 1939, did not arrive until April. Main items consist of a list of member societies and information as to their activity or otherwise. Twenty-six out of thirty-five are off the air, those continuing normal operation being Columbia, Cuba, Estonia, Hungary, Japan, Mexico, Spain, United States, and Venezuela.

Most societies appear to be carrying on, although in some European countries mobilisation has caused the cessation of all organised activity.

The C.C.I.R. conference, scheduled to have been held in Stockholm in June, 1940, has been postponed to a later date as yet undetermined.

The Burma Amateur Radio Society (B.A.R.S.), and the Lietuvos Trumpuju Bangu Radio Megeju Draugija (L.R.M.) Lithuania, have been admitted to membership of the I.A.R.U. and proposed new member societies are the Manchoukuo Amateur Radio League (M.A.R.L.) and the Radio Club Argentino (R.C.A.) Argentine.

VICTORIAN DIVISION. KEY SECTION NOTES.

By VK3CX.

The May meeting opened shortly after 8 p.m., with a fairly large attendance, and R.J. in the chair. Our visitors included G6LU, VK2HY, and VK3HG, and the warmth of their reception almost embarrassed them, which is saying something when you remember that they are hams.

The event of the evening was a most interesting lecture by Bert Hodge, VK3HE, on "Wired Wireless." He had the close attention of his audience, and at the conclusion of his talk, was kept answering questions for at least half an hour.

Another interesting visitor was 3TU resplendent in the uniform of a "Loot" in the A.I.F. Jim gave an interesting talk on the transmitters and receivers used in the Army, and

appealed for volunteers from amongst the ham ranks to work them, so if anyone wants a free trip to ZC6 they know where to apply. The usual questions were asked about when we were going to get on 2½ metres, and the representative of the Council gave a report on the possibility of incorporating features from "Radio" and "QST" in our magazine in the near future.

IK was there looking fit after several months in camp looking after the signals, and is now teaching a certain YL all there is to know about ham radio. RX was back in the fold, making witty remarks after a successful marriage, which hasn't repressed him in any way. RN has been trying cardboard tubing as a pick-up arm—no it's got nothing to do with women—and says that it is better than aluminium. UR has been putting lots of aluminium around his receiver, and talking of receivers, HK has at last got his 1852 tube in place of a 6C5 as oscillator. Thinks that the 1852 will make a good osc. for 28 and 56 mc work. His RX uses 2 I.F. freqs. 3000 and 525 kcs, the latter being coupled by four infinite rejection couplers and the result is single signal operation without a crystal.

IG says he has got a good alibi if the R.I. comes around, because his rotary beam is now covered with spiders webs. WQ has moved to Kew, and threatens to disturb the air around there when we get back on the air. FR has entirely shielded his RX, and now spends most of his time on the road with his car. Don't know what he will do if petrol goes up any further tho.

VQ is in the R.A.A.F. signals office, and probably gets plenty of radio there, but that doesn't excuse him when we learn that he has wrecked his communications receiver and made it into a dual-wave job. QK is farming down at Churchill Island and mournfully surveying the wide open spaces where the Vee beams

would be but for Adolf the twerpst.

KV is now the proud owner of a Junior Op., and is anxious to get back on the air and add to his 8 contacts before the aforesaid junior op. gets his ticket and beats his OM to it. DA is thinking of building a deluxe combined frequency meter-monitor-scope output meter while the going is good, and QV is in the process of building a new receiver covering all bands, including brass bands, string bands, rubber bands, etc.

ZU is taking the big jump—yes, the war must have been the cause of it as he couldn't go on the air, so had to spend his time with the YL and is now getting married and moving to Warrnambool. His new hobby is gardening. Anyway, all wish you the very best.

RJ has got rid of QRM and now devotes some time to listening. His enthusiasm in burning some QSL cards the other day had rather disastrous results, as he burnt the bottom out of the bath heater. Must have been one of those hot cards from W8DWV.

As the liquor referendum has long since passed, I cannot be accused of propaganda in retelling this story—It appears that an anti-liquor meeting was in progress and the lecturer said, "I now propose to carry out an interesting experiment—I have here two bottles, one containing water and the other alcohol. I now take an ordinary earth worm and drop it into the water—see, it is unharmed and swims around. I now take it out and drop it into the alcohol—ah, it shrivels up and drops to the bottom dead. Now, what does that prove?" A beer sodden voice answered from the back of the hall—"If you've got worms, drink beer!"

Cheerio, gang, until next month, when a further lecture is promised, so roll up.

NORTHERN ZONE NOTES.

By 3ZK and 3BM.

These notes have been missing in the last couple of issues of "A.R." The usual scribe has, no doubt, other things to keep his mind occupied, so I will endeavour to fill the gap for this month.

News is rather scarce as means of communication have been interrupted.

3EC, our local inventor, is a man of many parts. He was treasurer at

a recent flower show in this town. He said it was bad luck we are off the air. The cash he had would have bought quite a nice outfit. He has also made an arrangement to copy the C.W. from various sources. The system is similar to the tape systems seen at many railway stations. His latest is a generator. May be able to give more details at a later date. It depends how everything works out.

3JG has been on a visit to V.I.M. The baby Ford is still going places.

3CD is still in the district, his activities unknown.

3XF is a newcomer to the ranks of hamdon and W.I.A. membership. Les by name, situated on a wheat farm between Rupanyup and Murtoa. Was on 40 mx cw from batts for 3½ months before the fateful September 1st. Les had a V beam planned and the material to hand at that date.

3CE—Roy's letter is just like one of our FB rag-chews of the good old days. All about tractors, fallow, sheep and radio. Intends to complete the new 3 tube super and get some morse practice this winter.

3PR.—Ron is expecting the A.C. line to come along his way, after which he will build himself a 6 or 8 tube A.C. super. He built an electric fencer from a Ford coil and has the bull bluffed! He says 3IV is in Stawell, so that 3YW is not the only ham there.

Jim, 3DI, is still vying with QYL and, I believe, is getting married soon.

It is reported that 3OR has gained a commission in R.A.A.F. and is now a Flying Officer. Heartiest congrats., Murray!

3JG has completed his yacht and it's a beauty.

3QZ has built himself a very satisfactory producer gas plant for his Chev. Did you see the page devoted to it in the "Sun," complete with photo of the smiling 3QZ and the woiks?

3TL has started a Stamp Club in Kerang, and is running it with all the old efficiency and enthusiasm. Still suffers from the effects of that accident of months ago.

Chas. Stanford called here on his final leave. Expects to go in the "next lot." Good luck, Charlie!

3BM was laid up for two months when a bag of wheat fell on his right leg from a considerable altitude. Is still rather shaky on the pins, but managed a month's holiday to Sydney.

3RA. Still helping to keep local B/C station on the air. Hitting the high spots in his spare time. Is waiting to be called up for compulsory training.

3IH has been in camp for three months and is now back at Melb. Tech. swatting.

3HX has at long last settled in Melbourne. Hams should beware when they see a 1938 black Chev. approaching. It may be 3HX. You'll see the call letters on the wind screen.

3NN. No news to hand.

3ZK. Radio activities practically nil. Spiders, etc., having a great time in the shack. Gardening has been the main hobby. Annoy 3EC on occasions. Both 3EC and 3ZK were close to learning to play the harp. Reason. 3ZK and 3EC had a conference which lasted till 0050. 3EC's YF intervened. 3EC 3ZK hurried exit.

Would members of the zone please communicate with 3BM or 3ZK advising their doings. By so doing you are helping to keep the mag. in circulation, and also the W.I.A. functioning. Don't forget, the W.I.A. is our mouthpiece. Unity is strength, so do your bit to help.

S.A. DIVISION NOTES.

By D. S. Robertson, VK5RN.

At a general meeting, held on Wednesday, April 17th, it was decided to have quarterly meetings for the duration of the war, instead of holding them weekly in the form of code practices, as has, up till now been the case. This change has been made because of the poor attendance that we have been having.

Those present at the meeting were, Mr. J. McAllister, Mr. Elliott, 5RD; Mr. Kilgariff, 5JT; Mr. Adey, 5AJ; Mr. Baseby, 5BZ; Mr. Ragless, 5GR; Mr. Bourne, 5BU; Mr. Pearn, 5PN; Mr. James, 5BL; Mr. Hashard, 5RH; Mr. Sullivan, 5JK, Mr. Robinson, 5HN, Mr. Evans, 5OW; Mr. Goldsmith 5HM; Mr. Lucas, 5LL; and myself.

After heated discussion, it was decided that the quarterly meetings should be in the form of "smoke socials," and that each member should pay a minimum of 2/- in order to pay for refreshments.

After the secretary had read through the year's accounts, the council was elected, and new subscription rates were fixed.

The new council is as follows:— Mr. Kilgariff, 5JT, President; Mr.

Ragless, 5GR, Vice-President; Mr. Evans, 5OW, Treasurer; Mr. R. D. Elliott, 5RD, Secretary; Mr. McAllister, membership organiser, and myself assistant secretary

Unfortunately, Mr. Bowman, 5FM, has had to resign from the council because of work at night, as he is now an engineer in 5AD. We shall all be sorry that he cannot be on the council, and everyone, especially the country members will join in thanking him for his services to the Institute, and also in wishing him the best of luck.

Mr. McGrath, 5MO, has unfortunately, also had to resign, owing to illness, and we all hope that he will soon be well again, and will be able to join us once more.

The membership rates have been reduced, as we have decided that we must keep as many of our members as we can, and, at the same time, encourage others to join, as our only chance of getting back on the air again is to have a strong and united society of amateurs. The membership rates are now 12/- for city members and 7/6 for country amateurs, and, if by any chance we have a surplus at the end of the year, further reductions will be made. The country subscription has been cut as much as possible, and should only just cover expenses, and all country members are urged to join up again for the coming year, and thus help the Institute to keep going.

The next meeting will take place on Wednesday, May 22nd, and all subsequent meetings will be held quarterly.

(Continued from Page 13)

Other articles included in this issue of Radiotronics give hints on the operation of Radiotron 6J8-G, revised ratings for A.C. types, data on the 1.4 volt super-control R.F. pentode 1P5-GT, a complete 1.4 volt receiver circuit as well as data on new valve types.

Altogether, Radiotronics Bulletin 103 maintains the high standard which we have learnt to associate with this technical publication and is confidently recommended.

Radiotronics is available, on subscription, by application to the Amalgamated Wireless Valve Co. Pty. Ltd, and as the new year commences in July, intending subscribers are advised to give some thought to their applications.

HAMS

WHEN REBUILDING YOUR RECEIVER
REPLACE YOUR OLD SPEAKER WITH

AMPLION

THE NEW 12in. ELECTRICALLY WELDED
SPEAKERS

MODEL	Air Gap Flux	Weight of Magnet	POWER OUTPUT. Undistorted—Max		Diameter	PRICE
			10 watts	15 watts		
V	8,300	12 ozs.	10 watts	15 watts	12 $\frac{3}{16}$ "	£2 3 0
VL	9,000	22 „	13 „	20 „	12 $\frac{3}{16}$ "	£2 16 0
VP3	12,000	64 „	20 „	30 „	12 $\frac{3}{16}$ "	£5 10 0
VP2	9,000	20 „	12 „	18 „	12 $\frac{3}{16}$ "	£3 6 6
VPI	7,500	14 „	8 „	12 „	12 $\frac{3}{16}$ "	£2 10 0

Types V and VL are Field Type Speakers.
Types VPI, 2, 3 are Per-Magnetic Speakers.

**SILVERED
MICA**

T. C. C.

**CERAMIC
CONDENSERS**

T.C.C. Silvered Mica Condensers are guaranteed to maintain their capacity under all temperatures, thus insuring no frequency drift in Supers. The foil is actually plated on the mica.

We can supply these Condensers in any per cent. of accuracy, including 0%.

The Capacity Range is from 10 mmf to 800 mmf.

LIST PRICE, 1/- EACH.

We are Agents for—

I.R.C. RESISTERS.

T.C.C. CONDENSERS.

AMPLION SPEAKERS.

BRUNO MICROPHONES.

BIRNBACH INSULATORS.

TRIMAX TRANSFORMERS.

**AUSTRALASIAN ENGINEERING
EQUIPMENT CO. PTY. LTD.**

476 Latrobe St., Melb. Phone: F 5585

Let us quote you for your
PRINTING REQUIREMENTS



The House of Good Printing

**285-287 LATROBE STREET,
MELBOURNE, C.I**

Opposite "The Argus" Office

Telephone MU 2897 After Hours FU 6795

AMATEUR RADIO



Published in the interests of the Wireless Institute of Australia, Official Organ of all divisions of the W.I.A. and R.A.A.F.W.R.



PRICE

6^d

JULY, 1940

A Heritage of Quality

WESTON
Instruments



Dependable Testing Instruments for
Every Radio and Electrical Purpose

WARBURTON FRANKI
LTD.

380 Bourke St., Melbourne, Phone MU 6355
307 Kent St., Sydney; 233 Elizabeth St., Brisbane

AMATEUR RADIO

Published in the Interests of Radio Amateurs and
Experimenters throughout Australia.

VOL. 8. No. 6

1st JULY, 1940.

OUR ORGANISATION

Publishers.—

WIRELESS INSTITUTE OF AUSTRALIA
(Victorian Division)
191 Queen Street, Melbourne, C.I.

Editorial Department.—

W. R. GRONOW (VK3WG),
Editor.

R. H. CUNNINGHAM (VK3ML)
Technical Editor.

C. SERLE (VK3RX)
Notes Editor.

V. E. MARSHALL (VK3UK)
Compilation.

H. N. STEVENS (VK3JO)
Distribution.

L. T. POWERS (VK3PS)
Secretary.

Advertising Department.—

BEDGGOOD ADVERTISING CO.,
129 William Street, Melbourne.
Phone: MU 4046

Printers.—

H. HEARNE & CO. PTY. LTD.,
285 Latrobe Street, Melbourne, C.I.

Accounts Department.—

LARGE & POWERS,
Chartered Accountants (Aust.),
422 Collins Street, Melbourne.

MSS and Magazine Correspondence
should be forwarded to The Editor,
"Amateur Radio," Box 2611W, G.P.O.,
Melbourne.

Subscription Rate is 6/- per annum in advance (post paid).

NOTE.—Advertisers' change of copy must be in hand not later than the 20th of the month preceding publication, otherwise the previous month's copy will be reprinted.

CONTENTS.

	Page
Editorial - - - - -	3
Electrical Instruments - -	4
Applications of the Volt- age Doubler Rectifier -	8
40-CM Waves in Aviation	10
Frequency Modulation -	14
Illegal Radio - - - - -	19
Microphone Types - -	20
Bookshop Smatterings -	20
List of Short Wave Stations Heard - - - - -	21
Q.S.L. Bureau - - - - -	22
Divisional Notes - - - -	23

DIVISIONAL ADDRESSES.

FEDERAL HEADQUARTERS:
BOX 2611W, G.P.O., MELBOURNE

NEW SOUTH WALES:
BOX 1734JJ, G.P.O., SYDNEY.

VICTORIA:
BOX 2611W, G.P.O., MELBOURNE.

QUEENSLAND:
BOX 1524V, G.P.O., BRISBANE

SOUTH AUSTRALIA:
BOX 284D, G.P.O., ADELAIDE.

WESTERN AUSTRALIA:
BOX N.1002, G.P.O., PERTH.

TASMANIA:
BOX 547E, G.P.O., HOBART.

**You wouldn't put
solid tyres on a
Rolls Royce, so why
fit an ordinary loud-
speaker to a quality
set ?**

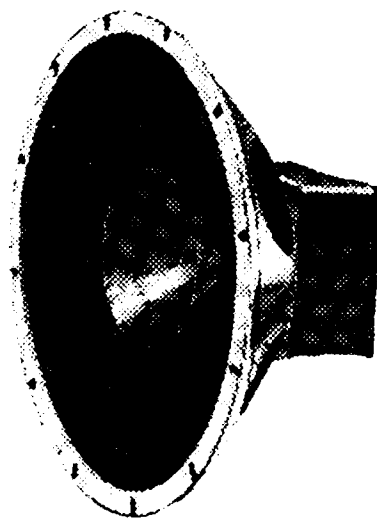

GOODMANS 10 INCH
HIGH FIDELITY SPEAKER

With your present loudspeaker you quite probably can't notice any difference between a studio broadcast and a session of recorded music.

Admittedly some of the latest vertical cut recordings are good, but there is always a difference between "potted" music and a live artist show when you use a GOODMANS QUALITY SPEAKER.

CALL IN AND HEAR ONE AT
J. H. MAGRATH PTY. LTD.,
208 LITTLE LONSDALE STREET, MELBOURNE.

WHOLESALE ONLY FROM THE AUSTRALIAN AGENTS:

TRIMAX TRANSFORMERS

(A DIVISION OF CLIFF & BUNTING PTY. LTD.)

29-35 FLEMINGTON ROAD, NORTH MELBOURNE
F 9127 (3 LINES)

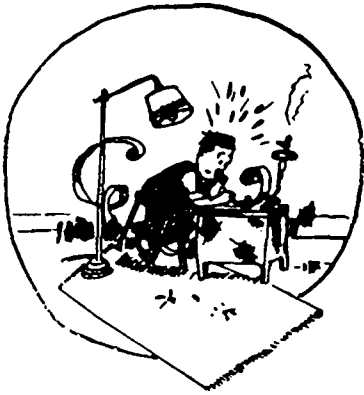

EDITORIAL

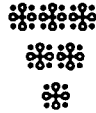

DIGESTIVE TECHNICALITIES.

We present this issue as a new attempt to supply technical matter of importance in semi-digest form. Frankly, we are no longer able to obtain local contributions in such volume as would be necessary to maintain our usual monthly issue. Owing to such a high percentage of our fraternity being away on active service, it has become increasingly difficult to obtain technical articles and divisional notes in the usual volume. We must therefore turn to the efforts of our overseas contemporaries for this material.

By special arrangement with one of our esteemed advertisers, McGill's Agency, Elizabeth Street, Melbourne, we have access to Mr. Radford's entire electrical and radio magazine department.

We intend to present each month outstanding extracts, suitably acknowledged, from the world's best technical journals, of subjects suited to the experimental game.

The choice of suitable articles by the technical editor entails a great deal of work and we will endeavour to present only such articles as will be of "first class" quality and those not usually perused by our readers.

We feel that no digest would be complete without a few notes and personal paragraphs not forgetting our new innovation, "Short Wave Notes." Also we hope you will appreciate the technical editor's "Bookshop Smatterings," which will give our readers a general outline on some good technical reading.

The editor receives a few letters

from overseas troops who write to advise some (censored) details of their movements under war conditions. You will find elsewhere in this issue a letter from ex VK3IR, which we are printing as an encouragement to others, similarly situated, to send along their contributions.

We have received many letters from "Amateurs" generally who have taken grave exception to the remarks attributed to the Post Master General, Mr. Thorby, and recorded in the daily press. Some of these reports of amateurs who infringe the law are unfair as well as humorous. It need not be pointed out that we in no way support anyone who breaks the law by transmitting signals of any kind, but we do feel that such remarks as appeared in the "Sydney Sunday Telegraph" to the effect that "Young people fiddle and tinker with radio transmitters and do not realise how serious it is," would pre-suppose that delicensed experimenters were children who did not know the difference between right and wrong.

We do not know for certain whether the persons detected operating unlicensed transmitters were delicensed experimenters, but we are prepared to bet that not more than one or two ever possessed a licence in pre-war days.

When one thinks of the fact that about eight hundred or more experimental licensees have joined up with the services, the percentage of one or two to eight hundred warrants a more exact definition by the authorities of the term amateur operators when reporting breaches of the regulations in the daily press.

Electrical Instruments

THEIR EARLY BEGINNINGS

By VK2WN.

When Prehistoric Man first communicated with his fellows by means of articulated speech, the first big step in communications had been achieved — Man could speak over short distances and convey information and directions. This advance was far more important to mankind than the entire development of the science of Radio communications—for without speech no civilisation is complete.

So it is that from insignificant, hardly perceptible beginnings spring the most radical and extensive sciences that go to make present day civilisation what it is.

It has been said that electrical instruments are the eyes and ears of industry to-day. They are essential to the maintenance of our communications and our industries. In this short article, the writer will say something of the early beginnings of electrical instruments and trace their developments to present day standards of perfection.

By electrical instruments we mean devices which indicate or record quantities or levels of electric charge, force, energy, and power, in the scientific sense. Since knowledge of electricity goes back barely over one century, one might expect that the first developments in instruments occurred since that time. However, the mechanical features of electrical instruments are fundamentally the same as those of other instruments such as used to measure water and air pressures, time (clocks), temperature, etc. We find that the first step was concerned with the measurement of time.

About the year 300 B.C., the Egyptians, apparently dissatisfied with the accepted forms of sundial, devised a clock which was driven by water power. A circular dial marked in 24 divisions was traversed daily by a pointer pivoted at the centre. The shaft carrying the pointer also had a small pinion fitted which meshed with a vertical rack. At its lower end the rack was attached to

a floating piston. This piston floated on the surface of the water contained in a cylinder. The level of the water in this cylinder is steadily raised by the dripping of water from an overhead tank. The rate of flow could be adjusted to correct the speed of the pointer so that it could be made to keep correct time.

This early device contains practically all the basic requirements of present - day instruments. The rack and pinion provides a good movement amplifier. The piston is automatically damped in its cylinder by the water and there is adjustment to correct inaccuracies.

We can safely give credit for the present day perfection of mechanical detail to the watchmakers of old and their present-day successors. This development is a story in itself, and could not be covered with full justice in this script. Suffice it to say that the most outstanding improvement in clocks, so far as their design affects electrical instruments, was the introduction of jewel bearings in 1704. This helped to overcome the big source of error-friction.

Most electrical instruments have, as part of their mechanism, a magnet, either of the permanent or electromagnetic type. It is not generally realised that magnets were in use by the Chinese many thousands of years ago. They used a natural magnetic ore of iron, Ferric Oxide (Lodestone) as a compass.

"In 2634 B.C., the Emperor Hoang-ti attacked one Tchi-yeou on the plains of Tchou-hou, and finding his army embarrassed by a thick fog raised by the enemy, constructed a chariot (Tchi-nan) for indicating the south so as to distinguish the four cardinal points, and was thus able to pursue Tchi-yeou and take him prisoner."

Lucretius, the Roman writer, has stated in his writings that the Romans and Greeks were aware, not only of the attraction of the magnetic ore for iron particles, but also of the repulsion of suitable poles of the



A PRECISION
INDUSTRY
of national importance

Backed by the complete resources of
Amalgamated Wireless
the manufacturers of Radiotron Valves
produce one million radio valves annu-
ally at the Company's Ashfield Works
—Australia's assurance of adequate
supplies of Valves for Radio purposes.

For improved tone—reliability and
lasting satisfaction always ensure
that your broadcast receiver is
fitted with Radiotron Valves.

magnetic ore. This being so, the major properties of permanent magnets were known in the first century before Christ. The Greeks and Romans also knew that soft iron could be made magnetic under the influence of magnetic ore.

From this point forward, great use was made of the properties of permanent magnets for navigation, and thus another branch of science contributed to the perfecting of our present-day electrical instruments.

The real tie-up with our subject did not come until the discovery of current electricity was made. This occurred in 1800, when Volta was experimenting with his "Voltaic pile" or "Crown of Cups." It was in 1819 that Oersted conducted a very simple experiment to show that magnetism was connected with electricity. He found that a magnetic needle was deflected when brought near a wire carrying a current so that it took up a position at right angles to the wire. This was rapidly followed by an experiment using parallel wires, and in 1837, a coil was used by Pouillet to construct his "Tangent Galvanometer," well known to students of electricity.

The Tangent Galvanometer was useful for measuring electric currents, but suffered a drawback in that it had to be set in a fixed direction so that the earth's magnetic field acted as a restraining force. In 1827, Nobeli constructed his "Astatic" Galvanometer, which used two permanent magnets of nearly equal strength set on a common shaft to oppose each other. The associated coil was set to influence both magnets, and as they were equal and opposite, the restoring force of the earth's field was very small and much greater sensitivity could be obtained. The instrument was called a "Galvanometer" in honour of Galvani.

In 1820-1821, Ampere and Arago working independently, passed currents through coils of wire, which were moved along bars of steel to make them strong permanent magnets. Four years later, Sturgeon made the first soft iron electro magnet on record. This only kept its magnetic current while the current flowed. In the succeeding few years, many powerful electro magnets were constructed by various people. Henry was the first person to use insulated wire in his coils, and it was after

him that the unit of inductance was named.

About this time something significant was happening in a different sphere. In 1821, Seebeck discovered the Thermoelectric effect, or as it is known, the "Seebeck Effect." A potential of a few millivolts is generated when the junction of dissimilar metals is heated. A closed circuit is essential, having both "hot" and "cold" junctions. In 1827, Ohm used a Thermoelectric "Pole," several elements each having a hot and cold junction to prove his now famous Ohm Law. This principle is used in present-day Pyrometers for the measurement of high temperature and also in Radio Frequency Ammeters.

One major problem in the mechanical design of instruments is that of damping. Obviously it is important to steady the pointer of an instrument so that it will not flicker backwards and forwards across the dial. Various methods have been used, from a simple vane moving in air to the magnetic damping produced by Eddy currents in a disc moving in a magnetic field. Some instruments are damped by means of oil, which limits the speed of movement of the pointer. The principle of Eddy current damping was discovered by Arago in 1825, but was not explained till Faraday found that the disc got warm by the passage of electric currents. That was twenty years later. This is the basis of electro magnetic damping used in present day instruments—in fact, even in the KW-hour meter installed outside your home may be found one such Eddy current damping device.

The principle of the moving coil-permanent magnet instrument was first employed by De La Rive in 1850, but we do not know if it was applied to this end. The first commercial patent for such an instrument was that of Varley, an Englishman, in 1856. The application stated that the device was intended for use both as an instrument and as a relay. It used a horseshoe permanent magnet and a soft iron magnet inside the coil to concentrate the magnetic field. The axle and pivots attached to the moving coil are very similar to later commercial designs. Varley in his patent application says that the current may be led into the

coil by means of hairsprings, by platinum dipped in mercury, or by dividing the axle in half and insulating the halves. The coil ends in this case connected to the two axles and the circuit was completed through the bearings.

Thus the business of measuring up electrical quantities was started. Since that time instruments have been of extreme value in providing quantitative measurements required by the advancing science of electricity.

Most readers will be familiar with the various types of instruments in use to-day for common measurements. We know that their accuracy is greatly improved, that they are more uniform in make-up, and now we notice quite a note of modernity in the streamline designs that are now coming to us.

However, perhaps a word about the trend in the near future would be in order.

The most striking advance in the U.S.A. is the general acceptance of plug-in instruments. A standard

type of socket has been devised, into which may be plugged ammeters, voltmeters, wattmeters, Power Factor meters, Kiliwatt-hour meters, both indicating and recording types. In fact, any type of indicator, recorder, or metering device may now be "plugged-in." By means of these, it is a matter of seconds to check up completely on the performance of any piece of apparatus or production equipment, be it in a laboratory, workshop, or factory production line.

The tendency with portable instruments to build many types of instruments in one compact case is going further and further.

Recording instruments are rapidly coming more and more into general usage, since it is realised that one cannot keep a continuous eye on all the instruments that confront one. Also, valuable production data may be obtained from the load curves obtained from these recorders, whilst complaints to power companies about varying voltages or frequencies are rapidly arbitrated.

(Continued on page 13)

GOODMANS

HIGH FIDELITY

LOUD SPEAKERS

FOR

1. Level Response.
2. Wide Frequency Range.
3. Reduction of Sub-Harmonics.
4. Good Transient Response.
5. Elimination of Bass Modulation of the Upper Frequencies.
6. Freedom from Hum.



GOODMANS 10" HIGH FIDELITY LOUDSPEAKERS.

CALL IN AND HEAR ONE

J. H. MAGRATH PTY. LTD.

208 LITTLE LONSDALE ST., MELBOURNE.

Cent. 3688

Applications of the Voltage Doubler Rectifier

By M. A. Honnell,
Instructor, Electrical Engineering, Georgia Tech.

The double-diode voltage-doubler rectifier is widely used in the power supplies of radio receivers and of amplifiers, but is used to a very limited extent in other electronic applications. A 6H6 twin diode tube connected as a voltage-doubler detector operates successfully at radio frequencies and presents certain inherent advantages not offered by the usual half-wave or full-wave detector circuits.

Fig. 1-A is the basic diagram of the half-wave rectifier detector. If R is large as compared to the diode resistance, and if C has a low reactance at the frequency of the applied voltage, E_{ac} , the d-c voltage developed across R is practically equal to the peak value of the applied voltage.

Fig. 1-B shows the conventional voltage-doubler rectifier circuit in which the series-connected condensers C_1 and C_2 are charged in succession on alternate half cycles of the applied voltage E_{ac} . For light loads, or a high load resistance, the d-c voltage developed across R is very nearly twice the peak a-c input voltage. The lowest ripple frequency present in the output is twice the input frequency.

Fig. 1-C shows another voltage-doubler rectifier circuit in which C_1 is charged to E_{ac} peak during the half cycle that diode No. 1 conducts current, and then C_1 in series with the line charges condenser C_2 to twice E_{ac} peak on the next half cycle, when diode No. 2 conducts current. From the power supply standpoint, this circuit presents two disadvantages:

- (1) Condenser C_2 must have a voltage rating of twice the peak a-c input voltage.
- (2) The lowest ripple frequency present in the output is the same as the input frequency, therefore, filtering is more difficult than in the conventional voltage-doubler circuit.

In Fig. 2 are shown performance curves for a 6H6 employed as a half-wave rectifier and as a voltage doubler obtained at a frequency of 60 cycles with C_1 and C_2 equal to two

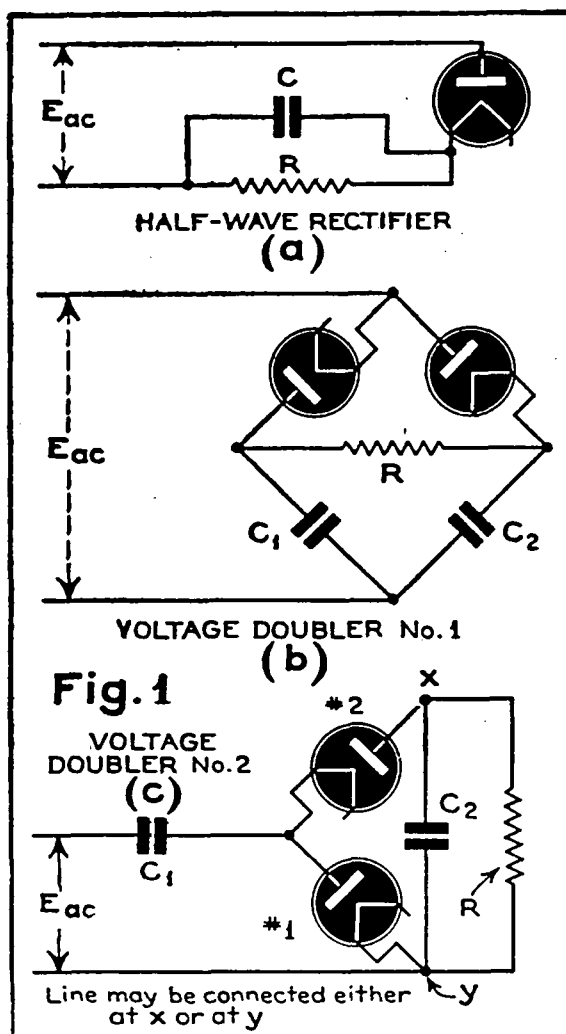

microfarads and load resistance as indicated. These values are the 60-cycle equivalents of the values ordinarily employed with diode detectors at broadcast frequencies. The curves check well at a frequency of one megacycle. At high frequencies the cathode-to-cathode capacity which is

shunted across one of the diodes in both circuits becomes objectionable.

A 6H6 used as a voltage-doubler detector develops approximately twice the audio-frequency voltage and d-c voltage as compared to the conventional half-wave detector for a given modulated input voltage. The detection efficiency, the ratio of the output d-c voltage to the peak a-c input voltage is from 160 per cent. to 190 per cent. in practical circuits. Fig. 2 shows that the voltage-doubler detector is quite linear for large input voltages.

It is seen that the voltage-doubler detector provides a high bias voltage for automatic volume control, volume expander, volume compressor and similar circuits. As the two voltage doublers deliver approximately the same output voltage when equivalent RC values are employed, the choice of either voltage doubler for use as a detector depends largely on the circuit arrangement desired.

The diode voltage doublers are particularly convenient for use in vacuum-tube voltmeters in which application they are sensitive full-wave peak voltmeters. With condensers C1 and C2 equal to from 0.01 mfd to 0.05 mfd and R equal to from 2 megohms to 10 megohms, or higher, the voltage developed across R is independent of frequency over a wide frequency range, and is directly proportional to the input voltage. If the voltmeter is to be used at low frequencies the condensers should be at least one microfarad.

The voltage developed across R is equal to the sum of the positive and the negative peaks of the input voltage. Therefore, the voltmeter is not subject to turnover, which is the change in reading of a vacuum-tube voltmeter when its input terminals are reversed, if the voltage measured contains even harmonics in such phase position that the positive and the negative half cycles have different peak values.

A decided advantage in the use of either voltage doubler in a voltmeter for a-c measurements is that the condensers break the d-c path in the input circuit so that the instrument will read only the a-c component of the input voltage, should it contain a d-c component. Doubler No. 2 possesses an advantage over doubler No. 1 in that there is a common input

and output terminal, which permits the use of a common ground point. For precise measurements, the small e-m-f due to the electron emission current flowing through R must be balanced out, as it approaches 0.5 to 1 volt in magnitude.

The indicating device to be used with the doubler voltmeter may consist of one of the following:—

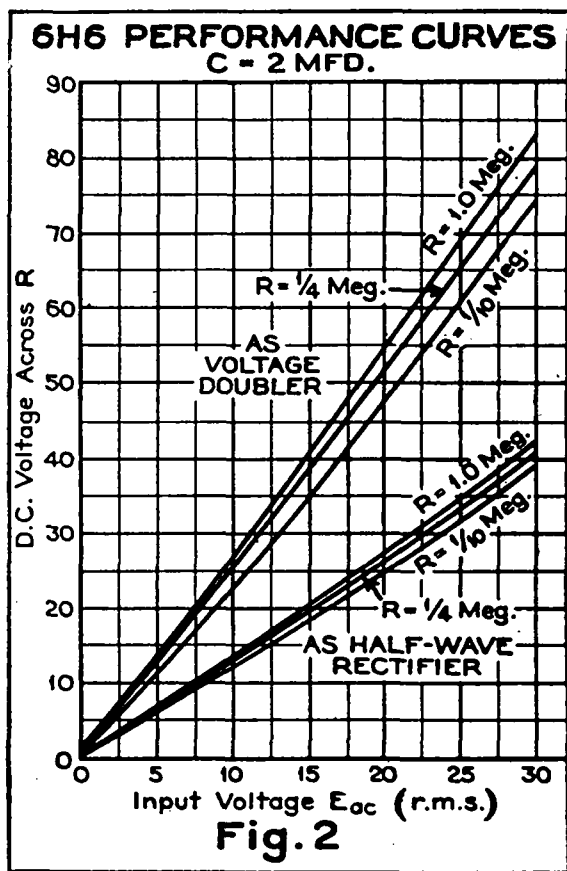

- (1) A microammeter or a milliammeter in series with R.
- (2) A d-c potentiometer with a galvanometer to indicate when a balance is obtained between the voltmeter output voltage and the voltage across the potentiometer terminals.
- (3) A triode d-c amplifier, preferably of the degenerative type with zero balance for the meter.

No matter how tough things get, that well-known Chinese operator, Wun Long See Cue, will be still going strong. As Confucius never said—
 "Lid who call CQ too long never paper wall, but sure plaster band."

—W1JPE

40-CM Waves in Aviation

Tests at M.I.T. reveal practical apparatus for generating a 40-cm. "hillside" of signal for blind landing of airplanes. Horn radiators and a receiver having 15-microvolt sensitivity show practicability of 700-mc. communication.

Recent progress in the field of the ultra-ultra high frequencies, above 500 Mc., has consisted principally in the development of more efficient generators, more sensitive detectors. Behind the scenes, however, several organizations have been working toward the application of the very short waves to the problems of aerial navigation and guidance. One of the outstanding examples of this work is the collaboration between the Civil Aeronautics Authority and the Massachusetts Institute of Technology on a system of instrument landing which employs 40 centimeter waves and which makes use of nearly all of the modern developments in the field of microwave research. The system is the solution of a problem proposed by a C.A.A. engineer, Irving Metcalf, and developed in practical form by the electrical engineering department staff of M.I.T., under Professor E. L. Bowles. The apparatus was recently demonstrated in experimental form to C.A.A. officials at the East Boston airport.

Beams from Horn Radiators.

The transmitting equipment operates on a frequency of approximately 700 Mc. At such high frequencies, beams may be formed by radiating the energy from horn structures of convenient dimensions. Two such horns were used in the demonstration, each fed by a separate transmitter. The horns are wooden structures, about 26 feet deep, and 10 by 2½ feet at the mouth. They are lined with copper sheeting. At the end of each horn is a rectangular box which closes the throat. Inside the box is a quarter-wave antenna which protrudes into the box directly from a coaxial transmission line. The length of the antenna

is about 19 cms, (roughly 4 inches). The 700-Mc. energy radiated from the antenna is conveyed down the horn to its mouth and there it spreads out in a flat fan-like pattern, whose width is at right angles to the long dimension of the mouth of the horn and parallel to the ground. (This relationship obeys the rule for diffraction effects, namely that the diffraction pattern spreads widest at right angles to the long dimension of the slit). Consequently the horn generates a flat nearly horizontal beam of signal, inclined at a slight angle to the airport surface. Two horns are used, each fed with signals of the same frequency, one modulated at 150 cps., the other at 90 cps. The horns are set up so that the central axis of one makes an angle of 5 degrees to the earth's surface, the other an angle of 10 degrees. The fan-like beams from the two horns overlap in a region which extends from about 3 degrees to 7 degrees. The overlap region constitutes a "hillside" of signal down which the plane glides to the airport surface. In the plane, the receiver tells the pilot when both signals (90 cps. and 150 cps. modulations), are received. When both are received at equal strength the glide angle is 7.5 degrees, which is somewhat steep for most aircraft, hence the receiver is set to indicate the proper position when the upper beam is received somewhat stronger than the lower, producing a normal glide of from 3 to 4 degrees.

The arrangement just described gives so-called "vertical guidance," that is it guides the plane in the up-down direction. Similar guidance in the horizontal or left-right direction is also necessary. In the demonstration the horizontal guidance was provided by a conventional long-range runway localiser transmitter, designed and operated by engineers of the Washington Institute of Technology. When the C.A.A.-M.I.T. system is completed the horizontal guidance may be set up by 40-cm. waves in the same fashion as the vertical guidance.

The 700-Mc. Generators.

The horn structures just described are highly directional (in the plane of the fan pattern), and hence conserve the energy fed to them from the transmitter proper. For this reason, very small amounts of transmitter power will suffice, so long as the receiver in the plane has adequate sensitivity. Two possibilities arise: a transmitter of several hundred watts power may be used with an insensitive receiver, or a few watts of transmitter power may be used with an elaborate receiver. The low-power arrangement was used at the demonstration, although the high-power method has been tested with success.

The generation of hundreds of watts of power at 700 Mc. has been possible only since the advent of the beam-type of cathode-ray generator. One of the "Klystron" generators originated at Stanford University was available for the purpose, and was set up in operating condition on the airport, mounted in a truck complete with high voltage power supply and a continuous vacuum-pumping system. With less than 100 watts output, in previous tests, adequate signal strength was received in the plane at a distance of more than 25 miles, which constitutes a record for microwave transmissions. In the demonstration, however, it was more convenient to use lower power and to rely on the high sensitivity of the receiver. Accordingly, two conventional triode oscillators were used, one for each horn radiator. The oscillators employed the Western Electric type 316A door-knob tubes in coaxial-line tuned circuits, and were fed with about 25 watts of power, one modulated at 90 cps., the other at 150 cps. The output of the oscillators was in the neighbourhood of one watt at 700 Mc. (43cms), but even this small power was adequate to produce a strong signal at distances greater than five miles. Since the glide path to the airport surface is usually less than five miles long, the performance was satisfactory, despite the very low power of the transmitters.

The 15-Microvolt Microwave Receiver.

From the standpoint of radio engineering, the most significant development in the project (save possibly the use of horn radiators) is the

40-cm. receiver. This receiver displays the phenomenal sensitivity of 15 microvolts input for full output (off-scale swing on the indicating meter). The tube lineup is shown in the accompanying figure. The antenna is of the coaxial variety developed by the Bell Labs. It is fixed to one of the wing struts. The coaxial lead-in connects to the input circuit. The first detector is a diode tube, a W.E. development type. This tube serves two functions. In the first place it develops the third harmonic of the oscillator output, and in the second place it mixes this third harmonic with the input signal, producing a 10-Mc. intermediate frequency. The dual aspect of the diode action is illustrated in the accompanying diagram. Three tuned circuits are connected in series with the diode, as shown. The first is tuned to 700 Mc., the input frequency.

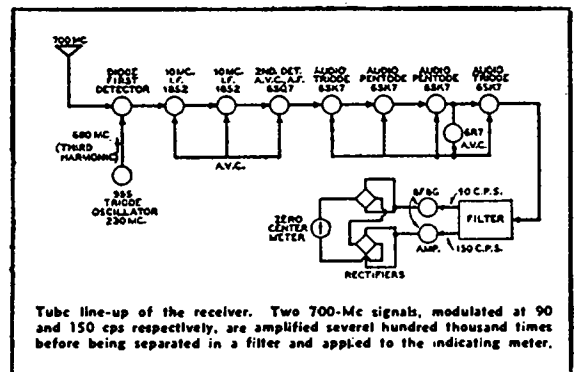

The second is tuned to 230 Mc., the oscillator frequency, and the third is tuned to 10 Mc., the intermediate frequency. At other than these resonant frequencies, the tuned circuits are essentially short circuits, so it is possible to consider the action of each circuit as though it were the only element in the series with the diode. Hence the diode produces a 690 Mc. frequency as the third harmonic of the oscillator voltage, mixes it with the 700 Mc., input, and derives the 10 Mc. i.f. voltage, simultaneously.

The oscillator proper, which employs a 955 acorn triode, is a specially designed coaxial tuned circuit similar to those developed by Peterson. The tuned circuit is in the form of a high-Q resonator, which encloses the tube, and which is so proportioned as to produce a highly stabilised output.

The i.f. output of the first detector is amplified in two 1852 i.f. stages,

airport surface, such as would be caused by a snowfall. The signal regions extend a considerable distance to the left and right of the horn openings, hence it is quite feasible to place the horns to one side of the glide path, and thus remove them from the airport surface.

(Continued from page 7)

On the technical side every year sees an improvement in the accuracy obtainable with commercial instruments. Friction and other losses are being reduced, torque and overload capacity increased. Sensible, easily read dials are more in prominence, and back of dial illumination is here to stay.

In conclusion, it should be said that the writer has drawn freely from a publication, "Electrical Instruments—the Eyes and Ears of Industry," for the historical items. This is a publication put out by the Westinghouse Electric and M'fg Co.,

The March issue of "QSO," the official organ of the Resau Belge, records the passing of its Vice-President, ON4LM, Colonel Martin.

Recent issues of "Break In," the journal of the N.Z.A.R.T., records the deaths of ZL1AR, ZL2LG, and ZL3JT.

ZL1AR, Les Mellars, of dx fame and well-known to all VK's., was drowned as the result of a yachting tragedy on January 13th.

ZL3JT, Aircraftsman Doug. Birbeck, met his death in a plane crash near Christchurch, while ZL2LG, Leading-Aircraftsman Jack Langridge, of the R.A.F., has been posted as missing during a Norwegian raid on April 11th.



The Power Equipment with a Powerful Reputation . . .

THE Organisation responsible for the
production of . . .

**HILCO TRANSFORMERS
CHOKES, etc.**

has proved its high standards for an article
of extreme merit as accepted by the
largest consumers in Australia.

**ALL PRODUCTS GUARANTEED FOR
TWELVE MONTHS.**

HILCO TRANSFORMERS PROPRIETARY LIMITED

97-111 BERKLEY ST., CARLTON, N.3., Vic. 'Phones; F1661-2
CABLES & TELEGRAMS: "HILCOY," MELBOURNE.

Frequency Modulation

An up-to-the-minute summary on frequency modulation. This is the first of a series of two articles on this interesting subject.

Something new and vital has come to radio. Wide-band frequency modulation offers the set manufacturer, the seller, and the user of radio the possibility for a new era in which performance will be paramount. The industry welcomed the recent upward trend in prices, small as it was. F-m is a proven system, standing ready to free it from "price" standards, give it instead a "quality" standard.

"Fortune" magazine, in its October issue, insists that 40,000,000 home receivers and 750 or 800 transmitters became obsolete on the day the f-m system was perfected. Engineers within the industry are more conservative. They know that years may be needed to change two billion dollars worth of equipment to another system, no matter how superior that system might be.

Those who have not followed the progress of f-m will be amazed at its advancement.

The scientist and engineer have presented this development to us all. Will the public demand the refinements and greater enjoyment promised by f-m? A tremendous replacement volume hangs on the answer.

From the standpoint of the consumer, f-m transmission has two major advantages. First, is its amazing fidelity. Music and speech have a natural sound, you hear a truer duplication of the original programme in the studio. High fidelity is commercial, not experimental.

Noise Reduction.

The freedom from atmospheric disturbances and local noise, which the buying public group together as static, is equally noteworthy. No longer will it be necessary to turn off your favourite programme because a thunder storm is brewing. A bolt of lightning may strike the transmitter and cause only a mild click in your receiver. All interference is reduced. Faults associated with radio since its

earliest days are wiped out or reduced far below what is considered acceptable to-day.

Many technical factors combine to give this vastly improved reception. One advantage of the f-m system is that radio-frequency noise which may occur between the transmitter and receiver is not evenly distributed throughout the audible range when it is reproduced in the speaker. It is a peculiarity of f-m that these noises, due to what we normally call static, are minimised at the lower audio frequencies. They increase steadily as we approach the limit of human hearing at about 15 kc. The noise and interference continue to increase still further up to 75 or 100 kc., and some part of this disturbance may pass through the receiver.

No human ear, however, can detect the part of this distortion which occurs above about 15 kc. The human ear also is much more sensitive to distortion at low pitch. Thus this peculiar distribution, of what we may call the disturbance energy, occurs in such a way that the human ear rejects by far the greatest part of it entirely, and is most sensitive in the region where the f-m system most completely wipes out the disturbing sounds. The amount of advantage accruing to f-m depends, of course, upon the keenness of hearing of each individual. A number of tests, however, show that at least 50 per cent. more actual audible distortion may be present in an f-m programme than in an a-m programme, yet the human ear would rank them both equally acceptable and free from objectionable disturbances. This means that an f-m programme may be received with enjoyment in an area where local electrical disturbances, whether natural or man-made, would normally make pleasant listening an impossibility. See Fig. 1.

In addition, some disturbances are themselves of definite band width, or affect only a certain band of fre-

quencies in the transmitted signal. If the programme we hear in our receiver is carried to us through a system which is only 10 kc. wide, then a disturbance affecting a band 1 kc. wide will cause a certain amount of distortion. If, on the other hand, our receiver brings us a programme by means of an energy band 100 kc. wide, then this 1 kc. disturbance will cause less distortion than occurred in the first case. If one f-m system operates with a swing of 50 kc. each side of its carrier, and another with a swing of 5 kc. each side of its carrier, the first transmitter should show an improvement of at least 10 to 1 as compared to the second in its ability to suppress noise.

The actual figures are astounding. When the peak value of the distur-

tried to use f-m in order to pack more transmitters in the broadcast band. A big advantage of modern f-m transmitters is that a number of them may be assigned to the same frequency, provided they are several hundred miles or more apart. There will be no cross-modulation or interference. This is due to the fact that the f-m receiver will reproduce only the stronger of two signals, suppressing the weaker one, provided the ratio of the signal voltages in the receiver is 2 to 1 or more. F-m is at present limited by the FCC to frequencies of 40 mc or higher. The limit of satisfactory signal strength for such transmission is somewhere between 100 and 150 miles. We can visualise a large number of transmitters, all on the same wavelength,

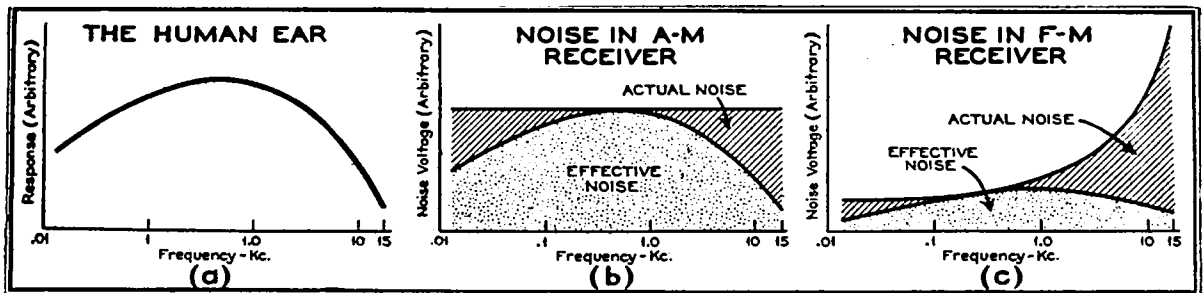

bance is less than 10 per cent. of the signal (both measured in the limiter stage of the f-m receiver) then the energy of this disturbance after rectification will be reduced by almost 1100 to 1. For noise voltage upwards of 25 per cent. of the signal voltage, the noise reduction in the rectified signal will be about 700 to 1. When the noise is one-half the signal it appears in the output reduced by a factor of about 400 to 1. If the noise and signal become approximately equal, the actual improvement drops to some very low value of 2 or 3 to 1. Although the primary service area would be considerably enlarged if the suppression could be kept up to 400 or 500 to 1 when noise and signal were about equal, let us not forget that high-fidelity a-m reception requires signal to noise ratio of about 100 to 1. This is the region where the f-m system's ability to suppress unwanted noise is a maximum.

Inter-Station Interference.

Reference has been made to the efforts of early experimenters who

scattered across the country at distances of approximately 300 miles from each other. Each one covers its own primary service area without being affected by, or interfering with, the other transmitters on the same band. Present experiments indicate that even better results could be had if the assigned frequencies of the stations were separated by amounts as small as 10 or 15 kc. Due to the action of the detecting device in the f-m receiver, the suppression of unwanted signals would be still further increased. It is often possible, however, to pick up the weaker signal with a directive antenna which would increase the amount of desired signal available to the receiver.

The ability of the f-m transmitter to minimise natural and man-made interference and to magnify the wanted signal gives the system a cumulative advantage over present types. If we calculate the performance of an f-m transmitter and an a-m transmitter, both drawing about the same number of kw. from the lines of the local utility, the f-m system with a

band width of 150 kc. and the a-m system with a band width of 10 kc., we find that a theoretical overall improvement of more than 1000 to 1 may be secured. This improvement is measured by the accepted method—comparing the ratios of signal to signal-plus-noise permissible for high-fidelity reproduction.

Actual comparisons have shown the possibility of approaching this ratio in practical, every-day operations. Some allowance should be made for the circumstances attending the test, since u-h-f transmission of any type has advantages over the same system operated in the broadcast band. The tests would have been more acceptable had they compared a-m and f-m, both at the same high frequency. Sufficient additional improvement exists, however, to convince many investigators.

AUDIO SIGNAL FREQUENCY (Cycles per Sec.)	CARRIER AMPLITUDE	SIDE FREQUENCY AMPLITUDES								CORRES. PONDING PHASE SHIFT.
		1st.	2nd.	3rd.	4th.	5th.	6th.	7th.	8th.	
10,000	100	2.5	-	-	-	-	-	-	-	2.9°
5000	100	5.0	-	-	-	-	-	-	-	5.7°
2500	99	9.9	-	-	-	-	-	-	-	11.5°
1000	93.8	242	3.1	-	-	-	-	-	-	28.6°
500	76.5	44	11.5	1.9	-	-	-	-	-	57.3°
250	22.4	57	353	129	3.4	-	-	-	-	114.6°
100	17.7	327	4.6	365	39.1	26.1	13.1	5.3	1.8	286°

Amplitudes are expressed as percent of unmodulated carrier.

TABLE II.—Roder's calculations for frequency-modulated amplitude variations. Phase modulation (last column) should be restricted to less than 30 degrees to avoid serious distortion. Note that in phase modulation the phase shift varies inversely as audio frequency; in true frequency modulation the frequency deviation varies directly as the audio frequency.

Phase Shift.

Another operating advantage of f-m rests upon the fact that high audio frequencies are transmitted with the minimum phase shift in output, and low frequencies with the maximum. In a typical case cited by Major Armstrong, 30 cycles per second would be represented by a phase shift of 30 degrees; 10,000 cycles by a shift of but .09 degrees. Even after the

series of multiplications required to change this shift to an f-m wave, the highest audio frequencies lie closest to the assigned carrier in phase relationship. Thus, a considerable amount of additional amplification may be given to all the higher audio frequencies without causing interference with adjacent programmes. Pronounced amplification of the highs in an a-m transmitter is limited in order to prevent cross-modulation of adjacent channels.

Cost Factors.

Another advantage of the f-m system is that the modulation of even the largest transmitter can be accomplished using the same type of tubes and components found in radio receivers, except for the final stages. A 50-kw. modulator bay is reduced to the approximate size of an 8 or 10 tube receiver chassis, although it includes its own power pack.

The maximum voltage (plate supply) applied to any component part of the modulator is only 180 volts. Such voltages are easily handled and filtered and represent an economical design which is reflected in the initial and lower maintenance cost of the complete transmitter. Voltages over 200 are found only in the power stages.

Further economy results from the fact that for equal transmitter power rating only about half the electrical energy is required from the power lines by an f-m system as compared to a-m. This economy is partly due to the fact that f-m lends itself admirably to the use of Class C output stages and also because the antenna current does not vary (during programme transmission) from the carrier level.

Some criticism of f-m is voiced because, in its modulating system, a small phase shift of not over 30 degrees must be multiplied, with strict linearity, several thousand times. The answer to this is that the modulator is relatively inexpensive. The carrier is modulated at a low energy level and the majority of the parts used in its construction, both tubes and components, are identical with those used in home receivers. This complexity of parts is merely that of numbers, since the actual circuits are doublers and triplers of a conventional type.

chain cannot change to f-m unless enough f-m receivers are in operation in his primary service area to permit him to charge the sponsor an adequate fee. The maker of receivers can offer f-m sets at attractive prices only if he is assured of a volume of sales. The public cannot be expected to buy an f-m receiver if it means that he must sacrifice the reception of his favourite programmes, or if the price is too high.

Transmission Fundamentals.

In order to compare the f-m and a-m systems in operation, we must first return to the fundamental problem of transmitting intelligence by radio. There are two variables which must be sent from the transmitter to the receiver, if we are faithfully to reproduce in the latter the programme originating in the studio. Each of these variables suffers wide changes independently of the other.

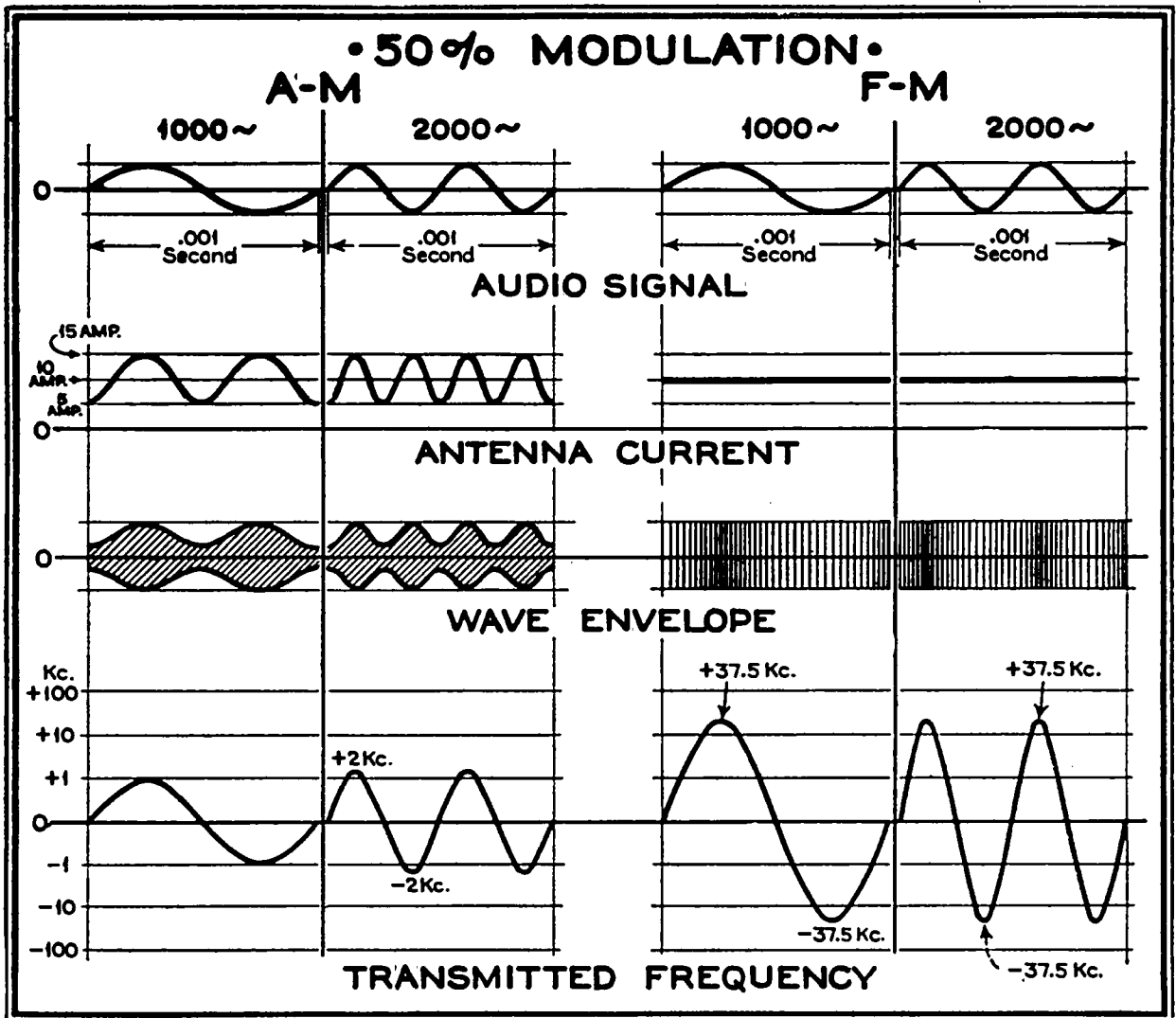

Since radio broadcasting in this country is a private undertaking, many factors must be weighed before a change can be authorised. Existing contracts with sponsors, competition, stockholders, patents, licences, are but a few. The remarkable point, in the opinion of many, is that a new and radical departure from the established system can have made the rapid progress which f-m has, in spite of these factors, all nominally opposed to sudden change.

They are the pitch or frequency of the programme material, and its volume.

In a conventional a-m transmitter the change in pitch is indicated by a change (in cycles per second) from the fixed carrier frequency. Thus, if an a-m transmitter, operating with double sidebands, were assigned a frequency of 42.8 mc., a 1000-cycle note would be broadcast when this transmitter was sending out a wave, the side frequencies of which would be

42.799 and 42.801 mc. Change in volume is signalled by a variation in the amount of current fed into the antenna of the transmitter. For example, if the antenna current is 10 amperes when no signal is being broadcast, this current would be increased to 20 amperes for 100 per cent. modulation, or the loudest sound which this system could transmit. An antenna current of 15 amperes would represent a sound about one-half as loud as the first, etc.

The first point of difference between the above system and f-m transmission is that the f-m station broadcasts a signal of constant amplitude whether modulated or not. Zero, 50 or 100 per cent. modulation would call for a 10 ampere antenna current in all cases, if we use the carrier power assumed for the a-m transmitter. The loudness of the sound presented to the microphone of the f-m system would be indicated by the frequency deviation of the side frequencies. If this station likewise operated on a carrier of 42.8 mc., 100 per cent. modulation would be indicated when the emitted frequency contained side frequencies of 42.725 to 42.875 mc. If 50 per cent. modulation was to be indicated, the frequency would vary between the limits of 42.7625 and 42.8375 mc. If no modulation was present, the transmitter would emit a single continuous frequency of 42.8 mc. If a 1000-cycle note is being fed into the microphone at an f-m station, the frequency swing will take place 1000 times in every second. Note that under no circumstances will the antenna current deviate from 10 amperes. We may summarise the comparison by stating that a-m indicates pitch by changing the frequency of the radiated energy; f-m by the time rate of change of frequency. The a-m system indicates percentage modulation by proportionate changes in the antenna current; f-m by varying the amount of frequency swing above and below its assigned carrier. See Fig. 5.

Experimenters have tried to apply frequency modulation to solve radio problems since the earliest days. It was tried on both spark transmitters and the early phone sets without success in either case. We can see now that one probable reason for these failures was that the experimenters were trying to compress the normal

ILLEGAL RADIO

Two Men Fined £100.

Extract from "The Argus," Wednesday, June 5.

SYDNEY, Tuesday.

Two men were each fined £100 by Mr. Balmain, S.M., at Bega Court today on charges of having established wireless transmitters and having sent messages without authority. They were Bertram James Schafer, of Bega Street, Bega, and Allen Henry Lee, of Newtown Street, Bega. Both pleaded guilty to the charges, brought under the Wireless Telegraphy Act.

Evidence showed that in October, 1939, the defendants constructed transmitting sets and sent messages and phonograph recordings to each other. From November, 1939, to April, 1940, observations were made by radio inspectors, and the transmitters were traced to the defendant's premises and seized. The defendants said that they had constructed the sets only to send messages to each other. However, they were heard in Sydney and Melbourne, and the sets were capable of sending messages oversea.

Mr. Balmain said that he regarded the matter as serious in view of the war. He imposed the maximum penalty in each case. Schafer and Lee were fined £50 on each charge, with £1/9/- costs, on each charge, in default 104 days' imprisonment. Both transmitters were ordered to be forfeited.

Frequency Modulation (Continued)

audio band of 10 kc. into one only 2 or 3 kc. wide. This, if successful, would have permitted many more transmitters to operate in the broadcast band. As we have seen, f-m has a solution to that problem to-day. It has achieved its success, however, by an exactly opposite method of attack. To-day's f-m transmitter transmits a band 100 or 150 kc. wide to reproduce in the home receiver an audio band of 15 kc. with fidelity. But there were many other problems which had to be overcome, however, before f-m could reach its present state of development.

(To be concluded.)

MICROPHONE TYPES

By A. G. Walz (ex-VK4AW)

(Continued from May, 1940.)

The Dynamic Microphone depends for its action on the induction of current in a coil of wire moving in a magnetic field. Similarity exists with the velocity except that in this case the currents induced could be termed eddy currents. An amateur version of the dynamic and used extensively, has been in the form of a midget permag speaker and very effective. The commercial product, of course, uses a dural diaphragm, and special chambers incorporated to relieve back pressure, enabling the whole job to be constructed in a convenient size for ease of handling. Along with the crystal, this type is now available in a streamlined case, not merely to add to the appearance, but with a definite object, a reduction of pick-up from the rear and sides, otherwise, a directional microphone, which finds many uses; P.A. equipment, especially where minimum feedback is essential, directional studio and outside work, where background noises are required to be suppressed. The beauty of these new types is that the mike can be tilted up to achieve non-directional pickup when it is required for that purpose.

The relative impedances and output levels of the various types should be of interest. These may be taken as average as variations with certain makes are quite appreciable.

	Impedance.	Level.
Magnetic Pickup ...	High Imp.	—10
D.B. Carbon	200 aside	—45
Reiss	500	?
Condenser	High Imp.	—97
Crystal Diaphragm	High Imp.	—45
Cell	High Imp.	—70
Velocity	1 ohm.	—100
Dynamic	10-30 ohms	—85

BOOKSHOP SMATTERINGS.

Signal Chaser.

("Radio News," March, 1940.)

This instrument would be invaluable to the conscientious serviceman who desires rapid signal checkings on a receiver. Briefly, the instrument is one whereby by means of probing rods one may check the signal in any part of a receiver, that is the RF, IF and AF channels and actually see what the signal is doing. Each section feeds into a 6 E5 magic eye tube giving visual indications of the happenings — full constructional details are given.

A Laboratory Vernier.

("Radio News," March, 1940.)

Where exact measurements are required some form of a precision vernier dial is essential and this article tells how to build one.

Standards on Electronics.

(Institute of Radio Eng's.)

A booklet set up by IRE to cover standards for testing vacuum tubes, phototubes, photoelectric devices, etc., showing circuits and details of tubes.

"Standards on Radio Receivers."

(Institute of Radio Engineers.)

A publication by IRE on standards for checking receiver performances from the input to the output.

"Standards on Transmitters and Antennas."

(Institute of Radio Engineers.)

Checks and efficiency performances on transmitters and aerials are listed in this booklet.

"Electronic Keying."

("QST," April and May, 1940.)

Two articles appear on a new and interesting form of keying a transmitter or oscillator. Briefly, the principle is based on the gaseous discharge tube, the 885, which is capable of building up an electronic flow up to the ionisation point, after which the plate current suddenly collapses. By the means described in the articles it is possible to press a key similar to the old side swiper and when contact is made on one side, dots pour out of the 885 as long as the key is held over. Dashes are made when the key is pressed in the opposite direction. Perfect dots and dashes are automatically made and can be controlled from 15 to 40 words per minute.

LIST OF SHORT WAVE STATIONS HEARD.

By J. F. Miller,
152 Chapel Street, St. Kilda, Vic.

KGEI—15,330 Kc. 1956 m.—San Francisco—Heard at this frequency between 4 and 5 p.m.

DXU—15,320 Kc., 19.58 m.—Berlin—This station is heard at quite good strength around midday, usually on Sundays with several announcements in English.

DJQ—15,280 Kc., 19.63 m.—Berlin—Not at their usual strength during the late afternoon.

2RO6—15,300 Kc., 19.61 m.—Rome News from this station is given at 4.35 p.m., and is heard well at this time.

JZK—15,160 Kc., 19.79 m.—Tokio—An excellent signal, with news at 10.30 p.m.

YDC—15,150 Kc., 19.8 m.—Bandoeng—This station is the only one heard at any strength at night on this band of late.

GSF—15,140 Kc., 19.82 m.—London—At excellent strength around 9 a.m.

FFZ—12,050 Kc., 24.89 m.—Shanghai—This French station is now heard regularly at night, but is badly spoilt by morse.

RNE—12,000 Kc., 25 m.—Moscow—This Russian is one of the most powerful heard just before closing at 8 a.m.

VUD4 — 11,870 Kc., 25.27 m.—Delhi—Another Indian regular.

WLWO—11,875 Kc., 25.28 m.—Cincinnati, Ohio—Heard at only fair strength between 4 and 5 p.m., and drops slightly at night.

XMHA — 11,855 Kc., 25.3 m.—Shanghai—This station seems to carry a native programme only.

Bookshop Smatterings (Continued)

"A Complete 56 mc. IF System."

("QST," April, 1940.)

The amplifier described, functions on 5 mc., and is usable for both FM and AM signal reception—an excellent article for UHF men.

"Improving the Flying Skywire,"

("QST," April, 1940.)

An article covering construction of kite aerials with (AWC) Automatic Wind Control. For use up to 1200 feet.

VLR3—11,850 Kc., 25.32 m.—Melbourne—Overseas and Australian news heard at excellent strength just before 8 a.m.

VLW3—11,830 Kc., 25.36 m.—Perth—Also heard with news at 7 p.m.—Excellent strength.

JZJ—11,800 Kc., 25.42 m.—Tokio—Heard at night with news at 10.0 p.m. JVV3 carries same programme but this station is at better strength.

Saigon.—11,780 Kc., 25.47 m.—F.I.C.—Definitely the loudest overseas station on this band, if not on the air. Special English programme in early evening.

DJD—11,770 Kc., 15.49 m.—Berlin—Heard at excellent strength around 1 p.m., with special broadcast to North America.

GSD—11,750 Kc., 25.53 m.—London—Heard with news at 4.15 p.m.

JVV3—11,720 Kc., 25.60 m.—Tokio—Carries same programme as JZJ, but not as good.

PLP—11,000 Kc., 27.27 m.—Bandoeng—Seems to be mainly native programme.

XGSE—9,780 Kc., 30.67 m.—Ching Quen, North China—Very poor quality, mainly native programme opening at 10 p.m.

ZHP—9,700 Kc., 30.94 m.—Singapore—News from the B.B.C. may be heard at 11.15 p.m.

GRX—9,690 Kc., 30.96 m.—London—This station is not usually heard here, but can be heard sometimes around 4 p.m.

XEQQ — 9,680 Kc., 30.99 m.—Mexico City—A fairly faint signal during the afternoon.

VLW2—9,650 Kc., 21.09 m.—Perth—Good at night.

KZRH — 9,640 Kc., 31.12 m.—Manilla—This is one of the regulars, carries excellent musical programme.

2RO3—9,630 Kc., 31.15 m.—Rome—Terrific strength, with news just before closing at 8 a.m.

TIPG—9,620 Kc., 31.19 m.—Costa Rica—Could easily identify the words "Costa Rico," which are mentioned quite often.

VLQ—9,615 Kc., 31.2 m.—Sydney—The best Australian around 11 p.m.

DXB—9,610 Kc., 31.22 m.—Berlin—Not as good as DJA.

HP5J—9,607 Kc., 31.23 m.—Panama City—Mainly native tongue spoken, but was fortunate to hear announcement sufficient to identify.

VUD3—9,590 Kc., 31.28 m.—Delhi—This Indian is the most powerful on this band, also the most regular.

VLR—9,580 Kc., 31.22 m.—Melbourne—Carries same programme as 3AR quite often.

KZRM — 9,570 Kc., 31.35 m.—Manilla—Another regular Phill. Is. station, and is at best strength.

DJA—9,560 Kc., 31.38 m.—Berlin—This station is particularly good just prior to 4 p.m.

VPD2—9,535 Kc., 31.47 m.—Fiji—Heard at quite fair strength around 8 p.m.

KGE1—9,530 Kc., 31.48 m.—San Francisco—Can be heard on this frequency very well with news at 10.30 p.m. and 12.30 a.m. News items are particularly interesting.

TPC—9,520 Kc., 31.55 m.—Paris—Heard on 9/6/40 with special broadcast to North America. Have not heard since.

GSB—9,510 Kc., 31.55 m.—London—Another B.B.C. station heard at night.

XGOY — 9,500 Kc., 31.58 m. —Szechwan, China. Mainly native tongue spoken. Fair strength.

KZIB—9,500 Kc., 31.58 m.—Manilla—not as good as KZRM or KZRH. Fair signal with XGOY off the air.

ZBW3—9,525 Kc., 31.5 m.—Hong Kong.—Fair signal only—news at 10 p.m.

THE ARMY NEEDS OPERATORS.

We have been asked to advise all amateurs who are thinking of joining the A.I.F. as radio operators to communicate with Capt. P. E. Dunne, Southern Command Signals, Mt. Martha Camp, Victoria, who will advise them of the best method to adopt when enlisting. Applications are urgently required.

The magazine has just completed its annual balance and we have to report a loss on operations to the extent of £14 for the year. Some people will think it cheap W.I.A. advertising, but we look to all divisions to help maintain our circulation in order to reduce this loss which is again being borne by the Victorian Division.

We are grateful for help received, even when it is not acknowledged publicly, and we look to you to keep the good work going to the best of your ability.

Q.S.L. BUREAU

The following statistics show the growth of this Bureau's activity:—

Year.	Cards Handled.
1931	9,790
1932	18,333
1933	18,686
1934	22,043
1935	27,110
1936	43,707
1937	43,296
1938	41,155
1939	20,962
Grand Total	245,082

Roughly a quarter of a million cards in nine years, is a record of which to be proud.

Snow Campbell, VK3MR, now in the R.A.A.F., finds that great concentration is necessary when signing VMR, so as not to unconsciously sign his old call.

Glad to welcome Tom Hogan, VK3HX of Charlton to a city address. Tom now resides at 46 Hopetoun Ave., Canterbury, Victoria. Attend the June K.P. meeting. Try and make it each month Tom.

Herman Asmus, VK3ET, has been appointed a civilian instructor in the R.A.A.F., and shortly gets down to tin tacks.

According to Max Howden, VK3BQ, Arthur Berry, VK3CZ, forsook his single blessedness early in June. We have not seen much of Patto, VK3YP, since he met the same fate, etc. Don't let this happen to you, Arthur.

Visitors to the June K.P. meeting included VK3PR, Ron Jardine, looking fit, and VK5ZZ, in the "blue uniform," and Jack Duncan, VK3VZ.

Stamp collectors requiring a South African contact should write to Mr. D. G. Alison, Secretary of the S.A.R.R.L., Box 7028, Johannesburg.

A complaint from VK5TK/BERS 195, Eric Trebilcock, now at Aeradio Station, Liverpool, N.S.W., re disposal of his Q.S.L.'s, will be thoroughly investigated. Please accept this as an acknowledgment of your letter, O.M.

According to latest advices, U.S. amateurs, have been forbidden to contact stations outside the States and its colonies.

The R.A.A.F. requires operators for ground duties within VK. Those

Divisional Notes

IMPORTANT.

To ensure insertion all copy must be in the hands of the Editor not later than the 18th of the month preceeding publication.

N.S.W. DIVISIONAL NOTES.

The May monthly meeting of the Division was held as usual at Y.M.C.A. Buildings, and the attendance was again very good considering the lack of transmitting activities, DX and QSL cards. The manner in which members are making an appearance at meetings is very heartening to Councillors.

Some considerable discussion took place regarding an item in the morning papers, very ambiguously worded, regarding the activities of so-called Amateurs during war time. It was pointed out to members that the persons so far detected using transmitters illegally were "pirates," and in no case had any Licenced Experimenter offended, and that the Senior Radio Inspector was much impressed by the manner in which Amateurs were obeying the Regulations. It was decided that the Division write Federal Headquarters and ask that they take the matter up with the Minister responsible and also that the local press be advised as to the real state of affairs.

Q.S.L. Bureau (Continued)

making application should be either medically Class 2 or above the ordinary enlistment age. Enquirers should contact Flying Officer Marshall, Century House, Swanston Street, Melbourne, or telephone Central 970, switch 87.

Harry Kinnear, VK3KN, writing his apologies for continued non-attendance at meetings, states that although business precludes his being present, his interest in the movement is as keen as ever.

As a gesture to members in the services, the Council of the Victorian Division has decided to reduce subscriptions to 7/6 per annum (including magazine), to Victorian Division members serving in the navy, army, or R.A.A.F.

The question of appointing an Historian to write the history of the Division was mentioned, and members were of the opinion that the work should be carried out, and that a comprehensive history of the oldest Amateur Radio organisation in the world should be written. Our new Vice-President, Mr. F. Carruthers, was appointed Historian, and members may look forward to a comprehensive story of this Division's activities since the year 1910.

Now that the Division is operating under the original Charter of Incorporation, issued in 1922, it was thought fitting that those original signatories to the Articles and Memorandum of Association, who were not already Life Members of the Institute should have this honor conferred upon them.

It was also decided that the position of Patron to the Division, rendered vacant by the death of the Marchese Marconi some few years ago, should be filled, and Council were empowered to offer this position to a past President of the Division, Sir Ernest Fisk.

An interesting letter, received from the N.Z.A.R.T., giving some details of Experimental Radio in New Zealand since the outbreak of war, was read to members.

At the conclusion of general business, a very interesting lecture on "Ultra Violet Radiation" was given by Mr. M. Lusby, VK2WN. His talk, although a little removed from Radio proved very illuminating, and demonstrated use of so-called death rays against every day forms of bacteria.

Upon conclusion, a very hearty vote of thanks was accorded the lecturer.

Members are again requested to make known to the Secretary any change of address.

VICTORIAN NOTES

By VK3CX

The 4th June saw a large gathering of Victorian Division members at the club rooms when the main items on the programme was a two hours' entertainment furnished by the P.M.G.'s Department with the aid of "talkie shorts," showing subjects which varied from Lyrebirds in their native setting and surfing in Australia to getting gold and catching salmon in Canada. (No, no Mickey Mouse). The films themselves were exceptionally good, and the reproducing unit one of the best heard yet. Everybody present voted it a most enjoyable evening.

Among the visitors present were VK5ZZ, VK3PR, who is looking fitter than ever, and G6LU, who can hardly be called a visitor now as he is regarded as one of the family. RJ distributed a few, very few, QSL cards, JO told us the usual fairy story that we might be getting another copy of the magazine in a few days or weeks and the Secretary, UM, rang up to say that we could hold the meeting without his assistance. Lieut. TU was there and added a touch of khaki to the usual Air Force blue, which lately has been predominating these meetings since the war started. BQ was back in the fold after an absence of about six months or so, and tells us that he is still grinding commercial crystals and will have a fine stack of rejects (drift over two cycles per degree) to palm off on the boys when they want them again.

WU paid a visit to the Telephone Exchange and came away with many bright ideas for using Relays to do all his work when he gets on the air again. JI is passing the dull hours away by playing records using a crystal pick-up, and considers them very good. CO has been annoying his neighbours with recordings, and all was going well until a week ago when one of the neighbours broke under the strain and came and threatened CO that he would break all his records—he also called him a few names which had nothing to do with ham radio.

The Builders are still with us — XJ having built a new BC receiver and wonder of wonders, it worked first pop. IG has also got ideas about building an oscilloscope in the near future. He thinks he will be able to get it to work, because HK lives nearby and can be depended on.

One of our visitors, 5ZZ, said he

is very disappointed with Melbourne beer, weather and women. We have always had a strong dislike for the weather anyway, but I don't think we will mention the other two subjects. He says he gets a kick out of working DX in the Air Force on low frequencies, but expects to go overseas very soon.

Speaking of the Air Force, I understand from Flying Officer V. Marshall, 3UK, that there are several vacancies for wireless operators in the home forces at the moment, and anyone interested should get in touch with him at Air Board immediately, when he will supply all particulars.

And still speaking of Air Raids, I overheard one ham ask another recently, "Did you see the mess they made of the Forth Bridge?" He queried, "Who?" "The seagulls." O.K., we will see ya at the next meeting, and once again don't forget that subscriptions will be due by the time that you read these lines. If you want the Institute to continue, don't forget to send along your sub. and attend the meetings, as you will be well repaid.

The Editor.

Dear Sir,

Whilst being in China and around the China coast, I have had the opportunity of meeting several "Amateurs" in the course of the last few months. Whilst in Hong Kong a few weeks ago, I met two English "hams" serving in the Royal Air Force, a very pleasant afternoon was spent chatting over radio news, etc.

In Hong Kong I was also introduced to several Chinese operators, mostly on ships, but running a station when ashore also. Is there any information re the "Amateur World" you would find handy? Of course, operations are banned here nowadays, but I could quite easily get any information you may desire. It might be interesting to know that radio gear here, including tubes, cost about half the price of the same goods in Australia, in fact, I have bought quite a lot of gear to bring home (someday!) Tubes being a quarter or even less.

I would esteem it a favour if you would inform any of the "Boys" (who may know me) of my present whereabouts, I left Australia in such a hurry that I didn't have time to see anyone!

Wishing you all the best, Sincerely,
HARRY WHITE,
ex-3IR.

HAMS

WHEN REBUILDING YOUR RECEIVER
REPLACE YOUR OLD SPEAKER WITH

AMPLION

THE NEW 12in. ELECTRICALLY WELDED
SPEAKERS

MODEL	Air Gap Flux	Weight of Magnet	POWER OUTPUT.		Diameter	PRICE
			Undistorted—Max			
V	8,300	12 ozs.	10 watts	15 watts	12 $\frac{3}{16}$ "	£2 3 0
VL	9,000	22 ..	13 ..	20 ..	12 $\frac{3}{16}$ "	£2 16 0
VP3	12,000	64 ..	20 ..	30 ..	12 $\frac{3}{16}$ "	£5 10 0
VP2	9,000	20 ..	12 ..	18 ..	12 $\frac{3}{16}$ "	£3 6 6
VPI	7,500	14 ..	8 ..	12 ..	12 $\frac{3}{16}$ "	£2 10 0

Types V and VL are Field Type Speakers.
Types VPI, 2, 3 are Per-Magnetic Speakers.

SILVERED
MICA

T. C. C.

CERAMIC
CONDENSERS

T.C.C. Silvered Mica Condensers are guaranteed to maintain their capacity under all temperatures, thus insuring no frequency drift in Supers. The foil is actually plated on the mica.

We can supply these Condensers in any per cent. of accuracy, including 0%.

The Capacity Range is from 10 mmf to 800 mmf.

LIST PRICE, 1/- EACH.

We are Agents for—

I.R.C. RESISTERS.

T.C.C. CONDENSERS.

AMPLION SPEAKERS.

BRUNO MICROPHONES.

BIRNBACH INSULATORS.

TRIMAX TRANSFORMERS.

**AUSTRALASIAN ENGINEERING
EQUIPMENT CO. PTY. LTD.**

476 Latrobe St., Melb. Phone: F 5585

Let us quote you for your
PRINTING REQUIREMENTS



The House of Good Printing

**285-287 LATROBE STREET,
MELBOURNE, C.I**

Opposite "The Argus" Office

Telephone MU 2897 After Hours FU 6795

H. HEARNE & CO. Pty. Ltd., Printers, Melbourne.

★ AUGUST

Amateur RADIO DIGEST

SIXPENCE

*Erecting
a
Tower*

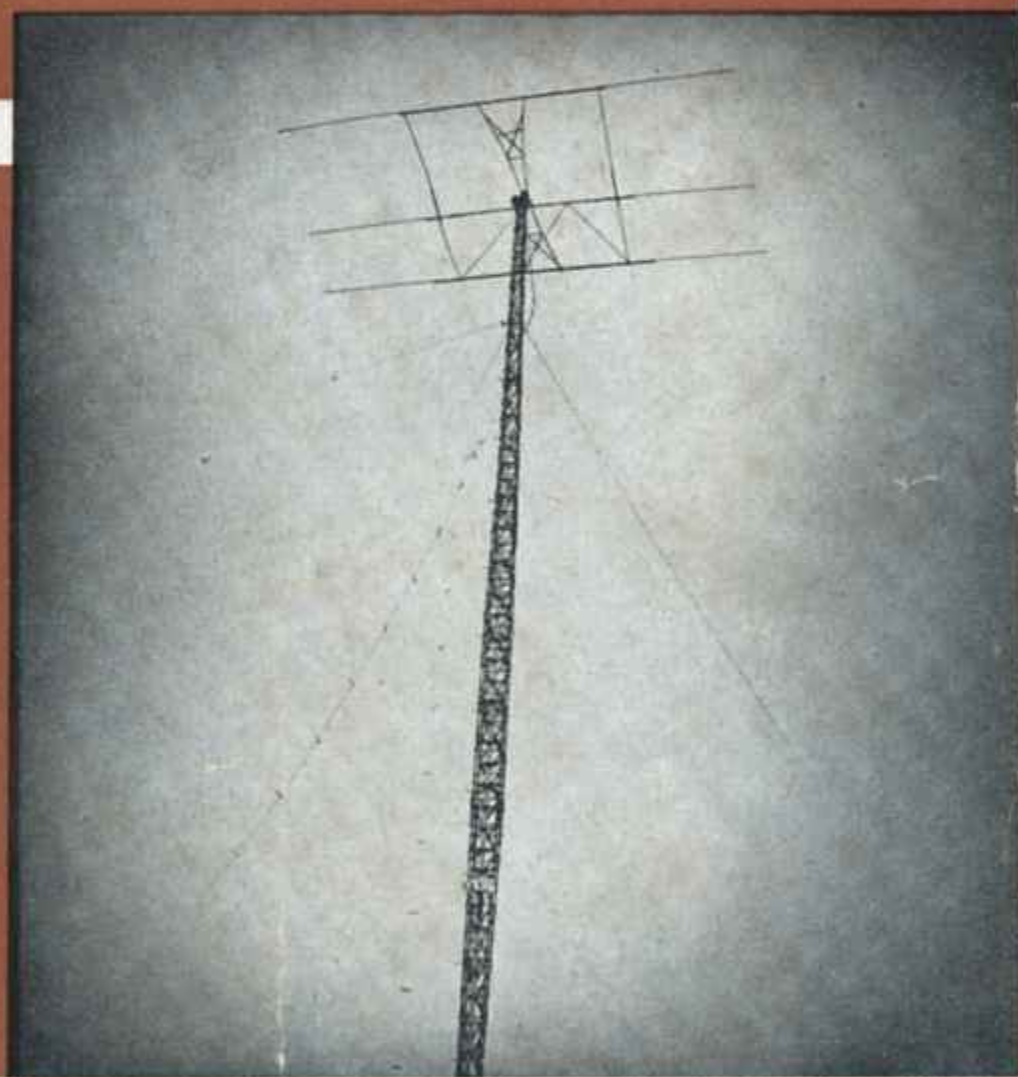

OFFICIAL ORGAN OF THE
WIRELESS INSTITUTE
OF AUSTRALIA ★ ★ ★

RADIOTRON

TECHNICAL SERVICES

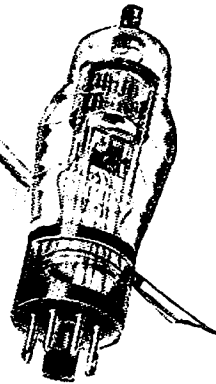

Radiotronics Technical Bulletins, illustrated with photographs, circuits and diagrams, annual subscription, 2/-

Valve Data Sheets, Characteristic Charts, Circuit Diagrams and Classification Tables : issued free as supplements to "Radiotronics."

Binder Covers for Bulletins	1/2
Binder Covers for Data Sheets	8d.
Valve Data Sheet Booklets complete in cover ..	2/2
Receiving Valve Manual	*1/8
Cathode Ray Tube Manual	*1/8
Transmitting Valve Manual	*2/2

Radiotron Designers Handbook —

Cloth bound, 8vo.	8/-
Paper bound, 8vo.	3/4

*Subject to stocks being available.

(The above prices all include postage)

- *The Radiotron Unified Sales-Engineering service is at your disposal without charge. All enquiries regarding technical problems are cordially invited.*

**AMALGAMATED WIRELESS
VALVE COMPANY PTY. LTD.**

G.P.O. BOX 2516 BB

47 YORK STREET, SYDNEY, N.S.W.

AMATEUR RADIO

Published in the Interests of Radio Amateurs and
Experimenters throughout Australia.

VOL. 8. No. 7.

1st AUGUST, 1940

OUR ORGANISATION

Publishers.—

WIRELESS INSTITUTE OF AUSTRALIA
(Victorian Division)
191 Queen Street, Melbourne, C.I.

Editorial Department.—

W. R. GRONOW (VK3WG),
Editor.

R. H. CUNNINGHAM (VK3ML)
Technical Editor.

C. SERLE (VK3RX)
Notes Editor.

V. E. MARSHALL (VK3UK)
Compilation.

H. N. STEVENS (VK3JO)
Distribution.

L. T. POWERS (VK3PS)
Secretary.

Advertising Department.—

BEDGGOOD ADVERTISING CO.,
129 William Street, Melbourne.
Phone: MU 4046

Printers.—

H. HEARNE & CO. PTY. LTD.,
285 Latrobe Street, Melbourne, C.I.

Accounts Department.—

LARGE & POWERS,
Chartered Accountants (Aust.),
422 Collins Street, Melbourne.

MSS and Magazine Correspondence
should be forwarded to The Editor,
"Amateur Radio," Box 2611W, G.P.O.,
Melbourne.

Subscription Rate is 6/- per annum in advance (post paid).

NOTE.—Advertisers' change of copy must be in hand not later than the 20th of the month preceding publication, otherwise the previous month's copy will be reprinted.

CONTENTS.

	Page
Editorial - - - - -	3
Description and Erection of a Tower - - - - -	4
Frequency Modulation - -	7
Overseas Broadcasting -	13
Divisional Notes - -	15

DIVISIONAL ADDRESSES.

FEDERAL HEADQUARTERS:
BOX 2611W, G.P.O., MELBOURNE

NEW SOUTH WALES:
BOX 1734JJ, G.P.O., SYDNEY.

VICTORIA:
BOX 2611W, G.P.O., MELBOURNE.

QUEENSLAND:
BOX 1524V, G.P.O., BRISBANE

SOUTH AUSTRALIA:
BOX 284D, G.P.O., ADELAIDE.

WESTERN AUSTRALIA:
BOX N.1002, G.P.O., PERTH.

TASMANIA:
BOX 547E, G.P.O., HOBART.

**You wouldn't put
solid tyres on a
Rolls Royce, so why
fit an ordinary loud-
speaker to a quality
set ?**

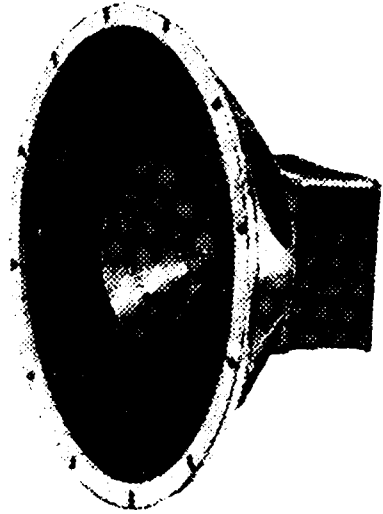

GOODMANS 10 INCH
HIGH FIDELITY SPEAKER

With your present loudspeaker you quite probably can't notice any difference between a studio broadcast and a session of recorded music.

Admittedly some of the latest vertical cut recordings are good, but there is always a difference between "potted" music and a live artist show when you use a GOODMANS QUALITY SPEAKER.

CALL IN AND HEAR ONE AT
J. H. MAGRATH PTY. LTD.,
208 LITTLE LONSDALE STREET, MELBOURNE.

WHOLESALE ONLY FROM THE AUSTRALIAN AGENTS:

TRIMAX TRANSFORMERS

(A DIVISION OF CLIFF & BUNTING PTY. LTD.)

29-35 FLEMINGTON ROAD, NORTH MELBOURNE
F 9127 (3 LINES)

EDITORIAL



With this issue our readers undoubtedly will have noticed the improvement in the appearance of our magazine. We have given it a little more "Shelf Appeal" so that it may take its place amongst the more attractive magazines.

We feel the change has been long overdue, but, as you know, this requires effort, yet the enthusiasm for our hobby, despite restricted activities, gives us the incentive to keep the magazine the link that holds together the fraternity of "Radio Hams" throughout Australia.

It is our earnest endeavour to ensure that this magazine comes to you regularly to keep you mindful of the existence of Amateur Radio, and desire to remind you again, that your co-operation, as well as ours, is necessary to keep it as such.

* *

The opinion has often been expressed, both by ourselves in our recent editorials and by numerous amateurs, that the war conditions prevailing today provide an unprecedented opportunity for the amateur operator to serve his country in a practical way.

Amateurs throughout Australia have clearly shown their patriotism by enlisting in one or other of the services in large numbers, whilst many are working in important and reserved occupations. Nevertheless, there is still a great deal that the other Amateurs, not so actively engaged, can do to assist Australia's war effort.

The Victorian Division has obtained the services of several competent Amateurs and various professional telegraphists to act as instructors to students who are being trained for entrance to one of the services.

This Morse class is a valuable and

definite move to assist and train applicants for enlistment, enabling them to attain a speed of twenty to twenty-five words per minute. The only condition for enrolment is that the applicant has enlisted, or will offer his services, either for active service, or for entrance to the Militia for home service.

This is a practical method for all divisions to assist our country, again demonstrating that the W.I.A. is really a live and active organisation, despite the difficulties we are facing to-day.

* *

EDITORIAL ABSTRACTS.

The W's have new examinations for all classes of amateur operator licenses. The scheme outlined in June "QST" tells us that the old ten-question type of examination, involving much writing on the part of the examinee, is to be abolished. The necessary mathematical questions will still hold as well as the check on one's ability to read and draw circuits. However, the novel system takes the form of "quizzes" of various sorts, wherein the quiz quotient is concealed in a selection of five answers, one of which is right. It sounds easy enough to pick the "goodies," but a fundamental knowledge is still necessary to select the right answer—otherwise the examiner can easily pick out the candidates practicing the art of guessing. The type B-C ticket contains 50 questions, and the class A, 40. It is claimed that a much better sampling of the candidate's knowledge can be provided by this system, which really allows much more ground to be covered—without making the examination any more difficult. Maybe we shall be trying it ourselves after the scrap.

The Description and Erection of a Tower

By G. W. Ireland, VK3IG.

Making of the Tower.

The tower is similar in design to one described earlier in "A.R." The material of the tower is hardwood throughout, both for cheapness and strength. The four corner pieces consist of four, twenty foot, and one ten foot length of 1" x 1" full, making a total length or height of 90 feet. The tower is 18" square at the centre and 6" square at the ends.

Each 20' length was butted together and lathes nailed over the four faces. Two of these 90' strips or corner pieces were then laid out on the ground, 18" wide at the centre, and 6" at each end. A line was stretched between them, so as to get the same amount of bulge each side of centre. Lathes were then nailed across every 18" apart, beginning at the middle and ends, and filling in, in between, so as to keep the bulge uniform, from one end to the other. Diagonal lathes were then nailed in position. They were put between each horizontal lathe, and they crossed over at the middle of each other second horizontal lathe. (Fig. 1 shows this).

At this point of crossover, the three lathes were nailed together. The other two 90' lengths were treated in the same way. Now I had, what appeared to be, two long ladders side by side, or maybe looked more like a couple of young battle ships lying flat on the ground. (They look much better up). The next job was to make 16 square pieces for the inside of the tower. These were made of 1" x 1" crossd over, and stayed. (See Fig. 2).

The sizes of the inside pieces were about 18" square for the middle, each one being smaller towards the ends, which are about 6" x 6". These pieces were made in pairs, one of each pair to go from the middle to the top, the other from middle to bottom. Now back to where the ladder shaped affairs were side by side on the ground. One was turned over and the 16 inside squares were mounted and nailed on it. The first 18" pair was fixed 3' each side of the centre. Then each pair in order

of size was spaced 6' apart towards each end. When this was done about five helpers lifted the other section, or side, on top of the 16 inside pieces. This was where things looked to be getting into shape. Blocks were then put under the bottom side, to raise each end, so as to give it the right shape. The top side was then nailed on. By sighting up through the middle of the tower it was an easy matter to get it symmetrical.

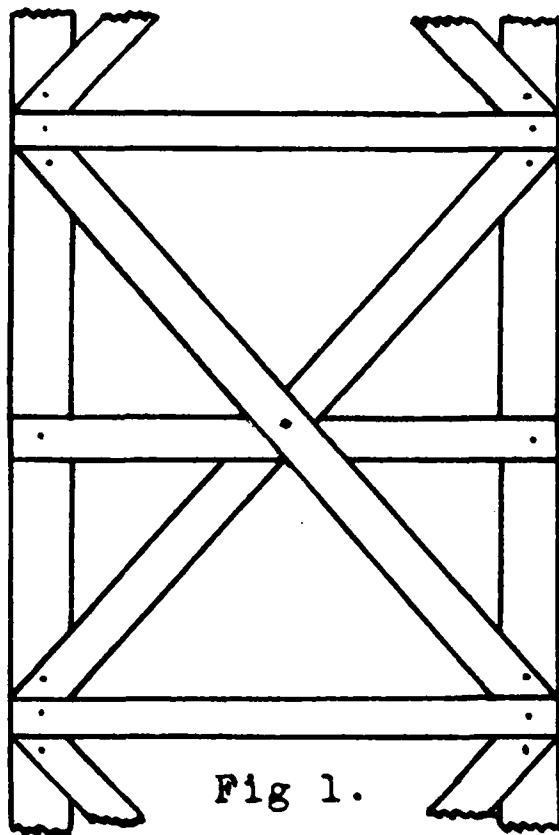
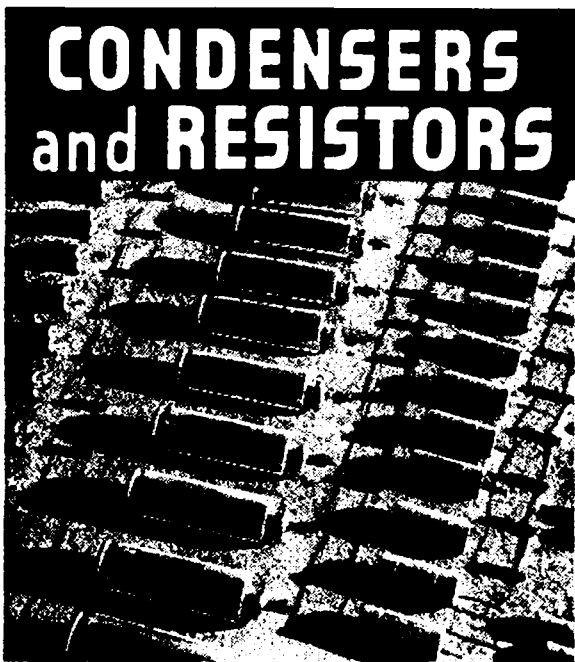

Fig 1.

A few lathes then tacked on the remaining two sides, which had yet to be lathed, made it strong enough to roll over, and bring the unlathed side up. This filled in, the remaining side was brought to the top and completed. The strength of the tower was found to be good. It could be lifted at the centre, with very little droop at the ends. When lifted at each end it supported a 12 stone chap sitting on the middle. Cost of all woodwork was only 27/6.



CONDENSERS and RESISTORS

DUCON-CHANEX
GUARANTEE
*Complete
Reliability*

Under the most exacting
conditions.

Ducon Condensers are admirably suited to withstand the peculiar conditions of amateur and experimental work.

In the new transmitting units of 2FC and 3LO, Ducon Condensers were installed, being specially chosen for their unique quality.

For all Condensers and Resistors
specify

DUCON CHANEX

73 BOURKE St. WATERLOO. N.S.W.
450 COLLINS St., MELBOURNE, C.I

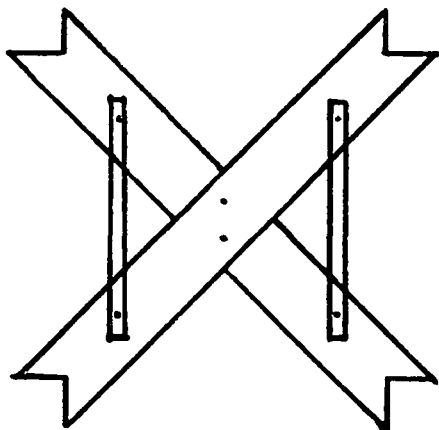

Inside piece of
tower.
Fig 2.

The Rotary.

A fair idea of the framework for the support of the elements can be seen in the photo. The pair of curved strips are 2" x 3/4" hardwood, and are bolted to a thick piece of wood at the middle, it being 15" x 6" and 3" thick. A few cross lathes were used to stay it. The supports for the elements are 2" x 2" oregon, about 17' long. Ordinary split conduit 5/8" was used for elements, and each one was supported at about six places with pairs of egg insulators, wired down to the wood, so as to form a "V" shape. The conduit was wired very tightly to the insulators, so that it could not roll. The conduit has an overhang of 9' on each side. It was kept straight, by giving it a kink, at the beginning of the overhang. It can now be seen that the conduit must not roll over.

Next an 8' piece of 1 1/4" pipe had enough thread put on one end to fit a flange, then passed through a hole which had been bored in the 3" thick piece of wood, then through another flange which locks down on this piece of wood, and finally a 1 1/4" x 3/4" reducing socket screws on the top. This made a very good joint between the wood and the pipe. A 3' length of 3/4" pipe screwed into the reducing socket, had a batch of stay wires on the top of it, to hold up and keep the wooden framework from sagging and flopping about.

A big roller bearing was procured from the wreckers for 2/- also a gear wheel and driving cog. The 1 1/4" pipe neatly fitted through the bearing, which was slid up until it rested

on the flange. The casing or bottom half of the bearing was set up securely on top of the tower. Another bearing was put inside the tower, about 7' from the top, which held the bottom end of the pipe. This bearing is only to stop wobble. It does not support any weight.

The 12" gear wheel was then bolted to the heavy piece of wood mentioned before. It was meshed with a 2½" driving cog, which was mounted on a shaft on the side of the tower. This shaft had a wooden pulley 12" in diameter fixed to it. The drive for the rotary is a rope passing around this pulley, and down through the tower. A few contraptions at the bottom bring the drive into the shack.

Erection.

The tower was then brought around into position with the top resting on a stack of cases to keep it high enough off the ground, so as to allow the rotary to be seated on the top of the tower or bearing. The feed line was made fast to the tower. Four guy wires were put on about 10' from the top. The bottom end of the tower was resting near a 66' oregon mast of 4" x 4". This may be noticed in the photo with steps on

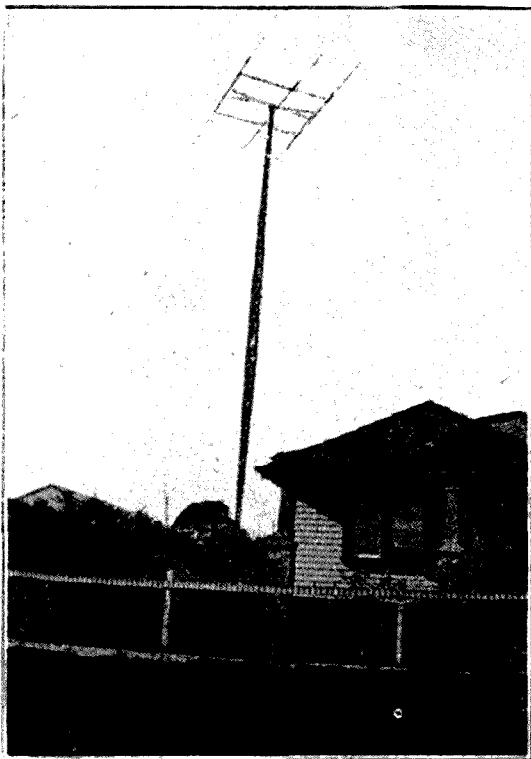

it. This mast was well guyed up with fencing wire.

Two pulleys were then fastened to the 66 feet mast, one at the top and the other 10 feet lower down. Two pulleys were also fixed on the tower, one near the top, the other 15 feet lower. Two long ropes were then anchored on the 66 ft. mast in suitable positions so as to distribute the strain on this mast. If all the strain is at the top the mast will belly out lower down. These two ropes were taken through the two pulleys on the tower, and brought back through the two pulleys on the mast, then down below to a windlass (a piece of ¾" pipe bent like a crank handle). This formed two separate single blocks and tackle.

When all was set and the local gang showed up to do their stuff, the weather busted, and never let up for the rest of the day. A couple of days later, with the word go, it stood vertical in no time. The lift or wind up was child's play, believe it or not, I wound it up one hand and steered the rope across the winder with the other. The weakest link was the 4" x 4" mast. It got very distorted, until the tower passed over the 45 degree angle.

Looking from below it appears to be the size of a ten meter rotary. Since being off the air I put another set of guys at the top to keep it up for the duration.

In conclusion, I'll say a better name for the 3 element rotary is a "qrm filter antenna."

Dawkins Epsy, 21 year old operator of W5CXH, New Orleans, has been named 1939 winner of the Maxim Memorial Trophy Award, which consists of 100 dollars in cash and a bronze replica of the "Wouff Hong" revered symbol of ham ops.

All round activity in amateur radio won the honor for this year's winner. Since 1932 he has been active in amateur doings, experimenting with antennas and writing articles about them for "Q.S.T." and experimenting with remote control.

W5CXH is currently graduating in electrical engineering from the California of Technology. Previous recipients of the award were W2JHB, 1938; W9RSO, 1937, and W6KFC, 1936.

Frequency Modulation

PART II.

By Charles H. Yocum.

With acknowledgments to "Communications."

Early experimenters tried to produce f-m systems, but failed largely because they did not expand the frequency swing, but tried to compress it. However, they did prove that an f-m system could not make use of conventional a-m modulation methods.

It would be well to review the basic requirements of a successful f-m system before attempting to understand its operation. Major Armstrong lists these requirements as follows:

(1) The frequency transmitted by an f-m system shall vary alternately above and below a fixed frequency which is the assigned carrier. These variations should be symmetrical with respect to the mid-frequency, pass through it, and return exactly to this carrier when modulation stops.

(2) In the transmitter, the frequency deviation of the f-m wave at any instant must be directly proportional to the modulating current resulting from the programme. This deviation in frequency, however, must be independent of the frequency of this modulating current.

(3) In the f-m receiver the detecting device, corresponding to the second detector in an a-m receiver, must respond to changes in frequency only. Changes in amplitude of the incoming signal must be prevented from affecting the detecting device.

(4) The transmitter carrier shall be considered 100% modulated when its output is such that a properly designed receiver is modulated 100%, or very nearly so. A lower percentage modulation at the transmitter must produce a strictly proportionate and lesser modulation in the receiver.

(5) In the f-m receiver, the amplitude of the current produced by the detecting device, as the result of the receipt of a signal, must be strictly proportionate to the change in frequency at the transmitter, and independent of the rate of change of this frequency.

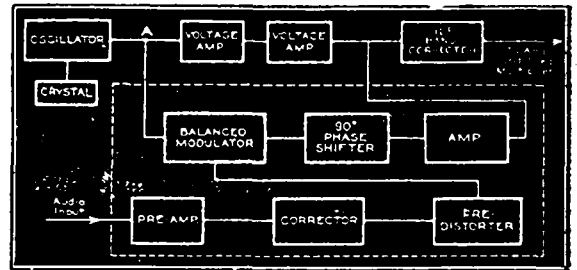

Figure 6a

Modulation means the continuous and reversible change of the r-f output of a transmitter from one set of conditions to another. In the earliest stations this change was accomplished by keying. If the operation of the key interrupts the signal, we have a crude form of amplitude modulation. If the key causes detuning, we have a crude equivalent to f-m transmission.

True frequency modulation is not developed in present day f-m transmitters. Actually phase modulation is produced, then converted to frequency modulation.

Late in 1931, Hans Roder, of General Electric, published a paper in which he developed the theory of three possible types of modulation. It was shown that the amplitude, or the phase, or the frequency of the emitted signal may be varied to convey intelligence. The mathematical derivation of his results is too lengthy for this discussion. Nevertheless, Roder's conclusions are the basis for present f-m designs and can be briefly summed up in the following statements.

Normal a-m transmission may be represented by a carrier of fixed frequency plus two side bands symmetrically located above and below the carrier frequency, in phase with the carrier. These side bands are proportional in amount to the amplitude of the applied programme material.

In both phase and frequency modulation, however, an unlimited

number of upper and lower side frequencies may be produced. With phase modulation, as long as the phase shift is kept less than 30°, the carrier and the first side frequencies predominate, while all the others are present in negligible amounts. Also, if this shift is kept small, the amplitudes of the important side frequencies are very nearly proportional to the impressed audio signal, and the percentage of energy in the undesired side frequencies of third and higher order is but one or two per cent. of the total. (See Table 2.) In both phase and frequency modulation the carrier is 90° (or 270°) out of phase with the side frequencies at peak modulation. At peak modulation the side frequencies are in phase with each other.

Frequency modulation is merely one type of phase modulation in which the amount of phase shift is

Table II. Roder's calculations for frequency-modulated amplitude variations. Phase modulation (last column) should be restricted to less than 30° to avoid serious distortion. Note that in phase modulation the phase shift varies inversely as audio frequency; in true frequency modulation the frequency deviation varies directly as the audio frequency.

AUDIO SIGNAL FREQUENCY (Cycles per Sec.)	CARRIER AMPLITUDE	SIDE FREQUENCY AMPLITUDES								CORRESPONDING PHASE SHIFT
		1st.	2nd.	3rd.	4th.	5th.	6th.	7th.	8th.	
10,000	100	2.5	-	-	-	-	-	-	-	2.9°
5000	100	5.0	-	-	-	-	-	-	-	5.7°
2500	99	9.9	-	-	-	-	-	-	-	11.5°
1000	93.8	24.2	3.1	-	-	-	-	-	-	28.6°
500	76.5	44	11.5	1.9	-	-	-	-	-	57.3°
250	22.4	57.7	35.3	12.9	3.4	-	-	-	-	114.6°
100	17.7	32.7	4.6	36.5	39.1	26.1	13.1	5.3	1.8	286°

Amplitudes are expressed as percent of unmodulated carrier.

inversely proportional to the frequency of the audio signal presented to the modulating device.

It is well known that a phase shift of a wave may be developed if we beat or mix with this wave a second wave which is out of phase with it. The amount of phase shift resulting at any instant will be proportional to the phase difference between the two and their respective amplitudes. Therefore, if we can set up a modu-

lating device which will produce a carrier, then mix with it a second wave of like frequency (but whose phase relationship to the carrier depends on the amount of input energy and is inversely proportional to the audio frequency of that input) our problem will be solved.

Two modulators will be discussed. One is the Armstrong circuit used in most transmitters on the air to-day. The other has not been installed in any transmitter to date. It was described at the recent IRE convention in September by Mr. R. E. Shelby of the National Broadcasting Company, who developed it.

Let us consider the Armstrong system first. If we refer to Fig. 6-a, we note a conventional oscillator, crystal controlled, producing a voltage which is divided at point A, part passing through normal voltage amplifiers. This ultimately will be the carrier. The other branch of this circuit is enclosed in dotted lines and represents a practical f-m design.

The input from the microphone passes into a correction network in which the higher audio frequencies are amplified more than the lower frequencies. In any system the higher frequencies are attenuated most in transmission. By use of the corrector we can overcome the attenuation and present a programme to the listener in which both high and low notes are equally well reproduced. This is a common practice in a-m transmission as well as f-m. It is limited in a-m by the necessity of avoiding adjacent channel interference. There is no such danger in the f-m system.

The corrector network contains a resistor R1 and a capacity C1. R1 and C1 are in series, and the voltage which drives the succeeding stage is that across C1. The impedance of C1 even at low audio frequencies is negligible compared to R1. Conse-

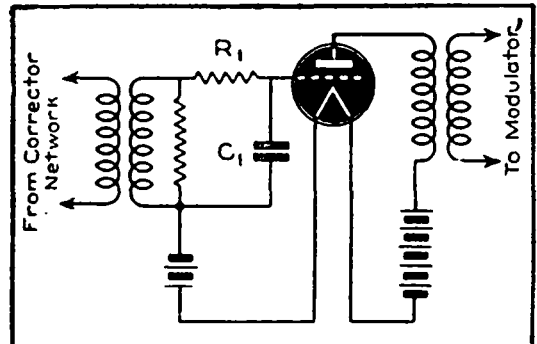

Figure 6b

quently, the voltage presented to the succeeding stages is inversely proportionate to frequency. See Fig. 6-b.

This output is fed to a pair of balanced modulator tubes through a transformer T1. The plate circuits of these modulator tubes are non-reactive for the crystal frequency. Thus, their plate currents are in phase with the control grid voltages. When their screen grids are energized, by a voltage from the input transformer, T1, the output from the modulators is fed to the primary of T2, which has a natural frequency well above that of the master oscillator. The side frequencies generated by this network are shifted 90°, amplified, and fed into resistive load RL. The amplified output of the oscillator also appears across RL. (See Fig. 7-b).

At any particular frequency, the amount of phase shift in the resultant voltage appearing across RL is proportional to the amplitude and inversely as that frequency. At any particular amplitude or per cent. modulation, the time necessary to change from the normal phase arrangement to some new arrangement,

and back to normal again, will be inversely proportional to the actual input frequency. The inverse of this time is called the **time rate of change**. The wave diagrams in Fig. 7-a will serve to make the progressive changes of the modulated energy more understandable.

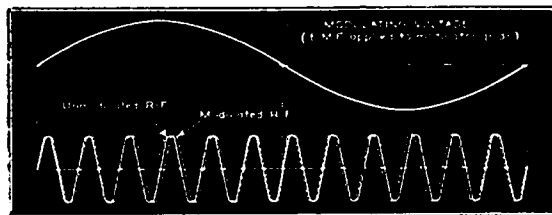

Figure 7a

In this method of modulation, if the maximum frequency swing of the modulator is large compared to the master oscillator frequency, the upper side frequency will be larger than the lower, due to the increased reactance of the primary of T2. If a 15,000 cycle band of frequencies is to be transmitted, and a master oscillator of 75 kc. is used, the upper side frequency will be almost twice the

GOODMANS

HIGH FIDELITY

LOUD SPEAKERS

FOR

1. Level Response.
2. Wide Frequency Range.
3. Reduction of Sub-Harmonics.
4. Good Transient Response.
5. Elimination of Bass Modulation of the Upper Frequencies.
6. Freedom from Hum.



GOODMANS 10" HIGH FIDELITY LOUDSPEAKERS.

CALL IN AND HEAR ONE

J. H. MAGRATH PTY. LTD.

208 LITTLE LONSDALE ST., MELBOURNE.

Cent. 3688

lower one. This would produce serious distortion in the receiver. This is corrected by an R-C network which is the side frequency equaliser. This correction is accomplished after the side frequencies are combined with the oscillator output at RL. The energy level is low, and little or no amplitude distortion has yet occurred. After equalisation, amplitude linearity is of no importance. Conventional frequency doublers and triplers, modified sufficiently to pass the requisite band width may be used to convert the phase-shifted fundamental frequency of 100 or 200 kc. to 14 or 15 megacycles. Here the output is heterodyned against a second crystal, bringing the fundamental frequency down to 1 or 2 megacycles, but leaving the phase shifts and side frequencies unchanged. This frequency is increased to 40 or 50 megacycles, which is the proper carrier. In this process the original phase shift has been multiplied several thousand times, causing an apparent frequency shift or modulation of the carrier. The large number of frequency doublers is necessary to produce sufficient modulation in the receiver. Suppose a receiver were so built that it required 45° of phase shift to give 100% modulation, as a minimum. We are limited to a maximum phase shift of 30° in the transmitter. (See Table 2). This phase shift will be inversely proportion to frequency. If we are to send an audio band of from 30 to 15,000 cycles per second, then 15,000 cycles would cause a shift of but $6/100$'s of one degree. Thus, in this assumed case, multiplication by about 1,000 would be required to correctly operate the receiver. Actually, to overcome losses with some safety margin, the original phase shift is increased about 3,000 times in commercial designs.

In the system suggested by R. E. Shelby regular amplitude modulation is produced, with or without high frequency correction. This a-m energy is fed into a phase changing device, which divides the input into two equal parts, 90° out of phase with each other. These quadrature components are fed to a special cathode-ray tube which produces the necessary phase shift as follows: If two voltages, equal in amplitude, but 90° out of phase, are fed to the horizontal and vertical plates of a c-r tube the electron beam will scan a

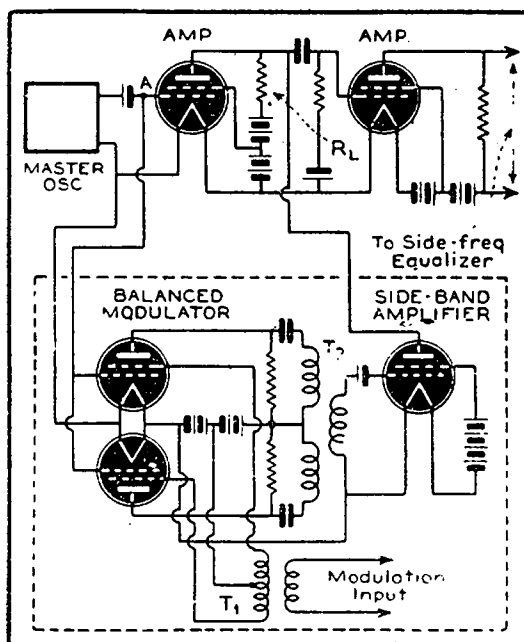

Figure 7b

circular path on the screen. The diameter of the circular path is proportional to the amplitude of the voltage. In place of the conventional c-r screen a mica target is used on which a spiral conducting ribbon is deposited. The spiral is of a particular type, known as the Archimedian spiral.

Phase shifts of upwards of 500 degrees are claimed for this device. Thus a considerable saving may be effected in the modulator unit. Fewer frequency doublers and triplers are required to reach the transmitting frequency than in the Armstrong system. But the amount of signal that must be fed to a cathode-ray tube is large. The difficulty of balancing the voltages fed to the horizontal and vertical plates of the cathode-ray tube is somewhat greater than that of balancing the modulator tubes. The output from the cathode-ray tube is far less than that from the balanced modulators, requiring added power amplification. Each circuit has disadvantages but certainly each is extremely ingenious. Hence, further simplification would seem to be inevitable.

The balance of the transmitter is of conventional design, except that in the 50 kw types certain problems had to be solved which were peculiar to the production of such power at 40 megacycles. These were not due to f-m, but were simply u-h-f considerations. The radiator is of special

construction, built to transmit horizontally polarized energy. See Fig. 9.

An f-m transmitter has a wide frequency range. Reasonable care in design and construction results in a system capable of handling frequencies from 30 to 15,000 cycles with ease. Consequently, programme material must be carefully presented to the f-m transmitter since distortion which would be of little importance in other transmitters might be quite objectionable with an f-m system.

Present recordings and wire services are flat to about half the above audio range. This is not objectionable if the transmitter likewise cuts off at about 7 or 8 kc. In f-m stations, however, only the best recordings may be used and many wire services are unsatisfactory because the higher audio frequencies are lost. Wire lines flat to 15 kc. can be built, but are very costly. It again becomes apparent that the change from a-m to f-m cannot come overnight. Not only must we change the transmitter, but the microphones, pre-amplifiers, disc recordings and pick-ups must also be of the finest type if full benefit is to be desired from f-m.

In this connection credit should be given to the Yankee Network. At their Boston studios they are operating a 250 watt, 136-mc. transmitter. This is the first such relay to be used for fixed service. This u-h-f transmitter covers an airline distance of 41 miles to the main transmitter at Paxton, Mass., where the programme is rebroadcast from a 2-kw. transmitter. Soon, however, it will be rebroadcast by a 50-kw. transmitter now under construction.

Two types of f-m receivers are on

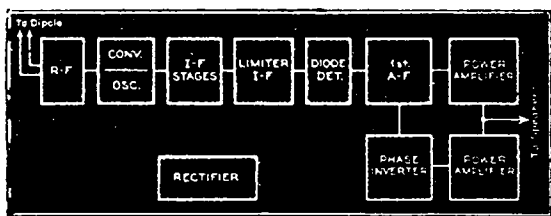

Figure 10

the market. One is for f-m only, one is for both f-m and a-m. Fig. 10 shows the block diagram of a typical f-m receiver. One or more stages of r-f of conventional design are generally used. The oscillator and mixer circuits are not at all different from those used in a-m receivers. However, the i-f transformers are simi-

lar to television types. They are really band-pass filters capable of passing a band width of 200 or even 300 kc. One mark of an f-m receiver is the resistance loading always present in these inter-stage transformers. Several problems are solved by this arrangement. These resistors broaden the pass width of the coupling. Also in these circuits, composed of L, C, and R, the rapidly changing frequencies passing through the network may cause the generation of a number of harmonics. These must be dissipated less they cause frequency or amplitude distortion. Loading resistors, of proper value, serve to absorb and dissipate these unwanted effects.

A radical departure in the f-m receiver is the use of a current limiter stage. This limiter follows the i-f amplifiers and is extremely important to the correct operation of the f-m receiver. The function of the limiter is to prevent changes in amplitude from reaching the discriminator. Such changes would appear in the speaker as noticeable distortion. A typical limiter starts to limit with an r-f input of about 3 volts peak, levels off at 5 volts and is reasonably flat to 100 volts or more. This tube is operated as a grid cathode rectifier, and the negative voltage developed across the resistor in the grid circuit from coil to ground may be used for a-v-c. This voltage may likewise be used for manual gain control by applying part of it to the r-f amplifier grids. If a magic eye is to be used as a tuning indicator, it may be located at this point. Note that both the screen and plate voltages of a limiter tube are equal and less than normal to secure sharp cut-off with zero bias.

The device corresponding to the second detector in an a-m receiver is known as the frequency discriminator. This circuit must be so designed that it transforms the frequency swing of the transmitted wave into variations in amplitude in the audio system of the receiver. Depending upon the set, between 20 and 80 volts will be developed when the transmitter frequency swings 75 kc. above or below the carrier. From this point to the loudspeaker the audio system may have any or all of the features associated with present models.

The most sensitive adjustment required in the servicing of the f-m re-

ceiver is that of the discriminator network. Condenser C1 in the primary of the transformer linking the limiter to the discriminator, insures that the receiver is correctly tuned to the exact carrier. If this adjustment is poorly made, the output will be distorted because the wave form fed to the audio system will accentuate the plus frequency changes, limiting the others, or vice versa. Condenser C2 in the secondary of the same transformer insures proportional voltage output for various amount of frequency swing.

These two condensers should be adjusted by feeding into the first i-f stage a signal from a service oscillator of the exact i-f of the set. The oscillator should produce as flat an output as possible, over the working range. Connect a v-t voltmeter between Point A and ground (Fig. 11).

limiting action should correspond to that described above.

Observe caution in aligning the i-f transformers. It is theoretically possible to widen the pass band of the i-f's by double peaking them. Nevertheless, the need for absolute linearity of phase shift throughout a band 100 or 200 kc. in width suggests that a single peak will introduce less possibility of distortion. This may best be checked by putting a milliammeter in the limiter grid circuit in series with the grid resistor. An oscillator should be connected to the last i-f stage. This stage should be so adjusted that it passes the entire band width with a change in reading of the milliammeter of not more than 1 ma. The same adjustment should then be made for the next i-f and so on, until the mixer tube is reached.

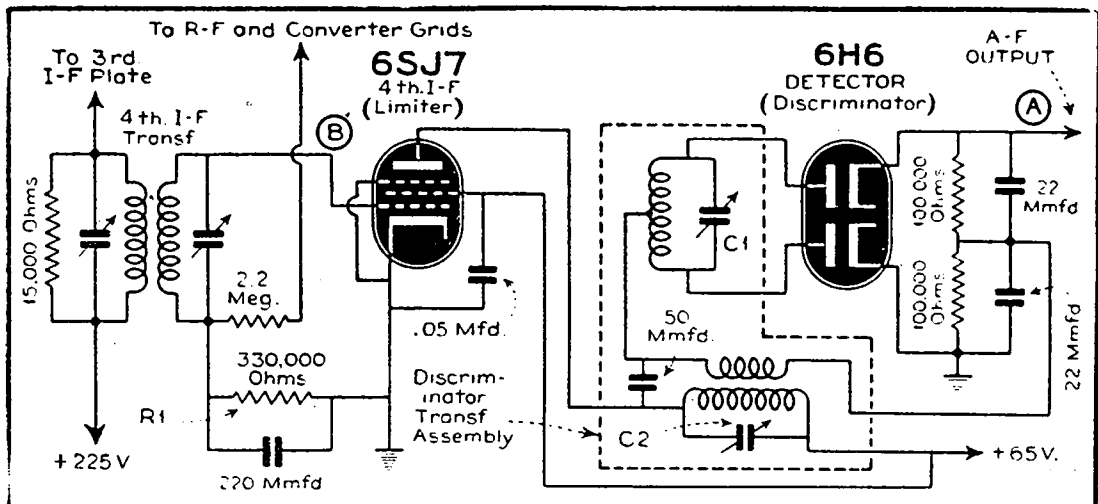

Figure 11

Now vary the frequency fed to the i-f by swinging the oscillator over a band at least 200 kc. wide, 100 kc. each side of the i-f. The voltage between point A and ground should be zero at the exact carrier frequency and should be equal in amount, although of opposite electrical sign when the frequency is set equal amounts above or below the i-f. Not more than 3db variation should occur, over the range +100 kc. to -100 kc.

The limiter may be checked by connecting a milliammeter in the limiter plate circuit, meanwhile varying the input voltage supplied by the signal generator, A v-t voltmeter between Point A and ground should indicate an input voltage from 1 or 2 volts to about 100. The

Faults, normally not objectionable will frequently appear in an f-m receiver. Ripple in the power supply, particularly to the plates of the tubes, must be avoided. Microphonics, due to insufficiently rigid mechanical support of coils and condensers, may cause frequency modulation in the receiver itself. Distortion at times may be due to insufficient d-c bias between heater and cathode in the r-f stages. In some cases, it may be necessary to filter the r-f heater leads at the sockets to remove r-f.

In those sets which are adapted to both f-m and a-m reception, it will be found that two general designs are available. In each case a conventional second detector is used for the a-m programmes and a limiter-
(Concluded on page 16)

Overseas Broadcasting

By Jack Harrower. Short Wave Editor, "Radio Times."

One of Europe's best known short wave networks is the latest victim of Nazi aggression. It is the French Government Short-wave station, "Paris Mondial."

In the first year of its history the station was known as "Radio Paris," but there were many conflicting reports as to the call sign. It was generally believed to be FYA. But FYA eventually turned out to be a commercial telegraphy station on 20 metres.

Then from out of the blue it was suddenly discovered that the call signs were TPA2, TPA3 and TPA4. At that time the station only had three channels, 15,243 kc., 11,885 kc., and 11,718 kc.

This was followed by a period of

rapid expansion. The station identification call became "Paris Mondial" (Paris World Wide), and numerous new channels were opened up for programme transmission from this city of life and gaiety. A new headache, however, was created for the DXer, who, was never quite able to discover all the call signs allocated to the different wave bands. The different transmitters used, and not the frequencies, were allocated call signs of the TPB variety in addition to TPA.

Life in Paris, however, has changed. Nazi stormtroopers strut along the Quai D'Orsay. A curfew has been imposed by Herr Himmler's dreaded Gestapo; everyone must be indoors by 10 p.m. The gay night-



The Power Equipment with a Powerful Reputation . . .

THE Organisation responsible for the production of . . .

**HILCO TRANSFORMERS
CHOKES, etc.**

has proved its high standards for an article of extreme merit as accepted by the largest consumers in Australia.

**ALL PRODUCTS GUARANTEED FOR
TWELVE MONTHS.**

HILCO TRANSFORMERS PROPRIETARY LIMITED

97-111 BERKLEY ST., CARLTON, N.3., Vic. 'Phones; F1661-2
CABLES & TELEGRAMS: "HILCOY," MELBOURNE.

life, which was once an integral part of the city, has disappeared for the Parisienne.

But the Eiffel Tower still towers 985 feet above the Seine, and some day Paris may again call the world. Au Revoir "Paris Mondial."

The FCC has granted the Westinghouse Elect. & Mfg. Co. a construction permit to move its international short wave transmitter, WPIT, from Saxonburg, Pa., to Hull, Mass., and increase its power from 40,000 to 50,000 watts. WRCA, owned by NBC-RCA, at Bound Brook, New Jersey, was granted special experimental authority to operate an additional 35 kw P.A. in parallel with its regular 35 kw amplifier to feed a separate directive antenna, making an effective operating power of 70 kw.

Recognising broadcasting as an American institution on equal footing with the press, and as entitled to the same constitutional right of freedom, the New York World's Fair has set aside July 4 as "Broadcasting Day." In association with the National Association of Broadcasters, the World's Fair directorate has arranged for the event fittingly set for Independence Day. The keystone will be free American radio.

President Roosevelt himself is expected to participate in the ceremonies with an address by remote control from Washington. To preserve a running story of the event, recordings of the day's activities will be made.

RCA's new system of large screen television was given its first public demonstration recently, when pictures $4\frac{1}{2} \times 6$ feet were produced.

Projection optics of extremely wide aperture, a kinescope capable of high voltage operation, using 56,000 volts as compared with the 6,000 or 7,000 volts as used by an ordinary receiver, and apparatus suited to those conditions are said to be the basic elements of the new system. The image on the face of the kinescope, which measures only 2.4 by 3.2 inches faces not toward the screen, but in the opposite direction, being thrown on a concave mirror surface 16 inches in diameter. The mirror collects the strong light from the screen and magnifies the image 22.5 times. The magnified image is then projected back through a glass lens surrounding the neck of the kinescope and thence 20 feet to the screen.

DEFENCE PLAN.

Conversion of the Philco Plant at Philadelphia into munitions plant is understood to be under consideration because of the war situation. Preliminary plans for the conversion are already said to be drafted. Several years ago, RCA, Camden, N.J., manufactured bullets for the government under contract at a time when the set field was slack.

Mr. J. Kilgariff, VK5JT, is anxious to contact any of the VK5 W.I.A. members who have joined up, as the South Australian Division is anxious to prepare an Honour List of all members who have enlisted. Please write him, giving call sign and general details.

H A M S !

DO YOU WANT TO BE
BACK ON THE AIR?

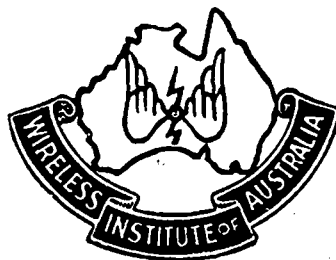

The Wireless Institute of Australia

is the recognised spokesman of the
AUSTRALIAN AMATEUR.

If you are not a member—

Join Now !

When the time comes that we can reasonably expect to go back on the air, we want to say that we represent—

EVERY ACTIVE HAM
in the Commonwealth.

Strengthen our hand by writing to The Secretary of the Institute in your State to-day.

All addresses are on the title page.

Divisonal Notes

IMPORTANT.

To ensure insertion all copy must be in the hands of the Editor not later than the 18th of the month preceding publication.

N.S.W. NOTES.

The June General Meeting of the Division was held as usual at Y.M.C.A. Buildings, and quite a large number of members were present.

Members were informed of the steps taken in an endeavour to remedy caustic comments made by the P.M.G. when speaking of those unlicensed persons, who had been caught breaking the ban on transmissions. Satisfaction was expressed when it was learned that questions had been asked of the P.M.G. in the House of Representatives as to the correctness of his statements.

The Divisional Treasurer, Harold Ackling, VK2PX, has enlisted in the A.I.F., and has been drafted to the Special Wireless Section, Australian Corp of Signals. It is believed that 2PX's birthday is on a sliding scale! Members decided that a presentation should be made to Harold as an appreciation of his services as Treasurer. Other hams in this unit at present are 2ES, 2AHB, 2OZ, and 2ZK (second in command). These amateurs were wished bon voyage by the President and Secretary prior to entraining for Melbourne.

2PX's enlistment necessitated some changes in the office-bearers, and Frank Goyen, 2UX, was elected to the position of Treasurer, and Alan Joscelyne, VK2AJO, Magazine Manager.

A very interesting letter from the South African Radio Relay League was read, and much disappointment was felt when it was learned that all amateur transmissions had ceased in February of this year.

Satisfaction was expressed by those present when it was learned that after nine months of war 95% of the membership was financial.

It has been decided to make the Institute letter of introduction to overseas hams available to all amateurs serving abroad with the forces.

A very interesting demonstration of home-made Talkie and Moving Picture apparatus was given by John

Howes, VK2ABS. This machine uses 35 mm. film and the quality of the projected film and its accompanying sound made it hard for members to realise that the whole outfit was home-constructed. It is quite safe to say that the performance could only be bettered by one or two of the leading talkie shows of Sydney.

VK2RA.—Another good ham gone West, or is it Warwick Farm. A few weeks ago, Ray joined the happy (?) band of Benedicts, and all members will wish Ray and his charming bride all the best. Wonder if Ray will put in phone when he gets back on the air again.

VK2PX.—Harold has decided that he would like to meet some of the DX he worked, and has joined the A.I.F. It is heard on good authority that 2PX refused to take his hat off when he went up. Wonder why? It is also understood that he swapped his hair brush for another article that may be more useful to him. Good luck, om.

VK2ZK. — Lieutenant Arthur Henry, winner of the Crawford Trophy, is second in command of Harold's unit, and like 2RA, was recently married. As one wag remarked that when you enlist it is for the duration and twelve months after, but when you get married, it's—oh, well, we better skip it!

VK2AHB.—Any member of His Majesty's Forces wishing to change his boots for a larger size should get in touch with Arthur. Size 12's. What a grip on Australia. What a terrific kick in the pants some person in the Mediterranean may get.

VK2SS.—Bob rushed into the last meeting very excited. What do you think of this, om. Six months after war's declared I get my first South American card. Now W.A.C.

VK2HC.—Ray has not been enjoying the best of health lately. Many hams will remember 2HC on 80 mx. with his Code lessons for the A.R.A. in the early days. Hope you soon get well again, om.

VK2JU.—To run a series of articles on how to learn the Code. Not really, John?

VK2AKO.—Changing from Flying Boats to Flying Fortresses.

QUEENSLAND DIVISION.

By 4ZU.

4LT.—Believed to belong to that now extinct race of creatures who used to roam this earth emitting a shrill cry sounding like "See-Kew." Hope I am not being too hard on you, Albert OM, but haven't heard of you for ages.

4AW.—Arthur is actually punching a key again. Yep, that's what I said. However, it's not his own, but one belonging to the R.A.A.F. Quite a few of the boys out at Archerfield now, some of them being 4AW, 4OK, 4AH, and 4KK.

4HR.—Tibby seems to be the Mr. Churchill of VK4, inasmuch as he is always smoking a vile cigar. Don't know if Mr. Churchill's are vile or not, but if they are like 4HR's I will feel very sorry for any Germans who come in contact with him. That's what I think of your cigars, Tibby. HI.

4WT.—Now I was going to place old Bill in the same category as 4LT, but rumour hath it that Bill is in camp or something to that effect.

4RT.—John still sharpens lawnmowers in his spare time (and other time), but beyond that I can't say much about him, except his ability to spin a really good yarn. When John says, "Did you hear the one about, etc., etc.," well the mouths shut and the ears fly up as if by magic.

4RY.—Bill still attends to the distribution of "Amateur Radio," so that all you fellows who are wading through these Notes receive your copies promptly.

Pat Kelly.—Well blow me down! That is a surprise, isn't it, Pat. In fact, I can almost hear you saying, "You bet!" How is Thursday Island doing anyway, OM. I hope your fancies haven't run to any of those dusky native girls up there. No doubt it will surprise you to know that the old W.I.A. is still holding out, but it is.

4RF.—Fred was responsible for a picture in "Pix" a couple of weeks back. In case some of you have phenomenal memories, it was a picture of Sydney taken from the port-hole of a boat. Of course, you all

know that Fred is a naval telegraphist.

4TH.—One of our country men, who continues to support the Institute. Believe me it's appreciated, Doc. Can't you persuade some of the other fellows up there to drop a line to Headquarters and tell us what they are doing.

4UU.—Here I am in the same position as with 4RT. I am quite sure by this that you all know he is Treasurer for this Division. Ah! I nearly forgot one thing—Bill has a motor bike.

4FJ.—Roy astonished everybody by turning up at the last General Meeting. We meet each month you know, Roy, not each six months.

4DY.—Another, shall I say, visitor at the last General Meeting. Hope you have quite recovered from that throat complaint, OM.

4ES.—Another of the old contemptibles, I mean dependables. We can always rely on Herb putting in an appearance each month. Herb has a bug. It has four wheels, too. Quite a fascinating little thing it is.

4JB.—Oscar is a cobbler of 4RY's, but beyond the fact that he lives next door to my Boss I haven't any real news.

4JF.—Is a call that used to be heard in many remote parts of the world. In fact, the cards are still filtering through for Jack.

4JU.—We are thinking of offering a prize to the sender of the best suggestion as to what Frank does with his spare time now.

4HU.—George is in the Radio business up in Miles. Used to be severe QRM for me when in VIB. However, QRM always cuts both ways.

4JP.—We see so little of George that I almost forgot you, OM. I suppose you will be using the Rotary to hang washing on any time now.

(Continued from page 12)
discriminator for the f-m. Either one of these is chosen by means of a switch. In order to prevent broad tuning on the a-m position, some designers use two sets of i-f transformers with their outputs ganged with the above switch. An alternate method involves the use of but one set of i-f transformers with a 10 or 20 kc. filter connected in series with the No. 1 grid of the second detector. If this filter is efficient, good results may be obtained on both types of programmes.

HAMS

WHEN REBUILDING YOUR RECEIVER
REPLACE YOUR OLD SPEAKER WITH

AMPLION

THE NEW 12in. ELECTRICALLY WELDED
SPEAKERS

MODEL	Air Gap Flux	Weight of Magnet	POWER OUTPUT. Undistorted—Max		Diameter	PRICE
V	8,300	12 ozs.	10 watts	15 watts	12 $\frac{3}{16}$ "	£2 3 0
VL	9,000	22 ..	13 ..	20 ..	12 $\frac{3}{16}$ "	£2 16 0
VP3	12,000	64 ..	20 ..	30 ..	12 $\frac{3}{16}$ "	£5 10 0
VP2	9,000	20 ..	12 ..	18 ..	12 $\frac{3}{16}$ "	£3 6 6
VPI	7,500	14 ..	8 ..	12 ..	12 $\frac{3}{16}$ "	£2 10 0

Types V and VL are Field Type Speakers.
Types VPI, 2, 3 are Per-Magnetic Speakers.

**SILVERED
MICA**

T. C. C.

**CERAMIC
CONDENSERS**

T.C.C. Silvered Mica Condensers are guaranteed to maintain their capacity under all temperatures, thus insuring no frequency drift in Supers. The foil is actually plated on the mica.

We can supply these Condensers in any per cent. of accuracy, including 0%.

The Capacity Range is from 10 mmf to 800 mmf.

LIST PRICE, 1/- EACH.

We are Agents for—

I.R.C. RESISTERS.

T.C.C. CONDENSERS.

AMPLION SPEAKERS.

BRUNO MICROPHONES.

BIRNBACH INSULATORS.

TRIMAX TRANSFORMERS.

**AUSTRALASIAN ENGINEERING
EQUIPMENT CO. PTY. LTD.**

476 Latrobe St., Melb. Phone: F 5585

Let us quote you for your
PRINTING REQUIREMENTS



The House of Good Printing.

**285-287 LATROBE STREET,
MELBOURNE, C.I**

Opposite "The Argus" Office

Telephone MU 2897 After Hours FU 6795

★ OCTOBER

Amateur RADIO DIGEST

SIXPENCE

*a
Simple
Super*

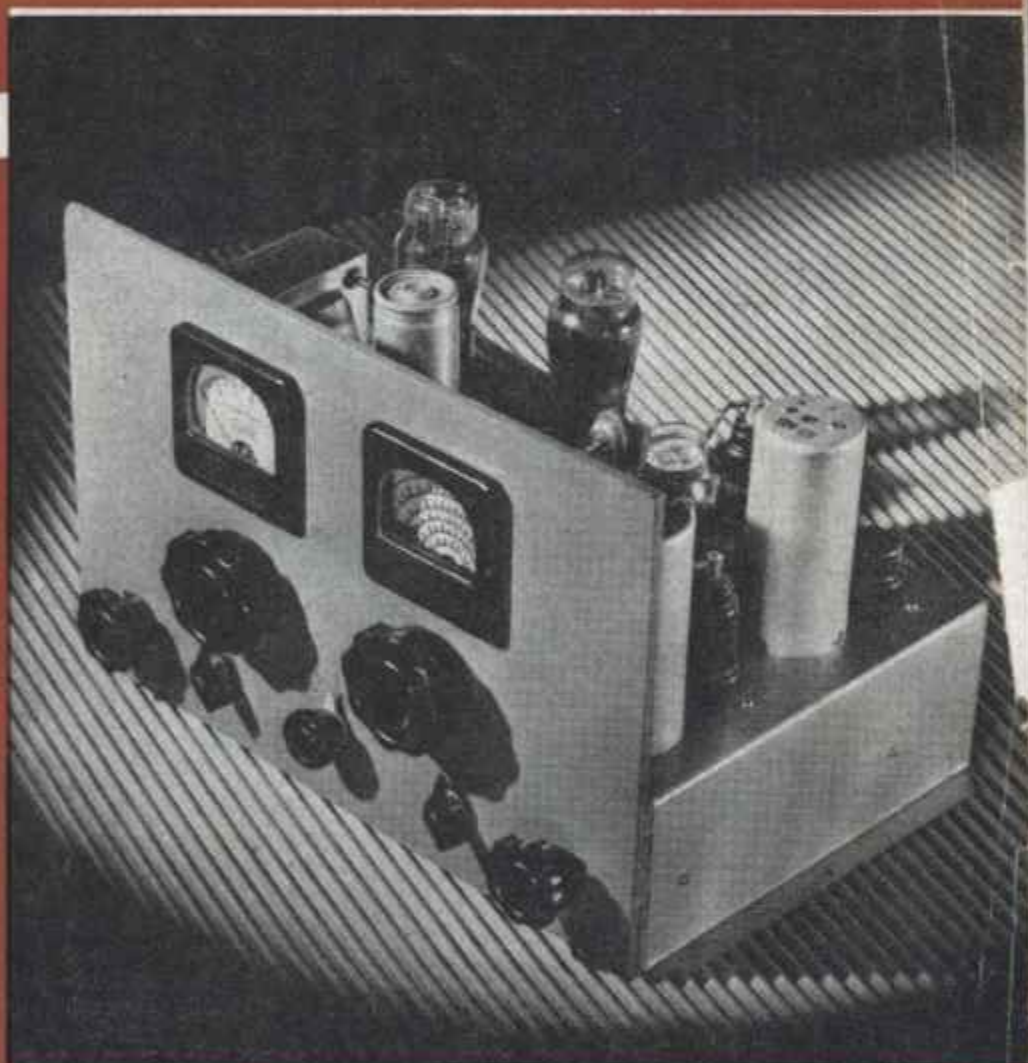

OFFICIAL ORGAN OF THE
WIRELESS INSTITUTE
OF AUSTRALIA ★ ★ ★



A Heritage of Quality

WESTON
Instruments

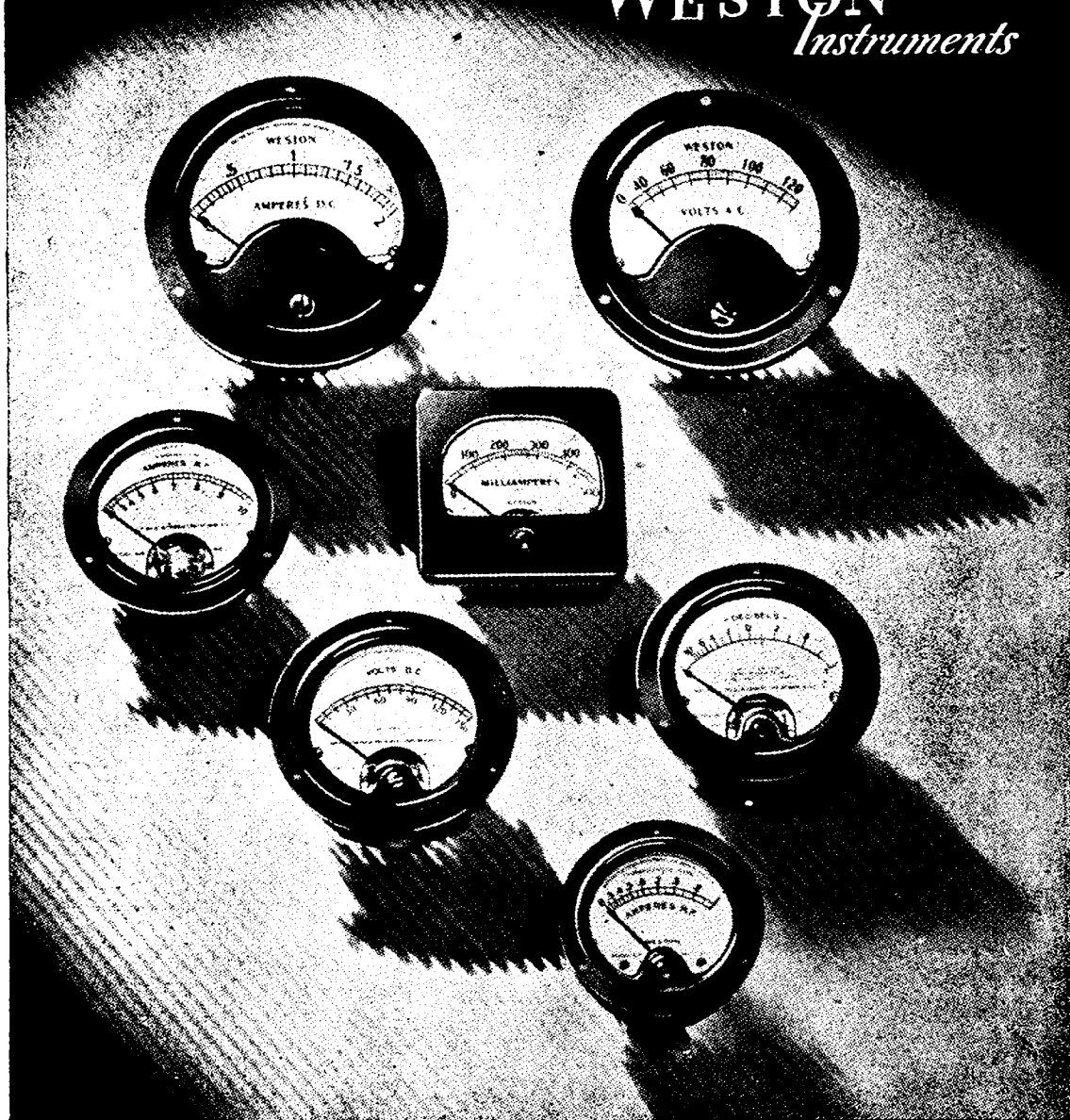

Dependable Testing Instruments for
Every Radio and Electrical Purpose

WARBURTON FRANKI
LTD.

380 Bourke St., Melbourne, Phone MU 6355
307 Kent St., Sydney; 233 Elizabeth St., Brisbane

AMATEUR RADIO

Published in the Interests of Radio Amateurs and
Experimenters throughout Australia.

Vol. 8. No. 8.

1st OCTOBER, 1940

OUR ORGANISATION

Publishers.—

WIRELESS INSTITUTE OF AUSTRALIA
(Victorian Division)
191 Queen Street, Melbourne, C.I.

Editorial Department.—

W. R. GRONOW (VK3WG),
Editor.

R. H. CUNNINGHAM (VK3ML)
Technical Editor.

C. SERLE (VK3RX)
Notes Editor.

V. E. MARSHALL (VK3UK)
Compilation.

M. McCARTNEY (VK3KV)
(Layout)

H. N. STEVENS (VK3JO)
Distribution.

L. T. POWERS (VK3PS)
Secretary.

Advertising Dept. and Printers:

H. HEARNE & CO. PTY. LTD.,
285 Latrobe Street, Melbourne, C.I.

Accounts Department.—

LARGE & POWERS,
Chartered Accountants (Aust.),
422 Collins Street, Melbourne.

MSS and Magazine Correspondence
should be forwarded to The Editor,
"Amateur Radio," Box 2611W, G.P.O.,
Melbourne.

Subscription Rate is 6/- per annum in advance (post paid).

NOTE.—Advertisers' change of copy must be in hand not later than the 20th of the month preceding publication, otherwise the previous month's copy will be reprinted.

CONTENTS.

	Page
Editorial - - - - -	2
A Simple Super - - - - -	3
Problems of H.F. Design -	5
Notes on the Suppression of Ignition Interference	7
Distortion - - - - -	8
H.F. Oscillator in Receivers	10
A 1-Tube Signal Tracer -	11
Radio Digest - - - - -	13
Ham Chatter - - - - -	16
Divisional Notes - - - - -	15

DIVISIONAL ADDRESSES.

FEDERAL HEADQUARTERS:
BOX 2611W, G.P.O., MELBOURNE

NEW SOUTH WALES:
BOX 1734JJ, G.P.O., SYDNEY.

VICTORIA:
BOX 2611W, G.P.O., MELBOURNE.

QUEENSLAND:
BOX 1524V, G.P.O., BRISBANE

SOUTH AUSTRALIA:
BOX 284D, G.P.O., ADELAIDE.

WESTERN AUSTRALIA:
BOX N.1002, G.P.O., PERTH.

TASMANIA:
BOX 547E, G.P.O., HOBART.

EDITORIAL



"Amateur Radio" has definitely improved its appearance as most of our readers will agree, our policy of development is now considerably advanced by the new cover which we think is both modern and attractive. When war commenced, we felt that many of our readers and advertisers would expect us to quietly fade out. We thought it possible, too, on occasions, but at no time has the magazine committee given up hope, that "Amateur Radio" could and would be continued. Working on the policy, that whatever stands still soon slips back, we thought it prudent to change the set up and cover from time to time, with the hope that these advances would increase our circulation. The circulation, which is dependent on enthusiastic support by our readers is likewise the controlling factor in securing the support of our advertisers. Anyone who has ever sold advertising space knows that advertisers as business men are not particularly anxious to support a journal which does not possess a healthy and increasing circulation. We are pleased to say that "Amateur Radio," in its new and improved form, has never been better value from an advertiser's point of view than it is to-day. It is sometimes difficult to impress advertisers that our circulation does not represent a declining market for their products, as the "hams" are off the air. The fact that Amateurs are to be found in all sections of the Radio Industry, in Broadcasting Stations, Design Laboratories, Radio Factories and in Radio Service work of all kinds, indicates that they can and do influence to a very great degree the purchase of radio parts, valves, radio receivers and manufactured radio products.

What Amateur does not do some service work, or is not frequently ap-

proached by some friend to give his technical advice on the purchase of this or that brand of radio receiver, speaker, pick-up, etc.? We repeat that the Amateur does still influence to a great degree the purchase of thousands of pounds worth of radio equipment annually, although we are at present off the air. Our "ham" readers are asked to read the advertisements in "Amateur Radio," support our advertisers, and when doing so tell them "Amateur Radio" was the medium which was responsible for the sale. Don't forget, continued circulation depends on advertising, without which we cannot go to press, and advertising relies on circulation, and more important still, your support of our advertisers' products.

* * *

EDITORIAL ABSTRACT.

Dispelling reports that high power border stations will remain in operation, Ramon Beteta, under secretary of State for Mexico, said recently that licences of all such stations, as a result of the Havana Treaty will expire when the pact becomes operative.

Before leaving Washington, Mr. Beteta declared all preliminary matters relative to the treaty terms had been cleared, and it was his definite understanding that such stations as the high powered border outlaws will stop operating as soon as the continental reallocation is effected.

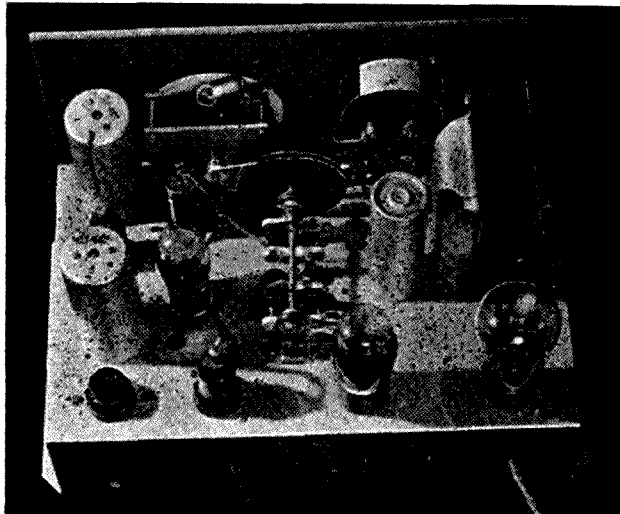

A SIMPLE SUPER



By G. M. Trythall, VK3DA
and M. McCartney, VK3KV.

**The main excuse for this article is hand-switching, it's there
and the set is a great performer.**

The ideal receiver is often depicted in radio cartoons as one with a multitudinous collection of tubes, oiled-wheel dial control, oceans of gain producing signals that shake the speaker moorings. The cartoons mention nothing about background rackets and signal jamming—we assume, of course, that such things just do not exist. It does not take the practical man long to wake up and realise that just ideals cost money and require skill in construction that is above the average. He is limited to the bank balance and, quite often, in superhet building, experience, and must turn to something that is within his means and ability. Fortunately, to-day, he can make these dream sets come true as far as signal producers are concerned through recent advances in tube design and component efficiency.

After experimenting and playing around with unwieldy 9-10 tube plug in coil Supers for some considerable time, the writers decided it was about time to scrap these ponderous "Signal Snarers" and go in for something modern and smaller.

We believe we have achieved our aim in this, a Simple Super, that with a flick of the Tuning Knob you

can cover the band; hear Signals swishing in and out, and if 20 is dead, switch up to 40 or down to 10.

The 1851 Mixer combined with the 6J.5. High C.Osc. is a system which out-performs by far any of the usual arrangements found in conventional Mixer Circuits. The net result of this combination is high sensitivity and a noise level that is conspicuous by its absence, and any inefficiencies that may be present in coil switching are certainly made up by the sensitivity of the R.F. end of this set.

The rest of the receiver is quite standard, one I.F. stage is used employing permatune iron cored transformers. Air core I.F.'s were originally used with very good results, but the added selectivity and gain obtainable from the iron cored is to be preferred. The second detector is a 6H6, which happened to be the only suitable tube on hand, a 6Q7 or any diode triode would be equally suitable and more economical, eliminating the 6F5 driver. A noise limiter is an intended addition, and the unused section of the 6H6 offers in this case a method of application. The output stage is quite conventional, and if fully driven will supply a good 4 watts.

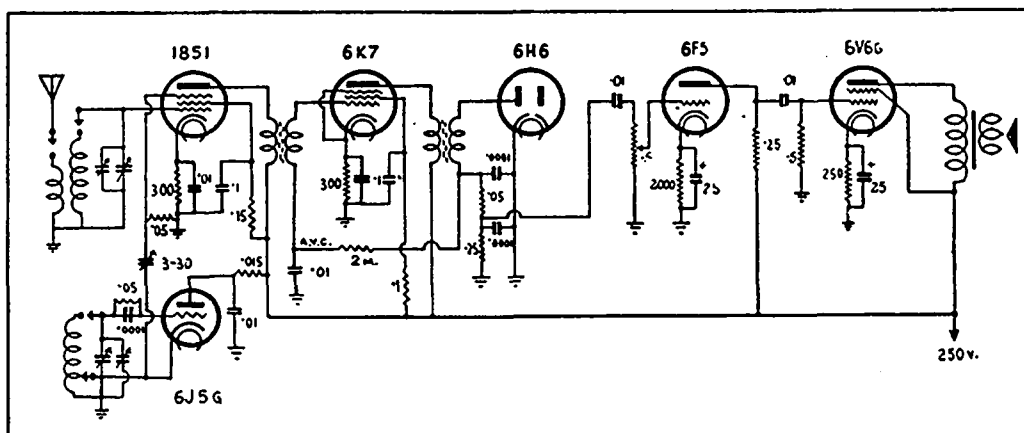

CONSTRUCTION: The components are assembled on a commercially obtainable chassis 14 x 8½ x 3½. The lay out is quite visible in the photographs. The tuning control is fashioned on the Hallicrafters S.X.16 and is a delight to operate, and a refinement well worth while. The mere flick of a finger sends the control spinning across the bands which makes for perfect ease in tuning. The reduction gearing is enclosed between two ½ in. brass plates 4 x 3¼. The gear wheel which carries the tuning knob and flywheel is ⅝ in. diam; this drive meshes with a 4 in. cog, which carries the spiral tuning dial at front and ⅝ in. pulley at rear end which in turn cord drives a 3 in. pulley on the condenser shaft. The result of this mechanism is an inertia control equal to the most expensive American communication receivers.

The controls on front panel from left to right are: H.T. Switch, Band Setter, Band Switch, Mixer Grid Trimmer, and Audio V.C. A large knob is used on the Meter Zero adjustment to balance up with the tuning control.

The bandswitch is a 2 bank 5 position unit, each bank switches 2 circuits.

On each bank, the grid of the mixer and one leg of the aerial winding is switched.

On second bank, Osc. Grid and cathode tap are switched and all other points are earthed.

It is advisable to get one set of coils going before proceeding to wire in next set and although these coils were home wound, commercially wound coils would suit.

In our case it seemed unnecessary to orientate the coils at right angles to each other.

OPERATION: It is advisable to measure the injector grid current of the mixer on each set of coils. To do this insert an 0-1 m/a meter between cold end of injector grid resistor and earth; the reading should be .15 m/a on all bands, adjustments being made in all cases on high frequency end of band. Finally a definite peak will be found when adjusting Osc. coupling condenser, this adjustment should be made on the H.F. coils.

Regarding bandspread.—On this particular set there is approximately 400 deg., this can be lessened by reducing the number of lanes on the spiral dial if so desired.

Reference to the photograph on the front cover will clear up any doubtful points regarding layout.

We feel, in conclusion, that the saying "U've got something there!" as expressed by several amateurs, amply sums up the fine performance of this simple Super.

Problems of H. F. Design

by

O. J. R U S S E L L.

+ +

The higher frequencies are becoming of increasing importance and the design of equipment presents a problem very different to that of normal short-wave design. While it has become more usual to extend the range of receivers down to 10 metres, it is sometimes apparent that compromises have been effected, and the extreme high frequency performance is inferior to the rest of the short-wave performance. The designer must nowadays be prepared to consider the prospect of operation down to 5 metres and lower.

Wave Range

The problem of the wide range receiver operating over a wide wave range extending down to the lowest wavelengths, is extremely difficult, as it is almost impossible to avoid having to make compromises of some kind or the other, with consequent lowering of performances on some wavebands. In general it is the highest frequency band which suffers, and because of the inherent difficulty of providing high-frequency gain at these frequencies, the specialised high-frequency receiver has been evolved.

In addition, to avoid the complications of multiband operation, there are also designs for some specific single waveband. In the case of single-waveband receivers for ultra-high frequencies, the designer can adopt measures impracticable for multi-waveband receivers, and ensure maximum efficiency for the selected wave range.

A discussion of the extent to which a designer may compromise between an ideal design, and a practical design is bound up with so many factors that the question can only be decided

by those concerned. The problem is naturally complicated by economic factors, and other questions outside the scope of strict radio theory and practice. However, it is of interest to examine the more strictly technical aspects of the problem of efficient operation upon the higher frequencies.

We may set the limit of normal short-wave operation as being in the neighbourhood of 20 metres (14 megacycles). At higher frequencies, the specific factors operating to limit efficient working are already becoming serious. The most serious factor is the effect of finite transit time of electrons in the valve. The lag, due to the time taken for the electrons emitted by the cathode to reach the anode, represents a loss, which may be expressed as a resistance shunted across the grid cathode input circuit; it makes itself felt as a damping of the grid tuned circuit in a high-frequency amplifier.

This input resistance decreases as this increase resistance decreases as the square of the wave-length, and in most high-frequency amplifying valves is of the order of only 5,000 ohms at 5 metres, or less. The valve becomes, in effect, a low resistance shunted across the input circuit, with loss of selectivity and gain. It is possible to build conventional tuned circuits having resonance resistances of much greater value than this, a value of 15,000 ohms or so being easily attainable.

A partial solution of the problem is to tap the grid of the high-frequency amplifier down on the tuned circuit. By so doing the loss in gain, due to tapping down the coil, is more than compensated, by the increased

voltage developed across the tuned circuit, as the damping is removed. Selectivity is correspondingly increased. In practice, no advantage will be derived by tapping more than about half-way down the coil, as the voltage applied to the grid of the valve will fall off rapidly below this, especially as the tuned circuit has a fairly low value of dynamic resistance with normal construction.

Television Receivers.

In television receivers, where even the moderate selectivity of normal tuned circuits would unduly attenuate the enormous sideband width of the vision signal, the damping, due to low input resistance, is no disadvantage. Special valves of very high mutual conductance have accordingly been evolved, in order to obtain appreciable gain with low input resistance values. It is of interest to note that with the normal type of valve construction, increase of mutual conductance is accompanied by decrease of input resistance, so that there is little advantage for normal purposes to be obtained by the use of these very high mutual conductance valves.

Finite Transit Time

The problem of finite transit time effects may be overcome in two ways. The transit time may be reduced by using higher anode voltages, or by reducing the spacing of the electrodes in the valve. Unfortunately the benefit obtained is proportional to the square root of the appropriate change, so far as the frequency of operation is concerned. Thus to obtain equivalent performance upon twice the normal frequency of operation, we should either have to decrease the electrode spacing to a quarter, or increase the anode voltage four times. In general the solution adopted is to decrease the electrode spacings. The acorn valve represents the practical limit, from present-day production viewpoint, of the reduction of electrode spacing. It must be remembered that for any specific frequency, the benefit obtained by either reducing the electrode spacing, or increasing the anode potential is directly proportional to these factors. In some cases it may be an advantage to oper-

ate a valve with increased anode potentials, and increased bias in order to improve performance at the limit of operation of some particular receiver.

It is unfortunately still true that most of the difficulties of high-frequency operation are caused by the imperfection of the valve. Losses due to other components are not nearly so serious, or can at any rate be obviated by special measures. The loss in dielectrics for example is not necessarily increased with frequency, and an excellent range of low loss insulating materials of ceramic and synthetic plastic types, is now available. Indeed the use of very low loss materials has reached at times to ludicrous lengths, as when the thin strip of paxolin type of valve holder is replaced by a holder many times thicker of low loss material, the losses of which, due to the added thickness of material, are probably not much less than the older type of holder. In any case the losses in the holder are much less than those in the base of the valve itself. It is only comparatively recently that the valve base has been modernised, and the footless types of valve have resulted in decreased losses in the valve base, and also shortened the length of the internal leads to the electrodes with reduction of the harmful back coupling effects due to the inductance of these leads.

The question of tuned circuits for high-frequency operation is at present in a state of compromise. For normal work, the conventional coil and condenser provides for reasonable values of Q down to 3 metres or so while extremely high values of Q may be obtained by the use of resonant systems of the concentric line type. Such systems may be tuned over a waveband by the use of a variable condenser, and may be operated up to 10 metres. The values of Q obtained are so great, however, that the use of Acorn valves is virtually essential, and it is desirable to tap the Acorn valve grid well down to the concentric line system, if full advantage is to be taken of the high Q values obtained. The chief advantage of such systems is that for a given diameter of the concentric line system, the Q actually increases with frequency, unlike more conventional

tuned circuits. Such concentric line systems are, however, too bulky for other than fairly specialised use.

In regard to conventional tuned circuits, it is of interest to note that at high frequencies the skin effect is accentuated by the phenomenon of the oscillatory current tending to flow only along the portion of the wire that would touch a cylinder enclosing the coil. The consequence of this effect is that the effective loss resistance of the coil is not greatly reduced by using very thick wire. However, if the coil is wound from flat strip

rather than wire, the current has a larger effective surface to traverse, and the loss resistance is proportionately reduced.

While the factors militating against efficiency may most fairly be ascribed to the shortcomings of valves, rather than to serious deficiencies in other components, it is possible by circuitual arrangements to obviate many of these losses. In particular, the attention given to by-passing, and to the cathode circuit, are of paramount importance.

+ +

NOTES ON THE SUPPRESSION OF IGNITION INTERFERENCE ON FREQUENCIES BETWEEN 40 AND 60 MC.

The following significant information on this subject is taken from the paper "The Ultra-Short-Wave Interference Suppression of the Electrical Ignition System of Motor Vehicles," by W. Scholz and G. Faust, T.F.T., November, 1939, Vol. 28, No. 11, pages 409-414. The usually recommended scheme of screening the whole ignition system is deemed too expensive as a general solution, while the introduction of high-frequency chokes merely serves to displace the interference to lower frequencies. Furthermore, the use of by-pass condensers large enough to be effective for the ultra-high frequencies reduces the efficiency of the engine, since capacitances greater than 100 uufd. are required. As for resistances, while they are effective for suppression of the ignition interference affecting reception on the standard broadcast band, the suppressing action decreases for frequencies above 15 Mc., because the capacitive leakage reactance becomes lower than the ohmic resistance value. An effective solution was found in using the distributed type of resistance rather than concentrated resistance units. This distributed resistance is obtained by making the ignition connecting leads of spirally-wound resistance wire on

an insulating core. This lead has a resistance of 5,000 to 10,000 ohms, about 3,000 ohms per foot of special cable. Leads of this type in combination with capacitances of only 10 uufd. and a fixed series resistance of about 2,000 ohms gives effective suppression not only on the ultra-high frequency range 40-60 Mc., but also on the frequencies below 15 Mc., to which the maximum interference was displaced by the inductance of the special spiral-wound resistance lead.

When combined with special spark plugs in which the resistor unit was enclosed, the interference level at a distance of 7 metres was brought down to a field strength so small that it could not be measured, although the field strength with the untreated motor was of the order of 32 millivolts per meter. With ordinary spark plugs the interference field strength was of the order of 13 mv. per metre with conventional suppressor type resistance units. The field strength of the ignition interference at this same distance was only 4.3 millivolts per metre with the special high-resistance lead and 2,000 ohm resistor unit in series in combination with an ordinary type of spark plug.

D I S T O R T I O N

by

D O U G L A S N. L I N N E T T.

Many factors have to be taken into consideration before we pass judgment on distorted radio reproduction. It will usually be found that there is something wrong with the receiver if the rendition is not realistic.

Analysis of distortion and the quality of reproduction soon shows that there is a human element to be considered. The receiver must give a type of rendition that is pleasing to the differing tastes of owners. This element protrudes itself in addition to the technical qualities of the set.

Evidence is not hard to find because many prefer a type of rendition that has the high notes suppressed and the bass notes brought into prominence. Others demand that the speech sounds, such as "S", "Sh," and "Z" are reproduced faithfully to give a clear and sharp effect which is easy to follow.

Neither of these differing tastes present great difficulty to design, but there is still another factor over which the designer has no control. This has a material influence upon the enjoyment to be derived from broadcasting and comes from the acoustical properties of the room in which the set is worked. Such acoustical properties have a definite effect upon quality, and they can only be compensated for by means of some special tone control.

The definition of quality of reproduction, therefore, has many different interpretations, and there are as many conceptions of the ideal as there are people listening to broadcasting.

A great many would not be satisfied with a receiver designed to give theoretically perfect reproduction and placed in an acoustically perfect room. They would want something different because our hearing mechanism is not perfect. This accounts

for much of the variation in taste as to the quality of the rendition to be desired.

Even so, there is often more evident distortion to ruin a broadcast programme. This type can be cured. It may be divided into two general classes for the purpose of discussion—frequency distortion and amplitude distortion.

Frequency distortion occurs in the suppression or exaggeration of some particular note or band of frequencies. In its worst form, there may be an entire absence of the bass or treble, or an unpleasant resonance at various points in the frequency range.

Amplitude distortion is quite different because the wave form of the original sound is mutilated. This becomes evident in a choking or blasting of the rendition.

Invariably, the trouble can be traced to a choice of unsuitable components, incorrect use, or perhaps there are incorrect voltages supplied. They can all be traced, even though there are many different causes and still more numerous cures. So it will be worth-while discussing a few, as one or more may be traced and rectified. That will give a considerable improvement in the quality of reproduction.

Frequency distortion is chiefly caused by couplings and speakers.

The most serious offender is the speaker itself.

Economic reasons demand that the radio must be contained completely within a wooden cabinet, so that the baffle, as provided by the front of the cabinet, is not in accordance with the theoretical ideal dimensions for uniform treatment of all frequencies within the audible range.

The inequalities are recognised and the receiver is balanced at one or more points, or a tone control fitted,

so that the degree of equalisation can be made a variable quantity. The tone control is by far the better arrangement, because it allows changes to be effected according to individual requirements.

The baffle itself is any partition separating the sound waves produced by the front of the speaker from those emanating from the rear surface of the cone. The lowest possible note that a speaker can radiate, is roughly one whose quarter wavelength is equal to the distance from the centre of the cone round the baffle to the same point at the rear.

Since the wavelength equals velocity (1100 feet a second) divided by frequency, an example in a 100 cycle note would be a wavelength of 11 feet, and a quarter wavelength would be $2\frac{3}{4}$ feet. This would be the theoretical size necessary to reproduce fully such a note at the same level as other higher frequencies.

The Baffle, therefore, has to be made smaller than the size demanded by theory. This does not mean, that none of the lower notes can be reproduced, but they will be partially suppressed.

The resultant tone depends solely upon the size of the baffle, and the amount of compensation allowed in the design of the receiver. This allowance also takes into account, the harmonics which are suppressed to some extent, but they give an indication of their presence in the quality of the reproduction.

Amplitude distortion can generally be traced to the incorrect use of valves. This is often due to the wrong voltages coming from the power supply. Another cause, which is often overlooked because we become accustomed to this form of distortion, is due to the valves losing their emitting properties. When the emission falls below the normal value, the cathode is unable to supply the necessary output, and so the tone gets poor. This gradual decrease in tone value is rarely noticed. The difference becomes very apparent however, when new valves are installed.

Incorrect plate and grid voltages are another great source of trouble. Test will quickly remove this cause.

The plate current, or amplified signals, vary with the grid voltages. If the incoming grid swings take place

over the wrong portion of the characteristic curve, the amplified signal cannot be a faithful replica of the input. The operating point must be changed accordingly.

This may mean that the positive half swings will be amplified to a greater extent than the negative swings. The result is what has become to be known as harmonic distortion.

The valves have to be correctly biased to get the right operating point. Here is a fruitful cause of trouble because it is very apparent that many receivers are still operated with a careless disregard for grid bias, especially where the old receivers are still in use.

The object of applying this bias to the valve is to obtain the most satisfactory operating point. Unless this is done, the valve can only work inefficiently and mar the quality of reproduction. A characteristic curve will soon show the correct voltage to apply.

Another form of valve distortion comes from the input signals. They are sometimes so large, that the plate current cannot cope with them. Both ends of the signal are lopped off in such a case. This manifests itself in blasting.

The cause of the trouble is found in the fact that the valve used has not an adequate grid acceptance to provide the high value of plate current. The valve must be changed for one which can deal with the input swings, and has an output sufficient to load the final stage without encroaching on the characteristic curvature.

Further distortion is found in detector circuits. The cause is usually an inability to handle very large voltages, especially where grid leak detection is employed.

The amount of direct current in the grid circuit causes the trouble because it is sufficient to overload the valve on strong signals and distortion results. This can be reduced to a minimum in design, although the trouble is less frequently found with the diode which has overcome many of the inherent defects.

Nevertheless, very keen ears are required with the modern radio functioning properly. It is hard to notice any deficiencies or preponderance of

notes throughout the musical range. Distortion only becomes evident when there is something wrong.

The excellence of quality attained is quite natural in the later designs, and there is some defect in the apparatus if it is not being obtained.

Nowadays, transmission and reception have attained a remarkable degree of faithfulness—that is electrically speaking—and it is possible with well-designed equipment for the musician to obtain all that is desired.

H.F. OSCILLATOR IN RECEIVERS

By Dana Bacon in "Q.S.T."

Last month we promised to tell you about a good high frequency oscillator for receivers. You may be surprised to find that we mean to talk about a tuned-plate grid-tickler oscillator which in itself is not new, but since receivers use electron-coupled, or tuned-grid oscillators almost exclusively, the merits of the tuned-plate arrangement are not generally realised and are therefore "news."

As a start, let us take a look at the electron-coupled oscillator shown in Fig. 1. In this, the cathode is at some R.F. potential above ground. As a result, the inter-electrode capacity between cathode and heater (which is grounded) will be across part of the tuned circuit. In addition to causing hum, this causes instability, since a slight shift in the position of the heater will change the oscillator frequency. This can be kept at a minimum by carefully selecting the oscillator tube. It is particularly important to choose a tube having a "folded heater", rather than a "spiral heater." However, when the frequency is high, the only practical cure is to keep the cathode at ground potential. This is most easily accomplished by using either a tuned-plate or tuned-grid oscillator.

It is our experience that it is much easier to make a tuned-plate oscillator stable than one of the tuned-grid variety. Most of the theory behind this is rather involved, and since this page is no place for vector analysis, we are not going to go into much detail. There is one point that we can cover easily, however.

In the usual tuned-grid oscillator, the grid current places a heavy load on the tuned circuit, which spoils its Q. At the same time, the tickler coil does not provide enough load impedance for the plate. The net re-

sult is poor frequency stability due to the low Q, and weak oscillation due to impedance mismatch in the plate.

With a tuned-plate, the situation is reversed, with happy results. The tuned circuit provides an excellent load for the plate, of course. At the same time, by adjusting the coupling of the grid tickler a reasonable impedance match can be obtained in the grid circuit, so that ample grid driving power can be obtained without spoiling the Q of the tuned circuit. The circuit for doing this is shown in Fig. 2. Of course there is one disadvantage to this circuit in that it allows DC plate voltage to appear on the condenser stator, but this can be easily avoided by using a blocking condenser.

The plate-tuned oscillator lends itself nicely to electron coupling either by using a separate mixer tube or by a pentode, as in Fig 1. But even without electron coupling we have found that the plate-tuned oscillator is preferable to the types usually found in receivers and possess the same advantages when used in monitors, "rubber crystals," and the like.

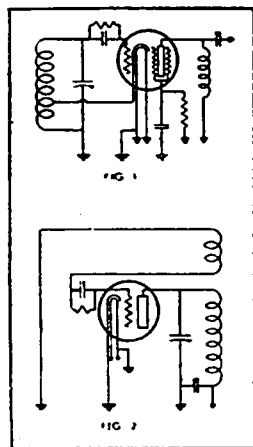

A 1-TUBE SIGNAL TRACER

by

CHARLES R. MERCHANT

(From "Radio News," June, 1940)

★ Try this extremely simple signal-tracer which only uses one tube. While it will not be as good as a multi-tube rig, it works.

In servicing radios, it is almost a truism that a totally inoperative set is easier to fix than one that "sort of works,"—i.e., is noisy, distorting or weak. It was to make it easier to diagnose these headaches that the following device was constructed, and judging by tests on a considerable number of actual cases it does all that it was intended to do.

It is essentially a signal-tracer which makes it possible to follow a signal, either from a broadcast station or from a modulated test oscillator, from stage to stage and from component to component through a set and find out just where it goes wrong. When that is settled, it is seldom much trouble to figure out what's the matter.

The hook up used is a pentagrid converter circuit whose oscillator section generates frequencies which lie in the regular broadcast band. This is coupled to the antenna and ground of a good set, either a T.R.F. or superheterodyne, but one preferably without A.V.C. A signal fed into the output of the set to be repaired may then be examined anywhere in its career, either as r.f., i.f., or audio, by being fed into the input of the converter circuit through special test cables. If the signal is to be examined in the r.f. stage, the oscillator of the converter is rendered inoperative and the signal is simply amplified and passed on to the test set. If the signal is in the i.f. stages, it is changed back to broadcast frequency in the converter, and if the signal is in the audio stages it is used to modulate the oscillator frequencies in the converter in the same manner as a phonograph oscillator. Thus any

defective stage may be located quickly.

One prerequisite in such trouble shooting is that the device used shall not load the circuit. That was one of the great difficulties of the analyzer method of set-checking; the extra capacitances introduced by the analyzer cables were generally sufficient to throw the set into an entirely different frame of mind, and with a sheet of analyzer readings on hand it was often more difficult to figure out what they indicated than it would have been to diagnose the trouble "by ear."

That difficulty is avoided in this instance by using a probe which puts such an infinitesimal load on the circuit that the effect is practically

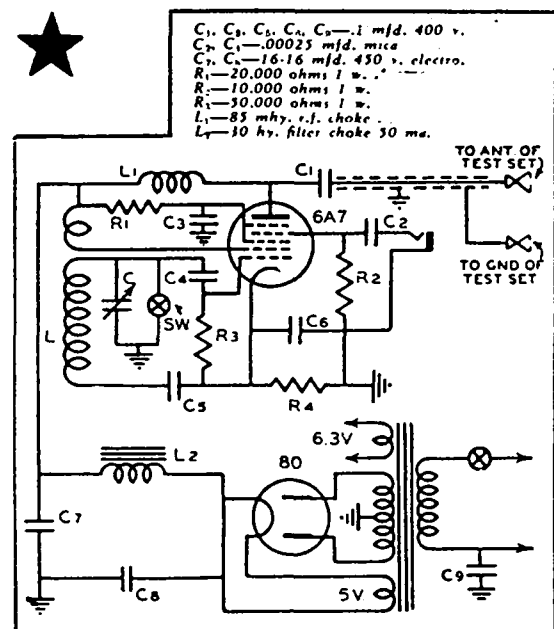

zero. In fact, if the set under observation is operating strongly at all, it is not necessary to touch the probe to the components; by simply holding the probe near them, enough energy can be picked up from the stray fields to enable one to judge the quality of the signal at that point.

The probe is constructed of a five-inch length of bakelite or fiber tubing of an inside diameter just large enough to admit a flat-headed metal thumb-tack. Two of these thumb-tacks separated by one-sixteenth inch, make up a minute air-gap condenser in the body of the probe, which very effectually shields the probe tip from the ground capacity of the shielded cable used to transfer the signal to the input of the converter.

To the point of one thumb-tack a one-inch length of stiff piano wire—gauge 20 or 21 is right—is soldered and the other end sharpened. A piece of wooden dowelling, of a diameter just large enough to fit snugly in the tubing, is cut one-half inch long, and a one-thirty-second inch hole is drilled from end to end down the centre. The piano wire is pushed through this until the thumb-tack is all the way in, and a turn or two of bare copper wire is wrapped around the free end of the piano wire, flush with the dowel, and soldered to hold the piano wire in place.

The centre wire of a piece of shielded cable about three feet long is pushed through another similar piece of another thumb-tack. The wire is then pulled through until the head of dowelling, and soldered to the pin of the thumb tack is flush with the end of the dowel, and the wire is secured in the same manner as the other.

A very thin coating of speaker cement is then applied to the second piece of dowel and it is pushed through the bakelite tubing until the head of the thumb-tack is just five-eighths of an inch from the other end. A very small hole is drilled through both the tube and the dowel and a small brad nailed through to hold the dowel in place. The other piece of dowel is then pushed into the open end of the tube, thumb-tack first, until the two thumb-tacks are separated by one-sixteenth inch. By pushing it in until the two thumb-tacks touch and then withdrawing it, this distance can be judged quite accurately. A few drops of cement and a brad hold it in place. The shield-

ing on the cable is then brought up about an inch over the other end of the probe and a couple of turns of friction tape wrapped around to hold it in place. A regular phone jack is fastened to the free end of the cable, the inside wire going to the tip and the shielding being connected to the ground side. It is then complete. This is the r.f.-i.f. probe.

Another cable is made up exactly like the first except for the probe, which in this case has a .00025 mf mica condenser set into a slot in the end of another similar bakelite tube and taped fast. The inside wire of the cable is soldered to one terminal of the condenser, and a one-inch length of piano wire is soldered to the other. This is the audio probe.

As to the converter itself, its construction is not difficult. The 6A7 should be well shielded, and the current well filtered; any hum which is introduced into this tube will be very confusing when you're using it to locate hum somewhere else. L and C in the diagram are any ordinary broadcast band r.f. transformer with its primary cut down to about a dozen turns, if it has more than that, and the tuning condenser that goes with it.

The leads to the primary will have to be reversed if the polarity is not correct, for then the tube will not oscillate. Satisfactory evidence of oscillation will be had by removing the grid cap from the 6A7 and, with the dial of the test set turned to about 60 and the volume control turned down low, slowing turning the tuning condenser on the converter. At about the same setting of the converter dial a loud hum should be heard when the finger tip is touched to the control grid of the 6A7. If no such hum is heard and the connections are all right otherwise, reverse the primary leads.

The method of using the instrument is quite simple. When listening in on the r.f. stages the switch on the tuning condenser is closed, rendering the oscillator inoperative. The set under observation is tuned to the strongest local available and the test set tuned to the same station. Either one wire to the voice coil of the set under observation should be unsoldered or a jumper should be put across the voice coil. Then with the r.f.-i.f. test prod the quality of the signal can be ascertained throughout the r.f. stages. If nothing suspicious

is disclosed there, the test set should be tuned to some place on the low-frequency end of the dial where no station whatever can be heard normally, the oscillator switch should be opened, and the oscillator dial set higher than the dial of the test set by an amount equal to the i.f. of the set in question. The test set will then receive the i.f. of this set and, still using the r.f.-i.f. probe, the

quality of the signal can be judged up to the grid of the second detector.

Passing to the audio frequency part of the receiver, the audio probe is used and the oscillator dial is set to the same reading as the dial of the test set and the volume of the latter turned down pretty low. The audio frequencies will then modulate the oscillator carrier wave and can be heard through the test set just as if there were being transmitted to it.

Radio Digest

+ +

A survey was made recently to determine just what types of vacuum tubes were being used throughout the radio industry with the thought of possible reduction in the number of types of tubes to be manufactured in the future. The findings of this survey conducted by RCA, were enlightening to say the least.

Out of 453 different tube types on the market to-day, about 90 per cent. of the sales are centered in only 90 tubes and for these 90 types, only 20 basic functions exist. That is, four types of tubes are being used as r-f amplifiers in say a-c receivers, four different types as mixers, four as a-f amplifiers and so on. Furthermore, it was thought that it would be possible to select about 36 basic types of tubes to perform all the functions required in radio receivers to be manufactured. This means, of course, that these 36 types would do the work of the 453 different tubes now being used.

There seems to be little doubt that this reduction in the number of tube types is a step in the right direction and one which will have advantages for all concerned—especially for the radio serviceman. In the first place, it would mean that he would be able to carry a much smaller stock of tubes and still have it complete. Today it is almost an impossibility for a serviceman to carry a stock that is anyway near complete; generally he

can not afford to tie up that much money in his tube inventory and so he stocks just those tubes which move most quickly.

Another advantage to the serviceman would be that he could become more familiar with the different types and their functions. Not only that, but the checking of the tubes in the shop and in the customer's home would be greatly simplified. To-day with the four hundred and some odd tube types it is a real task to check the tubes properly from any receiver. Look at the differences in filament or heater voltages, plate and screen-grid voltages and all the rest—adjustments of knobs and dials have to be made on a tube checker for each one before it can be tested—and all that takes time.

There are, of course, other advantages and also disadvantages, but on the whole it seems as if the standardization of tube types was a step ahead. At this writing nothing throughout the industry as a whole has been decided, but it has been said that RCA receiver engineers in the future will utilize just the 36 basic tube types in their new sets.

Power Output of Receivers.

In looking over the servicing data released by receiver manufacturers, more and more information has been noticed concerning the power output of their receivers at certain input levels. This power output is one of

the significant details associated with receivers and as such, the serviceman should be familiar with it.

A test to establish the power output of a receiver is not as simple as it might appear because of constructional difficulties. However, if two facts are known concerning the voice coil of the loud speaker, then it is possible to establish the power output at whatever signal input levels are specified in the manufacturer's data. In general, the impedance of the voice coil, usually given at 400 cycles, and the equivalent signal voltage across the voice coil are the necessary factors for checking the power output without very much trouble.

The power output may be expressed mathematically as: $W = E \times I$ where W is the power in watts, E , the voltage and I the current. However, it is difficult to insert current-indicating meters into the voice-coil system and since the impedance of the coil is generally given by the manufacturer, the power output can be more readily identified by establishing the voltage in accordance with the following equation: $E = \sqrt{R \times W}$ where R is the impedance of the voice-coil winding and W is the power output as given in the service manuals.

For example, if the voice-coil impedance, R , is 5 ohms and the power output W , is 0.05 watt (50 milliwatts) then the signal voltage, E , measured across the voice coil will be found to equal $E = \sqrt{5 \times .05}$.

In practice it has been found that the voice-coil impedance in the majority of receivers is 5 ohms or less. In some few cases, voice-coil impedances have been found up to as great as 15 ohms, but such values are not commonplace; on the contrary, a great many receivers have speakers with 3.5 ohm voice-coil impedances. Naturally, when calculating the value of E mentioned above, the exact value of R must be used, but these generalities have been given as it was felt that they would prove of value.

In the following table will be found a series of values of signal voltages and voice-coil impedances that are equivalent to a power output of 0.5 watt. This value of power output was chosen as a basis for these calculations inasmuch as the power output of many receivers on the market to-day are based on this figure.

Voice Coil Imped. ohms	Signal Voltage volt	Voice Coil Imped. ohms	Signal Voltage volt
.2	.33	2.0	1.0
.4	.446	2.25	1.06
.5	.5	2.50	1.12
.6	.547	2.75	1.17
.75	.61	3.0	1.22
.8	.632	3.25	1.27
1.0	.707	3.5	1.32
1.2	.774	3.75	1.36
1.4	.835	4.0	1.404
1.5	.864	4.5	1.49
1.75	.934	5.0	1.58

The fact that these figures for the voltages have been carried out to three places does not mean that this high order of accuracy is necessary. The vacuum tube voltmeter that the serviceman usually employs in his work will be found to be entirely satisfactory. The calculations in the above table were made with a slide rule and the nearest approximations are given, so that if a man works to the nearest tenth, he will obtain results that will suffice to all intents and purposes.

H A M S !

DO YOU WANT TO BE
BACK ON THE AIR?

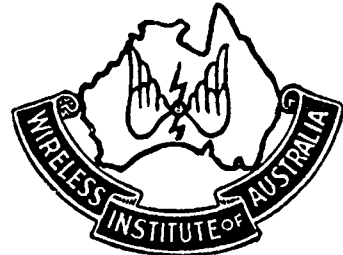

The Wireless Institute of Australia

is the recognised spokesman of the
AUSTRALIAN AMATEUR.

If you are not a member—

Join Now !

When the time comes that we can
reasonably expect to go back on the
air, we want to say that we represent—

EVERY ACTIVE HAM

in the Commonwealth.

Strengthen our hand by writing to The
Secretary of the Institute in your State
to-day.

All addresses are on the title page.

Divisonal Notes

IMPORTANT.

To ensure insertion all copy must be in the hands of the Editor not later than the 18th of the month preceding publication.

VK4 NOTES by 4ZU.

4RY—Bill just been appointed vice-president of this division. He hasn't told us whether he is pleased about it or not. Is also in the local A.R.P. Organisation.

4JF—Jack, one of our most regular attenders. Believe it or not, he still gets a card occasionally.

4LT—Albert is in camp; beyond that it is a case of know nothing, see nothing, hear nothing. Don't forget that you're supposed to write these notes Orm.!

4WT—Bill, rather an active man these days. He is one of the committee appointed to organise the listening scheme which we are getting under way. Made a very nice job of a frequency meter.

4HR—Tibby, along with John 4RT, have developed a habit of sinking down into the rather comfortable chairs in the room where we hold general meetings. All one can see of either of them is the top of their heads behind a book.

4AW—Still punching a key out at Archerfield for the R.A.A.F.

4SN—Visitor from the country down in VIB for the show. Frank says he has all the room he wants for beams now. Just too bad, isn't it Om.?

4ES—What's up Herb.? Haven't seen you the last couple of meetings.

4UU—Bill still holds the purse strings for us. He is pretty good at it too. I suppose it comes of long practice Bill?

4OK—Jack is another R.A.A.F. man. Spends most of his time in the radio hut at Archerfield.

4LS—Les, up in Toogoowalah, has made an appearance, and we wish you all the best. Om.

4AH—Teaches morse to Air Force men. Now you now why R.A.A.F. men are good ops.

4KH—Haven't had any news from you for a while, Om. What say?

ELIMINATING DOUBLE CALLS.

Elimination of double call letter designation of American broadcasting stations—plentiful in the early days of radio, but now only a few remain—is being tackled by the Federal Communications Commission.

To prevent confusion and in the interest of simplification, the FCC has asked WIOD-WMBF, Miami, and WSYR-WYU, Syracuse, to dispense with half of their combinations, allowing them to make a choice. Double call-letters have resulted from previous station amalgamations. The only other double combination is WABC-WBOQ, N. York. Such stations as WOOD-WASH, Grand Rapids, who use the same

transmitter, but hold separate licences for half-time are not affected.

Postponement of "Broadcasting Day" from July 4 to August, so that both New York and San Francisco World's Fairs will be able to collaborate in the event, has been decided upon by principals of the radio industry and the Fair Organisation.

Originally the event was planned for the New York Fair of Independence Day at which a plaque symbolic of radio was to be dedicated.

Under the revised plans, the ceremony will be held on either August 3 or 7. Separate plaques will be unveiled at New York and San Francisco. It is believed likely that President Roosevelt will take part in the ceremony.

Ham Chatter

+ +

THIS MONTH'S BEDTIME STORY.

(From "Radio News," June, 1940)

In the 7th District lived two hams. Unusual, too was the fact that they were husband and wife. Both had calls, and both used their tiny rigs for whatever pleasure you can get for operating with a tenth watt in the crowded 7mc. band. As receivers they had a one tube regenerative set each. One trouble developed and that was that each could pick up the other's receiver far better than they could any sigs. Also, in case I forgot to mention it, they were so poor, that the mice in the kitchen were moving back to the Church, and the Cockroaches were bringing in their own lunch.

When Christmas approached the OM thought things over, and decided that there would not be anything quite so nice, quite so welcome to the XYL, as a fb receiver. He had one all spotted, second-hand, at the local hamstore where they held a "blind" auction every week end. You were assigned a number and then you wrote your number and the amount you offered for the set on a card on the wall, and other hams who wanted to bid against you wrote their numbers and the amount higher than your bid which they wished to pay for the set. Our Hero started at \$5 which he expected to get as a present from the Simon Legree who employed him as dish-washer in the local hamslingery. The next day he went to the hamstore again during his lunch hour.

Sure enough, another couple of hams had raised the price to \$8. Our hero added his number and wrote

down \$8.50. The next day there were only two other hams left in the auction and our Hero had to go to \$9.75 to top them. The next day only one other ham was left and our Hero reluctantly placed his bid in at \$10. The other ham raised to \$10.50; our Hero raised back to \$10.75. The other ham raised to \$11; and our Hero raised it to \$12 to freeze out the other guy. He got the receiver. He snuk it home. "What a present for the XYL," he thought.

Christmas morning dawned clear, cold and cheerful. On the bare table reposed the heavy package which represented all our Hero's money, his lunches for the next two weeks, and an advance from the Boss.

His XYL opened the package, her face lighted up, then her chin trembled.

"Why, Harry," she cried, "You got this from the ZYX Hamstore, didn't you?"

"Yes, dear," Harry replied, "And I would have gotten it lots cheaper except I had to bid against a guy whose number was 65789 and he kept raising me."

The XYL went to the cupboard, took there from her purse and handed the OM a card without a word. It read:

"Dear Mrs Blank:

We have entered you in our weekly blind auction, for the Blahblah FXB-76T Receiver; and you have been assigned number 65789.

Very truly yours,
THE ZYX HAMSTORE."

A Heritage of Quality

WESTON
Instruments



Dependable Testing Instruments for
Every Radio and Electrical Purpose

WARBURTON FRANKI
LTD.

380 Bourke St., Melbourne, Phone MU 6355
307 Kent St., Sydney; 233 Elizabeth St., Brisbane

Let us quote you for your
PRINTING REQUIREMENTS



The House of Good Printing

**285-287 LATROBE STREET,
MELBOURNE, C.I**

Opposite "The Argus" Office

Telephone MU 2897 After Hours FU 6795

★ DECEMBER

Amateur RADIO D I G E S T

SIX PENCE

*Amateur
Direction
Finding*



OFFICIAL ORGAN OF THE
WIRELESS INSTITUTE
OF AUSTRALIA ★ ★ ★

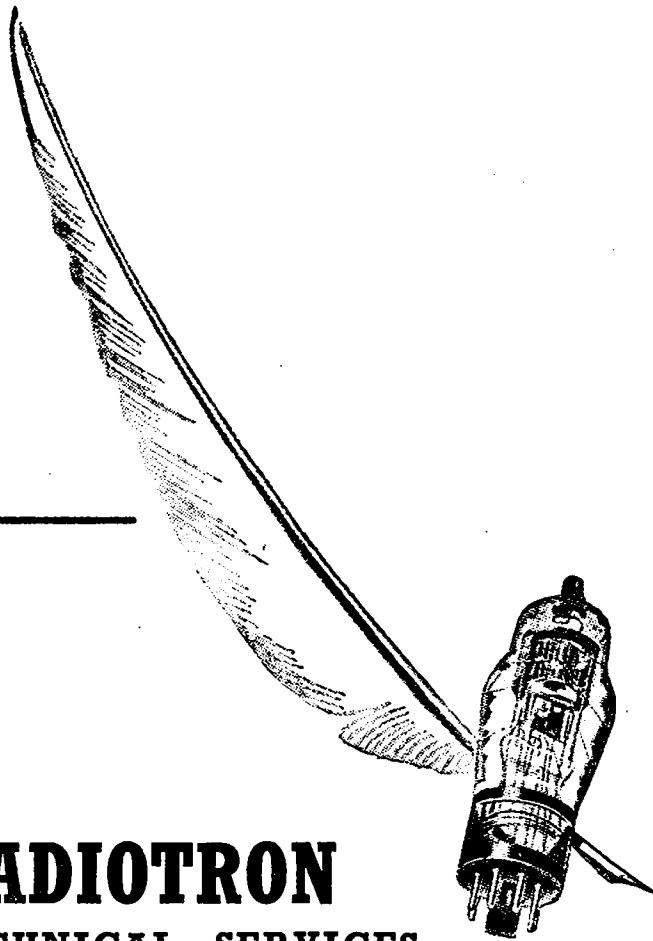

RADIOTRON

TECHNICAL SERVICES

Radiotronics Technical Bulletins, illustrated with photographs, circuits and diagrams, annual subscription, 2/-

Valve Data Sheets, Characteristic Charts, Circuit Diagrams and Classification Tables: issued free as supplements to "Radiotronics."

Binder Covers for Bulletins	1/2
Binder Covers for Data Sheets	8d.
Valve Data Sheet Booklets complete in cover ..	2/2
Receiving Valve Manual	*1/8
Cathode Ray Tube Manual	*1/8
Transmitting Valve Manual	*2/2

Radiotron Designers Handbook —

Cloth bound, 8vo.	8/-
Paper bound, 8vo.	3/4

*Subject to stocks being available.

(The above prices all include postage)

• *The Radiotron Unified Sales-Engineering service is at your disposal without charge. All enquiries regarding technical problems are cordially invited.*

**AMALGAMATED WIRELESS
VALVE COMPANY PTY. LTD.**

G.P.O. BOX 2516 BB

47 YORK STREET, SYDNEY, N.S.W.

AMATEUR RADIO

Published in the Interests of Radio Amateurs and
Experimenters throughout Australia.

Vol. 9 No. 10.

1st DECEMBER, 1940

OUR ORGANISATION

Publishers.—

WIRELESS INSTITUTE OF AUSTRALIA
(Victorian Division)
191 Queen Street, Melbourne, C.I.

Editorial Department.—

W. R. GRONOW (VK3WG),
Editor.

R. H. CUNNINGHAM (VK3ML)
Technical Editor.

T. D. HOGAN (VK3HX)
Notes Editor.

V. E. MARSHALL (VK3UK)
J. G. MARSLAND (VK3NY)
Compilation.

H. N. STEVENS (VK3JO)
Distribution.

L. T. POWERS (VK3PS)
Secretary.

Advertising Dept. and Printers:

H. HEARNE & CO. PTY. LTD.,
285 Latrobe Street, Melbourne, C.I.

Accounts Department.—

LARGE & POWERS,
Chartered Accountants (Aust.),
422 Collins Street, Melbourne.

MSS and Magazine Correspondence
should be forwarded to The Editor,
"Amateur Radio," Box 2611W, G.P.O.,
Melbourne.

Subscription Rate is 6/- per annum in advance (post paid).

NOTE.—Advertisers' change of copy must be in hand not later than the 20th of the month preceding publication, otherwise the previous month's copy will be reprinted.

CONTENTS.

	Page.
Editorial - - - - -	2
Amateur D.F.—A Simple Direction Finder - - -	3
Poorman's High Fidelity Receiver - - - - -	7
Short Wave Section - - -	10
Image Frequency - - - -	11
Hams on Defence Service	13
Divisional Notes - - - -	15

DIVISIONAL ADDRESSES.

FEDERAL HEADQUARTERS:
BOX 2611W, G.P.O., MELBOURNE

NEW SOUTH WALES:
BOX 1734JJ, G.P.O., SYDNEY.

VICTORIA:
BOX 2611W, G.P.O., MELBOURNE.

QUEENSLAND:
BOX 1524V, G.P.O., BRISBANE

SOUTH AUSTRALIA:
BOX 284D, G.P.O., ADELAIDE.

WESTERN AUSTRALIA:
BOX N.1002, G.P.O., PERTH.

TASMANIA:
BOX 547E, G.P.O., HOBART.

E D I T O R I A L



In this issue we commence a new Short Wave Listener's Section. The Magazine Committee has always tried to adapt its policy to changing conditions and, since the outbreak of war and the cancellation of all experimental licences, articles of more general interest have been published. Most amateurs received their introduction to radio through the medium of short wave listening and we hope, through the new section, to cater still more for the short wave listener—who will be the ham of the future.

If we are to cater for the short wave listener, the magazine must be, of necessity, more readily available and Amateur Radio may now be purchased through any newsagent.

With this issue we complete our eighth year of publication and although the past twelve months have been the most difficult of our existence, I venture to say that the magazine is a better publication now than at any other stage of its existence. To quote from a letter first

quoted in the Editorial of the second issue published—Mr. Malone (then Chief Inspector of Wireless) wrote: "The first number is a good one, worthy of its authors. There are better ones to follow. I know that because I know wireless amateurs never will let well alone, they want something better. Their happy combination of optimism, energy and ability will also ensure progress from success to success".

Our optimism and energy have enabled us to surmount many difficulties, the greatest of which has been the problem of maintaining a progressive magazine during a period in which we have been denied the opportunity of continuing our experimental activities. Nevertheless, the magazine has maintained the interest of a large body of experimenters and intends to increase its value and popularity among short wave listeners by publishing a series of technical and constructional articles of general interest to this section of our readers.

AMATEUR DF

DESIGN OF A SIMPLE DIRECTION FINDER.

By Alexander Black

("Wireless World.")



A very interesting branch of wireless experimenting for amateurs is that connected with the directional properties of frame aerials. Direction finding by wireless is primarily used by ships at sea during foggy weather and, of course, by aircraft as well. It has now reached a state of great reliability and precision in these spheres of usefulness.

Up to the outbreak of war, direction finding was an important activity of several wireless societies, notably of the Hendon and Golders Green Radio Society. Many amateurs had attained a high measure of skill, and anyone unable to take bearings within a margin of error not exceeding about two degrees stood a poor chance of winning a prize at the competitive field days that were organised periodically. It should be pointed out that this high order of accuracy was commonly attained with relatively simple and inexpensive portable apparatus. In practice it has been found that with a fairly skilful operator and a well-made receiver bearing can be taken to within

1°, up to a range of about 15 miles on 14 metres, therefore any error greater than this must be due to either the transmitter position in relation to the receiver or the effect of the objects in the immediate vicinity of the receiver or to atmospheric conditions. All this goes to show that amateur direction finders are far from being toys, and that the subject is worthy of the attention of anyone who treats wireless as a serious hobby.

Dealing now with the actual direction finding receiver and associated

equipment, it is assumed that a receiving set employing a loop or frame aerial will be used, therefore let us briefly consider the theory of the directional properties of a loop. Referring to Fig. 1, assuming the frame to be of square section, a signal from a transmitter lying in the same plane strikes the frame first at X then a fraction of a second later at Y. Then

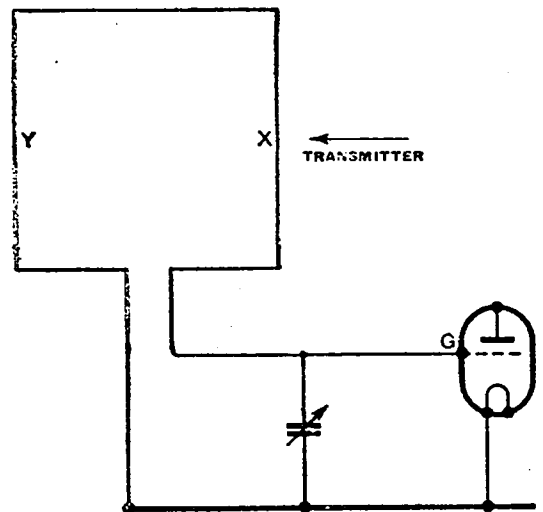

Fig. 1.—Explaining directional reception by means of a frame aerial.

if the dimensions of the frame are small in comparison with the signal wavelength, the voltages induced in opposite sides of the loop will be very nearly equal (the voltages induced in the horizontal portions will be zero and will have no effect on the circuit). When the voltage induced by the signal wave is a maximum in X it will be slightly less in

Y. It is the difference between the voltages at X and Y which causes a current to flow round the loop, thus producing a Pd across grid and filament of the valve at G. If the frame is now rotated through 90° so that the plane of X and Y are at right angles to the transmitter, the voltages induced in X and Y will be equal at any given moment and there no current will flow in the loop. If the frame is rotated a further 90° X and Y will again be in the same plane as the transmitter and current will flow, due to the difference of voltage, but as the wave will now strike Y before X the PD at G will be in the opposite phase. Rotating the frame through 360° the resultant PD at G may be plotted as the well-known figure-of-eight diagram, Fig. 2. It will be seen that the two points of minimum signal M and N are far more clearly defined than the points of maximum, hence the reason for always taking bearings on the minimum signal.

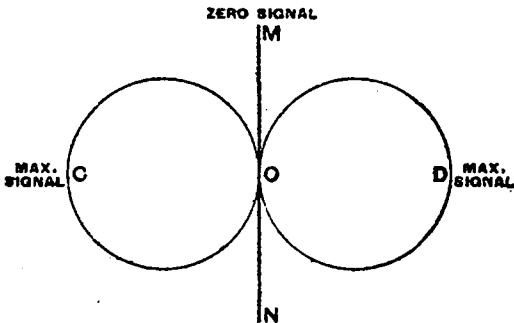

Fig. 2—The "figure-of-eight" diagram represents the waxing and waning of signal strength that occurs as a frame is rotated through 360 degrees.

Unfortunately, the frame aerial as a whole acts as an ordinary aerial due to its capacity to earth; this pick-up effect is practically the same irrespective of the plane of the frame to the transmitter. This is known as "vertical effect." The voltage applied at G by the vertical component of the signal can be represented as in Fig 3 by a circle AB with its centre at o. It will be realised that with the plane of the frame as in Fig. 1 the signal due to vertical effect may be in phase with, and therefore additive to, the signal received by the loop and can be shown as OE. When the frame is rotated through 180° the two signals will be out of phase and can be shown as OB. The result is that the minima

M. O. N are distorted instead of being at 180° as in Fig 2. Vertical effect also causes another trouble—that is, blunt or indefinite minima. It is possible to eliminate most of the vertical pick-up in frame aerials by connecting the centre tap to earth as in Fig. 4. The loop should always be wound as a solenoid, and for best results should have an electrostatic screen earthed to the centre tap of

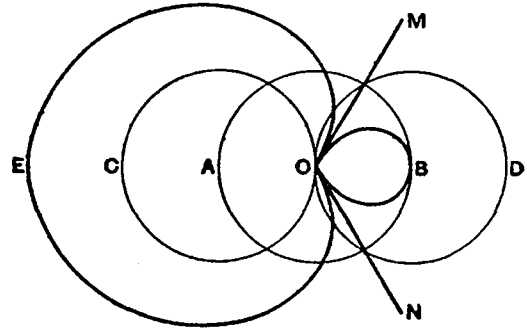

Fig. 3—Polar diagram showing strength of signal received by a frame combined with the signal due to the action of the frame as a vertical aerial.

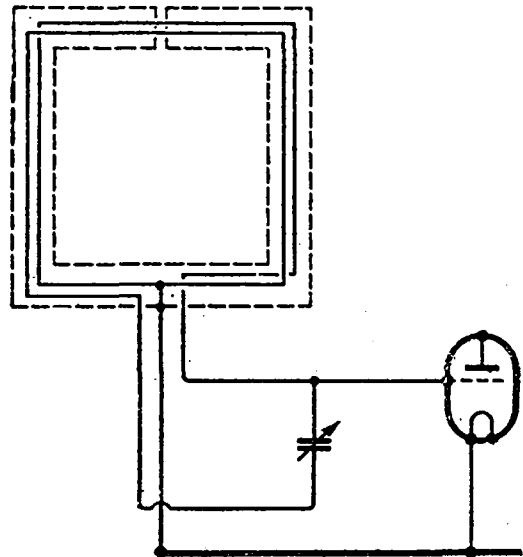

Fig. 4—"Vertical effect" which gives rise to errors, is minimised by centre tapping the frame and enclosing it in an almost complete screen.

the loop. It will be noticed that a gap is left at A to prevent the screen forming a closed loop.

Having taken the above precautions there will only be a very small amount of "vertical" to eliminate and this can be made use of to give a sense bearing, i.e., to show in which of the two possible directions the transmitter lies. If a small vertical road aerial is coupled either to one

side or the other of the frame aerial by means of a small differential condenser, as in Fig. 5, a little of the vertical component of the signal may be deliberately introduced in such a way, say, that it is in phase at one minimum position with the "vertical" signal due to the loop itself. This will cause an indefinite minimum, but if the frame is now rotated through 180° the injected signal from the "open" aerial will be out of phase with the loop signal and a sharp minimum will be obtainable. Instead of rotating the frame the differential condenser can be adjusted so that the vertical aerial is coupled to the other leg of the loop; again, only one sharp minimum will be obtainable on a transmission.

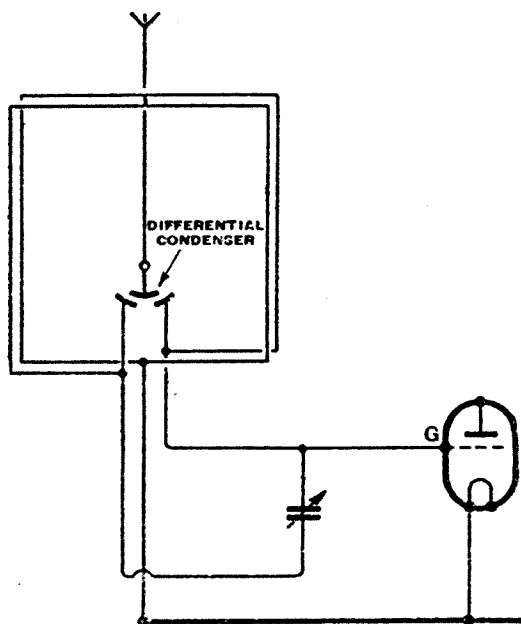

Fig. 5—Use of a differential condenser for balancing out "vertical effect."

Various types of receiving sets were used in the early days of amateur DF, but probably the most popular circuit was the Reinartz or Hartley detector followed by one or two stages of AF amplification; very little was done in the way of screening. Results, however, tended to be erratic as, owing to an oscillating frame aerial, body effects were troublesome and minima were indefinite and unreliable. Great improvements were effected by completely screening the receiver in metal and taking precautions to prevent direct signal pick-up on the headphone and battery leads. A further improvement was made by using an RF stage

coupled to the detector by a tuned anode or tuned grid circuit, reaction being obtained by variable capacity coupling to the coil. The frame aerial now being non-radiating, some of the body effects were eliminated.

A Practical Design.

A typical circuit for an amateur direction finder is shown at Fig. 6. It will be seen that the frame has an earthed tap and a small vertical aerial is coupled by a differential condenser to either end of the frame winding. The tuning condenser must, of course, be insulated from chassis when mounting. The grid leak of the detector valve is taken to a potentiometer across the filaments so that adjustment can be made for smooth reaction, which is always desirable, particularly if the set is used in an oscillating condition for taking bearings on CW stations. The detector valve may be followed by one or two stages of AF amplification. The author prefers two stages as shown; when dealing with a minimum signal

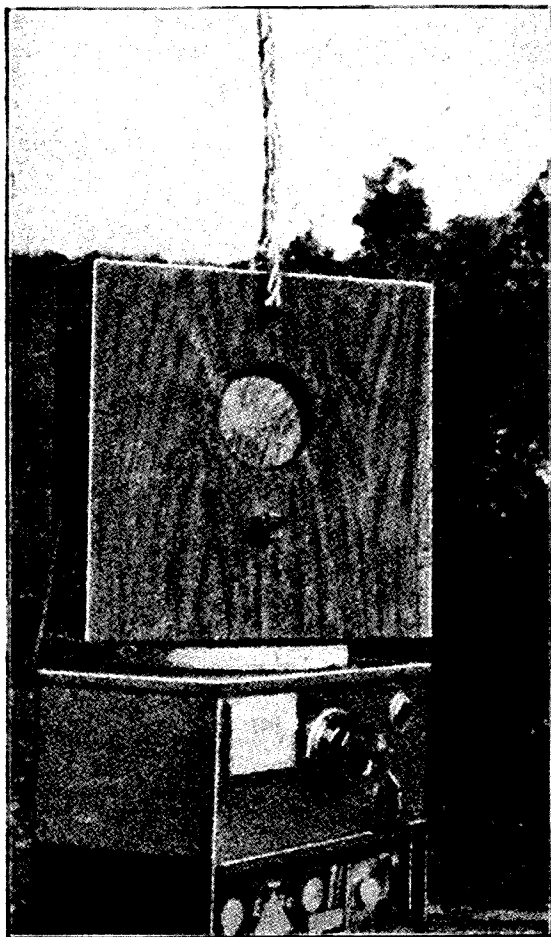

The author's D.F. unit. Note the loud speaker in the centre of the frame.

for taking bearings it is a great advantage to have plenty of magnification.

In the early days of DF the problem of indefinite minima was always a worry; on some occasions, as the frame was turned through 180°, the change in volume on headphones would vary from, say, R7 down to R2, and up again to R7 with no definite dip in volume to identify the minimum position of the frame. The only thing to do under these circumstances was to swing the frame backwards and forwards over the minimum and note a position on either side on which the signal appeared to be the same volume and then take the mean position as minimum. As can be readily understood, it was very much guesswork and sometimes it was impossible to get nearer than 10°, at other times, however, it would be easy to get the signal to completely disappear over about 1°. The author found that a compass scale fitted to the frame was a great help, as it was possible to re-check a bearing or see if the reciprocal bearing, i.e., the frame turned through 180°, coincided. The cause of the indefinite minima obtained was puzzling at first, as a receiver might be in one position for, say, four different transmitter positions and the sharpness or otherwise of minima obtained would vary greatly. It was found that the vertical component of the signal wave could vary during the day and that different transmitter positions also caused a variation. Fitting a small vertical aerial

as shown in the circuit overcame this trouble.

For 40 metres, four turns on a 10in. square is suitable for the frame, with a spacing of 5/16 in. between each turn. The author prefers a wooden box type frame, as it is mechanically rigid and protects the winding. When winding the aerial great care must be taken to see that the wires are taut and that the plane of each turn is parallel to the side of the frame case. The electrostatic screen should be at least 1¼ in. away from the winding of the frame. The screen can be made of copper foil bent into channel section approximately 3in. wide with 1¼ in. sides; the gap at the top need only be about ¼ in. The frame itself can be made of ½ in. wood, outside dimensions being 14in. square by 4in. The copper foil screen is fixed by drawing pins. To the bottom of the frame is fixed a piece of wood 7½ in. in diameter ¾ in. wide, which is marked out 0-360; a pointer is fixed to the lid of the set.

The set itself is completely enclosed in a copper box with the battery compartment below. It is important that the wires connecting each end of the loop to the set are individually run in screened tubing, earthed or something similar, in order not to upset the tuning whilst swinging the frame. Similarly, if a loud speaker is fitted in the centre of the frame as in the writer's set, the leads to it must be screened.

It is hoped to deal in a subsequent article with the best way of operating the set and taking bearings.

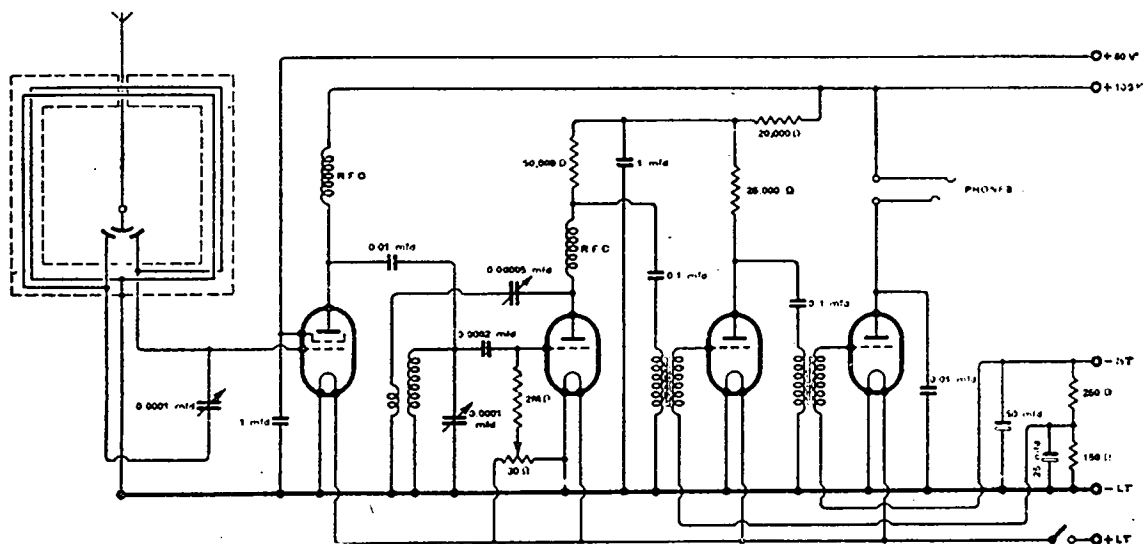

Fig. 6—Complete circuit diagram of the author's receiver.

POORMAN'S HIGH FIDELITY RECEIVER

By James Fulleylove
("Radio News.")

A nice high-fidelity receiver for the man who cannot afford to spend a whole lot for parts. It is easy to construct.

Judging by the majority of magazine articles to be read on the subject of high-fidelity broadcast receivers, one is very apt to get the impression that high fidelity and high cost go hand in hand, inseparably. Fortunately this is not the case. If one is willing to go without the numerous gadgets usually associated

theme kept in mind throughout its design. The single t.r.f. stage provides just the right amount of selectivity to separate broadcast stations 10 kc. apart and yet pass sufficient side-bands to ensure good high-frequency response. There is not an over-abundance of sensitivity, but quite good enough for good recep-

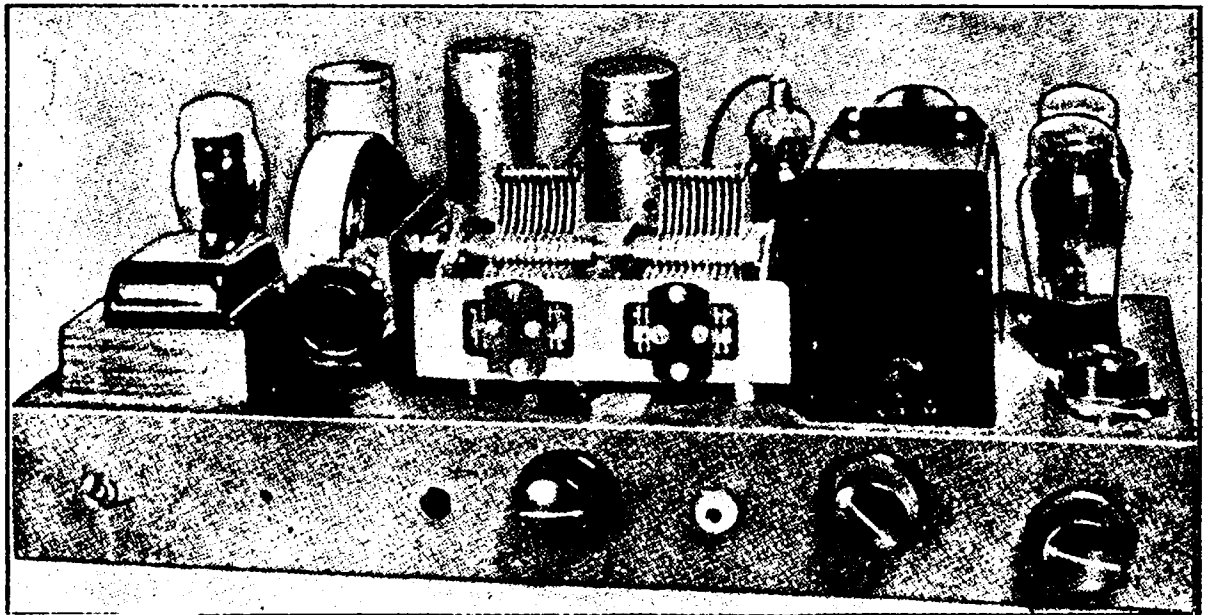

The panel is left off. The reader may use his own ideas on that.

with the modern hi-fi receiver but which really contribute more to ease of operation than quality of reproduction, he can build a set like the one described for as little as \$12 and still enjoy reproduction equal in quality to that of commercially built sets costing from four to eight times as much.

Upon first glance at the circuit, the reader will probably be struck most by its simplicity; for this was the

tion of local stations. This is **not** supposed to be a DX receiver.

In the interests of good base response, it is important to use large bypass and coupling condensers in the audio section. Due to the presence of the push-pull output stage and the phase-inverter, no audio voltages are present at the cathodes of these stages, and consequently no bypass condensers are needed here. There is, however, a large audio

frequency voltage built up across the detector bias resistor, and a 25 mfd. condenser is imperative for adequate bypassing at this point. As for the coupling condensers, a larger capacity than .05 mfd. does not seem to warrant itself.

The adjustment of the phase-inverter is quite simple; and while the use of a v.t. voltmeter or oscilloscope will give the most accurate results, a pair of headphones will do quite well. Simply connect whatever you have across first R12 and then R13, with some sort of steady signal applied to the amplifier input; and adjust the slider on R12 until the voltage across each resistor is the same, as indicated by the sound in the headphones, the reading of the meter, or the 'scope.

This condition indicates that the grid of the inverter section of the 53 tube is receiving the correct fractional part of the output of the amplifier section (equal to the reciprocal of the mu of the tube), so that no more amplification takes place, but only phase reversal; and the grids of the 45's receive exactly the same voltage, but in opposite phase. The signal used for this adjustment may come from any number of possible sources, such as a beat frequency audio oscillator, a code practice oscillator, a constant-note phono-

graph record, or the low voltage secondary of a transformer connected to the a.c. line; all of which should be connected in through the phono-graph jack.

The loudspeaker is, without doubt, the biggest problem in an installation such as this where quality reproduction and low cost are both important factors. There is no possible substitute for a good loudspeaker; and, on the other hand, a good speaker can very rarely, if ever, be bought cheaply. Probably the best advice one can give on this point is: "Spend the most you can afford." In this case, the cost of the receiver itself is so low that you should feel justified in spending a reasonable amount on the speaker. It will be worth it in added enjoyment.

In any case, the speaker should be a 10 in. or preferably a 12 in. dynamic, and should be mounted in as large a baffle as is practical. And incidentally, this is one item which should not be subjected to skimping. A good baffle can be built for an almost nominal sum, and its boosting effect upon bass response is little short of amazing. Celotex is generally accepted as a good material for this purpose, as it is both efficient and inexpensive. Another important point to remember is that the high

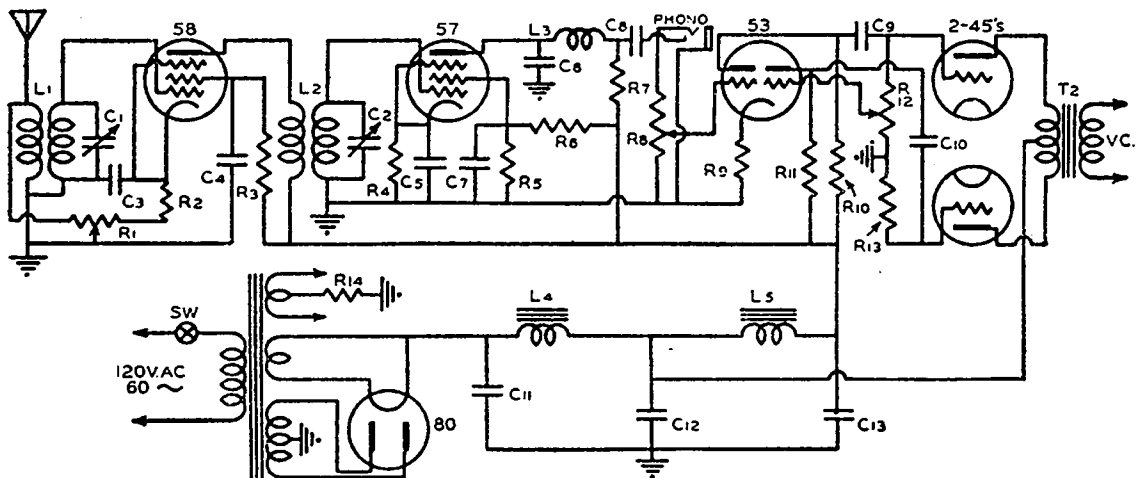

*L*₁, *L*₂—Antenna and interstage coils. Meissner.
*L*₃—85 mhy. rf. choke. Hammarlund
*L*₄, *L*₅—30 hy. filter choke. Kenyon
*C*₁, *C*₂—2-gang, 350 mmfd. variable. Reliance
*C*₃—.1 mfd. 200 v. paper. Aerovox
*C*₄—.01 mfd. 400 v. paper. Aerovox
*C*₅—25 mfd. 25 v. electro. Aerovox
*C*₆—5 mfd. 200 v. paper. Aerovox.
*C*₇—100 mmfd. mica. Aerovox
*C*₈, *C*₉, *C*₁₀—.05 mfd. 600 v. paper. Aerovox
*C*₁₁, *C*₁₂, *C*₁₃—8 mfd. 450 v. electro. Aerovox
*R*₁—25,000 ohms pot. Centralab
*R*₂—400 ohms, 1 w. Centralab

*R*₃—50,000 ohms, 1 w. Centralab
*R*₄—10,000 ohms, 1 w. Centralab
*R*₅—50,000 ohms, 1 w. Centralab
*R*₆—100,000 ohms, 1 w. Centralab
*R*₇, *R*₁₅—500,000 ohms, 1 w. Centralab
*R*₈, *R*₁₂—500,000 ohms pot. Centralab
*R*₉—2,000 ohms, 1 w. Centralab
*R*₁₀, *R*₁₁—100,000 ohms. Centralab.
*R*₁₄—750 ohms, 10 w. Ohmite
*T*₁—Pri. 115 v. 60 cycles, Sec. 650 v. ct., 5.0 v.
 2 A., 2½ v. 7 A.
*T*₂—Output trans. on speaker
*J*₁—Closed-circuit jack

frequencies are projected straight forward from the speaker cone in a narrow beam; consequently the speaker should be placed in such a position as to allow the listener to sit directly in front of it if the high frequencies are to be fully appreciated.

There are only two or three points to mention in regard to the mechanical construction of this set. Mount L1 and L2 at right angles to each other and at a reasonable distance apart to avoid regeneration in the r.f. stage, this being the cause of increased selectivity and resultant side-band cutting. For the same reason, the r.f. tube should be shielded. Mount R12 in some place where it cannot easily be tampered with; because after it has once been adjusted as described previously, it should be left strictly alone.

Aside from these details, the layout of the set is not particularly important. The illustration gives an idea of how it was done by the author, using junk-box parts almost exclusively.

During the eight months in which this receiver has been in operation in the author's home, it has given numerous demonstrations of its excellent frequency response and received the compliments of all those who have heard it. However, the most positive proof of its superior characteristics and the one which will be of the most interest to the reader is that which was shown in tests with a b.f. audio oscillator modulating an r.f. signal generator. The necessary apparatus was not on hand to take a genuine frequency response curve, but the results can easily be told verbally.

At the high end of the spectrum, frequencies up to 10 kc. came through with very little drop in volume; while the low notes kept coming through right down to the point where you could place your fingers on the speaker cone and count the cycles! An output meter indicated practically no drop in volume at 30 cps.

The effect of such an excellent response characteristic is instantly noticeable with even the poorest sort of programme. Music of any kind takes on an entirely new air of brilliance, and instruments which you never heard before come out in their full glory. Even speech sounds clearer and more natural.

MORSE CLASSES

The Victorian Division is conducting classes on—

MONDAY AND THURSDAY EVENINGS

at 8 p.m.

at the W.I.A. Rooms, 6th Floor,
191 Queen Street, Melbourne.

.. Instruction, using R.A.A.F. methods, is provided for both Beginners and Advanced Students.

Three instructors are in attendance and practice is provided for advanced students at 15-20 and 20-25 words per minute.

FEE - - 1/- PER NIGHT

Phone: F 6997

(Monday and Thursday evenings only)

or write

Box 2611 W., G.P.O., Melbourne
for further particulars.

H A M S !

**DO YOU WANT TO BE
BACK ON THE AIR ?**

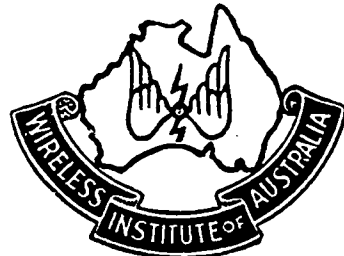

The Wireless Institute of Australia

is the recognised spokesman of the
AUSTRALIAN AMATEUR.

If you are not a member—

Join Now !

When the time comes that we can reasonably expect to go back on the air, we want to say that we represent—

EVERY ACTIVE HAM

in the Commonwealth.

Strengthen our hand by writing to The Secretary of the Institute in your State to-day:

All addresses are on the title page.

SHORT WAVES

Where? When? What?

By "Dialtwister."

Below the broadcast band as my readers know lie the short wave bands, where hours of radio enjoyment may be had, listening to the broadcasts of other lands.

The publishers have long felt the need of such a page as this in order to help and to keep readers in touch with what is doing on short wave bands. I have been deputed to conduct this page, and I am appealing to readers to help in forwarding to me, prior to the 18th of each month, reports of what they have heard, when they heard it, and where they heard it. In doing this, readers will help me to compile a page of interesting and informative notes of the doings of the month on short waves. Reports will be published and acknowledged. The address is Box 2611 W, G.P.O., Melbourne.

Now that the summer is firmly established, reception on short wave bands is excellent in the early mornings and particularly in the evenings, when signals are strong and noise level is practically non-existent.

Probably the most interesting event of the month was the visit of the Thailand Goodwill Mission, which will, of course, bring to short wave listeners' minds the station operated by this country, HSP5, Bangkok on 25.6 metres, and can be heard between 11 p.m. and 1 a.m. any night in the week. This station was formally known as HS8PJ and operated on 37 metres.

Radio Saigon in French Indo China on 25.47 m. appears to provide some of the most reliable and enjoyable programmes, with a talented female announcer at the "mike." She has lately been relieved on occasions by a male, whose English is not "so good." English news is given at 8.45 p.m. The Americans are as usual providing plenty of entertainment and there appears to be one about somewhere at any hour of the day or night. WLWO Cincinnati on 25.27 m. has a very strong signal at night and is heard at its best about 11 p.m. KGEI, San Francisco, 31.02 m. has a good signal and "puts over" many items of Australian interest. News is given at 10.30 p.m. This station is also on 19.56 m. but the signal is not as reliable as the 31 m. band. WGEO

Schenectady, 31.48m. is good in the mornings up to 8 a.m. WPIT Pittsburgh, 25.26 m. good between 6 and 8 a.m. WRUL Boston, 25.45 m. is also good at this time.

In the Philippines, KZRH, Manila, 31.06 m. seems to provide the best signal being strong during the evenings. 2RO4, Rome, Italy, on 25.4 m. is a very patchy station, some nights being strong while on others very poor. PLJ Bandoeing, 20.5 m. always very strong after 9 p.m. each night, while PLP also in Bandoeing on 27.27 m. is always good in the mornings.

ZBW3 Hongkong, 31.49 m. has been reported good around about 11.45 p.m. XGOK Canton, 25.38 m. also has a strong signal. JWV Tokyo on 25.6 m. cannot be missed when tuning over the bands at night. The characteristic Japanese music makes one wonder just where all the cats came from. VUD4 Delhi 25.36 m. fairly good between 9 and 10 p.m. GSF, one of the London stations on 19.82 m. might be mistaken for a local during the evenings. DJP Berlin ("I'm doubtful if it's still there) on 25.32 m. has a steadily increasing signal.

I recommend listeners to listen to the Switzerland station, HBH Geneva, on 16.23 m. every Friday night, all announcements are made in English and French; the entertainment provided is excellent.

IMAGE FREQUENCY

By John F. Rider.

In the checking of a superheterodyne receiver, it is of the utmost importance that the local oscillator circuit be adjusted at the proper frequency. The fact that the oscillator can be tuned to a frequency which differs from that of the desired signal by the intermediate frequency **but in the wrong direction**, makes it desirable to check the alignment by being certain that the image frequency occurs at the correct point.

Let us examine the functioning of the mixer and oscillator before going into the details of the procedure.

First of all, when a signal enters a superheterodyne receiver it beats with the signal generated by the local oscillator and so a beat note is produced in the mixer tube at the intermediate frequency which has all the characteristics of the incoming signal to which the receiver is tuned. In other words, let us assume that the incoming signal has a frequency of 10,000 kc., which is picked up by the antenna and fed to the mixer input circuit. The local oscillator is tuned to a frequency of 10,450 kc., which is also fed to the mixer, where it beats with the incoming 10,000 kc. signal. The resulting signal in the output of the mixer is 450 kc.—the difference between these two signals is the frequency to which the intermediate frequency amplifier is tuned. This is the normal functioning of the superheterodyne circuit.

Now since the selectivity of the mixer input stage is seldom sufficient to eliminate undesired signals altogether, interference may be experienced due to the fact that the local oscillator in the receiver will heterodyne or beat not only with the desired signal, but also with one undesired, both being fed as a consequence to the i.f. amplifier. One type of such interference is known as image frequency response.

In the above example it was assumed that the incoming signal was 10,000 kc. and the intermediate frequency was 450 kc., being produced by the heterodyning of the 10,000 kc.

signal and the 10,450 kc. frequency generated by the local oscillator. Remember that not only is the difference frequency present in the output of the mixer; there is also present the sum of the incoming signal and that locally generated: $10,000 + 10,450$ or 20,450 kc. Inasmuch as the i.f. amplifier is tuned to pass signals at 450 kc., this higher frequency will not be amplified and can be considered as rejected.

However, let us make another assumption: a strong signal of 10,900 kc. is picked up by the input circuit of the receiver. This is quite possible since there is but a single tuned circuit and usually this is not sufficient to eliminate completely a strong signal which does not differ by a large percentage in frequency from that of the desired signal.

When this unwanted 10,900 kc. signal is mixed with the 10,450 kc. signal supplied by the local oscillator, it will produce a difference frequency that is equal to the i.f.: $10,900 \text{ kc.} - 10,450 \text{ kc.} = 450 \text{ kc.}$ Since this is the frequency to which the i.f. amplifier is tuned, the undesired signal will be amplified along with the one that is desired, i.e., the 10,000 kc. signal. This will of course create interference and the frequency at which this occurs is called the image frequency.

Now let us see what relation exists between this image frequency and the desired signal frequency. If the receiver is tuned to 10,000 kc. and the image frequency under such conditions is a 10,900 kc. the difference between 10,000 kc. and 10,900 kc., which is equal to twice the intermediate frequency of 450 kc. Suppose that the intermediate frequency were 465 kc. instead of 450 kc., then the local oscillator would be tuned to 10,465 kc. when the receiver was tuned to bring in a signal of 10,000 kc., so that the difference would be 465 kc. In this case a signal of 10,930 kc. would also produce a difference frequency of 465; that is $10,930 - 10,465 = 465 \text{ kc.}$; here the difference-

between the desired and undesired frequencies would be 930 kc., or twice the i.f. of 465 kc. This may be stated as follows. The image frequency will always differ from that of the desired signal frequency by twice the intermediate frequency.

In the above examples, it has been shown that the image frequency is also higher in frequency than that of the incoming signal. In some receivers, particularly on short-wave bands, the oscillator functions at a frequency which is lower than that of the incoming signal. For instance, if the receiver be tuned to 10,000 kc. and the local oscillator operates at 9550 kc., an i.f. signal representing the difference between 10,000 and 9550 kc., or 450 kc., is produced.

If a 10,900 kc. signal were also present in such a mixer circuit, the beat between it and the local oscillator would result in the production of a signal frequency of 10,900—9550 or 1350 kc. Since the i.f. amplifier is tuned to 450 kc. and not 1350 kc., no interference will result. Therefore, 10,900 kc., though it differs by twice the i.f. from the desired signal frequency, will not produce interference when the oscillator frequency is lower than that of the signal frequency to which the receiver is tuned.

However, if a signal of 9,100 kc. instead of 10,900 kc. be present in the mixer circuit when the set is tuned to 10,000 kc. and the oscillator is functioning at 9550 kc., which is 450 kc. lower than that to which the receiver is tuned, a signal representing the difference between 9550 and 9100 kc., or 450 kc., will be set up and therefore will pass through the i.f. amplifier, causing interference. This 9100 kc. signal, it will be noted, also differs from the desired signal frequency (10,000 kc.) by 900kc., an amount which is also equal to twice the intermediate frequency. This then is the image frequency when the oscillator is lower in frequency than that of the incoming signal.

It may therefore be seen from the foregoing examples that the image frequency always differs from the desired signal frequency by an amount which is equal to twice the intermediate frequency. Also that when the oscillator in the receiver operates at a frequency which is higher than that to which the receiver is tuned, the image frequency will always be higher by twice the

amount of the intermediate frequency than the desired signal frequency. Conversely, when the set oscillator functions at a frequency that is lower than that of the desired signal frequency, the image frequency will likewise be lower in frequency than that of the desired signal.

One point should be borne in mind: image frequency has nothing to do with harmonics. While interference can also be produced due to harmonics of the oscillator beating with undesired signals, this type of interference is not due to image frequency response.

The extent to which interference is produced because of image response will depend upon the strength of the interfering signals, the intermediate frequency employed in the receiver and the percentage of difference in frequency between the image and the desired signal. Thus when the intermediate frequency is 450 kc., the image frequency differs from the desired frequency by 900 kc.; when the i.f. is 175 kc. the image frequency is only 250 kc. removed from the desired signal frequency. When the receiver is tuned to 550 kc. at the low frequency end of the broadcast band, and if the i.f. is 450 kc. the image frequency occurs at 1450 kc., which is the high-frequency end of this band. Here the percentage difference in frequency is large. On the other hand, when the receiver is tuned to 20,000 kc. under the same conditions, the image frequency at 20,900 kc. differs but little in percentage from that of the desired signal. Accordingly, interference due to this cause is much worse on short-wave bands than on the standard broadcast band.

The fact that the local oscillator on short-wave bands can often be tuned to a frequency which differs from that of the desired signal by the i.f., but in the wrong direction, makes it quite desirable to check the alignment by making certain that the image response is at the proper point.

Thus, when the receiver is to be aligned at 18 mc., the oscillator will be tuned normally to 18,450 kc. assuming the same i.f. peak of 450 kc. but if the trimmer is turned down too far, the oscillator frequency may be changed to 17,550 kc., which will

(Continued on page 16).

N.S.W. Hams with Defence Forces

Hereunder we publish a list of hams serving with the Defence Forces, together with their last known rank. Further information concerning any ham on service, especially those not listed, would be appreciated by the secretary of the Division concerned.

R.A.N.

P/O Telegraphist D. Duff	2EO
P/O Telegraphist W. Watson	2YY
Lead. Teleg. W. Harris	2ALF
Lead. Teleg. R. Mitchell	2AID
Lead. Teleg. F. Tregurtha	2FT
Lead. Teleg. G. S. McLeod	2ADC
Lead. Teleg. L. Dodds	2LD
Lead. Teleg. H. Young	2AMZ
Lead. Teleg. T. Dale	2QO
Lead. Teleg. L. Bracken	2FF
Lead. Teleg. B. Chapman	2BA
Lead. Teleg. L. Meyers	2KS
Lead. Teleg. J. Williams	2ADI
Lead. Teleg. E. Clunne	2DK
Lead. Teleg. M. Sobels	2OT
Lead. Teleg. G. B. Free	2IT
Lead. Teleg. S. Clarke	

ARMY AND MILITIA (Voluntary)

Lieutenant R. Priddle	2RA
Lieutenant D. Knock	2NO
Lieutenant F. Carruthers	2PF
Lieutenant J. Fraser	2AFJ
Lieutenant A. Henry	2ZK
Corporal J. Olle	2OZ
Signaller A. Ackling	2PX
Signaller A. Pearce	2AHB
Signaller E. Simpson	2ES
Signaller E. Austwick	2NW
Sar. Major Ackerman	2ALG
Sergeant Wells	2AME
Signaller Ackland	2AJR
Sergeant Cole	2ACS
Corporal Cumpston	2AJZ
Signaller Felton	2RF
Lieutenant London	2UP
Major P. J. Manley	2UQ
Sergeant R. H. Jones	2AHF

R.A.A.F.

F/O L. Grey	2AKO
F/O A. Furze	2HF
F/Sergeant F. Hine	2QL
F/Sergeant H. Sinfield	2TZ
Corp. M. Brown	2OR
Corp. M. Meyers	2VN
F/Sergeant D. Millen	2LQ
Corporal W. M. Moore	2HZ
Corporal J. Moyle	2EZ
Corporal J. Perooz	2PE
Sergeant B. Randall	2ALN
Corporal G. Robinson	2GR
Corporal A. Wallbridge	2UI
W/O A. A. Slight	2ZA
L.A.C. C. Bischoff	2LZ
L.A.C. E. Clune	2LK
L.A.C. R. Corthon	2CC
L.A.C. G. Curle	2AJM
L.A.C. J. Evans	2CX
L.A.C. G. Fenton	2GV
L.A.C. L. Gibson	2GH
L.A.C. J. Graydon	2AIS
L.A.C. G. Hume	2AMD
L.A.C. V. Jarvis	2VJ
L.A.C. A. Llewellyn	2AH
L.A.C. McNaughton	2ZH
L.A.C. J. Parris	2DN
L.A.C. A. Reynolds	2AP
L.A.C. W. Smith	2BS
L.A.C. E. White	2HA
L.A.C. J. Woodman	2ZE
A.C.1. E. Catt	2FU
A.C.1. D. Dawson	2DD
A.C.1 E. Marsella	2AEZ
A.C.1. C. Miller	2ADE
A.C.1 R. Traill	2XQ
A.C.1 J. Walters	2ALW
A.C.1 S. Weston	2AJH
A.C.1 K. J. Williams	2XD
A.C.1 L. McMahan	2ALM
A.C.1 J. M. Brennan	2ALQ
A.C.1 V. E. Tierney	2AIT
A.C.1 W. Nash	2VW
A.C.1 R. Black	2YA
A.C.1 N. McLeod	2PM
A.C.1 N. Southwell	2ZF

(Continued on page 16).

ROYAL AUSTRALIAN AIR FORCE.

**VACANCIES FOR MEN WITH WIRELESS OR
ELECTRICAL QUALIFICATIONS.**

Apply to your nearest Recruiting Centre for details of enlistment as:—

(1) WIRELESS OPERATORS (for training)

FOR YOUNG MEN WITH A SOUND EDUCATION AND WITH OR WITHOUT ABILITY IN MORSE CODE.

(2) AIRCRAFT ELECTRICIANS (for training)

FOR YOUNG MEN WITH A SOUND EDUCATION, PREFERABLY WITH A KNOWLEDGE OF ELECTRICAL PRINCIPLES. MUST HAVE HANDLING KNOWLEDGE OF COMMON HAND TOOLS.

(3) WIRELESS ELECTRICAL MECHANICS

FOR YOUNG MEN WITH A SOUND EDUCATION, EXPERIENCE IN FITTING AND WITH OR WITHOUT A KNOWLEDGE OF THE MORSE CODE.

(4) W/T OPERATORS (G)

FOR TELEGRAPHISTS WHO CAN SEND OR RECEIVE BUZZER AT OR OVER 20 WORDS PER MINUTE. EDUCATIONAL QUALIFICATIONS ARE NOT IMPORTANT.

Full details may be obtained on application to:—

THE SECRETARY,

Air Board, Century Building,

Swanston Street, MELBOURNE, C.I.

Divisional Notes

IMPORTANT.

To ensure insertion all copy must be in the hands of the Editor not later than the 18th of the month preceding publication.

N.S.W. DIVISIONAL NOTES

By VK2AJO

The lecture at the November meeting of the Division is to be delivered by Harry Stowe. Harry built his first gear in 1908, a Ford coil transmitter and crystal receiver, and commenced with the call FN, Licence No. 8, the later call signs being A-2CX and VK2CX. He is a life member of the Institute, and has chosen for his lecture the subject, "Some Recollections of the Early Days of Radio."

John Clarricoats, G6CL, states that the R.S.G.B., of which he is secretary, is growing despite the bombs, and is averaging 40 new members per month. The new edition of their "Amateur Radio Handbook," which was issued in July, is to be again reprinted owing to the demand.

We regret to note the deaths of GM8TT at Dunkirk, of G5ZQ, at sea, and G3FL in the air. On the brighter side is the award of the D.F.M. to G4HW for "shooting down five enemy aircraft and displaying a very fine offensive spirit coupled with a sense of resolute leadership."

In the U.S.A., ultra-highs appear to be holding the stage, records established during July were—112 m/c, W6BJI/6—W6KIN/6, 255 miles. 224 M/C WICOO/I—WIJK, 90 miles.

Badges and membership certificates are now available from the secretary, the badges at 2/6 per and the certificates free of charge at General Meetings. And Service Members—Don't forget to advise Wal of any change of unit, rank or address.

Lost—Con. Bischoff, 2LZ and N. MacNaughton, 2ZH.

Found—VK2AJH. Let's hear more about it, Sel!

VICTORIAN DIVISION.

To whom it may concern — and that's everyone.

Having recently accepted the post of Notes Editor to "this 'ere maga-

zine" I'm going to appeal to you all young and old—male and female—The Magazine Committee "expects every man and woman to do his or her duty."

Just in case you don't understand what it's all about, I'll be brief—I WANT SOME NOTES FROM EVERYONE. You can help a lot if you drop a note now and again and let me know what you are doing, and if you know what anyone else is doing, so much the better. To those who are in the forces, you can help also. We want to know what you are doing (censor permitting) and how you are.

I propose to put all the VK3 notes under the one heading as the Zones are to a large extent broken up for the time being. I hope that this meets with your approval.

VK3HX, Notes Editor.

3JG—has been reported to have joined the Army Signals, is this true John?

3BG—has been posted to the R.A.A.F. station at Darwin. It's a long, long trial, Roth.

3TL—I believe is in charge of the Returned Soldiers training at Kerang.

3AH—is with the R.A.E. at Queenscliff.

3YK—Believed to have transferred from the R.A.A.F. to the Navy. Understand his rank is Sub-Lieutenant R.A.N.

3ZK—reported to have been seen flat hunting in Sydney lately. Unfortunately we can't find a query mark big enough to end this with.

3OR—recently received his commission—Pilot Officer Orr to you—to be located at the Barracks.

3KR—To be found at Century House directing signals traffic.

3RJ—after spending some time with the R.A.A.F. in Sydney is now to be found at the Barracks.

(Continued on page 16).

(Continued from page 12)

likewise produce the required 450 kc. i.f. signal when an 18 mc. signal is tuned in.

To be sure that the receiver oscillator is adjusted properly, after aligning at 18 mc., adjust the test oscillator to 18,900 kc. (or whatever frequency which is twice the i.f. higher than that frequency to which the receiver is tuned) and without changing any of the adjustments, see if a signal response is obtained. If the receiver oscillator is adjusted to a frequency below that of the incoming signal, no response will result.

IMAGE RATIO.

When a receiver is tuned to a certain frequency, the ratio of the input signal voltage at the image frequency to that required at the frequency to which the receiver is tuned is called the image ratio.

For example, if the receiver is tuned to 1000 kc. and the i.f. is 450 kc., assuming that a 10 microvolt signal at 1000 kc. produces a 50 milliwatt output at the receiver voice coil, then, if a 10,000 microvolt signal is required at the image frequency of 1900 kc. to produce the same output while the receiver is tuned to 1000 kc., the image ratio is 10,000/10 or 1000.

Curves showing how the image ratio becomes lower as the frequency to which the set is tuned is increased are shown in the accompanying chart. In this graph Curve A is representative of the image ratios secured when an r.f. stage is used ahead of the mixer in a high-grade receiver, while Curve B shows the lower image ratios which result when no r.f. stage is employed.

In the first mentioned curve, the image ratio resulting when the set is tuned to 1200 kc. is 106 db, corresponding to a voltage ratio of

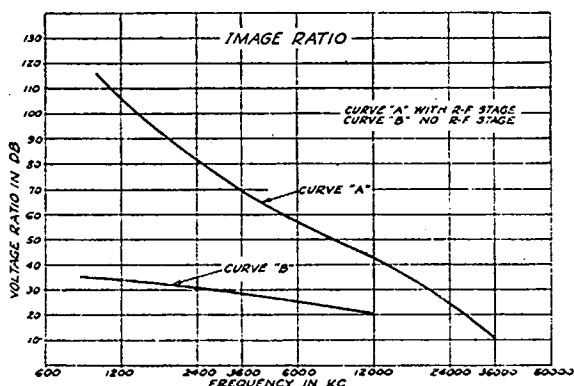

200,000 to 1. That is the signal input at the image frequency must be 200,000 times that required at the frequency to which the receiver is tuned, to produce the same output. This ratio decreases on the higher frequency bands because of the relatively small percentage difference in frequency between the image frequency and the desired frequency on such bands. At 12 mc., the image ratio is 43 db or 140 to 1, while at 36 mc. it is only 11 db or 3.5 to 1.

The improvement resulting from the use of an r.f. stage is much more evident at frequencies in the broadcast band than at higher frequencies. As shown in Curve B, the ratio secured with a representative receiver employing no r.f. stage is 34 db or 3500 to 1, at 1200 kc. compared with 200,000 to 1; which is obtained with a set employing an r.f. stage, over 50 times as great. Yet at 12 mc., where the image ratio on Curve B is 20 db, or 10 to 1, that obtained with the set using the r.f. stage is 140 to 1 at this frequency—only 14 times better. It is thus evident that the improvement decreases more rapidly at still higher frequencies.

(Continued from page 15).

3SQ—spending most of his time at the Marconi school.

3FR—although selling all the best in radio (so he tells us) has built himself a receiver from his junk box, a T.R.F., too.

3YI—does a little listening on the short waves.

3WY—tells us that he is going grey. We are wondering why.

3QS—works while we sleep. and sleeps while we work.

3PR—let's hear from you, Ron.

3CE—same goes for you, Roy.

3II—one of our vice-presidents. What about a note from you, Lee?

(Continued from page 13).

- A.C.1 J. Edwards 2AKE
- A.C.1 G. Thornton 2IP
- A.C.1 K. Sherlock 2TQ
- A.C.1 E. L. Aked 2AEU
- A.C.1 R. Stacey 2HY
- A.C.1 L. D. Cuffe 2AMA
- A.C.1 R. W. Eagling 2AEY
- A.C.1 A. Manwaring 2AJK
- A.C.1 A. Potts
- Radio Instructor N. G. Beard 2ALJ
- A.C.1 B. Dale 2XX/9XX

A Heritage of Quality

WESTON
Instruments



Dependable Testing Instruments for
Every Radio and Electrical Purpose

WARBURTON FRANKI
LTD.

380 Bourke St., Melbourne, Phone MU 6355
307 Kent St., Sydney; 233 Elizabeth St., Brisbane

Let us quote you for your
PRINTING REQUIREMENTS



The House of Good Printing

**285-287 LATROBE STREET,
MELBOURNE, C.I**

Opposite "The Argus" Office

Telephone MU 2897 After Hours FU 6795

H. HEARNE & CO. PTY. LTD., 285-7 LATROBE STREET, MELBOURNE, C.I.